



Test report No: 23A0506R-E3012110001-A

## FCC TEST REPORT

Product Name	Peplink Pepwave Wireless Product
Trademark	
Model and /or type reference	POTS Adapter POTS-ADP-LTE-US-T-PRM POTS-ADP-LTE-US-DC-T-PRM
FCC ID	U8G-P1PHONE9207
Applicant's name / address	PISMO LABS TECHNOLOGY LIMITED A8, 5/F, HK Spinners Industrial Building, Phase 6, 481 Castle Peak Road, Cheung Sha Wan, Hong Kong
Manufacturer's name / address	PISMO LABS TECHNOLOGY LIMITED A8, 5/F, HK Spinners Industrial Building, Phase 6, 481 Castle Peak Road, Cheung Sha Wan, Hong Kong
Test method requested, standard	FCC CFR Title 47 Part 15 Subpart B:2021, Class B
Verdict Summary	IN COMPLIANCE
Documented By	
(Senior Engineering Adm. Specialist / Anita Chou )	
Approved By	
( Director / Vincent Lin )	
Date of Report	2023/10/20
Date of Issue	2023/11/06
Report No.	23A0506R-E3012110001-A
Report Version	V1.0

## INDEX

---

Description	Page
1. General Information.....	5
1.1. EUT Description .....	5
1.2. Mode of Operation.....	6
1.3. Configuration & Details of Tested System .....	7
1.4. EUT Exercise Software.....	8
2. Technical Test.....	9
2.1. Summary of Test Result.....	9
2.2. List of Test Equipment .....	10
2.3. Measurement Uncertainty.....	11
2.4. Test Environment.....	12
3. Conducted Emission.....	13
3.1. Test Specification.....	13
3.2. Test Setup .....	13
3.3. Limit .....	13
3.4. Test Procedure .....	14
3.5. Test Result.....	15
4. Radiated Emission.....	17
4.1. Test Specification.....	17
4.2. Test Setup .....	17
4.3. Limit .....	18
4.4. Test Procedure .....	19
4.5. Test Result.....	20

Test Photos: Please refer to the file: 23A0506R-E3012110001-A Test Photos

Product Photos: Please refer to the file: 23A0506R-Product Photos

---

## Competences and Guarantees

---

DEKRA is a testing laboratory competent to carry out the tests described in this report.

In order to assure the traceability to other national and international laboratories, DEKRA has a calibration and maintenance program for its measurement equipment.

DEKRA guarantees the reliability of the data presented in this report, which is the result of the measurements and the tests performed to the item under test on the date and under the conditions stated in the report and it is based on the knowledge and technical facilities available at DEKRA at the time of performance of the test.

DEKRA is liable to the client for the maintenance of the confidentiality of all information related to the item under test and the results of the test.

The results presented in this Test Report apply only to the particular item under test established in this document.

**IMPORTANT:** No parts of this report may be reproduced or quoted out of context, in any form or by any means, except in full, without the previous written permission of DEKRA.

## General conditions

---

1. The test results relate only to the samples tested.
2. The test results shown in the test report are traceable to the national/international standard through the calibration report of the equipment and evaluated measurement uncertainty herein.
3. This report must not be used to claim product endorsement by TAF or any agency of the government.
4. The test report shall not be reproduced without the written approval of DEKRA Testing and Certification Co., Ltd.
5. Measurement uncertainties evaluated for each testing system and associated connections are given here to provide the system information for reference. Compliance determinations do not take into account measurement uncertainties for each testing system, but are based on the results of the compliance measurement.

## Revision History

Report No.	Version	Description	Issued Date
23A0506R-E3012110001-A	V1.0	Initial issue of report.	2023-11-06

## 1. General Information

### 1.1. EUT Description

Product Name	Peplink Pepwave Wireless Product	
Trademark		
Model No.	POTS Adapter POTS-ADP-LTE-US-T-PRM POTS-ADP-LTE-US-DC-T-PRM	
EUT Max Frequency	1910 MHz	
EUT Rated Voltage	Power Port	9-16V DC
	USB-C Port	5V DC
EUT Test Voltage (Final Test mode)	AC 120V / 60Hz to DC 12V (AC Adapter)	

Component	
Cellular Antenna	Brand: Master Wave Model: 98619ZSAX053 Antenna Type: omni directional
Adapter	Manufacturer: Zhuzhou Dachuan Electronic Technology Co., Ltd. Model: DCT24W120200US-E0 Power Rate: Input: 100- 240VA~50/60Hz 0.7A max. Output: 12.0V  2.0A

Note: The EUT is available in different model names for marketing purposes.

## 1.2. Mode of Operation

DEKRA has verified the construction and function in typical operation. All the test modes were carried out with the EUT in normal operation, which was shown in this test report and defined as:

Pre-Test Mode
Mode 1: Normal Operation(Phone + USB Type C + WWAN LTE B2 Link), Molex Power Port, DC 12V By Adapter: DCT24W120200US-E0
Mode 2: Normal Operation(Phone + USB Type C + WWAN LTE B2 Link), Molex Power Port, Molex Power Port, DC 9V
Mode 3: Normal Operation(Phone + USB Type C + WWAN LTE B2 Link), Molex Power Port, Molex Power Port, DC 16V
Mode 4: Normal Operation(Phone + USB Type C + WWAN LTE B2 Link), USB Type C 5V By PC
Final Test Mode
Emission
Mode 1: Normal Operation(Phone + USB Type C + WWAN LTE B2 Link), Molex Power Port, DC 12V By Adapter: DCT24W120200US-E0

Note:

1. Refer to Certified Cellular module report worst band to test.

### 1.3. Configuration & Details of Tested System

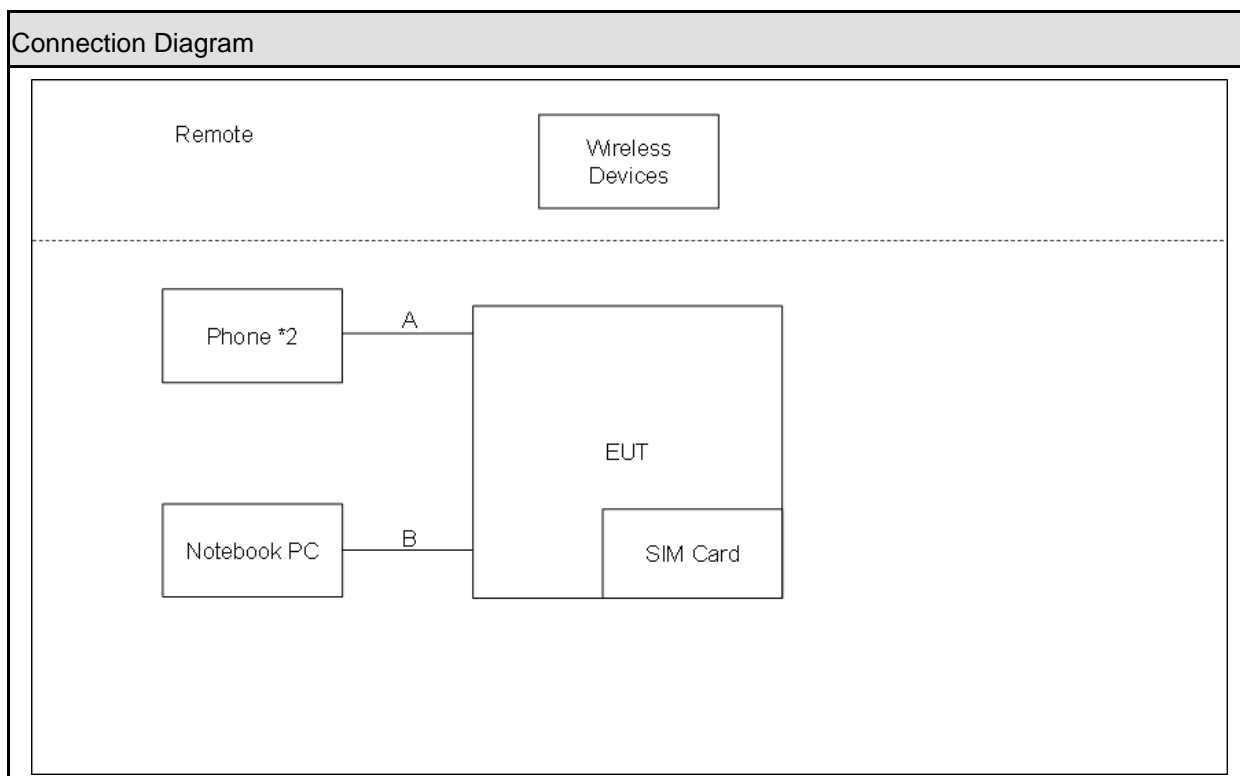

Tested System Details				
Product	Manufacturer	Model No.	No.	Cable Type & Description
Phone*2	WONDER	WD-303	A	RJ11 *2, non-shielded 1.5m
Notebook PC	Lenovo	TP00116D	B	USB-C, Shielded 1.0m
SIM Card	N/A	N/A		
Wireless Devices Inf.				
Product		Manufacturer		Model No.
Base Station		R&S		CMW500

Note:

- Use Full system setup configuration determines Worst-Case Mode.
- Use 2dB law program determines Max. Cable Configuration and Worst-Case Mode.
- Radiated emission item test: Performed using the Horn Antenna 3dB Beamwidth to 3m from the EUT size sufficient to cover the procedure.
- Radiated emission item test: Performed using the Horn Antenna 3dB Beamwidth non 3m distance sufficient to cover the size of the EUT program

#### 1.4. EUT Exercise Software

1	Setup the EUT and simulators as shown on 1.3.
2	Turn on the power of all equipment.
3	All the features of the EUT operation normally.



## 2. Technical Test

### 2.1. Summary of Test Result

- No deviations from the test standards  
 Deviations from the test standards as below description:

Emission				
Performed Item	Normative References	Test Performed	Test Site	Verdict
Conducted Emission	FCC CFR Title 47 Part 15 Subpart B:2021, Class B CISPR 22:2008, ANSI C63.4-2014 ANSI C63.4a-2017	Yes	HY-SR09	Pass
Radiated Emission	FCC CFR Title 47 Part 15 Subpart B:2021, Class B CISPR 22:2008, ANSI C63.4-2014 ANSI C63.4a-2017	Yes	HY-CB05	Pass

Note:

1. Test Site information refers to test Laboratory Information.

Test Laboratory:	DEKRA Testing and Certification Co., Ltd. Linkou Laboratory
Address:	No.5-22, Ruishukeng Linkou District, New Taipei City, 24451, Taiwan, R.O.C
Phone number:	+886-2-8601-3788
Fax number:	+886-2-8601-3789
Test Site	
LK: No.5-22, Ruishukeng Linkou District, New Taipei City, 24451, Taiwan, R.O.C	
FS: No.6, Lane 75, Wenlin St., Linkou Dist., New Taipei City, 244017, Taiwan, R.O.C	
HY: No.26, Huaya 1 st Rd., Guishan Dist., Taoyuan City 333411, Taiwan, R.O.C	

## 2.2. List of Test Equipment

### Conducted Emission / HY-SR09

Instrument	Manufacturer	Type No.	Serial No.	Cal. Date	Due Date
EMI TEST RECEIVER	R&S	ESR3	102917	2022/12/16	2023/12/15
Two-Line V-Network	R&S	ENV216	101493	2022/12/12	2023/12/11
Two-Line V-Network	R&S	ENV216	101492	2022/12/21	2023/12/20
Impedance Stabilization Network	TESEQ	ISN T800	61676	2023/6/17	2024/6/16
Impedance Stabilization Network	TESEQ	ISN T8-Cat6	61286	2023/6/15	2024/6/14
Impedance Stabilization Network	TESEQ	ISN ST08	61833	2023/6/19	2024/6/18
Coaxial Cable	SUHNER	RG 400	HC001-RG	2023/5/31	2024/5/30

Note : ISN T800 for LAN 10Mbps to 1Gbps, T8-Cat6 for LAN above 1Gbps, ST08 for Shielded LAN  
 Test Software version : E3 210616 Dekra, V9(C) Audix

**Note: Test Receiver Detector: Quasipeak and Average Bandwidth: 9kHz**

### Radiated Emission / HY-CB05

Instrument	Manufacturer	Type No.	Serial No.	Cal. Date	Due Date
Trilog-Broadband Antenna	SCHWARZBECK	VULB 9168	1398	2023/6/5	2024/6/4
EMI Test Receiver	R&S	ESR7	102502	2023/3/28	2024/3/27
Coaxial Cable	ROSNOL	R-Test EW0630	HC003R	2023/6/19	2024/6/18
Coaxial Cable	ROSNOL	R-Test EW0630	HC005R	2023/6/19	2024/6/18
Preamplifier	SGH	SGH0301-P	20220411-1	2023/6/26	2024/6/25
NSA	DEKRA	N/A	N/A	2023/8/24	2024/8/23

Test Software version : E3 210616 Dekra, V9(C) Audix

**Note: Test Receiver Detector: Quasipeak Bandwidth: 120kHz**

### Radiated Emission (Above 1GHz) / HY-CB05

Instrument	Manufacturer	Type No.	Serial No.	Cal. Date	Due Date
Double Ridged Guide Horn Antenna	RF SPIN	DRH18-E	210504A18ES	2023/5/26	2024/5/25
Horn Antenna	COM-POWER	AH-840	101088	2023/9/23	2024/9/24
EMI Test Receiver	R&S	ESR7	102502	2023/3/28	2024/3/27
Signal Analyzer	R&S	FSV3044	101245	2023/4/17	2024/4/16
Coaxial Cable	ROSNOL	R-Test EW0630	HC003R	2023/6/19	2024/6/18
Coaxial Cable	ROSNOL	R-Test EW0630	HC005R	2023/6/19	2024/6/18
Coaxial Cable	ROSNOL	R-Test EW0630	HC004R	2023/6/19	2024/6/18
Preamplifier	SGH	SGH118-HS	20220411-2	2023/4/26	2024/4/25
Microwave Preamplifier with cable	SGH	SGH184	20220411-3	2023/4/26	2024/4/25
VSWR	DEKRA	N/A	N/A	2023/8/23	2024/8/22

Test Software version : E3 210616 Dekra, V9(C) Audix

### **2.3. Measurement Uncertainty**

#### Conducted Emission

The measurement uncertainty is evaluated as  $\pm 2.00$  dB.

#### Radiated Emission(Under 1GHz)

The measurement uncertainty is evaluated as  $\pm 3.35$  dB.

#### Radiated Emission(Above 1GHz)

The measurement uncertainty is evaluated as  $\pm 4.64$  dB.

## 2.4. Test Environment

Performed Item	Items	Required
Conducted Emission	Temperature (°C)	10-40
	Humidity (%RH)	10-90
Radiated Emission	Temperature (°C)	10-40
	Humidity (%RH)	10-90

### 3. Conducted Emission

#### 3.1. Test Specification

According to Standard : FCC Part 15 Subpart B & CISPR 22

#### 3.2. Test Setup

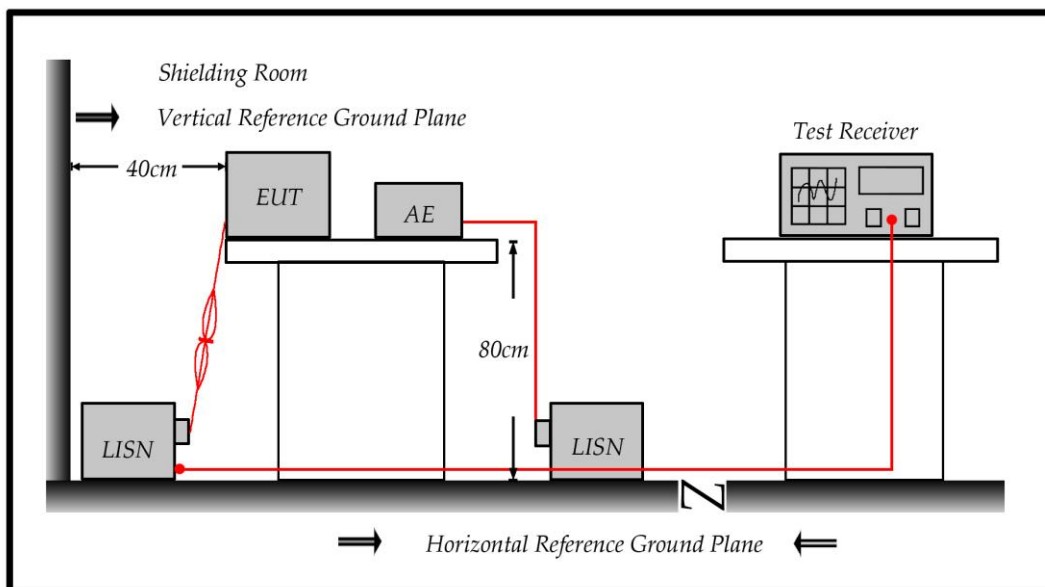

#### 3.3. Limit

Limits		
Frequency (MHz)	QP (dBuV)	AV (dBuV)
0.15 – 0.50	66 – 56	56 – 46
0.50 – 5.0	56	46
5.0 – 30	60	50

Remarks: In the above table, the tighter limit applies at the band edges.

### 3.4. Test Procedure

The EUT and simulators are connected to the main power through a line impedance stabilization network (L.I.S.N.). This provides a 50ohm/50uH coupling impedance for the measuring equipment. The peripheral devices are also connected to the main power through a LISN that provides a 50ohm/50uH coupling impedance with 50ohm termination.

(Please refers to the block diagram of the test setup and photographs.)

Both sides of A.C. line are checked for maximum conducted interference. In order to find the maximum emission, the relative positions of equipment and all of the interface cables must be changed on conducted measurement.

Conducted emissions were invested over the frequency range from 0.15MHz to 30MHz using a receiver bandwidth of 9kHz.

### 3.5. Test Result

Model No	POTS Adapter	Site	HY-SR09
Test Voltage	AC 120V / 60Hz to DC 12V (AC Adapter)	Test Date	2023-10-30
Test Mode	Mode 1	Engineer	Nat Cheng
Phase	Line	Temperature (°C)	25
Test Condition	--	Humidity (%RH)	66

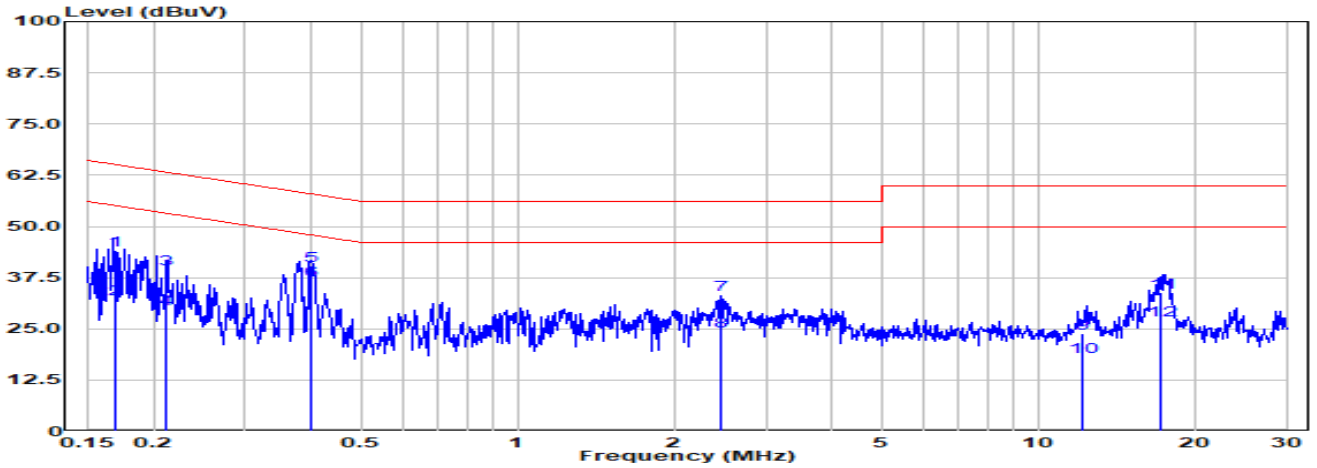

No	Frequency (MHz)	Emission Level (dBuV)	Limit (dBuV)	Margin (dB)	Reading Level (dBuV)	Correct Factor (dB)	Detector Type
1	0.169	44.29	65.03	-20.74	34.65	9.64	QP
2	0.169	32.36	55.03	-22.67	22.72	9.64	Average
3	0.212	39.60	63.12	-23.52	29.96	9.64	QP
4	0.212	29.77	53.12	-23.34	20.13	9.64	Average
5	0.400	40.27	57.85	-17.57	30.63	9.64	QP
6	0.400	36.92	47.85	-10.93	27.28	9.64	Average
7	2.458	33.26	56.00	-22.74	23.52	9.75	QP
8	2.458	24.51	46.00	-21.49	14.77	9.75	Average
9	12.160	23.82	60.00	-36.18	13.80	10.03	QP
10	12.160	18.12	50.00	-31.88	8.10	10.03	Average
11	17.290	33.97	60.00	-26.03	23.87	10.09	QP
12	17.290	27.10	50.00	-22.90	17.01	10.09	Average

Remark:

1. "\*" means this data is the worst margin;"!" means this data is over limit.
2. Emission Level=Reading Level + Correct Factor(Correct Factor=LISN Factor+Cable Loss).
3. Margin=Emission Level-Limit

Model No	POTS Adapter	Site	HY-SR09
Test Voltage	AC 120V / 60Hz to DC 12V (AC Adapter)	Test Date	2023-10-30
Test Mode	Mode 1	Engineer	Nat Cheng
Phase	Neutral	Temperature (°C)	25
Test Condition	--	Humidity (%RH)	66

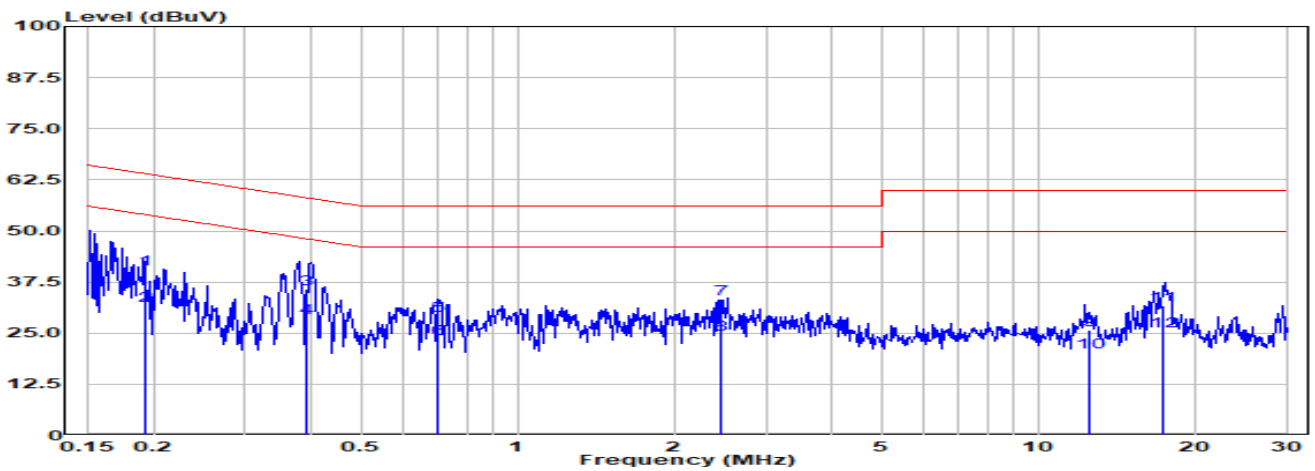

No	Frequency (MHz)	Emission Level (dBUV)	Limit (dBUV)	Margin (dB)	Reading Level (dBUV)	Correct Factor (dB)	Detector Type
1	0.192	40.62	63.94	-23.32	30.98	9.64	QP
2	0.192	31.70	53.94	-22.24	22.05	9.64	Average
3	0.394	35.76	57.98	-22.22	26.11	9.65	QP
4	0.394	28.61	47.98	-19.37	18.96	9.65	Average
5	0.704	29.40	56.00	-26.60	19.73	9.67	QP
6	0.704	23.58	46.00	-22.42	13.92	9.67	Average
7	2.456	33.30	56.00	-22.70	23.55	9.75	QP
8	2.456	24.71	46.00	-21.29	14.97	9.75	Average
9	12.504	25.62	60.00	-34.38	15.55	10.07	QP
10	12.504	20.39	50.00	-29.61	10.32	10.07	Average
11	17.325	31.71	60.00	-28.29	21.55	10.16	QP
12	17.325	25.34	50.00	-24.66	15.18	10.16	Average

Remark:

1. "\*" means this data is the worst margin;"!" means this data is over limit.
2. Emission Level=Reading Level + Correct Factor(Correct Factor=LISN Factor+Cable Loss).
3. Margin=Emission Level-Limit



## 4. Radiated Emission

### 4.1. Test Specification

According to Standard : FCC Part 15 Subpart B & CISPR 22

### 4.2. Test Setup

Under 1GHz Test Setup:

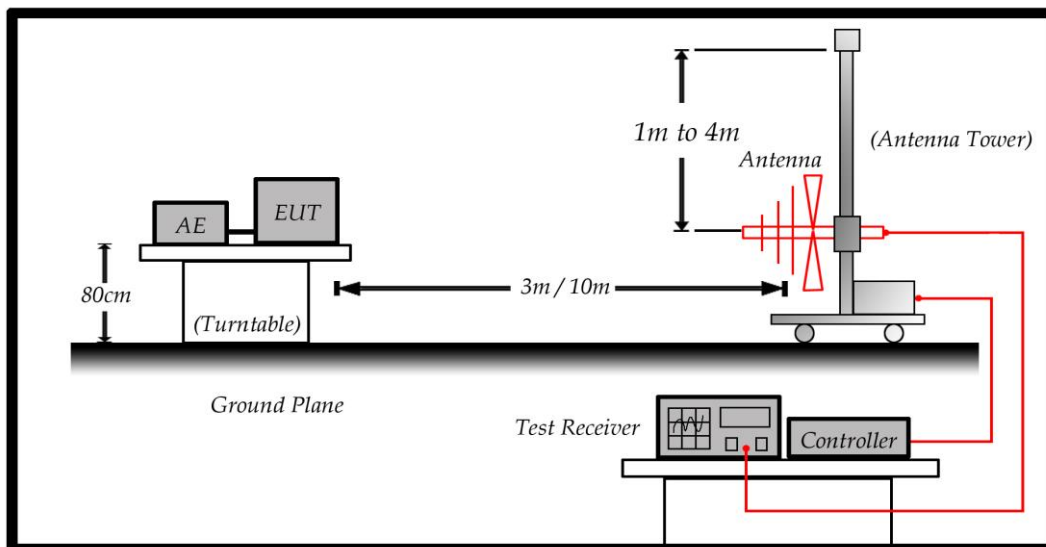

Above 1GHz Test Setup:

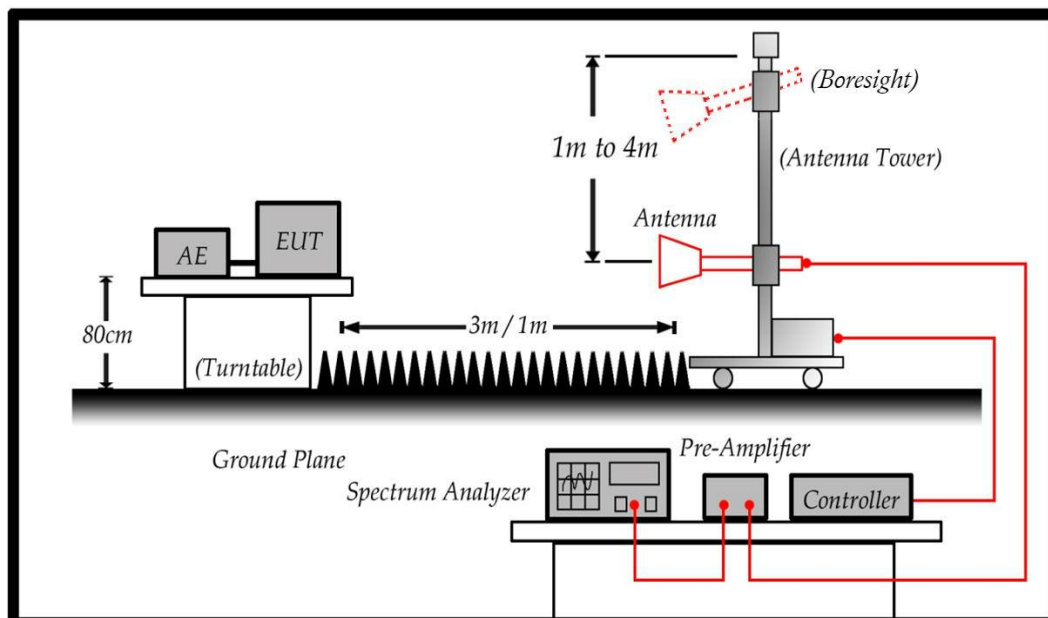

### 4.3. Limit

Above 1GHz test shall not exceed the following value:

FCC Part 15 Subpart B Paragraph 15.109 Limits (dBuV/m)		
Frequency (MHz)	Distance (m)	dBuV/m
30-88	3	40
88-216	3	43.5
216-960	3	46.0
960-1000	3	54
1000-40000	3	54
18000-40000	1	63.5

Remark:

1. The tighter limit shall apply at the edge between two frequency bands.
2. Distance refers to the distance in meters between the measuring instrument antenna and the closed point of any part of the device or system.
3. RF Voltage (dBuV/m) = 20 log RF Voltage (uV/m)

#### 4.4. Test Procedure

The EUT and its simulators are placed on a turn table which is 0.8 meter above ground.

The turn table can rotate 360 degrees to determine the position of the maximum emission level and the antenna (boresight antenna tower) can move up and down between 1 meter and 4 meters to find out the maximum emission level.

Both horizontal and vertical polarization of the antenna are set on measurement. In order to find the maximum emission, all of the interface cables must be manipulated on radiated measurement.

For an unintentional radiator, including a digital device, the spectrum shall be investigated from the lowest radio frequency signal generated or used in the device, without going below the lowest frequency for which a radiated emission limit is specified, up to the frequency shown in the following table:

Highest frequency generated or used in the device or on which the device operates or tunes (MHz)	Upper frequency of measurement range (MHz)
Below 1.705	30
1.705 – 108	1000
108 – 500	2000
500 – 1000	5000
Above 1000	5 <sup>th</sup> harmonic of the highest frequency or 40 GHz, whichever is lower

On any frequency or frequencies below or equal to 1000MHz, the radiated limits shown are based on measuring equipment employing a quasi-peak detector function and above 1000MHz, the radiated limits shown are based measuring equipment employing an average detector function.

When average radiated emission measurement are included emission measurement Above 1000MHz, there also is a limit on the radio frequency emissions, as measured using instrumentation with a peak detector function, corresponding to 20 dB above the maximum permitted average limit.

For class A, the measurement distance between the EUT and antenna is 10 meters for under 1GHz and above 1GHz.

For class B, the measurement distance between the EUT and antenna is 10 meters for under 1GHz and 3 meters for above 1GHz.

The bandwidth below 1GHz setting on the field strength meter (Test Receiver) is 120kHz and above 1GHz is 1MHz.

### 4.5. Test Result

Model No	POTS Adapter	Site	HY-CB05
Test Voltage	AC 120V / 60Hz to DC 12V (AC Adapter)	Test Date	2023-10-31
Test Mode	Mode 1	Engineer	Nat Cheng
Polarity	Horizontal	Temperature (°C)	20
Test Condition	--	Humidity (%RH)	53

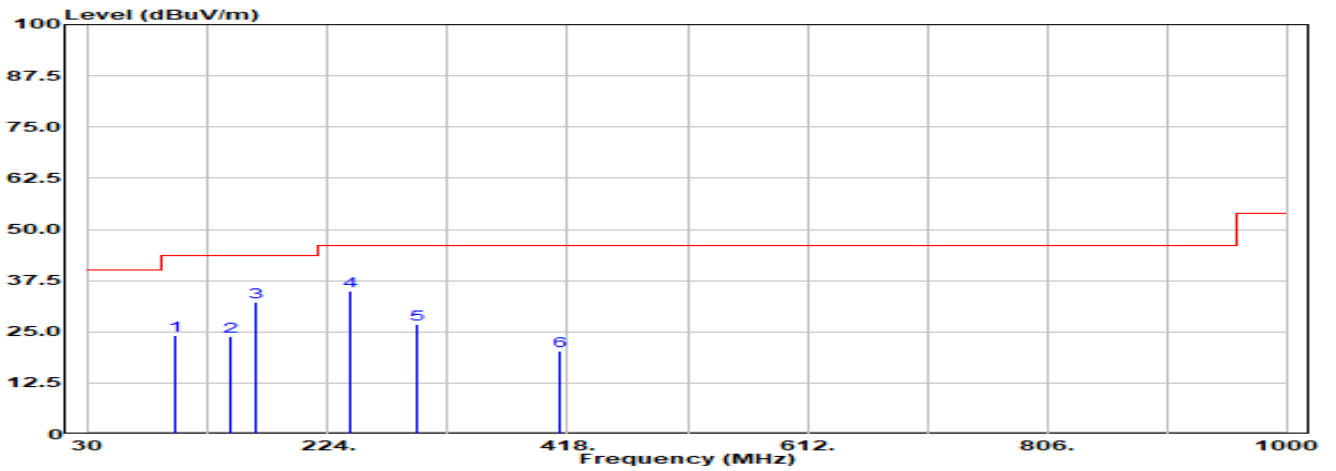

No	Frequency (MHz)	Emission Level (dBuV/m)	Limit (dBuV/m)	Margin (dB)	Reading Level (dBuV)	Correct Factor (dB/m)	Ant Pos (cm)	TT Pos (deg)	Detector Type
1	99.260	24.04	43.50	-19.46	53.00	-28.96	100	258	QP
2	144.890	23.83	43.50	-19.67	48.20	-24.37	100	295	QP
3	165.150	32.18	43.50	-11.32	56.40	-24.22	100	318	QP
4*	242.350	35.01	46.00	-10.99	60.30	-25.29	100	236	QP
5	295.780	26.80	46.00	-19.20	50.50	-23.70	100	260	QP
6	411.390	20.36	46.00	-25.64	40.80	-20.44	100	323	QP

Remark:

1. "\*" means this data is the worst margin; "!" means this data is over limit.
2. Emission Level=Reading Level + Correct Factor(Correct Factor=Ant Factor+Cable Loss-Pre Amp).
3. Margin=Emission Level - Limit.

Model No	POTS Adapter	Site	HY-CB05
Test Voltage	AC 120V / 60Hz to DC 12V (AC Adapter)	Test Date	2023-10-31
Test Mode	Mode 1	Engineer	Nat Cheng
Polarity	Vertical	Temperature (°C)	20
Test Condition	--	Humidity (%RH)	53

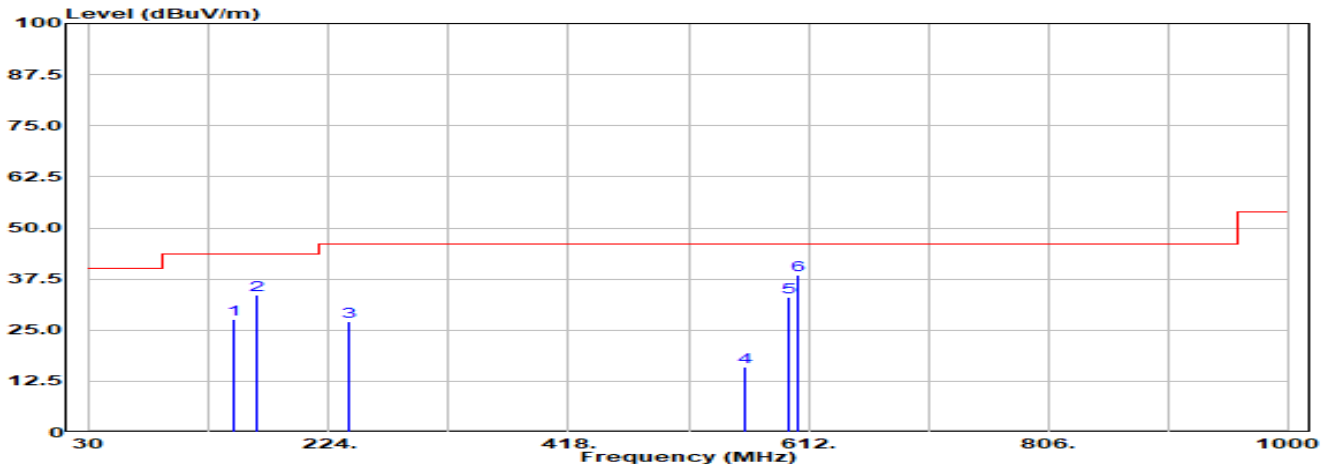

No	Frequency (MHz)	Emission Level (dBuV/m)	Limit (dBuV/m)	Margin (dB)	Reading Level (dBuV)	Correct Factor (dB/m)	Ant Pos (cm)	TT Pos (deg)	Detector Type
1	146.590	27.74	43.50	-15.76	51.80	-24.06	100	295	QP
2	165.810	33.58	43.50	-9.92	57.80	-24.22	100	353	QP
3	240.600	27.12	46.00	-18.88	52.50	-25.38	100	273	QP
4	561.510	15.90	46.00	-30.10	33.00	-17.10	100	244	QP
5	596.000	33.20	46.00	-12.80	49.50	-16.30	100	197	QP
6*	604.400	38.56	46.00	-7.44	54.60	-16.04	100	242	QP

Remark:

1. "\*" means this data is the worst margin;"!" means this data is over limit.
2. Emission Level=Reading Level + Correct Factor(Correct Factor=Ant Factor+Cable Loss-Pre Amp).
3. Margin=Emission Level - Limit.

Model No	POTS Adapter	Site	HY-CB05
Test Voltage	AC 120V / 60Hz to DC 12V (AC Adapter)	Test Date	2023-10-31
Test Mode	Mode 1	Engineer	Nat Cheng
Polarity	Horizontal	Temperature (°C)	20
Test Condition	--	Humidity (%RH)	53

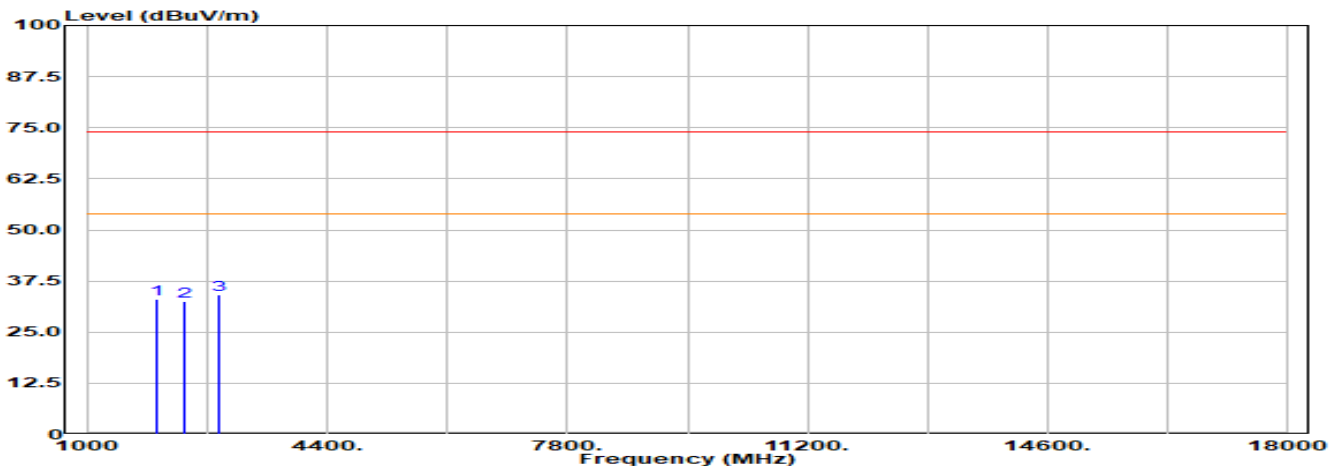

No	Frequency (MHz)	Emission Level (dBuV/m)	Limit (dBuV/m)	Margin (dB)	Reading Level (dBuV)	Correct Factor (dB/m)	Ant Pos (cm)	TT Pos (deg)	Detector Type
1	1965.000	32.94	74.00	-41.06	46.08	-13.14	100	220	Peak
2	2375.000	32.62	74.00	-41.38	44.58	-11.96	100	63	Peak
3*	2850.000	34.28	74.00	-39.72	44.98	-10.71	100	1	Peak

Remark:

1. "\*" means this data is the worst margin;"!" means this data is over limit.
2. Emission Level=Reading Level + Correct Factor(Correct Factor=Ant Factor+Cable Loss-Pre Amp).
3. Margin=Emission Level - Limit.

Model No	POTS Adapter	Site	HY-CB05
Test Voltage	AC 120V / 60Hz to DC 12V (AC Adapter)	Test Date	2023-10-31
Test Mode	Mode 1	Engineer	Nat Cheng
Polarity	Vertical	Temperature (°C)	20
Test Condition	--	Humidity (%RH)	53

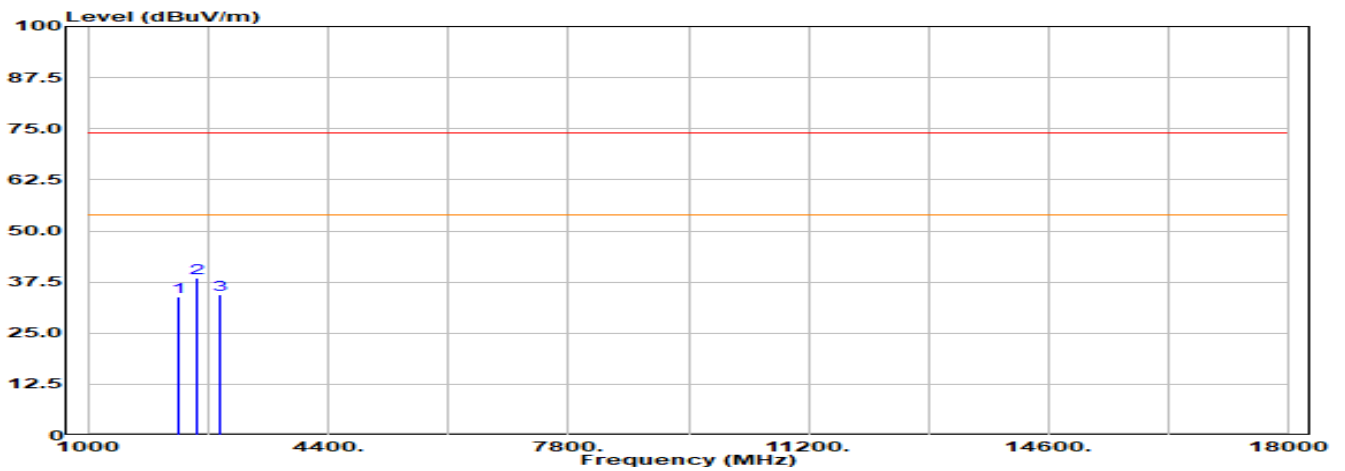

No	Frequency (MHz)	Emission Level (dBuV/m)	Limit (dBuV/m)	Margin (dB)	Reading Level (dBuV)	Correct Factor (dB/m)	Ant Pos (cm)	TT Pos (deg)	Detector Type
1	2260.000	33.93	74.00	-40.07	45.82	-11.88	100	304	Peak
2*	2535.000	38.59	74.00	-35.41	50.49	-11.90	100	42	Peak
3	2840.000	34.36	74.00	-39.64	45.07	-10.71	100	195	Peak

Remark:

1. "\*" means this data is the worst margin; "!" means this data is over limit.
2. Emission Level=Reading Level + Correct Factor(Correct Factor=Ant Factor+Cable Loss-Pre Amp).
3. Margin=Emission Level - Limit.