



Test report No.: 2360237R-RFUSV01S-A

# TEST REPORT

Product Name	Peplink Pepwave Wireless Product
Trademark	
Model and /or type reference	B One 5G B-ONE-5GN-T-PRM B One B-ONE-T-PRM B One Plus B-ONE-PLUS-LTE-US-T-PRM
FCC ID	U8G-P1AX23
Applicant's name / address	PISMO LABS TECHNOLOGY LIMITED A8, 5/F, HK Spinners Industrial Building, Phase 6, 481 Castle Peak Road, Cheung Sha Wan, Hong Kong
Manufacturer's name	PISMO LABS TECHNOLOGY LIMITED
Test method requested, standard	FCC CFR Title 47 Part 15 Subpart C ANSI C63.4: 2014, ANSI C63.10: 2013
Verdict Summary	IN COMPLIANCE
Documented By (Project Specialist / Ida Tung)	<i>Ida Tung</i>
Tested By (Senior Engineer / Bill Lin)	<i>Bill Lin</i>
Approved By (Senior Engineer / Jack Hsu)	<i>Jack Hsu</i>
Date of Receipt	2023/06/07
Date of Issue	2024/03/06
Report Version	V1.0

**INDEX**

Page

<b>1. General Information.....</b>	<b>6</b>
1.1. EUT Description.....	6
1.2. Tested System Details.....	8
1.3. Configuration of Tested System .....	8
1.4. EUT Exercise Software .....	8
1.5. Test Facility .....	9
1.6. List of Test Item and Equipment .....	10
1.7. Uncertainty .....	11
<b>2. Conducted Emission .....</b>	<b>12</b>
2.1. Test Setup .....	12
2.2. Limits.....	12
2.3. Test Procedure .....	12
2.4. Test Result of Conducted Emission.....	13
<b>3. Maximum Power Output .....</b>	<b>14</b>
3.1. Test Setup .....	14
3.2. Limits.....	14
3.3. Test Procedure .....	14
3.4. Test Result of Peak Power Output.....	15
<b>4. Radiated Emission .....</b>	<b>23</b>
4.1. Test Setup .....	23
4.2. Limits.....	24
4.3. Test Procedure .....	25
4.4. Test Result of Radiated Emission .....	27
<b>5. RF Antenna Conducted Test .....</b>	<b>37</b>
5.1. Test Setup .....	37
5.2. Limits.....	37
5.3. Test Procedure .....	37
5.4. Test Result of RF Antenna Conducted Test.....	38
<b>6. Band Edge .....</b>	<b>42</b>
6.1. Test Setup .....	42
6.2. Limits.....	43
6.3. Test Procedure .....	44

---

6.4.	Test Result of Band Edge .....	45
<b>7.</b>	<b>6 dB Bandwidth .....</b>	<b>61</b>
7.1.	Test Setup .....	61
7.2.	Limits.....	61
7.3.	Test Procedure .....	61
7.4.	Test Result of 6 dB Bandwidth.....	62
<b>8.</b>	<b>Power Density.....</b>	<b>66</b>
8.1.	Test Setup .....	66
8.2.	Limits.....	66
8.3.	Test Procedure .....	66
8.4.	Test Result of Power Density .....	67
<b>9.</b>	<b>Duty Cycle .....</b>	<b>71</b>
9.1.	Test Setup .....	71
9.2.	Test Procedure .....	71
9.3.	Test Result of Duty Cycle.....	72

Appendix 1: EUT Test Photographs

Appendix 2: Product Photos-Please refer to the file: 2360237R-Product Photos

---

## Competences and Guarantees

---

DEKRA is a testing laboratory competent to carry out the tests described in this report.

In order to assure the traceability to other national and international laboratories, DEKRA has a calibration and maintenance program for its measurement equipment.

DEKRA guarantees the reliability of the data presented in this report, which is the result of the measurements and the tests performed to the item under test on the date and under the conditions stated in the report and it is based on the knowledge and technical facilities available at DEKRA at the time of performance of the test.

DEKRA is liable to the client for the maintenance of the confidentiality of all information related to the item under test and the results of the test.

The results presented in this Test Report apply only to the particular item under test established in this document.

**IMPORTANT:** No parts of this report may be reproduced or quoted out of context, in any form or by any means, except in full, without the previous written permission of DEKRA.

## General conditions

---

1. The test results relate only to the samples tested.
2. The test results shown in the test report are traceable to the national/international standard through the calibration report of the equipment and evaluated measurement uncertainty herein.
3. This report must not be used to claim product endorsement by TAF or any agency of the government.
4. The test report shall not be reproduced without the written approval of DEKRA Testing and Certification Co., Ltd.
5. Measurement uncertainties evaluated for each testing system and associated connections are given here to provide the system information for reference. Compliance determinations do not take into account measurement uncertainties for each testing system, but are based on the results of the compliance measurement.

---

## Revision History

---

Report No.	Version	Description	Issued Date
2360237R-RFUSV01S-A	V1.0	Initial issue of report.	2024/03/06

## 1. General Information

### 1.1. EUT Description

Product Name	Peplink Pepwave Wireless Product
Trademark	
Model and /or type reference	B One 5G B-ONE-5GN-T-PRM B One B-ONE-T-PRM B One Plus B-ONE-PLUS-LTE-US-T-PRM
EUT Rated Voltage	DC 10~30V
EUT Test Voltage	AC 120V/60Hz to DC 12V (power by adapter)
Frequency Range	802.11b/g/n/ac/ax-20 MHz: 2412-2462 MHz 802.11n/ac/ax-40 MHz: 2422-2452 MHz
Number of Channels	802.11b/g/n/ac/ax-20 MHz: 11CH 802.11n/ac/ax-40 MHz: 7CH
Data Rate	802.11b: 1-11 Mbps, 802.11g: 6-54 Mbps, 802.11n: up to 300 Mbps 802.11ac: up to 400 Mbps, 802.11ax up to 573.6 Mbps
Channel separation	802.11b/g/n/ac/ax: 5 MHz
Type of Modulation	802.11b: DSSS, DBPSK, DQPSK, CCK 802.11g/n/ac/ax: OFDM, OFDMA, BPSK, QPSK, 16QAM, 64QAM, 256QAM, 1024QAM
Channel Control	Auto
Adapter #1	MFR: Zhuzhou Dachuan Electronic Technology Co., Ltd. M/N: DCT36W120300ZZ-D2 Input: AC 100-240V~50/60Hz, 1.0A max. Output: 12.0V=3.0A, 36.0W Cable Out: Non-shielded, 1.5m
Adapter #2	MFR: FLYPOWER M/N: PS36LA120K3000UD Input: AC 100-240V~50/60Hz, 1.0A Max. Output: 12.0V=3.0A, 36.0W Cable Out: Non-shielded, 1.5m

#### Antenna List

No.	Manufacturer	Part No.	Antenna Type	Peak Gain
1	INPAQ	RFDPA191300SBLB813	Omni-directional	4.53 dBi for 2400 MHz
2	INPAQ	RFDPA191300SBLB813	Omni-directional	4.53 dBi for 2400 MHz

Note: 1. The antenna of EUT is conforming to FCC 15.203.

2. The antenna gain as by the manufacturer provided.

**For CDD mode:**

For Power Directional gain  
 2400MHz: Directional gain =4.53 dBi  
 (Directional gain = G<sub>ANT MAX</sub> + Array Gain, Array  
 Gain = 0 dB for N<sub>ANT</sub> ≤ 4)

For PSD Directional gain  
 2400MHz: Directional gain = 7.54 dBi  
 Directional gain = 10 log<sub>10</sub>[(10<sup>G<sub>1</sub>/20</sup> + 10<sup>G<sub>2</sub>/20</sup>)<sup>2</sup> /  
 N<sub>ANT</sub>] dBi

802.11b/g/n/ac/ax-20 MHz Center Frequency of Each Channel:

Channel	Frequency (MHz)	Channel	Frequency (MHz)	Channel	Frequency (MHz)	Channel	Frequency (MHz)
01	2412	02	2417	03	2422	04	2427
05	2432	06	2437	07	2442	08	2447
09	2452	10	2457	11	2462	--	--

802.11n/ac/ax-40 MHz Center Frequency of Each Channel:

Channel	Frequency (MHz)	Channel	Frequency (MHz)	Channel	Frequency (MHz)	Channel	Frequency (MHz)
03	2422	04	2427	05	2432	06	2437
07	2442	08	2447	09	2452	--	--

Note:

1. The EUT is a Peplink Pepwave Wireless Product with a built-in WLAN and Bluetooth transceiver, this report for 2.4 GHz WLAN.
2. Difference of Models

Model	WWAN module	WWAN function	WIFI function	BT function
B One 5G	Quectel	V	V	V
B-ONE-5GN-T-PRM	RM520N-GL			
B One	N/A	N/A	V	V
B-ONE-T-PRM				
B One Plus	Quectel	V	V	V
B-ONE-PLUS-LTE-US-T-PRM	EC25-AFXD			

The EUT is available in different model names for marketing purposes. The identification of test sample is B One 5G.

3. Regarding to the operation frequency, the lowest, middle and highest frequency are selected to perform the test. The other channels are for reference only.
4. The radiation measurements are performed in X, Y, Z axis positioning. Only the worst case is shown in the report.
5. DEKRA has evaluated each test mode. Only the worst case is shown in the report.
6. Lowest and highest data rates are tested in each mode. Only worst case is shown in the report.
7. For radiated emission below 1 GHz and AC power line conducted emission have performed all modes of operation were investigated and the worst-case emissions are reported.
8. These tests are conducted on a sample for the purpose of demonstrating compliance of transmitter with Part 15 Subpart C Paragraph 15.247 of spread spectrum devices.

Test Mode	Mode 1
	Transmit (802.11b)-CDD
	Transmit (802.11g)-CDD
	Transmit (802.11n-20 MHz)-CDD
	Transmit (802.11n-40 MHz)-CDD
	Transmit (802.11ac-20 MHz)-CDD
	Transmit (802.11ac40 MHz)-CDD
	Transmit (802.11ax-20 MHz)-CDD
	Transmit (802.11ax-40 MHz)-CDD

### 1.2. Tested System Details

The types for all equipment, plus descriptions of all cables used in the tested system (including inserted cards) are:

Product	Manufacturer	Model No.	Serial No.	Power Cord
1 Power Adapter	Zhuzhou Dachuan Electronic Technology Co., Ltd.	DCT36W120300ZZ-D2	N/A	N/A
2 Power Adapter	FLYPOWER	PS36LA120K3000UD	N/A	N/A
3 Notebook PC	DELL	Latitude 5501	8JHGL13	N/A
4 Test Fixture	Askey	BBS tool Rev03	N/A	N/A
5 FLASH	Transcend	JetFlash 790C/64GB	N/A	N/A
6 Switch Hub	ZYXEL	GS-108B v3	N/A	N/A

Cable Type	Cable Description
A Power Cable	Non-shielded, 1.5m
B Power Cable	Non-shielded, 1.5m
C LAN Cable	Non-shielded, 3m, four PCS.
D USB TO MicroB Cable	Shielded, 1m
E Signal Cable	Non-shielded, 0.1m

### 1.3. Configuration of Tested System

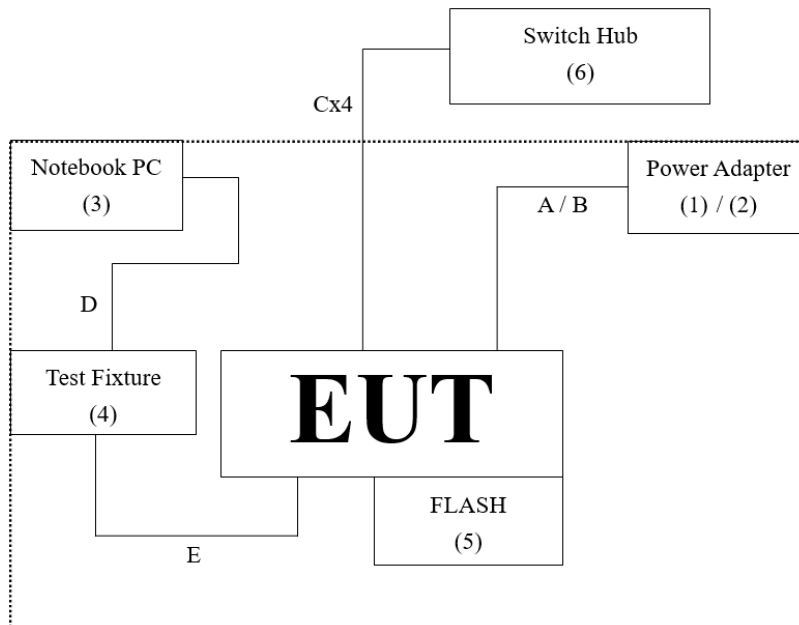

### 1.4. EUT Exercise Software

1	Setup the EUT as shown in Section 1.3.
2	Execute software “Qualcomm Sequence Profiling Resource Version 5.0-00197” on the Notebook PC.
3	Configure the test mode, the test channel, and the data rate.
4	Verify that the EUT works properly.



## 1.5. Test Facility

Ambient conditions in the laboratory:

Performed Item	Items	Required	Actual
Conducted Emission	Temperature (°C)	10~40 °C	27.3 °C
	Humidity (%RH)	10~90 %	48.5 %
Radiated Emission	Temperature (°C)	10~40 °C	21.4 °C
	Humidity (%RH)	10~90 %	62.6 %
Conductive	Temperature (°C)	10~40 °C	27.0 °C
	Humidity (%RH)	10~90 %	52.2 %

USA	FCC Registration Number: TW0033
Canada	CAB Identifier Number: TW3023 / Company Number: 26930

Site Description	Accredited by TAF
	Accredited Number: 3023

Test Laboratory	DEKRA Testing and Certification Co., Ltd.
	Linkou Laboratory
Address	No.5-22, Ruishukeng Linkou District, New Taipei City, 24451, Taiwan, R.O.C
Performed Location	No. 26, Huaya 1st Rd., Guishan Dist., Taoyuan City 333411, Taiwan, R.O.C.
Phone Number	+886-3-275-7255
Fax Number	+886-3-327-8031

## 1.6. List of Test Item and Equipment

**For Conduction Measurements / HY-SR01**

	Equipment	Manufacturer	Model No.	Serial No.	Cal. Date	Due Date
V	EMI Test Receiver	R&S	ESR7	101601	2023/06/20	2024/06/19
V	Two-Line V-Network	R&S	ENV216	101306	2023/03/16	2024/03/15
V	Two-Line V-Network	R&S	ENV216	102202	2022/08/08	2023/08/07
V	Coaxial Cable	SUHNER	RG400 BNC	RF001	2023/01/10	2024/01/09

Note:

1. All equipments are calibrated every one year.
2. The test instruments marked with “V” are used to measure the final test results.
3. Test Software Version: e3 230303 dekra V9.

**For Conducted Measurements / HY-SR02**

	Equipment	Manufacturer	Model No.	Serial No.	Cal. Date	Due Date
V	Spectrum Analyzer	R&S	FSV30	103466	2022/12/22	2023/12/21
V	Peak Power Analyzer	KEYSIGHT	8990B	MY51000539	2023/05/15	2024/05/14
V	Power Sensor	KEYSIGHT	N1923A	MY59240002	2023/05/18	2024/05/17
V	Power Sensor	KEYSIGHT	N1923A	MY59240003	2023/05/18	2024/05/17

Note:

1. All equipments are calibrated every one year.
2. The test instruments marked with “V” are used to measure the final test results.
3. Test Software Version: RF Conducted Test Tools R3 V3.0.0.14.

**For Radiated Measurements /HY-CB01**

	Equipment	Manufacturer	Model No.	Serial No.	Cal. Date	Due Date
V	Loop Antenna	AMETEK	HLA6121	56736	2023/05/23	2024/05/24
V	Bi-Log Antenna	SCHWARZBECK	VULB9168	9168-0675	2021/08/11	2023/08/10
V	Horn Antenna	RF SPIN	DRH18-E	210802A18ES	2023/03/23	2024/03/22
V	Horn Antenna	Com-Power	AH-840	101101	2021/11/30	2023/11/29
V	Pre-Amplifier	SGH	0301	20211007-7	2023/01/10	2024/01/09
V	Pre-Amplifier	EMCI	EMC051845SE	980632	2023/01/10	2024/01/09
V	Pre-Amplifier	EMCI	EMC05820SE	980362	2023/01/10	2024/01/09
V	Pre-Amplifier	EMCI	EMC184045SE	980369	2023/01/10	2024/01/09
	Coaxial Cable	EMCI	EMC102-KM-KM-600	1160314		
	Coaxial Cable	EMCI	EMC102-KM-KM-7000	170242		
V	Filter	MICRO TRONICS	BRM50702	G251	2023/01/05	2024/01/04
	Filter	MICRO TRONICS	BRM50716	067	2023/01/05	2024/01/04
V	EMI Test Receiver	R&S	ESR3	102792	2022/12/29	2023/12/28
V	Spectrum Analyzer	R&S	FSV3044	101115	2023/01/06	2024/01/05
V	Coaxial Cable	SUHNER	SUCOFLEX 106	25450/6	2023/01/10	2024/01/09
	Coaxial Cable	SGH	HA800	GD20110222-8		
	Coaxial Cable	SGH	SGH18	2021003-8		
	Coaxial Cable	EMCI	EMC106	151113		

Note:

1. Bi-Log Antenna and Horn Antenna (AH-840) is calibrated every two years, the other equipments are calibrated every one year.
2. The test instruments marked with “V” are used to measure the final test results.
3. Test Software Version: e3 230303 dekra V9.

## 1.7. Uncertainty

Uncertainties have been calculated according to the DEKRA internal document.

The reported expanded uncertainties are based on a standard uncertainty multiplied by a coverage factor of  $k=2$ , providing a level of confidence of approximately 95 %.

Measurement uncertainties evaluated for each testing system and associated connections are given here to provide the system information for reference. Compliance determinations do not take into account measurement uncertainties for each testing system, but are based on the results of the compliance measurement.

Test item	Uncertainty
Conducted Emission	$\pm 3.50$ dB
Maximum Power Output	Spectrum Analyzer: $\pm 2.14$ dB Power Meter: $\pm 1.05$ dB
Radiated Emission	9 kHz~30 MHz: $\pm 3.88$ dB 30 MHz~1 GHz: $\pm 4.42$ dB 1 GHz~18 GHz: $\pm 4.28$ dB 18 GHz~40 GHz: $\pm 3.90$ dB
RF Antenna Conducted Test	$\pm 2.14$ dB
Band Edge	9 kHz~30 MHz: $\pm 3.88$ dB 30 MHz~1 GHz: $\pm 4.42$ dB 1 GHz~18 GHz: $\pm 4.28$ dB 18 GHz~40 GHz: $\pm 3.90$ dB
6 dB Bandwidth	$\pm 1580.61$ Hz
Power Density	$\pm 2.14$ dB
Duty Cycle	$\pm 0.53$ %

## 2. Conducted Emission

### 2.1. Test Setup

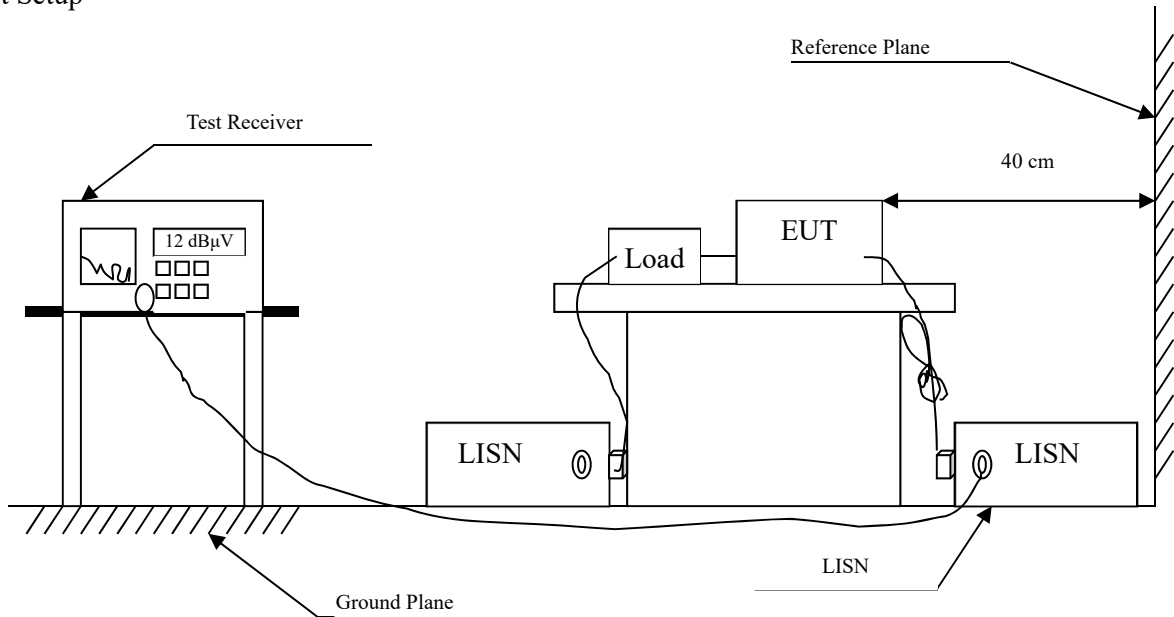

### 2.2. Limits

FCC Part 15 Subpart C Paragraph 15.207 (dB $\mu$ V) Limit		
Frequency MHz	Limits	
	QP	AVG
0.15 - 0.50	66-56	56-46
0.50 - 5.0	56	46
5.0 - 30	60	50

### 2.3. Test Procedure

The EUT and simulators are connected to the main power through a line impedance stabilization network (L.I.S.N.). This provides a 50 ohm /50 uH coupling impedance for the measuring equipment. The peripheral devices are also connected to the main power through a LISN that provides a 50 ohm /50 uH coupling impedance with 50 ohm termination. (Please refers to the block diagram of the test setup and photographs.)

Both sides of A.C. line are checked for maximum conducted interference. In order to find the maximum emission, the relative positions of equipment and all of the interface cables must be changed according to ANSI C63.4: 2014 on conducted measurement.

Conducted emissions were invested over the frequency range from 0.15 MHz to 30 MHz using a receiver bandwidth of 9 kHz.

### 2.4. Test Result of Conducted Emission

#### Adapter #1 (M/N: DCT36W120300ZZ-D2)

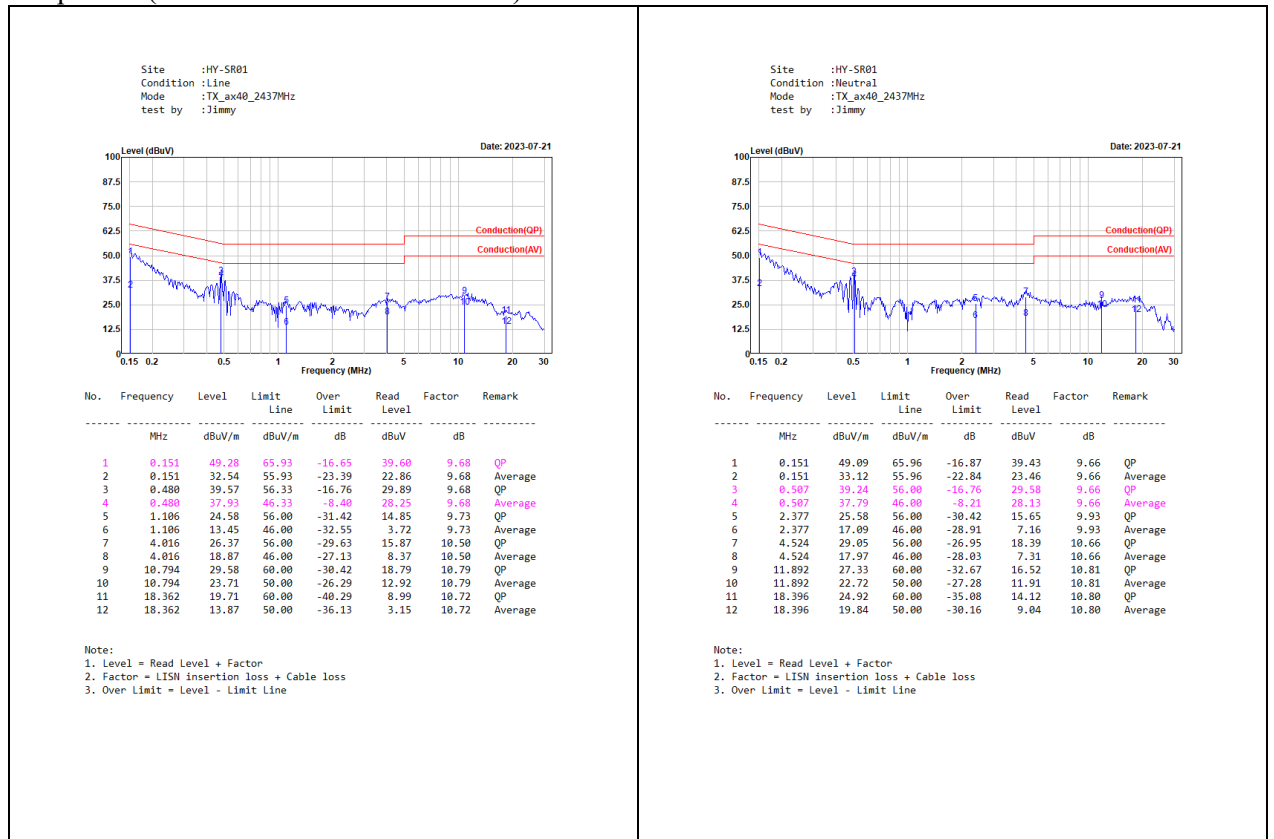

#### Adapter #2 (M/N: PS36LA120K3000UD)

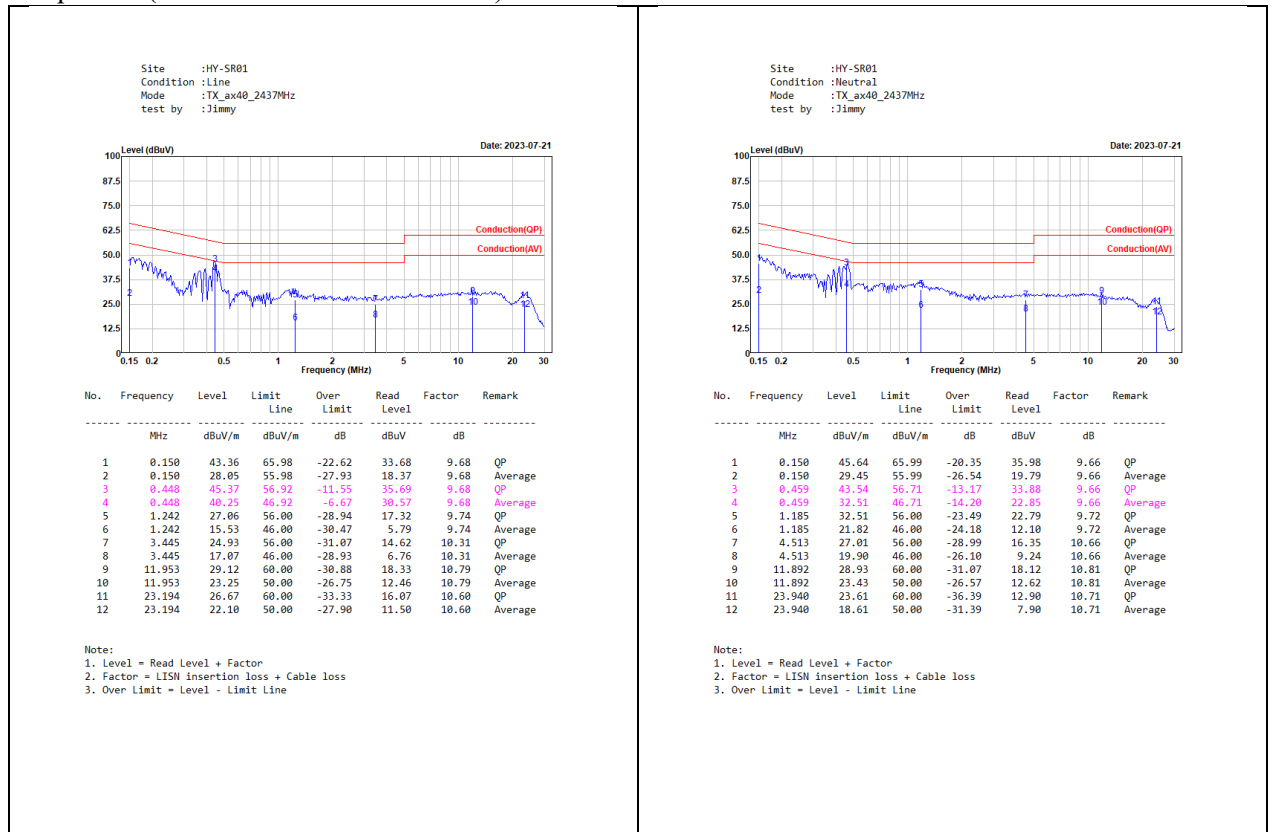

### 3. Maximum Power Output

#### 3.1. Test Setup



#### 3.2. Limits

The maximum peak power shall be less 1 Watt.

#### 3.3. Test Procedure

The EUT was tested according to C63.10:2013 for compliance to FCC 47CFR 15.247 requirements. The maximum peak conducted output power using C63.10:2013 Section 11.9.1.3 PKPM1 Peak power meter method. The maximum average conducted output power using C63.10:2013 Section 11.9.2.3 Measurement using a power meter (PM). (Measurement using a gated RF average-reading power meter).

### 3.4. Test Result of Peak Power Output

Product : Peplink Pepwave Wireless Product  
Test Item : Maximum Power Output Data  
Test Mode : Transmit (802.11b)-CDD  
Test Date : 2023/06/21

Channel No.	Frequency (MHz)	Data Rate (Mbps)	Chain A Power (dBm)	Chain B Power (dBm)	Average Output Power Chain A + B (dBm)	Limit (dBm)	Result
01	2412	1	17.82	18.30	21.08	<30	Pass
06	2437	1	21.44	22.68	25.11	<30	Pass
11	2462	1	18.18	19.67	22.00	<30	Pass

Note: Average Power Output (dBm) =  $10 \cdot \text{LOG} (\text{Chain A (mW)} + \text{Chain B (mW)})$

Product : Peplink Pepwave Wireless Product  
Test Item : Maximum Power Output Data  
Test Mode : Transmit (802.11g)-CDD  
Test Date : 2023/06/21

Channel No.	Frequency (MHz)	Data Rate (Mbps)	Chain A Power (dBm)	Chain B Power (dBm)	Average Output Power Chain A + B (dBm)	Limit (dBm)	Result
01	2412	6	16.78	17.51	20.17	<30	Pass
06	2437	6	20.65	21.47	24.09	<30	Pass
11	2462	6	16.68	17.93	20.36	<30	Pass

Note: Average Power Output (dBm) =  $10 \cdot \text{LOG} (\text{Chain A (mW)} + \text{Chain B (mW)})$



Product : Peplink Pepwave Wireless Product  
Test Item : Maximum Power Output Data  
Test Mode : Transmit (802.11n-20 MHz)-CDD  
Test Date : 2023/06/21

Channel No.	Frequency (MHz)	Data Rate	Chain A Power (dBm)	Chain B Power (dBm)	Average Output Power Chain A + B (dBm)	Limit (dBm)	Result
01	2412	MCS0	14.98	15.44	18.23	<30	Pass
06	2437	MCS0	19.21	19.66	22.45	<30	Pass
11	2462	MCS0	14.37	15.22	17.83	<30	Pass

Note: Average Power Output (dBm) =  $10 \cdot \text{LOG} (\text{Chain A (mW)} + \text{Chain B (mW)})$

Product : Peplink Pepwave Wireless Product  
Test Item : Maximum Power Output Data  
Test Mode : Transmit (802.11n-40 MHz)-CDD  
Test Date : 2023/06/21

Channel No.	Frequency (MHz)	Data Rate	Chain A Power (dBm)	Chain B Power (dBm)	Average Output Power Chain A + B (dBm)	Limit (dBm)	Result
03	2422	MCS0	13.19	13.54	16.38	<30	Pass
06	2437	MCS0	16.51	16.93	19.74	<30	Pass
09	2452	MCS0	13.40	13.97	16.70	<30	Pass

Note: Average Power Output (dBm) =  $10 \cdot \text{LOG} (\text{Chain A (mW)} + \text{Chain B (mW)})$

Product : Peplink Pepwave Wireless Product  
Test Item : Maximum Power Output Data  
Test Mode : Transmit (802.11ac-20 MHz)-CDD  
Test Date : 2023/06/21

Channel No.	Frequency (MHz)	Data Rate	Chain A Power (dBm)	Chain B Power (dBm)	Average Output Power Chain A + B (dBm)	Limit (dBm)	Result
01	2412	MCS0	15.03	15.58	18.32	<30	Pass
06	2437	MCS0	19.28	19.72	22.52	<30	Pass
11	2462	MCS0	14.42	15.31	17.90	<30	Pass

Note: Average Power Output (dBm) = 10\*LOG (Chain A (mW) + Chain B (mW))

Product : Peplink Pepwave Wireless Product  
Test Item : Maximum Power Output Data  
Test Mode : Transmit (802.11ac40 MHz)-CDD  
Test Date : 2023/06/21

Channel No.	Frequency (MHz)	Data Rate	Chain A Power (dBm)	Chain B Power (dBm)	Average Output Power Chain A + B (dBm)	Limit (dBm)	Result
03	2422	MCS0	13.24	13.61	16.44	<30	Pass
06	2437	MCS0	16.59	16.97	19.79	<30	Pass
09	2452	MCS0	13.47	14.09	16.80	<30	Pass

Note: Average Power Output (dBm) = 10\*LOG (Chain A (mW) + Chain B (mW))

Product : Peplink Pepwave Wireless Product  
Test Item : Maximum Power Output Data  
Test Mode : Transmit (802.11ax-20 MHz)-CDD  
Test Date : 2023/06/21

Channel No.	Frequency (MHz)	Data Rate	Chain A Power (dBm)	Chain B Power (dBm)	Average Output Power Chain A + B (dBm)	Limit (dBm)	Result
01	2412	MCS0	15.06	15.62	18.36	<30	Pass
06	2437	MCS0	19.32	19.78	22.57	<30	Pass
11	2462	MCS0	14.49	15.40	17.98	<30	Pass

Note: Average Power Output (dBm) =  $10 \cdot \text{LOG} (\text{Chain A (mW)} + \text{Chain B (mW)})$

Product : Peplink Pepwave Wireless Product  
Test Item : Maximum Power Output Data  
Test Mode : Transmit (802.11ax-40 MHz)-CDD  
Test Date : 2023/06/21

Channel No.	Frequency (MHz)	Data Rate	Chain A Power (dBm)	Chain B Power (dBm)	Average Output Power Chain A + B (dBm)	Limit (dBm)	Result
03	2422	MCS0	13.29	13.66	16.49	<30	Pass
06	2437	MCS0	16.64	17.00	19.83	<30	Pass
09	2452	MCS0	13.55	14.12	16.85	<30	Pass

Note: Average Power Output (dBm) =  $10 \cdot \text{LOG} (\text{Chain A (mW)} + \text{Chain B (mW)})$

## 4. Radiated Emission

### 4.1. Test Setup

#### Radiated Emission Under 30 MHz

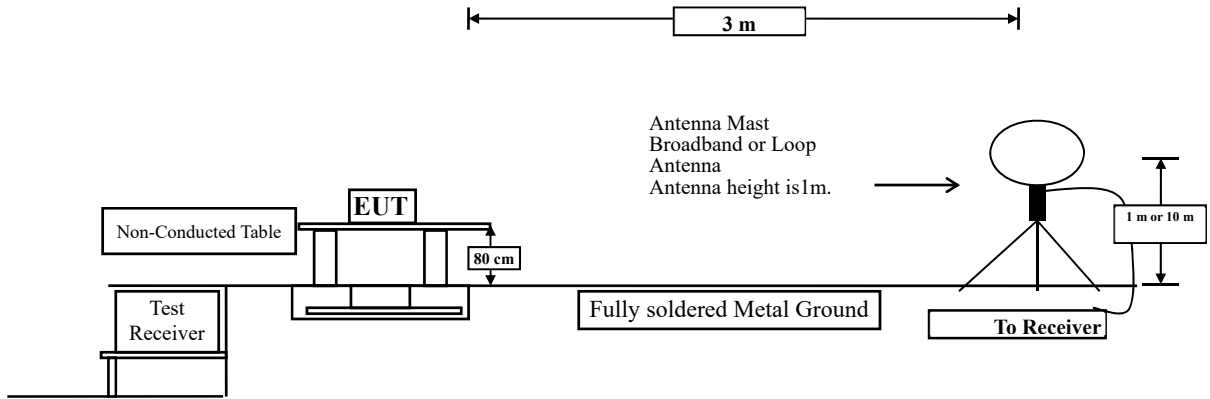

#### Radiated Emission Below 1 GHz

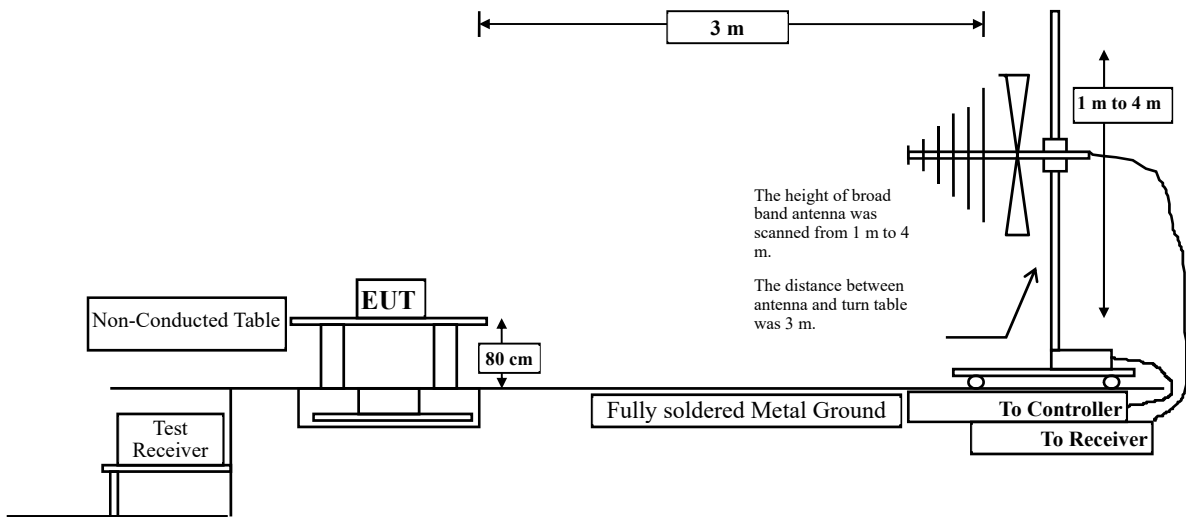

#### Radiated Emission Above 1 GHz

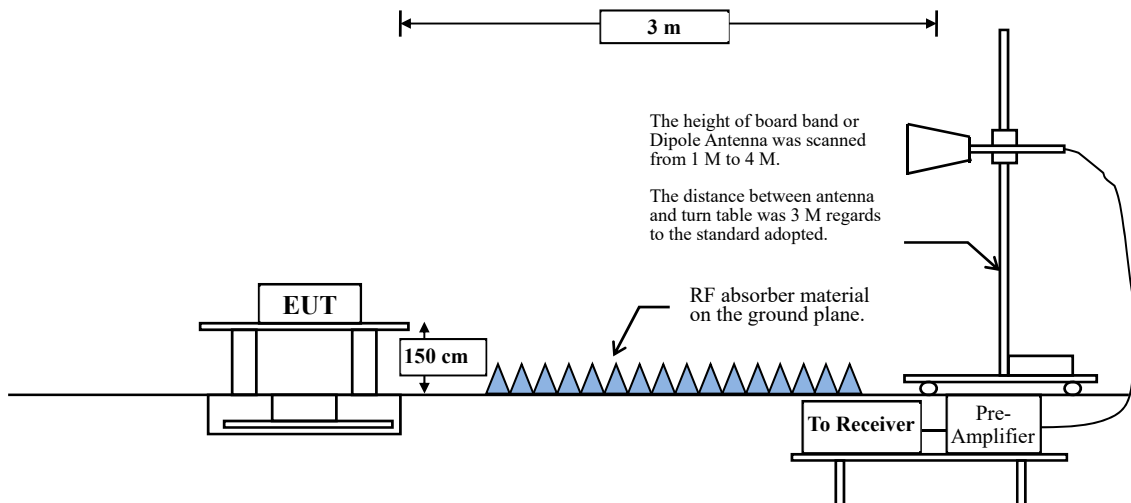

#### 4.2. Limits

##### ➤ General Radiated Emission Limits

Emissions radiated outside of the specified frequency bands, except for harmonics, shall be attenuated by at least 20 dB below the level of the fundamental or to the general radiated emission limits in paragraph 15.209, whichever is the lesser attenuation.

FCC Part 15 Subpart C Paragraph 15.209 Limits		
Frequency MHz	Field strength (microvolts/meter)	Measurement distance (meter)
0.009-0.490	2400/F(kHz)	300
0.490-1.705	24000/F(kHz)	30
1.705-30	30	30
30-88	100	3
88-216	150	3
216-960	200	3
Above 960	500	3

- Remarks:
1. RF Voltage (dB $\mu$ V) = 20 log RF Voltage ( $\mu$ V)
  2. In the Above Table, the tighter limit applies at the band edges.
  3. Distance refers to the distance in meters between the measuring instrument antenna and the closed point of any part of the device or system.



#### 4.3. Test Procedure

The EUT was setup according to ANSI C63.10: 2013 and tested according to C63.10:2013 Section 11.12.1 for compliance to FCC 47CFR 15.247 requirements.

Measuring the frequency range below 1 GHz, the EUT is placed on a turn table which is 0.8 meter above ground, when measuring the frequency range above 1GHz, the EUT is placed on a turn table which is 1.5 meter above ground.

The turn table is rotated 360 degrees to determine the position of the maximum emission level.

The EUT was positioned such that the distance from antenna to the EUT was 3 meters.

The antenna is scanned between 1 meter and 4 meters to find out the maximum emission level. This is repeated for both horizontal and vertical polarization of the antenna. In order to find the maximum emission, all of the interface cables were manipulated according to ANSI C63.10: 2013 on radiated measurement.

The resolution bandwidth below 30 MHz setting on the field strength meter is 9 kHz and 30 MHz~1 GHz is 120 kHz and above 1 GHz is 1 MHz.

Radiated emission measurements below 30 MHz are made using Loop Antenna and 30 MHz~1 GHz are made using broadband Bilog antenna and above 1 GHz are made using Horn Antennas.

The measurement is divided into the Preliminary Measurement and the Final Measurement.

The suspected frequencies are searched for in Preliminary Measurement with the measurement antenna kept pointed at the source of the emission both in azimuth and elevation, with the polarization of the antenna oriented for maximum response. The antenna is pointed at an angle towards the source of the emission, and the EUT is rotated in both height and polarization to maximize the measured emission. The emission is kept within the illumination area of the 3 dB bandwidth of the antenna.

The measurement frequency range from 9 kHz - 10th Harmonic of fundamental was investigated.

**RBW and VBW Parameter setting:**

According to C63.10 Section 11.12.2.4 Peak measurement procedure.

RBW = as specified in Table 1.

VBW  $\geq$  3 x RBW.

**Table 1 - RBW as a function of frequency**

Frequency	RBW
9-150 kHz	200-300 Hz
0.15-30 MHz	9-10 kHz
30-1000 MHz	100-120 kHz
> 1000 MHz	1 MHz

According to C63.10 Section 11.12.2.5 Average measurement procedure.

RBW = 1MHz.

VBW = 10Hz, when duty cycle  $\geq$  98 %

VBW  $\geq$  1/T, when duty cycle < 98 %

(T refers to the minimum transmission duration over which the transmitter is on and is transmitting at its maximum power control level for the tested mode of operation.)

2.4 GHz band	Duty Cycle (%)	T (ms)	1/T (Hz)	VBW (Hz)
802.11b	80.55	3.2400	1540	2000
802.11g	93.68	1.4342	697	1000
802.11ax-20 MHz	96.07	5.3800	186	200
802.11ax-40 MHz	96.39	5.3400	187	200

Note: Duty Cycle Refer to Section 9.

### 4.4. Test Result of Radiated Emission

Site :HY-CB01  
Condition :3m ,HORIZONTAL  
Mode :TX\_b\_2412MHz  
TEST BY :Caster

Date: 2023-06-15

No.	Frequency MHz	Level dBuV/m	Limit Line dBuV/m	Over Limit dB	Read Level dBuV	Factor dB	Remark
1	4824.000	42.44	74.00	-31.56	55.77	-13.33	Peak

Note:  
1. Level = Read Level + Factor  
2. Factor = Antenna Factor + Cable Loss - Preamp Factor  
3. Over Limit = Level - Limit Line  
4. The emission levels of other frequencies are very lower than the limit and not show in test report.

Site :HY-CB01  
Condition :3m ,VERTICAL  
Mode :TX\_b\_2412MHz  
TEST BY :Caster

Date: 2023-06-15

No.	Frequency MHz	Level dBuV/m	Limit Line dBuV/m	Over Limit dB	Read Level dBuV	Factor dB	Remark
1	4824.000	44.79	74.00	-29.21	58.12	-13.33	Peak
2	14472.000	55.36	74.00	-18.64	56.61	-1.25	Peak
3	14472.000	52.76	54.00	-1.24	54.01	-1.25	Average

Note:  
1. Level = Read Level + Factor  
2. Factor = Antenna Factor + Cable Loss - Preamp Factor  
3. Over Limit = Level - Limit Line  
4. The emission levels of other frequencies are very lower than the limit and not show in test report.

Site :HY-CB01  
Condition :3m ,HORIZONTAL  
Mode :TX\_b\_2437MHz  
TEST BY :Caster

Date: 2023-06-16

No.	Frequency MHz	Level dBuV/m	Limit Line dBuV/m	Over Limit dB	Read Level dBuV	Factor dB	Remark
1	4874.000	48.77	74.00	-25.23	62.11	-13.34	Peak
2	12185.000	57.17	74.00	-16.83	64.00	-6.83	Peak
3	12185.000	49.20	54.00	-4.80	56.03	-6.83	Average

Note:  
1. Level = Read Level + Factor  
2. Factor = Antenna Factor + Cable Loss - Preamp Factor  
3. Over Limit = Level - Limit Line  
4. The emission levels of other frequencies are very lower than the limit and not show in test report.

Site :HY-CB01  
Condition :3m ,VERTICAL  
Mode :TX\_b\_2437MHz  
TEST BY :Caster

Date: 2023-06-16

No.	Frequency MHz	Level dBuV/m	Limit Line dBuV/m	Over Limit dB	Read Level dBuV	Factor dB	Remark
1	4874.000	51.08	74.00	-22.92	64.42	-13.34	Peak
2	12185.000	58.33	74.00	-15.67	65.16	-6.83	Peak
3	12185.000	50.18	54.00	-3.82	57.01	-6.83	Average

Note:  
1. Level = Read Level + Factor  
2. Factor = Antenna Factor + Cable Loss - Preamp Factor  
3. Over Limit = Level - Limit Line  
4. The emission levels of other frequencies are very lower than the limit and not show in test report.

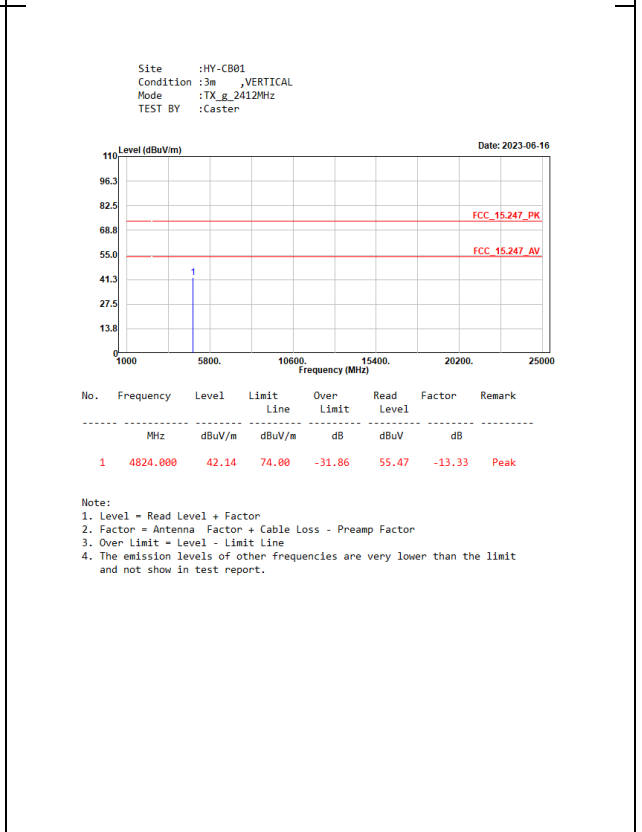
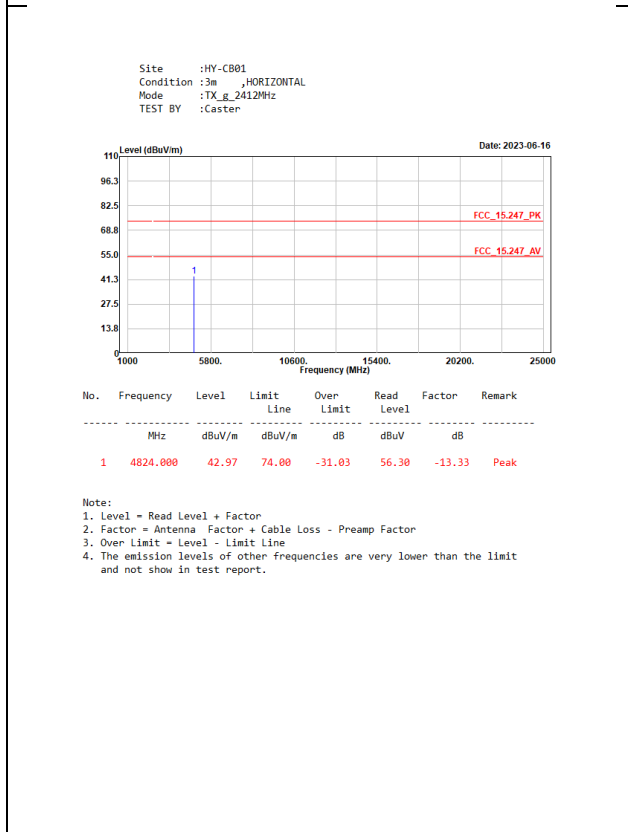
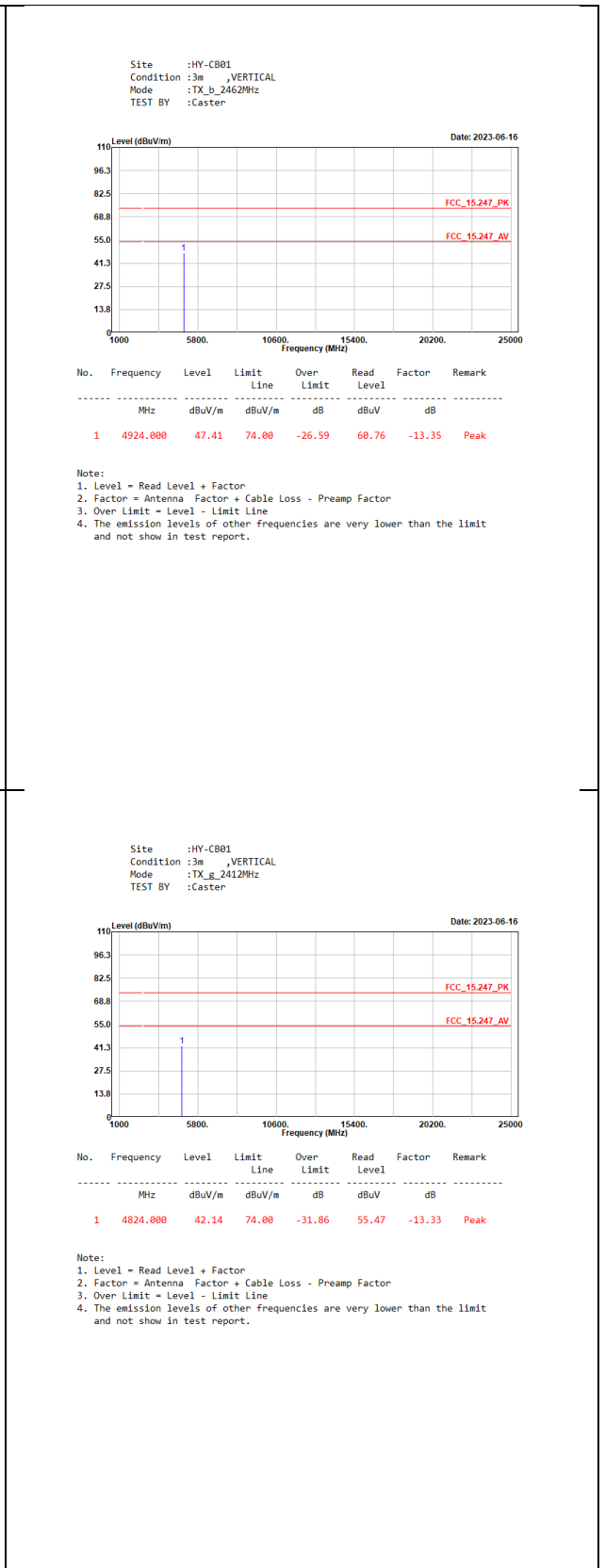
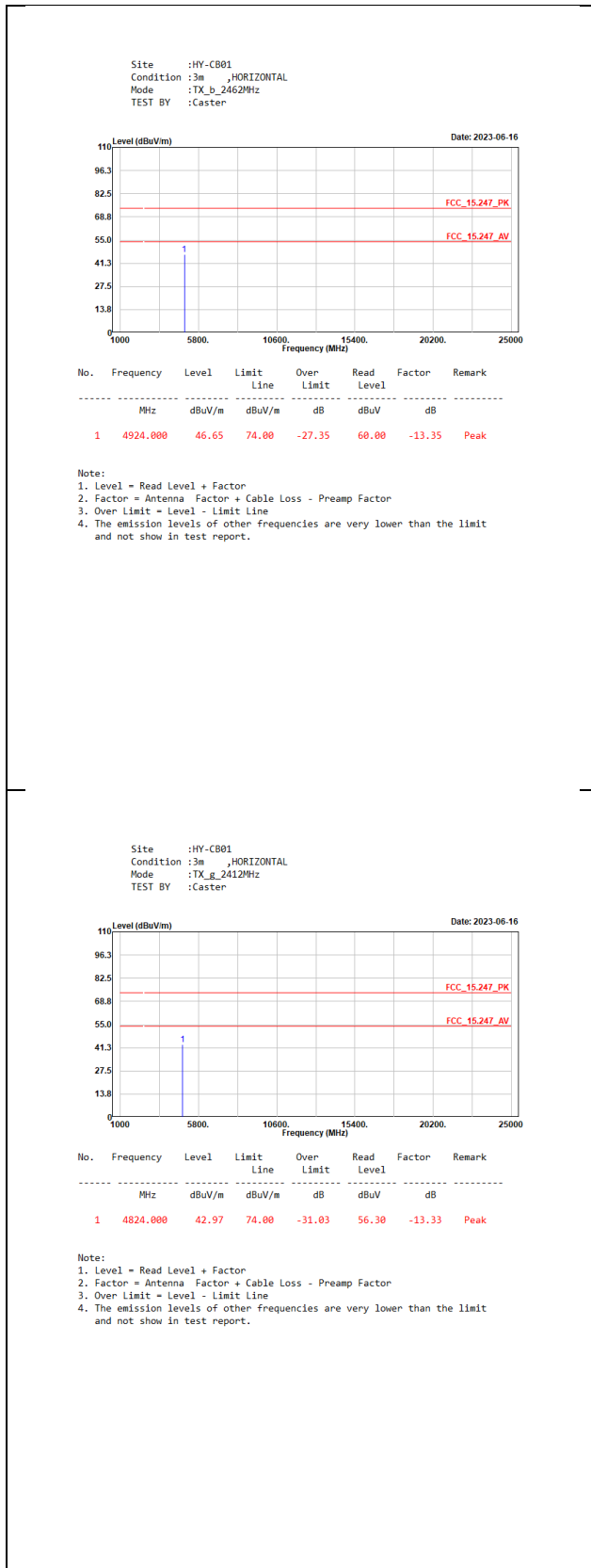

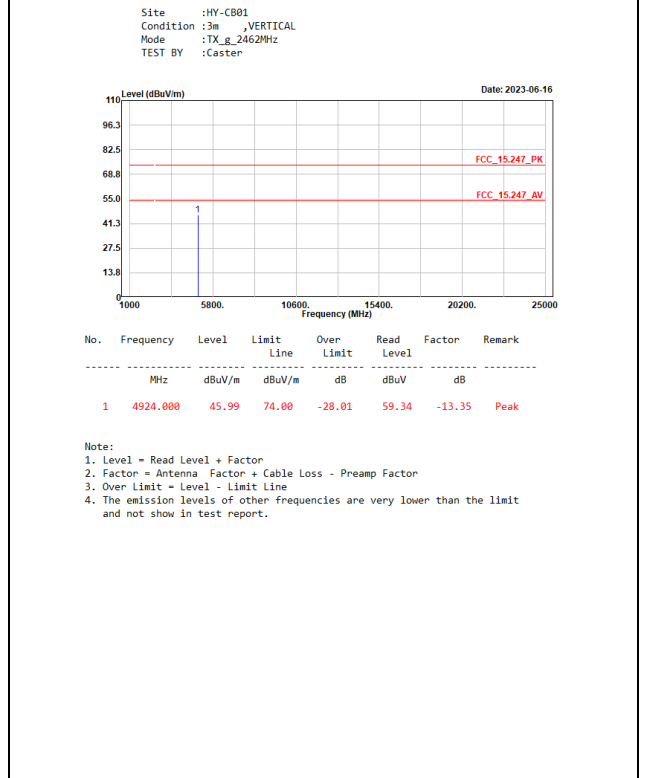
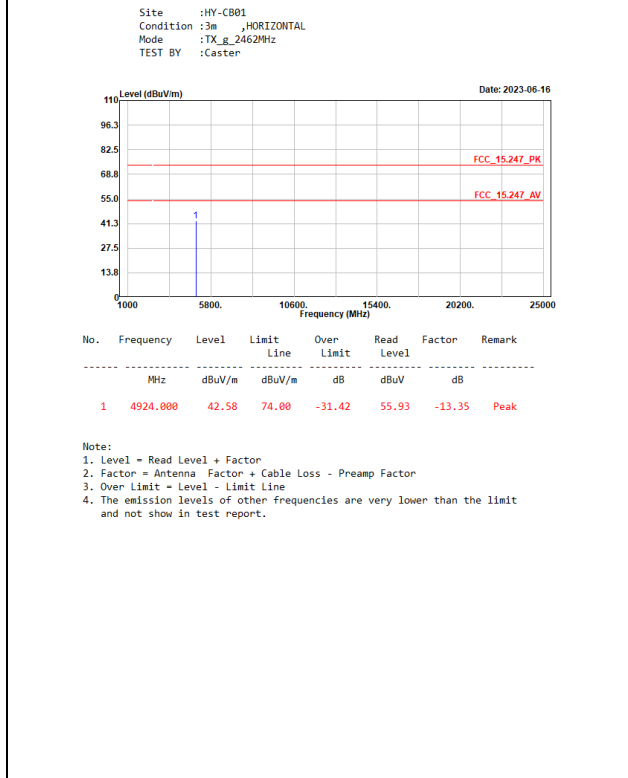
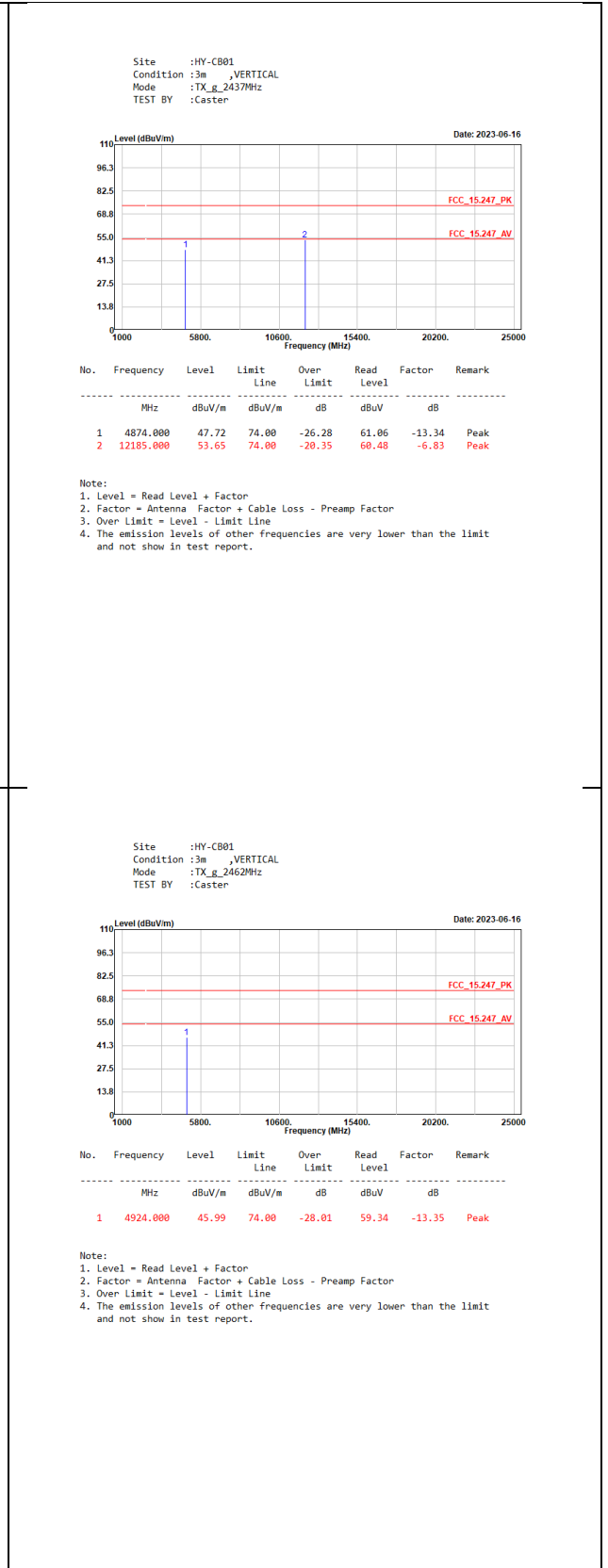
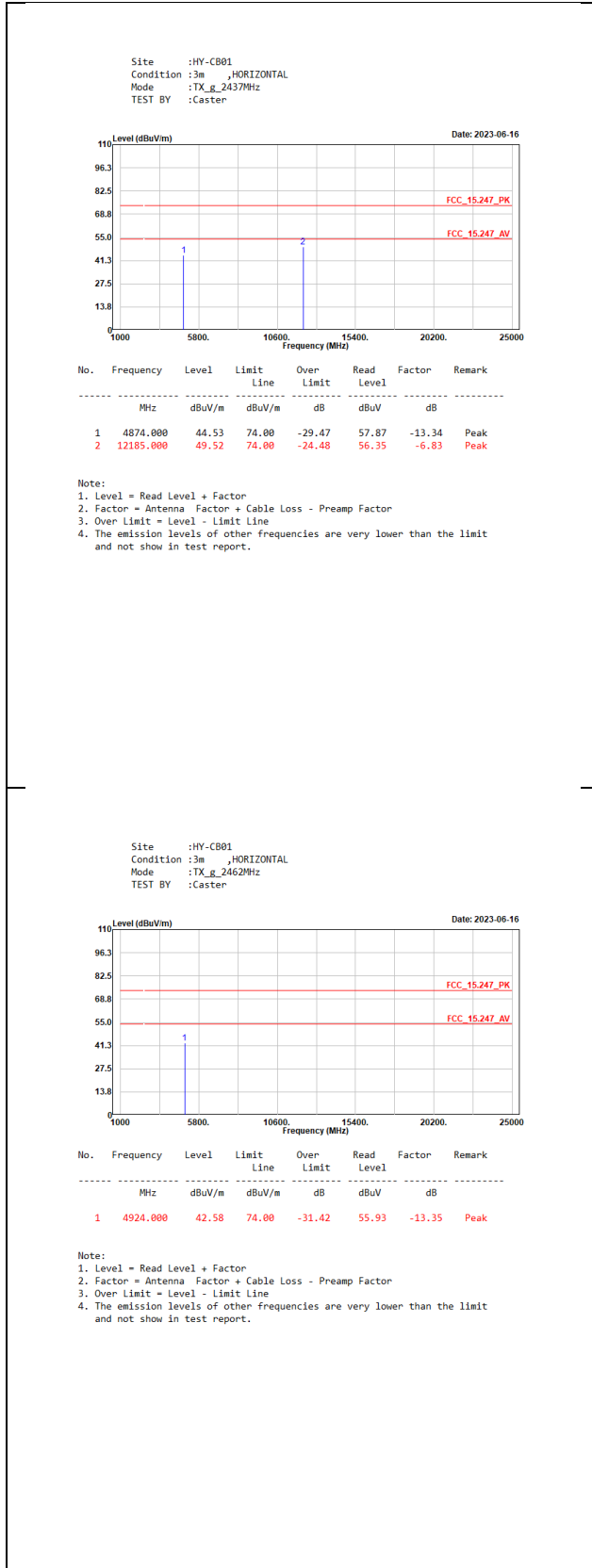

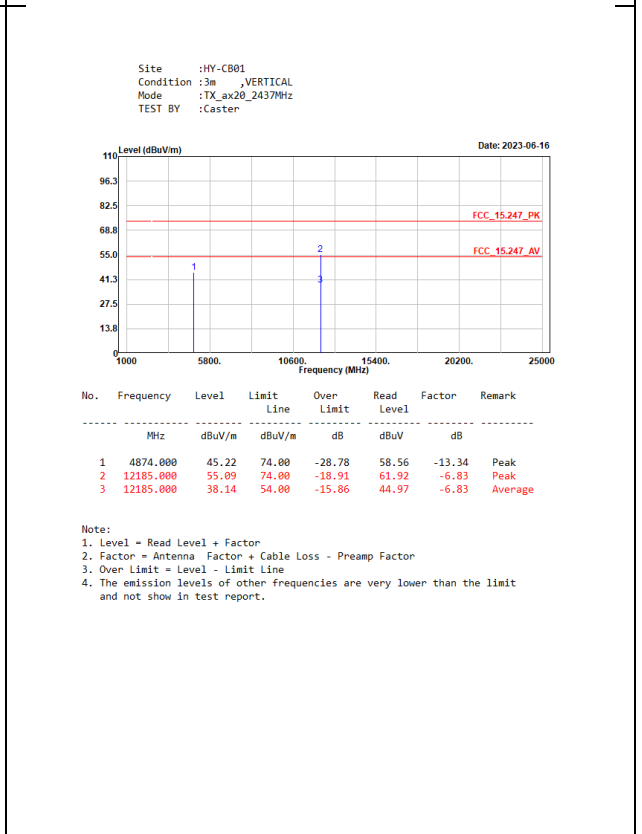
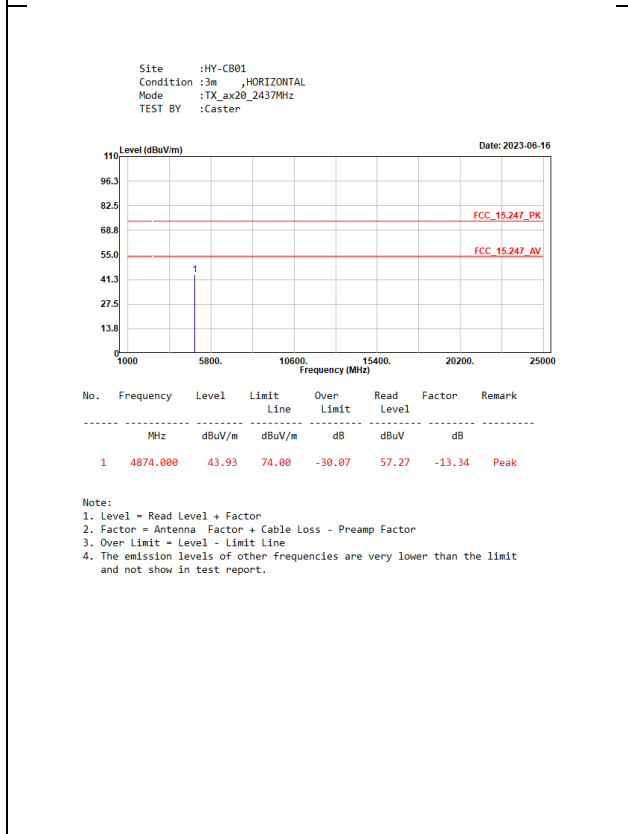
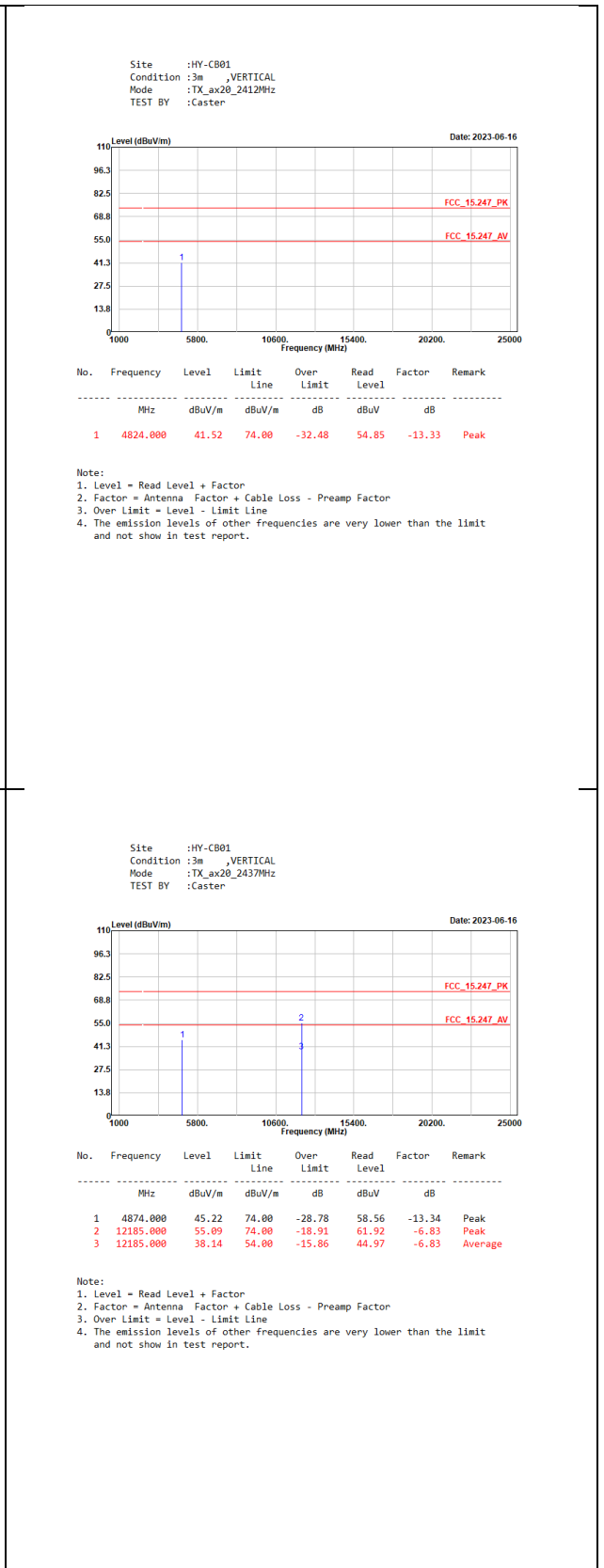
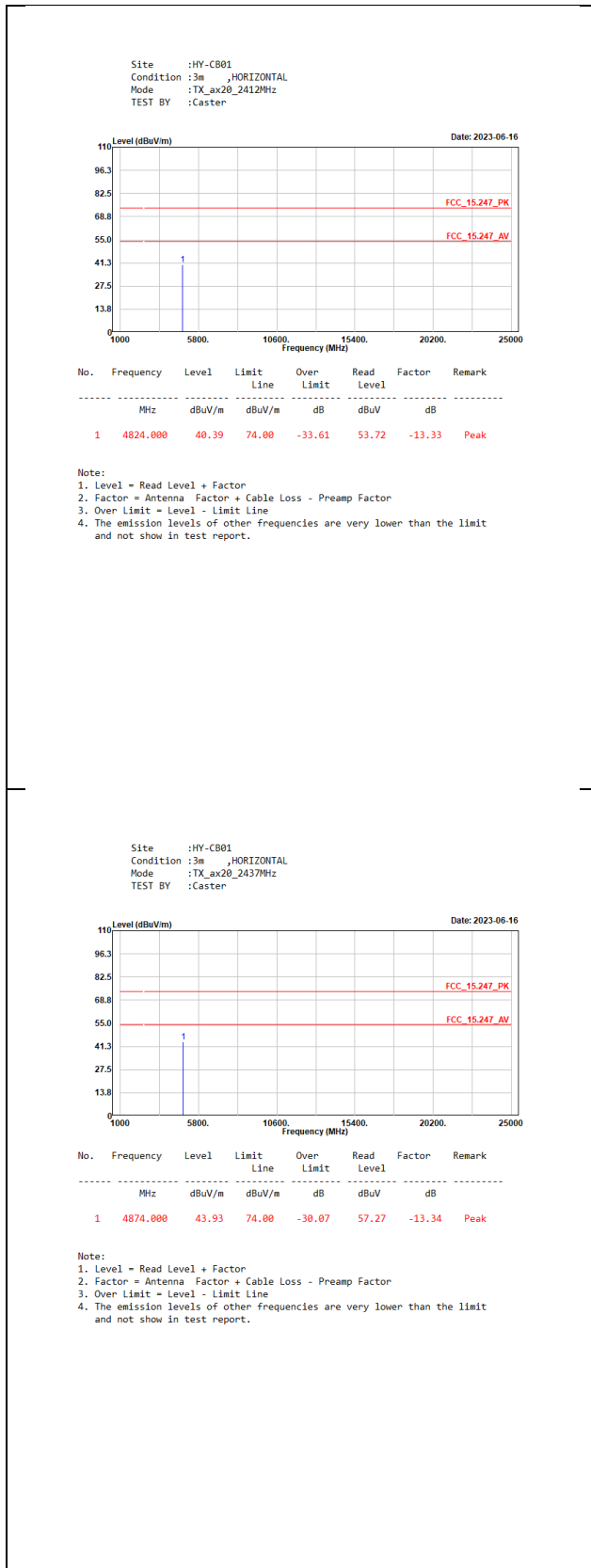

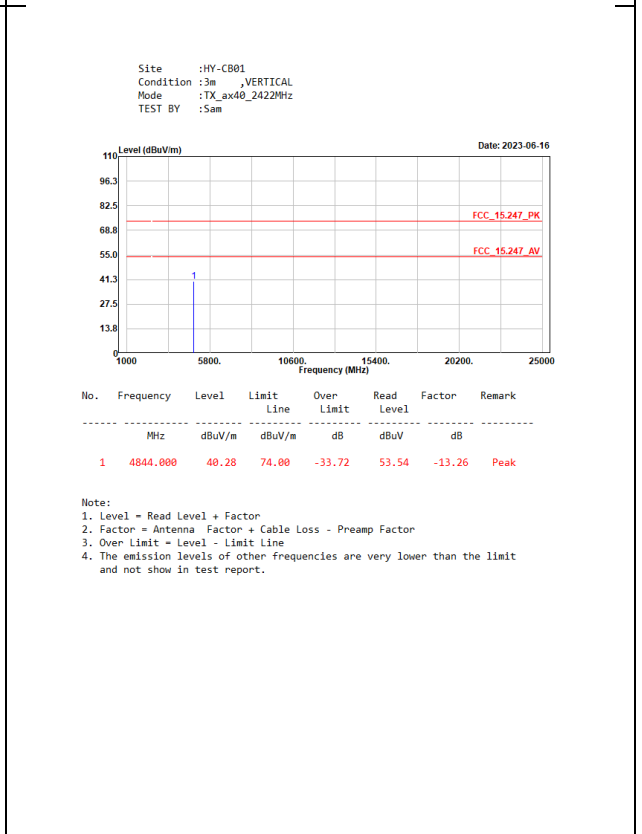
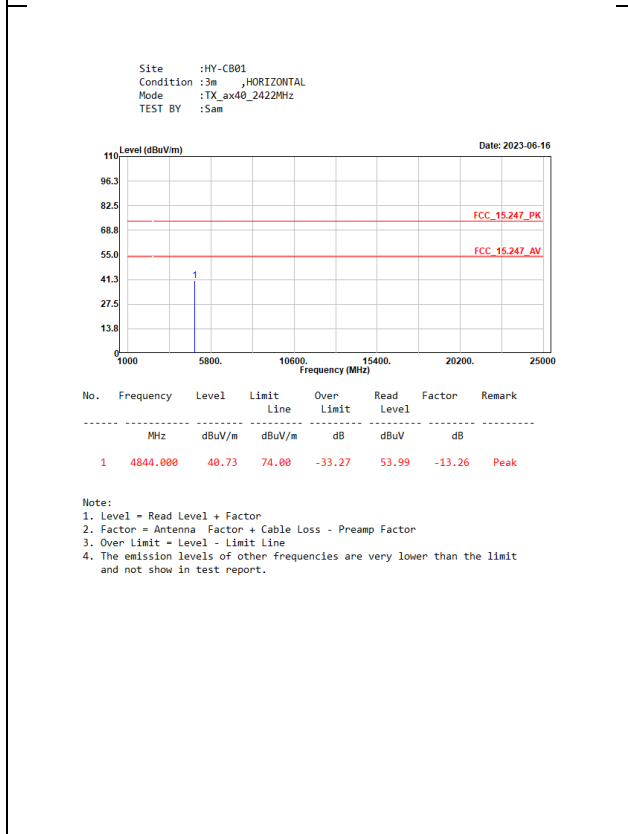
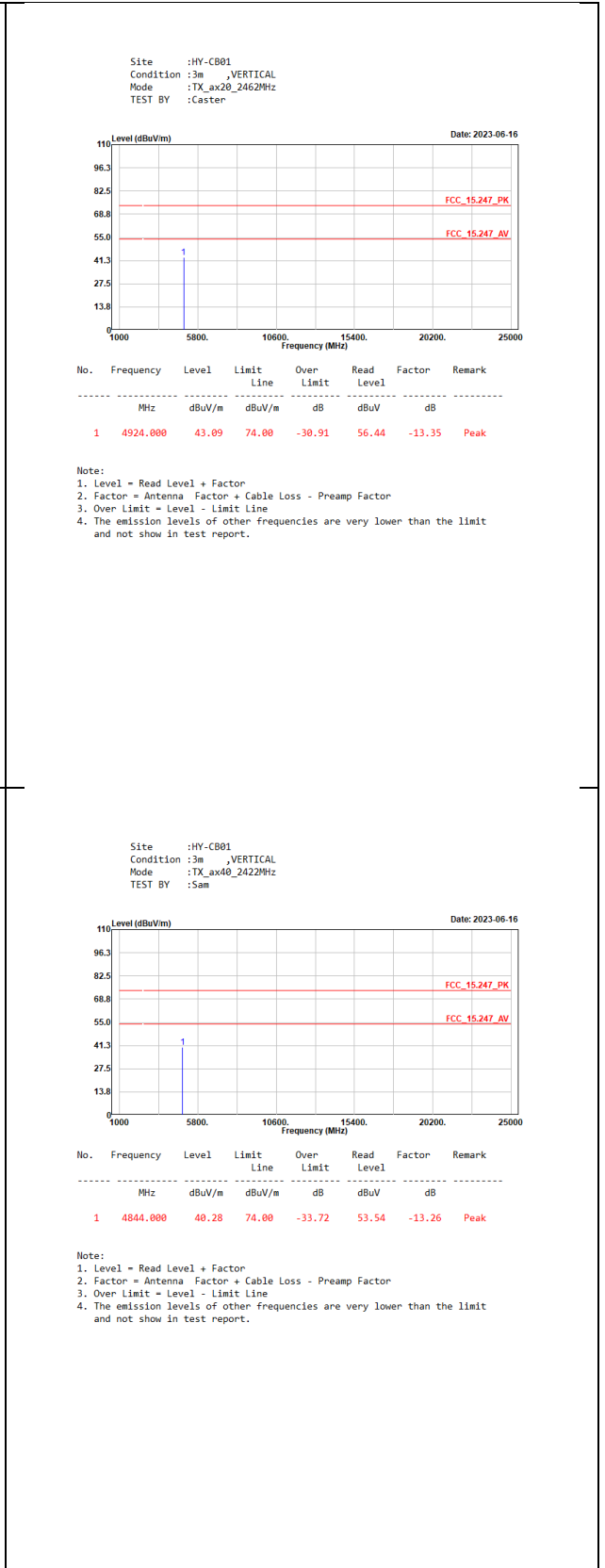
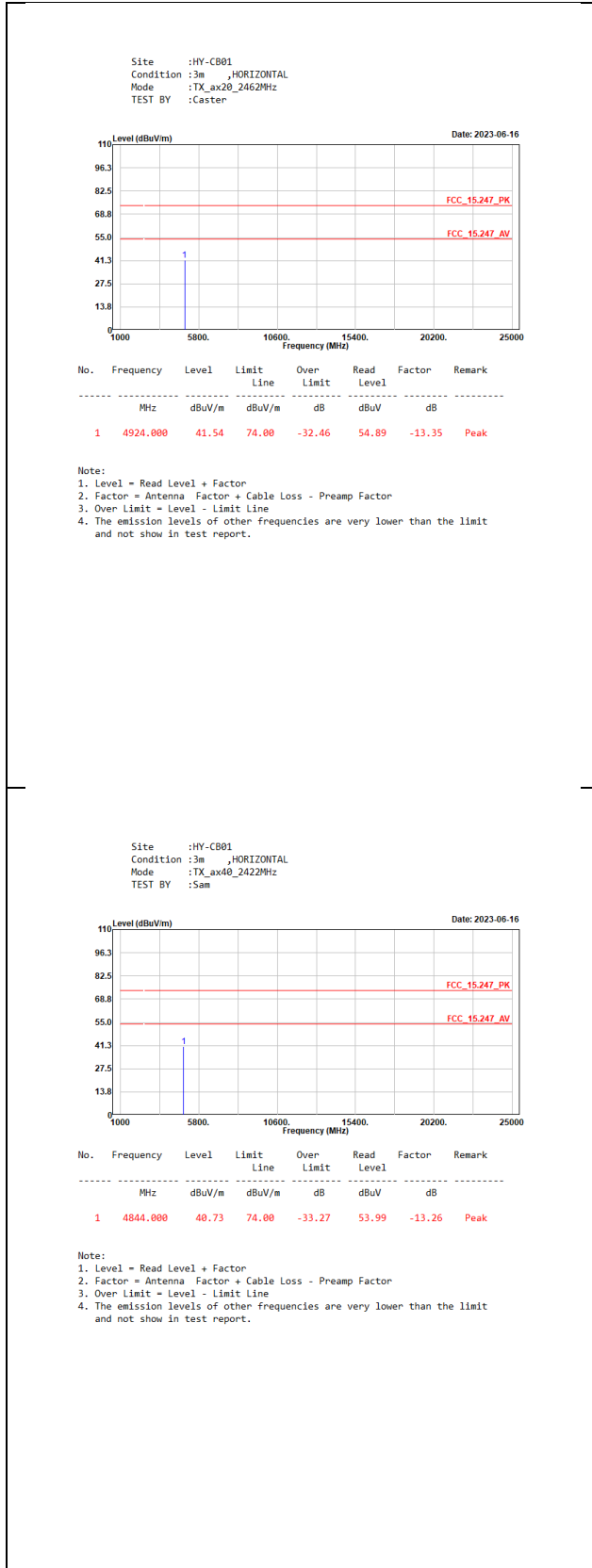

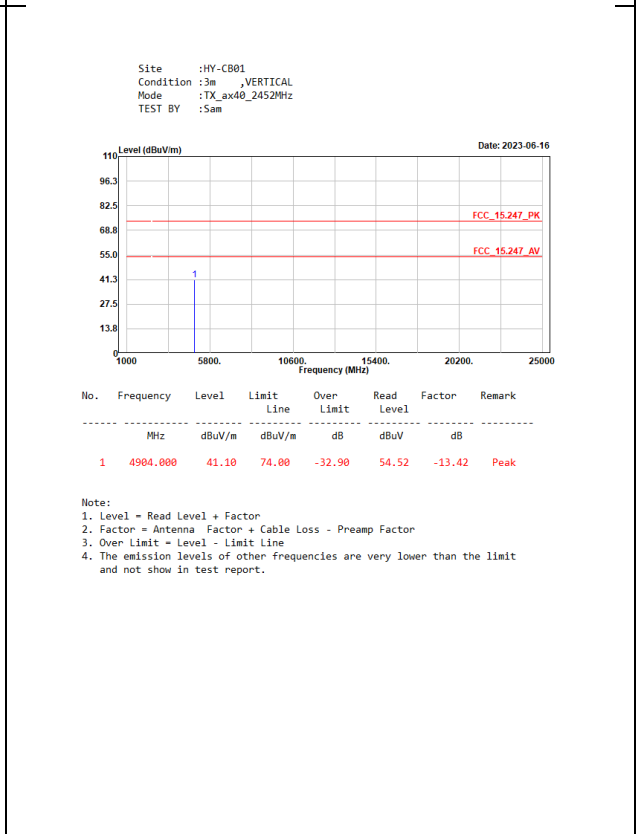
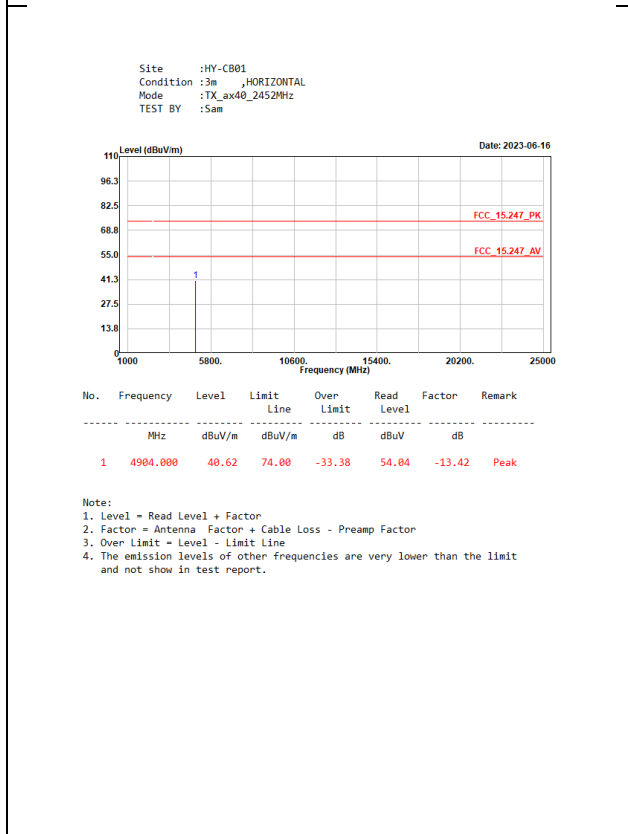
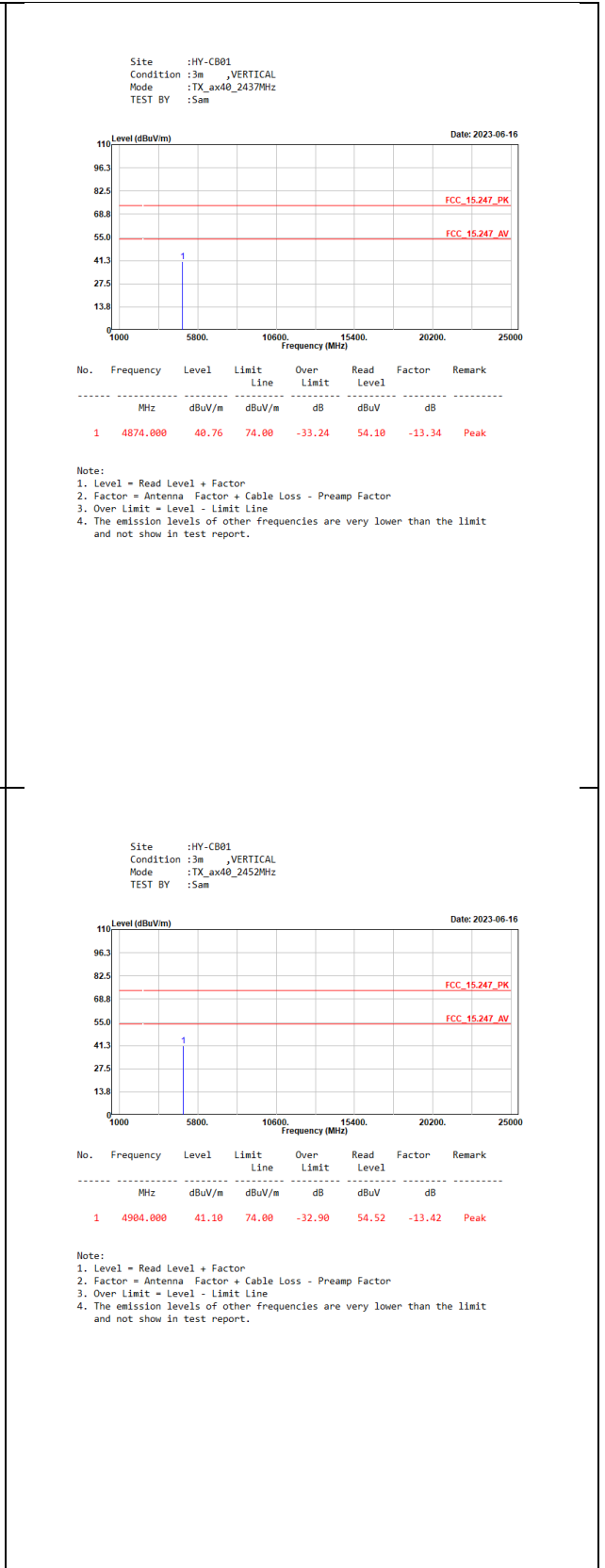
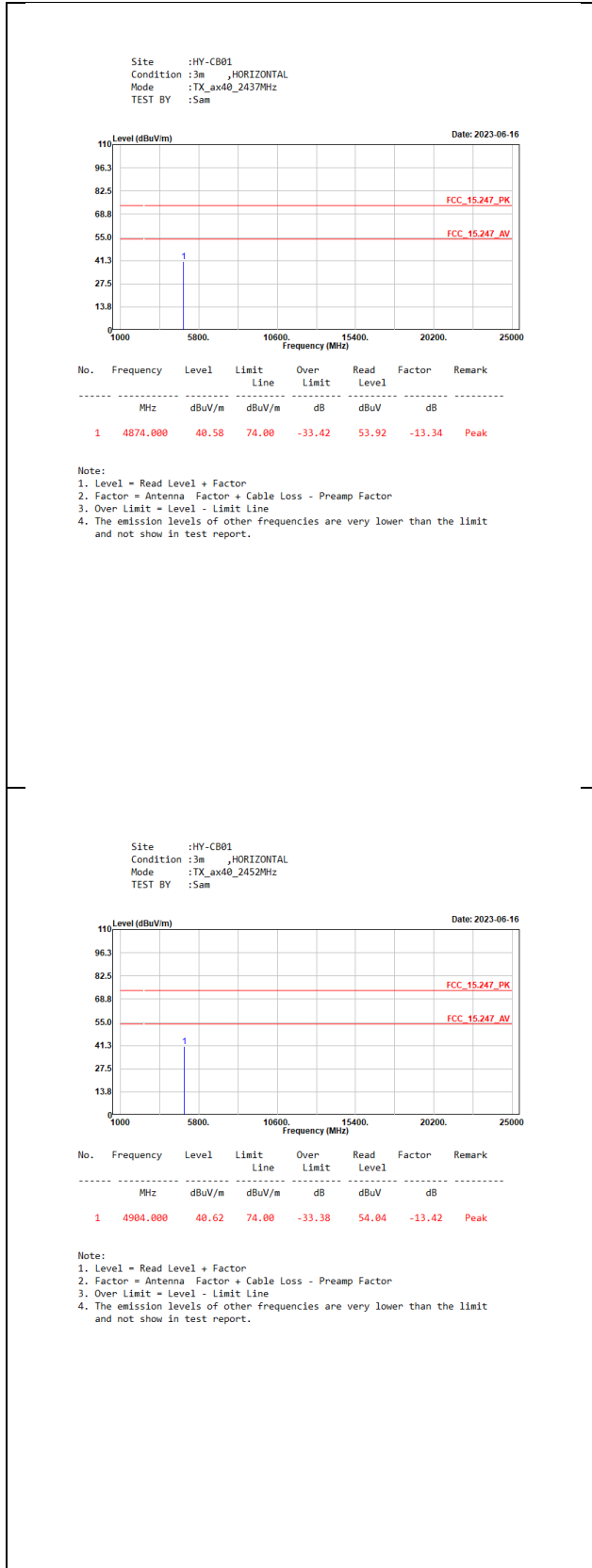



Adapter #1 (M/N: DCT36W120300ZZ-D2)

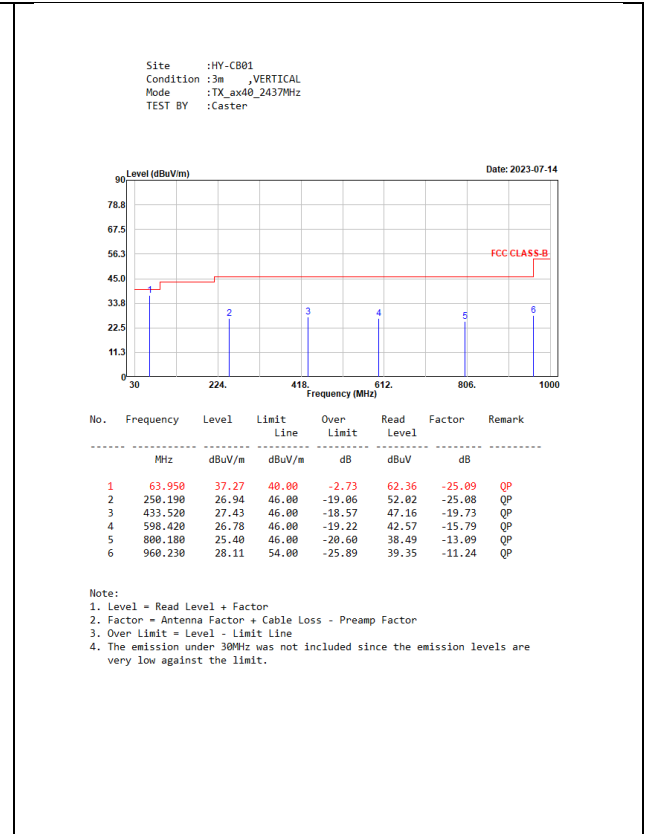
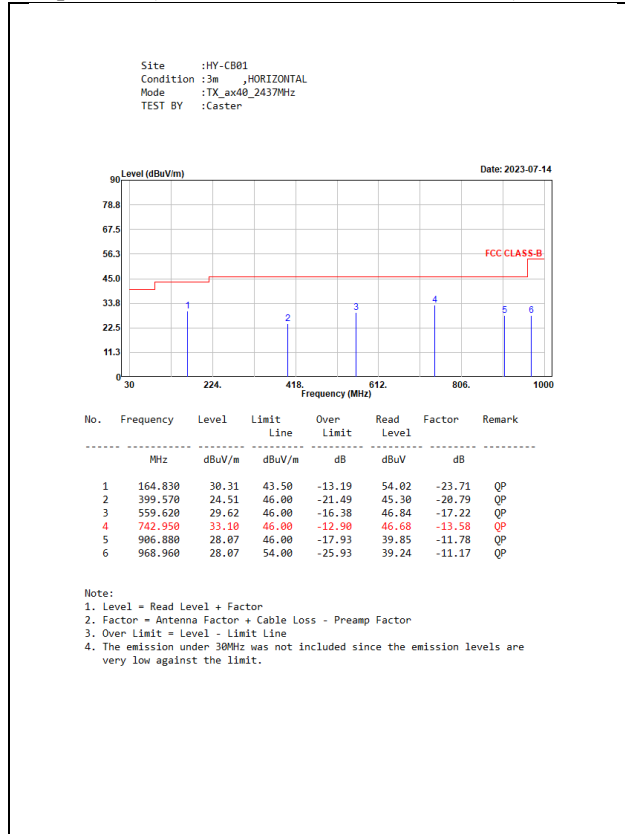

Adapter #2 (M/N: PS36LA120K300UD)

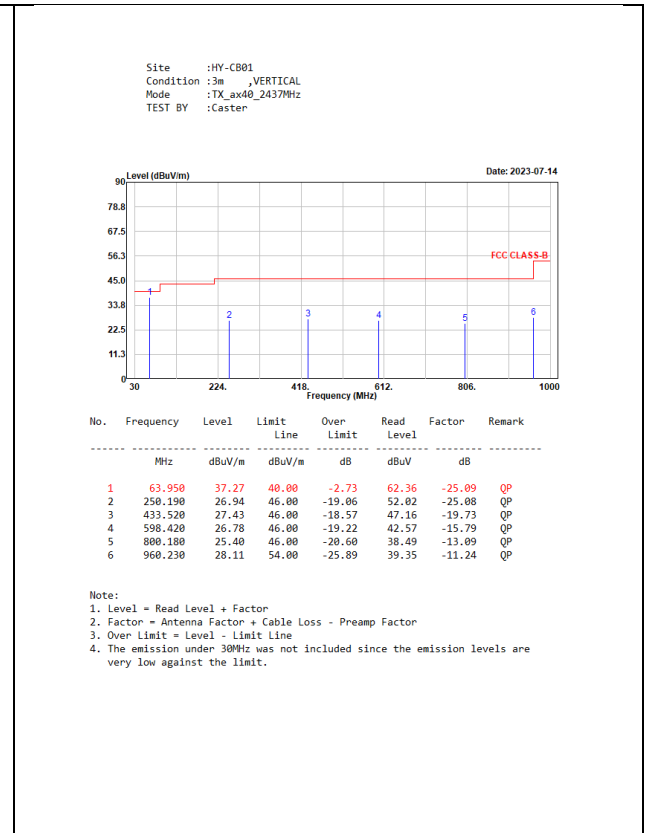
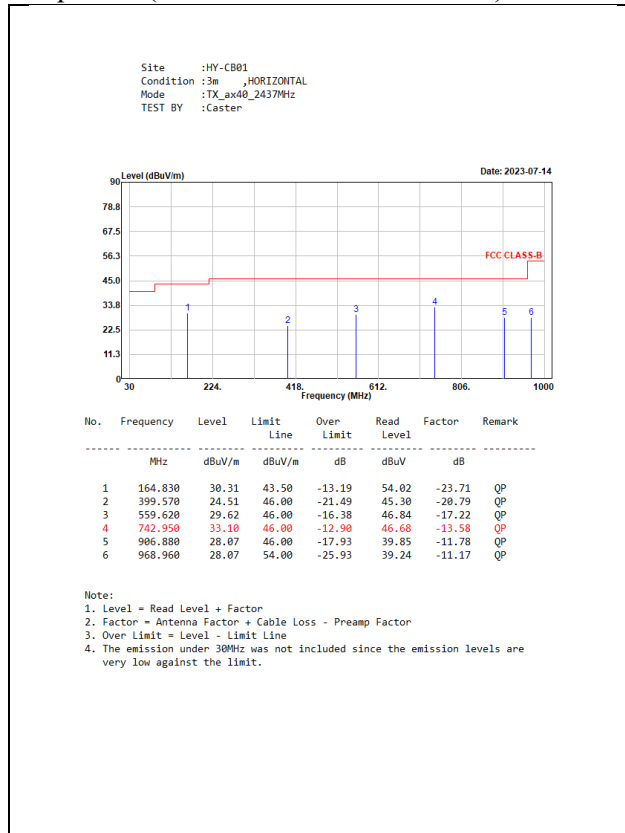

Test Result of Radiated Emission co-location

Site :HY-CB01  
 Condition :3m ,HORIZONTAL  
 Mode :TX\_11b\_2437M+11ax20\_5220M+ble2m 2402M+5G NR N77  
 TEST BY :Caster

Date: 2023-07-17

No.	Frequency	Level	Limit	Over	Read	Factor	Remark
	MHz	dBuV/m	dBuV/m	dB	dBuV	dB	
1	4804.000	41.27	74.00	-32.73	54.82	-13.55	Peak
2	4874.000	38.34	74.00	-35.66	51.68	-13.34	Peak
3	7500.000	45.35	74.00	-28.65	54.56	-9.21	Peak
4	10440.000	49.72	74.00	-24.28	58.70	-8.98	Peak

Note:  
 1. Level = Read Level + Factor  
 2. Factor = Antenna Factor + Cable Loss - Preamp Factor  
 3. Over Limit = Level - Limit Line  
 4. The emission levels of other frequencies are very lower than the limit and not show in test report.

Site :HY-CB01  
 Condition :3m ,VERTICAL  
 Mode :TX\_11b\_2437M+11ax20\_5220M+ble2m 2402M+5G NR N77  
 TEST BY :Caster

Date: 2023-07-17

No.	Frequency	Level	Limit	Over	Read	Factor	Remark
	MHz	dBuV/m	dBuV/m	dB	dBuV	dB	
1	4804.000	41.87	74.00	-32.13	55.42	-13.55	Peak
2	4874.000	39.44	74.00	-34.56	52.78	-13.34	Peak
3	7500.000	45.14	74.00	-28.86	54.35	-9.21	Peak
4	10440.000	49.27	74.00	-24.73	58.25	-8.98	Peak

Note:  
 1. Level = Read Level + Factor  
 2. Factor = Antenna Factor + Cable Loss - Preamp Factor  
 3. Over Limit = Level - Limit Line  
 4. The emission levels of other frequencies are very lower than the limit and not show in test report.

Site :HY-CB01  
 Condition :3m ,HORIZONTAL  
 Mode :TX\_11b\_2437M+11ax20\_5220M+ble2m 2402M+LTE B38  
 TEST BY :Caster

Date: 2023-07-17

No.	Frequency	Level	Limit	Over	Read	Factor	Remark
	MHz	dBuV/m	dBuV/m	dB	dBuV	dB	
1	4804.000	44.22	74.00	-29.78	57.77	-13.55	Peak
2	4874.000	38.76	74.00	-35.24	52.10	-13.34	Peak
3	5200.000	39.69	74.00	-34.31	52.85	-13.16	Peak
4	10440.000	47.18	74.00	-26.82	56.16	-8.98	Peak
5	12185.000	57.60	74.00	-16.40	64.43	-6.83	Peak
6	12185.000	50.53	54.00	-3.47	57.36	-6.83	Average

Note:  
 1. Level = Read Level + Factor  
 2. Factor = Antenna Factor + Cable Loss - Preamp Factor  
 3. Over Limit = Level - Limit Line  
 4. The emission levels of other frequencies are very lower than the limit and not show in test report.

Site :HY-CB01  
 Condition :3m ,VERTICAL  
 Mode :TX\_11b\_2437M+11ax20\_5220M+ble2m 2402M+LTE B38  
 TEST BY :Caster

Date: 2023-07-17

No.	Frequency	Level	Limit	Over	Read	Factor	Remark
	MHz	dBuV/m	dBuV/m	dB	dBuV	dB	
1	4804.000	45.54	74.00	-28.46	59.09	-13.55	Peak
2	4874.000	41.56	74.00	-32.44	54.90	-13.34	Peak
3	5200.000	39.94	74.00	-34.06	53.10	-13.16	Peak
4	10440.000	48.22	74.00	-25.78	57.20	-8.98	Peak
5	12185.000	58.95	74.00	-15.05	65.78	-6.83	Peak
6	12185.000	52.41	54.00	-1.59	59.24	-6.83	Average

Note:  
 1. Level = Read Level + Factor  
 2. Factor = Antenna Factor + Cable Loss - Preamp Factor  
 3. Over Limit = Level - Limit Line  
 4. The emission levels of other frequencies are very lower than the limit and not show in test report.

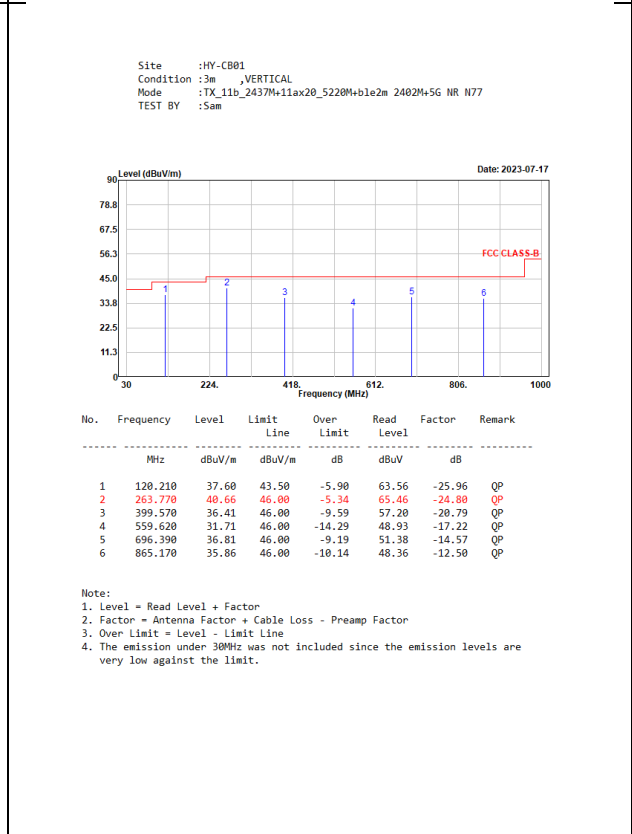
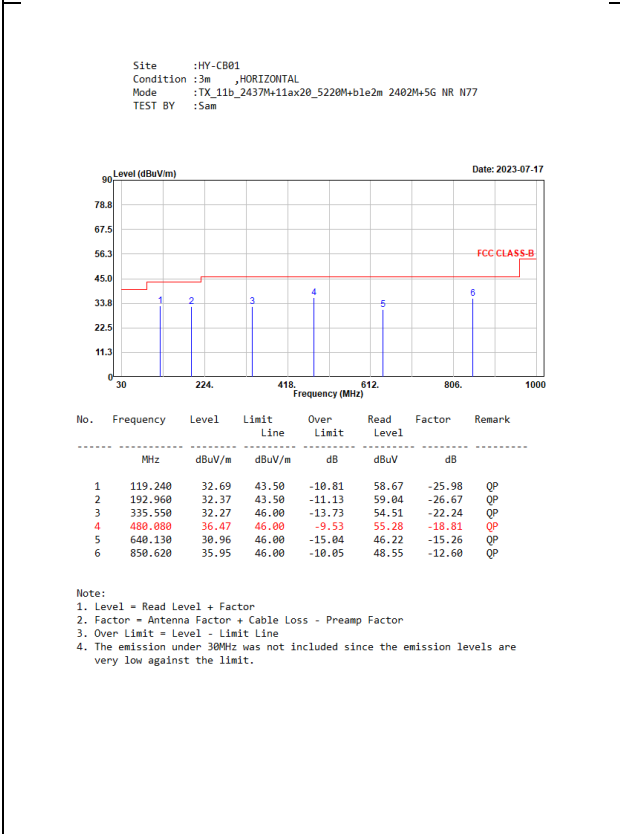
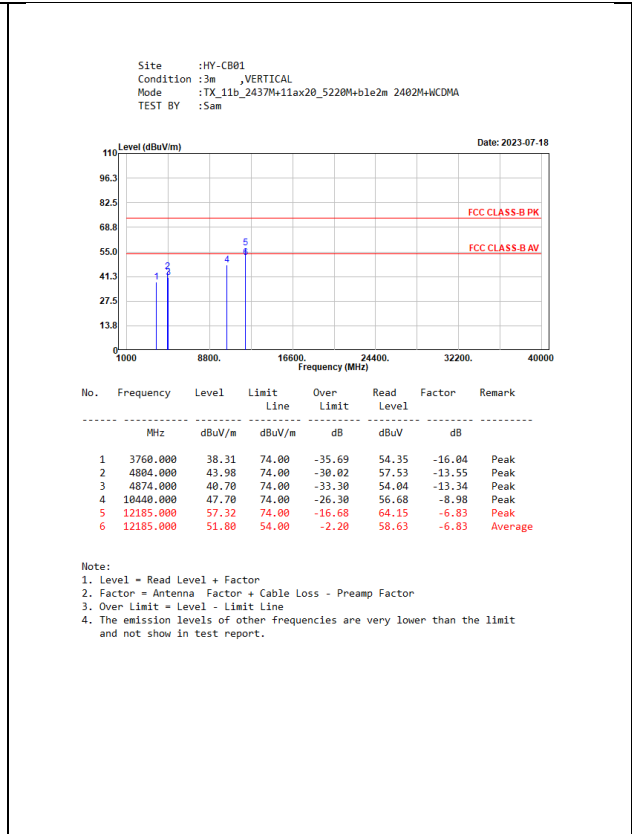
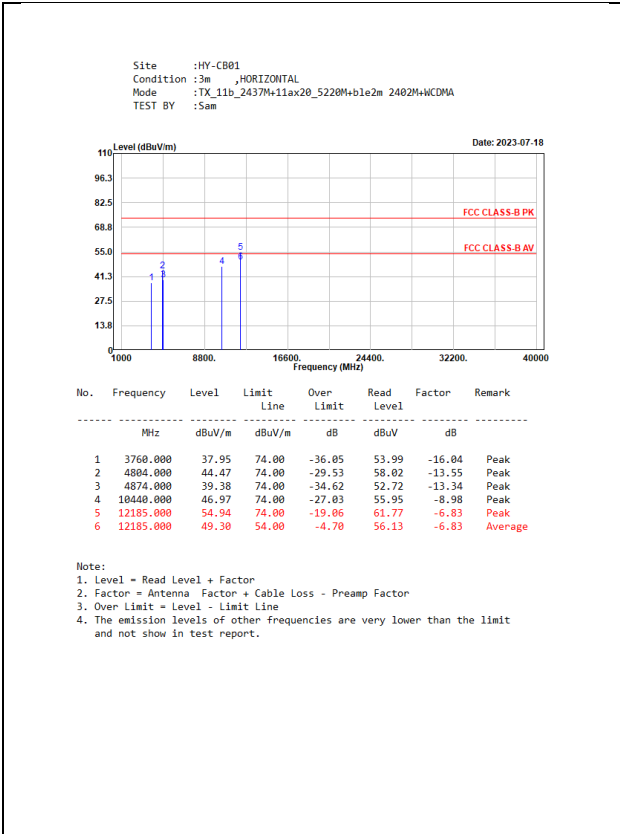

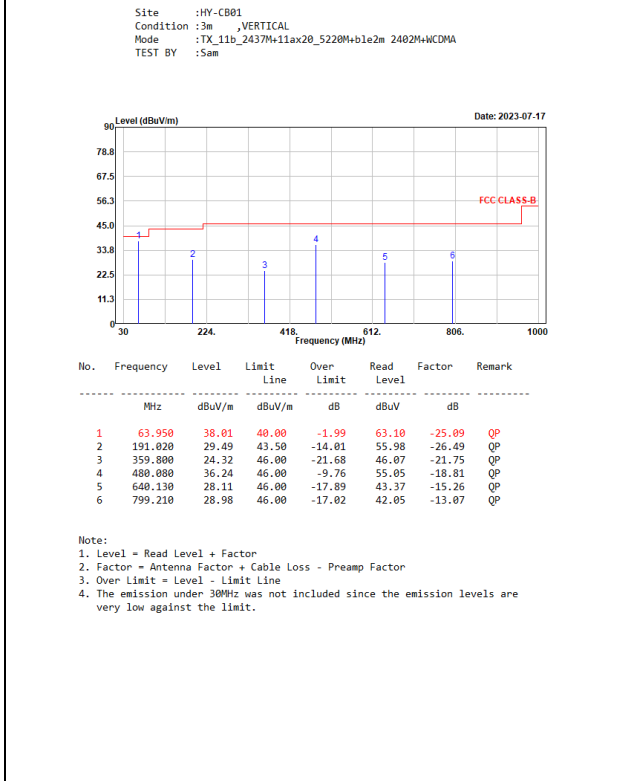
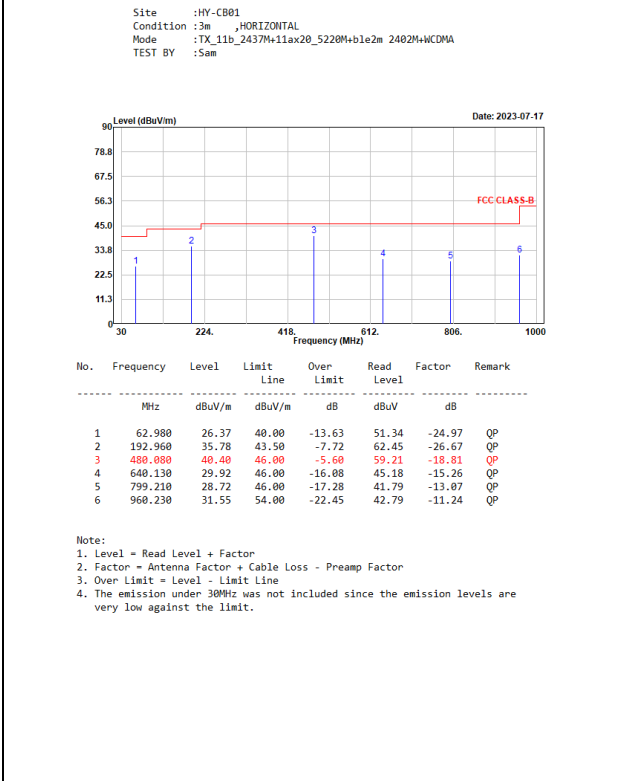
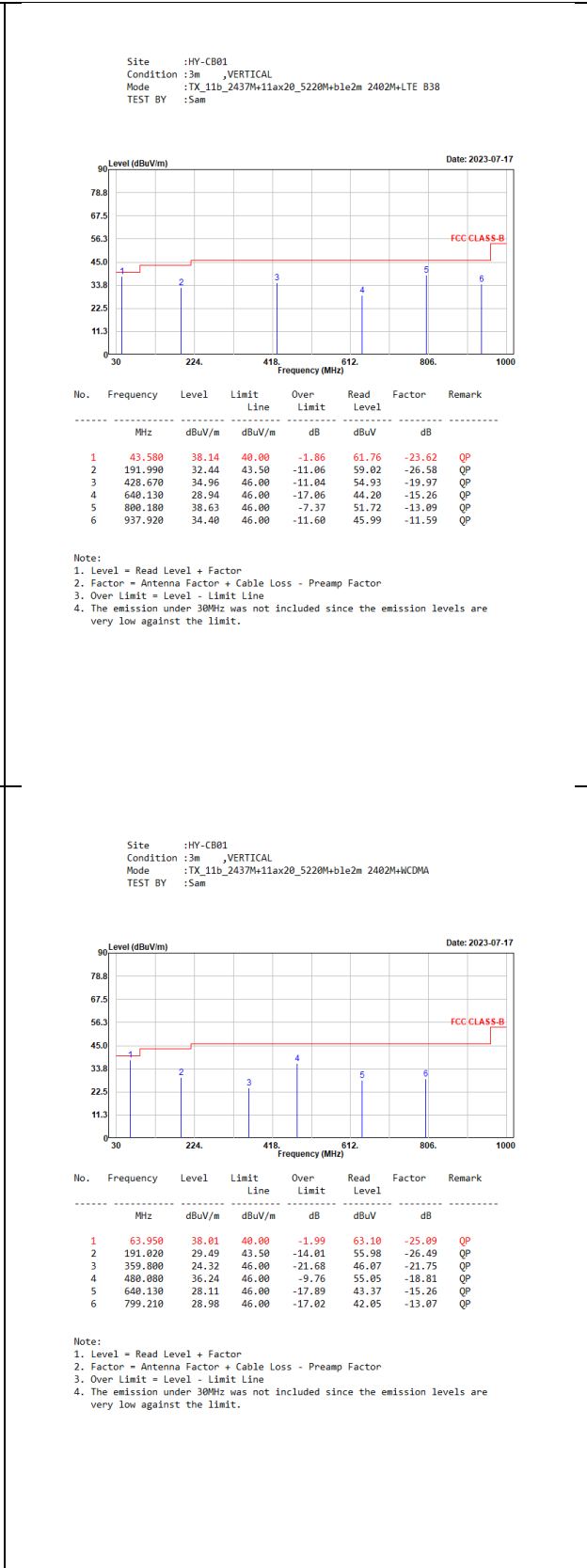
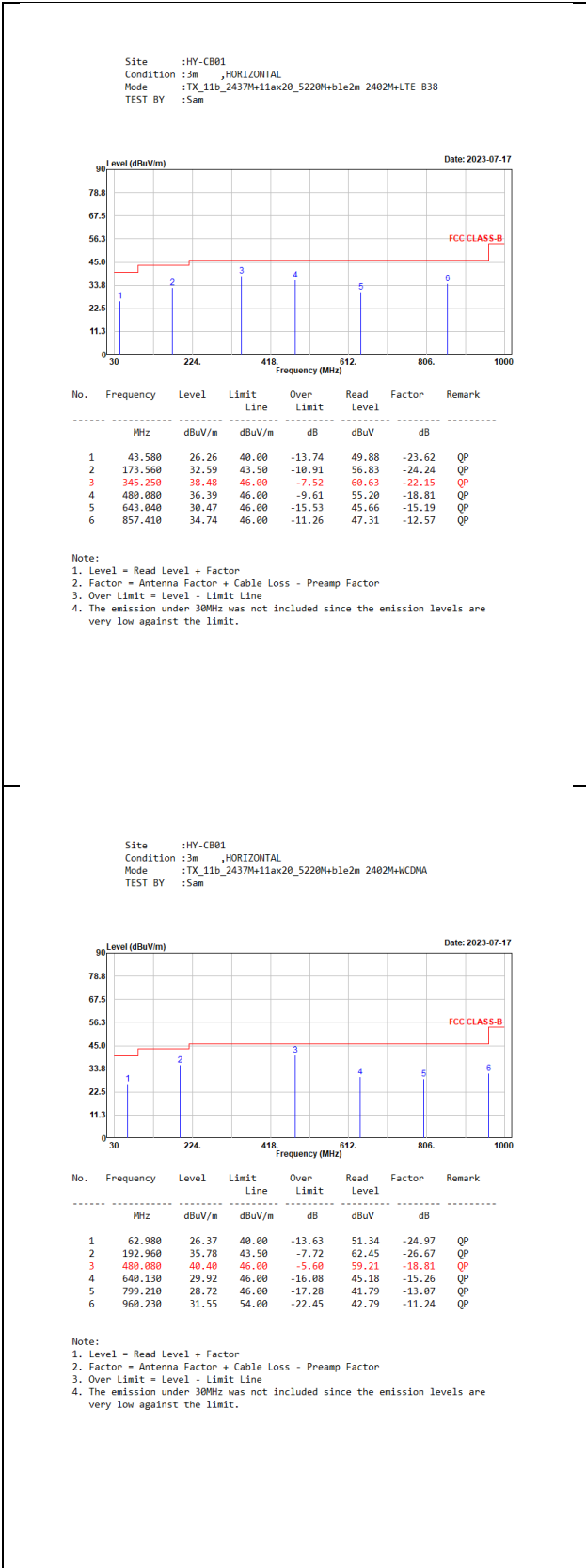

## 5. RF Antenna Conducted Test

### 5.1. Test Setup

RF antenna Conducted Measurement:

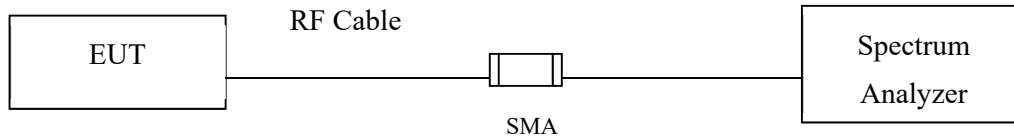

### 5.2. Limits

In any 100 kHz bandwidth outside the frequency band in which the spread spectrum intentional radiator is operating, the radio frequency power that is produced by the intentional radiator shall be at least 20 dB below that in the 100 kHz bandwidth within the band that contains the highest level of the desired power, based on either an RF conducted or a radiated measurement. Attenuation below the general limits specified in Section 15.209(a) is not required. In addition, radiated emissions which fall in the restricted bands, as defined in Section 15.205(a), must also comply with the radiated emission limits specified in Section 15.209(a) (see Section 15.205(c)).

### 5.3. Test Procedure

The EUT was tested according to C63.10:2013 Section 11.11 for compliance to FCC 47CFR 15.247 requirements.

Set RBW = 100 kHz, Set VBW > RBW, scan up through 10th harmonic.

5.4. Test Result of RF Antenna Conducted Test

Product : Peplink Pepwave Wireless Product  
 Test Item : RF antenna conducted test  
 Test Mode : Transmit (802.11b)-CDD  
 Test Date : 2023/06/20

Channel 06 - Chain A

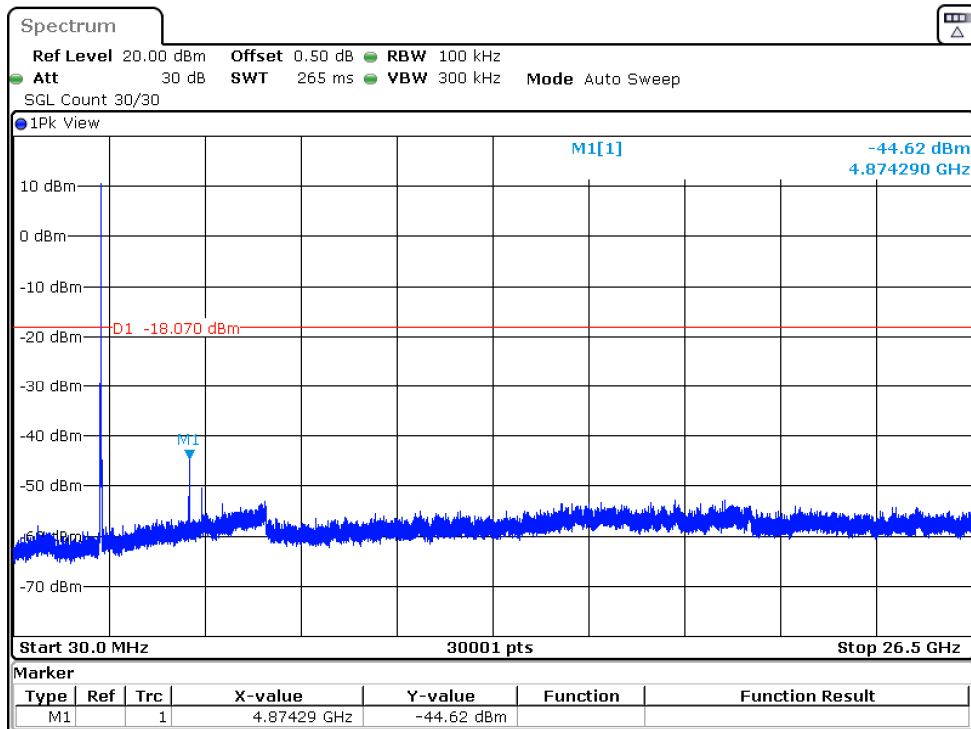

Product : Peplink Pepwave Wireless Product  
 Test Item : RF Antenna Conducted Spurious  
 Test Mode : Transmit (802.11g)-CDD  
 Test Date : 2023/06/20

Channel 06 - Chain B

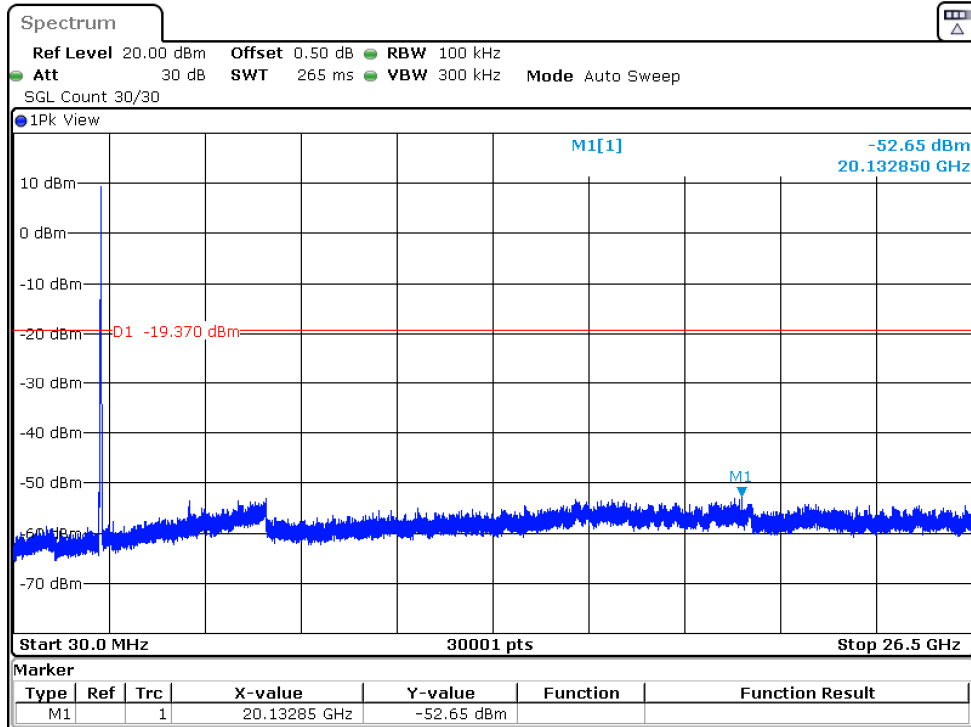

Product : Peplink Pepwave Wireless Product  
 Test Item : RF Antenna Conducted Spurious  
 Test Mode : Transmit (802.11ax-20 MHz)-CDD  
 Test Date : 2023/06/20

Channel 06 - Chain A

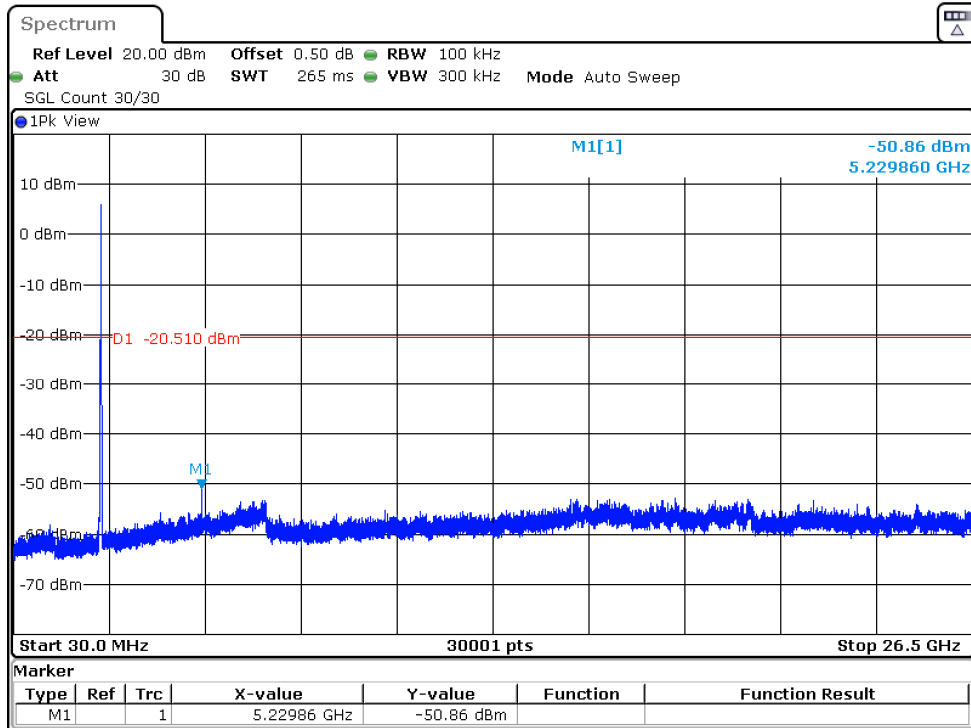



Product : Peplink Pepwave Wireless Product  
 Test Item : RF Antenna Conducted Spurious  
 Test Mode : Transmit (802.11ax-40 MHz)-CDD  
 Test Date : 2023/06/20

Channel 06 - Chain B

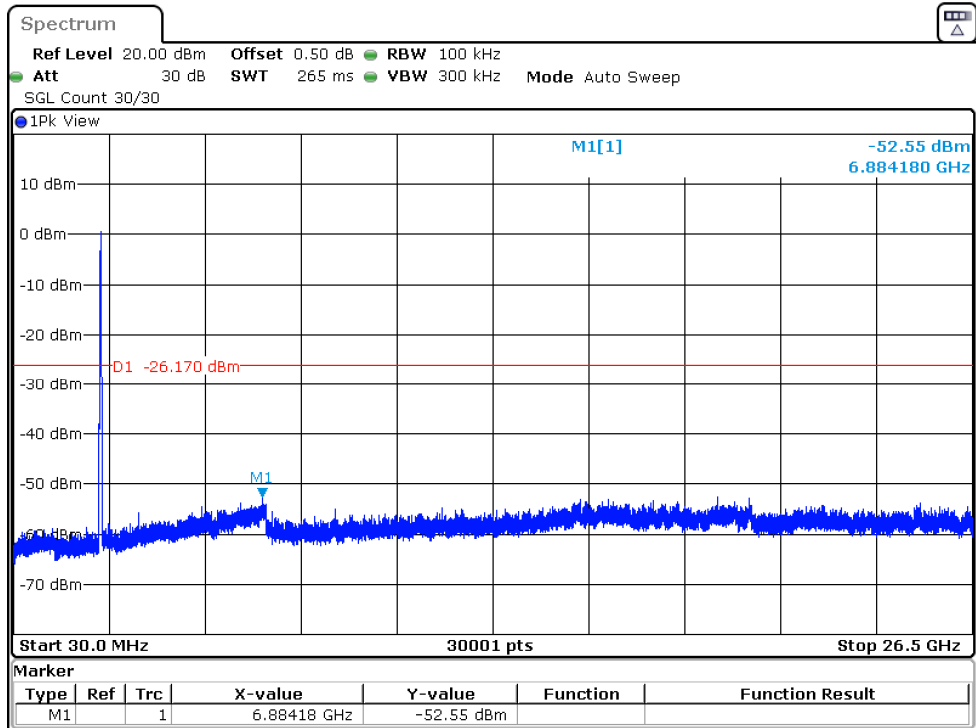

## 6. Band Edge

### 6.1. Test Setup

#### RF Conducted Measurement

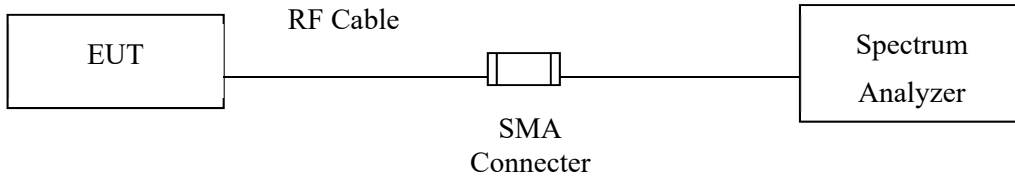

#### RF Radiated Measurement:

##### Above 1 GHz

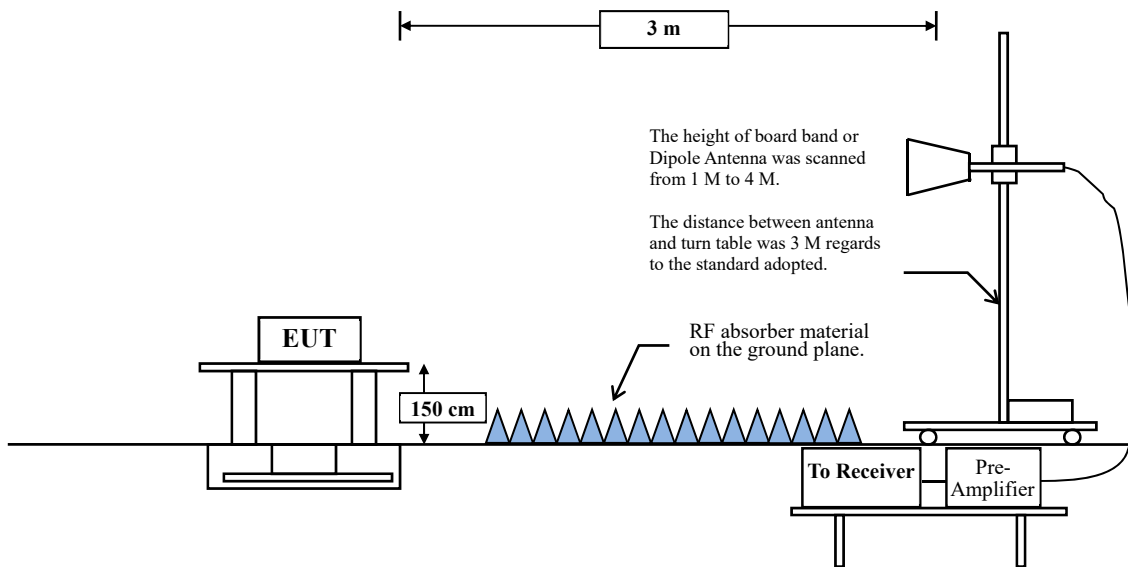

## 6.2. Limits

According to FCC Section 15.247(d). In any 100 kHz bandwidth outside the frequency band in which the spread spectrum or digitally modulated intentional radiator is operating, the radio frequency power that is produced by the intentional radiator shall be at least 20 dB below that in the 100 kHz bandwidth within the band that contains the highest level of the desired power, based on either an RF conducted or measurement, provided the transmitter demonstrates compliance with the peak conducted power limits. If the transmitter complies with the conducted power limits based on the use of RMS averaging over a time interval, the attenuation required under this paragraph shall be 30 dB instead of 20 dB. Attenuation below the general limits specified in Section 15.209(a) is not required. In addition, radiated emissions which fall in the restricted bands, as defined in Section 15.205(a), must also comply with the radiated emission limits specified in Section 15.209(a) (see Section 15.205(c)).

### 6.3. Test Procedure

The EUT was setup according to ANSI C63.10, 2013 and tested according to C63.10:2013 Section 11.12.1 for compliance to FCC 47CFR 15.247 requirements.

The EUT is placed on a turn table which is 1.5 meter above ground. The turn table is rotated 360 degrees to determine the position of the maximum emission level. The EUT was positioned such that the distance from antenna to the EUT was 3 meters.

The antenna is scanned from 1 meter to 4 meters to find out the maximum emission level. This is repeated for both horizontal and vertical polarization of the antenna. In order to find the maximum emission, all of the interface cables were manipulated according to ANSI C63.10:2013 on radiated measurement.

#### **RBW and VBW Parameter setting:**

According to C63.10 Section 11.12.2.4 Peak measurement procedure.

RBW = as specified in Table 1.

VBW  $\geq 3 \times$  RBW.

**Table 1 - RBW as a function of frequency**

Frequency	RBW
9-150 kHz	200-300 Hz
0.15-30 MHz	9-10 kHz
30-1000 MHz	100-120 kHz
> 1000 MHz	1 MHz

According to C63.10 Section 11.12.2.5 Average measurement procedure.

RBW = 1 MHz.

VBW = 10 Hz, when duty cycle  $\geq 98 \%$

VBW  $\geq 1/T$ , when duty cycle  $< 98 \%$

(T refers to the minimum transmission duration over which the transmitter is on and is transmitting at its maximum power control level for the tested mode of operation.)

2.4 GHz band	Duty Cycle (%)	T (ms)	1/T (Hz)	VBW (Hz)
802.11b	80.55	3.2400	1540	2000
802.11g	93.68	1.4342	697	1000
802.11ax-20 MHz	96.07	5.3800	186	200
802.11ax-40 MHz	96.39	5.3400	187	200

Note: Duty Cycle Refer to Section 9.

### 6.4. Test Result of Band Edge

Site :HY-CB01  
Condition :3m ,Horizontal  
Mode :TX\_b\_2412MHz  
TEST BY :Sam

Date: 2023-06-15

No.	Frequency MHz	Level dBuV/m	Limit Line dBuV/m	Over Limit dB	Read Level dBuV	Factor dB	Remark
1	2385.600	42.63	54.00	-11.37	36.94	5.69	Average
2	2411.000	100.49	-----	-----	94.87	5.62	Average

**Note:**  
 1. Level = Read Level + Factor  
 2. Factor = Antenna Factor + Cable Loss - Preamp Factor  
 3. Over Limit = Level - Limit Line  
 4. The emission levels of other frequencies are very lower than the limit and not show in test report.

Site :HY-CB01  
Condition :3m ,Horizontal  
Mode :TX\_b\_2412MHz  
TEST BY :Sam

Date: 2023-06-15

No.	Frequency MHz	Level dBuV/m	Limit Line dBuV/m	Over Limit dB	Read Level dBuV	Factor dB	Remark
1	2386.000	55.74	74.00	-18.26	50.05	5.69	Peak
2	2410.800	106.18	-----	-----	100.56	5.62	Peak

**Note:**  
 1. Level = Read Level + Factor  
 2. Factor = Antenna Factor + Cable Loss - Preamp Factor  
 3. Over Limit = Level - Limit Line  
 4. The emission levels of other frequencies are very lower than the limit and not show in test report.

Site :HY-CB01  
Condition :3m ,Vertical  
Mode :TX\_b\_2412MHz  
TEST BY :Sam

Date: 2023-06-15

No.	Frequency MHz	Level dBuV/m	Limit Line dBuV/m	Over Limit dB	Read Level dBuV	Factor dB	Remark
1	2387.200	52.76	54.00	-1.24	47.08	5.68	Average
2	2411.200	113.52	-----	-----	107.90	5.62	Average

**Note:**  
 1. Level = Read Level + Factor  
 2. Factor = Antenna Factor + Cable Loss - Preamp Factor  
 3. Over Limit = Level - Limit Line  
 4. The emission levels of other frequencies are very lower than the limit and not show in test report.

Site :HY-CB01  
Condition :3m ,Vertical  
Mode :TX\_b\_2412MHz  
TEST BY :Sam

Date: 2023-06-15

No.	Frequency MHz	Level dBuV/m	Limit Line dBuV/m	Over Limit dB	Read Level dBuV	Factor dB	Remark
1	2388.600	61.36	74.00	-12.64	55.68	5.68	Peak
2	2410.800	119.63	-----	-----	114.01	5.62	Peak

**Note:**  
 1. Level = Read Level + Factor  
 2. Factor = Antenna Factor + Cable Loss - Preamp Factor  
 3. Over Limit = Level - Limit Line  
 4. The emission levels of other frequencies are very lower than the limit and not show in test report.

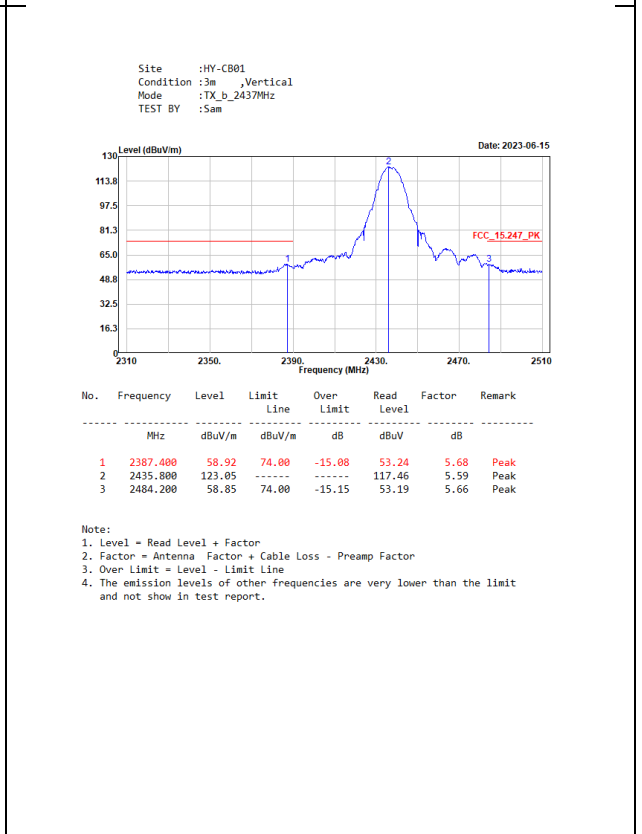
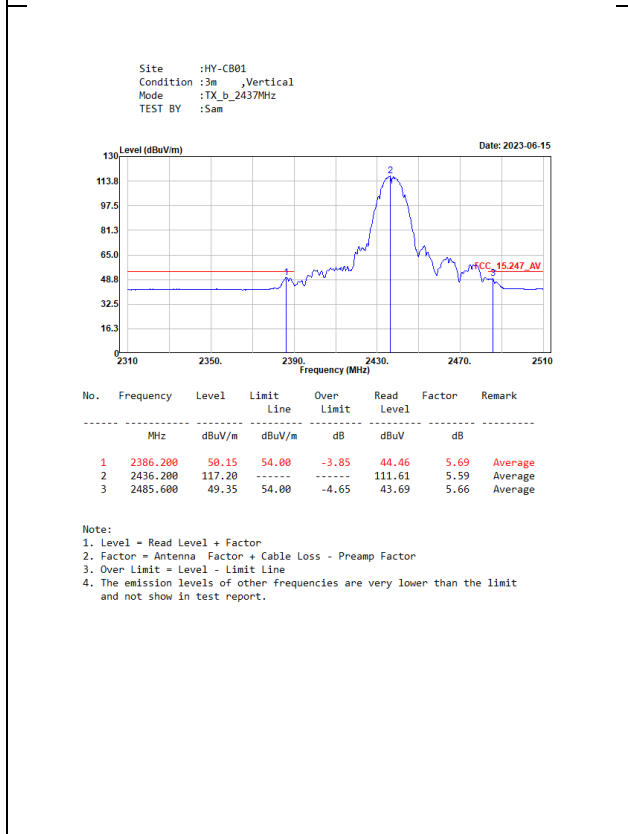
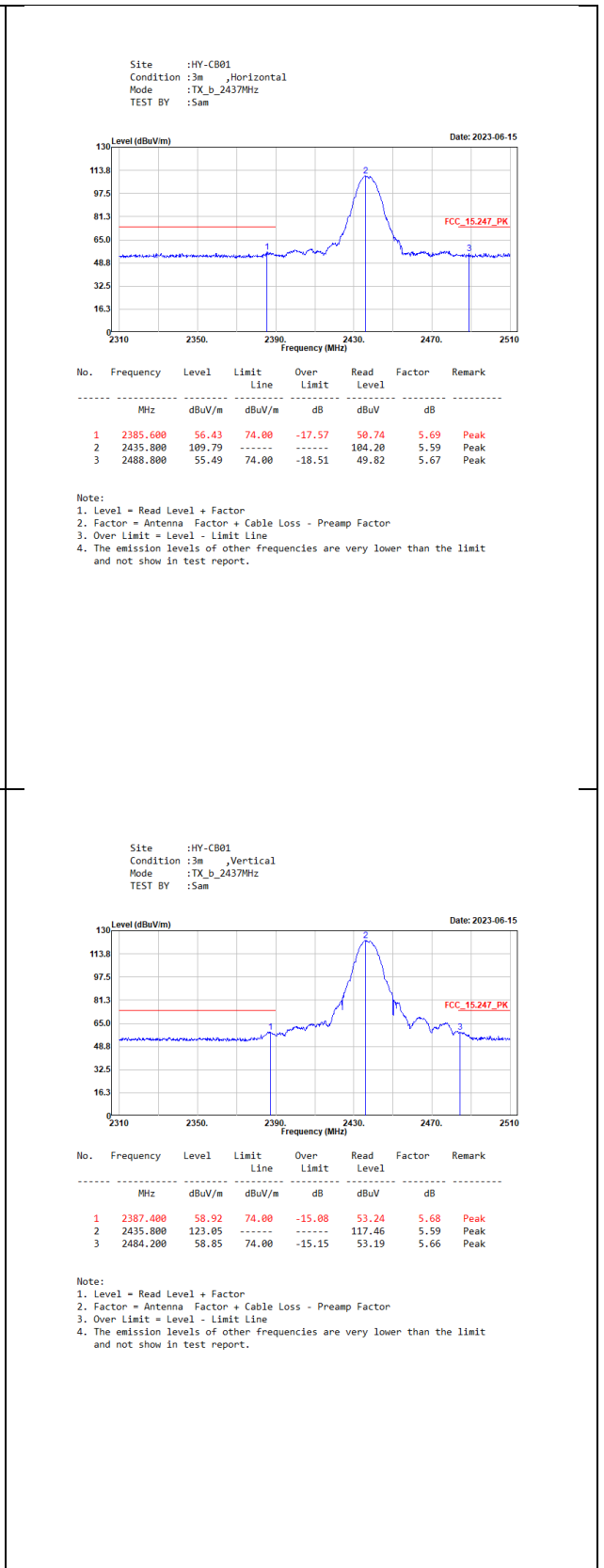
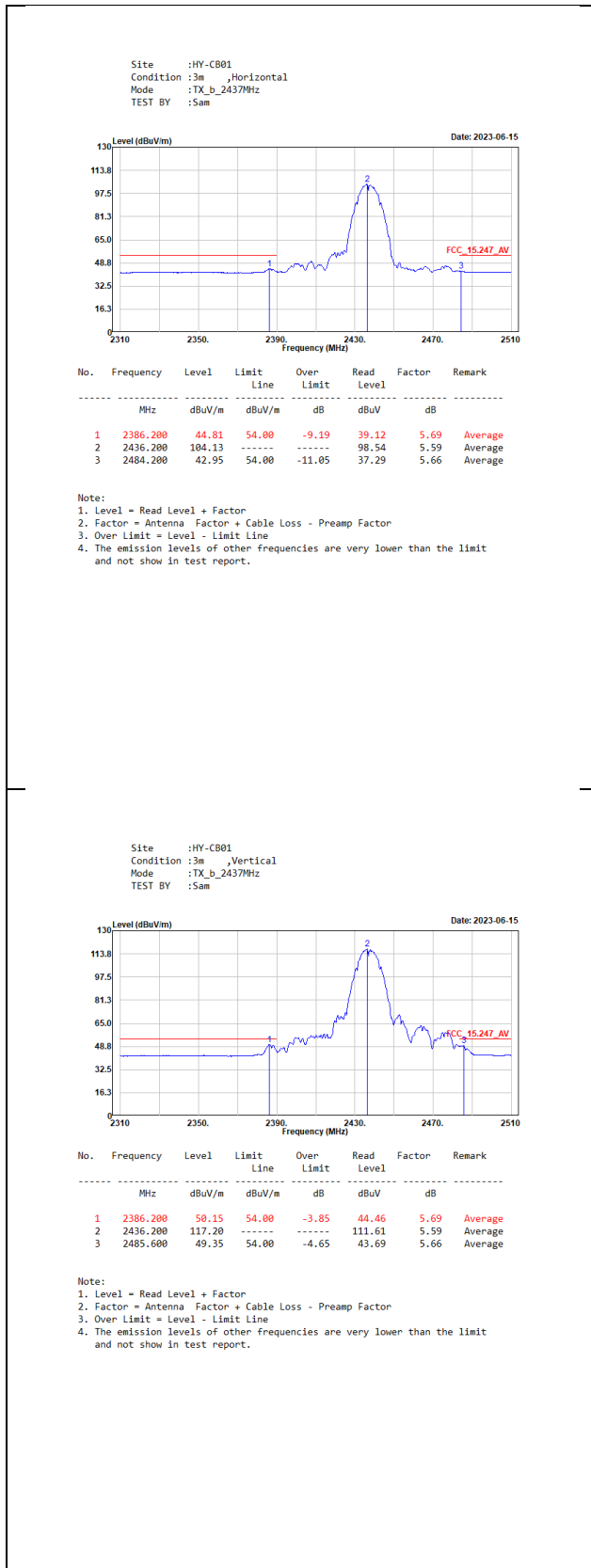

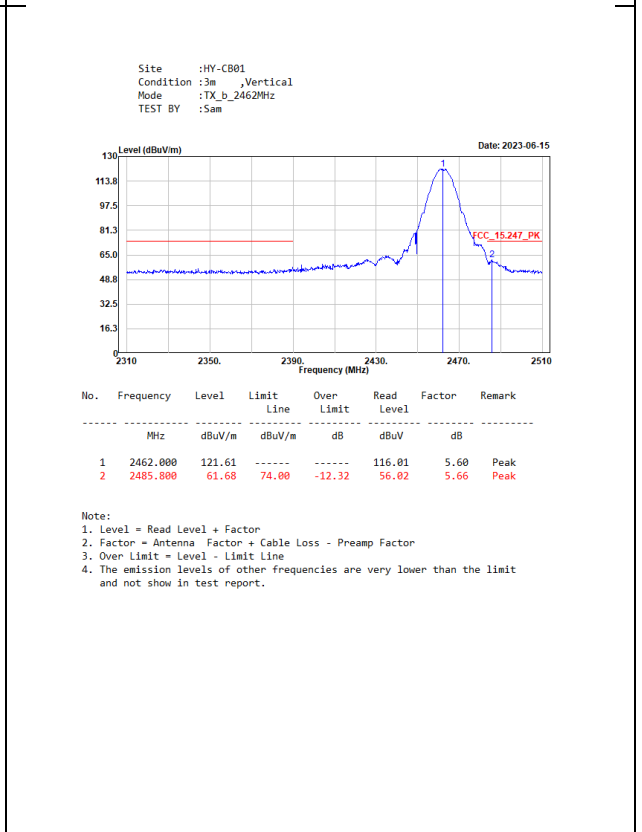
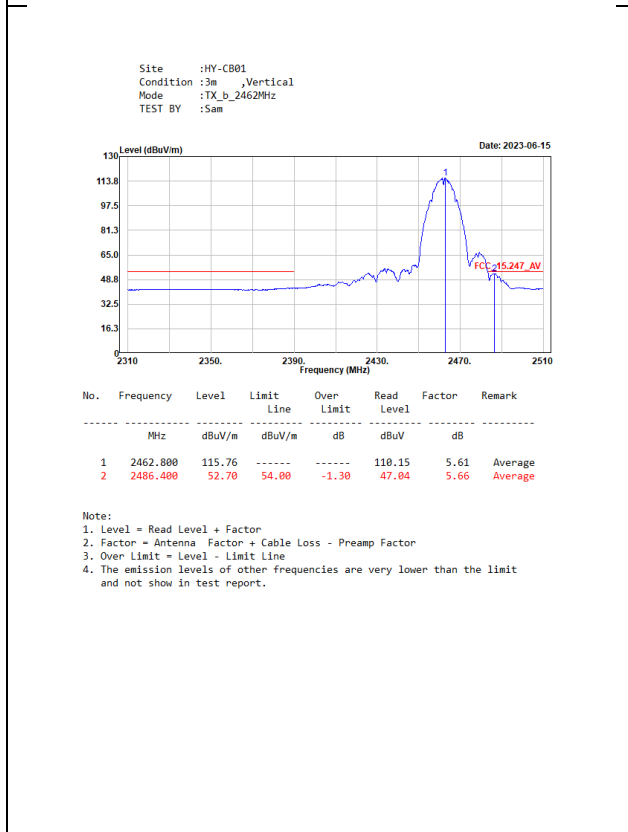
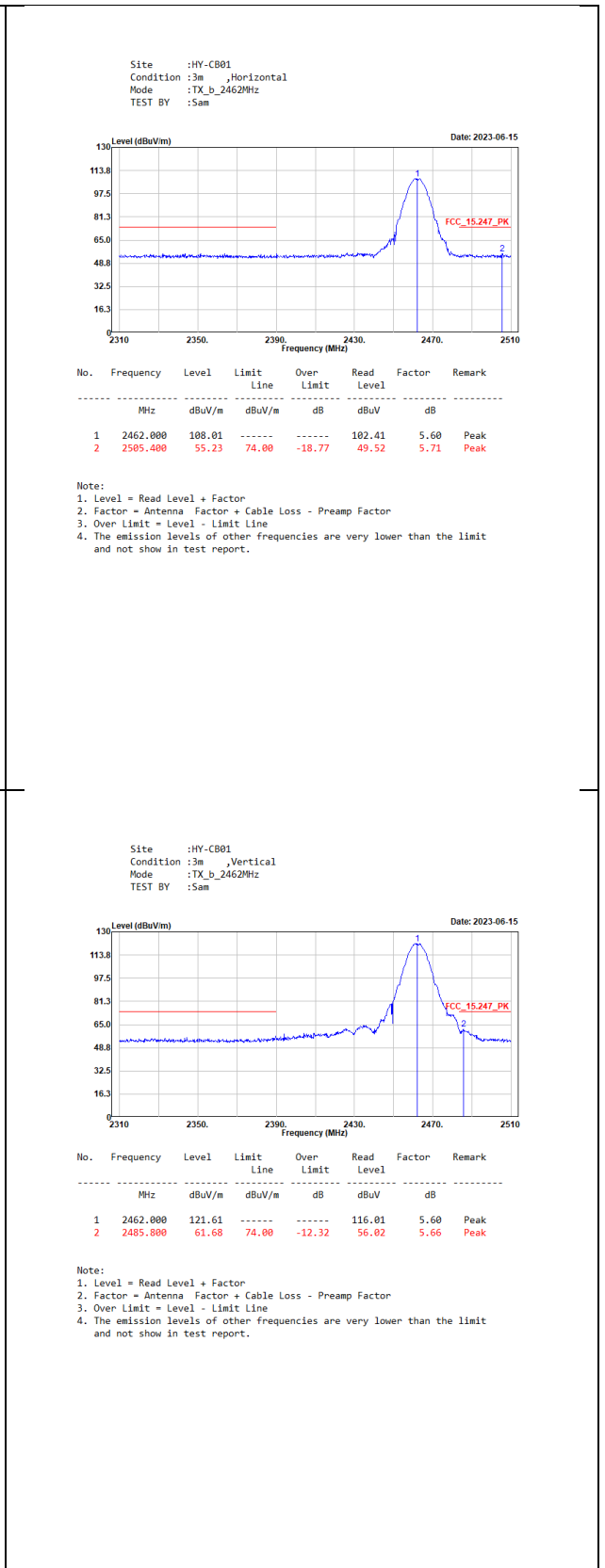
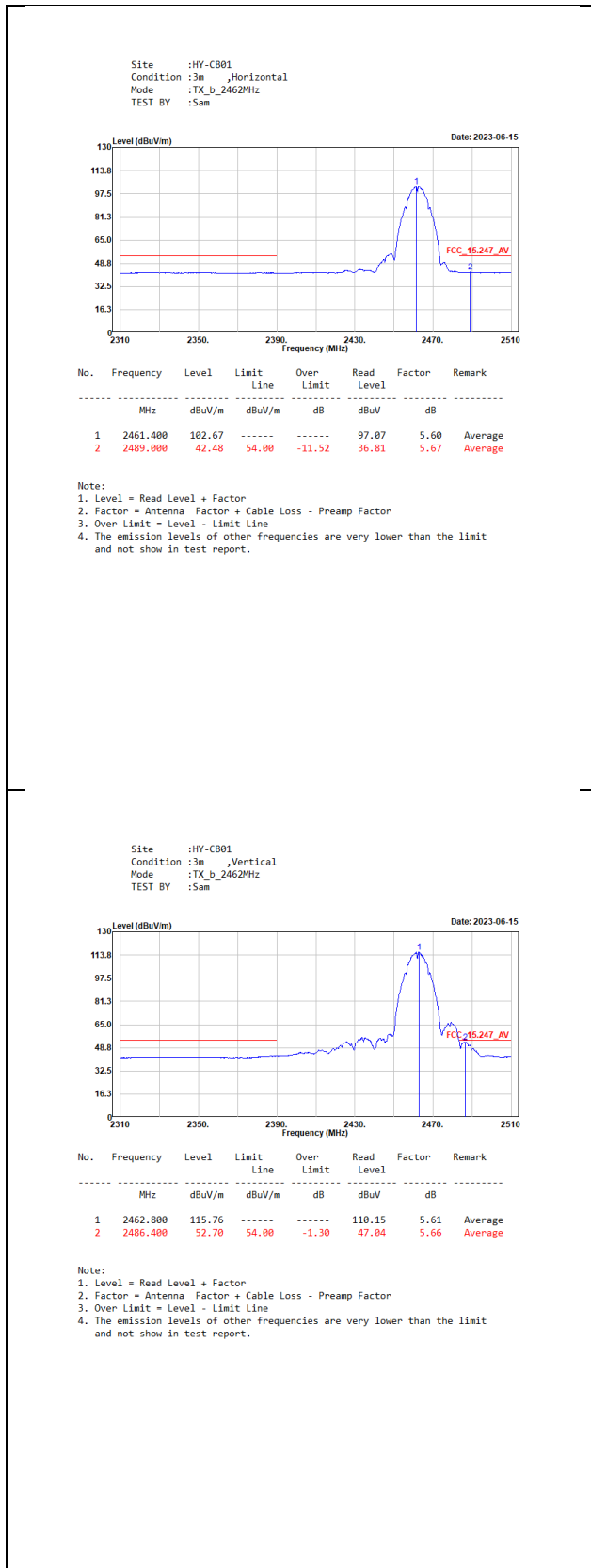

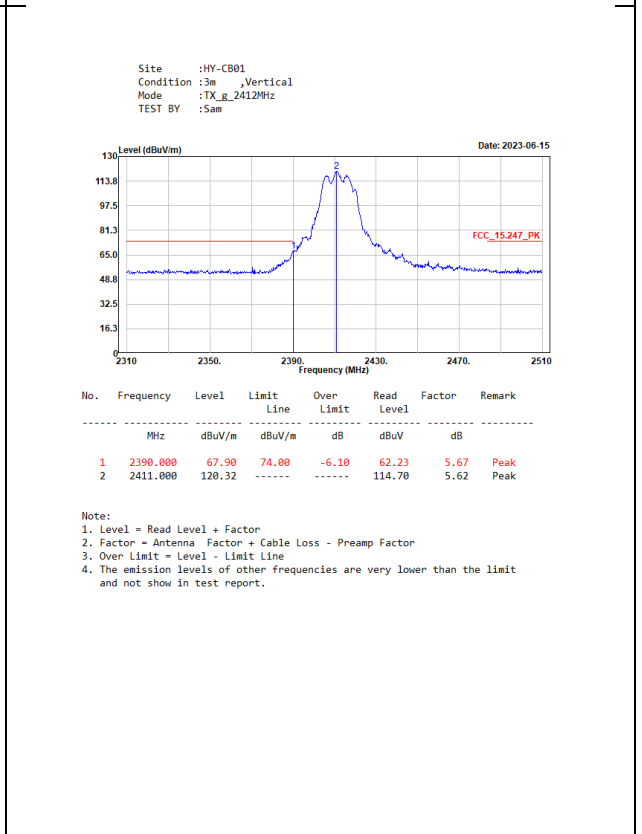
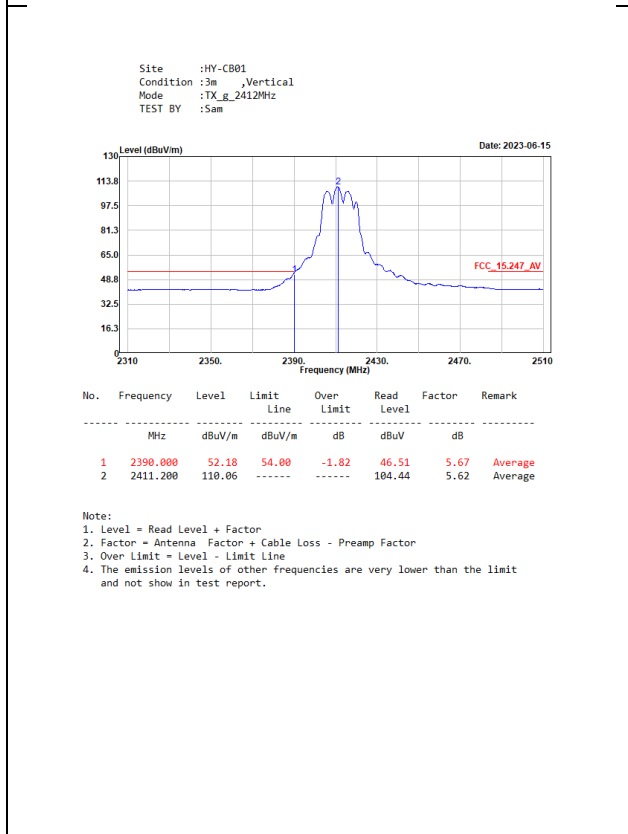
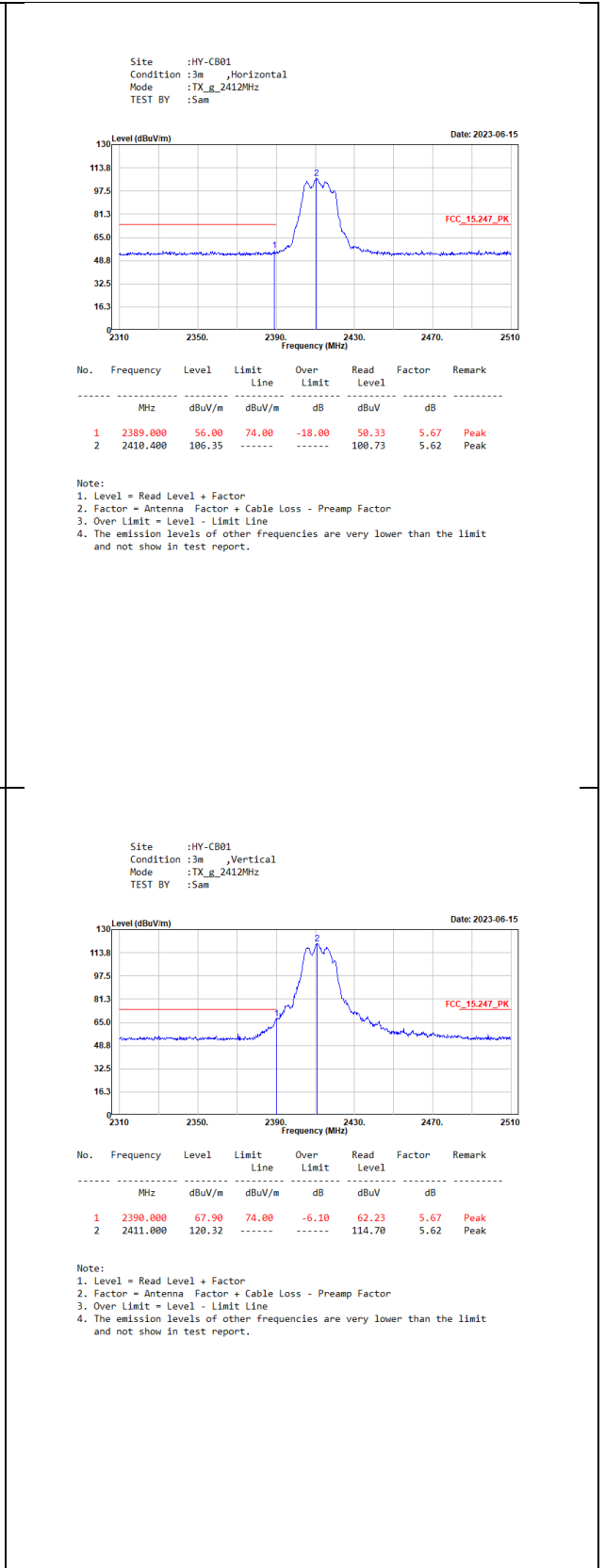
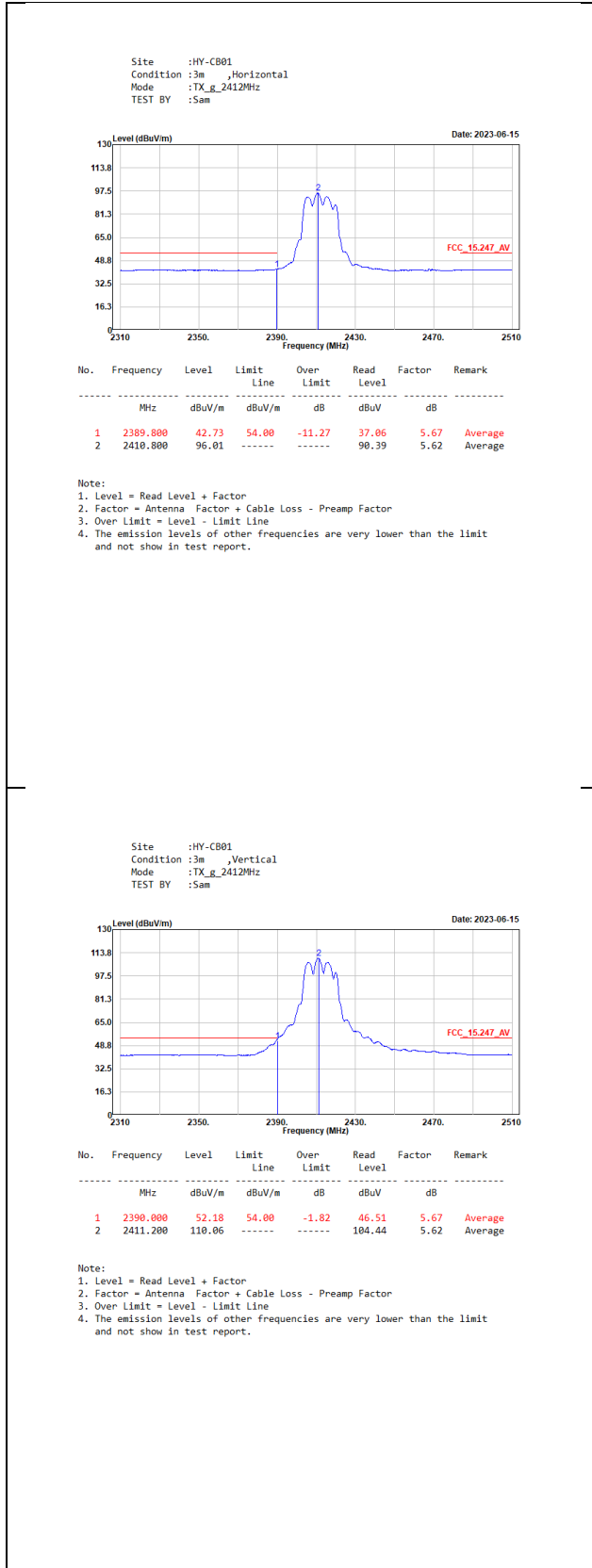



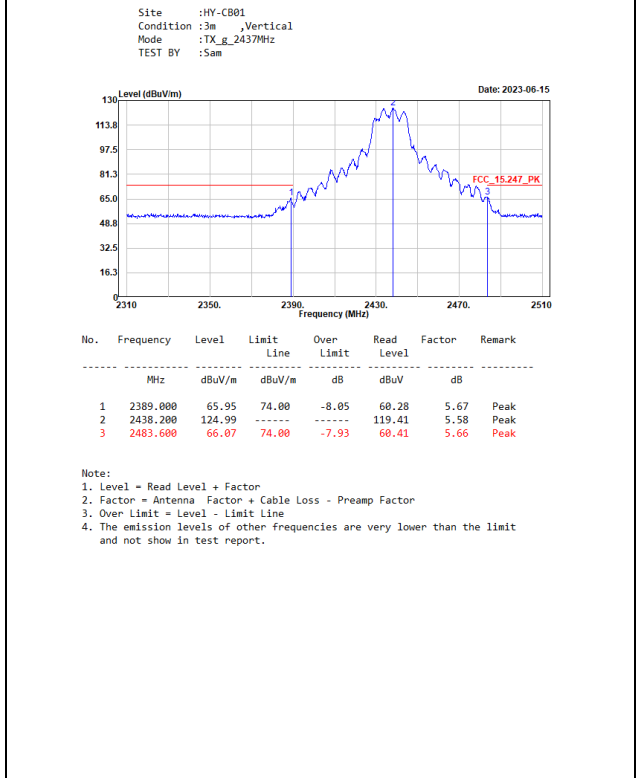
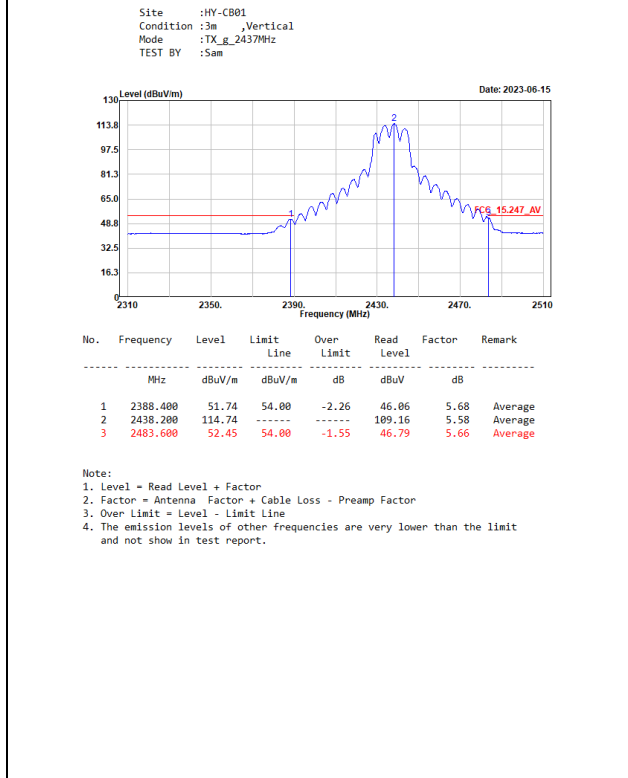
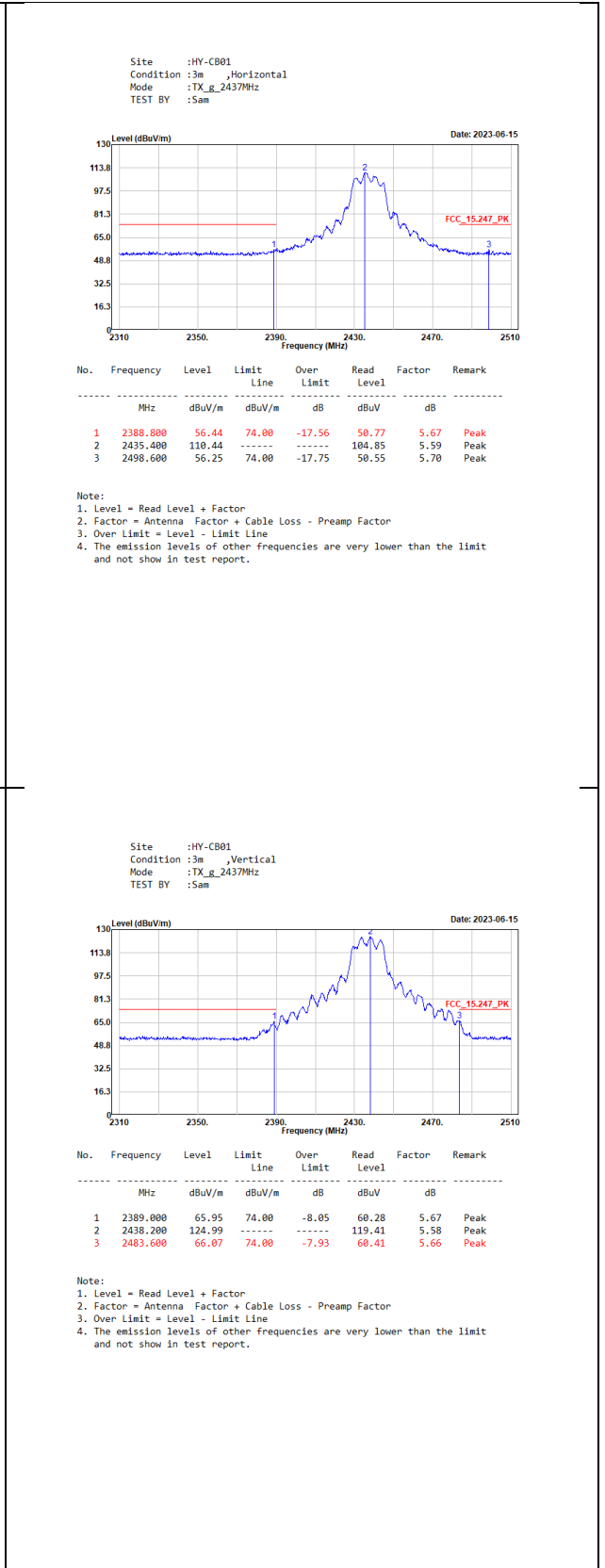
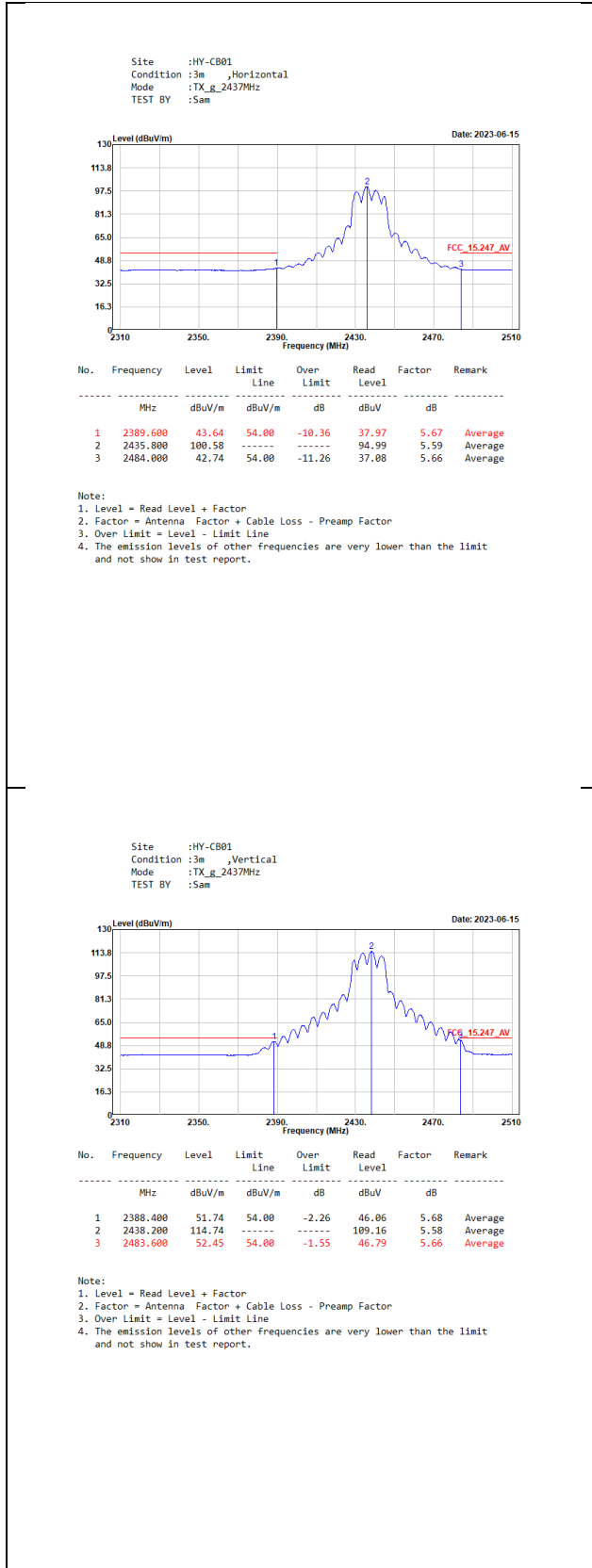

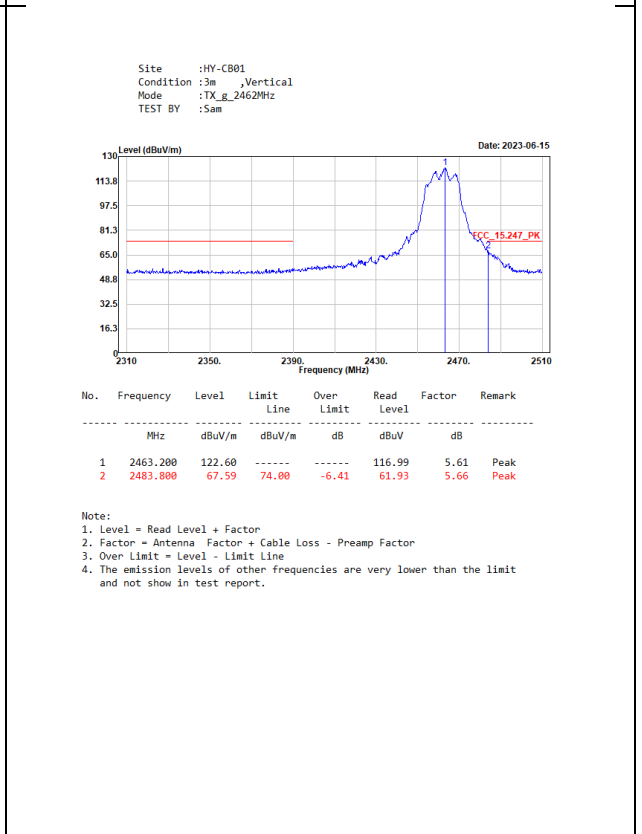
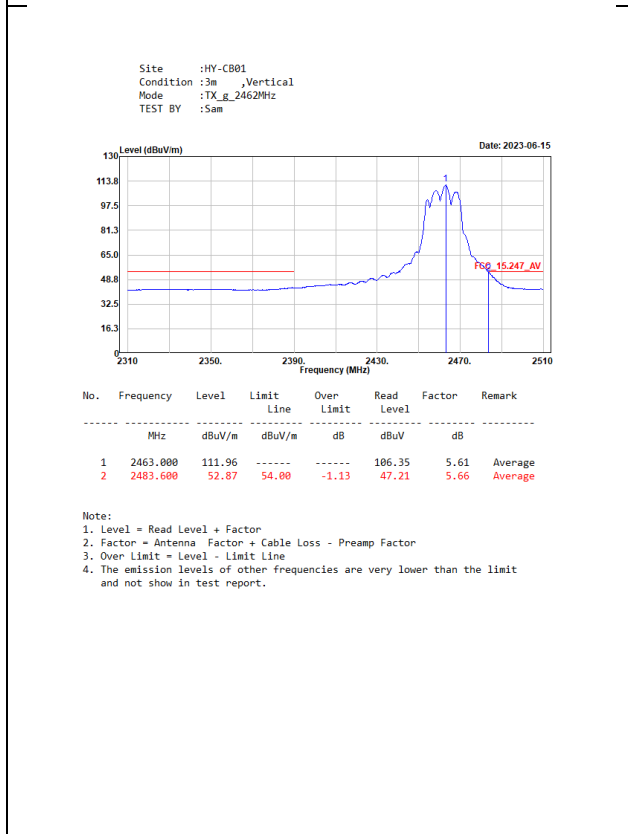
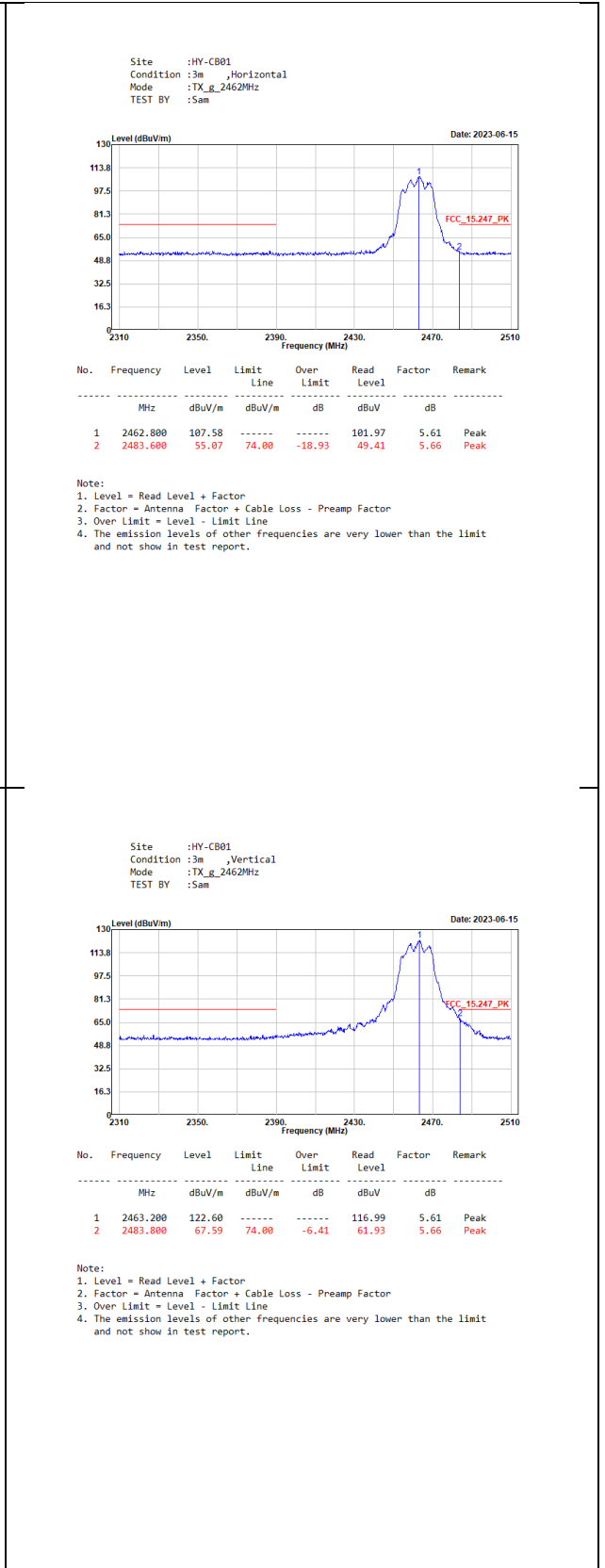
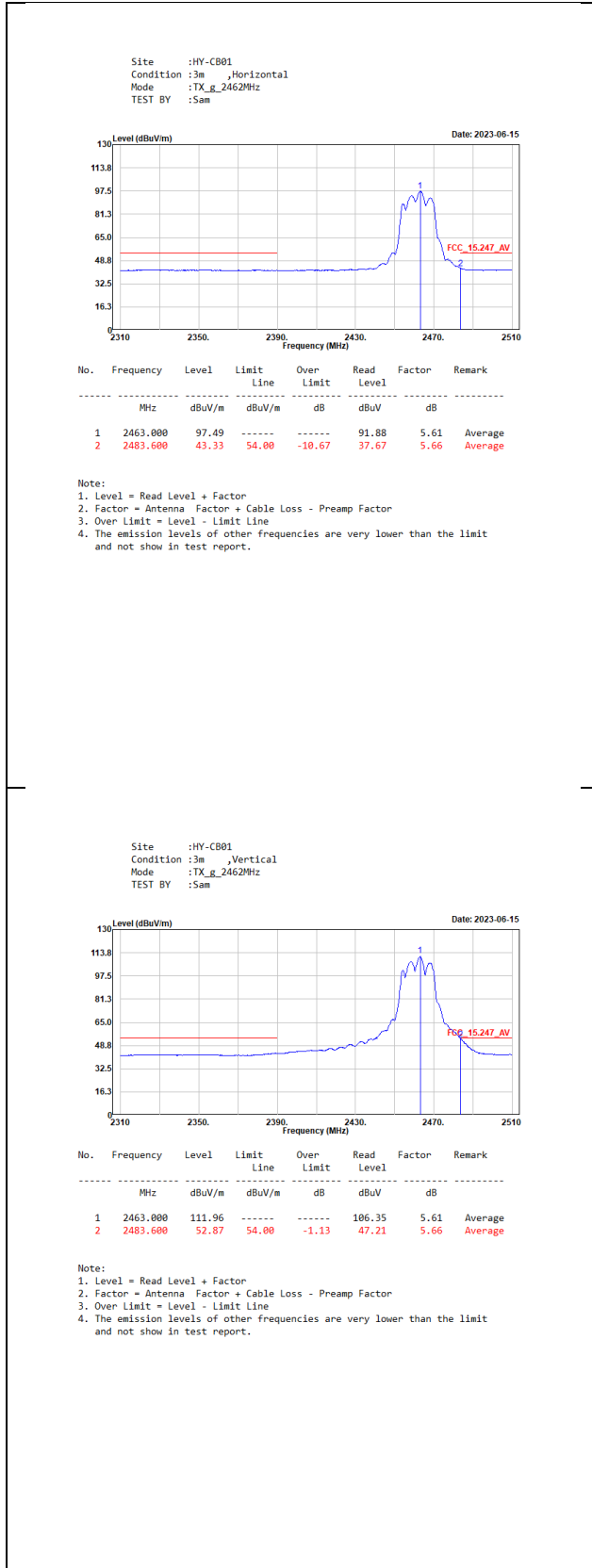

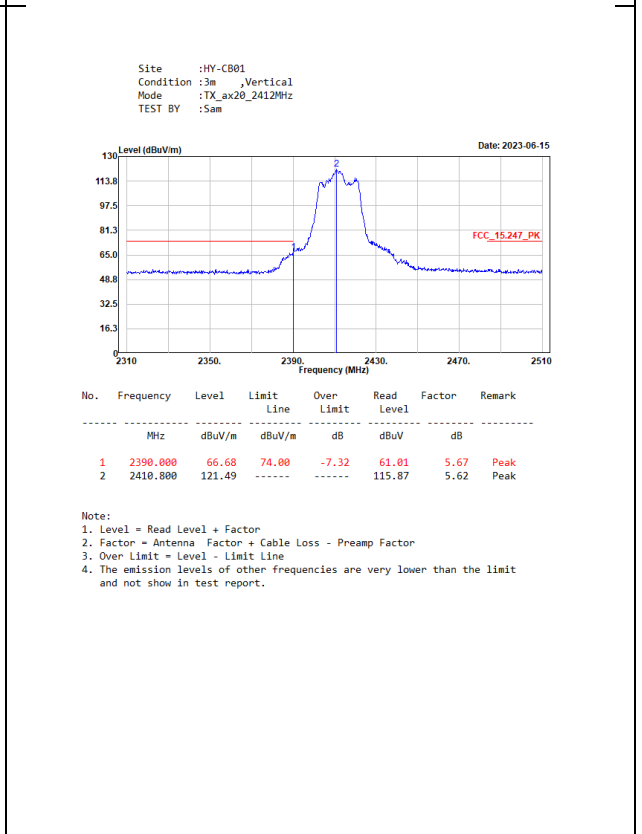
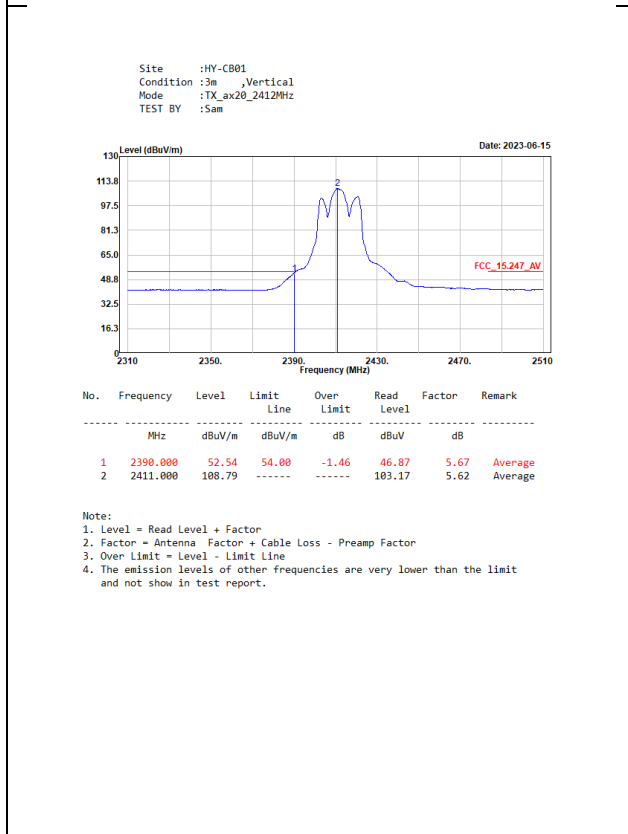
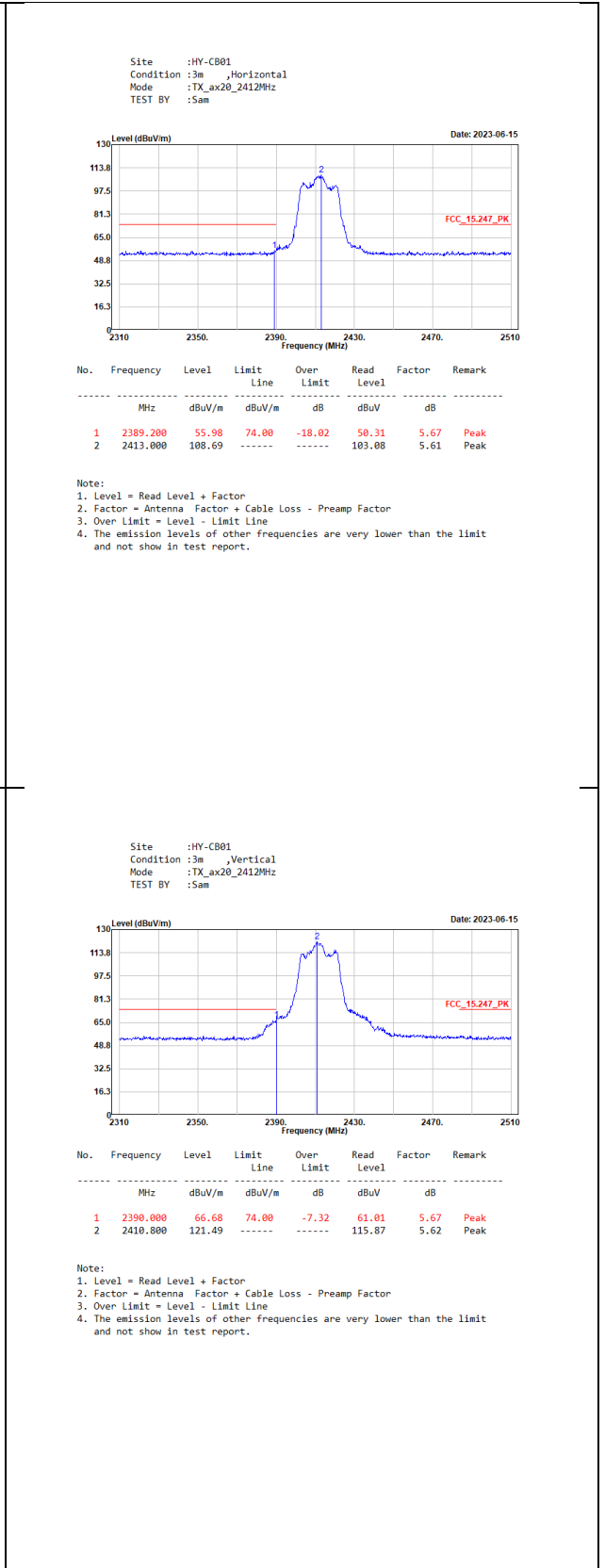
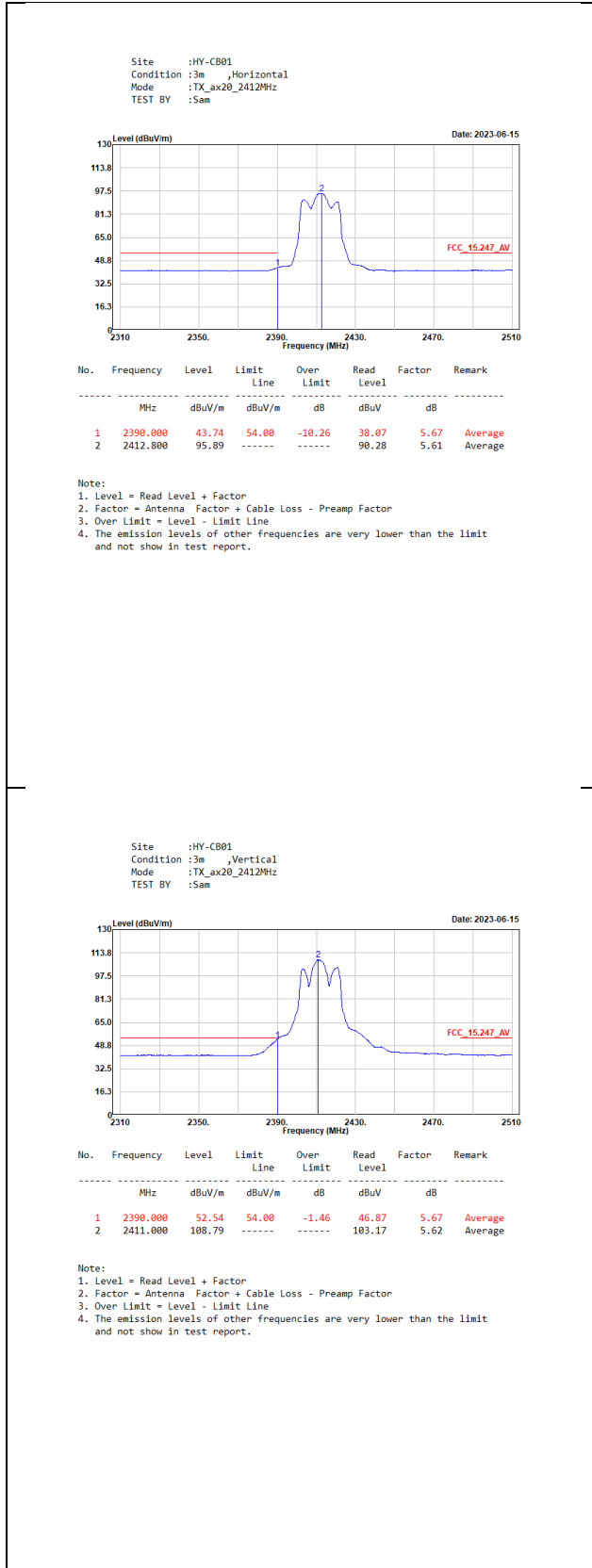

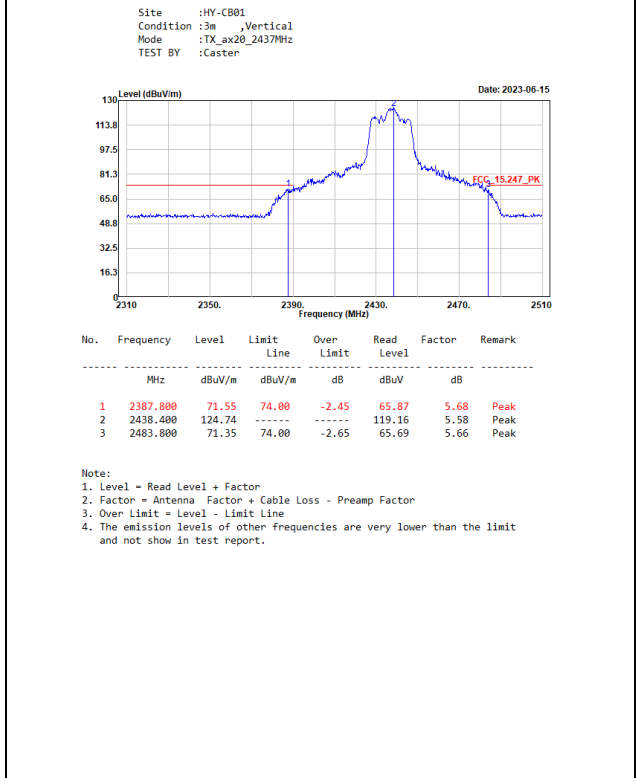
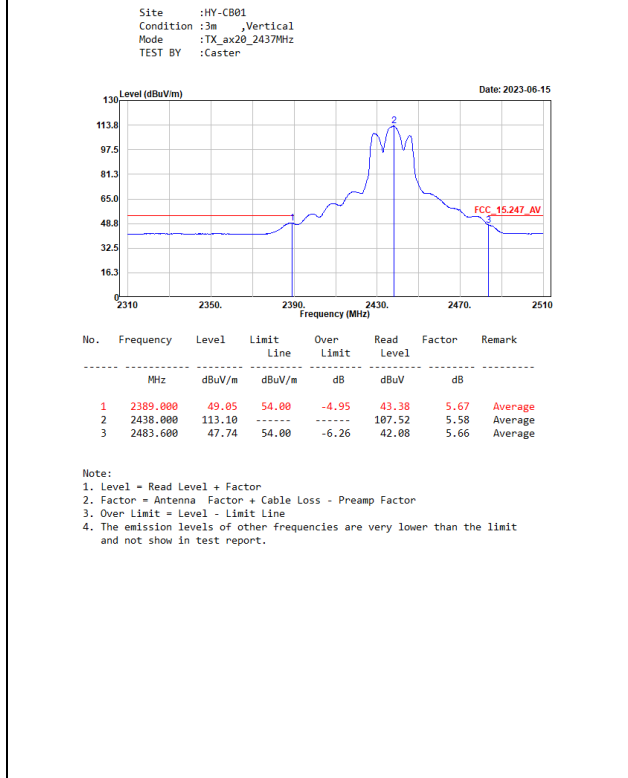
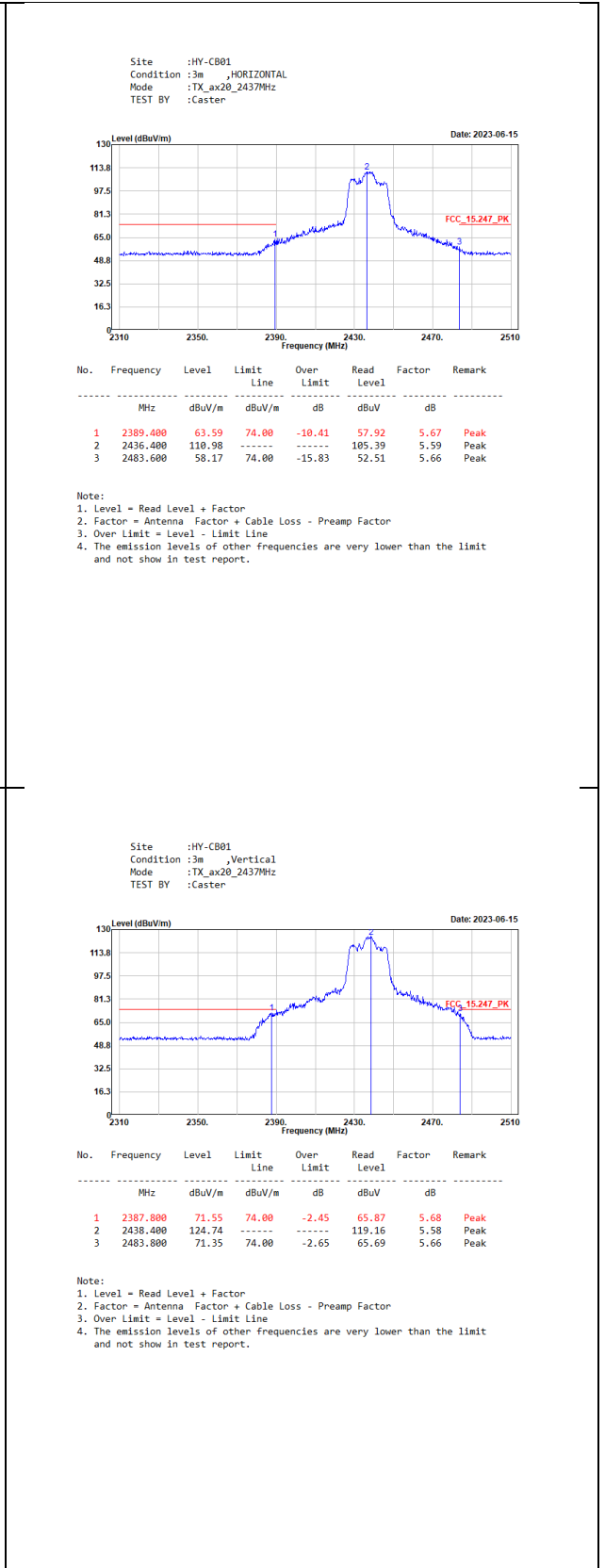
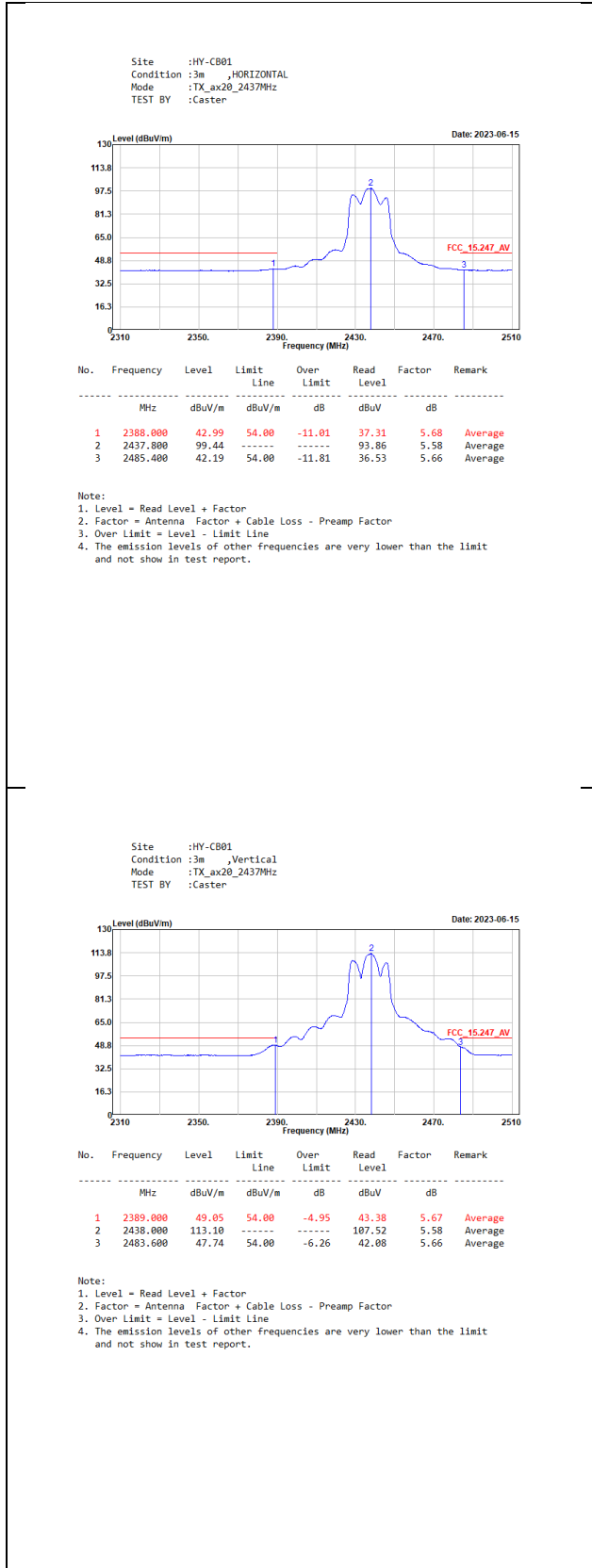

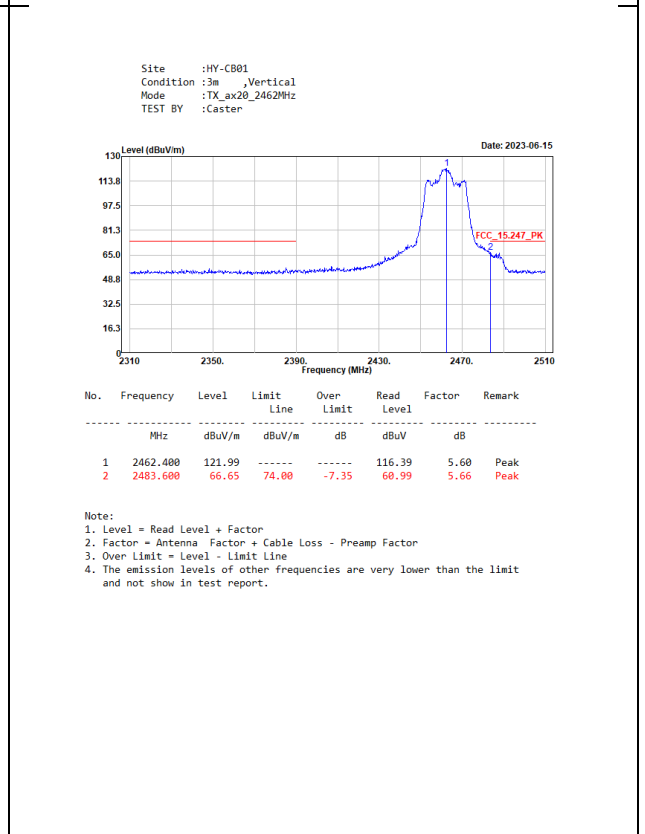
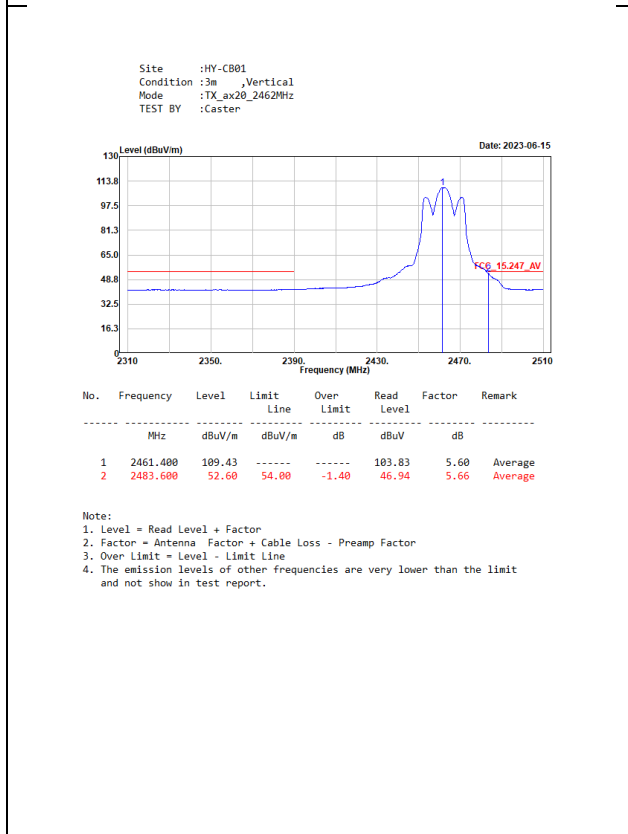
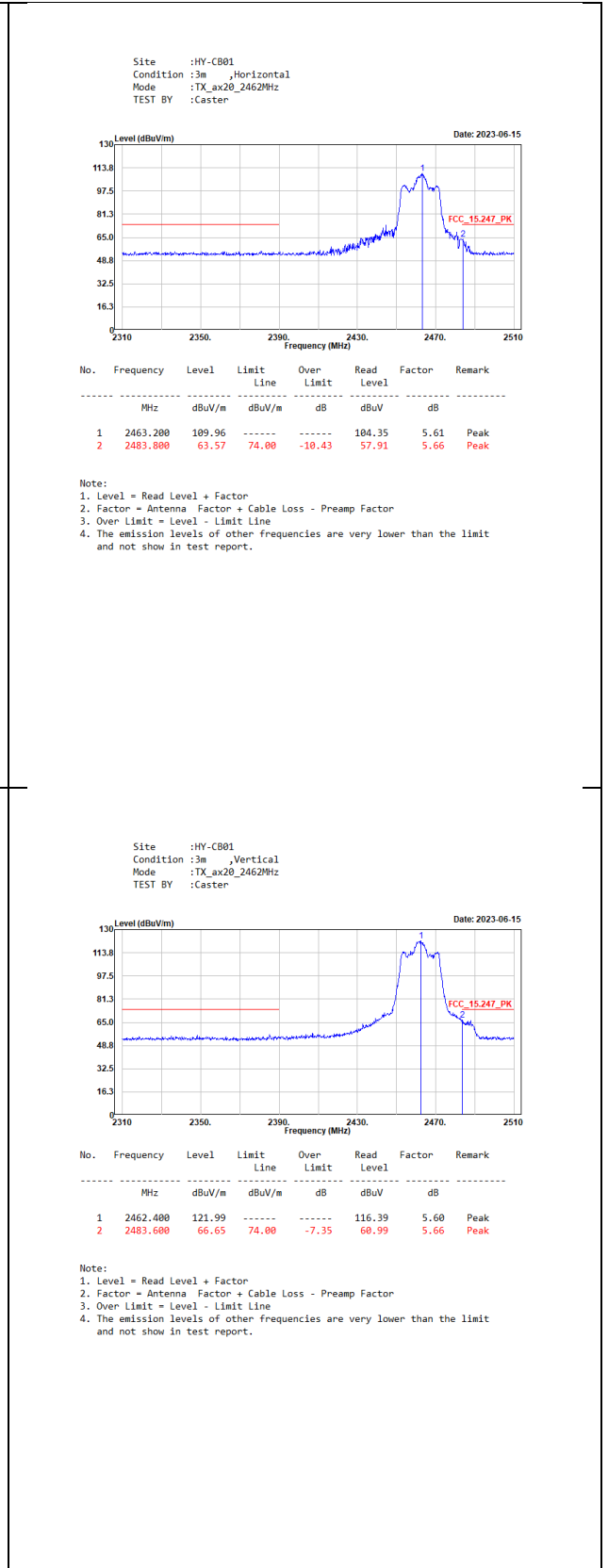
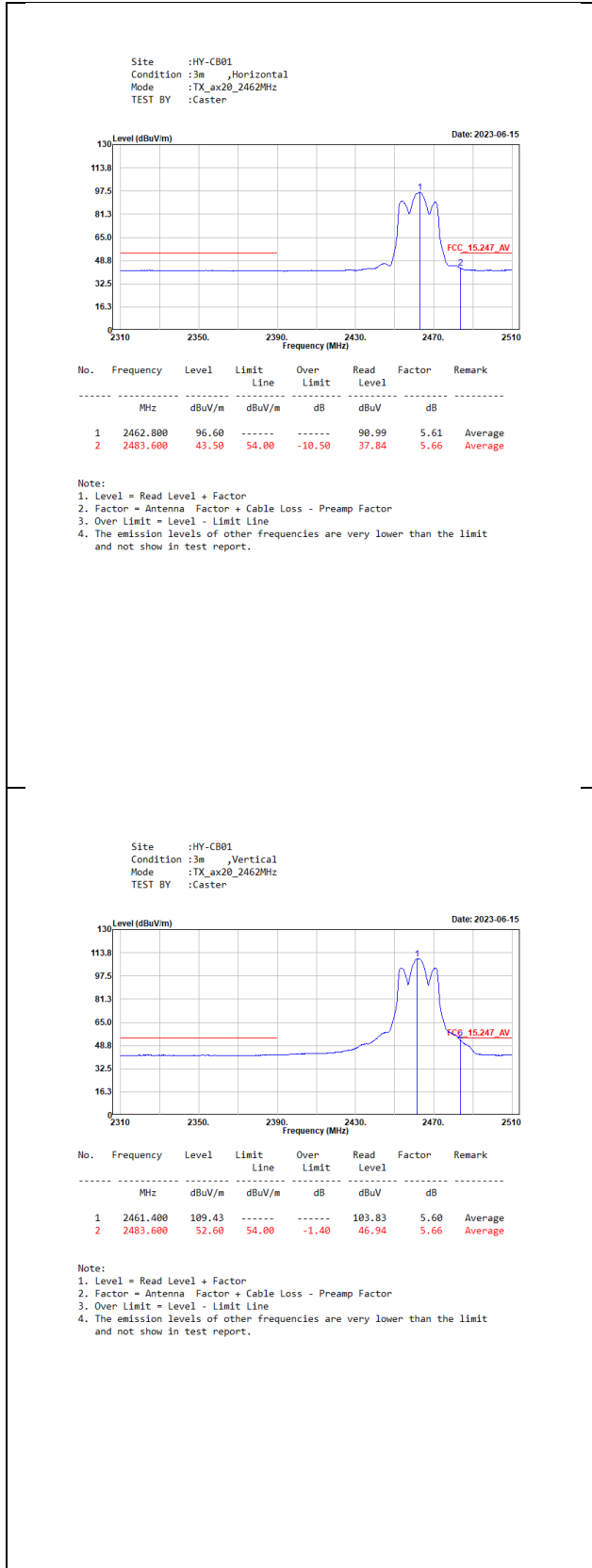

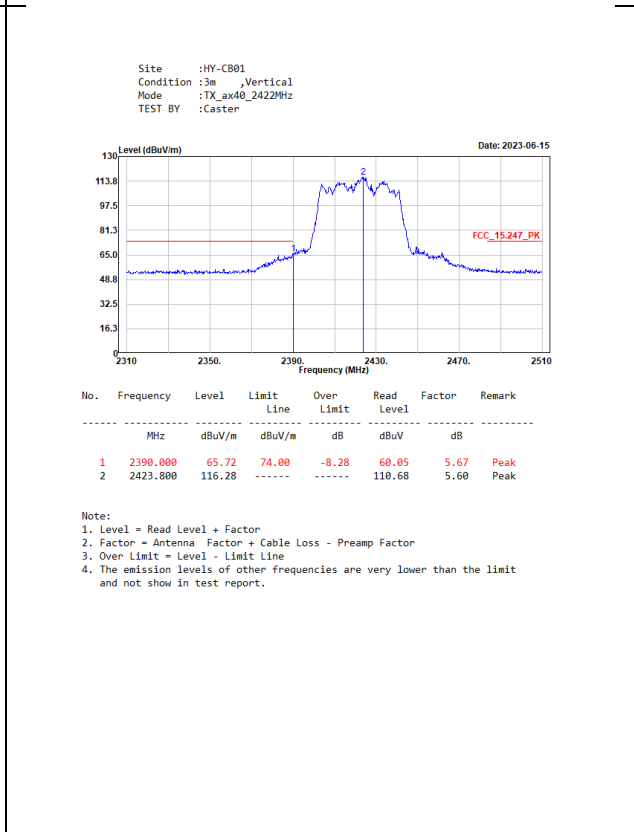
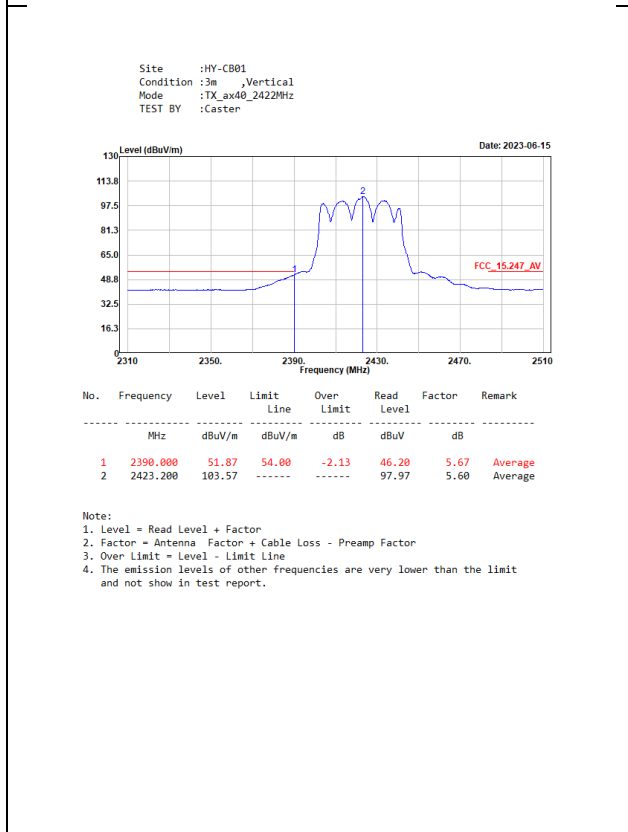
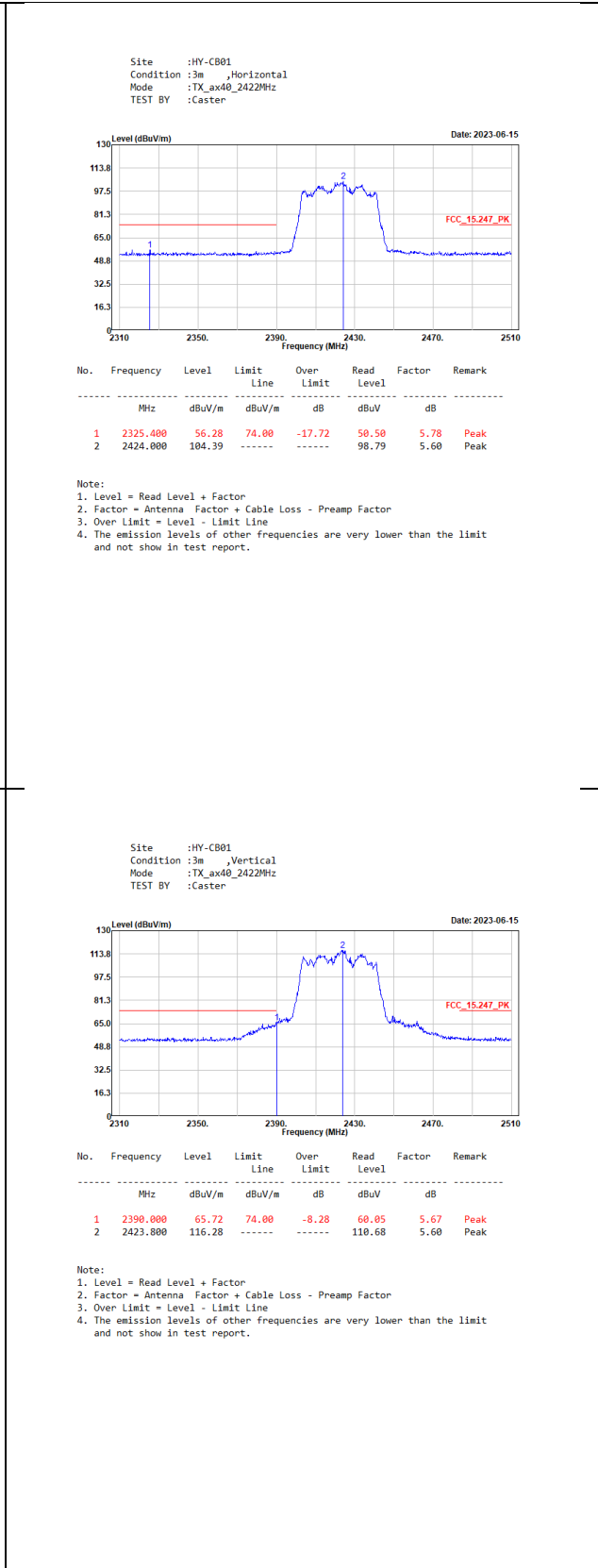
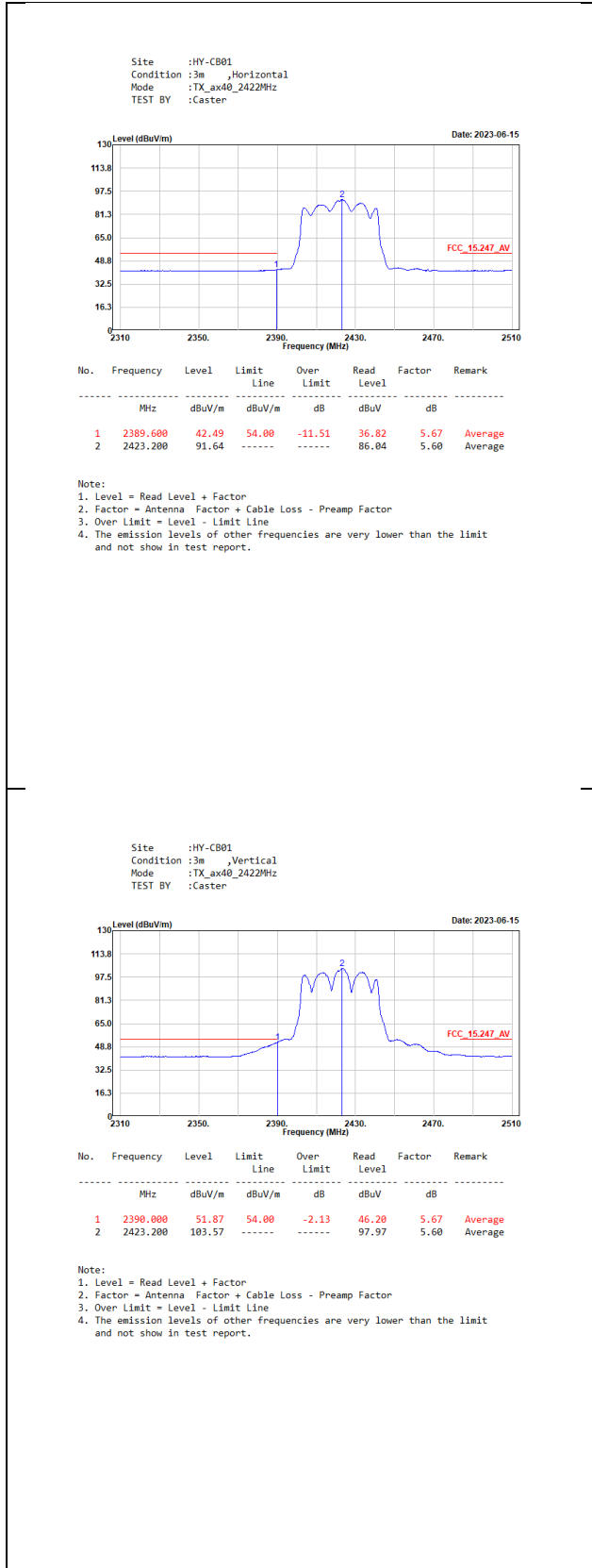

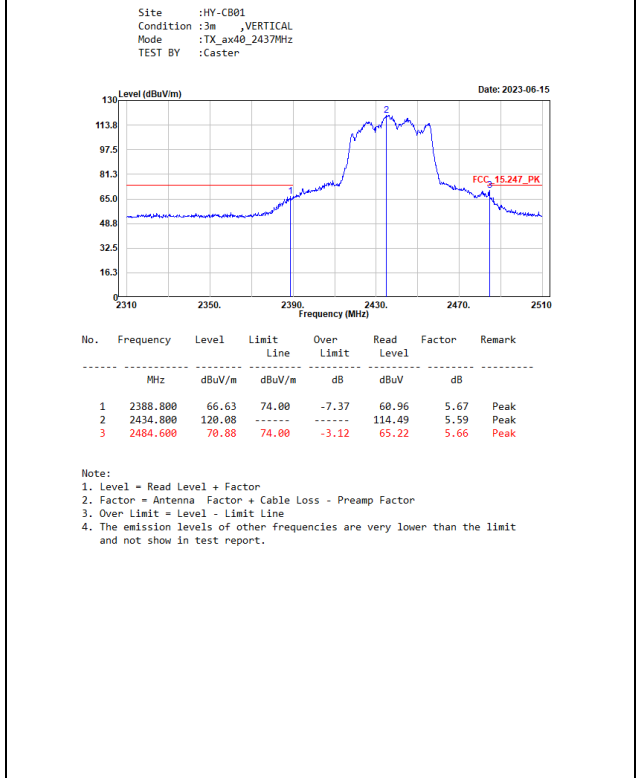
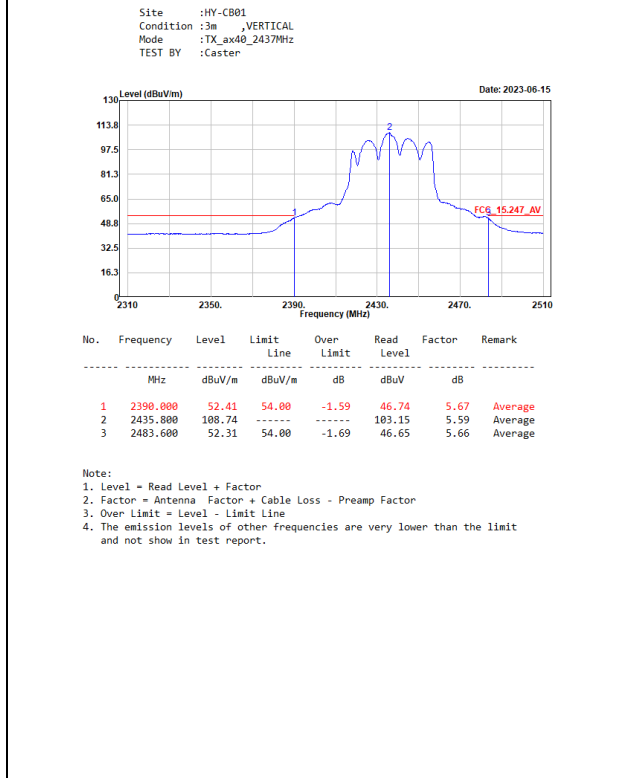
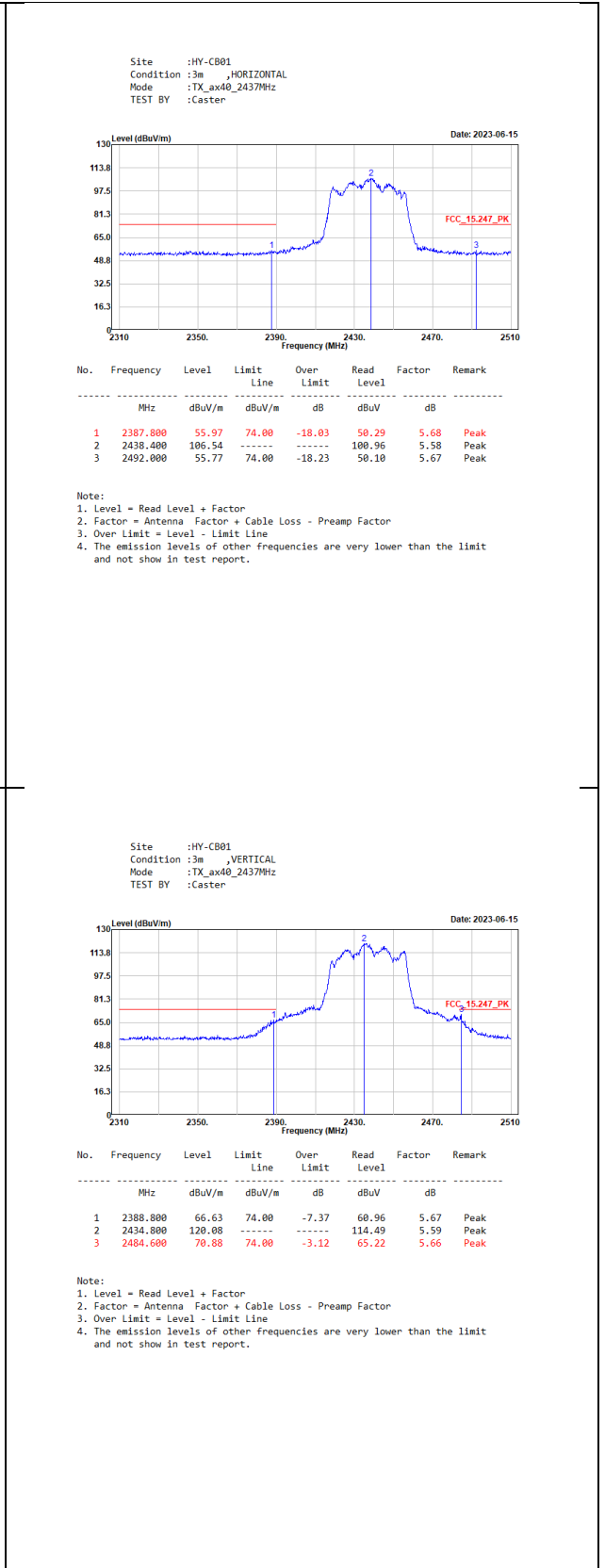
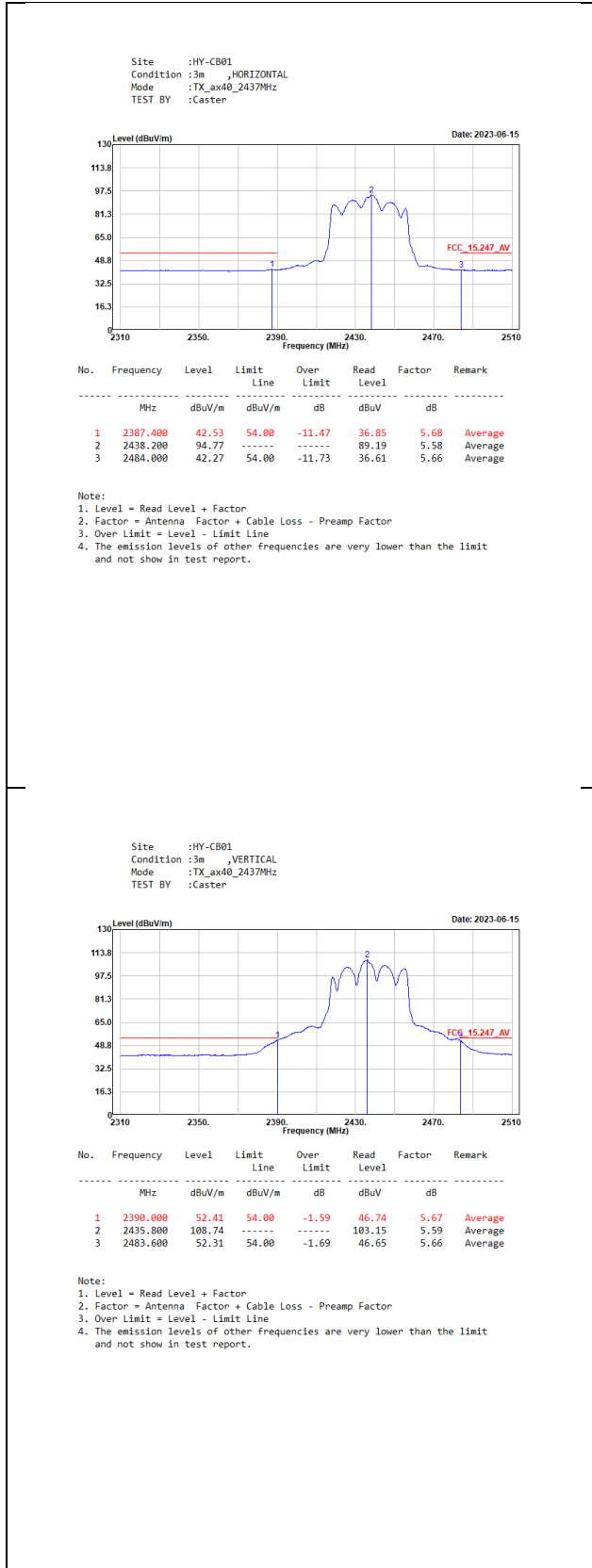

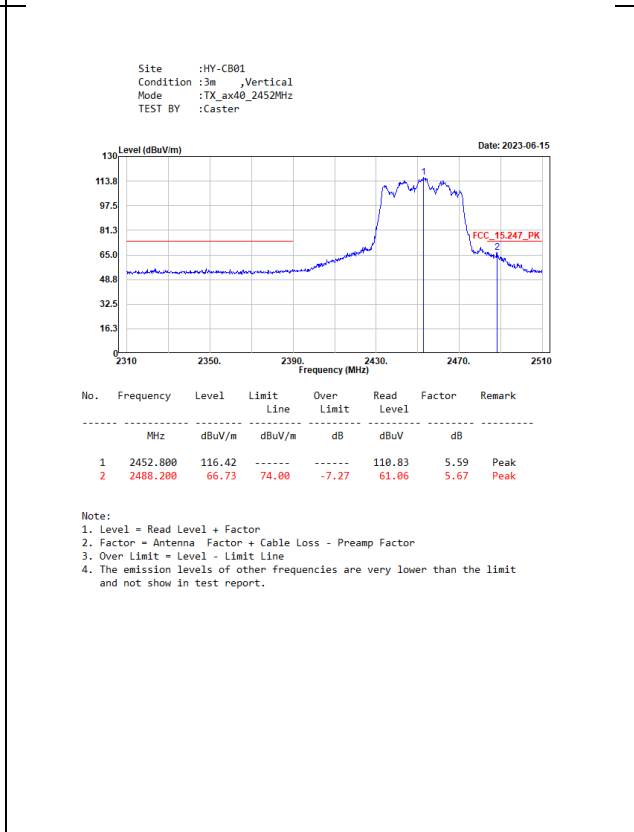
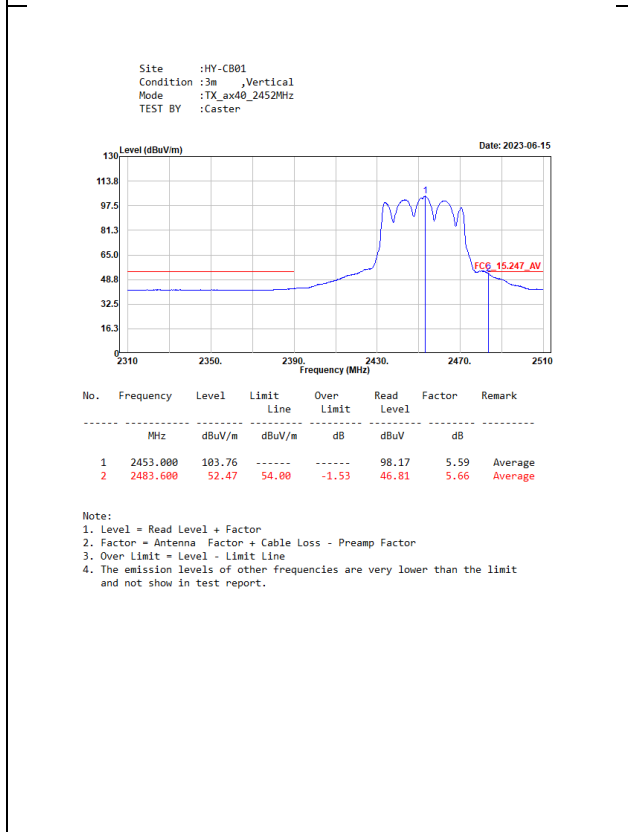
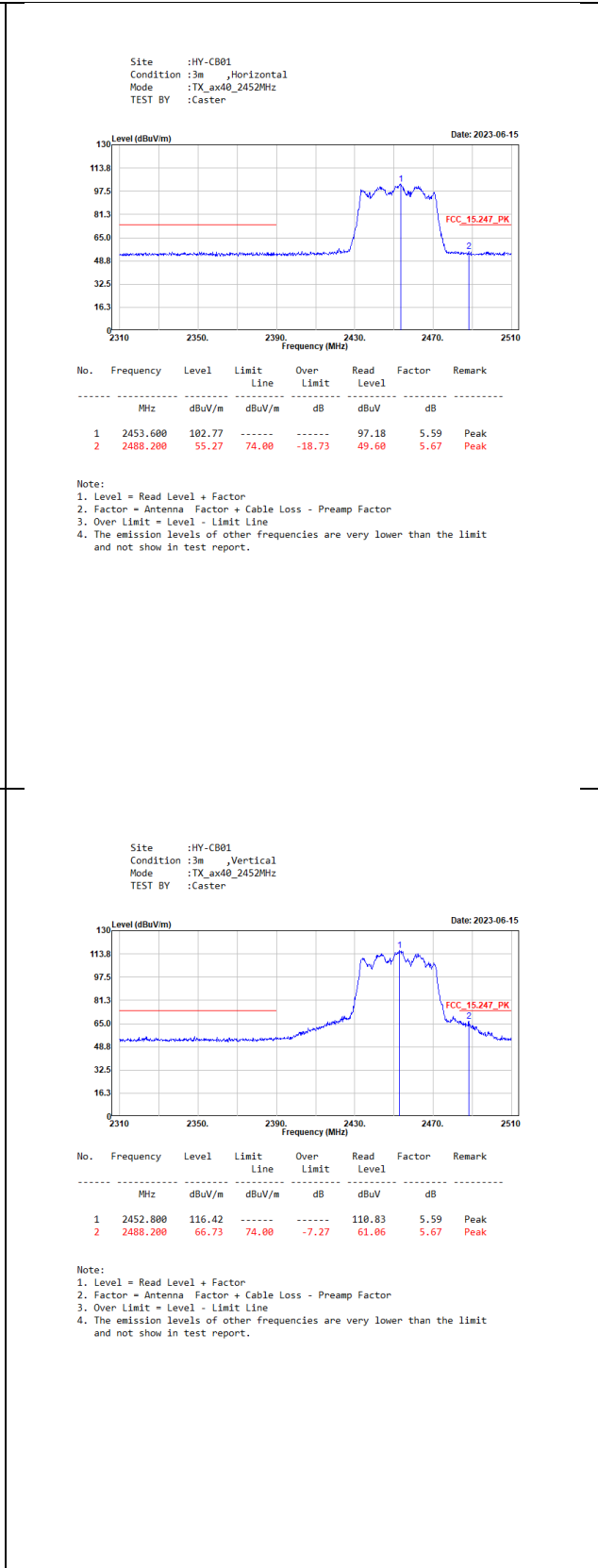
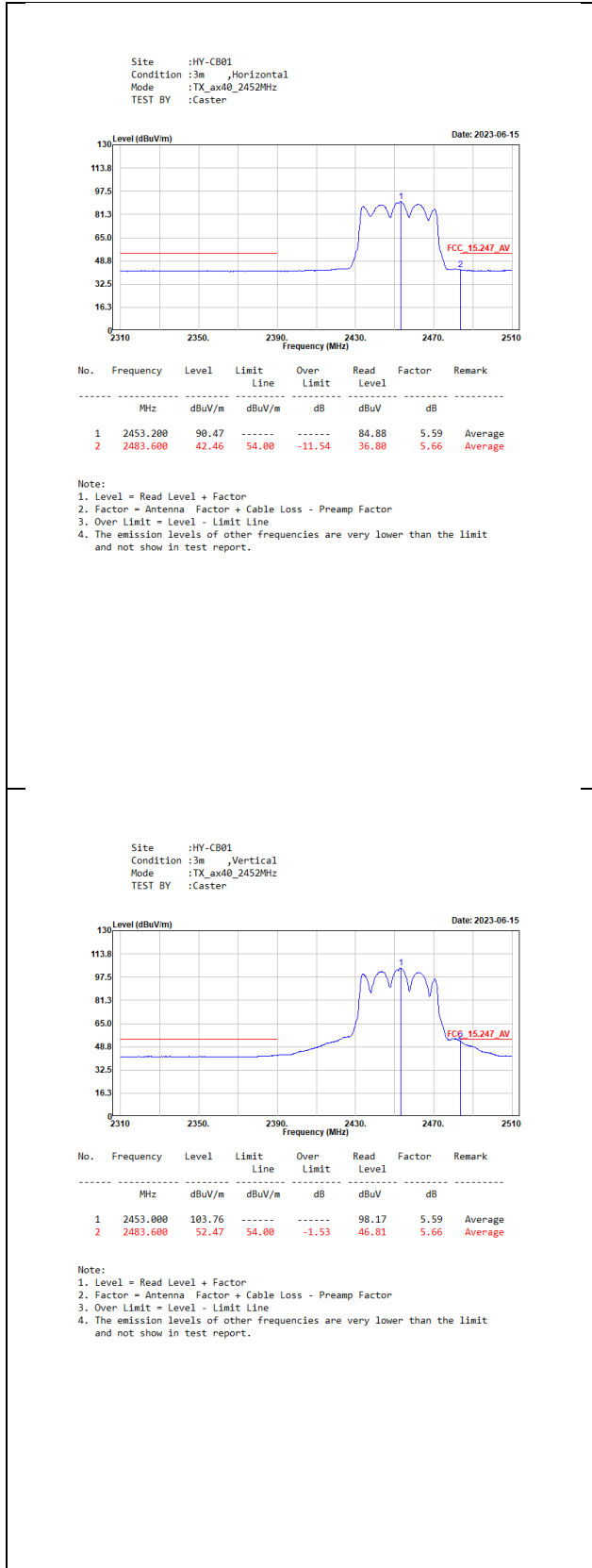



Product : Peplink Pepwave Wireless Product  
 Test Item : Band Edge  
 Test Mode : Transmit (802.11b)-CDD  
 Test Date : 2023/06/20

Measurement Level $\Delta$ (dB)	Result
> 20	PASS

Channel 01\_Chain A

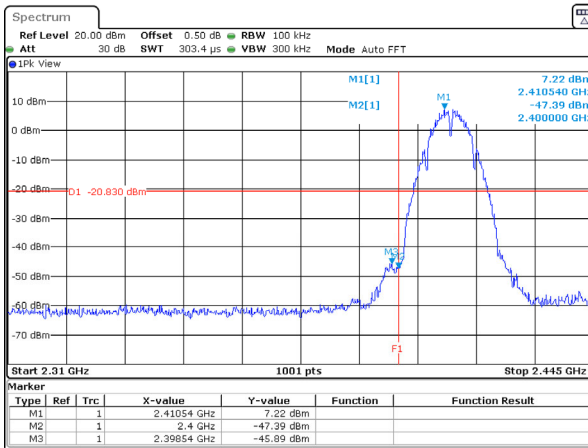

Channel 01\_Chain B

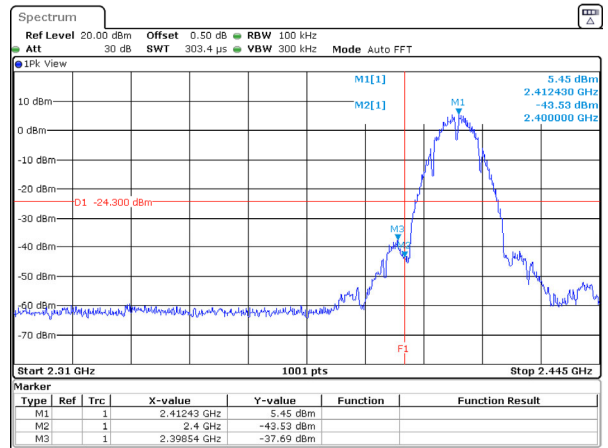

Channel 11\_Chain A

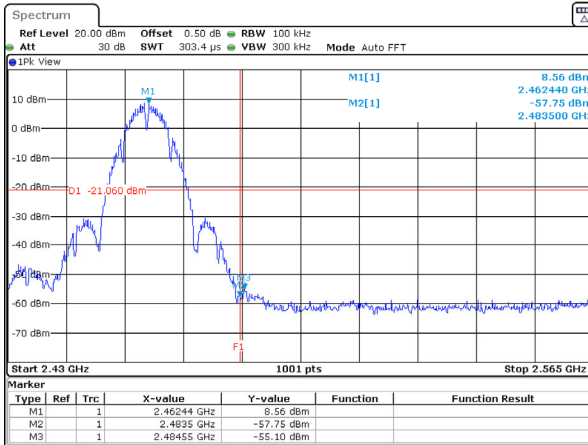

Channel 11\_Chain B

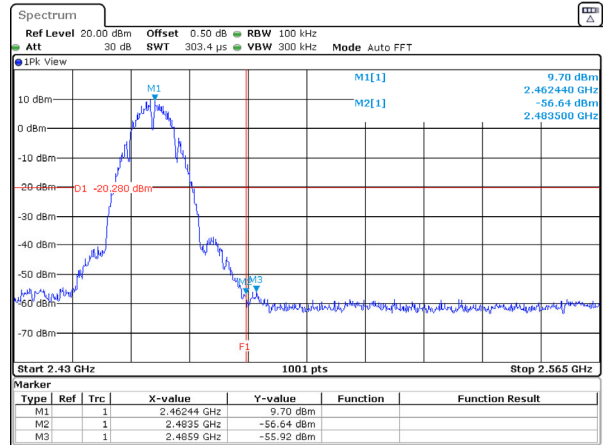

Product : Peplink Pepwave Wireless Product  
 Test Item : Band Edge  
 Test Mode : Transmit (802.11g)-CDD  
 Test Date : 2023/06/20

Measurement Level $\Delta$ (dB)	Result
> 20	PASS

Channel 01\_Chain A

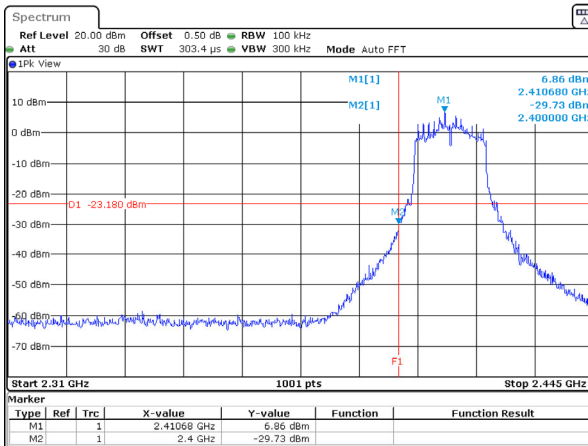

Channel 01\_Chain B

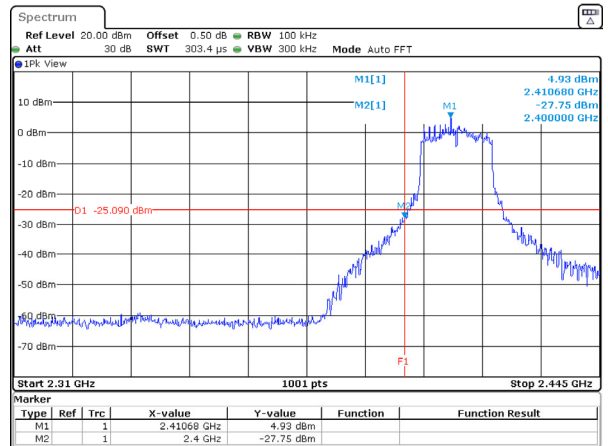

Channel 11\_Chain A

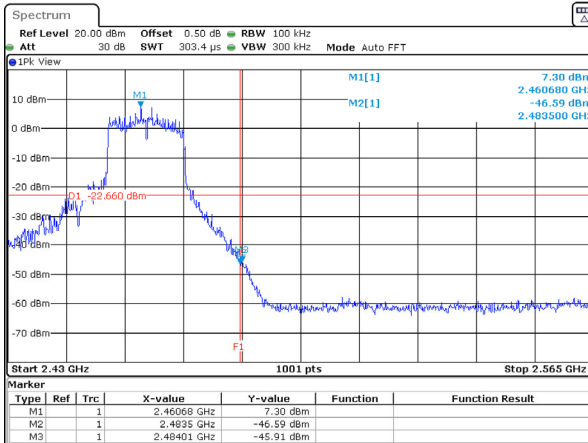

Channel 11\_Chain B

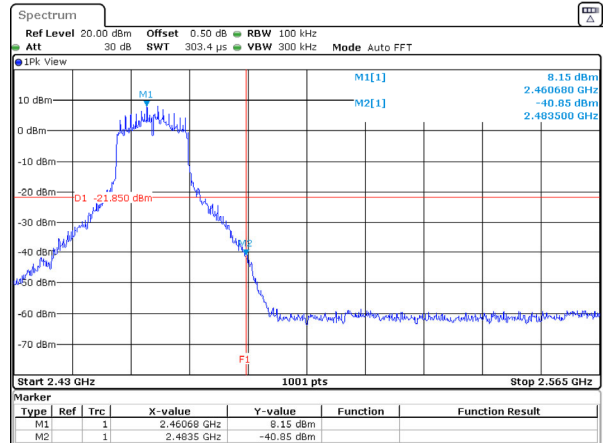

Product : Peplink Pepwave Wireless Product  
 Test Item : Band Edge  
 Test Mode : Transmit (802.11ax-20 MHz)-CDD  
 Test Date : 2023/06/20

Measurement Level	Result
$\Delta$ (dB)	
> 20	PASS

Channel 01\_Chain A

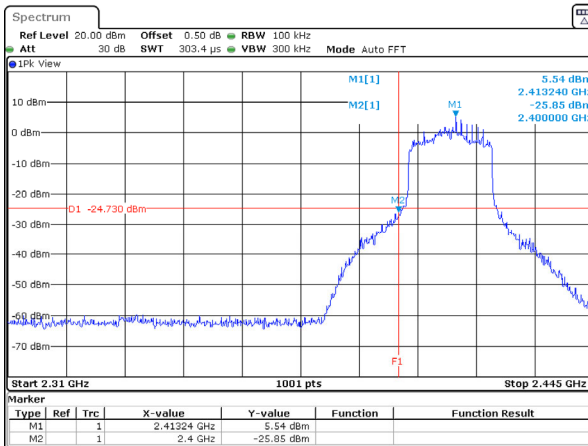

Channel 01\_Chain B

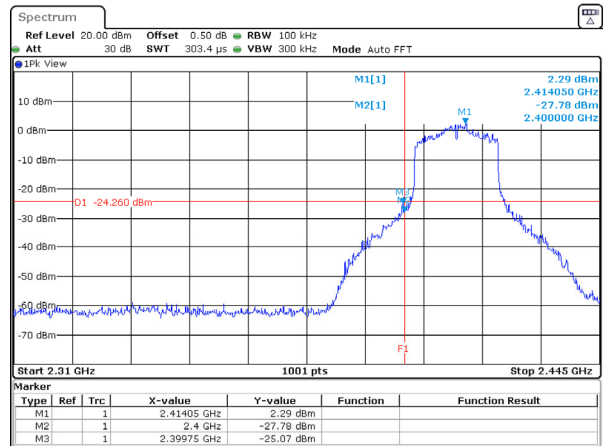

Channel 11\_Chain A

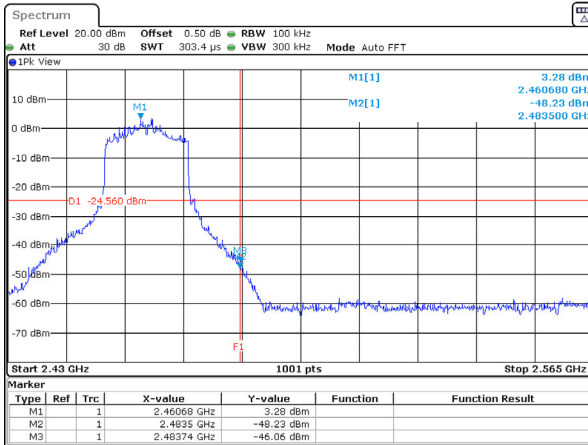

Channel 11\_Chain B

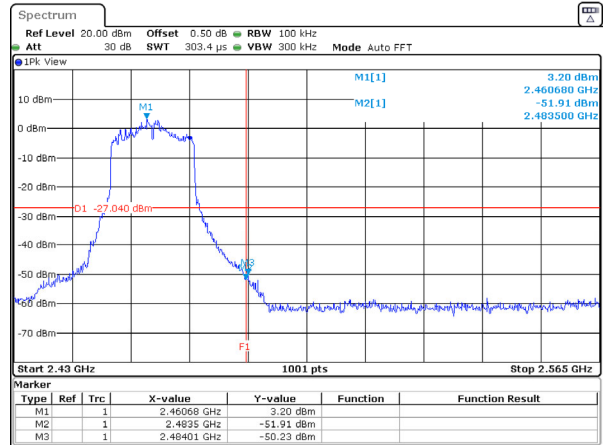

Product : Peplink Pepwave Wireless Product  
 Test Item : Band Edge  
 Test Mode : Transmit (802.11ax-40 MHz)-CDD  
 Test Date : 2023/06/20

Measurement Level $\Delta$ (dB)	Result
> 20	PASS

Channel 03\_Chain A

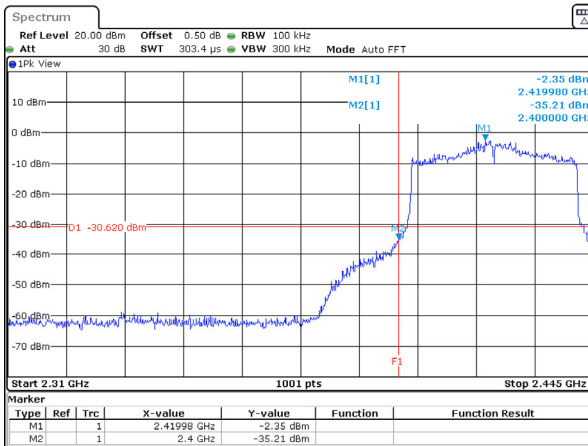

Channel 03\_Chain B

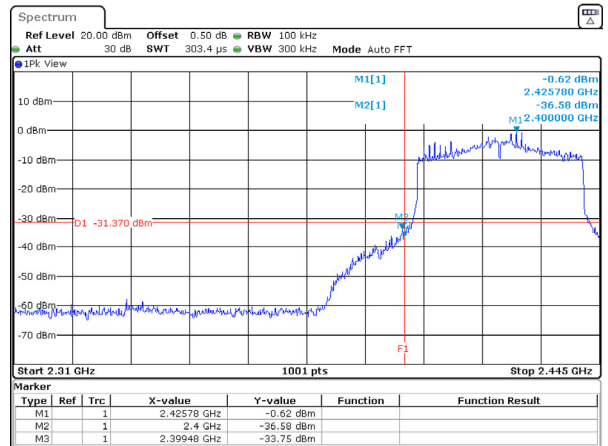

Channel 09\_Chain A

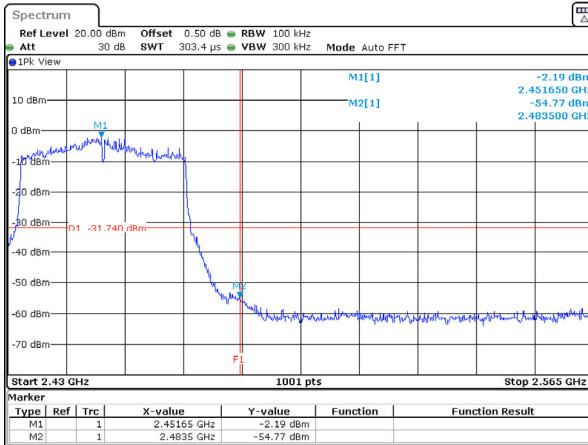

Channel 09\_Chain B

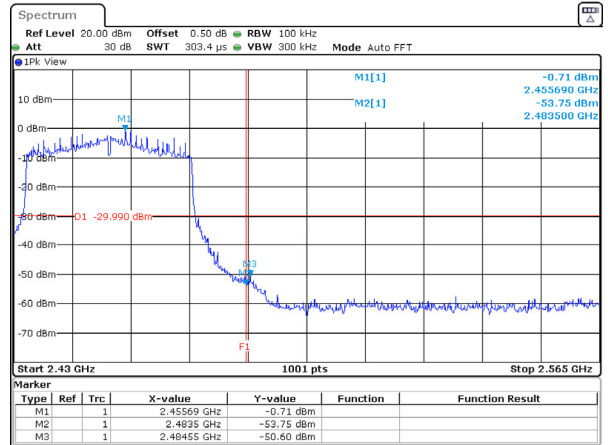

## 7. 6 dB Bandwidth

### 7.1. Test Setup

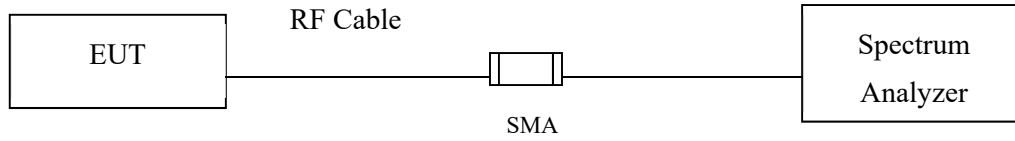

### 7.2. Limits

The minimum bandwidth shall be at least 500 kHz.

### 7.3. Test Procedure

The EUT was setup according to ANSI C63.4, 2014; tested according to ANSI C63.10 Section 11.8 for compliance to FCC 47CFR 15.247 requirements.

7.4. Test Result of 6 dB Bandwidth

Product : Peplink Pepwave Wireless Product  
 Test Item : 6 dB Bandwidth Data  
 Test Mode : Transmit (802.11b)-CDD

Chain A

Channel No.	Frequency (MHz)	Measurement Level (kHz)	Required Limit (kHz)	Result
01	2412	7112	>500	Pass
06	2437	8151	>500	Pass
11	2462	7112	>500	Pass

Chain B

Channel No.	Frequency (MHz)	Measurement Level (kHz)	Required Limit (kHz)	Result
01	2412	7112	>500	Pass
06	2437	7312	>500	Pass
11	2462	7072	>500	Pass

Channel 06 - Chain A

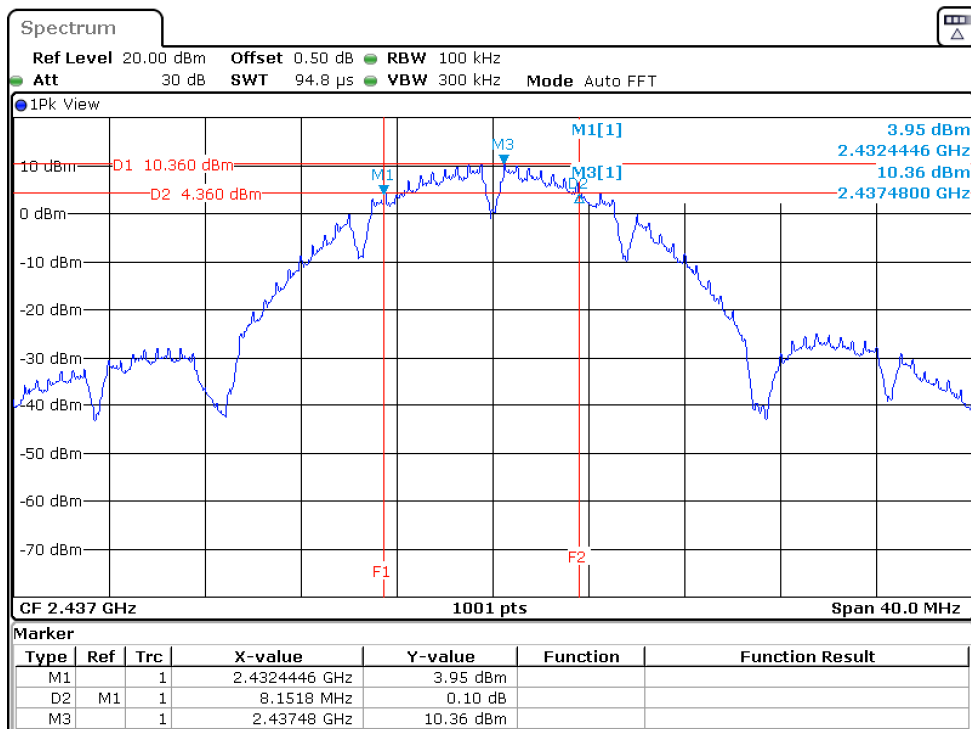

Product : Peplink Pepwave Wireless Product  
 Test Item : 6 dB Bandwidth Data  
 Test Mode : Transmit (802.11g)-CDD

Chain A

Channel No.	Frequency (MHz)	Measurement Level (kHz)	Required Limit (kHz)	Result
01	2412	15104	>500	Pass
06	2437	15025	>500	Pass
11	2462	17582	>500	Pass

Chain B

Channel No.	Frequency (MHz)	Measurement Level (kHz)	Required Limit (kHz)	Result
01	2412	15104	>500	Pass
06	2437	15064	>500	Pass
11	2462	15064	>500	Pass

Channel 06 - Chain B

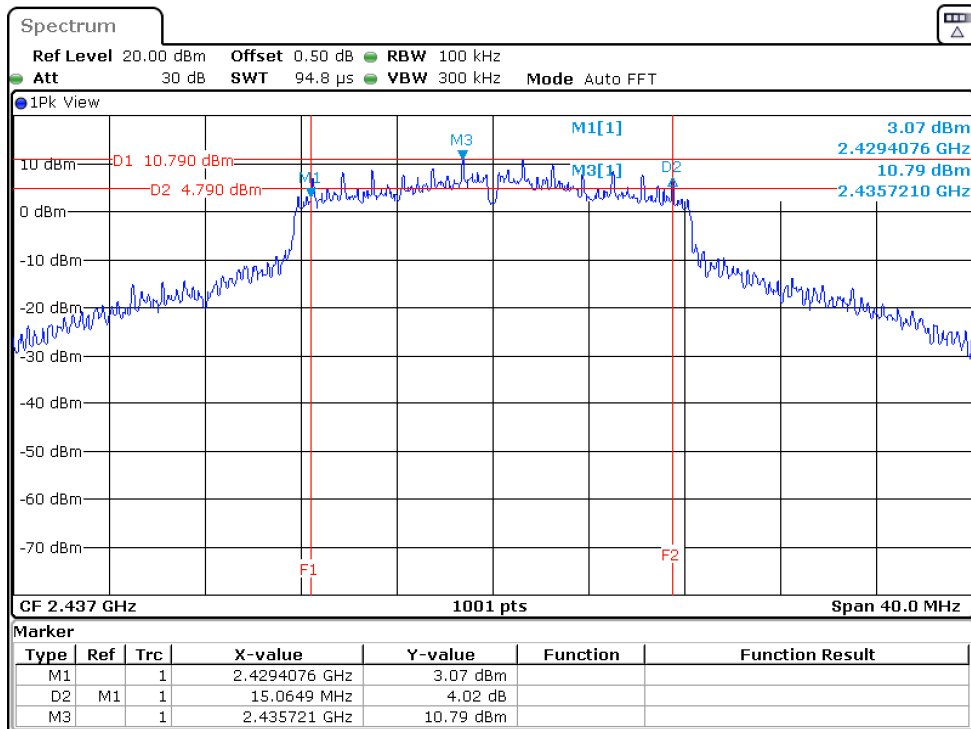

Product : Peplink Pepwave Wireless Product  
 Test Item : 6 dB Bandwidth Data  
 Test Mode : Transmit (802.11ax-20 MHz)-CDD

Chain A

Channel No.	Frequency (MHz)	Measurement Level (kHz)	Required Limit (kHz)	Result
01	2412	15224	>500	Pass
06	2437	17582	>500	Pass
11	2462	15064	>500	Pass

Chain B

Channel No.	Frequency (MHz)	Measurement Level (kHz)	Required Limit (kHz)	Result
01	2412	15064	>500	Pass
06	2437	18421	>500	Pass
11	2462	17262	>500	Pass

Channel 06 - Chain A

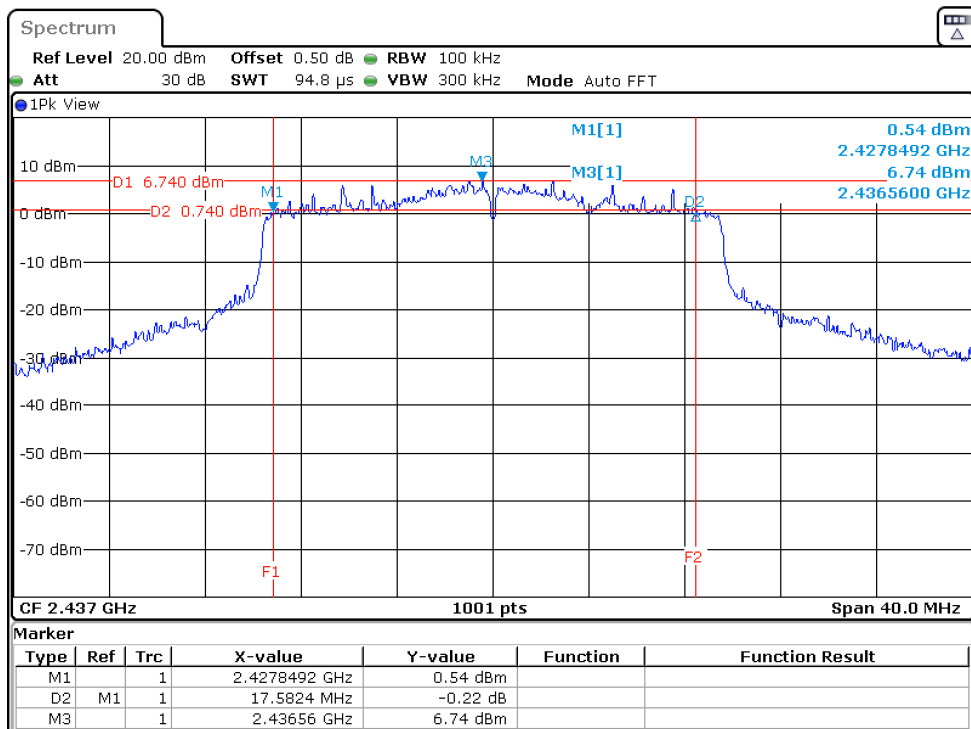



Product : Peplink Pepwave Wireless Product  
 Test Item : 6 dB Bandwidth Data  
 Test Mode : Transmit (802.11ax-40 MHz)-CDD

Chain A

Channel No.	Frequency (MHz)	Measurement Level (kHz)	Required Limit (kHz)	Result
03	2422	35005	>500	Pass
06	2437	35005	>500	Pass
09	2452	35084	>500	Pass

Chain B

Channel No.	Frequency (MHz)	Measurement Level (kHz)	Required Limit (kHz)	Result
03	2422	35005	>500	Pass
06	2437	33726	>500	Pass
09	2452	35005	>500	Pass

Channel 06 - Chain B

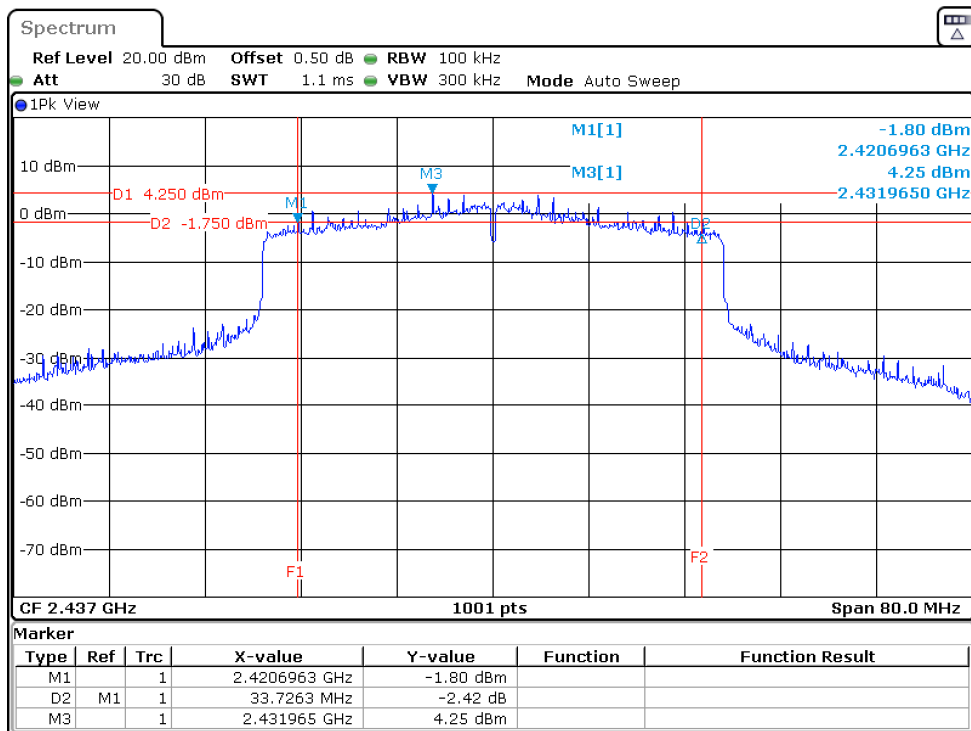

## 8. Power Density

### 8.1. Test Setup

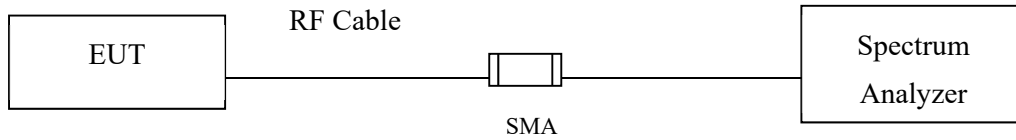

### 8.2. Limits

The transmitted power density averaged over any 1 second interval shall not be greater +8 dBm in any 3 kHz bandwidth.

### 8.3. Test Procedure

The EUT was setup according to ANSI C63.10, 2013; tested according to DTS test procedure of KDB 558074 for compliance to FCC 47CFR 15.247 requirements.

The maximum power spectral density using C63.10 Section 11.10.2 Method PKPSD (peak PSD)

8.4. Test Result of Power Density

Product : Peplink Pepwave Wireless Product  
 Test Item : Power Density Data  
 Test Mode : Transmit (802.11b)-CDD

Channel No.	Frequency (MHz)	Chain	PPSD (dBm)	Duty Factor (dB)	Total PPSD (dBm)	Limit (dBm)	Result
01	2412	A	-7.340	0.940	-4.61	6.46	Pass
		B	-10.250				Pass
06	2437	A	-6.240	0.940	-2.58	6.46	Pass
		B	-6.850				Pass
11	2462	A	-8.300	0.940	-3.47	6.46	Pass
		B	-6.680				Pass

Note: The quantity 10\*log 2 (two antennas) is added to the spectrum peak value according to document 662911 D01.

Channel 06 - Chain A

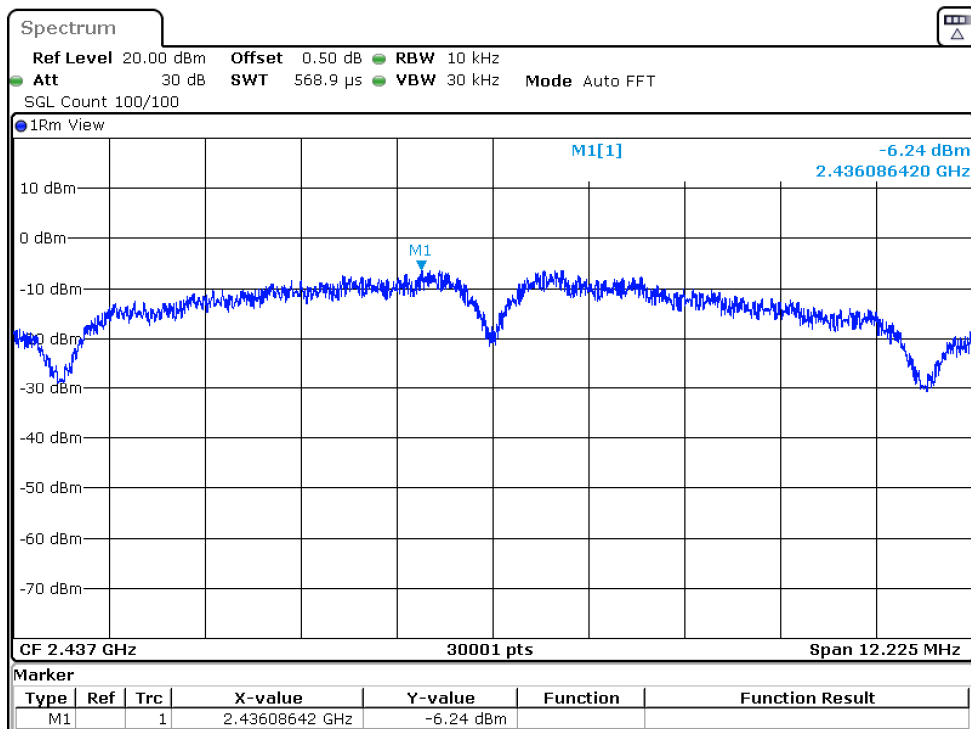

Product : Peplink Pepwave Wireless Product  
 Test Item : Power Density Data  
 Test Mode : Transmit (802.11g)-CDD

Channel No.	Frequency (MHz)	Chain	PPSD (dBm)	Duty Factor (dB)	Total PPSD (dBm)	Limit (dBm)	Result
01	2412	A	-11.610	0.284	-9.00	6.46	Pass
		B	-13.110				Pass
06	2437	A	-7.670	0.284	-4.04	6.46	Pass
		B	-7.030				Pass
11	2462	A	-11.180	0.284	-7.65	6.46	Pass
		B	-10.720				Pass

Note: The quantity  $10 \cdot \log 2$  (two antennas) is added to the spectrum peak value according to document 662911 D01.

Channel 06 - Chain B

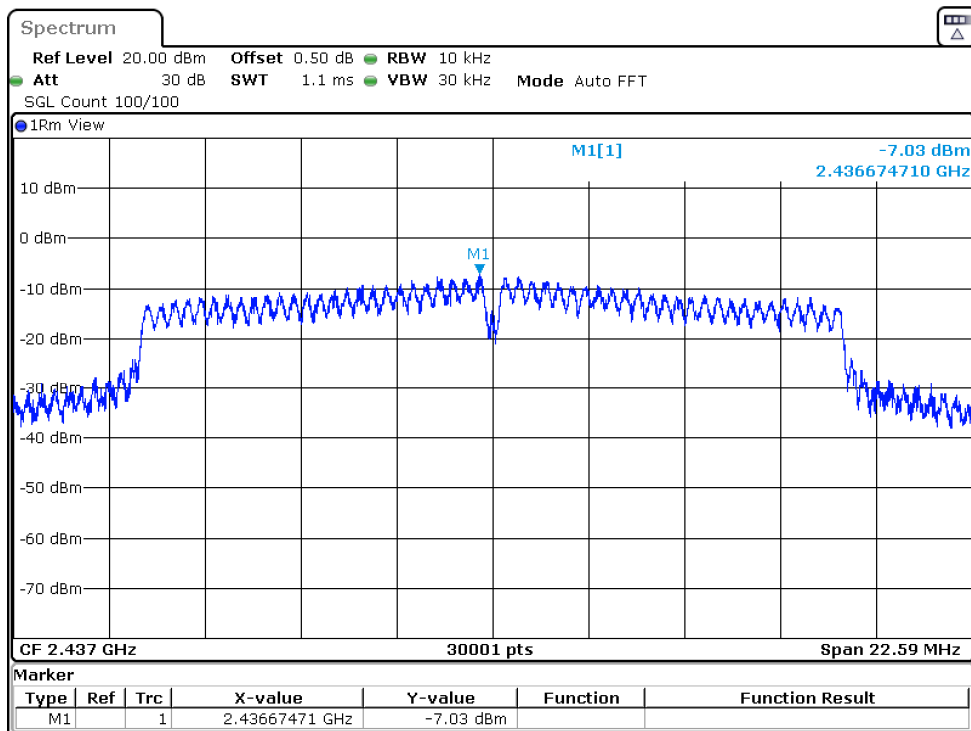

Product : Peplink Pepwave Wireless Product  
 Test Item : Power Density Data  
 Test Mode : Transmit (802.11ax-20 MHz)-CDD

Channel No.	Frequency (MHz)	Chain	PPSD (dBm)	Duty Factor (dB)	Total PPSD (dBm)	Limit (dBm)	Result
01	2412	A	-14.520	0.174	-11.31	6.46	Pass
		B	-14.470				Pass
06	2437	A	-10.720	0.174	-7.83	6.46	Pass
		B	-11.340				Pass
11	2462	A	-14.720	0.174	-11.44	6.46	Pass
		B	-14.540				Pass

Note: The quantity  $10 \cdot \log 2$  (two antennas) is added to the spectrum peak value according to document 662911 D01.

Channel 06 - Chain A

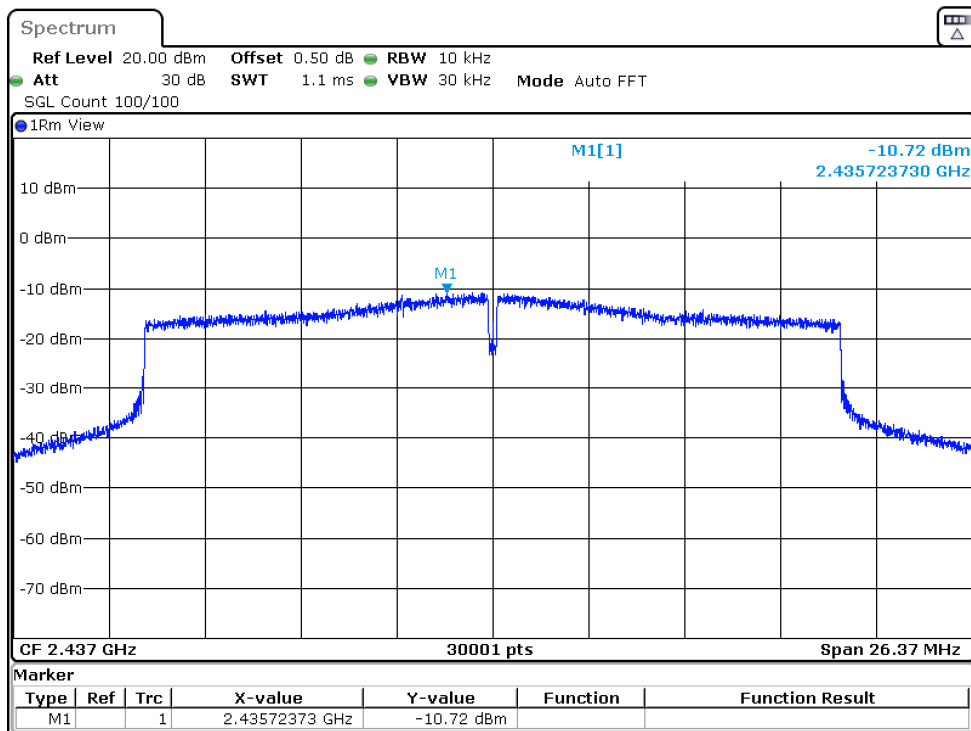

Product : Peplink Pepwave Wireless Product  
 Test Item : Power Density Data  
 Test Mode : Transmit (802.11ax-40 MHz)-CDD

Channel No.	Frequency (MHz)	Chain	PPSD (dBm)	Duty Factor (dB)	Total PPSD (dBm)	Limit (dBm)	Result
03	2422	A	-16.980	0.160	-13.77	6.46	Pass
		B	-16.910				Pass
06	2437	A	-14.590	0.160	-11.41	6.46	Pass
		B	-14.570				Pass
09	2452	A	-18.930	0.160	-15.29	6.46	Pass
		B	-18.040				Pass

Note: The quantity  $10 \cdot \log 2$  (two antennas) is added to the spectrum peak value according to document 662911 D01.

Channel 06 - Chain B

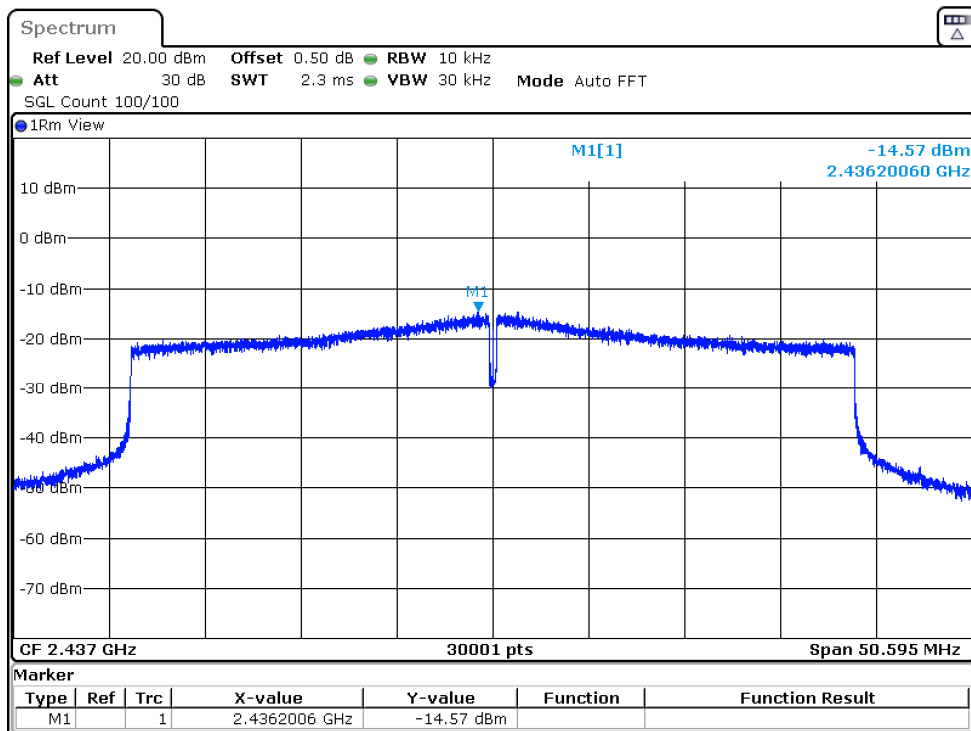

## 9. Duty Cycle

### 9.1. Test Setup

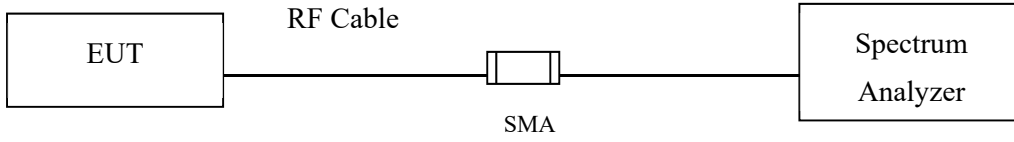

### 9.2. Test Procedure

The EUT was setup according to ANSI C63.10 2013; tested according to ANSI C63.10 2013 for compliance to FCC 47CFR 15.247 requirements.

### 9.3. Test Result of Duty Cycle

Product : Peplink Pepwave Wireless Product  
Test Item : Duty Cycle  
Test Mode : Transmit

Duty Cycle Formula:

Duty Cycle = Ton / (Ton + Toff)

Duty Factor = 10 Log (1/Duty Cycle)

Results:

2.4 GHz band	Ton (ms)	Ton + Toff (ms)	Duty Cycle (%)	Duty Factor (dB)
802.11b	0.6492	0.8060	80.55	0.94
802.11g	1.4342	1.5310	93.68	0.28
802.11ax-20 MHz	5.3800	5.6000	96.07	0.17
802.11ax-40 MHz	5.3400	5.5400	96.39	0.16



### 802.11b

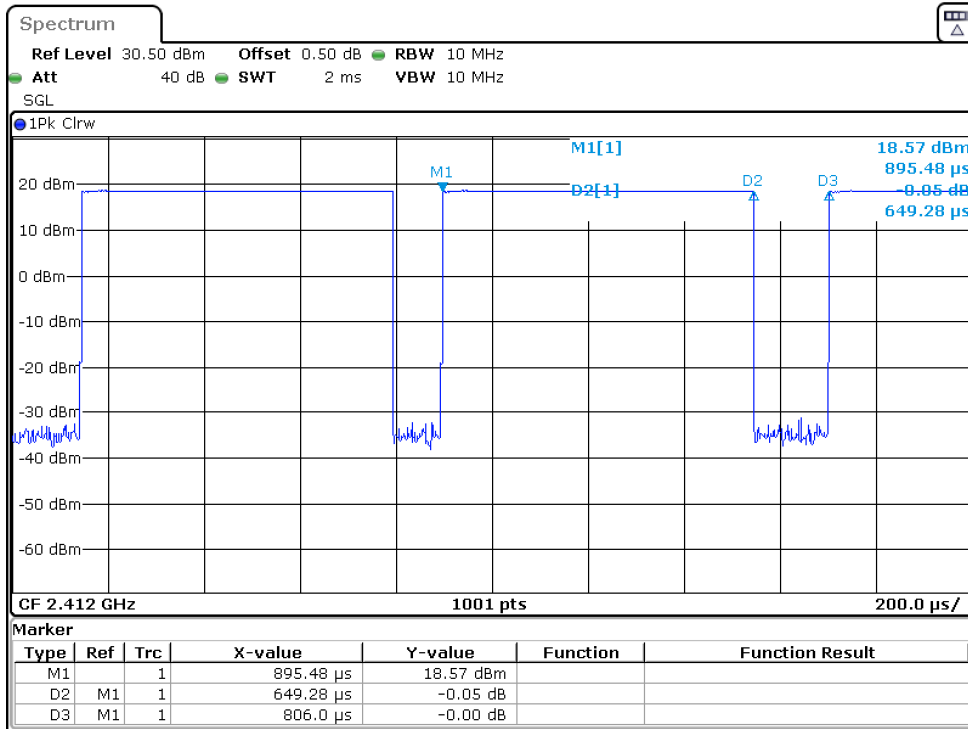

### 802.11g

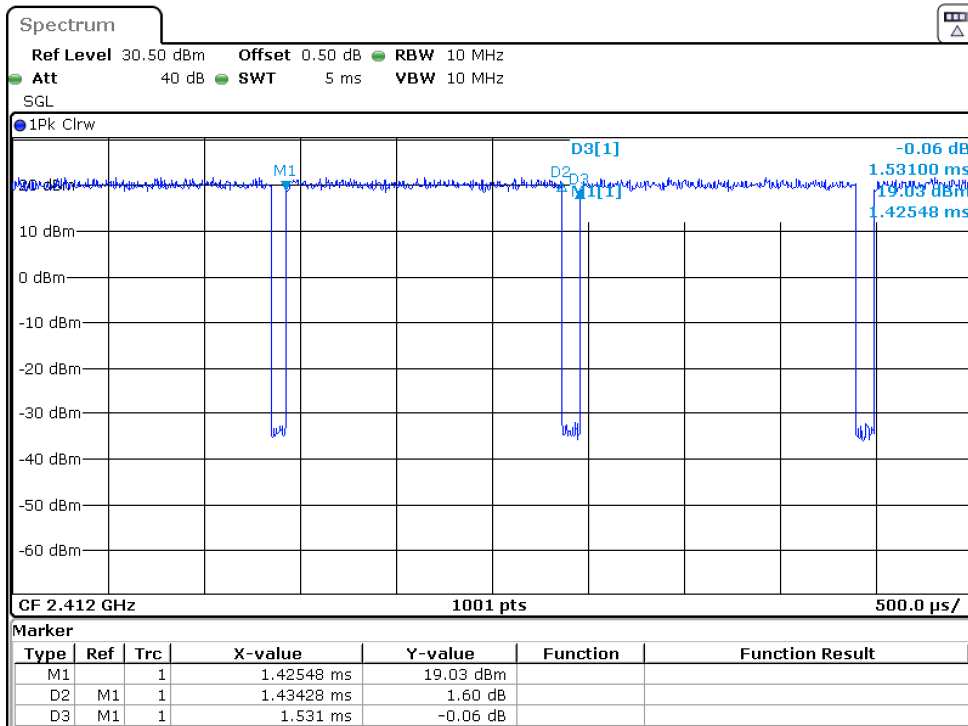

### 802.11ax-20 MHz

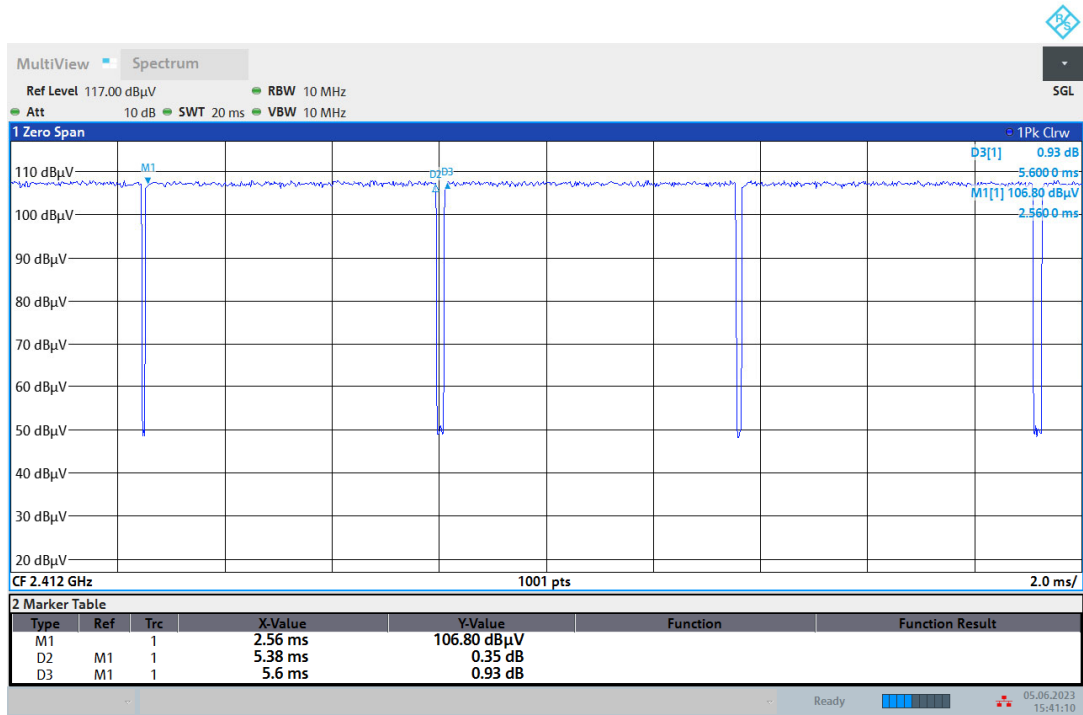

15:41:11 05.06.2023

### 802.11ax-40 MHz

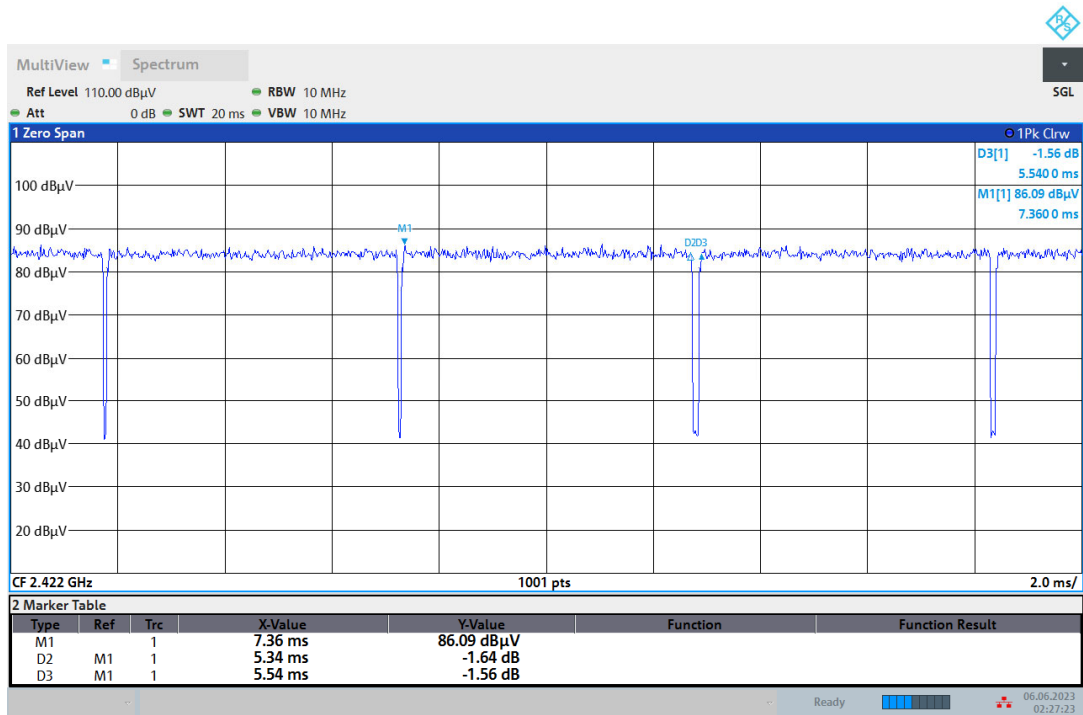

02:27:24 06.06.2023