

RF Test Report

Applicant : PISMO LABS TECHNOLOGY LIMITED

Product Type : PEPWAVE / peplink Wireless Product

Trade Name : PEPWAVE / peplink

Model Number : Balance 20X, B20X, Surf SOHO, Surf SOHO LTE,
Surf SOHO LTEA, Balance 20X LTE, Balance 20X LTEA, PismoAC8E,
BPL-021X-LTE-US-T, BPL-021X-LTEA-W-T, EXM-MINI-1LTEA-W,
EXM-MINI-1LTEA-P, PismoAC8P, PismoAC8

FCC ID : U8G-P1AC8E

Applicable Standard : FCC 47 CFR PART 15 SUBPART C
ANSI C63.10:2013

Receive Date : Jul. 01, 2019

Test Period : Jul. 29 ~ Aug. 07, 2019

Issue Date : Aug. 21, 2019

Issue by

A Test Lab Techno Corp.
No. 140-1, Changan Street, Bade District,
Taoyuan City 33465, Taiwan (R.O.C.)
Tel : +886-3-2710188 / Fax : +886-3-2710190



Taiwan Accreditation Foundation accreditation number: 1330

Test Firm MRA designation number: TW0010

Note:

1. The test results are valid only for samples provided by customers and under the test conditions described in this report.
2. This report shall not be reproduced except in full, without the written approval of A Test Lab Technology Corporation.
3. The relevant information is provided by customers in this test report. According to the correctness, appropriateness or completeness of the information provided by the customer, if there is any doubt or error in the information which affects the validity of the test results, the laboratory does not take the responsibility.



Revision History

Rev.	Issue Date	Revisions	Revised By
00	Aug. 21, 2019	Initial Issue	Nina Lin

Verification of Compliance

Issued Date: Aug. 21, 2019

Applicant : PISMO LABS TECHNOLOGY LIMITED

Product Type : PEPWAVE / peplink Wireless Product

Trade Name : PEPWAVE / peplink

Model Number : Balance 20X, B20X, Surf SOHO, Surf SOHO LTE,
Surf SOHO LTEA, Balance 20X LTE, Balance 20X LTEA, PismoAC8E,
BPL-021X-LTE-US-T, BPL-021X-LTEA-W-T, EXM-MINI-1LTEA-W,
EXM-MINI-1LTEA-P, PismoAC8P, PismoAC8

EUT Rated Voltage : DC 12 V, 3 A

Test Voltage : 120 Vac / 60 Hz

Applicable Standard : FCC 47 CFR PART 15 SUBPART C
ANSI C63.10:2013

Test Result : Complied

Performing Lab. : A Test Lab Techno Corp.
No. 140-1, Changan Street, Bade District,
Taoyuan City 33465, Taiwan (R.O.C.)
Tel : +886-3-2710188 / Fax : +886-3-2710190



Taiwan Accreditation Foundation accreditation number: 1330
<http://www.atl-lab.com.tw/e-index.htm>

A Test Lab Techno Corp. tested the above equipment in accordance with the requirements set forth in the above standards. All indications of Pass/Fail in this report are opinions expressed by A Test Lab Techno Corp. based on interpretations and/or observations of test results. The test results show that the equipment tested is capable of demonstrating compliance with the requirements as documented in this report.

Approved By : Fly Lu Reviewed By : Ken Yang
(Manager) (Fly Lu) (Testing Engineer) (Ken Yang)



TABLE OF CONTENTS

1	General Information	5
1.1.	Summary of Test Result	5
1.2.	Measurement Uncertainty	6
2	EUT Description.....	7
3	Test Methodology.....	8
3.1.	Mode of Operation.....	8
3.2.	EUT Test Step.....	12
3.3.	Configuration of Test System Details.....	12
3.4.	Test Instruments	15
3.5.	Test Site Environment.....	16
4	Measurement Procedure.....	17
4.1.	AC Power Line Conducted Emission Measurement.....	17
4.2.	Radiated Emission Measurement.....	19
4.3.	Maximum Conducted Output Power Measurement.....	23
4.4.	6 dB RF Bandwidth Measurement.....	24
4.5.	Maximum Power Density Measurement.....	25
4.6.	Out of Band Conducted Emissions Measurement.....	26
4.7.	Antenna Measurement	27
5	Test Results	28
	Annex A. Conducted Emission	28
	Annex B. Conducted Test Results	30
	Annex C. Radiated Emission Measurement.....	74



1 General Information

1.1. Summary of Test Result

Standard	Item	Result	Remark
15.207	AC Power Conducted Emission	PASS	-----
15.247(d)	Transmitter Radiated Emissions	PASS	-----
15.247(b)(3)	Max. Output Power	PASS	-----
15.247(a)(2)	6 dB RF Bandwidth	PASS	-----
15.247(e)	Maximum Power Spectral Density	PASS	-----
15.247(d)	Out of Band Conducted Spurious Emission	PASS	-----
15.203	Antenna Requirement	PASS	-----

Standard	Description
CFR47, Part 15, Subpart C	Intentional Radiators
ANSI C63. 10: 2013	American National Standard of Procedures for Compliance Testing of Unlicensed Wireless Devices
KDB 558074 D01 15.247 Meas Guidance v05r02	GUIDANCE FOR COMPLIANCE MEASUREMENTS ON DIGITAL TRANSMISSION SYSTEM, FREQUENCY HOPPING SPREAD SPECTRUM SYSTEM, AND HYBRID SYSTEM DEVICES OPERATING UNDER SECTION 15.247 OF THE FCC RULES



1.2. Measurement Uncertainty

Test Item	Frequency Range	Uncertainty (dB)
Conducted Emission	150 kHz ~ 30 MHz	2.8
Radiated Emission	9 kHz ~ 30 MHz	1.7
	30 MHz ~ 1000 MHz	5.7
	1000 MHz ~ 18000 MHz	5.6
	18000 MHz ~ 26500 MHz	4.9
	26500 MHz ~ 40000 MHz	4.8
Conducted Output Power	+0.27 dB / -0.28 dB	
RF Bandwidth	4.96 %	
Power Spectral Density	+0.71 dB / -0.77 dB	

Decision Rule

- Uncertainty is not included.
- Uncertainty is included.



2 EUT Description

Applicant	PISMO LABS TECHNOLOGY LIMITED A8, 5/F, HK Spinners Industrial Building, Phase 6, 481 Castle Peak Road, Cheung Sha Wan, Hong Kong			
Manufacturer	PISMO LABS TECHNOLOGY LIMITED A8, 5/F, HK Spinners Industrial Building, Phase 6, 481 Castle Peak Road, Cheung Sha Wan, Hong Kong			
Product Type	PEPWAVE / peplink Wireless Product			
Trade Name	PEPWAVE / peplink			
Model Number	Balance 20X, B20X, Surf SOHO, Surf SOHO LTE, Surf SOHO LTEA, Balance 20X LTE, Balance 20X LTEA, PismoAC8E, BPL-021X-LTE-US-T, BPL-021X-LTEA-W-T, EXM-MINI-1LTEA-W, EXM-MINI-1LTEA-P, PismoAC8P, PismoAC8			
Product Type /Trade Name / Model Number Different Description	These product types & trade names & model numbers differ from each other in selling region.			
FCC ID	U8G-P1AC8E			
Operate Freq. Band	Frequency Range (MHz)	Modulation	Channel Bandwidth	Data Rate 400 / 800 GI (ns)
IEEE 802.11b	2412 ~ 2462	DSSS	20 MHz	Up to 11 Mbps
IEEE 802.11g	2412 ~ 2462	OFDM	20 MHz	Up to 54 Mbps
IEEE 802.11n 2.4 GHz 20 MHz	2412 ~ 2462	OFDM (256QAM)	20 MHz	Up to 144.4 Mbps
IEEE 802.11n 2.4 GHz 40 MHz	2422 ~ 2452	OFDM (256QAM)	40 MHz	Up to 300 Mbps
Antenna information	ANT	Model Number	Type	Max. Gain (dBi)
	ANT-0/ANT-1	98614PRSX000	Replacement antenna (RP SMA)	2.44
Antenna Delivery	See section 3.1			
Operate Temp. Range	-10 ~ +45 °C			

Frequency Band	Max. RF Output Power (W)
IEEE 802.11b	0.183
IEEE 802.11g	0.456
IEEE 802.11n 2.4 GHz 20 MHz	0.327
IEEE 802.11n 2.4 GHz 40 MHz	0.097

3 Test Methodology

3.1. Mode of Operation

Decision of Test ATL has verified the construction and function in typical operation. All the test modes were carried out with the EUT in normal operation, which was shown in this test report and defined as:

Test Mode
Mode 1: Transmit mode
Mode 2: IEEE 802.11b Continuous TX mode
Mode 3: IEEE 802.11g Continuous TX mode
Mode 4: IEEE 802.11n 2.4 GHz 20 MHz Continuous TX mode
Mode 5: IEEE 802.11n 2.4 GHz 40 MHz Continuous TX mode

Software used to control the EUT for staying in continuous transmitting mode was programmed.

After verification, all tests were carried out with the worst case test modes.

By preliminary testing and verifying three axis (X, Y and Z) position of EUT transmitted status, it was found that "X axis" position was the worst, then the final test was executed the worst condition and test data were recorded in this report.

Note:The device had two models of WCDMA/LTE Module with two Antennas (Module:Telit, LE910C4-NF+Antenna Model:98619ZSAX053 and Module:Sierra, MC7455+Antenna Model:98619ZSAX025). In the test report, we use WCDMA/LTE Module:Sierra, MC7455+Antenna Model:98619ZSAX025 to test.

Test Mode	ANT-0	ANT-1	ANT-0+1
Mode 2	V	V	---
Mode 3	V	V	V
Mode 4	V	V	V
Mode 5	V	V	V

Test Mode	Antenna Delivery	Data Rate (Mbps)	Test Channel
Mode 2	1TX (Diversity)	1	1, 6, 11
Mode 3	2TX (CDD)	6	1, 6, 11
Mode 4	2TX (MIMO)	13	1, 6, 11
Mode 5	2TX (MIMO)	27	3, 6, 9



Duty cycle

Test Mode	Frequency (MHz)	on time (ms)	on+off time (ms)	Duty cycle	Duty Factor (dB)	1/T Minimum VBW (kHz)
Mode 2	2412.0	12.480	12.520	0.997	0.014	0.010
Mode 3	2412.0	2.090	2.150	0.972	0.123	0.478
Mode 4	2412.0	5.060	5.120	0.988	0.051	0.010
Mode 5	2422.0	2.460	2.520	0.976	0.105	0.407



Duty Cycle Graphs

Mode 2: IEEE 802.11b Continuous TX mode

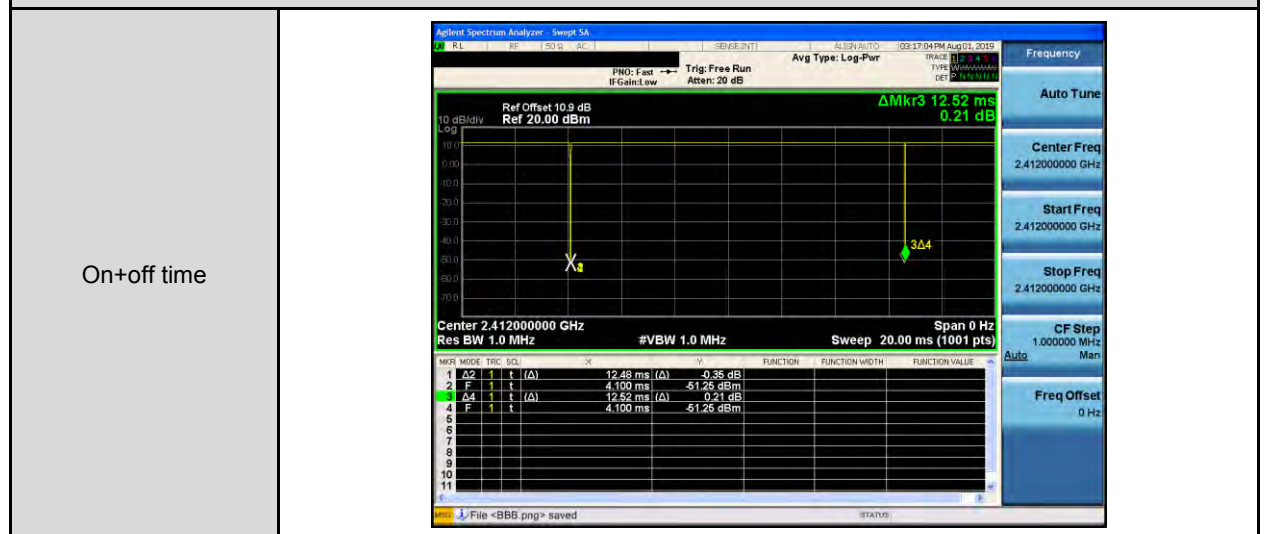

Mode 3: IEEE 802.11g Continuous TX mode





Mode 4: IEEE 802.11n 2.4 GHz 20 MHz Continuous TX mode

On+off time

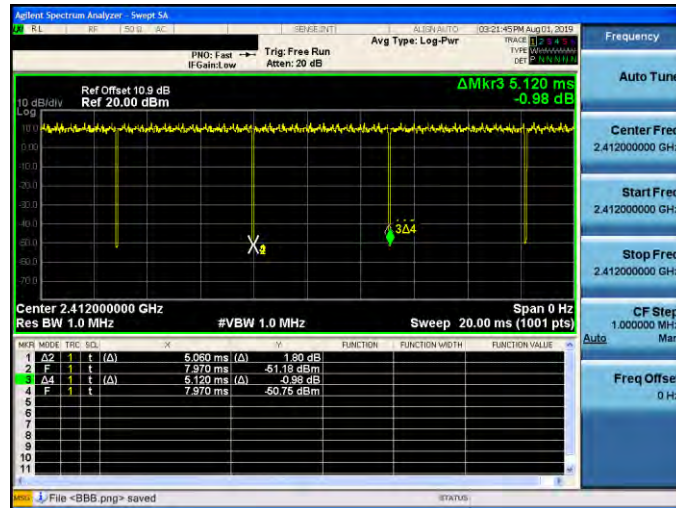

Mode 5: IEEE 802.11n 2.4 GHz 40 MHz Continuous TX mode

On+off time

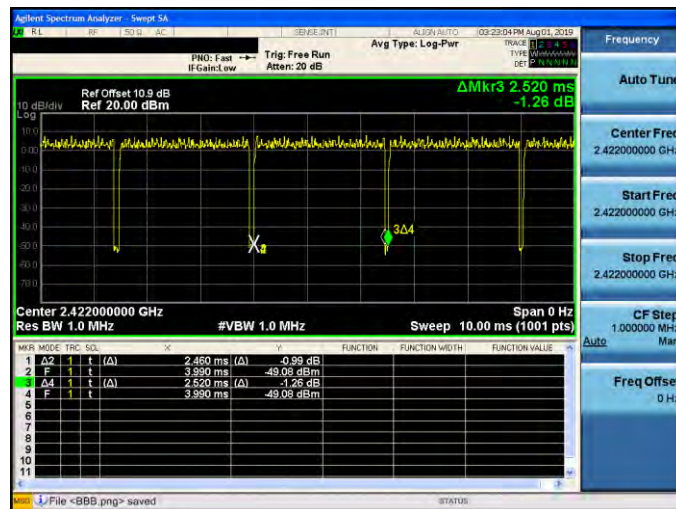

3.2. EUT Test Step

1.	Setup the EUT shown on “Configuration of Test System Details”.
2.	Turn on the power of all equipment.
3.	Turn Wi-Fi function link to Notebook.
4.	EUT run test program.

Measurement Software			
No.	Description	Software	Version
1	Conducted Emission	EZ EMC	1.1.4.3
2	Radiated Emission	EZ EMC	1.1.4.4

3.3. Configuration of Test System Details

Conducted Emissions

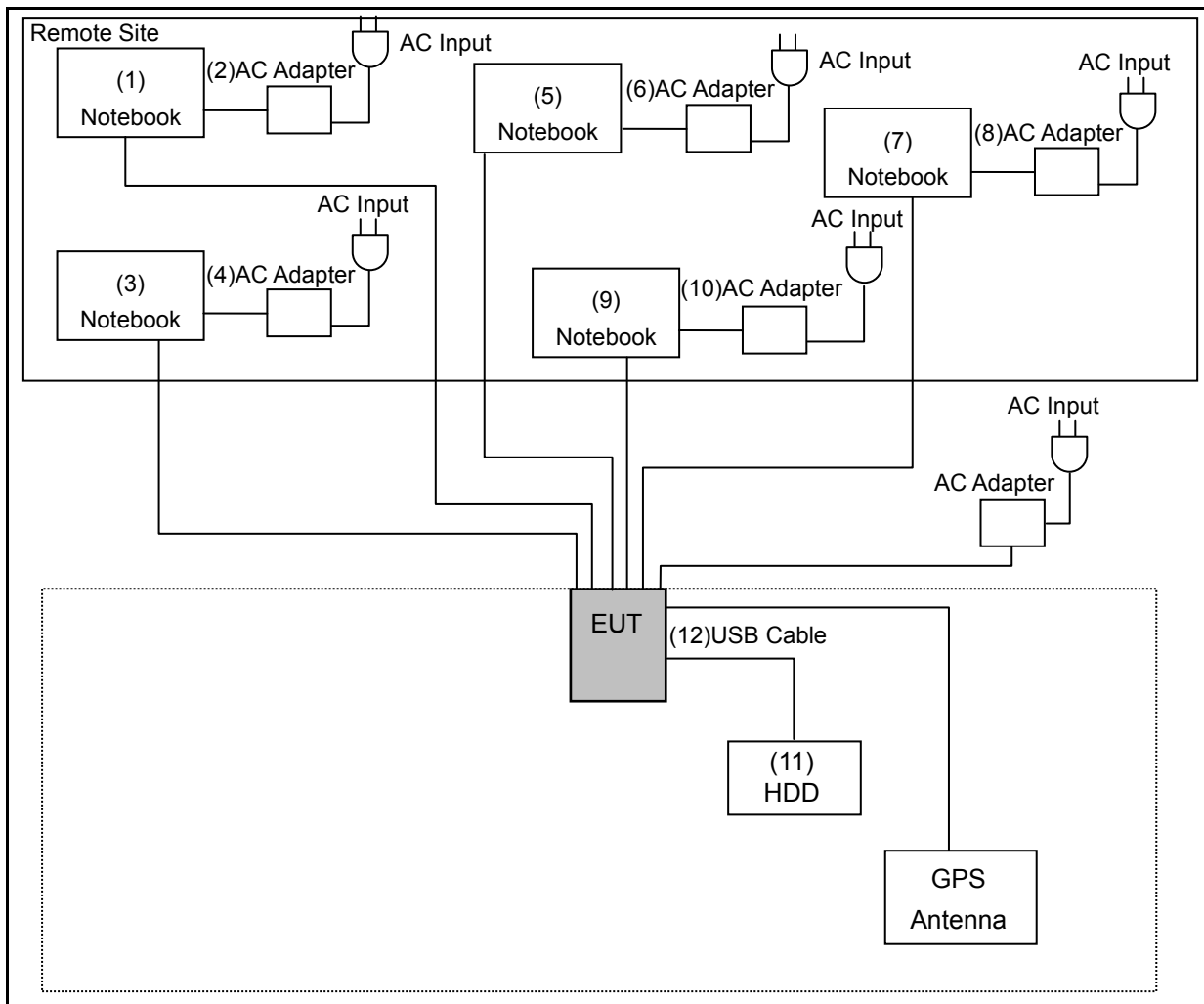

Radiated Emission_Below 1 GHz

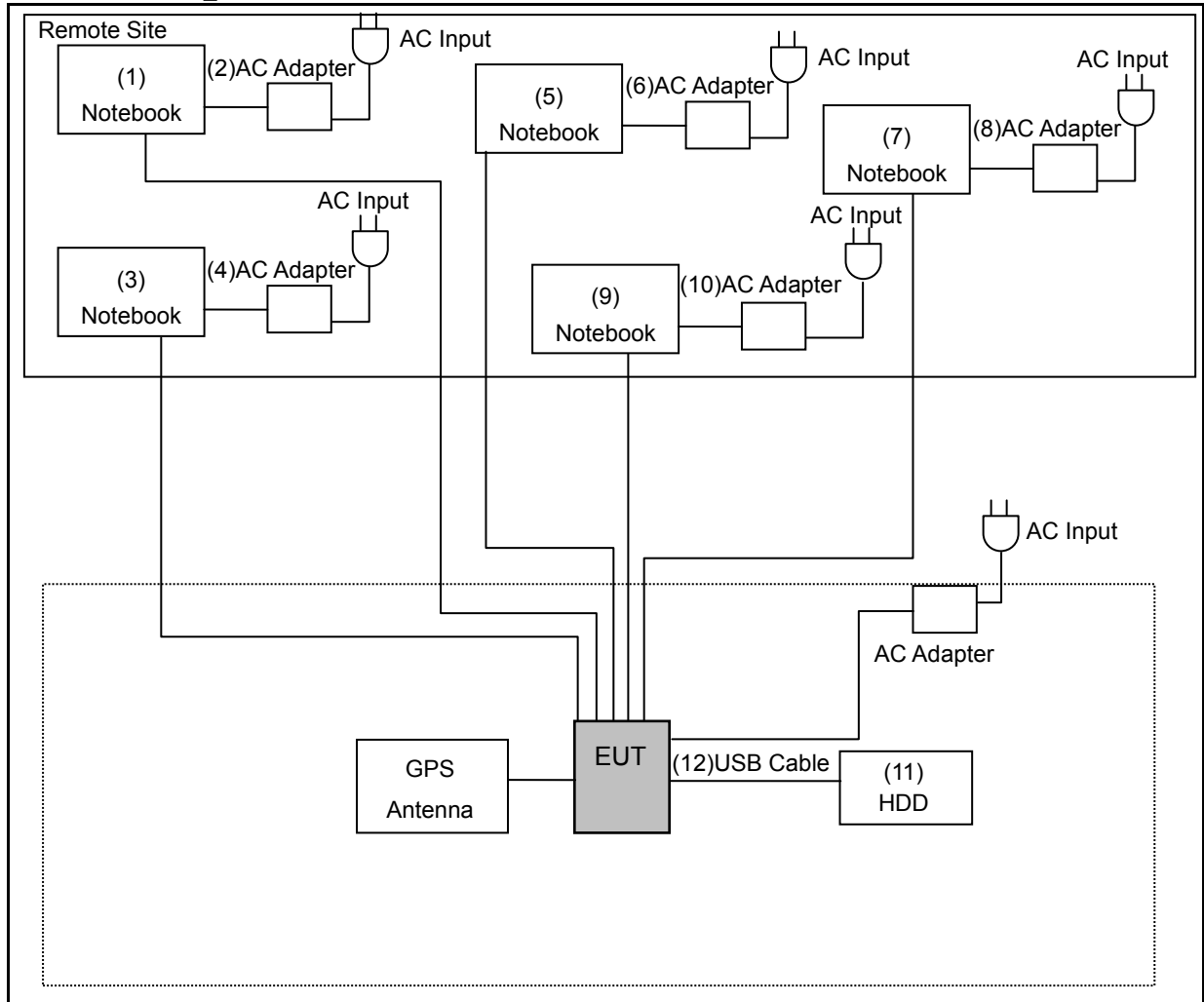

Radiated Emission_Above 1 GHz

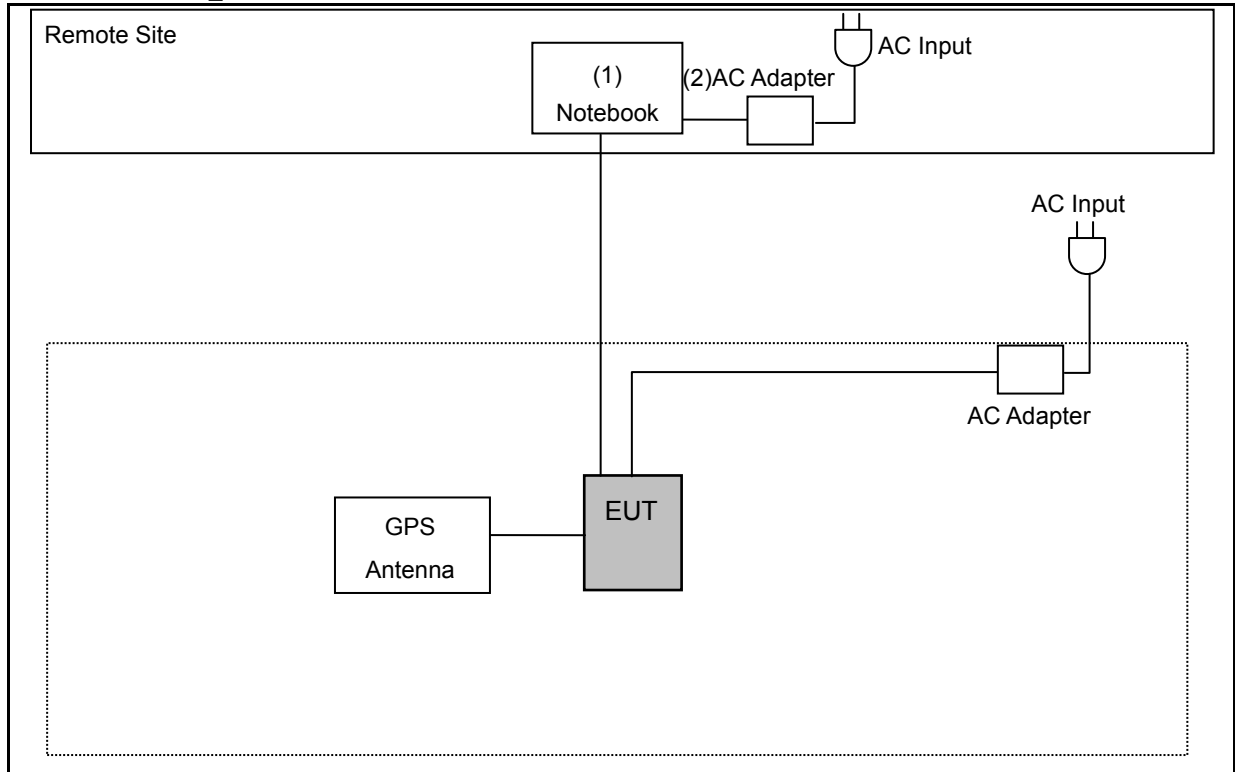

Devices Description					
	Product	Manufacturer	Model Number	Serial Number	Power Cord
(1)	Notebook	ASUS	P2430U	GANXCV04H86940A	---
(2)	AC Adapter	ASUS	ADP-65GD B	---	Non-Shielded, 0.8 m
(3)	Notebook	ASUS	P2430U	GANXCV04H82540A	---
(4)	AC Adapter	ASUS	ADP-65GD B	---	Non-Shielded, 0.8 m
(5)	Notebook	DELL	LATITUDE E6440	5HZBD72	---
(6)	AC Adapter	DELL	HA65NM130	---	Non-Shielded, 0.8 m
(7)	Notebook	DELL	LATITUDE E6440	48GBD72	---
(8)	AC Adapter	DELL	HA65NM130	---	Non-Shielded, 0.8 m
(9)	Notebook	ASUS	BU400A	D1NXAS148534020	---
(10)	AC Adapter	ASUS	EXA1203YH	---	Non-Shielded, 0.8 m
(11)	HDD	Transend	TS1TSJ25A3K-RU	D72654-0611	---
(12)	USB Cable	Transend	TS1TSJ25A3K-RU	D72654-0611	---



3.4. Test Instruments

For Conducted Emission

Test Period: Aug. 07, 2019

Equipment	Manufacturer	Model Number	Serial Number	Cal. Date	Cal. Period
Test Receiver	R&S	ESCI	100367	05/23/2019	1 year
LISN	R&S	ENV216	101040	04/03/2019	1 year
LISN	R&S	ENV216	101041	03/28/2019	1 year
RF Cable	Woken	00100D1380194M	TE-02-03	05/23/2019	1 year

For Radiated Emissions

Test Period: Jul. 29 ~ Jul. 31, 2019

Equipment	Manufacturer	Model Number	Serial Number	Cal. Date	Cal. Period
Spectrum Analyzer (10 Hz~44 GHz)	Keysight	N9010A	MY52221312	01/14/2019	1 year
Pre Amplifier (1~26.5 GHz)	Agilent	8449B	3008A02237	10/16/2018	1 year
Pre Amplifier (100 kHz~1.3 GHz)	Agilent	8447D	2944A11119	01/14/2019	1 year
Pre Amplifier (26.5~40 GHz)	EMCI	EMC2654045	980028	08/23/2018	1 year
Broadband Antenna	Schwarzbeck	VULB9168	416	10/19/2018	1 year
Horn Antenna (1~18 GHz)	SCHWARZBECK MESS-ELEKTRONIK	BBHA9120D	9120D-550	08/23/2018	1 year
Horn Antenna (18~40 GHz)	SCHWARZBECK MESS-ELEKTRONIK	BBHA9170	9170-320	08/07/2018	1 year
Loop Antenna	COM-POWER CORPORATION	AL-130	121014	03/29/2019	1 year
RF Cable	EMCI	EMC104-N-N-6000	TE01-1	02/20/2019	1 year
Microwave Cable	EMCI	EMC104-SM-SM-1 3000	170814	10/30/2018	1 year
Microwave Cable	EMCI	EMC102-KM-KM-1 4000	151001	02/20/2019	1 year

For Conducted

Test Period: Aug. 01 ~ Aug. 02, 2019

Equipment	Manufacturer	Model Number	Serial Number	Cal. Date	Cal. Period
Power Sensor	Anritsu	MA2411B	1126022	08/29/2018	1 year
Power Meter	Anritsu	ML2495A	1135009	08/29/2018	1 year
Spectrum Analyzer (3 Hz~50 GHz)	Agilent	N9030A	MY53120541	01/22/2019	1 year

Note: N.C.R. = No Calibration Request.



3.5. Test Site Environment

Items	Required (IEC 60068-1)	Actual
Temperature (°C)	15-35	26
Humidity (%RH)	25-75	60
Barometric pressure (mbar)	860-1060	990

4 Measurement Procedure

4.1. AC Power Line Conducted Emission Measurement

■ Limit

Frequency (MHz)	Quasi-peak	Average
0.15 - 0.5	66 to 56	56 to 46
0.50 - 5.0	56	46
5.0 - 30.0	60	50

■ Test Setup

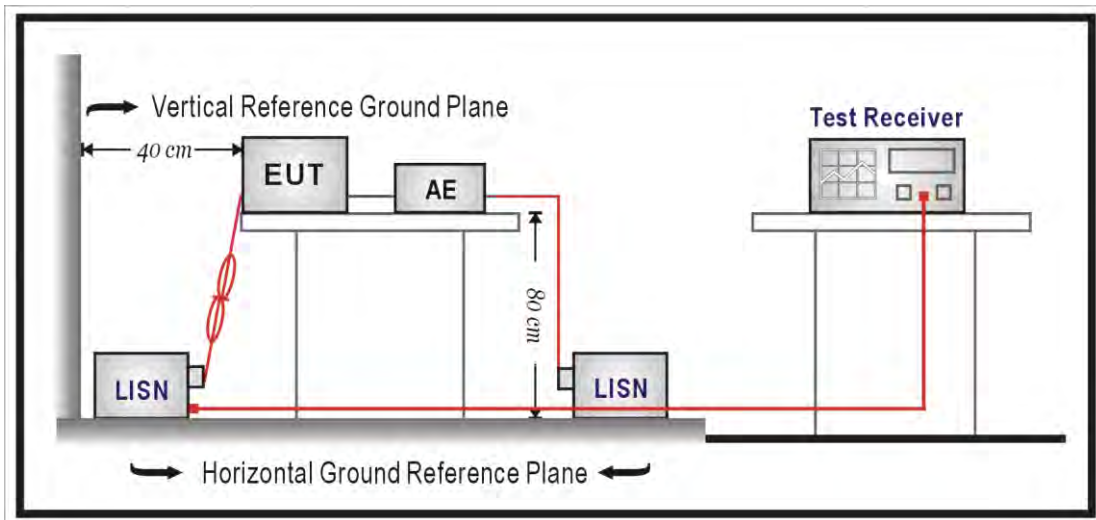

■ Test Procedure

The EUT and simulators are connected to the main power through a line impedance stabilization network (L.I.S.N.). This provides a $50 \Omega // 50 \mu\text{H}$ coupling impedance for the measuring equipment. The peripheral devices are also connected to the main power through a LISN that provides a $50 \Omega // 50 \mu\text{H}$ coupling impedance with 50 ohm termination.

Tabletop device shall be placed on a non-conducting platform, of nominal size 1 m by 1.5 m, raised 80 cm above the reference ground plane. The wall of screened room shall be located 40 cm to the rear of the EUT. Other surfaces of tabletop or floor standing EUT shall be at least 80 cm from any other ground conducting surface including one or more LISNs. For floor-standing device shall be placed under the EUT with a 12 mm insulating material.

Conducted emissions were investigated over the frequency range from 0.15 MHz to 30 MHz using a resolution bandwidth of 9 kHz. The equipment under test (EUT) shall be meet the limits in section 4.1, as applicable, including the average limit and the quasi-peak limit when using respectively, an average detector and quasi-peak detector measured in accordance with the methods described of related standard. When all of peak value were complied with quasi-peak and average limit from 150 kHz to 30 MHz then quasi-peak and average measurement was unnecessary.

The AMN shall be placed 0.8 m from the boundary of the unit under test and bonded to a ground reference plane for AMNs mounted on top of the ground reference plane. This distance is between the closest points of the AMN and the EUT. All other units of the EUT and associated equipment shall be at least 0.8 m from the AMN. If the mains power cable is longer than 1 m then the cable shall be folded back and forth at the centre of the lead to form a bundle no longer than 0.4 m. All of interconnecting cables that hang closer than 40 cm to the ground plane shall be folded back and forth in the center forming a bundle 30 cm to 40 cm long. All of EUT and AE shall be separate place more than 0.1 m. All 50Ω ports of the LISN shall be resistively terminated into 50Ω loads when not connected to the measuring instrument.

If the reading of the measuring receiver shows fluctuations close to the limit, the reading shall be observed for at least 15 s at each measurement frequency; the higher reading shall be recorded with the exception of any brief isolated high reading which shall be ignored.

4.2. Radiated Emission Measurement

■ Limit

According to §15.209(a), except as provided elsewhere in this subpart, the emissions from an intentional radiator shall not exceed the field strength levels specified in the following table:

Frequency (MHz)	Field Strength ($\mu\text{V}/\text{m}$ at meter)	Measurement Distance (meters)
0.009 – 0.490	$2400 / F$ (kHz)	300
0.490 – 1.705	$24000 / F$ (kHz)	30
1.705 – 30.0	30	30
30 - 88	100**	3
88-216	150**	3
216-960	200**	3
Above 960	500	3

** Except as provided in paragraph (g), fundamental emissions from intentional radiators operating under this Section shall not be located in the frequency bands 54-72 MHz, 76-88 MHz, 174-216 MHz or 470-806 MHz. However, operation within these frequency bands is permitted under other sections of this Part, e.g., Sections 15.231 and 15.241.

■ Setup

9 kHz ~ 30 MHz

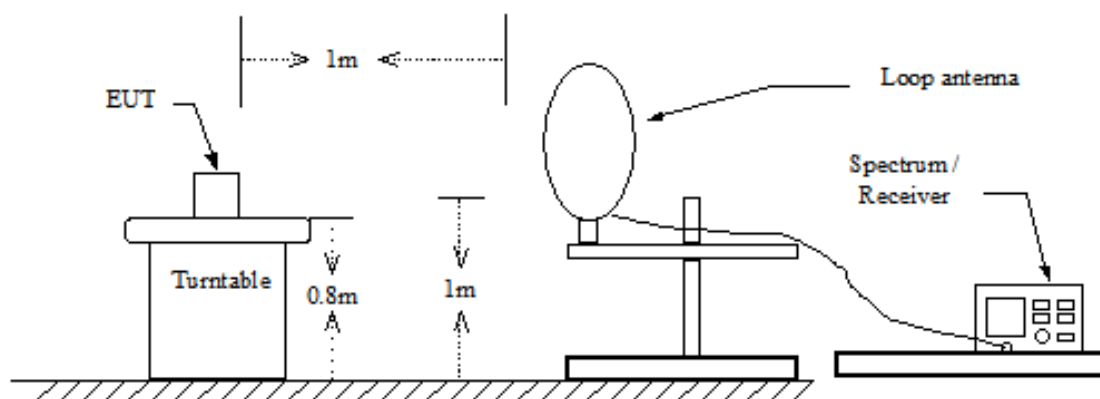

Below 1 GHz

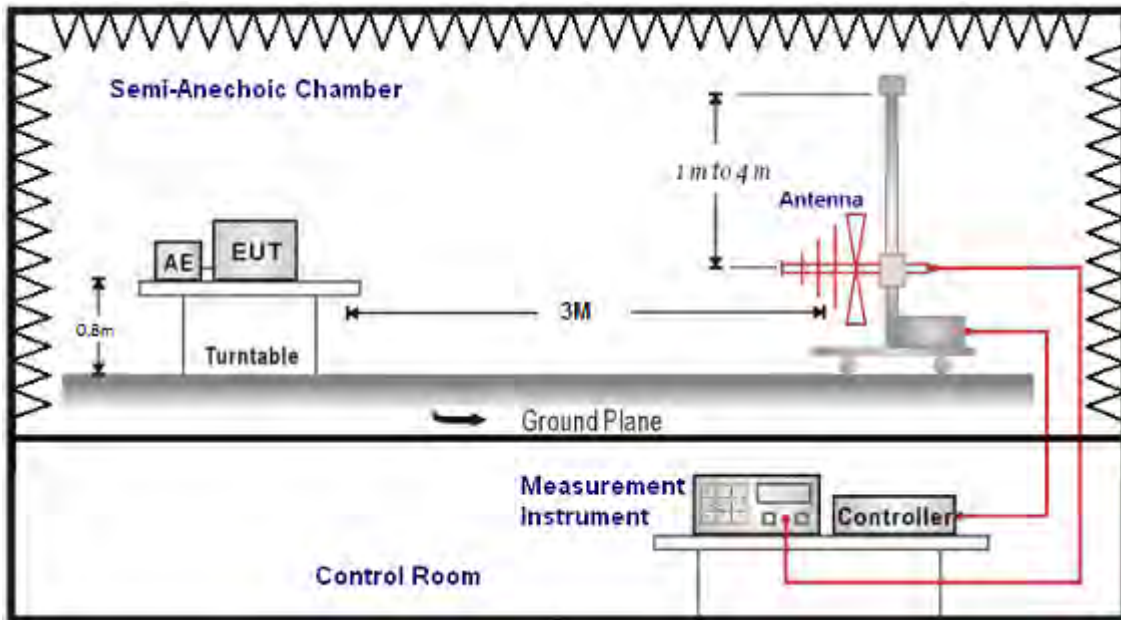

Above 1 GHz

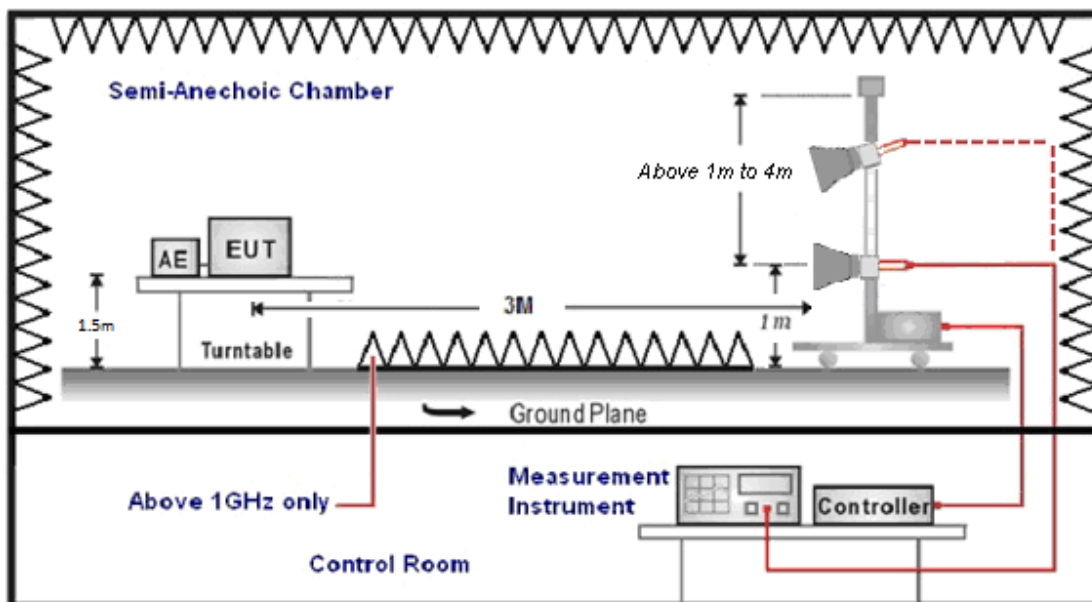

■ Test Procedure

Final radiation measurements were made on a three-meter, Semi Anechoic Chamber. The EUT system was placed on a nonconductive turntable which is 0.8 or 1.5 meters height, top surface 1.0 x 1.5 meter. The spectrum was examined from 250 MHz to 2.5 GHz in order to cover the whole spectrum below 10th harmonic which could generate from the EUT. During the test, EUT was set to transmit continuously & Measurements spectrum range from 9 kHz to 26.5 GHz is investigated.

For measurements below 1 GHz the resolution bandwidth is set to 100 kHz for peak detection measurements or 120 kHz for quasi-peak detection measurements. Peak detection is used unless otherwise noted as quasi-peak.

For measurements above 1 GHz the resolution bandwidth is set to 1 MHz, and then the video bandwidth is set to 3 MHz for peak measurements and 10 Hz for average measurements when Duty cycle $>0.98 / 1/T$ for average measurements when Duty cycle <0.98 . A nonconductive material surrounded the EUT to supporting the EUT for standing on three orthogonal planes. At each condition, the EUT was rotated 360 degrees, and the antenna was raised and lowered from one to four meters to find the maximum emission levels. Measurements were taken using both horizontal and vertical antenna polarization.

SCHWARZBECK MESS-ELEKTRONIK Biconilog Antenna at 3 Meter and the SCHWARZBECK Double Ridged Guide Antenna was used in frequencies 1 –26.5 GHz at a distance of 3 meter. The antenna at an angle toward the source of the emission. All test results were extrapolated to equivalent signal at 3 meters utilizing an inverse linear distance extrapolation Factor (20 dB/decade).

For testing above 1 GHz, the emission level of the EUT in peak mode was 20 dB lower than average limit (that means the emission level in peak mode also complies with the limit in average mode), then testing will be stopped and peak values of EUT will be reported, otherwise, the emissions will be measured in average mode again and reported.

Appropriate preamplifiers were used for improving sensitivity and precautions were taken to avoid overloading or desensitizing the spectrum analyzer. No post – detector video filters were used in the test.

The spectrum analyzer's 6 dB bandwidth was set to 1 MHz, and the analyzer was operated in the peak detection mode, for frequencies both below and up 1 GHz. The average levels were obtained by subtracting the duty cycle correction factor from the peak readings.

The following procedures were used to convert the emission levels measured in decibels referenced to 1 microvolt (dBuV) into field intensity in micro volts pre meter (uV/m).

The actual field intensity in decibels referenced to 1 microvolt in to field intensity in micro colts per meter (dBuV/m).



The actual field intensity in referenced to 1 microvolt per meter (dBuV/m) is determined by algebraically adding the measured reading in dBuV, the antenna factor (dB), and cable loss (dB) and Subtracting the gain of preamplifier (dB) is auto calculate in spectrum analyzer.

(1) $\text{Amplitude (dBuV/m)} = \text{FI (dBuV)} + \text{AF (dBuV)} + \text{CL (dBuV)} - \text{Gain (dB)}$

FI= Reading of the field intensity.

AF= Antenna factor.

CL= Cable loss.

P.S Amplitude is auto calculate in spectrum analyzer.

(2) $\text{Actual Amplitude (dBuV/m)} = \text{Amplitude (dBuV)} - \text{Dis(dB)}$

The FCC specified emission limits were calculated according the EUT operating frequency and by following linear interpolation equations:

(a) For fundamental frequency : Transmitter Output < +30 dBm

(b) For spurious frequency : Spurious emission limits = fundamental emission limit /10

Data of measurement within this frequency range without mark in the table above means the reading of emissions are attenuated more than 20 dB below the permissible limits or the field strength is too small to be measured.

4.3. Maximum Conducted Output Power Measurement

■ Limit

For systems using digital modulation in the 2400-2483.5 MHz, the limit for maximum output power is 30 dBm.

And According to 15.247 (b), if transmitting antennas of directional gain greater than 6 dBi are used, the power shall be reduced by the amount in dB that the directional gain of the antenna exceeds 6 dBi.

IEEE 802.11b

* Directional = Max. Gain : 2.44 dBi < 6 dBi

IEEE 802.11g

* Directional Gain = $10 \cdot \log\left\{\frac{10^{G1/10} + 10^{G2/10} + \dots + 10^{Gn/10}}{NANT}\right\} = 2.44 \text{ dBi} < 6 \text{ dBi}$.

IEEE 802.11n 2.4 GHz 20 MHz / IEEE 802.11n 2.4 GHz 40 MHz

* Directional Gain = $10 \cdot \log\left\{\frac{10^{G1/20} + 10^{G2/20} + \dots + 10^{Gn/20}}{NANT}\right\}^2 = 5.45 \text{ dBi} < 6 \text{ dBi}$

■ Test Setup

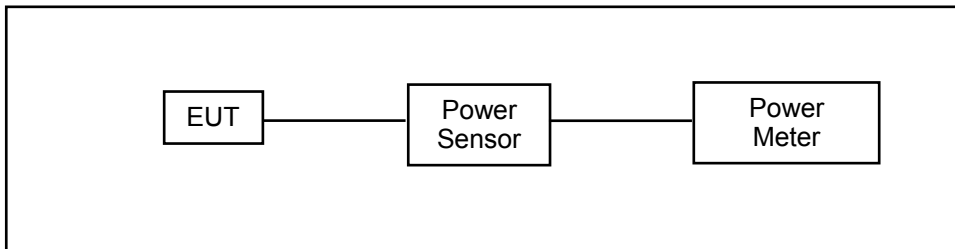

■ Test Procedure

The tests below are run with the EUT's transmitter set at high power in TX mode. The EUT is needed to force selection of output power level and channel number. While testing, EUT was set to transmit continuously. Remove the Subjective device's antenna and connect the RF output port to power sensor.

4.4. 6 dB RF Bandwidth Measurement

■ **Limit**

6 dB RF Bandwidth: Systems using digital modulation techniques may operate in the 2400–2483.5 MHz bands. The minimum 6 dB band-width shall be at least 500 kHz.

■ **Test Setup**

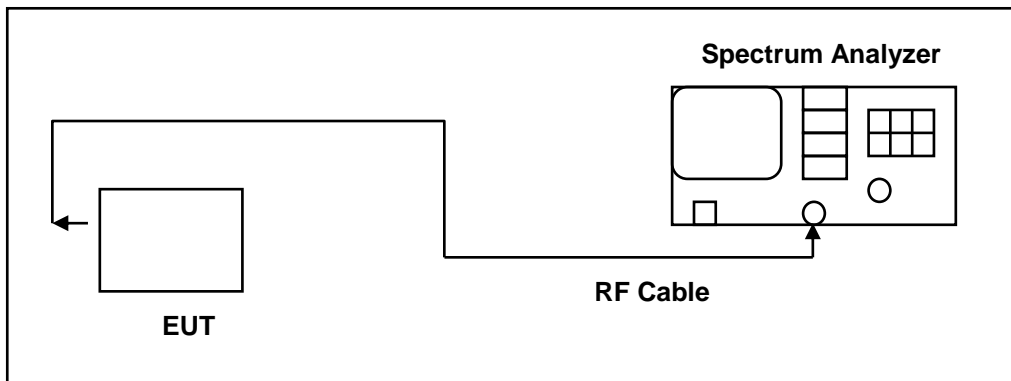

■ **Test Procedure**

The EUT tested to DTS test procedure of ANSI C63.10:2013 section 11.8.2 option2 for compliance to FCC 47CFR 15.247 requirements.

6 dB RF Bandwidth: The antenna port of the EUT was connected to the input of a spectrum analyzer. Analyzer RBW was set to 100 kHz. For each RF output channel investigated, the spectrum analyzer center frequency was set to the channel carrier. A peak output reading was taken, a DISPLAY line was drawn 6 dB lower than peak level. The 6 dB bandwidth was determined from where the channel output spectrum intersected the display line.

The test was performed at 3 channels (Channel low, middle, high)

4.5. Maximum Power Density Measurement

■ Limit

For digitally modulated systems, the power spectral density conducted from the intentional radiator to the antenna shall not be greater than 8 dBm in any 3 kHz band during any time interval of continuous transmission.

IEEE 802.11b

* Directional = Max. Gain : 2.44 dBi < 6 dBi

IEEE 802.11g / IEEE 802.11n 2.4 GHz 20 MHz / IEEE 802.11n 2.4 GHz 40 MHz

* Directional Gain = $10 \cdot \log\{[10^{(G1/20)} + 10^{(G2/20)} + \dots + 10^{(Gn/20)}]^2 / NANT\}$ = 5.45 dBi < 6 dBi

■ Test Setup

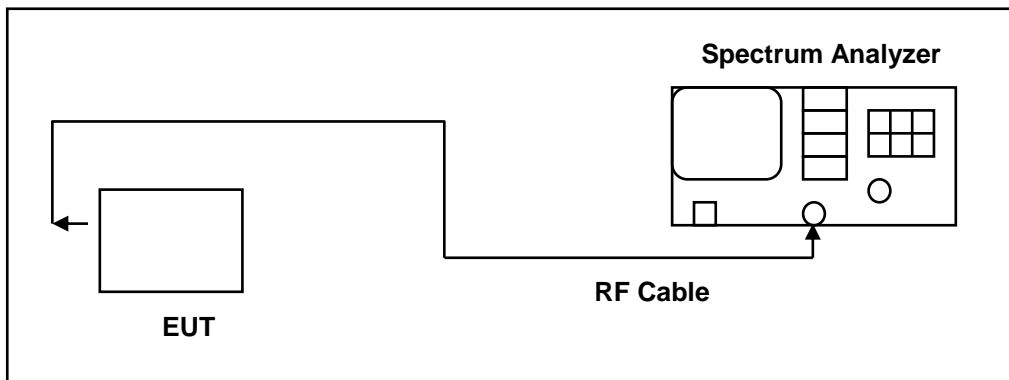

■ Test Procedure

The EUT tested to DTS test procedure of ANSI C63.10:2013 section 11.10.2 for compliance to FCC 47CFR 15.247 requirements.

1. Set analyzer center frequency to DTS channel center frequency.
2. Set the span to 1.5 times the DTS bandwidth.
3. Set the RBW to: $3 \text{ kHz} \leq \text{RBW} \leq 100 \text{ kHz}$.
4. Set the VBW $\geq 3 \times \text{RBW}$.
5. Detector = peak.
6. Sweep time = auto couple.
7. Trace mode = max hold.
8. Allow trace to fully stabilize.
9. Use the peak marker function to determine the maximum amplitude level within the RBW.
10. If measured value exceeds limit, reduce RBW (no less than 3 kHz) and repeat.

4.6. Out of Band Conducted Emissions Measurement

■ **Limit**

In any 100 kHz bandwidth outside the frequency band in which the spread spectrum or digitally modulated intentional radiator is operating, the radio frequency power that is produced by the intentional radiator shall be at least 30 dB below that in the 100 kHz bandwidth within the band that contains the highest level of the desired power

■ **Test Setup**

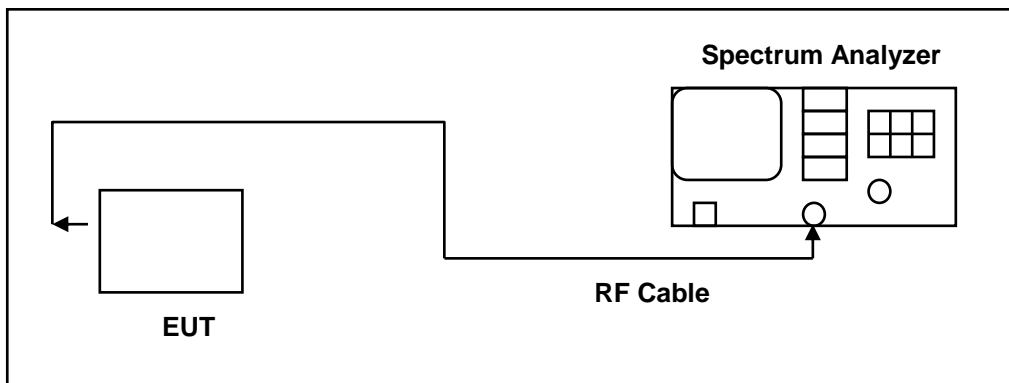

■ **Test Procedure**

In any 100 kHz bandwidth outside the EUT pass band, the RF power produced by the modulation products of the spreading sequence, the information sequence, and the carrier frequency shall be at least 30 dB below that of the maximum in-band 100 kHz emission, antenna output of the EUT was coupled directly to spectrum analyzer; if an external attenuator and/or cable was used, these losses are compensated for with the analyzer OFFSET function. All other types of emissions from the EUT shall meet the general limits for radiated frequencies outside the pass band. The test was performed at 3 channels.



4.7. Antenna Measurement

■ Limit

For intentional device, according to 15.203, an intentional radiator shall be designed to ensure that no antenna other than that furnished by the responsible party shall be used with the device.

And According to 15.247 (b), if transmitting antennas of directional gain greater than 6 dBi are used, the power shall be reduced by the amount in dB that the directional gain of the antenna exceeds 6 dBi.

■ Antenna Description

See section 2 – antenna information.

■ Directional Gain Calculated

For Maximum Conducted Output Power

Operate Freq. Band	Directional Gain (dBi)
IEEE 802.11b	2.44
IEEE 802.11g	2.44
IEEE 802.11n 2.4 GHz 20 MHz	5.45
IEEE 802.11n 2.4 GHz 40 MHz	5.45

For Maximum Power Density

Operate Freq. Band	Directional Gain (dBi)
IEEE 802.11b	2.44
IEEE 802.11g	5.45
IEEE 802.11n 2.4 GHz 20 MHz	5.45
IEEE 802.11n 2.4 GHz 40 MHz	5.45



5 Test Results

Annex A. Conducted Emission

Standard:	FCC Part 15.247	Line:	L1
Test item:	Conducted Emission	Power:	AC 120 V/60 Hz
Mode:	Mode 1	Temp.(°C)/Hum.(%RH):	26(°C)/60 %RH
Description:			

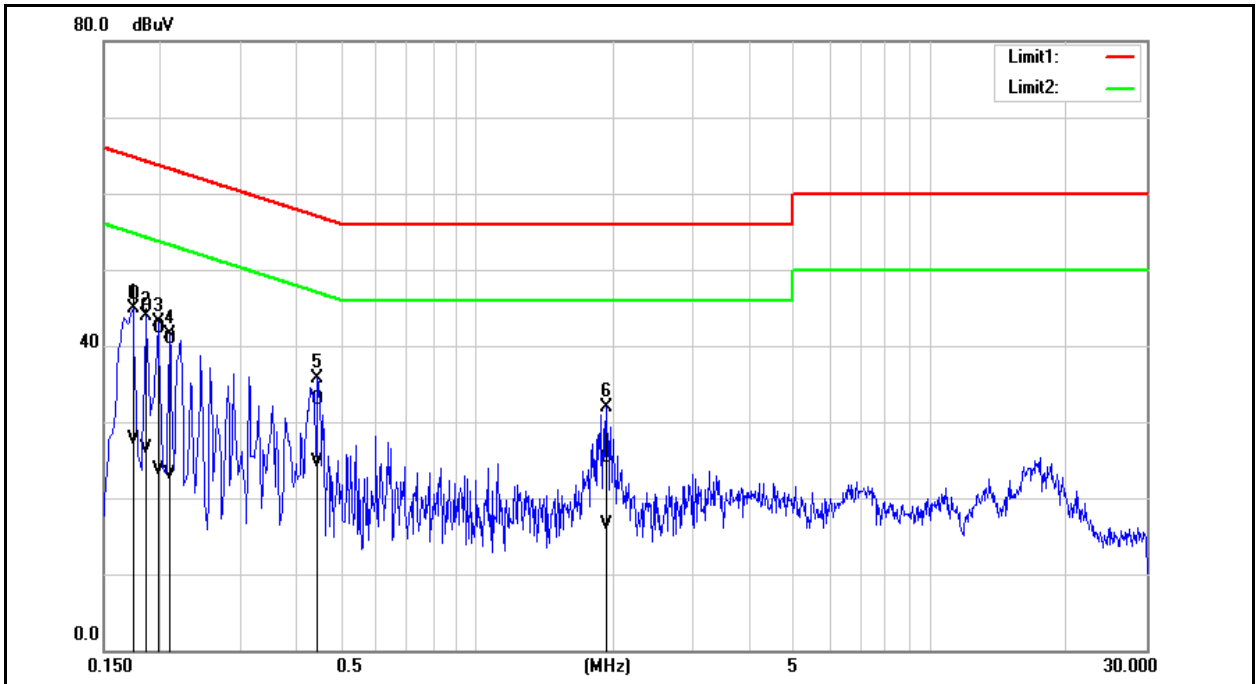

No.	Frequency (MHz)	QP reading (dBuV)	AVG reading (dBuV)	Correction factor (dB)	QP result (dBuV)	AVG result (dBuV)	QP limit (dBuV)	AVG limit (dBuV)	QP margin (dB)	AVG margin (dB)	Remark
1	0.1740	37.14	18.13	9.65	46.79	27.78	64.77	54.77	-17.98	-26.99	Pass
2	0.1860	35.56	16.85	9.64	45.20	26.49	64.21	54.21	-19.01	-27.72	Pass
3	0.1980	32.71	14.00	9.64	42.35	23.64	63.69	53.69	-21.34	-30.05	Pass
4	0.2100	31.29	13.41	9.64	40.93	23.05	63.21	53.21	-22.28	-30.16	Pass
5	0.4460	23.18	15.02	9.66	32.84	24.68	56.95	46.95	-24.11	-22.27	Pass
6	1.9300	15.51	6.72	9.72	25.23	16.44	56.00	46.00	-30.77	-29.56	Pass

Note: 1. Result (dBuV) = Correction factor (dB) + Reading(dBuV).
2. Correction factor (dB) = Cable loss (dB) + L.I.S.N. factor (dB).



Standard:	FCC Part 15.247	Line:	N
Test item:	Conducted Emission	Power:	AC 120 V/60 Hz
Mode:	Mode 1	Temp.(°C)/Hum.(%RH):	26(°C)/60 %RH
Description:			

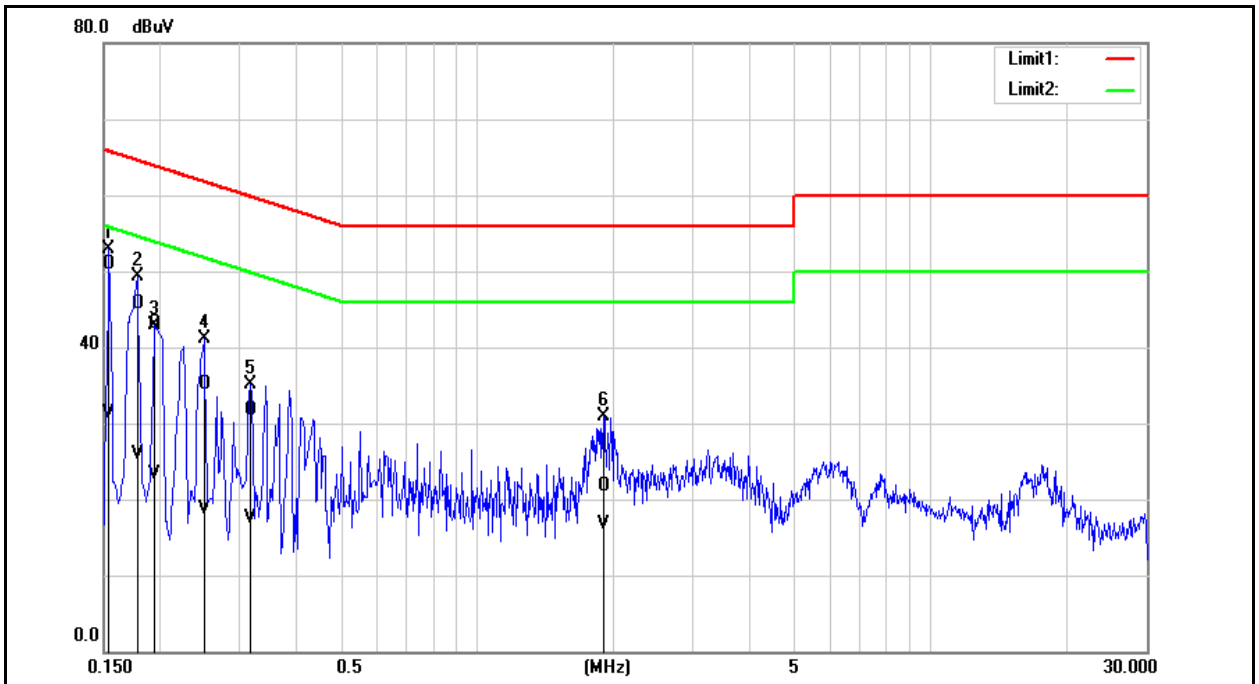

No.	Frequency (MHz)	QP reading (dBuV)	AVG reading (dBuV)	Correction factor (dB)	QP result (dBuV)	AVG result (dBuV)	QP limit (dBuV)	AVG limit (dBuV)	QP margin (dB)	AVG margin (dB)	Remark
1	0.1540	41.14	21.56	9.68	50.82	31.24	65.78	55.78	-14.96	-24.54	Pass
2	0.1780	36.05	16.31	9.67	45.72	25.98	64.58	54.58	-18.86	-28.60	Pass
3	0.1940	33.35	13.69	9.67	43.02	23.36	63.86	53.86	-20.84	-30.50	Pass
4	0.2500	25.40	9.08	9.67	35.07	18.75	61.76	51.76	-26.69	-33.01	Pass
5	0.3180	22.01	7.92	9.68	31.69	17.60	59.76	49.76	-28.07	-32.16	Pass
6	1.8980	12.01	6.92	9.75	21.76	16.67	56.00	46.00	-34.24	-29.33	Pass

Note: 1. Result (dBuV) = Correction factor (dB) + Reading(dBuV).
2. Correction factor (dB) = Cable loss (dB) + L.I.S.N. factor (dB).

Annex B. Conducted Test Results

Maximum Conducted Output Power Measurement

ANT-0					
Test Mode	Frequency (MHz)	Data Rate	Average Output Power		
			Measurement Results		Limit
			dBm	W	dBm
Mode 2	2412	1 M	20.08	0.102	≤ 30
	2437		22.62	0.183	≤ 30
	2462		20.92	0.124	≤ 30
Mode 3	2412	6 M	16.46	0.044	≤ 30
	2437		23.72	0.236	≤ 30
	2462		16.79	0.048	≤ 30
Mode 4	2412	13 M	16.41	0.044	≤ 30
	2437		22.31	0.170	≤ 30
	2462		15.31	0.034	≤ 30
Mode 5	2422	27 M	13.13	0.021	≤ 30
	2437		16.91	0.049	≤ 30
	2452		12.62	0.018	≤ 30

ANT-1					
Test Mode	Frequency (MHz)	Data Rate	Average Output Power		
			Measurement Results		Limit
			dBm	W	dBm
Mode 2	2412	1 M	20.46	0.111	≤ 30
	2437		22.46	0.176	≤ 30
	2462		20.95	0.124	≤ 30
Mode 3	2412	6 M	16.42	0.044	≤ 30
	2437		23.44	0.221	≤ 30
	2462		16.61	0.046	≤ 30
Mode 4	2412	13 M	16.42	0.044	≤ 30
	2437		21.94	0.156	≤ 30
	2462		14.95	0.031	≤ 30
Mode 5	2422	27 M	13.11	0.020	≤ 30
	2437		16.82	0.048	≤ 30
	2452		12.42	0.017	≤ 30

Note: The relevant measured result has the offset with cable loss already.



ANT-0+1					
Test Mode	Frequency (MHz)	Data Rate	Average Output Power		
			Measurement Results		Limit
			dBm	W	dBm
Mode 3	2412	6 M	19.45	0.088	≤ 30
	2437		26.59	0.456	≤ 30
	2462		19.71	0.094	≤ 30
Mode 4	2412	13 M	19.43	0.088	≤ 30
	2437		25.14	0.327	≤ 30
	2462		18.14	0.065	≤ 30
Mode 5	2422	27 M	16.13	0.041	≤ 30
	2437		19.88	0.097	≤ 30
	2452		15.53	0.036	≤ 30

Note: The relevant measured result has the offset with cable loss already.



6 dB RF Bandwidth Measurement

Test Mode	Frequency (MHz)	Measurement (kHz)		Limit (kHz)
		ANT-0	ANT-1	
Mode 2	2412	8107	8104	≥ 500
	2437	8096	8102	≥ 500
	2462	8095	8098	≥ 500
Mode 3	2412	16390	16400	≥ 500
	2437	16330	16330	≥ 500
	2462	16400	16400	≥ 500
Mode 4	2412	17600	17620	≥ 500
	2437	17160	17590	≥ 500
	2462	17630	17620	≥ 500
Mode 5	2422	35700	35140	≥ 500
	2437	35150	35170	≥ 500
	2452	35090	35190	≥ 500



■ Test Graphs

Mode 2: IEEE 802.11b Continuous TX mode_ANT-0

2412 MHz



2437 MHz



2462 MHz





Mode 3: IEEE 802.11g Continuous TX mode_ANT-0

2412 MHz



2437 MHz

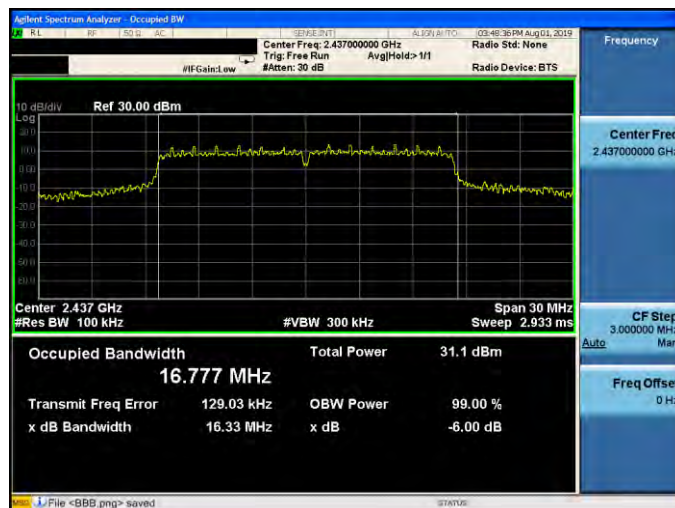

2462 MHz

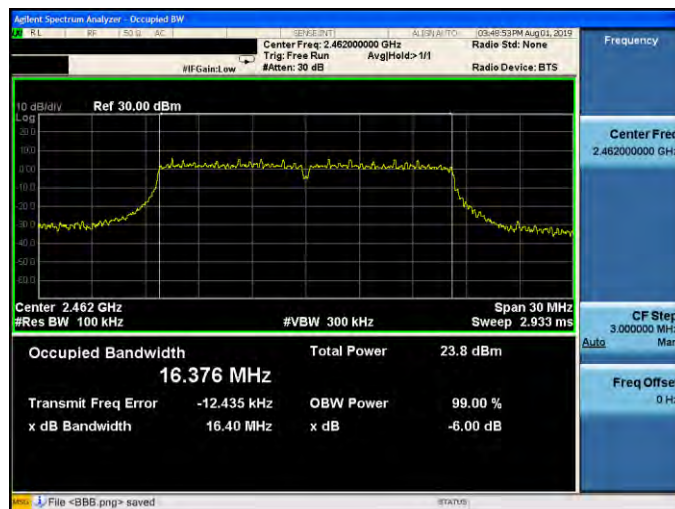



Mode 4: IEEE 802.11n 2.4 GHz 20 MHz Continuous TX mode _ANT-0

2412 MHz

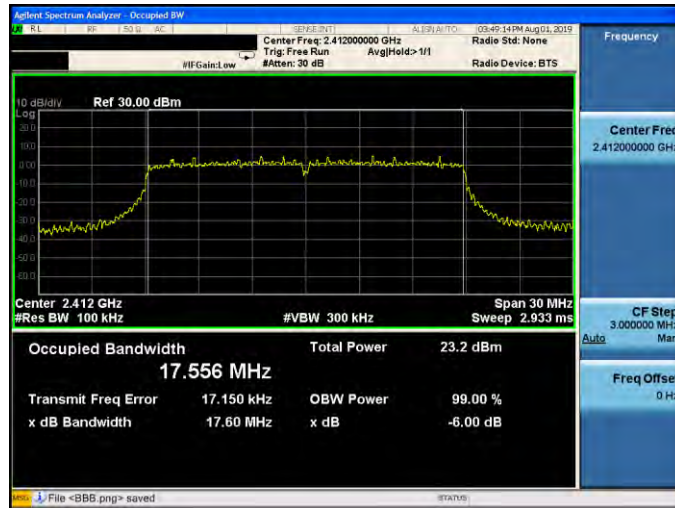

2437 MHz



2462 MHz





Mode 5: IEEE 802.11n 2.4 GHz 40 MHz Continuous TX mode_ANT-0

2422 MHz

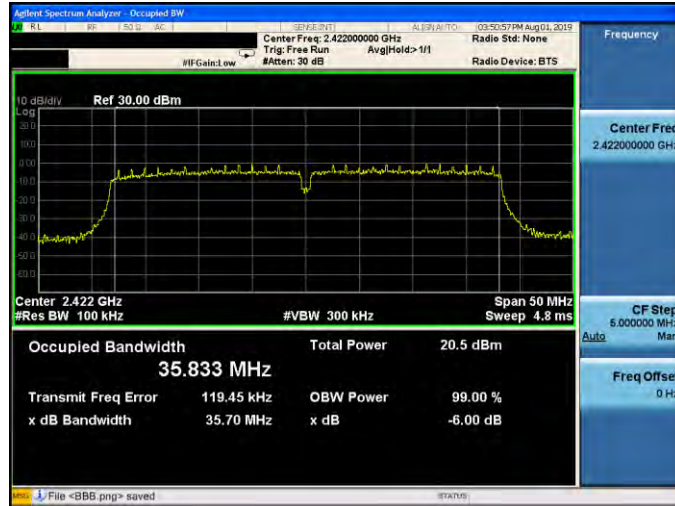

2437 MHz

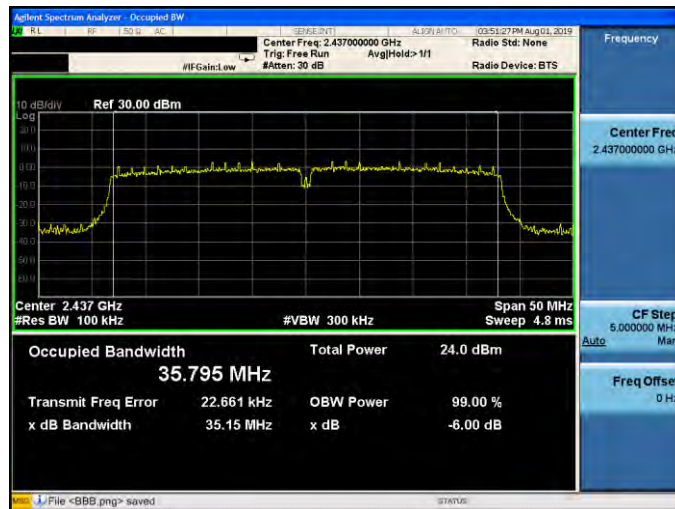

2452 MHz





Mode 2: IEEE 802.11b Continuous TX mode_ANT-1

2412 MHz



2437 MHz



2462 MHz





Mode 3: IEEE 802.11g Continuous TX mode_ANT-1

2412 MHz



2437 MHz

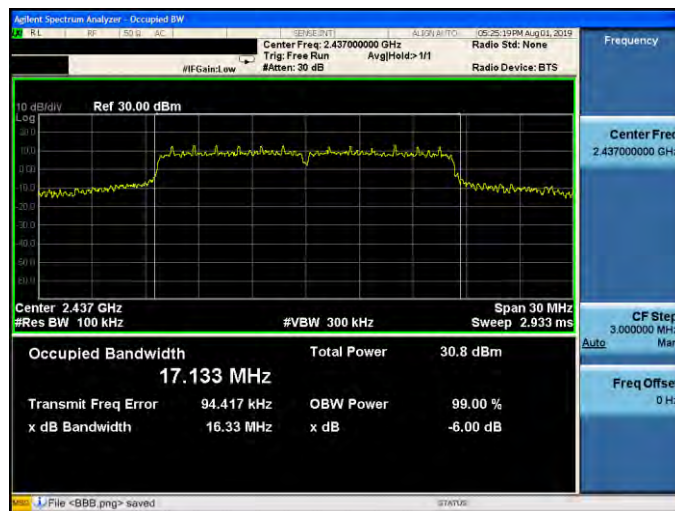

2462 MHz





Mode 4: IEEE 802.11n 2.4 GHz 20 MHz Continuous TX mode_ANT-1

2412 MHz

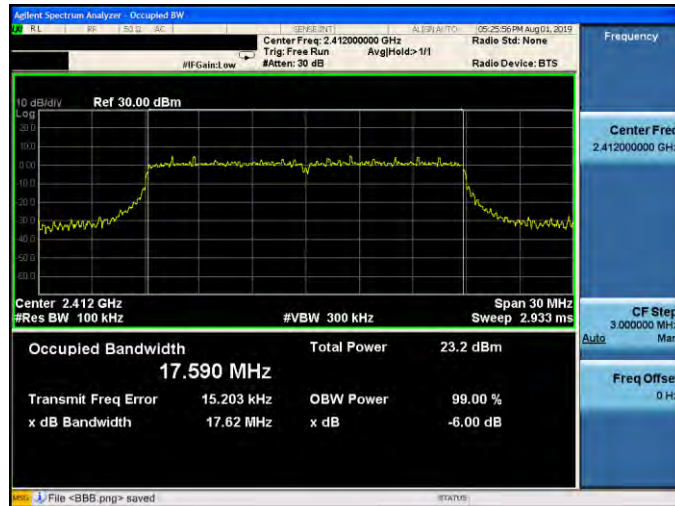

2437 MHz



2462 MHz





Mode 5: IEEE 802.11n 2.4 GHz 40 MHz Continuous TX mode _ANT-1

2422 MHz



2437 MHz

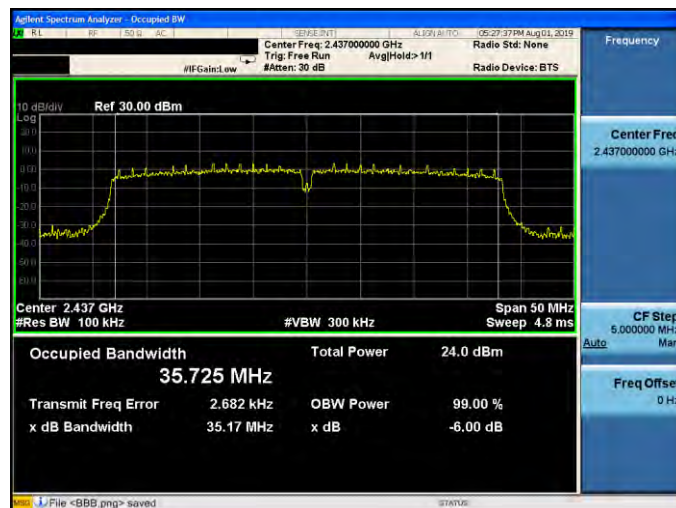

2452 MHz





Maximum Power Density Measurement

Test Mode	Frequency (MHz)	Measurement (dBm/3 kHz)			Limit (dBm/3 kHz)
		ANT-0	ANT-1	ANT-0+1	
Mode 2	2412	-4.368	-3.785	---	≤ 8
	2437	-1.707	-0.565	---	≤ 8
	2462	-3.340	-3.469	---	≤ 8
Mode 3	2412	-10.598	-9.638	-7.081	≤ 8
	2437	-2.570	-3.070	0.197	≤ 8
	2462	-11.101	-10.356	-7.702	≤ 8
Mode 4	2412	-11.197	-10.613	-7.885	≤ 8
	2437	-4.160	-5.462	-1.752	≤ 8
	2462	-11.986	-8.936	-7.188	≤ 8
Mode 5	2422	-16.386	-16.715	-13.537	≤ 8
	2437	-11.078	-10.193	-7.603	≤ 8
	2452	-15.914	-17.732	-13.718	≤ 8



■ Test Graphs

Mode 2: IEEE 802.11b Continuous TX mode_ANT-0

2412 MHz



2437 MHz



2462 MHz





Mode 3: IEEE 802.11g Continuous TX mode_ANT-0

2412 MHz

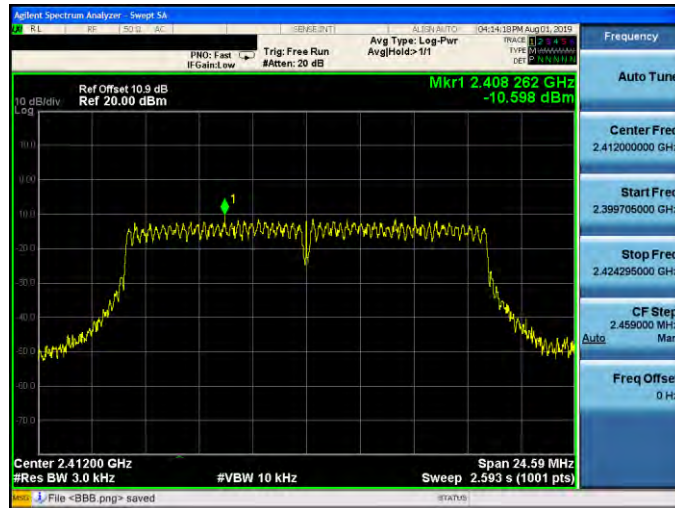

2437 MHz

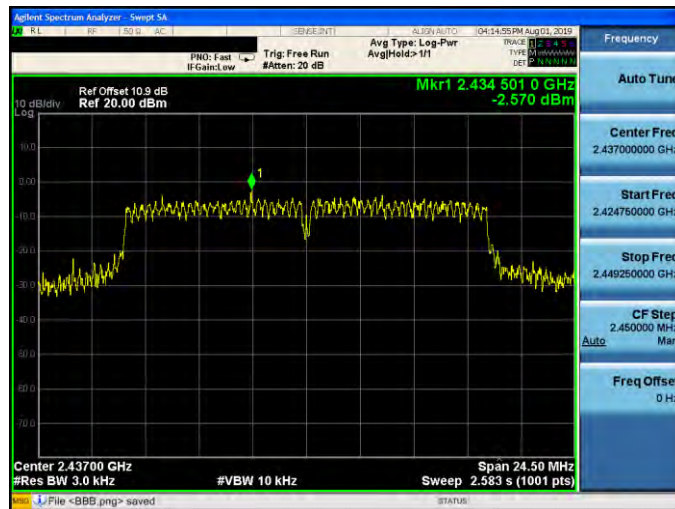

2462 MHz





Mode 4: IEEE 802.11n 2.4 GHz 20 MHz Continuous TX mode _ANT-0

2412 MHz

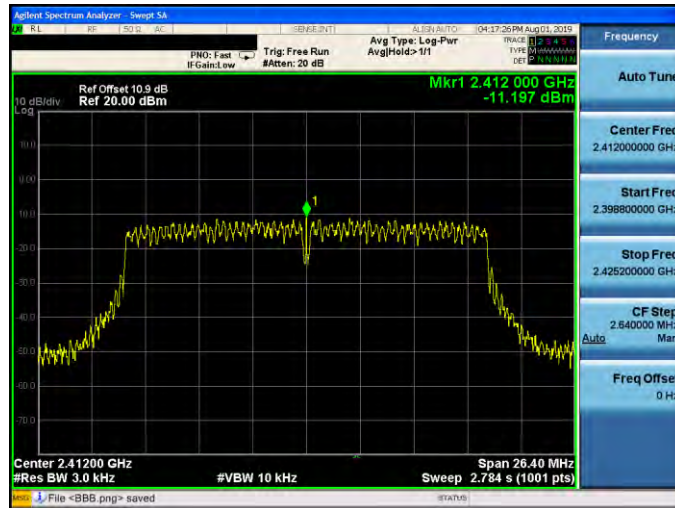

2437 MHz



2462 MHz

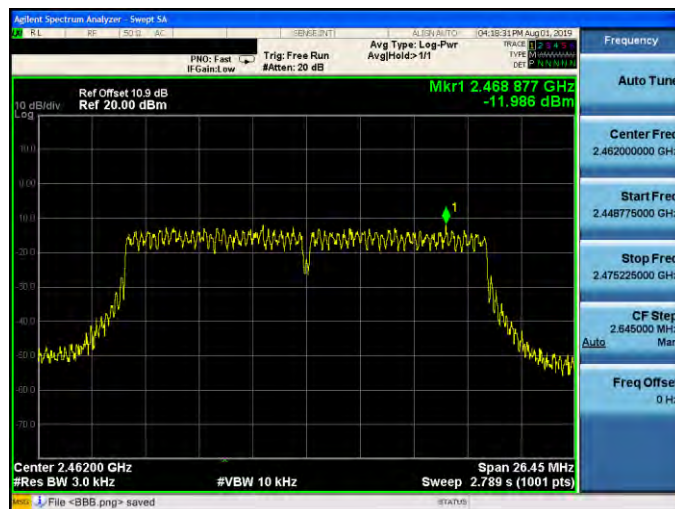



Mode 5: IEEE 802.11n 2.4 GHz 40 MHz Continuous TX mode _ANT-0

2422 MHz

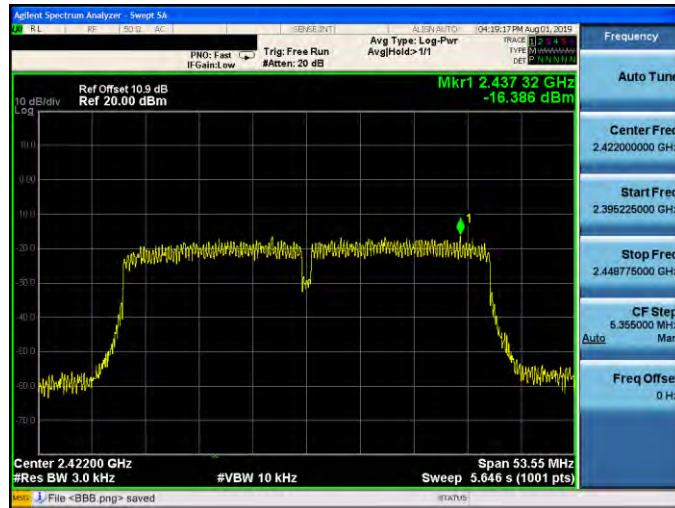

2437 MHz

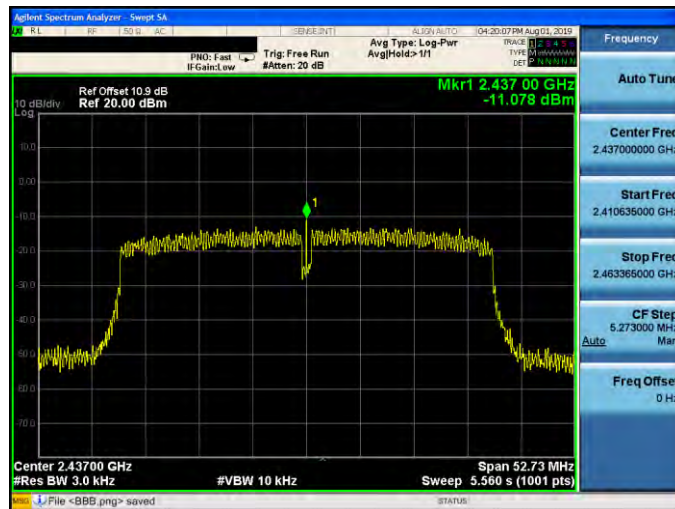

2452 MHz

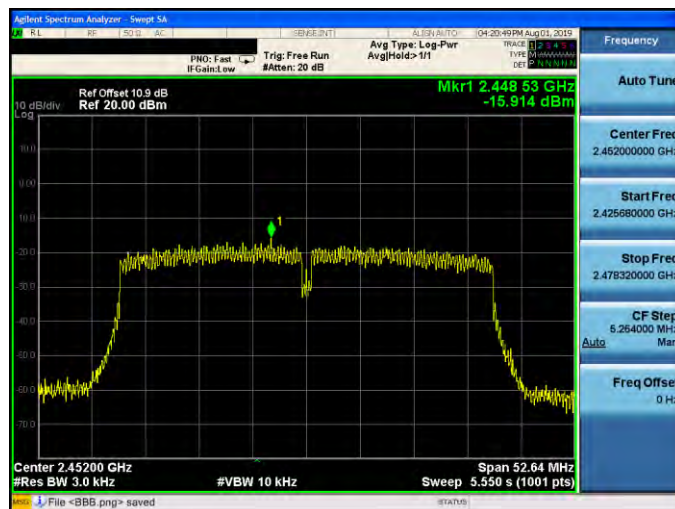



Mode 2: IEEE 802.11b Continuous TX mode_ANT-1

2412 MHz



2437 MHz



2462 MHz





Mode 4: IEEE 802.11n 2.4 GHz 20 MHz Continuous TX mode _ANT-1

2412 MHz

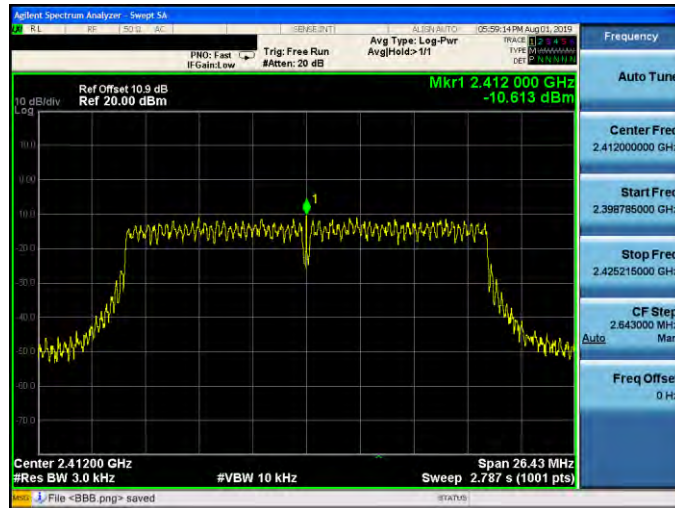

2437 MHz



2462 MHz





Mode 5: IEEE 802.11n 2.4 GHz 40 MHz Continuous TX mode_ANT-1

2422 MHz

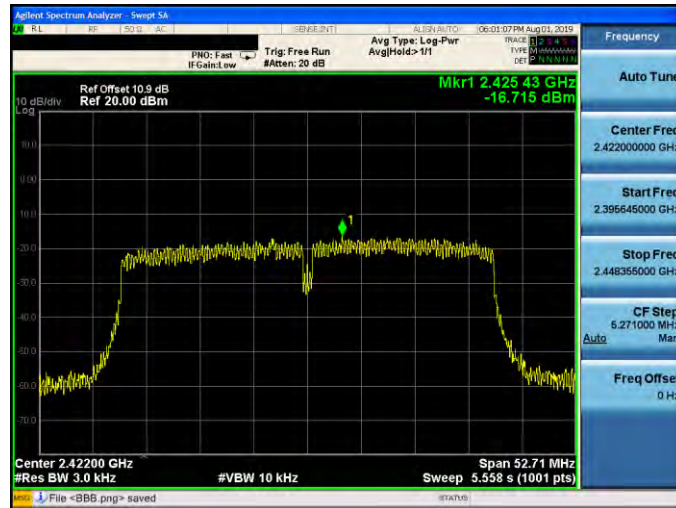

2437 MHz

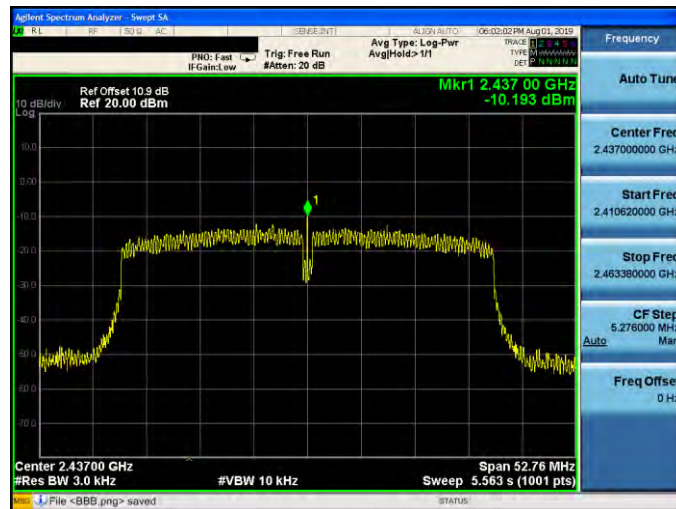

2452 MHz

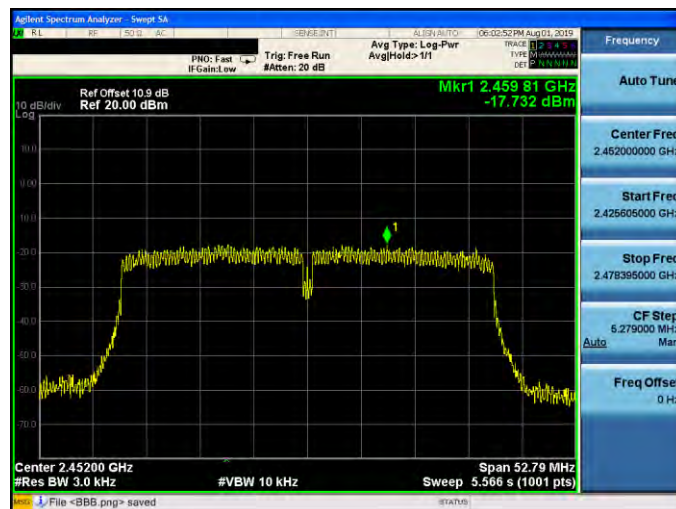

Out of Band Conducted Emissions Measurement

■ Test Graphs

Reference level

Mode 2: IEEE 802.11b Continuous TX mode_ANT-0

<p>2412 MHz</p>	
<p>2437 MHz</p>	
<p>2462 MHz</p>	



Mode 3: IEEE 802.11g Continuous TX mode_ANT-0

2412 MHz

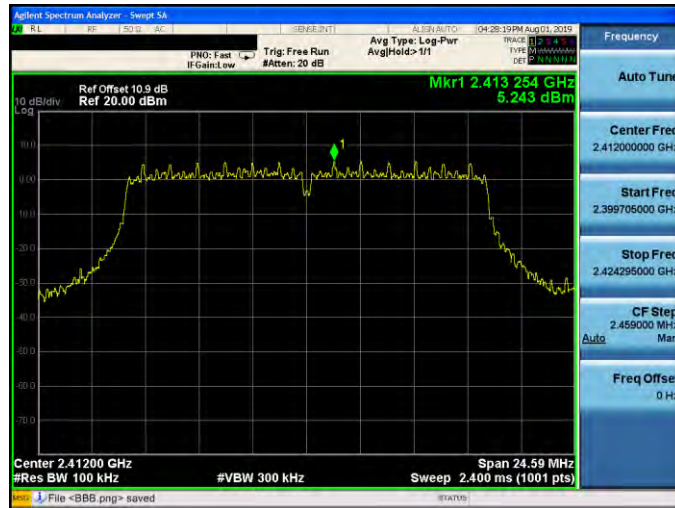

2437 MHz



2462 MHz





Mode 4: IEEE 802.11n 2.4 GHz 20 MHz Continuous TX mode _ANT-0

2412 MHz

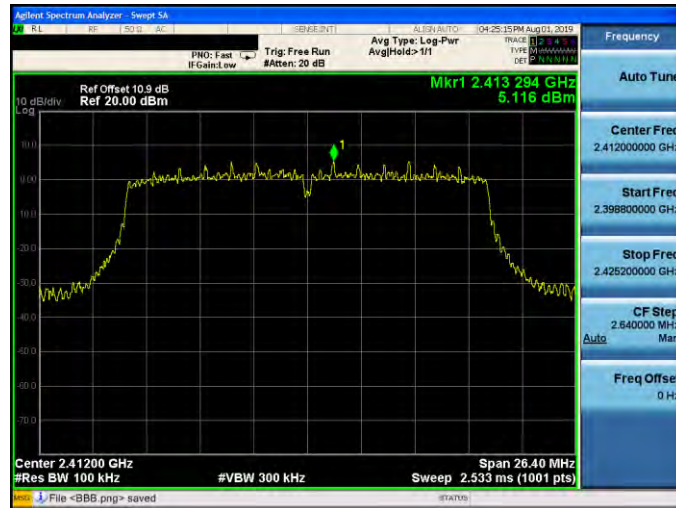

2437 MHz



2462 MHz





Mode 5: IEEE 802.11n 2.4 GHz 40 MHz Continuous TX mode _ANT-0

2422 MHz



2437 MHz



2452 MHz





Mode 2: IEEE 802.11b Continuous TX mode_ANT-1

2412 MHz



2437 MHz



2462 MHz





Mode 3: IEEE 802.11g Continuous TX mode_ANT-1

2412 MHz



2437 MHz



2462 MHz

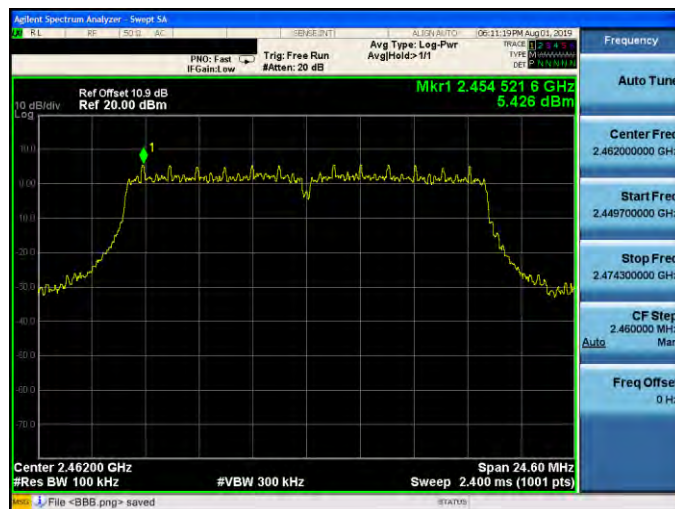



Mode 4: IEEE 802.11n 2.4 GHz 20 MHz Continuous TX mode _ANT-1

2412 MHz

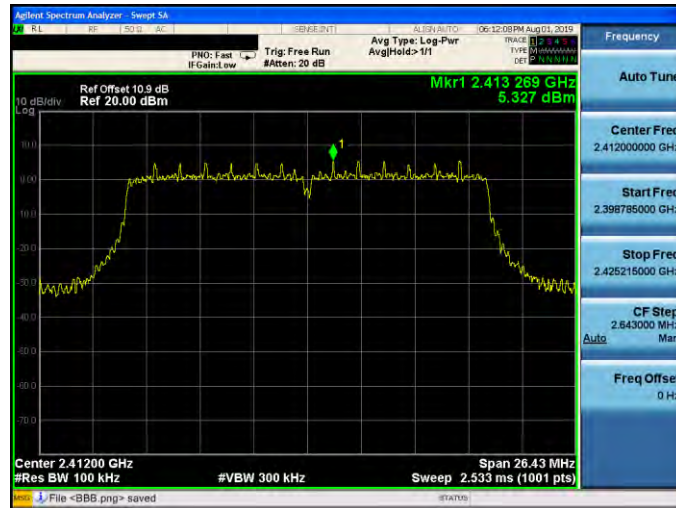

2437 MHz



2462 MHz





Mode 5: IEEE 802.11n 2.4 GHz 40 MHz Continuous TX mode_ANT-1

2422 MHz



2437 MHz



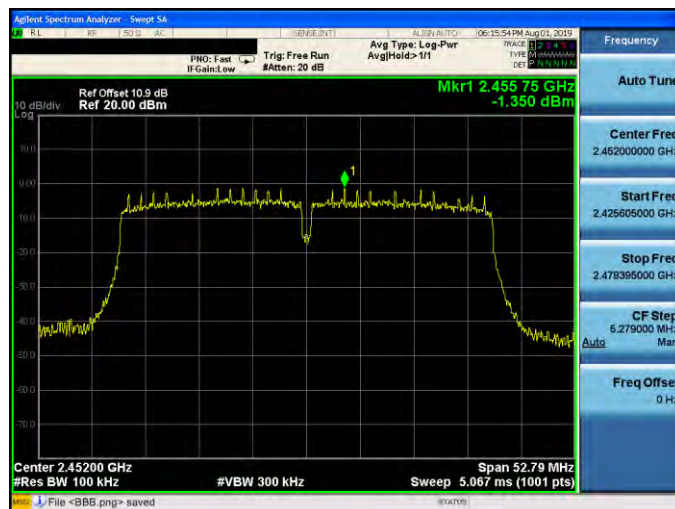

2452 MHz





Out of Band Conducted Emissions

Mode 2: IEEE 802.11b Continuous TX mode_ANT-0

<p>2412 MHz</p>	 <table border="1" data-bbox="646 712 1220 862"> <thead> <tr> <th>MKR</th> <th>MODE</th> <th>TRG</th> <th>SCN</th> <th>X</th> <th>Y</th> <th>FUNCTION</th> <th>FUNCTION WIDTH</th> <th>FUNCTION VALUE</th> </tr> </thead> <tbody> <tr> <td>1</td> <td>N</td> <td>1</td> <td>f</td> <td>2412.8 GHz</td> <td>-34.850 dBm</td> <td></td> <td></td> <td></td> </tr> <tr> <td>2</td> <td>N</td> <td>1</td> <td>f</td> <td>25.8243 GHz</td> <td>-34.850 dBm</td> <td></td> <td></td> <td></td> </tr> </tbody> </table>	MKR	MODE	TRG	SCN	X	Y	FUNCTION	FUNCTION WIDTH	FUNCTION VALUE	1	N	1	f	2412.8 GHz	-34.850 dBm				2	N	1	f	25.8243 GHz	-34.850 dBm			
MKR	MODE	TRG	SCN	X	Y	FUNCTION	FUNCTION WIDTH	FUNCTION VALUE																				
1	N	1	f	2412.8 GHz	-34.850 dBm																							
2	N	1	f	25.8243 GHz	-34.850 dBm																							
<p>2437 MHz</p>	 <table border="1" data-bbox="646 1249 1220 1400"> <thead> <tr> <th>MKR</th> <th>MODE</th> <th>TRG</th> <th>SCN</th> <th>X</th> <th>Y</th> <th>FUNCTION</th> <th>FUNCTION WIDTH</th> <th>FUNCTION VALUE</th> </tr> </thead> <tbody> <tr> <td>1</td> <td>N</td> <td>1</td> <td>f</td> <td>2437.4 GHz</td> <td>-35.150 dBm</td> <td></td> <td></td> <td></td> </tr> <tr> <td>2</td> <td>N</td> <td>1</td> <td>f</td> <td>25.8891 GHz</td> <td>-35.150 dBm</td> <td></td> <td></td> <td></td> </tr> </tbody> </table>	MKR	MODE	TRG	SCN	X	Y	FUNCTION	FUNCTION WIDTH	FUNCTION VALUE	1	N	1	f	2437.4 GHz	-35.150 dBm				2	N	1	f	25.8891 GHz	-35.150 dBm			
MKR	MODE	TRG	SCN	X	Y	FUNCTION	FUNCTION WIDTH	FUNCTION VALUE																				
1	N	1	f	2437.4 GHz	-35.150 dBm																							
2	N	1	f	25.8891 GHz	-35.150 dBm																							
<p>2462 MHz</p>	 <table border="1" data-bbox="646 1771 1220 1921"> <thead> <tr> <th>MKR</th> <th>MODE</th> <th>TRG</th> <th>SCN</th> <th>X</th> <th>Y</th> <th>FUNCTION</th> <th>FUNCTION WIDTH</th> <th>FUNCTION VALUE</th> </tr> </thead> <tbody> <tr> <td>1</td> <td>N</td> <td>1</td> <td>f</td> <td>2462.8 GHz</td> <td>-35.107 dBm</td> <td></td> <td></td> <td></td> </tr> <tr> <td>2</td> <td>N</td> <td>1</td> <td>f</td> <td>26.0229 GHz</td> <td>-35.107 dBm</td> <td></td> <td></td> <td></td> </tr> </tbody> </table>	MKR	MODE	TRG	SCN	X	Y	FUNCTION	FUNCTION WIDTH	FUNCTION VALUE	1	N	1	f	2462.8 GHz	-35.107 dBm				2	N	1	f	26.0229 GHz	-35.107 dBm			
MKR	MODE	TRG	SCN	X	Y	FUNCTION	FUNCTION WIDTH	FUNCTION VALUE																				
1	N	1	f	2462.8 GHz	-35.107 dBm																							
2	N	1	f	26.0229 GHz	-35.107 dBm																							



Mode 3: IEEE 802.11g Continuous TX mode_ANT-0

2412 MHz

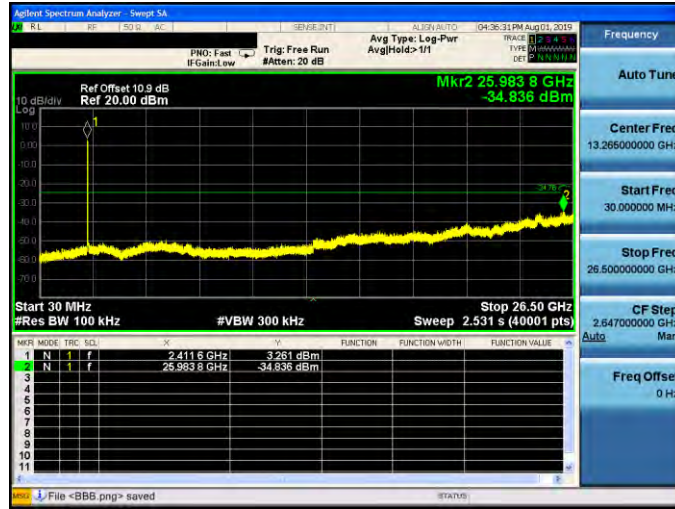

2437 MHz

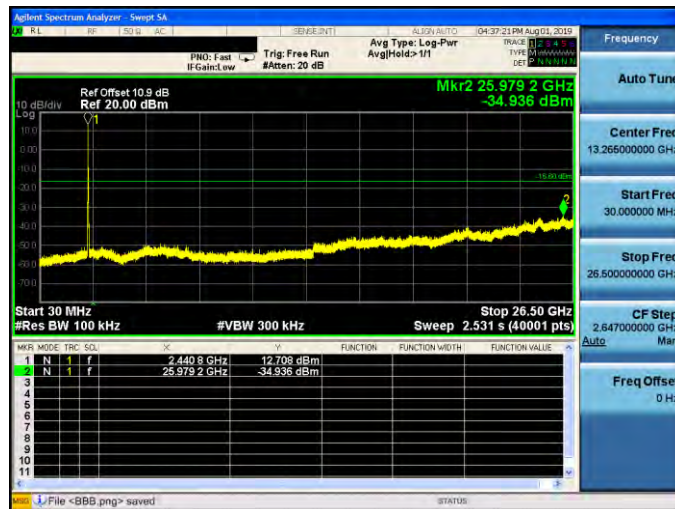

2462 MHz

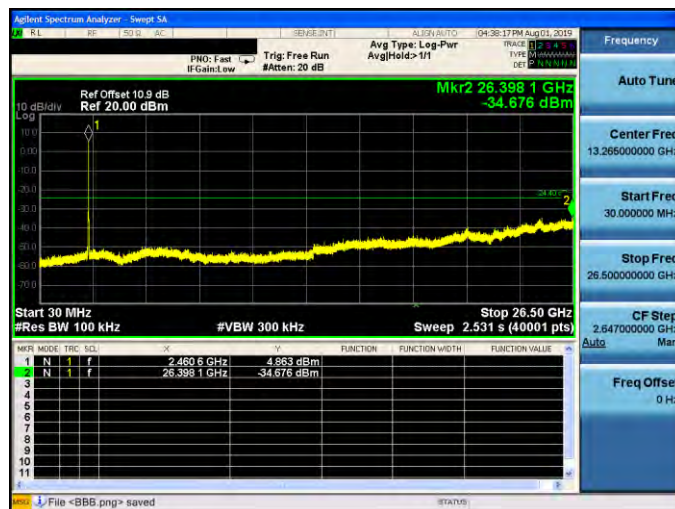



Mode 4: IEEE 802.11n 2.4 GHz 20 MHz Continuous TX mode_ANT-0

2412 MHz



2437 MHz

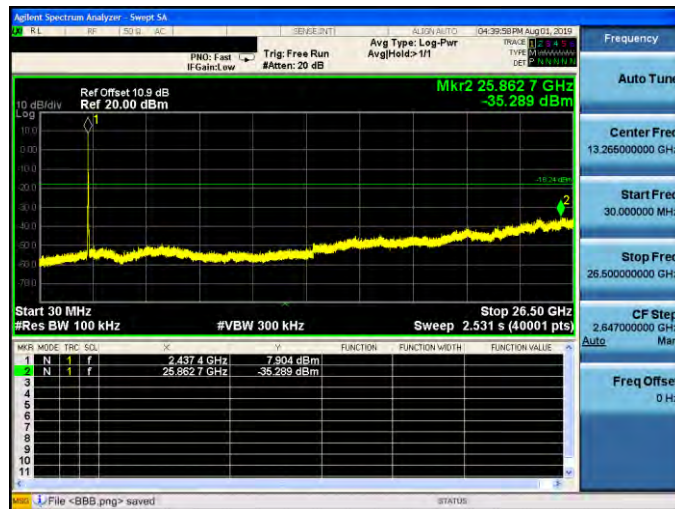

2462 MHz

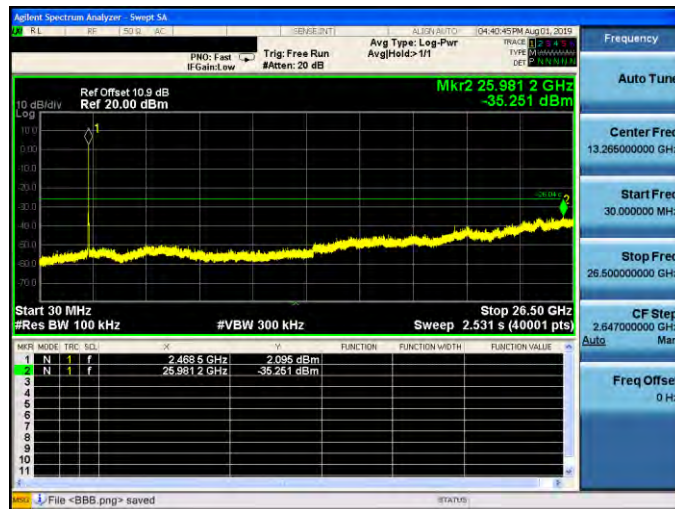



Mode 5: IEEE 802.11n 2.4 GHz 40 MHz Continuous TX mode _ANT-0

2422 MHz

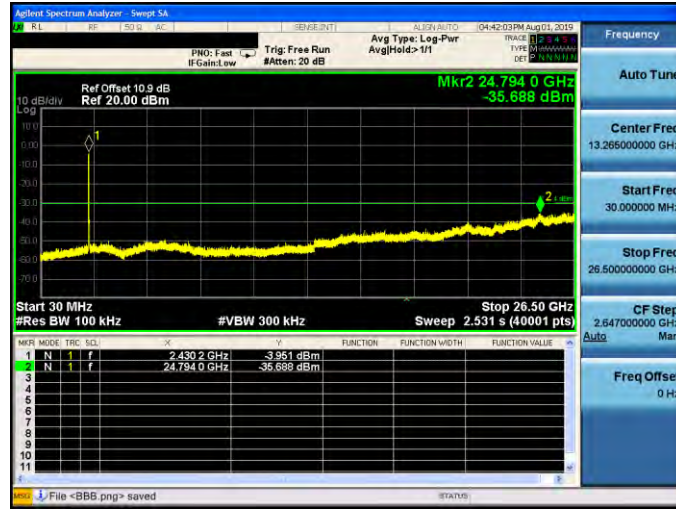

2437 MHz

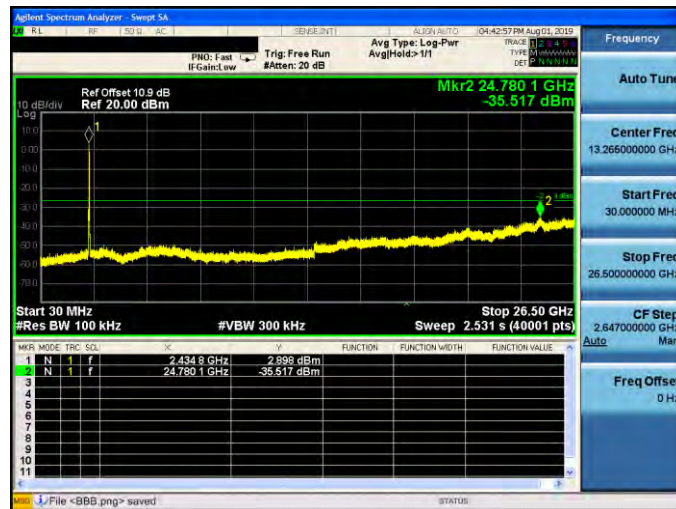

2452 MHz

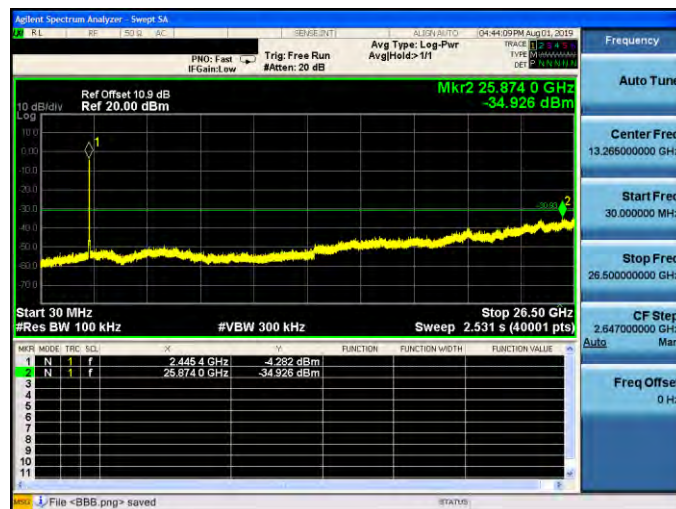



Mode 2: IEEE 802.11b Continuous TX mode_ANT-1

2412 MHz

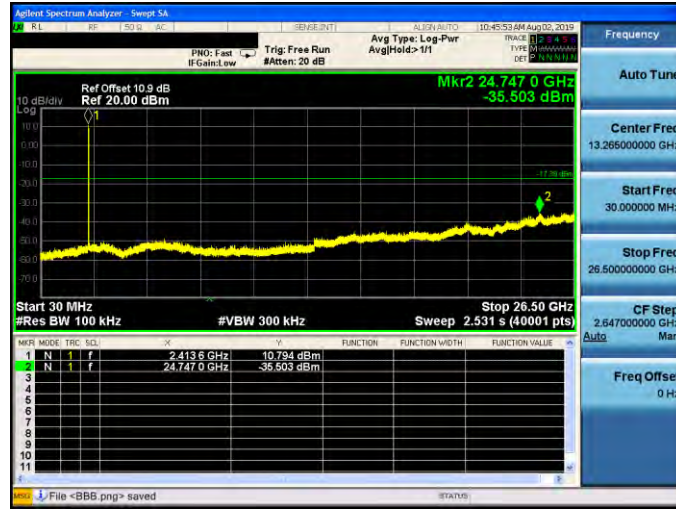

2437 MHz

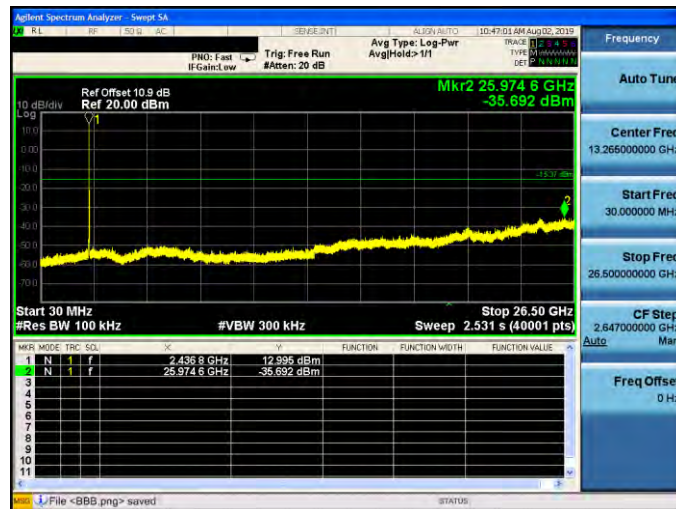

2462 MHz

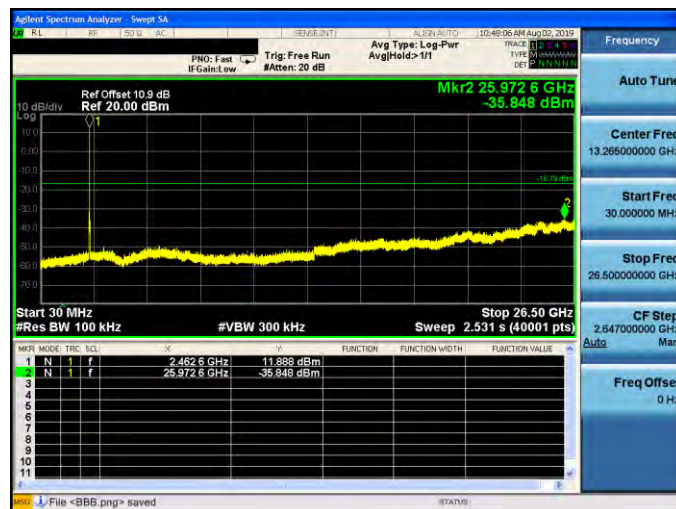



Mode 3: IEEE 802.11g Continuous TX mode_ANT-1

2412 MHz

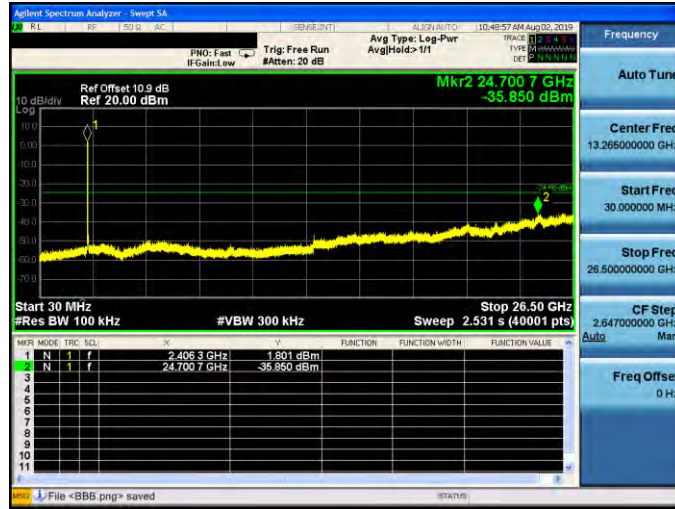

2437 MHz

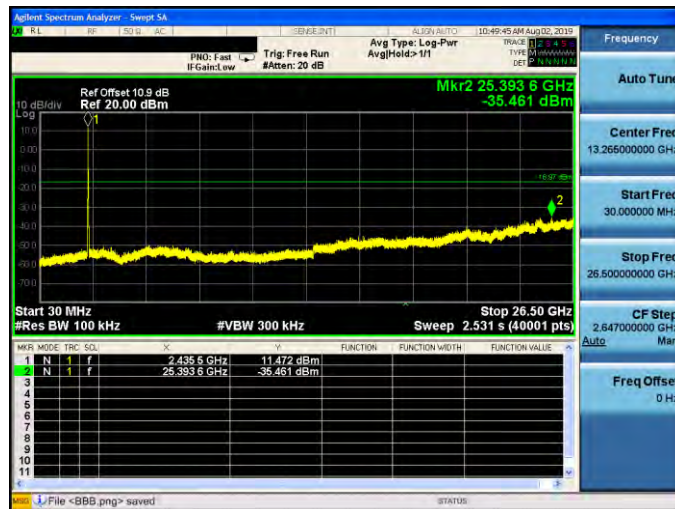

2462 MHz





Mode 4: IEEE 802.11n 2.4 GHz 20 MHz Continuous TX mode _ANT-1

2412 MHz



2437 MHz

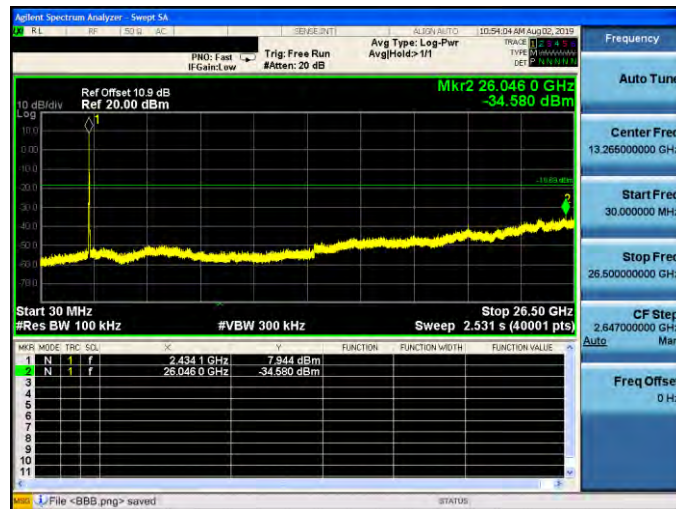

2462 MHz

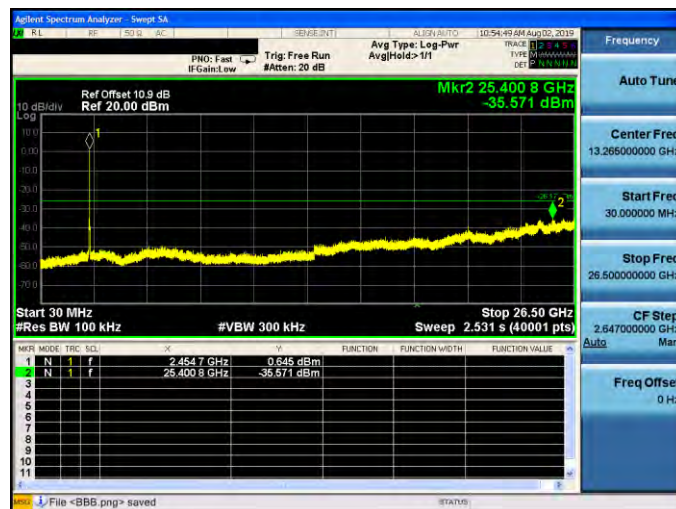



Mode 5: IEEE 802.11n 2.4 GHz 40 MHz Continuous TX mode _ANT-1

2422 MHz



2437 MHz

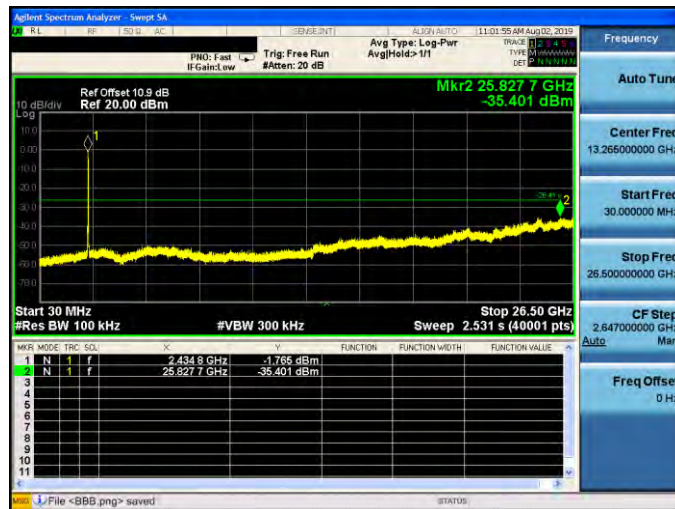

2452 MHz

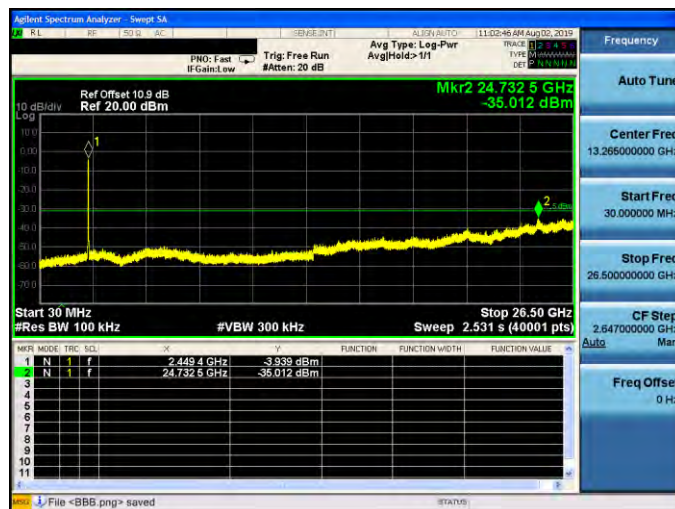



Conducted Band Edge

Mode 2: IEEE 802.11b Continuous TX mode_ANT-0

2412 MHz

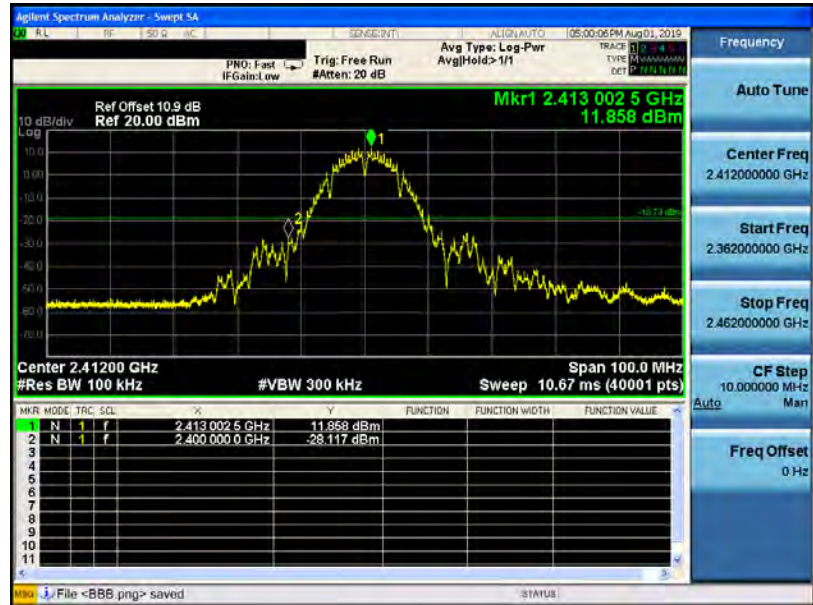

2462 MHz

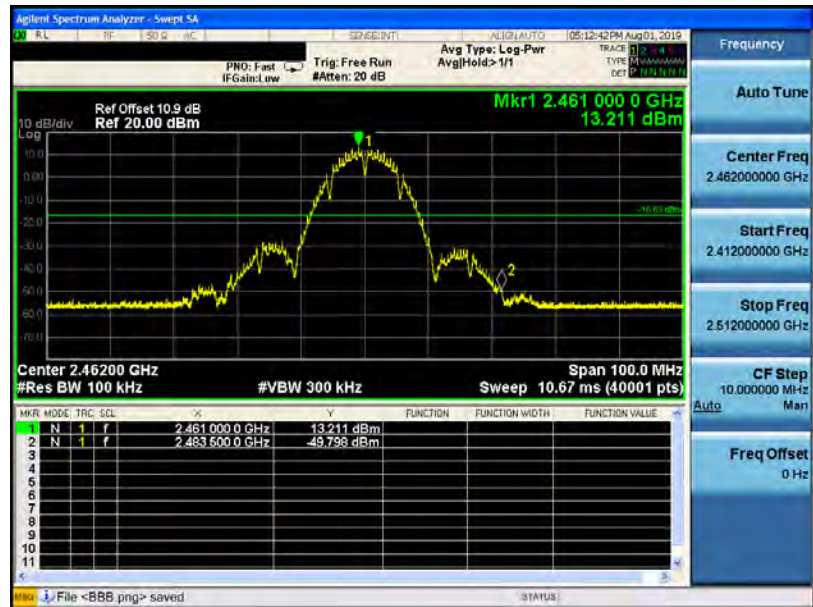



Mode 3: IEEE 802.11g Continuous TX mode_ANT-0

2412 MHz

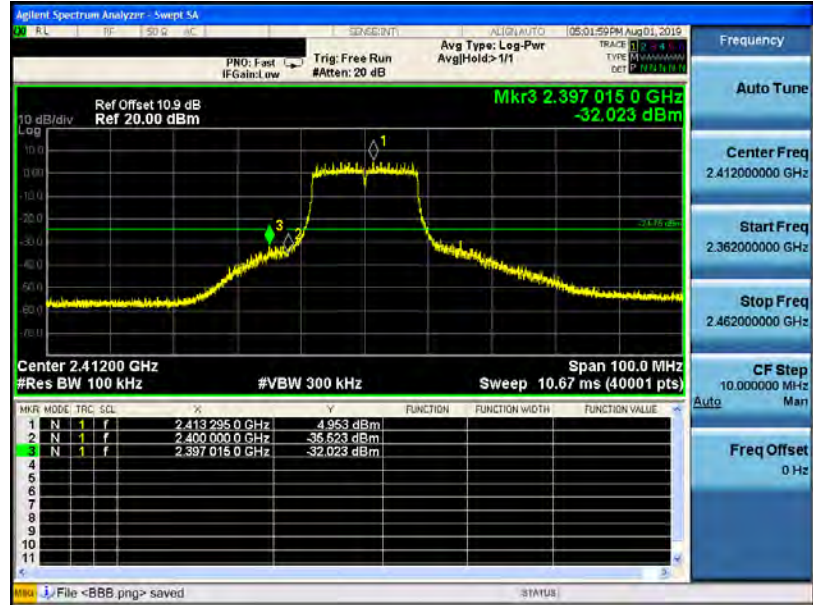

2462 MHz

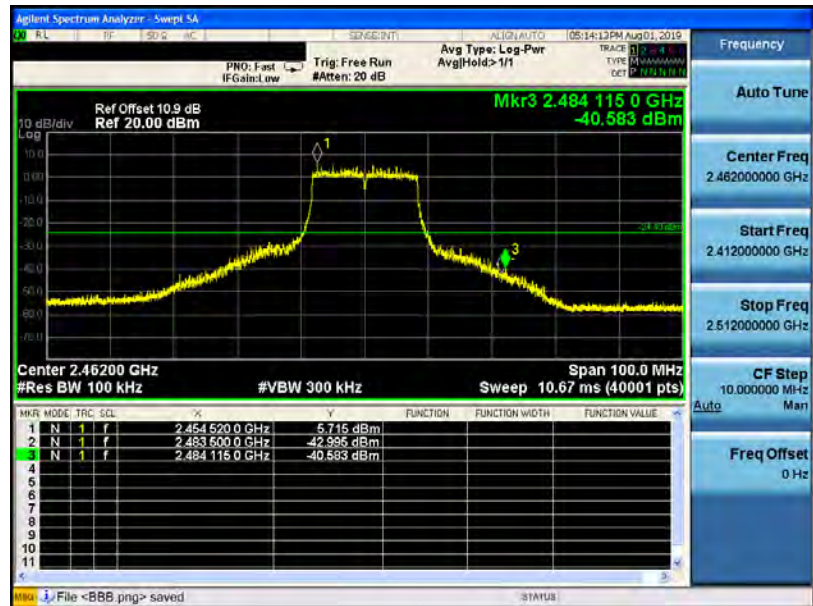

Mode 4: IEEE 802.11n 2.4 GHz 20 MHz Continuous TX mode_ANT-0

2412 MHz

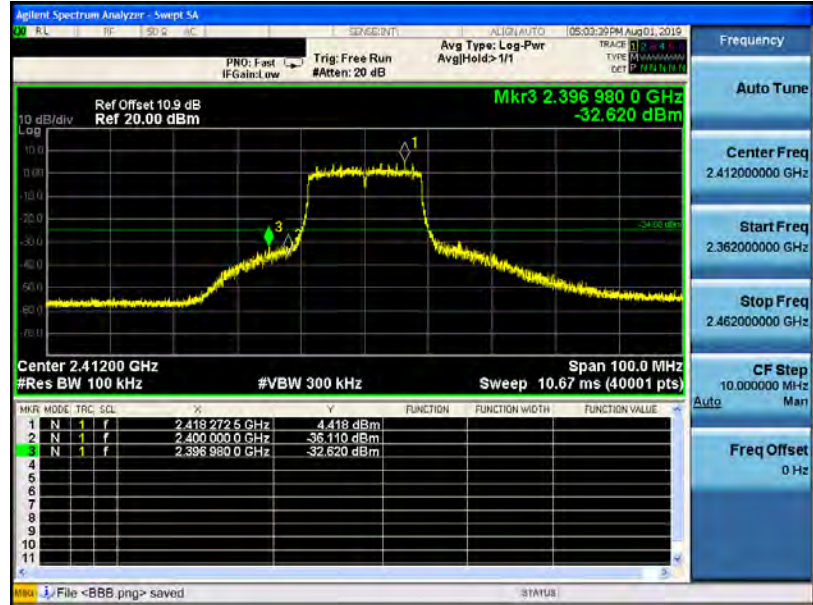

2462 MHz

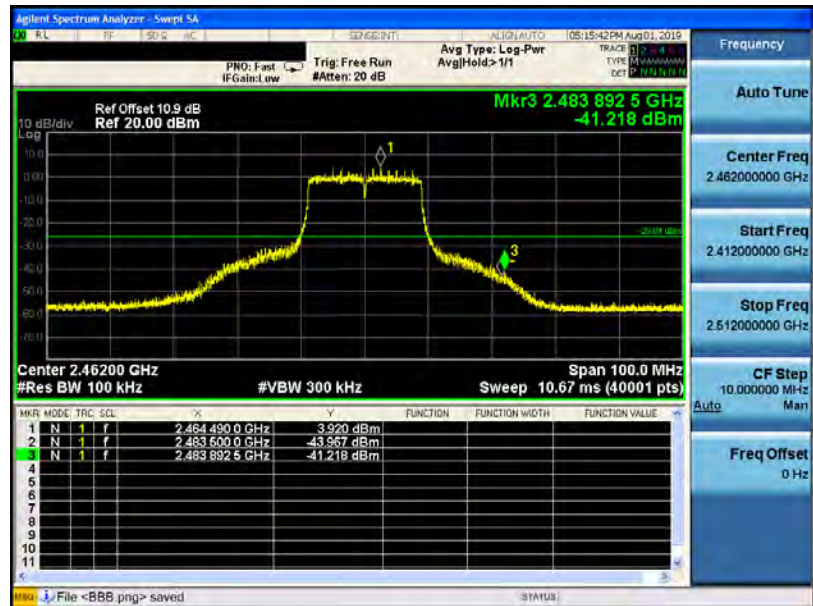

Mode 5: IEEE 802.11n 2.4 GHz 40 MHz Continuous TX mode_ANT-0

2422 MHz



2452 MHz

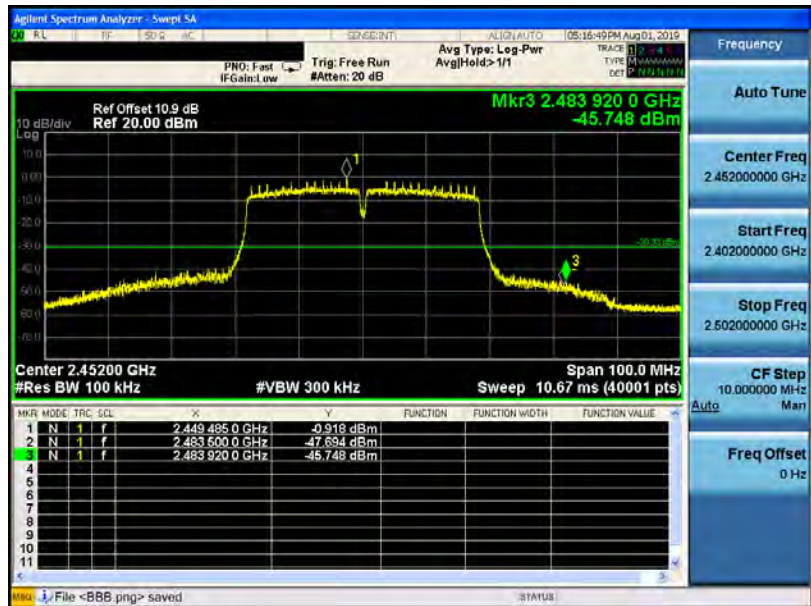

Mode 2: IEEE 802.11b Continuous TX mode_ANT-1

2412 MHz

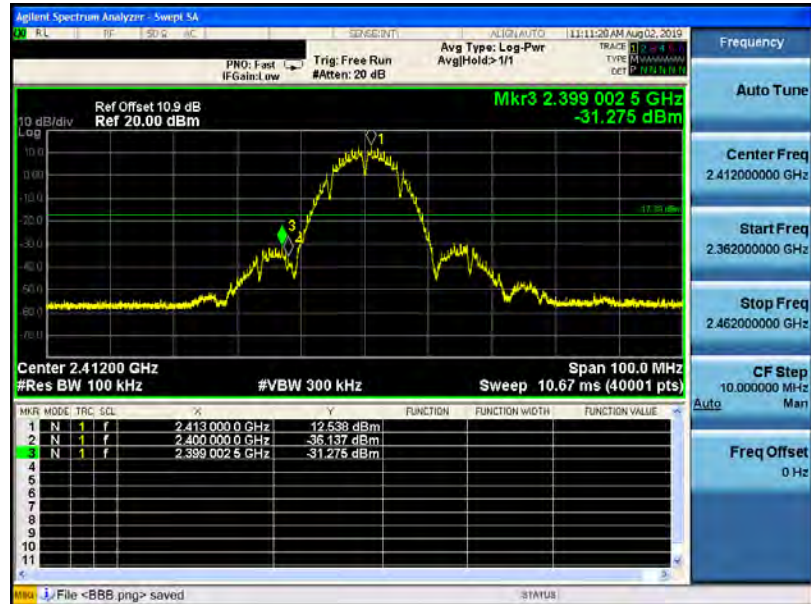

2462 MHz

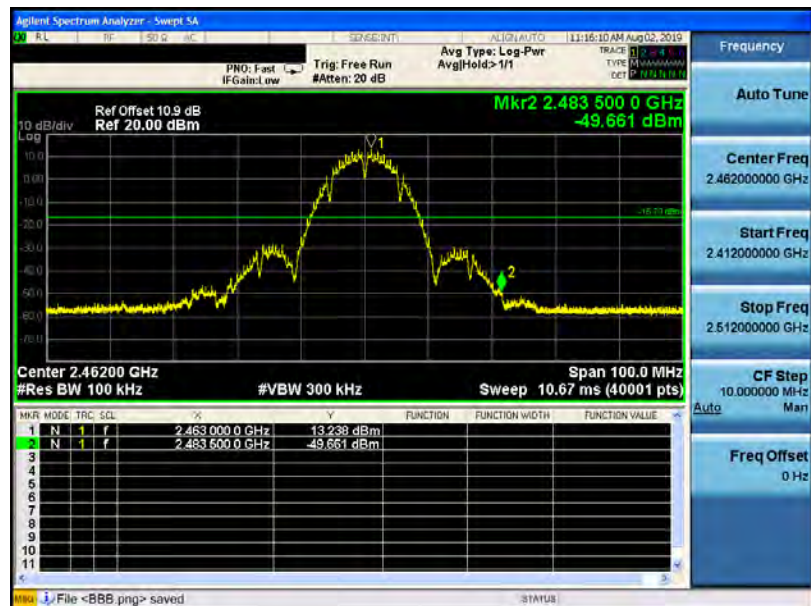



Mode 3: IEEE 802.11g Continuous TX mode_ANT-1

2412 MHz

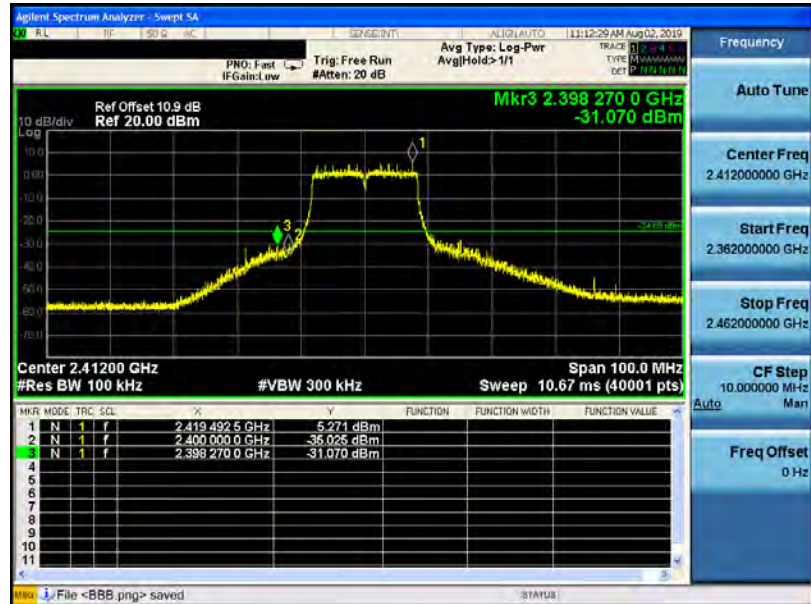

2462 MHz

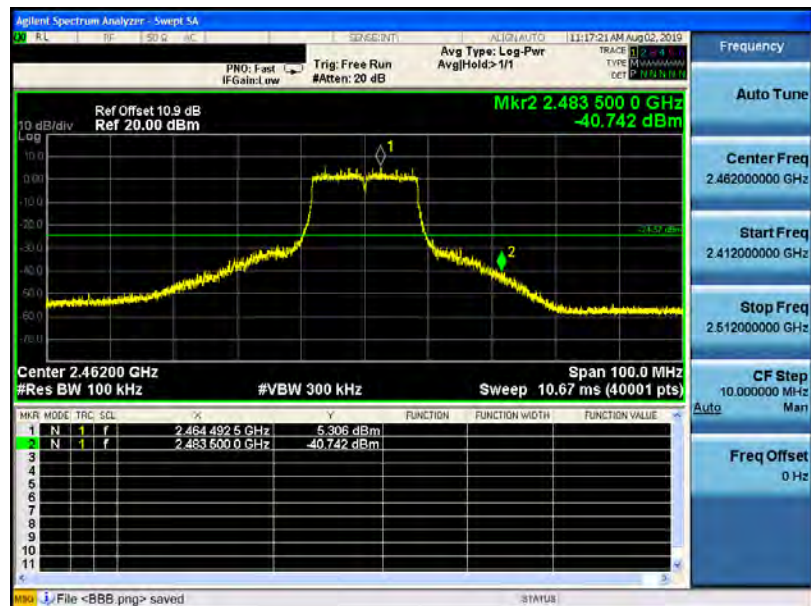

Mode 4: IEEE 802.11n 2.4 GHz 20 MHz Continuous TX mode_ANT-1

2412 MHz

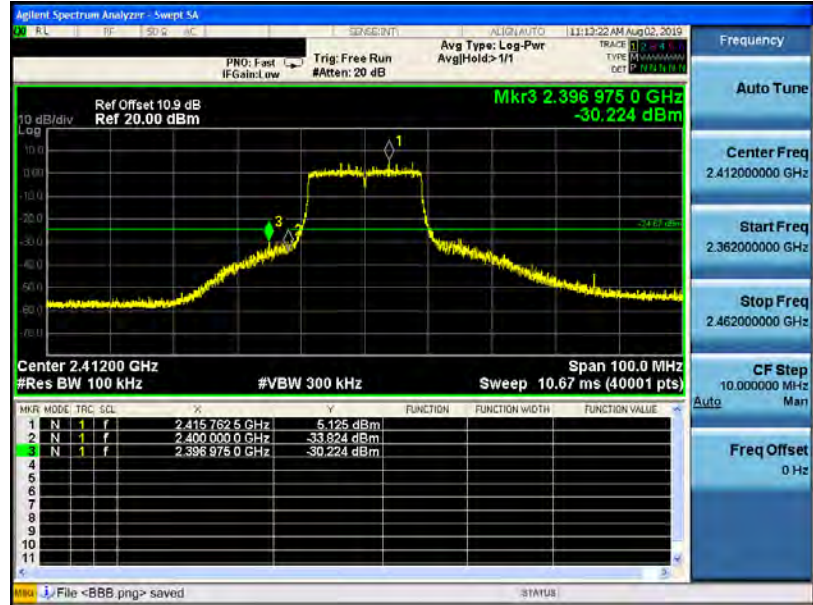

2462 MHz

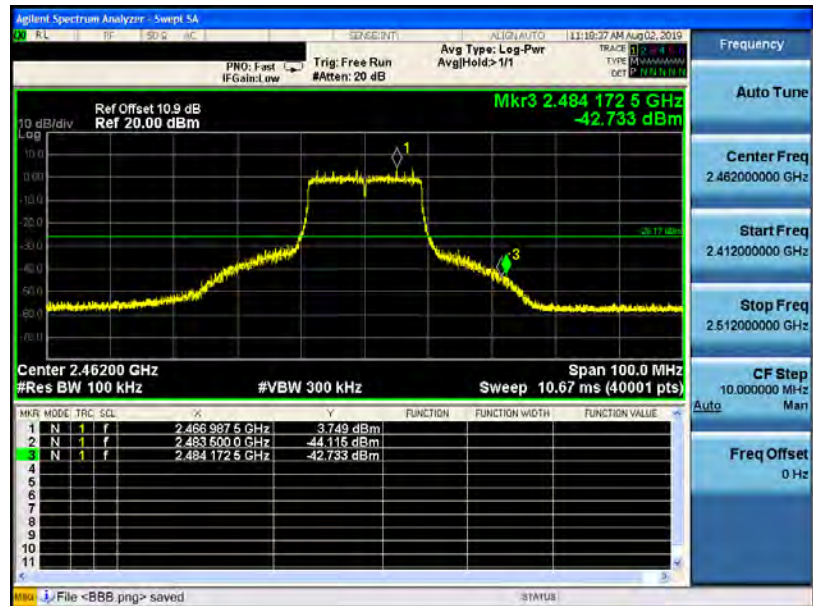



Mode 5: IEEE 802.11n 2.4 GHz 40 MHz Continuous TX mode_ANT-1

2422 MHz

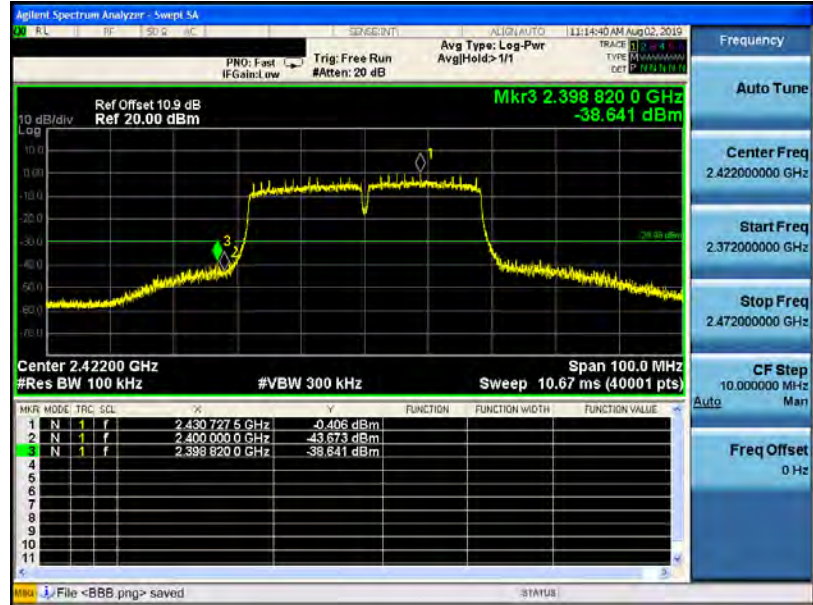

2452 MHz

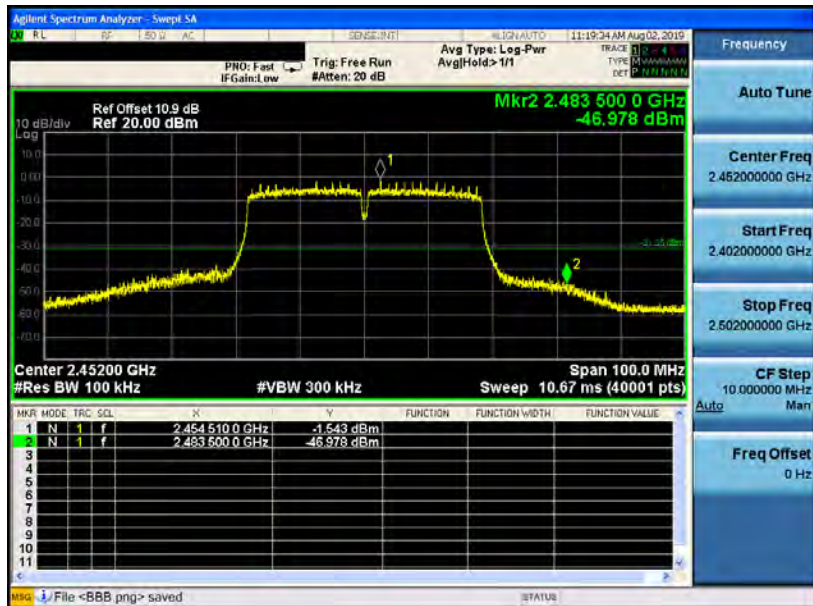



Annex C. Radiated Emission Measurement

Harmonic

Below 1 GHz

Standard:		FCC Part 15.247		Test Distance:		3 m	
Test item:		Harmonic		Power:		AC 120 V/60 Hz	
Mode:		Mode 1		Temp.(°C)/Hum.(%RH):		26(°C)/60 %RH	
Frequency (MHz)	Reading (dBuV)	Correct Factor (dB/m)	Result (dBuV/m)	Limit (dBuV/m)	Margin (dB)	Remark	Ant.Polar. H / V
100.8100	41.29	-10.94	30.35	43.50	-13.15	QP	H
224.9700	41.94	-7.39	34.55	46.00	-11.45	QP	H
288.0200	45.06	-4.48	40.58	46.00	-5.42	QP	H
313.2400	41.62	-3.83	37.79	46.00	-8.21	QP	H
325.8500	42.81	-3.61	39.20	46.00	-6.80	QP	H
350.1000	43.91	-3.20	40.71	46.00	-5.29	QP	H
38.7300	38.37	-7.10	31.27	40.00	-8.73	QP	V
92.0800	40.64	-12.06	28.58	43.50	-14.92	QP	V
300.6300	39.70	-4.03	35.67	46.00	-10.33	QP	V
313.2400	39.44	-3.83	35.61	46.00	-10.39	QP	V
325.8500	39.17	-3.61	35.56	46.00	-10.44	QP	V
337.4900	40.87	-3.41	37.46	46.00	-8.54	QP	V

Note:1.Result (dBuV/m) = Correct Factor (dB/m) + Reading(dBuV).

Example: 30.35=-10.94+41.29.

2.Correction factor (dB/m) = Antenna Factor (dB/m) + Cable loss (dB) – Pre-Amplifier gain (dB).

3.When the peak results are less than average limit, so not need to evaluate the average.



Above 1 GHz

Standard:	FCC Part 15.247	Test Distance:	3 m
Test item:	Harmonic	Power:	AC 120 V/60 Hz
Frequency:	2412 MHz	Temp.(°C)/Hum.(%RH):	26(°C)/60 %RH
Mode:	Mode 2		
Ant.Polar.:	Horizontal		

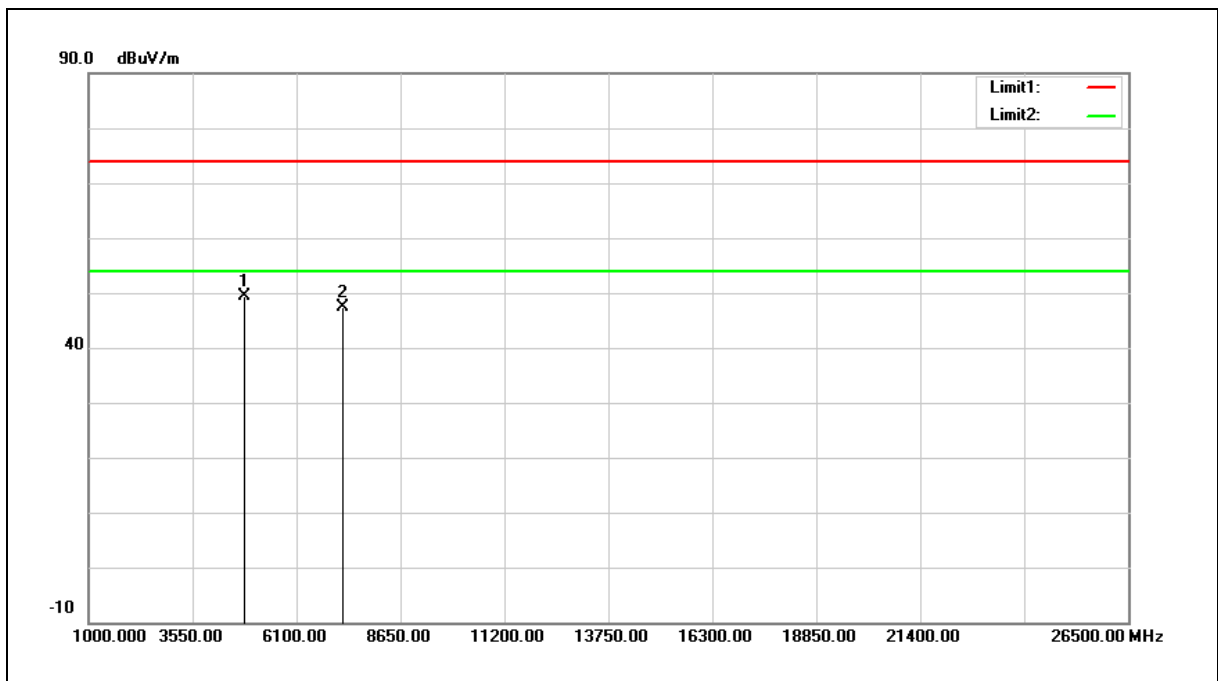

No.	Frequency (MHz)	Reading (dBuV)	Correct Factor (dB/m)	Result (dBuV/m)	Limit (dBuV/m)	Margin (dB)	Remark
1	4824.000	43.90	5.57	49.47	74.00	-24.53	peak
2	7236.000	35.45	11.98	47.43	74.00	-26.57	peak

Note:1.Result (dBuV/m) = Correct Factor (dB/m) + Reading(dBuV).

Example: 49.47=5.57+43.90.

2.Correction factor (dB/m) = Antenna Factor (dB/m) + Cable loss (dB) – Pre-Amplifier gain (dB).

3.When the peak results are less than average limit, so not need to evaluate the average.



Standard:	FCC Part 15.247	Test Distance:	3 m
Test item:	Harmonic	Power:	AC 120 V/60 Hz
Frequency:	2412 MHz	Temp.(°C)/Hum.(%RH):	26(°C)/60 %RH
Mode:	Mode 2		
Ant.Polar.:	Vertical		

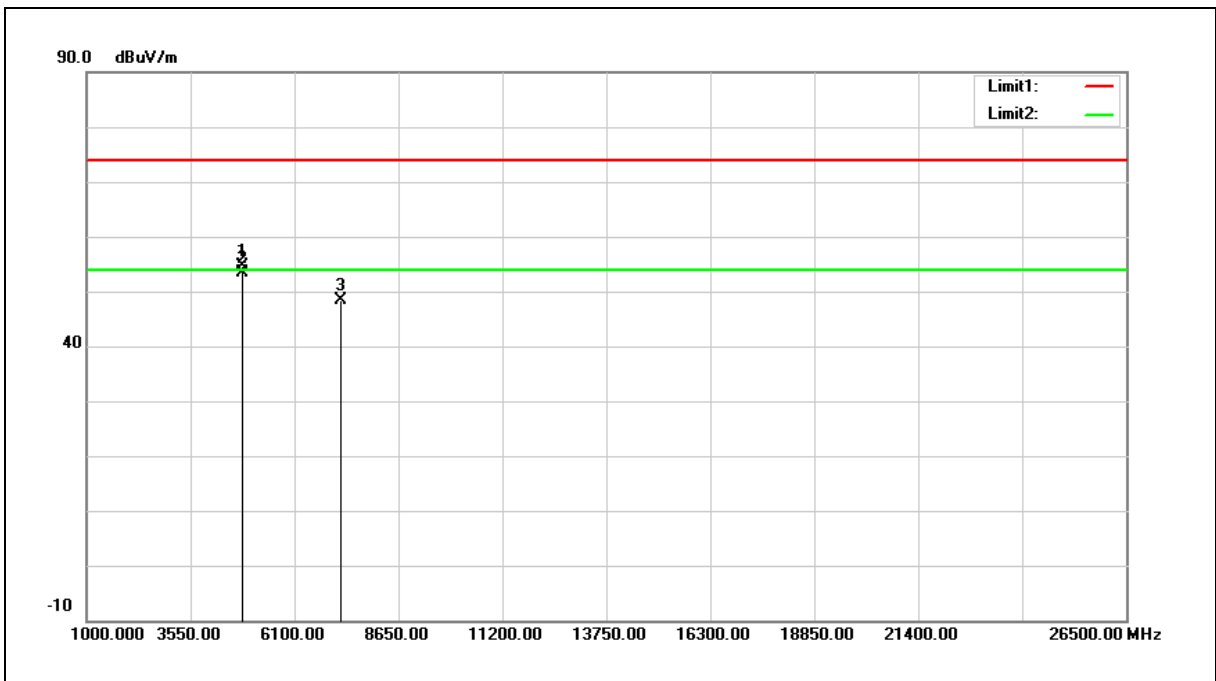

No.	Frequency (MHz)	Reading (dBuV)	Correct Factor (dB/m)	Result (dBuV/m)	Limit (dBuV/m)	Margin (dB)	Remark
1	4824.000	49.09	5.57	54.66	74.00	-19.34	peak
2	4824.000	47.71	5.57	53.28	54.00	-0.72	AVG
3	7236.000	36.35	11.98	48.33	74.00	-25.67	peak

Note:1.Result (dBuV/m) = Correct Factor (dB/m) + Reading(dBuV).

Example: 54.66=5.57+49.09.

2.Correction factor (dB/m) = Antenna Factor (dB/m) + Cable loss (dB) – Pre-Amplifier gain (dB).

3.When the peak results are less than average limit, so not need to evaluate the average.



Standard:	FCC Part 15.247	Test Distance:	3 m
Test item:	Harmonic	Power:	AC 120 V/60 Hz
Frequency:	2437 MHz	Temp.(°C)/Hum.(%RH):	26(°C)/60 %RH
Mode:	Mode 2		
Ant.Polar.:	Horizontal		

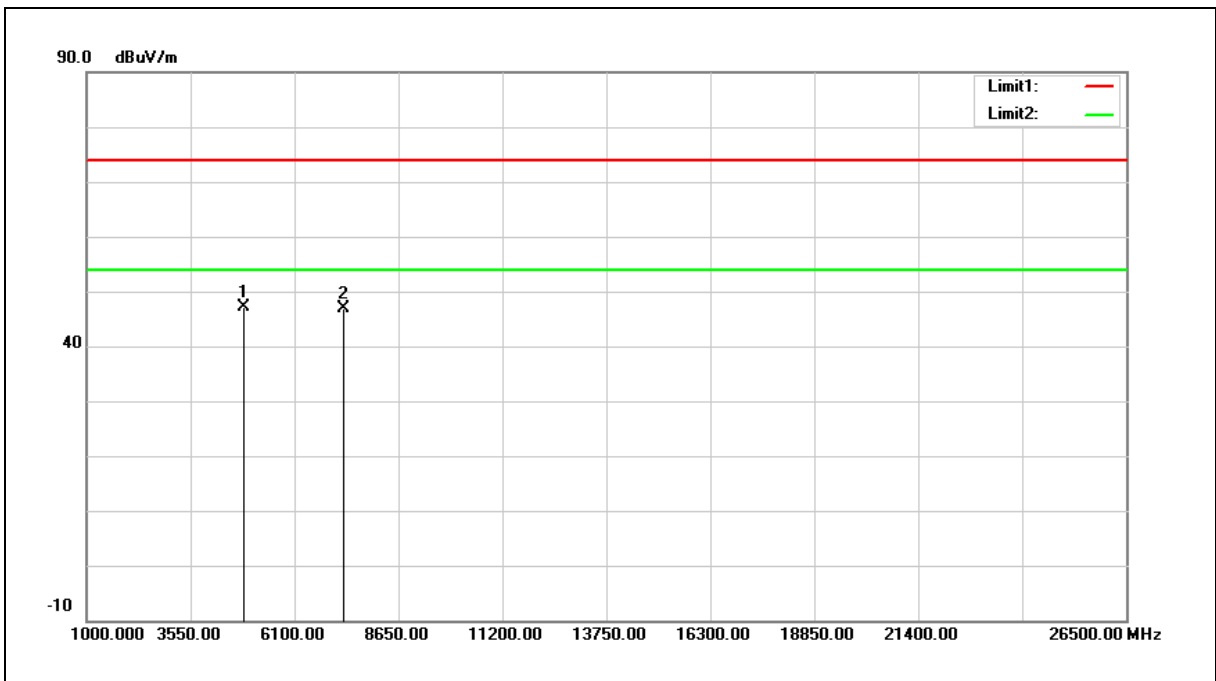

No.	Frequency (MHz)	Reading (dBuV)	Correct Factor (dB/m)	Result (dBuV/m)	Limit (dBuV/m)	Margin (dB)	Remark
1	4874.000	41.45	5.67	47.12	74.00	-26.88	peak
2	7311.000	34.85	12.15	47.00	74.00	-27.00	peak

- Note: 1.Result (dBuV/m) = Correct Factor (dB/m) + Reading(dBuV).
 2.Correction factor (dB/m) = Antenna Factor (dB/m) + Cable loss (dB) – Pre-Amplifier gain (dB).
 3.When the peak results are less than average limit, so not need to evaluate the average.



Standard:	FCC Part 15.247	Test Distance:	3 m
Test item:	Harmonic	Power:	AC 120 V/60 Hz
Frequency:	2437 MHz	Temp.(°C)/Hum.(%RH):	26(°C)/60 %RH
Mode:	Mode 2		
Ant.Polar.:	Vertical		

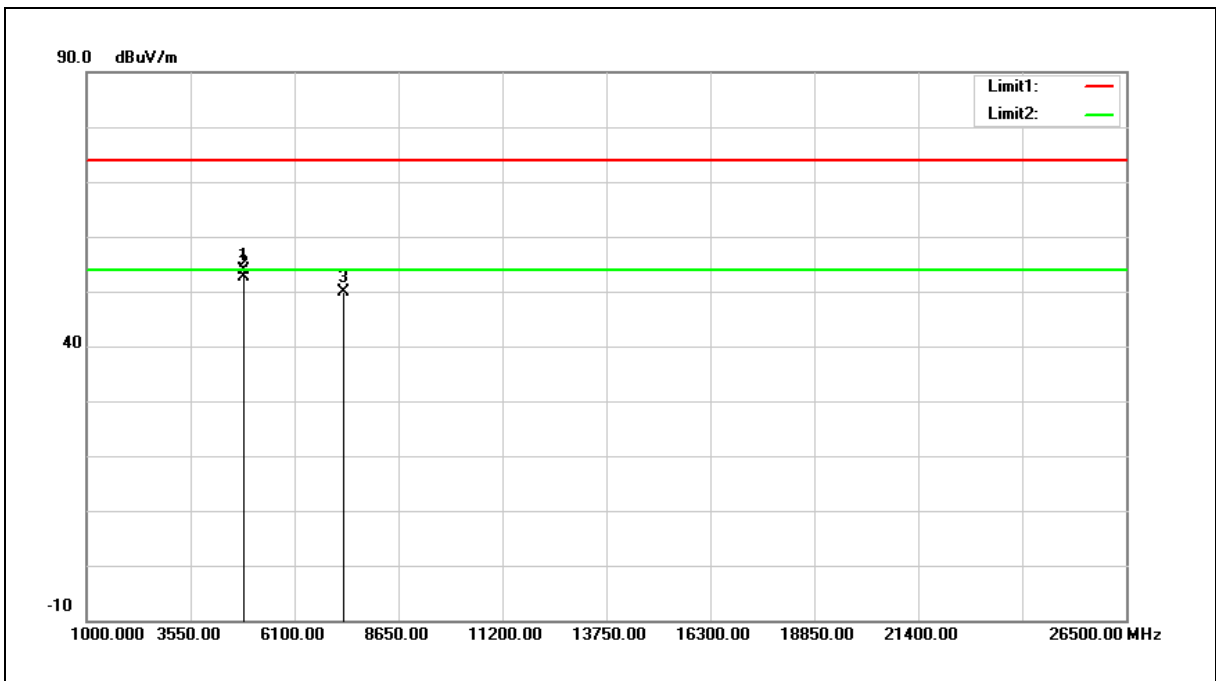

No.	Frequency (MHz)	Reading (dBuV)	Correct Factor (dB/m)	Result (dBuV/m)	Limit (dBuV/m)	Margin (dB)	Remark
1	4874.000	48.15	5.67	53.82	74.00	-20.18	peak
2	4874.000	46.89	5.67	52.56	54.00	-1.44	AVG
3	7311.000	37.77	12.15	49.92	74.00	-24.08	peak

Note:1.Result (dBuV/m) = Correct Factor (dB/m) + Reading(dBuV).

2.Correction factor (dB/m) = Antenna Factor (dB/m) + Cable loss (dB) – Pre-Amplifier gain (dB).

3.When the peak results are less than average limit, so not need to evaluate the average.



Standard:	FCC Part 15.247	Test Distance:	3 m
Test item:	Harmonic	Power:	AC 120 V/60 Hz
Frequency:	2462 MHz	Temp.(°C)/Hum.(%RH):	26(°C)/60 %RH
Mode:	Mode 2		
Ant.Polar.:	Horizontal		

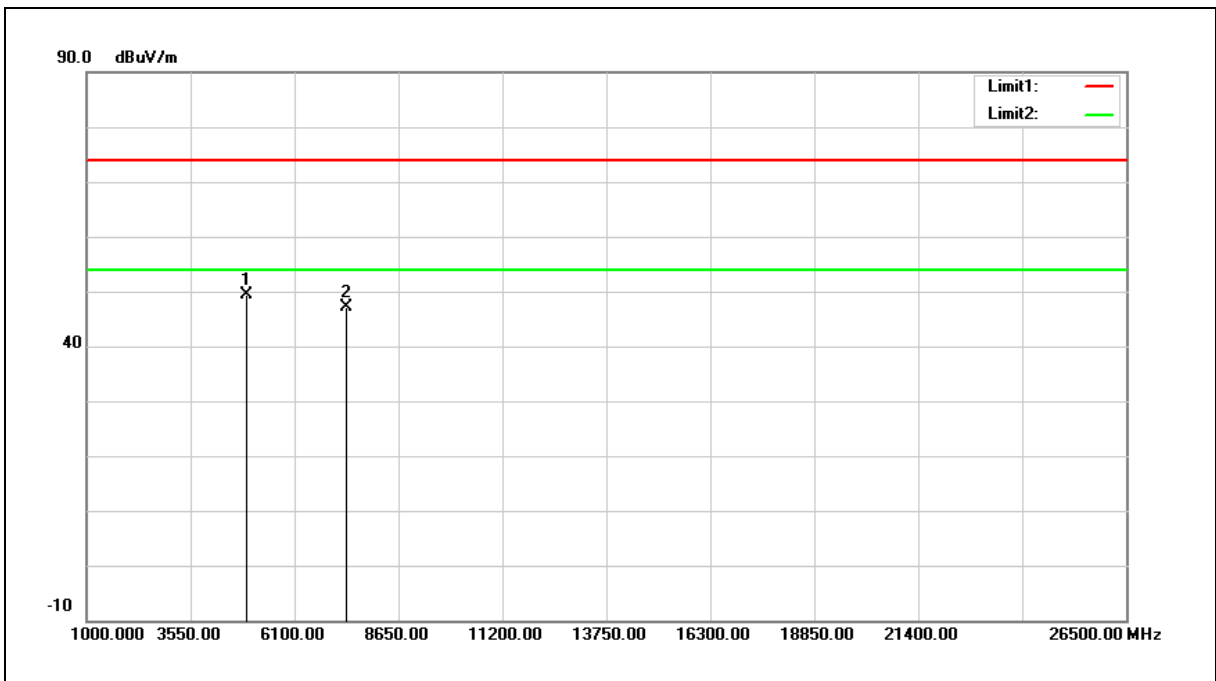

No.	Frequency (MHz)	Reading (dBuV)	Correct Factor (dB/m)	Result (dBuV/m)	Limit (dBuV/m)	Margin (dB)	Remark
1	4924.000	43.49	5.77	49.26	74.00	-24.74	peak
2	7386.000	34.80	12.33	47.13	74.00	-26.87	peak

Note: 1. Result (dBuV/m) = Correct Factor (dB/m) + Reading(dBuV).

2. Correction factor (dB/m) = Antenna Factor (dB/m) + Cable loss (dB) – Pre-Amplifier gain (dB).

3. When the peak results are less than average limit, so not need to evaluate the average.



Standard:	FCC Part 15.247	Test Distance:	3 m
Test item:	Harmonic	Power:	AC 120 V/60 Hz
Frequency:	2462 MHz	Temp.(°C)/Hum.(%RH):	26(°C)/60 %RH
Mode:	Mode 2		
Ant.Polar.:	Vertical		

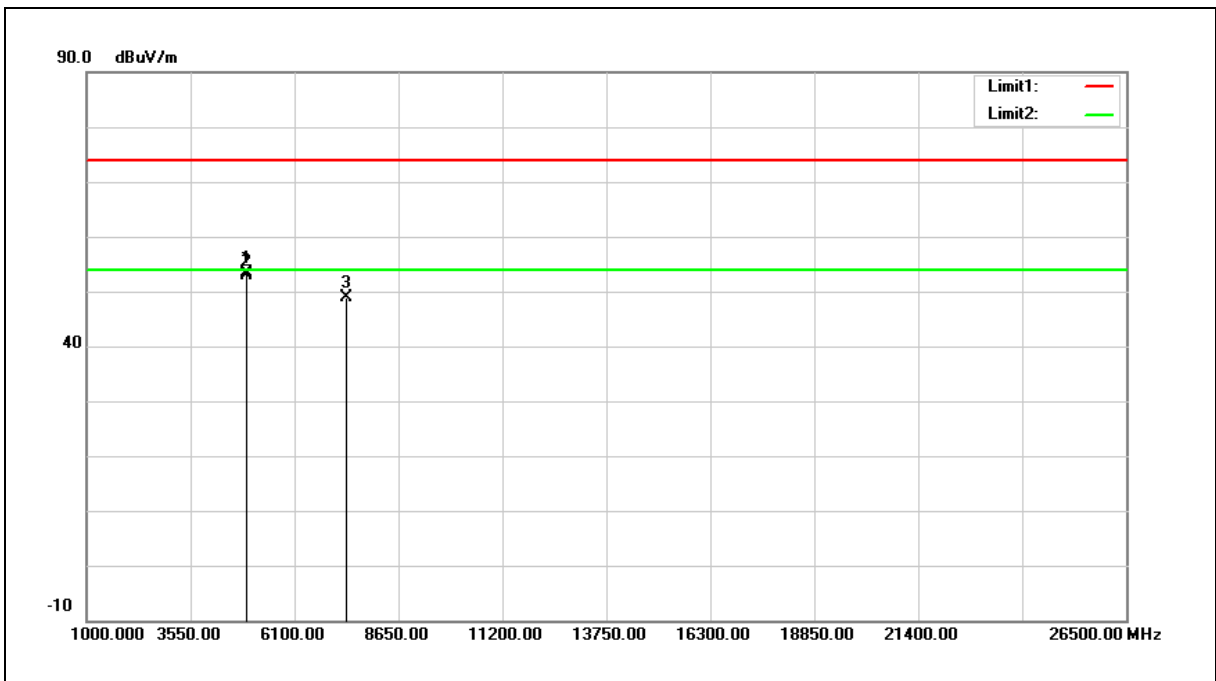

No.	Frequency (MHz)	Reading (dBuV)	Correct Factor (dB/m)	Result (dBuV/m)	Limit (dBuV/m)	Margin (dB)	Remark
1	4924.000	47.62	5.77	53.39	74.00	-20.61	peak
2	4924.000	47.10	5.77	52.87	54.00	-1.13	AVG
3	7386.000	36.67	12.33	49.00	74.00	-25.00	peak

Note:1.Result (dBuV/m) = Correct Factor (dB/m) + Reading(dBuV).

2.Correction factor (dB/m) = Antenna Factor (dB/m) + Cable loss (dB) – Pre-Amplifier gain (dB).

3.When the peak results are less than average limit, so not need to evaluate the average.



Standard:	FCC Part 15.247	Test Distance:	3 m
Test item:	Harmonic	Power:	AC 120 V/60 Hz
Frequency:	2412 MHz	Temp.(°C)/Hum.(%RH):	26(°C)/60 %RH
Mode:	Mode 3		
Ant.Polar.:	Horizontal		

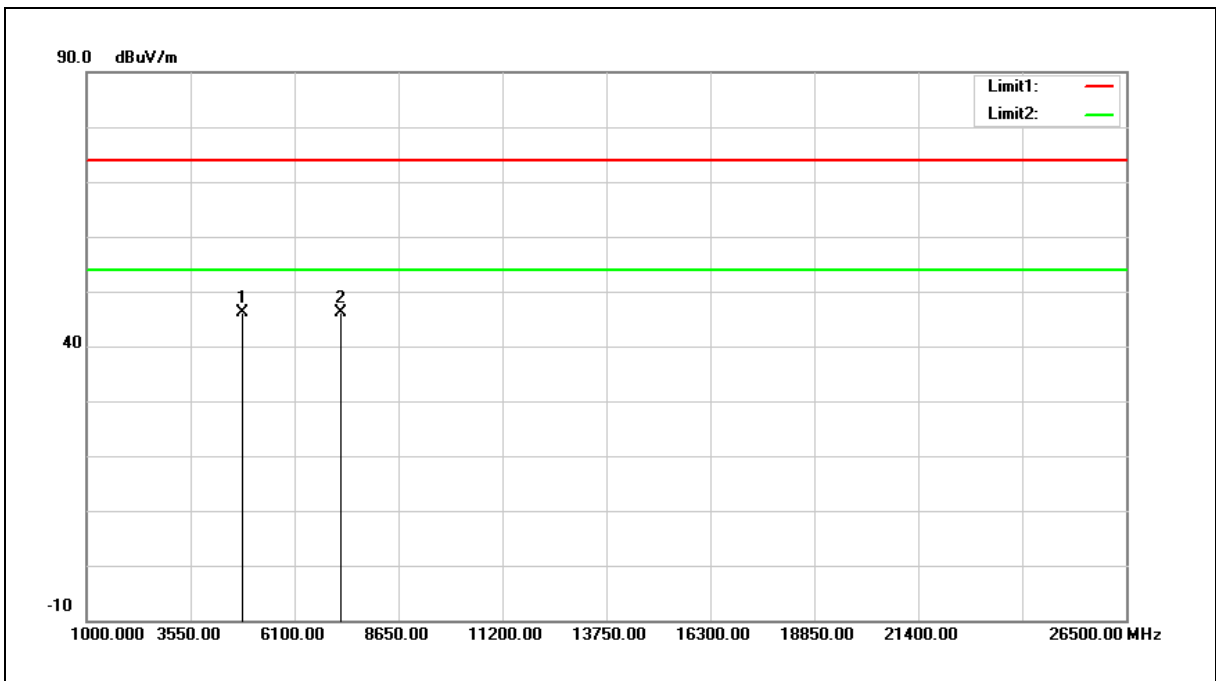

No.	Frequency (MHz)	Reading (dBuV)	Correct Factor (dB/m)	Result (dBuV/m)	Limit (dBuV/m)	Margin (dB)	Remark
1	4824.000	40.49	5.57	46.06	74.00	-27.94	peak
2	7236.000	34.21	11.98	46.19	74.00	-27.81	peak

- Note: 1.Result (dBuV/m) = Correct Factor (dB/m) + Reading(dBuV).
 2.Correction factor (dB/m) = Antenna Factor (dB/m) + Cable loss (dB) – Pre-Amplifier gain (dB).
 3.When the peak results are less than average limit, so not need to evaluate the average.



Standard:	FCC Part 15.247	Test Distance:	3 m
Test item:	Harmonic	Power:	AC 120 V/60 Hz
Frequency:	2412 MHz	Temp.(°C)/Hum.(%RH):	26(°C)/60 %RH
Mode:	Mode 3		
Ant.Polar.:	Vertical		

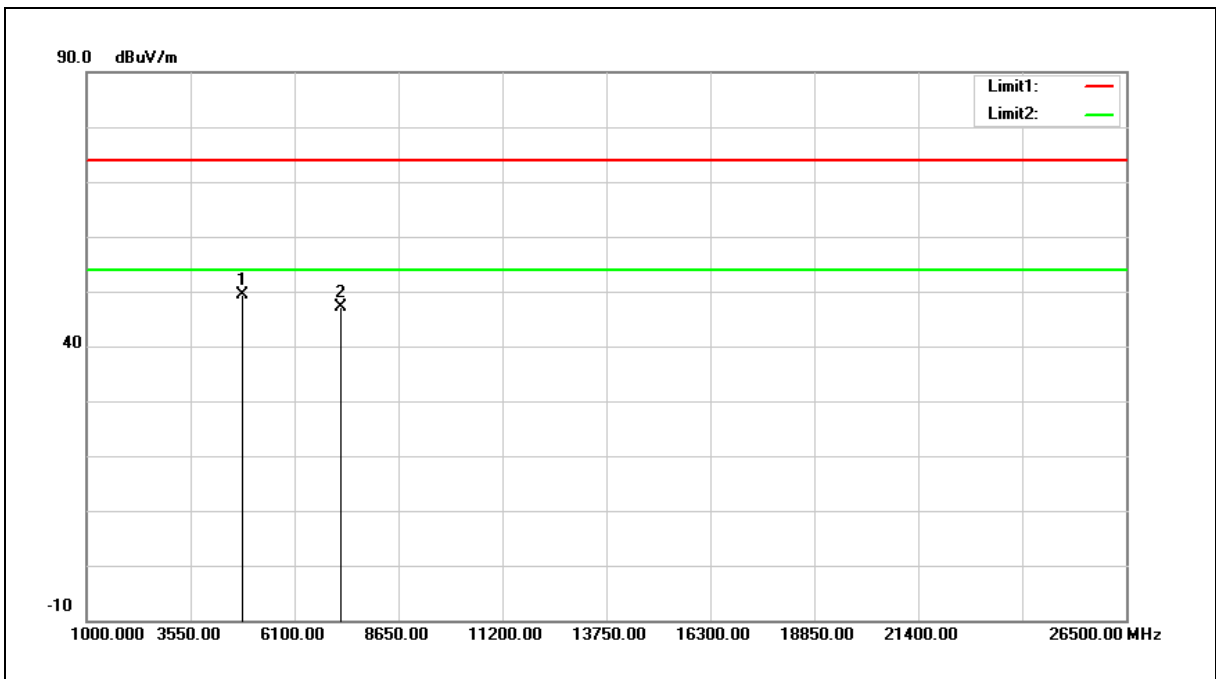

No.	Frequency (MHz)	Reading (dBuV)	Correct Factor (dB/m)	Result (dBuV/m)	Limit (dBuV/m)	Margin (dB)	Remark
1	4824.000	43.78	5.57	49.35	74.00	-24.65	peak
2	7236.000	35.15	11.98	47.13	74.00	-26.87	peak

- Note: 1.Result (dBuV/m) = Correct Factor (dB/m) + Reading(dBuV).
 2.Correction factor (dB/m) = Antenna Factor (dB/m) + Cable loss (dB) – Pre-Amplifier gain (dB).
 3.When the peak results are less than average limit, so not need to evaluate the average.



Standard:	FCC Part 15.247	Test Distance:	3 m
Test item:	Harmonic	Power:	AC 120 V/60 Hz
Frequency:	2437 MHz	Temp.(°C)/Hum.(%RH):	26(°C)/60 %RH
Mode:	Mode 3		
Ant.Polar.:	Horizontal		

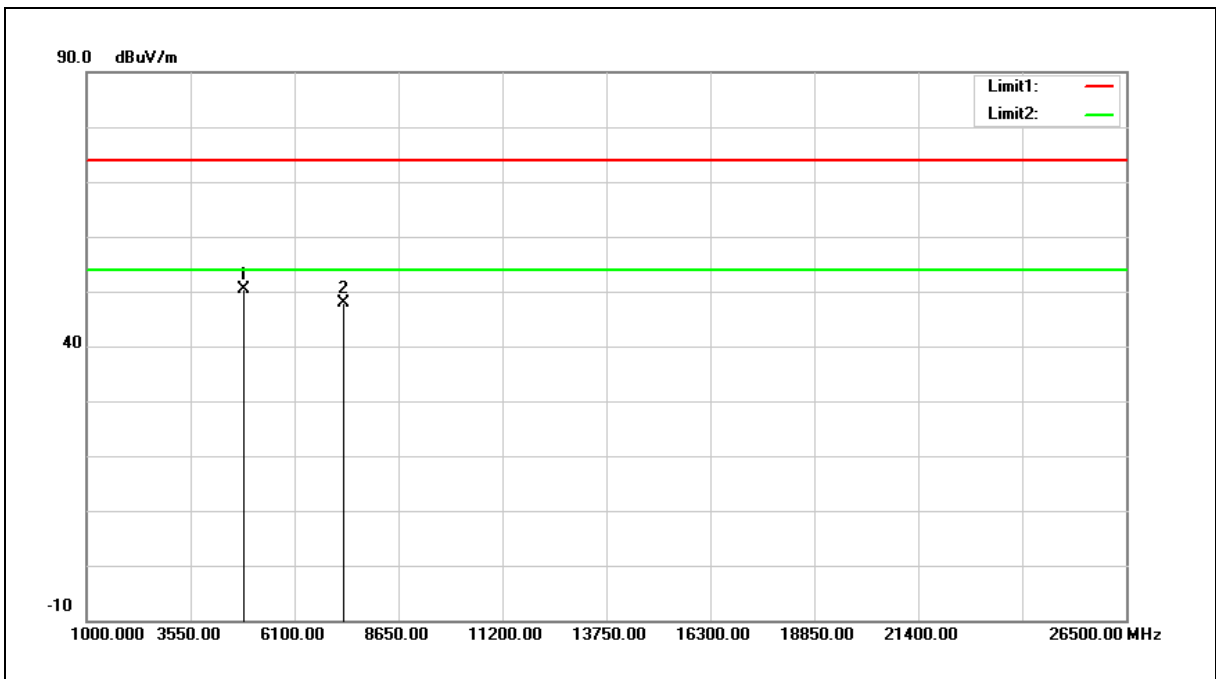

No.	Frequency (MHz)	Reading (dBuV)	Correct Factor (dB/m)	Result (dBuV/m)	Limit (dBuV/m)	Margin (dB)	Remark
1	4874.000	44.73	5.67	50.40	74.00	-23.60	peak
2	7311.000	35.82	12.15	47.97	74.00	-26.03	peak

- Note: 1.Result (dBuV/m) = Correct Factor (dB/m) + Reading(dBuV).
 2.Correction factor (dB/m) = Antenna Factor (dB/m) + Cable loss (dB) – Pre-Amplifier gain (dB).
 3.When the peak results are less than average limit, so not need to evaluate the average.



Standard:	FCC Part 15.247	Test Distance:	3 m
Test item:	Harmonic	Power:	AC 120 V/60 Hz
Frequency:	2437 MHz	Temp.(°C)/Hum.(%RH):	26(°C)/60 %RH
Mode:	Mode 3		
Ant.Polar.:	Vertical		

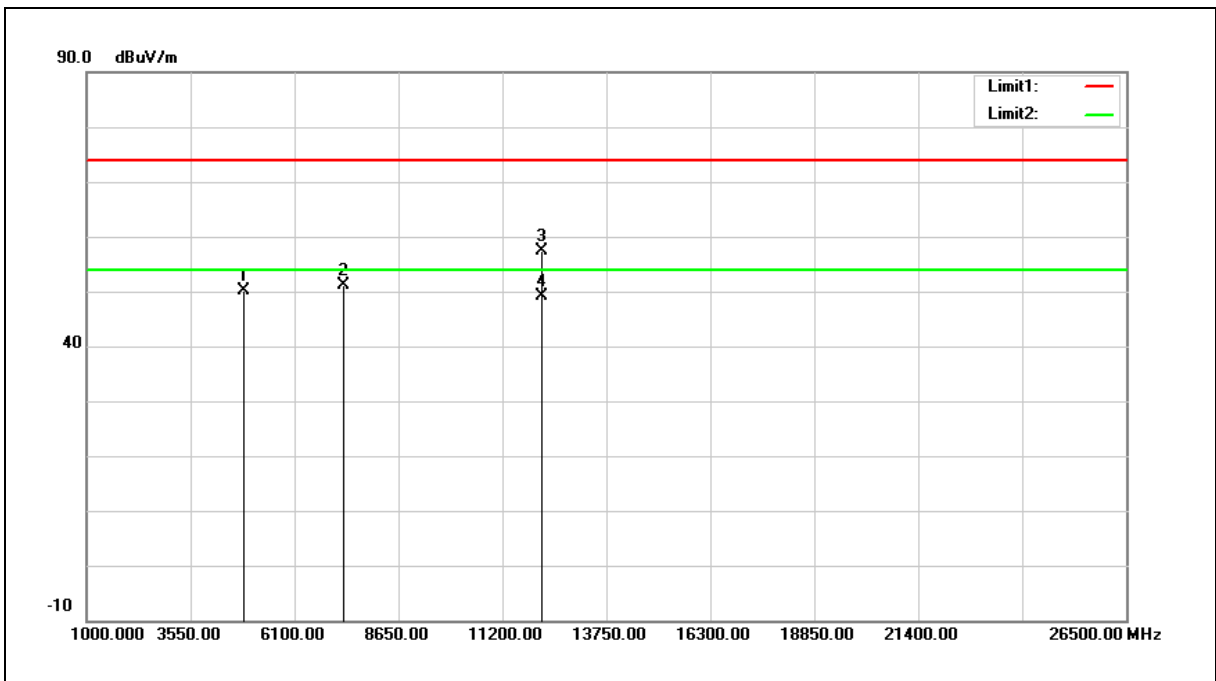

No.	Frequency (MHz)	Reading (dBuV)	Correct Factor (dB/m)	Result (dBuV/m)	Limit (dBuV/m)	Margin (dB)	Remark
1	4874.000	44.45	5.67	50.12	74.00	-23.88	peak
2	7311.000	39.05	12.15	51.20	74.00	-22.80	peak
3	12185.000	39.11	18.22	57.33	74.00	-16.67	peak
4	12185.000	31.01	18.22	49.23	54.00	-4.77	AVG

Note:1.Result (dBuV/m) = Correct Factor (dB/m) + Reading(dBuV).

2.Correction factor (dB/m) = Antenna Factor (dB/m) + Cable loss (dB) – Pre-Amplifier gain (dB).

3.When the peak results are less than average limit, so not need to evaluate the average.



Standard:	FCC Part 15.247	Test Distance:	3 m
Test item:	Harmonic	Power:	AC 120 V/60 Hz
Frequency:	2462 MHz	Temp.(°C)/Hum.(%RH):	26(°C)/60 %RH
Mode:	Mode 3		
Ant.Polar.:	Horizontal		

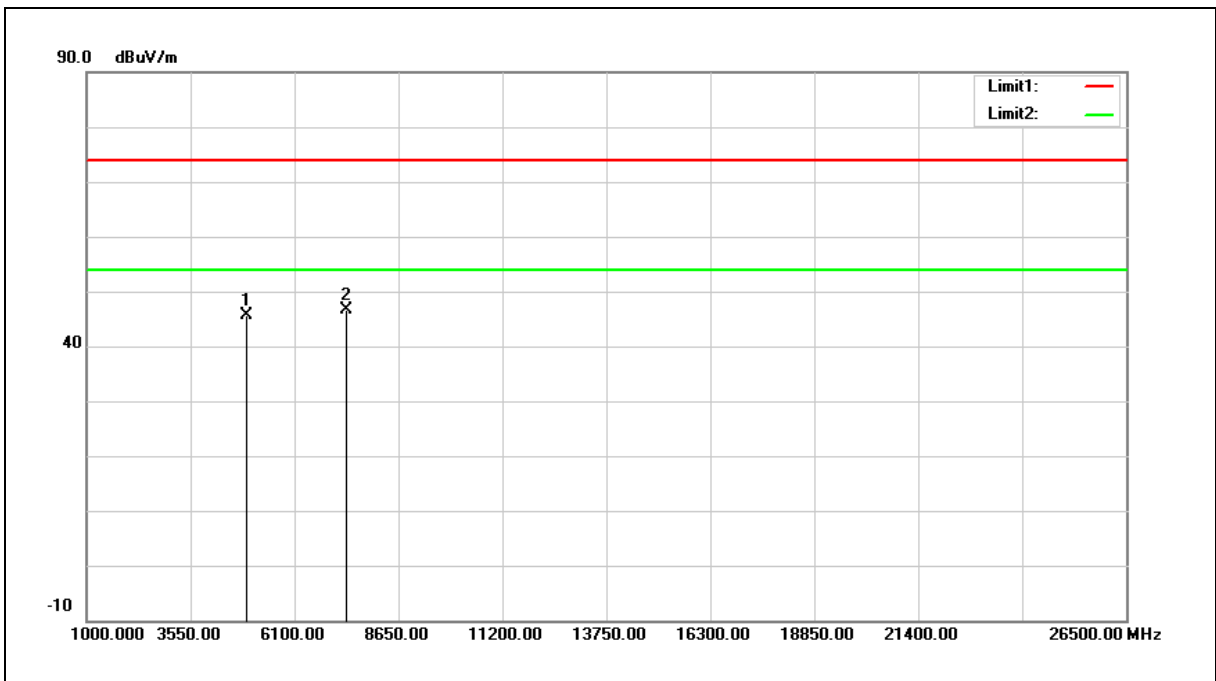

No.	Frequency (MHz)	Reading (dBuV)	Correct Factor (dB/m)	Result (dBuV/m)	Limit (dBuV/m)	Margin (dB)	Remark
1	4924.000	39.89	5.77	45.66	74.00	-28.34	peak
2	7386.000	34.27	12.33	46.60	74.00	-27.40	peak

- Note: 1.Result (dBuV/m) = Correct Factor (dB/m) + Reading(dBuV).
 2.Correction factor (dB/m) = Antenna Factor (dB/m) + Cable loss (dB) – Pre-Amplifier gain (dB).
 3.When the peak results are less than average limit, so not need to evaluate the average.



Standard:	FCC Part 15.247	Test Distance:	3 m
Test item:	Harmonic	Power:	AC 120 V/60 Hz
Frequency:	2462 MHz	Temp.(°C)/Hum.(%RH):	26(°C)/60 %RH
Mode:	Mode 3		
Ant.Polar.:	Vertical		

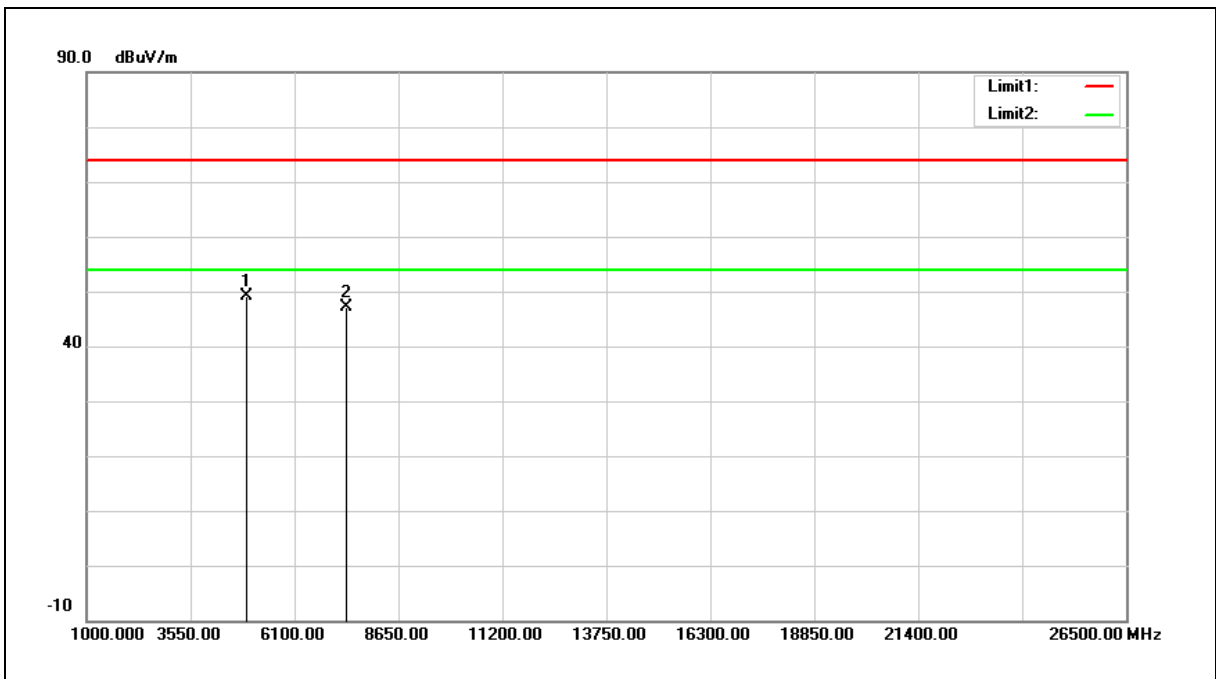

No.	Frequency (MHz)	Reading (dBuV)	Correct Factor (dB/m)	Result (dBuV/m)	Limit (dBuV/m)	Margin (dB)	Remark
1	4924.000	43.38	5.77	49.15	74.00	-24.85	peak
2	7386.000	34.83	12.33	47.16	74.00	-26.84	peak

- Note: 1.Result (dBuV/m) = Correct Factor (dB/m) + Reading(dBuV).
 2.Correction factor (dB/m) = Antenna Factor (dB/m) + Cable loss (dB) – Pre-Amplifier gain (dB).
 3.When the peak results are less than average limit, so not need to evaluate the average.



Standard:	FCC Part 15.247	Test Distance:	3 m
Test item:	Harmonic	Power:	AC 120 V/60 Hz
Frequency:	2412 MHz	Temp.(°C)/Hum.(%RH):	26(°C)/60 %RH
Mode:	Mode 4		
Ant.Polar.:	Horizontal		

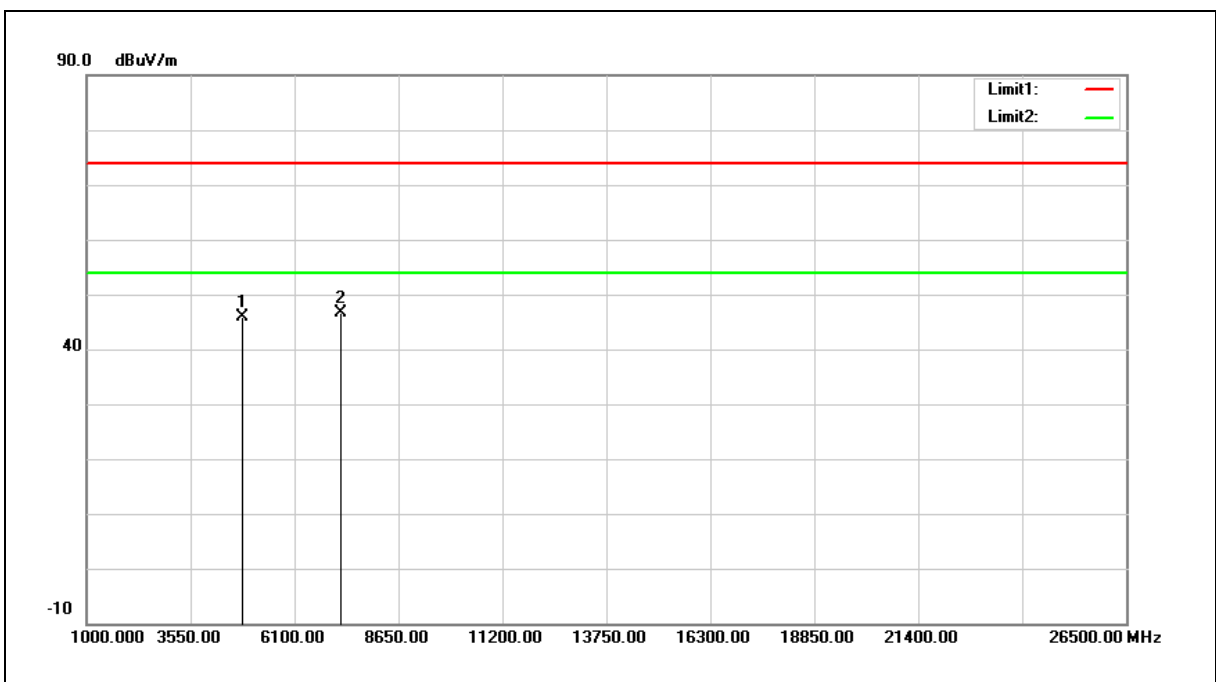

No.	Frequency (MHz)	Reading (dBuV)	Correct Factor (dB/m)	Result (dBuV/m)	Limit (dBuV/m)	Margin (dB)	Remark
1	4824.000	40.42	5.57	45.99	74.00	-28.01	peak
2	7236.000	34.63	11.98	46.61	74.00	-27.39	peak

- Note: 1.Result (dBuV/m) = Correct Factor (dB/m) + Reading(dBuV).
 2.Correction factor (dB/m) = Antenna Factor (dB/m) + Cable loss (dB) – Pre-Amplifier gain (dB).
 3.When the peak results are less than average limit, so not need to evaluate the average.



Standard:	FCC Part 15.247	Test Distance:	3 m
Test item:	Harmonic	Power:	AC 120 V/60 Hz
Frequency:	2412 MHz	Temp.(°C)/Hum.(%RH):	26(°C)/60 %RH
Mode:	Mode 4		
Ant.Polar.:	Vertical		

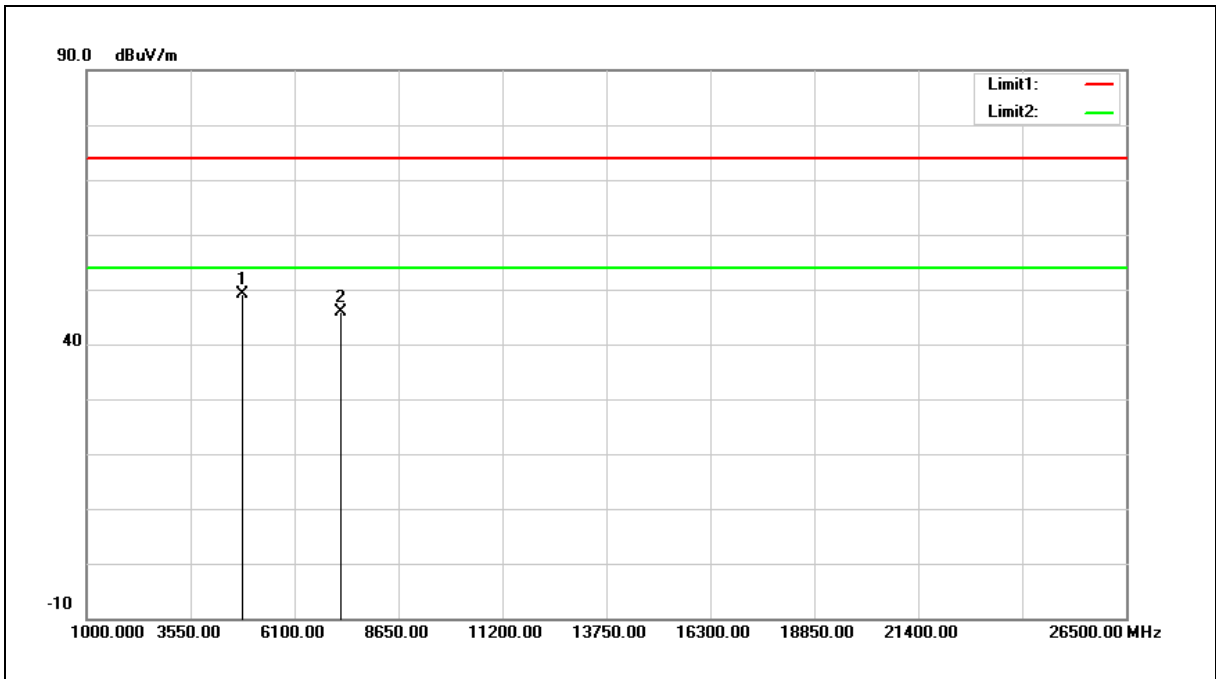

No.	Frequency (MHz)	Reading (dBuV)	Correct Factor (dB/m)	Result (dBuV/m)	Limit (dBuV/m)	Margin (dB)	Remark
1	4824.000	43.45	5.57	49.02	74.00	-24.98	peak
2	7236.000	34.01	11.98	45.99	74.00	-28.01	peak

- Note: 1.Result (dBuV/m) = Correct Factor (dB/m) + Reading(dBuV).
 2.Correction factor (dB/m) = Antenna Factor (dB/m) + Cable loss (dB) – Pre-Amplifier gain (dB).
 3.When the peak results are less than average limit, so not need to evaluate the average.



Standard:	FCC Part 15.247	Test Distance:	3 m
Test item:	Harmonic	Power:	AC 120 V/60 Hz
Frequency:	2437 MHz	Temp.(°C)/Hum.(%RH):	26(°C)/60 %RH
Mode:	Mode 4		
Ant.Polar.:	Horizontal		

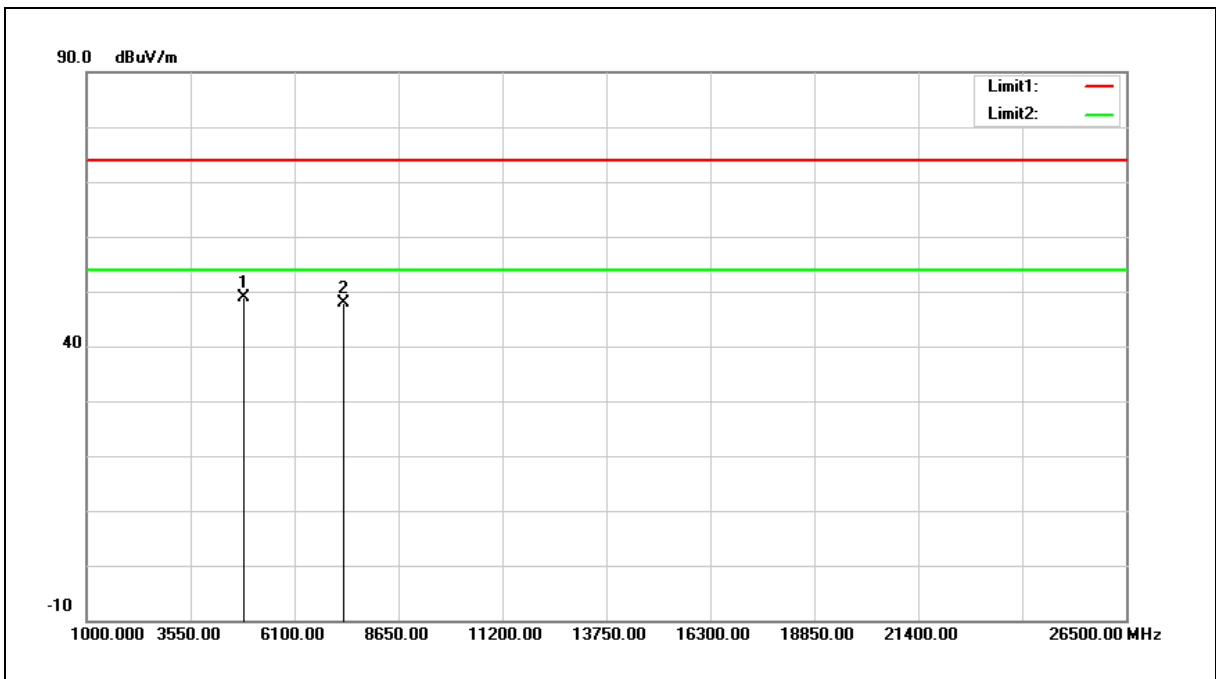

No.	Frequency (MHz)	Reading (dBuV)	Correct Factor (dB/m)	Result (dBuV/m)	Limit (dBuV/m)	Margin (dB)	Remark
1	4874.000	43.18	5.67	48.85	74.00	-25.15	peak
2	7311.000	35.71	12.15	47.86	74.00	-26.14	peak

- Note: 1.Result (dBuV/m) = Correct Factor (dB/m) + Reading(dBuV).
 2.Correction factor (dB/m) = Antenna Factor (dB/m) + Cable loss (dB) – Pre-Amplifier gain (dB).
 3.When the peak results are less than average limit, so not need to evaluate the average.



Standard:	FCC Part 15.247	Test Distance:	3 m
Test item:	Harmonic	Power:	AC 120 V/60 Hz
Frequency:	2437 MHz	Temp.(°C)/Hum.(%RH):	26(°C)/60 %RH
Mode:	Mode 4		
Ant.Polar.:	Vertical		

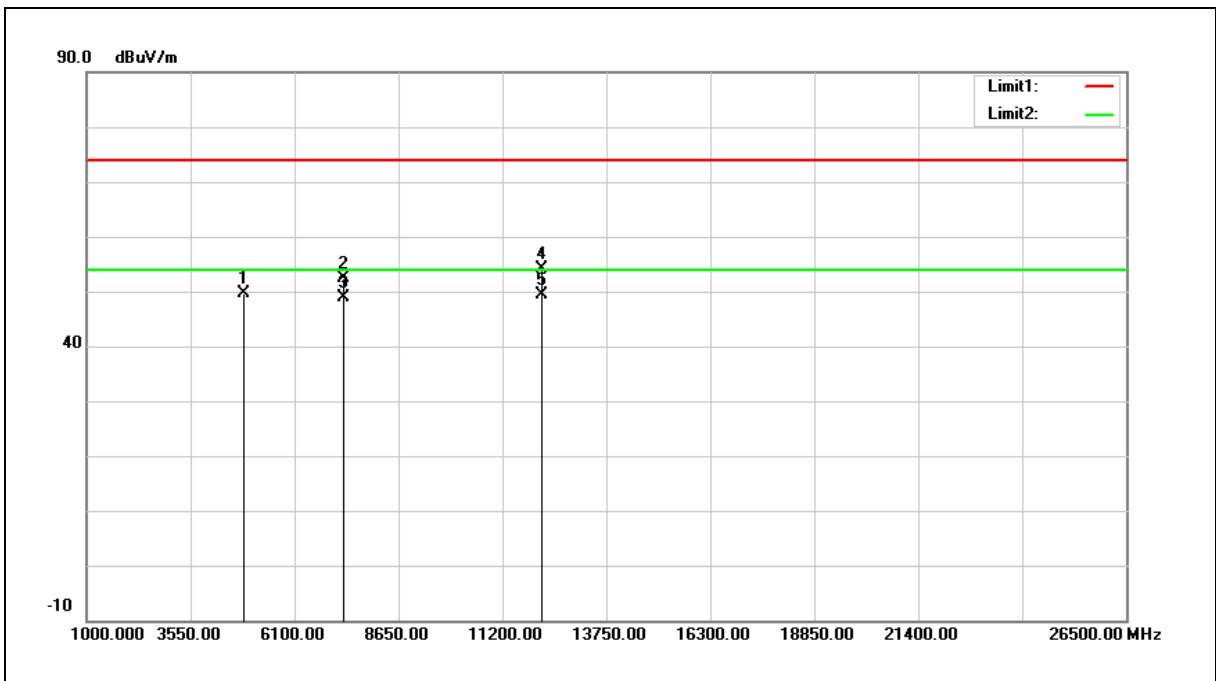

No.	Frequency (MHz)	Reading (dBuV)	Correct Factor (dB/m)	Result (dBuV/m)	Limit (dBuV/m)	Margin (dB)	Remark
1	4874.000	43.89	5.67	49.56	74.00	-24.44	peak
2	7311.000	40.31	12.15	52.46	74.00	-21.54	peak
3	7311.000	36.77	12.15	48.92	54.00	-5.08	AVG
4	12185.000	35.98	18.22	54.20	74.00	-19.80	peak
5	12185.000	31.13	18.22	49.35	54.00	-4.65	AVG

Note:1.Result (dBuV/m) = Correct Factor (dB/m) + Reading(dBuV).

2.Correction factor (dB/m) = Antenna Factor (dB/m) + Cable loss (dB) – Pre-Amplifier gain (dB).

3.When the peak results are less than average limit, so not need to evaluate the average.



Standard:	FCC Part 15.247	Test Distance:	3 m
Test item:	Harmonic	Power:	AC 120 V/60 Hz
Frequency:	2462 MHz	Temp.(°C)/Hum.(%RH):	26(°C)/60 %RH
Mode:	Mode 4		
Ant.Polar.:	Horizontal		

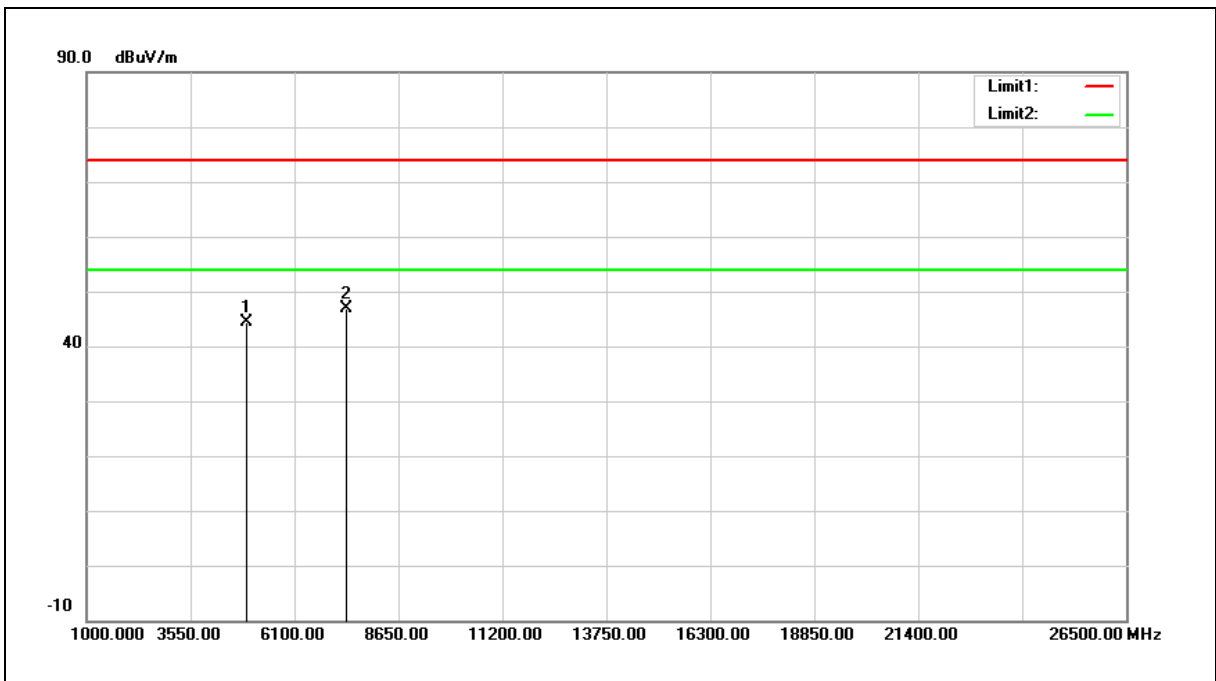

No.	Frequency (MHz)	Reading (dBuV)	Correct Factor (dB/m)	Result (dBuV/m)	Limit (dBuV/m)	Margin (dB)	Remark
1	4924.000	38.72	5.77	44.49	74.00	-29.51	peak
2	7386.000	34.54	12.33	46.87	74.00	-27.13	peak

- Note: 1.Result (dBuV/m) = Correct Factor (dB/m) + Reading(dBuV).
 2.Correction factor (dB/m) = Antenna Factor (dB/m) + Cable loss (dB) – Pre-Amplifier gain (dB).
 3.When the peak results are less than average limit, so not need to evaluate the average.



Standard:	FCC Part 15.247	Test Distance:	3 m
Test item:	Harmonic	Power:	AC 120 V/60 Hz
Frequency:	2462 MHz	Temp.(°C)/Hum.(%RH):	26(°C)/60 %RH
Mode:	Mode 4		
Ant.Polar.:	Vertical		

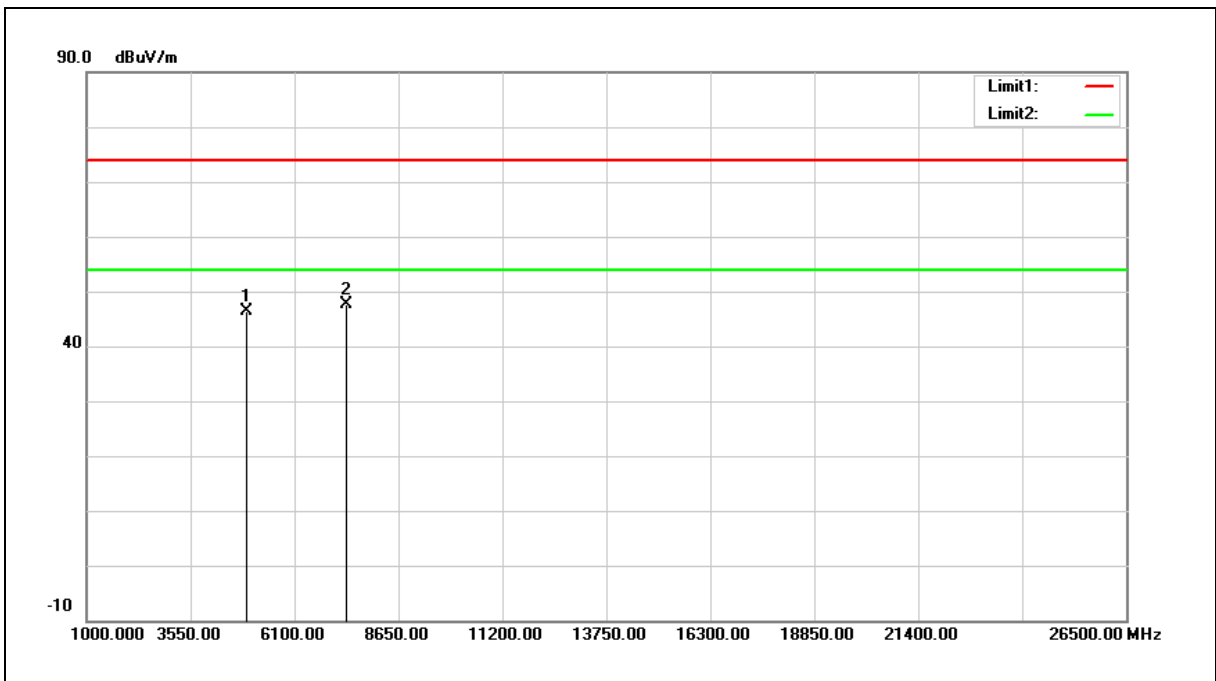

No.	Frequency (MHz)	Reading (dBuV)	Correct Factor (dB/m)	Result (dBuV/m)	Limit (dBuV/m)	Margin (dB)	Remark
1	4924.000	40.72	5.77	46.49	74.00	-27.51	peak
2	7386.000	35.38	12.33	47.71	74.00	-26.29	peak

- Note: 1.Result (dBuV/m) = Correct Factor (dB/m) + Reading(dBuV).
 2.Correction factor (dB/m) = Antenna Factor (dB/m) + Cable loss (dB) – Pre-Amplifier gain (dB).
 3.When the peak results are less than average limit, so not need to evaluate the average.



Standard:	FCC Part 15.247	Test Distance:	3 m
Test item:	Harmonic	Power:	AC 120 V/60 Hz
Frequency:	2422 MHz	Temp.(°C)/Hum.(%RH):	26(°C)/60 %RH
Mode:	Mode 5		
Ant.Polar.:	Horizontal		

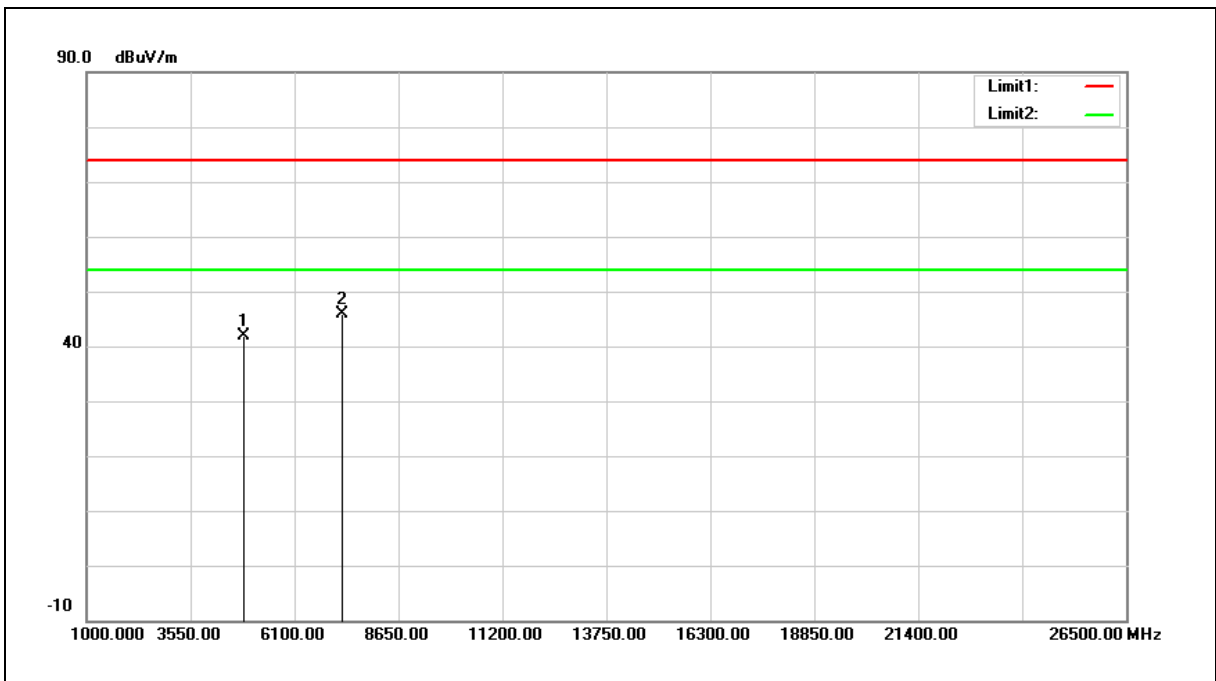

No.	Frequency (MHz)	Reading (dBuV)	Correct Factor (dB/m)	Result (dBuV/m)	Limit (dBuV/m)	Margin (dB)	Remark
1	4844.000	36.23	5.62	41.85	74.00	-32.15	peak
2	7266.000	33.95	12.04	45.99	74.00	-28.01	peak

- Note: 1.Result (dBuV/m) = Correct Factor (dB/m) + Reading(dBuV).
 2.Correction factor (dB/m) = Antenna Factor (dB/m) + Cable loss (dB) – Pre-Amplifier gain (dB).
 3.When the peak results are less than average limit, so not need to evaluate the average.



Standard:	FCC Part 15.247	Test Distance:	3 m
Test item:	Harmonic	Power:	AC 120 V/60 Hz
Frequency:	2422 MHz	Temp.(°C)/Hum.(%RH):	26(°C)/60 %RH
Mode:	Mode 5		
Ant.Polar.:	Vertical		

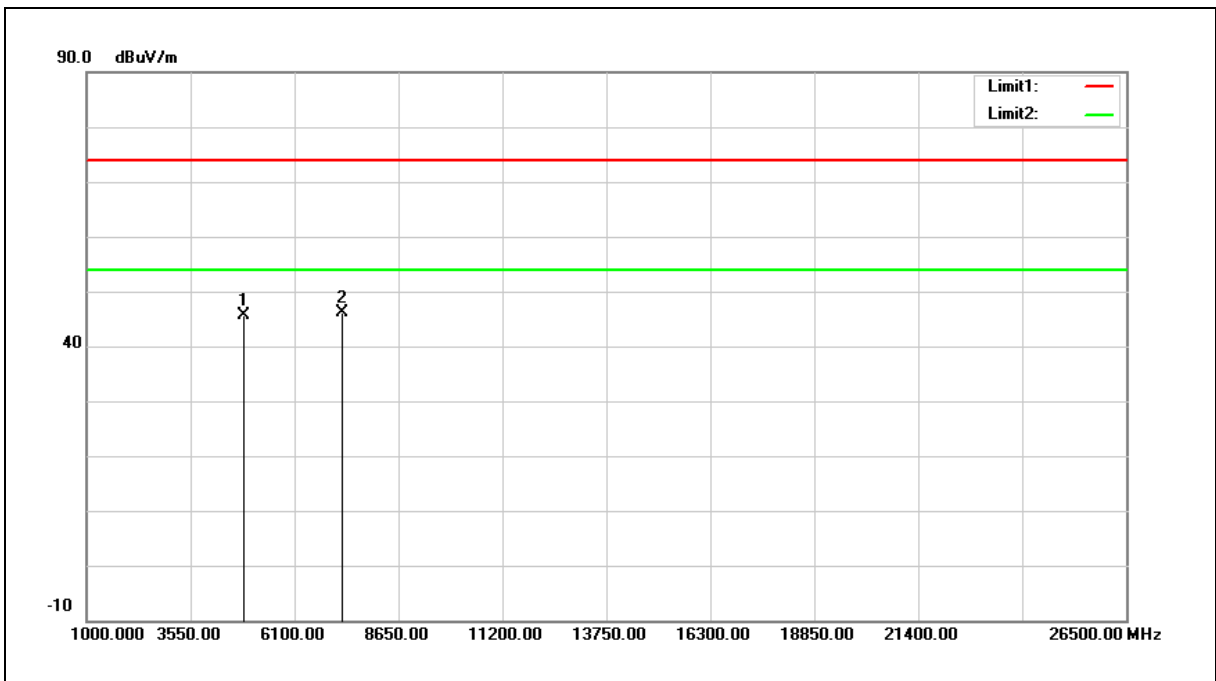

No.	Frequency (MHz)	Reading (dBuV)	Correct Factor (dB/m)	Result (dBuV/m)	Limit (dBuV/m)	Margin (dB)	Remark
1	4844.000	39.92	5.62	45.54	74.00	-28.46	peak
2	7266.000	34.09	12.04	46.13	74.00	-27.87	peak

- Note: 1.Result (dBuV/m) = Correct Factor (dB/m) + Reading(dBuV).
 2.Correction factor (dB/m) = Antenna Factor (dB/m) + Cable loss (dB) – Pre-Amplifier gain (dB).
 3.When the peak results are less than average limit, so not need to evaluate the average.



Standard:	FCC Part 15.247	Test Distance:	3 m
Test item:	Harmonic	Power:	AC 120 V/60 Hz
Frequency:	2437 MHz	Temp.(°C)/Hum.(%RH):	26(°C)/60 %RH
Mode:	Mode 5		
Ant.Polar.:	Horizontal		

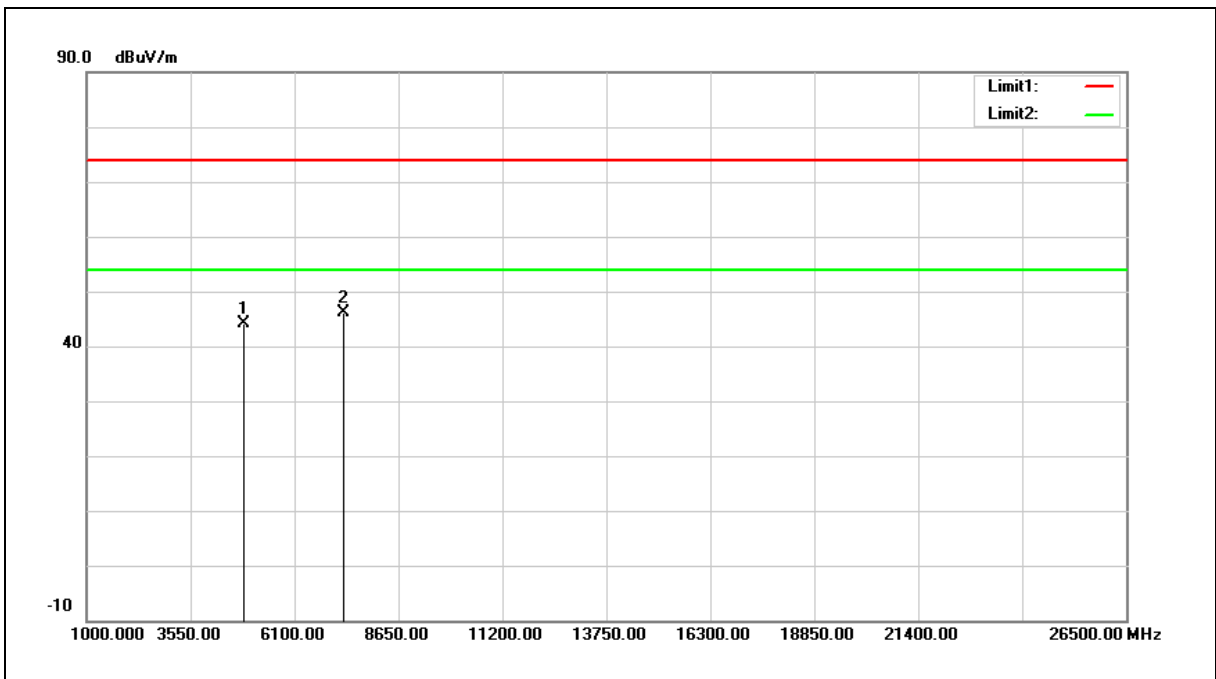

No.	Frequency (MHz)	Reading (dBuV)	Correct Factor (dB/m)	Result (dBuV/m)	Limit (dBuV/m)	Margin (dB)	Remark
1	4874.000	38.56	5.67	44.23	74.00	-29.77	peak
2	7311.000	34.03	12.15	46.18	74.00	-27.82	peak

- Note: 1.Result (dBuV/m) = Correct Factor (dB/m) + Reading(dBuV).
 2.Correction factor (dB/m) = Antenna Factor (dB/m) + Cable loss (dB) – Pre-Amplifier gain (dB).
 3.When the peak results are less than average limit, so not need to evaluate the average.



Standard:	FCC Part 15.247	Test Distance:	3 m
Test item:	Harmonic	Power:	AC 120 V/60 Hz
Frequency:	2437 MHz	Temp.(°C)/Hum.(%RH):	26(°C)/60 %RH
Mode:	Mode 5		
Ant.Polar.:	Vertical		

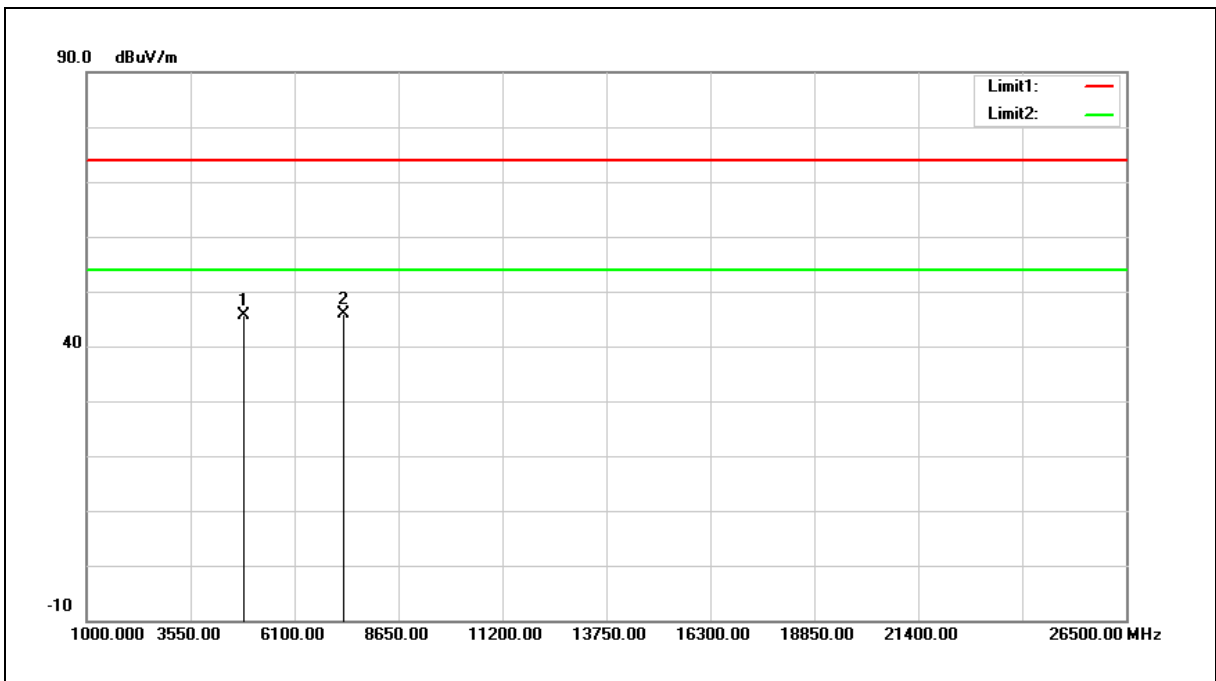

No.	Frequency (MHz)	Reading (dBuV)	Correct Factor (dB/m)	Result (dBuV/m)	Limit (dBuV/m)	Margin (dB)	Remark
1	4874.000	39.84	5.67	45.51	74.00	-28.49	peak
2	7311.000	33.79	12.15	45.94	74.00	-28.06	peak

- Note: 1.Result (dBuV/m) = Correct Factor (dB/m) + Reading(dBuV).
 2.Correction factor (dB/m) = Antenna Factor (dB/m) + Cable loss (dB) – Pre-Amplifier gain (dB).
 3.When the peak results are less than average limit, so not need to evaluate the average.



Standard:	FCC Part 15.247	Test Distance:	3 m
Test item:	Harmonic	Power:	AC 120 V/60 Hz
Frequency:	2452 MHz	Temp.(°C)/Hum.(%RH):	26(°C)/60 %RH
Mode:	Mode 5		
Ant.Polar.:	Horizontal		

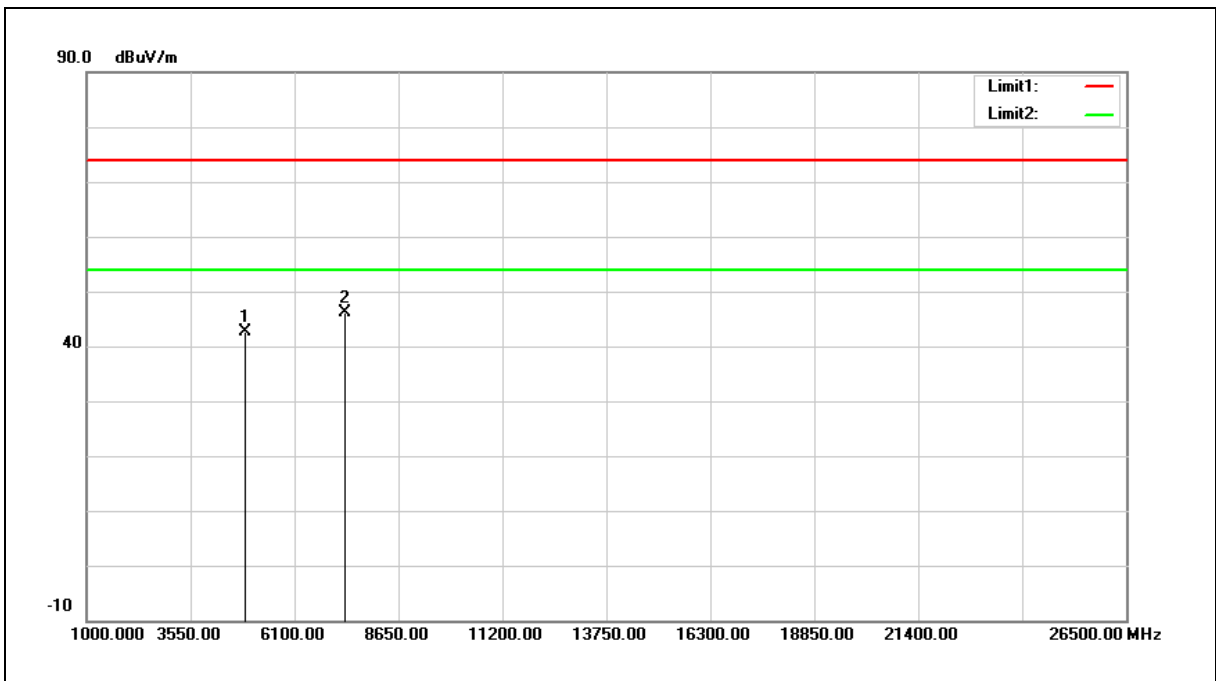

No.	Frequency (MHz)	Reading (dBuV)	Correct Factor (dB/m)	Result (dBuV/m)	Limit (dBuV/m)	Margin (dB)	Remark
1	4904.000	36.78	5.73	42.51	74.00	-31.49	peak
2	7356.000	33.79	12.25	46.04	74.00	-27.96	peak

- Note: 1.Result (dBuV/m) = Correct Factor (dB/m) + Reading(dBuV).
 2.Correction factor (dB/m) = Antenna Factor (dB/m) + Cable loss (dB) – Pre-Amplifier gain (dB).
 3.When the peak results are less than average limit, so not need to evaluate the average.



Standard:	FCC Part 15.247	Test Distance:	3 m
Test item:	Harmonic	Power:	AC 120 V/60 Hz
Frequency:	2452 MHz	Temp.(°C)/Hum.(%RH):	26(°C)/60 %RH
Mode:	Mode 5		
Ant.Polar.:	Vertical		

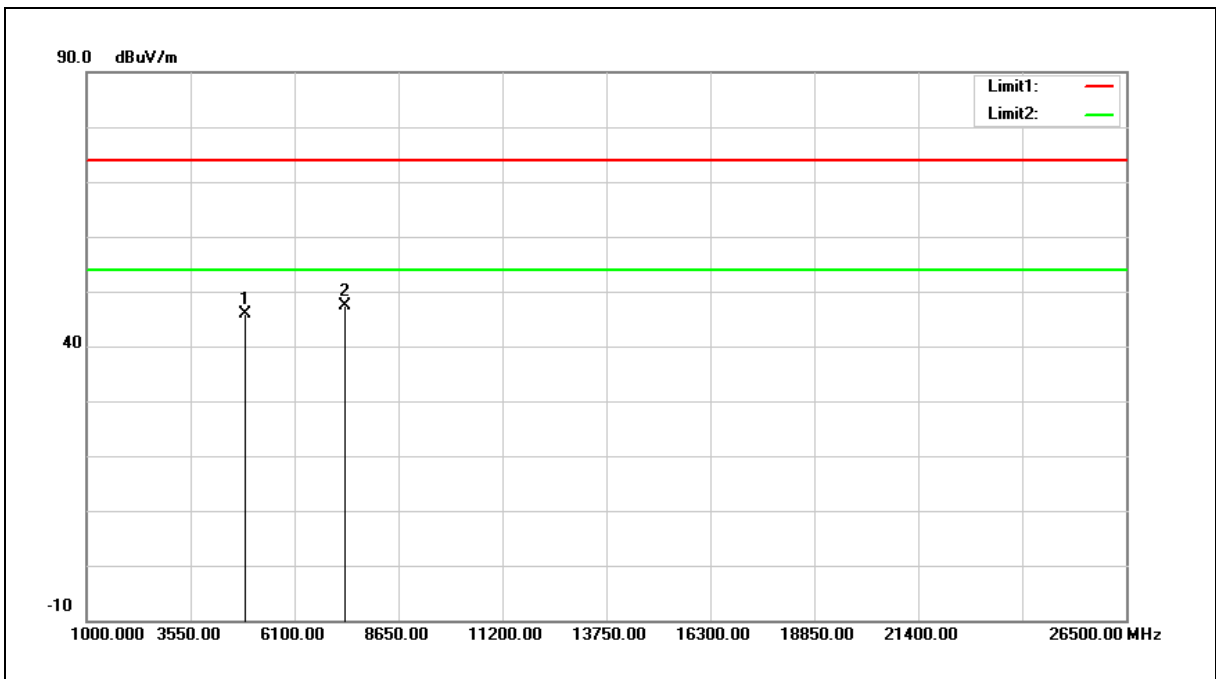

No.	Frequency (MHz)	Reading (dBuV)	Correct Factor (dB/m)	Result (dBuV/m)	Limit (dBuV/m)	Margin (dB)	Remark
1	4904.000	40.22	5.73	45.95	74.00	-28.05	peak
2	7356.000	35.01	12.25	47.26	74.00	-26.74	peak

- Note: 1.Result (dBuV/m) = Correct Factor (dB/m) + Reading(dBuV).
 2.Correction factor (dB/m) = Antenna Factor (dB/m) + Cable loss (dB) – Pre-Amplifier gain (dB).
 3.When the peak results are less than average limit, so not need to evaluate the average.



Standard:	FCC Part 15.247	Test Distance:	3 m
Test item:	Harmonic	Power:	AC 110 V/60 Hz
Mode:	Simultaneous Transmitting (DTS+NII)	Temp.(°C)/Hum.(%RH):	26(°C)/60 %RH
Ant.Polar.:	Horizontal		

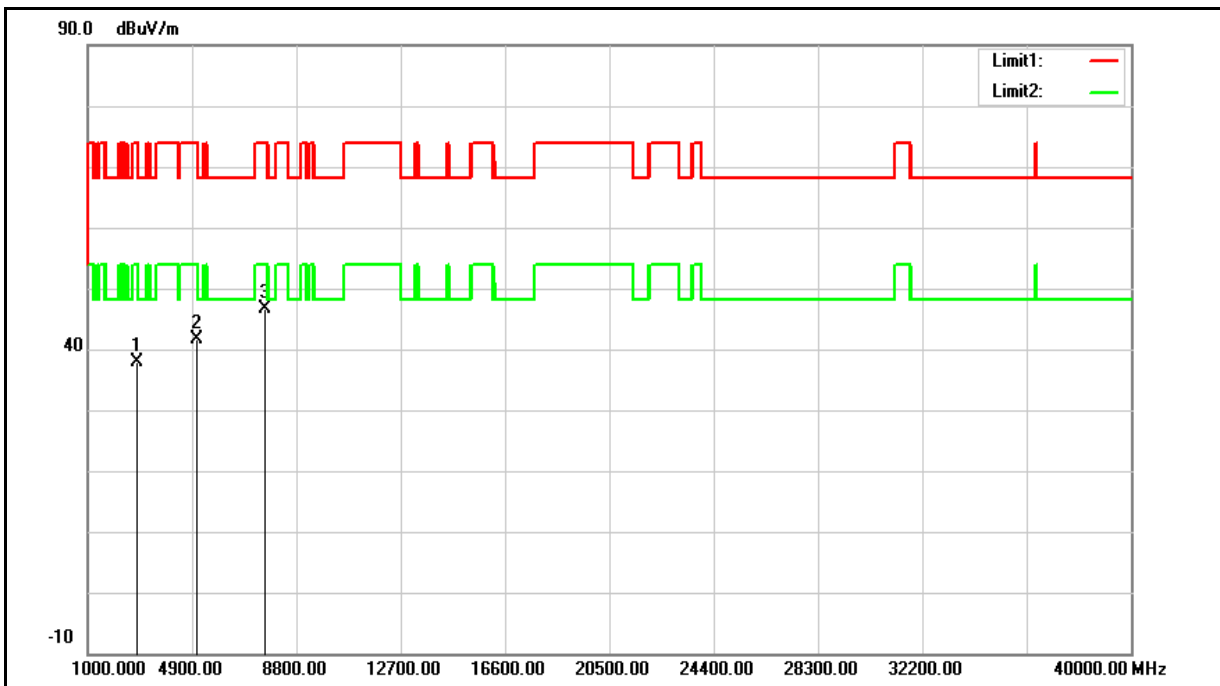

No.	Frequency (MHz)	Reading (dBuV)	Correct Factor (dB/m)	Result (dBuV/m)	Limit (dBuV/m)	Margin (dB)	Remark
1	2819.000	37.50	0.37	37.87	74.00	-36.13	peak
2	5063.000	35.57	6.06	41.63	74.00	-32.37	peak
3	7613.000	33.75	12.97	46.72	74.00	-27.28	peak

- Note:1.Result (dBuV/m) = Correct Factor (dB/m) + Reading(dBuV).
 2.Correction factor (dB/m) = Antenna Factor (dB/m) + Cable loss (dB) – Pre-Amplifier gain (dB).
 3.When the peak results are less than average limit, so not need to evaluate the average.



Standard:	FCC Part 15.247	Test Distance:	3 m
Test item:	Harmonic	Power:	AC 110 V/60 Hz
Mode:	Simultaneous Transmitting (DTS+NII)	Temp.(°C)/Hum.(%RH):	26(°C)/60 %RH
Ant.Polar.:	Vertical		

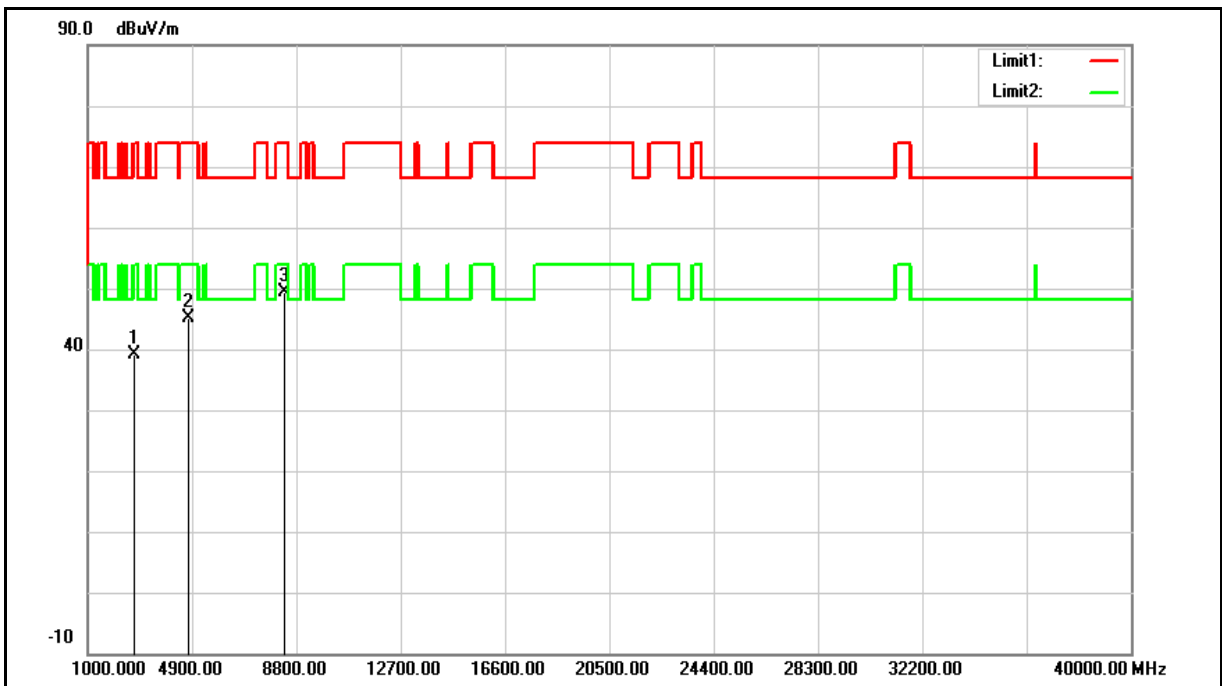

No.	Frequency (MHz)	Reading (dBuV)	Correct Factor (dB/m)	Result (dBuV/m)	Limit (dBuV/m)	Margin (dB)	Remark
1	2751.000	38.92	0.15	39.07	74.00	-34.93	peak
2	4723.000	39.72	5.39	45.11	74.00	-28.89	peak
3	8327.000	35.68	13.67	49.35	74.00	-24.65	peak

Note:1.Result (dBuV/m) = Correct Factor (dB/m) + Reading(dBuV).

2.Correction factor (dB/m) = Antenna Factor (dB/m) + Cable loss (dB) – Pre-Amplifier gain (dB).

3.When the peak results are less than average limit, so not need to evaluate the average.



Band Edge

Standard:	FCC Part 15.247	Test Distance:	3 m
Test item:	Band edge	Power:	AC 120 V/60 Hz
Frequency:	2412 MHz	Temp.(°C)/Hum.(%RH):	26(°C)/60 %RH
Mode:	Mode 2		
Ant.Polar.:	Horizontal		

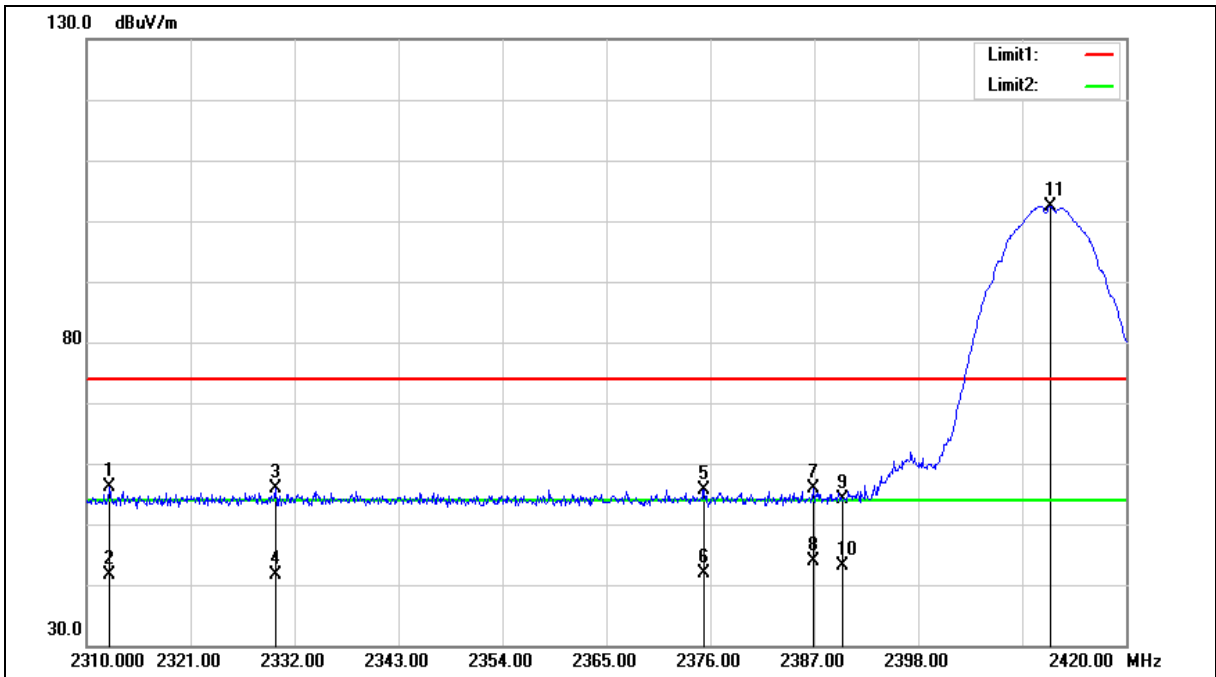



Standard:	FCC Part 15.247	Test Distance:	3 m
Test item:	Band edge	Power:	AC 120 V/60 Hz
Frequency:	2412 MHz	Temp.(°C)/Hum.(%RH):	26(°C)/60 %RH
Mode:	Mode 2		
Ant.Polar.:	Horizontal		

No.	Frequency (MHz)	Reading (dBUV)	Correct Factor (dB/m)	Result (dBUV/m)	Limit (dBUV/m)	Margin (dB)	Remark
1	2312.420	57.41	-1.34	56.07	74.00	-17.93	peak
2	2312.420	42.90	-1.34	41.56	54.00	-12.44	AVG
3	2330.020	57.10	-1.26	55.84	74.00	-18.16	peak
4	2330.020	42.83	-1.26	41.57	54.00	-12.43	AVG
5	2375.340	56.84	-1.10	55.74	74.00	-18.26	peak
6	2375.340	42.88	-1.10	41.78	54.00	-12.22	AVG
7	2386.890	56.93	-1.06	55.87	74.00	-18.13	peak
8	2386.890	45.01	-1.06	43.95	54.00	-10.05	AVG
9	2390.000	55.07	-1.05	54.02	74.00	-19.98	peak
10	2390.000	44.16	-1.05	43.11	54.00	-10.89	AVG
11	2411.970	103.40	-0.97	102.43	--	--	peak

Note:1.Result (dBUV/m) = Correct Factor (dB/m) + Reading(dBUV).

2.Correction factor (dB/m) = Antenna Factor (dB/m) + Cable loss (dB) – Pre-Amplifier gain (dB).

3.When the peak results are less than average limit, so not need to evaluate the average.



Standard:	FCC Part 15.247	Test Distance:	3 m
Test item:	Band edge	Power:	AC 120 V/60 Hz
Frequency:	2412 MHz	Temp.(°C)/Hum.(%RH):	26(°C)/60 %RH
Mode:	Mode 2		
Ant.Polar.:	Vertical		

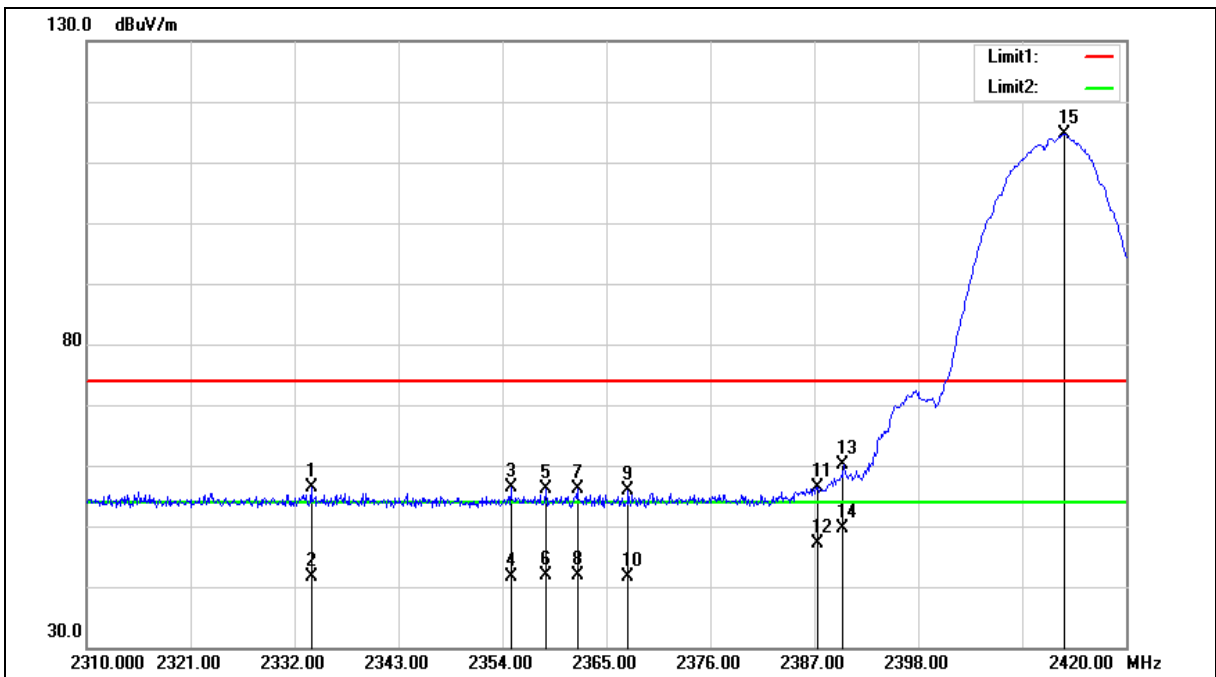



Standard:	FCC Part 15.247	Test Distance:	3 m
Test item:	Band edge	Power:	AC 120 V/60 Hz
Frequency:	2412 MHz	Temp.(°C)/Hum.(%RH):	26(°C)/60 %RH
Mode:	Mode 2		
Ant.Polar.:	Vertical		

No.	Frequency (MHz)	Reading (dBuV)	Correct Factor (dB/m)	Result (dBuV/m)	Limit (dBuV/m)	Margin (dB)	Remark
1	2333.760	57.74	-1.25	56.49	74.00	-17.51	peak
2	2333.760	42.93	-1.25	41.68	54.00	-12.32	AVG
3	2354.880	57.47	-1.17	56.30	74.00	-17.70	peak
4	2354.880	42.85	-1.17	41.68	54.00	-12.32	AVG
5	2358.620	57.24	-1.16	56.08	74.00	-17.92	peak
6	2358.620	42.92	-1.16	41.76	54.00	-12.24	AVG
7	2361.920	57.23	-1.15	56.08	74.00	-17.92	peak
8	2361.920	42.93	-1.15	41.78	54.00	-12.22	AVG
9	2367.310	57.07	-1.12	55.95	74.00	-18.05	peak
10	2367.310	42.85	-1.12	41.73	54.00	-12.27	AVG
11	2387.330	57.49	-1.06	56.43	74.00	-17.57	peak
12	2387.330	48.09	-1.06	47.03	54.00	-6.97	AVG
13	2390.000	61.27	-1.05	60.22	74.00	-13.78	peak
14	2390.000	50.80	-1.05	49.75	54.00	-4.25	AVG
15	2413.510	115.65	-0.95	114.70	--	--	peak

Note:1.Result (dBuV/m) = Correct Factor (dB/m) + Reading(dBuV).

2.Correction factor (dB/m) = Antenna Factor (dB/m) + Cable loss (dB) – Pre-Amplifier gain (dB).

3.When the peak results are less than average limit, so not need to evaluate the average.



Standard:	FCC Part 15.247	Test Distance:	3 m
Test item:	Band edge	Power:	AC 120 V/60 Hz
Frequency:	2437 MHz	Temp.(°C)/Hum.(%RH):	26(°C)/60 %RH
Mode:	Mode 2		
Ant.Polar.:	Horizontal		

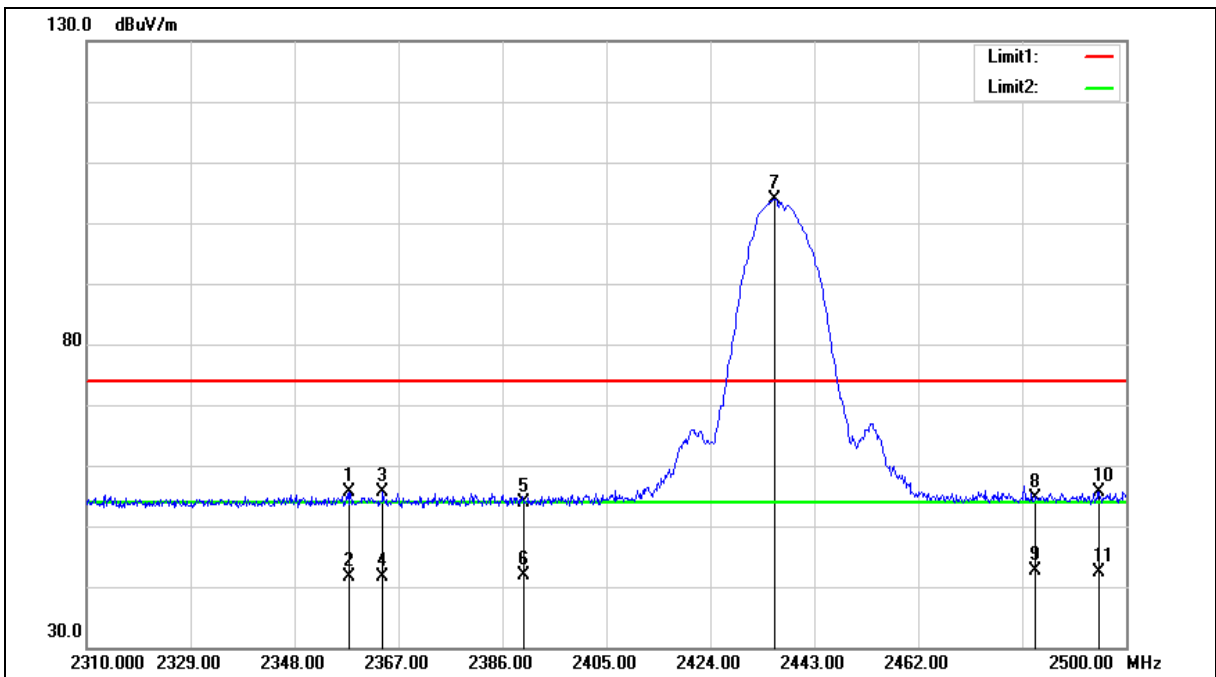



Standard:	FCC Part 15.247	Test Distance:	3 m
Test item:	Band edge	Power:	AC 120 V/60 Hz
Frequency:	2437 MHz	Temp.(°C)/Hum.(%RH):	26(°C)/60 %RH
Mode:	Mode 2		
Ant.Polar.:	Horizontal		

No.	Frequency (MHz)	Reading (dBuV)	Correct Factor (dB/m)	Result (dBuV/m)	Limit (dBuV/m)	Margin (dB)	Remark
1	2358.070	56.68	-1.16	55.52	74.00	-18.48	peak
2	2358.070	42.84	-1.16	41.68	54.00	-12.32	AVG
3	2364.150	56.78	-1.13	55.65	74.00	-18.35	peak
4	2364.150	42.88	-1.13	41.75	54.00	-12.25	AVG
5	2390.000	54.85	-1.05	53.80	74.00	-20.20	peak
6	2390.000	42.92	-1.05	41.87	54.00	-12.13	AVG
7	2435.780	104.87	-0.88	103.99	--	--	peak
8	2483.500	55.44	-0.70	54.74	74.00	-19.26	peak
9	2483.500	43.23	-0.70	42.53	54.00	-11.47	AVG
10	2495.060	56.33	-0.66	55.67	74.00	-18.33	peak
11	2495.060	43.01	-0.66	42.35	54.00	-11.65	AVG

Note:1.Result (dBuV/m) = Correct Factor (dB/m) + Reading(dBuV).

2.Correction factor (dB/m) = Antenna Factor (dB/m) + Cable loss (dB) – Pre-Amplifier gain (dB).

3.When the peak results are less than average limit, so not need to evaluate the average.



Standard:	FCC Part 15.247	Test Distance:	3 m
Test item:	Band edge	Power:	AC 120 V/60 Hz
Frequency:	2437 MHz	Temp.(°C)/Hum.(%RH):	26(°C)/60 %RH
Mode:	Mode 2		
Ant.Polar.:	Vertical		

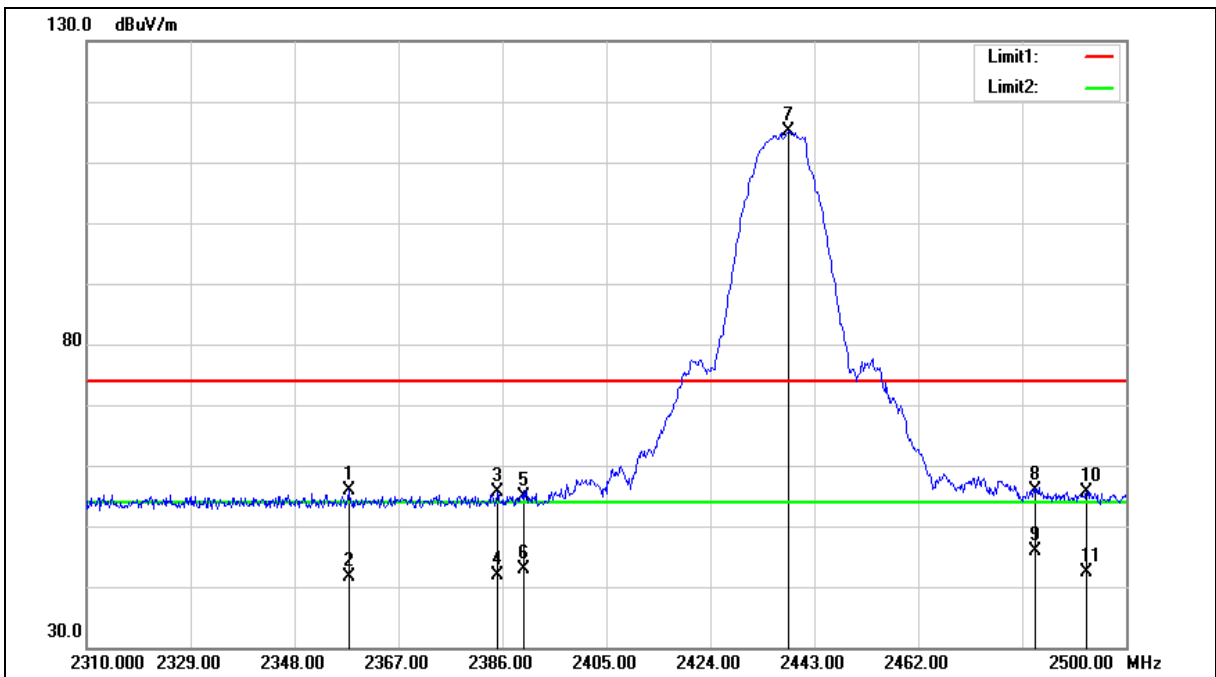



Standard:	FCC Part 15.247	Test Distance:	3 m
Test item:	Band edge	Power:	AC 120 V/60 Hz
Frequency:	2437 MHz	Temp.(°C)/Hum.(%RH):	26(°C)/60 %RH
Mode:	Mode 2		
Ant.Polar.:	Vertical		

No.	Frequency (MHz)	Reading (dBuV)	Correct Factor (dB/m)	Result (dBuV/m)	Limit (dBuV/m)	Margin (dB)	Remark
1	2358.070	57.16	-1.16	56.00	74.00	-18.00	peak
2	2358.070	42.84	-1.16	41.68	54.00	-12.32	AVG
3	2385.050	56.78	-1.07	55.71	74.00	-18.29	peak
4	2385.050	42.96	-1.07	41.89	54.00	-12.11	AVG
5	2390.000	56.05	-1.05	55.00	74.00	-19.00	peak
6	2390.000	43.88	-1.05	42.83	54.00	-11.17	AVG
7	2438.250	115.99	-0.86	115.13	--	--	peak
8	2483.500	56.65	-0.70	55.95	74.00	-18.05	peak
9	2483.500	46.54	-0.70	45.84	54.00	-8.16	AVG
10	2492.780	56.39	-0.67	55.72	74.00	-18.28	peak
11	2492.780	42.98	-0.67	42.31	54.00	-11.69	AVG

Note:1.Result (dBuV/m) = Correct Factor (dB/m) + Reading(dBuV).

2.Correction factor (dB/m) = Antenna Factor (dB/m) + Cable loss (dB) – Pre-Amplifier gain (dB).

3.When the peak results are less than average limit, so not need to evaluate the average.



Standard:	FCC Part 15.247	Test Distance:	3 m
Test item:	Band edge	Power:	AC 120 V/60 Hz
Frequency:	2462 MHz	Temp.(°C)/Hum.(%RH):	26(°C)/60 %RH
Mode:	Mode 2		
Ant.Polar.:	Horizontal		

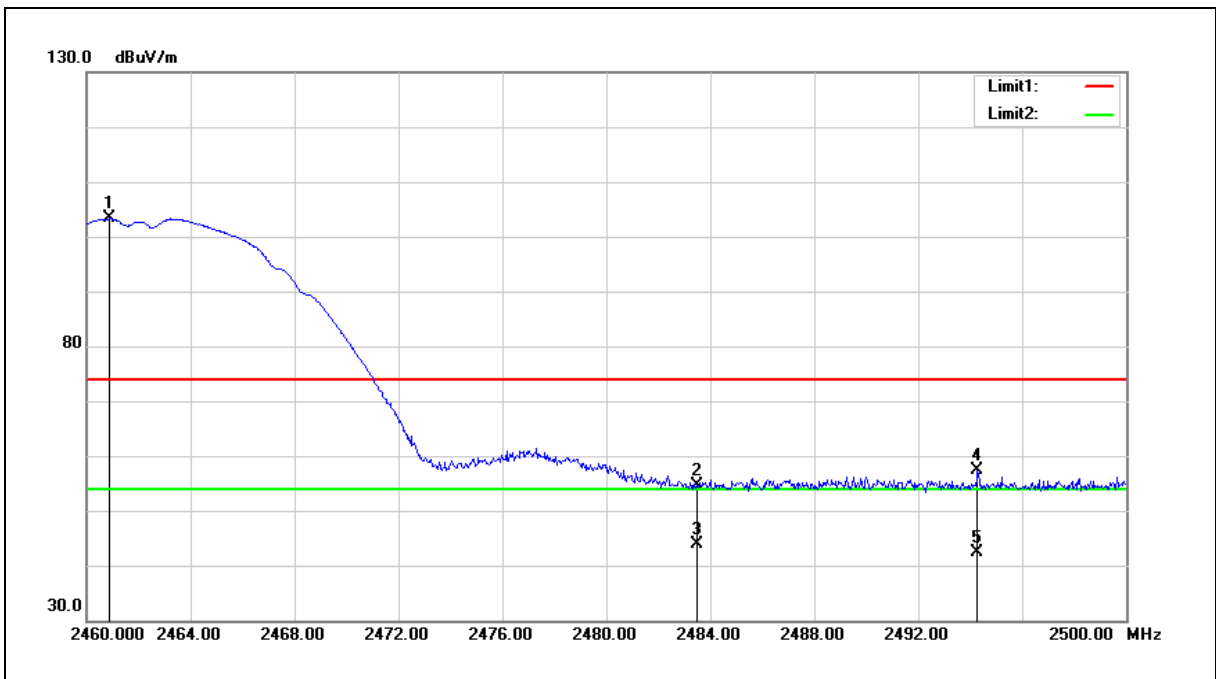

No.	Frequency (MHz)	Reading (dBuV)	Correct Factor (dB/m)	Result (dBuV/m)	Limit (dBuV/m)	Margin (dB)	Remark
1	2460.880	104.09	-0.79	103.30	--	--	peak
2	2483.500	55.43	-0.70	54.73	74.00	-19.27	peak
3	2483.500	44.61	-0.70	43.91	54.00	-10.09	AVG
4	2494.280	57.94	-0.66	57.28	74.00	-16.72	peak
5	2494.280	42.96	-0.66	42.30	54.00	-11.70	AVG

Note:1.Result (dBuV/m) = Correct Factor (dB/m) + Reading(dBuV).

2.Correction factor (dB/m) = Antenna Factor (dB/m) + Cable loss (dB) – Pre-Amplifier gain (dB).

3.When the peak results are less than average limit, so not need to evaluate the average.



Standard:	FCC Part 15.247	Test Distance:	3 m
Test item:	Band edge	Power:	AC 120 V/60 Hz
Frequency:	2462 MHz	Temp.(°C)/Hum.(%RH):	26(°C)/60 %RH
Mode:	Mode 2		
Ant.Polar.:	Vertical		

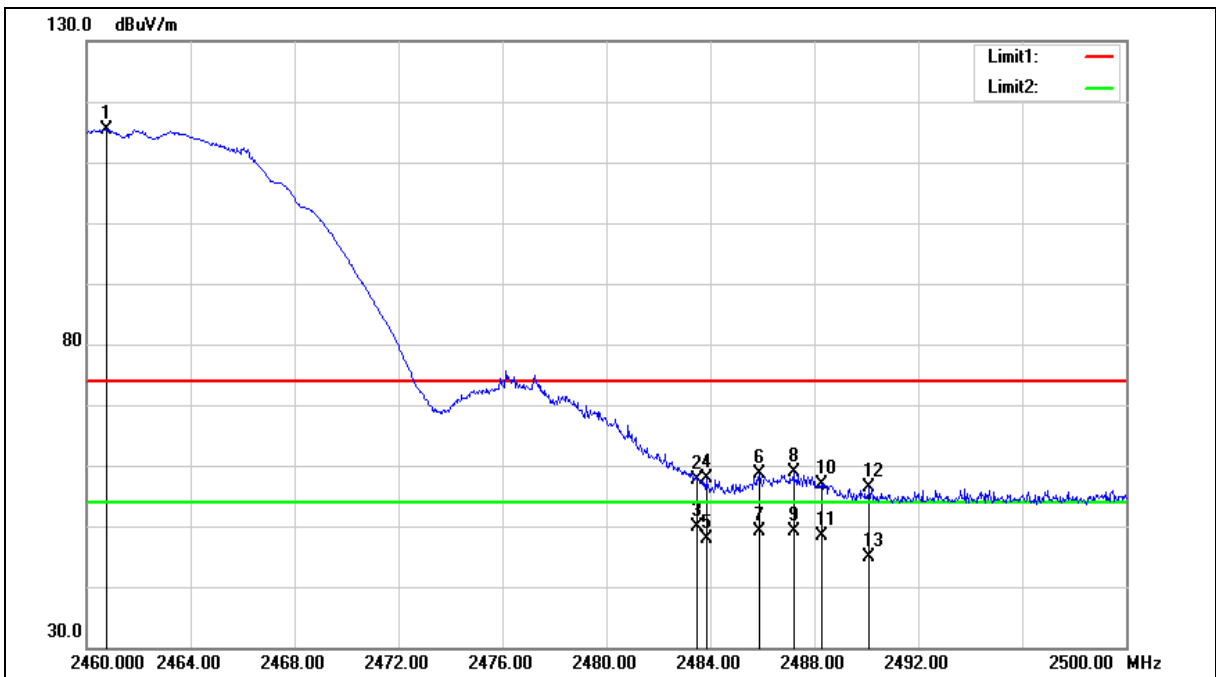



Standard:	FCC Part 15.247	Test Distance:	3 m
Test item:	Band edge	Power:	AC 120 V/60 Hz
Frequency:	2462 MHz	Temp.(°C)/Hum.(%RH):	26(°C)/60 %RH
Mode:	Mode 2		
Ant.Polar.:	Vertical		

No.	Frequency (MHz)	Reading (dBuV)	Correct Factor (dB/m)	Result (dBuV/m)	Limit (dBuV/m)	Margin (dB)	Remark
1	2460.760	116.17	-0.79	115.38	--	--	peak
2	2483.500	58.24	-0.70	57.54	74.00	-16.46	peak
3	2483.500	50.66	-0.70	49.96	54.00	-4.04	AVG
4	2483.840	58.52	-0.70	57.82	74.00	-16.18	peak
5	2483.840	48.50	-0.70	47.80	54.00	-6.20	AVG
6	2485.880	59.44	-0.70	58.74	74.00	-15.26	peak
7	2485.880	49.86	-0.70	49.16	54.00	-4.84	AVG
8	2487.200	59.65	-0.69	58.96	74.00	-15.04	peak
9	2487.200	49.91	-0.69	49.22	54.00	-4.78	AVG
10	2488.280	57.63	-0.68	56.95	74.00	-17.05	peak
11	2488.280	49.01	-0.68	48.33	54.00	-5.67	AVG
12	2490.120	57.15	-0.68	56.47	74.00	-17.53	peak
13	2490.120	45.65	-0.68	44.97	54.00	-9.03	AVG

Note:1.Result (dBuV/m) = Correct Factor (dB/m) + Reading(dBuV).

2.Correction factor (dB/m) = Antenna Factor (dB/m) + Cable loss (dB) – Pre-Amplifier gain (dB).

3.When the peak results are less than average limit, so not need to evaluate the average.



Standard:	FCC Part 15.247	Test Distance:	3 m
Test item:	Band edge	Power:	AC 120 V/60 Hz
Frequency:	2412 MHz	Temp.(°C)/Hum.(%RH):	26(°C)/60 %RH
Mode:	Mode 3		
Ant.Polar.:	Horizontal		

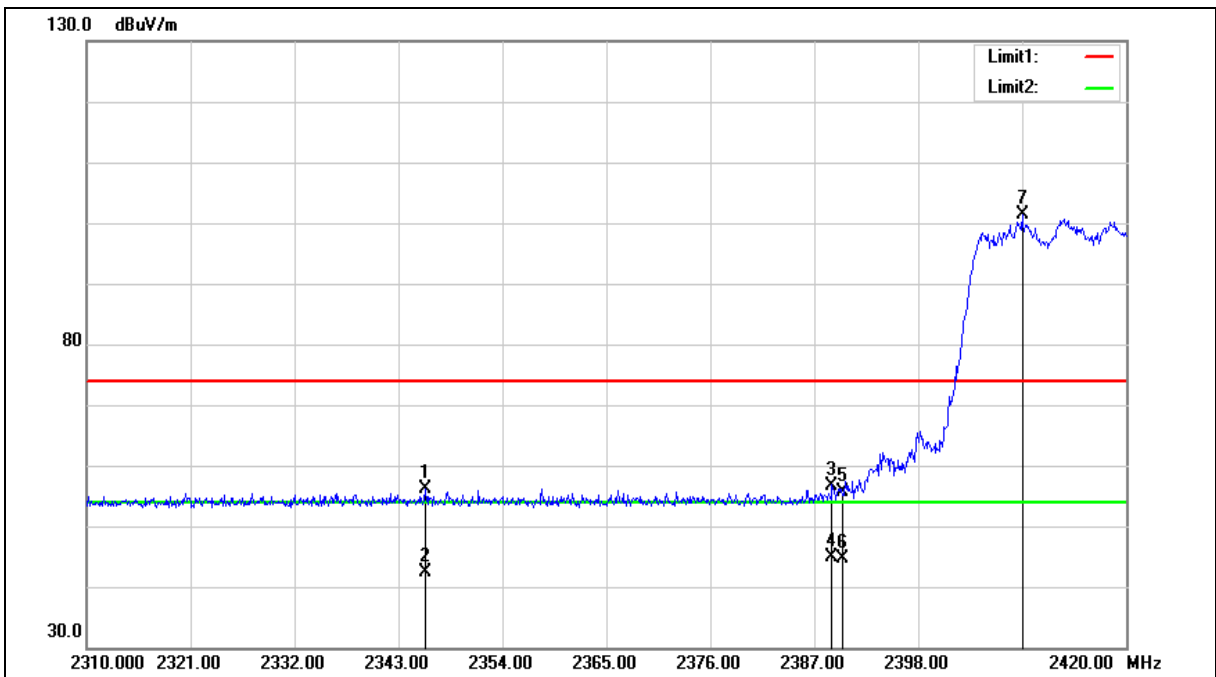



Standard:	FCC Part 15.247	Test Distance:	3 m
Test item:	Band edge	Power:	AC 120 V/60 Hz
Frequency:	2412 MHz	Temp.(°C)/Hum.(%RH):	26(°C)/60 %RH
Mode:	Mode 3		
Ant.Polar.:	Horizontal		

No.	Frequency (MHz)	Reading (dBuV)	Correct Factor (dB/m)	Result (dBuV/m)	Limit (dBuV/m)	Margin (dB)	Remark
1	2345.860	57.23	-1.20	56.03	74.00	-17.97	peak
2	2345.860	43.51	-1.20	42.31	54.00	-11.69	AVG
3	2388.870	57.80	-1.05	56.75	74.00	-17.25	peak
4	2388.870	45.82	-1.05	44.77	54.00	-9.23	AVG
5	2390.000	56.75	-1.05	55.70	74.00	-18.30	peak
6	2390.000	45.72	-1.05	44.67	54.00	-9.33	AVG
7	2409.000	102.28	-0.98	101.30	--	--	peak

Note:1.Result (dBuV/m) = Correct Factor (dB/m) + Reading(dBuV).

2.Correction factor (dB/m) = Antenna Factor (dB/m) + Cable loss (dB) – Pre-Amplifier gain (dB).

3.When the peak results are less than average limit, so not need to evaluate the average.



Standard:	FCC Part 15.247	Test Distance:	3 m
Test item:	Band edge	Power:	AC 120 V/60 Hz
Frequency:	2412 MHz	Temp.(°C)/Hum.(%RH):	26(°C)/60 %RH
Mode:	Mode 3		
Ant.Polar.:	Vertical		

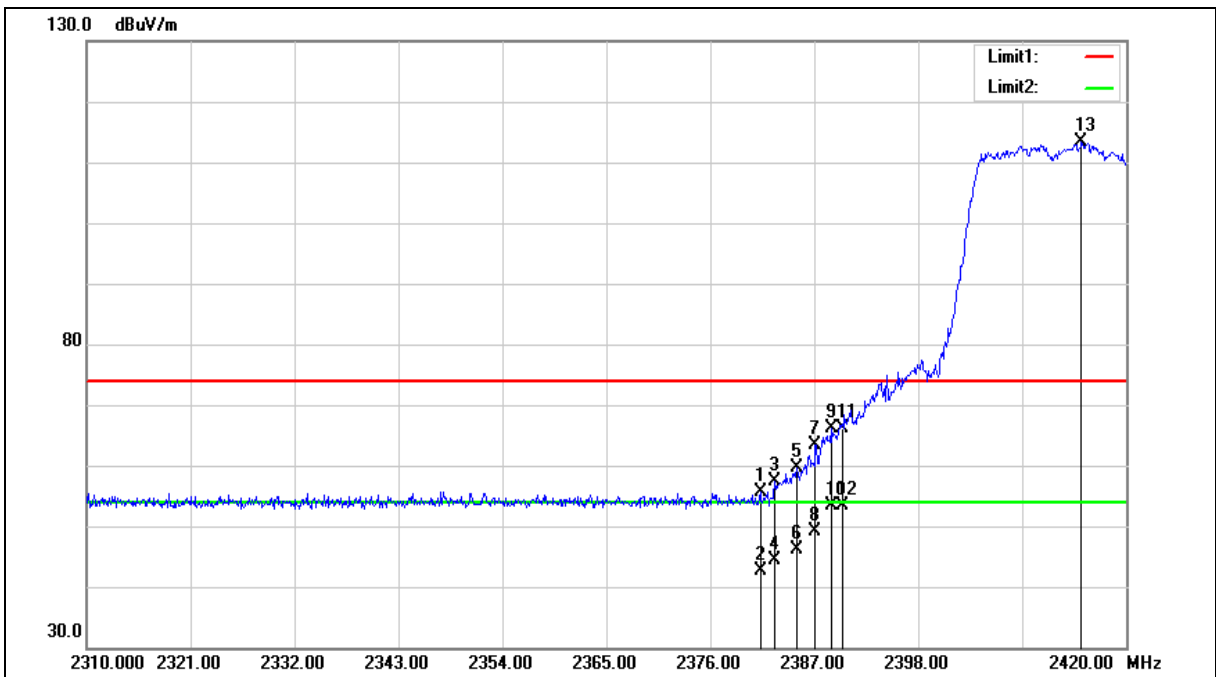



Standard:	FCC Part 15.247	Test Distance:	3 m
Test item:	Band edge	Power:	AC 120 V/60 Hz
Frequency:	2412 MHz	Temp.(°C)/Hum.(%RH):	26(°C)/60 %RH
Mode:	Mode 3		
Ant.Polar.:	Vertical		

No.	Frequency (MHz)	Reading (dBuV)	Correct Factor (dB/m)	Result (dBuV/m)	Limit (dBuV/m)	Margin (dB)	Remark
1	2381.280	56.75	-1.08	55.67	74.00	-18.33	peak
2	2381.280	43.67	-1.08	42.59	54.00	-11.41	AVG
3	2382.820	58.54	-1.07	57.47	74.00	-16.53	peak
4	2382.820	45.54	-1.07	44.47	54.00	-9.53	AVG
5	2385.130	60.82	-1.07	59.75	74.00	-14.25	peak
6	2385.130	47.16	-1.07	46.09	54.00	-7.91	AVG
7	2387.110	64.54	-1.06	63.48	74.00	-10.52	peak
8	2387.110	50.24	-1.06	49.18	54.00	-4.82	AVG
9	2388.760	67.26	-1.05	66.21	74.00	-7.79	peak
10	2388.760	54.39	-1.05	53.34	54.00	-0.66	AVG
11	2390.000	67.15	-1.05	66.10	74.00	-7.90	peak
12	2390.000	54.33	-1.05	53.28	54.00	-0.72	AVG
13	2415.270	114.21	-0.95	113.26	--	--	peak

Note:1.Result (dBuV/m) = Correct Factor (dB/m) + Reading(dBuV).

2.Correction factor (dB/m) = Antenna Factor (dB/m) + Cable loss (dB) – Pre-Amplifier gain (dB).

3.When the peak results are less than average limit, so not need to evaluate the average.



Standard:	FCC Part 15.247	Test Distance:	3 m
Test item:	Band edge	Power:	AC 120 V/60 Hz
Frequency:	2437 MHz	Temp.(°C)/Hum.(%RH):	26(°C)/60 %RH
Mode:	Mode 3		
Ant.Polar.:	Horizontal		

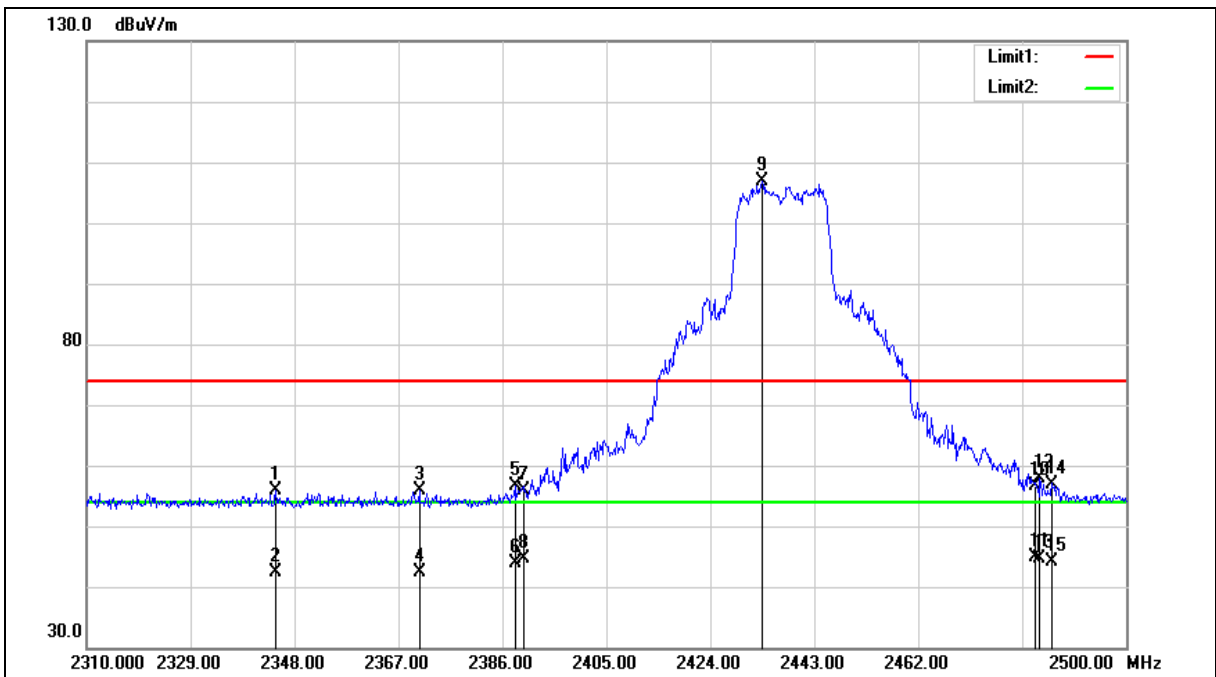



Standard:	FCC Part 15.247	Test Distance:	3 m
Test item:	Band edge	Power:	AC 120 V/60 Hz
Frequency:	2437 MHz	Temp.(°C)/Hum.(%RH):	26(°C)/60 %RH
Mode:	Mode 3		
Ant.Polar.:	Horizontal		

No.	Frequency (MHz)	Reading (dBuV)	Correct Factor (dB/m)	Result (dBuV/m)	Limit (dBuV/m)	Margin (dB)	Remark
1	2344.580	57.20	-1.21	55.99	74.00	-18.01	peak
2	2344.580	43.49	-1.21	42.28	54.00	-11.72	AVG
3	2370.800	56.96	-1.12	55.84	74.00	-18.16	peak
4	2370.800	43.43	-1.12	42.31	54.00	-11.69	AVG
5	2388.280	57.74	-1.05	56.69	74.00	-17.31	peak
6	2388.280	45.01	-1.05	43.96	54.00	-10.04	AVG
7	2390.000	57.03	-1.05	55.98	74.00	-18.02	peak
8	2390.000	45.58	-1.05	44.53	54.00	-9.47	AVG
9	2433.500	107.80	-0.88	106.92	--	--	peak
10	2483.500	57.39	-0.70	56.69	74.00	-17.31	peak
11	2483.500	45.58	-0.70	44.88	54.00	-9.12	AVG
12	2484.230	58.64	-0.70	57.94	74.00	-16.06	peak
13	2484.230	45.42	-0.70	44.72	54.00	-9.28	AVG
14	2486.510	57.66	-0.70	56.96	74.00	-17.04	peak
15	2486.510	44.72	-0.70	44.02	54.00	-9.98	AVG

Note:1.Result (dBuV/m) = Correct Factor (dB/m) + Reading(dBuV).

2.Correction factor (dB/m) = Antenna Factor (dB/m) + Cable loss (dB) – Pre-Amplifier gain (dB).

3.When the peak results are less than average limit, so not need to evaluate the average.



Standard:	RSS-247	Test Distance:	3 m
Test item:	Band edge	Power:	AC 120 V/60 Hz
Frequency:	2437 MHz	Temp.(°C)/Hum.(%RH):	26(°C)/60 %RH
Mode:	Mode 3		
Ant.Polar.:	Vertical		

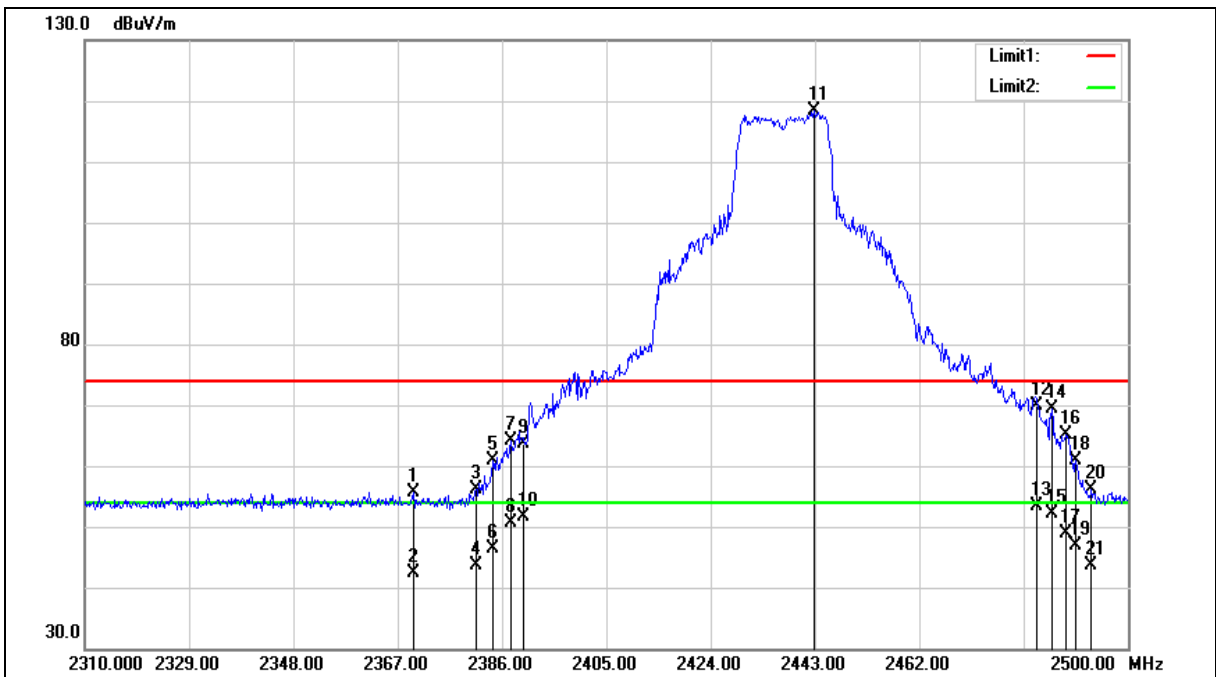



Standard:	RSS-247	Test Distance:	3 m
Test item:	Band edge	Power:	AC 120 V/60 Hz
Frequency:	2437 MHz	Temp.(°C)/Hum.(%RH):	26(°C)/60 %RH
Mode:	Mode 3		
Ant.Polar.:	Vertical		

No.	Frequency (MHz)	Reading (dBuV)	Correct Factor (dB/m)	Result (dBuV/m)	Limit (dBuV/m)	Margin (dB)	Remark
1	2369.850	56.81	-1.12	55.69	74.00	-18.31	peak
2	2369.850	43.56	-1.12	42.44	54.00	-11.56	AVG
3	2381.250	57.23	-1.08	56.15	74.00	-17.85	peak
4	2381.250	44.68	-1.08	43.60	54.00	-10.40	AVG
5	2384.290	61.93	-1.07	60.86	74.00	-13.14	peak
6	2384.290	47.42	-1.07	46.35	54.00	-7.65	AVG
7	2387.710	65.19	-1.05	64.14	74.00	-9.86	peak
8	2387.710	51.68	-1.05	50.63	54.00	-3.37	AVG
9	2390.000	64.57	-1.05	63.52	74.00	-10.48	peak
10	2390.000	52.66	-1.05	51.61	54.00	-2.39	AVG
11	2442.810	119.33	-0.85	118.48	--	--	peak
12	2483.500	70.70	-0.70	70.00	74.00	-4.00	peak
13	2483.500	54.08	-0.70	53.38	54.00	-0.62	AVG
14	2486.130	70.14	-0.70	69.44	74.00	-4.56	peak
15	2486.130	52.72	-0.70	52.02	54.00	-1.98	AVG
16	2488.600	65.90	-0.68	65.22	74.00	-8.78	peak
17	2488.600	49.57	-0.68	48.89	54.00	-5.11	AVG
18	2490.500	61.47	-0.67	60.80	74.00	-13.20	peak
19	2490.500	47.61	-0.67	46.94	54.00	-7.06	AVG
20	2493.350	56.79	-0.67	56.12	74.00	-17.88	peak
21	2493.350	44.33	-0.67	43.66	54.00	-10.34	AVG

Note:1.Result (dBuV/m) = Correct Factor (dB/m) + Reading(dBuV).

2.Correction factor (dB/m) = Antenna Factor (dB/m) + Cable loss (dB) – Pre-Amplifier gain (dB).

3.When the peak results are less than average limit, so not need to evaluate the average.



Standard:	FCC Part 15.247	Test Distance:	3 m
Test item:	Band edge	Power:	AC 120 V/60 Hz
Frequency:	2462 MHz	Temp.(°C)/Hum.(%RH):	26(°C)/60 %RH
Mode:	Mode 3		
Ant.Polar.:	Horizontal		

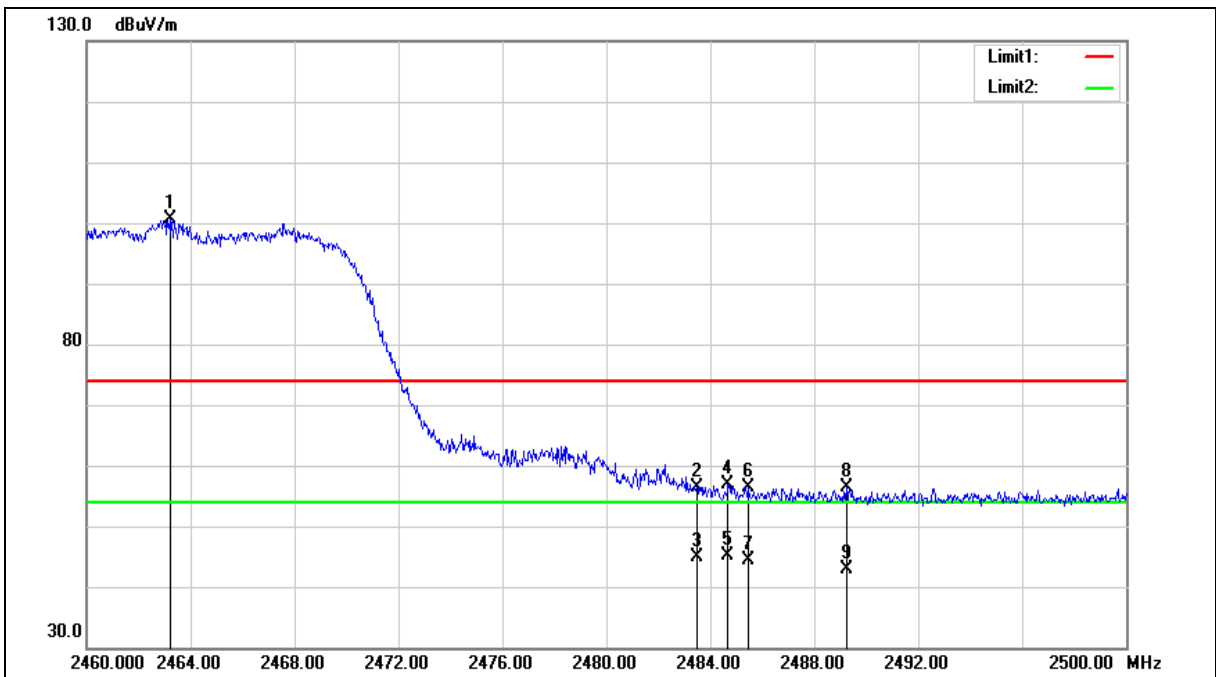



Standard:	FCC Part 15.247	Test Distance:	3 m
Test item:	Band edge	Power:	AC 120 V/60 Hz
Frequency:	2462 MHz	Temp.(°C)/Hum.(%RH):	26(°C)/60 %RH
Mode:	Mode 3		
Ant.Polar.:	Horizontal		

No.	Frequency (MHz)	Reading (dBuV)	Correct Factor (dB/m)	Result (dBuV/m)	Limit (dBuV/m)	Margin (dB)	Remark
1	2463.240	101.42	-0.78	100.64	--	--	peak
2	2483.500	57.15	-0.70	56.45	74.00	-17.55	peak
3	2483.500	45.59	-0.70	44.89	54.00	-9.11	AVG
4	2484.680	57.51	-0.70	56.81	74.00	-17.19	peak
5	2484.680	45.83	-0.70	45.13	54.00	-8.87	AVG
6	2485.480	57.15	-0.70	56.45	74.00	-17.55	peak
7	2485.480	45.13	-0.70	44.43	54.00	-9.57	AVG
8	2489.240	56.98	-0.68	56.30	74.00	-17.70	peak
9	2489.240	43.67	-0.68	42.99	54.00	-11.01	AVG

Note:1.Result (dBuV/m) = Correct Factor (dB/m) + Reading(dBuV).

2.Correction factor (dB/m) = Antenna Factor (dB/m) + Cable loss (dB) – Pre-Amplifier gain (dB).

3.When the peak results are less than average limit, so not need to evaluate the average.



Standard:	RSS-247	Test Distance:	3 m
Test item:	Band edge	Power:	AC 120 V/60 Hz
Frequency:	2462 MHz	Temp.(°C)/Hum.(%RH):	26(°C)/60 %RH
Mode:	Mode 3		
Ant.Polar.:	Vertical		

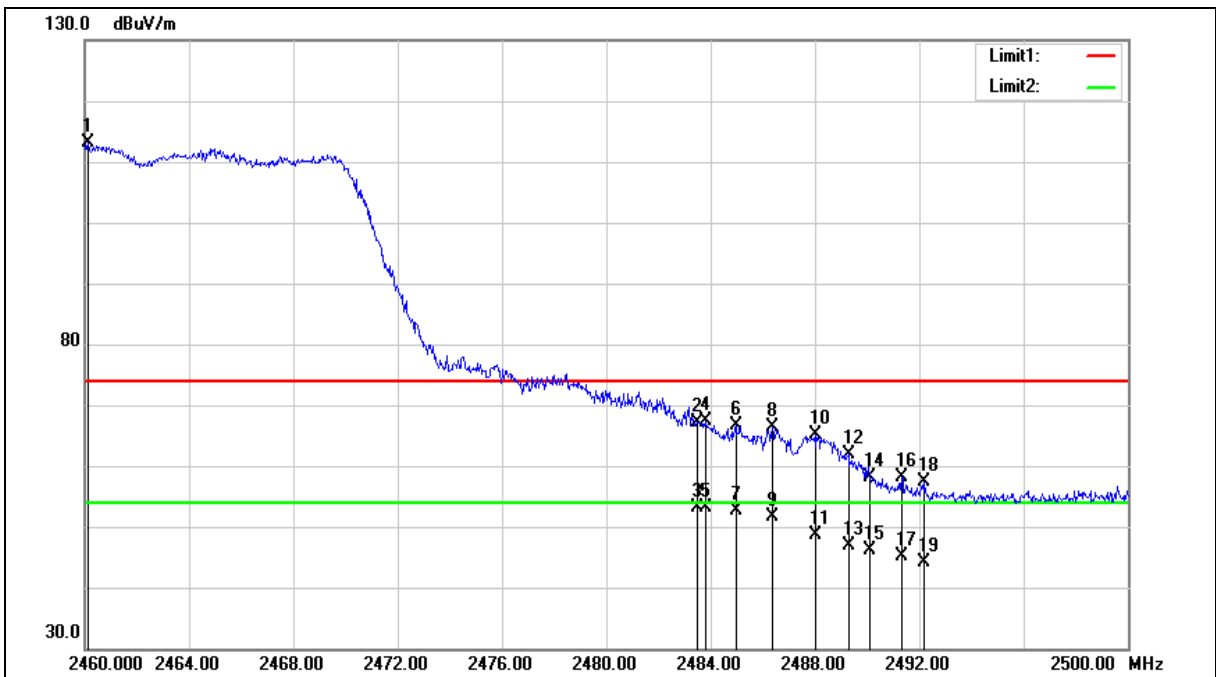



Standard:	RSS-247	Test Distance:	3 m
Test item:	Band edge	Power:	AC 120 V/60 Hz
Frequency:	2462 MHz	Temp.(°C)/Hum.(%RH):	26(°C)/60 %RH
Mode:	Mode 3		
Ant.Polar.:	Vertical		

No.	Frequency (MHz)	Reading (dBuV)	Correct Factor (dB/m)	Result (dBuV/m)	Limit (dBuV/m)	Margin (dB)	Remark
1	2460.120	113.90	-0.79	113.11	--	--	peak
2	2483.500	67.91	-0.70	67.21	74.00	-6.79	peak
3	2483.500	53.94	-0.70	53.24	54.00	-0.76	AVG
4	2483.800	68.07	-0.70	67.37	74.00	-6.63	peak
5	2483.800	53.85	-0.70	53.15	54.00	-0.85	AVG
6	2484.960	67.41	-0.70	66.71	74.00	-7.29	peak
7	2484.960	53.41	-0.70	52.71	54.00	-1.29	AVG
8	2486.360	67.09	-0.70	66.39	74.00	-7.61	peak
9	2486.360	52.22	-0.70	51.52	54.00	-2.48	AVG
10	2488.000	65.85	-0.68	65.17	74.00	-8.83	peak
11	2488.000	49.43	-0.68	48.75	54.00	-5.25	AVG
12	2489.280	62.45	-0.68	61.77	74.00	-12.23	peak
13	2489.280	47.68	-0.68	47.00	54.00	-7.00	AVG
14	2490.120	58.87	-0.68	58.19	74.00	-15.81	peak
15	2490.120	46.74	-0.68	46.06	54.00	-7.94	AVG
16	2491.320	58.85	-0.67	58.18	74.00	-15.82	peak
17	2491.320	45.73	-0.67	45.06	54.00	-8.94	AVG
18	2492.200	57.96	-0.67	57.29	74.00	-16.71	peak
19	2492.200	44.71	-0.67	44.04	54.00	-9.96	AVG

Note:1.Result (dBuV/m) = Correct Factor (dB/m) + Reading(dBuV).

2.Correction factor (dB/m) = Antenna Factor (dB/m) + Cable loss (dB) – Pre-Amplifier gain (dB).

3.When the peak results are less than average limit, so not need to evaluate the average.



Standard:	FCC Part 15.247	Test Distance:	3 m
Test item:	Band edge	Power:	AC 120 V/60 Hz
Frequency:	2412 MHz	Temp.(°C)/Hum.(%RH):	26(°C)/60 %RH
Mode:	Mode 4		
Ant.Polar.:	Horizontal		

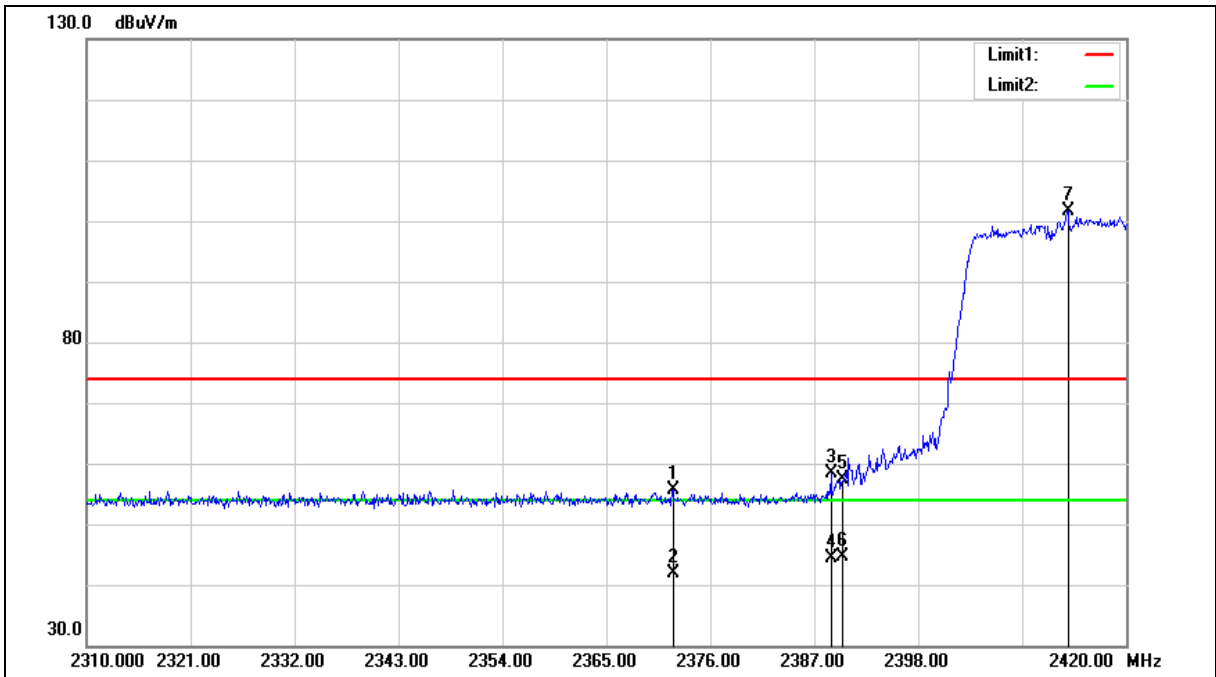



Standard:	FCC Part 15.247	Test Distance:	3 m
Test item:	Band edge	Power:	AC 120 V/60 Hz
Frequency:	2412 MHz	Temp.(°C)/Hum.(%RH):	26(°C)/60 %RH
Mode:	Mode 4		
Ant.Polar.:	Horizontal		

No.	Frequency (MHz)	Reading (dBuV)	Correct Factor (dB/m)	Result (dBuV/m)	Limit (dBuV/m)	Margin (dB)	Remark
1	2372.040	56.79	-1.10	55.69	74.00	-18.31	peak
2	2372.040	42.86	-1.10	41.76	54.00	-12.24	AVG
3	2388.760	59.52	-1.05	58.47	74.00	-15.53	peak
4	2388.760	45.48	-1.05	44.43	54.00	-9.57	AVG
5	2390.000	58.50	-1.05	57.45	74.00	-16.55	peak
6	2390.000	45.73	-1.05	44.68	54.00	-9.32	AVG
7	2413.840	102.62	-0.95	101.67	--	--	peak

Note:1.Result (dBuV/m) = Correct Factor (dB/m) + Reading(dBuV).

2.Correction factor (dB/m) = Antenna Factor (dB/m) + Cable loss (dB) – Pre-Amplifier gain (dB).

3.When the peak results are less than average limit, so not need to evaluate the average.



Standard:	FCC Part 15.247	Test Distance:	3 m
Test item:	Band edge	Power:	AC 120 V/60 Hz
Frequency:	2412 MHz	Temp.(°C)/Hum.(%RH):	26(°C)/60 %RH
Mode:	Mode 4		
Ant.Polar.:	Vertical		

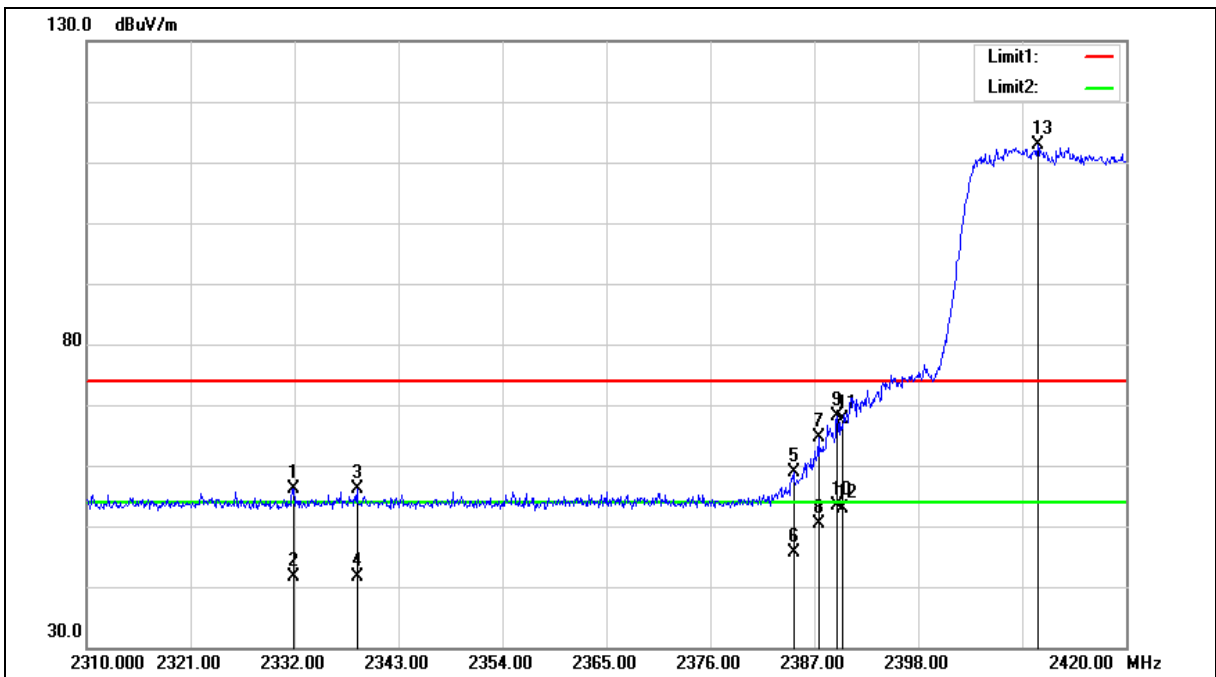



Standard:	FCC Part 15.247	Test Distance:	3 m
Test item:	Band edge	Power:	AC 120 V/60 Hz
Frequency:	2412 MHz	Temp.(°C)/Hum.(%RH):	26(°C)/60 %RH
Mode:	Mode 4		
Ant.Polar.:	Vertical		

No.	Frequency (MHz)	Reading (dBuV)	Correct Factor (dB/m)	Result (dBuV/m)	Limit (dBuV/m)	Margin (dB)	Remark
1	2331.890	57.49	-1.26	56.23	74.00	-17.77	peak
2	2331.890	42.87	-1.26	41.61	54.00	-12.39	AVG
3	2338.600	57.47	-1.23	56.24	74.00	-17.76	peak
4	2338.600	42.92	-1.23	41.69	54.00	-12.31	AVG
5	2384.800	59.91	-1.07	58.84	74.00	-15.16	peak
6	2384.800	46.66	-1.07	45.59	54.00	-8.41	AVG
7	2387.440	65.69	-1.06	64.63	74.00	-9.37	peak
8	2387.440	51.49	-1.06	50.43	54.00	-3.57	AVG
9	2389.420	69.08	-1.05	68.03	74.00	-5.97	peak
10	2389.420	54.35	-1.05	53.30	54.00	-0.70	AVG
11	2390.000	68.78	-1.05	67.73	74.00	-6.27	peak
12	2390.000	54.04	-1.05	52.99	54.00	-1.01	AVG
13	2410.650	113.90	-0.97	112.93	--	--	peak

Note:1.Result (dBuV/m) = Correct Factor (dB/m) + Reading(dBuV).

2.Correction factor (dB/m) = Antenna Factor (dB/m) + Cable loss (dB) – Pre-Amplifier gain (dB).

3.When the peak results are less than average limit, so not need to evaluate the average.



Standard:	FCC Part 15.247	Test Distance:	3 m
Test item:	Band edge	Power:	AC 120 V/60 Hz
Frequency:	2437 MHz	Temp.(°C)/Hum.(%RH):	26(°C)/60 %RH
Mode:	Mode 4		
Ant.Polar.:	Horizontal		

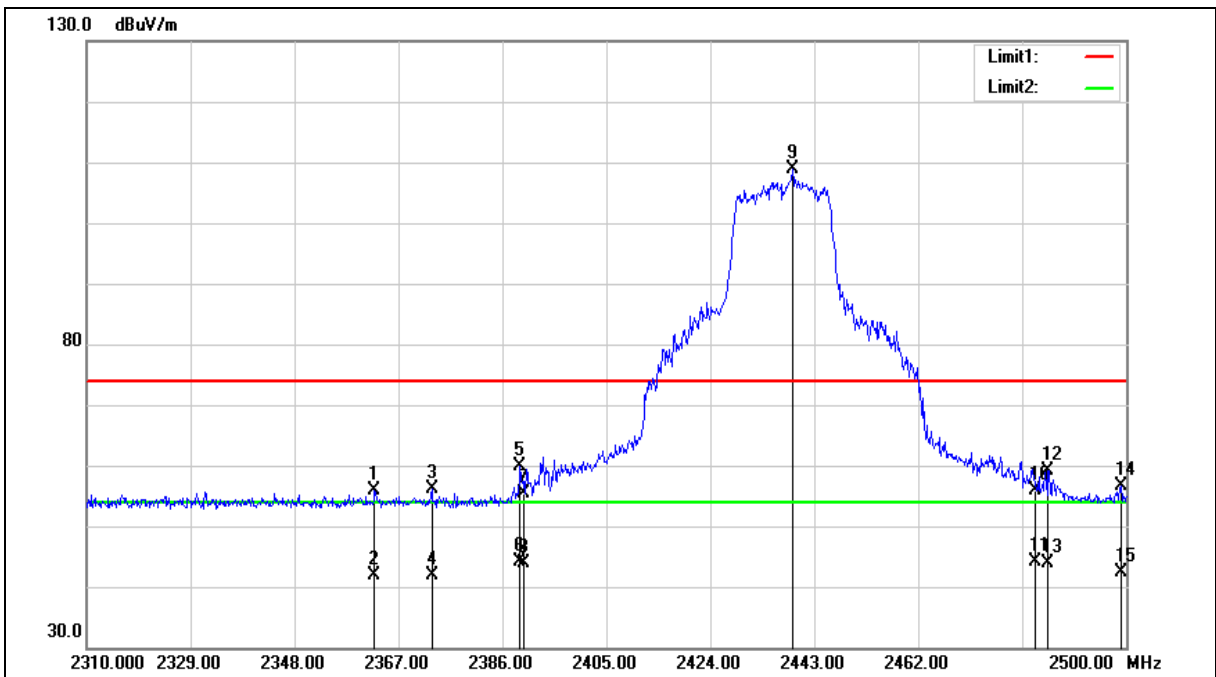



Standard:	FCC Part 15.247	Test Distance:	3 m
Test item:	Band edge	Power:	AC 120 V/60 Hz
Frequency:	2437 MHz	Temp.(°C)/Hum.(%RH):	26(°C)/60 %RH
Mode:	Mode 4		
Ant.Polar.:	Horizontal		

No.	Frequency (MHz)	Reading (dBUV)	Correct Factor (dB/m)	Result (dBUV/m)	Limit (dBUV/m)	Margin (dB)	Remark
1	2362.630	57.12	-1.14	55.98	74.00	-18.02	peak
2	2362.630	42.91	-1.14	41.77	54.00	-12.23	AVG
3	2373.080	57.34	-1.10	56.24	74.00	-17.76	peak
4	2373.080	42.89	-1.10	41.79	54.00	-12.21	AVG
5	2389.230	61.00	-1.05	59.95	74.00	-14.05	peak
6	2389.230	45.14	-1.05	44.09	54.00	-9.91	AVG
7	2390.000	56.43	-1.05	55.38	74.00	-18.62	peak
8	2390.000	44.96	-1.05	43.91	54.00	-10.09	AVG
9	2439.010	109.63	-0.86	108.77	--	--	peak
10	2483.500	56.47	-0.70	55.77	74.00	-18.23	peak
11	2483.500	44.93	-0.70	44.23	54.00	-9.77	AVG
12	2485.750	59.88	-0.70	59.18	74.00	-14.82	peak
13	2485.750	44.47	-0.70	43.77	54.00	-10.23	AVG
14	2499.050	57.21	-0.64	56.57	74.00	-17.43	peak
15	2499.050	43.04	-0.64	42.40	54.00	-11.60	AVG

Note:1.Result (dBUV/m) = Correct Factor (dB/m) + Reading(dBUV).

2.Correction factor (dB/m) = Antenna Factor (dB/m) + Cable loss (dB) – Pre-Amplifier gain (dB).

3.When the peak results are less than average limit, so not need to evaluate the average.



Standard:	FCC Part 15.247	Test Distance:	3 m
Test item:	Band edge	Power:	AC 120 V/60 Hz
Frequency:	2437 MHz	Temp.(°C)/Hum.(%RH):	26(°C)/60 %RH
Mode:	Mode 4		
Ant.Polar.:	Vertical		

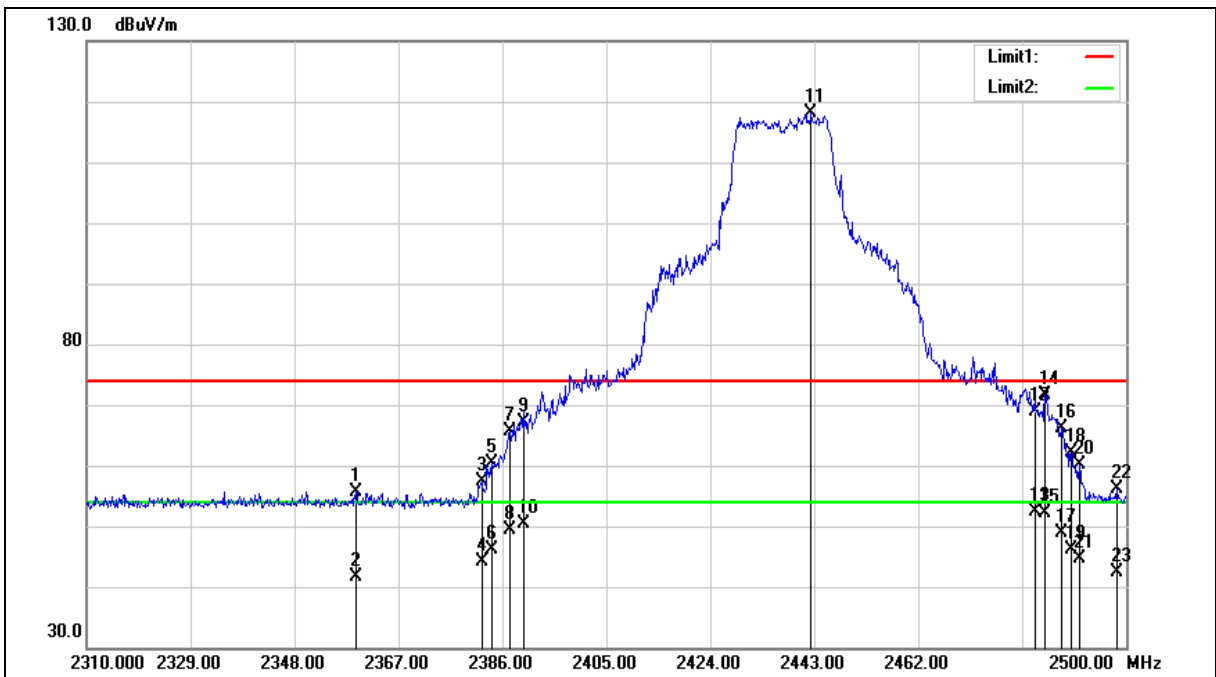



Standard:	FCC Part 15.247	Test Distance:	3 m
Test item:	Band edge	Power:	AC 120 V/60 Hz
Frequency:	2437 MHz	Temp.(°C)/Hum.(%RH):	26(°C)/60 %RH
Mode:	Mode 4		
Ant.Polar.:	Vertical		

No.	Frequency (MHz)	Reading (dBuV)	Correct Factor (dB/m)	Result (dBuV/m)	Limit (dBuV/m)	Margin (dB)	Remark
1	2359.210	56.86	-1.16	55.70	74.00	-18.30	peak
2	2359.210	42.89	-1.16	41.73	54.00	-12.27	AVG
3	2382.200	58.37	-1.08	57.29	74.00	-16.71	peak
4	2382.200	45.32	-1.08	44.24	54.00	-9.76	AVG
5	2384.100	61.37	-1.07	60.30	74.00	-13.70	peak
6	2384.100	47.10	-1.07	46.03	54.00	-7.97	AVG
7	2387.330	66.58	-1.06	65.52	74.00	-8.48	peak
8	2387.330	50.43	-1.06	49.37	54.00	-4.63	AVG
9	2390.000	68.16	-1.05	67.11	74.00	-6.89	peak
10	2390.000	51.39	-1.05	50.34	54.00	-3.66	AVG
11	2442.430	118.92	-0.85	118.07	--	--	peak
12	2483.500	69.55	-0.70	68.85	74.00	-5.15	peak
13	2483.500	53.19	-0.70	52.49	54.00	-1.51	AVG
14	2485.180	72.41	-0.70	71.71	74.00	-2.29	peak
15	2485.180	52.73	-0.70	52.03	54.00	-1.97	AVG
16	2488.220	66.76	-0.68	66.08	74.00	-7.92	peak
17	2488.220	49.57	-0.68	48.89	54.00	-5.11	AVG
18	2489.930	62.87	-0.68	62.19	74.00	-11.81	peak
19	2489.930	46.72	-0.68	46.04	54.00	-7.96	AVG
20	2491.450	60.73	-0.67	60.06	74.00	-13.94	peak
21	2491.450	45.28	-0.67	44.61	54.00	-9.39	AVG
22	2498.290	56.86	-0.64	56.22	74.00	-17.78	peak
23	2498.290	43.04	-0.64	42.40	54.00	-11.60	AVG

Note:1.Result (dBuV/m) = Correct Factor (dB/m) + Reading(dBuV).

2.Correction factor (dB/m) = Antenna Factor (dB/m) + Cable loss (dB) – Pre-Amplifier gain (dB).

3.When the peak results are less than average limit, so not need to evaluate the average.



Standard:	FCC Part 15.247	Test Distance:	3 m
Test item:	Band edge	Power:	AC 120 V/60 Hz
Frequency:	2462 MHz	Temp.(°C)/Hum.(%RH):	26(°C)/60 %RH
Mode:	Mode 4		
Ant.Polar.:	Horizontal		

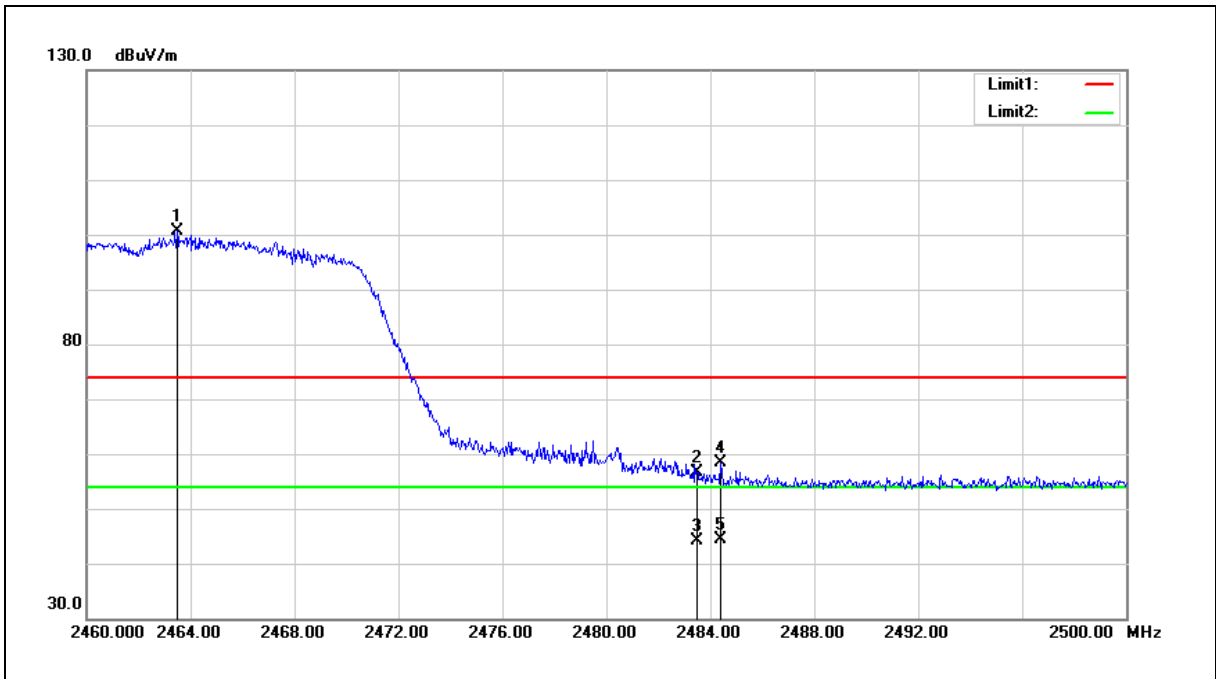

No.	Frequency (MHz)	Reading (dBuV)	Correct Factor (dB/m)	Result (dBuV/m)	Limit (dBuV/m)	Margin (dB)	Remark
1	2463.480	101.38	-0.77	100.61	--	--	peak
2	2483.500	57.31	-0.70	56.61	74.00	-17.39	peak
3	2483.500	44.91	-0.70	44.21	54.00	-9.79	AVG
4	2484.400	59.15	-0.70	58.45	74.00	-15.55	peak
5	2484.400	45.02	-0.70	44.32	54.00	-9.68	AVG

Note:1.Result (dBuV/m) = Correct Factor (dB/m) + Reading(dBuV).

2.Correction factor (dB/m) = Antenna Factor (dB/m) + Cable loss (dB) – Pre-Amplifier gain (dB).

3.When the peak results are less than average limit, so not need to evaluate the average.



Standard:	FCC Part 15.247	Test Distance:	3 m
Test item:	Band edge	Power:	AC 120 V/60 Hz
Frequency:	2462 MHz	Temp.(°C)/Hum.(%RH):	26(°C)/60 %RH
Mode:	Mode 4		
Ant.Polar.:	Vertical		

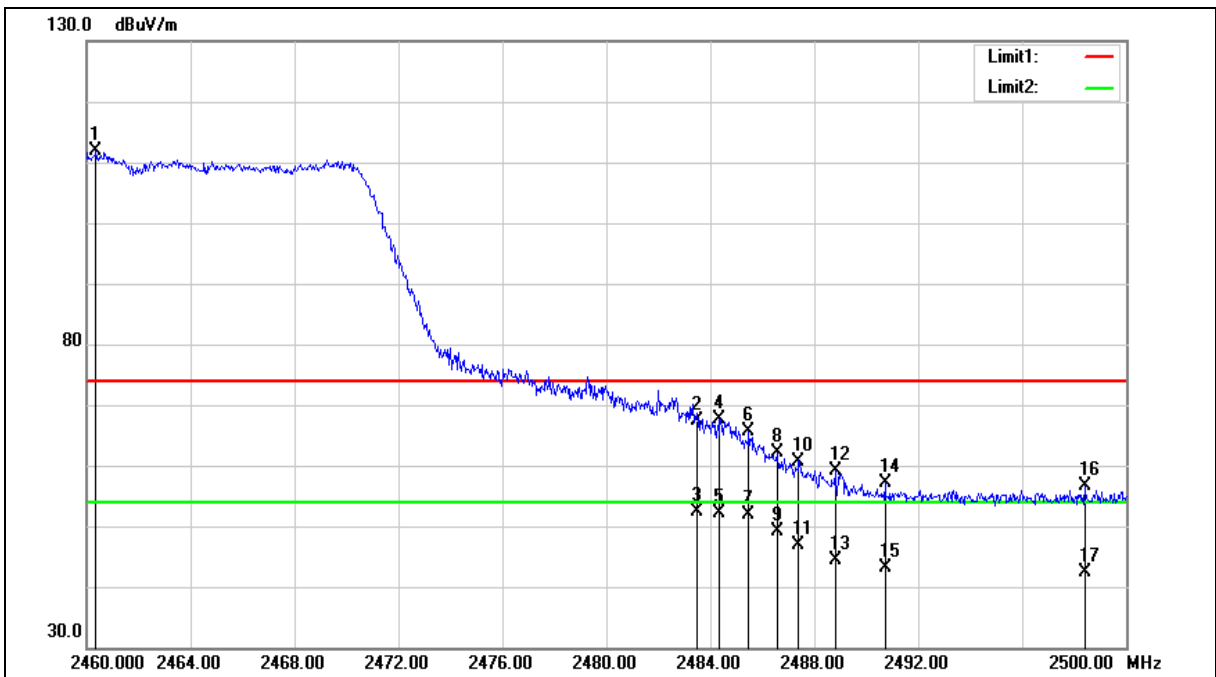



Standard:	FCC Part 15.247	Test Distance:	3 m
Test item:	Band edge	Power:	AC 120 V/60 Hz
Frequency:	2462 MHz	Temp.(°C)/Hum.(%RH):	26(°C)/60 %RH
Mode:	Mode 4		
Ant.Polar.:	Vertical		

No.	Frequency (MHz)	Reading (dBuV)	Correct Factor (dB/m)	Result (dBuV/m)	Limit (dBuV/m)	Margin (dB)	Remark
1	2460.360	112.64	-0.79	111.85	--	--	peak
2	2483.500	67.98	-0.70	67.28	74.00	-6.72	peak
3	2483.500	53.16	-0.70	52.46	54.00	-1.54	AVG
4	2484.360	68.29	-0.70	67.59	74.00	-6.41	peak
5	2484.360	52.79	-0.70	52.09	54.00	-1.91	AVG
6	2485.480	66.28	-0.70	65.58	74.00	-8.42	peak
7	2485.480	52.56	-0.70	51.86	54.00	-2.14	AVG
8	2486.560	62.74	-0.69	62.05	74.00	-11.95	peak
9	2486.560	49.90	-0.69	49.21	54.00	-4.79	AVG
10	2487.400	61.44	-0.69	60.75	74.00	-13.25	peak
11	2487.400	47.65	-0.69	46.96	54.00	-7.04	AVG
12	2488.800	59.88	-0.68	59.20	74.00	-14.80	peak
13	2488.800	45.16	-0.68	44.48	54.00	-9.52	AVG
14	2490.720	57.89	-0.67	57.22	74.00	-16.78	peak
15	2490.720	43.89	-0.67	43.22	54.00	-10.78	AVG
16	2498.400	57.33	-0.64	56.69	74.00	-17.31	peak
17	2498.400	43.07	-0.64	42.43	54.00	-11.57	AVG

Note:1.Result (dBuV/m) = Correct Factor (dB/m) + Reading(dBuV).

2.Correction factor (dB/m) = Antenna Factor (dB/m) + Cable loss (dB) – Pre-Amplifier gain (dB).

3.When the peak results are less than average limit, so not need to evaluate the average.



Standard:	FCC Part 15.247	Test Distance:	3 m
Test item:	Band edge	Power:	AC 120 V/60 Hz
Frequency:	2422 MHz	Temp.(°C)/Hum.(%RH):	26(°C)/60 %RH
Mode:	Mode 5		
Ant.Polar.:	Horizontal		

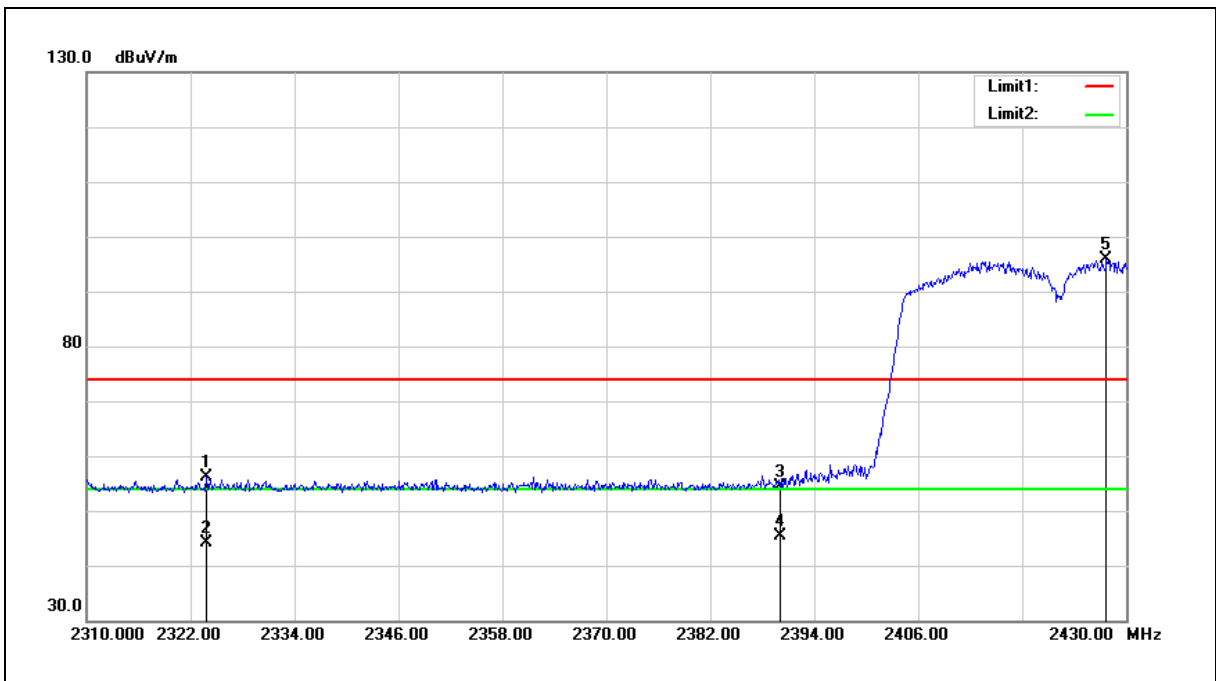

No.	Frequency (MHz)	Reading (dBuV)	Correct Factor (dB/m)	Result (dBuV/m)	Limit (dBuV/m)	Margin (dB)	Remark
1	2323.800	57.32	-1.29	56.03	74.00	-17.97	peak
2	2323.800	45.54	-1.29	44.25	54.00	-9.75	AVG
3	2390.000	55.44	-1.05	54.39	74.00	-19.61	peak
4	2390.000	46.37	-1.05	45.32	54.00	-8.68	AVG
5	2427.720	96.67	-0.91	95.76	--	--	peak

Note:1.Result (dBuV/m) = Correct Factor (dB/m) + Reading(dBuV).

2.Correction factor (dB/m) = Antenna Factor (dB/m) + Cable loss (dB) – Pre-Amplifier gain (dB).

3.When the peak results are less than average limit, so not need to evaluate the average.



Standard:	FCC Part 15.247	Test Distance:	3 m
Test item:	Band edge	Power:	AC 120 V/60 Hz
Frequency:	2422 MHz	Temp.(°C)/Hum.(%RH):	26(°C)/60 %RH
Mode:	Mode 5		
Ant.Polar.:	Vertical		

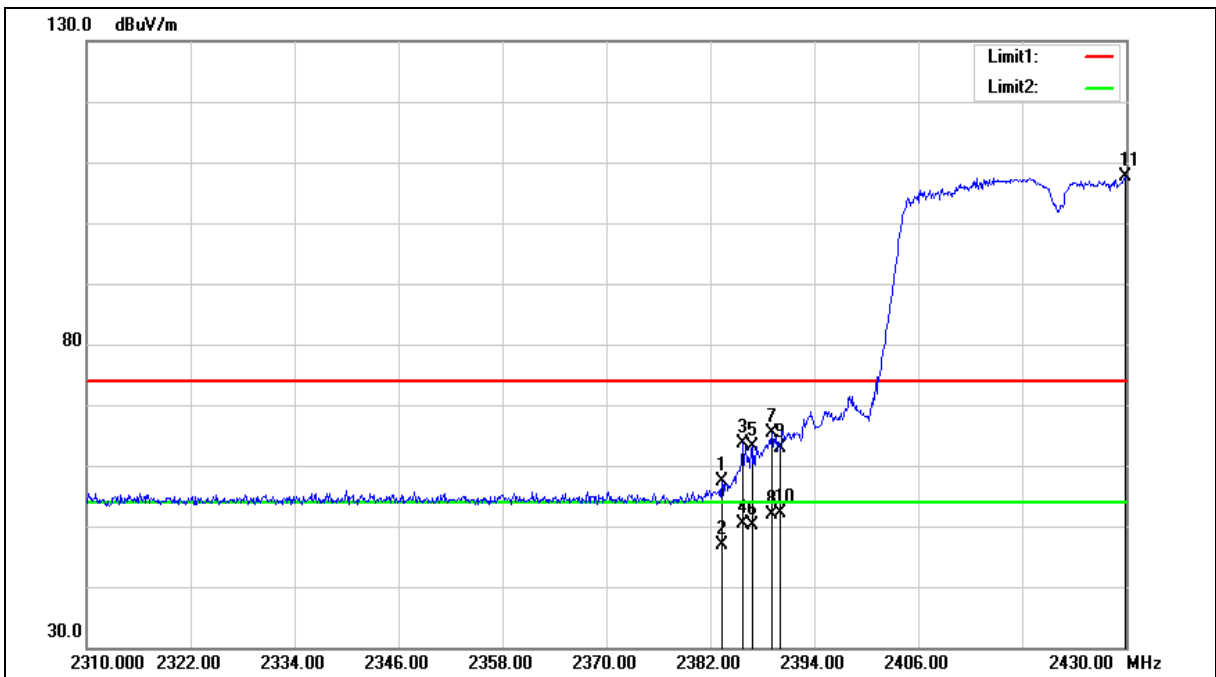



Standard:	FCC Part 15.247	Test Distance:	3 m
Test item:	Band edge	Power:	AC 120 V/60 Hz
Frequency:	2422 MHz	Temp.(°C)/Hum.(%RH):	26(°C)/60 %RH
Mode:	Mode 5		
Ant.Polar.:	Vertical		

No.	Frequency (MHz)	Reading (dBuV)	Correct Factor (dB/m)	Result (dBuV/m)	Limit (dBuV/m)	Margin (dB)	Remark
1	2383.320	58.51	-1.07	57.44	74.00	-16.56	peak
2	2383.320	47.99	-1.07	46.92	54.00	-7.08	AVG
3	2385.720	64.80	-1.07	63.73	74.00	-10.27	peak
4	2385.720	51.34	-1.07	50.27	54.00	-3.73	AVG
5	2386.920	64.25	-1.06	63.19	74.00	-10.81	peak
6	2386.920	51.22	-1.06	50.16	54.00	-3.84	AVG
7	2389.080	66.38	-1.05	65.33	74.00	-8.67	peak
8	2389.080	52.81	-1.05	51.76	54.00	-2.24	AVG
9	2390.000	63.88	-1.05	62.83	74.00	-11.17	peak
10	2390.000	53.10	-1.05	52.05	54.00	-1.95	AVG
11	2429.880	108.41	-0.89	107.52	--	--	peak

Note:1.Result (dBuV/m) = Correct Factor (dB/m) + Reading(dBuV).

2.Correction factor (dB/m) = Antenna Factor (dB/m) + Cable loss (dB) – Pre-Amplifier gain (dB).

3.When the peak results are less than average limit, so not need to evaluate the average.



Standard:	FCC Part 15.247	Test Distance:	3 m
Test item:	Band edge	Power:	AC 120 V/60 Hz
Frequency:	2437 MHz	Temp.(°C)/Hum.(%RH):	26(°C)/60 %RH
Mode:	Mode 5		
Ant.Polar.:	Horizontal		

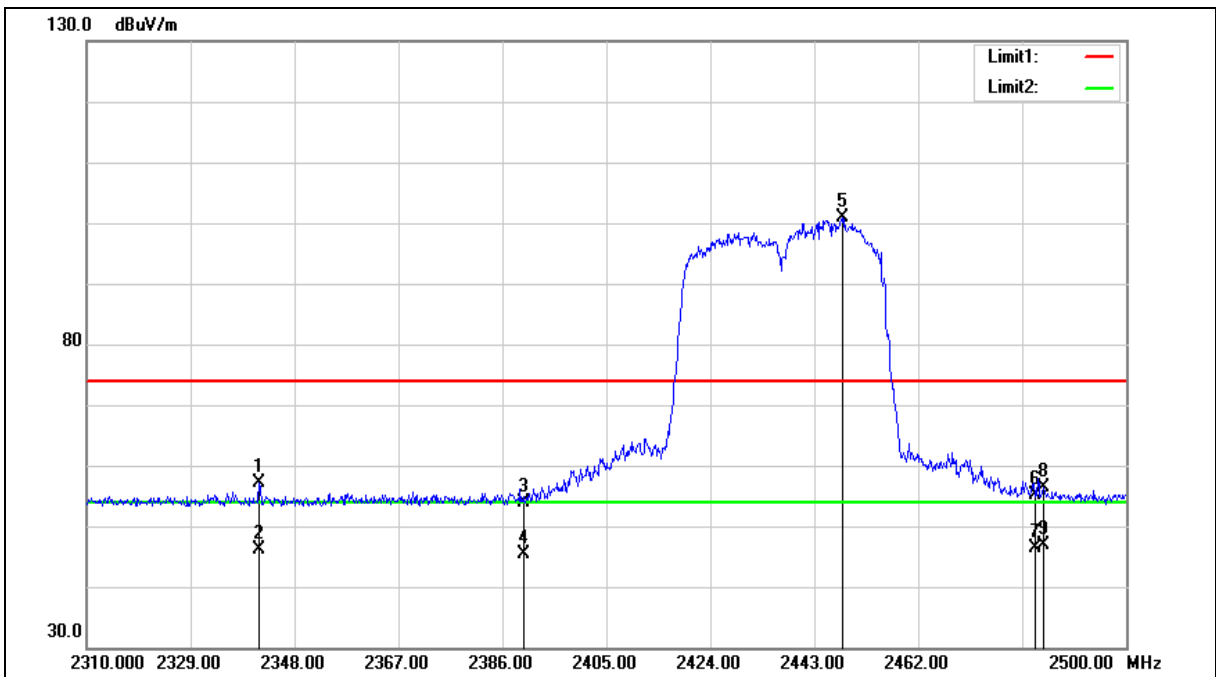



Standard:	FCC Part 15.247	Test Distance:	3 m
Test item:	Band edge	Power:	AC 120 V/60 Hz
Frequency:	2437 MHz	Temp.(°C)/Hum.(%RH):	26(°C)/60 %RH
Mode:	Mode 5		
Ant.Polar.:	Horizontal		

No.	Frequency (MHz)	Reading (dBuV)	Correct Factor (dB/m)	Result (dBuV/m)	Limit (dBuV/m)	Margin (dB)	Remark
1	2341.540	58.36	-1.22	57.14	74.00	-16.86	peak
2	2341.540	47.25	-1.22	46.03	54.00	-7.97	AVG
3	2390.000	55.03	-1.05	53.98	74.00	-20.02	peak
4	2390.000	46.36	-1.05	45.31	54.00	-8.69	AVG
5	2448.130	101.69	-0.82	100.87	--	--	peak
6	2483.500	55.72	-0.70	55.02	74.00	-18.98	peak
7	2483.500	47.07	-0.70	46.37	54.00	-7.63	AVG
8	2484.990	57.06	-0.70	56.36	74.00	-17.64	peak
9	2484.990	47.63	-0.70	46.93	54.00	-7.07	AVG

Note:1.Result (dBuV/m) = Correct Factor (dB/m) + Reading(dBuV).

2.Correction factor (dB/m) = Antenna Factor (dB/m) + Cable loss (dB) – Pre-Amplifier gain (dB).

3.When the peak results are less than average limit, so not need to evaluate the average.



Standard:	FCC Part 15.247	Test Distance:	3 m
Test item:	Band edge	Power:	AC 120 V/60 Hz
Frequency:	2437 MHz	Temp.(°C)/Hum.(%RH):	26(°C)/60 %RH
Mode:	Mode 5		
Ant.Polar.:	Vertical		

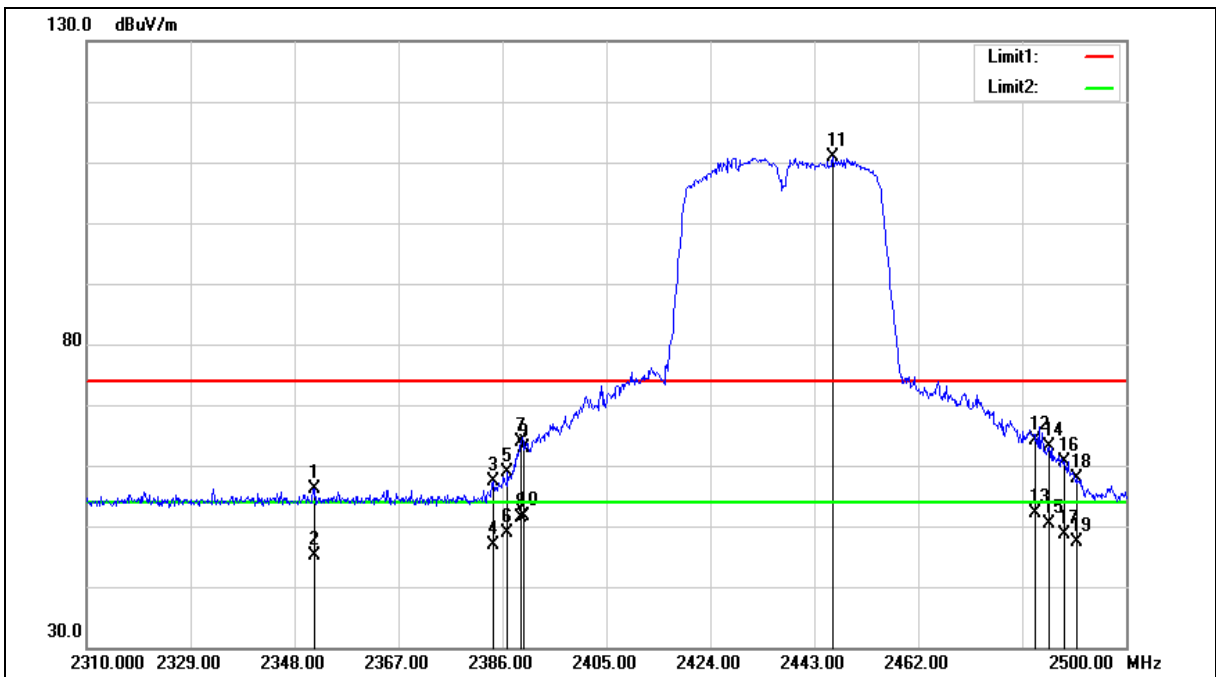



Standard:	FCC Part 15.247	Test Distance:	3 m
Test item:	Band edge	Power:	AC 120 V/60 Hz
Frequency:	2437 MHz	Temp.(°C)/Hum.(%RH):	26(°C)/60 %RH
Mode:	Mode 5		
Ant.Polar.:	Vertical		

No.	Frequency (MHz)	Reading (dBuV)	Correct Factor (dB/m)	Result (dBuV/m)	Limit (dBuV/m)	Margin (dB)	Remark
1	2351.610	57.31	-1.19	56.12	74.00	-17.88	peak
2	2351.610	46.35	-1.19	45.16	54.00	-8.84	AVG
3	2384.290	58.53	-1.07	57.46	74.00	-16.54	peak
4	2384.290	48.00	-1.07	46.93	54.00	-7.07	AVG
5	2386.950	59.97	-1.06	58.91	74.00	-15.09	peak
6	2386.950	49.82	-1.06	48.76	54.00	-5.24	AVG
7	2389.420	64.85	-1.05	63.80	74.00	-10.20	peak
8	2389.420	52.32	-1.05	51.27	54.00	-2.73	AVG
9	2390.000	63.81	-1.05	62.76	74.00	-11.24	peak
10	2390.000	52.73	-1.05	51.68	54.00	-2.32	AVG
11	2446.420	111.60	-0.83	110.77	--	--	peak
12	2483.500	64.90	-0.70	64.20	74.00	-9.80	peak
13	2483.500	52.85	-0.70	52.15	54.00	-1.85	AVG
14	2485.940	63.86	-0.70	63.16	74.00	-10.84	peak
15	2485.940	51.19	-0.70	50.49	54.00	-3.51	AVG
16	2488.600	61.35	-0.68	60.67	74.00	-13.33	peak
17	2488.600	49.33	-0.68	48.65	54.00	-5.35	AVG
18	2490.880	58.59	-0.67	57.92	74.00	-16.08	peak
19	2490.880	48.10	-0.67	47.43	54.00	-6.57	AVG

Note:1.Result (dBuV/m) = Correct Factor (dB/m) + Reading(dBuV).

2.Correction factor (dB/m) = Antenna Factor (dB/m) + Cable loss (dB) – Pre-Amplifier gain (dB).

3.When the peak results are less than average limit, so not need to evaluate the average.



Standard:	FCC Part 15.247	Test Distance:	3 m
Test item:	Band edge	Power:	AC 120 V/60 Hz
Frequency:	2452 MHz	Temp.(°C)/Hum.(%RH):	26(°C)/60 %RH
Mode:	Mode 5		
Ant.Polar.:	Horizontal		

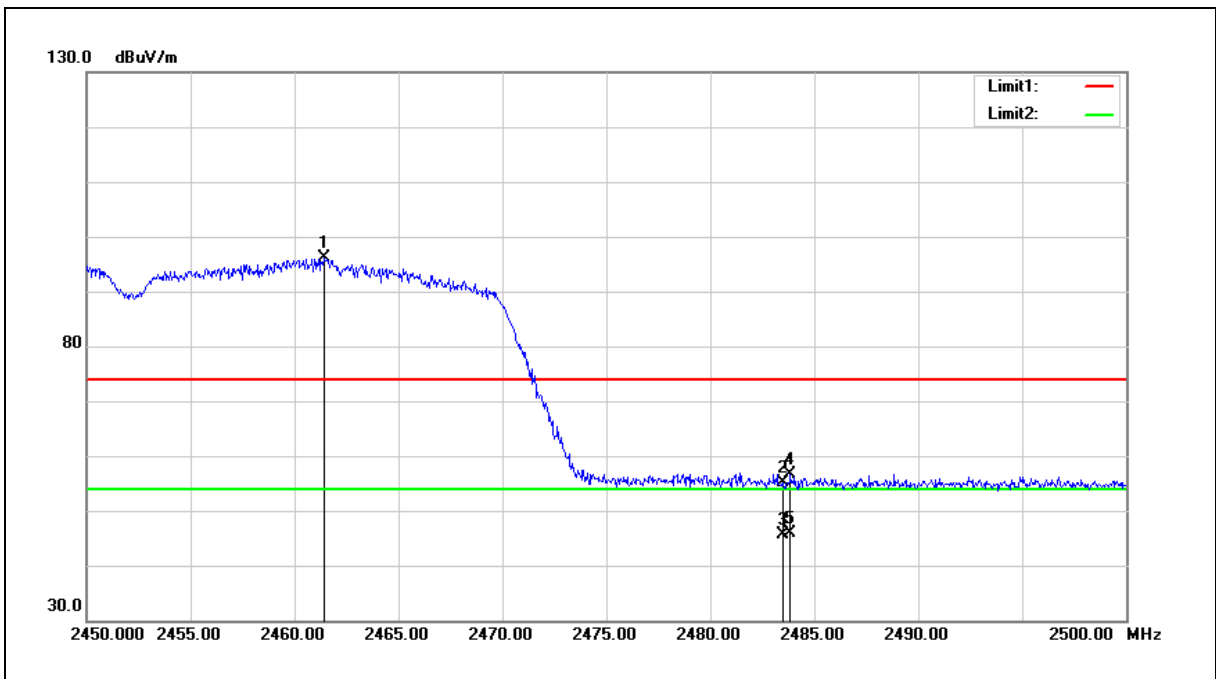

No.	Frequency (MHz)	Reading (dBuV)	Correct Factor (dB/m)	Result (dBuV/m)	Limit (dBuV/m)	Margin (dB)	Remark
1	2461.400	96.93	-0.79	96.14	--	--	peak
2	2483.500	55.83	-0.70	55.13	74.00	-18.87	peak
3	2483.500	46.32	-0.70	45.62	54.00	-8.38	AVG
4	2483.850	57.30	-0.70	56.60	74.00	-17.40	peak
5	2483.850	46.54	-0.70	45.84	54.00	-8.16	AVG

Note:1.Result (dBuV/m) = Correct Factor (dB/m) + Reading(dBuV).

2.Correction factor (dB/m) = Antenna Factor (dB/m) + Cable loss (dB) – Pre-Amplifier gain (dB).

3.When the peak results are less than average limit, so not need to evaluate the average.



Standard:	FCC Part 15.247	Test Distance:	3 m
Test item:	Band edge	Power:	AC 120 V/60 Hz
Frequency:	2452 MHz	Temp.(°C)/Hum.(%RH):	26(°C)/60 %RH
Mode:	Mode 5		
Ant.Polar.:	Vertical		

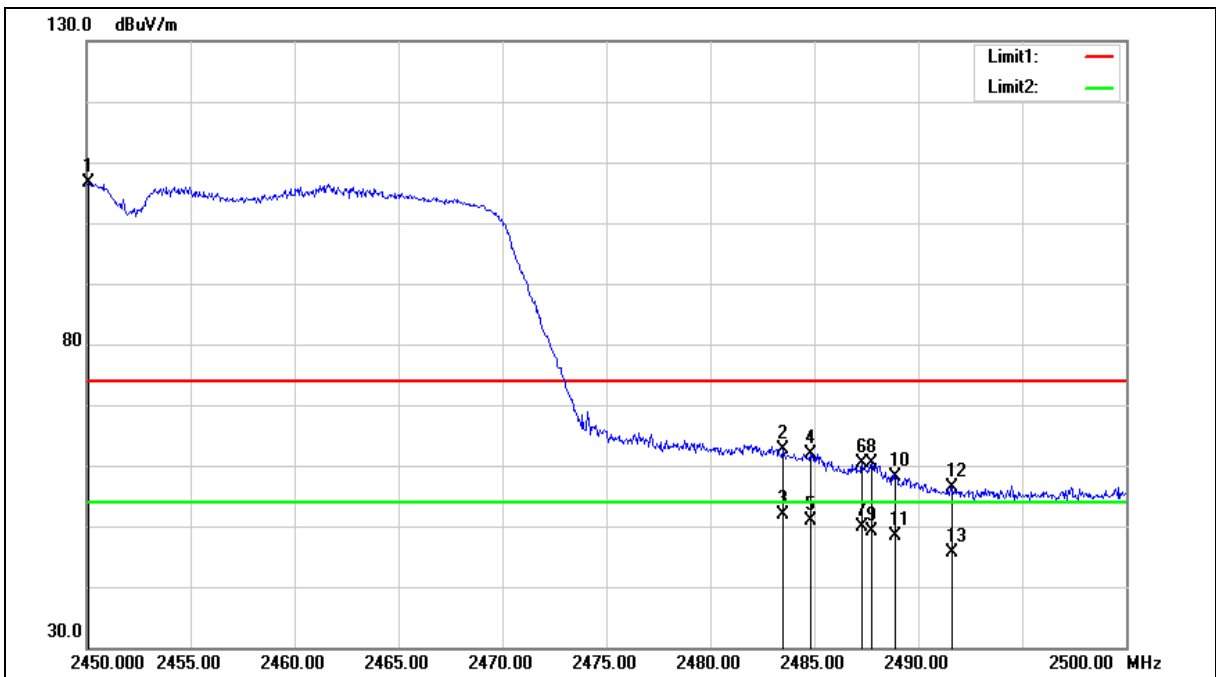



Standard:	FCC Part 15.247	Test Distance:	3 m
Test item:	Band edge	Power:	AC 120 V/60 Hz
Frequency:	2452 MHz	Temp.(°C)/Hum.(%RH):	26(°C)/60 %RH
Mode:	Mode 5		
Ant.Polar.:	Vertical		

No.	Frequency (MHz)	Reading (dBUV)	Correct Factor (dB/m)	Result (dBUV/m)	Limit (dBUV/m)	Margin (dB)	Remark
1	2450.100	107.53	-0.82	106.71	--	--	peak
2	2483.500	63.26	-0.70	62.56	74.00	-11.44	peak
3	2483.500	52.55	-0.70	51.85	54.00	-2.15	AVG
4	2484.800	62.58	-0.70	61.88	74.00	-12.12	peak
5	2484.800	51.51	-0.70	50.81	54.00	-3.19	AVG
6	2487.300	61.17	-0.69	60.48	74.00	-13.52	peak
7	2487.300	50.51	-0.69	49.82	54.00	-4.18	AVG
8	2487.750	61.11	-0.68	60.43	74.00	-13.57	peak
9	2487.750	49.90	-0.68	49.22	54.00	-4.78	AVG
10	2488.900	58.77	-0.68	58.09	74.00	-15.91	peak
11	2488.900	49.03	-0.68	48.35	54.00	-5.65	AVG
12	2491.600	57.03	-0.67	56.36	74.00	-17.64	peak
13	2491.600	46.37	-0.67	45.70	54.00	-8.30	AVG

Note:1.Result (dBUV/m) = Correct Factor (dB/m) + Reading(dBUV).

2.Correction factor (dB/m) = Antenna Factor (dB/m) + Cable loss (dB) – Pre-Amplifier gain (dB).

3.When the peak results are less than average limit, so not need to evaluate the average.

--- END---