

## RF Test Reprt

Applicant : PISMO LABS TECHNOLOGY LIMITED  
Product Type : PEPWAVE / peplink Wireless Product  
Trade Name : PEPWAVE / peplink  
Model Number : Balance 20X, B20X, Surf SOHO, Surf SOHO LTE,  
Surf SOHO LTEA, Balance 20X LTE, Balance 20X LTEA,  
PismoAC8E, BPL-021X-LTE-US-T, BPL-021X-LTEA-W-T,  
EXM-MINI-1LTEA-W, EXM-MINI-1LTEA-P, PismoAC8P,  
PismoAC8  
FCC ID : U8G-P1AC8E  
Test Specification : FCC 47 CFR PART 15 SUBPART E  
Receive Date : Jul. 01, 2019  
Test Period : Jul. 29 ~ Aug. 07, 2019  
Issue Date : Aug. 21, 2019

### Issue by

A Test Lab Techno Corp.  
No. 140-1, Changan Street, Bade District,  
Taoyuan City 33465, Taiwan (R.O.C.)  
Tel : +86-3-2710188 / Fax : +86-3-2710190



Taiwan Accreditation Foundation accreditation number: 1330  
Test Firm MRA designation number: TW0010

### Note:

- 1.The test results are valid only for samples provided by customers and under the test conditions described in this report.
- 2.This report shall not be reproduced except in full, without the written approval of A Test Lab Technology Corporation.
- 3.The relevant information is provided by customers in this test report. According to the correctness, appropriateness or completeness of the information provided by the customer, if there is any doubt or error in the information which affects the validity of the test results, the laboratory does not take the responsibility.



### **Revision History**

Rev.	Issue Date	Revisions	Revised By
00	Aug. 21, 2019	Initial Issue	Tobey Cheng

## Verification of Compliance

Issued Date: Aug. 21, 2019

Applicant : PISMO LABS TECHNOLOGY LIMITED  
Product Type : PEPWAVE / peplink Wireless Product  
Trade Name : PEPWAVE / peplink  
Model Number : Balance 20X, B20X, Surf SOHO, Surf SOHO LTE,  
Surf SOHO LTEA, Balance 20X LTE, Balance 20X LTEA,  
PismoAC8E, BPL-021X-LTE-US-T, BPL-021X-LTEA-W-T,  
EXM-MINI-1LTEA-W, EXM-MINI-1LTEA-P, PismoAC8P,  
PismoAC8  
EUT Rated Voltage : DC 12 V, 3 A  
Test Voltage : 120 Vac / 60 Hz  
Applicable Standard : FCC 47 CFR PART 15 SUBPART E  
ANSI C63.10:2013

Test Result : Complied

Performing Lab. : A Test Lab Techno Corp.  
No. 140-1, Changan Street, Bade District,  
Taoyuan City 33465, Taiwan (R.O.C.)  
Tel : +86-3-2710188 / Fax : +86-3-2710190



Taiwan Accreditation Foundation accreditation number: 1330

<http://www.atl-lab.com.tw/e-index.htm>

A Test Lab Techno Corp. tested the above equipment in accordance with the requirements set forth in the above standards. All indications of Pass/Fail in this report are opinions expressed by A Test Lab Techno Corp. based on interpretations and/or observations of test results. The test results show that the equipment tested is capable of demonstrating compliance with the requirements as documented in this report.

Approved By

Fly Lu

(Manager)

(Fly Lu)

Reviewed By

Ken Yang

(Testing Engineer)

(Ken Yang)

## TABLE OF CONTENTS

<b>1</b>	<b>General Information .....</b>	<b>5</b>
1.1.	Summary of Test Result.....	5
1.2.	Measurement Uncertainty.....	6
<b>2</b>	<b>EUT Description .....</b>	<b>7</b>
<b>3</b>	<b>Test Methodology.....</b>	<b>9</b>
3.1.	Mode of Operation .....	9
3.2.	EUT Test Step.....	12
3.3.	Configuration of Test System Details .....	13
3.4.	Test Instruments .....	15
3.5.	Test Site Environment.....	16
<b>4</b>	<b>Measurement Procedure.....</b>	<b>17</b>
4.1.	AC Power Conducted Emission Measurement .....	17
4.2.	Transmitter Radiated Emissions Measurement.....	19
4.3.	Maximum Conducted Output Power Measurement.....	24
4.4.	26 dB RF Bandwidth Measurement & 99 % Occupied Bandwidth Measurement .....	25
4.5.	6 dB RF Bandwidth Measurement .....	26
4.6.	Maximum Power Spectral Density Measurement.....	27
4.7.	Automatically discontinue transmission.....	29
4.8.	Antenna Requirement.....	29
<b>5</b>	<b>Test Results.....</b>	<b>31</b>
	Annex A. Conducted Emission .....	31
	Annex B. Radiated Emission Measurement .....	33
	Annex C. Conducted Test Results .....	132



# 1 General Information

## 1.1. Summary of Test Result

Standard	Item	Result	Remark
15.407(b)(6) 15.207	AC Power Conducted Emission	PASS	---
15.407(b) 15.205 / 15.209	Transmitter Radiated Emissions	PASS	---
15.407(a)	Maximum Conducted Output Power	PASS	---
15.407(a)	26 dB RF Bandwidth & 99 % Occupied Bandwidth	Reference	---
15.407(e)	6 dB RF Bandwidth	PASS	---
15.407(a)	Maximum Power Spectral Density	PASS	---
15.407(c)	Automatically discontinue transmission	PASS	---
15.407(a) 15.203	Antenna Requirement	PASS	---

Standard	Description
CFR47, Part 15, Subpart C §15.247	Intentional Radiators
ANSI C63. 10: 2013	American National Standard of Procedures for Compliance Testing of Unlicensed Wireless Devices
KDB 558074 D01 v05	GUIDANCE FOR COMPLIANCE MEASUREMENTS ON DIGITAL TRANSMISSION SYSTEM, FREQUENCY HOPPING SPREAD SPECTRUM SYSTEM, AND HYBRID SYSTEM DEVICES OPERATING UNDER SECTION 15.247 OF THE FCC RULES

## 1.2. Measurement Uncertainty

Test Item	Frequency Range	Uncertainty (dB)
Conducted Emission	150 kHz ~ 30 MHz	2.8
Radiated Emission	9 kHz ~ 30 MHz	1.7
	30 MHz ~ 1000 MHz	5.7
	1000 MHz ~ 18000 MHz	5.6
	18000 MHz ~ 26500 MHz	4.9
	26500 MHz ~ 40000 MHz	4.8
Conducted Output Power		+0.27 dB / -0.28 dB
RF Bandwidth		4.96 %
Power Spectral Density		+0.71 dB / -0.77 dB
Frequency Stability		+ 2.212 x 10 <sup>-7</sup> % / - 2.170 x 10 <sup>-7</sup>
Duty Cycle		1.06 %
Time Occupancy		1.40 %

Decision Rule

- Uncertainty is not included.
- Uncertainty is included.

## 2 EUT Description

Applicant	PISMO LABS TECHNOLOGY LIMITED A8, 5/F, HK Spinners Industrial Building, Phase 6, 481 Castle Peak Road, Cheung Sha Wan, Hong Kong				
Manufacturer	PISMO LABS TECHNOLOGY LIMITED A8, 5/F, HK Spinners Industrial Building, Phase 6, 481 Castle Peak Road, Cheung Sha Wan, Hong Kong				
Product Type	PEPWAVE / peplink Wireless Product				
Trade Name	PEPWAVE / peplink				
Model Number	Balance 20X, B20X, Surf SOHO, Surf SOHO LTE, Surf SOHO LTEA, Balance 20X LTE, Balance 20X LTEA, PismoAC8E, BPL-021X-LTE-US-T, BPL-021X-LTEA-W-T, EXM-MINI-1LTEA-W, EXM-MINI-1LTEA-P, PismoAC8P, PismoAC8				
Product Type /Trade Name / Model Number Different Description	These product Types & trade names & model numbers differ from each other in selling region.				
FCC ID	U8G-P1AC8E				
Operate Frequency	Frequency Band		Frequency Range (MHz)	Number of Channels	
	IEEE 802.11a	U-NII Band I	5180 – 5240	3	
		U-NII Band III	5745 – 5825	3	
	IEEE 802.11n 5 GHz 20 MHz / IEEE 802.11ac 20 MHz	U-NII Band I	5180 – 5240	3	
		U-NII Band III	5745 – 5825	3	
	IEEE 802.11n 5 GHz 40 MHz / IEEE 802.11ac 40 MHz	U-NII Band I	5190 – 5230	2	
		U-NII Band III	5755 – 5795	2	
	IEEE 802.11ac 80 MHz	U-NII Band I	5210	1	
U-NII Band III		5775	1		
Modulation Type	OFDM				
Equipment Type	Master/ Client				
Antenna information	Antenna	Model	Type	Frequency Range (MHz)	Max. Gain (dBi)
	ANT-0 / ANT-1	98614PRSX000	Replacement antenna (RP SMA)	5150 – 5250 5725 – 5850	4.10 4.73
Antenna Delivery	Reference section 3.1				
Operate Temp. Range	-10 ~ +45 °C				



Frequency Band		RF Output Power (W)
IEEE 802.11a	U-NII Band I	0.135
	U-NII Band III	0.099
IEEE 802.11ac 20 MHz	U-NII Band I	0.138
	U-NII Band III	0.096
IEEE 802.11ac 40 MHz	U-NII Band I	0.136
	U-NII Band III	0.111
IEEE 802.11ac 80 MHz	U-NII Band I	0.021
	U-NII Band III	0.063

Equipment Type		
Outdoor access point	point-to-point	---
	point-to-multipoint	---
Indoor access point		V
Fixed point-to-point access points		---
Client devices		V



### 3 Test Methodology

#### 3.1. Mode of Operation

Decision of Test ATL has verified the construction and function in typical operation. All the test modes were carried out with the EUT in normal operation, which was shown in this test report and defined as:

Test Mode
Mode 1: Transmit mode
Mode 2: IEEE 802.11a Continuous TX mode
Mode 3: IEEE 802.11ac 20 MHz Continuous TX mode
Mode 4: IEEE 802.11ac 40 MHz Continuous TX mode
Mode 5: IEEE 802.11ac 80 MHz Continuous TX mode

Software used to control the EUT for staying in continuous transmitting mode was programmed.

After verification, all tests were carried out with the worst case test modes.

Note: The device had two models of WCDMA/LTE Module with two Antennas (Module:Telit, LE910C4-NF+Antenna Model:98619ZSAX053 and Module:Sierra, MC7455+Antenna Model:98619ZSAX025). In the test report, we use WCDMA/LTE Module:Sierra, MC7455+Antenna Model:98619ZSAX025 to test.

Test Mode	ANT-0	ANT-1	ANT-0+1
Mode 2	V	V	V
Mode 3	V	V	V
Mode 4	V	V	V
Mode 5	V	V	V

Test Mode	Antenna Delivery	Data Rate (Mbps)	Band	Test Channel
Mode 2	2TX / 2RX (CDD)	6	U-NII Band I	36, 40, 48
			U-NII Band III	149, 157, 165
Mode 3	2TX / 2RX (MIMO)	13	U-NII Band I	36, 40, 48
			U-NII Band III	149, 157, 165
Mode 4	2TX / 2RX (MIMO)	27	U-NII Band I	38, 46
			U-NII Band III	151,159
Mode 5	2TX / 2RX (MIMO)	58.6	U-NII Band I	42
			U-NII Band III	155

### Duty cycle

Test Mode	Frequency (MHz)	on time (ms)	on+off time (ms)	Duty cycle	Duty Factor (dB)	1/T Minimum VBW (kHz)
Mode 2	5180.0	2.080	2.140	0.972	0.124	0.481
Mode 3	5180.0	5.080	5.120	0.992	0.034	0.010
Mode 4	5190.0	2.460	2.520	0.976	0.105	0.407
Mode 5	5210.0	1.155	1.230	0.939	0.273	0.866

### Duty Cycle Graphs

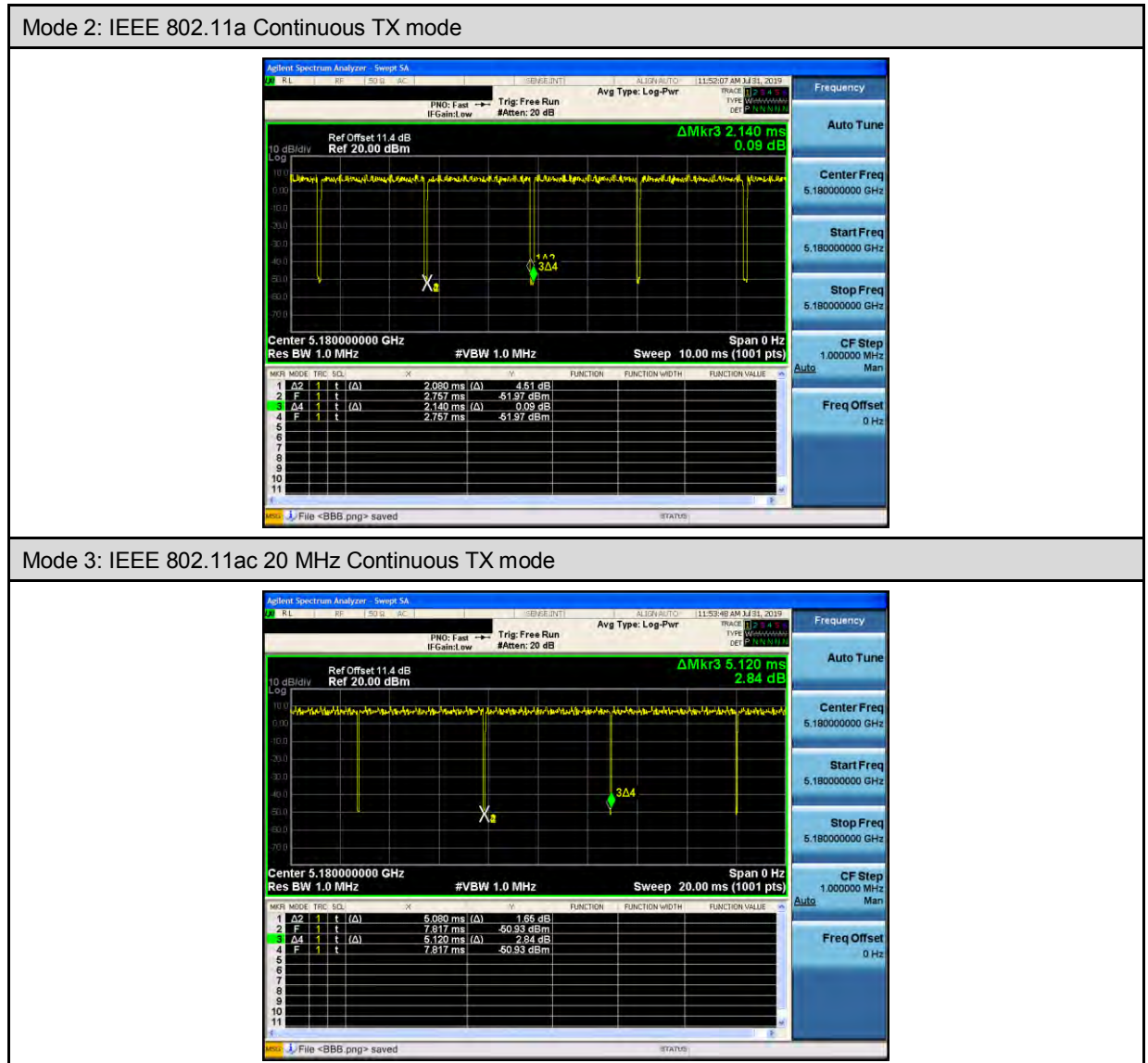



Mode 4: IEEE 802.11ac 40 MHz Continuous TX mode

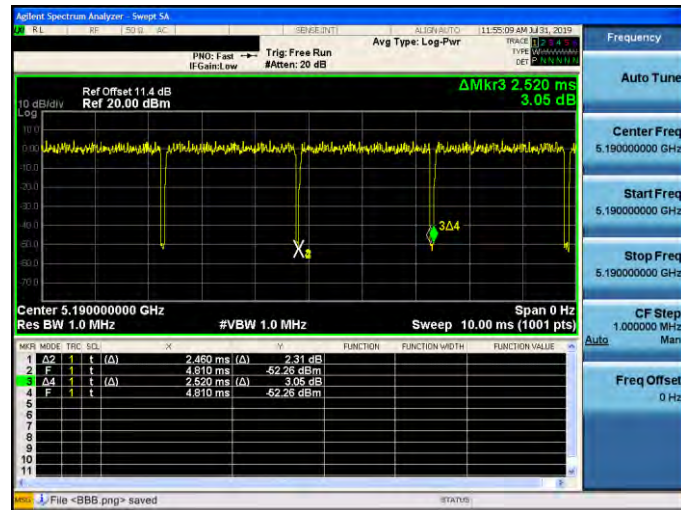

Mode 5: IEEE 802.11ac 80 MHz Continuous TX mode

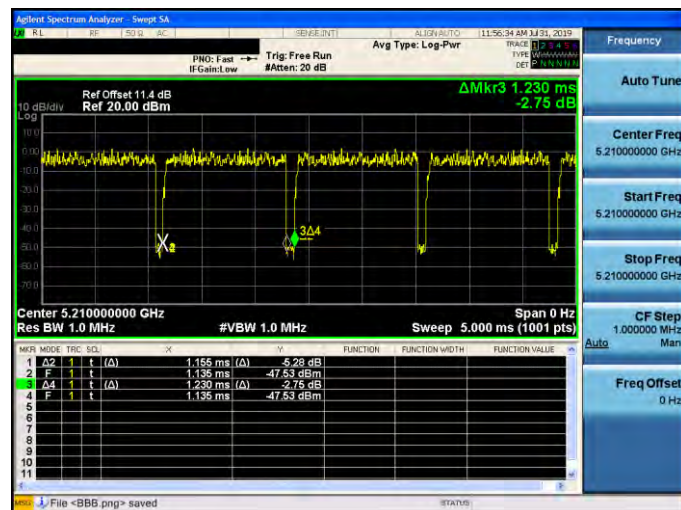



### 3.2. EUT Test Step

The EUT is operated in the engineering mode to fix the TX frequency for the purposes of measurement. According to its specifications, the EUT must comply with the requirements of Section 15.407 under the FCC Rules Part 15 Subpart E.

1.	Setup the EUT shown on "Configuration of Test System Details".
2.	Turn on the power of all equipment.
3.	Turn on TX function.
4.	EUT run test program.

Measurement Software			
No.	Description	Software	Version
1	Conducted Emission	EZ EMC	1.1.4.3
2	Radiated Emission	EZ EMC	1.1.4.4

### 3.3. Configuration of Test System Details

#### Conducted Emissions

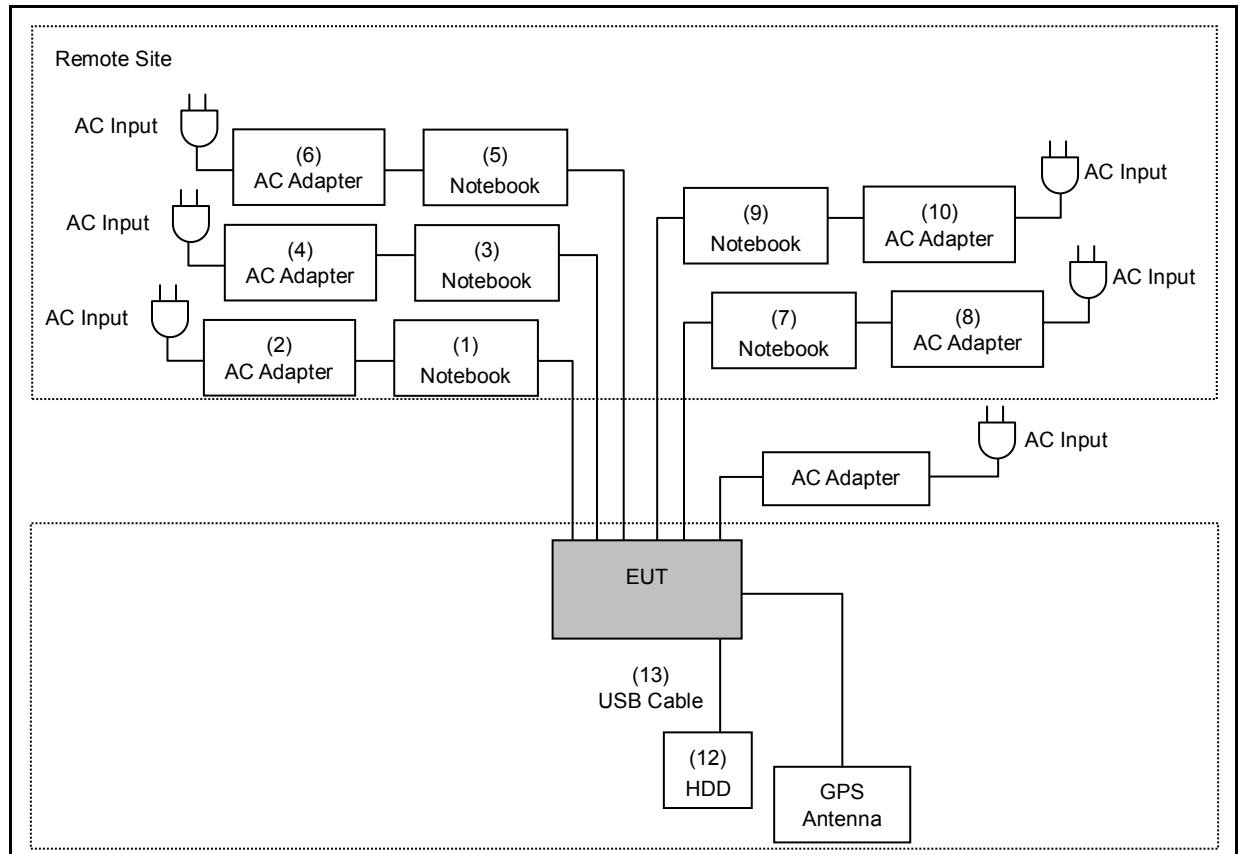

Radiated Emission (Below 1 GHz)

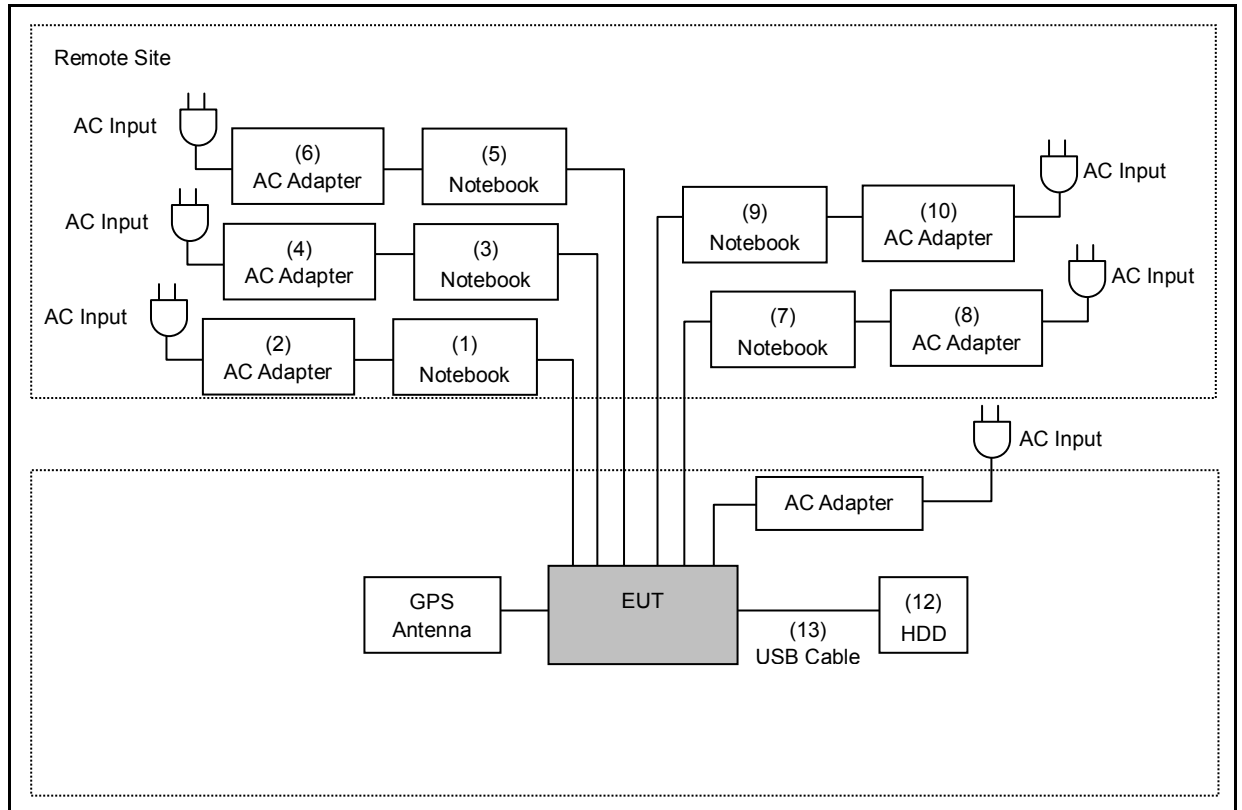

Radiated Emission (Below 1 GHz)

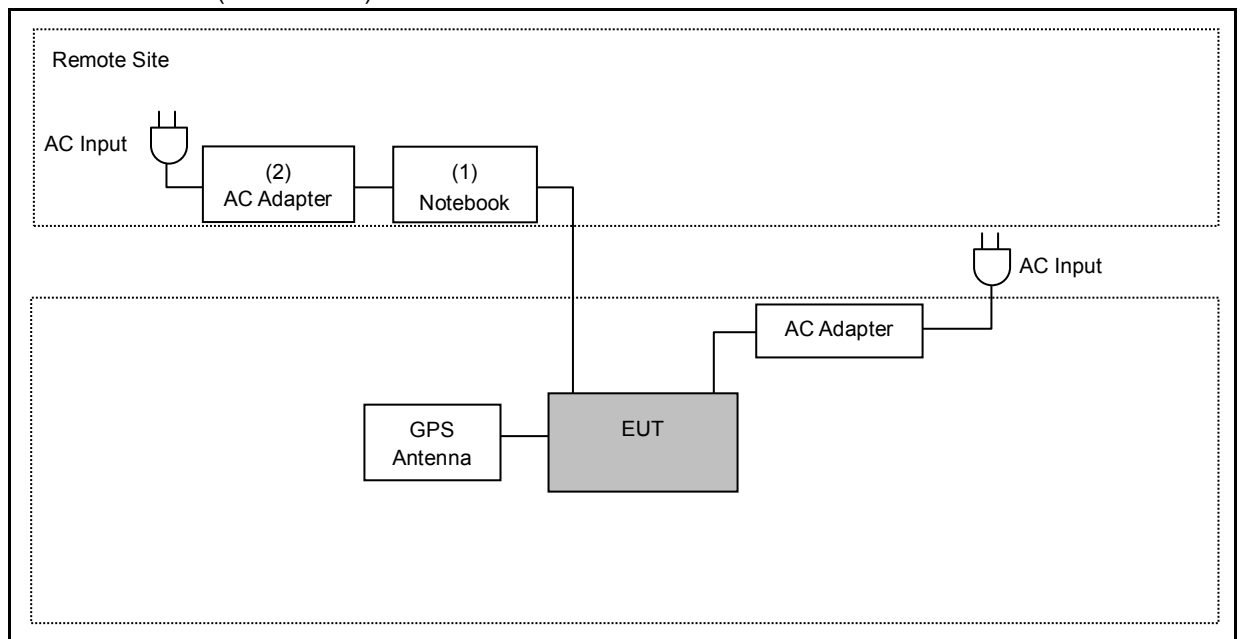



Devices Description					
	Product	Manufacturer	Model Number	Serial Number	Power Cord
(1)	Notebook	ASUS	P2430U	GANXCV04H86940A	---
(2)	AC Adapter	ASUS	ADP-65GD B	---	Non-Shielded, 0.8 m
(3)	Notebook	ASUS	P2430U	GANXCV04H82540A	---
(4)	AC Adapter	ASUS	ADP-65GD B	---	Non-Shielded, 0.8 m
(5)	Notebook	DELL	LATITUDE E6440	5HZBD72	---
(6)	AC Adapter	DELL	HA65NM130	---	Non-Shielded, 0.8 m
(7)	Notebook	DELL	LATITUDE E6440	48GBD72	---
(8)	AC Adapter	DELL	HA65NM130	---	Non-Shielded, 0.8 m
(9)	Notebook	ASUS	BU400A	D1NXAS148534020	---
(10)	AC Adapter	ASUS	EXA1203YH	---	Non-Shielded, 0.8 m
(12)	HDD	Transend	TS1TSJ25A3K-RU	D72654-0611	---
(13)	USB Cable	Transend	TS1TSJ25A3K-RU	D72654-0611	---

### 3.4. Test Instruments

For Conducted Emission

Test Period: Aug. 07, 2019

Equipment	Manufacturer	Model Number	Serial Number	Cal. Date	Cal. Period
Test Receiver	R&S	ESCI	100367	05/23/2019	1 year
LISN	R&S	ENV216	101040	04/03/2019	1 year
LISN	R&S	ENV216	101041	03/28/2019	1 year
RF Cable	Woken	00100D1380194M	TE-02-03	05/23/2019	1 year

Note: N.C.R. = No Calibration Request.



For Radiated Emissions

Test Period: Jul. 29 ~ Jul. 31, 2019

Equipment	Manufacturer	Model Number	Serial Number	Cal. Date	Cal. Period
Spectrum Analyzer (10 Hz~44 GHz)	Keysight	N9010A	MY52221312	01/14/2019	1 year
Pre Amplifier (1~26.5 GHz)	Agilent	8449B	3008A02237	10/16/2018	1 year
Pre Amplifier (100 kHz~1.3 GHz)	Agilent	8447D	2944A11119	01/14/2019	1 year
Pre Amplifier (26.5~40 GHz)	EMCI	EMC2654045	980028	08/23/2018	1 year
Broadband Antenna	Schwarzbeck	VULB9168	416	10/19/2018	1 year
Horn Antenna (1~18 GHz)	SCHWARZBECK MESS-ELEKTRONIK	BBHA9120D	9120D-550	08/23/2018	1 year
Horn Antenna (18~40 GHz)	SCHWARZBECK MESS-ELEKTRONIK	BBHA9170	9170-320	08/07/2018	1 year
Loop Antenna	COM-POWER CORPORATION	AL-130	121014	03/29/2019	1 year
RF Cable	EMCI	EMC104-N-N-6000	TE01-1	02/20/2019	1 year
Microwave Cable	EMCI	EMC104-SM -SM-13000	170814	10/30/2018	1 year
Microwave Cable	EMCI	EMC102-KM -KM-14000	151001	02/20/2019	1 year

For Conducted

Test Period: Jul. 31 ~ Aug. 01, 2019

Equipment	Manufacturer	Model Number	Serial Number	Cal. Date	Cal. Period
Power Sensor	Anritsu	MA2411B	1126022	08/29/2018	1 year
Power Meter	Anritsu	ML2495A	1135009	08/29/2018	1 year
Spectrum Analyzer (3 Hz~50 GHz)	Agilent	N9030A	MY53120541	01/22/2019	1 year

Note: N.C.R. = No Calibration Request.

### 3.5. Test Site Environment

Items	Required (IEC 60068-1)	Actual
Temperature (°C)	15-35	26
Humidity (%RH)	25-75	60
Barometric pressure (mbar)	860-1060	990



## 4 Measurement Procedure

### 4.1. AC Power Conducted Emission Measurement

#### ■ Limit

Frequency (MHz)	Quasi-peak	Average
0.15 - 0.5	66 to 56	56 to 46
0.50 - 5.0	56	46
5.0 - 30.0	60	50

#### ■ Test Setup

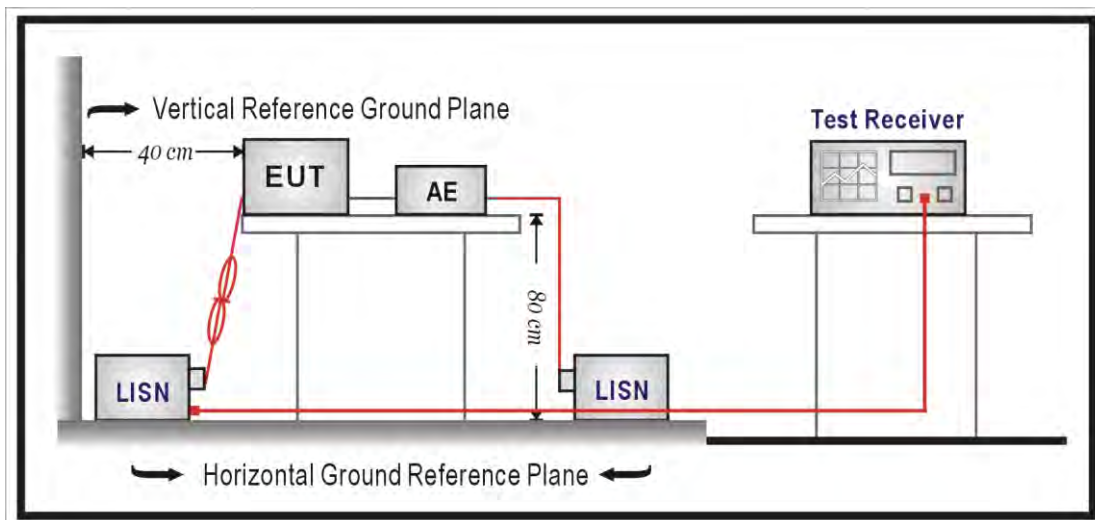

### ■ Test Procedure

The EUT and simulators are connected to the main power through a line impedance stabilization network (L.I.S.N.). This provides a  $50 \Omega // 50 \mu\text{H}$  coupling impedance for the measuring equipment. The peripheral devices are also connected to the main power through a LISN that provides a  $50 \Omega // 50 \mu\text{H}$  coupling impedance with 50 ohm termination.

Tabletop device shall be placed on a non-conducting platform, of nominal size 1 m by 1.5 m, raised 80 cm above the reference ground plane. The wall of screened room shall be located 40 cm to the rear of the EUT. Other surfaces of tabletop or floor standing EUT shall be at least 80 cm from any other ground conducting surface including one or more LISNs. For floor-standing device shall be placed under the EUT with a 12 mm insulating material.

Conducted emissions were investigated over the frequency range from 0.15 MHz to 30 MHz using a resolution bandwidth of 9 kHz. The equipment under test (EUT) shall be meet the limits in section 4.1, as applicable, including the average limit and the quasi-peak limit when using respectively, an average detector and quasi-peak detector measured in accordance with the methods described of related standard. When all of peak value were complied with quasi-peak and average limit from 150 kHz to 30 MHz then quasi-peak and average measurement was unnecessary.

The AMN shall be placed 0.8 m from the boundary of the unit under test and bonded to a ground reference plane for AMNs mounted on top of the ground reference plane. This distance is between the closest points of the AMN and the EUT. All other units of the EUT and associated equipment shall be at least 0.8 m from the AMN. If the mains power cable is longer than 1 m then the cable shall be folded back and forth at the centre of the lead to form a bundle no longer than 0.4 m. All of interconnecting cables that hang closer than 40 cm to the ground plane shall be folded back and forth in the center forming a bundle 30 cm to 40 cm long. All of EUT and AE shall be separate place more than 0.1 m. All  $50 \Omega$  ports of the LISN shall be resistively terminated into  $50 \Omega$  loads when not connected to the measuring instrument.

If the reading of the measuring receiver shows fluctuations close to the limit, the reading shall be observed for at least 15 s at each measurement frequency; the higher reading shall be recorded with the exception of any brief isolated high reading which shall be ignored

## 4.2. Transmitter Radiated Emissions Measurement

### ■ Limit

(1) Undesirable emission limits. Except as shown in paragraph (b)(7) of this section, the maximum emissions outside of the frequency bands of operation shall be attenuated in accordance with the following limits:

(a) For transmitters operating in the 5.15-5.25 GHz band: All emissions outside of the 5.15-5.35 GHz band shall not exceed an e.i.r.p. of -27 dBm/MHz.

(b) For transmitters operating in the 5.25-5.35 GHz band: All emissions outside of the 5.15-5.35 GHz band shall not exceed an e.i.r.p. of -27 dBm/MHz.

(c) For transmitters operating in the 5.47-5.725 GHz band: All emissions outside of the 5.47-5.725 GHz band shall not exceed an e.i.r.p. of -27 dBm/MHz.

(d) For transmitters operating in the 5.725-5.85 GHz band:

(i) All emissions shall be limited to a level of -27 dBm/MHz at 75 MHz or more above or below the band edge increasing linearly to 10 dBm/MHz at 25 MHz above or below the band edge, and from 25 MHz above or below the band edge increasing linearly to a level of 15.6 dBm/MHz at 5 MHz above or below the band edge, and from 5 MHz above or below the band edge increasing linearly to a level of 27 dBm/MHz at the band edge.

(2) Limits of Radiated Emission Measurement

Emissions radiated outside of the specified bands, shall be according to the general radiated limits in 15.209 as following:

Frequency Range (MHz)	Field Strength (microvolts/meter)	Measurement Distance (meters)
0.009 ~ 0.490	2400/F(kHz)	300
0.490 ~ 1.705	24000/F(kHz)	30
1.705 ~ 30.0	30	30
30 ~ 88	10	3
88 ~ 216	150	3
216 ~ 960	200	3
Above 960	500	3

- Note:
1. The lower limit shall apply at the transition frequencies.
  2. Emission level (dBuV/m) = 20 log Emission level (uV/m).
  3. As shown in 15.35(b), for frequencies above 1000 MHz, the field strength limits are based on average detector, however, the peak field strength of any emission shall not exceed the maximum permitted average limits, specified above by more than 20 dB under any condition of modulation.

■ Setup

9 kHz ~ 30 MHz

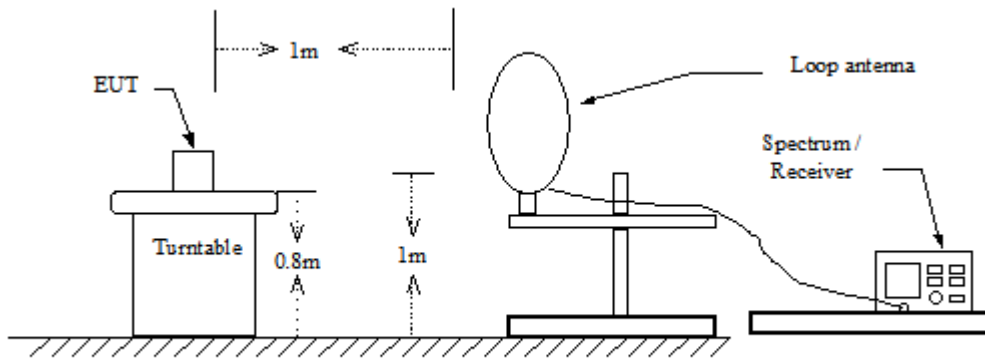

30 MHz ~ 1 GHz

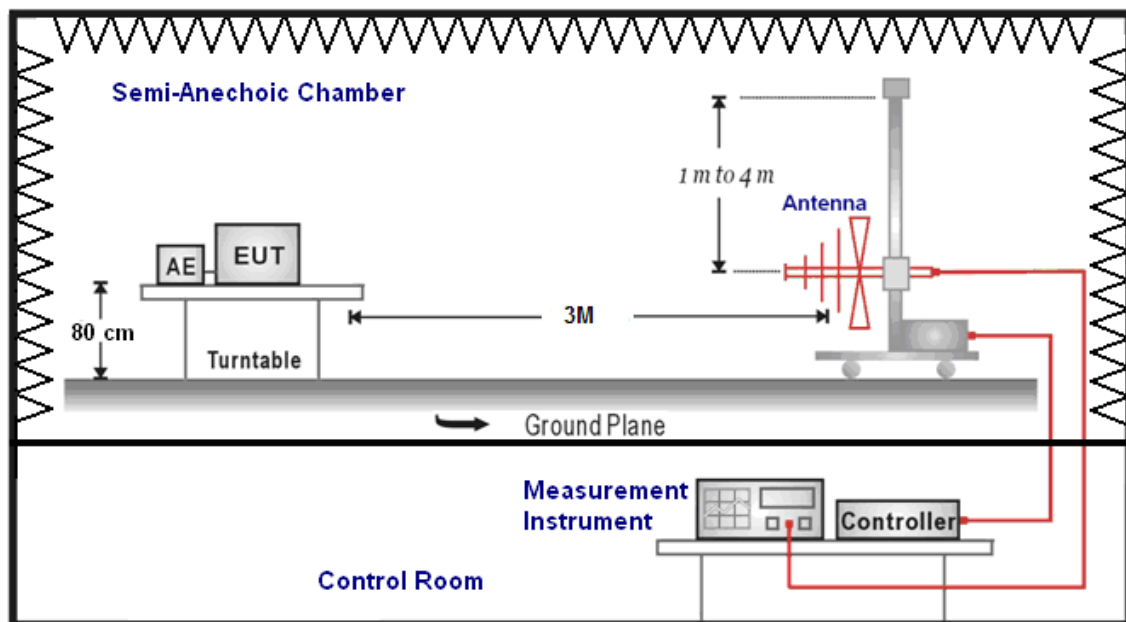

Above 1 GHz

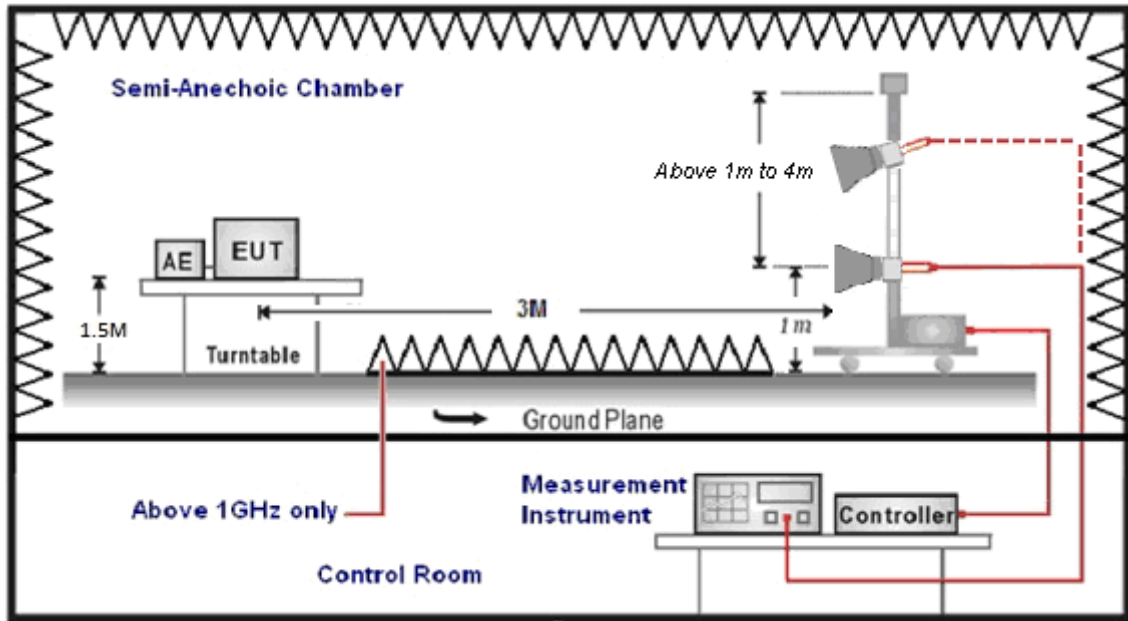

## ■ Test Procedure

Final radiation measurements were made on a three-meter, Semi Anechoic Chamber. The EUT system was placed on a nonconductive turntable which is 0.8 or 1.5 meters height (below 1 GHz use 0.8 m turntable / above 1 GHz use 1.5 m turntable), top surface 1.0 x 1.5 meter. The spectrum was examined from 250 MHz to 2.5 GHz in order to cover the whole spectrum below 10th harmonic which could generate from the EUT. During the test, EUT was set to transmit continuously & Measurements spectrum range from 9 kHz to 40 GHz is investigated.

For measurements below 1 GHz the resolution bandwidth is set to 100 kHz for peak detection measurements or 120 kHz for quasi-peak detection measurements. Peak detection is used unless otherwise noted as quasi-peak.

For restricted measurements above 1 GHz the resolution bandwidth is set to 1 MHz, and then the video bandwidth is set to 3 MHz for peak measurements and 10 Hz for average measurements when Duty cycle > 0.98 / 1/T for average measurements when Duty cycle < 0.98.

For out of band measurements above 1 GHz the resolution bandwidth is set to 1 MHz, and then the video bandwidth is set to 3 MHz for peak measurements.

A nonconductive material surrounded the EUT to supporting the EUT for standing on three orthogonal planes. At each condition, the EUT was rotated 360 degrees, and the antenna was raised and lowered from one to four meters to find the maximum emission levels. Measurements were taken using both horizontal and vertical antenna polarization.

SCHWARZBECK MESS-ELEKTRONIK Trilog-Broadband Antenna at 3 Meter and the ETS-Lindgren Double-Ridged Waveguide Horn antenna Schwarzbeck Mess-Elektronik Broadband Horn Antenna was used in frequencies 1 – 40 GHz at a distance of 3 meter. The antenna at an angle toward the source of the emission. All test results were extrapolated to equivalent signal at 3 meters utilizing an inverse linear distance extrapolation Factor (20 dB/decade).

For testing above 1 GHz, the emission level of the EUT in peak mode was 20 dB lower than average limit (that means the emission level in peak mode also complies with the limit in average mode), then testing will be stopped and peak values of EUT will be reported, otherwise, the emissions will be measured in average mode again and reported.

Appropriate preamplifiers were used for improving sensitivity and precautions were taken to avoid overloading or desensitizing the spectrum analyzer. No post – detector video filters were used in the test.

The spectrum analyzer's 6 dB bandwidth was set to 1 MHz, and the analyzer was operated in the peak detection mode, for frequencies both below and up 1 GHz. The average levels were obtained by subtracting the duty cycle correction factor from the peak readings.

The following procedures were used to convert the emission levels measured in decibels referenced to 1 microvolt (dBuV) into field intensity in micro volts per meter (uV/m).

The actual field intensity in decibels referenced to 1 microvolt in to field intensity in micro volts per meter (dBuV/m).



The actual field is intensity in referenced to 1 microvolt per meter (dBuV/m) is determined by algebraically adding the measured reading in dBuV, the antenna factor (dB), and cable loss (dB) and Subtracting the gain of preamplifier (dB) is auto calculate in spectrum analyzer.

(1)  $\text{Amplitude (dBuV/m)} = \text{FI (dBuV)} + \text{AF (dBuV)} + \text{CL (dBuV)} - \text{Gain (dB)}$

FI= Reading of the field intensity.

AF= Antenna factor.

CL= Cable loss.

P.S Amplitude is auto calculate in spectrum analyzer.

(2)  $\text{Actual Amplitude (dBuV/m)} = \text{Amplitude (dBuV)} - \text{Dis(dB)}$

The FCC specified emission limits were calculated according the EUT operating frequency and by following linear interpolation equations:

(a) For fundamental frequency : Transmitter Output < +30 dBm

(b) For spurious frequency : Spurious emission limits = fundamental emission limit /10

#### Measuring Instruments and setting

The following table is the setting of spectrum analyzer and receiver.

Spectrum Parameter	Setting
Attenuation	Auto
Start Frequency	1000 MHz
Stop Frequency	40 GHz
RBW/VBW(Emission in restricted band)	1 MHz / 3 MHz for Peak 1 MHz / (1/T) for Average
RBW/VBW(Emission in non-restricted band)	1 MHz / 3 MHz for Peak

### 4.3. Maximum Conducted Output Power Measurement

■ **Limit**

Frequency Range (MHz)	FCC Maximum Conducted Output Power Limit	
	Master	Client
5.150 ~ 5.250 GHz	The lesser of 1 W (30 dBm)	The lesser of 250 mW (24 dBm)
5.725 ~ 5.850 GHz	The lesser of 1 W (30 dBm)	The lesser of 1 W (30 dBm)

According to FCC KDB 662911 D01 v02r01 – for power measurements on IEEE802.11 devices,

IEEE 802.11a

Band I :

\* Directional Gain =  $10 \cdot \log\left\{\frac{10^{G1/10} + 10^{G2/10} + \dots + 10^{Gn/10}}{NANT}\right\} = 4.1 \text{ dBi} < 6 \text{ dBi}$

Band III :

\* Directional Gain =  $10 \cdot \log\left\{\frac{10^{G1/10} + 10^{G2/10} + \dots + 10^{Gn/10}}{NANT}\right\} = 4.73 \text{ dBi} < 6 \text{ dBi};$

IEEE 802.11ac 20 MHz / IEEE 802.11ac 40 MHz / IEEE 802.11ac 80 MHz

Band I :

\* Directional Gain =  $10 \cdot \log\left\{\frac{10^{G1/20} + 10^{G2/20} + \dots + 10^{Gn/20}}{NANT}\right\}^2 = 7.11 \text{ dBi} > 6 \text{ dBi}$

Master

\* Power Limit = 30 - 1.11 = 28.89 dBm

Client

\* Power Limit = 24 - 1.11 = 22.89 dBm

Band III :

\* Directional Gain =  $10 \cdot \log\left\{\frac{10^{G1/20} + 10^{G2/20} + \dots + 10^{Gn/20}}{NANT}\right\}^2 = 7.74 \text{ dBi} > 6 \text{ dBi}$

\* Power Limit = 30 - 1.74 = 28.26 dBm

■ **Test Setup**

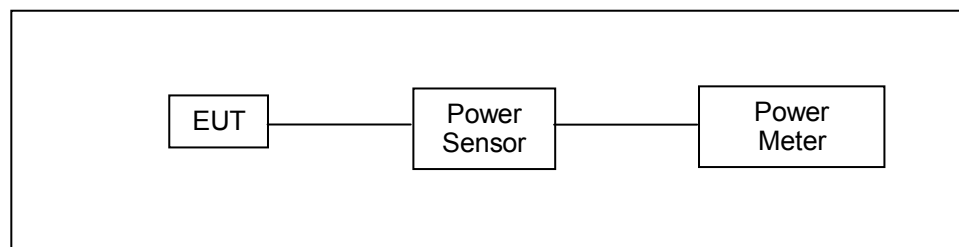

■ **Test Procedure**

The test is performed in accordance with ANSI C63.10:2013 section 12.3.3.2, Guidelines for Compliance Testing of Unlicensed National Information Infrastructure (U-NII) Devices

Section (E) Maximum Conducted Output Power

3. Measurement using a Power Meter (PM)

b) Method PM-G (Measurement using a gated RF average power meter)



#### 4.4. 26 dB RF Bandwidth Measurement & 99 % Occupied Bandwidth Measurement

■ **Limit**

N/A

■ **Test Setup**

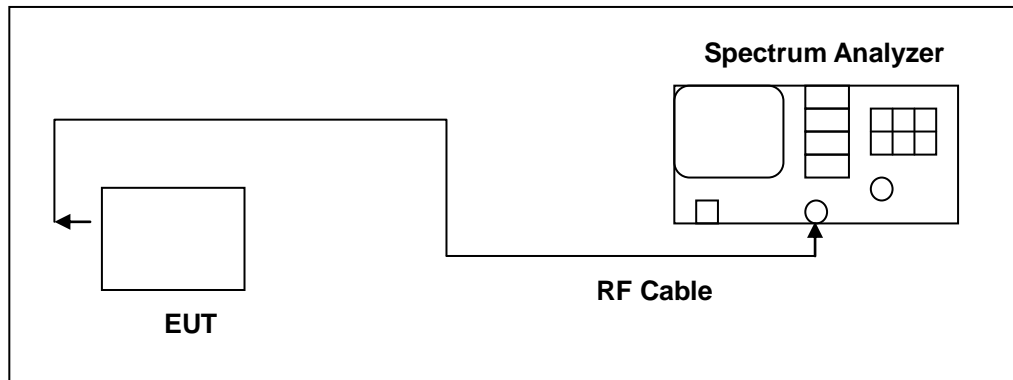

■ **Test Procedure**

The test is performed in accordance with ANSI C63.10:2013 section 12.4, Guidelines for Compliance Testing of Unlicensed National Information Infrastructure (U-NII) Devices - Part 15, Subpart E.

Spectrum Parameter	Setting
Attenuation	Auto
Span Frequency	>26 dB Bandwidth
RBW	Approximately 1 % of the emission bandwidth
VBW	VBW > RBW
Detector	Peak
Trace	Max Hold
Sweep Time	Auto

#### 4.5. 6 dB RF Bandwidth Measurement

- Limit

- 6 dB RF Bandwidth

- Systems using digital modulation techniques may operate in the 5725~5850 MHz bands. The minimum 6 dB band-width shall be at least 500 kHz.

- Test Setup

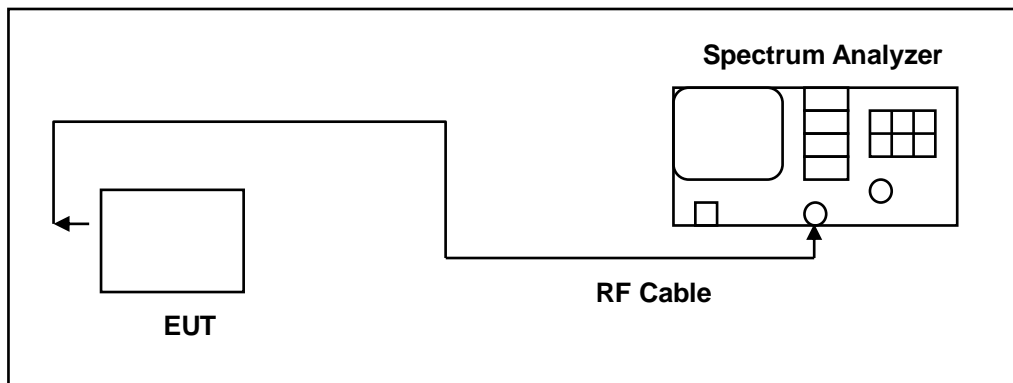

- Test Procedure

- 6 dB RF Bandwidth

- The EUT tested to UNII test procedure of ANSI C63.10:2013 section 6.9.2 for compliance to FCC 47CFR 15.407 requirements.

- The antenna port of the EUT was connected to the input of a spectrum analyzer. Analyzer RES BW was set to 100 kHz. For each RF output channel investigated, the spectrum analyzer center frequency was set to the channel carrier. A peak output reading was taken, a DISPLAY line was drawn 6 dB lower than peak level. The 6 dB bandwidth was determined from where the channel output spectrum intersected the display line.

- The test was performed at 3 channels.



#### 4.6. Maximum Power Spectral Density Measurement

■ **Limit**

Conducted power spectral density

Frequency Range (MHz)	FCC Maximum Conducted Output Power Limit	
	Master	Client
5.150 ~ 5.250 GHz	17 dBm/MHz	11 dBm/MHz
5.725 ~ 5.850 GHz	30 dBm/500 kHz	30 dBm/500 kHz

According FCC KDB 662911 D01 v02r01 – for power spectral density measurements on IEEE802.11 devices,

IEEE 802.11a / IEEE 802.11ac 20 MHz / IEEE 802.11ac 40 MHz / IEEE 802.11ac 80 MHz

Band I :

\* Directional Gain =  $10 \cdot \log\{[10^{G1/20} + 10^{G2/20} + \dots + 10^{Gn/20}]^2 / NANT\}$  = 7.11 dBi > 6 dBi

Master

\* Conducted Power Spectral Density Limit = 17 - 1.11 = 15.89 dBm/MHz

Client

\* Conducted Power Spectral Density Limit = 11 - 1.11 = 9.89 dBm/MHz

Band III :

\* Directional Gain =  $10 \cdot \log\{[10^{G1/20} + 10^{G2/20} + \dots + 10^{Gn/20}]^2 / NANT\}$  = 7.74 dBi > 6 dBi

\* Conducted Power Spectral Density Limit = 30 - 1.74 = 28.26 dBm/500 kHz

■ **Test Setup**

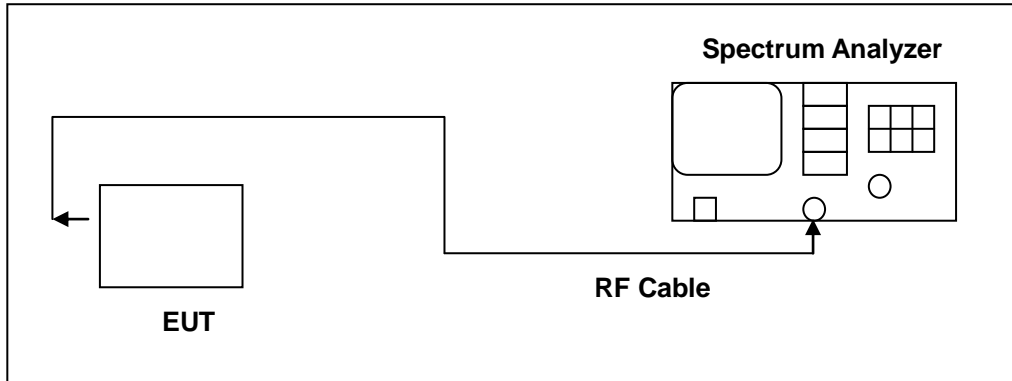

■ **Test Procedure**

The test is performed in accordance with ANSI C63.10:2013 section 12.5, Guidelines for Compliance Testing of Unlicensed National Information Infrastructure (U-NII) Devices - Part 15, Subpart E.

Spectrum Parameter	Setting
Attenuation	Auto
Span Frequency	Encompass the entire emissions bandwidth (EBW) of the signal
RBW	1 MHz (5725 ~ 5850 MHz use 100 kHz)
VBW	3 MHz (5725 ~ 5850 MHz use 300 kHz)
Detector	RMS
Trace	AVERAGE
Sweep Time	Auto
Trace Average	100 times
Note: If measurement bandwidth of Maximum PSD is specified in 500 kHz, add $10 \log(500 \text{ kHz}/100 \text{ kHz})$ to the measured result.	



#### 4.7. Automatically discontinue transmission

The device shall automatically discontinue transmission in case of either absence of information to transmit or operational failure. These provisions are not intended to preclude the transmission of control or signalling information or the use of repetitive codes used by certain digital technologies to complete frame or burst intervals. Applicants shall include in their application for equipment authorization a description of how this requirement is met.

##### ■ Declare

While the EUT is not transmitting any information, the EUT can automatically discontinue transmission and become standby mode for power saving.

The EUT can detect the controlling signal of ACK message transmitting from remote device and verify whether it shall resend or discontinue transmission.

#### 4.8. Antenna Requirement

##### ■ Limit

For intentional device, according to 15.203, an intentional radiator shall be designed to ensure that no antenna other than that furnished by the responsible party shall be used with the device.

And According to 15.407 (a), if transmitting antennas of directional gain greater than 6 dBi are used, the power shall be reduced by the amount in dB that the directional gain of the antenna exceeds 6 dBi.

##### ■ Antenna Connector Construction

See section 2 – antenna information.

##### ■ Directional Gain Calculated

For Maximum Conducted Output Power

Operate Freq. Band		Directional Gain (dBi)
IEEE 802.11a	U-NII Band I	4.10
	U-NII Band III	4.73
IEEE 802.11ac 20 MHz	U-NII Band I	7.11
	U-NII Band III	7.74
IEEE 802.11ac 40 MHz	U-NII Band I	7.11
	U-NII Band III	7.74
IEEE 802.11ac 80 MHz	U-NII Band I	7.11
	U-NII Band III	7.74



**For Maximum Power Density**

Operate Freq. Band		Directional Gain (dBi)
IEEE 802.11a	U-NII Band I	7.11
	U-NII Band III	7.74
IEEE 802.11ac 20 MHz	U-NII Band I	7.11
	U-NII Band III	7.74
IEEE 802.11ac 40 MHz	U-NII Band I	7.11
	U-NII Band III	7.74
IEEE 802.11ac 80 MHz	U-NII Band I	7.11
	U-NII Band III	7.74



## 5 Test Results

### Annex A. Conducted Emission

Standard:	FCC Part 15.407	Line:	L1
Test item:	Conducted Emission	Power:	AC 120 V/60 Hz
Test Mode:	Mode 1	Temp.(°C)/Hum.(%RH):	26(°C)/60 %RH
Description:			

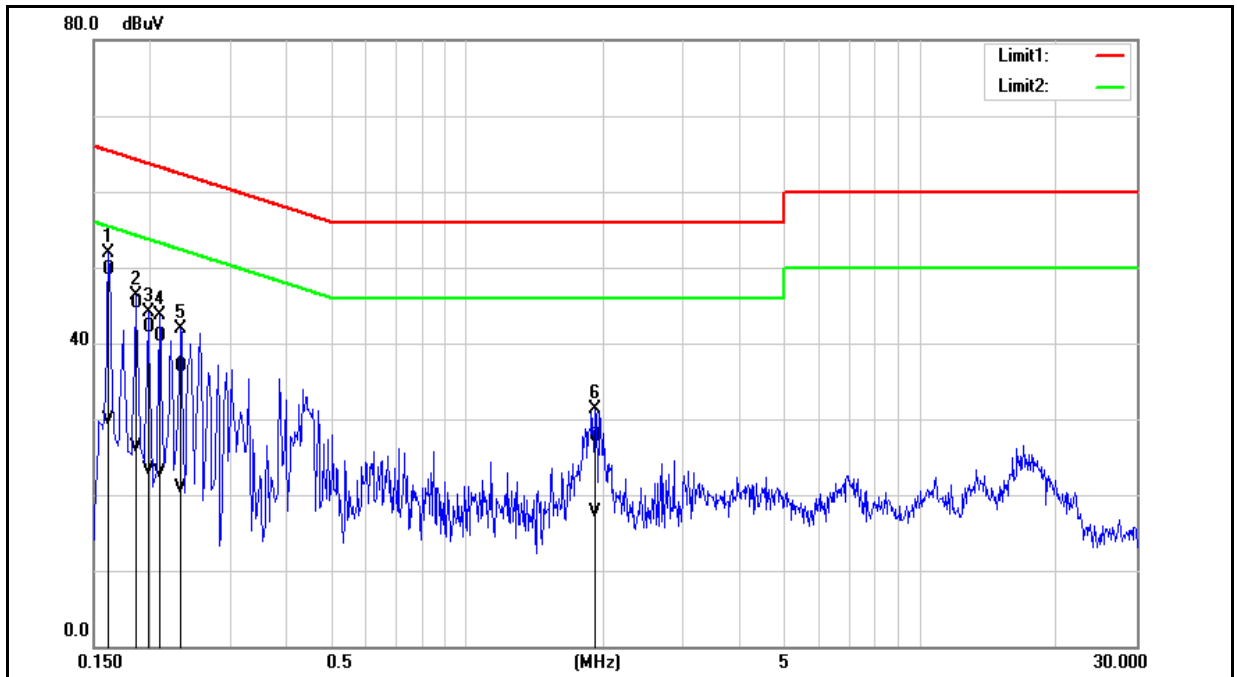

No.	Frequency (MHz)	QP reading (dBuV)	AVG reading (dBuV)	Correction factor (dB)	QP result (dBuV)	AVG result (dBuV)	QP limit (dBuV)	AVG limit (dBuV)	QP margin (dB)	AVG margin (dB)	Remark
1	0.1620	40.02	20.23	9.65	49.67	29.88	65.36	55.36	-15.69	-25.48	Pass
2	0.1860	35.57	16.70	9.64	45.21	26.34	64.21	54.21	-19.00	-27.87	Pass
3	0.1980	32.56	13.75	9.64	42.20	23.39	63.69	53.69	-21.49	-30.30	Pass
4	0.2100	31.20	13.28	9.64	40.84	22.92	63.21	53.21	-22.37	-30.29	Pass
5	0.2340	27.30	11.19	9.64	36.94	20.83	62.31	52.31	-25.37	-31.48	Pass
6	1.9140	17.89	8.07	9.72	27.61	17.79	56.00	46.00	-28.39	-28.21	Pass

Note: 1. Result (dBuV) = Correction factor (dB) + Reading(dBuV).

2. Correction factor (dB) = Cable loss (dB) + L.I.S.N. factor (dB).

Standard:	FCC Part 15.407	Line:	N
Test item:	Conducted Emission	Power:	AC 120 V/60 Hz
Test Mode:	Mode 1	Temp.(°C)/Hum.(%RH):	26(°C)/60 %RH
Description:			

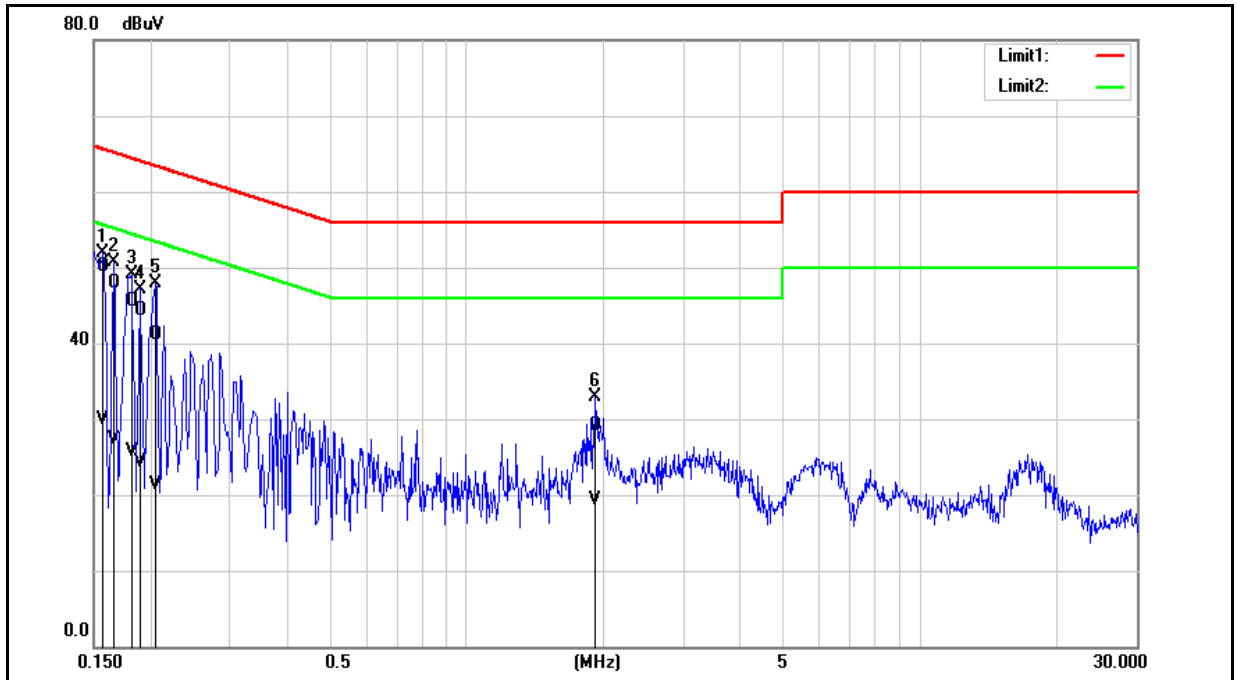

No.	Frequency (MHz)	QP reading (dBuV)	AVG reading (dBuV)	Correction factor (dB)	QP result (dBuV)	AVG result (dBuV)	QP limit (dBuV)	AVG limit (dBuV)	QP margin (dB)	AVG margin (dB)	Remark
1	0.1580	40.47	20.26	9.68	50.15	29.94	65.57	55.57	-15.42	-25.63	Pass
2	0.1660	38.27	17.70	9.68	47.95	27.38	65.16	55.16	-17.21	-27.78	Pass
3	0.1820	35.83	15.98	9.67	45.50	25.65	64.39	54.39	-18.89	-28.74	Pass
4	0.1900	34.61	14.71	9.67	44.28	24.38	64.04	54.04	-19.76	-29.66	Pass
5	0.2060	31.45	11.55	9.67	41.12	21.22	63.37	53.37	-22.25	-32.15	Pass
6	1.9260	19.39	9.57	9.75	29.14	19.32	56.00	46.00	-26.86	-26.68	Pass

Note: 1. Result (dBuV) = Correction factor (dB) + Reading(dBuV).

2. Correction factor (dB) = Cable loss (dB) + L.I.S.N. factor (dB).





## Annex B. Radiated Emission Measurement

### Harmonic

Below 1 GHz

Standard:		FCC Part 15.407		Test Distance:		3 m	
Test item:		Harmonic		Power:		AC 120 V/60 Hz	
Test Mode:		Mode 1		Temp.(°C)/Hum.(%RH):		26(°C)/60 %RH	
Frequency (MHz)	Reading (dBuV)	Correct Factor (dB/m)	Result (dBuV/m)	Limit (dBuV/m)	Margin (dB)	Remark	Ant.Polar. H / V
275.4100	42.01	-4.92	37.09	46.00	-8.91	QP	H
288.0200	46.24	-4.48	41.76	46.00	-4.24	QP	H
313.2400	41.69	-3.83	37.86	46.00	-8.14	QP	H
325.8500	42.17	-3.61	38.56	46.00	-7.44	QP	H
337.4900	44.35	-3.41	40.94	46.00	-5.06	QP	H
350.1000	43.02	-3.20	39.82	46.00	-6.18	QP	H
275.4100	37.73	-4.92	32.81	46.00	-13.19	QP	V
288.0200	39.01	-4.48	34.53	46.00	-11.47	QP	V
300.6300	41.51	-4.03	37.48	46.00	-8.52	QP	V
313.2400	38.28	-3.83	34.45	46.00	-11.55	QP	V
325.8500	38.93	-3.61	35.32	46.00	-10.68	QP	V
337.4900	41.17	-3.41	37.76	46.00	-8.24	QP	V

Note:1.Result (dBuV/m) = Correct Factor (dB/m) + Reading(dBuV).

Example:  $37.09 = -4.92 + 42.01$

2.Correction factor (dB/m) = Antenna Factor (dB/m) + Cable loss (dB) – Pre-Amplifier gain (dB).

3.When the peak results are less than average limit, so not need to evaluate the average.



Above 1 GHz

Standard:	FCC Part 15.407	Test Distance:	3 m
Test item:	Harmonic	Power:	AC 120 V/60 Hz
Frequency:	5180 MHz	Temp.(°C)/Hum.(%RH):	26(°C)/60 %RH
Mode:	Mode 2		
Ant.Polar.:	Horizontal		

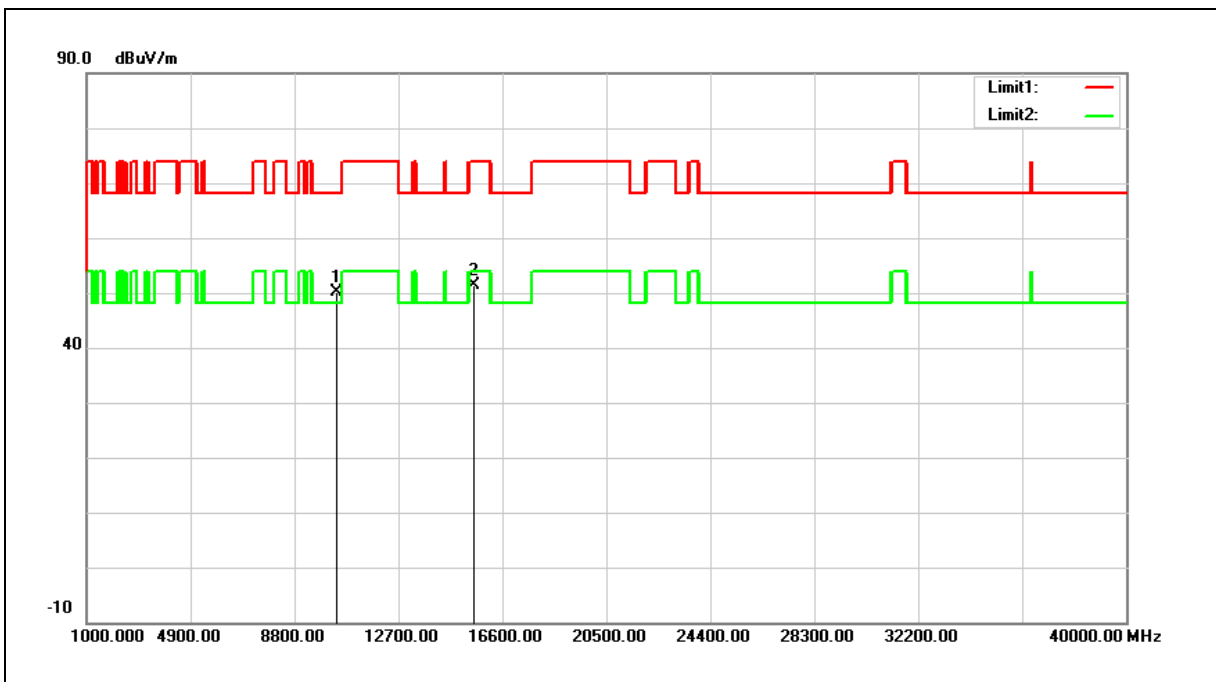

No.	Frequency (MHz)	Reading (dBuV)	Correct Factor (dB/m)	Result (dBuV/m)	Limit (dBuV/m)	Margin (dB)	Remark
1	10360.000	33.26	16.92	50.18	68.20	-18.02	peak
2	15540.000	32.29	19.18	51.47	74.00	-22.53	peak

Note:1.Result (dBuV/m) = Correct Factor (dB/m) + Reading(dBuV).

Example: 50.18 = 16.92 + 33.26

2.Correction factor (dB/m) = Antenna Factor (dB/m) + Cable loss (dB) – Pre-Amplifier gain (dB).

3. When the peak results are less than average limit, so not need to evaluate the average.



Standard:	FCC Part 15.407	Test Distance:	3 m
Test item:	Harmonic	Power:	AC 120 V/60 Hz
Frequency:	5180 MHz	Temp.(°C)/Hum.(%RH):	26(°C)/60 %RH
Mode:	Mode 2		
Ant.Polar.:	Vertical		

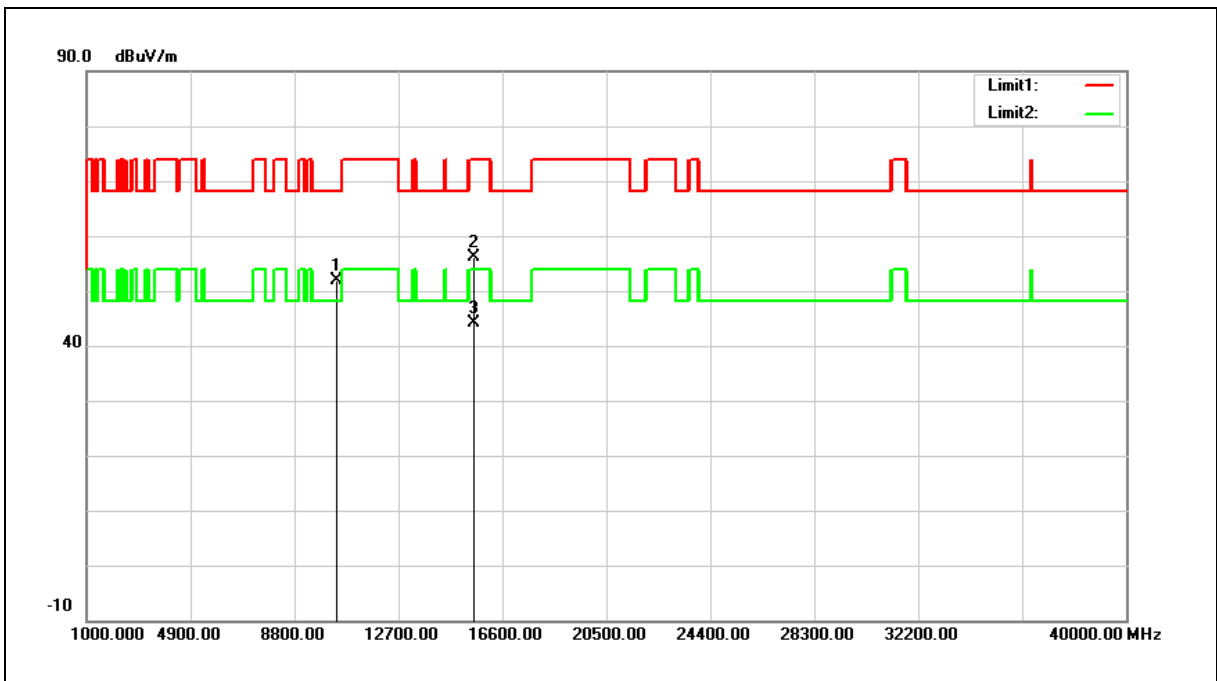

No.	Frequency (MHz)	Reading (dBuV)	Correct Factor (dB/m)	Result (dBuV/m)	Limit (dBuV/m)	Margin (dB)	Remark
1	10360.000	35.00	16.92	51.92	68.20	-16.28	peak
2	15540.000	36.91	19.18	56.09	74.00	-17.91	peak
3	15540.000	24.99	19.18	44.17	54.00	-9.83	AVG

Note:1.Result (dBuV/m) = Correct Factor (dB/m) + Reading(dBuV).

Example: 51.92 = 16.92 + 35.00

2.Correction factor (dB/m) = Antenna Factor (dB/m) + Cable loss (dB) – Pre-Amplifier gain (dB).

3. When the peak results are less than average limit, so not need to evaluate the average.



Standard:	FCC Part 15.407	Test Distance:	3 m
Test item:	Harmonic	Power:	AC 120 V/60 Hz
Frequency:	5200 MHz	Temp.(°C)/Hum.(%RH):	26(°C)/60 %RH
Mode:	Mode 2		
Ant.Polar.:	Horizontal		

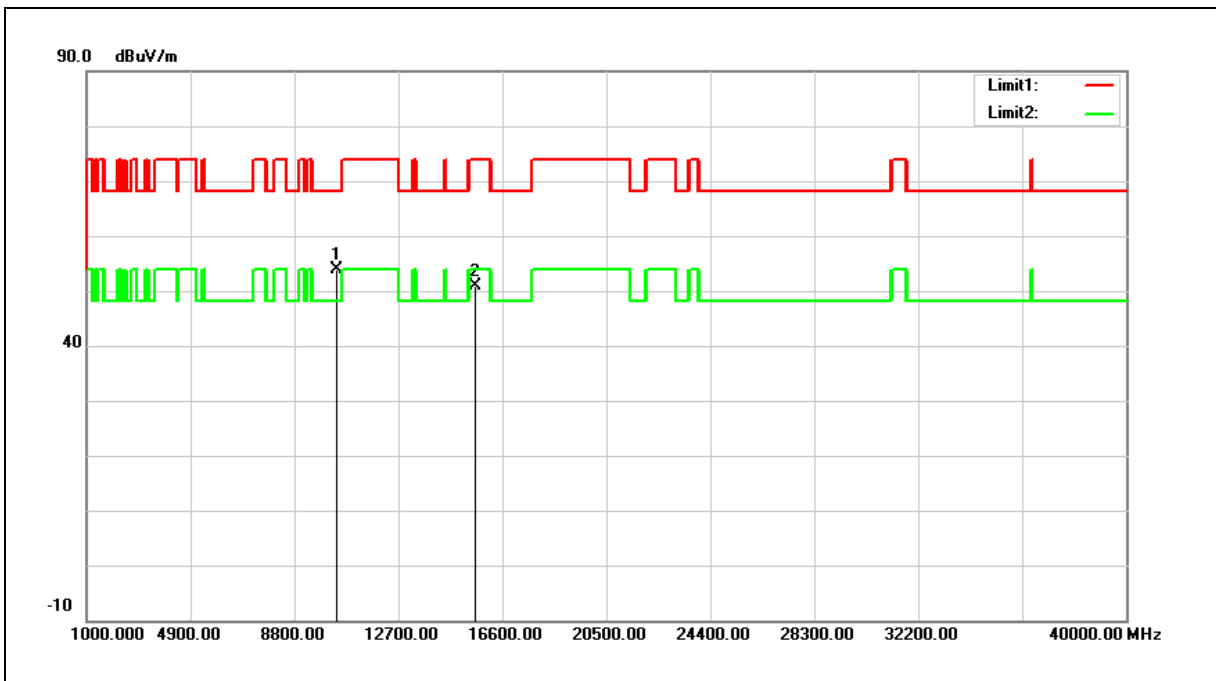

No.	Frequency (MHz)	Reading (dBuV)	Correct Factor (dB/m)	Result (dBuV/m)	Limit (dBuV/m)	Margin (dB)	Remark
1	10400.000	36.76	17.06	53.82	68.20	-14.38	peak
2	15600.000	31.87	19.02	50.89	74.00	-23.11	peak

- Note:1.Result (dBuV/m) = Correct Factor (dB/m) + Reading(dBuV).
- 2.Correction factor (dB/m) = Antenna Factor (dB/m) + Cable loss (dB) – Pre-Amplifier gain (dB).
3. When the peak results are less than average limit, so not need to evaluate the average.



Standard:	FCC Part 15.407	Test Distance:	3 m
Test item:	Harmonic	Power:	AC 120 V/60 Hz
Frequency:	5200 MHz	Temp.(°C)/Hum.(%RH):	26(°C)/60 %RH
Mode:	Mode 2		
Ant.Polar.:	Vertical		

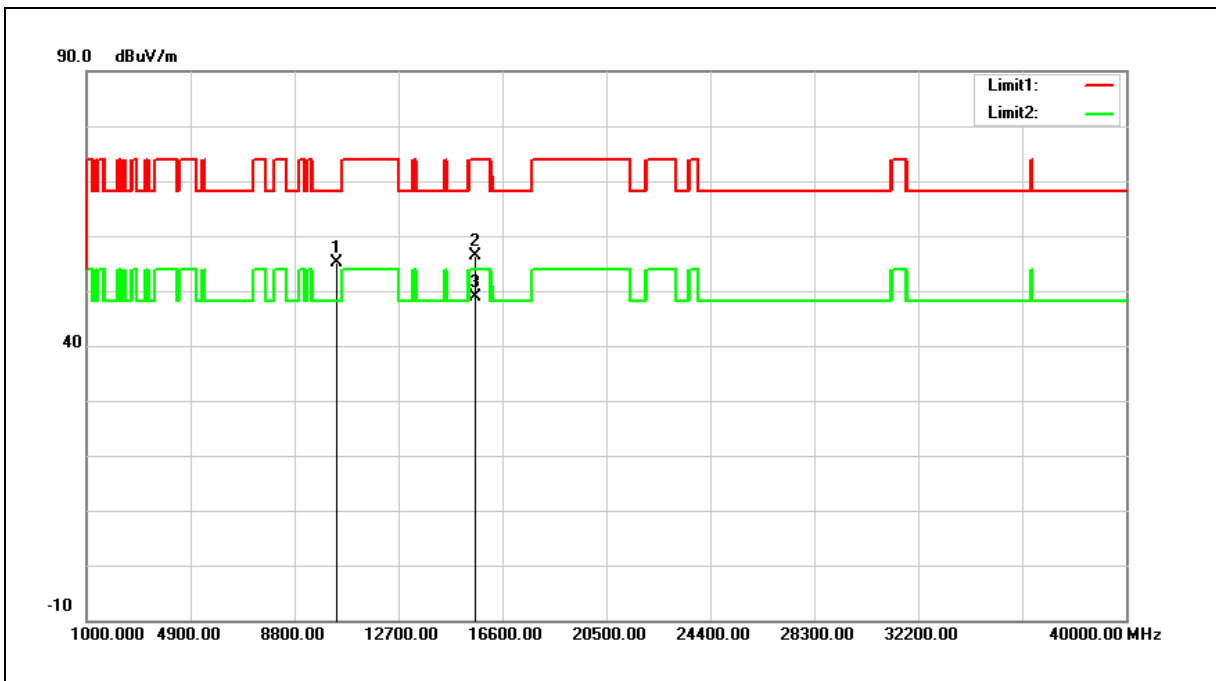

No.	Frequency (MHz)	Reading (dBuV)	Correct Factor (dB/m)	Result (dBuV/m)	Limit (dBuV/m)	Margin (dB)	Remark
1	10400.000	38.12	17.06	55.18	68.20	-13.02	peak
2	15600.000	37.28	19.02	56.30	74.00	-17.70	peak
3	15600.000	29.81	19.02	48.83	54.00	-5.17	AVG

Note:1.Result (dBuV/m) = Correct Factor (dB/m) + Reading(dBuV).

2.Correction factor (dB/m) = Antenna Factor (dB/m) + Cable loss (dB) – Pre-Amplifier gain (dB).

3. When the peak results are less than average limit, so not need to evaluate the average.



Standard:	FCC Part 15.407	Test Distance:	3 m
Test item:	Harmonic	Power:	AC 120 V/60 Hz
Frequency:	5240 MHz	Temp.(°C)/Hum.(%RH):	26(°C)/60 %RH
Mode:	Mode 2		
Ant.Polar.:	Horizontal		

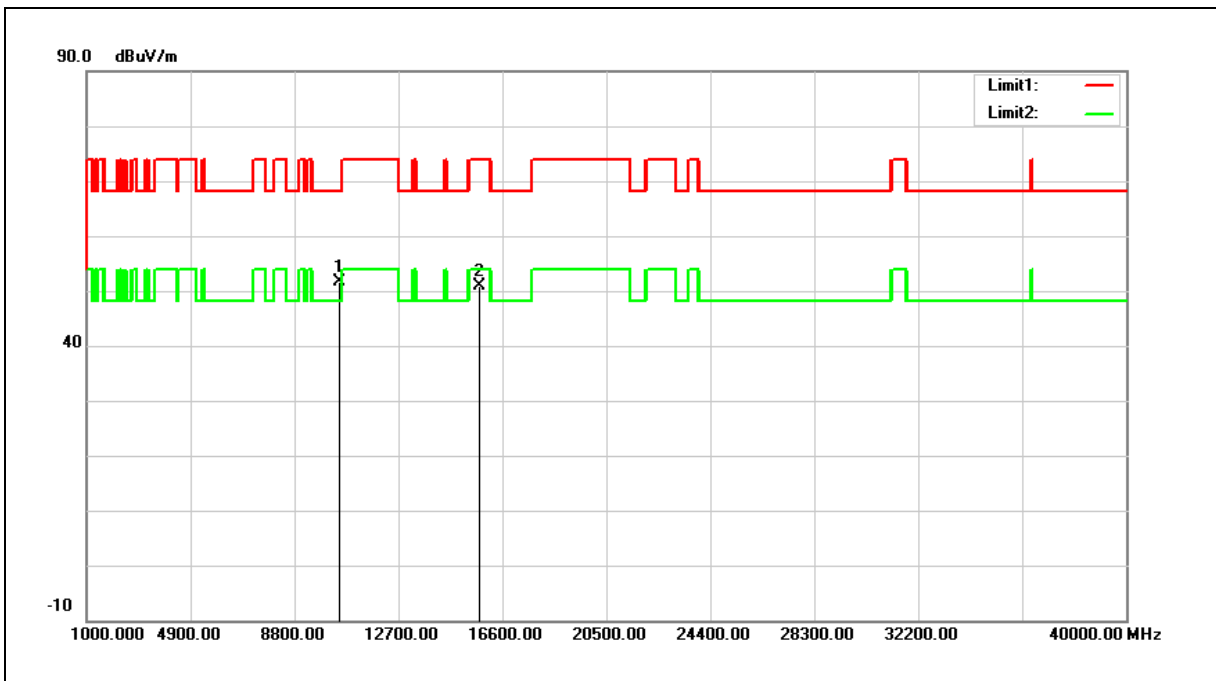

No.	Frequency (MHz)	Reading (dBuV)	Correct Factor (dB/m)	Result (dBuV/m)	Limit (dBuV/m)	Margin (dB)	Remark
1	10480.000	34.32	17.35	51.67	68.20	-16.53	peak
2	15720.000	32.18	18.71	50.89	74.00	-23.11	peak

- Note:1.Result (dBuV/m) = Correct Factor (dB/m) + Reading(dBuV).  
 2.Correction factor (dB/m) = Antenna Factor (dB/m) + Cable loss (dB) – Pre-Amplifier gain (dB).  
 3. When the peak results are less than average limit, so not need to evaluate the average.



Standard:	FCC Part 15.407	Test Distance:	3 m
Test item:	Harmonic	Power:	AC 120 V/60 Hz
Frequency:	5240 MHz	Temp.(°C)/Hum.(%RH):	26(°C)/60 %RH
Mode:	Mode 2		
Ant.Polar.:	Vertical		

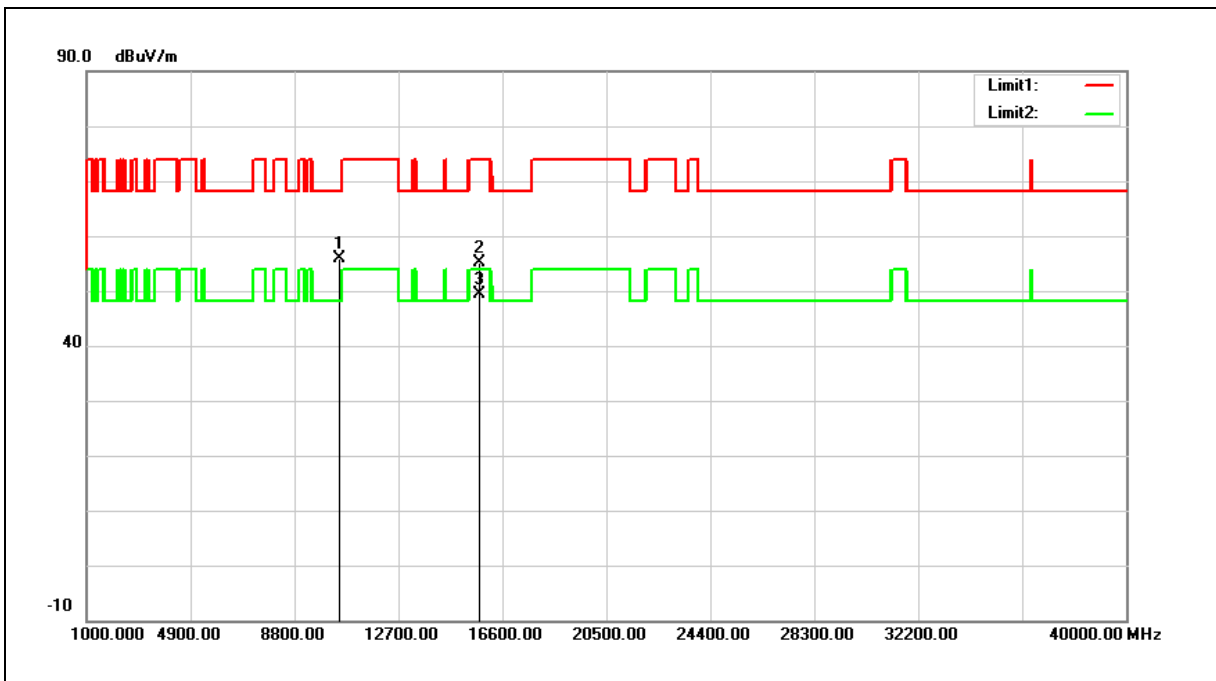

No.	Frequency (MHz)	Reading (dBuV)	Correct Factor (dB/m)	Result (dBuV/m)	Limit (dBuV/m)	Margin (dB)	Remark
1	10480.000	38.46	17.35	55.81	68.20	-12.39	peak
2	15720.000	36.38	18.71	55.09	74.00	-18.91	peak
3	15720.000	30.62	18.71	49.33	54.00	-4.67	AVG

Note:1.Result (dBuV/m) = Correct Factor (dB/m) + Reading(dBuV).

2.Correction factor (dB/m) = Antenna Factor (dB/m) + Cable loss (dB) – Pre-Amplifier gain (dB).

3. When the peak results are less than average limit, so not need to evaluate the average.



Standard:	FCC Part 15.407	Test Distance:	3 m
Test item:	Harmonic	Power:	AC 120 V/60 Hz
Frequency:	5745 MHz	Temp.(°C)/Hum.(%RH):	26(°C)/60 %RH
Mode:	Mode 2		
Ant.Polar.:	Horizontal		

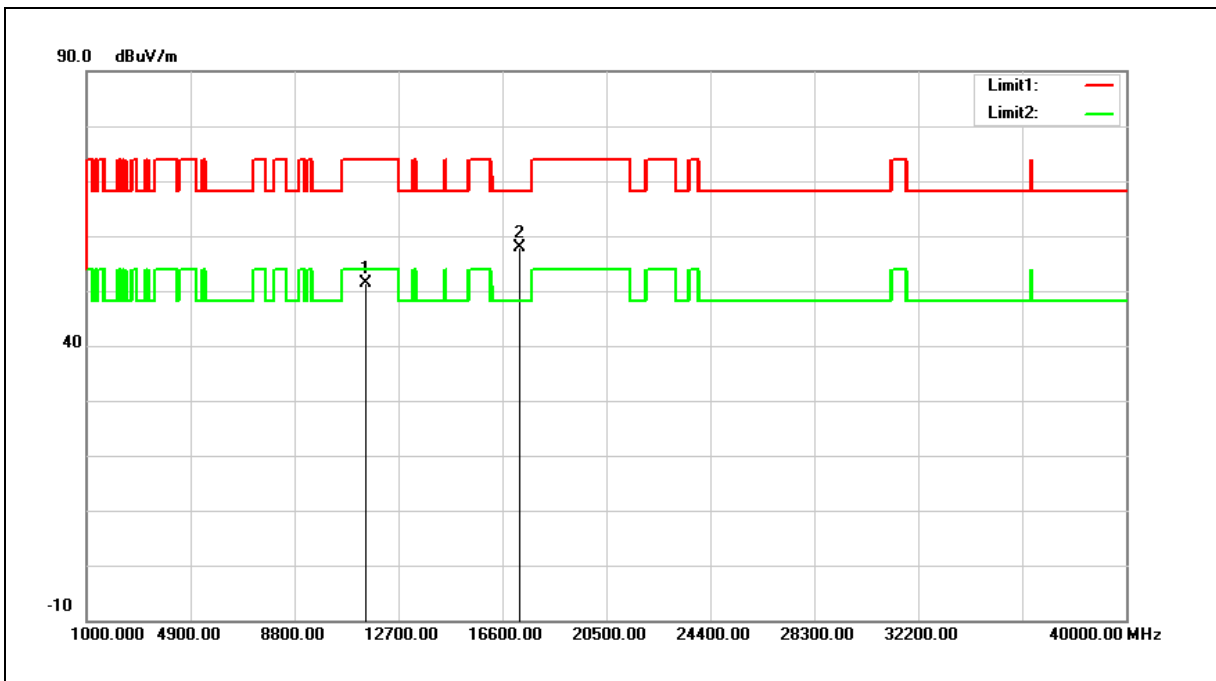

No.	Frequency (MHz)	Reading (dBuV)	Correct Factor (dB/m)	Result (dBuV/m)	Limit (dBuV/m)	Margin (dB)	Remark
1	11490.000	32.80	18.50	51.30	74.00	-22.70	peak
2	17235.000	33.56	24.31	57.87	68.20	-10.33	peak

Note:1.Result (dBuV/m) = Correct Factor (dB/m) + Reading(dBuV).

2.Correction factor (dB/m) = Antenna Factor (dB/m) + Cable loss (dB) – Pre-Amplifier gain (dB).

3. When the peak results are less than average limit, so not need to evaluate the average.





Standard:	FCC Part 15.407	Test Distance:	3 m
Test item:	Harmonic	Power:	AC 120 V/60 Hz
Frequency:	5745 MHz	Temp.(°C)/Hum.(%RH):	26(°C)/60 %RH
Mode:	Mode 2		
Ant.Polar.:	Vertical		

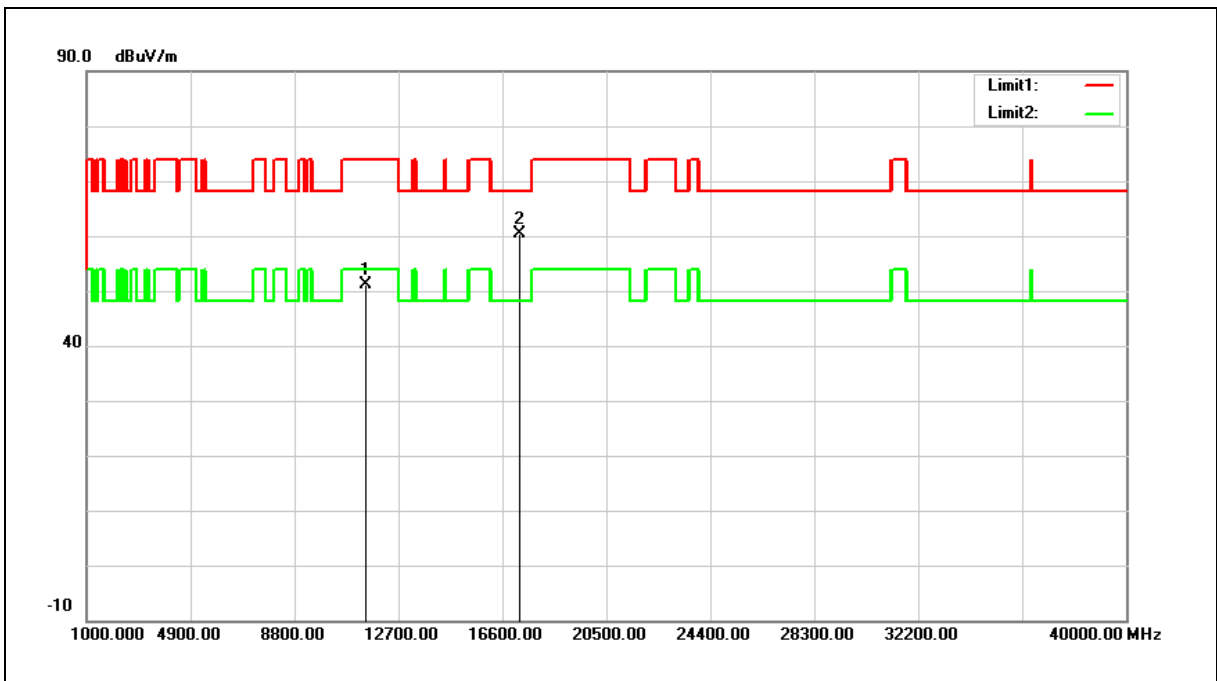

No.	Frequency (MHz)	Reading (dBuV)	Correct Factor (dB/m)	Result (dBuV/m)	Limit (dBuV/m)	Margin (dB)	Remark
1	11490.000	32.60	18.50	51.10	74.00	-22.90	peak
2	17235.000	36.17	24.31	60.48	68.20	-7.72	peak

Note:1.Result (dBuV/m) = Correct Factor (dB/m) + Reading(dBuV).

2.Correction factor (dB/m) = Antenna Factor (dB/m) + Cable loss (dB) – Pre-Amplifier gain (dB).

3. When the peak results are less than average limit, so not need to evaluate the average.



Standard:	FCC Part 15.407	Test Distance:	3 m
Test item:	Harmonic	Power:	AC 120 V/60 Hz
Frequency:	5785 MHz	Temp.(°C)/Hum.(%RH):	26(°C)/60 %RH
Mode:	Mode 2		
Ant.Polar.:	Horizontal		

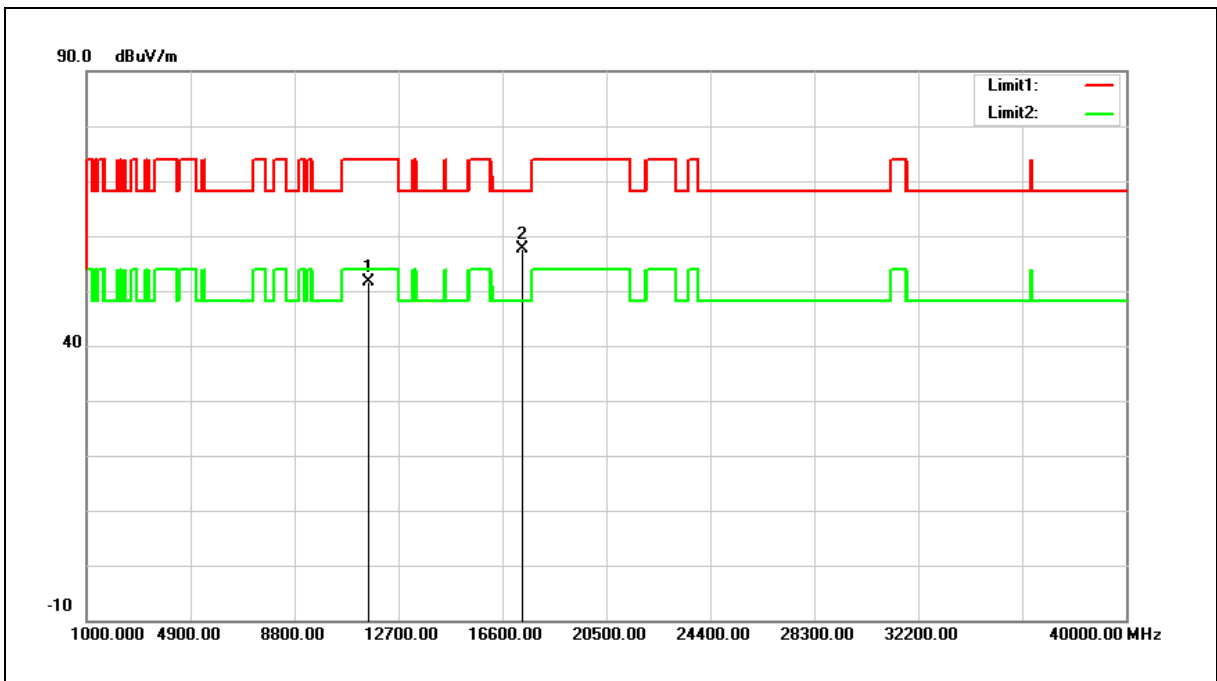

No.	Frequency (MHz)	Reading (dBuV)	Correct Factor (dB/m)	Result (dBuV/m)	Limit (dBuV/m)	Margin (dB)	Remark
1	11570.000	33.26	18.44	51.70	74.00	-22.30	peak
2	17355.000	32.82	24.79	57.61	68.20	-10.59	peak

Note:1.Result (dBuV/m) = Correct Factor (dB/m) + Reading(dBuV).

2.Correction factor (dB/m) = Antenna Factor (dB/m) + Cable loss (dB) – Pre-Amplifier gain (dB).

3. When the peak results are less than average limit, so not need to evaluate the average.



Standard:	FCC Part 15.407	Test Distance:	3 m
Test item:	Harmonic	Power:	AC 120 V/60 Hz
Frequency:	5785 MHz	Temp.(°C)/Hum.(%RH):	26(°C)/60 %RH
Mode:	Mode 2		
Ant.Polar.:	Vertical		

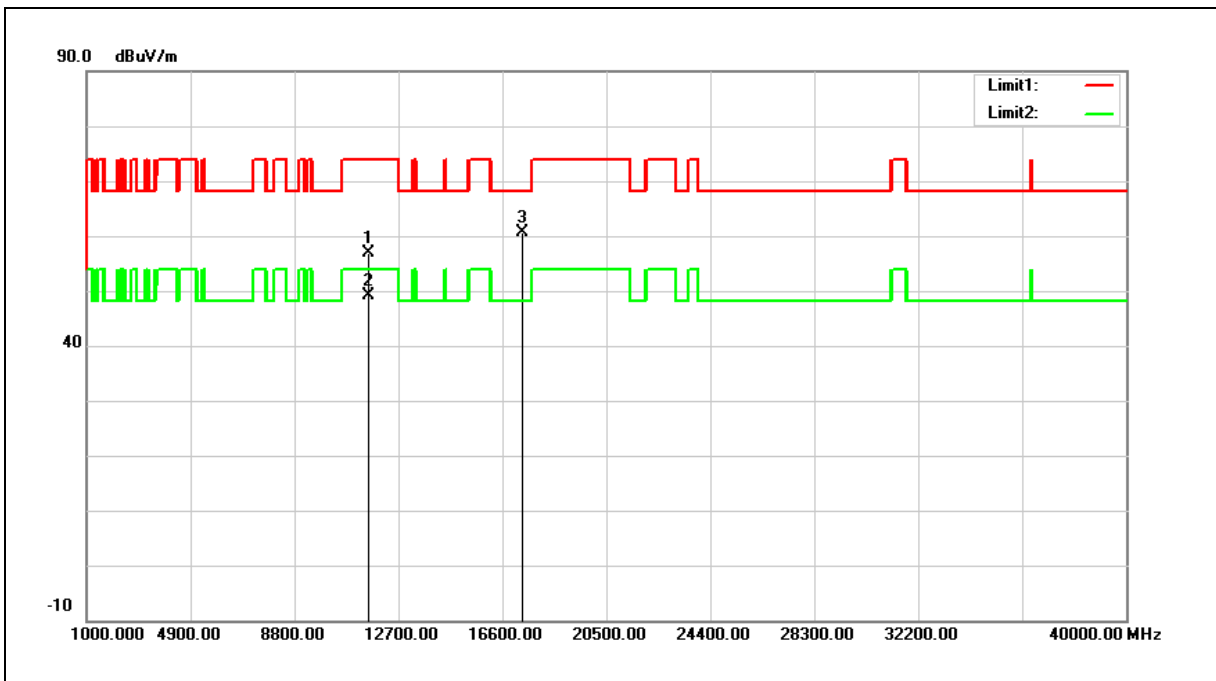

No.	Frequency (MHz)	Reading (dBuV)	Correct Factor (dB/m)	Result (dBuV/m)	Limit (dBuV/m)	Margin (dB)	Remark
1	11570.000	38.46	18.44	56.90	74.00	-17.10	peak
2	11570.000	30.57	18.44	49.01	54.00	-4.99	AVG
3	17355.000	35.73	24.79	60.52	68.20	-7.68	peak

Note:1.Result (dBuV/m) = Correct Factor (dB/m) + Reading(dBuV).

2.Correction factor (dB/m) = Antenna Factor (dB/m) + Cable loss (dB) – Pre-Amplifier gain (dB).

3. When the peak results are less than average limit, so not need to evaluate the average.



Standard:	FCC Part 15.407	Test Distance:	3 m
Test item:	Harmonic	Power:	AC 120 V/60 Hz
Frequency:	5825 MHz	Temp.(°C)/Hum.(%RH):	26(°C)/60 %RH
Mode:	Mode 2		
Ant.Polar.:	Horizontal		

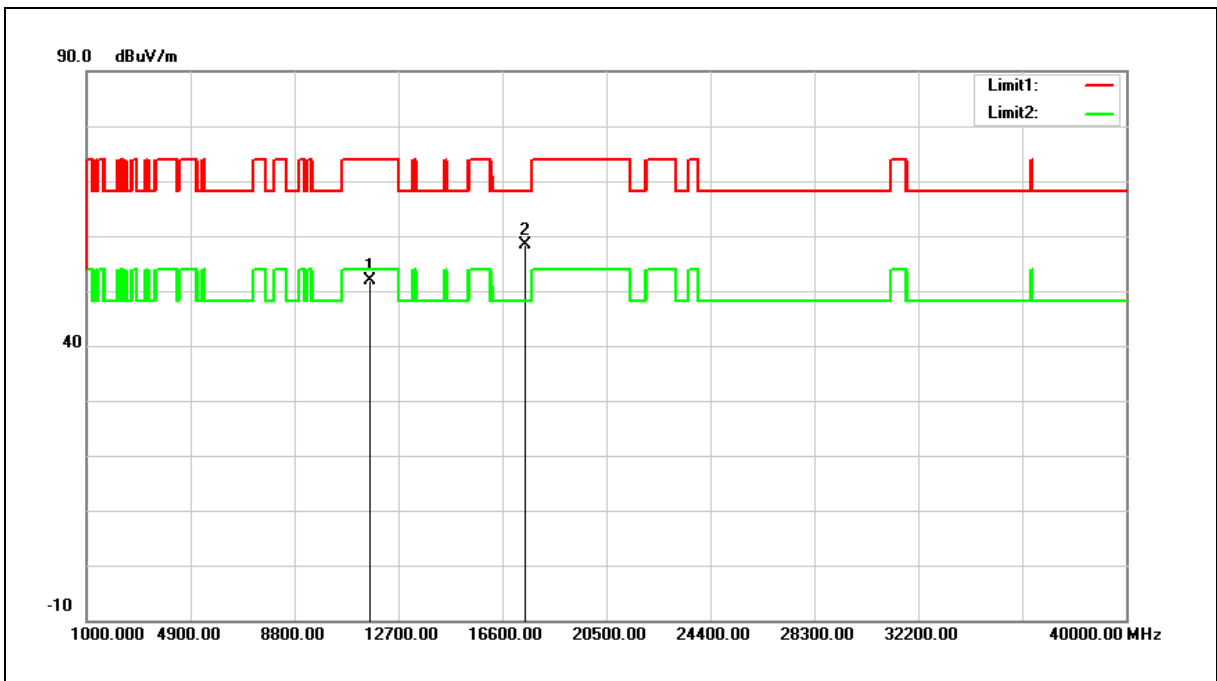

No.	Frequency (MHz)	Reading (dBuV)	Correct Factor (dB/m)	Result (dBuV/m)	Limit (dBuV/m)	Margin (dB)	Remark
1	11650.000	33.47	18.38	51.85	74.00	-22.15	peak
2	17475.000	33.00	25.26	58.26	68.20	-9.94	peak

Note:1.Result (dBuV/m) = Correct Factor (dB/m) + Reading(dBuV).

2.Correction factor (dB/m) = Antenna Factor (dB/m) + Cable loss (dB) – Pre-Amplifier gain (dB).

3. When the peak results are less than average limit, so not need to evaluate the average.



Standard:	FCC Part 15.407	Test Distance:	3 m
Test item:	Harmonic	Power:	AC 120 V/60 Hz
Frequency:	5825 MHz	Temp.(°C)/Hum.(%RH):	26(°C)/60 %RH
Mode:	Mode 2		
Ant.Polar.:	Vertical		

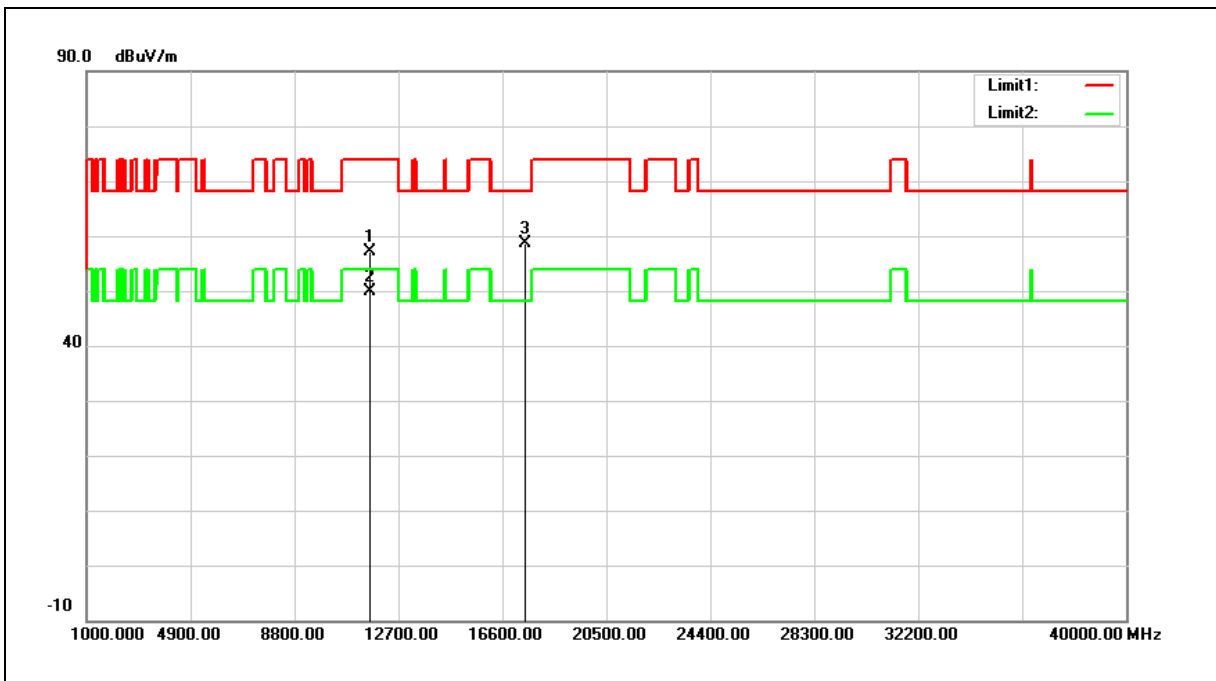

No.	Frequency (MHz)	Reading (dBuV)	Correct Factor (dB/m)	Result (dBuV/m)	Limit (dBuV/m)	Margin (dB)	Remark
1	11650.000	38.64	18.38	57.02	74.00	-16.98	peak
2	11650.000	31.50	18.38	49.88	54.00	-4.12	AVG
3	17475.000	33.31	25.26	58.57	68.20	-9.63	peak

Note:1.Result (dBuV/m) = Correct Factor (dB/m) + Reading(dBuV).

2.Correction factor (dB/m) = Antenna Factor (dB/m) + Cable loss (dB) – Pre-Amplifier gain (dB).

3. When the peak results are less than average limit, so not need to evaluate the average.



Standard:	FCC Part 15.407	Test Distance:	3 m
Test item:	Harmonic	Power:	AC 120 V/60 Hz
Frequency:	5180 MHz	Temp.(°C)/Hum.(%RH):	26(°C)/60 %RH
Mode:	Mode 3		
Ant.Polar.:	Horizontal		

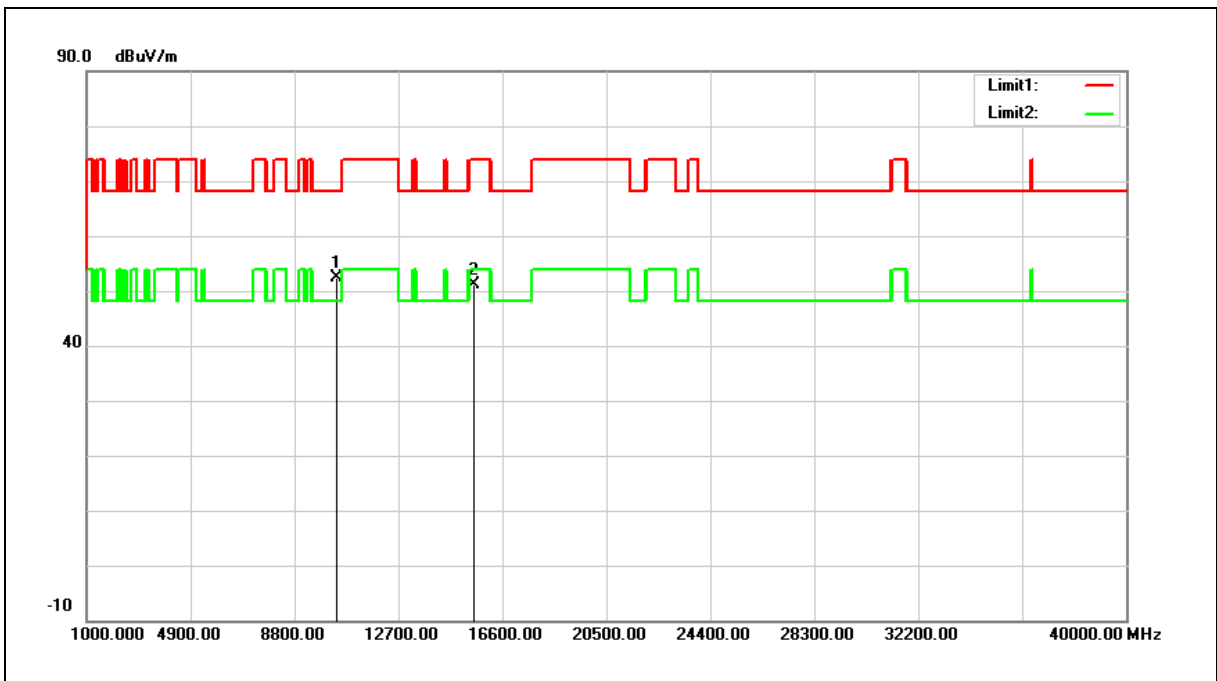

No.	Frequency (MHz)	Reading (dBuV)	Correct Factor (dB/m)	Result (dBuV/m)	Limit (dBuV/m)	Margin (dB)	Remark
1	10360.000	35.47	16.92	52.39	68.20	-15.81	peak
2	15540.000	31.98	19.18	51.16	74.00	-22.84	peak

Note:1.Result (dBuV/m) = Correct Factor (dB/m) + Reading(dBuV).

2.Correction factor (dB/m) = Antenna Factor (dB/m) + Cable loss (dB) – Pre-Amplifier gain (dB).

3. When the peak results are less than average limit, so not need to evaluate the average.



Standard:	FCC Part 15.407	Test Distance:	3 m
Test item:	Harmonic	Power:	AC 120 V/60 Hz
Frequency:	5180 MHz	Temp.(°C)/Hum.(%RH):	26(°C)/60 %RH
Mode:	Mode 3		
Ant.Polar.:	Vertical		

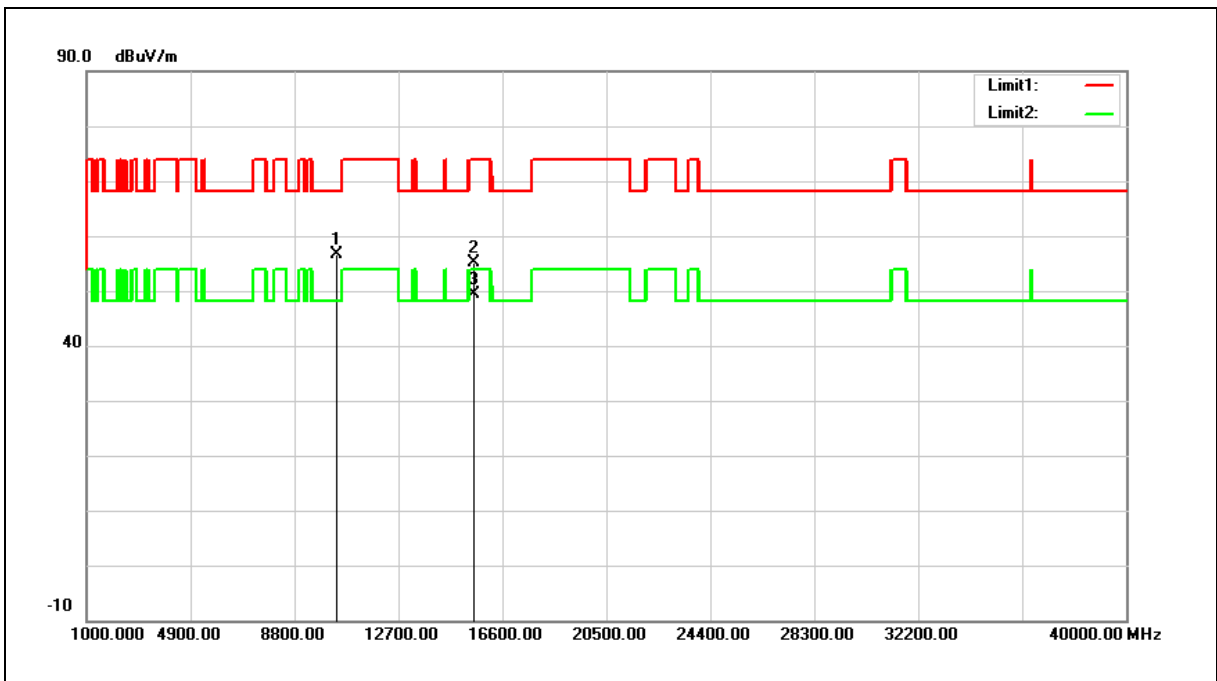

No.	Frequency (MHz)	Reading (dBuV)	Correct Factor (dB/m)	Result (dBuV/m)	Limit (dBuV/m)	Margin (dB)	Remark
1	10360.000	39.60	16.92	56.52	68.20	-11.68	peak
2	15540.000	36.06	19.18	55.24	74.00	-18.76	peak
3	15540.000	30.20	19.18	49.38	54.00	-4.62	AVG

Note:1.Result (dBuV/m) = Correct Factor (dB/m) + Reading(dBuV).

2.Correction factor (dB/m) = Antenna Factor (dB/m) + Cable loss (dB) – Pre-Amplifier gain (dB).

3. When the peak results are less than average limit, so not need to evaluate the average.



Standard:	FCC Part 15.407	Test Distance:	3 m
Test item:	Harmonic	Power:	AC 120 V/60 Hz
Frequency:	5200 MHz	Temp.(°C)/Hum.(%RH):	26(°C)/60 %RH
Mode:	Mode 3		
Ant.Polar.:	Horizontal		

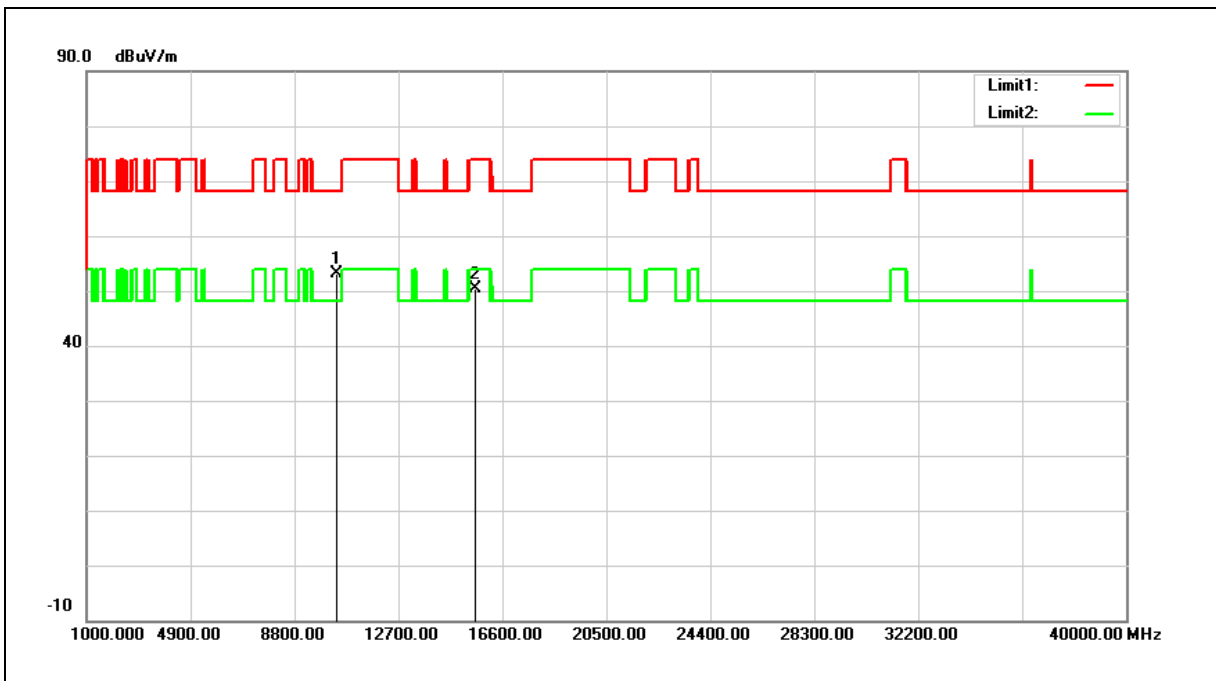

No.	Frequency (MHz)	Reading (dBuV)	Correct Factor (dB/m)	Result (dBuV/m)	Limit (dBuV/m)	Margin (dB)	Remark
1	10400.000	36.15	17.06	53.21	68.20	-14.99	peak
2	15600.000	31.47	19.02	50.49	74.00	-23.51	peak

- Note:1.Result (dBuV/m) = Correct Factor (dB/m) + Reading(dBuV).
- 2.Correction factor (dB/m) = Antenna Factor (dB/m) + Cable loss (dB) – Pre-Amplifier gain (dB).
3. When the peak results are less than average limit, so not need to evaluate the average.





Standard:	FCC Part 15.407	Test Distance:	3 m
Test item:	Harmonic	Power:	AC 120 V/60 Hz
Frequency:	5200 MHz	Temp.(°C)/Hum.(%RH):	26(°C)/60 %RH
Mode:	Mode 3		
Ant.Polar.:	Vertical		

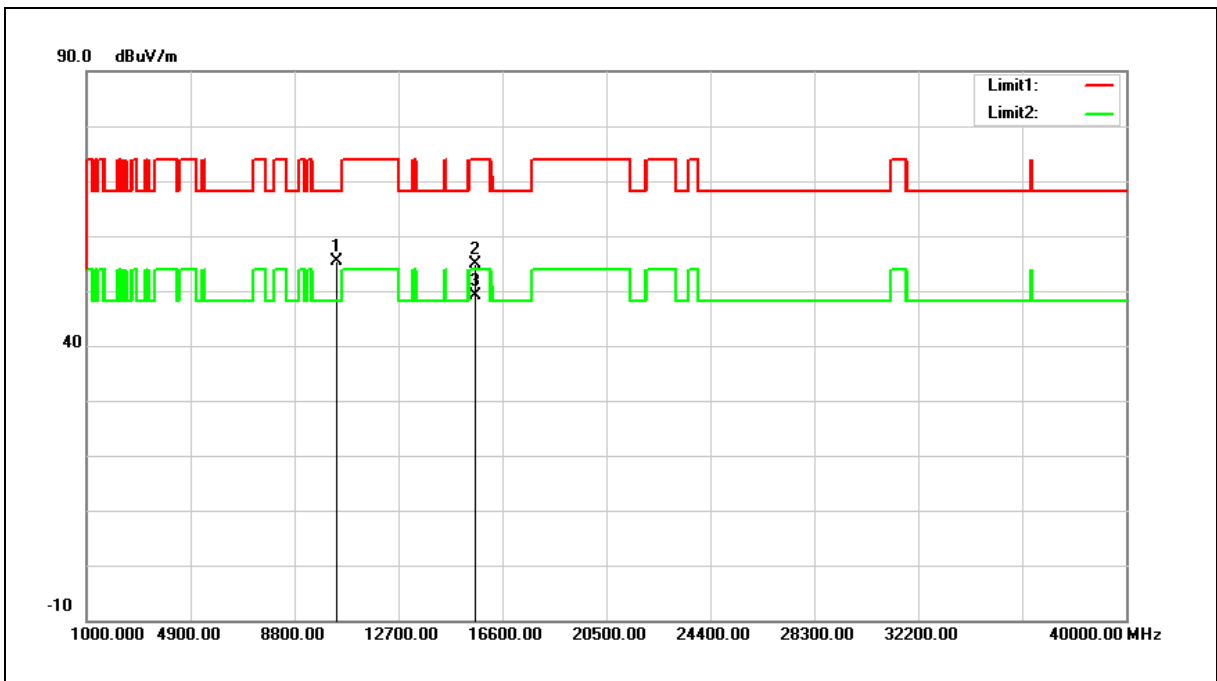

No.	Frequency (MHz)	Reading (dBuV)	Correct Factor (dB/m)	Result (dBuV/m)	Limit (dBuV/m)	Margin (dB)	Remark
1	10400.000	38.44	17.06	55.50	68.20	-12.70	peak
2	15600.000	35.93	19.02	54.95	74.00	-19.05	peak
3	15600.000	30.00	19.02	49.02	54.00	-4.98	AVG

Note:1.Result (dBuV/m) = Correct Factor (dB/m) + Reading(dBuV).

2.Correction factor (dB/m) = Antenna Factor (dB/m) + Cable loss (dB) – Pre-Amplifier gain (dB).

3. When the peak results are less than average limit, so not need to evaluate the average.



Standard:	FCC Part 15.407	Test Distance:	3 m
Test item:	Harmonic	Power:	AC 120 V/60 Hz
Frequency:	5240 MHz	Temp.(°C)/Hum.(%RH):	26(°C)/60 %RH
Mode:	Mode 3		
Ant.Polar.:	Horizontal		

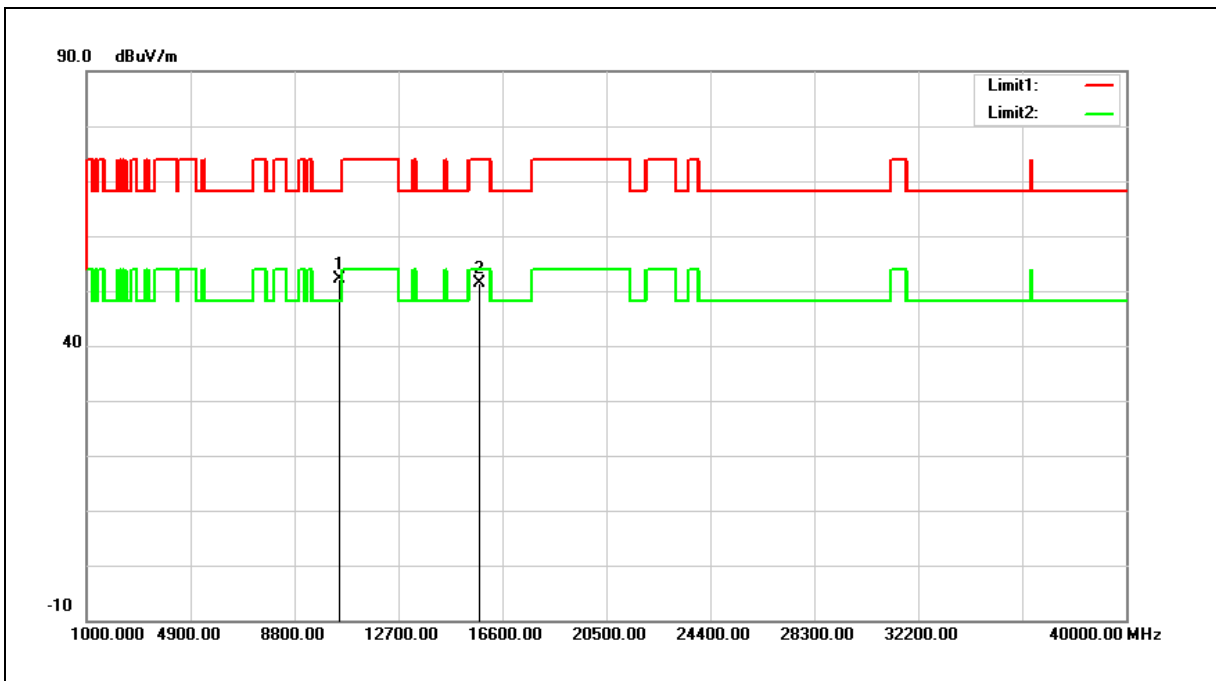

No.	Frequency (MHz)	Reading (dBuV)	Correct Factor (dB/m)	Result (dBuV/m)	Limit (dBuV/m)	Margin (dB)	Remark
1	10480.000	34.87	17.35	52.22	68.20	-15.98	peak
2	15720.000	32.65	18.71	51.36	74.00	-22.64	peak

- Note:1.Result (dBuV/m) = Correct Factor (dB/m) + Reading(dBuV).  
 2.Correction factor (dB/m) = Antenna Factor (dB/m) + Cable loss (dB) – Pre-Amplifier gain (dB).  
 3. When the peak results are less than average limit, so not need to evaluate the average.



Standard:	FCC Part 15.407	Test Distance:	3 m
Test item:	Harmonic	Power:	AC 120 V/60 Hz
Frequency:	5240 MHz	Temp.(°C)/Hum.(%RH):	26(°C)/60 %RH
Mode:	Mode 3		
Ant.Polar.:	Vertical		

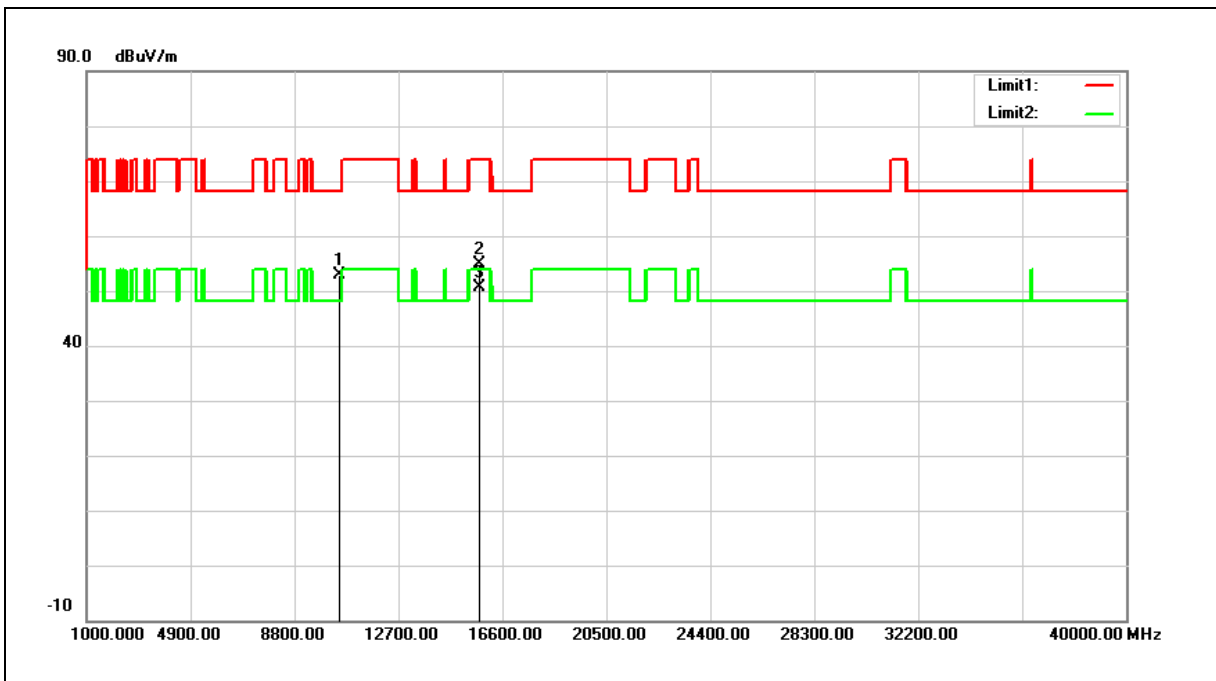

No.	Frequency (MHz)	Reading (dBuV)	Correct Factor (dB/m)	Result (dBuV/m)	Limit (dBuV/m)	Margin (dB)	Remark
1	10480.000	35.47	17.35	52.82	68.20	-15.38	peak
2	15720.000	36.15	18.71	54.86	74.00	-19.14	peak
3	15720.000	31.97	18.71	50.68	54.00	-3.32	AVG

Note:1.Result (dBuV/m) = Correct Factor (dB/m) + Reading(dBuV).

2.Correction factor (dB/m) = Antenna Factor (dB/m) + Cable loss (dB) – Pre-Amplifier gain (dB).

3. When the peak results are less than average limit, so not need to evaluate the average.



Standard:	FCC Part 15.407	Test Distance:	3 m
Test item:	Harmonic	Power:	AC 120 V/60 Hz
Frequency:	5745 MHz	Temp.(°C)/Hum.(%RH):	26(°C)/60 %RH
Mode:	Mode 3		
Ant.Polar.:	Horizontal		

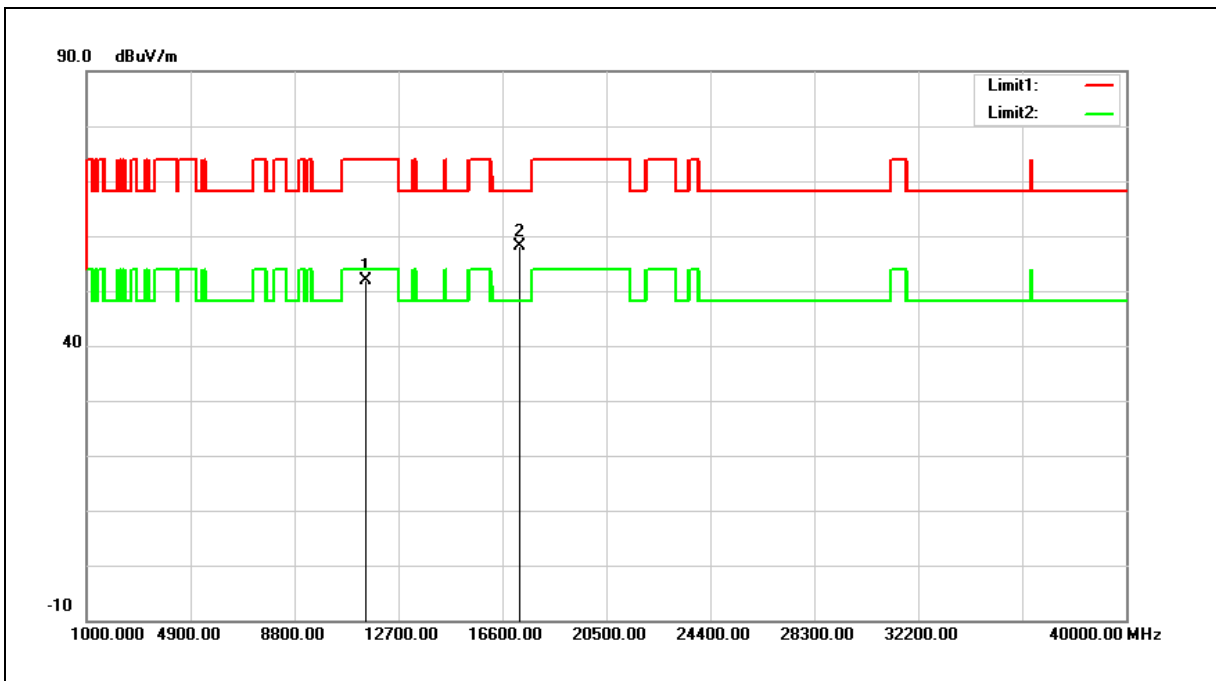

No.	Frequency (MHz)	Reading (dBuV)	Correct Factor (dB/m)	Result (dBuV/m)	Limit (dBuV/m)	Margin (dB)	Remark
1	11490.000	33.38	18.50	51.88	74.00	-22.12	peak
2	17235.000	33.89	24.31	58.20	68.20	-10.00	peak

Note:1.Result (dBuV/m) = Correct Factor (dB/m) + Reading(dBuV).

2.Correction factor (dB/m) = Antenna Factor (dB/m) + Cable loss (dB) – Pre-Amplifier gain (dB).

3. When the peak results are less than average limit, so not need to evaluate the average.



Standard:	FCC Part 15.407	Test Distance:	3 m
Test item:	Harmonic	Power:	AC 120 V/60 Hz
Frequency:	5745 MHz	Temp.(°C)/Hum.(%RH):	26(°C)/60 %RH
Mode:	Mode 3		
Ant.Polar.:	Vertical		

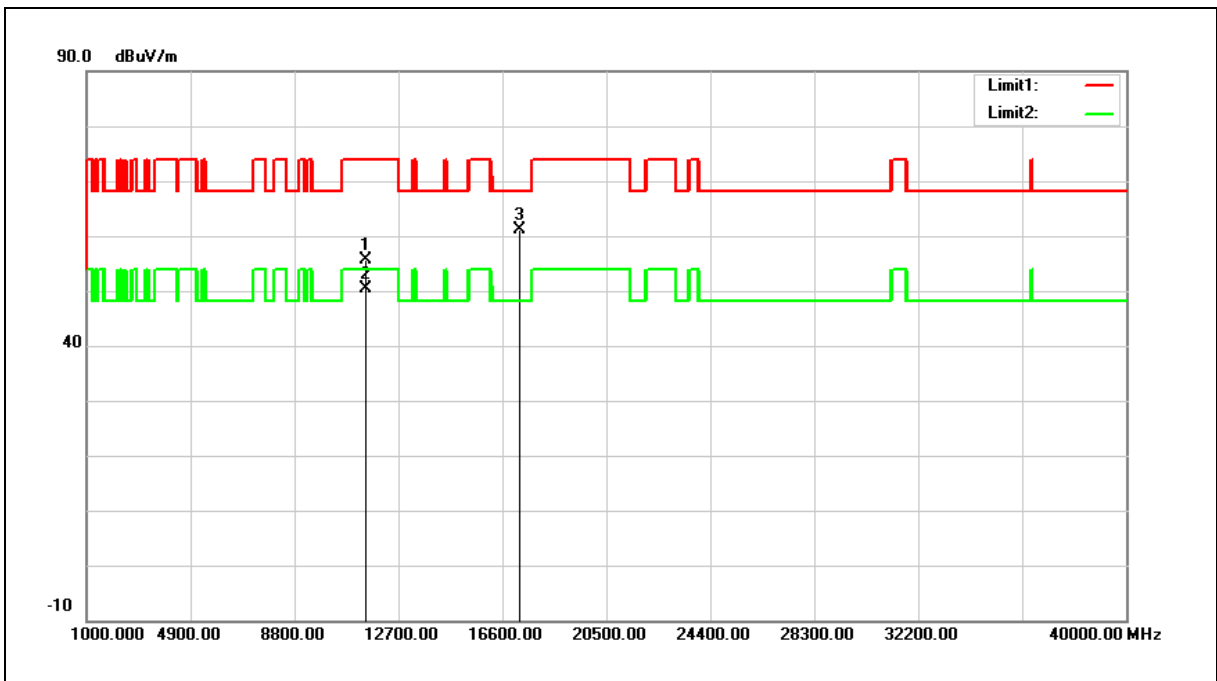

No.	Frequency (MHz)	Reading (dBuV)	Correct Factor (dB/m)	Result (dBuV/m)	Limit (dBuV/m)	Margin (dB)	Remark
1	11490.000	37.01	18.50	55.51	74.00	-18.49	peak
2	11490.000	31.91	18.50	50.41	54.00	-3.59	AVG
3	17235.000	36.86	24.31	61.17	68.20	-7.03	peak

Note:1.Result (dBuV/m) = Correct Factor (dB/m) + Reading(dBuV).

2.Correction factor (dB/m) = Antenna Factor (dB/m) + Cable loss (dB) – Pre-Amplifier gain (dB).

3. When the peak results are less than average limit, so not need to evaluate the average.



Standard:	FCC Part 15.407	Test Distance:	3 m
Test item:	Harmonic	Power:	AC 120 V/60 Hz
Frequency:	5785 MHz	Temp.(°C)/Hum.(%RH):	26(°C)/60 %RH
Mode:	Mode 3		
Ant.Polar.:	Horizontal		

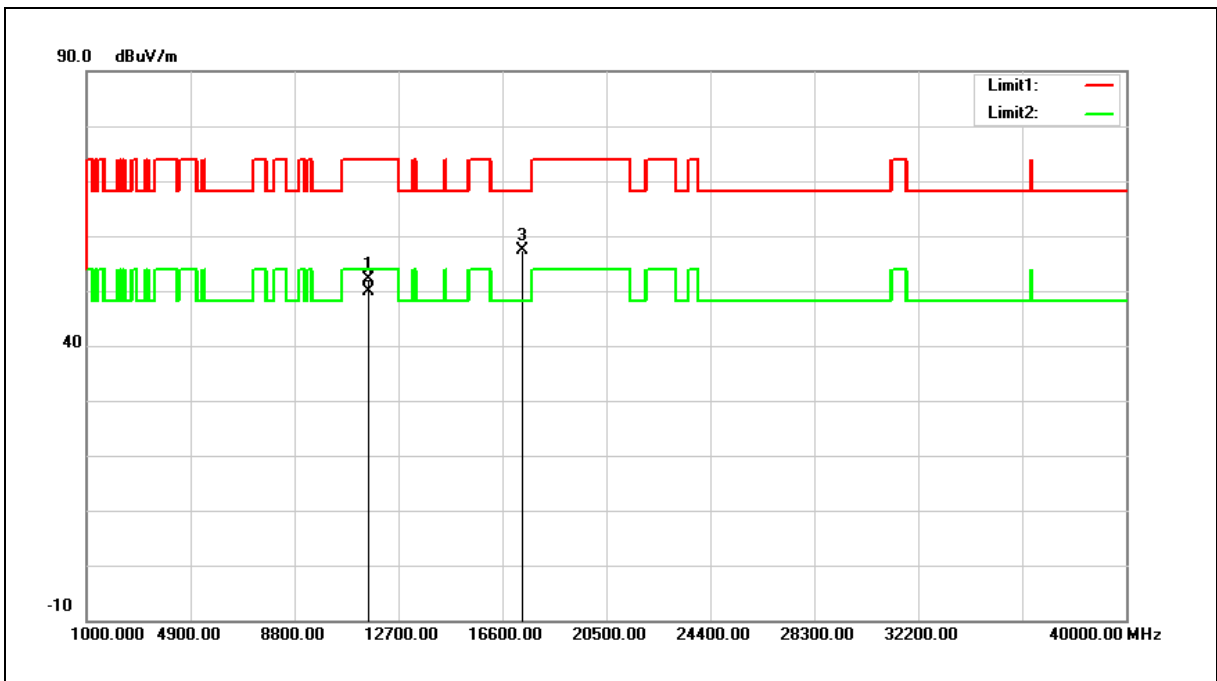

No.	Frequency (MHz)	Reading (dBuV)	Correct Factor (dB/m)	Result (dBuV/m)	Limit (dBuV/m)	Margin (dB)	Remark
1	11570.000	33.70	18.44	52.14	74.00	-21.86	peak
2	11570.000	31.45	18.44	49.89	54.00	-4.11	AVG
3	17355.000	32.68	24.79	57.47	68.20	-10.73	peak

Note:1.Result (dBuV/m) = Correct Factor (dB/m) + Reading(dBuV).

2.Correction factor (dB/m) = Antenna Factor (dB/m) + Cable loss (dB) – Pre-Amplifier gain (dB).

3. When the peak results are less than average limit, so not need to evaluate the average.



Standard:	FCC Part 15.407	Test Distance:	3 m
Test item:	Harmonic	Power:	AC 120 V/60 Hz
Frequency:	5785 MHz	Temp.(°C)/Hum.(%RH):	26(°C)/60 %RH
Mode:	Mode 3		
Ant.Polar.:	Vertical		

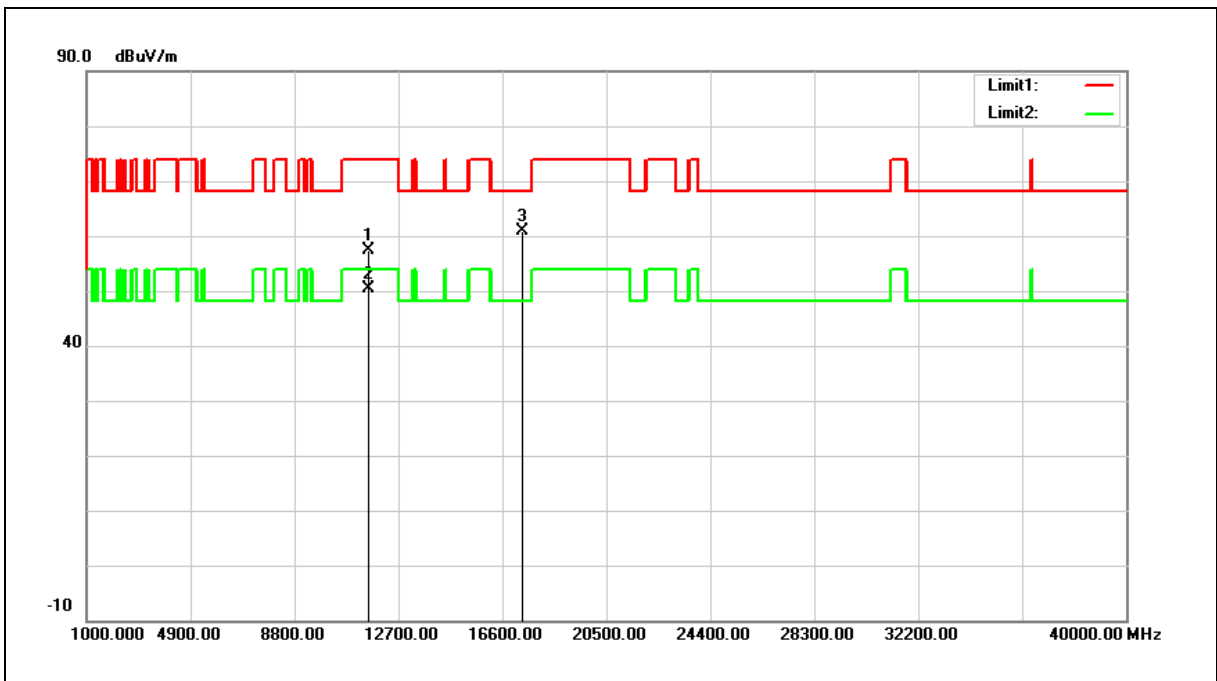

No.	Frequency (MHz)	Reading (dBuV)	Correct Factor (dB/m)	Result (dBuV/m)	Limit (dBuV/m)	Margin (dB)	Remark
1	11570.000	38.84	18.44	57.28	74.00	-16.72	peak
2	11570.000	31.91	18.44	50.35	54.00	-3.65	AVG
3	17355.000	36.07	24.79	60.86	68.20	-7.34	peak

Note:1.Result (dBuV/m) = Correct Factor (dB/m) + Reading(dBuV).

2.Correction factor (dB/m) = Antenna Factor (dB/m) + Cable loss (dB) – Pre-Amplifier gain (dB).

3. When the peak results are less than average limit, so not need to evaluate the average.



Standard:	FCC Part 15.407	Test Distance:	3 m
Test item:	Harmonic	Power:	AC 120 V/60 Hz
Frequency:	5825 MHz	Temp.(°C)/Hum.(%RH):	26(°C)/60 %RH
Mode:	Mode 3		
Ant.Polar.:	Horizontal		

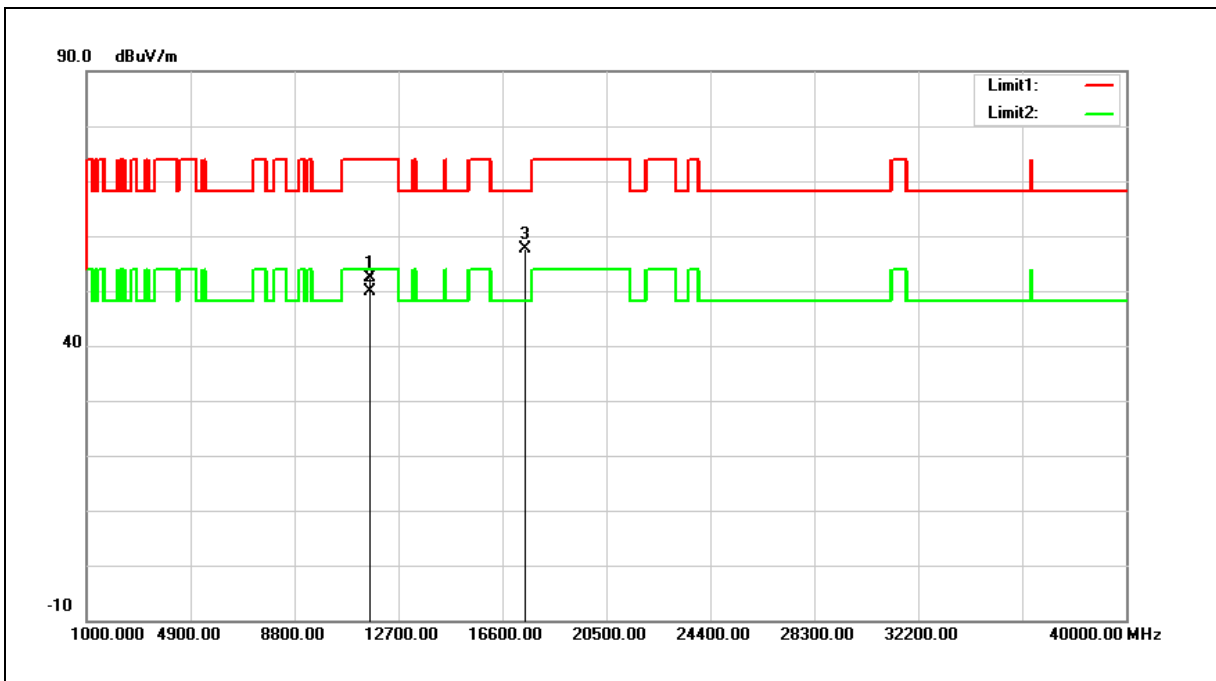

No.	Frequency (MHz)	Reading (dBuV)	Correct Factor (dB/m)	Result (dBuV/m)	Limit (dBuV/m)	Margin (dB)	Remark
1	11650.000	34.10	18.38	52.48	74.00	-21.52	peak
2	11650.000	31.41	18.38	49.79	54.00	-4.21	AVG
3	17475.000	32.47	25.26	57.73	68.20	-10.47	peak

Note:1.Result (dBuV/m) = Correct Factor (dB/m) + Reading(dBuV).

2.Correction factor (dB/m) = Antenna Factor (dB/m) + Cable loss (dB) – Pre-Amplifier gain (dB).

3. When the peak results are less than average limit, so not need to evaluate the average.





Standard:	FCC Part 15.407	Test Distance:	3 m
Test item:	Harmonic	Power:	AC 120 V/60 Hz
Frequency:	5825 MHz	Temp.(°C)/Hum.(%RH):	26(°C)/60 %RH
Mode:	Mode 3		
Ant.Polar.:	Vertical		

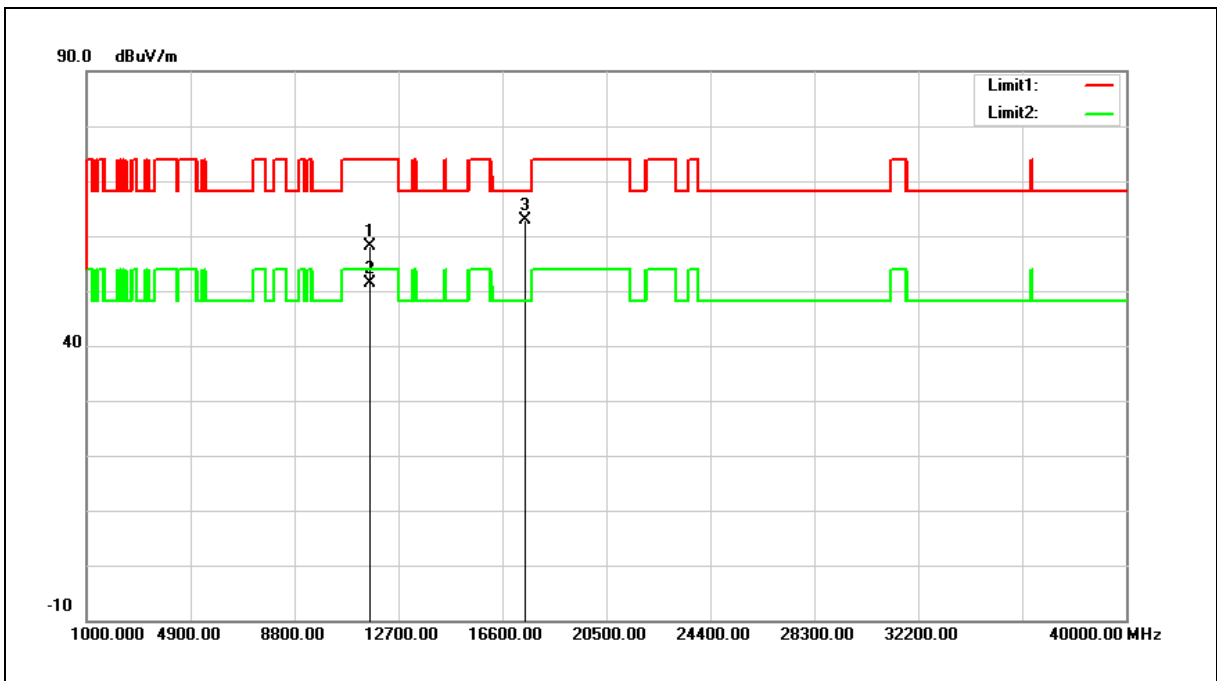

No.	Frequency (MHz)	Reading (dBuV)	Correct Factor (dB/m)	Result (dBuV/m)	Limit (dBuV/m)	Margin (dB)	Remark
1	11650.000	39.70	18.38	58.08	74.00	-15.92	peak
2	11650.000	32.88	18.38	51.26	54.00	-2.74	AVG
3	17475.000	37.52	25.26	62.78	68.20	-5.42	peak

Note:1.Result (dBuV/m) = Correct Factor (dB/m) + Reading(dBuV).

2.Correction factor (dB/m) = Antenna Factor (dB/m) + Cable loss (dB) – Pre-Amplifier gain (dB).

3. When the peak results are less than average limit, so not need to evaluate the average.



Standard:	FCC Part 15.407	Test Distance:	3 m
Test item:	Harmonic	Power:	AC 120 V/60 Hz
Frequency:	5190 MHz	Temp.(°C)/Hum.(%RH):	26(°C)/60 %RH
Mode:	Mode 4		
Ant.Polar.:	Horizontal		

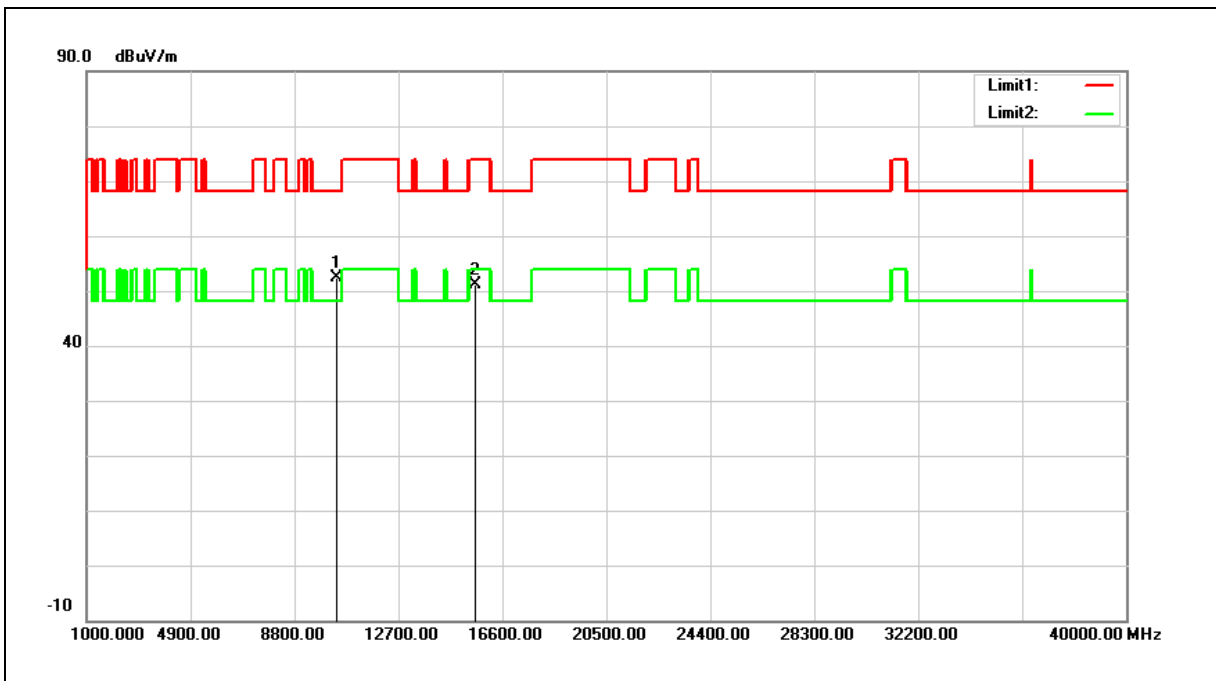

No.	Frequency (MHz)	Reading (dBuV)	Correct Factor (dB/m)	Result (dBuV/m)	Limit (dBuV/m)	Margin (dB)	Remark
1	10380.000	35.32	16.98	52.30	68.20	-15.90	peak
2	15570.000	32.12	19.11	51.23	74.00	-22.77	peak

- Note:1.Result (dBuV/m) = Correct Factor (dB/m) + Reading(dBuV).
- 2.Correction factor (dB/m) = Antenna Factor (dB/m) + Cable loss (dB) – Pre-Amplifier gain (dB).
3. When the peak results are less than average limit, so not need to evaluate the average.



Standard:	FCC Part 15.407	Test Distance:	3 m
Test item:	Harmonic	Power:	AC 120 V/60 Hz
Frequency:	5190 MHz	Temp.(°C)/Hum.(%RH):	26(°C)/60 %RH
Mode:	Mode 4		
Ant.Polar.:	Vertical		

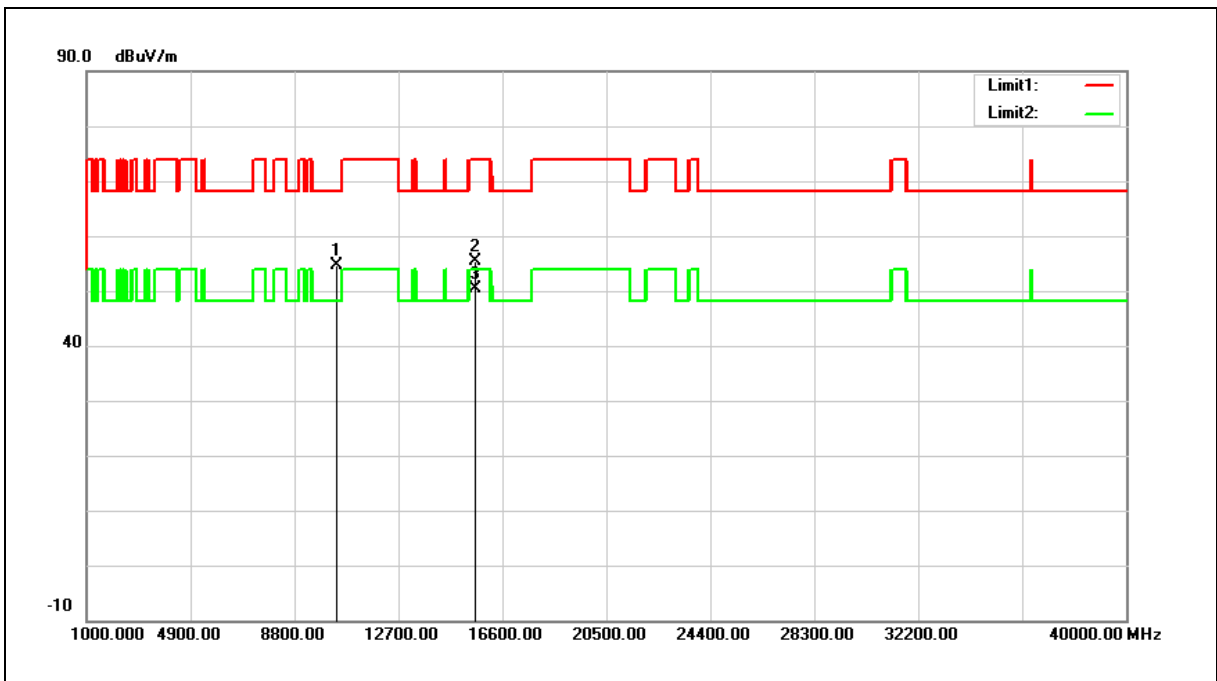

No.	Frequency (MHz)	Reading (dBuV)	Correct Factor (dB/m)	Result (dBuV/m)	Limit (dBuV/m)	Margin (dB)	Remark
1	10380.000	37.56	16.98	54.54	68.20	-13.66	peak
2	15570.000	36.16	19.11	55.27	74.00	-18.73	peak
3	15570.000	31.16	19.11	50.27	54.00	-3.73	AVG

Note:1.Result (dBuV/m) = Correct Factor (dB/m) + Reading(dBuV).

2.Correction factor (dB/m) = Antenna Factor (dB/m) + Cable loss (dB) – Pre-Amplifier gain (dB).

3. When the peak results are less than average limit, so not need to evaluate the average.



Standard:	FCC Part 15.407	Test Distance:	3 m
Test item:	Harmonic	Power:	AC 120 V/60 Hz
Frequency:	5230 MHz	Temp.(°C)/Hum.(%RH):	26(°C)/60 %RH
Mode:	Mode 4		
Ant.Polar.:	Horizontal		

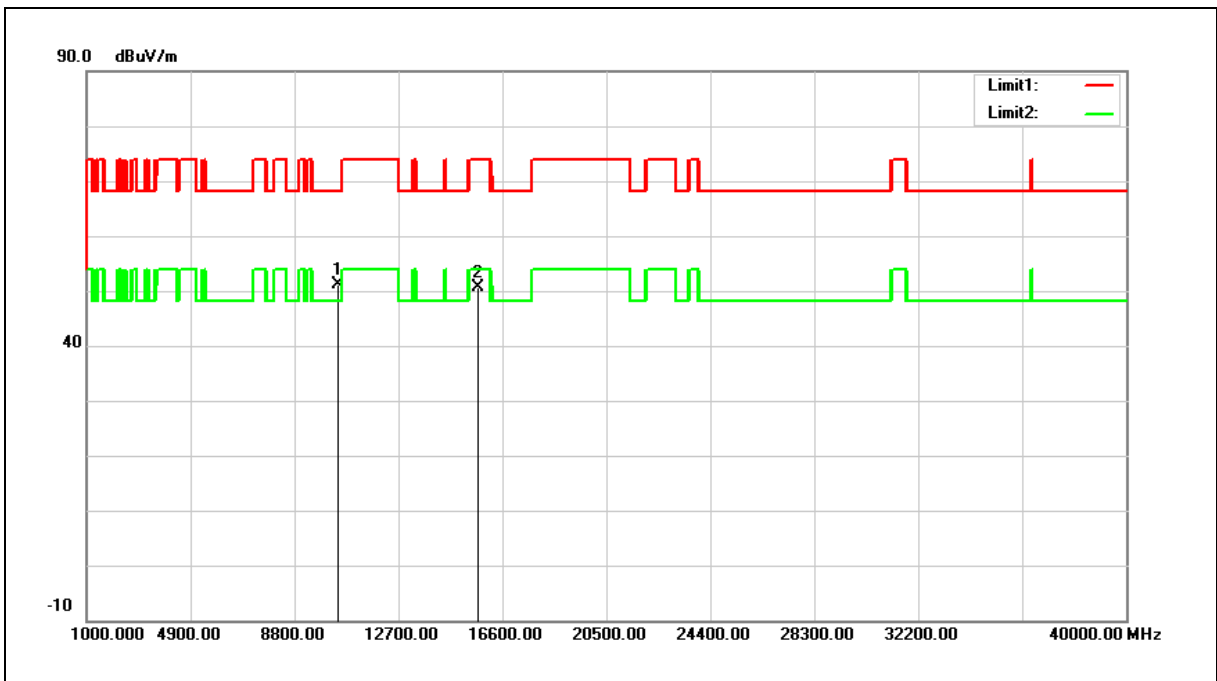

No.	Frequency (MHz)	Reading (dBuV)	Correct Factor (dB/m)	Result (dBuV/m)	Limit (dBuV/m)	Margin (dB)	Remark
1	10460.000	33.89	17.27	51.16	68.20	-17.04	peak
2	15690.000	31.77	18.78	50.55	74.00	-23.45	peak

Note:1.Result (dBuV/m) = Correct Factor (dB/m) + Reading(dBuV).

2.Correction factor (dB/m) = Antenna Factor (dB/m) + Cable loss (dB) – Pre-Amplifier gain (dB).

3. When the peak results are less than average limit, so not need to evaluate the average.



Standard:	FCC Part 15.407	Test Distance:	3 m
Test item:	Harmonic	Power:	AC 120 V/60 Hz
Frequency:	5230 MHz	Temp.(°C)/Hum.(%RH):	26(°C)/60 %RH
Mode:	Mode 4		
Ant.Polar.:	Vertical		

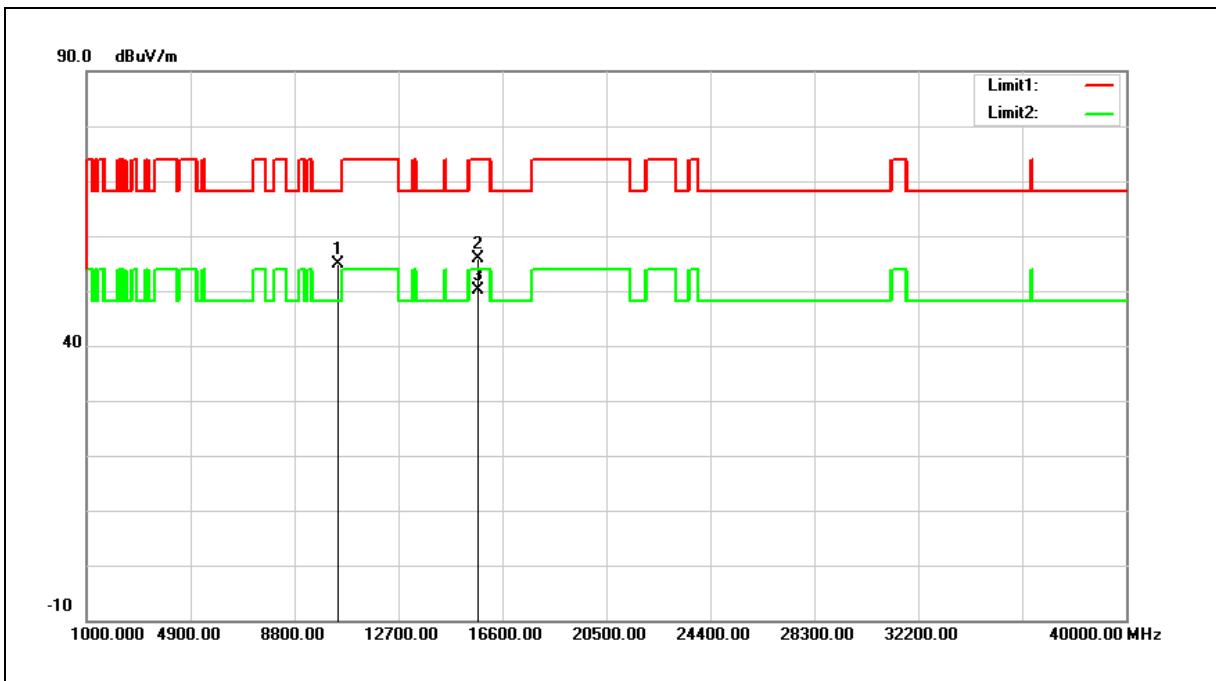

No.	Frequency (MHz)	Reading (dBuV)	Correct Factor (dB/m)	Result (dBuV/m)	Limit (dBuV/m)	Margin (dB)	Remark
1	10460.000	37.54	17.27	54.81	68.20	-13.39	peak
2	15690.000	37.08	18.78	55.86	74.00	-18.14	peak
3	15690.000	31.30	18.78	50.08	54.00	-3.92	AVG

Note:1.Result (dBuV/m) = Correct Factor (dB/m) + Reading(dBuV).

2.Correction factor (dB/m) = Antenna Factor (dB/m) + Cable loss (dB) – Pre-Amplifier gain (dB).

3. When the peak results are less than average limit, so not need to evaluate the average.



Standard:	FCC Part 15.407	Test Distance:	3 m
Test item:	Harmonic	Power:	AC 120 V/60 Hz
Frequency:	5755 MHz	Temp.(°C)/Hum.(%RH):	26(°C)/60 %RH
Mode:	Mode 4		
Ant.Polar.:	Horizontal		

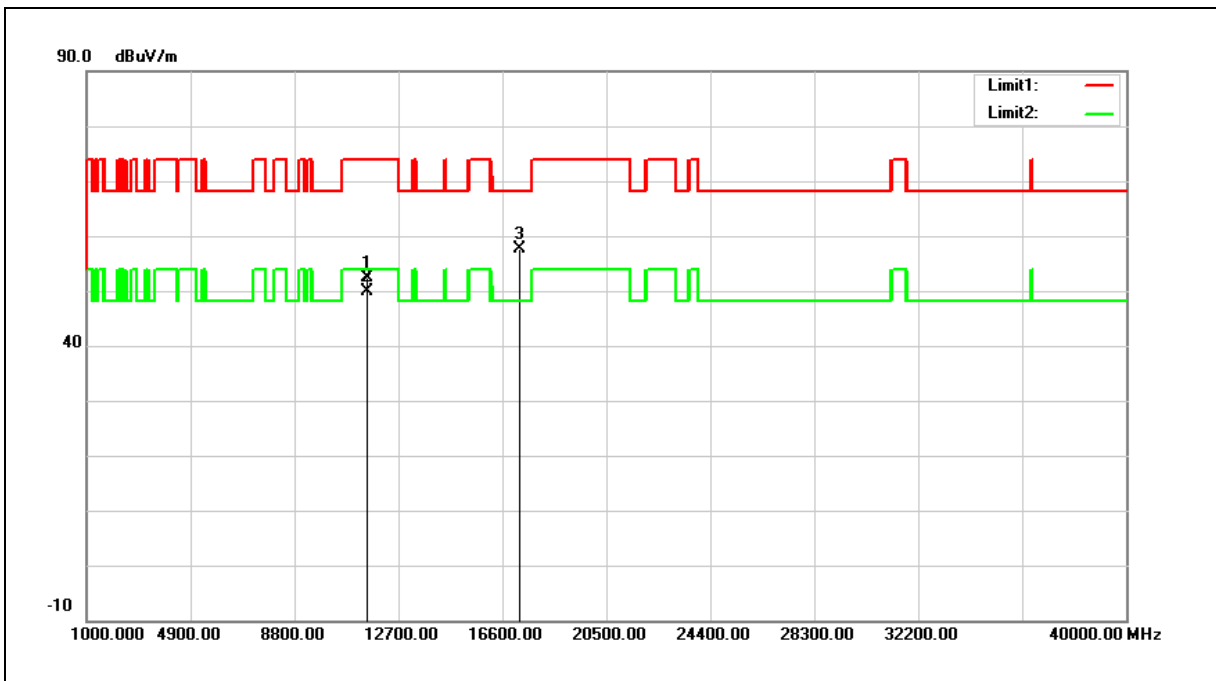

No.	Frequency (MHz)	Reading (dBuV)	Correct Factor (dB/m)	Result (dBuV/m)	Limit (dBuV/m)	Margin (dB)	Remark
1	11510.000	33.92	18.49	52.41	74.00	-21.59	peak
2	11510.000	31.32	18.49	49.81	54.00	-4.19	AVG
3	17265.000	33.22	24.44	57.66	68.20	-10.54	peak

Note:1.Result (dBuV/m) = Correct Factor (dB/m) + Reading(dBuV).

2.Correction factor (dB/m) = Antenna Factor (dB/m) + Cable loss (dB) – Pre-Amplifier gain (dB).

3. When the peak results are less than average limit, so not need to evaluate the average.



Standard:	FCC Part 15.407	Test Distance:	3 m
Test item:	Harmonic	Power:	AC 120 V/60 Hz
Frequency:	5755 MHz	Temp.(°C)/Hum.(%RH):	26(°C)/60 %RH
Mode:	Mode 4		
Ant.Polar.:	Vertical		

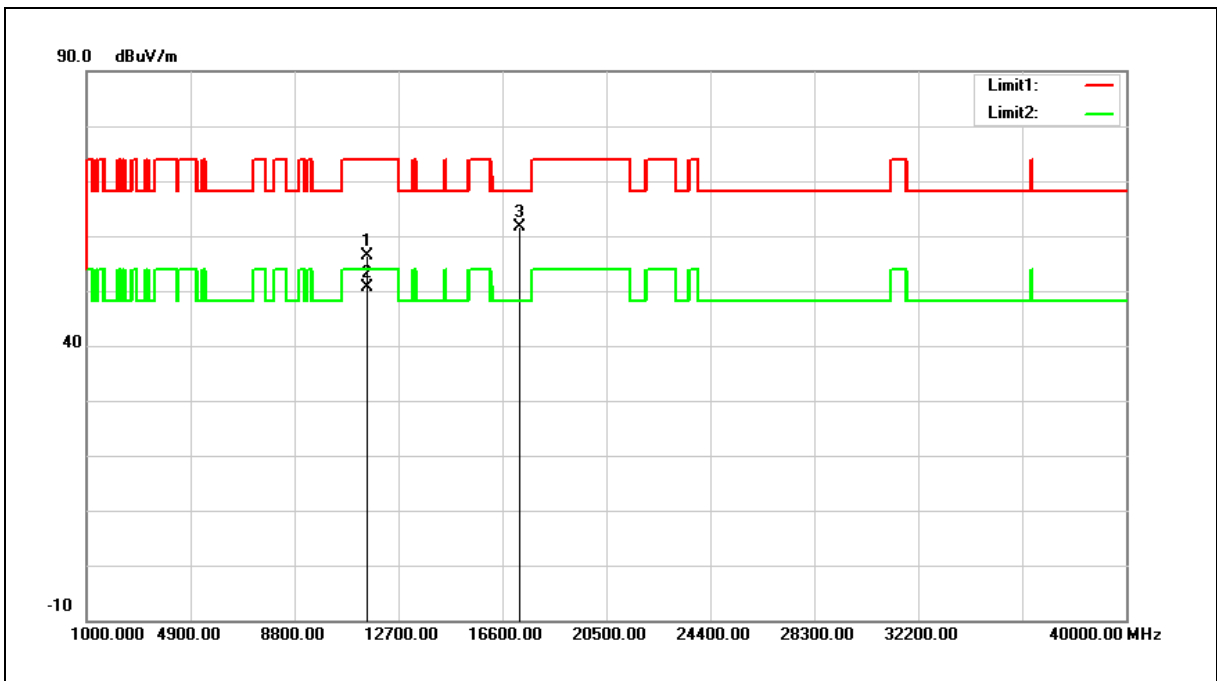

No.	Frequency (MHz)	Reading (dBuV)	Correct Factor (dB/m)	Result (dBuV/m)	Limit (dBuV/m)	Margin (dB)	Remark
1	11510.000	37.93	18.49	56.42	74.00	-17.58	peak
2	11510.000	32.12	18.49	50.61	54.00	-3.39	AVG
3	17265.000	37.30	24.44	61.74	68.20	-6.46	peak

Note:1.Result (dBuV/m) = Correct Factor (dB/m) + Reading(dBuV).

2.Correction factor (dB/m) = Antenna Factor (dB/m) + Cable loss (dB) – Pre-Amplifier gain (dB).

3. When the peak results are less than average limit, so not need to evaluate the average.

Standard:	FCC Part 15.407	Test Distance:	3 m
Test item:	Harmonic	Power:	AC 120 V/60 Hz
Frequency:	5795 MHz	Temp.(°C)/Hum.(%RH):	26(°C)/60 %RH
Mode:	Mode 4		
Ant.Polar.:	Horizontal		

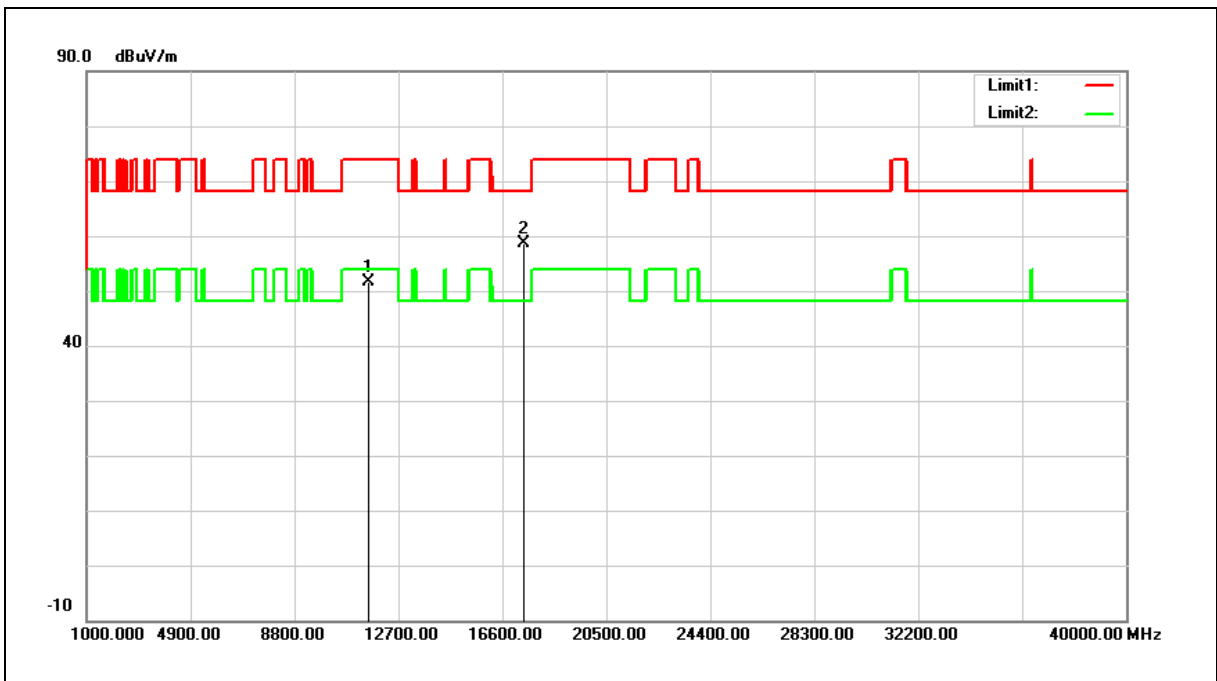

No.	Frequency (MHz)	Reading (dBuV)	Correct Factor (dB/m)	Result (dBuV/m)	Limit (dBuV/m)	Margin (dB)	Remark
1	11590.000	33.19	18.43	51.62	74.00	-22.38	peak
2	17385.000	33.70	24.90	58.60	68.20	-9.60	peak

Note:1.Result (dBuV/m) = Correct Factor (dB/m) + Reading(dBuV).

2.Correction factor (dB/m) = Antenna Factor (dB/m) + Cable loss (dB) – Pre-Amplifier gain (dB).

3. When the peak results are less than average limit, so not need to evaluate the average.





Standard:	FCC Part 15.407	Test Distance:	3 m
Test item:	Harmonic	Power:	AC 120 V/60 Hz
Frequency:	5795 MHz	Temp.(°C)/Hum.(%RH):	26(°C)/60 %RH
Mode:	Mode 4		
Ant.Polar.:	Vertical		

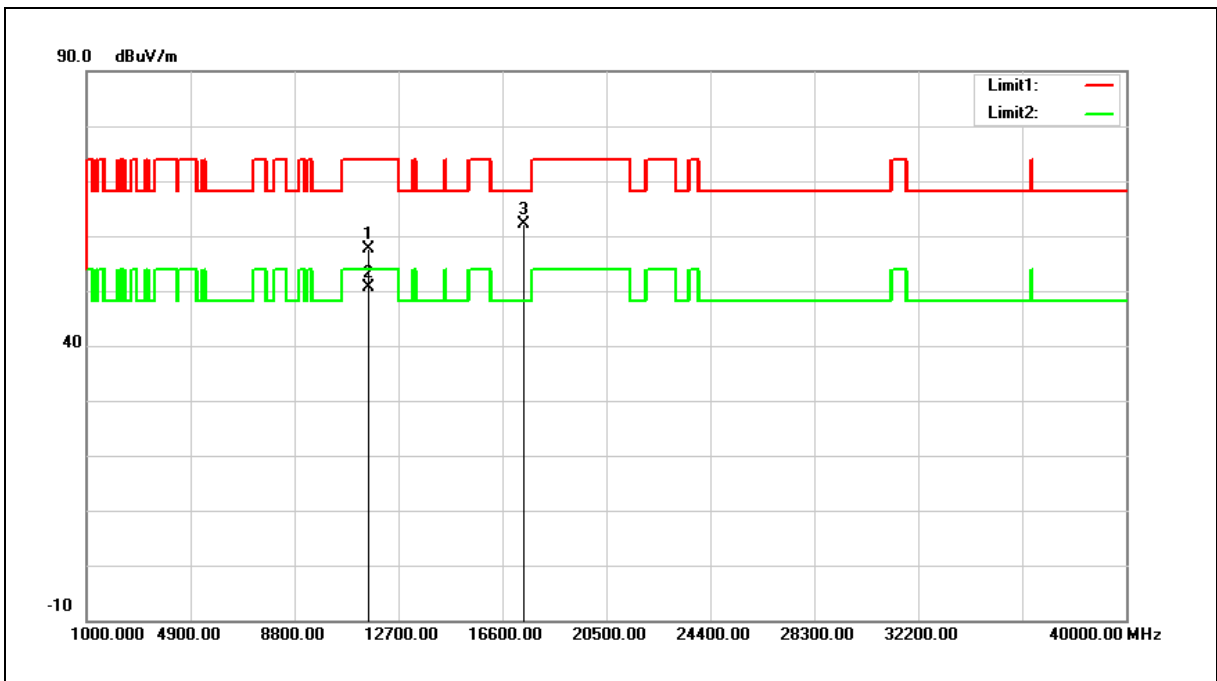

No.	Frequency (MHz)	Reading (dBuV)	Correct Factor (dB/m)	Result (dBuV/m)	Limit (dBuV/m)	Margin (dB)	Remark
1	11590.000	39.16	18.43	57.59	74.00	-16.41	peak
2	11590.000	32.10	18.43	50.53	54.00	-3.47	AVG
3	17385.000	37.23	24.90	62.13	68.20	-6.07	peak

Note:1.Result (dBuV/m) = Correct Factor (dB/m) + Reading(dBuV).

2.Correction factor (dB/m) = Antenna Factor (dB/m) + Cable loss (dB) – Pre-Amplifier gain (dB).

3. When the peak results are less than average limit, so not need to evaluate the average.



Standard:	FCC Part 15.407	Test Distance:	3 m
Test item:	Harmonic	Power:	AC 120 V/60 Hz
Frequency:	5210 MHz	Temp.(°C)/Hum.(%RH):	26(°C)/60 %RH
Mode:	Mode 5		
Ant.Polar.:	Horizontal		

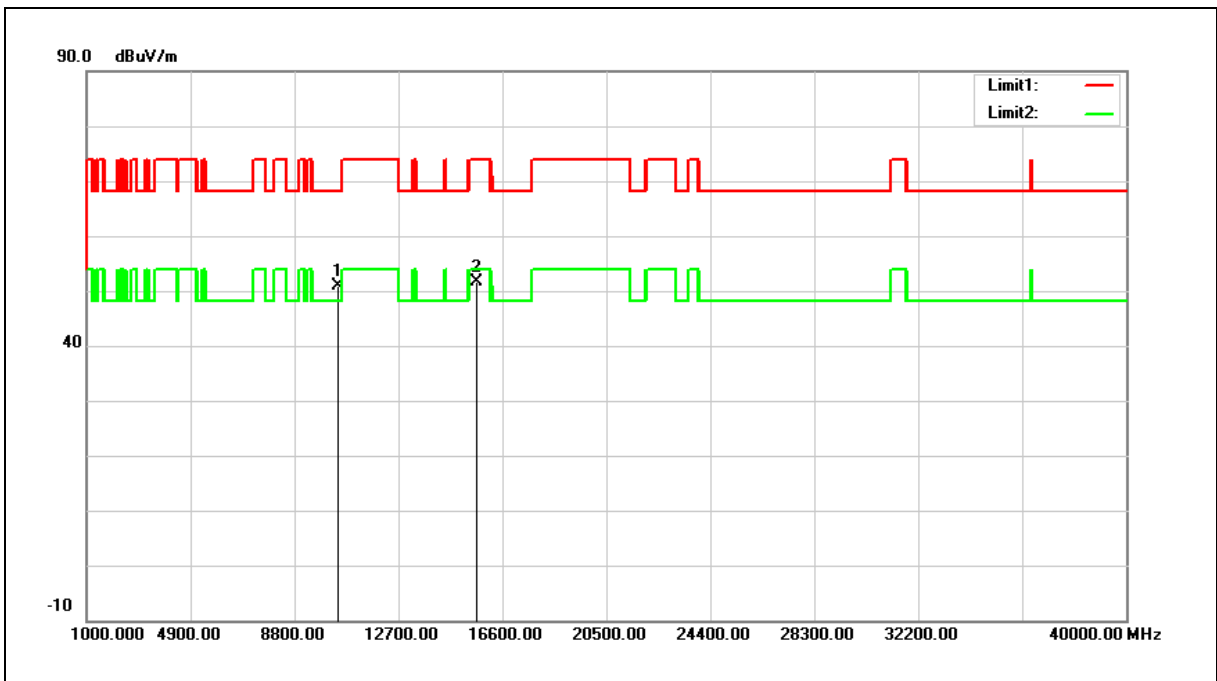

No.	Frequency (MHz)	Reading (dBuV)	Correct Factor (dB/m)	Result (dBuV/m)	Limit (dBuV/m)	Margin (dB)	Remark
1	10420.000	33.81	17.13	50.94	68.20	-17.26	peak
2	15630.000	32.72	18.94	51.66	74.00	-22.34	peak

Note:1.Result (dBuV/m) = Correct Factor (dB/m) + Reading(dBuV).

2.Correction factor (dB/m) = Antenna Factor (dB/m) + Cable loss (dB) – Pre-Amplifier gain (dB).

3. When the peak results are less than average limit, so not need to evaluate the average.



Standard:	FCC Part 15.407	Test Distance:	3 m
Test item:	Harmonic	Power:	AC 120 V/60 Hz
Frequency:	5210 MHz	Temp.(°C)/Hum.(%RH):	26(°C)/60 %RH
Mode:	Mode 5		
Ant.Polar.:	Vertical		

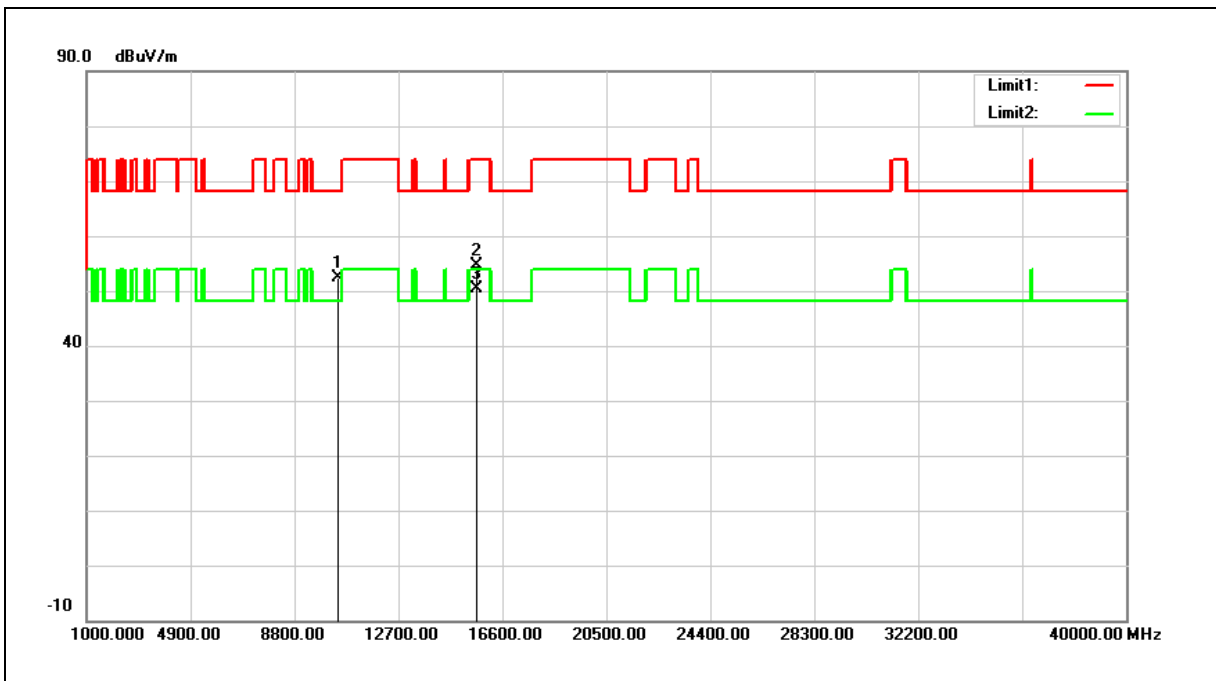

No.	Frequency (MHz)	Reading (dBuV)	Correct Factor (dB/m)	Result (dBuV/m)	Limit (dBuV/m)	Margin (dB)	Remark
1	10420.000	35.37	17.13	52.50	68.20	-15.70	peak
2	15630.000	35.78	18.94	54.72	74.00	-19.28	peak
3	15630.000	31.33	18.94	50.27	54.00	-3.73	AVG

Note:1.Result (dBuV/m) = Correct Factor (dB/m) + Reading(dBuV).

2.Correction factor (dB/m) = Antenna Factor (dB/m) + Cable loss (dB) – Pre-Amplifier gain (dB).

3. When the peak results are less than average limit, so not need to evaluate the average.



Standard:	FCC Part 15.407	Test Distance:	3 m
Test item:	Harmonic	Power:	AC 120 V/60 Hz
Frequency:	5775 MHz	Temp.(°C)/Hum.(%RH):	26(°C)/60 %RH
Mode:	Mode 5		
Ant.Polar.:	Horizontal		

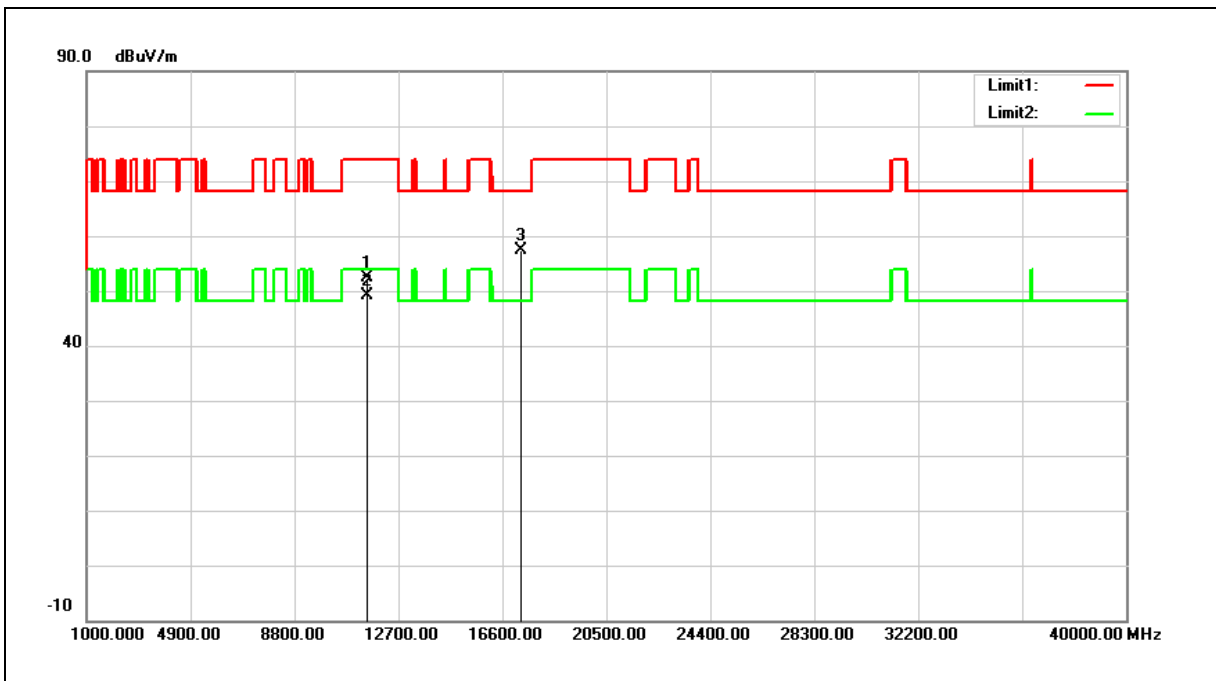

No.	Frequency (MHz)	Reading (dBuV)	Correct Factor (dB/m)	Result (dBuV/m)	Limit (dBuV/m)	Margin (dB)	Remark
1	11550.000	33.80	18.46	52.26	74.00	-21.74	peak
2	11550.000	30.66	18.46	49.12	54.00	-4.88	AVG
3	17325.000	32.58	24.68	57.26	68.20	-10.94	peak

Note:1.Result (dBuV/m) = Correct Factor (dB/m) + Reading(dBuV).

2.Correction factor (dB/m) = Antenna Factor (dB/m) + Cable loss (dB) – Pre-Amplifier gain (dB).

3. When the peak results are less than average limit, so not need to evaluate the average.



Standard:	FCC Part 15.407	Test Distance:	3 m
Test item:	Harmonic	Power:	AC 120 V/60 Hz
Frequency:	5775 MHz	Temp.(°C)/Hum.(%RH):	26(°C)/60 %RH
Mode:	Mode 5		
Ant.Polar.:	Vertical		

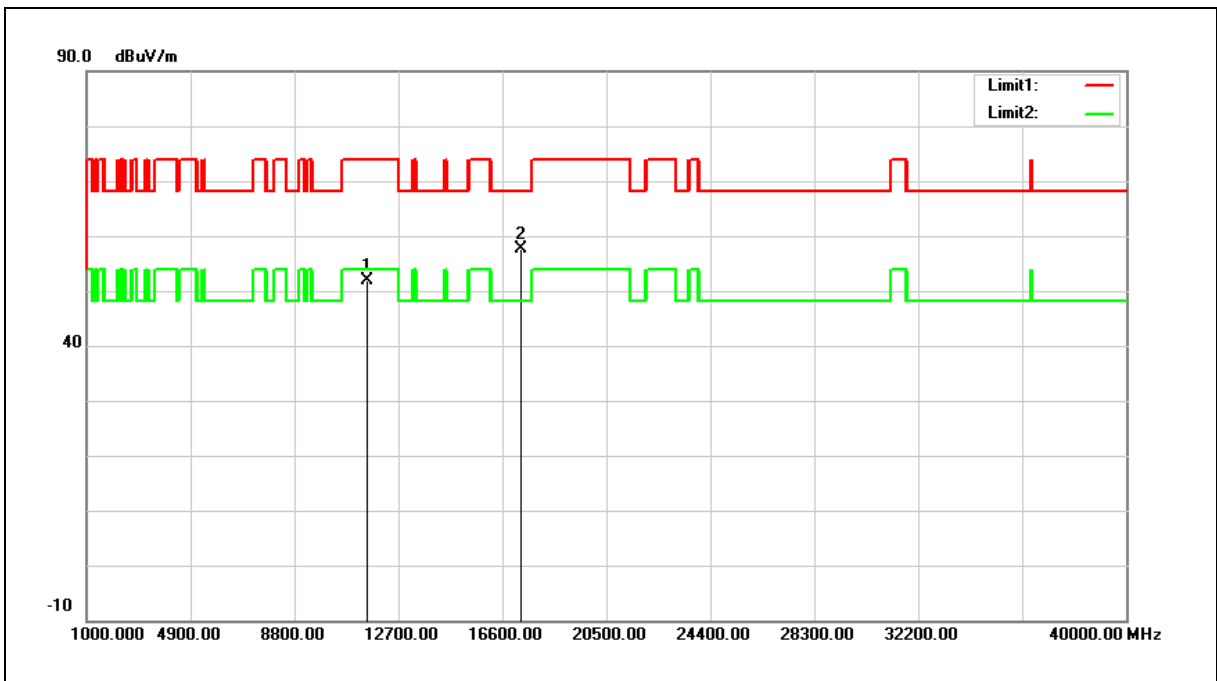

No.	Frequency (MHz)	Reading (dBuV)	Correct Factor (dB/m)	Result (dBuV/m)	Limit (dBuV/m)	Margin (dB)	Remark
1	11550.000	33.40	18.46	51.86	74.00	-22.14	peak
2	17325.000	32.93	24.68	57.61	68.20	-10.59	peak

Note:1.Result (dBuV/m) = Correct Factor (dB/m) + Reading(dBuV).

2.Correction factor (dB/m) = Antenna Factor (dB/m) + Cable loss (dB) – Pre-Amplifier gain (dB).

3. When the peak results are less than average limit, so not need to evaluate the average.

Standard:	FCC Part 15.407	Test Distance:	3 m
Test item:	Transmitter Unwanted Emissions	Power:	AC 120 V/60 Hz
Frequency:	Simultaneous Transmitting	Temp.(°C )/Hum.(%RH):	26(°C )/60 %RH
Mode:	(WLAN 2.4 GHz + 5 GHz)		
Ant.Polar.:	Horizontal		

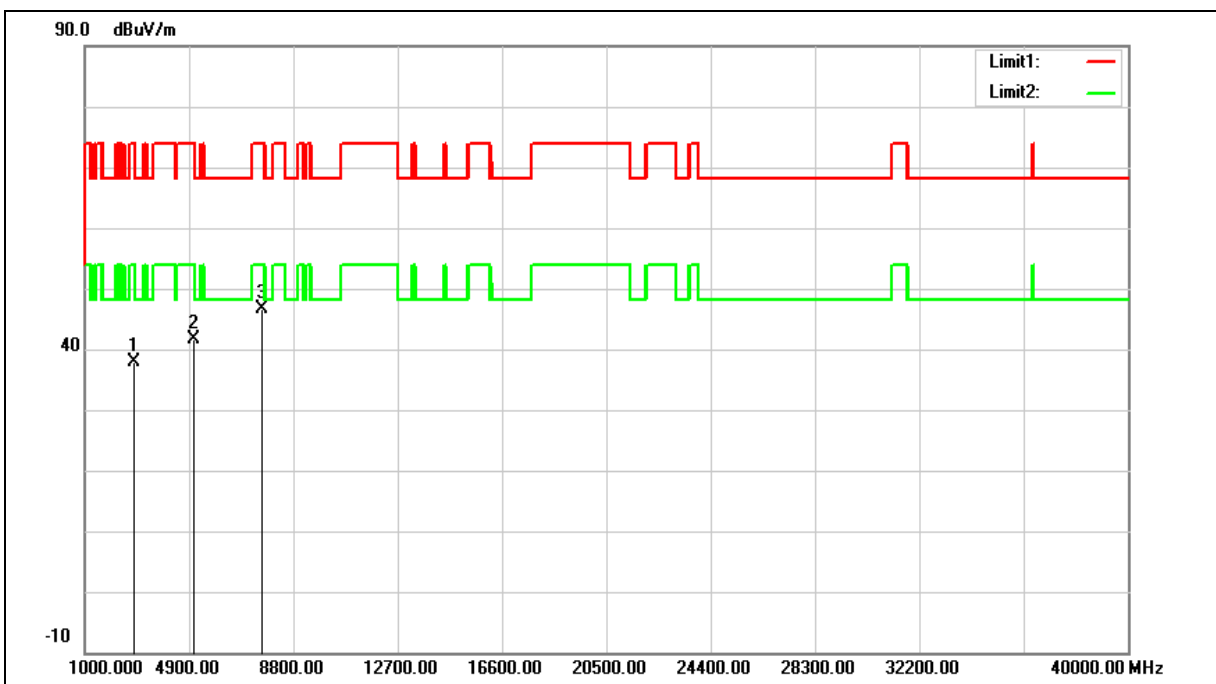

No.	Frequency (MHz)	Reading (dBuV)	Correct Factor (dB/m)	Result (dBuV/m)	Limit (dBuV/m)	Margin (dB)	Remark
1	2819.000	37.50	0.37	37.87	74.00	-36.13	peak
2	5063.000	35.57	6.06	41.63	74.00	-32.37	peak
3	7613.000	33.75	12.97	46.72	74.00	-27.28	peak

Note:1.Result (dBuV/m) = Correct Factor (dB/m) + Reading(dBuV).

2.Correction factor (dB/m) = Antenna Factor (dB/m) + Cable loss (dB) – Pre-Amplifier gain (dB).

3. When the peak results are less than average limit, so not need to evaluate the average.

Standard:	FCC Part 15.407	Test Distance:	3 m
Test item:	Transmitter Unwanted Emissions	Power:	AC 120 V/60 Hz
Frequency:	Simultaneous Transmitting	Temp.(°C)/Hum.(%RH):	26(°C)/60 %RH
Mode:	(WLAN 2.4 GHz + 5 GHz)		
Ant.Polar.:	Vertical		

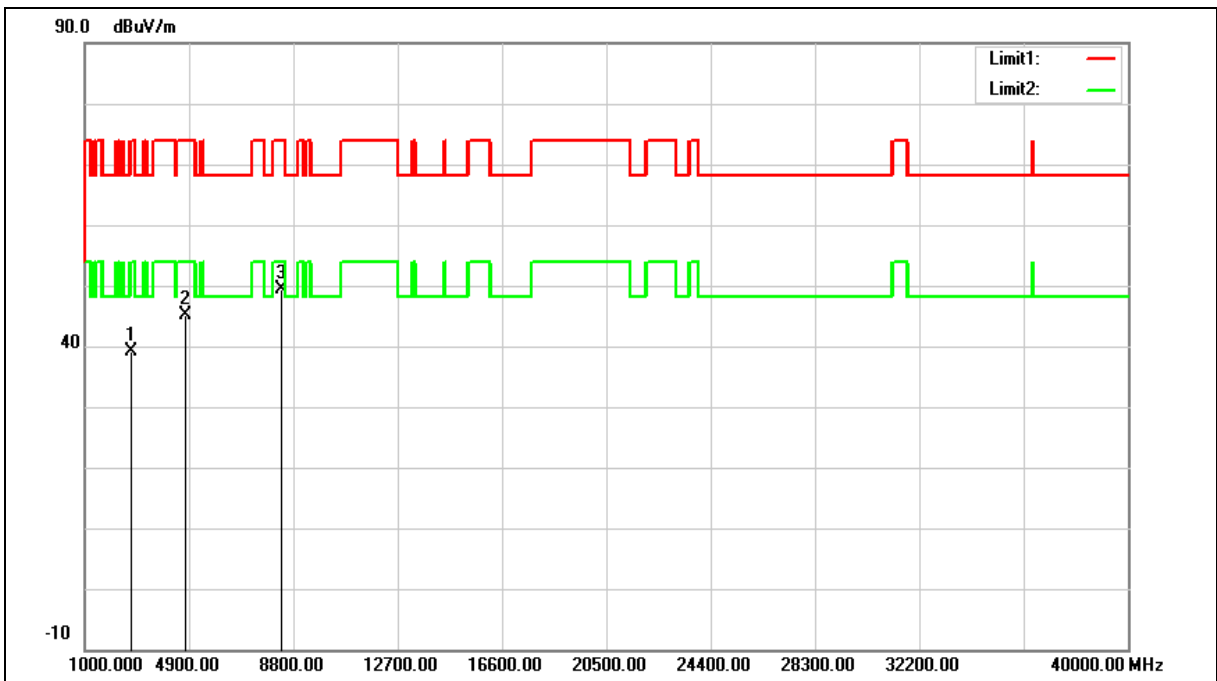

No.	Frequency (MHz)	Reading (dBuV)	Correct Factor (dB/m)	Result (dBuV/m)	Limit (dBuV/m)	Margin (dB)	Remark
1	2751.000	38.92	0.15	39.07	74.00	-34.93	peak
2	4723.000	39.72	5.39	45.11	74.00	-28.89	peak
3	8327.000	35.68	13.67	49.35	74.00	-24.65	peak

Note:1.Result (dBuV/m) = Correct Factor (dB/m) + Reading(dBuV).

2.Correction factor (dB/m) = Antenna Factor (dB/m) + Cable loss (dB) – Pre-Amplifier gain (dB).

3. When the peak results are less than average limit, so not need to evaluate the average.



### Band Edge

Standard:	FCC Part 15.407	Test Distance:	3 m
Test item:	Band edge	Power:	AC 120 V/60 Hz
Frequency:	5180 MHz	Temp.(°C)/Hum.(%RH):	26(°C)/60 %RH
Mode:	Mode 2		
Ant.Polar.:	Horizontal		

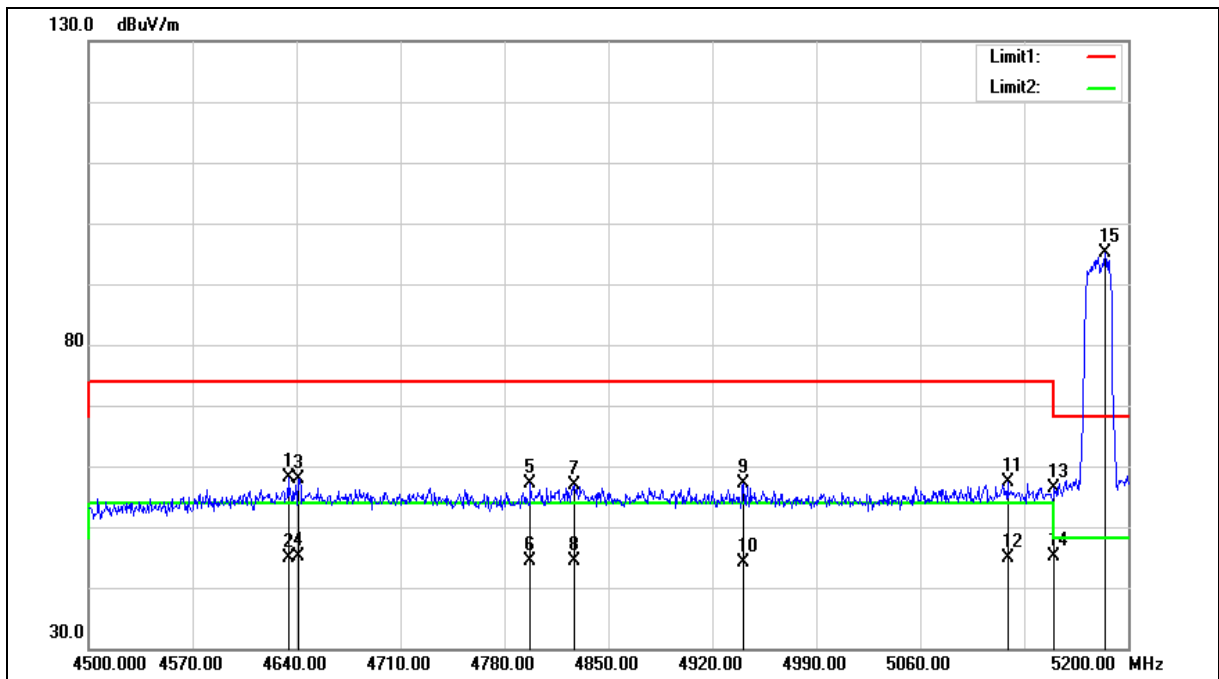





Standard:	FCC Part 15.407	Test Distance:	3 m
Test item:	Band edge	Power:	AC 120 V/60 Hz
Frequency:	5180 MHz	Temp.(°C)/Hum.(%RH):	26(°C)/60 %RH
Mode:	Mode 2		
Ant.Polar.:	Horizontal		

No.	Frequency (MHz)	Reading (dBuV)	Correct Factor (dB/m)	Result (dBuV/m)	Limit (dBuV/m)	Margin (dB)	Remark
1	4634.400	52.80	5.22	58.02	74.00	-15.98	peak
2	4634.400	39.70	5.22	44.92	54.00	-9.08	AVG
3	4641.400	52.77	5.23	58.00	74.00	-16.00	peak
4	4641.400	39.82	5.23	45.05	54.00	-8.95	AVG
5	4797.500	51.69	5.53	57.22	74.00	-16.78	peak
6	4797.500	38.81	5.53	44.34	54.00	-9.66	AVG
7	4826.900	51.35	5.57	56.92	74.00	-17.08	peak
8	4826.900	38.77	5.57	44.34	54.00	-9.66	AVG
9	4941.000	51.36	5.79	57.15	74.00	-16.85	peak
10	4941.000	38.28	5.79	44.07	54.00	-9.93	AVG
11	5118.800	51.22	6.20	57.42	74.00	-16.58	peak
12	5118.800	38.65	6.20	44.85	54.00	-9.15	AVG
13	5150.000	50.06	6.27	56.33	74.00	-17.67	peak
14	5150.000	38.87	6.27	45.14	54.00	-8.86	AVG
15	5184.600	88.82	6.34	95.16	---	---	peak

Note:1.Result (dBuV/m) = Correct Factor (dB/m) + Reading(dBuV).

2.Correction factor (dB/m) = Antenna Factor (dB/m) + Cable loss (dB) – Pre-Amplifier gain (dB).

3. When the peak results are less than average limit, so not need to evaluate the average.



Standard:	FCC Part 15.407	Test Distance:	3 m
Test item:	Band edge	Power:	AC 120 V/60 Hz
Frequency:	5180 MHz	Temp.(°C)/Hum.(%RH):	26(°C )/60 %RH
Mode:	Mode 2		
Ant.Polar.:	Vertical		

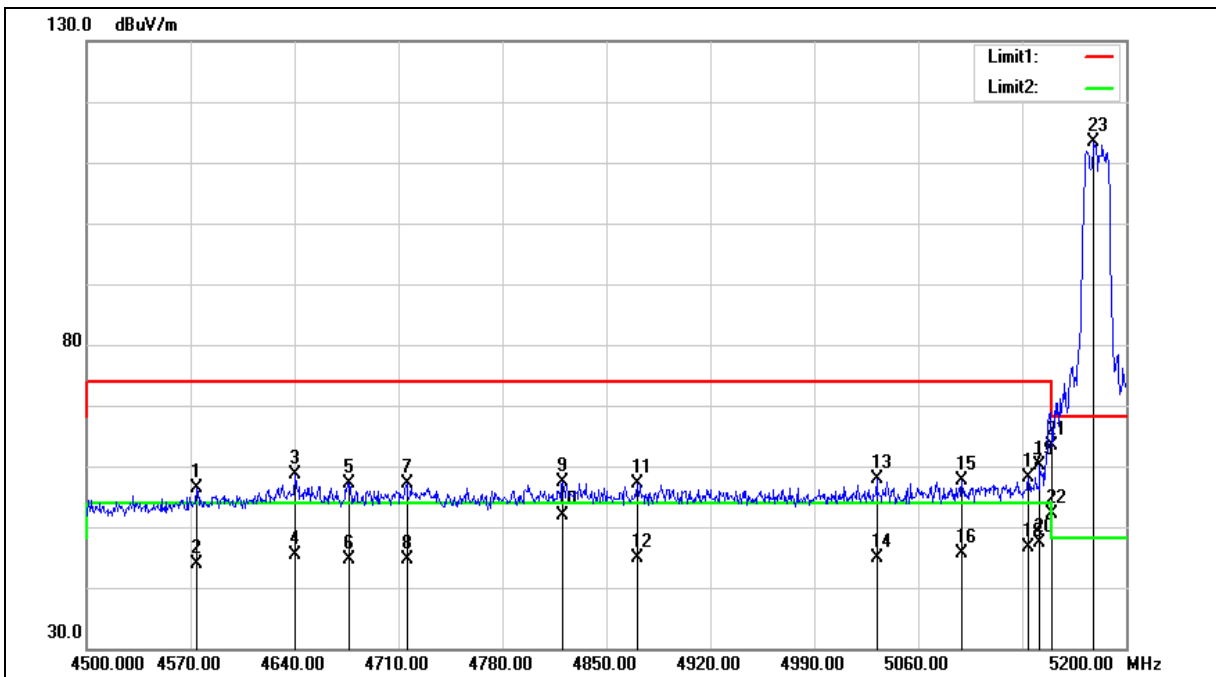



Standard:	FCC Part 15.407	Test Distance:	3 m
Test item:	Band edge	Power:	AC 120 V/60 Hz
Frequency:	5180 MHz	Temp.(°C)/Hum.(%RH):	26(°C)/60 %RH
Mode:	Mode 2		
Ant.Polar.:	Vertical		

No.	Frequency (MHz)	Reading (dBuV)	Correct Factor (dB/m)	Result (dBuV/m)	Limit (dBuV/m)	Margin (dB)	Remark
1	4574.200	51.21	5.10	56.31	74.00	-17.69	peak
2	4574.200	38.71	5.10	43.81	54.00	-10.19	AVG
3	4640.700	53.51	5.23	58.74	74.00	-15.26	peak
4	4640.700	40.23	5.23	45.46	54.00	-8.54	AVG
5	4676.400	51.83	5.29	57.12	74.00	-16.88	peak
6	4676.400	39.28	5.29	44.57	54.00	-9.43	AVG
7	4715.600	51.66	5.37	57.03	74.00	-16.97	peak
8	4715.600	39.28	5.37	44.65	54.00	-9.35	AVG
9	4820.600	51.82	5.56	57.38	74.00	-16.62	peak
10	4820.600	46.26	5.56	51.82	54.00	-2.18	AVG
11	4871.000	51.45	5.66	57.11	74.00	-16.89	peak
12	4871.000	39.34	5.66	45.00	54.00	-9.00	AVG
13	5032.000	52.01	5.98	57.99	74.00	-16.01	peak
14	5032.000	39.02	5.98	45.00	54.00	-9.00	AVG
15	5089.400	51.49	6.13	57.62	74.00	-16.38	peak
16	5089.400	39.49	6.13	45.62	54.00	-8.38	AVG
17	5134.200	51.96	6.23	58.19	74.00	-15.81	peak
18	5134.200	40.43	6.23	46.66	54.00	-7.34	AVG
19	5141.900	53.91	6.25	60.16	74.00	-13.84	peak
20	5141.900	41.06	6.25	47.31	54.00	-6.69	AVG
21	5150.000	57.10	6.27	63.37	74.00	-10.63	peak
22	5150.000	45.86	6.27	52.13	54.00	-1.87	AVG
23	5178.300	106.95	6.33	113.28	---	---	peak

Note:1.Result (dBuV/m) = Correct Factor (dB/m) + Reading(dBuV).

2.Correction factor (dB/m) = Antenna Factor (dB/m) + Cable loss (dB) – Pre-Amplifier gain (dB).

3. When the peak results are less than average limit, so not need to evaluate the average.



Standard:	FCC Part 15.407	Test Distance:	3 m
Test item:	Band edge	Power:	AC 120 V/60 Hz
Frequency:	5200 MHz	Temp.(°C)/Hum.(%RH):	26(°C)/60 %RH
Mode:	Mode 2		
Ant.Polar.:	Horizontal		

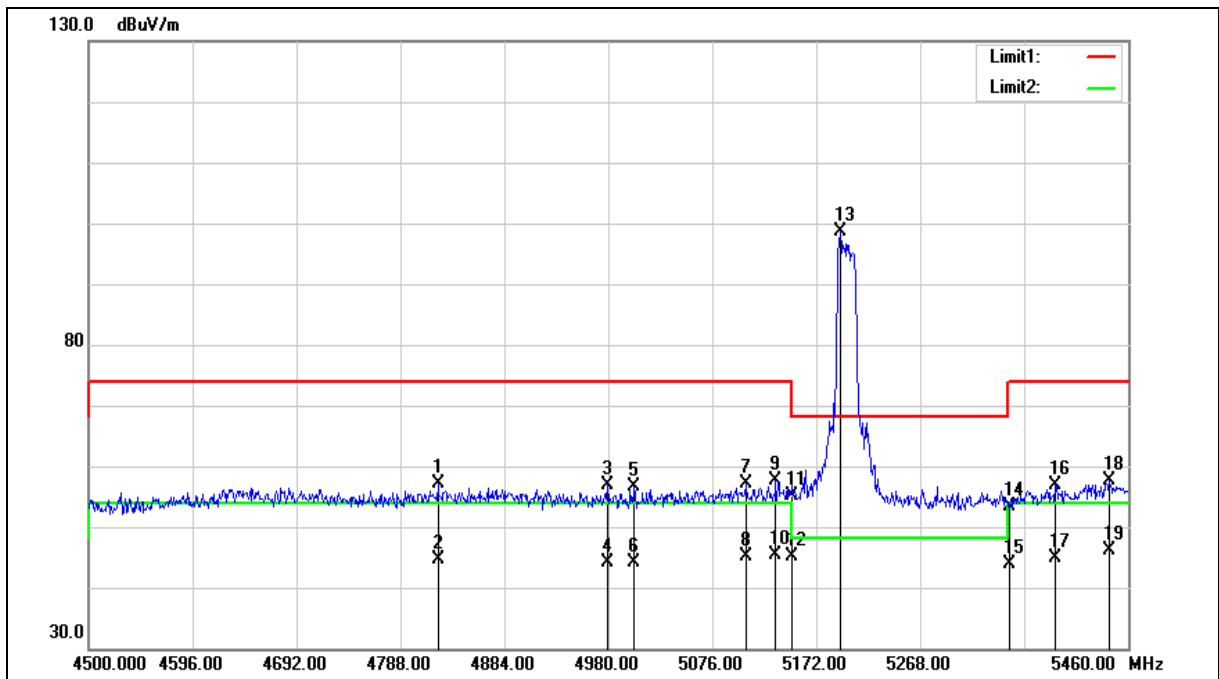



Standard:	FCC Part 15.407	Test Distance:	3 m
Test item:	Band edge	Power:	AC 120 V/60 Hz
Frequency:	5200 MHz	Temp.(°C)/Hum.(%RH):	26(°C )/60 %RH
Mode:	Mode 2		
Ant.Polar.:	Horizontal		

No.	Frequency (MHz)	Reading (dBuV)	Correct Factor (dB/m)	Result (dBuV/m)	Limit (dBuV/m)	Margin (dB)	Remark
1	4822.560	51.45	5.57	57.02	74.00	-16.98	peak
2	4822.560	39.16	5.57	44.73	54.00	-9.27	AVG
3	4979.040	50.88	5.88	56.76	74.00	-17.24	peak
4	4979.040	38.34	5.88	44.22	54.00	-9.78	AVG
5	5004.000	50.73	5.92	56.65	74.00	-17.35	peak
6	5004.000	38.29	5.92	44.21	54.00	-9.79	AVG
7	5106.720	50.91	6.16	57.07	74.00	-16.93	peak
8	5106.720	38.90	6.16	45.06	54.00	-8.94	AVG
9	5134.560	51.31	6.23	57.54	74.00	-16.46	peak
10	5134.560	39.07	6.23	45.30	54.00	-8.70	AVG
11	5150.000	48.83	6.27	55.10	74.00	-18.90	peak
12	5150.000	38.90	6.27	45.17	54.00	-8.83	AVG
13	5194.080	92.38	6.37	98.75	---	---	peak
14	5350.000	46.54	6.74	53.28	74.00	-20.72	peak
15	5350.000	37.20	6.74	43.94	54.00	-10.06	AVG
16	5392.800	50.13	6.84	56.97	74.00	-17.03	peak
17	5392.800	38.15	6.84	44.99	54.00	-9.01	AVG
18	5442.720	50.57	6.97	57.54	74.00	-16.46	peak
19	5442.720	39.04	6.97	46.01	54.00	-7.99	AVG

Note:1.Result (dBuV/m) = Correct Factor (dB/m) + Reading(dBuV).

2.Correction factor (dB/m) = Antenna Factor (dB/m) + Cable loss (dB) – Pre-Amplifier gain (dB).

3. When the peak results are less than average limit, so not need to evaluate the average.



Standard:	FCC Part 15.407	Test Distance:	3 m
Test item:	Band edge	Power:	AC 120 V/60 Hz
Frequency:	5200 MHz	Temp.(°C)/Hum.(%RH):	26(°C)/60 %RH
Mode:	Mode 2		
Ant.Polar.:	Vertical		

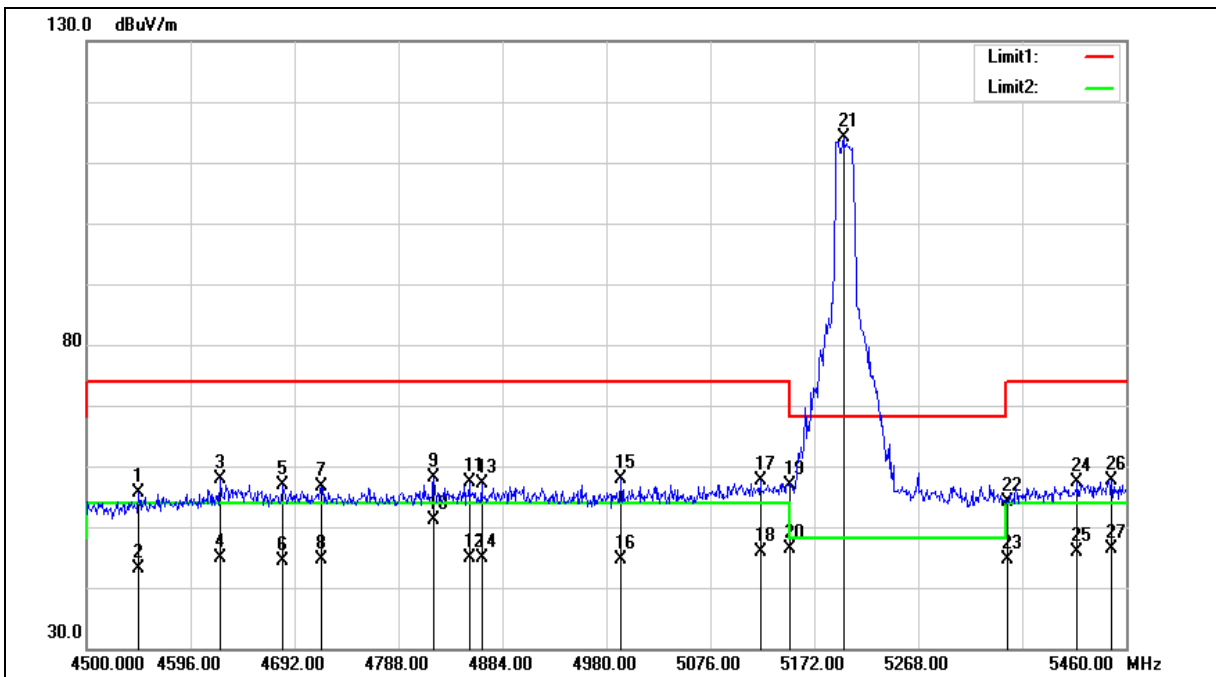

No.	Frequency (MHz)	Reading (dBuV)	Correct Factor (dB/m)	Result (dBuV/m)	Limit (dBuV/m)	Margin (dB)	Remark
1	4548.000	50.52	5.05	55.57	74.00	-18.43	peak
2	4548.000	38.04	5.05	43.09	54.00	-10.91	AVG
3	4622.880	52.68	5.19	57.87	74.00	-16.13	peak
4	4622.880	39.61	5.19	44.80	54.00	-9.20	AVG
5	4681.440	51.51	5.30	56.81	74.00	-17.19	peak
6	4681.440	39.13	5.30	44.43	54.00	-9.57	AVG
7	4716.960	51.16	5.37	56.53	74.00	-17.47	peak
8	4716.960	39.21	5.37	44.58	54.00	-9.42	AVG
9	4820.640	52.46	5.56	58.02	74.00	-15.98	peak

Note:1.Result (dBuV/m) = Correct Factor (dB/m) + Reading(dBuV).

2.Correction factor (dB/m) = Antenna Factor (dB/m) + Cable loss (dB) – Pre-Amplifier gain (dB).

3. When the peak results are less than average limit, so not need to evaluate the average.



Standard:	FCC Part 15.407	Test Distance:	3 m
Test item:	Band edge	Power:	AC 120 V/60 Hz
Frequency:	5200 MHz	Temp.(°C)/Hum.(%RH):	26(°C )/60 %RH
Mode:	Mode 2		
Ant.Polar.:	Vertical		

No.	Frequency (MHz)	Reading (dBUV)	Correct Factor (dB/m)	Result (dBUV/m)	Limit (dBUV/m)	Margin (dB)	Remark
10	4820.640	45.64	5.56	51.20	54.00	-2.80	AVG
11	4853.280	51.79	5.64	57.43	74.00	-16.57	peak
12	4853.280	39.21	5.64	44.85	54.00	-9.15	AVG
13	4864.800	51.58	5.65	57.23	74.00	-16.77	peak
14	4864.800	39.23	5.65	44.88	54.00	-9.12	AVG
15	4993.440	52.01	5.90	57.91	74.00	-16.09	peak
16	4993.440	38.74	5.90	44.64	54.00	-9.36	AVG
17	5122.080	51.43	6.20	57.63	74.00	-16.37	peak
18	5122.080	39.58	6.20	45.78	54.00	-8.22	AVG
19	5150.000	50.60	6.27	56.87	74.00	-17.13	peak
20	5150.000	39.99	6.27	46.26	54.00	-7.74	AVG
21	5198.880	107.67	6.38	114.05	---	---	peak
22	5350.000	47.36	6.74	54.10	74.00	-19.90	peak
23	5350.000	37.97	6.74	44.71	54.00	-9.29	AVG
24	5414.880	50.43	6.90	57.33	74.00	-16.67	peak
25	5414.880	38.89	6.90	45.79	54.00	-8.21	AVG
26	5446.560	50.57	6.98	57.55	74.00	-16.45	peak
27	5446.560	39.32	6.98	46.30	54.00	-7.70	AVG

Note:1.Result (dBUV/m) = Correct Factor (dB/m) + Reading(dBUV).

2.Correction factor (dB/m) = Antenna Factor (dB/m) + Cable loss (dB) – Pre-Amplifier gain (dB).

3. When the peak results are less than average limit, so not need to evaluate the average.



Standard:	FCC Part 15.407	Test Distance:	3 m
Test item:	Band edge	Power:	AC 120 V/60 Hz
Frequency:	5240 MHz	Temp.(°C)/Hum.(%RH):	26(°C)/60 %RH
Mode:	Mode 2		
Ant.Polar.:	Horizontal		

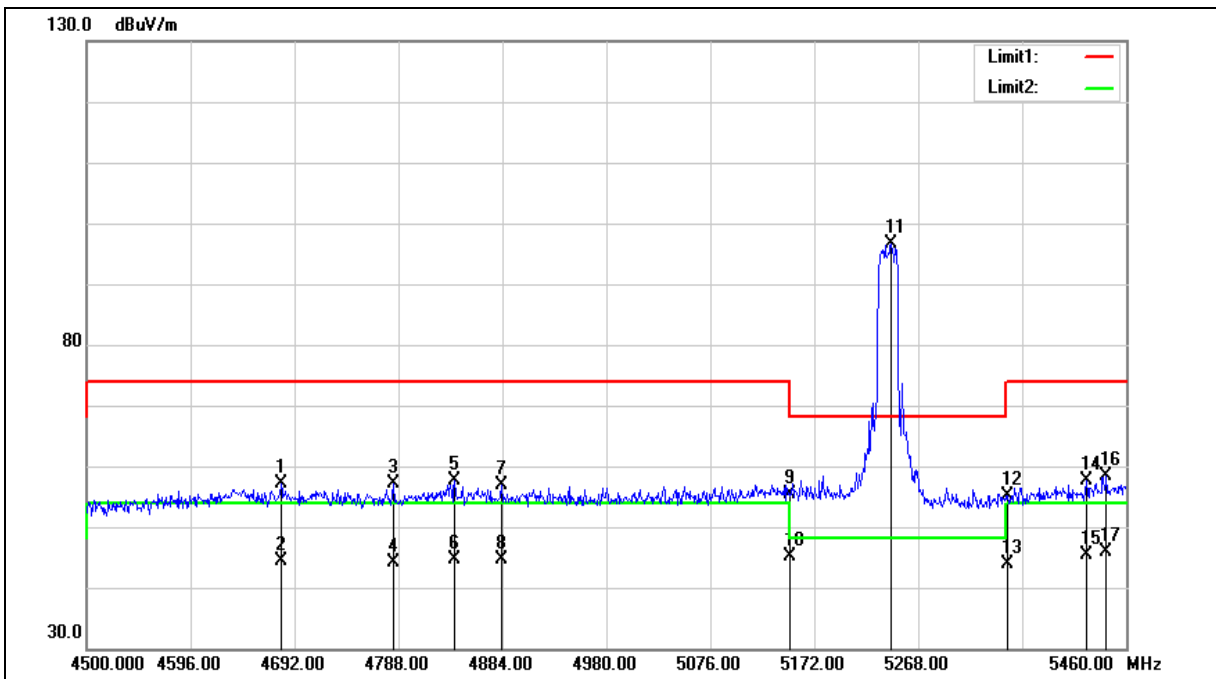





Standard:	FCC Part 15.407	Test Distance:	3 m
Test item:	Band edge	Power:	AC 120 V/60 Hz
Frequency:	5240 MHz	Temp.(°C)/Hum.(%RH):	26(°C )/60 %RH
Mode:	Mode 2		
Ant.Polar.:	Horizontal		

No.	Frequency (MHz)	Reading (dBuV)	Correct Factor (dB/m)	Result (dBuV/m)	Limit (dBuV/m)	Margin (dB)	Remark
1	4679.520	51.80	5.30	57.10	74.00	-16.90	peak
2	4679.520	39.16	5.30	44.46	54.00	-9.54	AVG
3	4783.200	51.58	5.50	57.08	74.00	-16.92	peak
4	4783.200	38.59	5.50	44.09	54.00	-9.91	AVG
5	4839.840	52.06	5.61	57.67	74.00	-16.33	peak
6	4839.840	39.11	5.61	44.72	54.00	-9.28	AVG
7	4883.040	51.14	5.69	56.83	74.00	-17.17	peak
8	4883.040	38.91	5.69	44.60	54.00	-9.40	AVG
9	5150.000	49.13	6.27	55.40	74.00	-18.60	peak
10	5150.000	38.89	6.27	45.16	54.00	-8.84	AVG
11	5243.040	90.20	6.49	96.69	---	---	peak
12	5350.000	48.37	6.74	55.11	74.00	-18.89	peak
13	5350.000	37.10	6.74	43.84	54.00	-10.16	AVG
14	5423.520	50.65	6.92	57.57	74.00	-16.43	peak
15	5423.520	38.57	6.92	45.49	54.00	-8.51	AVG
16	5441.760	51.32	6.97	58.29	74.00	-15.71	peak
17	5441.760	38.89	6.97	45.86	54.00	-8.14	AVG

Note:1.Result (dBuV/m) = Correct Factor (dB/m) + Reading(dBuV).

2.Correction factor (dB/m) = Antenna Factor (dB/m) + Cable loss (dB) – Pre-Amplifier gain (dB).

3. When the peak results are less than average limit, so not need to evaluate the average.



Standard:	FCC Part 15.407	Test Distance:	3 m
Test item:	Band edge	Power:	AC 120 V/60 Hz
Frequency:	5240 MHz	Temp.(°C)/Hum.(%RH):	26(°C)/60 %RH
Mode:	Mode 2		
Ant.Polar.:	Vertical		

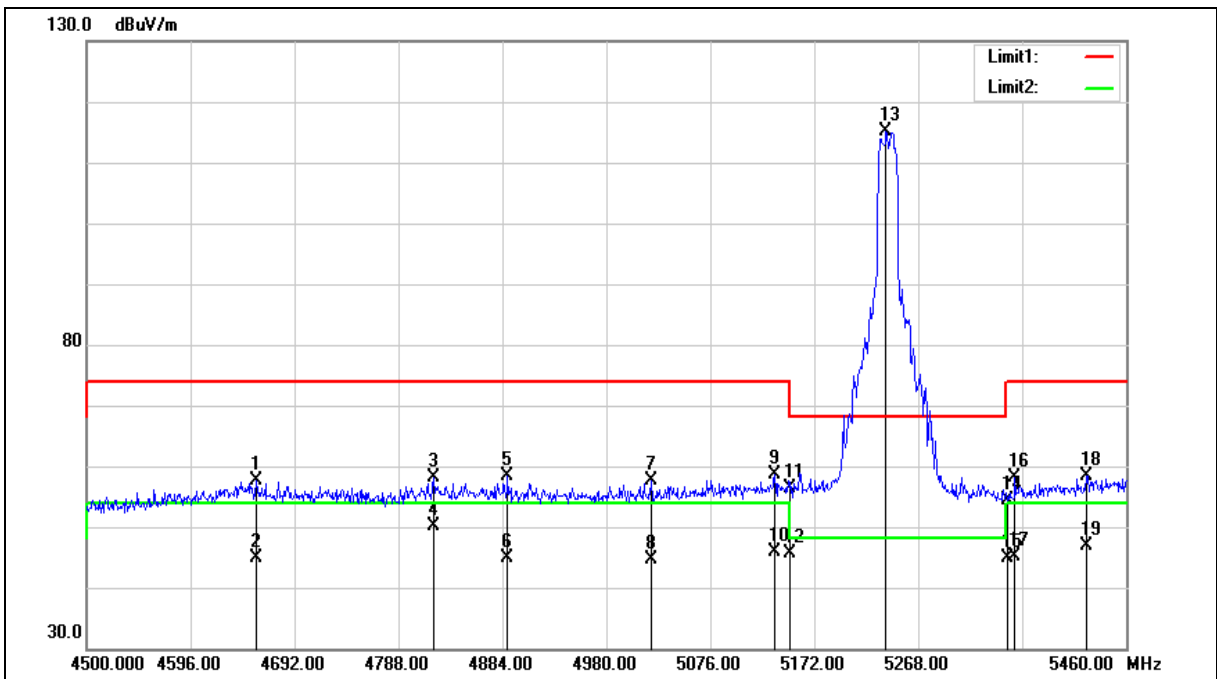



Standard:	FCC Part 15.407	Test Distance:	3 m
Test item:	Band edge	Power:	AC 120 V/60 Hz
Frequency:	5240 MHz	Temp.(°C)/Hum.(%RH):	26(°C )/60 %RH
Mode:	Mode 2		
Ant.Polar.:	Vertical		

No.	Frequency (MHz)	Reading (dBuV)	Correct Factor (dB/m)	Result (dBuV/m)	Limit (dBuV/m)	Margin (dB)	Remark
1	4656.480	52.46	5.25	57.71	74.00	-16.29	peak
2	4656.480	39.71	5.25	44.96	54.00	-9.04	AVG
3	4820.640	52.52	5.56	58.08	74.00	-15.92	peak
4	4820.640	44.68	5.56	50.24	54.00	-3.76	AVG
5	4888.800	52.61	5.70	58.31	74.00	-15.69	peak
6	4888.800	39.09	5.70	44.79	54.00	-9.21	AVG
7	5021.280	51.62	5.96	57.58	74.00	-16.42	peak
8	5021.280	38.76	5.96	44.72	54.00	-9.28	AVG
9	5135.520	52.31	6.23	58.54	74.00	-15.46	peak
10	5135.520	39.65	6.23	45.88	54.00	-8.12	AVG
11	5150.000	50.22	6.27	56.49	74.00	-17.51	peak
12	5150.000	39.28	6.27	45.55	54.00	-8.45	AVG
13	5238.240	108.53	6.48	115.01	---	---	peak
14	5350.000	47.58	6.74	54.32	74.00	-19.68	peak
15	5350.000	38.07	6.74	44.81	54.00	-9.19	AVG
16	5357.280	51.25	6.76	58.01	74.00	-15.99	peak
17	5357.280	38.26	6.76	45.02	54.00	-8.98	AVG
18	5423.520	51.44	6.92	58.36	74.00	-15.64	peak
19	5423.520	39.97	6.92	46.89	54.00	-7.11	AVG

Note:1.Result (dBuV/m) = Correct Factor (dB/m) + Reading(dBuV).

2.Correction factor (dB/m) = Antenna Factor (dB/m) + Cable loss (dB) – Pre-Amplifier gain (dB).

3. When the peak results are less than average limit, so not need to evaluate the average.



Standard:	FCC Part 15.407	Test Distance:	3 m
Test item:	Band edge	Power:	AC 120 V/60 Hz
Frequency:	5745 MHz	Temp.(°C)/Hum.(%RH):	26(°C)/60 %RH
Mode:	Mode 2		
Ant.Polar.:	Horizontal		

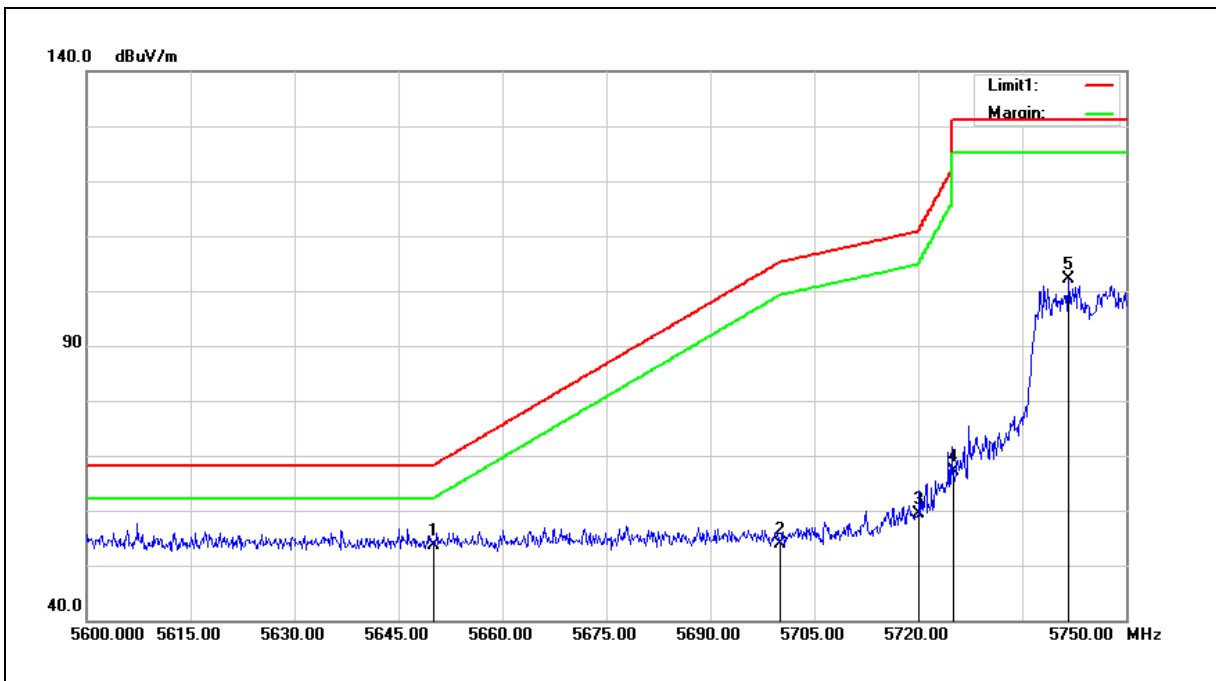

No.	Frequency (MHz)	Reading (dBuV)	Correct Factor (dB/m)	Result (dBuV/m)	Limit (dBuV/m)	Margin (dB)	Remark
1	5650.000	46.18	7.42	53.60	68.20	-14.60	peak
2	5700.000	46.45	7.52	53.97	105.20	-51.23	peak
3	5720.000	51.71	7.56	59.27	110.80	-51.53	peak
4	5725.000	59.52	7.57	67.09	122.20	-55.11	peak
5	5741.750	94.41	7.61	102.02	---	---	peak

Note:1.Result (dBuV/m) = Correct Factor (dB/m) + Reading(dBuV).

2.Correction factor (dB/m) = Antenna Factor (dB/m) + Cable loss (dB) – Pre-Amplifier gain (dB).

3. When the peak results are less than average limit, so not need to evaluate the average.



Standard:	FCC Part 15.407	Test Distance:	3 m
Test item:	Band edge	Power:	AC 120 V/60 Hz
Frequency:	5745 MHz	Temp.(°C)/Hum.(%RH):	26(°C)/60 %RH
Mode:	Mode 2		
Ant.Polar.:	Vertical		

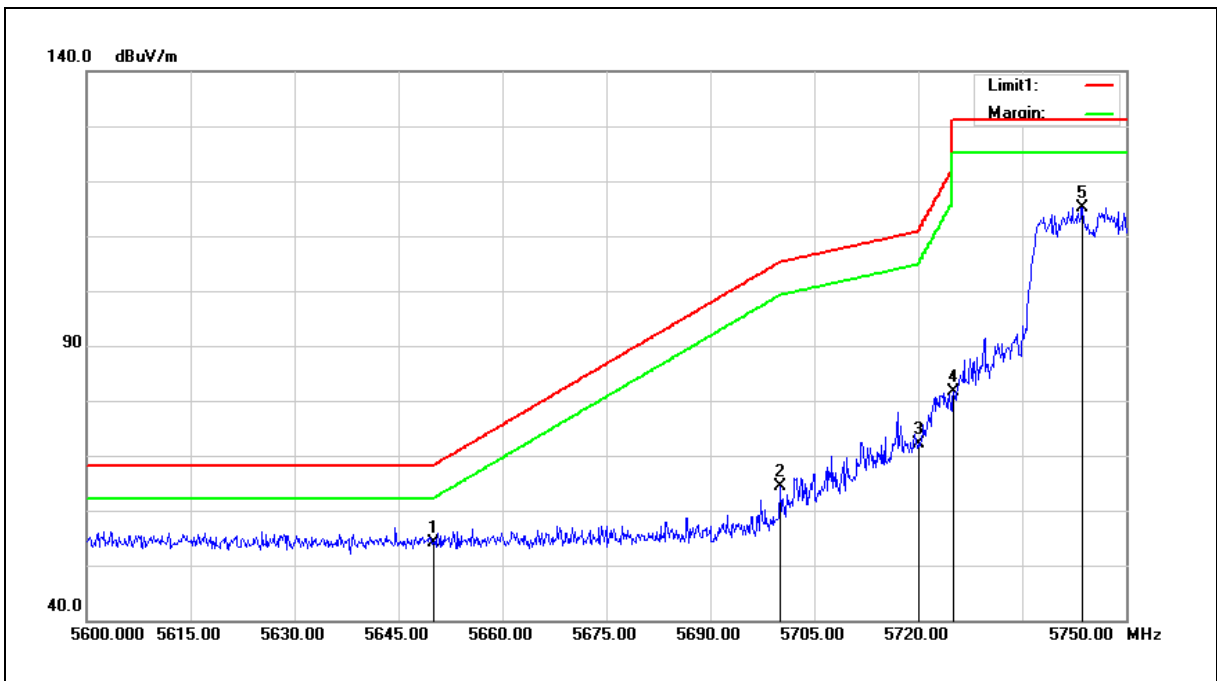

No.	Frequency (MHz)	Reading (dBuV)	Correct Factor (dB/m)	Result (dBuV/m)	Limit (dBuV/m)	Margin (dB)	Remark
1	5650.000	46.77	7.42	54.19	68.20	-14.01	peak
2	5700.000	56.95	7.52	64.47	105.20	-40.73	peak
3	5720.000	64.67	7.56	72.23	110.80	-38.57	peak
4	5725.000	74.04	7.57	81.61	122.20	-40.59	peak
5	5743.700	107.49	7.61	115.10	---	---	peak

Note:1.Result (dBuV/m) = Correct Factor (dB/m) + Reading(dBuV).

2.Correction factor (dB/m) = Antenna Factor (dB/m) + Cable loss (dB) – Pre-Amplifier gain (dB).

3. When the peak results are less than average limit, so not need to evaluate the average.



Standard:	FCC Part 15.407	Test Distance:	3 m
Test item:	Band edge	Power:	AC 120 V/60 Hz
Frequency:	5785 MHz	Temp.(°C)/Hum.(%RH):	26(°C)/60 %RH
Mode:	Mode 2		
Ant.Polar.:	Horizontal		

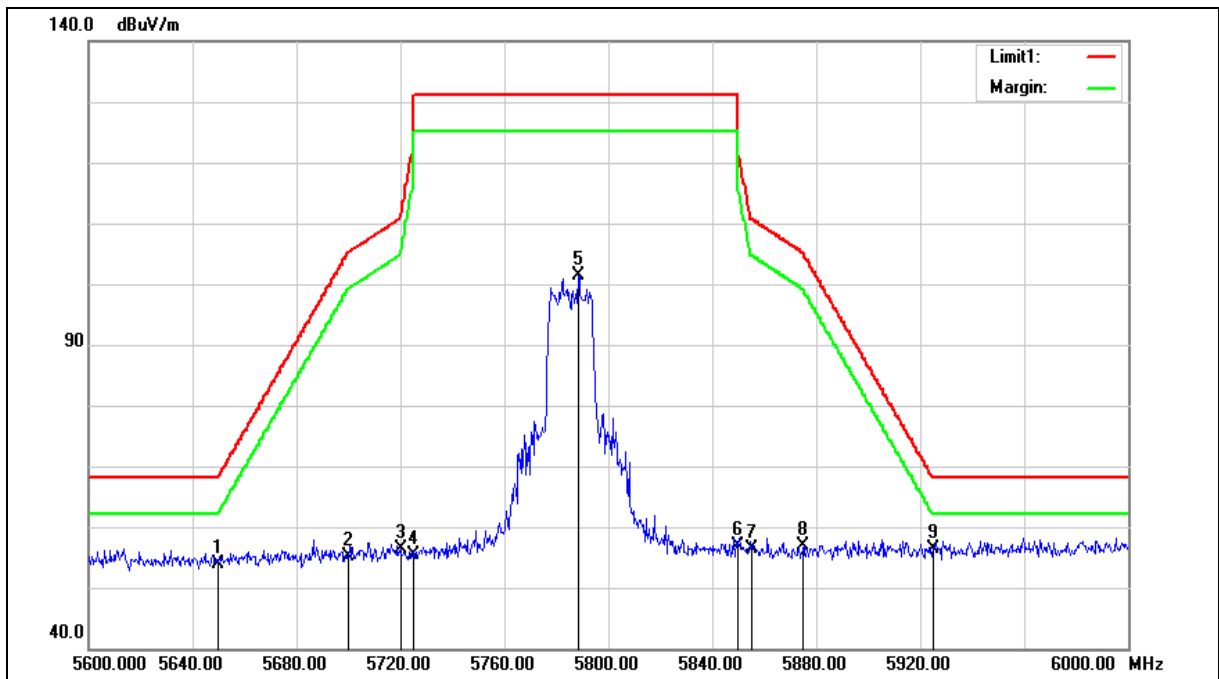



Standard:	FCC Part 15.407	Test Distance:	3 m
Test item:	Band edge	Power:	AC 120 V/60 Hz
Frequency:	5785 MHz	Temp.(°C)/Hum.(%RH):	26(°C )/60 %RH
Mode:	Mode 2		
Ant.Polar.:	Horizontal		

No.	Frequency (MHz)	Reading (dBuV)	Correct Factor (dB/m)	Result (dBuV/m)	Limit (dBuV/m)	Margin (dB)	Remark
1	5650.000	46.51	7.42	53.93	68.20	-14.27	peak
2	5700.000	47.58	7.52	55.10	105.20	-50.10	peak
3	5720.000	48.94	7.56	56.50	110.80	-54.30	peak
4	5725.000	47.74	7.57	55.31	122.20	-66.89	peak
5	5788.400	93.71	7.71	101.42	---	---	peak
6	5850.000	48.98	7.83	56.81	122.20	-65.39	peak
7	5855.000	48.47	7.85	56.32	110.80	-54.48	peak
8	5875.000	48.88	7.88	56.76	105.20	-48.44	peak
9	5925.000	48.41	8.00	56.41	68.20	-11.79	peak

Note:1.Result (dBuV/m) = Correct Factor (dB/m) + Reading(dBuV).

2.Correction factor (dB/m) = Antenna Factor (dB/m) + Cable loss (dB) – Pre-Amplifier gain (dB).

3. When the peak results are less than average limit, so not need to evaluate the average.



Standard:	FCC Part 15.407	Test Distance:	3 m
Test item:	Band edge	Power:	AC 120 V/60 Hz
Frequency:	5785 MHz	Temp.(°C)/Hum.(%RH):	26(°C)/60 %RH
Mode:	Mode 2		
Ant.Polar.:	Vertical		

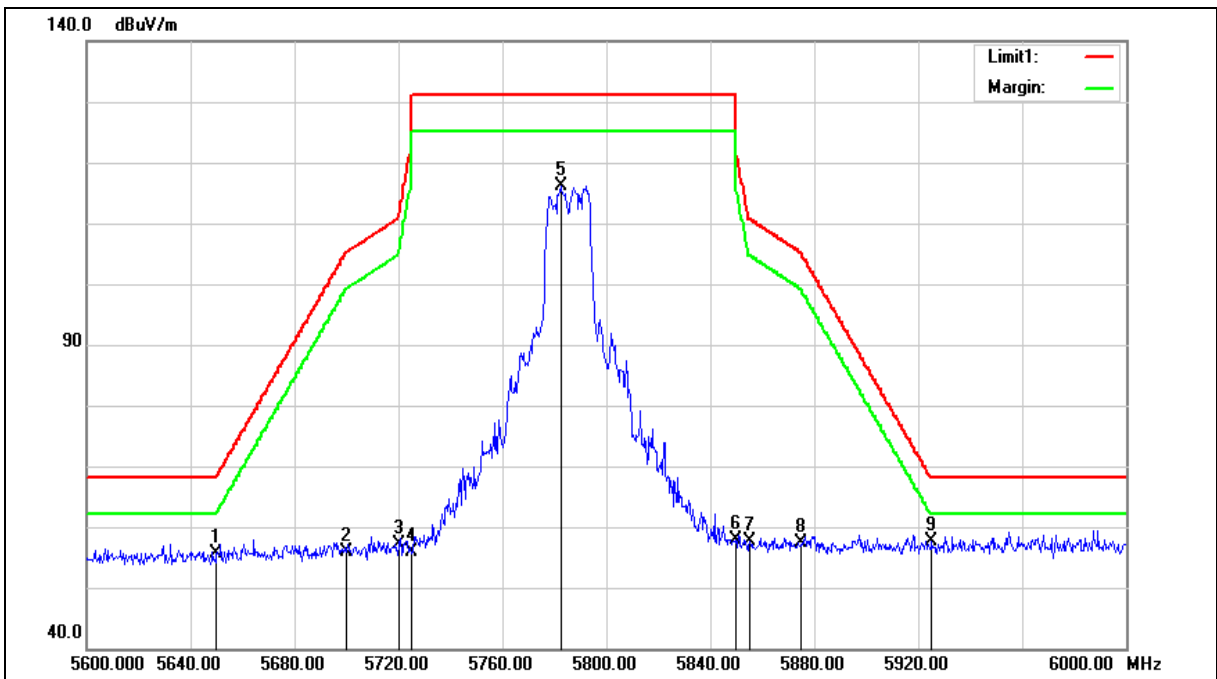





Standard:	FCC Part 15.407	Test Distance:	3 m
Test item:	Band edge	Power:	AC 120 V/60 Hz
Frequency:	5785 MHz	Temp.(°C)/Hum.(%RH):	26(°C )/60 %RH
Mode:	Mode 2		
Ant.Polar.:	Vertical		

No.	Frequency (MHz)	Reading (dBuV)	Correct Factor (dB/m)	Result (dBuV/m)	Limit (dBuV/m)	Margin (dB)	Remark
1	5650.000	48.12	7.42	55.54	68.20	-12.66	peak
2	5700.000	48.24	7.52	55.76	105.20	-49.44	peak
3	5720.000	49.52	7.56	57.08	110.80	-53.72	peak
4	5725.000	48.33	7.57	55.90	122.20	-66.30	peak
5	5782.400	108.47	7.69	116.16	---	---	peak
6	5850.000	50.00	7.83	57.83	122.20	-64.37	peak
7	5855.000	49.73	7.85	57.58	110.80	-53.22	peak
8	5875.000	49.52	7.88	57.40	105.20	-47.80	peak
9	5925.000	49.62	8.00	57.62	68.20	-10.58	peak

Note:1.Result (dBuV/m) = Correct Factor (dB/m) + Reading(dBuV).

2.Correction factor (dB/m) = Antenna Factor (dB/m) + Cable loss (dB) – Pre-Amplifier gain (dB).

3. When the peak results are less than average limit, so not need to evaluate the average.



Standard:	FCC Part 15.407	Test Distance:	3 m
Test item:	Band edge	Power:	AC 120 V/60 Hz
Frequency:	5825 MHz	Temp.(°C)/Hum.(%RH):	26(°C)/60 %RH
Mode:	Mode 2		
Ant.Polar.:	Horizontal		

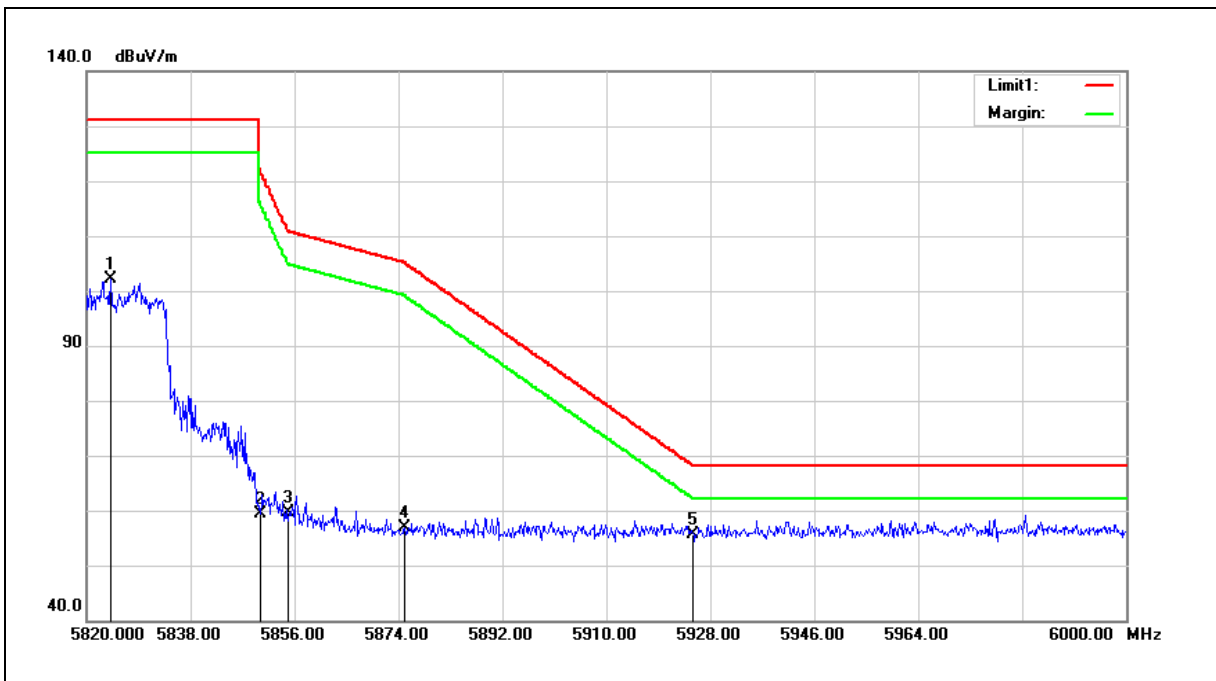

No.	Frequency (MHz)	Reading (dBuV)	Correct Factor (dB/m)	Result (dBuV/m)	Limit (dBuV/m)	Margin (dB)	Remark
1	5824.140	94.36	7.78	102.14	---	---	peak
2	5850.000	51.51	7.83	59.34	122.20	-62.86	peak
3	5855.000	51.68	7.85	59.53	110.80	-51.27	peak
4	5875.000	49.07	7.88	56.95	105.20	-48.25	peak
5	5925.000	47.74	8.00	55.74	68.20	-12.46	peak

Note:1.Result (dBuV/m) = Correct Factor (dB/m) + Reading(dBuV).

2.Correction factor (dB/m) = Antenna Factor (dB/m) + Cable loss (dB) – Pre-Amplifier gain (dB).

3. When the peak results are less than average limit, so not need to evaluate the average.



Standard:	FCC Part 15.407	Test Distance:	3 m
Test item:	Band edge	Power:	AC 120 V/60 Hz
Frequency:	5825 MHz	Temp.(°C)/Hum.(%RH):	26(°C)/60 %RH
Mode:	Mode 2		
Ant.Polar.:	Vertical		

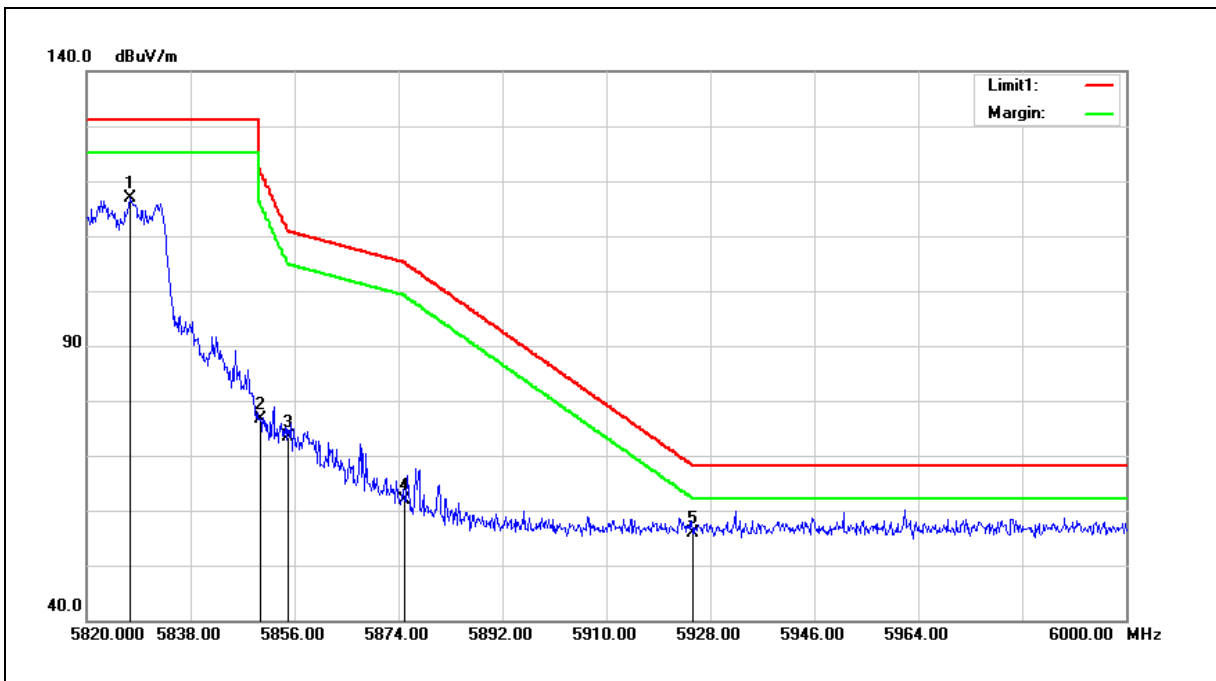

No.	Frequency (MHz)	Reading (dBuV)	Correct Factor (dB/m)	Result (dBuV/m)	Limit (dBuV/m)	Margin (dB)	Remark
1	5827.560	108.98	7.78	116.76	---	---	peak
2	5850.000	68.91	7.83	76.74	122.20	-45.46	peak
3	5855.000	65.46	7.85	73.31	110.80	-37.49	peak
4	5875.000	54.05	7.88	61.93	105.20	-43.27	peak
5	5925.000	47.97	8.00	55.97	68.20	-12.23	peak

Note:1.Result (dBuV/m) = Correct Factor (dB/m) + Reading(dBuV).

2.Correction factor (dB/m) = Antenna Factor (dB/m) + Cable loss (dB) – Pre-Amplifier gain (dB).

3. When the peak results are less than average limit, so not need to evaluate the average.



Standard:	FCC Part 15.407	Test Distance:	3 m
Test item:	Band edge	Power:	AC 120 V/60 Hz
Frequency:	5180 MHz	Temp.(°C)/Hum.(%RH):	26(°C)/60 %RH
Mode:	Mode 3		
Ant.Polar.:	Horizontal		

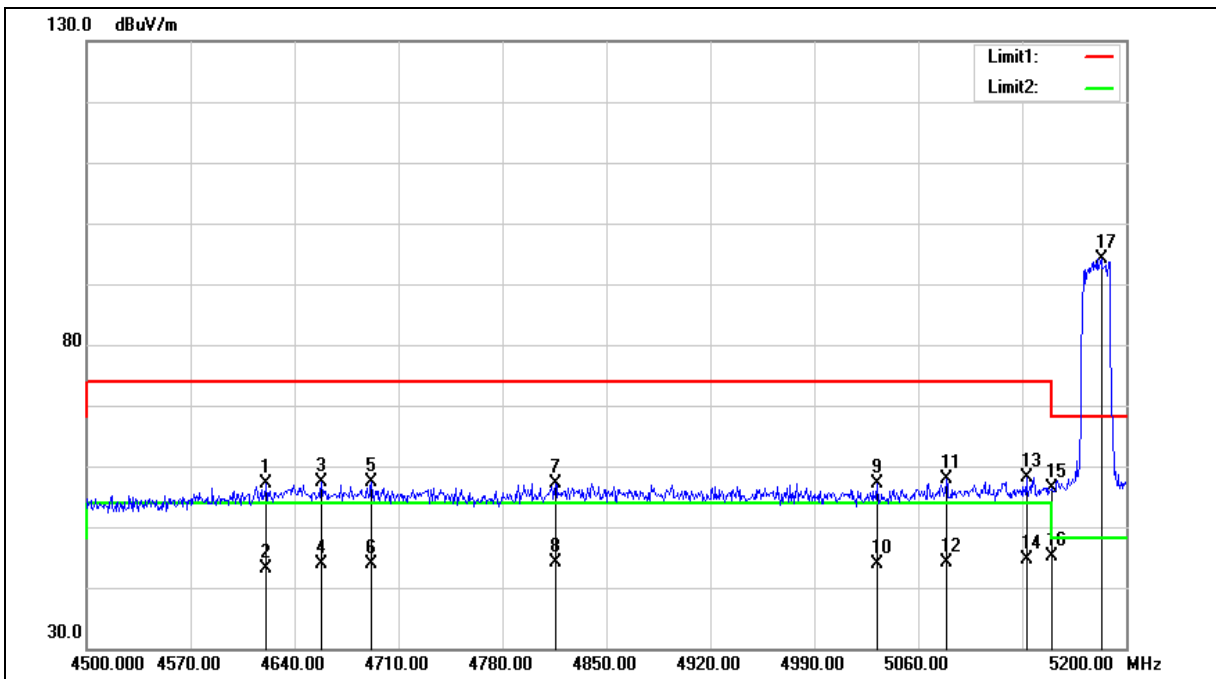



Standard:	FCC Part 15.407	Test Distance:	3 m
Test item:	Band edge	Power:	AC 120 V/60 Hz
Frequency:	5180 MHz	Temp.(°C)/Hum.(%RH):	26(°C )/60 %RH
Mode:	Mode 3		
Ant.Polar.:	Horizontal		

No.	Frequency (MHz)	Reading (dBuV)	Correct Factor (dB/m)	Result (dBuV/m)	Limit (dBuV/m)	Margin (dB)	Remark
1	4621.100	51.86	5.18	57.04	74.00	-16.96	peak
2	4621.100	37.83	5.18	43.01	54.00	-10.99	AVG
3	4658.200	52.03	5.26	57.29	74.00	-16.71	peak
4	4658.200	38.73	5.26	43.99	54.00	-10.01	AVG
5	4691.800	52.13	5.31	57.44	74.00	-16.56	peak
6	4691.800	38.60	5.31	43.91	54.00	-10.09	AVG
7	4815.700	51.67	5.55	57.22	74.00	-16.78	peak
8	4815.700	38.50	5.55	44.05	54.00	-9.95	AVG
9	5032.000	51.15	5.98	57.13	74.00	-16.87	peak
10	5032.000	37.78	5.98	43.76	54.00	-10.24	AVG
11	5078.900	51.78	6.09	57.87	74.00	-16.13	peak
12	5078.900	38.05	6.09	44.14	54.00	-9.86	AVG
13	5132.800	51.89	6.22	58.11	74.00	-15.89	peak
14	5132.800	38.48	6.22	44.70	54.00	-9.30	AVG
15	5150.000	50.07	6.27	56.34	74.00	-17.66	peak
16	5150.000	38.90	6.27	45.17	54.00	-8.83	AVG
17	5183.200	87.82	6.34	94.16	---	---	peak

Note:1.Result (dBuV/m) = Correct Factor (dB/m) + Reading(dBuV).

2.Correction factor (dB/m) = Antenna Factor (dB/m) + Cable loss (dB) – Pre-Amplifier gain (dB).

3. When the peak results are less than average limit, so not need to evaluate the average.



Standard:	FCC Part 15.407	Test Distance:	3 m
Test item:	Band edge	Power:	AC 120 V/60 Hz
Frequency:	5180 MHz	Temp.(°C)/Hum.(%RH):	26(°C)/60 %RH
Mode:	Mode 3		
Ant.Polar.:	Vertical		

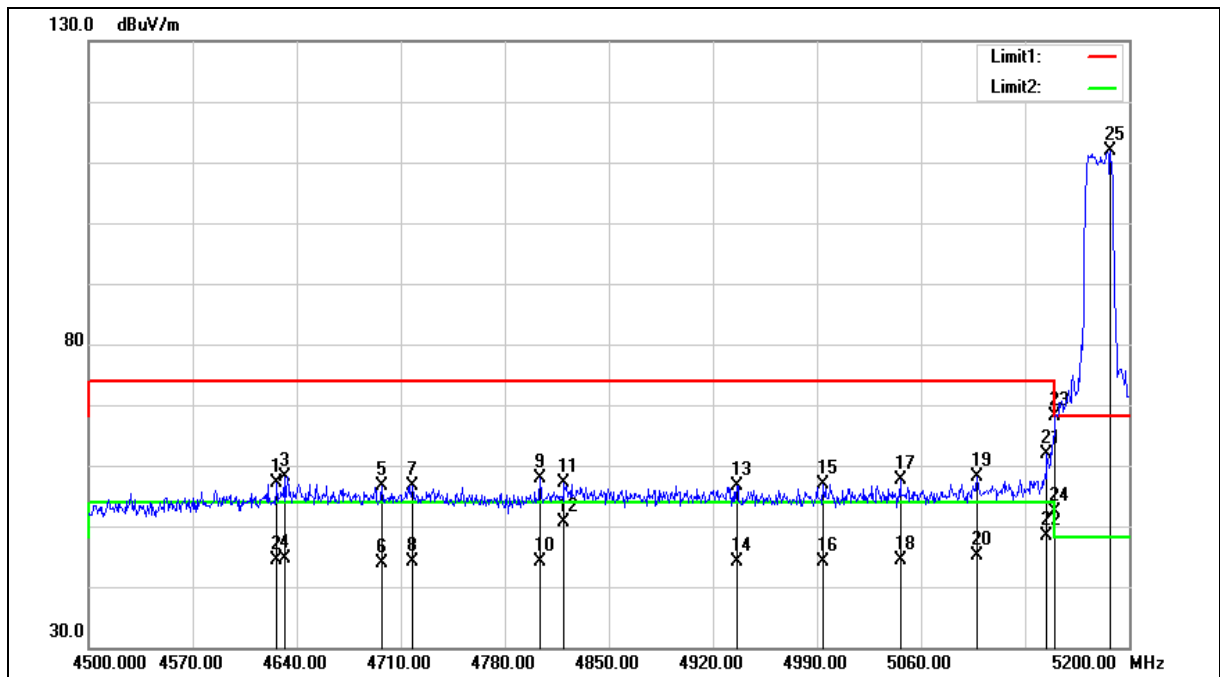



Standard:	FCC Part 15.407	Test Distance:	3 m
Test item:	Band edge	Power:	AC 120 V/60 Hz
Frequency:	5180 MHz	Temp.(°C)/Hum.(%RH):	26(°C)/60 %RH
Mode:	Mode 3		
Ant.Polar.:	Vertical		

No.	Frequency (MHz)	Reading (dBUV)	Correct Factor (dB/m)	Result (dBUV/m)	Limit (dBUV/m)	Margin (dB)	Remark
1	4626.700	51.86	5.19	57.05	74.00	-16.95	peak
2	4626.700	39.26	5.19	44.45	54.00	-9.55	AVG
3	4631.600	53.03	5.20	58.23	74.00	-15.77	peak
4	4631.600	39.49	5.20	44.69	54.00	-9.31	AVG
5	4697.400	51.41	5.32	56.73	74.00	-17.27	peak
6	4697.400	38.63	5.32	43.95	54.00	-10.05	AVG
7	4717.700	51.25	5.38	56.63	74.00	-17.37	peak
8	4717.700	38.73	5.38	44.11	54.00	-9.89	AVG
9	4803.800	52.37	5.54	57.91	74.00	-16.09	peak
10	4803.800	38.59	5.54	44.13	54.00	-9.87	AVG
11	4819.900	51.52	5.56	57.08	74.00	-16.92	peak
12	4819.900	45.13	5.56	50.69	54.00	-3.31	AVG
13	4936.100	50.86	5.79	56.65	74.00	-17.35	peak
14	4936.100	38.27	5.79	44.06	54.00	-9.94	AVG
15	4994.200	51.08	5.90	56.98	74.00	-17.02	peak
16	4994.200	38.23	5.90	44.13	54.00	-9.87	AVG
17	5046.000	51.67	6.02	57.69	74.00	-16.31	peak
18	5046.000	38.35	6.02	44.37	54.00	-9.63	AVG
19	5097.800	51.97	6.15	58.12	74.00	-15.88	peak
20	5097.800	38.98	6.15	45.13	54.00	-8.87	AVG
21	5144.700	55.68	6.26	61.94	74.00	-12.06	peak
22	5144.700	42.09	6.26	48.35	54.00	-5.65	AVG
23	5150.000	61.87	6.27	68.14	74.00	-5.86	peak
24	5150.000	46.00	6.27	52.27	54.00	-1.73	AVG
25	5187.400	105.50	6.35	111.85	---	---	peak

Note:1.Result (dBUV/m) = Correct Factor (dB/m) + Reading(dBUV).

2.Correction factor (dB/m) = Antenna Factor (dB/m) + Cable loss (dB) – Pre-Amplifier gain (dB).

3. When the peak results are less than average limit, so not need to evaluate the average.



Standard:	FCC Part 15.407	Test Distance:	3 m
Test item:	Band edge	Power:	AC 120 V/60 Hz
Frequency:	5200 MHz	Temp.(°C)/Hum.(%RH):	26(°C)/60 %RH
Mode:	Mode 3		
Ant.Polar.:	Horizontal		

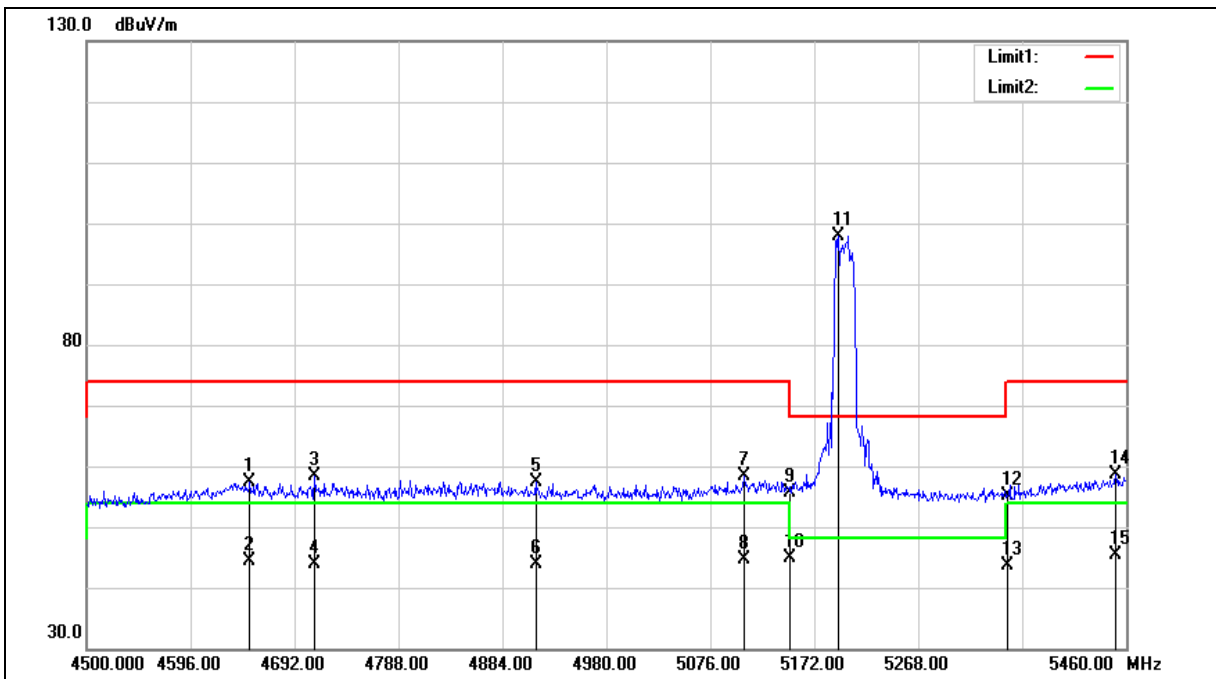





Standard:	FCC Part 15.407	Test Distance:	3 m
Test item:	Band edge	Power:	AC 120 V/60 Hz
Frequency:	5200 MHz	Temp.(°C)/Hum.(%RH):	26(°C )/60 %RH
Mode:	Mode 3		
Ant.Polar.:	Horizontal		

No.	Frequency (MHz)	Reading (dBuV)	Correct Factor (dB/m)	Result (dBuV/m)	Limit (dBuV/m)	Margin (dB)	Remark
1	4650.720	52.05	5.24	57.29	74.00	-16.71	peak
2	4650.720	39.24	5.24	44.48	54.00	-9.52	AVG
3	4710.240	53.14	5.36	58.50	74.00	-15.50	peak
4	4710.240	38.48	5.36	43.84	54.00	-10.16	AVG
5	4914.720	51.73	5.75	57.48	74.00	-16.52	peak
6	4914.720	38.25	5.75	44.00	54.00	-10.00	AVG
7	5107.680	52.11	6.17	58.28	74.00	-15.72	peak
8	5107.680	38.37	6.17	44.54	54.00	-9.46	AVG
9	5150.000	49.44	6.27	55.71	74.00	-18.29	peak
10	5150.000	38.52	6.27	44.79	54.00	-9.21	AVG
11	5194.080	91.62	6.37	97.99	---	---	peak
12	5350.000	48.43	6.74	55.17	74.00	-18.83	peak
13	5350.000	36.77	6.74	43.51	54.00	-10.49	AVG
14	5450.400	51.63	6.98	58.61	74.00	-15.39	peak
15	5450.400	38.37	6.98	45.35	54.00	-8.65	AVG

Note:1.Result (dBuV/m) = Correct Factor (dB/m) + Reading(dBuV).

2.Correction factor (dB/m) = Antenna Factor (dB/m) + Cable loss (dB) – Pre-Amplifier gain (dB).

3. When the peak results are less than average limit, so not need to evaluate the average.



Standard:	FCC Part 15.407	Test Distance:	3 m
Test item:	Band edge	Power:	AC 120 V/60 Hz
Frequency:	5200 MHz	Temp.(°C)/Hum.(%RH):	26(°C)/60 %RH
Mode:	Mode 3		
Ant.Polar.:	Vertical		

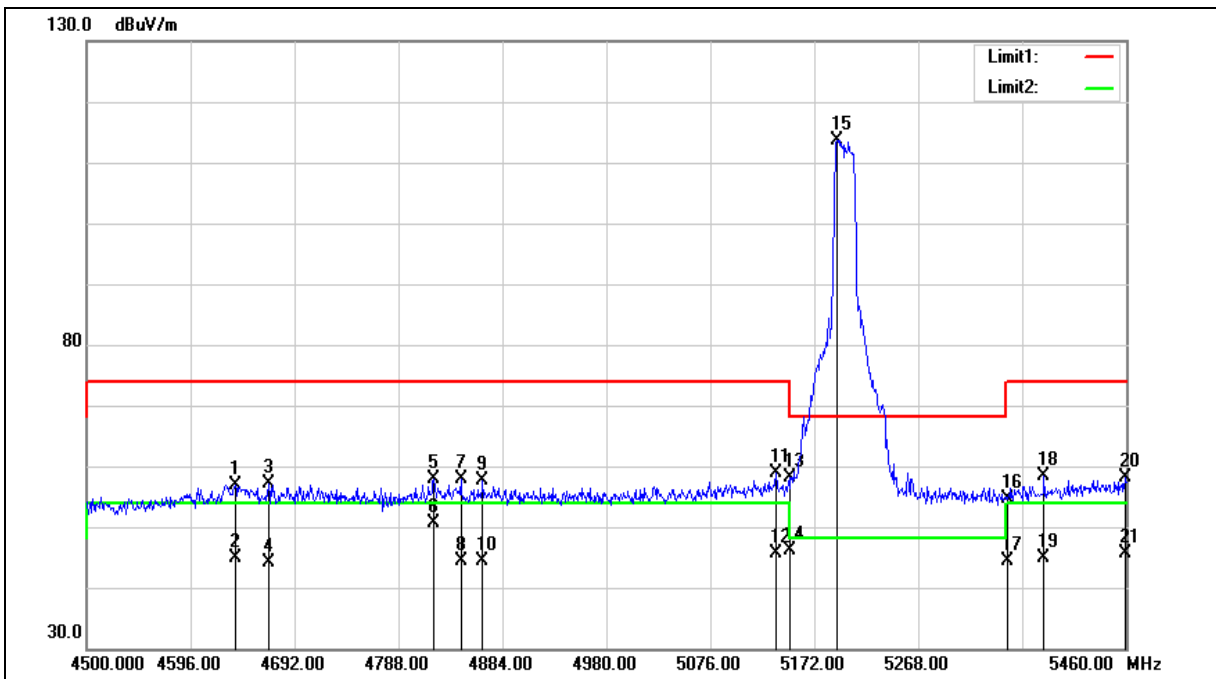



Standard:	FCC Part 15.407	Test Distance:	3 m
Test item:	Band edge	Power:	AC 120 V/60 Hz
Frequency:	5200 MHz	Temp.(°C)/Hum.(%RH):	26(°C)/60 %RH
Mode:	Mode 3		
Ant.Polar.:	Vertical		

No.	Frequency (MHz)	Reading (dBuV)	Correct Factor (dB/m)	Result (dBuV/m)	Limit (dBuV/m)	Margin (dB)	Remark
1	4637.280	51.67	5.22	56.89	74.00	-17.11	peak
2	4637.280	39.64	5.22	44.86	54.00	-9.14	AVG
3	4668.000	51.88	5.28	57.16	74.00	-16.84	peak
4	4668.000	38.86	5.28	44.14	54.00	-9.86	AVG
5	4820.640	52.34	5.56	57.90	74.00	-16.10	peak
6	4820.640	45.18	5.56	50.74	54.00	-3.26	AVG
7	4845.600	52.30	5.62	57.92	74.00	-16.08	peak
8	4845.600	38.85	5.62	44.47	54.00	-9.53	AVG
9	4865.760	52.04	5.65	57.69	74.00	-16.31	peak
10	4865.760	38.75	5.65	44.40	54.00	-9.60	AVG
11	5136.480	52.61	6.23	58.84	74.00	-15.16	peak
12	5136.480	39.52	6.23	45.75	54.00	-8.25	AVG
13	5150.000	51.87	6.27	58.14	74.00	-15.86	peak
14	5150.000	39.92	6.27	46.19	54.00	-7.81	AVG
15	5193.120	107.30	6.37	113.67	---	---	peak
16	5350.000	47.84	6.74	54.58	74.00	-19.42	peak
17	5350.000	37.52	6.74	44.26	54.00	-9.74	AVG
18	5384.160	51.48	6.82	58.30	74.00	-15.70	peak
19	5384.160	38.02	6.82	44.84	54.00	-9.16	AVG
20	5459.040	51.09	7.00	58.09	74.00	-15.91	peak
21	5459.040	38.62	7.00	45.62	54.00	-8.38	AVG

Note:1.Result (dBuV/m) = Correct Factor (dB/m) + Reading(dBuV).

2.Correction factor (dB/m) = Antenna Factor (dB/m) + Cable loss (dB) – Pre-Amplifier gain (dB).

3. When the peak results are less than average limit, so not need to evaluate the average.



Standard:	FCC Part 15.407	Test Distance:	3 m
Test item:	Band edge	Power:	AC 120 V/60 Hz
Frequency:	5240 MHz	Temp.(°C)/Hum.(%RH):	26(°C)/60 %RH
Mode:	Mode 3		
Ant.Polar.:	Horizontal		

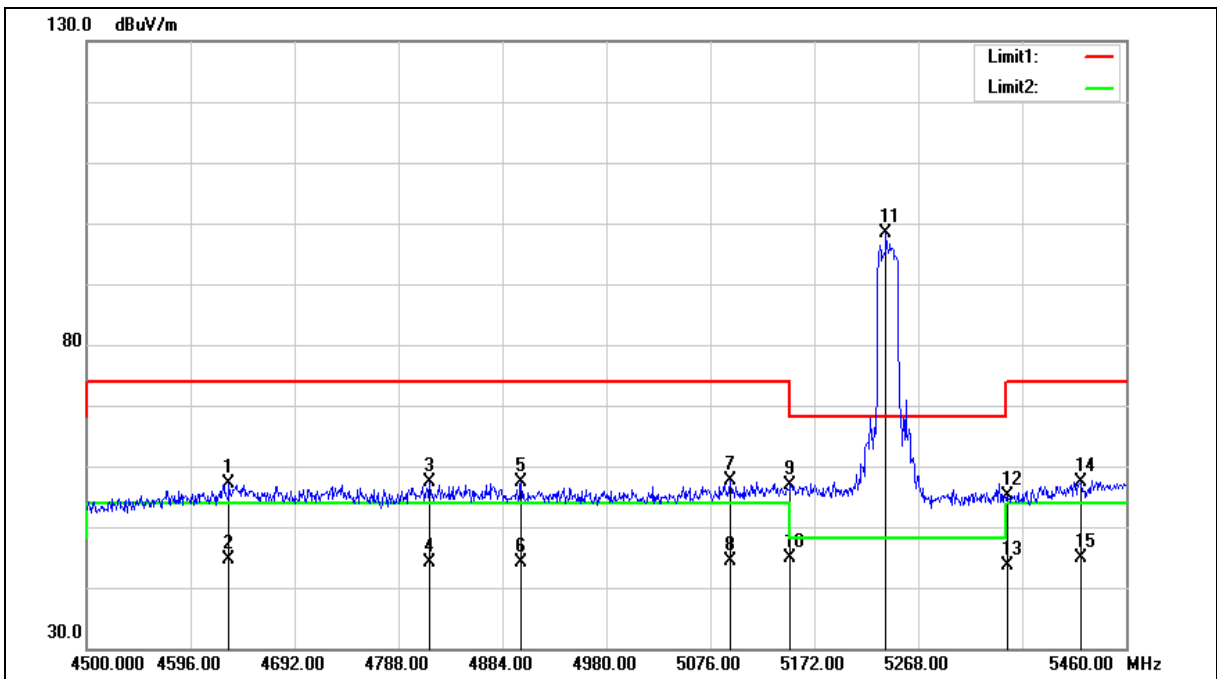



Standard:	FCC Part 15.407	Test Distance:	3 m
Test item:	Band edge	Power:	AC 120 V/60 Hz
Frequency:	5240 MHz	Temp.(°C)/Hum.(%RH):	26(°C )/60 %RH
Mode:	Mode 3		
Ant.Polar.:	Horizontal		

No.	Frequency (MHz)	Reading (dBuV)	Correct Factor (dB/m)	Result (dBuV/m)	Limit (dBuV/m)	Margin (dB)	Remark
1	4631.520	51.96	5.20	57.16	74.00	-16.84	peak
2	4631.520	39.50	5.20	44.70	54.00	-9.30	AVG
3	4816.800	51.71	5.55	57.26	74.00	-16.74	peak
4	4816.800	38.68	5.55	44.23	54.00	-9.77	AVG
5	4901.280	51.59	5.72	57.31	74.00	-16.69	peak
6	4901.280	38.39	5.72	44.11	54.00	-9.89	AVG
7	5094.240	51.40	6.14	57.54	74.00	-16.46	peak
8	5094.240	38.26	6.14	44.40	54.00	-9.60	AVG
9	5150.000	50.50	6.27	56.77	74.00	-17.23	peak
10	5150.000	38.49	6.27	44.76	54.00	-9.24	AVG
11	5238.240	91.79	6.48	98.27	---	---	peak
12	5350.000	48.45	6.74	55.19	74.00	-18.81	peak
13	5350.000	36.81	6.74	43.55	54.00	-10.45	AVG
14	5417.760	50.46	6.91	57.37	74.00	-16.63	peak
15	5417.760	38.04	6.91	44.95	54.00	-9.05	AVG

Note:1.Result (dBuV/m) = Correct Factor (dB/m) + Reading(dBuV).

2.Correction factor (dB/m) = Antenna Factor (dB/m) + Cable loss (dB) – Pre-Amplifier gain (dB).

3. When the peak results are less than average limit, so not need to evaluate the average.



Standard:	FCC Part 15.407	Test Distance:	3 m
Test item:	Band edge	Power:	AC 120 V/60 Hz
Frequency:	5240 MHz	Temp.(°C)/Hum.(%RH):	26(°C)/60 %RH
Mode:	Mode 3		
Ant.Polar.:	Vertical		

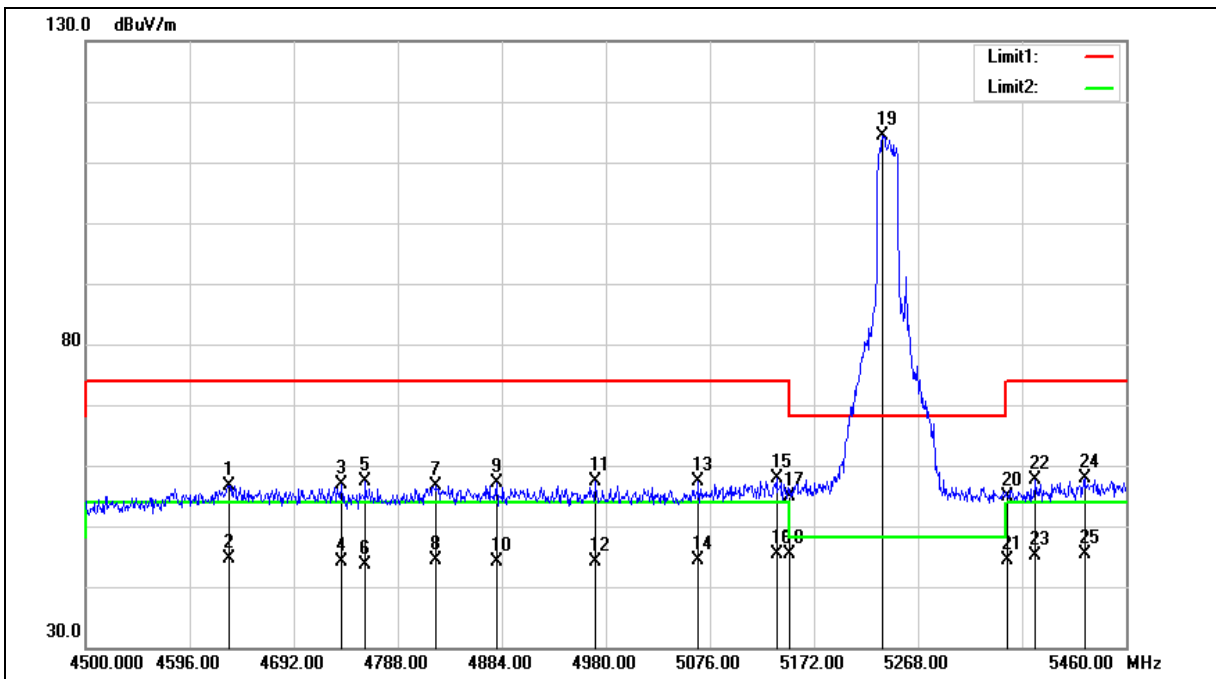



Standard:	FCC Part 15.407	Test Distance:	3 m
Test item:	Band edge	Power:	AC 120 V/60 Hz
Frequency:	5240 MHz	Temp.(°C)/Hum.(%RH):	26(°C)/60 %RH
Mode:	Mode 3		
Ant.Polar.:	Vertical		

No.	Frequency (MHz)	Reading (dBUV)	Correct Factor (dB/m)	Result (dBUV/m)	Limit (dBUV/m)	Margin (dB)	Remark
1	4632.480	51.38	5.20	56.58	74.00	-17.42	peak
2	4632.480	39.54	5.20	44.74	54.00	-9.26	AVG
3	4736.160	51.39	5.40	56.79	74.00	-17.21	peak
4	4736.160	38.66	5.40	44.06	54.00	-9.94	AVG
5	4758.240	51.99	5.45	57.44	74.00	-16.56	peak
6	4758.240	38.26	5.45	43.71	54.00	-10.29	AVG
7	4823.520	51.06	5.57	56.63	74.00	-17.37	peak
8	4823.520	38.80	5.57	44.37	54.00	-9.63	AVG
9	4879.200	51.37	5.68	57.05	74.00	-16.95	peak
10	4879.200	38.56	5.68	44.24	54.00	-9.76	AVG
11	4970.400	51.55	5.86	57.41	74.00	-16.59	peak
12	4970.400	38.15	5.86	44.01	54.00	-9.99	AVG
13	5065.440	51.25	6.07	57.32	74.00	-16.68	peak
14	5065.440	38.33	6.07	44.40	54.00	-9.60	AVG
15	5137.440	51.66	6.23	57.89	74.00	-16.11	peak
16	5137.440	39.15	6.23	45.38	54.00	-8.62	AVG
17	5150.000	48.58	6.27	54.85	74.00	-19.15	peak
18	5150.000	39.00	6.27	45.27	54.00	-8.73	AVG
19	5235.360	108.02	6.46	114.48	---	---	peak
20	5350.000	48.06	6.74	54.80	74.00	-19.20	peak
21	5350.000	37.66	6.74	44.40	54.00	-9.60	AVG
22	5376.480	50.80	6.80	57.60	74.00	-16.40	peak
23	5376.480	38.36	6.80	45.16	54.00	-8.84	AVG
24	5421.600	50.95	6.92	57.87	74.00	-16.13	peak
25	5421.600	38.49	6.92	45.41	54.00	-8.59	AVG

Note:1.Result (dBUV/m) = Correct Factor (dB/m) + Reading(dBUV).

2.Correction factor (dB/m) = Antenna Factor (dB/m) + Cable loss (dB) – Pre-Amplifier gain (dB).

3. When the peak results are less than average limit, so not need to evaluate the average.



Standard:	FCC Part 15.407	Test Distance:	3 m
Test item:	Band edge	Power:	AC 120 V/60 Hz
Frequency:	5745 MHz	Temp.(°C)/Hum.(%RH):	26(°C)/60 %RH
Mode:	Mode 3		
Ant.Polar.:	Horizontal		

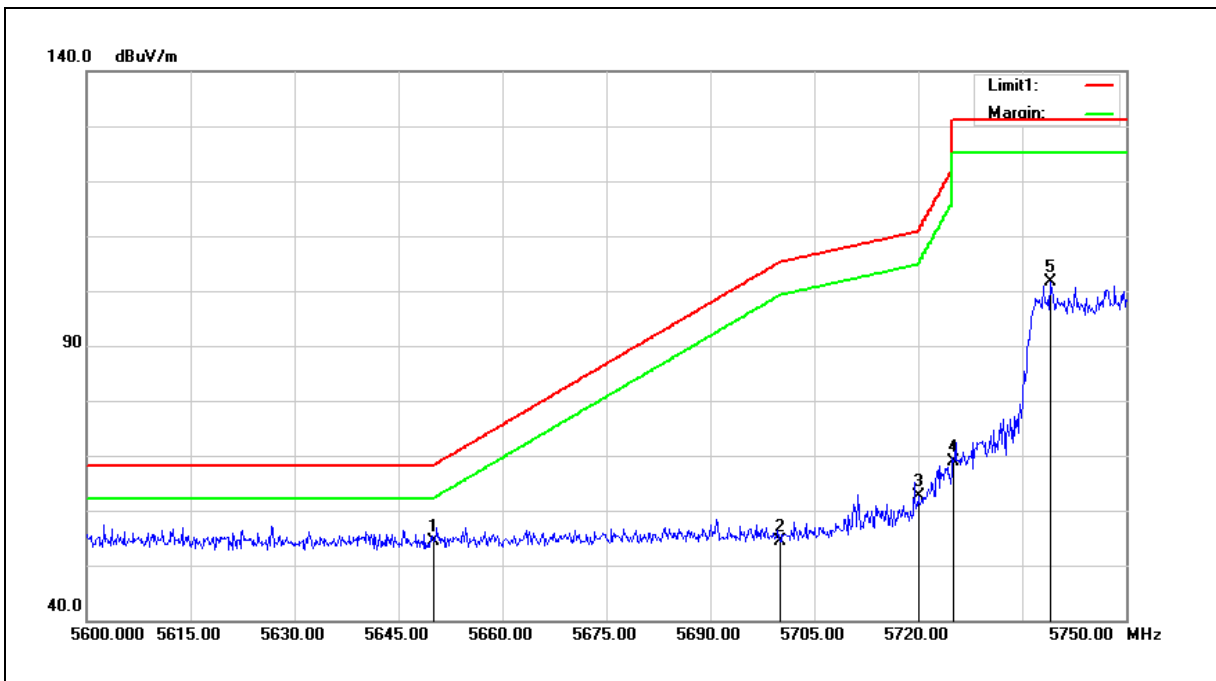

No.	Frequency (MHz)	Reading (dBuV)	Correct Factor (dB/m)	Result (dBuV/m)	Limit (dBuV/m)	Margin (dB)	Remark
1	5650.000	46.93	7.42	54.35	68.20	-13.85	peak
2	5700.000	46.89	7.52	54.41	105.20	-50.79	peak
3	5720.000	54.99	7.56	62.55	110.80	-48.25	peak
4	5725.000	61.30	7.57	68.87	122.20	-53.33	peak
5	5739.050	93.93	7.60	101.53	---	---	peak

Note:1.Result (dBuV/m) = Correct Factor (dB/m) + Reading(dBuV).

2.Correction factor (dB/m) = Antenna Factor (dB/m) + Cable loss (dB) – Pre-Amplifier gain (dB).

3. When the peak results are less than average limit, so not need to evaluate the average.





Standard:	FCC Part 15.407	Test Distance:	3 m
Test item:	Band edge	Power:	AC 120 V/60 Hz
Frequency:	5745 MHz	Temp.(°C)/Hum.(%RH):	26(°C)/60 %RH
Mode:	Mode 3		
Ant.Polar.:	Vertical		

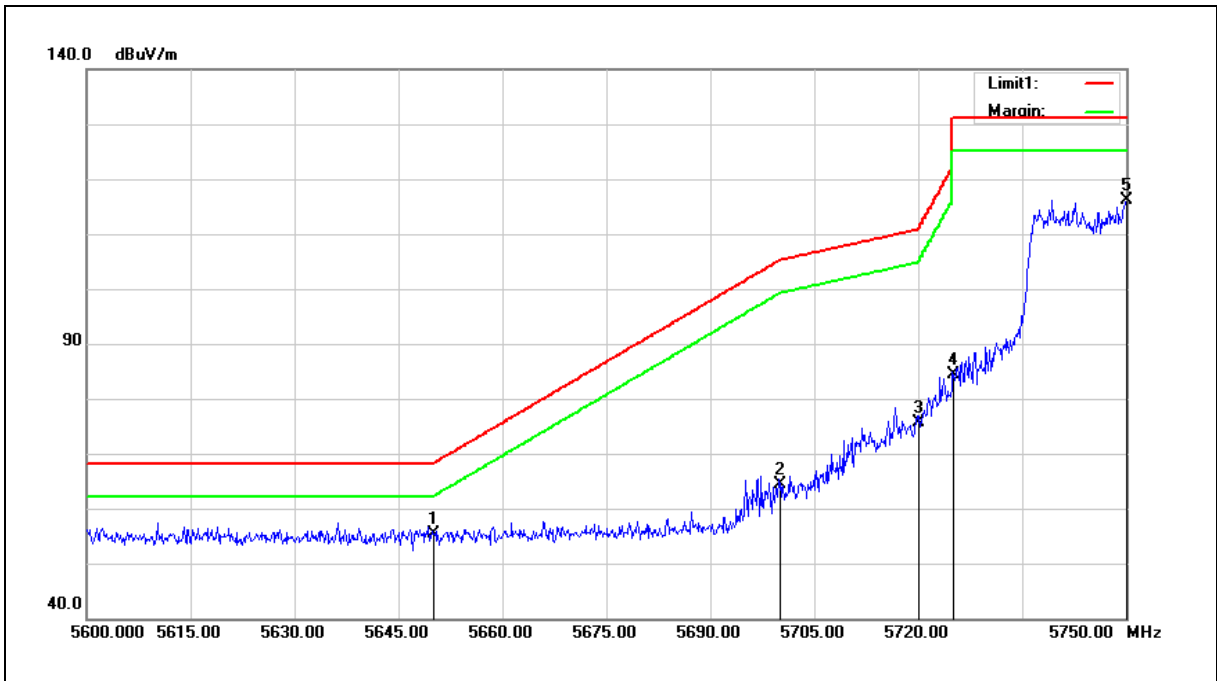

No.	Frequency (MHz)	Reading (dBuV)	Correct Factor (dB/m)	Result (dBuV/m)	Limit (dBuV/m)	Margin (dB)	Remark
1	5650.000	47.90	7.42	55.32	68.20	-12.88	peak
2	5700.000	56.95	7.52	64.47	105.20	-40.73	peak
3	5720.000	67.97	7.56	75.53	110.80	-35.27	peak
4	5725.000	76.71	7.57	84.28	122.20	-37.92	peak
5	5750.000	108.57	7.62	116.19	---	---	peak

Note:1.Result (dBuV/m) = Correct Factor (dB/m) + Reading(dBuV).

2.Correction factor (dB/m) = Antenna Factor (dB/m) + Cable loss (dB) – Pre-Amplifier gain (dB).

3. When the peak results are less than average limit, so not need to evaluate the average.



Standard:	FCC Part 15.407	Test Distance:	3 m
Test item:	Band edge	Power:	AC 120 V/60 Hz
Frequency:	5785 MHz	Temp.(°C)/Hum.(%RH):	26(°C)/60 %RH
Mode:	Mode 3		
Ant.Polar.:	Horizontal		

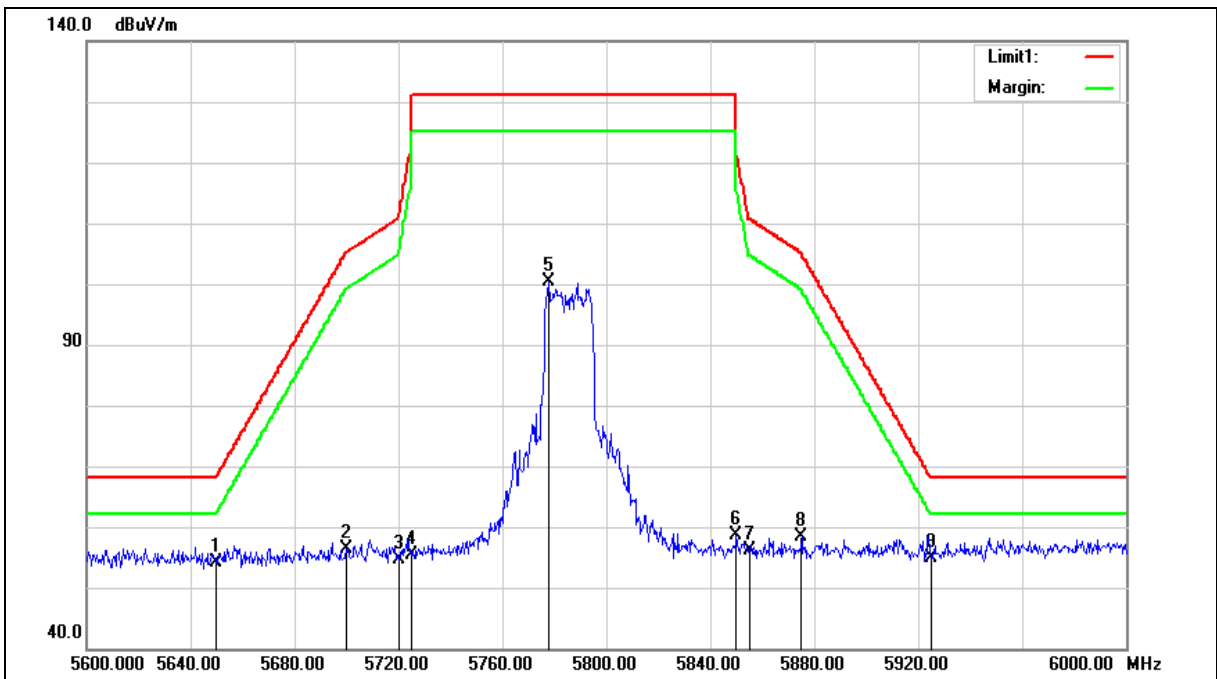



Standard:	FCC Part 15.407	Test Distance:	3 m
Test item:	Band edge	Power:	AC 120 V/60 Hz
Frequency:	5785 MHz	Temp.(°C)/Hum.(%RH):	26(°C )/60 %RH
Mode:	Mode 3		
Ant.Polar.:	Horizontal		

No.	Frequency (MHz)	Reading (dBuV)	Correct Factor (dB/m)	Result (dBuV/m)	Limit (dBuV/m)	Margin (dB)	Remark
1	5650.000	46.79	7.42	54.21	68.20	-13.99	peak
2	5700.000	48.94	7.52	56.46	105.20	-48.74	peak
3	5720.000	47.13	7.56	54.69	110.80	-56.11	peak
4	5725.000	47.92	7.57	55.49	122.20	-66.71	peak
5	5778.000	92.70	7.68	100.38	---	---	peak
6	5850.000	50.82	7.83	58.65	122.20	-63.55	peak
7	5855.000	48.35	7.85	56.20	110.80	-54.60	peak
8	5875.000	50.44	7.88	58.32	105.20	-46.88	peak
9	5925.000	46.97	8.00	54.97	68.20	-13.23	peak

Note:1.Result (dBuV/m) = Correct Factor (dB/m) + Reading(dBuV).

2.Correction factor (dB/m) = Antenna Factor (dB/m) + Cable loss (dB) – Pre-Amplifier gain (dB).

3. When the peak results are less than average limit, so not need to evaluate the average.



Standard:	FCC Part 15.407	Test Distance:	3 m
Test item:	Band edge	Power:	AC 120 V/60 Hz
Frequency:	5785 MHz	Temp.(°C)/Hum.(%RH):	26(°C)/60 %RH
Mode:	Mode 3		
Ant.Polar.:	Vertical		

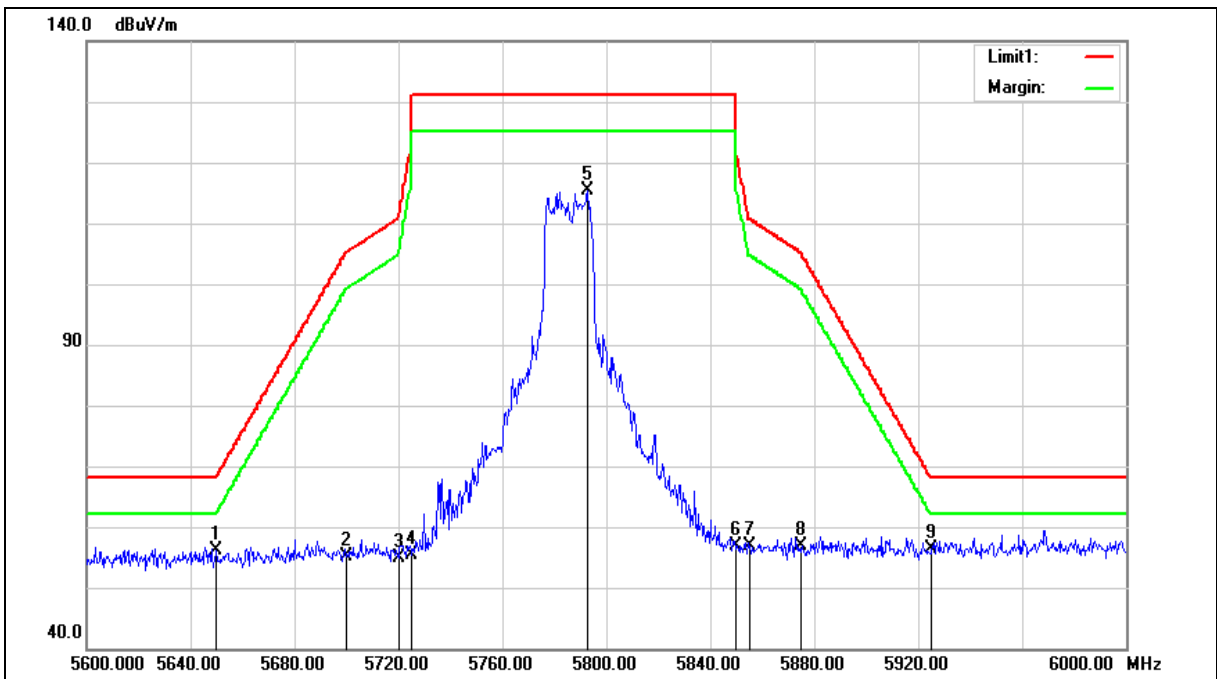



Standard:	FCC Part 15.407	Test Distance:	3 m
Test item:	Band edge	Power:	AC 120 V/60 Hz
Frequency:	5785 MHz	Temp.(°C)/Hum.(%RH):	26(°C )/60 %RH
Mode:	Mode 3		
Ant.Polar.:	Vertical		

No.	Frequency (MHz)	Reading (dBuV)	Correct Factor (dB/m)	Result (dBuV/m)	Limit (dBuV/m)	Margin (dB)	Remark
1	5650.000	48.59	7.42	56.01	68.20	-12.19	peak
2	5700.000	47.50	7.52	55.02	105.20	-50.18	peak
3	5720.000	47.41	7.56	54.97	110.80	-55.83	peak
4	5725.000	47.87	7.57	55.44	122.20	-66.76	peak
5	5792.800	107.75	7.72	115.47	---	---	peak
6	5850.000	49.02	7.83	56.85	122.20	-65.35	peak
7	5855.000	48.94	7.85	56.79	110.80	-54.01	peak
8	5875.000	49.11	7.88	56.99	105.20	-48.21	peak
9	5925.000	48.27	8.00	56.27	68.20	-11.93	peak

Note:1.Result (dBuV/m) = Correct Factor (dB/m) + Reading(dBuV).

2.Correction factor (dB/m) = Antenna Factor (dB/m) + Cable loss (dB) – Pre-Amplifier gain (dB).

3. When the peak results are less than average limit, so not need to evaluate the average.

Standard:	FCC Part 15.407	Test Distance:	3 m
Test item:	Band edge	Power:	AC 120 V/60 Hz
Frequency:	5825 MHz	Temp.(°C)/Hum.(%RH):	26(°C)/60 %RH
Mode:	Mode 3		
Ant.Polar.:	Horizontal		

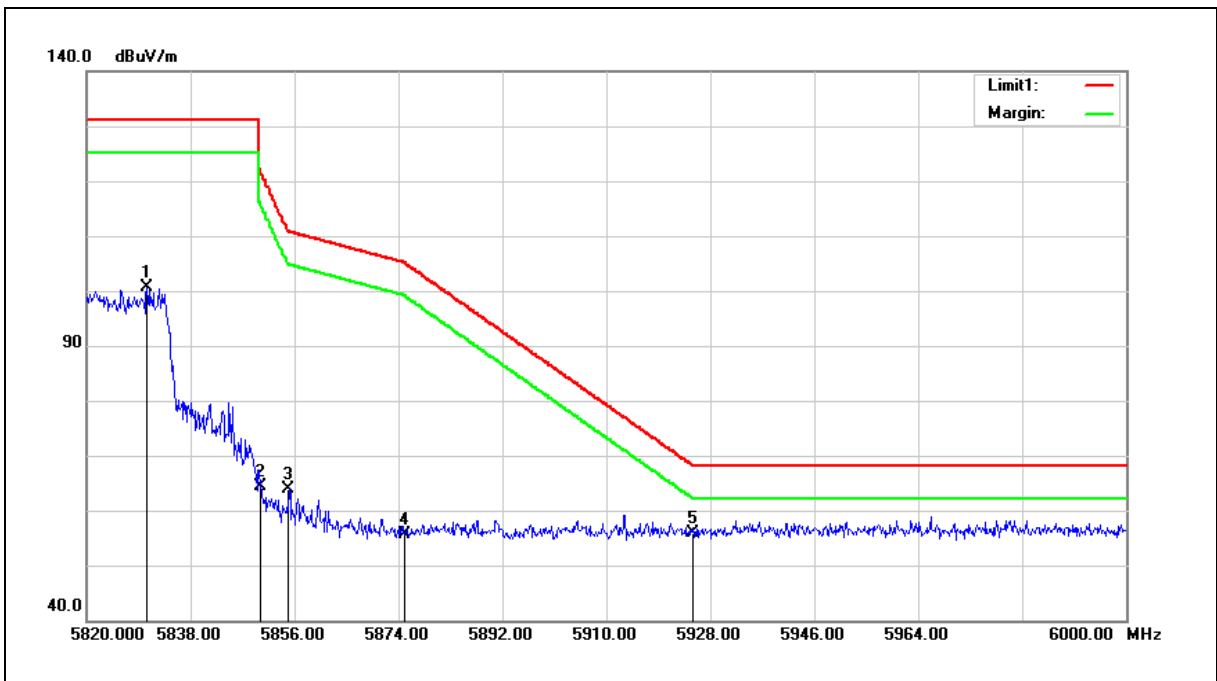

No.	Frequency (MHz)	Reading (dBuV)	Correct Factor (dB/m)	Result (dBuV/m)	Limit (dBuV/m)	Margin (dB)	Remark
1	5830.440	92.75	7.80	100.55	---	---	peak
2	5850.000	56.57	7.83	64.40	122.20	-57.80	peak
3	5855.000	55.99	7.85	63.84	110.80	-46.96	peak
4	5875.000	47.77	7.88	55.65	105.20	-49.55	peak
5	5925.000	47.78	8.00	55.78	68.20	-12.42	peak

Note:1.Result (dBuV/m) = Correct Factor (dB/m) + Reading(dBuV).

2.Correction factor (dB/m) = Antenna Factor (dB/m) + Cable loss (dB) – Pre-Amplifier gain (dB).

3. When the peak results are less than average limit, so not need to evaluate the average.



Standard:	FCC Part 15.407	Test Distance:	3 m
Test item:	Band edge	Power:	AC 120 V/60 Hz
Frequency:	5825 MHz	Temp.(°C)/Hum.(%RH):	26(°C)/60 %RH
Mode:	Mode 3		
Ant.Polar.:	Vertical		

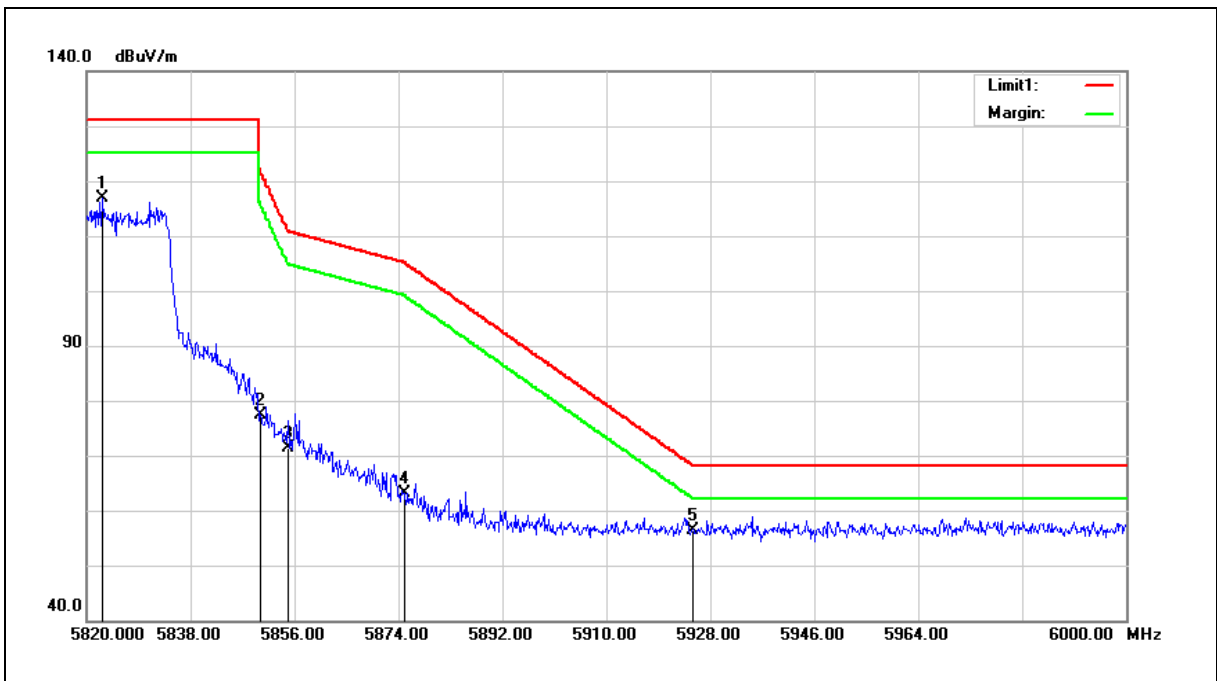

No.	Frequency (MHz)	Reading (dBuV)	Correct Factor (dB/m)	Result (dBuV/m)	Limit (dBuV/m)	Margin (dB)	Remark
1	5822.700	109.01	7.78	116.79	---	---	peak
2	5850.000	69.53	7.83	77.36	122.20	-44.84	peak
3	5855.000	63.60	7.85	71.45	110.80	-39.35	peak
4	5875.000	55.21	7.88	63.09	105.20	-42.11	peak
5	5925.000	48.41	8.00	56.41	68.20	-11.79	peak

Note:1.Result (dBuV/m) = Correct Factor (dB/m) + Reading(dBuV).

2.Correction factor (dB/m) = Antenna Factor (dB/m) + Cable loss (dB) – Pre-Amplifier gain (dB).

3. When the peak results are less than average limit, so not need to evaluate the average.



Standard:	FCC Part 15.407	Test Distance:	3 m
Test item:	Band edge	Power:	AC 120 V/60 Hz
Frequency:	5190 MHz	Temp.(°C)/Hum.(%RH):	26(°C)/60 %RH
Mode:	Mode 4		
Ant.Polar.:	Horizontal		

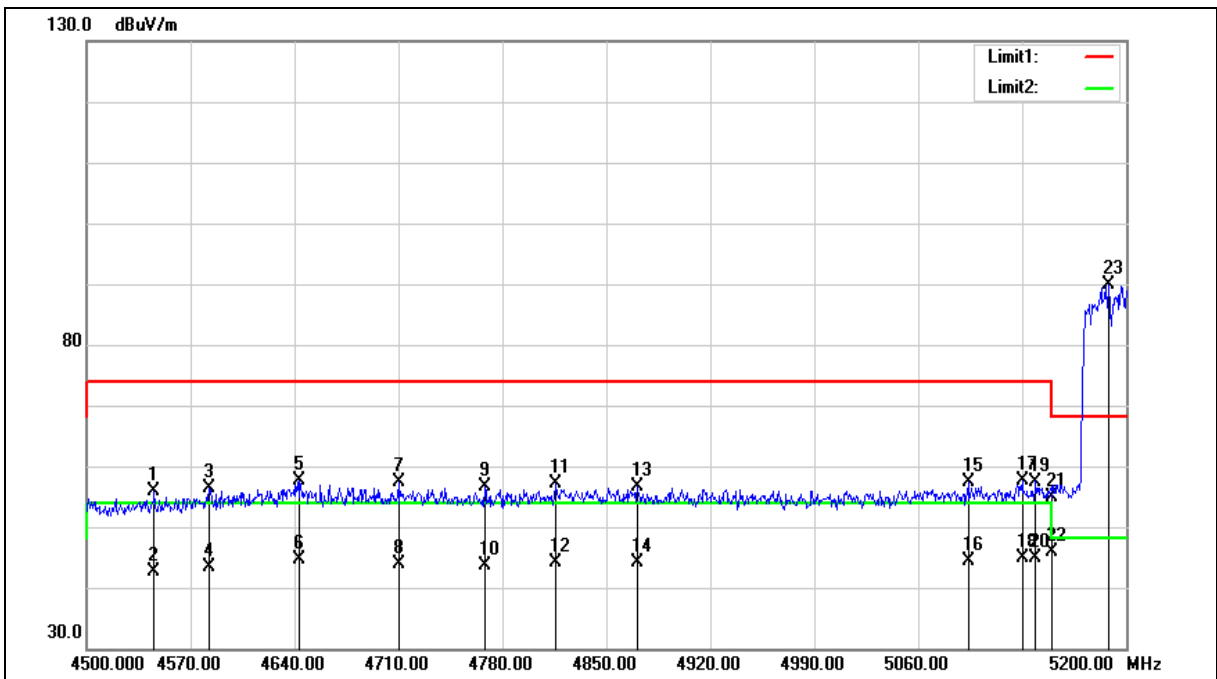





Standard:	FCC Part 15.407	Test Distance:	3 m
Test item:	Band edge	Power:	AC 120 V/60 Hz
Frequency:	5190 MHz	Temp.(°C)/Hum.(%RH):	26(°C)/60 %RH
Mode:	Mode 4		
Ant.Polar.:	Horizontal		

No.	Frequency (MHz)	Reading (dBuV)	Correct Factor (dB/m)	Result (dBuV/m)	Limit (dBuV/m)	Margin (dB)	Remark
1	4545.500	50.89	5.04	55.93	74.00	-18.07	peak
2	4545.500	37.58	5.04	42.62	54.00	-11.38	AVG
3	4582.600	51.27	5.12	56.39	74.00	-17.61	peak
4	4582.600	38.16	5.12	43.28	54.00	-10.72	AVG
5	4643.500	52.48	5.24	57.72	74.00	-16.28	peak
6	4643.500	39.49	5.24	44.73	54.00	-9.27	AVG
7	4710.000	52.03	5.36	57.39	74.00	-16.61	peak
8	4710.000	38.47	5.36	43.83	54.00	-10.17	AVG
9	4768.100	51.08	5.48	56.56	74.00	-17.44	peak
10	4768.100	38.09	5.48	43.57	54.00	-10.43	AVG
11	4815.700	51.47	5.55	57.02	74.00	-16.98	peak
12	4815.700	38.68	5.55	44.23	54.00	-9.77	AVG
13	4871.000	50.91	5.66	56.57	74.00	-17.43	peak
14	4871.000	38.47	5.66	44.13	54.00	-9.87	AVG
15	5093.600	51.17	6.14	57.31	74.00	-16.69	peak
16	5093.600	38.26	6.14	44.40	54.00	-9.60	AVG
17	5130.000	51.47	6.22	57.69	74.00	-16.31	peak
18	5130.000	38.54	6.22	44.76	54.00	-9.24	AVG
19	5139.100	51.25	6.25	57.50	74.00	-16.50	peak
20	5139.100	38.56	6.25	44.81	54.00	-9.19	AVG
21	5150.000	48.56	6.27	54.83	74.00	-19.17	peak
22	5150.000	39.52	6.27	45.79	54.00	-8.21	AVG
23	5188.100	83.50	6.36	89.86	---	---	peak

Note:1.Result (dBuV/m) = Correct Factor (dB/m) + Reading(dBuV).

2.Correction factor (dB/m) = Antenna Factor (dB/m) + Cable loss (dB) – Pre-Amplifier gain (dB).

3. When the peak results are less than average limit, so not need to evaluate the average.



Standard:	FCC Part 15.407	Test Distance:	3 m
Test item:	Band edge	Power:	AC 120 V/60 Hz
Frequency:	5190 MHz	Temp.(°C)/Hum.(%RH):	26(°C)/60 %RH
Mode:	Mode 4		
Ant.Polar.:	Vertical		

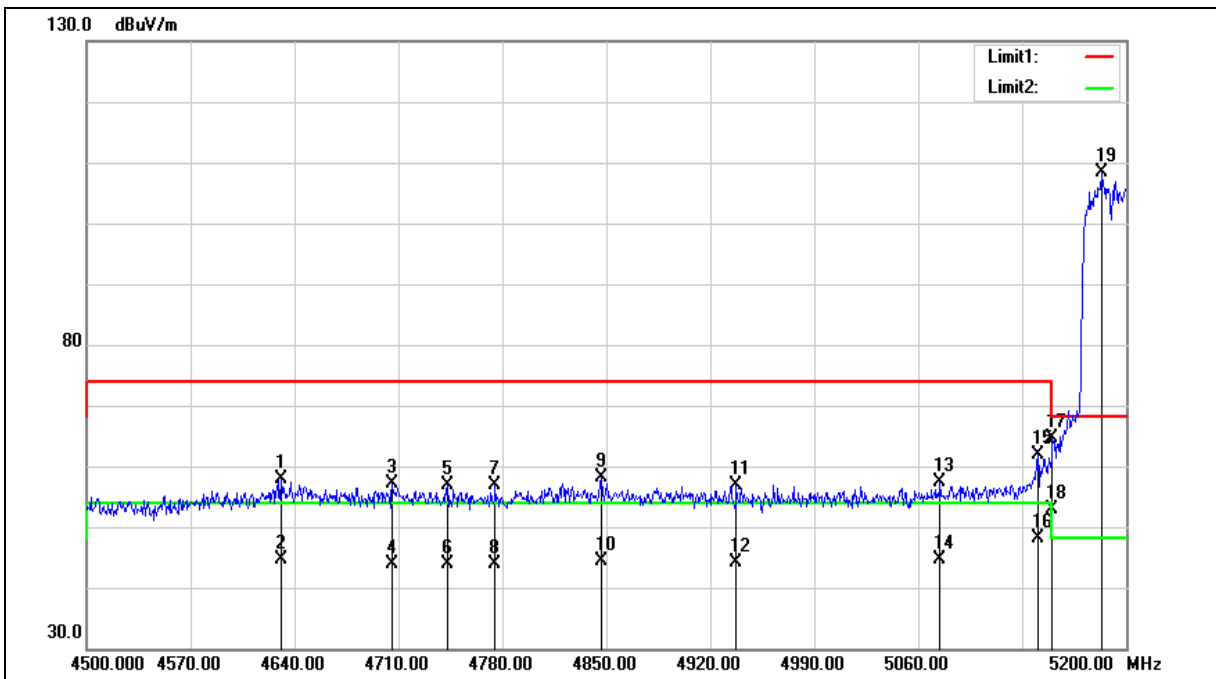



Standard:	FCC Part 15.407	Test Distance:	3 m
Test item:	Band edge	Power:	AC 120 V/60 Hz
Frequency:	5190 MHz	Temp.(°C)/Hum.(%RH):	26(°C )/60 %RH
Mode:	Mode 4		
Ant.Polar.:	Vertical		

No.	Frequency (MHz)	Reading (dBuV)	Correct Factor (dB/m)	Result (dBuV/m)	Limit (dBuV/m)	Margin (dB)	Remark
1	4630.900	52.59	5.20	57.79	74.00	-16.21	peak
2	4630.900	39.48	5.20	44.68	54.00	-9.32	AVG
3	4705.800	51.74	5.35	57.09	74.00	-16.91	peak
4	4705.800	38.63	5.35	43.98	54.00	-10.02	AVG
5	4742.900	51.43	5.42	56.85	74.00	-17.15	peak
6	4742.900	38.43	5.42	43.85	54.00	-10.15	AVG
7	4775.100	51.52	5.48	57.00	74.00	-17.00	peak
8	4775.100	38.28	5.48	43.76	54.00	-10.24	AVG
9	4846.500	52.54	5.62	58.16	74.00	-15.84	peak
10	4846.500	38.80	5.62	44.42	54.00	-9.58	AVG
11	4937.500	51.16	5.80	56.96	74.00	-17.04	peak
12	4937.500	38.27	5.80	44.07	54.00	-9.93	AVG
13	5074.700	51.23	6.08	57.31	74.00	-16.69	peak
14	5074.700	38.51	6.08	44.59	54.00	-9.41	AVG
15	5140.500	55.57	6.25	61.82	74.00	-12.18	peak
16	5140.500	41.80	6.25	48.05	54.00	-5.95	AVG
17	5150.000	58.41	6.27	64.68	74.00	-9.32	peak
18	5150.000	46.64	6.27	52.91	54.00	-1.09	AVG
19	5183.200	101.94	6.34	108.28	---	---	peak

Note:1.Result (dBuV/m) = Correct Factor (dB/m) + Reading(dBuV).

2.Correction factor (dB/m) = Antenna Factor (dB/m) + Cable loss (dB) – Pre-Amplifier gain (dB).

3. When the peak results are less than average limit, so not need to evaluate the average.



Standard:	FCC Part 15.407	Test Distance:	3 m
Test item:	Band edge	Power:	AC 120 V/60 Hz
Frequency:	5230 MHz	Temp.(°C)/Hum.(%RH):	26(°C)/60 %RH
Mode:	Mode 4		
Ant.Polar.:	Horizontal		

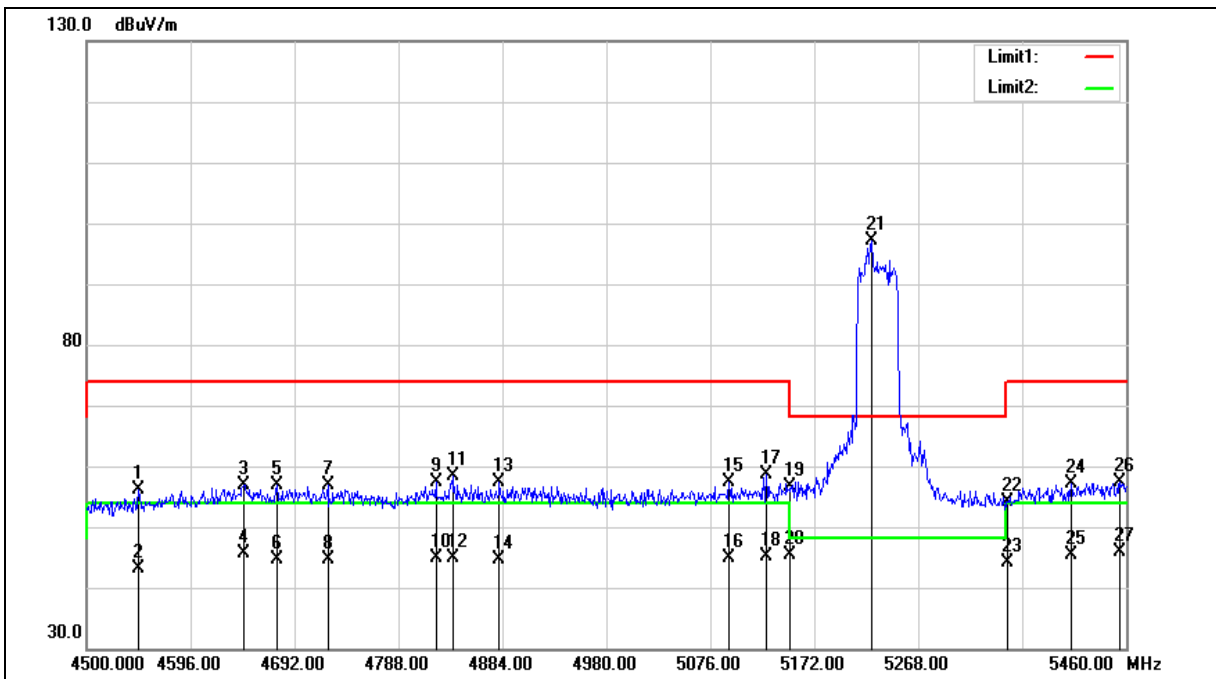

No.	Frequency (MHz)	Reading (dBuV)	Correct Factor (dB/m)	Result (dBuV/m)	Limit (dBuV/m)	Margin (dB)	Remark
1	4548.000	50.96	5.05	56.01	74.00	-17.99	peak
2	4548.000	38.18	5.05	43.23	54.00	-10.77	AVG
3	4644.960	51.64	5.24	56.88	74.00	-17.12	peak
4	4644.960	40.48	5.24	45.72	54.00	-8.28	AVG
5	4675.680	51.50	5.29	56.79	74.00	-17.21	peak
6	4675.680	39.31	5.29	44.60	54.00	-9.40	AVG
7	4722.720	51.46	5.39	56.85	74.00	-17.15	peak
8	4722.720	39.21	5.39	44.60	54.00	-9.40	AVG
9	4822.560	51.72	5.57	57.29	74.00	-16.71	peak

Note:1.Result (dBuV/m) = Correct Factor (dB/m) + Reading(dBuV).

2.Correction factor (dB/m) = Antenna Factor (dB/m) + Cable loss (dB) – Pre-Amplifier gain (dB).

3. When the peak results are less than average limit, so not need to evaluate the average.



Standard:	FCC Part 15.407	Test Distance:	3 m
Test item:	Band edge	Power:	AC 120 V/60 Hz
Frequency:	5230 MHz	Temp.(°C)/Hum.(%RH):	26(°C)/60 %RH
Mode:	Mode 4		
Ant.Polar.:	Horizontal		

No.	Frequency (MHz)	Reading (dBUV)	Correct Factor (dB/m)	Result (dBUV/m)	Limit (dBUV/m)	Margin (dB)	Remark
10	4822.560	39.25	5.57	44.82	54.00	-9.18	AVG
11	4837.920	52.73	5.61	58.34	74.00	-15.66	peak
12	4837.920	39.23	5.61	44.84	54.00	-9.16	AVG
13	4881.120	51.66	5.68	57.34	74.00	-16.66	peak
14	4881.120	38.97	5.68	44.65	54.00	-9.35	AVG
15	5093.280	51.19	6.14	57.33	74.00	-16.67	peak
16	5093.280	38.75	6.14	44.89	54.00	-9.11	AVG
17	5127.840	52.39	6.22	58.61	74.00	-15.39	peak
18	5127.840	39.02	6.22	45.24	54.00	-8.76	AVG
19	5150.000	50.35	6.27	56.62	74.00	-17.38	peak
20	5150.000	39.23	6.27	45.50	54.00	-8.50	AVG
21	5224.800	90.73	6.44	97.17	---	---	peak
22	5350.000	47.34	6.74	54.08	74.00	-19.92	peak
23	5350.000	37.27	6.74	44.01	54.00	-9.99	AVG
24	5409.120	50.34	6.88	57.22	74.00	-16.78	peak
25	5409.120	38.42	6.88	45.30	54.00	-8.70	AVG
26	5454.240	50.41	6.99	57.40	74.00	-16.60	peak
27	5454.240	38.93	6.99	45.92	54.00	-8.08	AVG

Note:1.Result (dBUV/m) = Correct Factor (dB/m) + Reading(dBUV).

2.Correction factor (dB/m) = Antenna Factor (dB/m) + Cable loss (dB) – Pre-Amplifier gain (dB).

3. When the peak results are less than average limit, so not need to evaluate the average.



Standard:	FCC Part 15.407	Test Distance:	3 m
Test item:	Band edge	Power:	AC 120 V/60 Hz
Frequency:	5230 MHz	Temp.(°C)/Hum.(%RH):	26(°C)/60 %RH
Mode:	Mode 4		
Ant.Polar.:	Vertical		

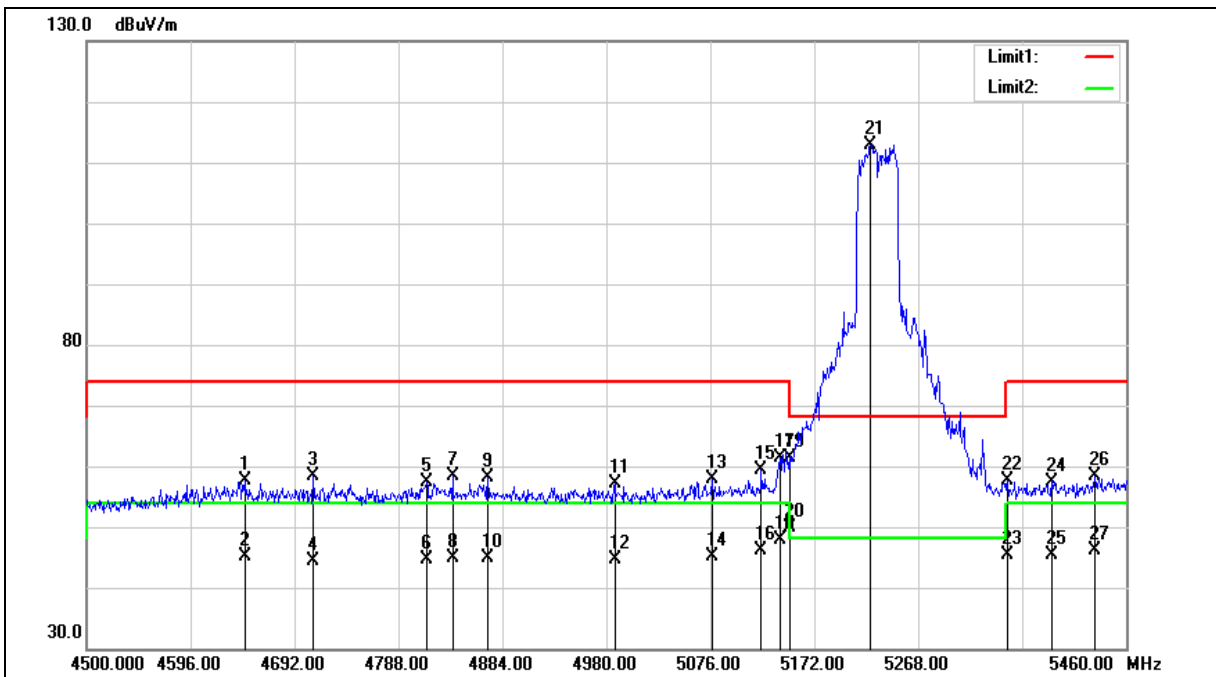

No.	Frequency (MHz)	Reading (dBuV)	Correct Factor (dB/m)	Result (dBuV/m)	Limit (dBuV/m)	Margin (dB)	Remark
1	4645.920	52.36	5.23	57.59	74.00	-16.41	peak
2	4645.920	39.96	5.23	45.19	54.00	-8.81	AVG
3	4709.280	53.05	5.36	58.41	74.00	-15.59	peak
4	4709.280	39.04	5.36	44.40	54.00	-9.60	AVG
5	4813.920	51.81	5.55	57.36	74.00	-16.64	peak
6	4813.920	39.15	5.55	44.70	54.00	-9.30	AVG
7	4837.920	52.75	5.61	58.36	74.00	-15.64	peak
8	4837.920	39.30	5.61	44.91	54.00	-9.09	AVG
9	4870.560	52.49	5.66	58.15	74.00	-15.85	peak

Note:1.Result (dBuV/m) = Correct Factor (dB/m) + Reading(dBuV).

2.Correction factor (dB/m) = Antenna Factor (dB/m) + Cable loss (dB) – Pre-Amplifier gain (dB).

3. When the peak results are less than average limit, so not need to evaluate the average.



Standard:	FCC Part 15.407	Test Distance:	3 m
Test item:	Band edge	Power:	AC 120 V/60 Hz
Frequency:	5230 MHz	Temp.(°C)/Hum.(%RH):	26(°C )/60 %RH
Mode:	Mode 4		
Ant.Polar.:	Vertical		

No.	Frequency (MHz)	Reading (dBUV)	Correct Factor (dB/m)	Result (dBUV/m)	Limit (dBUV/m)	Margin (dB)	Remark
10	4870.560	39.23	5.66	44.89	54.00	-9.11	AVG
11	4987.680	51.12	5.89	57.01	74.00	-16.99	peak
12	4987.680	38.63	5.89	44.52	54.00	-9.48	AVG
13	5077.920	51.88	6.09	57.97	74.00	-16.03	peak
14	5077.920	39.10	6.09	45.19	54.00	-8.81	AVG
15	5123.040	53.05	6.21	59.26	74.00	-14.74	peak
16	5123.040	39.88	6.21	46.09	54.00	-7.91	AVG
17	5140.320	55.08	6.25	61.33	74.00	-12.67	peak
18	5140.320	41.72	6.25	47.97	54.00	-6.03	AVG
19	5150.000	55.04	6.27	61.31	74.00	-12.69	peak
20	5150.000	43.60	6.27	49.87	54.00	-4.13	AVG
21	5223.840	106.48	6.44	112.92	---	---	peak
22	5350.000	50.83	6.74	57.57	74.00	-16.43	peak
23	5350.000	38.60	6.74	45.34	54.00	-8.66	AVG
24	5390.880	50.66	6.84	57.50	74.00	-16.50	peak
25	5390.880	38.62	6.84	45.46	54.00	-8.54	AVG
26	5431.200	51.33	6.94	58.27	74.00	-15.73	peak
27	5431.200	39.07	6.94	46.01	54.00	-7.99	AVG

Note:1.Result (dBUV/m) = Correct Factor (dB/m) + Reading(dBUV).

2.Correction factor (dB/m) = Antenna Factor (dB/m) + Cable loss (dB) – Pre-Amplifier gain (dB).

3. When the peak results are less than average limit, so not need to evaluate the average.



Standard:	FCC Part 15.407	Test Distance:	3 m
Test item:	Band edge	Power:	AC 120 V/60 Hz
Frequency:	5755 MHz	Temp.(°C)/Hum.(%RH):	26(°C)/60 %RH
Mode:	Mode 4		
Ant.Polar.:	Horizontal		

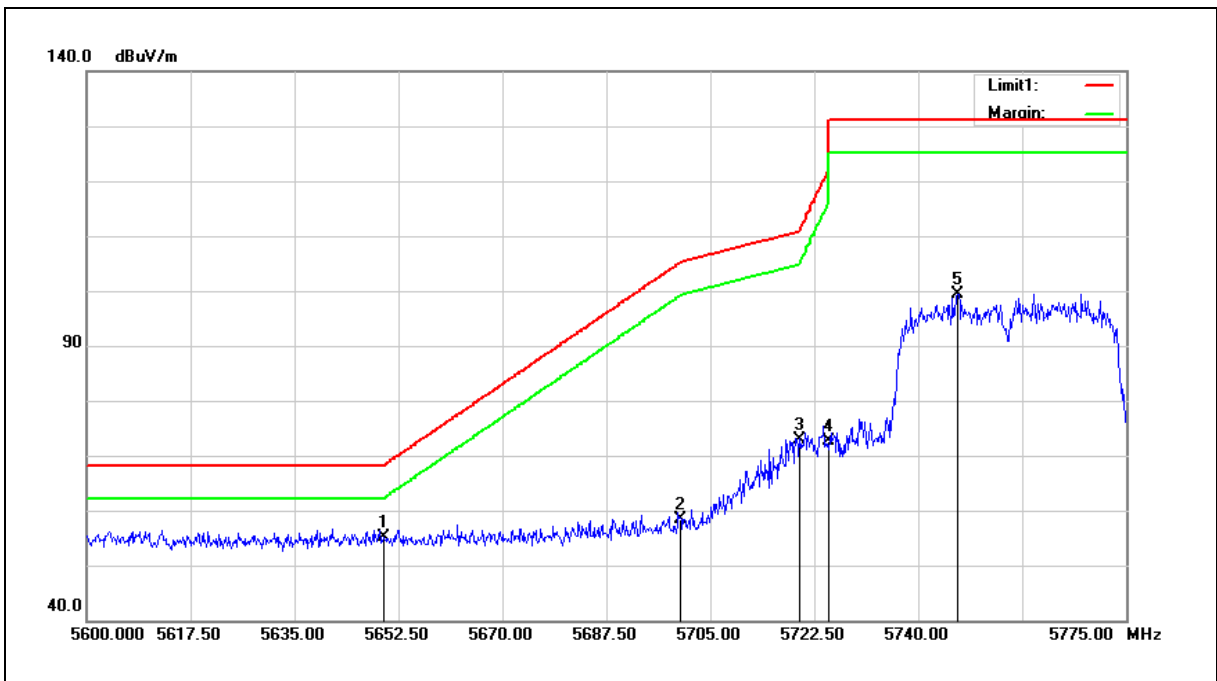

No.	Frequency (MHz)	Reading (dBuV)	Correct Factor (dB/m)	Result (dBuV/m)	Limit (dBuV/m)	Margin (dB)	Remark
1	5650.000	47.74	7.42	55.16	68.20	-13.04	peak
2	5700.000	50.74	7.52	58.26	105.20	-46.94	peak
3	5720.000	65.44	7.56	73.00	110.80	-37.80	peak
4	5725.000	65.13	7.57	72.70	122.20	-49.50	peak
5	5746.650	91.76	7.61	99.37	---	---	peak

Note:1.Result (dBuV/m) = Correct Factor (dB/m) + Reading(dBuV).

2.Correction factor (dB/m) = Antenna Factor (dB/m) + Cable loss (dB) – Pre-Amplifier gain (dB).

3. When the peak results are less than average limit, so not need to evaluate the average.





Standard:	FCC Part 15.407	Test Distance:	3 m
Test item:	Band edge	Power:	AC 120 V/60 Hz
Frequency:	5755 MHz	Temp.(°C)/Hum.(%RH):	26(°C)/60 %RH
Mode:	Mode 4		
Ant.Polar.:	Vertical		

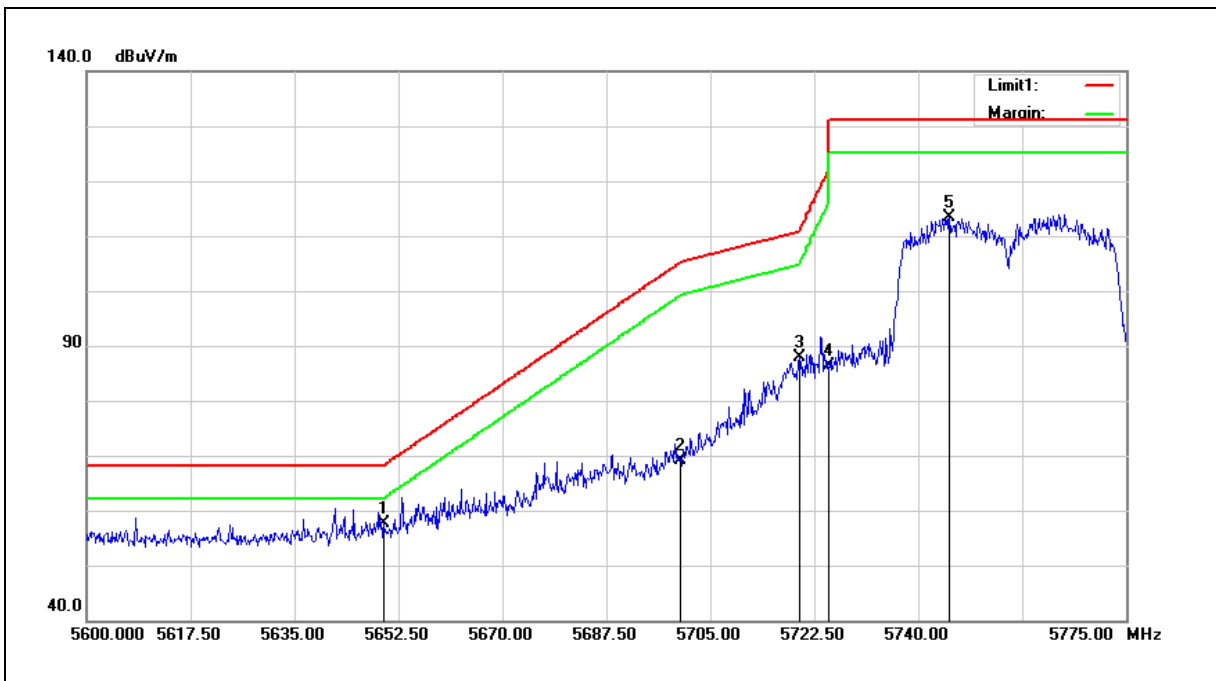

No.	Frequency (MHz)	Reading (dBuV)	Correct Factor (dB/m)	Result (dBuV/m)	Limit (dBuV/m)	Margin (dB)	Remark
1	5650.000	50.26	7.42	57.68	68.20	-10.52	peak
2	5700.000	61.61	7.52	69.13	105.20	-36.07	peak
3	5720.000	80.21	7.56	87.77	110.80	-23.03	peak
4	5725.000	78.78	7.57	86.35	122.20	-35.85	peak
5	5745.250	105.78	7.61	113.39	---	---	peak

Note:1.Result (dBuV/m) = Correct Factor (dB/m) + Reading(dBuV).

2.Correction factor (dB/m) = Antenna Factor (dB/m) + Cable loss (dB) – Pre-Amplifier gain (dB).

3. When the peak results are less than average limit, so not need to evaluate the average.



Standard:	FCC Part 15.407	Test Distance:	3 m
Test item:	Band edge	Power:	AC 120 V/60 Hz
Frequency:	5795 MHz	Temp.(°C)/Hum.(%RH):	26(°C)/60 %RH
Mode:	Mode 4		
Ant.Polar.:	Horizontal		

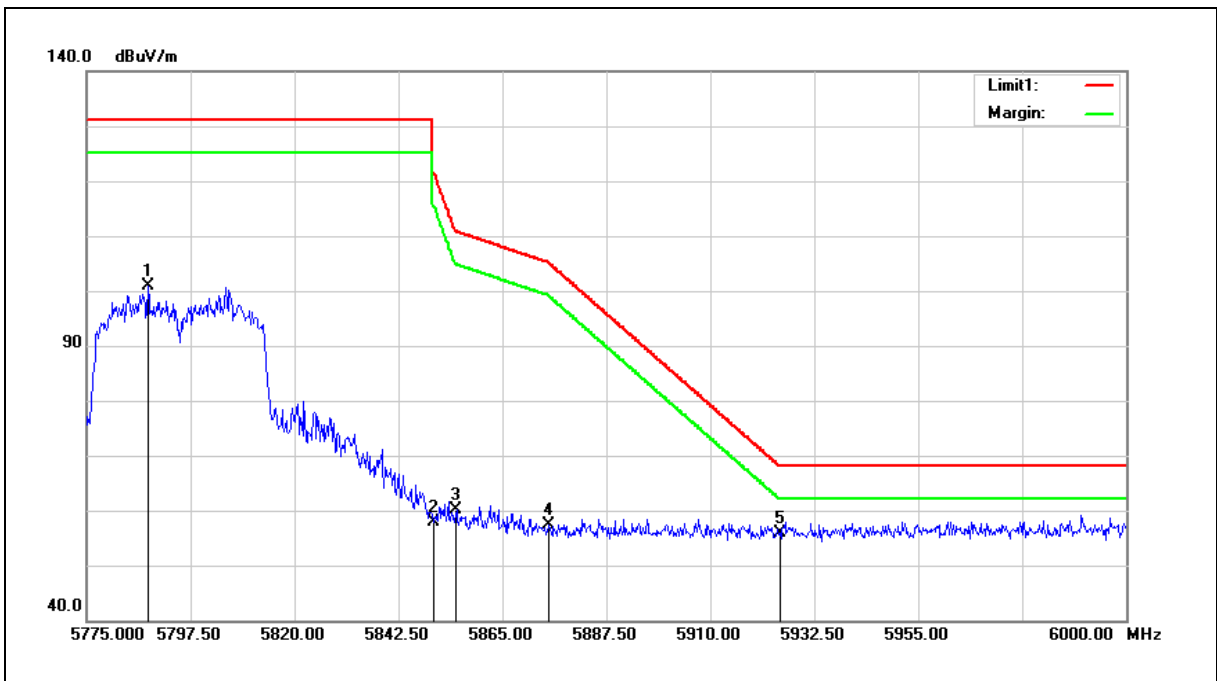

No.	Frequency (MHz)	Reading (dBuV)	Correct Factor (dB/m)	Result (dBuV/m)	Limit (dBuV/m)	Margin (dB)	Remark
1	5788.275	93.05	7.71	100.76	---	---	peak
2	5850.000	50.17	7.83	58.00	122.20	-64.20	peak
3	5855.000	52.35	7.85	60.20	110.80	-50.60	peak
4	5875.000	49.39	7.88	57.27	105.20	-47.93	peak
5	5925.000	47.92	8.00	55.92	68.20	-12.28	peak

Note:1.Result (dBuV/m) = Correct Factor (dB/m) + Reading(dBuV).

2.Correction factor (dB/m) = Antenna Factor (dB/m) + Cable loss (dB) – Pre-Amplifier gain (dB).

3. When the peak results are less than average limit, so not need to evaluate the average.



Standard:	FCC Part 15.407	Test Distance:	3 m
Test item:	Band edge	Power:	AC 120 V/60 Hz
Frequency:	5795 MHz	Temp.(°C)/Hum.(%RH):	26(°C)/60 %RH
Mode:	Mode 4		
Ant.Polar.:	Vertical		

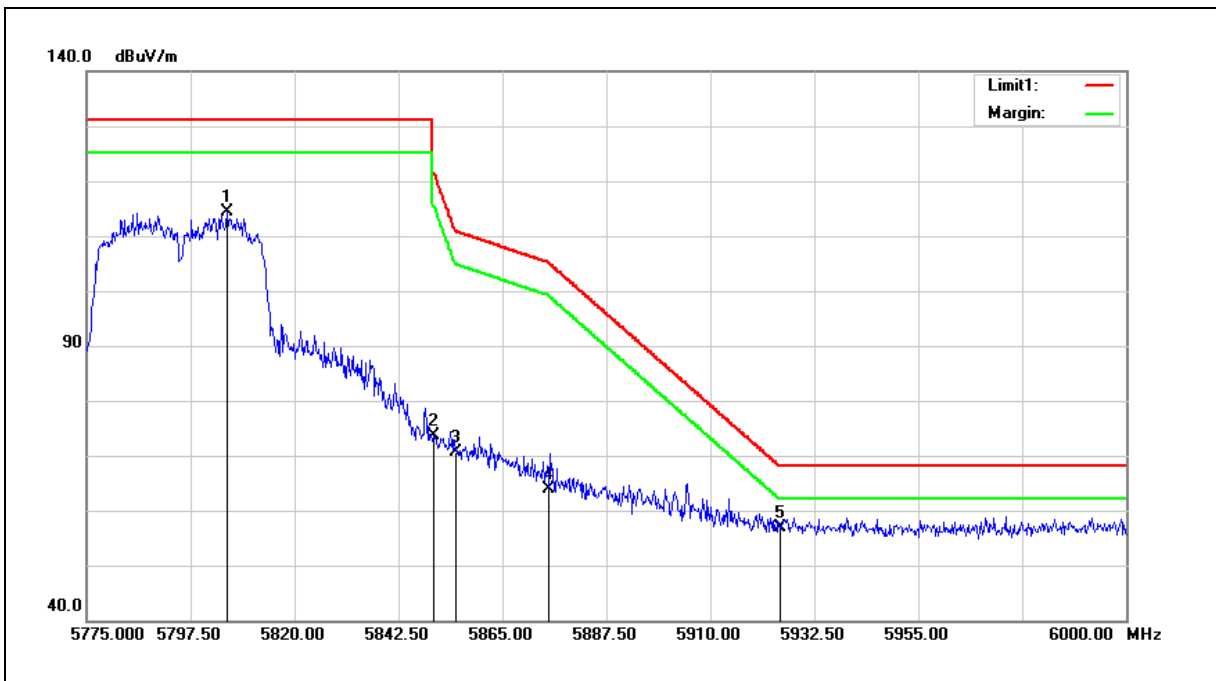

No.	Frequency (MHz)	Reading (dBuV)	Correct Factor (dB/m)	Result (dBuV/m)	Limit (dBuV/m)	Margin (dB)	Remark
1	5805.375	106.65	7.74	114.39	---	---	peak
2	5850.000	65.80	7.83	73.63	122.20	-48.57	peak
3	5855.000	62.83	7.85	70.68	110.80	-40.12	peak
4	5875.000	55.94	7.88	63.82	105.20	-41.38	peak
5	5925.000	48.83	8.00	56.83	68.20	-11.37	peak

Note:1.Result (dBuV/m) = Correct Factor (dB/m) + Reading(dBuV).

2.Correction factor (dB/m) = Antenna Factor (dB/m) + Cable loss (dB) – Pre-Amplifier gain (dB).

3. When the peak results are less than average limit, so not need to evaluate the average.



Standard:	FCC Part 15.407	Test Distance:	3 m
Test item:	Band edge	Power:	AC 120 V/60 Hz
Frequency:	5210 MHz	Temp.(°C)/Hum.(%RH):	26(°C)/60 %RH
Mode:	Mode 5		
Ant.Polar.:	Horizontal		

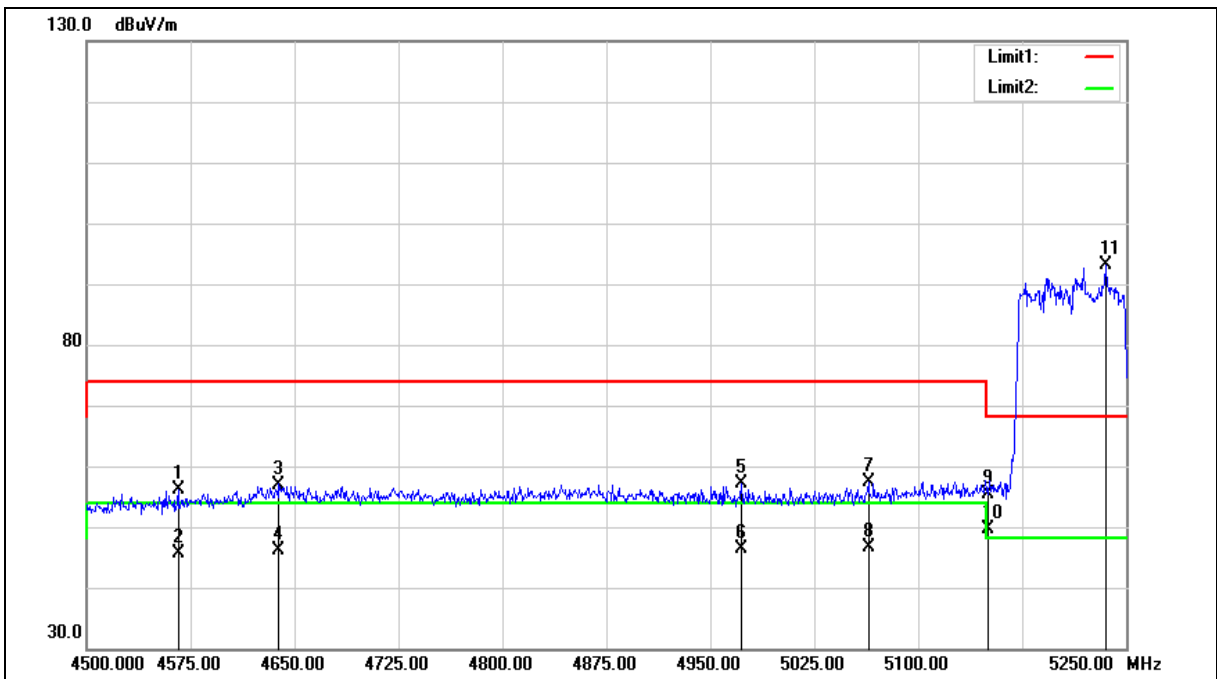



Standard:	FCC Part 15.407	Test Distance:	3 m
Test item:	Band edge	Power:	AC 120 V/60 Hz
Frequency:	5210 MHz	Temp.(°C)/Hum.(%RH):	26(°C )/60 %RH
Mode:	Mode 5		
Ant.Polar.:	Horizontal		

No.	Frequency (MHz)	Reading (dBUV)	Correct Factor (dB/m)	Result (dBUV/m)	Limit (dBUV/m)	Margin (dB)	Remark
1	4566.000	50.95	5.07	56.02	74.00	-17.98	peak
2	4566.000	40.65	5.07	45.72	54.00	-8.28	AVG
3	4638.750	51.77	5.23	57.00	74.00	-17.00	peak
4	4638.750	40.87	5.23	46.10	54.00	-7.90	AVG
5	4972.500	51.16	5.87	57.03	74.00	-16.97	peak
6	4972.500	40.42	5.87	46.29	54.00	-7.71	AVG
7	5064.000	51.42	6.06	57.48	74.00	-16.52	peak
8	5064.000	40.45	6.06	46.51	54.00	-7.49	AVG
9	5150.000	49.04	6.27	55.31	74.00	-18.69	peak
10	5150.000	43.48	6.27	49.75	54.00	-4.25	AVG
11	5235.000	86.74	6.46	93.20	---	---	peak

Note:1.Result (dBUV/m) = Correct Factor (dB/m) + Reading(dBUV).

2.Correction factor (dB/m) = Antenna Factor (dB/m) + Cable loss (dB) – Pre-Amplifier gain (dB).

3. When the peak results are less than average limit, so not need to evaluate the average.



Standard:	FCC Part 15.407	Test Distance:	3 m
Test item:	Band edge	Power:	AC 120 V/60 Hz
Frequency:	5210 MHz	Temp.(°C)/Hum.(%RH):	26(°C)/60 %RH
Mode:	Mode 5		
Ant.Polar.:	Vertical		

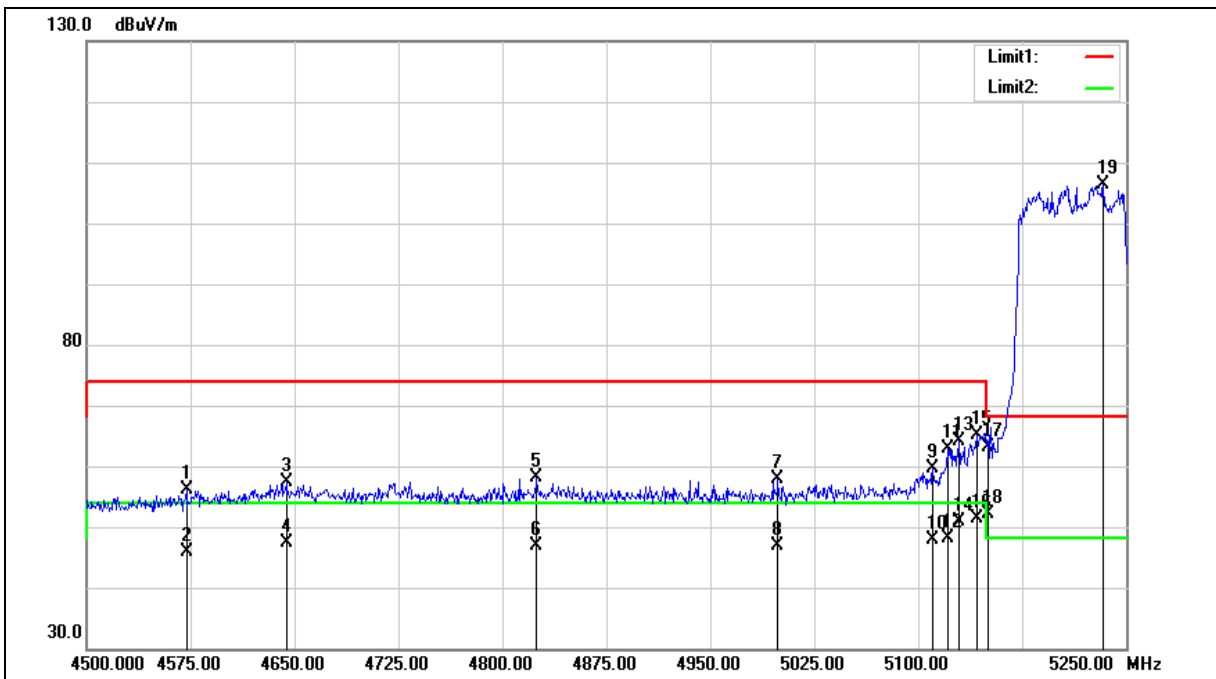



Standard:	FCC Part 15.407	Test Distance:	3 m
Test item:	Band edge	Power:	AC 120 V/60 Hz
Frequency:	5210 MHz	Temp.(°C)/Hum.(%RH):	26(°C )/60 %RH
Mode:	Mode 5		
Ant.Polar.:	Vertical		

No.	Frequency (MHz)	Reading (dBuV)	Correct Factor (dB/m)	Result (dBuV/m)	Limit (dBuV/m)	Margin (dB)	Remark
1	4572.000	51.05	5.09	56.14	74.00	-17.86	peak
2	4572.000	40.79	5.09	45.88	54.00	-8.12	AVG
3	4644.000	52.15	5.24	57.39	74.00	-16.61	peak
4	4644.000	42.19	5.24	47.43	54.00	-6.57	AVG
5	4824.750	52.59	5.57	58.16	74.00	-15.84	peak
6	4824.750	41.28	5.57	46.85	54.00	-7.15	AVG
7	4998.750	51.89	5.91	57.80	74.00	-16.20	peak
8	4998.750	40.87	5.91	46.78	54.00	-7.22	AVG
9	5110.500	53.52	6.17	59.69	74.00	-14.31	peak
10	5110.500	41.78	6.17	47.95	54.00	-6.05	AVG
11	5121.000	56.57	6.20	62.77	74.00	-11.23	peak
12	5121.000	41.97	6.20	48.17	54.00	-5.83	AVG
13	5129.250	57.80	6.22	64.02	74.00	-9.98	peak
14	5129.250	44.57	6.22	50.79	54.00	-3.21	AVG
15	5142.000	58.79	6.25	65.04	74.00	-8.96	peak
16	5142.000	45.24	6.25	51.49	54.00	-2.51	AVG
17	5150.000	56.78	6.27	63.05	74.00	-10.95	peak
18	5150.000	45.75	6.27	52.02	54.00	-1.98	AVG
19	5233.500	99.81	6.46	106.27	---	---	peak

Note:1.Result (dBuV/m) = Correct Factor (dB/m) + Reading(dBuV).

2.Correction factor (dB/m) = Antenna Factor (dB/m) + Cable loss (dB) – Pre-Amplifier gain (dB).

3. When the peak results are less than average limit, so not need to evaluate the average.



Standard:	FCC Part 15.407	Test Distance:	3 m
Test item:	Band edge	Power:	AC 120 V/60 Hz
Frequency:	5775 MHz	Temp.(°C)/Hum.(%RH):	26(°C)/60 %RH
Mode:	Mode 5		
Ant.Polar.:	Horizontal		

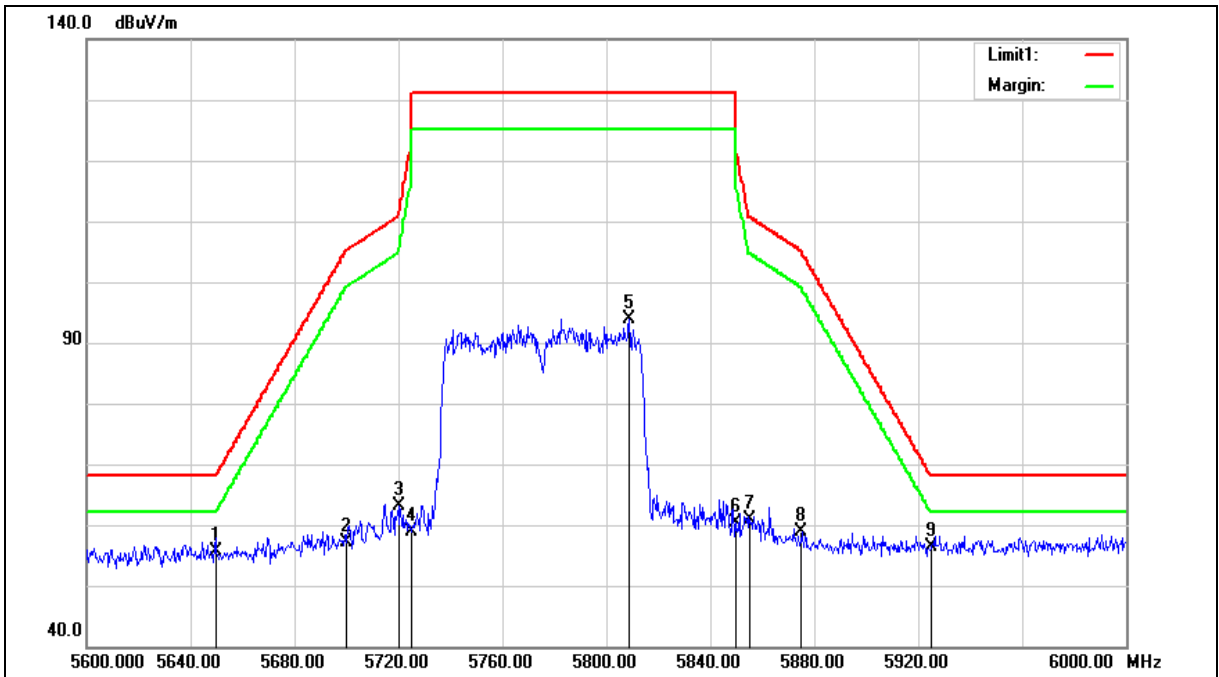





Standard:	FCC Part 15.407	Test Distance:	3 m
Test item:	Band edge	Power:	AC 120 V/60 Hz
Frequency:	5775 MHz	Temp.(°C)/Hum.(%RH):	26(°C )/60 %RH
Mode:	Mode 5		
Ant.Polar.:	Horizontal		

No.	Frequency (MHz)	Reading (dBuV)	Correct Factor (dB/m)	Result (dBuV/m)	Limit (dBuV/m)	Margin (dB)	Remark
1	5650.000	48.24	7.42	55.66	68.20	-12.54	peak
2	5700.000	49.72	7.52	57.24	105.20	-47.96	peak
3	5720.000	55.61	7.56	63.17	110.80	-47.63	peak
4	5725.000	51.41	7.57	58.98	122.20	-63.22	peak
5	5808.800	86.08	7.75	93.83	---	---	peak
6	5850.000	52.51	7.83	60.34	122.20	-61.86	peak
7	5855.000	52.97	7.85	60.82	110.80	-49.98	peak
8	5875.000	50.95	7.88	58.83	105.20	-46.37	peak
9	5925.000	48.50	8.00	56.50	68.20	-11.70	peak

Note:1.Result (dBuV/m) = Correct Factor (dB/m) + Reading(dBuV).

2.Correction factor (dB/m) = Antenna Factor (dB/m) + Cable loss (dB) – Pre-Amplifier gain (dB).

3. When the peak results are less than average limit, so not need to evaluate the average.



Standard:	FCC Part 15.407	Test Distance:	3 m
Test item:	Band edge	Power:	AC 120 V/60 Hz
Frequency:	5775 MHz	Temp.(°C)/Hum.(%RH):	26(°C)/60 %RH
Mode:	Mode 5		
Ant.Polar.:	Vertical		

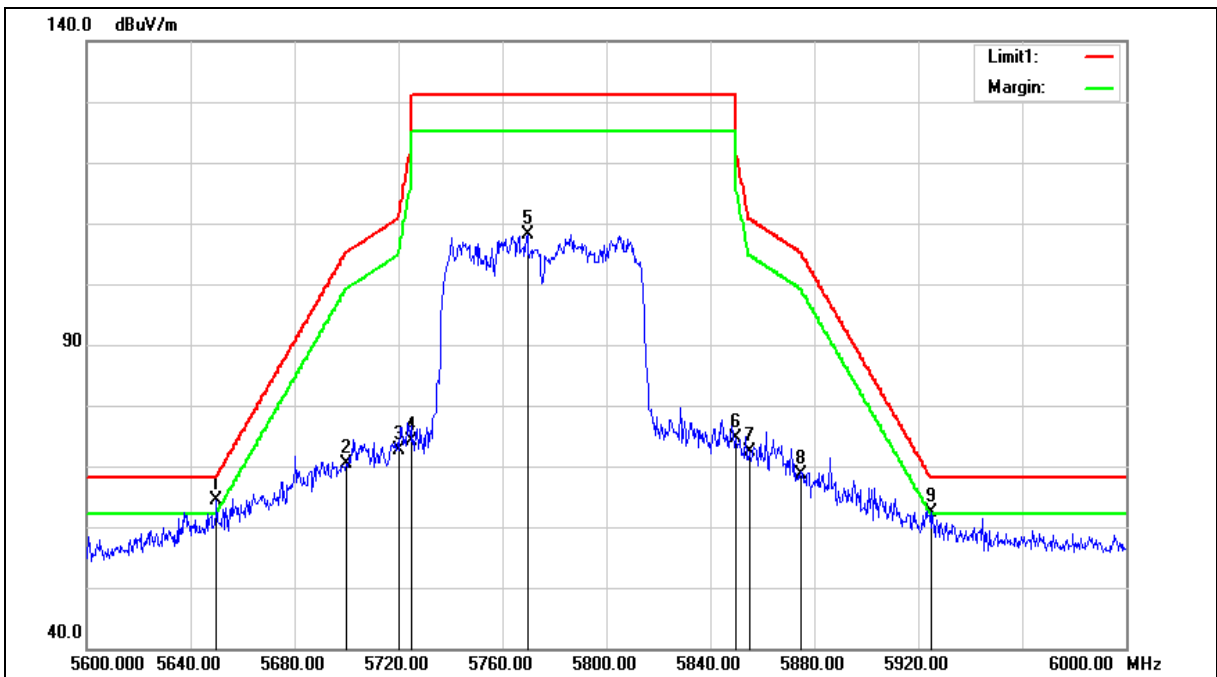



Standard:	FCC Part 15.407	Test Distance:	3 m
Test item:	Band edge	Power:	AC 120 V/60 Hz
Frequency:	5775 MHz	Temp.(°C)/Hum.(%RH):	26(°C )/60 %RH
Mode:	Mode 5		
Ant.Polar.:	Vertical		

No.	Frequency (MHz)	Reading (dBuV)	Correct Factor (dB/m)	Result (dBuV/m)	Limit (dBuV/m)	Margin (dB)	Remark
1	5650.000	56.98	7.42	64.40	68.20	-3.80	peak
2	5700.000	62.92	7.52	70.44	105.20	-34.76	peak
3	5720.000	65.13	7.56	72.69	110.80	-38.11	peak
4	5725.000	66.64	7.57	74.21	122.20	-47.99	peak
5	5769.600	100.41	7.67	108.08	---	---	peak
6	5850.000	66.79	7.83	74.62	122.20	-47.58	peak
7	5855.000	64.42	7.85	72.27	110.80	-38.53	peak
8	5875.000	60.86	7.88	68.74	105.20	-36.46	peak
9	5925.000	54.45	8.00	62.45	68.20	-5.75	peak

Note:1.Result (dBuV/m) = Correct Factor (dB/m) + Reading(dBuV).

2.Correction factor (dB/m) = Antenna Factor (dB/m) + Cable loss (dB) – Pre-Amplifier gain (dB).

3. When the peak results are less than average limit, so not need to evaluate the average.



## Annex C. Conducted Test Results

### Maximum Conducted Output Power Measurement

Test Mode		Mode 2: IEEE 802.11a Continuous TX mode					
Frequency (MHz)	Data Rate	ANT-0		ANT-1		FCC Limit (dBm)	
		(dBm)	(W)	(dBm)	(W)	Master	Client
5180	6 M	16.31	0.043	16.03	0.040	≤ 30.00	≤ 24.00
5200		18.22	0.066	18.02	0.063		
5220		18.25	0.067	18.12	0.065		
5240		18.31	0.068	18.25	0.067	≤ 30.00	≤ 30.00
5745		17.25	0.053	16.64	0.046		
5765		17.15	0.052	16.63	0.046		
5785		17.07	0.051	16.57	0.045		
5805		16.93	0.049	16.53	0.045		
5825		16.96	0.050	16.61	0.046		

Test Mode		Mode 2: IEEE 802.11a Continuous TX mode			
Frequency (MHz)	Data Rate	ANT-0+1		FCC Limit (dBm)	
		(dBm)	(dBm)	Master	Client
5180	6 M	19.18	0.083	≤ 30.00	≤ 24.00
5200		21.13	0.130		
5220		21.20	0.132		
5240		<b>21.29</b>	<b>0.135</b>	≤ 30.00	≤ 30.00
5745		<b>19.97</b>	<b>0.099</b>		
5765		19.91	0.098		
5785		19.84	0.096		
5805		19.74	0.094		
5825		19.80	0.095		

Note:1. The relevant measured result has the offset with cable loss already.

2. Evaluated high and low data rate, the report record worst case low data rate measurement results.



Test Mode		Mode 3: IEEE 802.11n 5 GHz 20 MHz Continuous TX mode					
Frequency (MHz)	Data Rate	ANT-0		ANT-1		FCC Limit (dBm)	
		(dBm)	(W)	(dBm)	(W)	Master	Client
5180	13 M	16.35	0.043	16.18	0.041	≤ 28.89	≤ 22.89
5200		18.25	0.067	18.07	0.064		
5220		18.31	0.068	18.22	0.066		
5240		18.41	0.069	18.35	0.068		
5745		17.25	0.053	16.35	0.043	≤ 28.26	≤ 28.26
5765		17.16	0.052	16.31	0.043		
5785		16.98	0.050	16.25	0.042		
5805		16.81	0.048	16.35	0.043		
5825		16.84	0.048	16.55	0.045		

Test Mode		Mode 3: IEEE 802.11n 5 GHz 20 MHz Continuous TX mode			
Frequency (MHz)	Data Rate	ANT-0+1		FCC Limit (dBm)	
		(dBm)	(dBm)	Master	Client
5180	13 M	19.28	0.085	≤ 28.89	≤ 22.89
5200		21.17	0.131		
5220		21.28	0.134		
5240		<b>21.39</b>	<b>0.138</b>		
5745		<b>19.83</b>	<b>0.096</b>	≤ 28.26	≤ 28.26
5765		19.77	0.095		
5785		19.64	0.092		
5805		19.60	0.091		
5825		19.71	0.093		

Note:1. The relevant measured result has the offset with cable loss already.

2. Evaluated high and low data rate, the report record worst case low data rate measurement results.



Test Mode		Mode 4: IEEE 802.11n 5 GHz 40 MHz Continuous TX mode					
Frequency (MHz)	Data Rate	ANT-0		ANT-1		FCC Limit (dBm)	
		(dBm)	(W)	(dBm)	(W)	Master	Client
5190	27 M	13.42	0.022	13.12	0.021	≤ 28.89	≤ 22.89
5230		18.35	0.068	18.31	0.068		
5755		17.86	0.061	17.02	0.050	≤ 28.26	≤ 28.26
5795		17.64	0.058	17.01	0.050		

Test Mode		Mode 4: IEEE 802.11n 5 GHz 40 MHz Continuous TX mode			
Frequency (MHz)	Data Rate	ANT-0+1		FCC Limit (dBm)	
		(dBm)	(dBm)	Master	Client
5190	27 M	16.28	0.042	≤ 28.89	≤ 22.89
5230		<b>21.34</b>	<b>0.136</b>		
5755		<b>20.47</b>	<b>0.111</b>	≤ 28.26	≤ 28.26
5795		20.35	0.108		

Test Mode		Mode 5: IEEE 802.11ac 80 MHz Continuous TX mode					
Frequency (MHz)	Data Rate	ANT-0		ANT-1		FCC Limit (dBm)	
		(dBm)	(W)	(dBm)	(W)	Master	Client
5210	58.6 M	10.37	0.011	10.05	0.010	≤ 28.89	≤ 22.89
5775		15.35	0.034	14.55	0.029	≤ 28.26	≤ 28.26

Test Mode		Mode 5: IEEE 802.11ac 80 MHz Continuous TX mode			
Frequency (MHz)	Data Rate	ANT-0+1		FCC Limit (dBm)	
		(dBm)	(dBm)	Master	Client
5210	58.6 M	<b>13.22</b>	<b>0.021</b>	≤ 28.89	≤ 22.89
5775		<b>17.98</b>	<b>0.063</b>	≤ 28.26	≤ 28.26

Note:1. The relevant measured result has the offset with cable loss already.

2. Evaluated high and low data rate, the report record worst case low data rate measurement results.



**26 dB RF Bandwidth Measurement & 99 % Occupied Bandwidth Measurement**

Test Mode	Mode 2: IEEE 802.11a Continuous TX mode			
Frequency (MHz)	26 dB Bandwidth (MHz)		99 % Occupied Bandwidth (MHz)	
	Ant-0	Ant-1	Ant-0	Ant-1
5180	19.060	19.230	16.436	16.480
5200	20.730	19.710	16.495	16.544
5240	21.020	20.800	16.522	16.519

Test Mode	Mode 3: IEEE 802.11ac 20 MHz Continuous TX mode			
Frequency (MHz)	26 dB Bandwidth (MHz)		99 % Occupied Bandwidth (MHz)	
	Ant-0	Ant-1	Ant-0	Ant-1
5180	19.990	20.180	17.614	17.637
5200	20.370	20.330	17.665	17.686
5240	22.510	20.140	17.662	17.645

Test Mode	Mode 4: IEEE 802.11ac 40 MHz Continuous TX mode			
Frequency (MHz)	26 dB Bandwidth (MHz)		99 % Occupied Bandwidth (MHz)	
	Ant-0	Ant-1	Ant-0	Ant-1
5190	40.340	40.070	36.052	35.990
5230	55.220	51.530	36.324	36.178

Test Mode	Mode 5: IEEE 802.11ac 80 MHz Continuous TX mode			
Frequency (MHz)	26 dB Bandwidth (MHz)		99 % Occupied Bandwidth (MHz)	
	Ant-0	Ant-1	Ant-0	Ant-1
5210	83.130	83.390	75.705	75.736

Note: The 99 % occupied bandwidth not crossed 5250 MHz.



■ Test Graphs

Mode 2: IEEE 802.11a Continuous TX mode_ ANT-0													
5180 MHz	<p>Center Freq: 5.18000000 GHz #Res BW: 300 kHz #VBW: 1 MHz Span: 40 MHz Sweep: 1 ms</p> <table border="1"><tr><td>Occupied Bandwidth</td><td>16.436 MHz</td><td>Total Power</td><td>21.1 dBm</td></tr><tr><td>Transmit Freq Error</td><td>6.324 kHz</td><td>OBW Power</td><td>99.00 %</td></tr><tr><td>x dB Bandwidth</td><td>19.06 MHz</td><td>x dB</td><td>-26.00 dB</td></tr></table>	Occupied Bandwidth	16.436 MHz	Total Power	21.1 dBm	Transmit Freq Error	6.324 kHz	OBW Power	99.00 %	x dB Bandwidth	19.06 MHz	x dB	-26.00 dB
Occupied Bandwidth	16.436 MHz	Total Power	21.1 dBm										
Transmit Freq Error	6.324 kHz	OBW Power	99.00 %										
x dB Bandwidth	19.06 MHz	x dB	-26.00 dB										
5200 MHz	<p>Center Freq: 5.20000000 GHz #Res BW: 300 kHz #VBW: 1 MHz Span: 40 MHz Sweep: 1 ms</p> <table border="1"><tr><td>Occupied Bandwidth</td><td>16.495 MHz</td><td>Total Power</td><td>22.7 dBm</td></tr><tr><td>Transmit Freq Error</td><td>12.399 kHz</td><td>OBW Power</td><td>99.00 %</td></tr><tr><td>x dB Bandwidth</td><td>20.73 MHz</td><td>x dB</td><td>-26.00 dB</td></tr></table>	Occupied Bandwidth	16.495 MHz	Total Power	22.7 dBm	Transmit Freq Error	12.399 kHz	OBW Power	99.00 %	x dB Bandwidth	20.73 MHz	x dB	-26.00 dB
Occupied Bandwidth	16.495 MHz	Total Power	22.7 dBm										
Transmit Freq Error	12.399 kHz	OBW Power	99.00 %										
x dB Bandwidth	20.73 MHz	x dB	-26.00 dB										
5240 MHz	<p>Center Freq: 5.24000000 GHz #Res BW: 300 kHz #VBW: 1 MHz Span: 40 MHz Sweep: 1 ms</p> <table border="1"><tr><td>Occupied Bandwidth</td><td>16.522 MHz</td><td>Total Power</td><td>22.9 dBm</td></tr><tr><td>Transmit Freq Error</td><td>18.528 kHz</td><td>OBW Power</td><td>99.00 %</td></tr><tr><td>x dB Bandwidth</td><td>21.02 MHz</td><td>x dB</td><td>-26.00 dB</td></tr></table>	Occupied Bandwidth	16.522 MHz	Total Power	22.9 dBm	Transmit Freq Error	18.528 kHz	OBW Power	99.00 %	x dB Bandwidth	21.02 MHz	x dB	-26.00 dB
Occupied Bandwidth	16.522 MHz	Total Power	22.9 dBm										
Transmit Freq Error	18.528 kHz	OBW Power	99.00 %										
x dB Bandwidth	21.02 MHz	x dB	-26.00 dB										





Mode 3: IEEE 802.11ac 20 MHz Continuous TX mode_ ANT-0	
5180 MHz	<p>Center Freq: 5.18000000 GHz</p> <p>Occupied Bandwidth: 17.614 MHz</p> <p>Total Power: 20.8 dBm</p> <p>Transmit Freq Error: 1.453 kHz</p> <p>x dB Bandwidth: 19.99 MHz</p> <p>OBW Power: 99.00 %</p> <p>x dB: -26.00 dB</p>
5200 MHz	<p>Center Freq: 5.20000000 GHz</p> <p>Occupied Bandwidth: 17.665 MHz</p> <p>Total Power: 22.6 dBm</p> <p>Transmit Freq Error: 6.060 kHz</p> <p>x dB Bandwidth: 20.37 MHz</p> <p>OBW Power: 99.00 %</p> <p>x dB: -26.00 dB</p>
5240 MHz	<p>Center Freq: 5.24000000 GHz</p> <p>Occupied Bandwidth: 17.662 MHz</p> <p>Total Power: 23.0 dBm</p> <p>Transmit Freq Error: -2.071 kHz</p> <p>x dB Bandwidth: 22.51 MHz</p> <p>OBW Power: 99.00 %</p> <p>x dB: -26.00 dB</p>

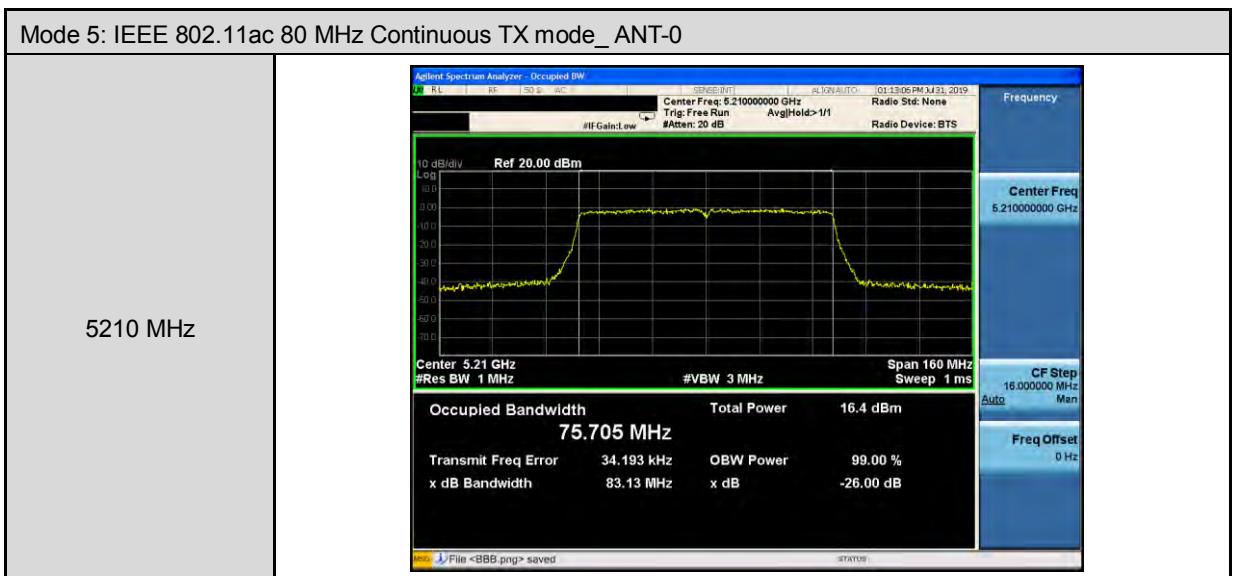
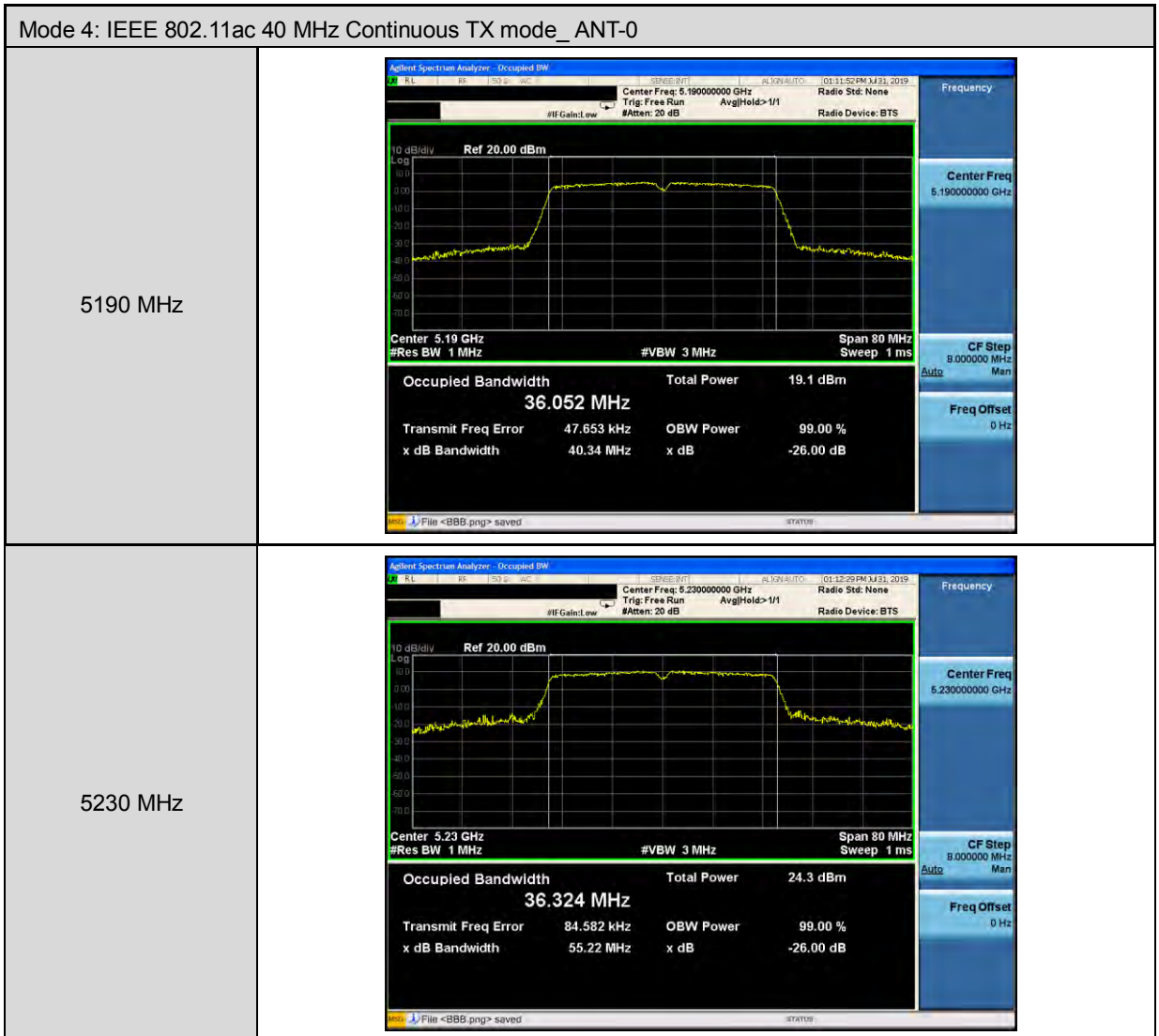



Mode 2: IEEE 802.11a Continuous TX mode_ ANT-1	
5180 MHz	<p>Center Freq: 5.18000000 GHz Occupied Bandwidth: 16.480 MHz Total Power: 20.6 dBm Transmit Freq Error: -9.459 kHz x dB Bandwidth: 19.23 MHz OBW Power: 99.00 % x dB: -26.00 dB</p>
5200 MHz	<p>Center Freq: 5.20000000 GHz Occupied Bandwidth: 16.544 MHz Total Power: 22.5 dBm Transmit Freq Error: -1.399 kHz x dB Bandwidth: 19.71 MHz OBW Power: 99.00 % x dB: -26.00 dB</p>
5240 MHz	<p>Center Freq: 5.24000000 GHz Occupied Bandwidth: 16.519 MHz Total Power: 23.1 dBm Transmit Freq Error: 13.135 kHz x dB Bandwidth: 20.80 MHz OBW Power: 99.00 % x dB: -26.00 dB</p>



Mode 3: IEEE 802.11ac 20 MHz Continuous TX mode_ ANT-1	
5180 MHz	<p>Center Freq: 5.18000000 GHz</p> <p>Occupied Bandwidth: 17.637 MHz</p> <p>Total Power: 20.5 dBm</p> <p>Transmit Freq Error: -6.153 kHz</p> <p>x dB Bandwidth: 20.18 MHz</p> <p>OBW Power: 99.00 %</p> <p>x dB: -26.00 dB</p>
5200 MHz	<p>Center Freq: 5.20000000 GHz</p> <p>Occupied Bandwidth: 17.686 MHz</p> <p>Total Power: 22.3 dBm</p> <p>Transmit Freq Error: 2.379 kHz</p> <p>x dB Bandwidth: 20.33 MHz</p> <p>OBW Power: 99.00 %</p> <p>x dB: -26.00 dB</p>
5240 MHz	<p>Center Freq: 5.24000000 GHz</p> <p>Occupied Bandwidth: 17.645 MHz</p> <p>Total Power: 23.0 dBm</p> <p>Transmit Freq Error: 11.867 kHz</p> <p>x dB Bandwidth: 20.14 MHz</p> <p>OBW Power: 99.00 %</p> <p>x dB: -26.00 dB</p>

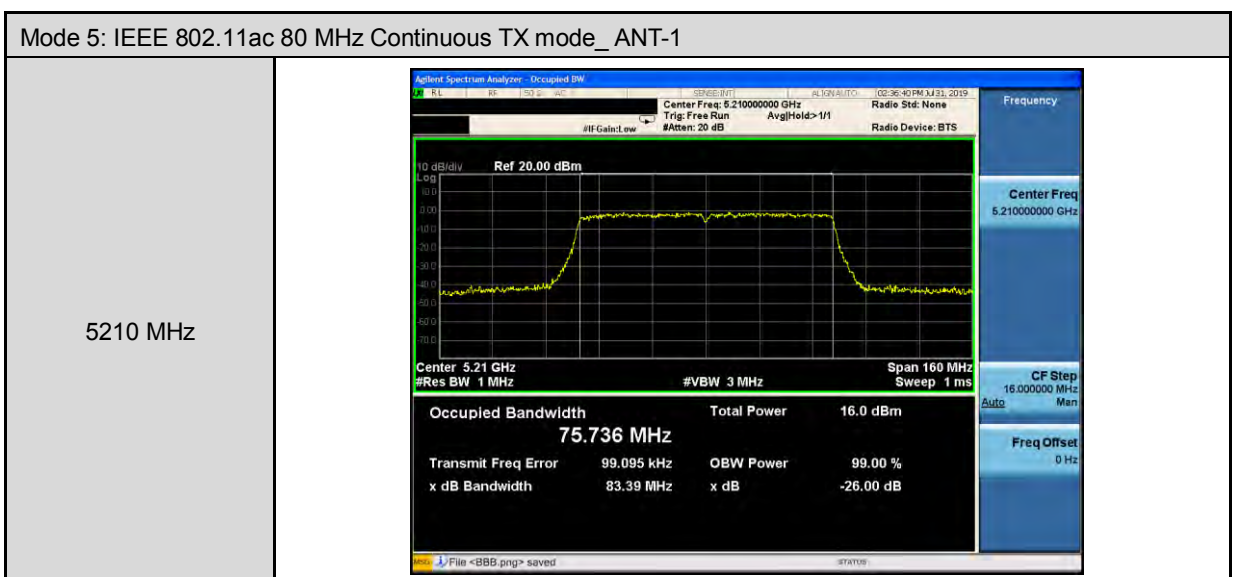
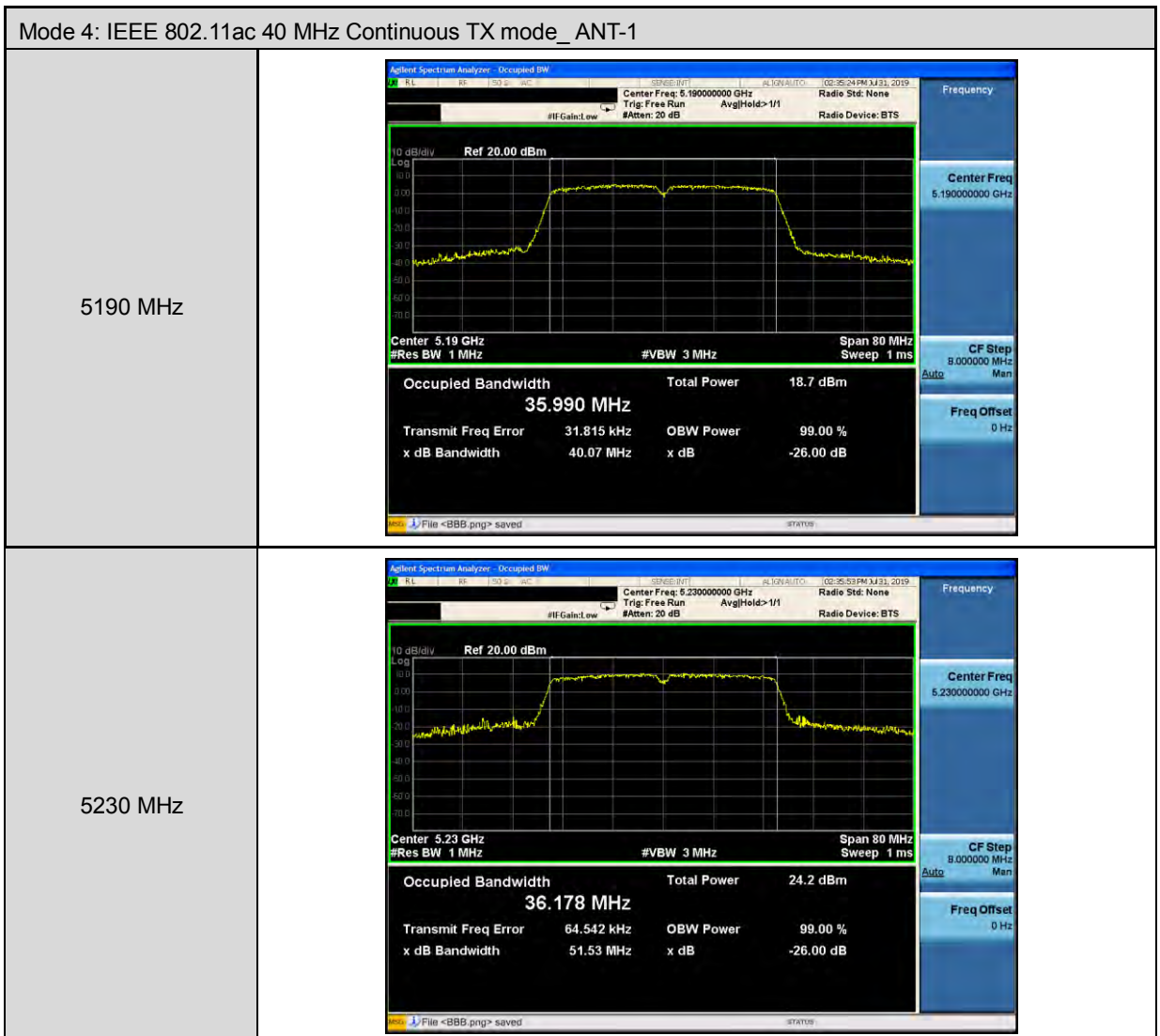



### 6 dB RF Bandwidth Measurement

Test Mode	Mode 2: IEEE 802.11a Continuous TX mode		
Frequency (MHz)	ANT-0	ANT-1	Limit (kHz)
5745	16380	16340	≥ 500
5785	16400	16350	≥ 500
5825	16380	16080	≥ 500

Test Mode	Mode 3: IEEE 802.11ac 20 MHz Continuous TX mode		
Frequency (MHz)	ANT-0	ANT-1	Limit (kHz)
5745	17620	17680	≥ 500
5785	17580	17240	≥ 500
5825	17620	17660	≥ 500

Test Mode	Mode 4: IEEE 802.11ac 40 MHz Continuous TX mode		
Frequency (MHz)	ANT-0	ANT-1	Limit (kHz)
5755	34240	35080	≥ 500
5795	35220	35190	≥ 500

Test Mode	Mode 5: IEEE 802.11ac 80 MHz Continuous TX mode		
Frequency (MHz)	ANT-0	ANT-1	Limit (kHz)
5775	75530	75380	≥ 500



■ Test Graphs

Mode 2: IEEE 802.11a Continuous TX mode_ANT-0	
5745 MHz	<p>Center Freq: 5.74500000 GHz #Res BW: 100 kHz #VBW: 300 kHz Span: 40 MHz Sweep: 3.867 ms</p> <p>Occupied Bandwidth: <b>16.620 MHz</b> Total Power: 21.9 dBm Transmit Freq Error: 2.766 kHz x dB Bandwidth: 16.38 MHz OBW Power: 99.00 % x dB: -6.00 dB</p>
5785 MHz	<p>Center Freq: 5.78500000 GHz #Res BW: 100 kHz #VBW: 300 kHz Span: 40 MHz Sweep: 3.867 ms</p> <p>Occupied Bandwidth: <b>17.124 MHz</b> Total Power: 21.5 dBm Transmit Freq Error: 156.03 kHz x dB Bandwidth: 16.40 MHz OBW Power: 99.00 % x dB: -6.00 dB</p>
5825 MHz	<p>Center Freq: 5.82500000 GHz #Res BW: 100 kHz #VBW: 300 kHz Span: 40 MHz Sweep: 3.867 ms</p> <p>Occupied Bandwidth: <b>17.986 MHz</b> Total Power: 21.8 dBm Transmit Freq Error: 340.95 kHz x dB Bandwidth: 16.38 MHz OBW Power: 99.00 % x dB: -6.00 dB</p>



Mode 3: IEEE 802.11ac 20 MHz Continuous TX mode_ANT-0	
5745 MHz	<p>Agilent Spectrum Analyzer - Occupied BW</p> <p>Center Freq: 5.745000000 GHz Trig: Free Run #IF Gain: Low #Atten: 20 dB Avg Hold&gt;1/1 Radio Std: None Radio Device: BTS</p> <p>Ref 20.00 dBm</p> <p>Center 5.745 GHz #Res BW 100 kHz #VBW 300 kHz Span 40 MHz Sweep 3.867 ms</p> <p>Occupied Bandwidth 17.801 MHz Total Power 21.5 dBm</p> <p>Transmit Freq Error 395 Hz OBW Power 99.00 % x dB Bandwidth 17.62 MHz x dB -6.00 dB</p> <p>File &lt;BBB.png&gt; saved</p>
5785 MHz	<p>Agilent Spectrum Analyzer - Occupied BW</p> <p>Center Freq: 5.785000000 GHz Trig: Free Run #IF Gain: Low #Atten: 20 dB Avg Hold&gt;1/1 Radio Std: None Radio Device: BTS</p> <p>Ref 20.00 dBm</p> <p>Center 5.785 GHz #Res BW 100 kHz #VBW 300 kHz Span 40 MHz Sweep 3.867 ms</p> <p>Occupied Bandwidth 18.049 MHz Total Power 21.4 dBm</p> <p>Transmit Freq Error 63.227 kHz OBW Power 99.00 % x dB Bandwidth 17.58 MHz x dB -6.00 dB</p> <p>File &lt;BBB.png&gt; saved</p>
5825 MHz	<p>Agilent Spectrum Analyzer - Occupied BW</p> <p>Center Freq: 5.825000000 GHz Trig: Free Run #IF Gain: Low #Atten: 20 dB Avg Hold&gt;1/1 Radio Std: None Radio Device: BTS</p> <p>Ref 20.00 dBm</p> <p>Center 5.825 GHz #Res BW 100 kHz #VBW 300 kHz Span 40 MHz Sweep 3.867 ms</p> <p>Occupied Bandwidth 18.543 MHz Total Power 21.6 dBm</p> <p>Transmit Freq Error 282.80 kHz OBW Power 99.00 % x dB Bandwidth 17.62 MHz x dB -6.00 dB</p> <p>File &lt;BBB.png&gt; saved</p>





Mode 4: IEEE 802.11ac 40 MHz Continuous TX mode\_ANT-0

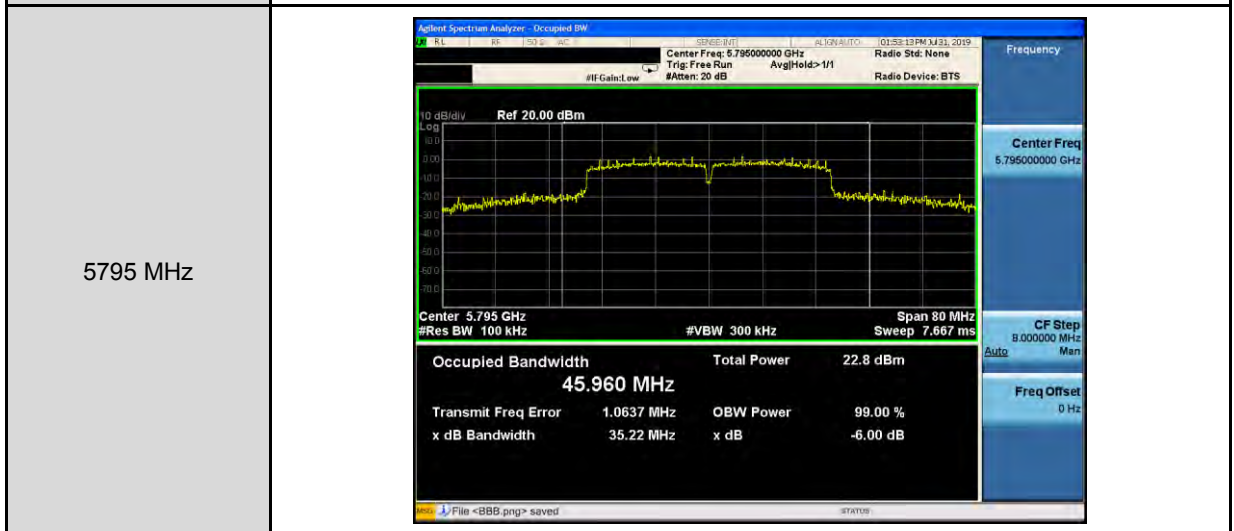
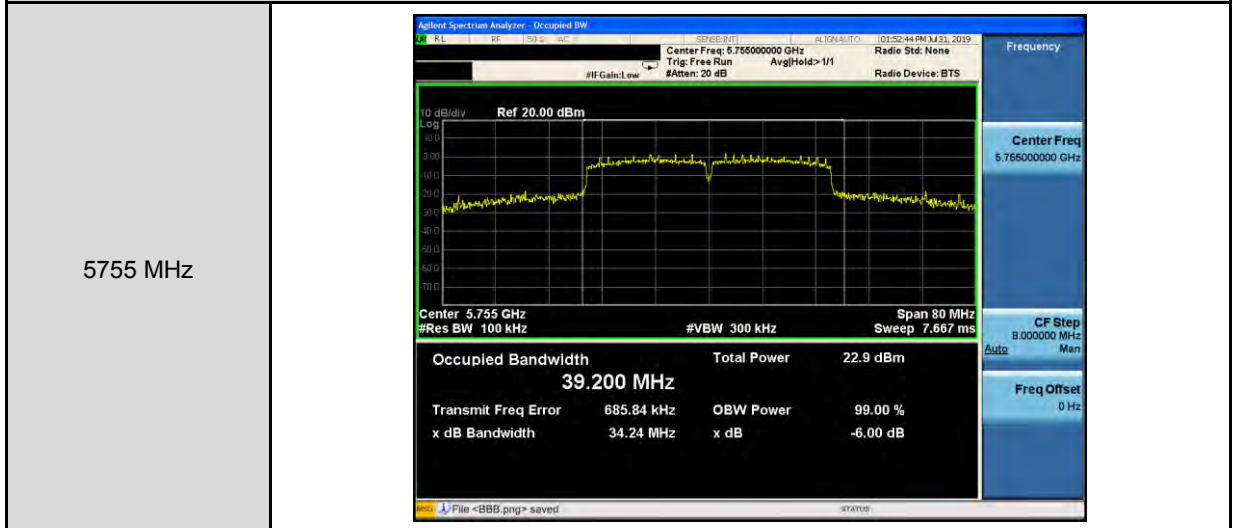

Mode 5: IEEE 802.11ac 80 MHz Continuous TX mode\_ANT-0





Mode 2: IEEE 802.11a Continuous TX mode_ANT-1	
5745 MHz	<p>Agilent Spectrum Analyzer - Occupied BW</p> <p>Center Freq: 5.745000000 GHz Trig: Free Run #IF Gain: Low #Atten: 20 dB Avg/Hold: 1/1 Radio Std: None Radio Device: BTS</p> <p>Ref 20.00 dBm</p> <p>Center: 5.745 GHz #Res BW: 100 kHz #VBW: 300 kHz Span: 40 MHz Sweep: 3.867 ms</p> <p>Occupied Bandwidth: 16.503 MHz Total Power: 21.3 dBm</p> <p>Transmit Freq Error: 10.547 kHz OBW Power: 99.00 % x dB Bandwidth: 16.34 MHz x dB: -6.00 dB</p> <p>File &lt;BBB.png&gt; saved</p>
5785 MHz	<p>Agilent Spectrum Analyzer - Occupied BW</p> <p>Center Freq: 5.785000000 GHz Trig: Free Run #IF Gain: Low #Atten: 20 dB Avg/Hold: 1/1 Radio Std: None Radio Device: BTS</p> <p>Ref 20.00 dBm</p> <p>Center: 5.785 GHz #Res BW: 100 kHz #VBW: 300 kHz Span: 40 MHz Sweep: 3.867 ms</p> <p>Occupied Bandwidth: 16.474 MHz Total Power: 21.4 dBm</p> <p>Transmit Freq Error: 7.383 kHz OBW Power: 99.00 % x dB Bandwidth: 16.35 MHz x dB: -6.00 dB</p> <p>File &lt;BBB.png&gt; saved</p>
5825 MHz	<p>Agilent Spectrum Analyzer - Occupied BW</p> <p>Center Freq: 5.825000000 GHz Trig: Free Run #IF Gain: Low #Atten: 20 dB Avg/Hold: 1/1 Radio Std: None Radio Device: BTS</p> <p>Ref 20.00 dBm</p> <p>Center: 5.825 GHz #Res BW: 100 kHz #VBW: 300 kHz Span: 40 MHz Sweep: 3.867 ms</p> <p>Occupied Bandwidth: 16.448 MHz Total Power: 21.6 dBm</p> <p>Transmit Freq Error: 20.676 kHz OBW Power: 99.00 % x dB Bandwidth: 16.08 MHz x dB: -6.00 dB</p> <p>File &lt;BBB.png&gt; saved</p>



Mode 3: IEEE 802.11ac 20 MHz Continuous TX mode_ANT-1	
5745 MHz	<p>Agilent Spectrum Analyzer - Occupied BW</p> <p>Center Freq: 5.745000000 GHz Trig: Free Run #IF Gain: Low #Atten: 20 dB Avg/Hold: 1/1 Radio Std: None Radio Device: BTS</p> <p>Ref 20.00 dBm</p> <p>Center 5.745 GHz #Res BW 100 kHz #VBW 300 kHz Span 40 MHz Sweep 3.867 ms</p> <p>Occupied Bandwidth 17.717 MHz Total Power 21.0 dBm</p> <p>Transmit Freq Error 12.234 kHz OBW Power 99.00 % x dB Bandwidth 17.68 MHz x dB -6.00 dB</p> <p>File &lt;BBB.png&gt; saved</p>
5785 MHz	<p>Agilent Spectrum Analyzer - Occupied BW</p> <p>Center Freq: 5.785000000 GHz Trig: Free Run #IF Gain: Low #Atten: 20 dB Avg/Hold: 1/1 Radio Std: None Radio Device: BTS</p> <p>Ref 20.00 dBm</p> <p>Center 5.785 GHz #Res BW 100 kHz #VBW 300 kHz Span 40 MHz Sweep 3.867 ms</p> <p>Occupied Bandwidth 17.688 MHz Total Power 20.8 dBm</p> <p>Transmit Freq Error -12.011 kHz OBW Power 99.00 % x dB Bandwidth 17.24 MHz x dB -6.00 dB</p> <p>File &lt;BBB.png&gt; saved</p>
5825 MHz	<p>Agilent Spectrum Analyzer - Occupied BW</p> <p>Center Freq: 5.825000000 GHz Trig: Free Run #IF Gain: Low #Atten: 20 dB Avg/Hold: 1/1 Radio Std: None Radio Device: BTS</p> <p>Ref 20.00 dBm</p> <p>Center 5.825 GHz #Res BW 100 kHz #VBW 300 kHz Span 40 MHz Sweep 3.867 ms</p> <p>Occupied Bandwidth 17.658 MHz Total Power 21.3 dBm</p> <p>Transmit Freq Error -16.994 kHz OBW Power 99.00 % x dB Bandwidth 17.66 MHz x dB -6.00 dB</p> <p>File &lt;BBB.png&gt; saved</p>



Mode 4: IEEE 802.11ac 40 MHz Continuous TX mode\_ANT-1

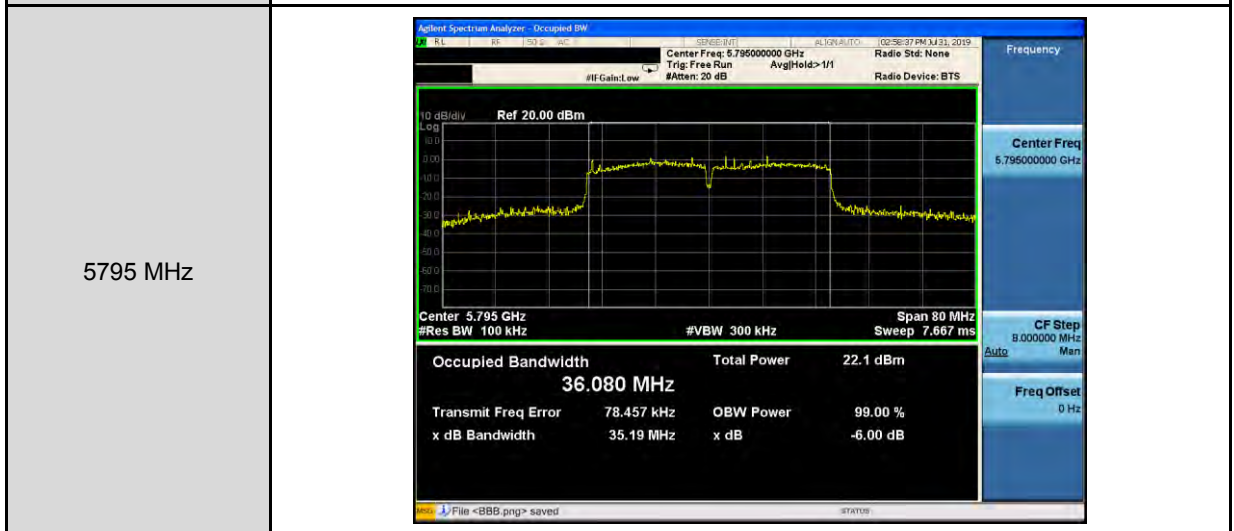

Mode 5: IEEE 802.11ac 80 MHz Continuous TX mode\_ANT-1

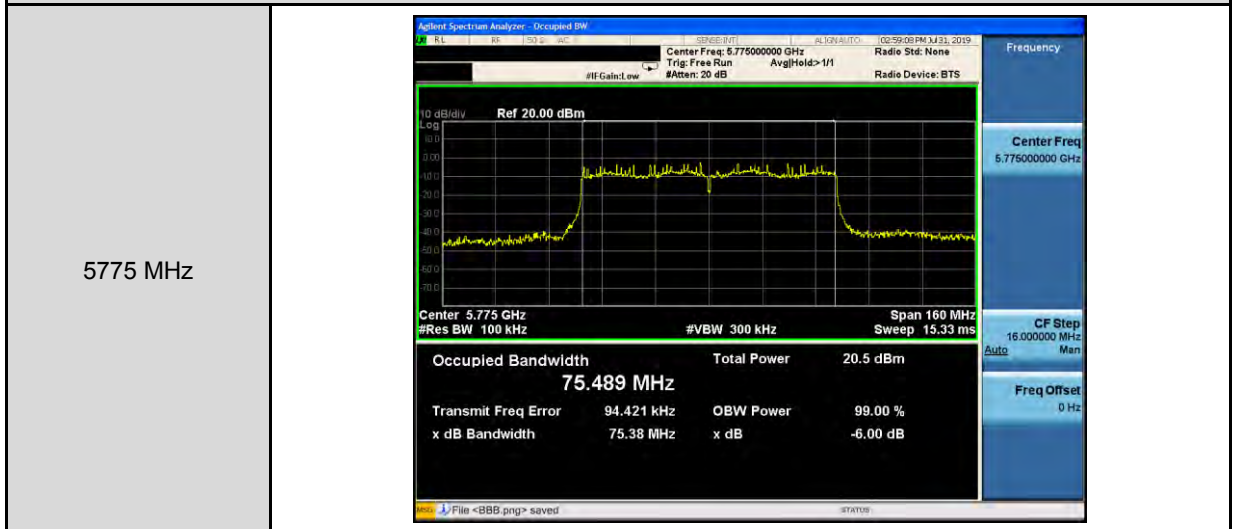



**Maximum Power Spectral Density Measurement**

Test Mode	Mode 2: IEEE 802.11a Continuous TX mode					
Conducted power spectral density						
Frequency (MHz)	ANT-0				Limit (dBm/MHz)	
	Measurement (dBm/MHz)	Duty Factor (dB)	Calculated (dBm/MHz)	Master	Client	
5180	2.803	0.124	2.927	≤ 15.89	≤ 9.89	
5200	4.813	0.124	4.937			
5240	5.453	0.124	5.577			
Frequency (MHz)	ANT-1				Limit (dBm/MHz)	
	Measurement (dBm/MHz)	Duty Factor (dB)	Calculated (dBm/MHz)	Master	Client	
5180	3.137	0.124	3.261	≤ 15.89	≤ 9.89	
5200	5.110	0.124	5.234			
5240	5.582	0.124	5.706			
Power Spectral Density						
Frequency (MHz)	ANT-0+1			Limit (dBm/MHz)		
	Calculated (dBm/MHz)			Master	Client	
5180.0	6.107			≤ 15.89	≤ 9.89	
5200.0	8.098					
5240.0	8.652					

Note: Method SA-2, Power density = measured result + 10 log(1/duty cycle) + Conversion ratio = measured result + duty factor.



Test Mode	Mode 2: IEEE 802.11a Continuous TX mode				
Conducted power spectral density					
Frequency (MHz)	ANT-0				
	Measurement (dBm/100 kHz)	Duty Factor (dB)	Calculated (dBm/500 kHz)	Limit (dBm/500 kHz)	
				Master	Client
5745	-4.973	0.124	2.140	≤ 28.26	≤ 28.26
5785	-4.591	0.124	2.522		
5825	-4.633	0.124	2.480		
Frequency (MHz)	ANT-1				
	Measurement (dBm/100 kHz)	Duty Factor (dB)	Calculated (dBm/500 kHz)	Limit (dBm/500 kHz)	
				Master	Client
5745	-4.530	0.124	2.583	≤ 28.26	≤ 28.26
5785	-4.362	0.124	2.751		
5825	-4.607	0.124	2.506		
Frequency (MHz)	ANT-0+1				
		Calculated (dBm/500 kHz)	Limit (dBm/500 kHz)		
			Master	Client	
5745		5.378	≤ 28.26	≤ 28.26	
5785		5.649			
5825		5.504			

Note: Method SA-2, Power density = measured result + 10 log(1/duty cycle) + Conversion ratio = measured result + duty factor.

Conversion ratio = 10\*Log(500 k/100 k)



Test Mode	Mode 3: IEEE 802.11ac 20 MHz Continuous TX mode					
Conducted power spectral density						
Frequency (MHz)	ANT-0				Limit (dBm/MHz)	
	Measurement (dBm/MHz)	Duty Factor (dB)	Calculated (dBm/MHz)	Limit (dBm/MHz)		
				Master	Client	
5180	3.277	0.034	3.311	≤ 15.89	≤ 9.89	
5200	4.973	0.034	5.007			
5240	5.360	0.034	5.394			
Frequency (MHz)	ANT-1				Limit (dBm/MHz)	
	Measurement (dBm/MHz)	Duty Factor (dB)	Calculated (dBm/MHz)	Limit (dBm/MHz)		
				Master	Client	
5180	2.784	0.034	2.818	≤ 15.89	≤ 9.89	
5200	4.714	0.034	4.748			
5240	5.247	0.034	5.281			
Power Spectral Density						
Frequency (MHz)	ANT-0+1			Limit (dBm/MHz)		
	Calculated (dBm/MHz)			Limit (dBm/MHz)		
				Master	Client	
5180.0	6.082			≤ 15.89	≤ 9.89	
5200.0	7.890					
5240.0	8.348					

Note: Method SA-2, Power density = measured result + 10 log(1/duty cycle) + Conversion ratio = measured result + duty factor.



Test Mode	Mode 3: IEEE 802.11ac 20 MHz Continuous TX mode				
Conducted power spectral density					
Frequency (MHz)	ANT-0				
	Measurement (dBm/100 kHz)	Duty Factor (dB)	Calculated (dBm/500 kHz)	Limit (dBm/500 kHz)	
				Master	Client
5745	-5.138	0.034	1.886	≤ 28.26	≤ 28.26
5785	-5.324	0.034	1.700		
5825	-5.186	0.034	1.838		
Frequency (MHz)	ANT-1				
	Measurement (dBm/100 kHz)	Duty Factor (dB)	Calculated (dBm/500 kHz)	Limit (dBm/500 kHz)	
				Master	Client
5745	-4.932	0.034	2.092	≤ 28.26	≤ 28.26
5785	-5.071	0.034	1.953		
5825	-4.688	0.034	2.336		
Frequency (MHz)	ANT-0+1				
		Calculated (dBm/500 kHz)	Limit (dBm/500 kHz)		
			Master	Client	
5745		5.000	≤ 28.26	≤ 28.26	
5785		4.838			
5825		5.104			

Note: Method SA-2, Power density = measured result + 10 log(1/duty cycle) + Conversion ratio = measured result + duty factor.

Conversion ratio = 10\*Log(500 k/100 k)





Test Mode	Mode 4: IEEE 802.11ac 40 MHz Continuous TX mode				
Conducted power spectral density					
Frequency (MHz)	ANT-0				
	Measurement (dBm/MHz)	Duty Factor (dB)	Calculated (dBm/MHz)	Limit (dBm/MHz)	
				Master	Client
5190	-2.735	0.105	-2.630	≤ 15.89	≤ 9.89
5230	2.636	0.105	2.741		
Frequency (MHz)	ANT-1				
	Measurement (dBm/MHz)	Duty Factor (dB)	Calculated (dBm/MHz)	Limit (dBm/MHz)	
				Master	Client
5190	-2.661	0.105	-2.556	≤ 15.89	≤ 9.89
5230	2.675	0.105	2.780		
Power Spectral Density					
Frequency (MHz)	ANT-0+1			Limit (dBm/MHz)	
	Calculated (dBm/MHz)			Master	Client
	5190.0	0.417			
5230.0	5.770				

Note: Method SA-2, Power density = measured result + 10 log(1/duty cycle) + Conversion ratio = measured result + duty factor.



Test Mode	Mode 4: IEEE 802.11ac 40 MHz Continuous TX mode					
Conducted power spectral density						
Frequency (MHz)	ANT-0					
	Measurement (dBm/100 kHz)	Duty Factor (dB)	Calculated (dBm/500 kHz)	Limit (dBm/500 kHz)		
				Master	Client	
5755	-7.416	0.105	-0.322	≤ 28.26	≤ 28.26	
5795	-7.337	0.105	-0.243			
Frequency (MHz)	ANT-1					
	Measurement (dBm/100 kHz)	Duty Factor (dB)	Calculated (dBm/500 kHz)	Limit (dBm/500 kHz)		
				Master	Client	
5755	-7.301	0.105	-0.207	≤ 28.26	≤ 28.26	
5795	-7.356	0.105	-0.262			
Frequency (MHz)	ANT-0+1					
		Calculated (dBm/500 kHz)			Limit (dBm/500 kHz)	
					Master	Client
5755		2.747			≤ 28.26	≤ 28.26
5795		2.758				

Note: Method SA-2, Power density = measured result + 10 log(1/duty cycle) + Conversion ratio = measured result + duty factor.

Conversion ratio = 10\*Log(500 k/100 k)



Test Mode	Mode 5: IEEE 802.11ac 80 MHz Continuous TX mode				
Conducted power spectral density					
Frequency (MHz)	ANT-0				
	Measurement (dBm/MHz)	Duty Factor (dB)	Calculated (dBm/MHz)	Limit (dBm/MHz)	
				Master	Client
5210	-9.340	0.273	-9.067	≤ 15.89	≤ 9.89
Frequency (MHz)	ANT-1				
	Measurement (dBm/MHz)	Duty Factor (dB)	Calculated (dBm/MHz)	Limit (dBm/MHz)	
				Master	Client
5210	-9.384	0.273	-9.111	≤ 15.89	≤ 9.89
Power Spectral Density					
Frequency (MHz)	ANT-0+1			Limit (dBm/MHz)	
	Calculated (dBm/MHz)			Master	Client
	5210.0	-6.078			

Note: Method SA-2, Power density = measured result + 10 log(1/duty cycle) + Conversion ratio = measured result + duty factor.



Test Mode	Mode 5: IEEE 802.11ac 80 MHz Continuous TX mode				
Conducted power spectral density					
Frequency (MHz)	ANT-0				
	Measurement (dBm/100 kHz)	Duty Factor (dB)	Calculated (dBm/500 kHz)	Limit (dBm/500 kHz)	
				Master	Client
5775	-13.437	0.273	-6.174	≤ 28.26	≤ 28.26
Frequency (MHz)	ANT-1				
	Measurement (dBm/100 kHz)	Duty Factor (dB)	Calculated (dBm/500 kHz)	Limit (dBm/500 kHz)	
				Master	Client
5775	-12.708	0.273	-5.445	≤ 28.26	≤ 28.26
Frequency (MHz)	ANT-0+1				
	Calculated (dBm/500 kHz)			Limit (dBm/500 kHz)	
				Master	Client
5775	-2.784			≤ 28.26	≤ 28.26

Note: Method SA-2, Power density = measured result + 10 log(1/duty cycle) + Conversion ratio = measured result + duty factor.



Conversion ratio = 10\*Log(500 k/100 k)



■ Test Graphs

Mode 2: IEEE 802.11a Continuous TX mode_ ANT-0	
5180 MHz	
5200 MHz	
5240 MHz	

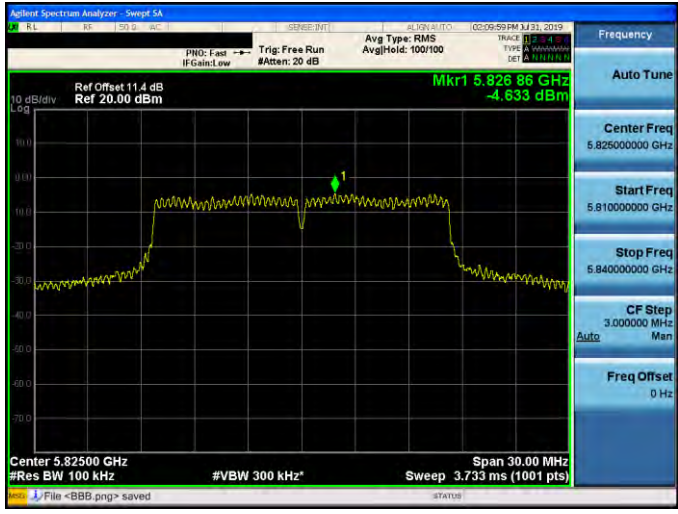

Mode 2: IEEE 802.11a Continuous TX mode_ ANT-0	
5745 MHz	
5785 MHz	
5825 MHz	



Mode 3: IEEE 802.11ac 20 MHz Continuous TX mode _ ANT-0	
5180 MHz	
5200 MHz	
5240 MHz	



Mode 3: IEEE 802.11ac 20 MHz Continuous TX mode _ANT-0	
5745 MHz	<p>Ref Offset 11.4 dB Ref 20.00 dBm Mkr1 5.753 13 GHz -5.138 dBm</p> <p>Center 5.74500 GHz #Res BW 100 kHz #VBW 300 kHz Span 30.00 MHz Sweep 3.733 ms (1001 pts)</p>
5785 MHz	<p>Ref Offset 11.4 dB Ref 20.00 dBm Mkr1 5.789 38 GHz -5.324 dBm</p> <p>Center 5.78500 GHz #Res BW 100 kHz #VBW 300 kHz Span 30.00 MHz Sweep 3.733 ms (1001 pts)</p>
5825 MHz	<p>Ref Offset 11.4 dB Ref 20.00 dBm Mkr1 5.832 20 GHz -5.186 dBm</p> <p>Center 5.82500 GHz #Res BW 100 kHz #VBW 300 kHz Span 30.00 MHz Sweep 3.733 ms (1001 pts)</p>







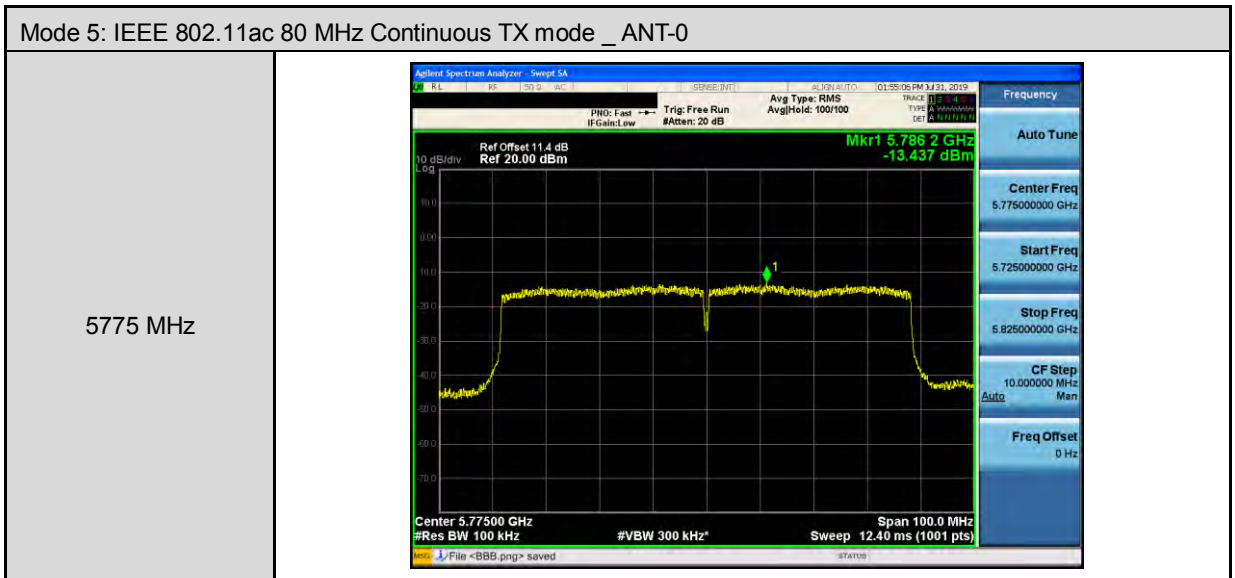
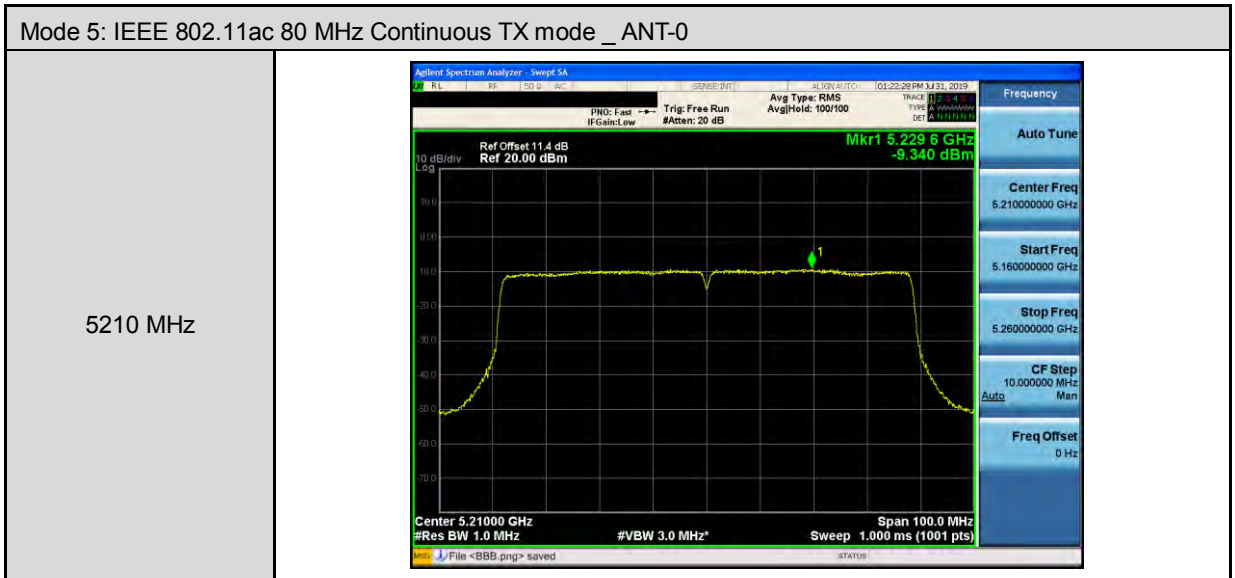







Mode 2: IEEE 802.11a Continuous TX mode_ ANT-1	
5180 MHz	
5200 MHz	
5240 MHz	

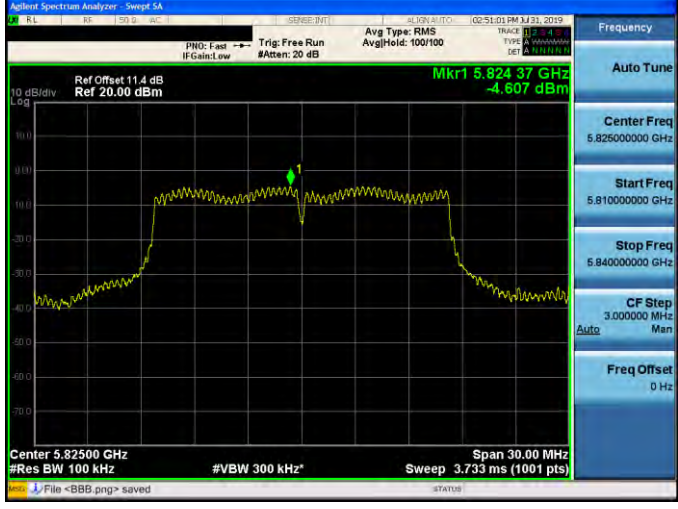

Mode 2: IEEE 802.11a Continuous TX mode_ ANT-1	
5745 MHz	 <p>Ref Offset 11.4 dB Ref 20.00 dBm Mkr1 5.747 82 GHz -4.530 dBm</p> <p>Center 5.74500 GHz #Res BW 100 kHz #VBW 300 kHz Span 30.00 MHz Sweep 3.733 ms (1001 pts)</p>
5785 MHz	 <p>Ref Offset 11.4 dB Ref 20.00 dBm Mkr1 5.783 74 GHz -4.362 dBm</p> <p>Center 5.78500 GHz #Res BW 100 kHz #VBW 300 kHz Span 30.00 MHz Sweep 3.733 ms (1001 pts)</p>
5825 MHz	 <p>Ref Offset 11.4 dB Ref 20.00 dBm Mkr1 5.824 37 GHz -4.607 dBm</p> <p>Center 5.82500 GHz #Res BW 100 kHz #VBW 300 kHz Span 30.00 MHz Sweep 3.733 ms (1001 pts)</p>



Mode 3: IEEE 802.11ac 20 MHz Continuous TX mode _ANT-1	
5180 MHz	 <p>Ref Offset 11.4 dB Ref 20.00 dBm Mkr1 5.17716 GHz 2.784 dBm Center 5.18000 GHz #Res BW 1.0 MHz #VBW 3.0 MHz Span 40.00 MHz Sweep 1.000 ms (1001 pts)</p>
5200 MHz	 <p>Ref Offset 11.4 dB Ref 20.00 dBm Mkr1 5.19648 GHz 4.714 dBm Center 5.20000 GHz #Res BW 1.0 MHz #VBW 3.0 MHz Span 40.00 MHz Sweep 1.000 ms (1001 pts)</p>
5240 MHz	 <p>Ref Offset 11.4 dB Ref 20.00 dBm Mkr1 5.23568 GHz 5.247 dBm Center 5.24000 GHz #Res BW 1.0 MHz #VBW 3.0 MHz Span 40.00 MHz Sweep 1.000 ms (1001 pts)</p>



Mode 3: IEEE 802.11ac 20 MHz Continuous TX mode _ANT-1	
5745 MHz	
5785 MHz	
5825 MHz	

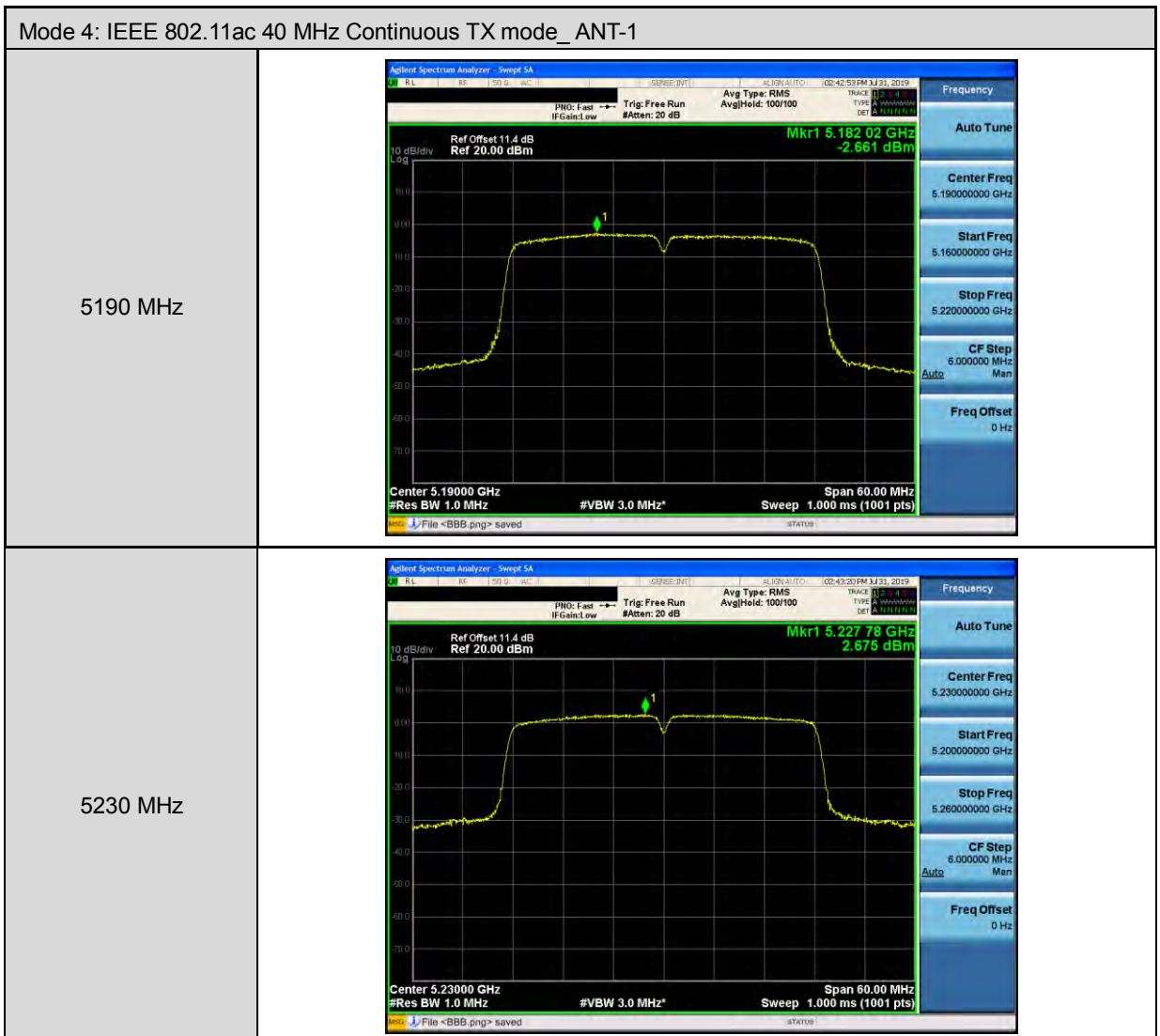





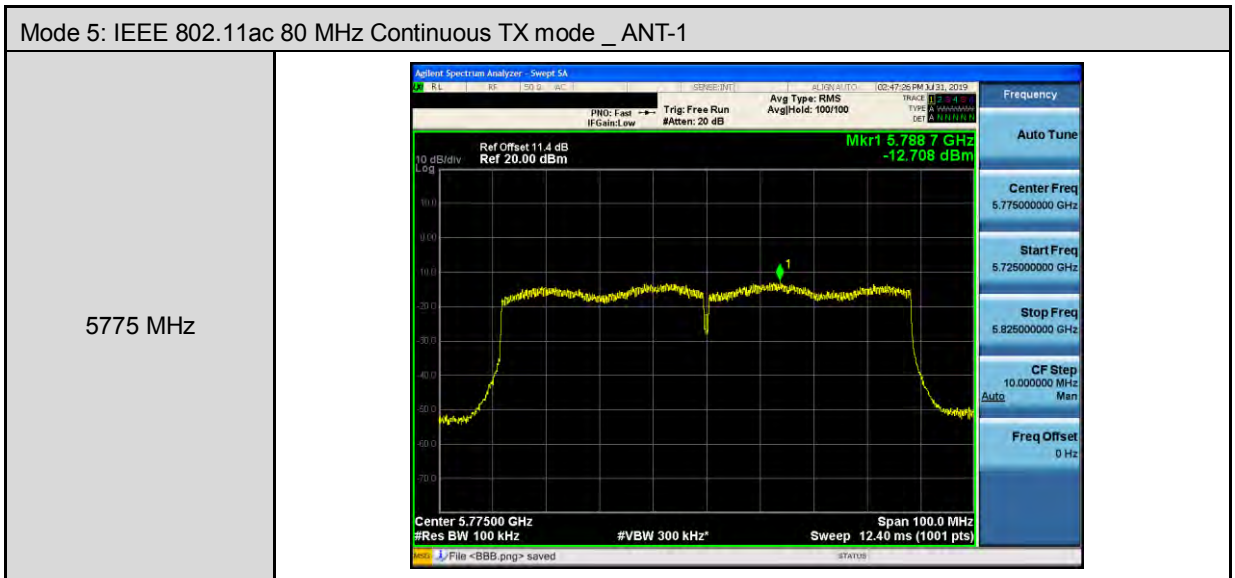
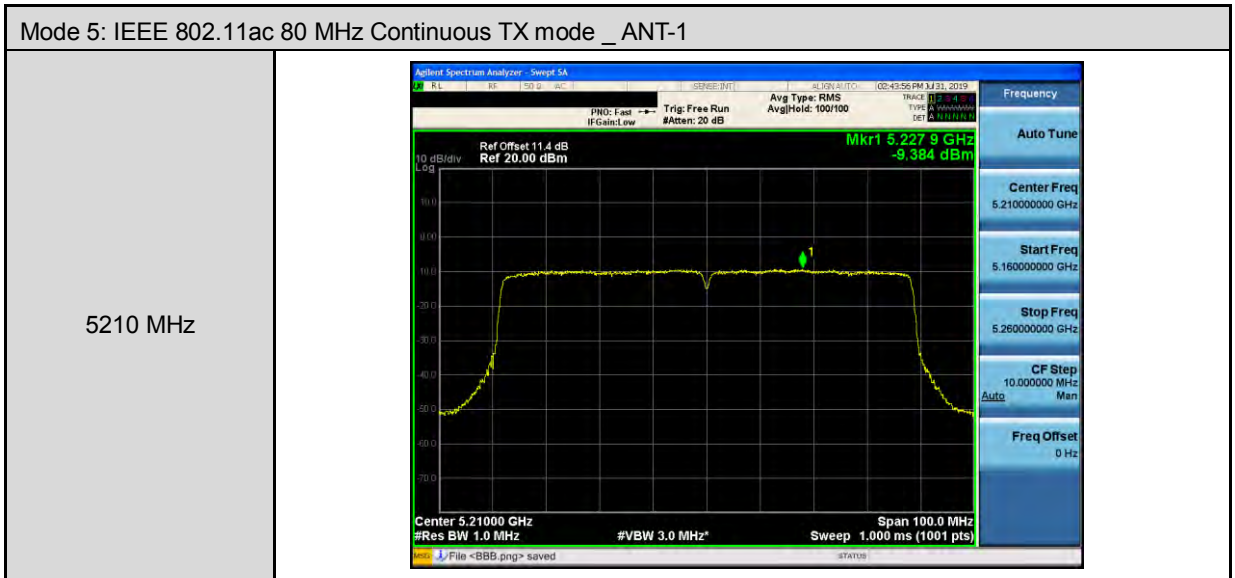

--- END---