

FCC Test Report

Report No.: RF160902E01-1

FCC ID: U8G-P1AC8

Test Model: Surf SOHO MK-III

Series Model: Pismo AC8, SOHO-AC-T, Surf SOHO

Received Date: Sep. 02, 2016

Test Date: Sep. 10 to Oct. 01, 2016

Issued Date: Oct. 24, 2016

Applicant: Pismo Labs Technology Limited

Address: FLAT/RM A5, 5/F, HK SPINNERS IND BLDG PHASE 6, 481 CASTLE PEAK ROAD, CHEUNG SHA WAN, HONG KONG.

Issued By: Bureau Veritas Consumer Products Services (H.K.) Ltd., Taoyuan Branch
Hsin Chu Laboratory

Lab Address: E-2, No.1, Li Hsin 1st Road, Hsinchu Science Park, Hsinchu City 300,
Taiwan R.O.C.

Test Location (1): E-2, No.1, Li Hsin 1st Road, Hsinchu Science Park, Hsinchu City 300,
Taiwan R.O.C.

Test Location (2): No. 49, Ln. 206, Wende Rd., Shangshan Tsuen, Chiung Lin Hsiang, Hsin
Chu Hsien 307, Taiwan R.O.C.



This report is for your exclusive use. Any copying or replication of this report to or for any other person or entity, or use of our name or trademark, is permitted only with our prior written permission. This report sets forth our findings solely with respect to the test samples identified herein. The results set forth in this report are not indicative or representative of the quality or characteristics of the lot from which a test sample was taken or any similar or identical product unless specifically and expressly noted. Our report includes all of the tests requested by you and the results thereof based upon the information that you provided to us. You have 60 days from date of issuance of this report to notify us of any material error or omission caused by our negligence, provided, however, that such notice shall be in writing and shall specifically address the issue you wish to raise. A failure to raise such issue within the prescribed time shall constitute your unqualified acceptance of the completeness of this report, the tests conducted and the correctness of the report contents. Unless specific mention, the uncertainty of measurement has been explicitly taken into account to declare the compliance or non-compliance to the specification. The report must not be used by the client to claim product certification, approval, or endorsement by TAF or any government agencies.

Table of Contents

Release Control Record	4
1 Certificate of Conformity	5
2 Summary of Test Results	6
2.1 Measurement Uncertainty	6
2.2 Modification Record	6
3 General Information	7
3.1 General Description of EUT	7
3.2 Description of Test Modes	10
3.2.1 Test Mode Applicability and Tested Channel Detail	11
3.3 Duty Cycle of Test Signal	13
3.4 Description of Support Units	14
3.4.1 Configuration of System under Test	15
3.5 General Description of Applied Standard	16
4 Test Types and Results	17
4.1 Radiated Emission and Bandedge Measurement	17
4.1.1 Limits of Radiated Emission and Bandedge Measurement	17
4.1.2 Test Instruments	18
4.1.3 Test Procedure	19
4.1.4 Deviation from Test Standard	20
4.1.5 Test Setup	20
4.1.6 EUT Operating Condition	21
4.1.7 Test Results	22
4.2 Conducted Emission Measurement	41
4.2.1 Limits of Conducted Emission Measurement	41
4.2.2 Test Instruments	41
4.2.3 Test Procedure	42
4.2.4 Deviation from Test Standard	42
4.2.5 Test Setup	42
4.2.6 EUT Operating Condition	42
4.2.7 Test Results	43
4.3 Transmit Power Measurement	45
4.3.1 Limits of Transmit Power Measurement	45
4.3.2 Test Setup	45
4.3.3 Test Instruments	45
4.3.4 Test Procedure	45
4.3.5 Deviation from Test Standard	45
4.3.6 EUT Operating Condition	45
4.3.7 Test Result	46
4.4 Occupied Bandwidth Measurement	48
4.4.1 Test Setup	48
4.4.2 Test Instruments	48
4.4.3 Test Procedure	48
4.4.4 Test Results	49
4.5 Peak Power Spectral Density Measurement	55
4.5.1 Limits of Peak Power Spectral Density Measurement	55
4.5.2 Test Setup	55
4.5.3 Test Instruments	55
4.5.4 Test Procedure	56
4.5.5 Deviation from Test Standard	56
4.5.6 EUT Operating Condition	56
4.5.7 Test Results	57
4.6 Frequency Stability Measurement	63
4.6.1 Limits of Frequency Stability Measurement	63

4.6.2	Test Setup.....	63
4.6.3	Test Instruments	63
4.6.4	Test Procedure	63
4.6.5	Deviation from Test Standard	63
4.6.6	EUT Operating Condition	63
4.6.7	Test Results	64
4.7	6dB Bandwidth Measurement	65
4.7.1	Limits of 6dB Bandwidth Measurement.....	65
4.7.2	Test Setup.....	65
4.7.3	Test Instruments	65
4.7.4	Test Procedure	65
4.7.5	Deviation from Test Standard	65
4.7.6	EUT Operating Condition	65
4.7.7	Test Results	66
5	Pictures of Test Arrangements.....	68
	Annex A- Radiated Out of Band Emission (OOBE) Measurement (For U-NII-3 band)	69
	Appendix – Information on the Testing Laboratories	72

Release Control Record

Issue No.	Description	Date Issued
RF160902E01-1	Original release.	Oct. 24, 2016

1 Certificate of Conformity

Product: Pepwave / Peplink / Pismo Labs Wireless Product

Brand: Pepwave / Peplink / Pismo

Test Model: Surf SOHO MK-III

Series Model: Pismo AC8, SOHO-AC-T, Surf SOHO

Sample Status: ENGINEERING SAMPLE

Applicant: Pismo Labs Technology Limited

Test Date: Sep. 10 to Oct. 01, 2016

Standard: 47 CFR FCC Part 15, Subpart E (Section 15.407)
ANSI C63.10: 2013

The above equipment has been tested by **Bureau Veritas Consumer Products Services (H.K.) Ltd., Taoyuan Branch**, and found compliance with the requirement of the above standards. The test record, data evaluation & Equipment Under Test (EUT) configurations represented herein are true and accurate accounts of the measurements of the sample's EMC characteristics under the conditions specified in this report.

Prepared by : Wendy Wu , **Date:** Oct. 24, 2016
Wendy Wu / Specialist

Approved by : May Chen , **Date:** Oct. 24, 2016
May Chen / Manager

2 Summary of Test Results

47 CFR FCC Part 15, Subpart E (Section 15.407)			
FCC Clause	Test Item	Result	Remarks
15.407(b)(6)	AC Power Conducted Emissions	Pass	Meet the requirement of limit. Minimum passing margin is -1.46dB at 0.43941MHz.
15.407(b) (1/2/3/4(i/ii)/6)	Radiated Emissions & Band Edge Measurement*	Pass	Meet the requirement of limit. Minimum passing margin is -0.1dB at 5645.48MHz.
15.407(a)(1/2/3)	Max Average Transmit Power	Pass	Meet the requirement of limit.
---	Occupied Bandwidth Measurement	-	Reference only.
15.407(a)(1/2/3)	Peak Power Spectral Density	Pass	Meet the requirement of limit.
15.407(e)	6dB bandwidth	Pass	Meet the requirement of limit. (U-NII-3 Band only)
15.407(g)	Frequency Stability	Pass	Meet the requirement of limit.
15.203	Antenna Requirement	Pass	Antenna connector is RSMA not a standard connector.

*For U-NII-3 band compliance with rule part 15.407(b)(4)(i), the OOB test plots were recorded in Annex A.

2.1 Measurement Uncertainty

Where relevant, the following measurement uncertainty levels have been estimated for tests performed on the EUT as specified in CISPR 16-4-2:

Measurement	Frequency	Expanded Uncertainty (k=2) (±)
Conducted Emissions at mains ports	150kHz ~ 30MHz	1.83 dB
Radiated Emissions up to 1 GHz	30MHz ~ 1GHz	5.43 dB
Radiated Emissions above 1 GHz	1GHz ~ 6GHz	3.72 dB
	6GHz ~ 18GHz	4.00 dB
	18GHz ~ 40GHz	4.11 dB

2.2 Modification Record

There were no modifications required for compliance.

3 General Information

3.1 General Description of EUT

Product	Pepwave / Peplink / Pismo Labs Wireless Product
Brand	Pepwave / Peplink / Pismo
Test Model	Surf SOHO MK-III
Series Model	Pismo AC8, SOHO-AC-T, Surf SOHO
Status of EUT	ENGINEERING SAMPLE
Power Supply Rating	12Vdc from power adapter
Modulation Type	CCK, DQPSK, DBPSK for DSSS 64QAM, 16QAM, QPSK, BPSK for OFDM 256QAM for OFDM in 11ac mode and VHT20/40 in 2.4GHz band
Modulation Technology	DSSS, OFDM
Transfer Rate	802.11b: up to 11Mbps 802.11a/g: up to 54Mbps 802.11n: up to 450Mbps 802.11ac: up to 1300Mbps
Operating Frequency	2.4GHz: 2.412GHz ~ 2.462GHz 5GHz: 5.18GHz ~ 5.24GHz, 5.745GHz ~ 5.825GHz
Number of Channel	2.4GHz: 802.11b, 802.11g, 802.11n (HT20), VHT20: 11 802.11n (HT40), VHT40: 7 5GHz: 802.11a, 802.11n (HT20), 802.11ac (VHT20): 9 802.11n (HT40), 802.11ac (VHT40): 4 802.11ac (VHT80): 2
Output Power	2.4GHz: 850.531mW 5GHz: 5.18GHz ~ 5.24GHz: 214.299mW 5.745GHz ~ 5.825GHz: 189.083mW
Antenna Type	Refer to Note
Antenna Connector	Refer to Note
Accessory Device	Adapter x 1
Data Cable Supplied	NA

Note:

1. The EUT has below model names, which are identical to each other in all aspects except for the following:

Product name	Brand	Model	Difference
Pepwave / Peplink / Pismo Labs Wireless Product	Pepwave / Peplink / Pismo	Surf SOHO	For marketing requirement
		Pismo AC8	
		SOHO-AC-T	
		Surf SOHO MK-III	

From the above models, model: **Surf SOHO MK-III** was selected as representative model for the test and its data was recorded in this report.

2. There are WLAN and WWAN(3G) technology used for the EUT.

3. EUT could be applied with a plug in USB cellular device,

4. The EUT must be supplied with a power adapter as following table:

Brand	Model No.	Spec.
Ten Pao	S040QM1200300	Input: 100-240Vac, 50/60Hz, 1.0A Output: 12Vdc, 3000mA DC output cable (Unshielded, 1.5m with one core)

5. Simultaneously transmission condition.

Condition	Technology		
1	WLAN (2.4GHz)	WLAN (5GHz)	WWAN (USB cellular device)

Note: The emission of the simultaneous operation has been evaluated and no non-compliance was found.

6. The antennas provided to the EUT, please refer to the following table:

Antenna No.	Chain No.	Brand	Model	Antenna Net Gain(dBi)	Frequency range (GHz ~ GHz)	Antenna Type	Connector Type	Cable Length (mm)	Cable Loss (dB)	Antenna Gain(dBi) <excluding cable loss>
1	Chain 0	SmartAnt	SAA06-220690-V1	1.4	2.4~2.4835	Dipole	R-SMA	210	1.6	3
				3.9	5.15~5.35					5.5
				4.4	5.35~5.85					6
2	Chain 1	SmartAnt	SAA06-220690-V1	1.8	2.4~2.4835	Dipole	R-SMA	150	1.2	3
				4.3	5.15~5.35					5.5
				4.8	5.35~5.85					6
3	Chain 2	SmartAnt	SAA06-220690-V1	2	2.4~2.4835	Dipole	R-SMA	120	1	3
				4.5	5.15~5.35					5.5
				5	5.35~5.85					6

7. The EUT incorporates a MIMO function.

2.4GHz Band			
MODULATION MODE	DATA RATE (MCS)	TX & RX CONFIGURATION	
802.11b	1 ~ 11Mbps	3TX	3RX
802.11g	6 ~ 54Mbps	3TX	3RX
802.11n (HT20)	MCS 0~7	3TX	3RX
	MCS 8~15	3TX	3RX
	MCS 16~23	3TX	3RX
802.11n (HT40)	MCS 0~7	3TX	3RX
	MCS 8~15	3TX	3RX
	MCS 16~23	3TX	3RX
VHT20	MCS 0~7	3TX	3RX
	MCS 8~15	3TX	3RX
	MCS 16~23	3TX	3RX
VHT40	MCS 0~7	3TX	3RX
	MCS 8~15	3TX	3RX
	MCS 16~23	3TX	3RX
5GHz Band			
MODULATION MODE	DATA RATE (MCS)	TX & RX CONFIGURATION	
802.11a	6 ~ 54Mbps	3TX	3RX
802.11n (HT20)	MCS 0~7	3TX	3RX
	MCS 8~15	3TX	3RX
	MCS 16~23	3TX	3RX
802.11n (HT40)	MCS 0~7	3TX	3RX
	MCS 8~15	3TX	3RX
	MCS 16~23	3TX	3RX
802.11ac (VHT20)	MCS0~8 Nss=1	3TX	3RX
	MCS0~8 Nss=2	3TX	3RX
	MCS0~9 Nss=3	3TX	3RX
802.11ac (VHT40)	MCS0~9 Nss=1	3TX	3RX
	MCS0~9 Nss=2	3TX	3RX
	MCS0~9 Nss=3	3TX	3RX
802.11ac (VHT80)	MCS0~9 Nss=1	3TX	3RX
	MCS0~9 Nss=2	3TX	3RX
	MCS0~9 Nss=3	3TX	3RX

Note:

1. The modulation and bandwidth are similar for 802.11n mode for 20MHz (40MHz) and 802.11ac mode for 20MHz (40MHz), therefore investigated worst case to representative mode in test report. (Final test mode refer section 3.2.1)

8. The above EUT information is declared by manufacturer and for more detailed features description, please refer to the manufacturer's specifications or user's manual.

3.2 Description of Test Modes

FOR 5180 ~ 5240MHz

4 channels are provided for 802.11a, 802.11n (HT20), 802.11ac (VHT20):

Channel	Frequency	Channel	Frequency
36	5180MHz	44	5220MHz
40	5200MHz	48	5240MHz

2 channels are provided for 802.11n (HT40), 802.11ac (VHT40):

Channel	Frequency	Channel	Frequency
38	5190MHz	46	5230MHz

1 channel is provided for 802.11ac (VHT80):

Channel	Frequency
42	5210MHz

FOR 5745 ~ 5825MHz:

5 channels are provided for 802.11a, 802.11n (HT20), 802.11ac (VHT20):

Channel	Frequency	Channel	Frequency
149	5745MHz	161	5805MHz
153	5765MHz	165	5825MHz
157	5785MHz		

2 channels are provided for 802.11n (HT40), 802.11ac (VHT40):

Channel	Frequency	Channel	Frequency
151	5755MHz	159	5795MHz

1 channel is provided for 802.11ac (VHT80):

Channel	Frequency
155	5775MHz

3.2.1 Test Mode Applicability and Tested Channel Detail

EUT Configure Mode	Applicable To				Description
	RE \geq 1G	RE<1G	PLC	APCM	
-	√	√	√	√	

Where **RE \geq 1G**: Radiated Emission above 1GHz **RE<1G**: Radiated Emission below 1GHz
PLC: Power Line Conducted Emission **APCM**: Antenna Port Conducted Measurement

Radiated Emission Test (Above 1GHz):

- Pre-Scan has been conducted to determine the worst-case mode from all possible combinations between available modulations, data rates and antenna ports (if EUT with antenna diversity architecture).
- Following channel(s) was (were) selected for the final test as listed below.

Mode	FREQ. Band (MHz)	Available Channel	Tested Channel	Modulation Technology	Modulation Type	Data Rate (Mbps)
802.11a	5180-5240	36 to 48	36, 40, 48	OFDM	BPSK	6
802.11ac (VHT20)		36 to 48	36, 40, 48	OFDM	BPSK	6.5
802.11ac (VHT40)		38 to 46	38, 46	OFDM	BPSK	13.5
802.11ac (VHT80)		42	42	OFDM	BPSK	29.3
802.11a	5745-5825	149 to 165	149, 157, 165	OFDM	BPSK	6
802.11ac (VHT20)		149 to 165	149, 157, 165	OFDM	BPSK	6.5
802.11ac (VHT40)		151 to 159	151, 159	OFDM	BPSK	13.5
802.11ac (VHT80)		155	155	OFDM	BPSK	29.3

Radiated Emission Test (Below 1GHz):

- Pre-Scan has been conducted to determine the worst-case mode from all possible combinations between available modulations, data rates and antenna ports (if EUT with antenna diversity architecture).
- Following channel(s) was (were) selected for the final test as listed below.

Mode	FREQ. Band (MHz)	Available Channel	Tested Channel	Modulation Technology	Modulation Type	Data Rate (Mbps)
802.11ac (VHT40)	5180-5240	38 to 46	46	OFDM	BPSK	13.5

Power Line Conducted Emission Test:

- Pre-Scan has been conducted to determine the worst-case mode from all possible combinations between available modulations, data rates and antenna ports (if EUT with antenna diversity architecture).
- Following channel(s) was (were) selected for the final test as listed below.

Mode	FREQ. Band (MHz)	Available Channel	Tested Channel	Modulation Technology	Modulation Type	Data Rate (Mbps)
802.11ac (VHT40)	5180-5240	38 to 46	46	OFDM	BPSK	13.5

Antenna Port Conducted Measurement:

- This item includes all test value of each mode, but only includes spectrum plot of worst value of each mode.
- Pre-Scan has been conducted to determine the worst-case mode from all possible combinations between available modulations, data rates and antenna ports (if EUT with antenna diversity architecture).
- Following channel(s) was (were) selected for the final test as listed below.

Mode	FREQ. Band (MHz)	Available Channel	Tested Channel	Modulation Technology	Modulation Type	Data Rate (Mbps)
802.11a	5180-5240	36 to 48	36, 40, 48	OFDM	BPSK	6
802.11ac (VHT20)		36 to 48	36, 40, 48	OFDM	BPSK	6.5
802.11ac (VHT40)		38 to 46	38, 46	OFDM	BPSK	13.5
802.11ac (VHT80)		42	42	OFDM	BPSK	29.3
802.11a	5745-5825	149 to 165	149, 157, 165	OFDM	BPSK	6
802.11ac (VHT20)		149 to 165	149, 157, 165	OFDM	BPSK	6.5
802.11ac (VHT40)		151 to 159	151, 159	OFDM	BPSK	13.5
802.11ac (VHT80)		155	155	OFDM	BPSK	29.3

Test Condition:

APPLICABLE TO	ENVIRONMENTAL CONDITIONS	INPUT POWER	TESTED BY
RE \geq 1G	25deg. C, 66%RH	120Vac, 60Hz	Weiwei Lo
RE $<$ 1G	25deg. C, 70%RH	120Vac, 60Hz	Andy Ho
PLC	25deg. C, 75%RH	120Vac, 60Hz	Andy Ho
APCM	25deg. C, 60%RH	120Vac, 60Hz	Tim Ho

3.3 Duty Cycle of Test Signal

If duty cycle of test signal is $\geq 98\%$, duty factor is not required.

If duty cycle of test signal is $< 98\%$, duty factor shall be considered.

802.11a: Duty cycle = $5.345 \text{ ms} / 5.43 \text{ ms} = 0.984$

802.11ac (VHT20): Duty cycle = $4.973 \text{ ms} / 5.068 \text{ ms} = 0.981$

802.11ac (VHT40): Duty cycle = $3.592 \text{ ms} / 3.661 \text{ ms} = 0.981$

802.11ac (VHT80): Duty cycle = $1.679 \text{ ms} / 1.759 \text{ ms} = 0.955$, Duty factor = $10 * \log(1/0.955) = 0.2$

802.11a

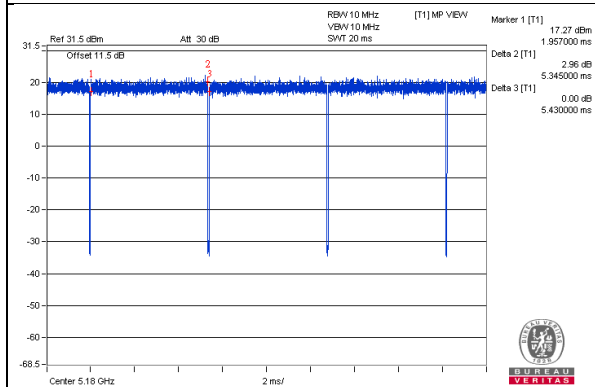

802.11ac (VHT20)

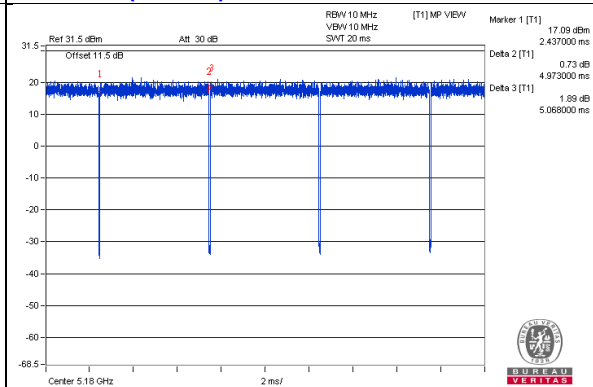

802.11ac (VHT40)

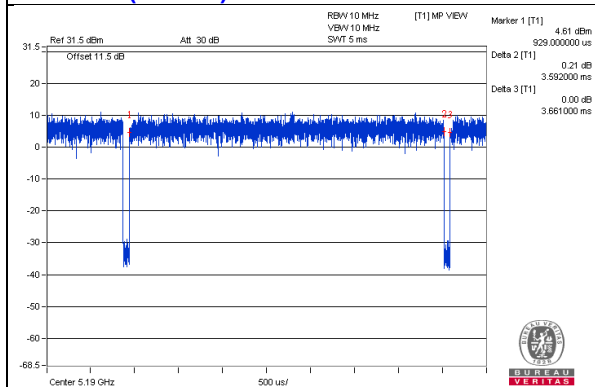

802.11ac (VHT80)

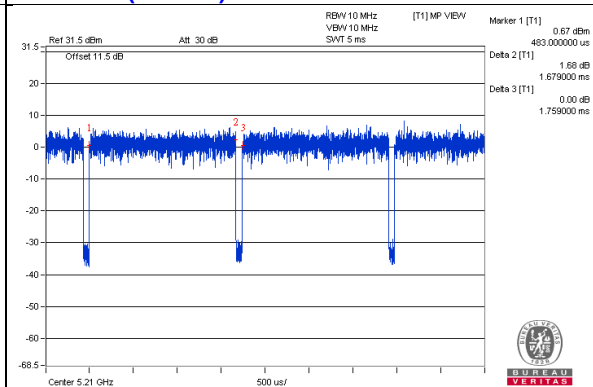

3.4 Description of Support Units

The EUT has been tested as an independent unit together with other necessary accessories or support units. The following support units or accessories were used to form a representative test configuration during the tests.

ID	Product	Brand	Model No.	Serial No.	FCC ID	Remarks
A.	Laptop	DELL	E6440	F9LYQ32	FCC DoC	Provided by Lab
B.	Laptop	DELL	E6420	B92T3R1	FCC DoC	Provided by Lab
C.	3G Dongle	D-Link	DWM-156	Q2011A4000812	KA2WM156A2	Provided by Lab

Note:

1. All power cords of the above support units are non-shielded (1.8m).

ID	Descriptions	Qty.	Length (m)	Shielding (Yes/No)	Cores (Qty.)	Remarks
1.	RJ-45 Cable	1	10	No	0	Provided by Lab
2.	RJ-45 Cable	1	10	No	0	Provided by Lab
3.	DC Cable	1	1.5	No	1	Supplied by client

Note: The core(s) is(are) originally attached to the cable(s).

3.4.1 Configuration of System under Test

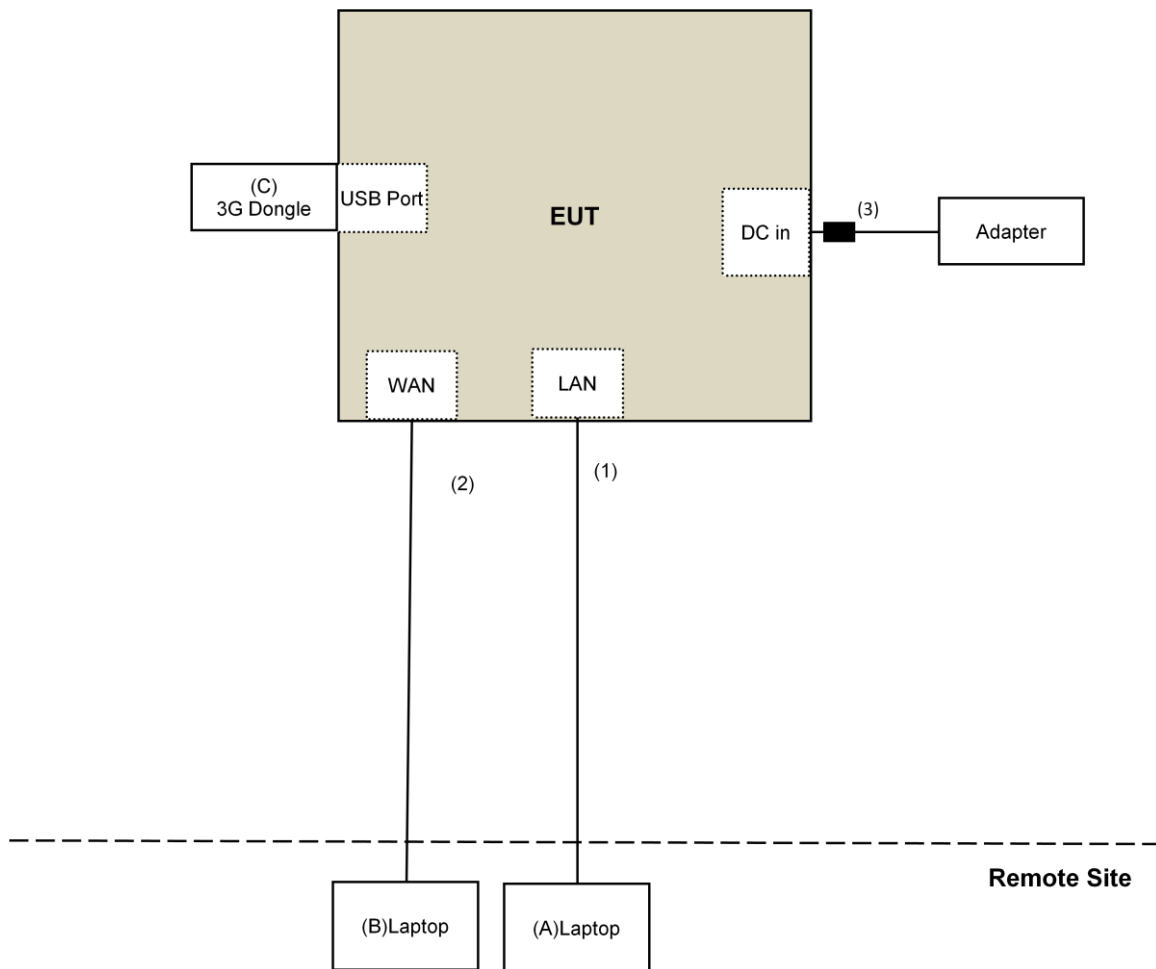

3.5 General Description of Applied Standard

The EUT is a RF Product. According to the specifications of the manufacturer, it must comply with the requirements of the following standards:

FCC Part 15, Subpart E (15.407)
KDB 789033 D02 General UNII Test Procedure New Rules v01r03
KDB 662911 D01 Multiple Transmitter Output v02r01
ANSI C63.10-2013

All test items have been performed and recorded as per the above standards.

4 Test Types and Results

4.1 Radiated Emission and Bandedge Measurement

4.1.1 Limits of Radiated Emission and Bandedge Measurement

Radiated emissions which fall in the restricted bands must comply with the radiated emission limits specified as below table.

Frequencies (MHz)	Field Strength (microvolts/meter)	Measurement Distance (meters)
0.009 ~ 0.490	2400/F(kHz)	300
0.490 ~ 1.705	24000/F(kHz)	30
1.705 ~ 30.0	30	30
30 ~ 88	100	3
88 ~ 216	150	3
216 ~ 960	200	3
Above 960	500	3

NOTE:

1. The lower limit shall apply at the transition frequencies.
2. Emission level (dBuV/m) = 20 log Emission level (uV/m).
3. For frequencies above 1000MHz, the field strength limits are based on average detector, however, the peak field strength of any emission shall not exceed the maximum permitted average limits, specified above by more than 20dB under any condition of modulation.

Limits of unwanted emission out of the restricted bands

Applicable To		Limit	
789033 D02 General UNII Test Procedure New Rules v01r02		Field Strength at 3m	
		PK:74 (dBμV/m)	AV:54 (dBμV/m)
Frequency Band	Applicable To	EIRP Limit	Equivalent Field Strength at 3m
5150~5250 MHz	15.407(b)(1)	PK:-27 (dBm/MHz)	PK:68.2(dBμV/m)
5250~5350 MHz	15.407(b)(2)		
5470~5725 MHz	15.407(b)(3)		
5725~5850 MHz	<input checked="" type="checkbox"/> 15.407(b)(4)(i)	PK:-27 (dBm/MHz) ^{*1} PK:10 (dBm/MHz) ^{*2} PK:15.6 (dBm/MHz) ^{*3} PK:27 (dBm/MHz) ^{*4}	PK: 68.2(dBμV/m) ^{*1} PK:105.2 (dBμV/m) ^{*2} PK: 110.8(dBμV/m) ^{*3} PK:122.2 (dBμV/m) ^{*4}
	<input type="checkbox"/> 15.407(b)(4)(ii)	Emission limits in section 15.247(d)	
^{*1} beyond 75 MHz or more above of the band edge.		^{*2} below the band edge increasing linearly to 10 dBm/MHz at 25 MHz above.	
^{*3} below the band edge increasing linearly to a level of 15.6 dBm/MHz at 5 MHz above.		^{*4} from 5 MHz above or below the band edge increasing linearly to a level of 27 dBm/MHz at the band edge.	

Note:

The following formula is used to convert the equipment isotropic radiated power (eirp) to field strength:

$$E = \frac{1000000\sqrt{30P}}{3} \mu\text{V/m, where } P \text{ is the eirp (Watts).}$$

4.1.2 Test Instruments

DESCRIPTION & MANUFACTURER	MODEL NO.	SERIAL NO.	CALIBRATED DATE	CALIBRATED UNTIL
Test Receiver Agilent	N9038A	MY51210202	Dec. 16, 2015	Dec. 15, 2016
Pre-Amplifier ^(*) EMCI	EMC001340	980142	Jan. 20, 2016	Jan. 19, 2018
Loop Antenna(*) Electro-Metrics	EM-6879	264	Dec. 16, 2014	Dec. 15, 2016
RF Cable	NA	LOOPCAB-001 LOOPCAB-002	Jan. 18, 2016	Jan. 17, 2017
Pre-Amplifier Mini-Circuits	ZFL-1000VH2B	AMP-ZFL-04	Nov. 11, 2015	Nov. 10, 2016
Trilog Broadband Antenna SCHWARZBECK	VULB 9168	9168-361	Jan. 07, 2016	Jan. 06, 2017
RF Cable	8D-FB	CHHCAB-001-1 CHHCAB-001-2	Oct. 04, 2015	Oct. 03, 2016
	RF-141	CHHCAB-004	Oct. 04, 2015	Oct. 03, 2016
Horn Antenna FT-RF	HA-07M18G-NF	0000220091110	Jan. 18, 2016	Jan. 17, 2017
Pre-Amplifier Agilent	8449B	3008A01923	Oct. 27, 2015	Oct. 26, 2016
RF Cable	NA	131206 131213 131215 SNMY23685/4	Jan. 15, 2016	Jan. 14, 2017
Spectrum Analyzer Agilent	E4446A	MY48250254	Nov. 25, 2015	Nov. 24, 2016
Pre-Amplifier SPACEK LABS	SLKKA-48-6	9K16	Dec. 11, 2015	Dec. 10, 2016
Horn Antenna SCHWARZBECK	BBHA 9170	9170-424	Jan. 18, 2016	Jan. 17, 2017
RF Cable	SUCOFLEX 102	36442/2 36434/2	Dec. 10, 2015	Dec.09, 2016
Software	ADT_Radiated_V8.7.08	NA	NA	NA
Antenna Tower & Turn Table CT	CM100	NA	NA	NA
Boresight Antenna Fixture	FBA-01	FBA-WD02	NA	NA
Spectrum Analyzer R&S	FSP40	100060	May 11, 2016	May 10, 2017
Power meter Anritsu	ML2495A	1014008	May 5, 2016	May 4, 2017
Power sensor Anritsu	MA2411B	0917122	May 5, 2016	May 4, 2017
AC Power Source Extech Electronics	6205	1440452	NA	NA
Temperature & Humidity Chamber Giant Force	GTH-150-40-SP-AR	MAA0812-008	Jan. 15, 2016	Jan. 14, 2017
Digital Multimeter FLUKE	87III	73680266	Nov. 10, 2015	Nov. 09, 2016

Note:

1. The calibration interval of the above test instruments is 12 months and the calibrations are traceable to NML/ROC and NIST/USA.
2. *The calibration interval of the above test instruments is 24 months and the calibrations are traceable to NML/ROC and NIST/USA.
3. The test was performed in 966 Chamber No. H.
4. The FCC Site Registration No. is 797305.
5. The CANADA Site Registration No. is IC 7450H-3.
6. Loop antenna was used for all emissions below 30 MHz.
7. Tested Date: Sep. 10 to Oct. 01, 2016

4.1.3 Test Procedure

For Radiated emission below 30MHz

- a. The EUT was placed on the top of a rotating table 0.8 meters above the ground at a 3 meter chamber room. The table was rotated 360 degrees to determine the position of the highest radiation.
- b. The EUT was set 3 meters away from the interference-receiving antenna, which was mounted on the top of a variable-height antenna tower.
- c. Both X and Y axes of the antenna are set to make the measurement.
- d. For each suspected emission, the EUT was arranged to its worst case and the rotatable table was turned from 0 degrees to 360 degrees to find the maximum reading.
- e. The test-receiver system was set to Quasi-Peak Detect Function and Specified Bandwidth with Maximum Hold Mode.

NOTE:

1. The resolution bandwidth and video bandwidth of test receiver/spectrum analyzer is 9kHz at frequency below 30MHz.

For Radiated emission above 30MHz

- a. The EUT was placed on the top of a rotating table 0.8 meters (for 30MHz ~ 1GHz) / 1.5 meters (for above 1GHz) above the ground at 3 meter chamber room for test. The table was rotated 360 degrees to determine the position of the highest radiation.
- b. The EUT was set 3 meters away from the interference-receiving antenna, which was mounted on the top of a variable-height antenna tower.
- c. The height of antenna is varied from one meter to four meters above the ground to determine the maximum value of the field strength. Both horizontal and vertical polarizations of the antenna are set to make the measurement.
- d. For each suspected emission, the EUT was arranged to its worst case and then the antenna was tuned to heights from 1 meter to 4 meters and the rotatable table was turned from 0 degrees to 360 degrees to find the maximum reading.
- e. The test-receiver system was set to quasi-peak detect function and specified bandwidth with maximum hold mode when the test frequency is below 1 GHz.
- f. The test-receiver system was set to peak and average detect function and specified bandwidth with maximum hold mode when the test frequency is above 1 GHz. If the peak reading value also meets average limit, measurement with the average detector is unnecessary.

Note:

1. The resolution bandwidth and video bandwidth of test receiver/spectrum analyzer is 120kHz for Quasi-peak detection (QP) at frequency below 1GHz.
2. The resolution bandwidth of test receiver/spectrum analyzer is 1 MHz and the video bandwidth is 3 MHz for Peak detection (PK) at frequency above 1GHz.
3. The resolution bandwidth of test receiver/spectrum analyzer is 1MHz and the video bandwidth is $\geq 1/T$ (Duty cycle < 98%) or 10Hz (Duty cycle $\geq 98\%$) for Average detection (AV) at frequency above 1GHz.
4. All modes of operation were investigated and the worst-case emissions are reported.

4.1.4 Deviation from Test Standard

No deviation.

4.1.5 Test Setup

For Radiated emission below 30MHz

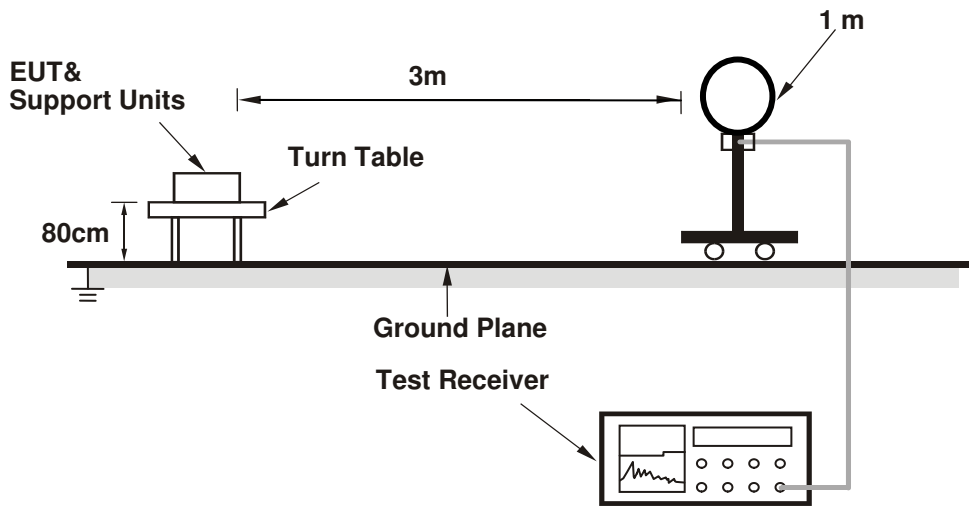

For Radiated emission 30MHz to 1GHz

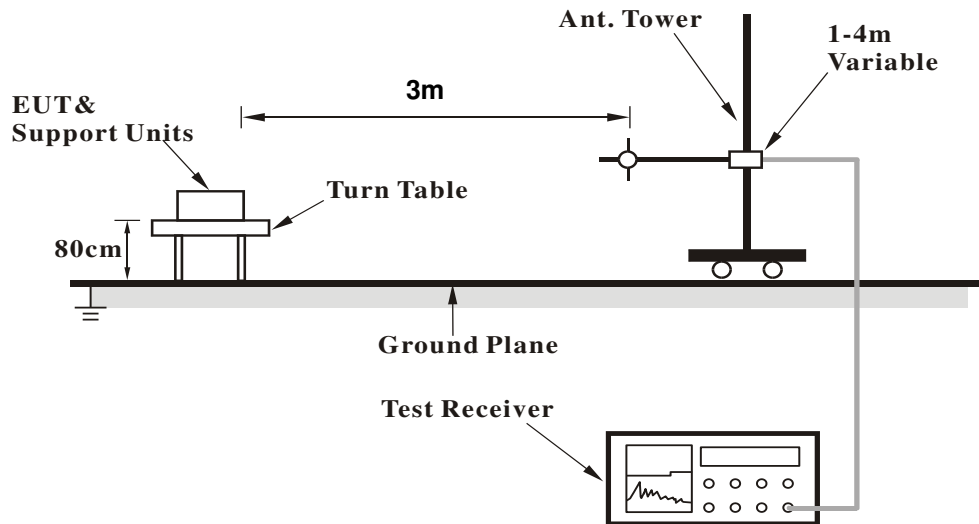

For Radiated emission above 1GHz

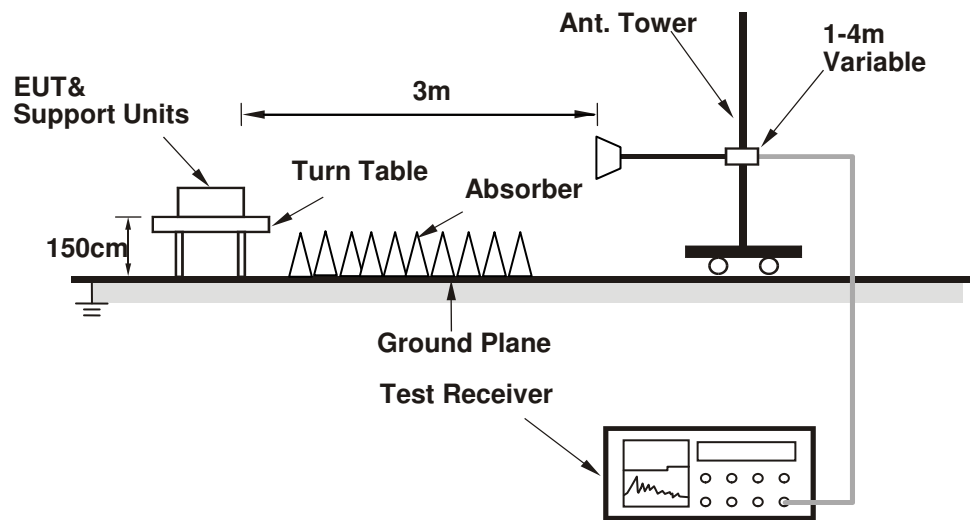

For the actual test configuration, please refer to the attached file (Test Setup Photo).

4.1.6 EUT Operating Condition

- a. Connected the EUT with the laptop which is placed on remote site.
- b. Controlling software (Atheros Radio Test 2 (ART2-GUI)) has been activated to set the EUT on specific status.

4.1.7 Test Results

Above 1GHz Data:

802.11a

CHANNEL	TX Channel 36	DETECTOR FUNCTION	Peak (PK)
FREQUENCY RANGE	1GHz ~ 40GHz		Average (AV)

ANTENNA POLARITY & TEST DISTANCE: HORIZONTAL AT 3 M

NO.	FREQ. (MHz)	EMISSION LEVEL (dBuV/m)	LIMIT (dBuV/m)	MARGIN (dB)	ANTENNA HEIGHT (m)	TABLE ANGLE (Degree)	RAW VALUE (dBuV)	CORRECTION FACTOR (dB/m)
1	5150.00	57.4 PK	74.0	-16.6	1.72 H	187	46.4	11.0
2	5150.00	47.2 AV	54.0	-6.8	1.72 H	187	36.2	11.0
3	*5180.00	109.8 PK			1.72 H	187	98.5	11.3
4	*5180.00	98.9 AV			1.72 H	187	87.6	11.3
5	#10360.00	59.2 PK	74.0	-14.8	1.42 H	90	41.9	17.3
6	#10360.00	47.1 AV	54.0	-6.9	1.42 H	90	29.8	17.3
7	15540.00	63.6 PK	74.0	-10.4	1.36 H	96	42.4	21.2
8	15540.00	50.6 AV	54.0	-3.4	1.36 H	96	29.4	21.2

ANTENNA POLARITY & TEST DISTANCE: VERTICAL AT 3 M

NO.	FREQ. (MHz)	EMISSION LEVEL (dBuV/m)	LIMIT (dBuV/m)	MARGIN (dB)	ANTENNA HEIGHT (m)	TABLE ANGLE (Degree)	RAW VALUE (dBuV)	CORRECTION FACTOR (dB/m)
1	5150.00	66.1 PK	74.0	-7.9	1.85 V	358	55.1	11.0
2	5150.00	53.7 AV	54.0	-0.3	1.85 V	358	42.7	11.0
3	*5180.00	118.1 PK			1.85 V	358	106.8	11.3
4	*5180.00	108.2 AV			1.85 V	358	96.9	11.3
5	#10360.00	59.8 PK	74.0	-14.2	1.34 V	131	42.5	17.3
6	#10360.00	47.3 AV	54.0	-6.7	1.34 V	131	30.0	17.3
7	15540.00	64.4 PK	74.0	-9.6	1.41 V	147	43.2	21.2
8	15540.00	51.4 AV	54.0	-2.6	1.41 V	147	30.2	21.2

REMARKS:

1. Emission Level(dBuV/m) = Raw Value(dBuV) + Correction Factor(dB/m)
2. Correction Factor(dB/m) = Antenna Factor(dB/m) + Cable Factor(dB) – Pre-Amplifier Factor(dB)
3. The other emission levels were very low against the limit.
4. Margin value = Emission Level – Limit value
5. " * ": Fundamental frequency.
6. " # ": The radiated frequency is out of the restricted band.

CHANNEL	TX Channel 40	DETECTOR FUNCTION	Peak (PK)
FREQUENCY RANGE	1GHz ~ 40GHz		Average (AV)

ANTENNA POLARITY & TEST DISTANCE: HORIZONTAL AT 3 M

NO.	FREQ. (MHz)	EMISSION LEVEL (dBuV/m)	LIMIT (dBuV/m)	MARGIN (dB)	ANTENNA HEIGHT (m)	TABLE ANGLE (Degree)	RAW VALUE (dBuV)	CORRECTION FACTOR (dB/m)
1	5150.00	50.4 PK	74.0	-23.6	1.72 H	179	39.4	11.0
2	5150.00	41.0 AV	54.0	-13.0	1.72 H	179	30.0	11.0
3	*5200.00	112.8 PK			1.72 H	179	101.5	11.3
4	*5200.00	102.3 AV			1.72 H	179	91.0	11.3
5	5350.00	51.6 PK	74.0	-22.4	1.72 H	179	40.2	11.4
6	5350.00	41.8 AV	54.0	-12.2	1.72 H	179	30.4	11.4
7	#10400.00	58.9 PK	74.0	-15.1	1.43 H	89	41.4	17.5
8	#10400.00	47.2 AV	54.0	-6.8	1.43 H	89	29.7	17.5
9	15600.00	63.6 PK	74.0	-10.4	1.39 H	87	41.9	21.7
10	15600.00	50.6 AV	54.0	-3.4	1.39 H	87	28.9	21.7

ANTENNA POLARITY & TEST DISTANCE: VERTICAL AT 3 M

NO.	FREQ. (MHz)	EMISSION LEVEL (dBuV/m)	LIMIT (dBuV/m)	MARGIN (dB)	ANTENNA HEIGHT (m)	TABLE ANGLE (Degree)	RAW VALUE (dBuV)	CORRECTION FACTOR (dB/m)
1	5150.00	59.1 PK	74.0	-14.9	1.76 V	351	48.1	11.0
2	5150.00	47.7 AV	54.0	-6.3	1.76 V	351	36.7	11.0
3	*5200.00	120.8 PK			1.76 V	351	109.5	11.3
4	*5200.00	111.1 AV			1.76 V	351	99.8	11.3
5	5350.00	60.6 PK	74.0	-13.4	1.76 V	351	49.2	11.4
6	5350.00	48.3 AV	54.0	-5.7	1.76 V	351	36.9	11.4
7	#10400.00	62.2 PK	74.0	-11.8	1.28 V	161	44.7	17.5
8	#10400.00	49.4 AV	54.0	-4.6	1.28 V	161	31.9	17.5
9	15600.00	65.6 PK	74.0	-8.4	1.23 V	146	43.9	21.7
10	15600.00	53.7 AV	54.0	-0.3	1.23 V	146	32.0	21.7

REMARKS:

1. Emission Level(dBuV/m) = Raw Value(dBuV) + Correction Factor(dB/m)
2. Correction Factor(dB/m) = Antenna Factor(dB/m) + Cable Factor(dB) – Pre-Amplifier Factor(dB)
3. The other emission levels were very low against the limit.
4. Margin value = Emission Level – Limit value
5. " * ": Fundamental frequency.
6. " # ": The radiated frequency is out of the restricted band.

CHANNEL	TX Channel 48	DETECTOR FUNCTION	Peak (PK)
FREQUENCY RANGE	1GHz ~ 40GHz		Average (AV)

ANTENNA POLARITY & TEST DISTANCE: HORIZONTAL AT 3 M

NO.	FREQ. (MHz)	EMISSION LEVEL (dBuV/m)	LIMIT (dBuV/m)	MARGIN (dB)	ANTENNA HEIGHT (m)	TABLE ANGLE (Degree)	RAW VALUE (dBuV)	CORRECTION FACTOR (dB/m)
1	5150.00	50.4 PK	74.0	-23.6	1.70 H	180	39.4	11.0
2	5150.00	40.8 AV	54.0	-13.2	1.70 H	180	29.8	11.0
3	*5240.00	113.2 PK			1.70 H	180	101.8	11.4
4	*5240.00	101.4 AV			1.70 H	180	90.0	11.4
5	5350.00	53.1 PK	74.0	-20.9	1.70 H	180	41.7	11.4
6	5350.00	42.6 AV	54.0	-11.4	1.70 H	180	31.2	11.4
7	#10480.00	58.0 PK	74.0	-16.0	1.44 H	74	40.9	17.1
8	#10480.00	46.3 AV	54.0	-7.7	1.44 H	74	29.2	17.1
9	15720.00	63.9 PK	74.0	-10.1	1.42 H	107	42.3	21.6
10	15720.00	51.2 AV	54.0	-2.8	1.42 H	107	29.6	21.6

ANTENNA POLARITY & TEST DISTANCE: VERTICAL AT 3 M

NO.	FREQ. (MHz)	EMISSION LEVEL (dBuV/m)	LIMIT (dBuV/m)	MARGIN (dB)	ANTENNA HEIGHT (m)	TABLE ANGLE (Degree)	RAW VALUE (dBuV)	CORRECTION FACTOR (dB/m)
1	5150.00	58.9 PK	74.0	-15.1	1.86 V	360	47.9	11.0
2	5150.00	46.9 AV	54.0	-7.1	1.86 V	360	35.9	11.0
3	*5240.00	121.4 PK			1.86 V	360	110.0	11.4
4	*5240.00	110.7 AV			1.86 V	360	99.3	11.4
5	5350.00	61.1 PK	74.0	-12.9	1.86 V	360	49.7	11.4
6	5350.00	48.6 AV	54.0	-5.4	1.86 V	360	37.2	11.4
7	#10480.00	62.0 PK	74.0	-12.0	1.31 V	141	44.9	17.1
8	#10480.00	48.9 AV	54.0	-5.1	1.31 V	141	31.8	17.1
9	15720.00	67.2 PK	74.0	-6.8	1.32 V	147	45.6	21.6
10	15720.00	53.7 AV	54.0	-0.3	1.32 V	147	32.1	21.6

REMARKS:

1. Emission Level(dBuV/m) = Raw Value(dBuV) + Correction Factor(dB/m)
2. Correction Factor(dB/m) = Antenna Factor(dB/m) + Cable Factor(dB) – Pre-Amplifier Factor(dB)
3. The other emission levels were very low against the limit.
4. Margin value = Emission Level – Limit value
5. " * ": Fundamental frequency.
6. " # ": The radiated frequency is out of the restricted band.

CHANNEL	TX Channel 149	DETECTOR FUNCTION	Peak (PK)
FREQUENCY RANGE	1GHz ~ 40GHz		Average (AV)

ANTENNA POLARITY & TEST DISTANCE: HORIZONTAL AT 3 M

NO.	FREQ. (MHz)	EMISSION LEVEL (dBuV/m)	LIMIT (dBuV/m)	MARGIN (dB)	ANTENNA HEIGHT (m)	TABLE ANGLE (Degree)	RAW VALUE (dBuV)	CORRECTION FACTOR (dB/m)
1	#5565.68	63.9 PK	68.2	-4.3	1.72 H	355	52.2	11.7
2	*5745.00	101.9 PK			1.72 H	355	90.0	11.9
3	*5745.00	93.3 AV			1.72 H	355	81.4	11.9
4	#6005.52	65.0 PK	68.2	-3.2	1.72 H	355	53.0	12.0
5	11490.00	63.1 PK	74.0	-10.9	1.35 H	245	45.3	17.8
6	11490.00	50.7 AV	54.0	-3.3	1.35 H	245	32.9	17.8
7	#17235.00	59.9 PK	74.0	-14.1	1.36 H	251	33.5	26.4
8	#17235.00	47.3 AV	54.0	-6.7	1.36 H	251	20.9	26.4

ANTENNA POLARITY & TEST DISTANCE: VERTICAL AT 3 M

NO.	FREQ. (MHz)	EMISSION LEVEL (dBuV/m)	LIMIT (dBuV/m)	MARGIN (dB)	ANTENNA HEIGHT (m)	TABLE ANGLE (Degree)	RAW VALUE (dBuV)	CORRECTION FACTOR (dB/m)
1	#5568.05	66.6 PK	68.2	-1.6	1.76 V	360	54.9	11.7
2	*5745.00	117.8 PK			1.76 V	360	105.9	11.9
3	*5745.00	109.5 AV			1.76 V	360	97.6	11.9
4	#5947.10	64.3 PK	68.2	-3.9	1.76 V	360	52.7	11.6
5	11490.00	66.4 PK	74.0	-7.6	1.31 V	171	48.6	17.8
6	11490.00	53.6 AV	54.0	-0.4	1.31 V	171	35.8	17.8
7	#17235.00	63.4 PK	74.0	-10.6	1.36 V	171	37.0	26.4
8	#17235.00	51.1 AV	54.0	-2.9	1.36 V	171	24.7	26.4

REMARKS:

1. Emission Level(dBuV/m) = Raw Value(dBuV) + Correction Factor(dB/m)
2. Correction Factor(dB/m) = Antenna Factor(dB/m) + Cable Factor(dB) – Pre-Amplifier Factor(dB)
3. The other emission levels were very low against the limit.
4. Margin value = Emission Level – Limit value
5. " * ": Fundamental frequency.
6. " # ": The radiated frequency is out of the restricted band.

CHANNEL	TX Channel 157	DETECTOR FUNCTION	Peak (PK)
FREQUENCY RANGE	1GHz ~ 40GHz		Average (AV)

ANTENNA POLARITY & TEST DISTANCE: HORIZONTAL AT 3 M

NO.	FREQ. (MHz)	EMISSION LEVEL (dBuV/m)	LIMIT (dBuV/m)	MARGIN (dB)	ANTENNA HEIGHT (m)	TABLE ANGLE (Degree)	RAW VALUE (dBuV)	CORRECTION FACTOR (dB/m)
1	#5590.37	65.4 PK	68.2	-2.8	1.93 H	336	53.7	11.7
2	*5785.00	102.4 PK			1.93 H	336	90.4	12.0
3	*5785.00	93.9 AV			1.93 H	336	81.9	12.0
4	#5967.52	64.4 PK	68.2	-3.8	1.93 H	336	52.7	11.7
5	11570.00	63.1 PK	74.0	-10.9	1.31 H	251	45.3	17.8
6	11570.00	50.5 AV	54.0	-3.5	1.31 H	251	32.7	17.8
7	#17355.00	59.5 PK	74.0	-14.5	1.37 H	240	33.0	26.5
8	#17355.00	47.0 AV	54.0	-7.0	1.37 H	240	20.5	26.5

ANTENNA POLARITY & TEST DISTANCE: VERTICAL AT 3 M

NO.	FREQ. (MHz)	EMISSION LEVEL (dBuV/m)	LIMIT (dBuV/m)	MARGIN (dB)	ANTENNA HEIGHT (m)	TABLE ANGLE (Degree)	RAW VALUE (dBuV)	CORRECTION FACTOR (dB/m)
1	#5561.87	64.3 PK	68.2	-3.9	1.72 V	360	52.7	11.6
2	*5785.00	117.9 PK			1.72 V	360	105.9	12.0
3	*5785.00	109.8 AV			1.72 V	360	97.8	12.0
4	#5995.55	65.3 PK	68.2	-2.9	1.72 V	360	53.4	11.9
5	11570.00	66.7 PK	74.0	-7.3	1.14 V	164	48.9	17.8
6	11570.00	53.7 AV	54.0	-0.3	1.14 V	164	35.9	17.8
7	#17355.00	61.4 PK	74.0	-12.6	1.33 V	168	34.9	26.5
8	#17355.00	50.8 AV	54.0	-3.2	1.33 V	168	24.3	26.5

REMARKS:

1. Emission Level(dBuV/m) = Raw Value(dBuV) + Correction Factor(dB/m)
2. Correction Factor(dB/m) = Antenna Factor(dB/m) + Cable Factor(dB) – Pre-Amplifier Factor(dB)
3. The other emission levels were very low against the limit.
4. Margin value = Emission Level – Limit value
5. " * ": Fundamental frequency.
6. " # ": The radiated frequency is out of the restricted band.

CHANNEL	TX Channel 165	DETECTOR FUNCTION	Peak (PK)
FREQUENCY RANGE	1GHz ~ 40GHz		Average (AV)

ANTENNA POLARITY & TEST DISTANCE: HORIZONTAL AT 3 M

NO.	FREQ. (MHz)	EMISSION LEVEL (dBuV/m)	LIMIT (dBuV/m)	MARGIN (dB)	ANTENNA HEIGHT (m)	TABLE ANGLE (Degree)	RAW VALUE (dBuV)	CORRECTION FACTOR (dB/m)
1	#5618.40	63.5 PK	68.2	-4.7	1.89 H	327	51.8	11.7
2	*5825.00	100.2 PK			1.89 H	327	88.4	11.8
3	*5825.00	92.3 AV			1.89 H	327	80.5	11.8
4	#5977.02	64.7 PK	68.2	-3.5	1.89 H	327	52.9	11.8
5	11650.00	63.3 PK	74.0	-10.7	1.36 H	243	45.7	17.6
6	11650.00	50.9 AV	54.0	-3.1	1.36 H	243	33.3	17.6
7	#17475.00	59.6 PK	74.0	-14.4	1.37 H	236	33.0	26.6
8	#17475.00	47.2 AV	54.0	-6.8	1.37 H	236	20.6	26.6

ANTENNA POLARITY & TEST DISTANCE: VERTICAL AT 3 M

NO.	FREQ. (MHz)	EMISSION LEVEL (dBuV/m)	LIMIT (dBuV/m)	MARGIN (dB)	ANTENNA HEIGHT (m)	TABLE ANGLE (Degree)	RAW VALUE (dBuV)	CORRECTION FACTOR (dB/m)
1	#5559.02	64.2 PK	68.2	-4.0	1.72 V	357	52.6	11.6
2	*5825.00	118.1 PK			1.72 V	357	106.3	11.8
3	*5825.00	109.8 AV			1.72 V	357	98.0	11.8
4	#5962.30	64.0 PK	68.2	-4.2	1.72 V	357	52.3	11.7
5	11650.00	68.3 PK	74.0	-5.7	1.16 V	169	50.7	17.6
6	11650.00	53.7 AV	54.0	-0.3	1.16 V	169	36.1	17.6
7	#17475.00	61.3 PK	74.0	-12.7	1.36 V	153	34.7	26.6
8	#17475.00	51.0 AV	54.0	-3.0	1.36 V	153	24.4	26.6

REMARKS:

1. Emission Level(dBuV/m) = Raw Value(dBuV) + Correction Factor(dB/m)
2. Correction Factor(dB/m) = Antenna Factor(dB/m) + Cable Factor(dB) – Pre-Amplifier Factor(dB)
3. The other emission levels were very low against the limit.
4. Margin value = Emission Level – Limit value
5. " * ": Fundamental frequency.
6. " # ": The radiated frequency is out of the restricted band.

802.11ac (VHT20)

CHANNEL	TX Channel 36	DETECTOR FUNCTION	Peak (PK)
FREQUENCY RANGE	1GHz ~ 40GHz		Average (AV)

ANTENNA POLARITY & TEST DISTANCE: HORIZONTAL AT 3 M

NO.	FREQ. (MHz)	EMISSION LEVEL (dBuV/m)	LIMIT (dBuV/m)	MARGIN (dB)	ANTENNA HEIGHT (m)	TABLE ANGLE (Degree)	RAW VALUE (dBuV)	CORRECTION FACTOR (dB/m)
1	5150.00	58.1 PK	74.0	-15.9	1.89 H	335	47.1	11.0
2	5150.00	46.7 AV	54.0	-7.3	1.89 H	335	35.7	11.0
3	*5180.00	110.7 PK			1.89 H	335	99.4	11.3
4	*5180.00	99.7 AV			1.89 H	335	88.4	11.3
5	#10360.00	58.8 PK	74.0	-15.2	1.43 H	83	41.5	17.3
6	#10360.00	46.8 AV	54.0	-7.2	1.43 H	83	29.5	17.3
7	15540.00	64.6 PK	74.0	-9.4	1.43 H	122	43.4	21.2
8	15540.00	51.3 AV	54.0	-2.7	1.43 H	122	30.1	21.2

ANTENNA POLARITY & TEST DISTANCE: VERTICAL AT 3 M

NO.	FREQ. (MHz)	EMISSION LEVEL (dBuV/m)	LIMIT (dBuV/m)	MARGIN (dB)	ANTENNA HEIGHT (m)	TABLE ANGLE (Degree)	RAW VALUE (dBuV)	CORRECTION FACTOR (dB/m)
1	5150.00	67.4 PK	74.0	-6.6	1.80 V	360	56.4	11.0
2	5150.00	53.6 AV	54.0	-0.4	1.80 V	360	42.6	11.0
3	*5180.00	118.7 PK			1.80 V	360	107.4	11.3
4	*5180.00	108.8 AV			1.80 V	360	97.5	11.3
5	#10360.00	62.2 PK	74.0	-11.8	1.37 V	163	44.9	17.3
6	#10360.00	46.0 AV	54.0	-8.0	1.37 V	163	28.7	17.3
7	15540.00	63.9 PK	74.0	-10.1	1.31 V	144	42.7	21.2
8	15540.00	50.8 AV	54.0	-3.2	1.31 V	144	29.6	21.2

REMARKS:

- Emission Level(dBuV/m) = Raw Value(dBuV) + Correction Factor(dB/m)
- Correction Factor(dB/m) = Antenna Factor(dB/m) + Cable Factor(dB) – Pre-Amplifier Factor(dB)
- The other emission levels were very low against the limit.
- Margin value = Emission Level – Limit value
- " * ": Fundamental frequency.
- " # ": The radiated frequency is out of the restricted band.

CHANNEL	TX Channel 40	DETECTOR FUNCTION	Peak (PK)
FREQUENCY RANGE	1GHz ~ 40GHz		Average (AV)

ANTENNA POLARITY & TEST DISTANCE: HORIZONTAL AT 3 M

NO.	FREQ. (MHz)	EMISSION LEVEL (dBuV/m)	LIMIT (dBuV/m)	MARGIN (dB)	ANTENNA HEIGHT (m)	TABLE ANGLE (Degree)	RAW VALUE (dBuV)	CORRECTION FACTOR (dB/m)
1	5150.00	58.5 PK	74.0	-15.5	1.85 H	319	47.5	11.0
2	5150.00	46.8 AV	54.0	-7.2	1.85 H	319	35.8	11.0
3	*5200.00	114.1 PK			1.85 H	319	102.8	11.3
4	*5200.00	102.0 AV			1.85 H	319	90.7	11.3
5	5350.00	50.4 PK	74.0	-23.6	1.85 H	319	39.0	11.4
6	5350.00	40.6 AV	54.0	-13.4	1.85 H	319	29.2	11.4
7	#10400.00	59.0 PK	74.0	-15.0	1.43 H	98	41.5	17.5
8	#10400.00	46.8 AV	54.0	-7.2	1.43 H	98	29.3	17.5
9	15600.00	63.5 PK	74.0	-10.5	1.37 H	95	41.8	21.7
10	15600.00	50.4 AV	54.0	-3.6	1.37 H	95	28.7	21.7

ANTENNA POLARITY & TEST DISTANCE: VERTICAL AT 3 M

NO.	FREQ. (MHz)	EMISSION LEVEL (dBuV/m)	LIMIT (dBuV/m)	MARGIN (dB)	ANTENNA HEIGHT (m)	TABLE ANGLE (Degree)	RAW VALUE (dBuV)	CORRECTION FACTOR (dB/m)
1	5150.00	59.1 PK	74.0	-14.9	1.70 V	360	48.1	11.0
2	5150.00	47.9 AV	54.0	-6.1	1.70 V	360	36.9	11.0
3	*5200.00	122.1 PK			1.70 V	360	110.8	11.3
4	*5200.00	111.4 AV			1.70 V	360	100.1	11.3
5	5350.00	61.7 PK	74.0	-12.3	1.70 V	360	50.3	11.4
6	5350.00	48.8 AV	54.0	-5.2	1.70 V	360	37.4	11.4
7	#10400.00	61.1 PK	74.0	-12.9	1.23 V	162	43.6	17.5
8	#10400.00	48.7 AV	54.0	-5.3	1.23 V	162	31.2	17.5
9	15600.00	66.1 PK	74.0	-7.9	1.30 V	145	44.4	21.7
10	15600.00	53.6 AV	54.0	-0.4	1.30 V	145	31.9	21.7

REMARKS:

- Emission Level(dBuV/m) = Raw Value(dBuV) + Correction Factor(dB/m)
- Correction Factor(dB/m) = Antenna Factor(dB/m) + Cable Factor(dB) – Pre-Amplifier Factor(dB)
- The other emission levels were very low against the limit.
- Margin value = Emission Level – Limit value
- " * ": Fundamental frequency.
- " # ": The radiated frequency is out of the restricted band.

CHANNEL	TX Channel 48	DETECTOR FUNCTION	Peak (PK)
FREQUENCY RANGE	1GHz ~ 40GHz		Average (AV)

ANTENNA POLARITY & TEST DISTANCE: HORIZONTAL AT 3 M

NO.	FREQ. (MHz)	EMISSION LEVEL (dBuV/m)	LIMIT (dBuV/m)	MARGIN (dB)	ANTENNA HEIGHT (m)	TABLE ANGLE (Degree)	RAW VALUE (dBuV)	CORRECTION FACTOR (dB/m)
1	*5240.00	113.5 PK			1.86 H	319	102.1	11.4
2	*5240.00	101.7 AV			1.86 H	319	90.3	11.4
3	5350.00	58.3 PK	74.0	-15.7	1.86 H	319	46.9	11.4
4	5350.00	47.1 AV	54.0	-6.9	1.86 H	319	35.7	11.4
5	#10480.00	59.2 PK	74.0	-14.8	1.44 H	107	42.1	17.1
6	#10480.00	46.8 AV	54.0	-7.2	1.44 H	107	29.7	17.1
7	15720.00	63.6 PK	74.0	-10.4	1.41 H	92	42.0	21.6
8	15720.00	50.8 AV	54.0	-3.2	1.41 H	92	29.2	21.6

ANTENNA POLARITY & TEST DISTANCE: VERTICAL AT 3 M

NO.	FREQ. (MHz)	EMISSION LEVEL (dBuV/m)	LIMIT (dBuV/m)	MARGIN (dB)	ANTENNA HEIGHT (m)	TABLE ANGLE (Degree)	RAW VALUE (dBuV)	CORRECTION FACTOR (dB/m)
1	*5240.00	122.7 PK			1.84 V	360	111.3	11.4
2	*5240.00	111.6 AV			1.84 V	360	100.2	11.4
3	5350.00	60.4 PK	74.0	-13.6	1.84 V	360	49.0	11.4
4	5350.00	48.4 AV	54.0	-5.6	1.84 V	360	37.0	11.4
5	#10480.00	60.9 PK	74.0	-13.1	1.24 V	177	43.8	17.1
6	#10480.00	48.3 AV	54.0	-5.7	1.24 V	177	31.2	17.1
7	15720.00	66.6 PK	74.0	-7.4	1.27 V	145	45.0	21.6
8	15720.00	53.4 AV	54.0	-0.6	1.27 V	145	31.8	21.6

REMARKS:

1. Emission Level(dBuV/m) = Raw Value(dBuV) + Correction Factor(dB/m)
2. Correction Factor(dB/m) = Antenna Factor(dB/m) + Cable Factor(dB) – Pre-Amplifier Factor(dB)
3. The other emission levels were very low against the limit.
4. Margin value = Emission Level – Limit value
5. " * ": Fundamental frequency.
6. " # ": The radiated frequency is out of the restricted band.

CHANNEL	TX Channel 149	DETECTOR FUNCTION	Peak (PK)
FREQUENCY RANGE	1GHz ~ 40GHz		Average (AV)

ANTENNA POLARITY & TEST DISTANCE: HORIZONTAL AT 3 M

NO.	FREQ. (MHz)	EMISSION LEVEL (dBuV/m)	LIMIT (dBuV/m)	MARGIN (dB)	ANTENNA HEIGHT (m)	TABLE ANGLE (Degree)	RAW VALUE (dBuV)	CORRECTION FACTOR (dB/m)
1	#5569.95	64.1 PK	68.2	-4.1	2.29 H	322	52.4	11.7
2	*5745.00	102.8 PK			2.29 H	322	90.9	11.9
3	*5745.00	92.3 AV			2.29 H	322	80.4	11.9
4	#6004.57	64.6 PK	68.2	-3.6	2.29 H	322	52.7	11.9
5	11490.00	63.3 PK	74.0	-10.7	1.30 H	242	45.5	17.8
6	11490.00	50.2 AV	54.0	-3.8	1.30 H	242	32.4	17.8
7	#17235.00	59.7 PK	74.0	-14.3	1.33 H	219	33.3	26.4
8	#17235.00	47.2 AV	54.0	-6.8	1.33 H	219	20.8	26.4

ANTENNA POLARITY & TEST DISTANCE: VERTICAL AT 3 M

NO.	FREQ. (MHz)	EMISSION LEVEL (dBuV/m)	LIMIT (dBuV/m)	MARGIN (dB)	ANTENNA HEIGHT (m)	TABLE ANGLE (Degree)	RAW VALUE (dBuV)	CORRECTION FACTOR (dB/m)
1	#5580.87	64.8 PK	68.2	-3.4	1.75 V	356	53.1	11.7
2	*5745.00	119.1 PK			1.75 V	356	107.2	11.9
3	*5745.00	110.5 AV			1.75 V	356	98.6	11.9
4	#5933.32	63.6 PK	68.2	-4.6	1.75 V	356	52.0	11.6
5	11490.00	66.2 PK	74.0	-7.8	1.22 V	170	48.4	17.8
6	11490.00	53.7 AV	54.0	-0.3	1.22 V	170	35.9	17.8
7	#17235.00	61.1 PK	74.0	-12.9	1.30 V	168	34.7	26.4
8	#17235.00	49.4 AV	54.0	-4.6	1.30 V	168	23.0	26.4

REMARKS:

1. Emission Level(dBuV/m) = Raw Value(dBuV) + Correction Factor(dB/m)
2. Correction Factor(dB/m) = Antenna Factor(dB/m) + Cable Factor(dB) – Pre-Amplifier Factor(dB)
3. The other emission levels were very low against the limit.
4. Margin value = Emission Level – Limit value
5. " * ": Fundamental frequency.
6. " # ": The radiated frequency is out of the restricted band.

CHANNEL	TX Channel 157	DETECTOR FUNCTION	Peak (PK)
FREQUENCY RANGE	1GHz ~ 40GHz		Average (AV)

ANTENNA POLARITY & TEST DISTANCE: HORIZONTAL AT 3 M

NO.	FREQ. (MHz)	EMISSION LEVEL (dBuV/m)	LIMIT (dBuV/m)	MARGIN (dB)	ANTENNA HEIGHT (m)	TABLE ANGLE (Degree)	RAW VALUE (dBuV)	CORRECTION FACTOR (dB/m)
1	#5606.52	64.5 PK	68.2	-3.7	2.23 H	336	52.9	11.6
2	*5785.00	103.3 PK			2.23 H	336	91.3	12.0
3	*5785.00	92.7 AV			2.23 H	336	80.7	12.0
4	#6005.05	64.3 PK	68.2	-3.9	2.23 H	336	52.3	12.0
5	11570.00	63.1 PK	74.0	-10.9	1.33 H	247	45.3	17.8
6	11570.00	50.3 AV	54.0	-3.7	1.33 H	247	32.5	17.8
7	#17355.00	59.4 PK	74.0	-14.6	1.36 H	233	32.9	26.5
8	#17355.00	46.8 AV	54.0	-7.2	1.36 H	233	20.3	26.5

ANTENNA POLARITY & TEST DISTANCE: VERTICAL AT 3 M

NO.	FREQ. (MHz)	EMISSION LEVEL (dBuV/m)	LIMIT (dBuV/m)	MARGIN (dB)	ANTENNA HEIGHT (m)	TABLE ANGLE (Degree)	RAW VALUE (dBuV)	CORRECTION FACTOR (dB/m)
1	#5576.60	65.9 PK	68.2	-2.3	1.76 V	356	54.2	11.7
2	*5785.00	118.1 PK			1.77 V	357	106.1	12.0
3	*5785.00	109.5 AV			1.77 V	357	97.5	12.0
4	#5977.02	64.0 PK	68.2	-4.2	1.76 V	356	52.2	11.8
5	11570.00	66.7 PK	74.0	-7.3	1.21 V	171	48.9	17.8
6	11570.00	53.1 AV	54.0	-0.9	1.21 V	171	35.3	17.8
7	#17355.00	61.3 PK	74.0	-12.7	1.33 V	156	34.8	26.5
8	#17355.00	49.5 AV	54.0	-4.5	1.33 V	156	23.0	26.5

REMARKS:

1. Emission Level(dBuV/m) = Raw Value(dBuV) + Correction Factor(dB/m)
2. Correction Factor(dB/m) = Antenna Factor(dB/m) + Cable Factor(dB) – Pre-Amplifier Factor(dB)
3. The other emission levels were very low against the limit.
4. Margin value = Emission Level – Limit value
5. " * ": Fundamental frequency.
6. " # ": The radiated frequency is out of the restricted band.

CHANNEL	TX Channel 165	DETECTOR FUNCTION	Peak (PK)
FREQUENCY RANGE	1GHz ~ 40GHz		Average (AV)

ANTENNA POLARITY & TEST DISTANCE: HORIZONTAL AT 3 M

NO.	FREQ. (MHz)	EMISSION LEVEL (dBuV/m)	LIMIT (dBuV/m)	MARGIN (dB)	ANTENNA HEIGHT (m)	TABLE ANGLE (Degree)	RAW VALUE (dBuV)	CORRECTION FACTOR (dB/m)
1	#5586.57	63.5 PK	68.2	-4.7	2.31 H	337	51.8	11.7
2	*5825.00	101.8 PK			2.31 H	337	90.0	11.8
3	*5825.00	91.6 AV			2.31 H	337	79.8	11.8
4	#6007.43	64.9 PK	68.2	-3.3	2.31 H	337	52.9	12.0
5	11650.00	63.1 PK	74.0	-10.9	1.37 H	248	45.5	17.6
6	11650.00	50.6 AV	54.0	-3.4	1.37 H	248	33.0	17.6
7	#17475.00	59.1 PK	74.0	-14.9	1.39 H	226	32.5	26.6
8	#17475.00	46.7 AV	54.0	-7.3	1.39 H	226	20.1	26.6

ANTENNA POLARITY & TEST DISTANCE: VERTICAL AT 3 M

NO.	FREQ. (MHz)	EMISSION LEVEL (dBuV/m)	LIMIT (dBuV/m)	MARGIN (dB)	ANTENNA HEIGHT (m)	TABLE ANGLE (Degree)	RAW VALUE (dBuV)	CORRECTION FACTOR (dB/m)
1	#5611.27	65.7 PK	68.2	-2.5	1.74 V	356	54.1	11.6
2	*5825.00	116.6 PK			1.74 V	356	104.8	11.8
3	*5825.00	108.7 AV			1.74 V	356	96.9	11.8
4	#5932.37	64.8 PK	68.2	-3.4	1.74 V	356	53.2	11.6
5	11650.00	66.6 PK	74.0	-7.4	1.24 V	168	49.0	17.6
6	11650.00	53.6 AV	54.0	-0.4	1.24 V	168	36.0	17.6
7	#17475.00	61.7 PK	74.0	-12.3	1.32 V	162	35.1	26.6
8	#17475.00	50.0 AV	54.0	-4.0	1.32 V	162	23.4	26.6

REMARKS:

1. Emission Level(dBuV/m) = Raw Value(dBuV) + Correction Factor(dB/m)
2. Correction Factor(dB/m) = Antenna Factor(dB/m) + Cable Factor(dB) – Pre-Amplifier Factor(dB)
3. The other emission levels were very low against the limit.
4. Margin value = Emission Level – Limit value
5. " * ": Fundamental frequency.
6. " # ": The radiated frequency is out of the restricted band.

802.11ac (VHT40)

CHANNEL	TX Channel 38	DETECTOR FUNCTION	Peak (PK)
FREQUENCY RANGE	1GHz ~ 40GHz		Average (AV)

ANTENNA POLARITY & TEST DISTANCE: HORIZONTAL AT 3 M

NO.	FREQ. (MHz)	EMISSION LEVEL (dBuV/m)	LIMIT (dBuV/m)	MARGIN (dB)	ANTENNA HEIGHT (m)	TABLE ANGLE (Degree)	RAW VALUE (dBuV)	CORRECTION FACTOR (dB/m)
1	5150.00	58.3 PK	74.0	-15.7	2.25 H	329	47.3	11.0
2	5150.00	46.6 AV	54.0	-7.4	2.25 H	329	35.6	11.0
3	*5190.00	97.4 PK			2.25 H	329	86.1	11.3
4	*5190.00	85.7 AV			2.25 H	329	74.4	11.3
5	5350.00	51.2 PK	74.0	-22.8	2.25 H	329	39.8	11.4
6	5350.00	41.1 AV	54.0	-12.9	2.25 H	329	29.7	11.4
7	#10380.00	49.8 PK	74.0	-24.2	1.42 H	238	32.5	17.3
8	#10380.00	37.2 AV	54.0	-16.8	1.42 H	238	19.9	17.3
9	15570.00	55.1 PK	74.0	-18.9	1.41 H	235	33.7	21.4
10	15570.00	44.5 AV	54.0	-9.5	1.41 H	235	23.1	21.4

ANTENNA POLARITY & TEST DISTANCE: VERTICAL AT 3 M

NO.	FREQ. (MHz)	EMISSION LEVEL (dBuV/m)	LIMIT (dBuV/m)	MARGIN (dB)	ANTENNA HEIGHT (m)	TABLE ANGLE (Degree)	RAW VALUE (dBuV)	CORRECTION FACTOR (dB/m)
1	5150.00	66.0 PK	74.0	-8.0	1.87 V	174	55.0	11.0
2	5150.00	53.6 AV	54.0	-0.4	1.87 V	174	42.6	11.0
3	*5190.00	110.0 PK			1.87 V	174	98.7	11.3
4	*5190.00	99.4 AV			1.87 V	174	88.1	11.3
5	5350.00	59.5 PK	74.0	-14.5	1.87 V	174	48.1	11.4
6	5350.00	47.6 AV	54.0	-6.4	1.87 V	174	36.2	11.4
7	#10380.00	50.7 PK	74.0	-23.3	1.40 V	131	33.4	17.3
8	#10380.00	36.5 AV	54.0	-17.5	1.40 V	131	19.2	17.3
9	15570.00	53.1 PK	74.0	-20.9	1.34 V	122	31.7	21.4
10	15570.00	43.1 AV	54.0	-10.9	1.34 V	122	21.7	21.4

REMARKS:

- Emission Level(dBuV/m) = Raw Value(dBuV) + Correction Factor(dB/m)
- Correction Factor(dB/m) = Antenna Factor(dB/m) + Cable Factor(dB) – Pre-Amplifier Factor(dB)
- The other emission levels were very low against the limit.
- Margin value = Emission Level – Limit value
- " * ": Fundamental frequency.
- " # ": The radiated frequency is out of the restricted band.

CHANNEL	TX Channel 46	DETECTOR FUNCTION	Peak (PK)
FREQUENCY RANGE	1GHz ~ 40GHz		Average (AV)

ANTENNA POLARITY & TEST DISTANCE: HORIZONTAL AT 3 M

NO.	FREQ. (MHz)	EMISSION LEVEL (dBuV/m)	LIMIT (dBuV/m)	MARGIN (dB)	ANTENNA HEIGHT (m)	TABLE ANGLE (Degree)	RAW VALUE (dBuV)	CORRECTION FACTOR (dB/m)
1	5150.00	50.8 PK	74.0	-23.2	2.29 H	324	39.8	11.0
2	5150.00	41.0 AV	54.0	-13.0	2.29 H	324	30.0	11.0
3	*5230.00	107.2 PK			2.29 H	324	95.9	11.3
4	*5230.00	96.2 AV			2.29 H	324	84.9	11.3
5	5350.00	58.2 PK	74.0	-15.8	2.29 H	324	46.8	11.4
6	5350.00	46.6 AV	54.0	-7.4	2.29 H	324	35.2	11.4
7	#10460.00	58.7 PK	74.0	-15.3	1.44 H	224	41.6	17.1
8	#10460.00	48.1 AV	54.0	-5.9	1.44 H	224	31.0	17.1
9	15690.00	62.1 PK	74.0	-11.9	1.46 H	235	40.4	21.7
10	15690.00	49.9 AV	54.0	-4.1	1.46 H	235	28.2	21.7

ANTENNA POLARITY & TEST DISTANCE: VERTICAL AT 3 M

NO.	FREQ. (MHz)	EMISSION LEVEL (dBuV/m)	LIMIT (dBuV/m)	MARGIN (dB)	ANTENNA HEIGHT (m)	TABLE ANGLE (Degree)	RAW VALUE (dBuV)	CORRECTION FACTOR (dB/m)
1	5150.00	68.8 PK	74.0	-5.2	1.87 V	181	57.8	11.0
2	5150.00	53.7 AV	54.0	-0.3	1.87 V	181	42.7	11.0
3	*5230.00	120.4 PK			1.87 V	181	109.1	11.3
4	*5230.00	110.1 AV			1.87 V	181	98.8	11.3
5	5350.00	62.2 PK	74.0	-11.8	1.87 V	181	50.8	11.4
6	5350.00	50.1 AV	54.0	-3.9	1.87 V	181	38.7	11.4
7	#10460.00	59.3 PK	74.0	-14.7	1.36 V	165	42.2	17.1
8	#10460.00	47.8 AV	54.0	-6.2	1.36 V	165	30.7	17.1
9	15690.00	63.3 PK	74.0	-10.7	1.38 V	128	41.6	21.7
10	15690.00	50.7 AV	54.0	-3.3	1.38 V	128	29.0	21.7

REMARKS:

- Emission Level(dBuV/m) = Raw Value(dBuV) + Correction Factor(dB/m)
- Correction Factor(dB/m) = Antenna Factor(dB/m) + Cable Factor(dB) – Pre-Amplifier Factor(dB)
- The other emission levels were very low against the limit.
- Margin value = Emission Level – Limit value
- " * ": Fundamental frequency.
- " # ": The radiated frequency is out of the restricted band.

CHANNEL	TX Channel 151	DETECTOR FUNCTION	Peak (PK)
FREQUENCY RANGE	1GHz ~ 40GHz		Average (AV)

ANTENNA POLARITY & TEST DISTANCE: HORIZONTAL AT 3 M

NO.	FREQ. (MHz)	EMISSION LEVEL (dBuV/m)	LIMIT (dBuV/m)	MARGIN (dB)	ANTENNA HEIGHT (m)	TABLE ANGLE (Degree)	RAW VALUE (dBuV)	CORRECTION FACTOR (dB/m)
1	#5572.80	64.9 PK	68.2	-3.3	2.21 H	334	53.2	11.7
2	*5755.00	103.2 PK			2.21 H	334	91.3	11.9
3	*5755.00	93.5 AV			2.21 H	334	81.6	11.9
4	#5946.15	63.6 PK	68.2	-4.6	2.21 H	334	52.0	11.6
5	11510.00	59.6 PK	74.0	-14.4	1.41 H	115	41.8	17.8
6	11510.00	47.0 AV	54.0	-7.0	1.41 H	115	29.2	17.8
7	#17265.00	63.8 PK	74.0	-10.2	1.40 H	105	37.3	26.5
8	#17265.00	50.9 AV	54.0	-3.1	1.40 H	105	24.4	26.5

ANTENNA POLARITY & TEST DISTANCE: VERTICAL AT 3 M

NO.	FREQ. (MHz)	EMISSION LEVEL (dBuV/m)	LIMIT (dBuV/m)	MARGIN (dB)	ANTENNA HEIGHT (m)	TABLE ANGLE (Degree)	RAW VALUE (dBuV)	CORRECTION FACTOR (dB/m)
1	#5628.37	64.5 PK	68.2	-3.7	1.79 V	355	52.8	11.7
2	*5755.00	115.7 PK			1.79 V	355	103.8	11.9
3	*5755.00	107.2 AV			1.79 V	355	95.3	11.9
4	#6004.10	63.2 PK	68.2	-5.0	1.79 V	355	51.2	12.0
5	11510.00	67.8 PK	74.0	-6.2	1.03 V	168	50.0	17.8
6	11510.00	53.2 AV	54.0	-0.8	1.03 V	168	35.4	17.8
7	#17265.00	61.8 PK	74.0	-12.2	1.32 V	173	35.3	26.5
8	#17265.00	49.8 AV	54.0	-4.2	1.32 V	173	23.3	26.5

REMARKS:

1. Emission Level(dBuV/m) = Raw Value(dBuV) + Correction Factor(dB/m)
2. Correction Factor(dB/m) = Antenna Factor(dB/m) + Cable Factor(dB) – Pre-Amplifier Factor(dB)
3. The other emission levels were very low against the limit.
4. Margin value = Emission Level – Limit value
5. " * ": Fundamental frequency.
6. " # ": The radiated frequency is out of the restricted band.

CHANNEL	TX Channel 159	DETECTOR FUNCTION	Peak (PK)
FREQUENCY RANGE	1GHz ~ 40GHz		Average (AV)

ANTENNA POLARITY & TEST DISTANCE: HORIZONTAL AT 3 M

NO.	FREQ. (MHz)	EMISSION LEVEL (dBuV/m)	LIMIT (dBuV/m)	MARGIN (dB)	ANTENNA HEIGHT (m)	TABLE ANGLE (Degree)	RAW VALUE (dBuV)	CORRECTION FACTOR (dB/m)
1	#5641.68	65.1 PK	68.2	-3.1	2.16 H	281	53.4	11.7
2	*5795.00	103.7 PK			2.16 H	281	91.8	11.9
3	*5795.00	93.8 AV			2.16 H	281	81.9	11.9
4	#5938.55	64.7 PK	68.2	-3.5	2.16 H	281	53.1	11.6
5	11590.00	59.2 PK	74.0	-14.8	1.47 H	119	41.5	17.7
6	11590.00	47.0 AV	54.0	-7.0	1.47 H	119	29.3	17.7
7	#17385.00	63.1 PK	74.0	-10.9	1.40 H	106	36.4	26.7
8	#17385.00	50.5 AV	54.0	-3.5	1.40 H	106	23.8	26.7

ANTENNA POLARITY & TEST DISTANCE: VERTICAL AT 3 M

NO.	FREQ. (MHz)	EMISSION LEVEL (dBuV/m)	LIMIT (dBuV/m)	MARGIN (dB)	ANTENNA HEIGHT (m)	TABLE ANGLE (Degree)	RAW VALUE (dBuV)	CORRECTION FACTOR (dB/m)
1	#5612.23	65.1 PK	68.2	-3.1	1.64 V	360	53.5	11.6
2	*5795.00	116.1 PK			1.64 V	360	104.2	11.9
3	*5795.00	107.5 AV			1.64 V	360	95.6	11.9
4	#5957.55	64.4 PK	68.2	-3.8	1.64 V	360	52.7	11.7
5	11590.00	66.7 PK	74.0	-7.3	1.05 V	169	49.0	17.7
6	11590.00	53.3 AV	54.0	-0.7	1.05 V	169	35.6	17.7
7	#17385.00	61.5 PK	74.0	-12.5	1.29 V	160	34.8	26.7
8	#17385.00	49.5 AV	54.0	-4.5	1.29 V	160	22.8	26.7

REMARKS:

1. Emission Level(dBuV/m) = Raw Value(dBuV) + Correction Factor(dB/m)
2. Correction Factor(dB/m) = Antenna Factor(dB/m) + Cable Factor(dB) – Pre-Amplifier Factor(dB)
3. The other emission levels were very low against the limit.
4. Margin value = Emission Level – Limit value
5. " * ": Fundamental frequency.
6. " # ": The radiated frequency is out of the restricted band.

802.11ac (VHT80)

CHANNEL	TX Channel 42	DETECTOR FUNCTION	Peak (PK)
FREQUENCY RANGE	1GHz ~ 40GHz		Average (AV)

ANTENNA POLARITY & TEST DISTANCE: HORIZONTAL AT 3 M

NO.	FREQ. (MHz)	EMISSION LEVEL (dBuV/m)	LIMIT (dBuV/m)	MARGIN (dB)	ANTENNA HEIGHT (m)	TABLE ANGLE (Degree)	RAW VALUE (dBuV)	CORRECTION FACTOR (dB/m)
1	5150.00	58.0 PK	74.0	-16.0	2.00 H	260	47.0	11.0
2	5150.00	46.6 AV	54.0	-7.4	2.00 H	260	35.6	11.0
3	*5210.00	93.0 PK			2.00 H	260	81.7	11.3
4	*5210.00	82.2 AV			2.00 H	260	70.9	11.3
5	5350.00	50.4 PK	74.0	-23.6	2.00 H	260	39.0	11.4
6	5350.00	40.4 AV	54.0	-13.6	2.00 H	260	29.0	11.4
7	#10420.00	49.8 PK	74.0	-24.2	1.40 H	231	32.5	17.3
8	#10420.00	36.9 AV	54.0	-17.1	1.40 H	231	19.6	17.3
9	15630.00	55.1 PK	74.0	-18.9	1.40 H	228	33.4	21.7
10	15630.00	44.5 AV	54.0	-9.5	1.40 H	228	22.8	21.7

ANTENNA POLARITY & TEST DISTANCE: VERTICAL AT 3 M

NO.	FREQ. (MHz)	EMISSION LEVEL (dBuV/m)	LIMIT (dBuV/m)	MARGIN (dB)	ANTENNA HEIGHT (m)	TABLE ANGLE (Degree)	RAW VALUE (dBuV)	CORRECTION FACTOR (dB/m)
1	5150.00	64.4 PK	74.0	-9.6	1.77 V	174	53.4	11.0
2	5150.00	53.8 AV	54.0	-0.2	1.77 V	174	42.8	11.0
3	*5210.00	105.9 PK			1.77 V	174	94.6	11.3
4	*5210.00	95.9 AV			1.77 V	174	84.6	11.3
5	5350.00	58.8 PK	74.0	-15.2	1.77 V	174	47.4	11.4
6	5350.00	47.3 AV	54.0	-6.7	1.77 V	174	35.9	11.4
7	#10420.00	46.1 PK	74.0	-27.9	1.13 V	140	28.8	17.3
8	#10420.00	38.4 AV	54.0	-15.6	1.13 V	140	21.1	17.3
9	15630.00	46.5 PK	74.0	-27.5	1.28 V	224	24.8	21.7
10	15630.00	33.8 AV	54.0	-20.2	1.28 V	224	12.1	21.7

REMARKS:

- Emission Level(dBuV/m) = Raw Value(dBuV) + Correction Factor(dB/m)
- Correction Factor(dB/m) = Antenna Factor(dB/m) + Cable Factor(dB) – Pre-Amplifier Factor(dB)
- The other emission levels were very low against the limit.
- Margin value = Emission Level – Limit value
- " * ": Fundamental frequency.
- " # ": The radiated frequency is out of the restricted band.

CHANNEL	TX Channel 155	DETECTOR FUNCTION	Peak (PK)
FREQUENCY RANGE	1GHz ~ 40GHz		Average (AV)

ANTENNA POLARITY & TEST DISTANCE: HORIZONTAL AT 3 M

NO.	FREQ. (MHz)	EMISSION LEVEL (dBuV/m)	LIMIT (dBuV/m)	MARGIN (dB)	ANTENNA HEIGHT (m)	TABLE ANGLE (Degree)	RAW VALUE (dBuV)	CORRECTION FACTOR (dB/m)
1	#5595.12	63.8 PK	68.2	-4.4	2.21 H	282	52.1	11.7
2	*5775.00	100.8 PK			2.21 H	282	88.8	12.0
3	*5775.00	90.8 AV			2.21 H	282	78.8	12.0
4	#5979.40	63.6 PK	68.2	-4.6	2.21 H	282	51.7	11.9
5	11550.00	58.4 PK	74.0	-15.6	1.49 H	240	40.6	17.8
6	11550.00	48.0 AV	54.0	-6.0	1.49 H	240	30.2	17.8
7	#17325.00	62.4 PK	74.0	-11.6	1.51 H	236	35.9	26.5
8	#17325.00	50.0 AV	54.0	-4.0	1.51 H	236	23.5	26.5

ANTENNA POLARITY & TEST DISTANCE: VERTICAL AT 3 M

NO.	FREQ. (MHz)	EMISSION LEVEL (dBuV/m)	LIMIT (dBuV/m)	MARGIN (dB)	ANTENNA HEIGHT (m)	TABLE ANGLE (Degree)	RAW VALUE (dBuV)	CORRECTION FACTOR (dB/m)
1	#5645.48	68.1 PK	68.2	-0.1	1.64 V	358	56.4	11.7
2	*5775.00	113.7 PK			1.64 V	358	101.7	12.0
3	*5775.00	104.5 AV			1.64 V	358	92.5	12.0
4	#5974.65	64.0 PK	68.2	-4.2	1.64 V	358	52.2	11.8
5	11550.00	60.8 PK	74.0	-13.2	1.28 V	170	43.0	17.8
6	11550.00	46.0 AV	54.0	-8.0	1.28 V	170	28.2	17.8
7	#17325.00	54.9 PK	74.0	-19.1	1.27 V	146	28.4	26.5
8	#17325.00	43.0 AV	54.0	-11.0	1.27 V	146	16.5	26.5

REMARKS:

1. Emission Level(dBuV/m) = Raw Value(dBuV) + Correction Factor(dB/m)
2. Correction Factor(dB/m) = Antenna Factor(dB/m) + Cable Factor(dB) – Pre-Amplifier Factor(dB)
3. The other emission levels were very low against the limit.
4. Margin value = Emission Level – Limit value
5. " * ": Fundamental frequency.
6. " # ": The radiated frequency is out of the restricted band.

Below 1GHz Data:

802.11ac (VHT40)

CHANNEL	TX Channel 46	DETECTOR FUNCTION	Quasi-Peak (QP)
FREQUENCY RANGE	9kHz ~ 1GHz		

ANTENNA POLARITY & TEST DISTANCE: HORIZONTAL AT 3 M

NO.	FREQ. (MHz)	EMISSION LEVEL (dBuV/m)	LIMIT (dBuV/m)	MARGIN (dB)	ANTENNA HEIGHT (m)	TABLE ANGLE (Degree)	RAW VALUE (dBuV)	CORRECTION FACTOR (dB/m)
1	125.01	33.7 QP	43.5	-9.8	2.00 H	100	43.3	-9.6
2	250.00	35.3 QP	46.0	-10.7	1.00 H	81	44.3	-9.0
3	300.05	37.5 QP	46.0	-8.5	1.00 H	203	44.1	-6.6
4	375.00	37.4 QP	46.0	-8.6	1.00 H	83	42.1	-4.7
5	625.00	39.9 QP	46.0	-6.1	1.50 H	331	38.6	1.3
6	949.54	37.3 QP	46.0	-8.7	1.00 H	144	30.4	6.9

ANTENNA POLARITY & TEST DISTANCE: VERTICAL AT 3 M

NO.	FREQ. (MHz)	EMISSION LEVEL (dBuV/m)	LIMIT (dBuV/m)	MARGIN (dB)	ANTENNA HEIGHT (m)	TABLE ANGLE (Degree)	RAW VALUE (dBuV)	CORRECTION FACTOR (dB/m)
1	124.99	34.0 QP	43.5	-9.5	1.50 V	360	43.5	-9.5
2	299.95	35.1 QP	46.0	-10.9	1.00 V	63	41.7	-6.6
3	375.00	37.5 QP	46.0	-8.5	1.50 V	360	42.2	-4.7
4	499.99	38.3 QP	46.0	-7.7	2.00 V	24	39.8	-1.5
5	625.00	39.4 QP	46.0	-6.6	1.50 V	360	38.1	1.3
6	874.99	41.6 QP	46.0	-4.4	1.00 V	351	36.4	5.2

REMARKS:

1. Emission Level(dBuV/m) = Raw Value(dBuV) + Correction Factor(dB/m)
2. Correction Factor(dB/m) = Antenna Factor(dB/m) + Cable Factor(dB) – Pre-Amplifier Factor(dB)
3. The other emission levels were very low against the limit.
4. Margin value = Emission Level – Limit value

4.2 Conducted Emission Measurement

4.2.1 Limits of Conducted Emission Measurement

Frequency (MHz)	Conducted Limit (dBuV)	
	Quasi-peak	Average
0.15 - 0.5	66 - 56	56 - 46
0.50 - 5.0	56	46
5.0 - 30.0	60	50

Note: 1. The lower limit shall apply at the transition frequencies.

2. The limit decreases in line with the logarithm of the frequency in the range of 0.15 to 0.50MHz.

4.2.2 Test Instruments

DESCRIPTION & MANUFACTURER	MODEL NO.	SERIAL NO.	CALIBRATED DATE	CALIBRATED UNTIL
Test Receiver R&S	ESCS 30	100375	May 09, 2016	May 08, 2017
Line-Impedance Stabilization Network (for EUT) SCHWARZBECK	NSLK-8127	8127-522	Aug. 31, 2016	Aug. 30, 2017
Line-Impedance Stabilization Network (for Peripheral) R&S	ENV216	100072	June 13, 2016	June 12, 2017
RF Cable	5D-FB	COACAB-002	Mar. 04, 2016	Mar. 03, 2017
10 dB PAD Mini-Circuits	HAT-10+	CONATT-003	Sep. 13, 2016	Sep. 12, 2017
50 ohms Terminator	N/A	04	Nov. 18, 2015	Nov. 17, 2016
50 ohms Terminator	50	3	Oct. 21, 2015	Oct. 20, 2016
Software BVADT	BVADT_Cond_ V7.3.7.4	NA	NA	NA

Note:

1. The calibration interval of the above test instruments are 12 months and the calibrations are traceable to NML/ROC and NIST/USA.
2. The test was performed in Shielded Room No. C.
- 3 The VCCI Con C Registration No. is C-3611.
- 4 Tested Date: Sep. 15, 2016

4.2.3 Test Procedure

- The EUT was placed 0.4 meters from the conducting wall of the shielded room with EUT being connected to the power mains through a line impedance stabilization network (LISN). Other support units were connected to the power mains through another LISN. The two LISNs provide 50 ohm/ 50uH of coupling impedance for the measuring instrument.
- Both lines of the power mains connected to the EUT were checked for maximum conducted interference.
- The frequency range from 150kHz to 30MHz was searched. Emission levels under (Limit - 20dB) was not recorded.

NOTE: All modes of operation were investigated and the worst-case emissions are reported.

4.2.4 Deviation from Test Standard

No deviation.

4.2.5 Test Setup

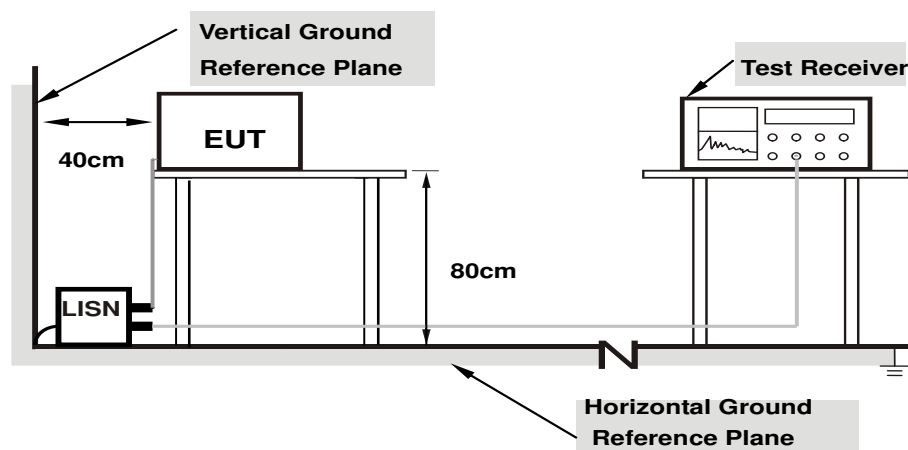

Note: 1.Support units were connected to second LISN.

For the actual test configuration, please refer to the attached file (Test Setup Photo).

4.2.6 EUT Operating Condition

Same as 4.1.6.

4.2.7 Test Results

Phase	Line (L)	Detector Function	Quasi-Peak (QP) / Average (AV)
-------	----------	-------------------	--------------------------------

No	Freq. [MHz]	Corr.	Reading Value		Emission Level		Limit		Margin	
		Factor (dB)	[dB (uV)]		[dB (uV)]		[dB (uV)]		(dB)	
			Q.P.	AV.	Q.P.	AV.	Q.P.	AV.	Q.P.	AV.
1	0.19687	10.25	32.33	30.10	42.58	40.35	63.74	53.74	-21.16	-13.39
2	0.26328	10.25	31.37	29.03	41.62	39.28	61.33	51.33	-19.71	-12.05
3	0.39609	10.24	30.06	27.35	40.30	37.59	57.93	47.93	-17.63	-10.34
4	0.43941	10.24	36.71	35.37	46.95	45.61	57.07	47.07	-10.12	-1.46
5	0.94297	10.28	27.72	24.07	38.00	34.35	56.00	46.00	-18.00	-11.65
6	12.63672	10.96	25.89	21.13	36.85	32.09	60.00	50.00	-23.15	-17.91

REMARKS:

1. Q.P. and AV. are abbreviations of quasi-peak and average individually.
2. The emission levels of other frequencies were very low against the limit.
3. Margin value = Emission level - Limit value
4. Correction factor = Insertion loss + Cable loss
5. Emission Level = Correction Factor + Reading Value.

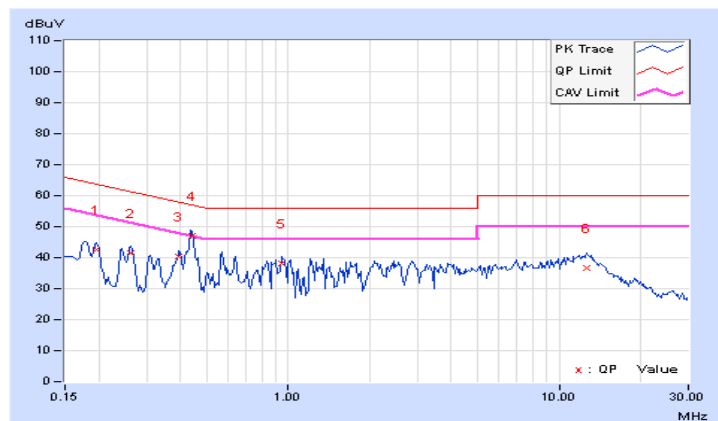

Phase	Neutral (N)	Detector Function	Quasi-Peak (QP) / Average (AV)
-------	-------------	-------------------	--------------------------------

No	Freq.	Corr.	Reading Value		Emission Level		Limit		Margin	
	[MHz]	Factor	[dB (uV)]		[dB (uV)]		[dB (uV)]		(dB)	
		(dB)	Q.P.	AV.	Q.P.	AV.	Q.P.	AV.	Q.P.	AV.
1	0.15000	10.28	27.21	22.02	37.49	32.30	66.00	56.00	-28.51	-23.70
2	0.17734	10.25	34.38	31.13	44.63	41.38	64.61	54.61	-19.98	-13.23
3	0.39609	10.30	32.90	30.14	43.20	40.44	57.93	47.93	-14.73	-7.49
4	0.44016	10.31	36.36	35.06	46.67	45.37	57.06	47.06	-10.39	-1.69
5	3.97266	10.60	26.61	16.13	37.21	26.73	56.00	46.00	-18.79	-19.27
6	12.21484	10.99	27.93	23.55	38.92	34.54	60.00	50.00	-21.08	-15.46

REMARKS:

1. Q.P. and AV. are abbreviations of quasi-peak and average individually.
2. The emission levels of other frequencies were very low against the limit.
3. Margin value = Emission level - Limit value
4. Correction factor = Insertion loss + Cable loss
5. Emission Level = Correction Factor + Reading Value.

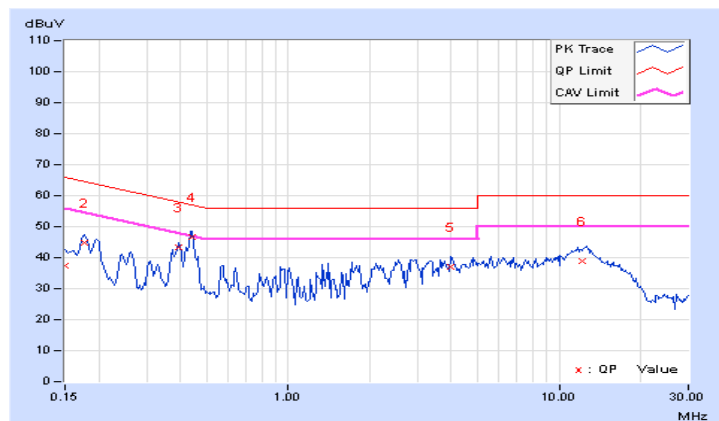

4.3 Transmit Power Measurement

4.3.1 Limits of Transmit Power Measurement

Operation Band	EUT Category		Limit
U-NII-1		Outdoor Access Point	1 Watt (30 dBm) (Max. e.i.r.p \leq 125mW(21 dBm) at any elevation angle above 30 degrees as measured from the horizon)
		Fixed point-to-point Access Point	1 Watt (30 dBm)
	√	Indoor Access Point	1 Watt (30 dBm)
		Mobile and Portable client device	250mW (24 dBm)
U-NII-2A			250mW (24 dBm) or 11 dBm+10 log B*
U-NII-2C			250mW (24 dBm) or 11 dBm+10 log B*
U-NII-3		√	1 Watt (30 dBm)

*B is the 26 dB emission bandwidth in megahertz

Per KDB 662911 Method of conducted output power measurement on IEEE 802.11 devices,

Array Gain = 0 dB (i.e., no array gain) for $N_{ANT} \leq 4$;

Array Gain = 0 dB (i.e., no array gain) for channel widths ≥ 40 MHz for any N_{ANT} ;

Array Gain = $5 \log(N_{ANT}/N_{SS})$ dB or 3 dB, whichever is less for 20-MHz channel widths with $N_{ANT} \geq 5$.

For power measurements on all other devices: Array Gain = $10 \log(N_{ANT}/N_{SS})$ dB.

4.3.2 Test Setup

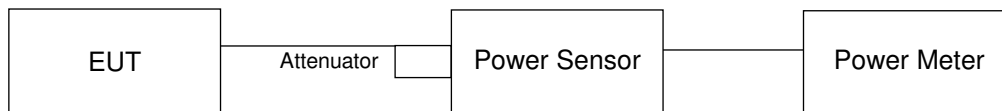

4.3.3 Test Instruments

Refer to section 4.1.2 to get information of above instrument.

4.3.4 Test Procedure

Method PM is used to perform output power measurement, trigger and gating function of wide band power meter is enabled to measure max output power of TX on burst. Duty factor is not added to measured value.

4.3.5 Deviation from Test Standard

No deviation.

4.3.6 EUT Operating Condition

The software provided by client to enable the EUT under transmission condition continuously at lowest, middle and highest channel frequencies individually.

4.3.7 Test Result

802.11a

Chan.	Chan. Freq. (MHz)	Maximum Conducted Power (dBm)			Total Power (mW)	Total Power (dBm)	Limit (dBm)	Pass / Fail
		Chain 0	Chain 1	Chain 2				
36	5180	15.51	14.41	16.36	106.42	20.27	30	Pass
40	5200	18.19	17.28	18.48	189.842	22.78	30	Pass
48	5240	16.55	15.75	16.77	130.304	21.15	30	Pass
149	5745	11.97	12.15	13.81	56.19	17.50	30	Pass
157	5785	13.10	12.52	13.17	59.031	17.71	30	Pass
165	5825	12.40	11.57	11.86	47.079	16.73	30	Pass

802.11ac (VHT20)

Chan.	Chan. Freq. (MHz)	Maximum Conducted Power (dBm)			Total Power (mW)	Total Power (dBm)	Limit (dBm)	Pass / Fail
		Chain 0	Chain 1	Chain 2				
36	5180	14.95	13.97	15.60	92.515	19.66	30	Pass
40	5200	17.84	17.15	18.81	188.727	22.76	30	Pass
48	5240	17.54	16.51	17.84	162.339	22.10	30	Pass
149	5745	12.22	11.95	13.83	56.495	17.52	30	Pass
157	5785	12.98	11.61	12.88	53.758	17.30	30	Pass
165	5825	12.85	11.53	11.99	49.31	16.93	30	Pass

802.11ac (VHT40)

Chan.	Chan. Freq. (MHz)	Maximum Conducted Power (dBm)			Total Power (mW)	Total Power (dBm)	Limit (dBm)	Pass / Fail
		Chain 0	Chain 1	Chain 2				
38	5190	8.14	7.29	8.66	19.219	12.84	30	Pass
46	5230	18.62	17.66	19.20	214.299	23.31	30	Pass
151	5755	14.85	14.36	15.73	95.25	19.79	30	Pass
159	5795	15.81	15.20	15.45	106.295	20.27	30	Pass

802.11ac (VHT80)

Chan.	Chan. Freq. (MHz)	Maximum Conducted Power (dBm)			Total Power (mW)	Total Power (dBm)	Limit (dBm)	Pass / Fail
		Chain 0	Chain 1	Chain 2				
42	5210	6.31	5.20	6.90	12.485	10.96	30	Pass
155	5775	18.33	17.35	18.24	189.083	22.77	30	Pass

4.4 Occupied Bandwidth Measurement

4.4.1 Test Setup

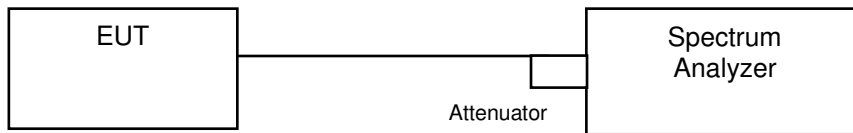

4.4.2 Test Instruments

Refer to section 4.1.2 to get information of above instrument.

4.4.3 Test Procedure

The transmitter output was connected to the spectrum analyzer through an attenuator. The bandwidth of the fundamental frequency was measured by spectrum analyzer with resolution bandwidth in the range of 1% to 5% of the anticipated emission bandwidth, and a video bandwidth at least 3x the resolution bandwidth and set the detector to SAMPLE. The width of a frequency band such that, below the lower and above the upper frequency limits, the mean powers emitted are each equal to a specified percentage 0.5 %of the total mean power of a given emission.

4.4.4 Test Results

802.11a

Channel	Channel Frequency (MHz)	Occupied Bandwidth (MHz)		
		Chain 0	Chain 1	Chain 2
36	5180	16.80	16.80	16.80
40	5200	16.80	16.80	16.68
48	5240	16.68	16.68	16.68
149	5745	16.80	16.68	16.80
157	5785	16.68	16.68	16.80
165	5825	16.68	16.68	16.68

802.11ac (VHT20)

Channel	Channel Frequency (MHz)	Occupied Bandwidth (MHz)		
		Chain 0	Chain 1	Chain 2
36	5180	17.88	18.00	17.88
40	5200	18.00	17.88	17.88
48	5240	17.88	17.88	17.88
149	5745	17.88	17.88	17.88
157	5785	18.00	17.88	17.88
165	5825	17.88	17.88	17.88

802.11ac (VHT40)

Channel	Channel Frequency (MHz)	Occupied Bandwidth (MHz)		
		Chain 0	Chain 1	Chain 2
38	5190	36.96	36.72	36.72
46	5230	36.96	36.72	36.96
151	5755	36.72	36.72	36.72
159	5795	36.96	36.72	36.72

802.11ac (VHT80)

Channel	Channel Frequency (MHz)	Occupied Bandwidth (MHz)		
		Chain 0	Chain 1	Chain 2
42	5210	76.32	76.32	75.84
155	5775	76.32	76.32	75.84

Spectrum Plot of Worst Value

802.11a_Chain0 / CH40

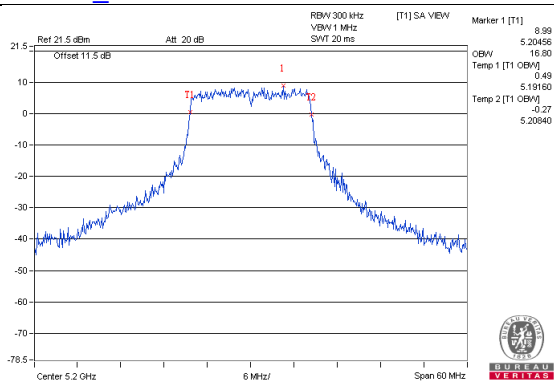

802.11ac (VHT20)_Chain0 / CH40

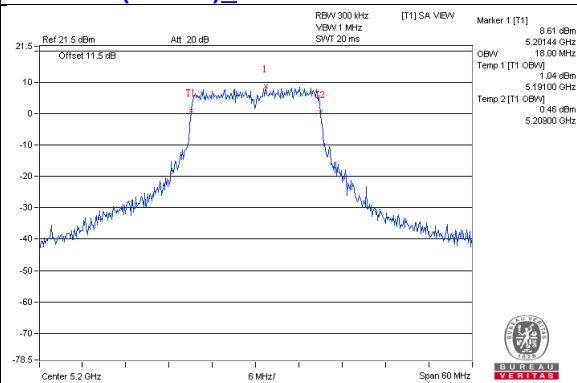

802.11ac (VHT40)_Chain2 / CH46

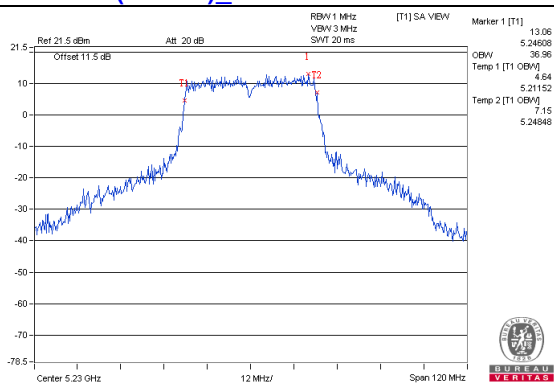

802.11ac (VHT80)_Chain0 / CH155

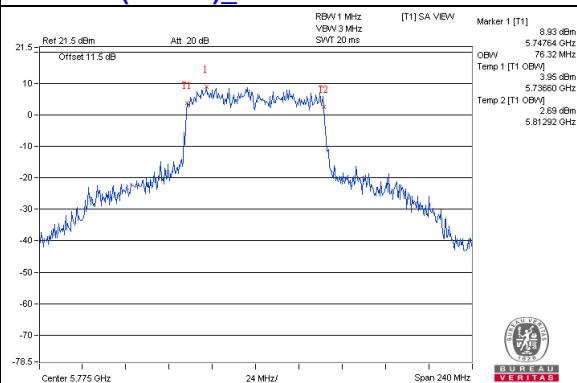

Spectrum Plot for near by DFS band (DFS is required, if 99% OCP straddle into U-NII-2A band)

802.11a_Chain0 / CH48

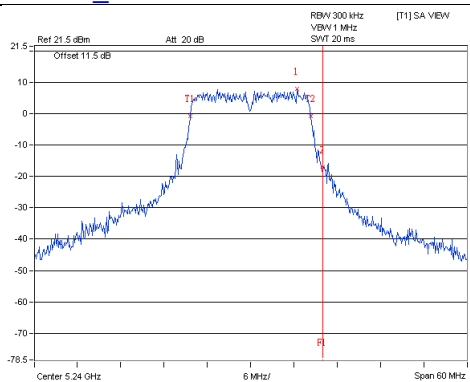

802.11a_Chain1 / CH48

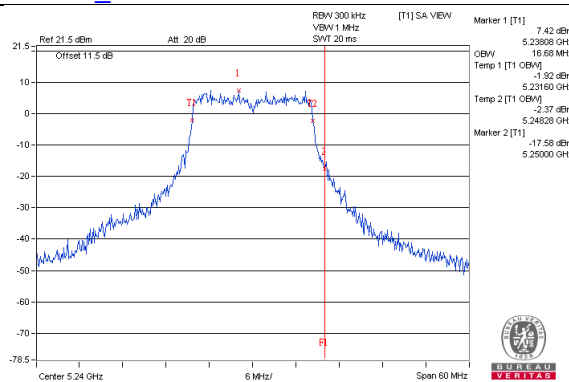

802.11a_Chain2 / CH48

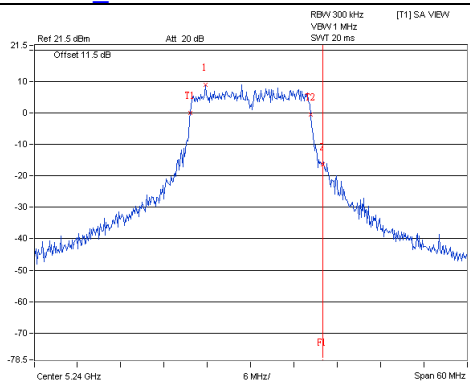

802.11ac(VHT20)_Chain0 / CH48

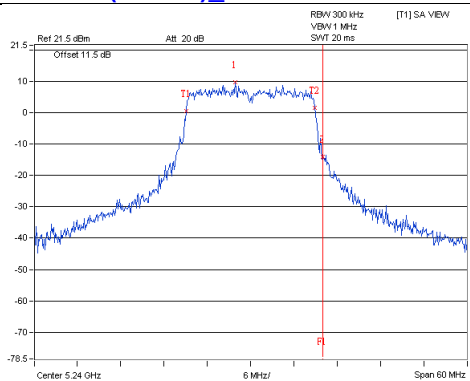

802.11ac(VHT20)_Chain1 / CH48

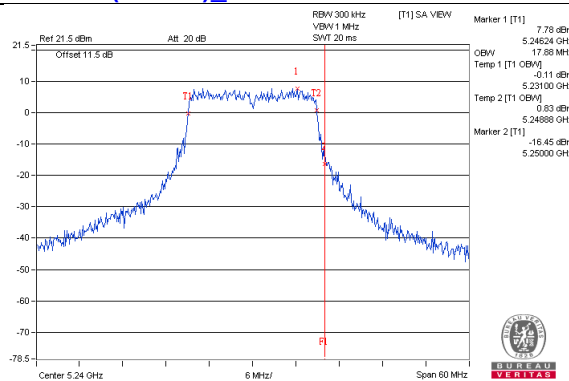

802.11ac(VHT20)_Chain2 / CH48

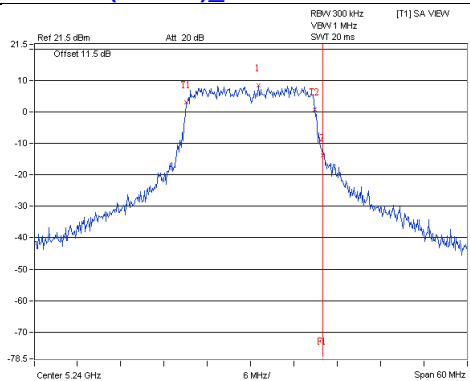

Spectrum Plot for near by DFS band (DFS is required, if 99% OCP straddle into U-NII-2A band)

802.11ac(VHT40)_Chain0 / CH46

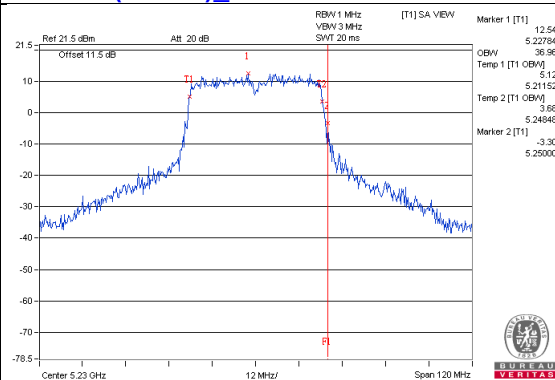

802.11ac(VHT40)_Chain1 / CH46

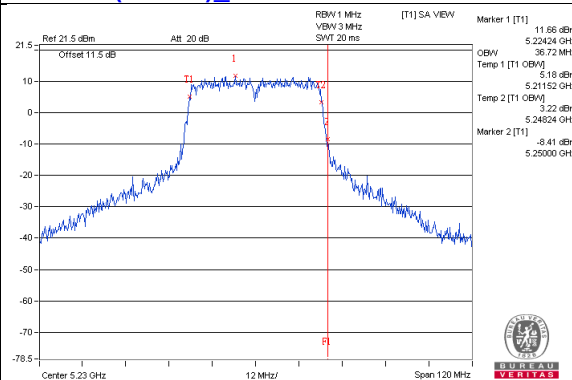

802.11ac(VHT40)_Chain2 / CH46

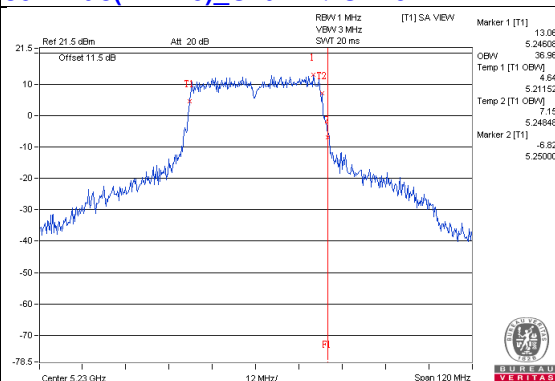

802.11ac(VHT80)_Chain0 / CH42

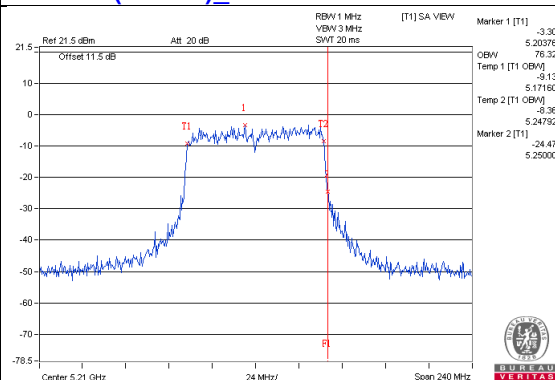

802.11ac(VHT80)_Chain1 / CH42

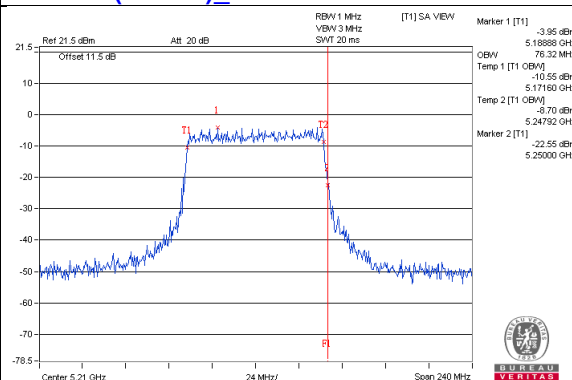

802.11ac(VHT80)_Chain2 / CH42

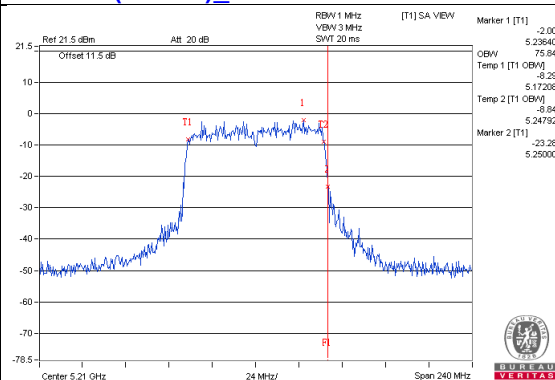

**Spectrum Plot for near by DFS band
(DFS is required, if 99% OCP straddle into U-NII-2C band)**

802.11a_Chain0 / CH149

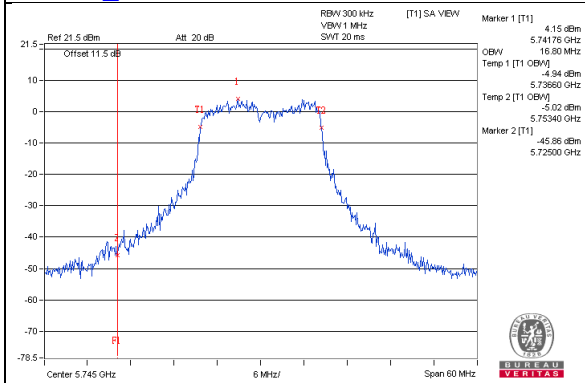

802.11a_Chain1 / CH149

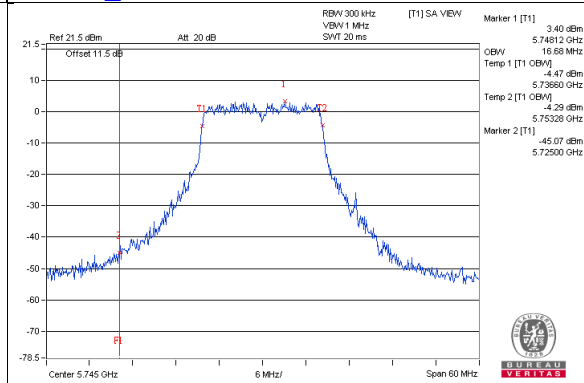

802.11a_Chain2 / CH149

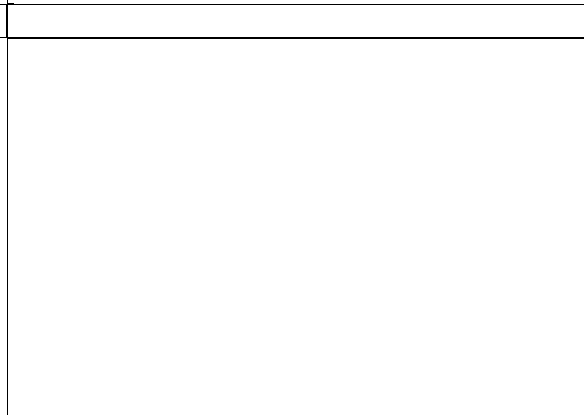
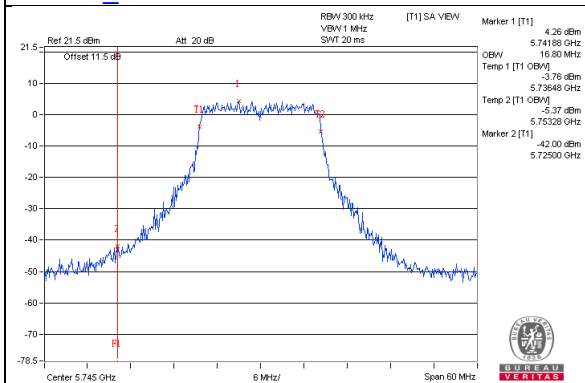

802.11ac(VHT20)_Chain0 / CH149

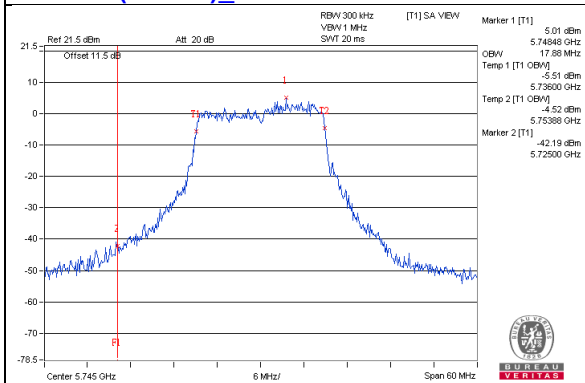

802.11ac(VHT20)_Chain1 / CH149

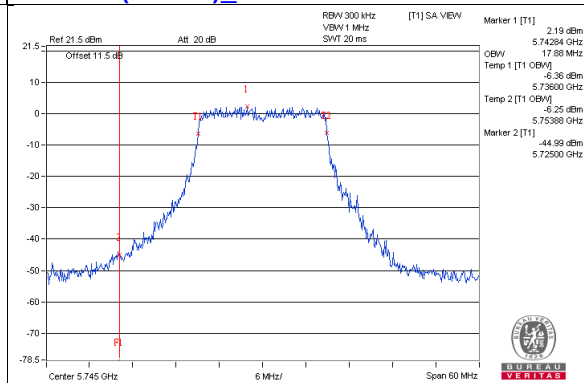

802.11ac(VHT20)_Chain2 / CH149

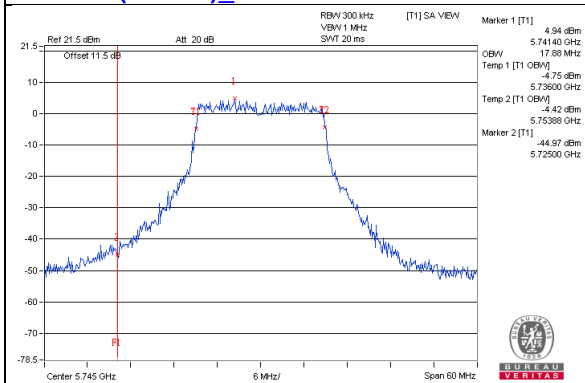

Spectrum Plot for near by DFS band (DFS is required, if 99% OCP straddle into U-NII-2C band)

802.11ac(VHT40)_Chain0 / CH151

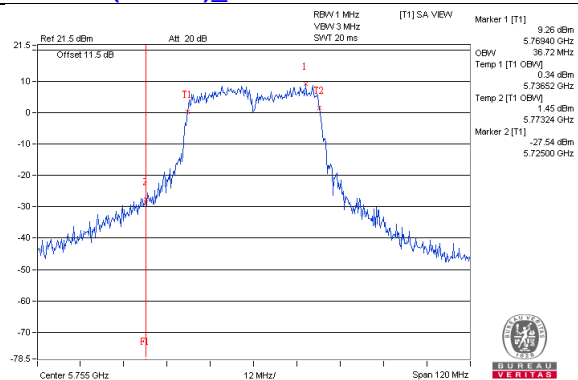

802.11ac(VHT40)_Chain1 / CH151

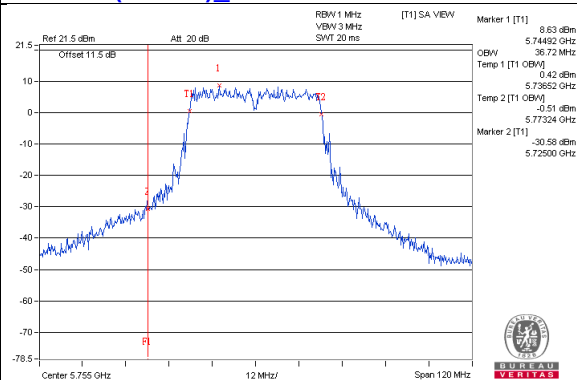

802.11ac(VHT40)_Chain2 / CH151

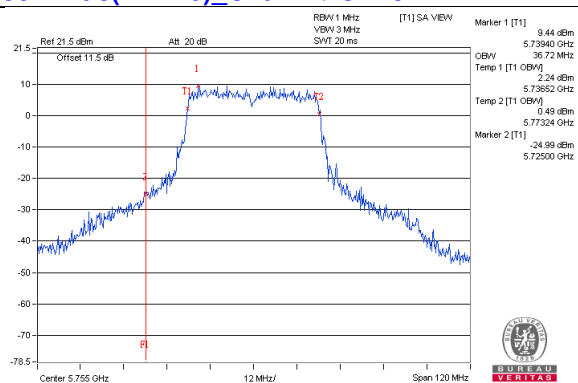

802.11ac(VHT80)_Chain0 / CH155

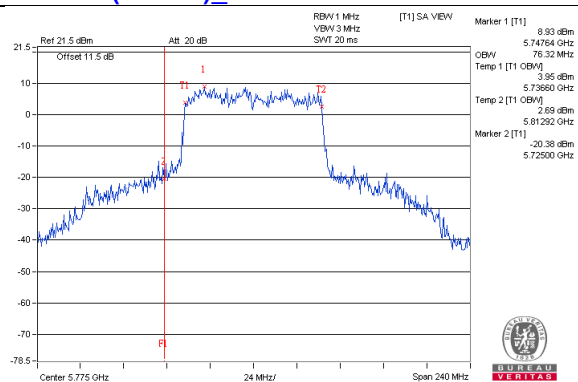

802.11ac(VHT80)_Chain1 / CH155

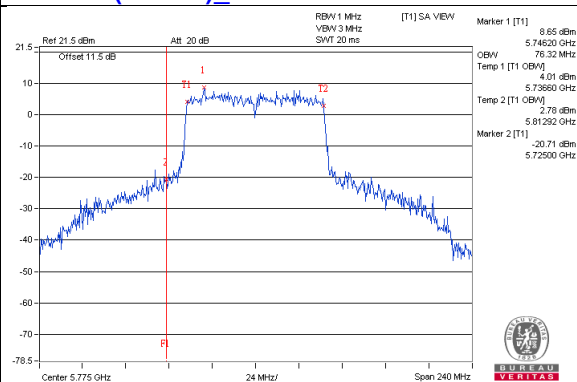

802.11ac(VHT80)_Chain2 / CH155

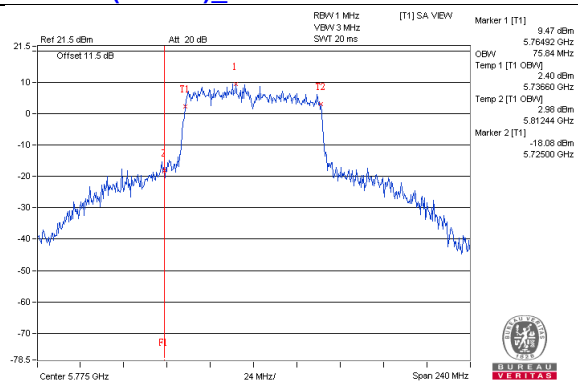

4.5 Peak Power Spectral Density Measurement

4.5.1 Limits of Peak Power Spectral Density Measurement

Operation Band	EUT Category		Limit
U-NII-1		Outdoor Access Point	17dBm/ MHz
		Fixed point-to-point Access Point	
	√	Indoor Access Point	
		Mobile and Portable client device	11dBm/ MHz
U-NII-2A			11dBm/ MHz
U-NII-2C			11dBm/ MHz
U-NII-3	√		30dBm/ 500kHz

4.5.2 Test Setup

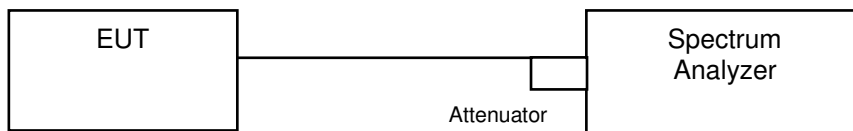

4.5.3 Test Instruments

Refer to section 4.1.2 to get information of above instrument.

4.5.4 Test Procedure

802.11a, 802.11ac (VHT20), 802.11ac (VHT40)

For U-NII-1:

Using method SA-1

1. Set span to encompass the entire emission bandwidth (EBW) of the signal.
2. Set RBW = 1 MHz, Set VBW \geq 3 MHz, Detector = RMS
3. Sweep time = auto, trigger set to "free run".
4. Trace average at least 100 traces in power averaging mode.
5. Record the max value

For U-NII-3:

1. Set span to encompass the entire emission bandwidth (EBW) of the signal.
2. Set RBW = 300 kHz, Set VBW \geq 1 MHz, Detector = RMS
3. Use the peak marker function to determine the maximum power level in any 300 kHz band segment within the fundamental EBW.
4. Scale the observed power level to an equivalent value in 500 kHz by adjusting (reducing) the measured power by a bandwidth correction factor (BWCF) where $BWCF = 10\log(500 \text{ kHz}/300\text{kHz})$
5. Sweep time = auto, trigger set to "free run".
6. Trace average at least 100 traces in power averaging mode.
7. Record the max value

802.11ac (VHT80)

For U-NII-1:

Using method SA-2

1. Set span to encompass the entire emission bandwidth (EBW) of the signal.
2. Set RBW = 1 MHz, Set VBW \geq 3 MHz, Detector = RMS
3. Sweep time = auto, trigger set to "free run".
4. Trace average at least 100 traces in power averaging mode.
5. Record the max value and add $10 \log (1/\text{duty cycle})$

For U-NII-3:

1. Set span to encompass the entire emission bandwidth (EBW) of the signal.
2. Set RBW = 300 kHz, Set VBW \geq 1 MHz, Detector = RMS
3. Use the peak marker function to determine the maximum power level in any 300 kHz band segment within the fundamental EBW.
4. Scale the observed power level to an equivalent value in 500 kHz by adjusting (reducing) the measured power by a bandwidth correction factor (BWCF) where $BWCF = 10\log(500 \text{ kHz}/300\text{kHz})$
5. Sweep time = auto, trigger set to "free run".
6. Trace average at least 100 traces in power averaging mode.
7. Record the max value and add $10 \log (1/\text{duty cycle})$

4.5.5 Deviation from Test Standard

No deviation.

4.5.6 EUT Operating Condition

Same as Item 4.3.6.

4.5.7 Test Results

For U-NII-1:

802.11a

Chan.	Chan. Freq. (MHz)	PSD (dBm/MHz)			Total Power Density (dBm/MHz)	MAX. Limit (dBm/MHz)	Pass / Fail
		Chain 0	Chain 1	Chain 2			
36	5180	2.10	0.85	2.52	6.65	13.99	Pass
40	5200	4.77	3.82	5.03	9.34	13.99	Pass
48	5240	3.82	2.74	3.87	8.28	13.99	Pass

- Note:** 1. Method a) of power density measurement of KDB 662911 is using for calculating total power density. Total power density is summing entire spectra across corresponding frequency bins on the various outputs by computer.
 2. Directional gain = $10 \log[(10^{G1/20} + 10^{G2/20} + 10^{G3/20})^2 / 3] = 9.01 \text{dBi} > 6 \text{dBi}$, so the power density limit shall be reduced to $17 - (9.01 - 6) = 13.99 \text{dBm}$.

802.11ac (VHT20)

Chan.	Chan. Freq. (MHz)	PSD (dBm/MHz)			Total Power Density (dBm/MHz)	MAX. Limit (dBm/MHz)	Pass / Fail
		Chain 0	Chain 1	Chain 2			
36	5180	0.93	0.12	1.80	5.78	13.99	Pass
40	5200	4.86	3.51	4.73	9.18	13.99	Pass
48	5240	4.66	3.72	4.48	9.08	13.99	Pass

- Note:** 1. Method a) of power density measurement of KDB 662911 is using for calculating total power density. Total power density is summing entire spectra across corresponding frequency bins on the various outputs by computer.
 2. Directional gain = $10 \log[(10^{G1/20} + 10^{G2/20} + 10^{G3/20})^2 / 3] = 9.01 \text{dBi} > 6 \text{dBi}$, so the power density limit shall be reduced to $17 - (9.01 - 6) = 13.99 \text{dBm}$.

802.11ac (VHT40)

Chan.	Chan. Freq. (MHz)	PSD (dBm/MHz)			Total Power Density (dBm/MHz)	MAX. Limit (dBm/MHz)	Pass / Fail
		Chain 0	Chain 1	Chain 2			
38	5190	-8.79	-9.58	-7.81	-3.89	13.99	Pass
46	5230	2.43	1.75	2.87	7.15	13.99	Pass

- Note:** 1. Method a) of power density measurement of KDB 662911 is using for calculating total power density. Total power density is summing entire spectra across corresponding frequency bins on the various outputs by computer.
 2. Directional gain = $10 \log[(10^{G1/20} + 10^{G2/20} + 10^{G3/20})^2 / 3] = 9.01 \text{dBi} > 6 \text{dBi}$, so the power density limit shall be reduced to $17 - (9.01 - 6) = 13.99 \text{dBm}$.

802.11ac (VHT80)

Chan.	Chan. Freq. (MHz)	PSD W/O Duty Factor (dBm/MHz)			Duty Factor (dB)	Total PSD With Duty Factor (dBm/MHz)	MAX. Limit (dBm/MHz)	Pass / Fail
		Chain 0	Chain 1	Chain 2				
42	5210	-12.84	-14.43	-12.50	0.20	-8.21	13.99	Pass

- Note:**
- Method a) of power density measurement of KDB 662911 is using for calculating total power density. Total power density is summing entire spectra across corresponding frequency bins on the various outputs by computer.
 - Directional gain = $10 \log[(10^{G1/20} + 10^{G2/20} + 10^{G3/20})^2 / 3] = 9.01 \text{dBi} > 6 \text{dBi}$, so the power density limit shall be reduced to $17 - (9.01 - 6) = 13.99 \text{dBm}$.
 - Refer to section 3.3 for duty cycle spectrum plot

Spectrum Plot of Worst Value

802.11a_Chain 2 / CH40

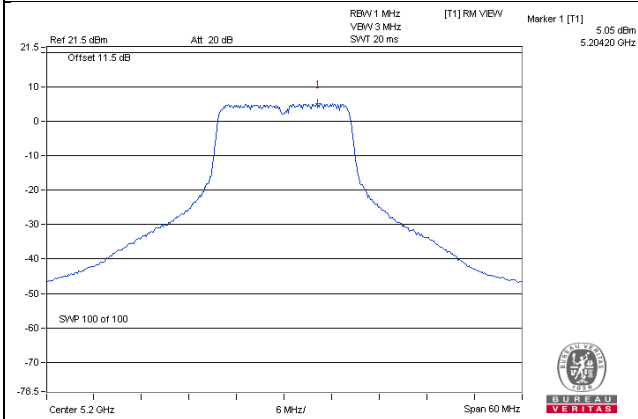

802.11ac (VHT20)_Chain 0 / CH40

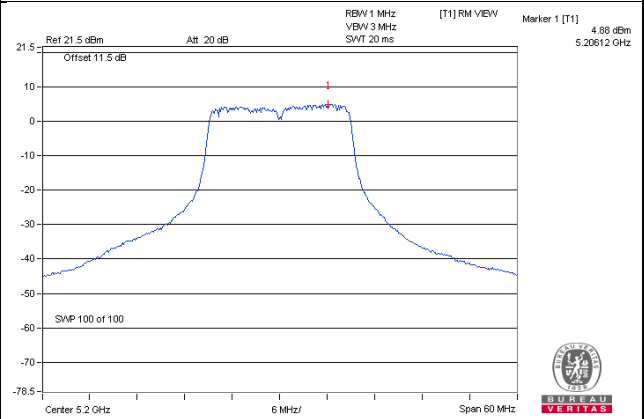

802.11ac (VHT40)_Chain 2 / CH46

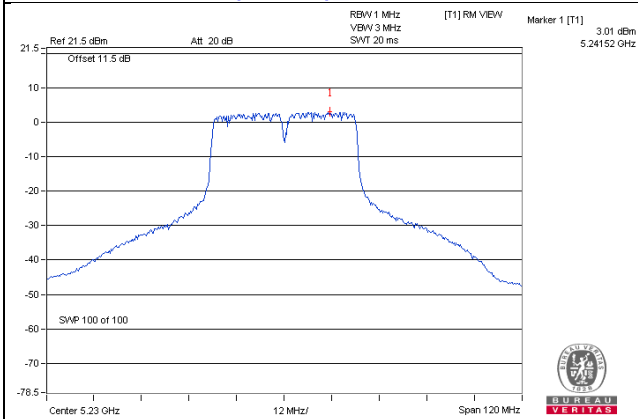

802.11ac (VHT80)_Chain 2 / CH42

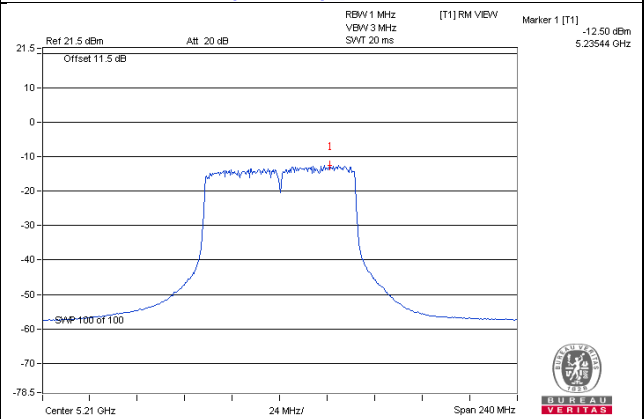

For U-NII-3:
802.11a

TX chain	Channel	Freq. (MHz)	PSD (dBm/300kHz)	PSD (dBm/500kHz)	10 log (N=3) dB	Total PSD (dBm/500kHz)	Limit (dBm/500kHz)	Pass /Fail
0	149	5745	-8.18	-5.96	4.77	-1.19	26.49	Pass
	157	5785	-7.15	-4.93	4.77	-0.16	26.49	Pass
	165	5825	-8.13	-5.91	4.77	-1.14	26.49	Pass
1	149	5745	-9.10	-6.88	4.77	-2.11	26.49	Pass
	157	5785	-8.84	-6.62	4.77	-1.85	26.49	Pass
	165	5825	-9.67	-7.45	4.77	-2.68	26.49	Pass
2	149	5745	-8.06	-5.84	4.77	-1.07	26.49	Pass
	157	5785	-8.26	-6.04	4.77	-1.27	26.49	Pass
	165	5825	-9.28	-7.06	4.77	-2.29	26.49	Pass

Note: 1. Directional gain = $10 \log[(10^{G1/20} + 10^{G2/20} + 10^{G3/20})^2 / 3] = 9.51\text{dBi} > 6\text{dBi}$, so the power density limit shall be reduced to $30 - (9.51 - 6) = 26.49\text{dBm}$.

802.11ac (VHT20)

TX chain	Channel	Freq. (MHz)	PSD (dBm/300kHz)	PSD (dBm/500kHz)	10 log (N=3) dB	Total PSD (dBm/500kHz)	Limit (dBm/500kHz)	Pass /Fail
0	149	5745	-8.31	-6.09	4.77	-1.32	26.49	Pass
	157	5785	-7.26	-5.04	4.77	-0.27	26.49	Pass
	165	5825	-8.61	-6.39	4.77	-1.62	26.49	Pass
1	149	5745	-9.76	-7.54	4.77	-2.77	26.49	Pass
	157	5785	-9.00	-6.78	4.77	-2.01	26.49	Pass
	165	5825	-10.25	-8.03	4.77	-3.26	26.49	Pass
2	149	5745	-8.11	-5.89	4.77	-1.12	26.49	Pass
	157	5785	-8.79	-6.57	4.77	-1.80	26.49	Pass
	165	5825	-9.64	-7.42	4.77	-2.65	26.49	Pass

Note: 1. Directional gain = $10 \log[(10^{G1/20} + 10^{G2/20} + 10^{G3/20})^2 / 3] = 9.51\text{dBi} > 6\text{dBi}$, so the power density limit shall be reduced to $30 - (9.51 - 6) = 26.49\text{dBm}$.

802.11ac (VHT40)

TX chain	Channel	Freq. (MHz)	PSD (dBm/300kHz)	PSD (dBm/500kHz)	10 log (N=3) dB	Total PSD (dBm/500kHz)	Limit (dBm/500kHz)	Pass /Fail
0	151	5755	-8.69	-6.47	4.77	-1.70	26.49	Pass
	159	5795	-7.70	-5.48	4.77	-0.71	26.49	Pass
1	151	5755	-10.43	-8.21	4.77	-3.44	26.49	Pass
	159	5795	-9.94	-7.72	4.77	-2.95	26.49	Pass
2	151	5755	-8.77	-6.55	4.77	-1.78	26.49	Pass
	159	5795	-9.67	-7.45	4.77	-2.68	26.49	Pass

Note: 1. Directional gain = $10 \log[(10^{G1/20} + 10^{G2/20} + 10^{G3/20})^2 / 3] = 9.51\text{dBi} > 6\text{dBi}$, so the power density limit shall be reduced to $30 - (9.51 - 6) = 26.49\text{dBm}$.

802.11ac (VHT80)

TX chain	Chan.	Chan. Freq. (MHz)	PSD W/O Duty Factor		10 log (N=3) dB	Duty Factor (dB)	Total PSD With Duty Factor (dBm/500kHz)	Limit (dBm/500kHz)	Pass /Fail
			(dBm/300kHz)	(dBm/500kHz)					
0	155	5775	-8.73	-6.51	4.77	0.20	-1.54	26.49	Pass
1	155	5775	-10.93	-8.71	4.77	0.20	-3.74	26.49	Pass
2	155	5775	-9.92	-7.70	4.77	0.20	-2.73	26.49	Pass

Note: 1. Directional gain = $10 \log[(10^{G1/20} + 10^{G2/20} + 10^{G3/20})^2 / 3] = 9.51 \text{dBi} > 6 \text{dBi}$, so the power density limit shall be reduced to $30 - (9.51 - 6) = 26.49 \text{dBm}$.

2. Refer to section 3.3 for duty cycle spectrum plot.

Spectrum Plot of Worst Value

802.11a – Chain 0: CH 157

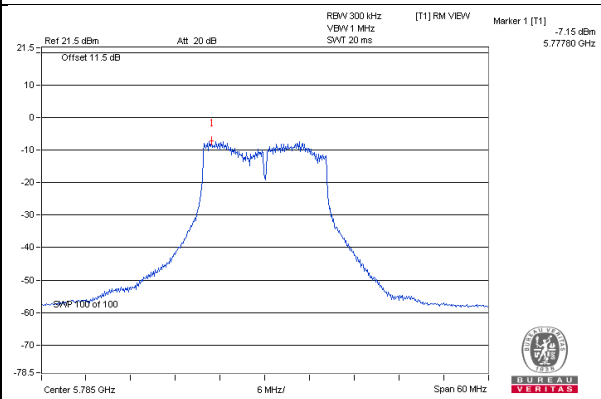

802.11ac (VHT20) – Chain 0: CH 157

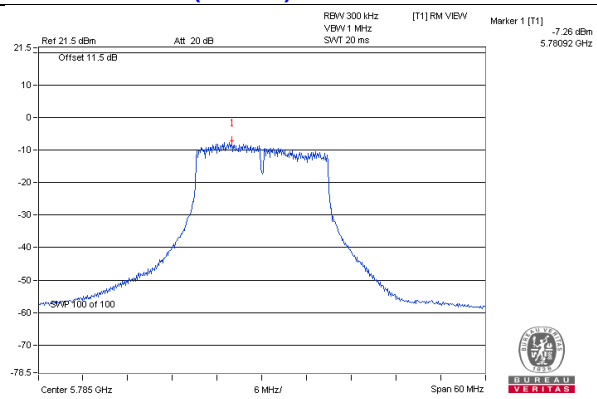

802.11ac (VHT40) – Chain 0: CH 159

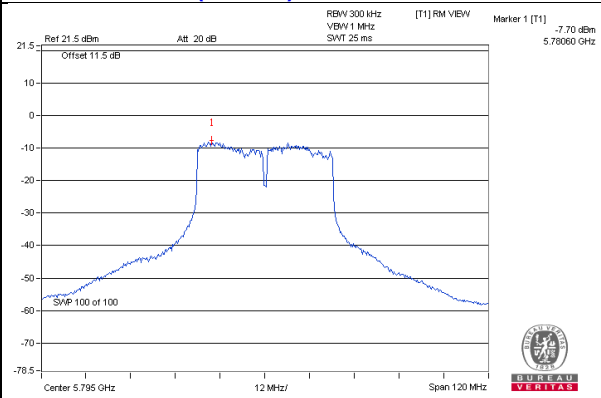

802.11ac (VHT80) – Chain 0: CH 155

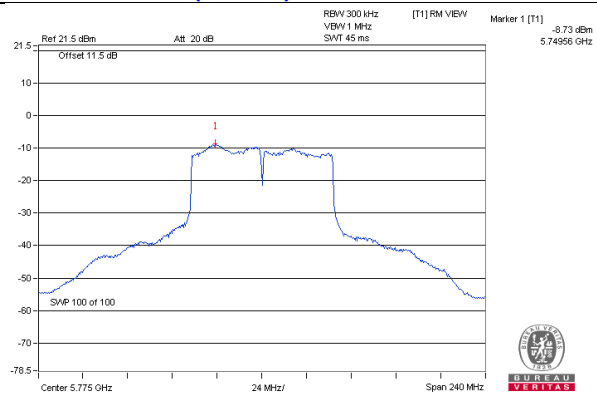

4.6 Frequency Stability Measurement

4.6.1 Limits of Frequency Stability Measurement

The frequency of the carrier signal shall be maintained within band of operation

4.6.2 Test Setup

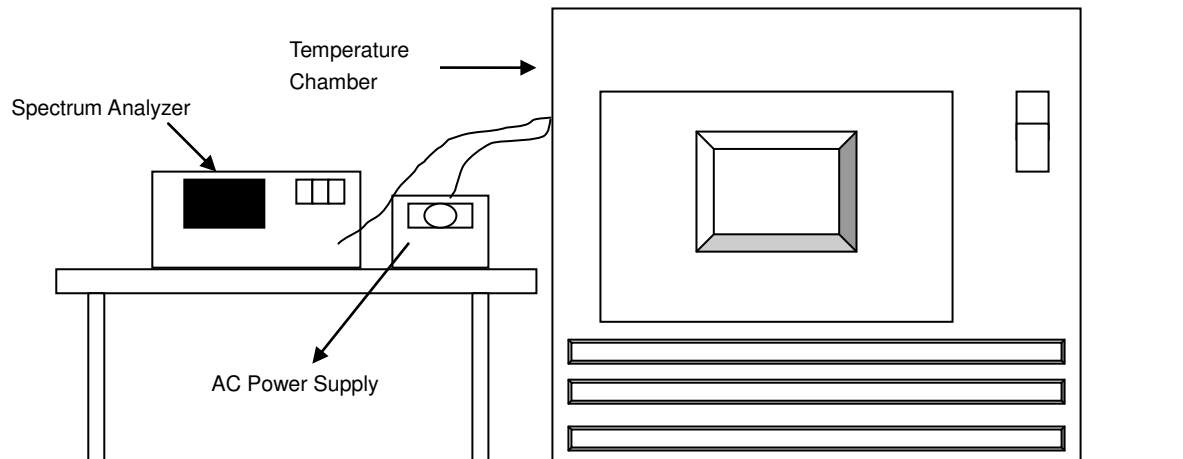

4.6.3 Test Instruments

Refer to section 4.1.2 to get information of above instrument.

4.6.4 Test Procedure

- The EUT was placed inside the environmental test chamber and powered by nominal AC voltage.
- Turn the EUT on and couple its output to a spectrum analyzer.
- Turn the EUT off and set the chamber to the highest temperature specified.
- Allow sufficient time (approximately 30 min) for the temperature of the chamber to stabilize, turn the EUT on and measure the operating frequency after 2, 5, and 10 Minutes.
- Repeat step 2 and 3 with the temperature chamber set to the lowest temperature.
- The test chamber was allowed to stabilize at +20 degree C for a minimum of 30 Minutes. The supply voltage was then adjusted on the EUT from 85% to 115% and the frequency record.

4.6.5 Deviation from Test Standard

No deviation.

4.6.6 EUT Operating Condition

Set the EUT transmit at un-modulation mode to test frequency stability.

4.6.7 Test Results

Frequency Stability Versus Temp.									
Operating Frequency: 5180 MHz									
TEMP. (°C)	Power Supply (Vac)	0 Minute		2 Minute		5 Minute		10 Minute	
		Measured Frequency (MHz)	Pass/Fail	Measured Frequency (MHz)	Pass/Fail	Measured Frequency (MHz)	Pass/Fail	Measured Frequency (MHz)	Pass/Fail
50	120	5179.9758	Pass	5179.9758	Pass	5179.974	Pass	5179.9778	Pass
40	120	5180.0027	Pass	5180.0003	Pass	5180.0017	Pass	5180.0047	Pass
30	120	5179.9821	Pass	5179.9838	Pass	5179.9817	Pass	5179.98	Pass
20	120	5179.9783	Pass	5179.9806	Pass	5179.9816	Pass	5179.978	Pass
10	120	5179.9727	Pass	5179.9734	Pass	5179.9778	Pass	5179.9753	Pass
0	120	5180.0127	Pass	5180.0127	Pass	5180.0089	Pass	5180.011	Pass
-10	120	5179.9762	Pass	5179.9754	Pass	5179.9777	Pass	5179.9768	Pass
-20	120	5180.0141	Pass	5180.0135	Pass	5180.0162	Pass	5180.0129	Pass
-30	120	5179.9812	Pass	5179.9804	Pass	5179.9837	Pass	5179.9796	Pass

Frequency Stability Versus Voltage									
Operating Frequency: 5180 MHz									
TEMP. (°C)	Power Supply (Vac)	0 Minute		2 Minute		5 Minute		10 Minute	
		Measured Frequency (MHz)	Pass/Fail	Measured Frequency (MHz)	Pass/Fail	Measured Frequency (MHz)	Pass/Fail	Measured Frequency (MHz)	Pass/Fail
20	138	5179.9792	Pass	5179.9808	Pass	5179.9813	Pass	5179.977	Pass
	120	5179.9783	Pass	5179.9806	Pass	5179.9816	Pass	5179.978	Pass
	102	5179.9791	Pass	5179.9806	Pass	5179.9813	Pass	5179.9786	Pass

4.7 6dB Bandwidth Measurement

4.7.1 Limits of 6dB Bandwidth Measurement

The minimum of 6dB Bandwidth Measurement is 0.5MHz.

4.7.2 Test Setup

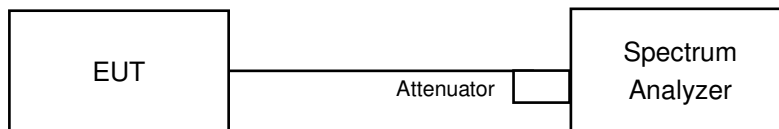

4.7.3 Test Instruments

Refer to section 4.1.2 to get information of above instrument.

4.7.4 Test Procedure

MEASUREMENT PROCEDURE REF

- a. Set resolution bandwidth (RBW) = 100kHz
- b. Set the video bandwidth (VBW) $\geq 3 \times$ RBW, Detector = Peak.
- c. Trace mode = max hold.
- d. Sweep = auto couple.
- e. Measure the maximum width of the emission that is constrained by the frequencies associated with the two amplitude points (upper and lower) that are attenuated by 6 dB relative to the maximum level measured in the fundamental emission

4.7.5 Deviation from Test Standard

No deviation.

4.7.6 EUT Operating Condition

The software provided by client to enable the EUT under transmission condition continuously at lowest, middle and highest channel frequencies individually.

4.7.7 Test Results

802.11a

Channel	Frequency (MHz)	6dB Bandwidth (MHz)			Minimum Limit (MHz)	Pass / Fail
		Chain 0	Chain 1	Chain 2		
149	5745	15.77	16.43	16.42	0.5	PASS
157	5785	16.38	16.41	16.44	0.5	PASS
165	5825	16.41	16.42	16.43	0.5	PASS

802.11ac (VHT20)

Channel	Frequency (MHz)	6dB Bandwidth (MHz)			Minimum Limit (MHz)	Pass / Fail
		Chain 0	Chain 1	Chain 2		
149	5745	16.77	17.67	17.65	0.5	PASS
157	5785	17.22	17.63	17.65	0.5	PASS
165	5825	17.60	17.62	17.59	0.5	PASS

802.11ac (VHT40)

Channel	Frequency (MHz)	6dB Bandwidth (MHz)			Minimum Limit (MHz)	Pass / Fail
		Chain 0	Chain 1	Chain 2		
151	5755	36.18	36.45	35.79	0.5	PASS
159	5795	35.77	36.43	36.20	0.5	PASS

802.11ac (VHT80)

Channel	Frequency (MHz)	6dB Bandwidth (MHz)			Minimum Limit (MHz)	Pass / Fail
		Chain 0	Chain 1	Chain 2		
155	5775	69.99	75.89	70.89	0.5	PASS

Spectrum Plot of Worst Value

802.11a_Chain 0 / CH149

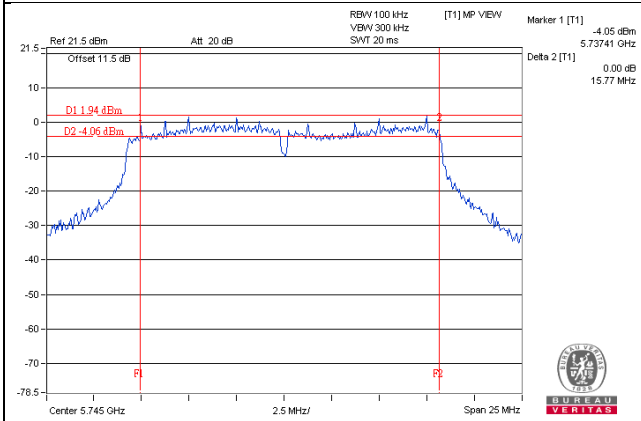

802.11ac (VHT20)_Chain 0 / CH149

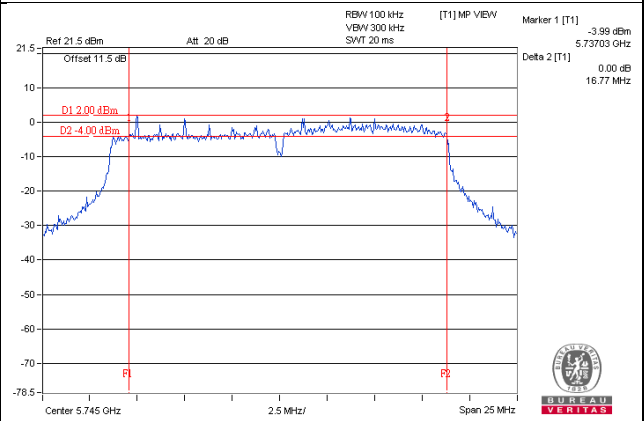

802.11ac (VHT40)_Chain 0 / CH159

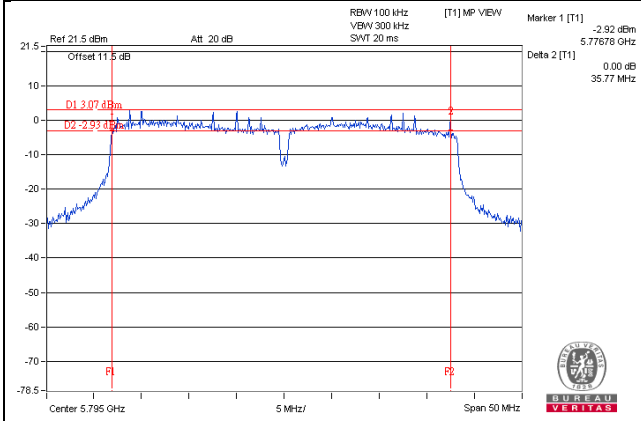

802.11ac (VHT80)_Chain 0 / CH155

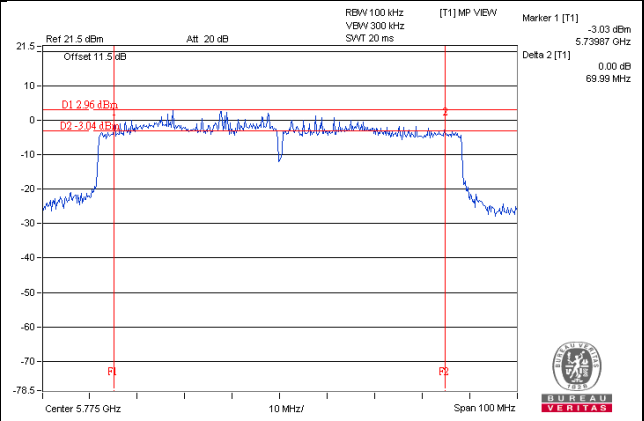

5 Pictures of Test Arrangements

Please refer to the attached file (Test Setup Photo).

Annex A- Radiated Out of Band Emission (OOBE) Measurement (For U-NII-3 band)

802.11a

CH 149 5745 MHz

Horizontal

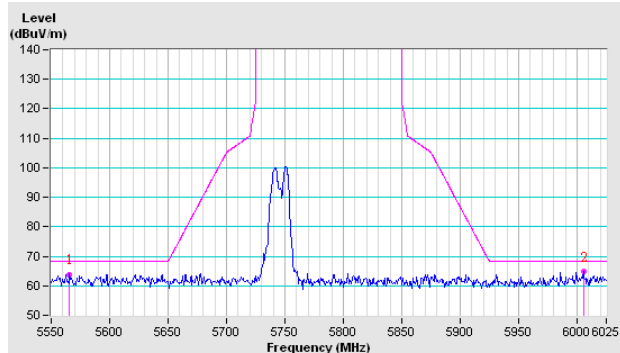

Vertical

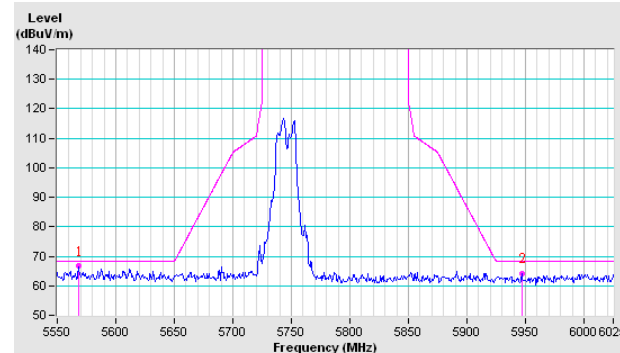

CH 157 5785 MHz

Horizontal

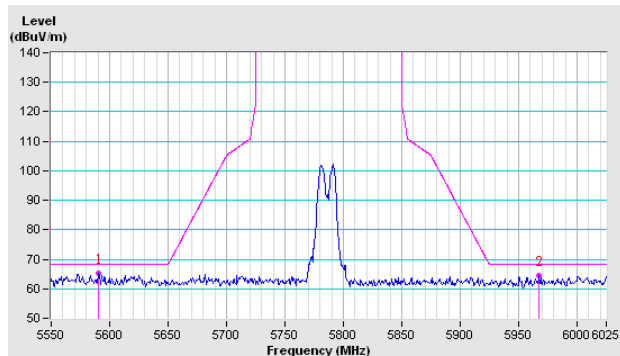

Vertical

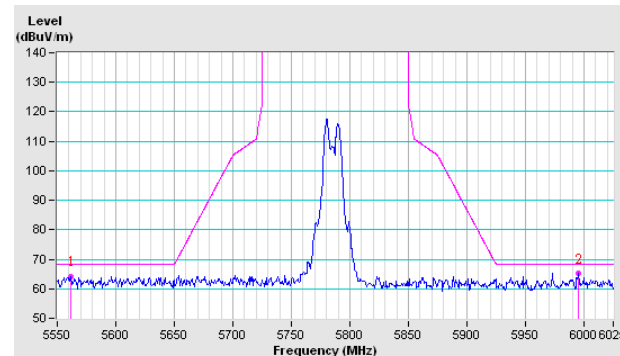

CH 165 5825 MHz

Horizontal

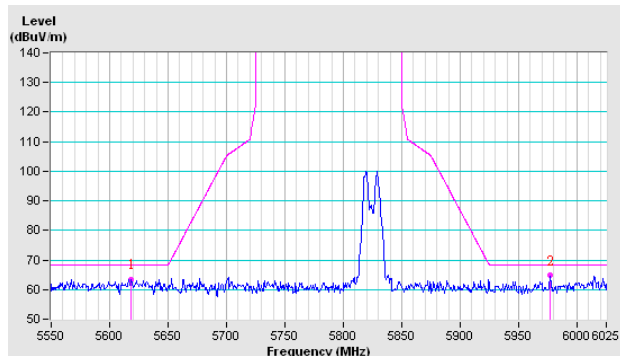

Vertical

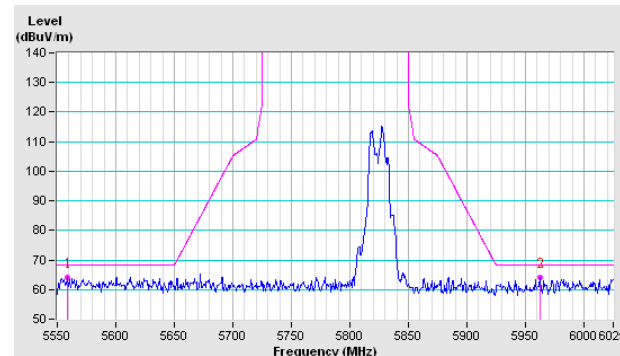

802.11ac (VHT20)

CH 149 5745 MHz

Horizontal

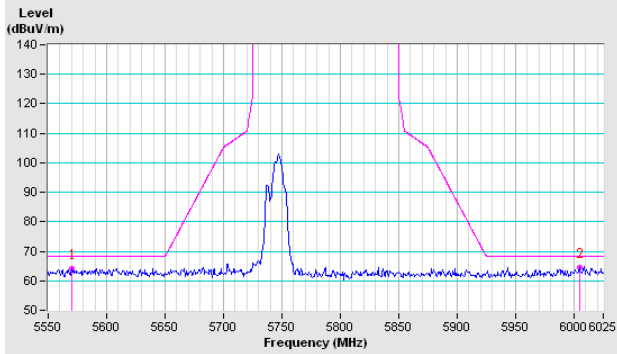

Vertical

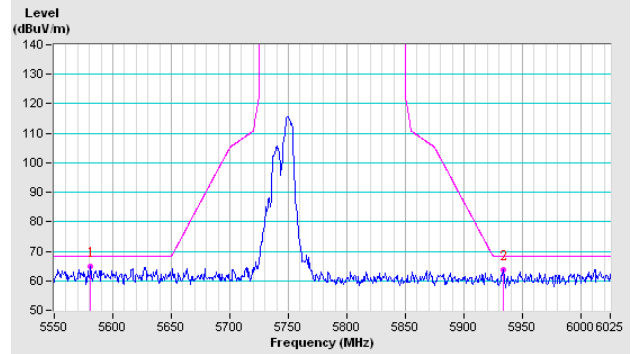

CH 157 5785 MHz

Horizontal

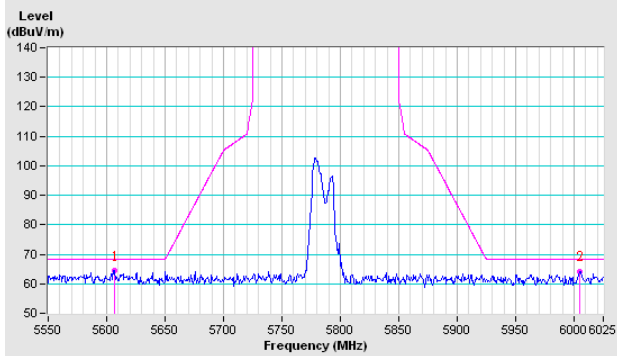

Vertical

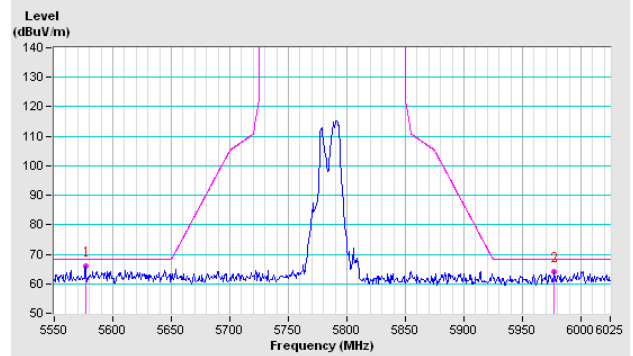

CH 165 5825 MHz

Horizontal

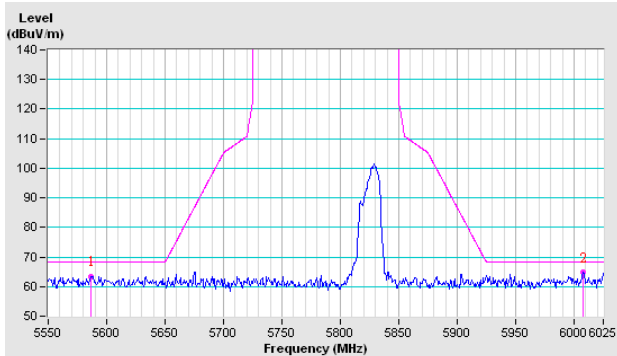

Vertical

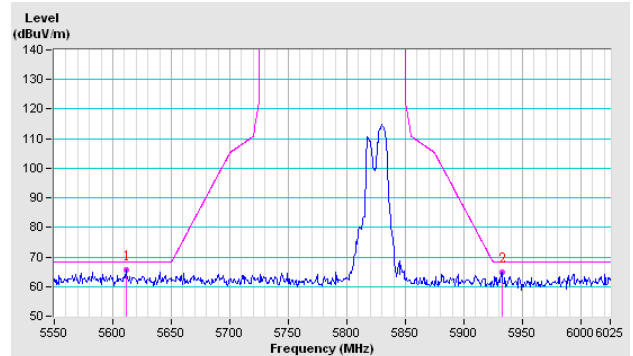

802.11ac (VHT40)

CH 151 5755 MHz

Horizontal

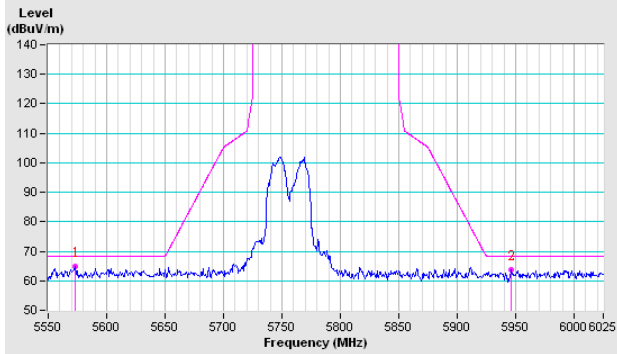

Vertical

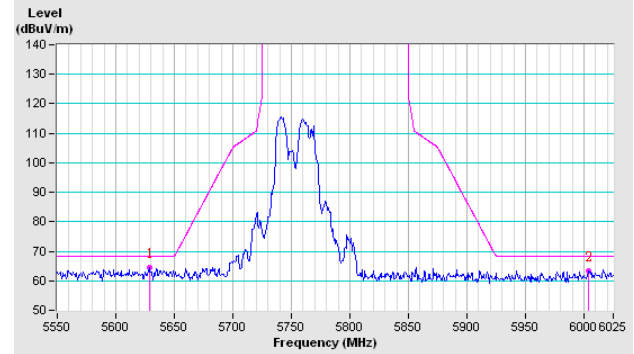

CH 159 5795 MHz

Horizontal

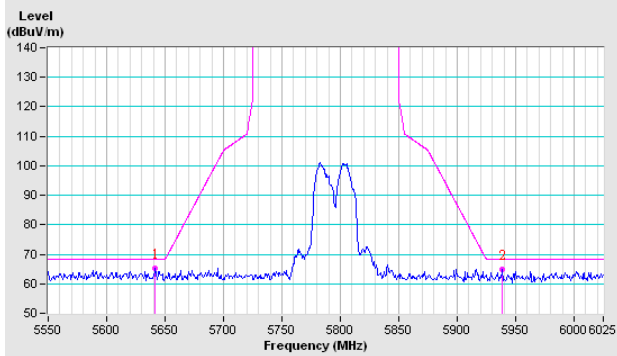

Vertical

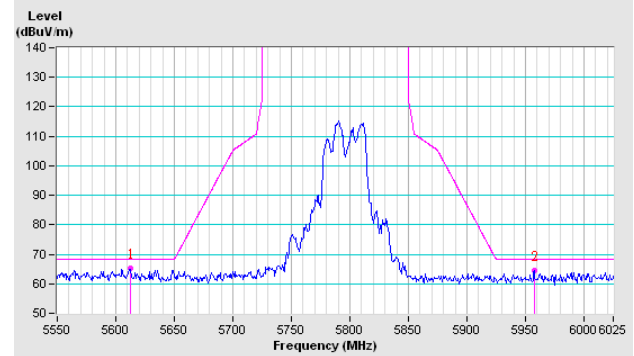

802.11ac (VHT80)

CH 155 5775 MHz

Horizontal

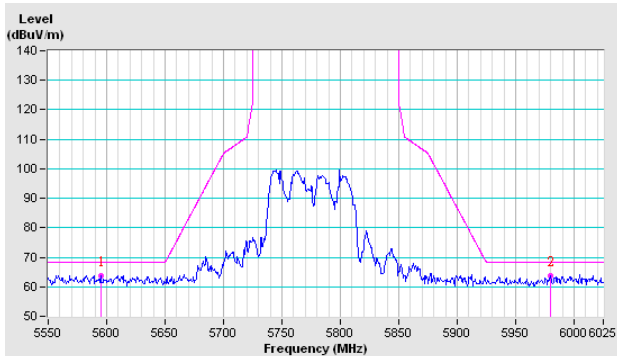

Vertical

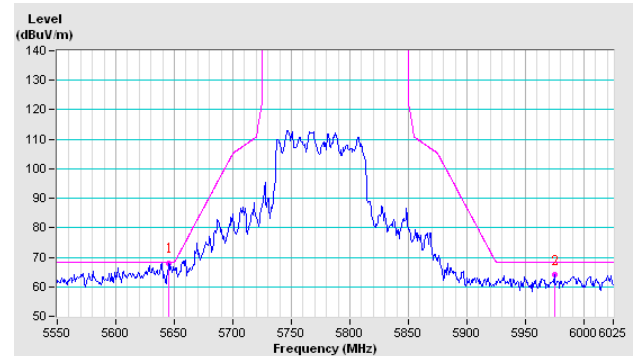

Appendix – Information on the Testing Laboratories

We, Bureau Veritas Consumer Products Services (H.K.) Ltd., Taoyuan Branch, were founded in 1988 to provide our best service in EMC, Radio, Telecom and Safety consultation. Our laboratories are accredited and approved according to ISO/IEC 17025.

If you have any comments, please feel free to contact us at the following:

Linko EMC/RF Lab

Tel: 886-2-26052180

Fax: 886-2-26051924

Hsin Chu EMC/RF/Telecom Lab

Tel: 886-3-6668565

Fax: 886-3-6668323

Hwa Ya EMC/RF/Safety Lab

Tel: 886-3-3183232

Fax: 886-3-3270892

Email: service.adt@tw.bureauveritas.com

Web Site: www.bureauveritas-adt.com

The address and road map of all our labs can be found in our web site also.

--- END ---