

FCC Test Report

Report No.: RF160809E04-1

FCC ID: U8G-P1AC4

Test Model: MAX BR1 MK2

Received Date: Aug. 09, 2016

Test Date: Oct. 02, 2016 to May 09, 2017

Issued Date: July 27, 2017

Applicant: Pismo Labs Technology Limited

Address: FLAT/RM A5, 5/F, HK SPINNERS IND BLDG PHASE 6, 481 CASTLE PEAK ROAD, CHEUNG SHA WAN, HONG KONG.

Issued By: Bureau Veritas Consumer Products Services (H.K.) Ltd., Taoyuan Branch Hsin Chu Laboratory

Lab Address: E-2, No.1, Li Hsin 1st Road, Hsinchu Science Park, Hsinchu City 300, Taiwan R.O.C.

Test Location (1): E-2, No.1, Li Hsin 1st Road, Hsinchu Science Park, Hsinchu City 300, Taiwan R.O.C.

Test Location (2): No. 49, Ln. 206, Wende Rd., Shangshan Tsuen, Chiung Lin Hsiang, Hsin Chu Hsien 307, Taiwan R.O.C.



This report is for your exclusive use. Any copying or replication of this report to or for any other person or entity, or use of our name or trademark, is permitted only with our prior written permission. This report sets forth our findings solely with respect to the test samples identified herein. The results set forth in this report are not indicative or representative of the quality or characteristics of the lot from which a test sample was taken or any similar or identical product unless specifically and expressly noted. Our report includes all of the tests requested by you and the results thereof based upon the information that you provided to us. You have 60 days from date of issuance of this report to notify us of any material error or omission caused by our negligence, provided, however, that such notice shall be in writing and shall specifically address the issue you wish to raise. A failure to raise such issue within the prescribed time shall constitute your unqualified acceptance of the completeness of this report, the tests conducted and the correctness of the report contents. Unless specific mention, the uncertainty of measurement has been explicitly taken into account to declare the compliance or non-compliance to the specification. The report must not be used by the client to claim product certification, approval, or endorsement by TAF or any government agencies.

Table of Contents

Release Control Record	4
1 Certificate of Conformity	5
2 Summary of Test Results	6
2.1 Measurement Uncertainty	6
2.2 Modification Record	6
3 General Information	7
3.1 General Description of EUT	7
3.2 Description of Test Modes	10
3.2.1 Test Mode Applicability and Tested Channel Detail	11
3.3 Duty Cycle of Test Signal	13
3.4 Description of Support Units	14
3.4.1 Configuration of System under Test	15
3.5 General Description of Applied Standard	17
4 Test Types and Results	18
4.1 Radiated Emission and Bandedge Measurement	18
4.1.1 Limits of Radiated Emission and Bandedge Measurement	18
4.1.2 Test Instruments	19
4.1.3 Test Procedure	21
4.1.4 Deviation from Test Standard	21
4.1.5 Test Setup	22
4.1.6 EUT Operating Condition	23
4.1.7 Test Results	24
4.2 Conducted Emission Measurement	43
4.2.1 Limits of Conducted Emission Measurement	43
4.2.2 Test Instruments	43
4.2.3 Test Procedure	44
4.2.4 Deviation from Test Standard	44
4.2.5 Test Setup	44
4.2.6 EUT Operating Condition	44
4.2.7 Test Results (Mode 1)	45
4.2.8 Test Results (Mode 2)	47
4.3 Transmit Power Measurement	49
4.3.1 Limits of Transmit Power Measurement	49
4.3.2 Test Setup	50
4.3.3 Test Instruments	50
4.3.4 Test Procedure	50
4.3.5 Deviation from Test Standard	50
4.3.6 EUT Operating Condition	50
4.3.7 Test Result	51
4.4 Occupied Bandwidth Measurement	53
4.4.1 Test Setup	53
4.4.2 Test Instruments	53
4.4.3 Test Procedure	53
4.4.4 Test Results	54
4.5 Peak Power Spectral Density Measurement	59
4.5.1 Limits of Peak Power Spectral Density Measurement	59
4.5.2 Test Setup	59
4.5.3 Test Instruments	59
4.5.4 Test Procedure	59
4.5.5 Deviation from Test Standard	60
4.5.6 EUT Operating Condition	60
4.5.7 Test Results	61
4.6 Frequency Stability Measurement	67

4.6.1	Limits of Frequency Stability Measurement	67
4.6.2	Test Setup.....	67
4.6.3	Test Instruments	67
4.6.4	Test Procedure	67
4.6.5	Deviation from Test Standard	67
4.6.6	EUT Operating Condition	67
4.6.7	Test Results	68
4.7	6dB Bandwidth Measurement	69
4.7.1	Limits of 6dB Bandwidth Measurement.....	69
4.7.2	Test Setup.....	69
4.7.3	Test Instruments	69
4.7.4	Test Procedure	69
4.7.5	Deviation from Test Standard	69
4.7.6	EUT Operating Condition	69
4.7.7	Test Results	70
5	Pictures of Test Arrangements.....	72
	Annex A- Radiated Out of Band Emission (OOBE) Measurement (For U-NII-3 band)	73
	Appendix – Information on the Testing Laboratories	77

Release Control Record

Issue No.	Description	Date Issued
RF160809E04-1	Original release.	July 27, 2017

1 Certificate of Conformity

Product: Pepwave / Peplink / Pismo Wireless Product

Brand: Pepwave / Peplink / Pismo

Test Model: MAX BR1 MK2

Sample Status: ENGINEERING SAMPLE

Applicant: Pismo Labs Technology Limited

Test Date: Oct. 02, 2016 to May 09, 2017

Standard: 47 CFR FCC Part 15, Subpart E (Section 15.407)
ANSI C63.10: 2013

The above equipment has been tested by **Bureau Veritas Consumer Products Services (H.K.) Ltd., Taoyuan Branch**, and found compliance with the requirement of the above standards. The test record, data evaluation & Equipment Under Test (EUT) configurations represented herein are true and accurate accounts of the measurements of the sample's EMC characteristics under the conditions specified in this report.

Prepared by : Cindy Hsin , **Date:** July 27, 2017
Cindy Hsin / Specialist

Approved by : May Chen , **Date:** July 27, 2017
May Chen / Manager

2 Summary of Test Results

47 CFR FCC Part 15, Subpart E (Section 15.407)			
FCC Clause	Test Item	Result	Remarks
15.407(b)(6)	AC Power Conducted Emissions	Pass	Meet the requirement of limit. Minimum passing margin is -8.92dB at 0.40000MHz.
15.407(b) (1/2/3/4(i/ii)/6)	Radiated Emissions & Band Edge Measurement*	Pass	Meet the requirement of limit. Minimum passing margin is -0.1dB at 5150.00MHz.
15.407(a)(1/2/3)	Max Average Transmit Power	Pass	Meet the requirement of limit.
---	Occupied Bandwidth Measurement	-	Reference only.
15.407(a)(1/2/3)	Peak Power Spectral Density	Pass	Meet the requirement of limit.
15.407(e)	6dB bandwidth	Pass	Meet the requirement of limit. (U-NII-3 Band only)
15.407(g)	Frequency Stability	Pass	Meet the requirement of limit.
15.203	Antenna Requirement	Pass	Antenna connector is R-SMA not a standard connector.

*For U-NII-3 band compliance with rule part 15.407(b)(4)(i), the OOB test plots were recorded in Annex A.

2.1 Measurement Uncertainty

Where relevant, the following measurement uncertainty levels have been estimated for tests performed on the EUT as specified in CISPR 16-4-2:

Measurement	Frequency	Expanded Uncertainty (k=2) (±)
Conducted Emissions at mains ports	150kHz ~ 30MHz	1.84 dB
Radiated Emissions up to 1 GHz	30MHz ~ 1GHz	5.30 dB
Radiated Emissions above 1 GHz	1GHz ~ 6GHz	5.16 dB
	6GHz ~ 18GHz	4.91 dB
	18GHz ~ 40GHz	5.30 dB

2.2 Modification Record

There were no modifications required for compliance.

3 General Information

3.1 General Description of EUT

Product	Pepwave / Peplink / Pismo Wireless Product
Brand	Pepwave / Peplink / Pismo
Test Model	MAX BR1 MK2
Status of EUT	ENGINEERING SAMPLE
Power Supply Rating	12Vdc from power adapter or 10-30Vdc from DC power supply
Modulation Type	CCK, DQPSK, DBPSK for DSSS 64QAM, 16QAM, QPSK, BPSK for OFDM 256QAM for OFDM in 11ac mode only
Modulation Technology	DSSS, OFDM
Transfer Rate	802.11b: up to 11Mbps 802.11a/g: up to 54Mbps 802.11n: up to 300Mbps 802.11ac: up to 866.7Mbps
Operating Frequency	2.4GHz: 2.412 ~ 2.462GHz 5GHz: 5.18 ~ 5.24GHz, 5.745 ~ 5.825GHz
Number of Channel	2.4GHz: 802.11b, 802.11g, 802.11n (HT20): 11 802.11n (HT40): 7 5GHz: 802.11a, 802.11n (HT20), 802.11ac (VHT20): 9 802.11n (HT40), 802.11ac (VHT40): 4 802.11ac (VHT80): 2
Output Power	2.4GHz: 789.828mW 5GHz: 5.18 ~ 5.24GHz: 195.769mW 5.745 ~ 5.825GHz: 181.276mW
Antenna Type	Refer to Note
Antenna Connector	Refer to Note
Accessory Device	Adapter x 1
Data Cable Supplied	NA

Note:

1. There are WLAN (2.4GHz/5GHz), WWAN (3G), LTE (4G) and GPS technology used for the EUT.
2. EUT contains a certified module which FCC ID : N7NMC7455 or N7NMC7355.
3. Simultaneously transmission condition.

Condition	Technology		
	1	WLAN (2.4GHz)	WLAN (5GHz)
2	WLAN (2.4GHz)	WLAN (5GHz)	WWAN / LTE module (FCC ID : N7NMC7355)

Note: The emission of the simultaneous operation has been evaluated and no non-compliance was found.

4. The EUT could be supplied with a power adapter as following table:

Brand Name	Model No.	Spec.
Ten Pao	S024AMM1200200	Input: 100-240V, 600mA, 50/60Hz Output: 12V, 2000mA DC output cable: unshielded, 1.5m with 1 core

5. The EUT was pre-tested in chamber under the following modes:

Pre-test Mode	Description
Mode A	Power from DC power supply: 30Vdc (Terminal Block)
Mode B	Power from Adapter

The worse radiated emission was found in **Mode A**. Therefore only the test data of the modes were recorded in this report.

6. The antennas provided to the EUT, please refer to the following table:

For WLAN						
Antenna No.	Brand	Model	Ant. Gain (dBi)	Frequency range	Antenna Type	Connector Type
1	NA	NA	3	2400 MHz - 2500 MHz	Dipole	R-SMA
			4~5.5	5150 MHz - 5350 MHz		
			5.5~6	5350 MHz - 5875 MHz		
2	NA	NA	3	2400 MHz - 2500 MHz	Dipole	R-SMA
			4~5.5	5150 MHz - 5350 MHz		
			5.5~6	5350 MHz - 5875 MHz		
For GPS						
Antenna No.	Brand	Model	Ant. Gain (dBi)	Frequency range	Antenna Type	Connector Type
1	MASTER WAVE TECHNOLOGY CO., LTD.	98335KSAF000	4.5 ±0.5	1575.42MHz	Magnetic	SMA
For LTE						
Antenna No.	Brand	Model	Ant. Gain (dBi)	Frequency range	Antenna Type	Connector Type
1	MASTER WAVE TECHNOLOGY CO., LTD.	98619ZSAX025	1.99	699~960 MHz	Dipole	SMA
			4	1575~2170 MHz		
			1	2300~2320MHz		
			2.8	2325~2690 MHz		
2	MASTER WAVE TECHNOLOGY CO., LTD.	98619ZSAX025	1.99	699~960 MHz	Dipole	SMA
			4	1575~2170 MHz		
			1	2300~2320MHz		
			2.8	2325~2690 MHz		

7. The EUT incorporates a MIMO function.

For 2.4GHz Band			
MODULATION MODE	DATA RATE (MCS)	TX & RX CONFIGURATION	
802.11b	1 ~ 11Mbps	2TX	2RX
802.11g	6 ~ 54Mbps	2TX	2RX
802.11n (HT20)	MCS 0~7	2TX	2RX
	MCS 8~15	2TX	2RX
802.11n (HT40)	MCS 0~7	2TX	2RX
	MCS 8~15	2TX	2RX
For 5GHz Band			
MODULATION MODE	DATA RATE (MCS)	TX & RX CONFIGURATION	
802.11a	6 ~ 54Mbps	2TX	2RX
802.11n (HT20)	MCS 0~7	2TX	2RX
	MCS 8~15	2TX	2RX
802.11n (HT40)	MCS 0~7	2TX	2RX
	MCS 8~15	2TX	2RX
802.11ac (VHT20)	MCS 0~8, Nss=1	2TX	2RX
	MCS 0~8, Nss=2	2TX	2RX
802.11ac (VHT40)	MCS 0~9, Nss=1	2TX	2RX
	MCS 0~9, Nss=2	2TX	2RX
802.11ac (VHT80)	MCS 0~9, Nss=1	2TX	2RX
	MCS 0~9, Nss=2	2TX	2RX

8. The above EUT information is declared by the manufacturer and for more detailed features description, please refer to the manufacturer's specifications or User's Manual.

3.2 Description of Test Modes

FOR 5180 ~ 5240MHz

4 channels are provided for 802.11a, 802.11n (HT20), 802.11ac (VHT20):

Channel	Frequency	Channel	Frequency
36	5180MHz	44	5220MHz
40	5200MHz	48	5240MHz

2 channels are provided for 802.11n (HT40), 802.11ac (VHT40):

Channel	Frequency	Channel	Frequency
38	5190MHz	46	5230MHz

1 channel is provided for 802.11ac (VHT80):

Channel	Frequency
42	5210MHz

FOR 5745 ~ 5825MHz:

5 channels are provided for 802.11a, 802.11n (HT20), 802.11ac (VHT20):

Channel	Frequency	Channel	Frequency
149	5745MHz	161	5805MHz
153	5765MHz	165	5825MHz
157	5785MHz		

2 channels are provided for 802.11n (HT40), 802.11ac (VHT40):

Channel	Frequency	Channel	Frequency
151	5755MHz	159	5795MHz

1 channel is provided for 802.11ac (VHT80):

Channel	Frequency
155	5775MHz

3.2.1 Test Mode Applicability and Tested Channel Detail

EUT Configure Mode	Applicable To				Description
	RE \geq 1G	RE $<$ 1G	PLC	APCM	
1	√	√	√	√	Power from DC power supply: 30Vdc
2	-	-	√	-	Power from Adapter

Where **RE \geq 1G**: Radiated Emission above 1GHz **RE $<$ 1G**: Radiated Emission below 1GHz
PLC: Power Line Conducted Emission **APCM**: Antenna Port Conducted Measurement

NOTE:

1. The EUT had been pre-tested on the positioned of each 2 axis. The worst case was found when positioned on **X-plane**.
2. "-" means no effect.

Radiated Emission Test (Above 1GHz):

- Pre-Scan has been conducted to determine the worst-case mode from all possible combinations between available modulations, data rates and antenna ports (if EUT with antenna diversity architecture).
- Following channel(s) was (were) selected for the final test as listed below.

Mode	FREQ. Band (MHz)	Available Channel	Tested Channel	Modulation Technology	Modulation Type	Data Rate (Mbps)
802.11a	5180-5240	36 to 48	36, 40, 48	OFDM	BPSK	6
802.11n (VHT20)		36 to 48	36, 40, 48	OFDM	BPSK	6.5
802.11n (VHT40)		38 to 46	38, 46	OFDM	BPSK	13.5
802.11ac (VHT80)		42	42	OFDM	BPSK	29.3
802.11a	5745-5825	149 to 165	149, 157, 165	OFDM	BPSK	6
802.11n (VHT20)		149 to 165	149, 157, 165	OFDM	BPSK	6.5
802.11n (VHT40)		151 to 159	151, 159	OFDM	BPSK	13.5
802.11ac (VHT80)		155	155	OFDM	BPSK	29.3

Radiated Emission Test (Below 1GHz):

- Pre-Scan has been conducted to determine the worst-case mode from all possible combinations between available modulations, data rates and antenna ports (if EUT with antenna diversity architecture).
- Following channel(s) was (were) selected for the final test as listed below.

Mode	FREQ. Band (MHz)	Available Channel	Tested Channel	Modulation Technology	Modulation Type	Data Rate (Mbps)
802.11n (VHT20)	5180-5320 5745-5825	36 to 48 149 to 165	157	OFDM	BPSK	6.5

Power Line Conducted Emission Test:

- Pre-Scan has been conducted to determine the worst-case mode from all possible combinations between available modulations, data rates and antenna ports (if EUT with antenna diversity architecture).
- Following channel(s) was (were) selected for the final test as listed below.

Mode	FREQ. Band (MHz)	Available Channel	Tested Channel	Modulation Technology	Modulation Type	Data Rate (Mbps)
802.11n (VHT20)	5180-5320 5745-5825	36 to 48 149 to 165	157	OFDM	BPSK	6.5

Antenna Port Conducted Measurement:

- This item includes all test value of each mode, but only includes spectrum plot of worst value of each mode.
- Pre-Scan has been conducted to determine the worst-case mode from all possible combinations between available modulations, data rates and antenna ports (if EUT with antenna diversity architecture).
- Following channel(s) was (were) selected for the final test as listed below.

Mode	FREQ. Band (MHz)	Available Channel	Tested Channel	Modulation Technology	Modulation Type	Data Rate (Mbps)
802.11a	5180-5240	36 to 48	36, 40, 48	OFDM	BPSK	6
802.11n (VHT20)		36 to 48	36, 40, 48	OFDM	BPSK	6.5
802.11n (VHT40)		38 to 46	38, 46	OFDM	BPSK	13.5
802.11ac (VHT80)		42	42	OFDM	BPSK	29.3
802.11a	5745-5825	149 to 165	149, 157, 165	OFDM	BPSK	6
802.11n (VHT20)		149 to 165	149, 157, 165	OFDM	BPSK	6.5
802.11n (VHT40)		151 to 159	151, 159	OFDM	BPSK	13.5
802.11ac (VHT80)		155	155	OFDM	BPSK	29.3

Test Condition:

Applicable To	Environmental Conditions	Input Power (SYSTEM)	Tested By
RE \geq 1G	23deg. C, 62%RH	120Vac, 60Hz	Jyunchun Lin
RE $<$ 1G	24deg. C, 66%RH	120Vac, 60Hz	Weiwei Lo
PLC	25deg. C, 67%RH	120Vac, 60Hz	Bear Lee
APCM	23deg. C, 62%RH	120Vac, 60Hz	Robert Cheng

3.3 Duty Cycle of Test Signal

If duty cycle of test signal is $\geq 98\%$, duty factor is not required

802.11a: Duty cycle = $23.95/24.05 = 0.996$

802.11n (VHT20): Duty cycle = $23.875/23.963 = 0.996$

802.11n (VHT40): Duty cycle = $23.95/24.044 = 0.996$

802.11ac (VHT80): Duty cycle = $23.956/24.049 = 0.996$

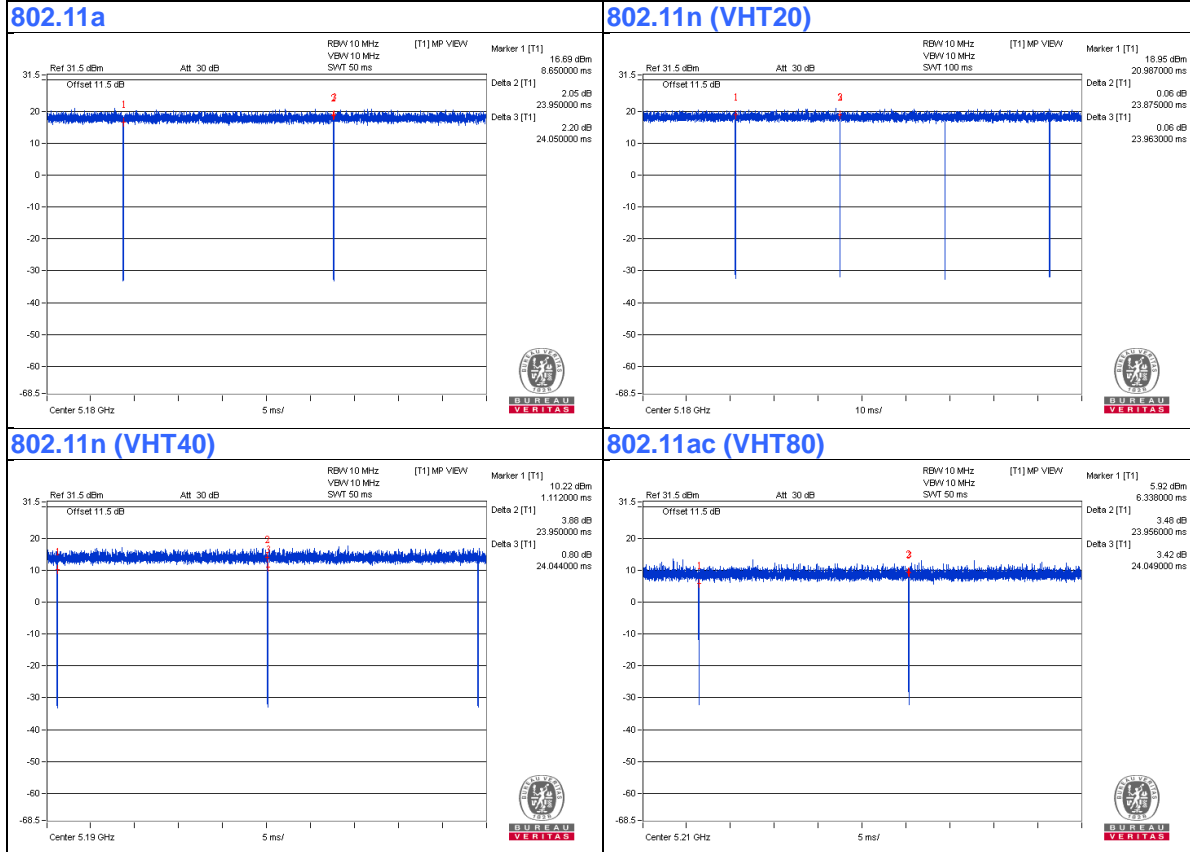

3.4 Description of Support Units

The EUT has been tested as an independent unit together with other necessary accessories or support units. The following support units or accessories were used to form a representative test configuration during the tests.

ID	Product	Brand	Model No.	Serial No.	FCC ID	Remarks
A.	Laptop	DELL	E6420	B92T3R1	FCC DoC	Provided by Lab
B.	Laptop	DELL	E6440	F9LYQ32	FCC DoC	Provided by Lab
C.	Cellular SIM A	R&S	CRT-Z3	NA	NA	Provided by Lab
D.	Cellular SIM B	R&S	CRT-Z3	NA	NA	Provided by Lab
E.	DC Power Supply	Topward	6603D	795558	NA	Provided by Lab

Note:

1. All power cords of the above support units are non-shielded (1.8m).

ID	Descriptions	Qty.	Length (m)	Shielding (Yes/No)	Cores (Qty.)	Remarks
1.	RJ-45	1	10	NO	0	Provided by Lab
2.	RJ-45	1	10	NO	0	Provided by Lab
3.	DC Cable	1	1.5	No	1	Supplied by client
4.	DC Cable	1	3	No	0	Provided by Lab

Note: The core(s) is(are) originally attached to the cable(s).

3.4.1 Configuration of System under Test

For Mode 1:

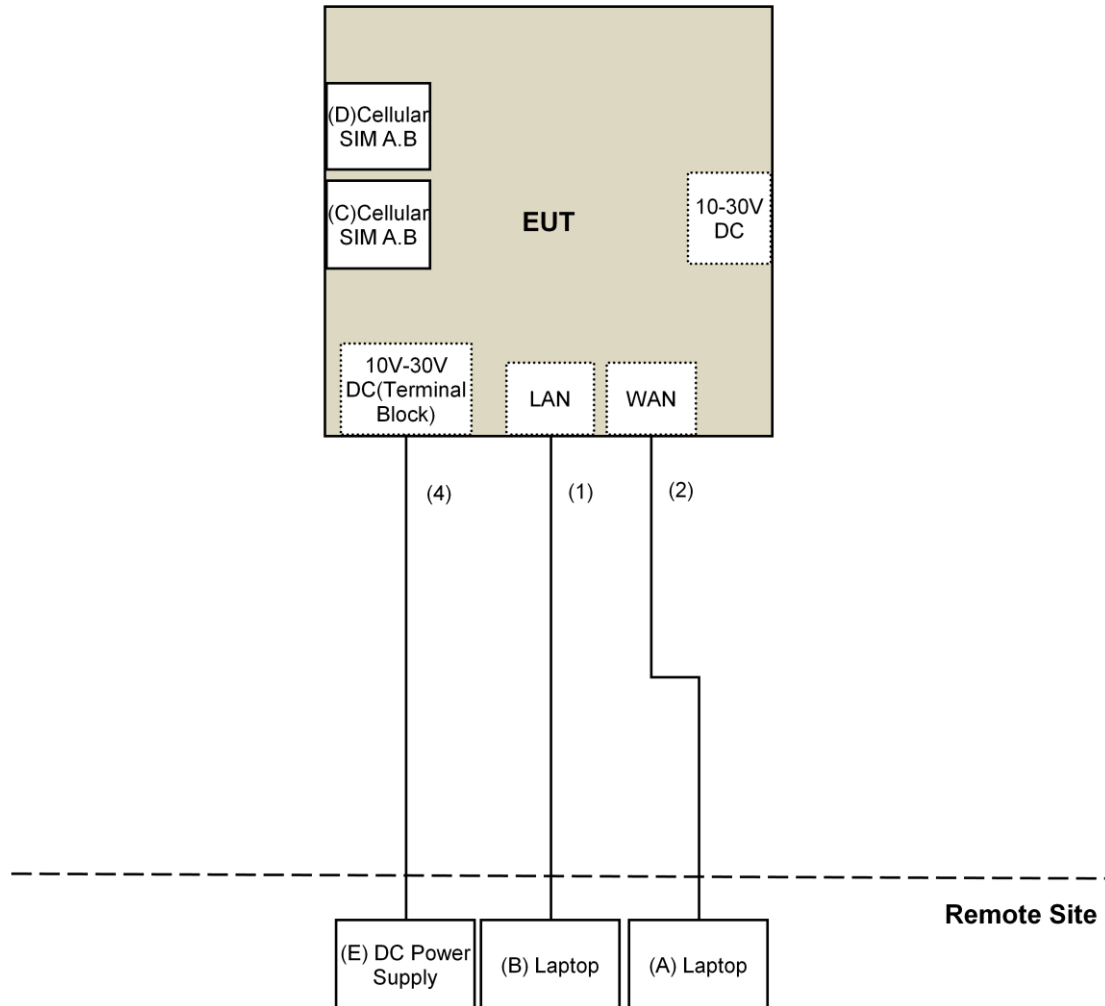

For Mode 2 :

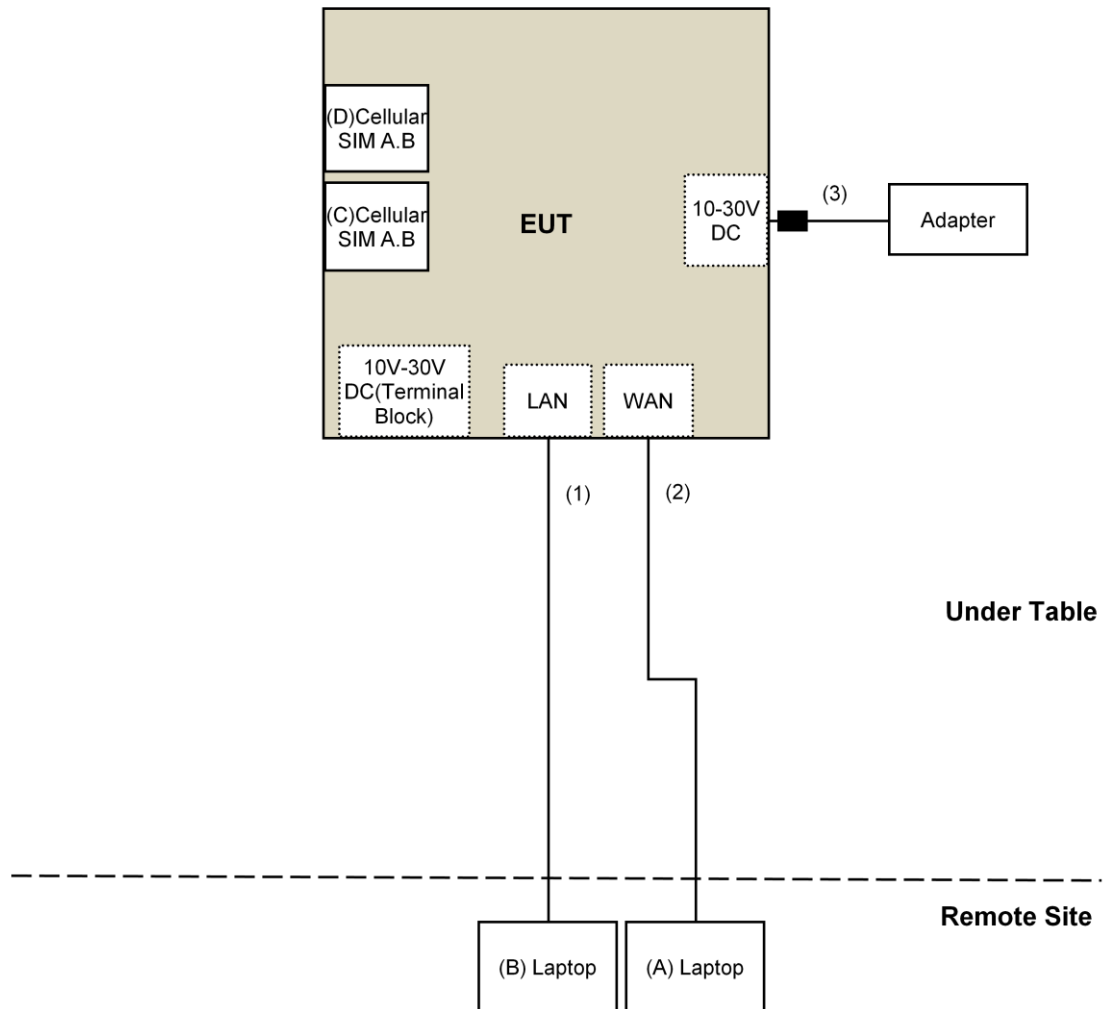

3.5 General Description of Applied Standard

The EUT is a RF Product. According to the specifications of the manufacturer, it must comply with the requirements of the following standards:

FCC Part 15, Subpart E (15.407)
KDB 789033 D02 General UNII Test Procedure New Rules v01r04
KDB 662911 D01 Multiple Transmitter Output v02r01
ANSI C63.10-2013

All test items have been performed and recorded as per the above standards.

4 Test Types and Results

4.1 Radiated Emission and Bandedge Measurement

4.1.1 Limits of Radiated Emission and Bandedge Measurement

Radiated emissions which fall in the restricted bands must comply with the radiated emission limits specified as below table.

Frequencies (MHz)	Field Strength (microvolts/meter)	Measurement Distance (meters)
0.009 ~ 0.490	2400/F(kHz)	300
0.490 ~ 1.705	24000/F(kHz)	30
1.705 ~ 30.0	30	30
30 ~ 88	100	3
88 ~ 216	150	3
216 ~ 960	200	3
Above 960	500	3

NOTE:

- The lower limit shall apply at the transition frequencies.
- Emission level (dBuV/m) = 20 log Emission level (uV/m).
- For frequencies above 1000MHz, the field strength limits are based on average detector, however, the peak field strength of any emission shall not exceed the maximum permitted average limits, specified above by more than 20dB under any condition of modulation.

Limits of unwanted emission out of the restricted bands

Applicable To		Limit	
789033 D02 General UNII Test Procedure New Rules v01r03		Field Strength at 3m	
		PK:74 (dBuV/m)	AV:54 (dBuV/m)
Frequency Band	Applicable To	EIRP Limit	Equivalent Field Strength at 3m
5150~5250 MHz	15.407(b)(1)	PK:-27 (dBm/MHz)	PK:68.2(dBuV/m)
5250~5350 MHz	15.407(b)(2)		
5470~5725 MHz	15.407(b)(3)		
5725~5850 MHz	<input checked="" type="checkbox"/> 15.407(b)(4)(i)	PK:-27 (dBm/MHz) ^{*1} PK:10 (dBm/MHz) ^{*2} PK:15.6 (dBm/MHz) ^{*3} PK:27 (dBm/MHz) ^{*4}	PK: 68.2(dBuV/m) ^{*1} PK:105.2 (dBuV/m) ^{*2} PK: 110.8(dBuV/m) ^{*3} PK:122.2 (dBuV/m) ^{*4}
	<input type="checkbox"/> 15.407(b)(4)(ii)	Emission limits in section 15.247(d)	
^{*1} beyond 75 MHz or more above of the band edge.		^{*2} below the band edge increasing linearly to 10 dBm/MHz at 25 MHz above.	
^{*3} below the band edge increasing linearly to a level of 15.6 dBm/MHz at 5 MHz above.		^{*4} from 5 MHz above or below the band edge increasing linearly to a level of 27 dBm/MHz at the band edge.	

Note:

The following formula is used to convert the equipment isotropic radiated power (eirp) to field strength:

$$E = \frac{1000000\sqrt{30P}}{3} \mu\text{V/m, where P is the eirp (Watts).}$$

4.1.2 Test Instruments

For above 1GHz :

DESCRIPTION & MANUFACTURER	MODEL NO.	SERIAL NO.	CALIBRATED DATE	CALIBRATED UNTIL
Test Receiver Keysight	N9038A	MY54450088	July 20, 2016	July 19, 2017
Horn_Antenna SCHWARZBECK	BBHA 9120D	9120D-783	Jan. 19, 2016	Jan. 18, 2017
Pre-Amplifier Agilent	8449B	3008A01922	Sep. 18, 2016	Sep. 17, 2017
RF Cable	EMC104-SM-SM-2000 EMC104-SM-SM-5000 EMC104-SM-SM-5000	150318 150323 150324	Mar. 30, 2016	Mar. 29, 2017
Pre-Amplifier EMCI	EMC184045	980143	Jan. 15, 2016	Jan. 14, 2017
Horn_Antenna SCHWARZBECK	BBHA 9170	BBHA9170608	Jan. 08, 2016	Jan. 07, 2017
RF Cable	SUCOFLEX 102	36432/2 36441/2	Jan. 16, 2016	Jan. 15, 2017
Software	ADT_Radiated_V8.7.08	NA	NA	NA
Antenna Tower & Turn Table Max-Full	MF-7802	MF780208410	NA	NA
Boresight Antenna Fixture	FBA-01	FBA-SIP02	NA	NA
Spectrum Analyzer R&S	FSv40	100964	June 28, 2016	June 27, 2017
Power meter Anritsu	ML2495A	1014008	May 5, 2016	May 4, 2017
Power sensor Anritsu	MA2411B	0917122	May 5, 2016	May 4, 2017

Note:

1. The calibration interval of the above test instruments is 12 months and the calibrations are traceable to NML/ROC and NIST/USA.
2. The test was performed in 966 Chamber No. 4.
3. The FCC Site Registration No. is 292998
4. The CANADA Site Registration No. is 20331-2
5. Tested Date:Dec. 30, 2016

For below 1GHz :

DESCRIPTION & MANUFACTURER	MODEL NO.	SERIAL NO.	CALIBRATED DATE	CALIBRATED UNTIL
Test Receiver Keysight	N9038A	MY54450088	July 20, 2016	July 19, 2017
Pre-Amplifier ^(*) EMCI	EMC001340	980142	Jan. 20, 2016	Jan. 19, 2018
Loop Antenna ^(*) Electro-Metrics	EM-6879	264	Dec. 16, 2016	Dec. 15, 2018
RF Cable	NA	LOOPCAB-001 LOOPCAB-002	Jan. 17, 2017	Jan. 16, 2018
Pre-Amplifier Mini-Circuits	ZFL-1000VH2B	AMP-ZFL-01	Nov. 10, 2016	Nov. 09, 2017
Trilog Broadband Antenna SCHWARZBECK	VULB 9168	9168-406	Dec. 13, 2016	Dec. 12, 2017
RF Cable	8D	966-4-1 966-4-2 966-4-3	Apr. 01, 2017	Mar. 31, 2018
Fixed attenuator Mini-Circuits	UNAT-5+	PAD-3m-4-01	Oct. 05, 2016	Oct. 04, 2017
Software	ADT_Radiated_V8.7.08	NA	NA	NA
Antenna Tower & Turn Table Max-Full	MF-7802	MF780208410	NA	NA

Note:

1. The calibration interval of the above test instruments is 12 months and the calibrations are traceable to NML/ROC and NIST/USA.
2. *The calibration interval of the above test instruments is 24 months and the calibrations are traceable to NML/ROC and NIST/USA.
3. The test was performed in 966 Chamber No. 4.
4. The FCC Site Registration No. is 292998
5. The CANADA Site Registration No. is 20331-2
- 6 Loop antenna was used for all emissions below 30 MHz.
7. Tested Date: May 09, 2017

4.1.3 Test Procedure

For Radiated emission below 30MHz

- a. The EUT was placed on the top of a rotating table 0.8 meters above the ground at a 3 meter chamber room. The table was rotated 360 degrees to determine the position of the highest radiation.
- b. The EUT was set 3 meters away from the interference-receiving antenna, which was mounted on the top of a variable-height antenna tower.
- c. Both X and Y axes of the antenna are set to make the measurement.
- d. For each suspected emission, the EUT was arranged to its worst case and the rotatable table was turned from 0 degrees to 360 degrees to find the maximum reading.
- e. The test-receiver system was set to Quasi-Peak Detect Function and Specified Bandwidth with Maximum Hold Mode.

NOTE:

1. The resolution bandwidth and video bandwidth of test receiver/spectrum analyzer is 9kHz at frequency below 30MHz.

For Radiated emission above 30MHz

- a. The EUT was placed on the top of a rotating table 0.8 meters (for 30MHz ~ 1GHz) / 1.5 meters (for above 1GHz) above the ground at 3 meter chamber room for test. The table was rotated 360 degrees to determine the position of the highest radiation.
- b. The EUT was set 3 meters away from the interference-receiving antenna, which was mounted on the top of a variable-height antenna tower.
- c. The height of antenna is varied from one meter to four meters above the ground to determine the maximum value of the field strength. Both horizontal and vertical polarizations of the antenna are set to make the measurement.
- d. For each suspected emission, the EUT was arranged to its worst case and then the antenna was tuned to heights from 1 meter to 4 meters and the rotatable table was turned from 0 degrees to 360 degrees to find the maximum reading.
- e. The test-receiver system was set to quasi-peak detect function and specified bandwidth with maximum hold mode when the test frequency is below 1 GHz.
- f. The test-receiver system was set to peak and average detect function and specified bandwidth with maximum hold mode when the test frequency is above 1 GHz. If the peak reading value also meets average limit, measurement with the average detector is unnecessary.

Note:

1. The resolution bandwidth and video bandwidth of test receiver/spectrum analyzer is 120kHz for Quasi-peak detection (QP) at frequency below 1GHz.
2. The resolution bandwidth of test receiver/spectrum analyzer is 1 MHz and the video bandwidth is 3 MHz for Peak detection (PK) at frequency above 1GHz.
3. The resolution bandwidth of test receiver/spectrum analyzer is 1MHz and the video bandwidth is $\geq 1/T$ (Duty cycle < 98%) or 10Hz (Duty cycle $\geq 98\%$) for Average detection (AV) at frequency above 1GHz.
4. All modes of operation were investigated and the worst-case emissions are reported.

4.1.4 Deviation from Test Standard

No deviation.

4.1.5 Test Setup

For Radiated emission below 30MHz

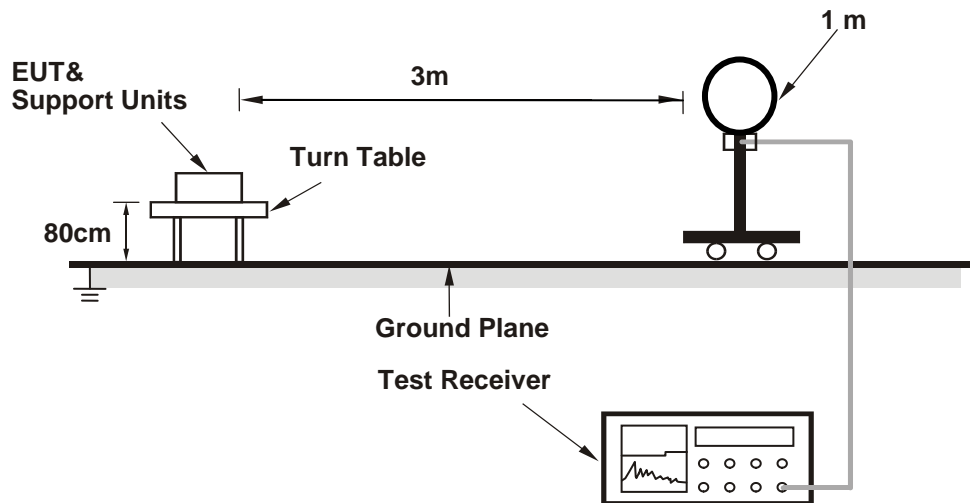

For Radiated emission 30MHz to 1GHz

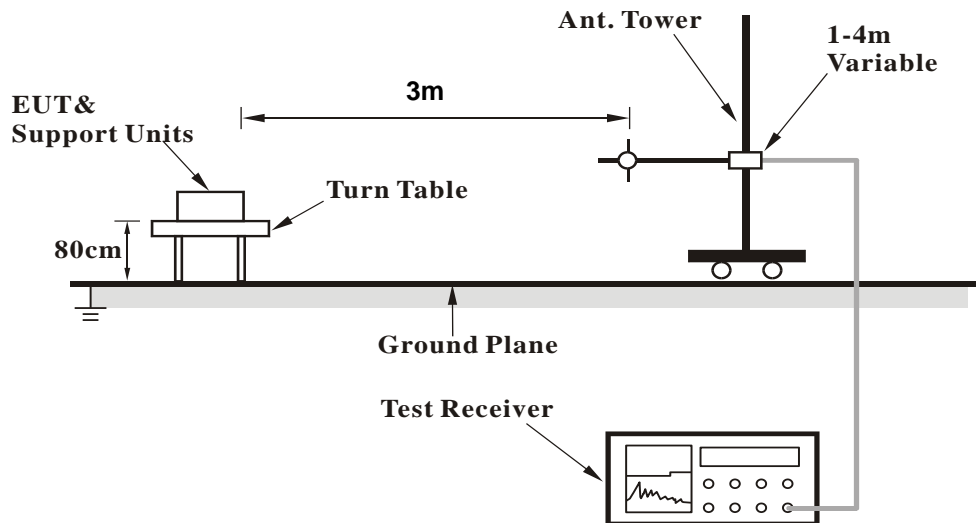

For Radiated emission above 1GHz

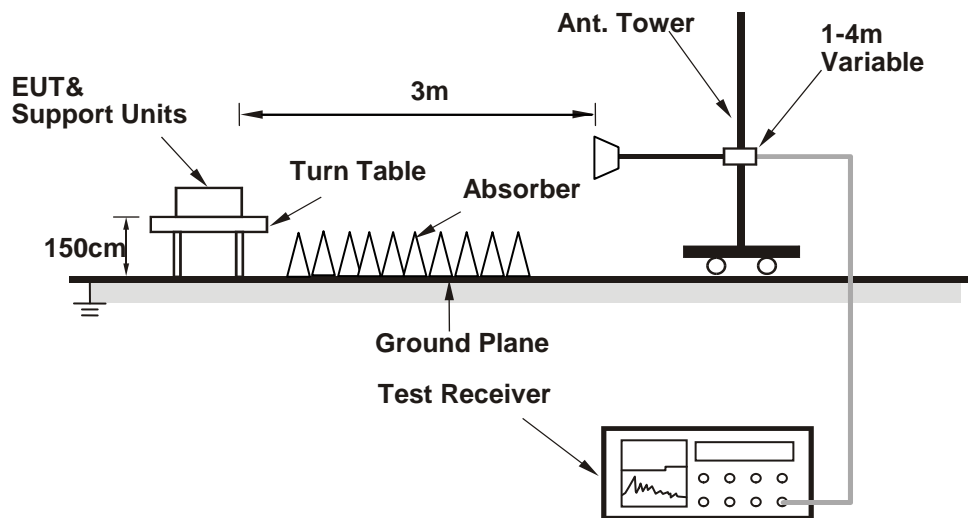

For the actual test configuration, please refer to the attached file (Test Setup Photo).

4.1.6 EUT Operating Condition

- a. Connected the EUT with the Laptop which is placed on remote site.
- b. Controlling software (Atheros Radio Test 2(ART2-GUI)) has been activated to set the EUT on specific status.

4.1.7 Test Results

Above 1GHz Data:

802.11a

CHANNEL	TX Channel 36	DETECTOR FUNCTION	Peak (PK)
FREQUENCY RANGE	1GHz ~ 40GHz		Average (AV)

ANTENNA POLARITY & TEST DISTANCE: HORIZONTAL AT 3 M

NO.	FREQ. (MHz)	EMISSION LEVEL (dBuV/m)	LIMIT (dBuV/m)	MARGIN (dB)	ANTENNA HEIGHT (m)	TABLE ANGLE (Degree)	RAW VALUE (dBuV)	CORRECTION FACTOR (dB/m)
1	5150.00	64.1 PK	74.0	-9.9	2.74 H	233	61.1	3.0
2	5150.00	46.1 AV	54.0	-7.9	2.74 H	233	43.1	3.0
3	*5180.00	100.9 PK			2.74 H	233	97.7	3.2
4	*5180.00	90.8 AV			2.74 H	233	87.6	3.2
5	#10360.00	52.6 PK	74.0	-21.4	1.00 H	348	39.5	13.1
6	#10360.00	40.4 AV	54.0	-13.6	1.00 H	348	27.3	13.1
7	15540.00	55.4 PK	74.0	-18.6	1.53 H	16	40.7	14.7
8	15540.00	42.7 AV	54.0	-11.3	1.53 H	16	28.0	14.7

ANTENNA POLARITY & TEST DISTANCE: VERTICAL AT 3 M

NO.	FREQ. (MHz)	EMISSION LEVEL (dBuV/m)	LIMIT (dBuV/m)	MARGIN (dB)	ANTENNA HEIGHT (m)	TABLE ANGLE (Degree)	RAW VALUE (dBuV)	CORRECTION FACTOR (dB/m)
1	5150.00	72.2 PK	74.0	-1.8	1.99 V	177	69.2	3.0
2	5150.00	53.9 AV	54.0	-0.1	1.99 V	177	50.9	3.0
3	*5180.00	115.8 PK			1.99 V	177	112.6	3.2
4	*5180.00	105.4 AV			1.99 V	177	102.2	3.2
5	#10360.00	52.4 PK	74.0	-21.6	1.02 V	356	39.3	13.1
6	#10360.00	40.6 AV	54.0	-13.4	1.02 V	356	27.5	13.1
7	15540.00	55.5 PK	74.0	-18.5	1.97 V	3	40.8	14.7
8	15540.00	42.9 AV	54.0	-11.1	1.97 V	3	28.2	14.7

REMARKS:

1. Emission Level(dBuV/m) = Raw Value(dBuV) + Correction Factor(dB/m)
2. Correction Factor(dB/m) = Antenna Factor(dB/m) + Cable Factor(dB) – Pre-Amplifier Factor(dB)
3. The other emission levels were very low against the limit.
4. Margin value = Emission Level – Limit value
5. " * ": Fundamental frequency.
6. " # ": The radiated frequency is out of the restricted band.

CHANNEL	TX Channel 40	DETECTOR FUNCTION	Peak (PK)
FREQUENCY RANGE	1GHz ~ 40GHz		Average (AV)

ANTENNA POLARITY & TEST DISTANCE: HORIZONTAL AT 3 M

NO.	FREQ. (MHz)	EMISSION LEVEL (dBuV/m)	LIMIT (dBuV/m)	MARGIN (dB)	ANTENNA HEIGHT (m)	TABLE ANGLE (Degree)	RAW VALUE (dBuV)	CORRECTION FACTOR (dB/m)
1	5150.00	60.7 PK	74.0	-13.3	2.75 H	221	57.7	3.0
2	5150.00	46.0 AV	54.0	-8.0	2.75 H	221	43.0	3.0
3	*5200.00	104.8 PK			2.75 H	221	101.6	3.2
4	*5200.00	94.2 AV			2.75 H	221	91.0	3.2
5	5350.00	56.4 PK	74.0	-17.6	2.75 H	221	53.2	3.2
6	5350.00	43.2 AV	54.0	-10.8	2.75 H	221	40.0	3.2
7	#10400.00	52.5 PK	74.0	-21.5	1.00 H	341	39.1	13.4
8	#10400.00	40.5 AV	54.0	-13.5	1.00 H	341	27.1	13.4
9	15600.00	55.7 PK	74.0	-18.3	1.50 H	30	40.9	14.8
10	15600.00	43.2 AV	54.0	-10.8	1.50 H	30	28.4	14.8

ANTENNA POLARITY & TEST DISTANCE: VERTICAL AT 3 M

NO.	FREQ. (MHz)	EMISSION LEVEL (dBuV/m)	LIMIT (dBuV/m)	MARGIN (dB)	ANTENNA HEIGHT (m)	TABLE ANGLE (Degree)	RAW VALUE (dBuV)	CORRECTION FACTOR (dB/m)
1	5150.00	68.9 PK	74.0	-5.1	1.99 V	178	65.9	3.0
2	5150.00	53.8 AV	54.0	-0.2	1.99 V	178	50.8	3.0
3	*5200.00	119.8 PK			1.99 V	178	116.6	3.2
4	*5200.00	108.9 AV			1.99 V	178	105.7	3.2
5	5350.00	60.5 PK	74.0	-13.5	1.99 V	178	57.3	3.2
6	5350.00	48.0 AV	54.0	-6.0	1.99 V	178	44.8	3.2
7	#10400.00	55.4 PK	74.0	-18.6	1.00 V	343	42.0	13.4
8	#10400.00	42.9 AV	54.0	-11.1	1.00 V	343	29.5	13.4
9	15600.00	55.6 PK	74.0	-18.4	2.02 V	10	40.8	14.8
10	15600.00	43.3 AV	54.0	-10.7	2.02 V	10	28.5	14.8

REMARKS:

1. Emission Level(dBuV/m) = Raw Value(dBuV) + Correction Factor(dB/m)
2. Correction Factor(dB/m) = Antenna Factor(dB/m) + Cable Factor(dB) – Pre-Amplifier Factor(dB)
3. The other emission levels were very low against the limit.
4. Margin value = Emission Level – Limit value
5. " * ": Fundamental frequency.
6. " # ": The radiated frequency is out of the restricted band.

CHANNEL	TX Channel 48	DETECTOR FUNCTION	Peak (PK)
FREQUENCY RANGE	1GHz ~ 40GHz		Average (AV)

ANTENNA POLARITY & TEST DISTANCE: HORIZONTAL AT 3 M

NO.	FREQ. (MHz)	EMISSION LEVEL (dBuV/m)	LIMIT (dBuV/m)	MARGIN (dB)	ANTENNA HEIGHT (m)	TABLE ANGLE (Degree)	RAW VALUE (dBuV)	CORRECTION FACTOR (dB/m)
1	*5240.00	102.0 PK			2.74 H	213	98.9	3.1
2	*5240.00	92.0 AV			2.74 H	213	88.9	3.1
3	5350.00	56.5 PK	74.0	-17.5	2.74 H	213	53.3	3.2
4	5350.00	43.7 AV	54.0	-10.3	2.74 H	213	40.5	3.2
5	#10480.00	52.8 PK	74.0	-21.2	1.00 H	360	39.9	12.9
6	#10480.00	40.3 AV	54.0	-13.7	1.00 H	360	27.4	12.9
7	15720.00	55.0 PK	74.0	-19.0	1.51 H	15	40.0	15.0
8	15720.00	42.5 AV	54.0	-11.5	1.51 H	15	27.5	15.0

ANTENNA POLARITY & TEST DISTANCE: VERTICAL AT 3 M

NO.	FREQ. (MHz)	EMISSION LEVEL (dBuV/m)	LIMIT (dBuV/m)	MARGIN (dB)	ANTENNA HEIGHT (m)	TABLE ANGLE (Degree)	RAW VALUE (dBuV)	CORRECTION FACTOR (dB/m)
1	*5240.00	117.1 PK			1.99 V	176	114.0	3.1
2	*5240.00	106.8 AV			1.99 V	176	103.7	3.1
3	5350.00	62.8 PK	74.0	-11.2	1.99 V	176	59.6	3.2
4	5350.00	49.8 AV	54.0	-4.2	1.99 V	176	46.6	3.2
5	#10480.00	52.8 PK	74.0	-21.2	1.07 V	346	39.9	12.9
6	#10480.00	40.7 AV	54.0	-13.3	1.07 V	346	27.8	12.9
7	15720.00	55.3 PK	74.0	-18.7	2.03 V	4	40.3	15.0
8	15720.00	42.8 AV	54.0	-11.2	2.03 V	4	27.8	15.0

REMARKS:

1. Emission Level(dBuV/m) = Raw Value(dBuV) + Correction Factor(dB/m)
2. Correction Factor(dB/m) = Antenna Factor(dB/m) + Cable Factor(dB) – Pre-Amplifier Factor(dB)
3. The other emission levels were very low against the limit.
4. Margin value = Emission Level – Limit value
5. " * ": Fundamental frequency.
6. " # ": The radiated frequency is out of the restricted band.

CHANNEL	TX Channel 149	DETECTOR FUNCTION	Peak (PK)
FREQUENCY RANGE	1GHz ~ 40GHz		Average (AV)

ANTENNA POLARITY & TEST DISTANCE: HORIZONTAL AT 3 M

NO.	FREQ. (MHz)	EMISSION LEVEL (dBuV/m)	LIMIT (dBuV/m)	MARGIN (dB)	ANTENNA HEIGHT (m)	TABLE ANGLE (Degree)	RAW VALUE (dBuV)	CORRECTION FACTOR (dB/m)
1	#5602.86	56.4 PK	68.2	-11.8	1.09 H	133	54.0	2.4
2	*5745.00	103.5 PK			1.09 H	133	99.5	4.0
3	*5745.00	92.6 AV			1.09 H	133	88.6	4.0
4	#5956.45	55.3 PK	68.2	-12.9	1.09 H	133	52.3	3.0
5	11490.00	54.6 PK	74.0	-19.4	1.00 H	320	40.6	14.0
6	11490.00	42.5 AV	54.0	-11.5	1.00 H	320	28.5	14.0
7	#17235.00	58.7 PK	74.0	-15.3	1.50 H	40	39.0	19.7
8	#17235.00	46.8 AV	54.0	-7.2	1.50 H	40	27.1	19.7

ANTENNA POLARITY & TEST DISTANCE: VERTICAL AT 3 M

NO.	FREQ. (MHz)	EMISSION LEVEL (dBuV/m)	LIMIT (dBuV/m)	MARGIN (dB)	ANTENNA HEIGHT (m)	TABLE ANGLE (Degree)	RAW VALUE (dBuV)	CORRECTION FACTOR (dB/m)
1	#5570.39	60.6 PK	68.2	-7.6	1.98 V	32	58.3	2.3
2	*5745.00	118.3 PK			1.98 V	32	114.3	4.0
3	*5745.00	107.4 AV			1.98 V	32	103.4	4.0
4	#5947.29	56.3 PK	68.2	-11.9	1.98 V	32	53.4	2.9
5	11490.00	58.3 PK	74.0	-15.7	1.00 V	349	44.3	14.0
6	11490.00	45.6 AV	54.0	-8.4	1.00 V	349	31.6	14.0
7	#17235.00	58.6 PK	74.0	-15.4	2.07 V	358	38.9	19.7
8	#17235.00	46.5 AV	54.0	-7.5	2.07 V	358	26.8	19.7

REMARKS:

1. Emission Level(dBuV/m) = Raw Value(dBuV) + Correction Factor(dB/m)
2. Correction Factor(dB/m) = Antenna Factor(dB/m) + Cable Factor(dB) – Pre-Amplifier Factor(dB)
3. The other emission levels were very low against the limit.
4. Margin value = Emission Level – Limit value
5. " * ": Fundamental frequency.
6. " # ": The radiated frequency is out of the restricted band.

CHANNEL	TX Channel 157	DETECTOR FUNCTION	Peak (PK)
FREQUENCY RANGE	1GHz ~ 40GHz		Average (AV)

ANTENNA POLARITY & TEST DISTANCE: HORIZONTAL AT 3 M

NO.	FREQ. (MHz)	EMISSION LEVEL (dBuV/m)	LIMIT (dBuV/m)	MARGIN (dB)	ANTENNA HEIGHT (m)	TABLE ANGLE (Degree)	RAW VALUE (dBuV)	CORRECTION FACTOR (dB/m)
1	#5554.13	56.2 PK	68.2	-12.0	1.30 H	135	53.9	2.3
2	*5785.00	104.1 PK			1.30 H	135	100.1	4.0
3	*5785.00	93.4 AV			1.30 H	135	89.4	4.0
4	#5942.86	56.7 PK	68.2	-11.5	1.30 H	135	53.8	2.9
5	11570.00	54.5 PK	74.0	-19.5	1.00 H	323	40.7	13.8
6	11570.00	42.3 AV	54.0	-11.7	1.00 H	323	28.5	13.8
7	#17355.00	59.2 PK	74.0	-14.8	1.52 H	36	38.8	20.4
8	#17355.00	47.0 AV	54.0	-7.0	1.52 H	36	26.6	20.4

ANTENNA POLARITY & TEST DISTANCE: VERTICAL AT 3 M

NO.	FREQ. (MHz)	EMISSION LEVEL (dBuV/m)	LIMIT (dBuV/m)	MARGIN (dB)	ANTENNA HEIGHT (m)	TABLE ANGLE (Degree)	RAW VALUE (dBuV)	CORRECTION FACTOR (dB/m)
1	#5606.10	60.4 PK	68.2	-7.8	1.98 V	36	57.9	2.5
2	*5785.00	118.0 PK			1.98 V	36	114.0	4.0
3	*5785.00	107.0 AV			1.98 V	36	103.0	4.0
4	#5949.85	56.8 PK	68.2	-11.4	1.98 V	36	53.8	3.0
5	11570.00	58.7 PK	74.0	-15.3	1.05 V	345	44.9	13.8
6	11570.00	46.0 AV	54.0	-8.0	1.05 V	345	32.2	13.8
7	#17355.00	58.9 PK	74.0	-15.1	2.08 V	343	38.5	20.4
8	#17355.00	46.7 AV	54.0	-7.3	2.08 V	343	26.3	20.4

REMARKS:

1. Emission Level(dBuV/m) = Raw Value(dBuV) + Correction Factor(dB/m)
2. Correction Factor(dB/m) = Antenna Factor(dB/m) + Cable Factor(dB) – Pre-Amplifier Factor(dB)
3. The other emission levels were very low against the limit.
4. Margin value = Emission Level – Limit value
5. " * ": Fundamental frequency.
6. " # ": The radiated frequency is out of the restricted band.

CHANNEL	TX Channel 165	DETECTOR FUNCTION	Peak (PK)
FREQUENCY RANGE	1GHz ~ 40GHz		Average (AV)

ANTENNA POLARITY & TEST DISTANCE: HORIZONTAL AT 3 M

NO.	FREQ. (MHz)	EMISSION LEVEL (dBuV/m)	LIMIT (dBuV/m)	MARGIN (dB)	ANTENNA HEIGHT (m)	TABLE ANGLE (Degree)	RAW VALUE (dBuV)	CORRECTION FACTOR (dB/m)
1	#5612.77	57.9 PK	68.2	-10.3	1.30 H	135	55.4	2.5
2	*5825.00	104.0 PK			1.30 H	135	100.0	4.0
3	*5825.00	93.3 AV			1.30 H	135	89.3	4.0
4	#5985.42	55.9 PK	68.2	-12.3	1.30 H	135	52.7	3.2
5	11650.00	54.0 PK	74.0	-20.0	1.01 H	321	40.3	13.7
6	11650.00	42.0 AV	54.0	-12.0	1.01 H	321	28.3	13.7
7	#17475.00	58.7 PK	74.0	-15.3	1.55 H	32	38.0	20.7
8	#17475.00	46.7 AV	54.0	-7.3	1.55 H	32	26.0	20.7

ANTENNA POLARITY & TEST DISTANCE: VERTICAL AT 3 M

NO.	FREQ. (MHz)	EMISSION LEVEL (dBuV/m)	LIMIT (dBuV/m)	MARGIN (dB)	ANTENNA HEIGHT (m)	TABLE ANGLE (Degree)	RAW VALUE (dBuV)	CORRECTION FACTOR (dB/m)
1	#5570.52	60.0 PK	68.2	-8.2	1.98 V	37	57.7	2.3
2	*5825.00	117.9 PK			1.98 V	37	113.9	4.0
3	*5825.00	106.9 AV			1.98 V	37	102.9	4.0
4	#5927.47	56.6 PK	68.2	-11.6	1.98 V	37	53.7	2.9
5	11650.00	58.5 PK	74.0	-15.5	1.00 V	333	44.8	13.7
6	11650.00	45.9 AV	54.0	-8.1	1.00 V	333	32.2	13.7
7	#17475.00	58.5 PK	74.0	-15.5	2.04 V	358	37.8	20.7
8	#17475.00	46.6 AV	54.0	-7.4	2.04 V	358	25.9	20.7

REMARKS:

1. Emission Level(dBuV/m) = Raw Value(dBuV) + Correction Factor(dB/m)
2. Correction Factor(dB/m) = Antenna Factor(dB/m) + Cable Factor(dB) – Pre-Amplifier Factor(dB)
3. The other emission levels were very low against the limit.
4. Margin value = Emission Level – Limit value
5. " * ": Fundamental frequency.
6. " # ": The radiated frequency is out of the restricted band.

802.11ac (VHT20)

CHANNEL	TX Channel 36	DETECTOR FUNCTION	Peak (PK)
FREQUENCY RANGE	1GHz ~ 40GHz		Average (AV)

ANTENNA POLARITY & TEST DISTANCE: HORIZONTAL AT 3 M								
NO.	FREQ. (MHz)	EMISSION LEVEL (dBuV/m)	LIMIT (dBuV/m)	MARGIN (dB)	ANTENNA HEIGHT (m)	TABLE ANGLE (Degree)	RAW VALUE (dBuV)	CORRECTION FACTOR (dB/m)
1	5150.00	61.2 PK	74.0	-12.8	2.76 H	223	58.2	3.0
2	5150.00	46.1 AV	54.0	-7.9	2.76 H	223	43.1	3.0
3	*5180.00	100.8 PK			2.76 H	223	97.6	3.2
4	*5180.00	90.4 AV			2.76 H	223	87.2	3.2
5	#10360.00	52.2 PK	74.0	-21.8	1.05 H	311	39.1	13.1
6	#10360.00	40.2 AV	54.0	-13.8	1.05 H	311	27.1	13.1
7	15540.00	55.3 PK	74.0	-18.7	1.57 H	16	40.6	14.7
8	15540.00	42.3 AV	54.0	-11.7	1.57 H	16	27.6	14.7

ANTENNA POLARITY & TEST DISTANCE: VERTICAL AT 3 M								
NO.	FREQ. (MHz)	EMISSION LEVEL (dBuV/m)	LIMIT (dBuV/m)	MARGIN (dB)	ANTENNA HEIGHT (m)	TABLE ANGLE (Degree)	RAW VALUE (dBuV)	CORRECTION FACTOR (dB/m)
1	5150.00	68.9 PK	74.0	-5.1	1.99 V	177	65.9	3.0
2	5150.00	53.8 AV	54.0	-0.2	1.99 V	177	50.8	3.0
3	*5180.00	114.5 PK			1.99 V	177	111.3	3.2
4	*5180.00	104.0 AV			1.99 V	177	100.8	3.2
5	#10360.00	52.1 PK	74.0	-21.9	1.01 V	359	39.0	13.1
6	#10360.00	40.4 AV	54.0	-13.6	1.01 V	359	27.3	13.1
7	15540.00	55.5 PK	74.0	-18.5	1.94 V	7	40.8	14.7
8	15540.00	43.0 AV	54.0	-11.0	1.94 V	7	28.3	14.7

REMARKS:

1. Emission Level(dBuV/m) = Raw Value(dBuV) + Correction Factor(dB/m)
2. Correction Factor(dB/m) = Antenna Factor(dB/m) + Cable Factor(dB) – Pre-Amplifier Factor(dB)
3. The other emission levels were very low against the limit.
4. Margin value = Emission Level – Limit value
5. " * ": Fundamental frequency.
6. " # ": The radiated frequency is out of the restricted band.

CHANNEL	TX Channel 40	DETECTOR FUNCTION	Peak (PK)
FREQUENCY RANGE	1GHz ~ 40GHz		Average (AV)

ANTENNA POLARITY & TEST DISTANCE: HORIZONTAL AT 3 M

NO.	FREQ. (MHz)	EMISSION LEVEL (dBuV/m)	LIMIT (dBuV/m)	MARGIN (dB)	ANTENNA HEIGHT (m)	TABLE ANGLE (Degree)	RAW VALUE (dBuV)	CORRECTION FACTOR (dB/m)
1	5150.00	60.9 PK	74.0	-13.1	2.75 H	225	57.9	3.0
2	5150.00	45.9 AV	54.0	-8.1	2.75 H	225	42.9	3.0
3	*5200.00	104.8 PK			2.75 H	225	101.6	3.2
4	*5200.00	94.1 AV			2.75 H	225	90.9	3.2
5	5350.00	56.3 PK	74.0	-17.7	2.75 H	225	53.1	3.2
6	5350.00	43.3 AV	54.0	-10.7	2.75 H	225	40.1	3.2
7	#10400.00	52.4 PK	74.0	-21.6	1.03 H	343	39.0	13.4
8	#10400.00	40.5 AV	54.0	-13.5	1.03 H	343	27.1	13.4
9	15600.00	55.4 PK	74.0	-18.6	1.45 H	44	40.6	14.8
10	15600.00	43.1 AV	54.0	-10.9	1.45 H	44	28.3	14.8

ANTENNA POLARITY & TEST DISTANCE: VERTICAL AT 3 M

NO.	FREQ. (MHz)	EMISSION LEVEL (dBuV/m)	LIMIT (dBuV/m)	MARGIN (dB)	ANTENNA HEIGHT (m)	TABLE ANGLE (Degree)	RAW VALUE (dBuV)	CORRECTION FACTOR (dB/m)
1	5150.00	68.5 PK	74.0	-5.5	1.99 V	172	65.5	3.0
2	5150.00	53.6 AV	54.0	-0.4	1.99 V	172	50.6	3.0
3	*5200.00	118.5 PK			1.99 V	172	115.3	3.2
4	*5200.00	107.9 AV			1.99 V	172	104.7	3.2
5	5350.00	60.1 PK	74.0	-13.9	1.99 V	172	56.9	3.2
6	5350.00	47.6 AV	54.0	-6.4	1.99 V	172	44.4	3.2
7	#10400.00	55.3 PK	74.0	-18.7	1.00 V	347	41.9	13.4
8	#10400.00	42.7 AV	54.0	-11.3	1.00 V	347	29.3	13.4
9	15600.00	56.1 PK	74.0	-17.9	2.00 V	24	41.3	14.8
10	15600.00	43.6 AV	54.0	-10.4	2.00 V	24	28.8	14.8

REMARKS:

- Emission Level(dBuV/m) = Raw Value(dBuV) + Correction Factor(dB/m)
- Correction Factor(dB/m) = Antenna Factor(dB/m) + Cable Factor(dB) – Pre-Amplifier Factor(dB)
- The other emission levels were very low against the limit.
- Margin value = Emission Level – Limit value
- " * ": Fundamental frequency.
- " # ": The radiated frequency is out of the restricted band.

CHANNEL	TX Channel 48	DETECTOR FUNCTION	Peak (PK)
FREQUENCY RANGE	1GHz ~ 40GHz		Average (AV)

ANTENNA POLARITY & TEST DISTANCE: HORIZONTAL AT 3 M

NO.	FREQ. (MHz)	EMISSION LEVEL (dBuV/m)	LIMIT (dBuV/m)	MARGIN (dB)	ANTENNA HEIGHT (m)	TABLE ANGLE (Degree)	RAW VALUE (dBuV)	CORRECTION FACTOR (dB/m)
1	*5240.00	101.0 PK			2.80 H	217	97.9	3.1
2	*5240.00	91.2 AV			2.80 H	217	88.1	3.1
3	5350.00	56.8 PK	74.0	-17.2	2.80 H	217	53.6	3.2
4	5350.00	43.6 AV	54.0	-10.4	2.80 H	217	40.4	3.2
5	#10480.00	52.9 PK	74.0	-21.1	1.05 H	360	40.0	12.9
6	#10480.00	40.4 AV	54.0	-13.6	1.05 H	360	27.5	12.9
7	15720.00	55.3 PK	74.0	-18.7	1.47 H	11	40.3	15.0
8	15720.00	42.9 AV	54.0	-11.1	1.47 H	11	27.9	15.0

ANTENNA POLARITY & TEST DISTANCE: VERTICAL AT 3 M

NO.	FREQ. (MHz)	EMISSION LEVEL (dBuV/m)	LIMIT (dBuV/m)	MARGIN (dB)	ANTENNA HEIGHT (m)	TABLE ANGLE (Degree)	RAW VALUE (dBuV)	CORRECTION FACTOR (dB/m)
1	*5240.00	114.8 PK			1.99 V	174	111.7	3.1
2	*5240.00	105.1 AV			1.99 V	174	102.0	3.1
3	5350.00	61.2 PK	74.0	-12.8	1.99 V	174	58.0	3.2
4	5350.00	48.0 AV	54.0	-6.0	1.99 V	174	44.8	3.2
5	#10480.00	52.8 PK	74.0	-21.2	1.02 V	341	39.9	12.9
6	#10480.00	40.9 AV	54.0	-13.1	1.02 V	341	28.0	12.9
7	15720.00	55.5 PK	74.0	-18.5	1.99 V	8	40.5	15.0
8	15720.00	43.1 AV	54.0	-10.9	1.99 V	8	28.1	15.0

REMARKS:

1. Emission Level(dBuV/m) = Raw Value(dBuV) + Correction Factor(dB/m)
2. Correction Factor(dB/m) = Antenna Factor(dB/m) + Cable Factor(dB) – Pre-Amplifier Factor(dB)
3. The other emission levels were very low against the limit.
4. Margin value = Emission Level – Limit value
5. " * ": Fundamental frequency.
6. " # ": The radiated frequency is out of the restricted band.

CHANNEL	TX Channel 149	DETECTOR FUNCTION	Peak (PK)
FREQUENCY RANGE	1GHz ~ 40GHz		Average (AV)

ANTENNA POLARITY & TEST DISTANCE: HORIZONTAL AT 3 M

NO.	FREQ. (MHz)	EMISSION LEVEL (dBuV/m)	LIMIT (dBuV/m)	MARGIN (dB)	ANTENNA HEIGHT (m)	TABLE ANGLE (Degree)	RAW VALUE (dBuV)	CORRECTION FACTOR (dB/m)
1	#5582.82	57.2 PK	68.2	-11.0	1.09 H	134	54.9	2.3
2	*5745.00	103.2 PK			1.09 H	134	99.2	4.0
3	*5745.00	92.6 AV			1.09 H	134	88.6	4.0
4	#5925.84	55.9 PK	68.2	-12.3	1.09 H	134	53.0	2.9
5	11490.00	54.8 PK	74.0	-19.2	1.07 H	325	40.8	14.0
6	11490.00	42.5 AV	54.0	-11.5	1.07 H	325	28.5	14.0
7	#17235.00	58.5 PK	74.0	-15.5	1.55 H	34	38.8	19.7
8	#17235.00	46.5 AV	54.0	-7.5	1.55 H	34	26.8	19.7

ANTENNA POLARITY & TEST DISTANCE: VERTICAL AT 3 M

NO.	FREQ. (MHz)	EMISSION LEVEL (dBuV/m)	LIMIT (dBuV/m)	MARGIN (dB)	ANTENNA HEIGHT (m)	TABLE ANGLE (Degree)	RAW VALUE (dBuV)	CORRECTION FACTOR (dB/m)
1	#5567.27	60.7 PK	68.2	-7.5	1.98 V	37	58.4	2.3
2	*5745.00	117.0 PK			1.98 V	37	113.0	4.0
3	*5745.00	106.5 AV			1.98 V	37	102.5	4.0
4	#5986.36	57.0 PK	68.2	-11.2	1.98 V	37	53.8	3.2
5	11490.00	58.7 PK	74.0	-15.3	1.09 V	360	44.7	14.0
6	11490.00	45.7 AV	54.0	-8.3	1.09 V	360	31.7	14.0
7	#17235.00	58.6 PK	74.0	-15.4	2.11 V	351	38.9	19.7
8	#17235.00	46.2 AV	54.0	-7.8	2.11 V	351	26.5	19.7

REMARKS:

1. Emission Level(dBuV/m) = Raw Value(dBuV) + Correction Factor(dB/m)
2. Correction Factor(dB/m) = Antenna Factor(dB/m) + Cable Factor(dB) – Pre-Amplifier Factor(dB)
3. The other emission levels were very low against the limit.
4. Margin value = Emission Level – Limit value
5. " * ": Fundamental frequency.
6. " # ": The radiated frequency is out of the restricted band.

CHANNEL	TX Channel 157	DETECTOR FUNCTION	Peak (PK)
FREQUENCY RANGE	1GHz ~ 40GHz		Average (AV)

ANTENNA POLARITY & TEST DISTANCE: HORIZONTAL AT 3 M

NO.	FREQ. (MHz)	EMISSION LEVEL (dBuV/m)	LIMIT (dBuV/m)	MARGIN (dB)	ANTENNA HEIGHT (m)	TABLE ANGLE (Degree)	RAW VALUE (dBuV)	CORRECTION FACTOR (dB/m)
1	#5615.03	56.0 PK	68.2	-12.2	1.09 H	134	53.5	2.5
2	*5785.00	103.0 PK			1.09 H	134	99.0	4.0
3	*5785.00	92.5 AV			1.09 H	134	88.5	4.0
4	#5935.23	56.2 PK	68.2	-12.0	1.09 H	134	53.3	2.9
5	11570.00	54.9 PK	74.0	-19.1	1.03 H	317	41.1	13.8
6	11570.00	42.5 AV	54.0	-11.5	1.03 H	317	28.7	13.8
7	#17355.00	59.0 PK	74.0	-15.0	1.48 H	37	38.6	20.4
8	#17355.00	47.0 AV	54.0	-7.0	1.48 H	37	26.6	20.4

ANTENNA POLARITY & TEST DISTANCE: VERTICAL AT 3 M

NO.	FREQ. (MHz)	EMISSION LEVEL (dBuV/m)	LIMIT (dBuV/m)	MARGIN (dB)	ANTENNA HEIGHT (m)	TABLE ANGLE (Degree)	RAW VALUE (dBuV)	CORRECTION FACTOR (dB/m)
1	#5618.25	60.7 PK	68.2	-7.5	1.97 V	37	58.2	2.5
2	*5785.00	118.0 PK			1.97 V	37	114.0	4.0
3	*5785.00	107.4 AV			1.97 V	37	103.4	4.0
4	#5927.53	57.2 PK	68.2	-11.0	1.97 V	37	54.3	2.9
5	11570.00	57.9 PK	74.0	-16.1	1.04 V	353	44.1	13.8
6	11570.00	45.3 AV	54.0	-8.7	1.04 V	353	31.5	13.8
7	#17355.00	58.8 PK	74.0	-15.2	2.04 V	360	38.4	20.4
8	#17355.00	46.6 AV	54.0	-7.4	2.04 V	360	26.2	20.4

REMARKS:

1. Emission Level(dBuV/m) = Raw Value(dBuV) + Correction Factor(dB/m)
2. Correction Factor(dB/m) = Antenna Factor(dB/m) + Cable Factor(dB) – Pre-Amplifier Factor(dB)
3. The other emission levels were very low against the limit.
4. Margin value = Emission Level – Limit value
5. " * ": Fundamental frequency.
6. " # ": The radiated frequency is out of the restricted band.

CHANNEL	TX Channel 165	DETECTOR FUNCTION	Peak (PK)
FREQUENCY RANGE	1GHz ~ 40GHz		Average (AV)

ANTENNA POLARITY & TEST DISTANCE: HORIZONTAL AT 3 M

NO.	FREQ. (MHz)	EMISSION LEVEL (dBuV/m)	LIMIT (dBuV/m)	MARGIN (dB)	ANTENNA HEIGHT (m)	TABLE ANGLE (Degree)	RAW VALUE (dBuV)	CORRECTION FACTOR (dB/m)
1	#5606.23	57.0 PK	68.2	-11.2	1.09 H	133	54.5	2.5
2	*5825.00	103.0 PK			1.09 H	133	99.0	4.0
3	*5825.00	92.4 AV			1.09 H	133	88.4	4.0
4	#6021.05	55.7 PK	68.2	-12.5	1.09 H	133	52.4	3.3
5	11650.00	54.5 PK	74.0	-19.5	1.01 H	320	40.8	13.7
6	11650.00	42.6 AV	54.0	-11.4	1.01 H	320	28.9	13.7
7	#17475.00	58.6 PK	74.0	-15.4	1.53 H	39	37.9	20.7
8	#17475.00	46.5 AV	54.0	-7.5	1.53 H	39	25.8	20.7

ANTENNA POLARITY & TEST DISTANCE: VERTICAL AT 3 M

NO.	FREQ. (MHz)	EMISSION LEVEL (dBuV/m)	LIMIT (dBuV/m)	MARGIN (dB)	ANTENNA HEIGHT (m)	TABLE ANGLE (Degree)	RAW VALUE (dBuV)	CORRECTION FACTOR (dB/m)
1	#5590.91	60.0 PK	68.2	-8.2	1.97 V	38	57.7	2.3
2	*5825.00	117.7 PK			1.97 V	38	113.7	4.0
3	*5825.00	107.2 AV			1.97 V	38	103.2	4.0
4	#5913.02	57.9 PK	77.0	-19.1	1.97 V	38	55.0	2.9
5	11650.00	57.8 PK	74.0	-16.2	1.02 V	357	44.1	13.7
6	11650.00	45.3 AV	54.0	-8.7	1.02 V	357	31.6	13.7
7	#17475.00	59.1 PK	74.0	-14.9	2.05 V	350	38.4	20.7
8	#17475.00	46.8 AV	54.0	-7.2	2.05 V	350	26.1	20.7

REMARKS:

1. Emission Level(dBuV/m) = Raw Value(dBuV) + Correction Factor(dB/m)
2. Correction Factor(dB/m) = Antenna Factor(dB/m) + Cable Factor(dB) – Pre-Amplifier Factor(dB)
3. The other emission levels were very low against the limit.
4. Margin value = Emission Level – Limit value
5. " * ": Fundamental frequency.
6. " # ": The radiated frequency is out of the restricted band.

802.11ac (VHT40)

CHANNEL	TX Channel 38	DETECTOR FUNCTION	Peak (PK)
FREQUENCY RANGE	1GHz ~ 40GHz		Average (AV)

ANTENNA POLARITY & TEST DISTANCE: HORIZONTAL AT 3 M

NO.	FREQ. (MHz)	EMISSION LEVEL (dBuV/m)	LIMIT (dBuV/m)	MARGIN (dB)	ANTENNA HEIGHT (m)	TABLE ANGLE (Degree)	RAW VALUE (dBuV)	CORRECTION FACTOR (dB/m)
1	5150.00	61.3 PK	74.0	-12.7	1.07 H	119	58.3	3.0
2	5150.00	45.9 AV	54.0	-8.1	1.07 H	119	42.9	3.0
3	*5190.00	94.5 PK			1.07 H	119	91.3	3.2
4	*5190.00	84.6 AV			1.07 H	119	81.4	3.2
5	5350.00	56.6 PK	74.0	-17.4	1.07 H	119	53.4	3.2
6	5350.00	43.2 AV	54.0	-10.8	1.07 H	119	40.0	3.2
7	#10380.00	52.9 PK	74.0	-21.1	1.11 H	308	39.7	13.2
8	#10380.00	40.6 AV	54.0	-13.4	1.11 H	308	27.4	13.2
9	15570.00	55.1 PK	74.0	-18.9	1.58 H	11	40.4	14.7
10	15570.00	42.0 AV	54.0	-12.0	1.58 H	11	27.3	14.7

ANTENNA POLARITY & TEST DISTANCE: VERTICAL AT 3 M

NO.	FREQ. (MHz)	EMISSION LEVEL (dBuV/m)	LIMIT (dBuV/m)	MARGIN (dB)	ANTENNA HEIGHT (m)	TABLE ANGLE (Degree)	RAW VALUE (dBuV)	CORRECTION FACTOR (dB/m)
1	5150.00	68.9 PK	74.0	-5.1	1.98 V	177	65.9	3.0
2	5150.00	53.7 AV	54.0	-0.3	1.98 V	177	50.7	3.0
3	*5190.00	109.2 PK			1.98 V	177	106.0	3.2
4	*5190.00	99.4 AV			1.98 V	177	96.2	3.2
5	5350.00	56.8 PK	74.0	-17.2	1.98 V	177	53.6	3.2
6	5350.00	43.4 AV	54.0	-10.6	1.98 V	177	40.2	3.2
7	#10380.00	52.5 PK	74.0	-21.5	1.08 V	354	39.3	13.2
8	#10380.00	40.6 AV	54.0	-13.4	1.08 V	354	27.4	13.2
9	15570.00	55.9 PK	74.0	-18.1	1.98 V	13	41.2	14.7
10	15570.00	43.4 AV	54.0	-10.6	1.98 V	13	28.7	14.7

REMARKS:

- Emission Level(dBuV/m) = Raw Value(dBuV) + Correction Factor(dB/m)
- Correction Factor(dB/m) = Antenna Factor(dB/m) + Cable Factor(dB) – Pre-Amplifier Factor(dB)
- The other emission levels were very low against the limit.
- Margin value = Emission Level – Limit value
- " * ": Fundamental frequency.
- " # ": The radiated frequency is out of the restricted band.

CHANNEL	TX Channel 46	DETECTOR FUNCTION	Peak (PK)
FREQUENCY RANGE	1GHz ~ 40GHz		Average (AV)

ANTENNA POLARITY & TEST DISTANCE: HORIZONTAL AT 3 M

NO.	FREQ. (MHz)	EMISSION LEVEL (dBuV/m)	LIMIT (dBuV/m)	MARGIN (dB)	ANTENNA HEIGHT (m)	TABLE ANGLE (Degree)	RAW VALUE (dBuV)	CORRECTION FACTOR (dB/m)
1	5150.00	58.6 PK	74.0	-15.4	1.11 H	134	55.6	3.0
2	5150.00	44.6 AV	54.0	-9.4	1.11 H	134	41.6	3.0
3	*5230.00	97.8 PK			1.11 H	134	94.7	3.1
4	*5230.00	88.2 AV			1.11 H	134	85.1	3.1
5	5350.00	52.6 PK	74.0	-21.4	1.11 H	134	49.4	3.2
6	5350.00	43.9 AV	54.0	-10.1	1.11 H	134	40.7	3.2
7	#10460.00	52.3 PK	74.0	-21.7	1.02 H	323	39.3	13.0
8	#10460.00	40.3 AV	54.0	-13.7	1.02 H	323	27.3	13.0
9	15690.00	55.5 PK	74.0	-18.5	1.58 H	19	40.4	15.1
10	15690.00	42.6 AV	54.0	-11.4	1.58 H	19	27.5	15.1

ANTENNA POLARITY & TEST DISTANCE: VERTICAL AT 3 M

NO.	FREQ. (MHz)	EMISSION LEVEL (dBuV/m)	LIMIT (dBuV/m)	MARGIN (dB)	ANTENNA HEIGHT (m)	TABLE ANGLE (Degree)	RAW VALUE (dBuV)	CORRECTION FACTOR (dB/m)
1	5150.00	66.3 PK	74.0	-7.7	1.98 V	176	63.3	3.0
2	5150.00	51.7 AV	54.0	-2.3	1.98 V	176	48.7	3.0
3	*5230.00	112.5 PK			1.98 V	176	109.4	3.1
4	*5230.00	102.9 AV			1.98 V	176	99.8	3.1
5	5350.00	61.2 PK	74.0	-12.8	1.98 V	176	58.0	3.2
6	5350.00	48.0 AV	54.0	-6.0	1.98 V	176	44.8	3.2
7	#10460.00	52.1 PK	74.0	-21.9	1.08 V	355	39.1	13.0
8	#10460.00	40.6 AV	54.0	-13.4	1.08 V	355	27.6	13.0
9	15690.00	55.8 PK	74.0	-18.2	1.89 V	14	40.7	15.1
10	15690.00	43.1 AV	54.0	-10.9	1.89 V	14	28.0	15.1

REMARKS:

1. Emission Level(dBuV/m) = Raw Value(dBuV) + Correction Factor(dB/m)
2. Correction Factor(dB/m) = Antenna Factor(dB/m) + Cable Factor(dB) – Pre-Amplifier Factor(dB)
3. The other emission levels were very low against the limit.
4. Margin value = Emission Level – Limit value
5. " * ": Fundamental frequency.
6. " # ": The radiated frequency is out of the restricted band.

CHANNEL	TX Channel 151	DETECTOR FUNCTION	Peak (PK)
FREQUENCY RANGE	1GHz ~ 40GHz		Average (AV)

ANTENNA POLARITY & TEST DISTANCE: HORIZONTAL AT 3 M

NO.	FREQ. (MHz)	EMISSION LEVEL (dBuV/m)	LIMIT (dBuV/m)	MARGIN (dB)	ANTENNA HEIGHT (m)	TABLE ANGLE (Degree)	RAW VALUE (dBuV)	CORRECTION FACTOR (dB/m)
1	#5627.16	56.3 PK	68.2	-11.9	1.09 H	135	53.8	2.5
2	*5755.00	99.6 PK			1.09 H	135	95.6	4.0
3	*5755.00	89.2 AV			1.09 H	135	85.2	4.0
4	#6021.01	55.4 PK	68.2	-12.8	1.09 H	135	52.1	3.3
5	11510.00	53.5 PK	74.0	-20.5	1.04 H	337	39.5	14.0
6	11510.00	41.8 AV	54.0	-12.2	1.04 H	337	27.8	14.0
7	#17265.00	58.2 PK	74.0	-15.8	1.51 H	17	38.3	19.9
8	#17265.00	46.5 AV	54.0	-7.5	1.51 H	17	26.6	19.9

ANTENNA POLARITY & TEST DISTANCE: VERTICAL AT 3 M

NO.	FREQ. (MHz)	EMISSION LEVEL (dBuV/m)	LIMIT (dBuV/m)	MARGIN (dB)	ANTENNA HEIGHT (m)	TABLE ANGLE (Degree)	RAW VALUE (dBuV)	CORRECTION FACTOR (dB/m)
1	#5638.84	66.5 PK	68.2	-1.7	1.98 V	32	64.0	2.5
2	*5755.00	115.5 PK			1.97 V	32	111.5	4.0
3	*5755.00	104.7 AV			1.97 V	32	100.7	4.0
4	#5937.96	57.1 PK	68.2	-11.1	1.98 V	32	54.2	2.9
5	11510.00	56.9 PK	74.0	-17.1	1.10 V	360	42.9	14.0
6	11510.00	43.9 AV	54.0	-10.1	1.10 V	360	29.9	14.0
7	#17265.00	58.6 PK	74.0	-15.4	2.09 V	342	38.7	19.9
8	#17265.00	46.0 AV	54.0	-8.0	2.09 V	342	26.1	19.9

REMARKS:

1. Emission Level(dBuV/m) = Raw Value(dBuV) + Correction Factor(dB/m)
2. Correction Factor(dB/m) = Antenna Factor(dB/m) + Cable Factor(dB) – Pre-Amplifier Factor(dB)
3. The other emission levels were very low against the limit.
4. Margin value = Emission Level – Limit value
5. " * ": Fundamental frequency.
6. " # ": The radiated frequency is out of the restricted band.

CHANNEL	TX Channel 159	DETECTOR FUNCTION	Peak (PK)
FREQUENCY RANGE	1GHz ~ 40GHz		Average (AV)

ANTENNA POLARITY & TEST DISTANCE: HORIZONTAL AT 3 M

NO.	FREQ. (MHz)	EMISSION LEVEL (dBuV/m)	LIMIT (dBuV/m)	MARGIN (dB)	ANTENNA HEIGHT (m)	TABLE ANGLE (Degree)	RAW VALUE (dBuV)	CORRECTION FACTOR (dB/m)
1	#5575.83	57.0 PK	68.2	-11.2	1.06 H	134	54.7	2.3
2	*5795.00	99.8 PK			1.06 H	134	95.8	4.0
3	*5795.00	89.3 AV			1.06 H	134	85.3	4.0
4	#5966.54	56.6 PK	68.2	-11.6	1.06 H	134	53.6	3.0
5	11590.00	54.3 PK	74.0	-19.7	1.06 H	316	40.7	13.6
6	11590.00	42.4 AV	54.0	-11.6	1.06 H	316	28.8	13.6
7	#17385.00	58.4 PK	74.0	-15.6	1.59 H	43	37.9	20.5
8	#17385.00	46.6 AV	54.0	-7.4	1.59 H	43	26.1	20.5

ANTENNA POLARITY & TEST DISTANCE: VERTICAL AT 3 M

NO.	FREQ. (MHz)	EMISSION LEVEL (dBuV/m)	LIMIT (dBuV/m)	MARGIN (dB)	ANTENNA HEIGHT (m)	TABLE ANGLE (Degree)	RAW VALUE (dBuV)	CORRECTION FACTOR (dB/m)
1	#5640.42	61.9 PK	68.2	-6.3	1.94 V	31	59.4	2.5
2	*5795.00	115.3 PK			1.94 V	31	111.3	4.0
3	*5795.00	104.6 AV			1.94 V	31	100.6	4.0
4	#5927.67	64.8 PK	68.2	-3.4	1.94 V	31	61.9	2.9
5	11590.00	56.5 PK	74.0	-17.5	1.07 V	360	42.9	13.6
6	11590.00	43.7 AV	54.0	-10.3	1.07 V	360	30.1	13.6
7	#17385.00	59.0 PK	74.0	-15.0	2.11 V	337	38.5	20.5
8	#17385.00	46.2 AV	54.0	-7.8	2.11 V	337	25.7	20.5

REMARKS:

1. Emission Level(dBuV/m) = Raw Value(dBuV) + Correction Factor(dB/m)
2. Correction Factor(dB/m) = Antenna Factor(dB/m) + Cable Factor(dB) – Pre-Amplifier Factor(dB)
3. The other emission levels were very low against the limit.
4. Margin value = Emission Level – Limit value
5. " * ": Fundamental frequency.
6. " # ": The radiated frequency is out of the restricted band.

802.11ac (VHT80)

CHANNEL	TX Channel 42	DETECTOR FUNCTION	Peak (PK)
FREQUENCY RANGE	1GHz ~ 40GHz		Average (AV)

ANTENNA POLARITY & TEST DISTANCE: HORIZONTAL AT 3 M

NO.	FREQ. (MHz)	EMISSION LEVEL (dBuV/m)	LIMIT (dBuV/m)	MARGIN (dB)	ANTENNA HEIGHT (m)	TABLE ANGLE (Degree)	RAW VALUE (dBuV)	CORRECTION FACTOR (dB/m)
1	5150.00	57.9 PK	74.0	-16.1	1.02 H	135	54.9	3.0
2	5150.00	45.6 AV	54.0	-8.4	1.02 H	135	42.6	3.0
3	*5210.00	88.5 PK			1.02 H	135	85.3	3.2
4	*5210.00	79.0 AV			1.02 H	135	75.8	3.2
5	5350.00	52.8 PK	74.0	-21.2	1.02 H	135	49.6	3.2
6	5350.00	43.6 AV	54.0	-10.4	1.02 H	135	40.4	3.2
7	#10420.00	52.0 PK	74.0	-22.0	1.04 H	324	38.8	13.2
8	#10420.00	40.3 AV	54.0	-13.7	1.04 H	324	27.1	13.2
9	15630.00	55.6 PK	74.0	-18.4	1.55 H	5	40.7	14.9
10	15630.00	42.6 AV	54.0	-11.4	1.55 H	5	27.7	14.9

ANTENNA POLARITY & TEST DISTANCE: VERTICAL AT 3 M

NO.	FREQ. (MHz)	EMISSION LEVEL (dBuV/m)	LIMIT (dBuV/m)	MARGIN (dB)	ANTENNA HEIGHT (m)	TABLE ANGLE (Degree)	RAW VALUE (dBuV)	CORRECTION FACTOR (dB/m)
1	5150.00	65.6 PK	74.0	-8.4	1.98 V	181	62.6	3.0
2	5150.00	53.4 AV	54.0	-0.6	1.98 V	181	50.4	3.0
3	*5210.00	104.0 PK			1.98 V	181	100.8	3.2
4	*5210.00	94.3 AV			1.98 V	181	91.1	3.2
5	5350.00	60.7 PK	74.0	-13.3	1.98 V	181	57.5	3.2
6	5350.00	48.1 AV	54.0	-5.9	1.98 V	181	44.9	3.2
7	#10420.00	55.6 PK	74.0	-18.4	1.10 V	360	42.4	13.2
8	#10420.00	42.4 AV	54.0	-11.6	1.10 V	360	29.2	13.2
9	15630.00	58.8 PK	74.0	-15.2	2.18 V	333	43.9	14.9
10	15630.00	45.8 AV	54.0	-8.2	2.18 V	333	30.9	14.9

REMARKS:

- Emission Level(dBuV/m) = Raw Value(dBuV) + Correction Factor(dB/m)
- Correction Factor(dB/m) = Antenna Factor(dB/m) + Cable Factor(dB) – Pre-Amplifier Factor(dB)
- The other emission levels were very low against the limit.
- Margin value = Emission Level – Limit value
- " * ": Fundamental frequency.
- " # ": The radiated frequency is out of the restricted band.

CHANNEL	TX Channel 155	DETECTOR FUNCTION	Peak (PK)
FREQUENCY RANGE	1GHz ~ 40GHz		Average (AV)

ANTENNA POLARITY & TEST DISTANCE: HORIZONTAL AT 3 M

NO.	FREQ. (MHz)	EMISSION LEVEL (dBuV/m)	LIMIT (dBuV/m)	MARGIN (dB)	ANTENNA HEIGHT (m)	TABLE ANGLE (Degree)	RAW VALUE (dBuV)	CORRECTION FACTOR (dB/m)
1	#5596.79	56.6 PK	68.2	-11.6	1.08 H	133	54.3	2.3
2	*5775.00	94.4 PK			1.08 H	133	90.4	4.0
3	*5775.00	83.4 AV			1.08 H	133	79.4	4.0
4	#6006.56	55.8 PK	68.2	-12.4	1.08 H	133	52.5	3.3
5	11550.00	53.1 PK	74.0	-20.9	1.04 H	333	39.2	13.9
6	11550.00	41.5 AV	54.0	-12.5	1.04 H	333	27.6	13.9
7	#17325.00	58.1 PK	74.0	-15.9	1.48 H	19	37.9	20.2
8	#17325.00	46.5 AV	54.0	-7.5	1.48 H	19	26.3	20.2

ANTENNA POLARITY & TEST DISTANCE: VERTICAL AT 3 M

NO.	FREQ. (MHz)	EMISSION LEVEL (dBuV/m)	LIMIT (dBuV/m)	MARGIN (dB)	ANTENNA HEIGHT (m)	TABLE ANGLE (Degree)	RAW VALUE (dBuV)	CORRECTION FACTOR (dB/m)
1	#5645.83	67.8 PK	68.2	-0.4	1.94 V	32	65.3	2.5
2	*5775.00	110.1 PK			1.94 V	32	106.1	4.0
3	*5775.00	99.3 AV			1.94 V	32	95.3	4.0
4	#5922.42	62.9 PK	70.1	-7.2	1.94 V	32	60.0	2.9
5	11550.00	52.5 PK	74.0	-21.5	1.07 V	344	38.6	13.9
6	11550.00	40.8 AV	54.0	-13.2	1.07 V	344	26.9	13.9
7	#17325.00	56.0 PK	74.0	-18.0	1.97 V	6	35.8	20.2
8	#17325.00	43.2 AV	54.0	-10.8	1.97 V	6	23.0	20.2

REMARKS:

1. Emission Level(dBuV/m) = Raw Value(dBuV) + Correction Factor(dB/m)
2. Correction Factor(dB/m) = Antenna Factor(dB/m) + Cable Factor(dB) – Pre-Amplifier Factor(dB)
3. The other emission levels were very low against the limit.
4. Margin value = Emission Level – Limit value
5. " * ": Fundamental frequency.
6. " # ": The radiated frequency is out of the restricted band.

Below 1GHz Data:

802.11ac (VHT20)

CHANNEL	TX Channel 157	DETECTOR FUNCTION	Quasi-Peak (QP)
FREQUENCY RANGE	9kHz ~ 1GHz		

ANTENNA POLARITY & TEST DISTANCE: HORIZONTAL AT 3 M

NO.	FREQ. (MHz)	EMISSION LEVEL (dBuV/m)	LIMIT (dBuV/m)	MARGIN (dB)	ANTENNA HEIGHT (m)	TABLE ANGLE (Degree)	RAW VALUE (dBuV)	CORRECTION FACTOR (dB/m)
1	124.96	38.1 QP	43.5	-5.4	1.50 H	110	47.7	-9.6
2	132.06	34.3 QP	43.5	-9.2	2.50 H	78	43.3	-9.0
3	353.50	41.9 QP	46.0	-4.1	1.00 H	225	48.3	-6.4
4	625.02	40.9 QP	46.0	-5.1	1.50 H	329	41.0	-0.1
5	813.66	36.0 QP	46.0	-10.0	1.00 H	314	33.4	2.6
6	874.99	38.4 QP	46.0	-7.6	1.00 H	328	34.8	3.6

ANTENNA POLARITY & TEST DISTANCE: VERTICAL AT 3 M

NO.	FREQ. (MHz)	EMISSION LEVEL (dBuV/m)	LIMIT (dBuV/m)	MARGIN (dB)	ANTENNA HEIGHT (m)	TABLE ANGLE (Degree)	RAW VALUE (dBuV)	CORRECTION FACTOR (dB/m)
1	131.41	33.8 QP	43.5	-9.7	1.00 V	272	43.0	-9.2
2	202.37	34.2 QP	43.5	-9.3	1.00 V	360	45.7	-11.5
3	374.98	38.0 QP	46.0	-8.0	1.00 V	330	43.8	-5.8
4	500.01	38.6 QP	46.0	-7.4	1.00 V	52	41.4	-2.8
5	625.00	41.0 QP	46.0	-5.0	1.00 V	294	41.1	-0.1
6	875.02	34.7 QP	46.0	-11.3	1.50 V	323	31.1	3.6

REMARKS:

1. Emission Level(dBuV/m) = Raw Value(dBuV) + Correction Factor(dB/m)
2. Correction Factor(dB/m) = Antenna Factor(dB/m) + Cable Factor(dB) – Pre-Amplifier Factor(dB)
3. The other emission levels were very low against the limit.
4. Margin value = Emission Level – Limit value

4.2 Conducted Emission Measurement

4.2.1 Limits of Conducted Emission Measurement

Frequency (MHz)	Conducted Limit (dBuV)	
	Quasi-peak	Average
0.15 - 0.5	66 - 56	56 - 46
0.50 - 5.0	56	46
5.0 - 30.0	60	50

Note: 1. The lower limit shall apply at the transition frequencies.

2. The limit decreases in line with the logarithm of the frequency in the range of 0.15 to 0.50MHz.

4.2.2 Test Instruments

DESCRIPTION & MANUFACTURER	MODEL NO.	SERIAL NO.	CALIBRATED DATE	CALIBRATED UNTIL
Test Receiver R&S	ESCS 30	100375	May 09, 2016	May 08, 2017
Line-Impedance Stabilization Network (for EUT) SCHWARZBECK	NSLK-8127	8127-522	Aug. 31, 2016	Aug. 30, 2017
Line-Impedance Stabilization Network (for Peripheral) R&S	ENV216	100072	June 13, 2016	June 12, 2017
RF Cable	5D-FB	COACAB-002	Mar. 04, 2016	Mar. 03, 2017
10 dB PAD Mini-Circuits	HAT-10+	CONATT-003	Sep. 13, 2016	Sep. 12, 2017
50 ohms Terminator	N/A	04	Nov. 18, 2015	Nov. 17, 2016
50 ohms Terminator	50	3	Oct. 21, 2015	Oct. 20, 2016
Software BVADT	BVADT_Cond_ V7.3.7.4	NA	NA	NA

Note:

1. The calibration interval of the above test instruments are 12 months and the calibrations are traceable to NML/ROC and NIST/USA.
2. The test was performed in Shielded Room No. C.
- 3 The VCCI Con C Registration No. is C-3611.
- 4 Tested Date:Oct. 02, 2016

4.2.3 Test Procedure

- The EUT was placed 0.4 meters from the conducting wall of the shielded room with EUT being connected to the power mains through a line impedance stabilization network (LISN). Other support units were connected to the power mains through another LISN. The two LISNs provide 50 ohm/ 50uH of coupling impedance for the measuring instrument.
- Both lines of the power mains connected to the EUT were checked for maximum conducted interference.
- The frequency range from 150kHz to 30MHz was searched. Emission levels under (Limit - 20dB) was not recorded.

NOTE: All modes of operation were investigated and the worst-case emissions are reported.

4.2.4 Deviation from Test Standard

No deviation.

4.2.5 Test Setup

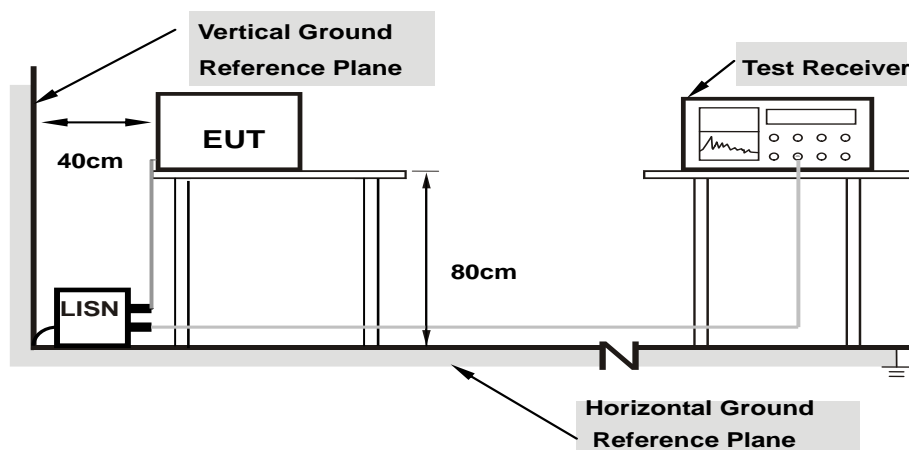

Note: 1.Support units were connected to second LISN.

For the actual test configuration, please refer to the attached file (Test Setup Photo).

4.2.6 EUT Operating Condition

Same as 4.1.6.

4.2.7 Test Results (Mode 1)

Phase	Line (L)	Detector Function	Quasi-Peak (QP) / Average (AV)
-------	----------	-------------------	--------------------------------

No	Freq. [MHz]	Corr.	Reading Value		Emission Level		Limit		Margin	
		Factor	[dB (uV)]		[dB (uV)]		[dB (uV)]		(dB)	
	(dB)	Q.P.	AV.	Q.P.	AV.	Q.P.	AV.	Q.P.	AV.	
1	0.15000	10.14	33.48	7.55	43.62	17.69	66.00	56.00	-22.38	-38.31
2	0.18125	10.13	29.72	1.57	39.85	11.70	64.43	54.43	-24.58	-42.73
3	0.23984	10.12	16.25	-4.61	26.37	5.51	62.10	52.10	-35.73	-46.59
4	0.45078	10.11	7.70	-7.82	17.81	2.29	56.86	46.86	-39.05	-44.57
5	10.37891	10.45	33.29	30.40	43.74	40.85	60.00	50.00	-16.26	-9.15
6	12.77344	10.54	22.54	20.63	33.08	31.17	60.00	50.00	-26.92	-18.83

REMARKS:

1. Q.P. and AV. are abbreviations of quasi-peak and average individually.
2. The emission levels of other frequencies were very low against the limit.
3. Margin value = Emission level - Limit value
4. Correction factor = Insertion loss + Cable loss
5. Emission Level = Correction Factor + Reading Value.

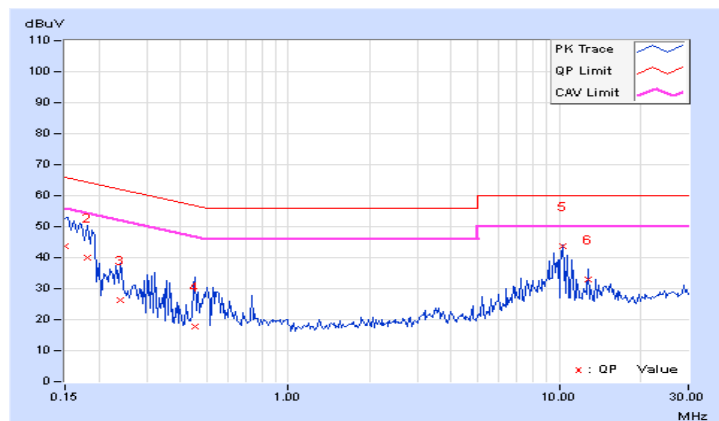

Phase	Neutral (N)	Detector Function	Quasi-Peak (QP) / Average (AV)
-------	-------------	-------------------	--------------------------------

No	Freq. [MHz]	Corr. Factor	Reading Value [dB (uV)]		Emission Level [dB (uV)]		Limit [dB (uV)]		Margin (dB)	
		(dB)	Q.P.	AV.	Q.P.	AV.	Q.P.	AV.	Q.P.	AV.
	1	0.15391	10.18	33.34	7.47	43.52	17.65	65.79	55.79	-22.27
2	0.20078	10.07	23.71	-1.96	33.78	8.11	63.58	53.58	-29.80	-45.47
3	0.41563	10.09	11.34	-6.85	21.43	3.24	57.54	47.54	-36.11	-44.30
4	7.18750	10.40	24.71	23.61	35.11	34.01	60.00	50.00	-24.89	-15.99
5	10.37500	10.49	30.81	25.20	41.30	35.69	60.00	50.00	-18.70	-14.31
6	23.27344	10.95	9.98	5.63	20.93	16.58	60.00	50.00	-39.07	-33.42

REMARKS:

1. Q.P. and AV. are abbreviations of quasi-peak and average individually.
2. The emission levels of other frequencies were very low against the limit.
3. Margin value = Emission level - Limit value
4. Correction factor = Insertion loss + Cable loss
5. Emission Level = Correction Factor + Reading Value.

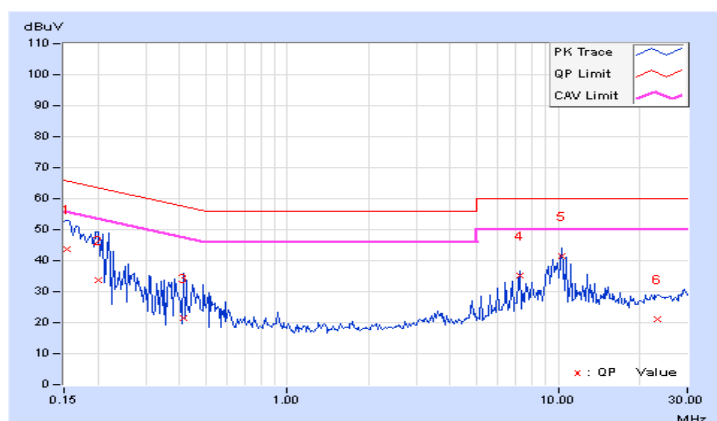

4.2.8 Test Results (Mode 2)

Phase	Line (L)	Detector Function	Quasi-Peak (QP) / Average (AV)
-------	----------	-------------------	--------------------------------

No	Freq. [MHz]	Corr. Factor	Reading Value [dB (uV)]		Emission Level [dB (uV)]		Limit [dB (uV)]		Margin (dB)	
		(dB)	Q.P.	AV.	Q.P.	AV.	Q.P.	AV.	Q.P.	AV.
	1	0.15000	10.14	34.72	15.15	44.86	25.29	66.00	56.00	-21.14
2	0.18125	10.13	30.88	11.42	41.01	21.55	64.43	54.43	-23.42	-32.88
3	0.26328	10.12	22.97	8.65	33.09	18.77	61.33	51.33	-28.24	-32.56
4	0.39609	10.11	30.89	21.06	41.00	31.17	57.93	47.93	-16.93	-16.76
5	5.95313	10.35	7.66	1.95	18.01	12.30	60.00	50.00	-41.99	-37.70
6	13.60156	10.58	14.46	7.07	25.04	17.65	60.00	50.00	-34.96	-32.35

REMARKS:

1. Q.P. and AV. are abbreviations of quasi-peak and average individually.
2. The emission levels of other frequencies were very low against the limit.
3. Margin value = Emission level - Limit value
4. Correction factor = Insertion loss + Cable loss
5. Emission Level = Correction Factor + Reading Value.

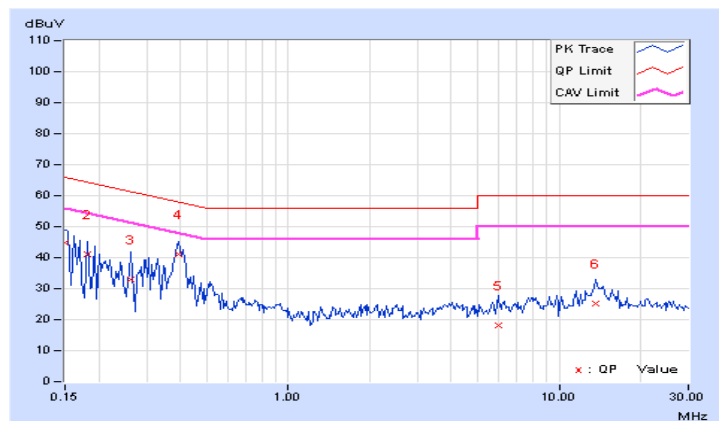

Phase	Neutral (N)	Detector Function	Quasi-Peak (QP) / Average (AV)
-------	-------------	-------------------	--------------------------------

No	Freq. [MHz]	Corr. Factor	Reading Value [dB (uV)]		Emission Level [dB (uV)]		Limit [dB (uV)]		Margin (dB)	
		(dB)	Q.P.	AV.	Q.P.	AV.	Q.P.	AV.	Q.P.	AV.
	1	0.16172	10.16	34.76	24.21	44.92	34.37	65.38	55.38	-20.46
2	0.31797	10.08	29.97	19.10	40.05	29.18	59.76	49.76	-19.71	-20.58
3	0.40000	10.09	36.79	28.84	46.88	38.93	57.85	47.85	-10.97	-8.92
4	3.66406	10.29	12.17	6.45	22.46	16.74	56.00	46.00	-33.54	-29.26
5	9.86719	10.48	17.24	9.87	27.72	20.35	60.00	50.00	-32.28	-29.65
6	14.99219	10.67	16.48	9.56	27.15	20.23	60.00	50.00	-32.85	-29.77

REMARKS:

1. Q.P. and AV. are abbreviations of quasi-peak and average individually.
2. The emission levels of other frequencies were very low against the limit.
3. Margin value = Emission level - Limit value
4. Correction factor = Insertion loss + Cable loss
5. Emission Level = Correction Factor + Reading Value.

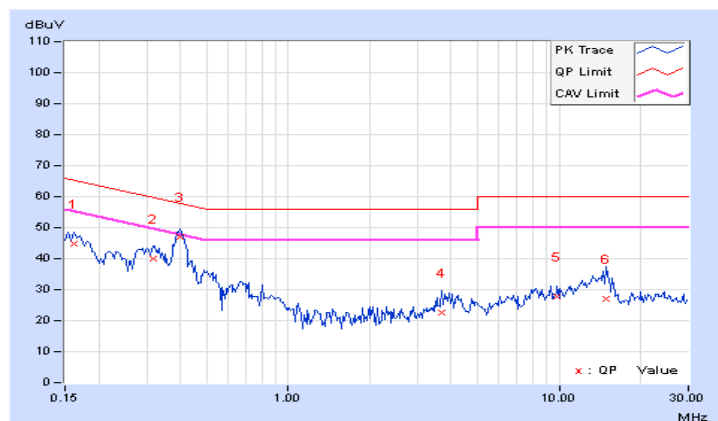

4.3 Transmit Power Measurement

4.3.1 Limits of Transmit Power Measurement

Operation Band	EUT Category		Limit
U-NII-1		Outdoor Access Point	1 Watt (30 dBm) (Max. e.i.r.p \leq 125mW(21 dBm) at any elevation angle above 30 degrees as measured from the horizon)
		Fixed point-to-point Access Point	1 Watt (30 dBm)
	√	Indoor Access Point	1 Watt (30 dBm)
		Mobile and Portable client device	250mW (24 dBm)
U-NII-2A	---		250mW (24 dBm) or 11 dBm+10 log B*
U-NII-2C	---		250mW (24 dBm) or 11 dBm+10 log B*
U-NII-3	√		1 Watt (30 dBm)

*B is the 26 dB emission bandwidth in megahertz

Per KDB 662911 Method of conducted output power measurement on IEEE 802.11 devices,

Array Gain = 0 dB (i.e., no array gain) for $N_{ANT} \leq 4$;

Array Gain = 0 dB (i.e., no array gain) for channel widths ≥ 40 MHz for any N_{ANT} ;

Array Gain = $5 \log(N_{ANT}/N_{SS})$ dB or 3 dB, whichever is less for 20-MHz channel widths with $N_{ANT} \geq 5$.

For power measurements on all other devices: Array Gain = $10 \log(N_{ANT}/N_{SS})$ dB.

4.3.2 Test Setup

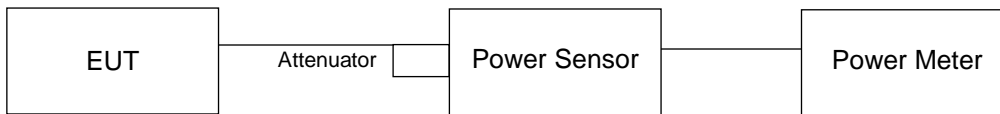

4.3.3 Test Instruments

Refer to section 4.1.2 to get information of above instrument.

4.3.4 Test Procedure

Method PM is used to perform output power measurement, trigger and gating function of wide band power meter is enabled to measure max output power of TX on burst. Duty factor is not added to measured value.

4.3.5 Deviation from Test Standard

No deviation.

4.3.6 EUT Operating Condition

The software provided by client to enable the EUT under transmission condition continuously at lowest, middle and highest channel frequencies individually.

4.3.7 Test Result

802.11a

CHAN.	FREQ. (MHz)	Maximum Conducted Power (dBm)		Total Power (mW)	Total Power (dBm)	Power Limit (dBm)	Pass/Fail
		CHAIN 0	CHAIN 1				
36	5180	15.36	15.47	69.593	18.43	30	Pass
40	5200	19.57	20.22	195.769	22.92	30	Pass
48	5240	16.68	17.92	108.503	20.35	30	Pass
149	5745	20.13	18.41	172.382	22.36	30	Pass
157	5785	20.51	18.09	176.877	22.48	30	Pass
165	5825	20.45	17.78	170.896	22.33	30	Pass

802.11ac (VHT20)

CHAN.	FREQ. (MHz)	Maximum Conducted Power (dBm)		Total Power (mW)	Total Power (dBm)	Power Limit (dBm)	Pass/Fail
		CHAIN 0	CHAIN 1				
36	5180	15.75	16.43	81.538	19.11	30	Pass
40	5200	19.67	20.08	194.542	22.89	30	Pass
48	5240	16.74	17.89	108.724	20.36	30	Pass
149	5745	20.31	18.67	181.02	22.58	30	Pass
157	5785	20.58	18.26	181.276	22.58	30	Pass
165	5825	20.65	17.80	176.401	22.47	30	Pass

802.11ac (VHT40)

CHAN.	FREQ. (MHz)	Maximum Conducted Power (dBm)		Total Power (mW)	Total Power (dBm)	Power Limit (dBm)	Pass/Fail
		CHAIN 0	CHAIN 1				
38	5190	14.26	13.40	48.547	16.86	30	Pass
46	5230	17.55	17.40	111.839	20.49	30	Pass
151	5755	20.09	18.33	170.171	22.31	30	Pass
159	5795	20.28	18.01	169.901	22.30	30	Pass

802.11ac (VHT80)

CHAN.	CHAN. FREQ. (MHz)	Maximum Conducted Power (dBm)		Total Power (mW)	Total Power (dBm)	Power Limit (dBm)	Pass/Fail
		CHAIN 0	CHAIN 1				
42	5210	12.15	14.92	47.452	16.76	30	Pass
155	5775	18.86	16.91	126.004	21.00	30	Pass

4.4 Occupied Bandwidth Measurement

4.4.1 Test Setup

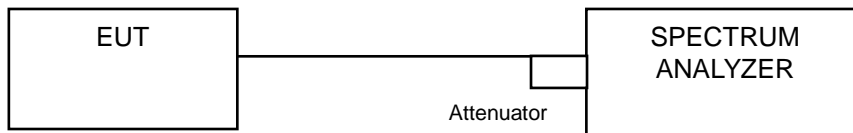

4.4.2 Test Instruments

Refer to section 4.1.2 to get information of above instrument.

4.4.3 Test Procedure

The transmitter output was connected to the spectrum analyzer through an attenuator. The bandwidth of the fundamental frequency was measured by spectrum analyzer with resolution bandwidth in the range of 1% to 5% of the anticipated emission bandwidth, and a video bandwidth at least 3x the resolution bandwidth and set the detector to SAMPLE. The width of a frequency band such that, below the lower and above the upper frequency limits, the mean powers emitted are each equal to a specified percentage 0.5 %of the total mean power of a given emission.

4.4.4 Test Results

802.11a

Channel	Channel Frequency (MHz)	Occupied Bandwidth (MHz)	
		CHAIN 0	CHAIN 1
36	5180	16.80	16.80
40	5200	24.36	27.84
48	5240	16.92	17.88
149	5745	28.44	36.24
157	5785	28.92	36.36
165	5825	30.24	37.80

802.11ac (VHT20)

Channel	Channel Frequency (MHz)	Occupied Bandwidth (MHz)	
		CHAIN 0	CHAIN 1
36	5180	18.00	18.00
40	5200	27.00	30.12
48	5240	18.12	18.72
149	5745	30.60	37.56
157	5785	30.96	38.64
165	5825	31.44	39.24

802.11ac (VHT40)

Channel	Channel Frequency (MHz)	Occupied Bandwidth (MHz)	
		CHAIN 0	CHAIN 1
38	5190	36.72	36.72
46	5230	37.20	37.68
151	5755	55.44	58.32
159	5795	58.56	76.08

802.11ac (VHT80)

Channel	Channel Frequency (MHz)	Occupied Bandwidth (MHz)	
		CHAIN 0	CHAIN 1
42	5210	75.84	75.84
155	5775	81.60	90.72

Spectrum Plot of Worst Value

802.11a_Chain1 / CH165

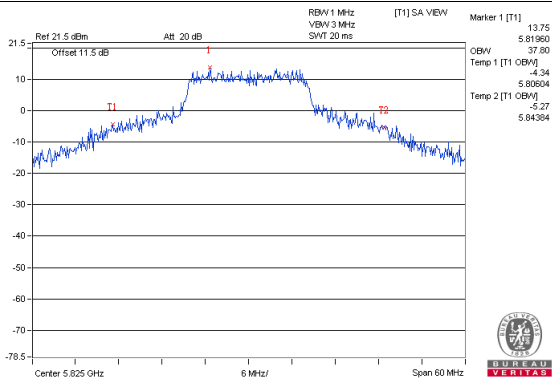

802.11n (HT20)_Chain1 / CH165

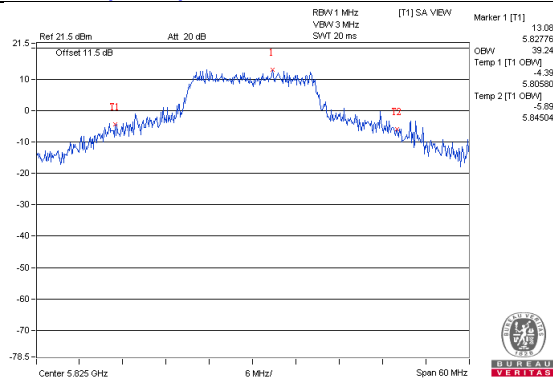

802.11n (HT40)_Chain1 / CH159

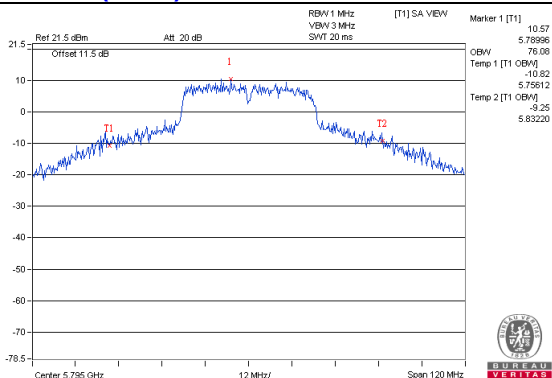

802.11ac (VHT80)_Chain1 / CH155

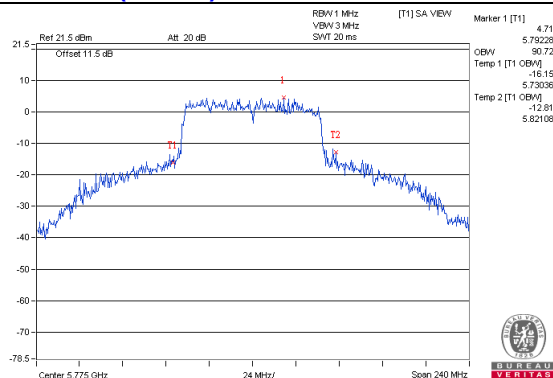

**Spectrum Plot for near by DFS band
(DFS is required, if 99% OCP straddle into U-NII-2A band)**

802.11a_Chain0 / CH48

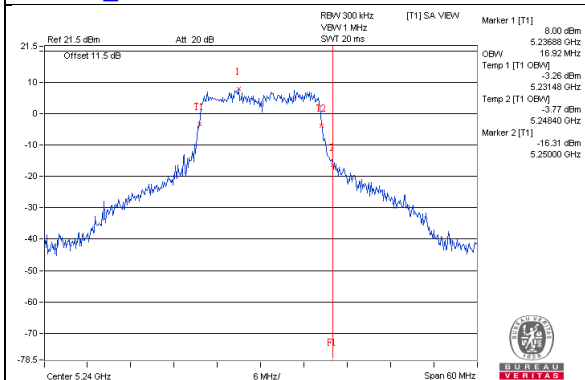

802.11a_Chain1 / CH48

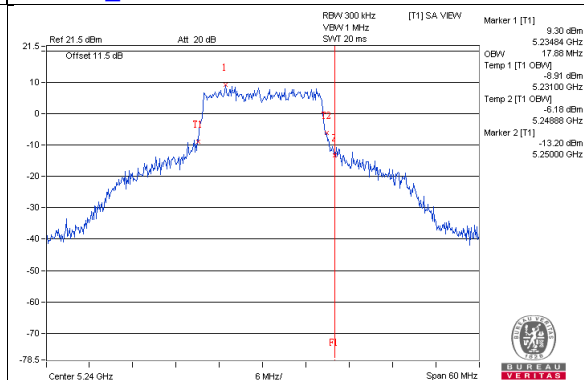

802.11ac(VHT20)_Chain0 / CH48

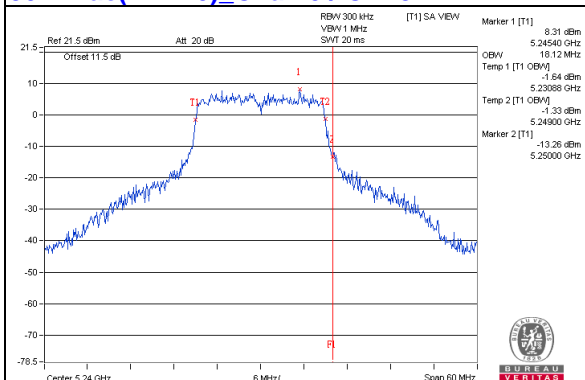

802.11ac(VHT20)_Chain1 / CH48

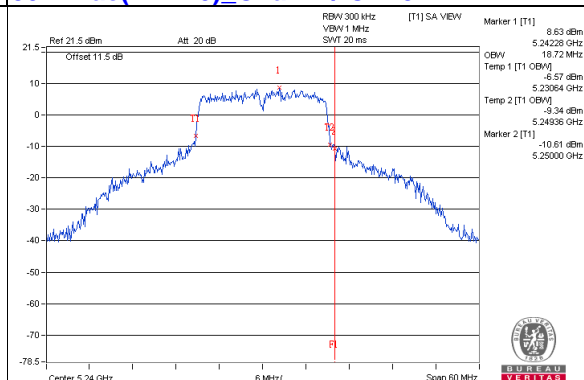

802.11ac(VHT40)_Chain0 / CH46

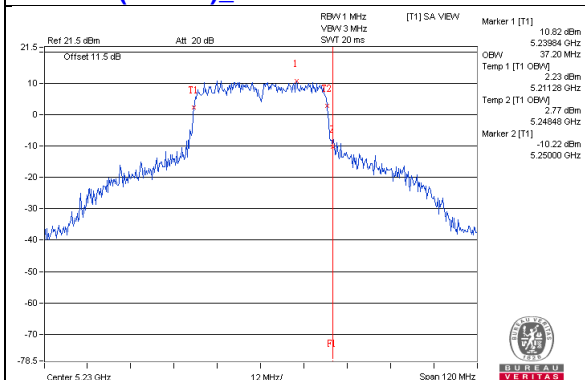

802.11ac(VHT40)_Chain1 / CH46

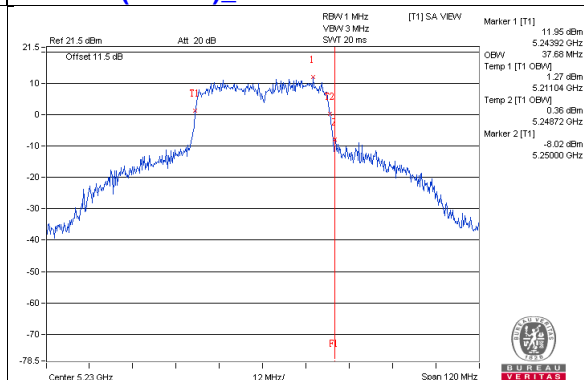

802.11ac(VHT80)_Chain0 / CH42

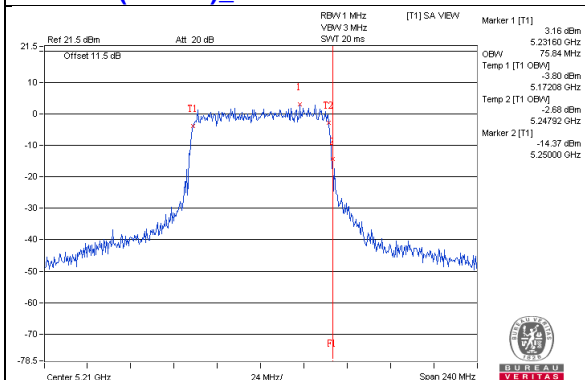

802.11ac(VHT80)_Chain1 / CH42

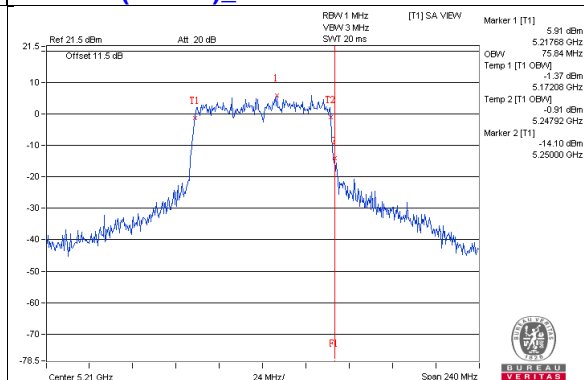

**Spectrum Plot for near by DFS band
(DFS is required, if 99% OCP straddle into U-NII-2C band)**

802.11a_Chain0 / CH149

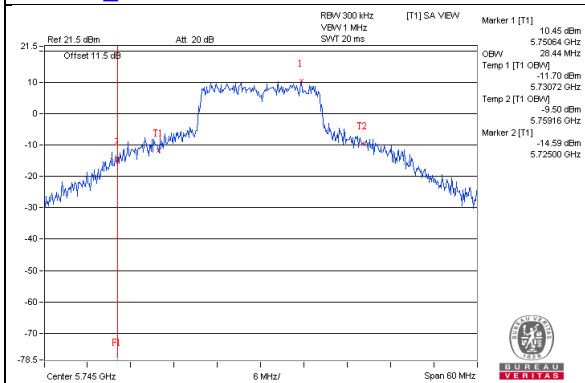

802.11a_Chain1 / CH149

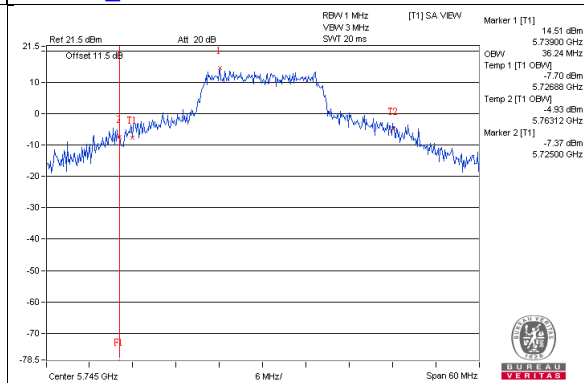

802.11ac(VHT20)_Chain0 / CH149

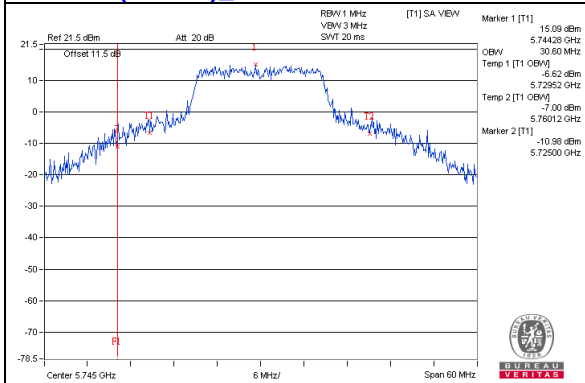

802.11ac(VHT20)_Chain1 / CH149

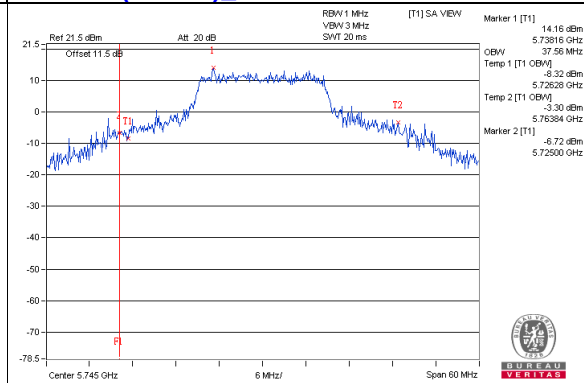

802.11ac(VHT40)_Chain0 / CH151

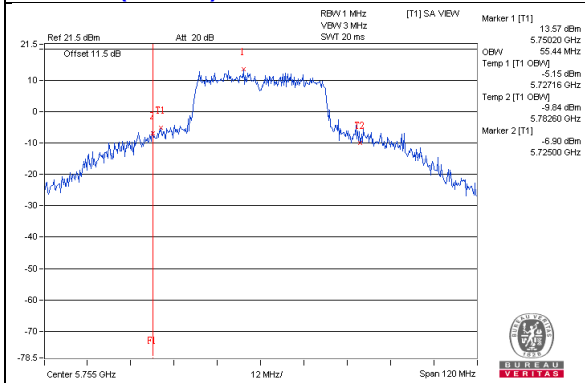

802.11ac(VHT40)_Chain1 / CH151

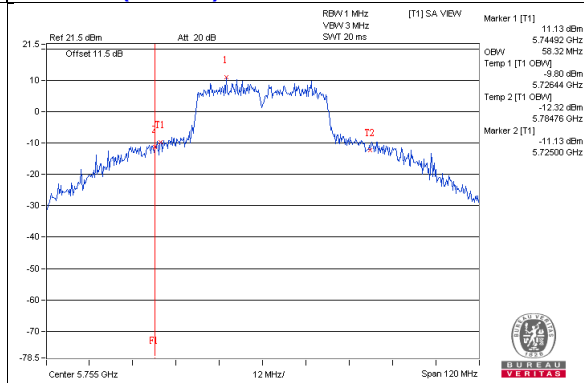

802.11ac(VHT80)_Chain0 / CH155

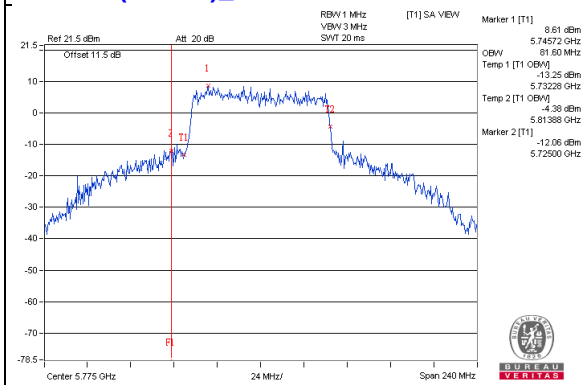

802.11ac(VHT80)_Chain1 / CH155

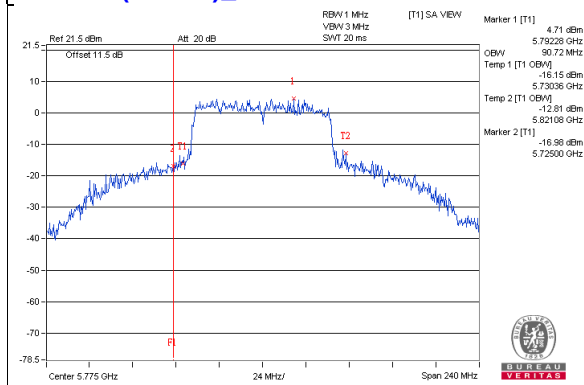

4.5 Peak Power Spectral Density Measurement

4.5.1 Limits of Peak Power Spectral Density Measurement

Operation Band	EUT Category		Limit
U-NII-1		Outdoor Access Point	17dBm/ MHz
		Fixed point-to-point Access Point	
	√	Indoor Access Point	11dBm/ MHz
		Mobile and Portable client device	
U-NII-2A	---		11dBm/ MHz
U-NII-2C	---		11dBm/ MHz
U-NII-3	√		30dBm/ 500kHz

4.5.2 Test Setup

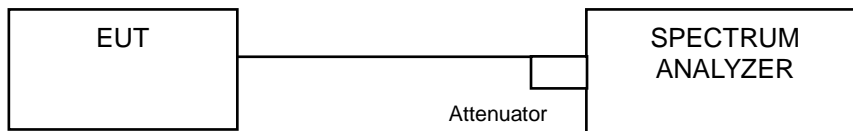

4.5.3 Test Instruments

Refer to section 4.1.2 to get information of above instrument.

4.5.4 Test Procedure

For U-NII-1:

Using method SA-1

- 1) Set span to encompass the entire emission bandwidth (EBW) of the signal.
- 2) Set RBW = 30 kHz, Set VBW ≥ 1 MHz, Detector = RMS
- 3) Set Channel power measure = 1MHz
- 4) Sweep time = auto, trigger set to “free run”.
- 5) Trace average at least 100 traces in power averaging mode.
- 6) Record the max value

For U-NII-3

1. Set span to encompass the entire emission bandwidth (EBW) of the signal.
2. Set RBW = 300 kHz, Set VBW ≥ 1 MHz, Detector = RMS
3. Use the peak marker function to determine the maximum power level in any 300 kHz band segment within the fundamental EBW.
4. Scale the observed power level to an equivalent value in 500 kHz by adjusting (reducing) the measured power by a bandwidth correction factor (BWCF) where $BWCF = 10\log(500\text{ kHz}/300\text{kHz})$
5. Sweep time = auto, trigger set to “free run”.
6. Trace average at least 100 traces in power averaging mode.
7. Record the max value

4.5.5 Deviation from Test Standard

No deviation.

4.5.6 EUT Operating Condition

Same as Item 4.3.6.

4.5.7 Test Results

For U-NII-1:

802.11a

Chan.	Chan. Freq. (MHz)	PSD (dBm/MHz)		Total Power Density (dBm/MHz)	MAX. Limit (dBm/MHz)	Pass / Fail
		Chain 0	Chain 1			
36	5180	1.37	2.53	5.00	14.49	Pass
40	5200	5.99	6.80	9.42	14.49	Pass
48	5240	3.38	4.98	7.26	14.49	Pass

- Note:** 1. Method a) of power density measurement of KDB 662911 is using for calculating total power density. Total power density is summing entire spectra across corresponding frequency bins on the various outputs by computer.
2. Directional gain = $5.5\text{dBi} + 10\log(2) = 8.51\text{dBi} > 6\text{dBi}$, so the power density limit shall be reduced to $17-(8.51-6) = 14.49\text{dBm}$.

802.11ac (VHT20)

Chan.	Chan. Freq. (MHz)	PSD (dBm/MHz)		Total Power Density (dBm/MHz)	MAX. Limit (dBm/MHz)	Pass / Fail
		Chain 0	Chain 1			
36	5180	1.53	2.57	5.09	14.49	Pass
40	5200	5.68	6.42	9.08	14.49	Pass
48	5240	3.05	4.45	6.82	14.49	Pass

- Note:** 1. Method a) of power density measurement of KDB 662911 is using for calculating total power density. Total power density is summing entire spectra across corresponding frequency bins on the various outputs by computer.
2. Directional gain = $5.5\text{dBi} + 10\log(2) = 8.51\text{dBi} > 6\text{dBi}$, so the power density limit shall be reduced to $17-(8.51-6) = 14.49\text{dBm}$.

802.11ac (VHT40)

Chan.	Chan. Freq. (MHz)	PSD (dBm/MHz)		Total Power Density (dBm/MHz)	MAX. Limit (dBm/MHz)	Pass / Fail
		Chain 0	Chain 1			
38	5190	-2.39	-2.86	0.39	14.49	Pass
46	5230	1.32	1.59	4.47	14.49	Pass

- Note:** 1. Method a) of power density measurement of KDB 662911 is using for calculating total power density. Total power density is summing entire spectra across corresponding frequency bins on the various outputs by computer.
2. Directional gain = $5.5\text{dBi} + 10\log(2) = 8.51\text{dBi} > 6\text{dBi}$, so the power density limit shall be reduced to $17-(8.51-6) = 14.49\text{dBm}$.

802.11ac (VHT80)

Chan.	Chan. Freq. (MHz)	PSD (dBm/MHz)		Total Power Density (dBm/MHz)	MAX. Limit (dBm/MHz)	Pass / Fail
		Chain 0	Chain 1			
42	5210	-6.64	-4.42	-2.38	14.49	Pass

- Note:** 1. Method a) of power density measurement of KDB 662911 is using for calculating total power density. Total power density is summing entire spectra across corresponding frequency bins on the various outputs by computer.
2. Directional gain = $5.5\text{dBi} + 10\log(2) = 8.51\text{dBi} > 6\text{dBi}$, so the power density limit shall be reduced to $17 - (8.51 - 6) = 14.49\text{dBm}$.

Spectrum Plot of Worst Value

802.11a_Chain 1 / CH40

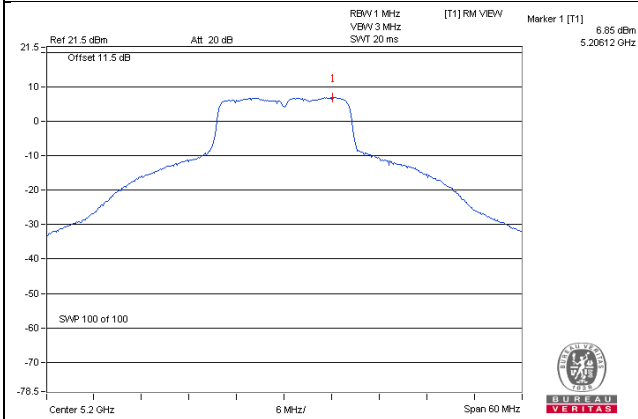

802.11ac (VHT20)_Chain 1 / CH40

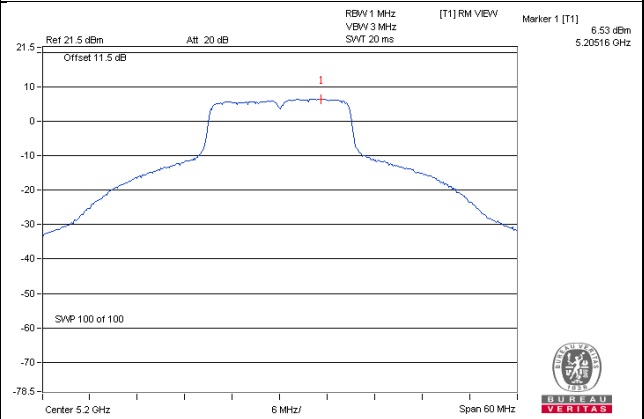

802.11ac (VHT40)_Chain 1 / CH46

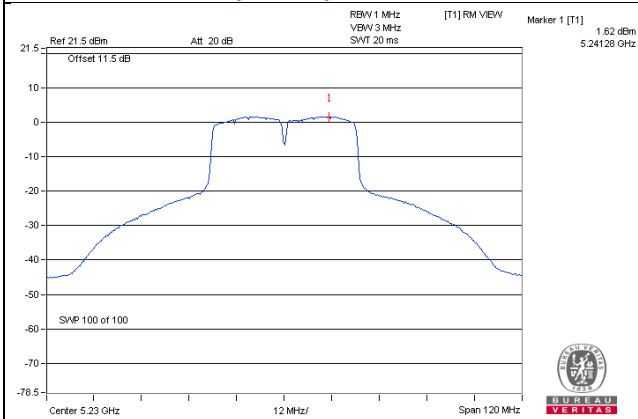

802.11ac (VHT80)_Chain 1 / CH42

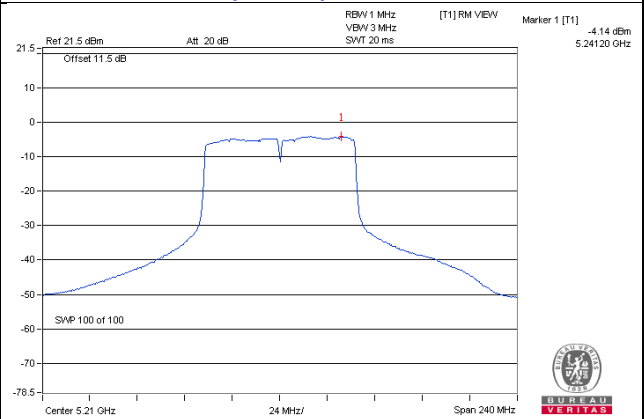

**For U-NII-3:
802.11a**

TX chain	Channel	Freq. (MHz)	PSD (dBm/300kHz)	PSD (dBm/500kHz)	10 log (N=2) dB	Total PSD (dBm/500kHz)	Limit (dBm/500kHz)	Pass /Fail
0	149	5745	-1.99	0.23	3.01	3.24	26.99	Pass
	157	5785	-1.97	0.25	3.01	3.26	26.99	Pass
	165	5825	-1.55	0.67	3.01	3.68	26.99	Pass
1	149	5745	-4.31	-2.09	3.01	0.92	26.99	Pass
	157	5785	-4.59	-2.37	3.01	0.64	26.99	Pass
	165	5825	-4.91	-2.69	3.01	0.32	26.99	Pass

Note: 1. Directional gain = 6dBi + 10log(2) = 9.01dBi > 6dBi , so the power density limit shall be reduced to 30-(9.01-6) = 26.99dBm.

802.11ac (VHT20)

TX chain	Channel	Freq. (MHz)	PSD (dBm/300kHz)	PSD (dBm/500kHz)	10 log (N=2) dB	Total PSD (dBm/500kHz)	Limit (dBm/500kHz)	Pass /Fail
0	149	5745	-2.05	0.17	3.01	3.18	26.99	Pass
	157	5785	-2.00	0.22	3.01	3.23	26.99	Pass
	165	5825	-2.34	-0.12	3.01	2.89	26.99	Pass
1	149	5745	-4.74	-2.52	3.01	0.49	26.99	Pass
	157	5785	-4.85	-2.63	3.01	0.38	26.99	Pass
	165	5825	-5.33	-3.11	3.01	-0.10	26.99	Pass

Note: 1. Directional gain = 6dBi + 10log(2) = 9.01dBi > 6dBi , so the power density limit shall be reduced to 30-(9.01-6) = 26.99dBm.

802.11ac (VHT40)

TX chain	Channel	Freq. (MHz)	PSD (dBm/300kHz)	PSD (dBm/500kHz)	10 log (N=2) dB	Total PSD (dBm/500kHz)	Limit (dBm/500kHz)	Pass /Fail
0	151	5755	-5.39	-3.17	3.01	-0.16	26.99	Pass
	159	5795	-5.80	-3.58	3.01	-0.57	26.99	Pass
1	151	5755	-8.17	-5.95	3.01	-2.94	26.99	Pass
	159	5795	-8.42	-6.20	3.01	-3.19	26.99	Pass

Note: 1. Directional gain = 6dBi + 10log(2) = 9.01dBi > 6dBi , so the power density limit shall be reduced to 30-(9.01-6) = 26.99dBm.

802.11ac (VHT80)

TX chain	Channel	Freq. (MHz)	PSD (dBm/300kHz)	PSD (dBm/500kHz)	10 log (N=2) dB	Total PSD (dBm/500kHz)	Limit (dBm/500kHz)	Pass /Fail
0	155	5775	-9.88	-7.66	3.01	-4.65	26.99	Pass
1	155	5775	-12.79	-10.57	3.01	-7.56	26.99	Pass

Note: 1. Directional gain = $6\text{dBi} + 10\log(2) = 9.01\text{dBi} > 6\text{dBi}$, so the power density limit shall be reduced to $30-(9.01-6) = 26.99\text{dBm}$.

Spectrum Plot of Worst Value

802.11a – Chain 0: CH 165

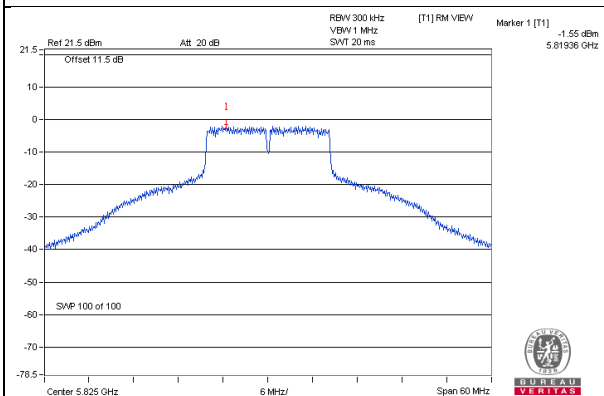

802.11ac (VHT20) – Chain 0: CH 157

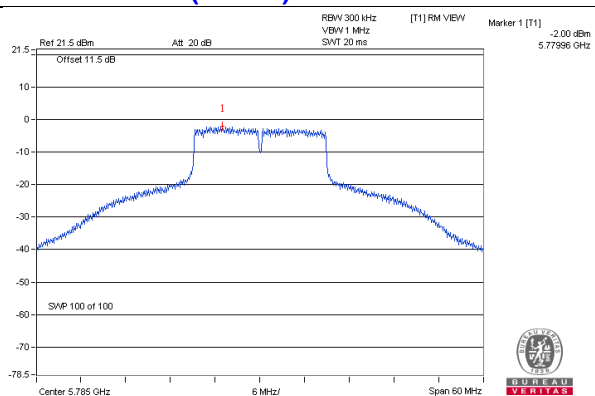

802.11ac (VHT40) – Chain 0: CH 151

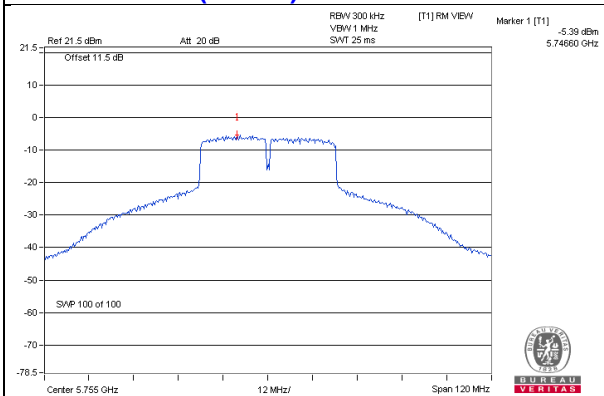

802.11ac (VHT80) – Chain 0: CH 155

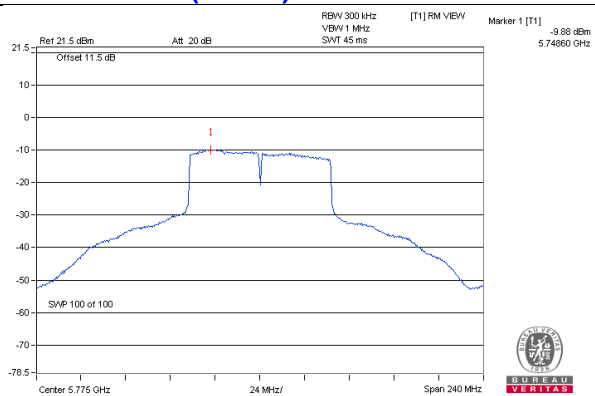

4.6 Frequency Stability Measurement

4.6.1 Limits of Frequency Stability Measurement

The frequency of the carrier signal shall be maintained within band of operation

4.6.2 Test Setup

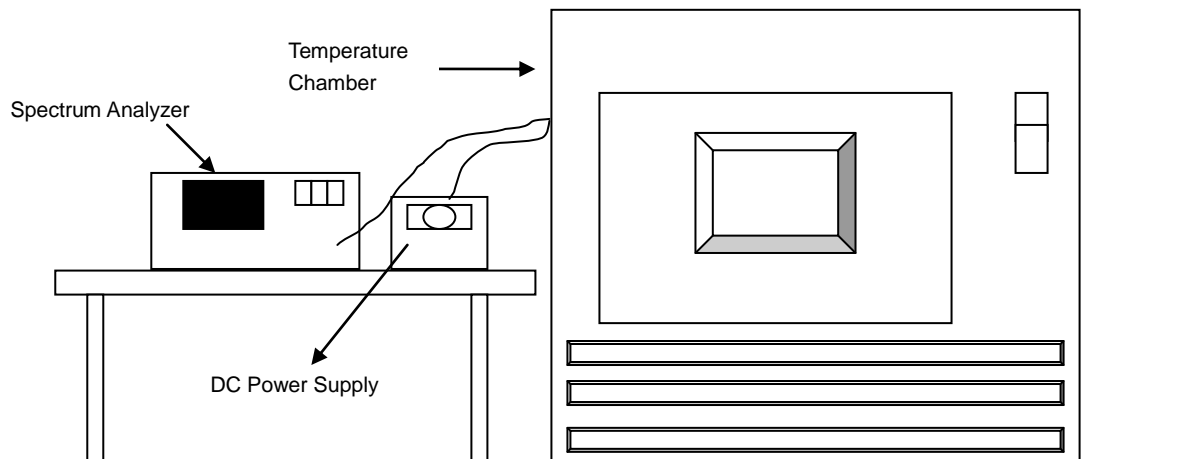

4.6.3 Test Instruments

Refer to section 4.1.2 to get information of above instrument.

4.6.4 Test Procedure

- The EUT was placed inside the environmental test chamber and powered by nominal DC voltage.
- Turn the EUT on and couple its output to a spectrum analyzer.
- Turn the EUT off and set the chamber to the highest temperature specified.
- Allow sufficient time (approximately 30 min) for the temperature of the chamber to stabilize, turn the EUT on and measure the operating frequency after 2, 5, and 10 Minutes.
- Repeat step 2 and 3 with the temperature chamber set to the lowest temperature.
- The test chamber was allowed to stabilize at +20 degree C for a minimum of 30 Minutes. The supply voltage was then adjusted on the EUT from 85% to 115% and the frequency record.

4.6.5 Deviation from Test Standard

No deviation.

4.6.6 EUT Operating Condition

Set the EUT transmit at un-modulation mode to test frequency stability.

4.6.7 Test Results

Frequency Stability Versus Temp.									
Operating Frequency: 5180 MHz									
TEMP. (°C)	Power Supply (Vdc)	0 Minute		2 Minute		5 Minute		10 Minute	
		Measured Frequency (MHz)	Pass/Fail	Measured Frequency (MHz)	Pass/Fail	Measured Frequency (MHz)	Pass/Fail	Measured Frequency (MHz)	Pass/Fail
50	30	5179.9725	Pass	5179.9768	Pass	5179.9738	Pass	5179.9773	Pass
40	30	5179.9762	Pass	5179.9772	Pass	5179.9747	Pass	5179.9752	Pass
30	30	5180.0034	Pass	5180.0045	Pass	5180.0056	Pass	5180.0058	Pass
20	30	5180.0111	Pass	5180.0124	Pass	5180.0126	Pass	5180.0128	Pass
10	30	5180.0214	Pass	5180.0175	Pass	5180.0212	Pass	5180.0168	Pass
0	30	5180.001	Pass	5180.004	Pass	5180.0028	Pass	5180.0034	Pass
-10	30	5179.9767	Pass	5179.9796	Pass	5179.9774	Pass	5179.9809	Pass
-20	30	5179.9772	Pass	5179.9747	Pass	5179.9742	Pass	5179.9765	Pass
-30	30	5180.0092	Pass	5180.0123	Pass	5180.0106	Pass	5180.0124	Pass

Frequency Stability Versus Voltage									
Operating Frequency: 5180 MHz									
TEMP. (°C)	Power Supply (Vdc)	0 Minute		2 Minute		5 Minute		10 Minute	
		Measured Frequency (MHz)	Pass/Fail	Measured Frequency (MHz)	Pass/Fail	Measured Frequency (MHz)	Pass/Fail	Measured Frequency (MHz)	Pass/Fail
20	34.5	5180.0109	Pass	5180.0124	Pass	5180.0122	Pass	5180.0128	Pass
	30	5180.0111	Pass	5180.0124	Pass	5180.0126	Pass	5180.0128	Pass
	25.5	5180.0105	Pass	5180.0134	Pass	5180.012	Pass	5180.013	Pass

4.7 6dB Bandwidth Measurement

4.7.1 Limits of 6dB Bandwidth Measurement

The minimum of 6dB Bandwidth Measurement is 0.5MHz.

4.7.2 Test Setup

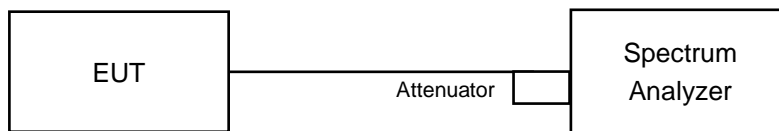

4.7.3 Test Instruments

Refer to section 4.1.2 to get information of above instrument.

4.7.4 Test Procedure

MEASUREMENT PROCEDURE REF

- a. Set resolution bandwidth (RBW) = 100kHz
- b. Set the video bandwidth (VBW) $\geq 3 \times$ RBW, Detector = Peak.
- c. Trace mode = max hold.
- d. Sweep = auto couple.
- e. Measure the maximum width of the emission that is constrained by the frequencies associated with the two amplitude points (upper and lower) that are attenuated by 6 dB relative to the maximum level measured in the fundamental emission

4.7.5 Deviation from Test Standard

No deviation.

4.7.6 EUT Operating Condition

The software provided by client to enable the EUT under transmission condition continuously at lowest, middle and highest channel frequencies individually.

4.7.7 Test Results

802.11a

Channel	Frequency (MHz)	6dB Bandwidth (MHz)		Minimum Limit (MHz)	Pass / Fail
		Chain 0	Chain 1		
149	5745	16.37	16.48	0.5	PASS
157	5785	16.39	16.47	0.5	PASS
165	5825	16.34	16.46	0.5	PASS

802.11ac (VHT20)

Channel	Frequency (MHz)	6dB Bandwidth (MHz)		Minimum Limit (MHz)	Pass / Fail
		Chain 0	Chain 1		
149	5745	17.70	17.73	0.5	PASS
157	5785	17.63	17.64	0.5	PASS
165	5825	17.60	17.66	0.5	PASS

802.11ac (VHT40)

Channel	Frequency (MHz)	6dB Bandwidth (MHz)		Minimum Limit (MHz)	Pass / Fail
		Chain 0	Chain 1		
151	5755	36.12	36.48	0.5	PASS
159	5795	36.46	36.52	0.5	PASS

802.11ac (VHT80)

Channel	Frequency (MHz)	6dB Bandwidth (MHz)		Minimum Limit (MHz)	Pass / Fail
		Chain 0	Chain 1		
155	5775	75.46	73.44	0.5	PASS

Spectrum Plot of Worst Value

802.11a_Chain 0 / CH165

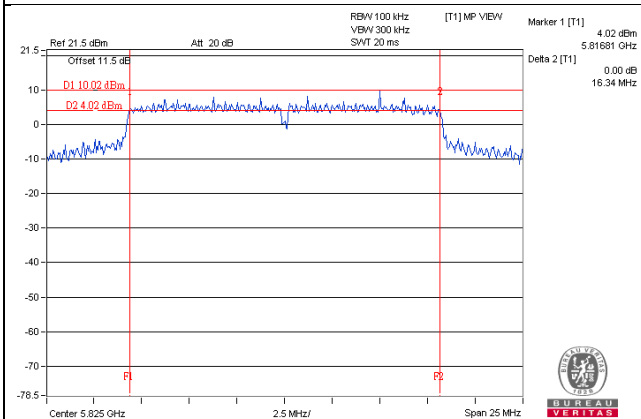

802.11ac (VHT20)_Chain 0 / CH165

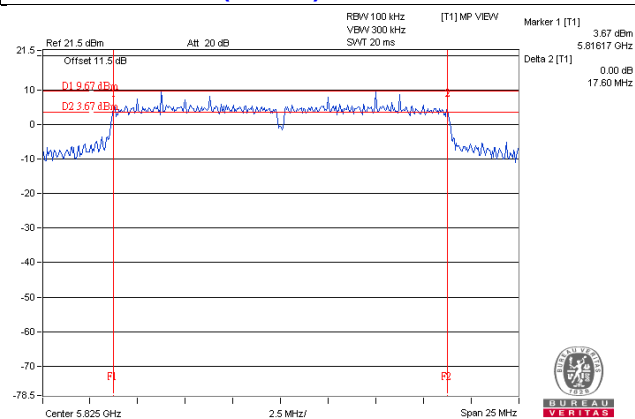

802.11ac (VHT40)_Chain 0 / CH151

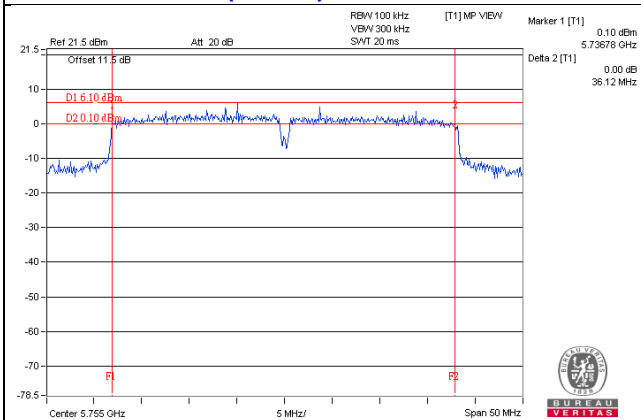

802.11ac (VHT80)_Chain 1 / CH151

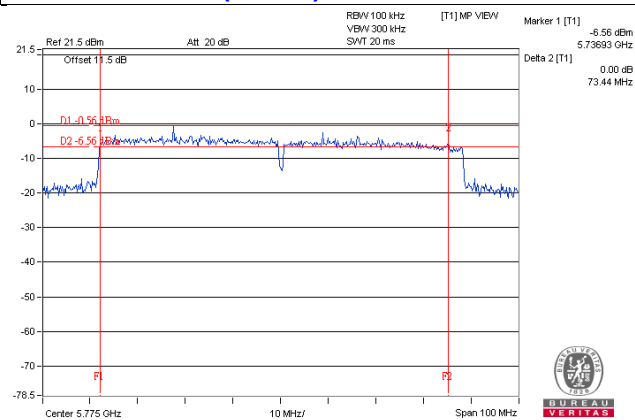

5 Pictures of Test Arrangements

Please refer to the attached file (Test Setup Photo).

Annex A- Radiated Out of Band Emission (OOBE) Measurement (For U-NII-3 band)

802.11a

CH 149 5745 MHz

Horizontal

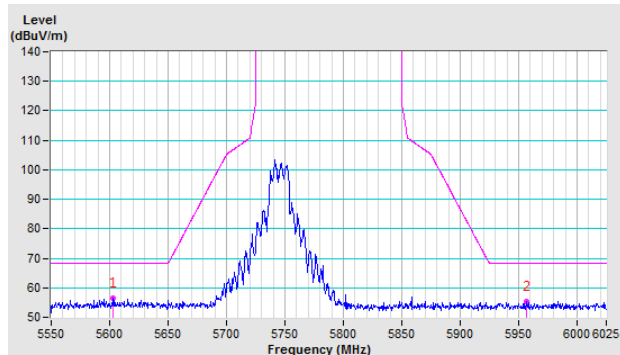

Vertical

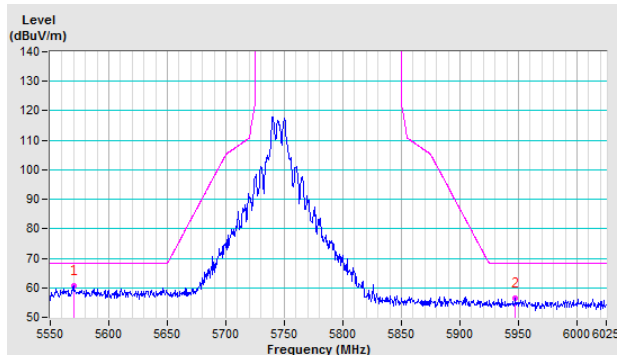

CH 157 5785 MHz

Horizontal

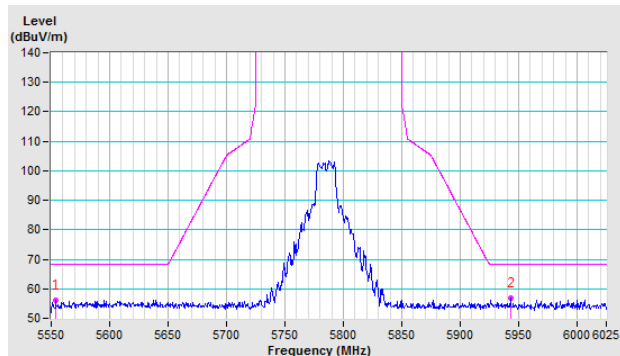

Vertical

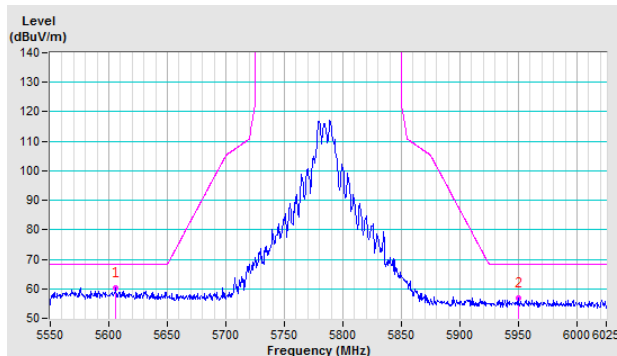

CH 165 5825 MHz

Horizontal

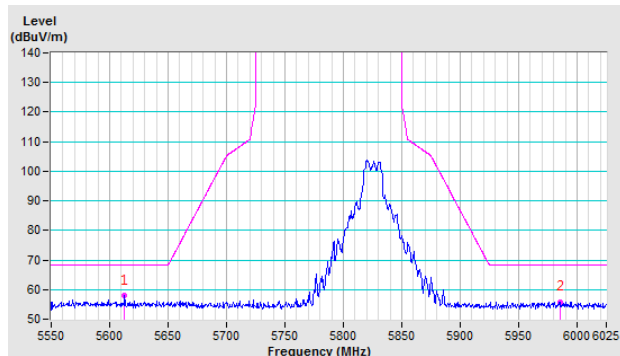

Vertical

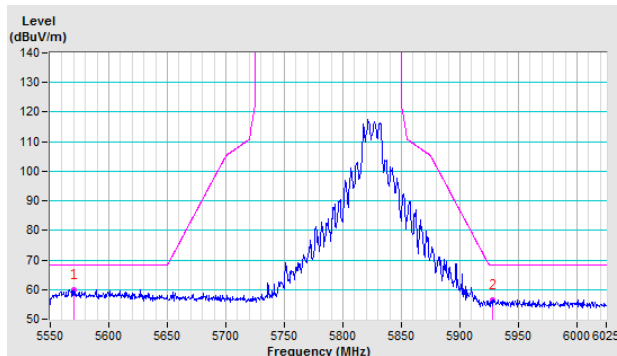

802.11ac (VHT20)

CH 149 5745 MHz

Horizontal

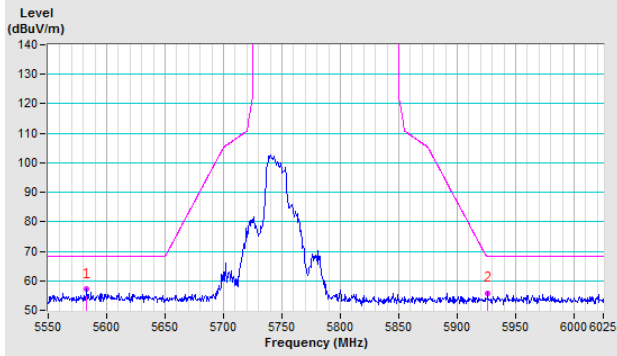

Vertical

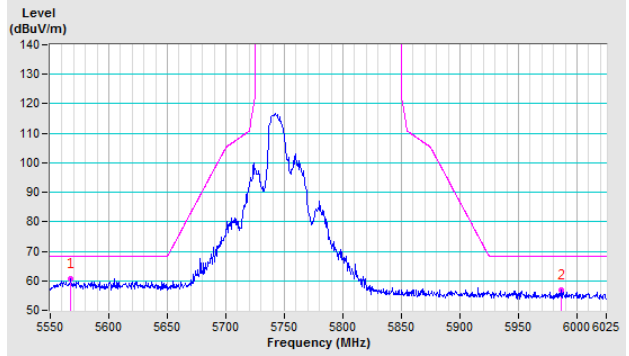

CH 157 5785 MHz

Horizontal

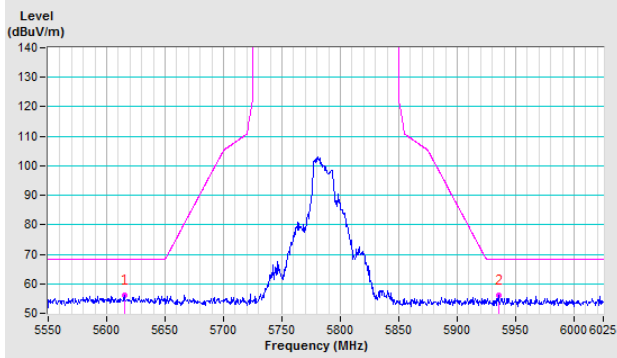

Vertical

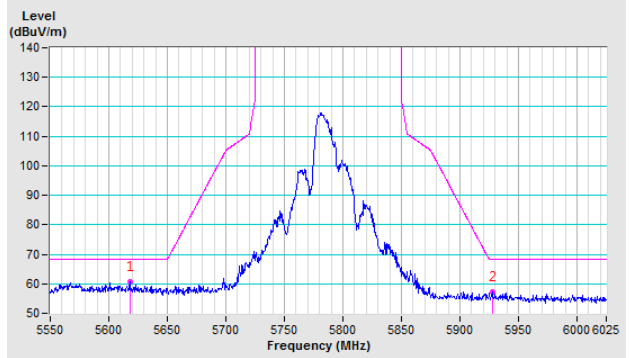

CH 165 5825 MHz

Horizontal

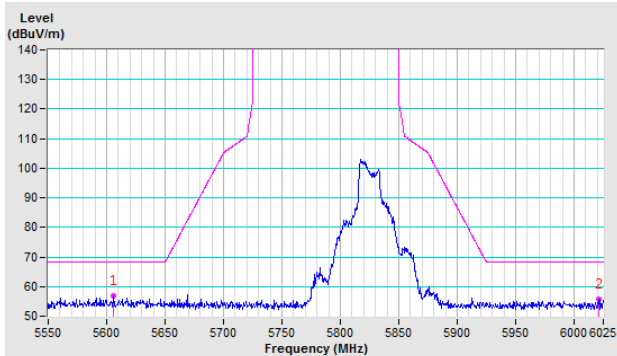

Vertical

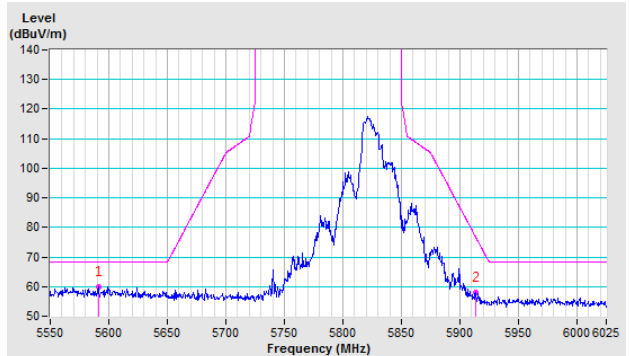

802.11ac (VHT40)

CH 151 5755 MHz

Horizontal

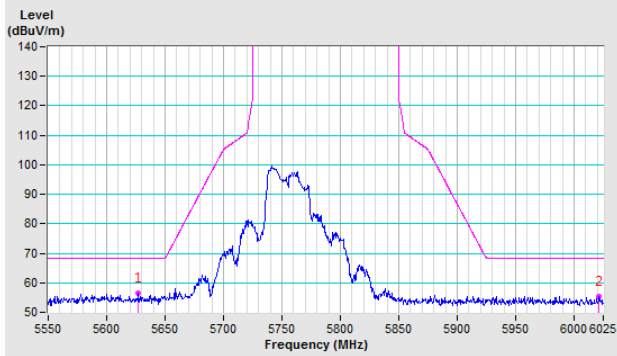

Vertical

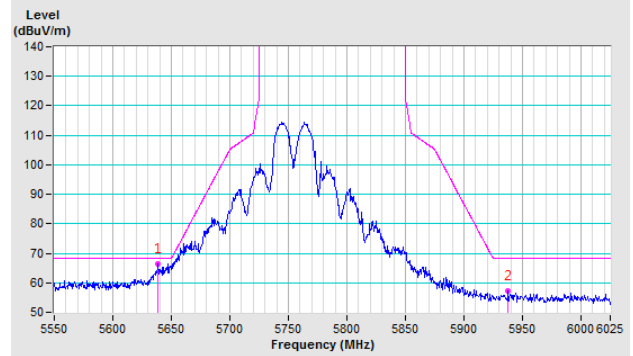

CH 159 5795 MHz

Horizontal

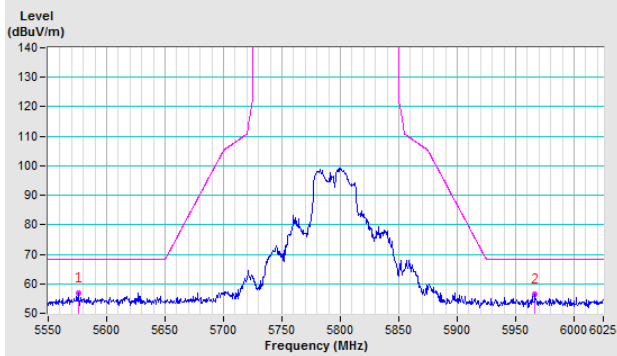

Vertical

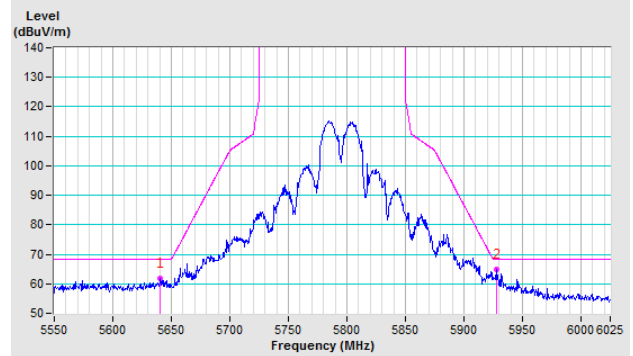

802.11ac (VHT80)

CH 155 5775 MHz

Horizontal

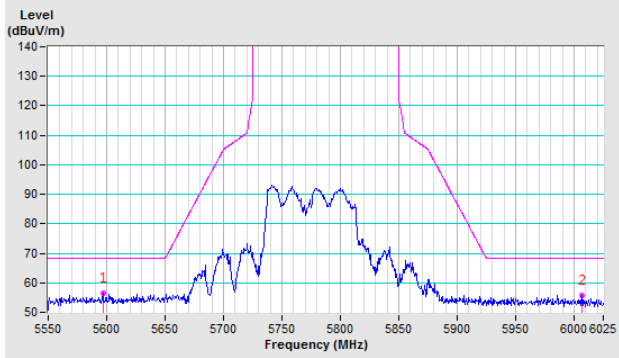

Vertical

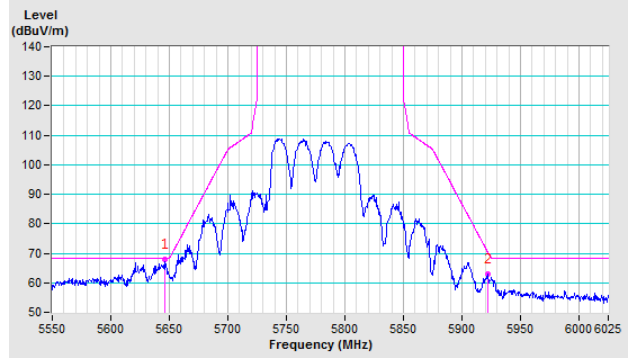

Appendix – Information on the Testing Laboratories

We, Bureau Veritas Consumer Products Services (H.K.) Ltd., Taoyuan Branch, were founded in 1988 to provide our best service in EMC, Radio, Telecom and Safety consultation. Our laboratories are accredited and approved according to ISO/IEC 17025.

If you have any comments, please feel free to contact us at the following:

Linko EMC/RF Lab

Tel: 886-2-26052180

Fax: 886-2-26051924

Hsin Chu EMC/RF/Telecom Lab

Tel: 886-3-6668565

Fax: 886-3-6668323

Hwa Ya EMC/RF/Safety Lab

Tel: 886-3-3183232

Fax: 886-3-3270892

Email: service.adt@tw.bureauveritas.com

Web Site: www.bureauveritas-adt.com

The address and road map of all our labs can be found in our web site also.

--- END ---