

RF Test Report

Applicant : PISMO LABS TECHNOLOGY LIMITED
Product Type : PEPWAVE / peplink Wireless Product
Trade Name : PEPWAVE, peplink
Model Number : AP One AC Mini, PismoAC0P, AC0P, APO-AC-MINI,
AP One series, AC0E, PismoAC0E
FCC ID : U8G-P1AC0P
Applicable Standard : FCC 47 CFR PART 15 SUBPART C
ANSI C63.10:2013
Receive Date : Jun. 13, 2019
Test Period : Jun. 24 ~ Jul. 09, 2019
Issue Date : Jul. 31, 2019

Issue by

A Test Lab Techno Corp.
No. 140-1, Changan Street, Bade District,
Taoyuan City 33465, Taiwan (R.O.C.)
Tel : +886-3-2710188 / Fax : +886-3-2710190



Taiwan Accreditation Foundation accreditation number: 1330
Test Firm MRA designation number: TW0010

Note:

1. The test results are valid only for samples provided by customers and under the test conditions described in this report.
2. This report shall not be reproduced except in full, without the written approval of A Test Lab Technology Corporation.
3. The relevant information is provided by customers in this test report. According to the correctness, appropriateness or completeness of the information provided by the customer, if there is any doubt or error in the information which affects the validity of the test results, the laboratory does not take the responsibility.



Revision History

Rev.	Issue Date	Revisions	Revised By
00	Jul. 31, 2019	Initial Issue	Tobey Cheng

Verification of Compliance

Issued Date: Jul. 31, 2019

Applicant : PISMO LABS TECHNOLOGY LIMITED

Product Type : PEPWAVE / peplink Wireless Product

Trade Name : PEPWAVE, peplink

Model Number : AP One AC Mini, PismoAC0P, AC0P, APO-AC-MINI,
AP One series, AC0E, PismoAC0E

EUT Rated Voltage : DC 12 V, 2 A

Test Voltage : 120 Vac / 60 Hz

Applicable Standard : FCC 47 CFR PART 15 SUBPART C
ANSI C63.10:2013

Test Result : Complied

Performing Lab. : A Test Lab Techno Corp.
No. 140-1, Changan Street, Bade District,
Taoyuan City 33465, Taiwan (R.O.C.)
Tel : +886-3-2710188 / Fax : +886-3-2710190
Taiwan Accreditation Foundation accreditation number: 1330
<http://www.atl-lab.com.tw/e-index.htm>



A Test Lab Techno Corp. tested the above equipment in accordance with the requirements set forth in the above standards. All indications of Pass/Fail in this report are opinions expressed by A Test Lab Techno Corp. based on interpretations and/or observations of test results. The test results show that the equipment tested is capable of demonstrating compliance with the requirements as documented in this report.

Approved By : Fly Lu Reviewed By : Eric Ou Yang
(Manager) (Fly Lu) (Testing Engineer) (Eric Ou Yang)



TABLE OF CONTENTS

1	General Information	5
1.1.	Summary of Test Result.....	5
1.2.	Measurement Uncertainty.....	6
2	EUT Description	7
3	Test Methodology	8
3.1.	Mode of Operation.....	8
3.2.	EUT Test Step	11
3.3.	Configuration of Test System Details	12
3.4.	Test Instruments	13
3.5.	Test Site Environment.....	14
4	Measurement Procedure	15
4.1.	AC Power Line Conducted Emission Measurement.....	15
4.2.	Radiated Emission Measurement.....	17
4.3.	Maximum Conducted Output Power Measurement.....	21
4.4.	6 dB RF Bandwidth Measurement	22
4.5.	Maximum Power Spectral Density Measurement.....	23
4.6.	Out of Band Conducted Emissions Measurement.....	24
4.7.	Antenna Measurement	25
5	Test Results.....	26
	Annex A. Conducted Emission	26
	Annex B. Conducted Test Results	28
	Annex C. Radiated Emission Measurement	73



1 General Information

1.1. Summary of Test Result

Standard	Item	Result	Remark
15.207	AC Power Conducted Emission	PASS	----
15.247(d)	Transmitter Radiated Emissions	PASS	----
15.247(b)(3)	Max. Output Power	PASS	----
15.247(a)(2)	6 dB RF Bandwidth	PASS	----
15.247(e)	Maximum Power Spectral Density	PASS	----
15.247(d)	Out of Band Conducted Spurious Emission	PASS	----
15.203	Antenna Requirement	PASS	----

Standard	Description
CFR47, Part 15, Subpart C	Intentional Radiators
ANSI C63. 10: 2013	American National Standard of Procedures for Compliance Testing of Unlicensed Wireless Devices
KDB 558074 D01 15.247 Meas Guidance v05r02	GUIDANCE FOR COMPLIANCE MEASUREMENTS ON DIGITAL TRANSMISSION SYSTEM, FREQUENCY HOPPING SPREAD SPECTRUM SYSTEM, AND HYBRID SYSTEM DEVICES OPERATING UNDER SECTION 15.247 OF THE FCC RULES
KDB 662911 D01 v02r01	Emissions Testing of Transmitters with Multiple Outputs in the Same Band (e.g., MIMO, Smart Antenna, etc)



1.2. Measurement Uncertainty

Test Item	Frequency Range	Uncertainty (dB)
Conducted Emission	150 kHz ~ 30 MHz	2.8
Radiated Emission	9 kHz ~ 30 MHz	1.7
	30 MHz ~ 1000 MHz	5.7
	1000 MHz ~ 18000 MHz	5.6
	18000 MHz ~ 26500 MHz	4.9
	26500 MHz ~ 40000 MHz	4.8
Conducted Output Power	+0.27 dB / -0.28 dB	
RF Bandwidth	4.96 %	
Power Spectral Density	+0.71 dB / -0.77 dB	

Decision Rule

- Uncertainty is not included.
- Uncertainty is included.



2 EUT Description

Applicant	PISMO LABS TECHNOLOGY LIMITED A8, 5/F, HK Spinners Industrial Building, Phase 6, 481 Castle Peak Road, Cheung Sha Wan, Hong Kong			
Manufacturer	PISMO LABS TECHNOLOGY LIMITED A8, 5/F, HK Spinners Industrial Building, Phase 6, 481 Castle Peak Road, Cheung Sha Wan, Hong Kong			
Product Type	PEPWAVE / peplink Wireless Product			
Trade Name	PEPWAVE, peplink			
Model Number	AP One AC Mini, PismoAC0P, AC0P, APO-AC-MINI, AP One series, AC0E, PismoAC0E			
Product Type /Trade Name / Model Number Different Description	Those product Type & trade names & model numbers differ from each other in selling region.			
FCC ID	U8G-P1AC0P			
Operate Freq. Band	Frequency Range (MHz)	Modulation	Channel Bandwidth	Data Rate 400 / 800 GI (ns)
IEEE 802.11b	2412 ~ 2462	DSSS	20 MHz	Up to 11 Mbps
IEEE 802.11g	2412 ~ 2462	OFDM	20 MHz	Up to 54 Mbps
IEEE 802.11n 2.4 GHz 20 MHz	2412 ~ 2462	OFDM (64QAM/256QAM)	20 MHz	Up to 173.4 Mbps
IEEE 802.11n 2.4 GHz 40 MHz	2422 ~ 2452	OFDM (64QAM/256QAM)	40 MHz	Up to 400 Mbps
Antenna information	ANT	Model Number	Type	Max. Gain (dBi)
	ANT-0	SSP-16713	PIFA Antenna	2.13
	ANT-1	SSP-16713	PIFA Antenna	1.99
Antenna Delivery	See section 3.1			
Operate Temp. Range	-5 ~ +45 °C			

Frequency Band	Max. RF Output Power (W)
IEEE 802.11b	0.074
IEEE 802.11g	0.168
IEEE 802.11n 2.4 GHz 20 MHz (64QAM)	0.164
IEEE 802.11n 2.4 GHz 40 MHz (64QAM)	0.070
IEEE 802.11n 2.4 GHz 20 MHz (256QAM)	0.170
IEEE 802.11n 2.4 GHz 40 MHz (256QAM)	0.073

3 Test Methodology

3.1. Mode of Operation

Decision of Test ATL has verified the construction and function in typical operation. All the test modes were carried out with the EUT in normal operation, which was shown in this test report and defined as:

Test Mode
Mode 1: Transmit mode
Mode 2: IEEE 802.11b Continuous TX mode
Mode 3: IEEE 802.11g Continuous TX mode
Mode 4: IEEE 802.11n 2.4 GHz 20 MHz (64QAM) Continuous TX mode
Mode 5: IEEE 802.11n 2.4 GHz 40 MHz (64QAM) Continuous TX mode
Mode 6: IEEE 802.11n 2.4 GHz 20 MHz (256QAM) Continuous TX mode
Mode 7: IEEE 802.11n 2.4 GHz 40 MHz (256QAM) Continuous TX mode

Software used to control the EUT for staying in continuous transmitting mode was programmed.

After verification, all tests were carried out with the worst case test modes.

Note: Investigation has been done on all the possible configurations for searching the worst cases (256QAM covers 64QAM). The table is a list of the test modes show in this test report.

Test Mode	ANT-0	ANT-1	ANT-0+1
Mode 2	V	V	V
Mode 3	V	V	V
Mode 4	V	V	V
Mode 5	V	V	V
Mode 6	V	V	V
Mode 7	V	V	V

Test Mode	Antenna Delivery	Data Rate (Mbps)	Test Channel
Mode 2	2TX / 2RX (CDD)	1	1, 6, 11
Mode 3	2TX / 2RX (CDD)	6	1, 6, 11
Mode 4	2TX / 2RX (MIMO)	13	1, 6, 11
Mode 5	2TX / 2RX (MIMO)	27	3, 6, 9
Mode 6	2TX / 2RX (MIMO)	13	1, 6, 11
Mode 7	2TX / 2RX (MIMO)	27	3, 6, 9



Duty cycle

Test Mode	Frequency (MHz)	on time (ms)	on+off time (ms)	Duty cycle	Duty Factor (dB)	1/T Minimum VBW (kHz)
Mode 2	2412.0	12.480	12.510	0.998	0.010	0.010
Mode 3	2412.0	2.075	2.145	0.967	0.144	0.482
Mode 6	2412.0	5.030	5.090	0.988	0.051	0.010
Mode 7	2422.0	2.440	2.515	0.970	0.131	0.410

Duty Cycle Graphs

Mode 2: IEEE 802.11b Continuous TX mode

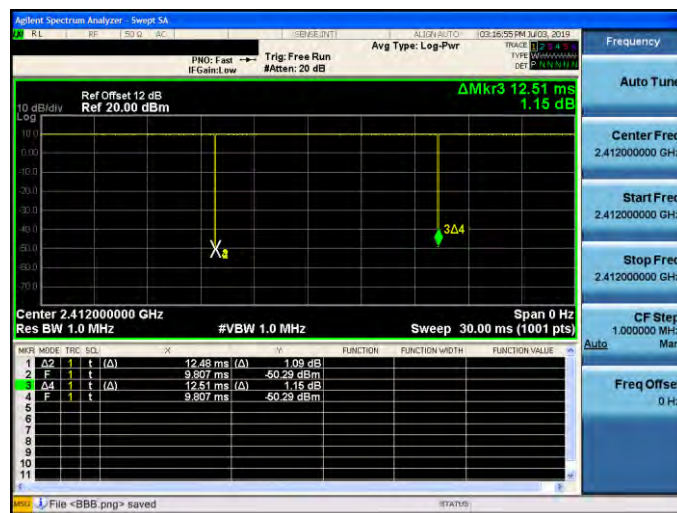

Mode 3: IEEE 802.11g Continuous TX mode

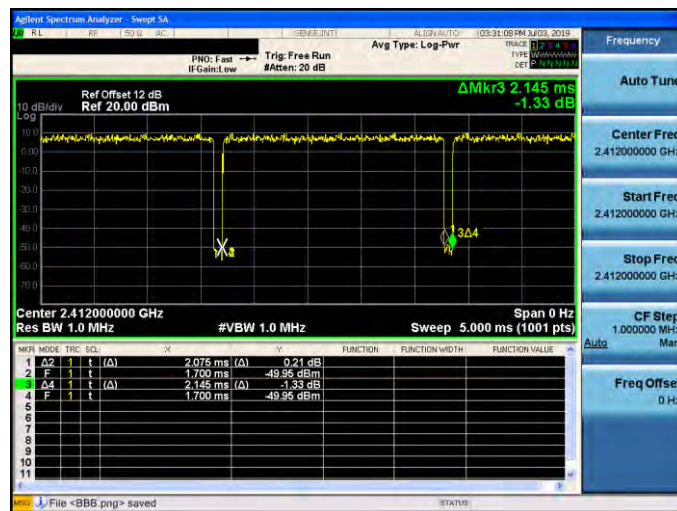



Mode 6: IEEE 802.11n 2.4 GHz 20 MHz (256QAM) Continuous TX mode



Mode 7: IEEE 802.11n 2.4 GHz 40 MHz (256QAM) Continuous TX mode

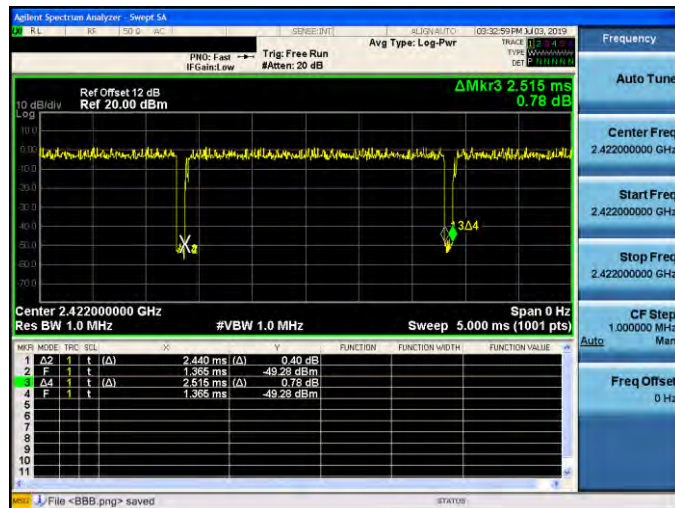



3.2. EUT Test Step

1.	Setup the EUT shown on "Configuration of Test System Details".
2.	Turn on the power of all equipment.
3.	Turn on TX function
4.	EUT run test program.

Measurement Software			
No.	Description	Software	Version
1	Conducted Emission	EZ EMC	1.1.4.3
2	Radiated Emission	EZ EMC	1.1.4.4

3.3. Configuration of Test System Details

Conducted Emissions

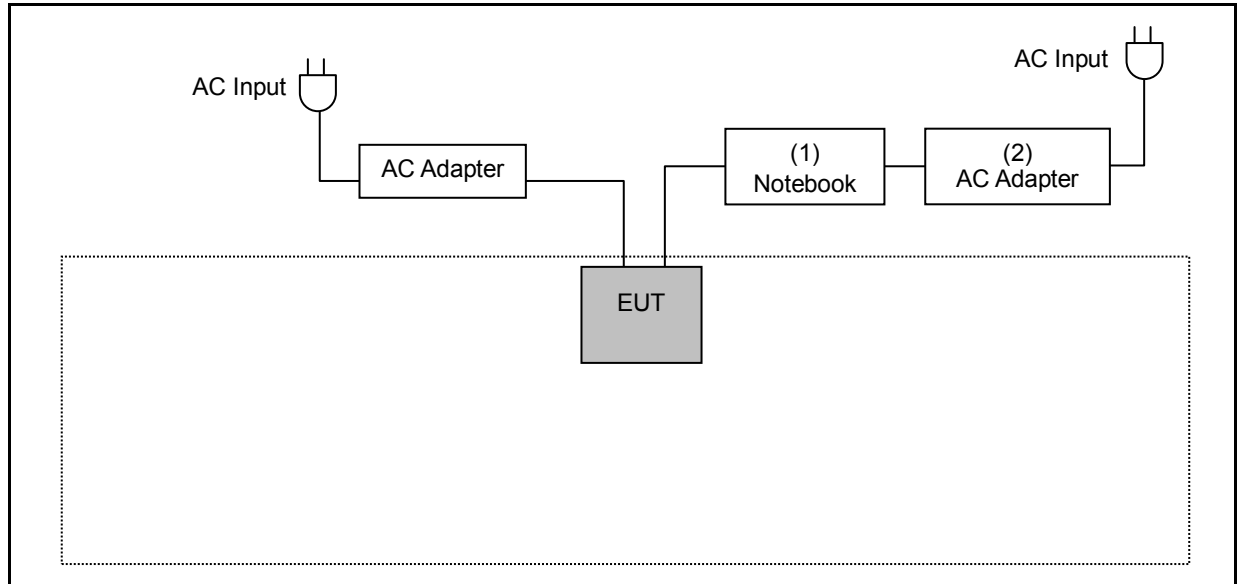

Radiated Emission

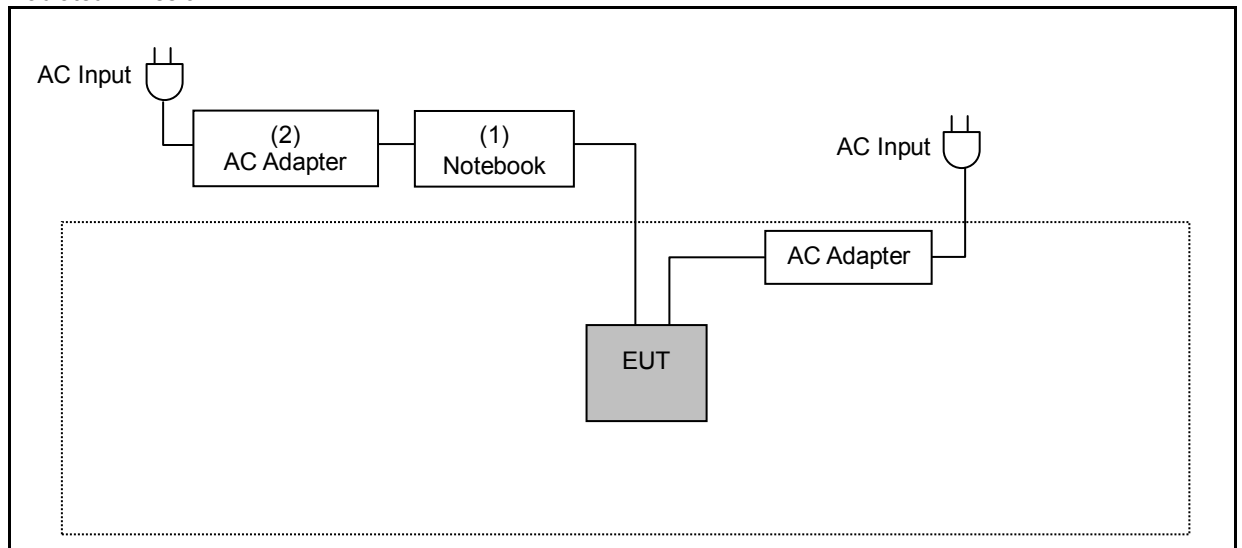

Devices Description					
	Product	Manufacturer	Model Number	Serial Number	Power Cord
(1)	Notebook	DELL	LATITUDE E6440	5HZBD72	---
(2)	AC Adapter	DELL	HA65NM130	---	Non-Shielded, 1.7 m



3.4. Test Instruments

For Conducted Emission

Test Period: Jul. 09, 2019

Equipment	Manufacturer	Model Number	Serial Number	Cal. Date	Cal. Period
Test Receiver	R&S	ESCI	100367	05/23/2019	1 year
LISN	R&S	ENV216	101040	04/03/2019	1 year
LISN	R&S	ENV216	101041	03/28/2019	1 year
RF Cable	Woken	00100D1380194M	TE-02-03	05/23/2019	1 year

For Radiated Emissions

Test Period: Jun. 24 ~ Jun. 28, 2019

Equipment	Manufacturer	Model Number	Serial Number	Cal. Date	Cal. Period
Spectrum Analyzer (10 Hz~44 GHz)	Keysight	N9010A	MY52221312	01/14/2019	1 year
Pre Amplifier (1~26.5 GHz)	Agilent	8449B	3008A02237	10/16/2018	1 year
Pre Amplifier (100 kHz~1.3 GHz)	Agilent	8447D	2944A11119	01/14/2019	1 year
Broadband Antenna	Schwarzbeck	VULB9168	416	10/19/2018	1 year
Horn Antenna (1~18 GHz)	SCHWARZBECK MESS-ELEKTRONIK	BBHA9120D	9120D-550	08/23/2018	1 year
Horn Antenna (18~40 GHz)	SCHWARZBECK MESS-ELEKTRONIK	BBHA9170	9170-320	08/07/2018	1 year
Loop Antenna	COM-POWER CORPORATION	AL-130	121014	03/29/2019	1 year
RF Cable	EMCI	EMC104-N -N-6000	TE01-1	02/20/2019	1 year
Microwave Cable	EMCI	EMC104-SM -SM-13000	170814	10/30/2018	1 year
Microwave Cable	EMCI	EMC102-KM -KM-14000	151001	02/20/2019	1 year

Note: N.C.R. = No Calibration Request.



For Conducted

Test Period: Jul. 03 ~ Jul. 05, 2019

Equipment	Manufacturer	Model Number	Serial Number	Cal. Date	Cal. Period
Spectrum Analyzer (20 Hz~26.5 GHz)	Agilent	N9020A	US47520902	09/25/2018	1 year
Power Sensor	Anritsu	MA2411B	1126022	08/29/2018	1 year
Power Meter	Anritsu	ML2495A	1135009	08/29/2018	1 year

Note: N.C.R. = No Calibration Request.

3.5. Test Site Environment

Items	Required (IEC 60068-1)	Actual
Temperature (°C)	15-35	26
Humidity (%RH)	25-75	60
Barometric pressure (mbar)	860-1060	990

4 Measurement Procedure

4.1. AC Power Line Conducted Emission Measurement

■ Limit

Frequency (MHz)	Quasi-peak	Average
0.15 - 0.5	66 to 56	56 to 46
0.50 - 5.0	56	46
5.0 - 30.0	60	50

■ Test Setup

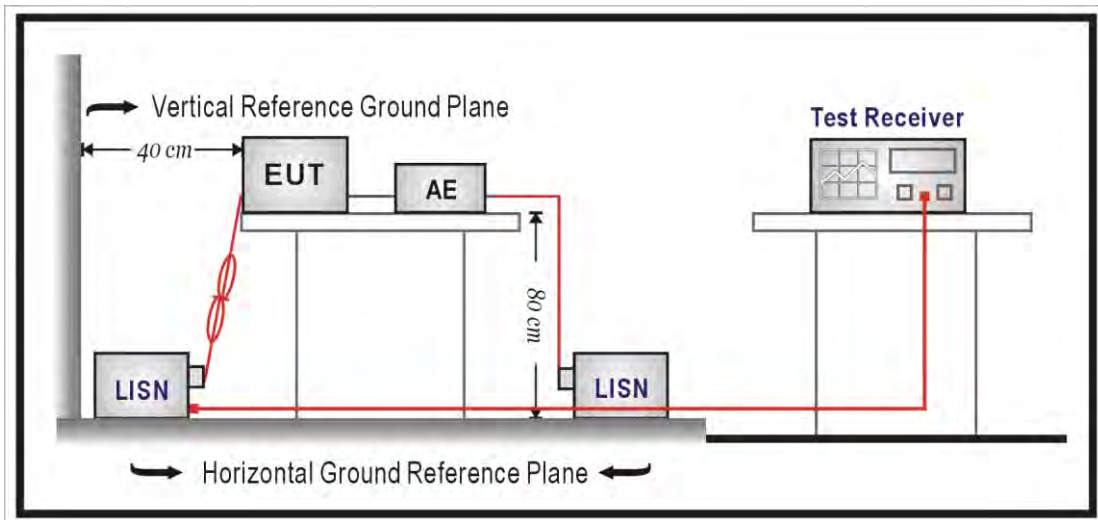

■ Test Procedure

The EUT and simulators are connected to the main power through a line impedance stabilization network (L.I.S.N.). This provides a $50 \Omega // 50 \mu\text{H}$ coupling impedance for the measuring equipment. The peripheral devices are also connected to the main power through a LISN that provides a $50 \Omega // 50 \mu\text{H}$ coupling impedance with 50 ohm termination.

Tabletop device shall be placed on a non-conducting platform, of nominal size 1 m by 1.5 m, raised 80 cm above the reference ground plane. The wall of screened room shall be located 40 cm to the rear of the EUT. Other surfaces of tabletop or floor standing EUT shall be at least 80 cm from any other ground conducting surface including one or more LISNs. For floor-standing device shall be placed under the EUT with a 12 mm insulating material.

Conducted emissions were investigated over the frequency range from 0.15 MHz to 30 MHz using a resolution bandwidth of 9 kHz. The equipment under test (EUT) shall be meet the limits in section 4.1, as applicable, including the average limit and the quasi-peak limit when using respectively, an average detector and quasi-peak detector measured in accordance with the methods described of related standard. When all of peak value were complied with quasi-peak and average limit from 150 kHz to 30 MHz then quasi-peak and average measurement was unnecessary.

The AMN shall be placed 0.8 m from the boundary of the unit under test and bonded to a ground reference plane for AMNs mounted on top of the ground reference plane. This distance is between the closest points of the AMN and the EUT. All other units of the EUT and associated equipment shall be at least 0.8 m from the AMN. If the mains power cable is longer than 1 m then the cable shall be folded back and forth at the centre of the lead to form a bundle no longer than 0.4 m. All of interconnecting cables that hang closer than 40 cm to the ground plane shall be folded back and forth in the center forming a bundle 30 cm to 40 cm long. All of EUT and AE shall be separate place more than 0.1 m. All 50Ω ports of the LISN shall be resistively terminated into 50Ω loads when not connected to the measuring instrument.

If the reading of the measuring receiver shows fluctuations close to the limit, the reading shall be observed for at least 15 s at each measurement frequency; the higher reading shall be recorded with the exception of any brief isolated high reading which shall be ignored.

4.2. Radiated Emission Measurement

■ Limit

According to §15.209(a), except as provided elsewhere in this subpart, the emissions from an intentional radiator shall not exceed the field strength levels specified in the following table:

Frequency (MHz)	Field Strength ($\mu\text{V}/\text{m}$ at meter)	Measurement Distance (meters)
0.009 – 0.490	$2400 / F$ (kHz)	300
0.490 – 1.705	$24000 / F$ (kHz)	30
1.705 – 30.0	30	30
30 - 88	100**	3
88-216	150**	3
216-960	200**	3
Above 960	500	3

** Except as provided in paragraph (g), fundamental emissions from intentional radiators operating under this Section shall not be located in the frequency bands 54-72 MHz, 76-88 MHz, 174-216 MHz or 470-806 MHz. However, operation within these frequency bands is permitted under other sections of this Part, e.g., Sections 15.231 and 15.241.

■ Setup

9 kHz ~ 30 MHz

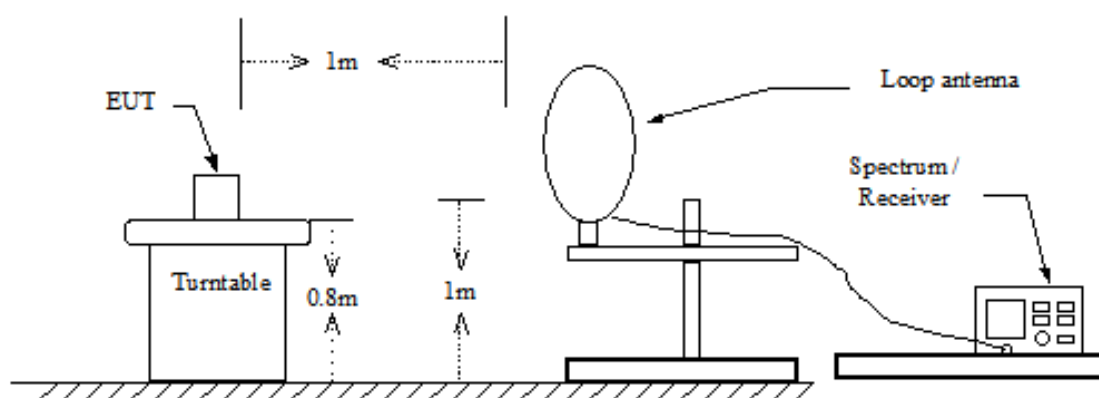

Below 1 GHz

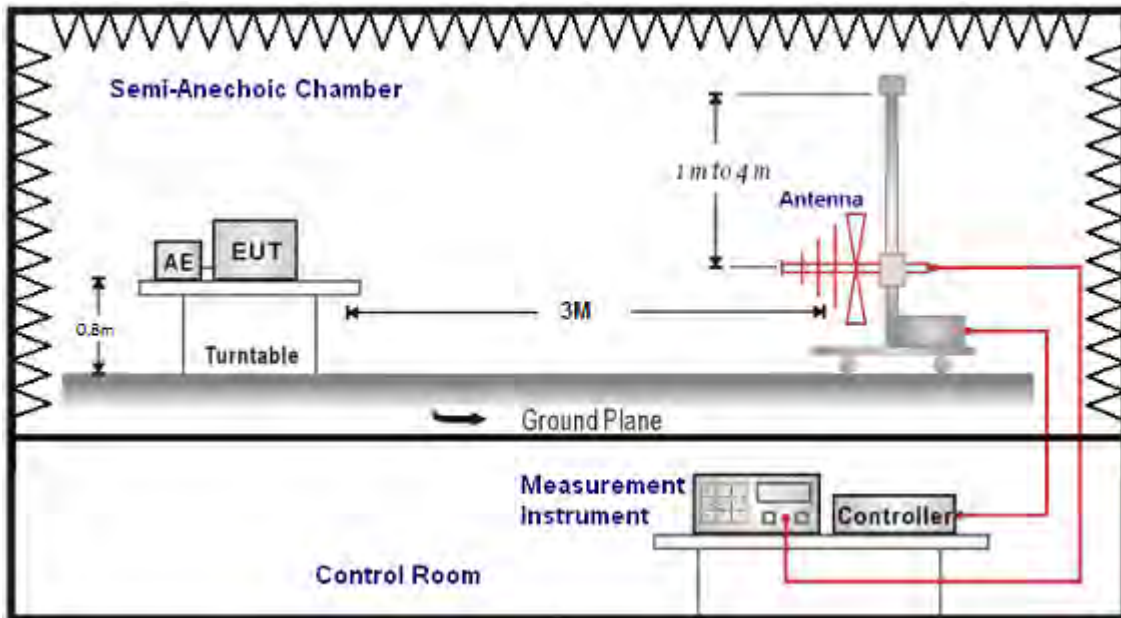

Above 1 GHz

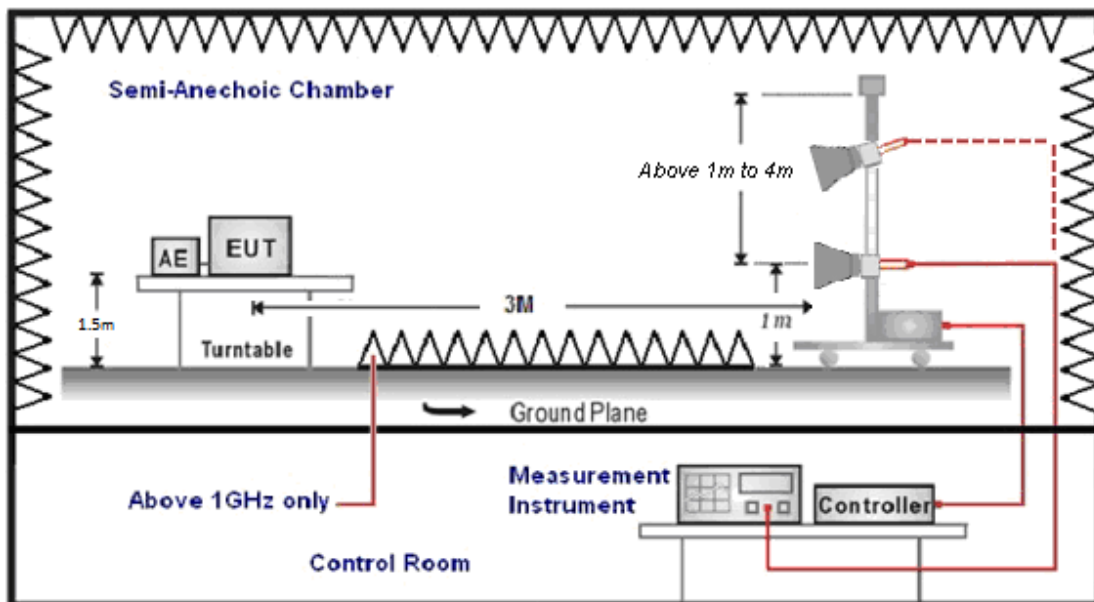

■ Test Procedure

Final radiation measurements were made on a three-meter, Semi Anechoic Chamber. The EUT system was placed on a nonconductive turntable which is 0.8 or 1.5 meters height, top surface 1.0 x 1.5 meter. The spectrum was examined from 250 MHz to 2.5 GHz in order to cover the whole spectrum below 10th harmonic which could generate from the EUT. During the test, EUT was set to transmit continuously & Measurements spectrum range from 9 kHz to 26.5 GHz is investigated.

For measurements below 1 GHz the resolution bandwidth is set to 100 kHz for peak detection measurements or 120 kHz for quasi-peak detection measurements. Peak detection is used unless otherwise noted as quasi-peak.

For measurements above 1 GHz the resolution bandwidth is set to 1 MHz, and then the video bandwidth is set to 3 MHz for peak measurements and 10 Hz for average measurements when Duty cycle >0.98 / 1/T for average measurements when Duty cycle <0.98. A nonconductive material surrounded the EUT to supporting the EUT for standing on three orthogonal planes. At each condition, the EUT was rotated 360 degrees, and the antenna was raised and lowered from one to four meters to find the maximum emission levels. Measurements were taken using both horizontal and vertical antenna polarization.

SCHWARZBECK MESS-ELEKTRONIK Biconilog Antenna at 3 Meter and the SCHWARZBECK Double Ridged Guide Antenna was used in frequencies 1 –26.5 GHz at a distance of 3 meter. The antenna at an angle toward the source of the emission. All test results were extrapolated to equivalent signal at 3 meters utilizing an inverse linear distance extrapolation Factor (20 dB/decade).

For testing above 1 GHz, the emission level of the EUT in peak mode was 20 dB lower than average limit (that means the emission level in peak mode also complies with the limit in average mode), then testing will be stopped and peak values of EUT will be reported, otherwise, the emissions will be measured in average mode again and reported.

Appropriate preamplifiers were used for improving sensitivity and precautions were taken to avoid overloading or desensitizing the spectrum analyzer. No post – detector video filters were used in the test.

The spectrum analyzer's 6 dB bandwidth was set to 1 MHz, and the analyzer was operated in the peak detection mode, for frequencies both below and up 1 GHz. The average levels were obtained by subtracting the duty cycle correction factor from the peak readings.

The following procedures were used to convert the emission levels measured in decibels referenced to 1 microvolt (dBuV) into field intensity in micro volts pre meter (uV/m).

The actual field intensity in decibels referenced to 1 microvolt in to field intensity in micro volts per meter (dBuV/m).



The actual field intensity in referenced to 1 microvolt per meter (dBuV/m) is determined by algebraically adding the measured reading in dBuV, the antenna factor (dB), and cable loss (dB) and Subtracting the gain of preamplifier (dB) is auto calculate in spectrum analyzer.

(1) $\text{Amplitude (dBuV/m)} = \text{FI (dBuV)} + \text{AF (dBuV)} + \text{CL (dBuV)} - \text{Gain (dB)}$

FI= Reading of the field intensity.

AF= Antenna factor.

CL= Cable loss.

P.S Amplitude is auto calculate in spectrum analyzer.

(2) $\text{Actual Amplitude (dBuV/m)} = \text{Amplitude (dBuV)} - \text{Dis(dB)}$

The FCC specified emission limits were calculated according the EUT operating frequency and by following linear interpolation equations:

(a) For fundamental frequency : Transmitter Output < +30 dBm

(b) For spurious frequency : Spurious emission limits = fundamental emission limit /10

Data of measurement within this frequency range without mark in the table above means the reading of emissions are attenuated more than 20 dB below the permissible limits or the field strength is too small to be measured.

4.3. Maximum Conducted Output Power Measurement

■ Limit

For systems using digital modulation in the 2400-2483.5 MHz, the limit for maximum output power is 30 dBm.

And According to 15.247 (b), if transmitting antennas of directional gain greater than 6 dBi are used, the power shall be reduced by the amount in dB that the directional gain of the antenna exceeds 6 dBi.

IEEE 802.11b / IEEE 802.11g

$$* \text{Directional Gain} = 10 \cdot \log\left\{\frac{10^{(G1/10)} + 10^{(G2/10)} + \dots + 10^{(Gn/10)}}{NANT}\right\} = 2.06 \text{ dBi} < 6 \text{ dBi}$$

IEEE 802.11n 2.4 GHz 20 MHz (64QAM) / IEEE 802.11n 2.4 GHz 40 MHz (64QAM) /

IEEE 802.11n 2.4 GHz 20 MHz (256QAM) / IEEE 802.11n 2.4 GHz 40 MHz (256QAM)

$$* \text{Directional Gain} = 10 \cdot \log\left\{\frac{10^{(G1/20)} + 10^{(G2/20)} + \dots + 10^{(Gn/20)}}{NANT}\right\} = 5.07 \text{ dBi} < 6 \text{ dBi}$$

■ Test Setup

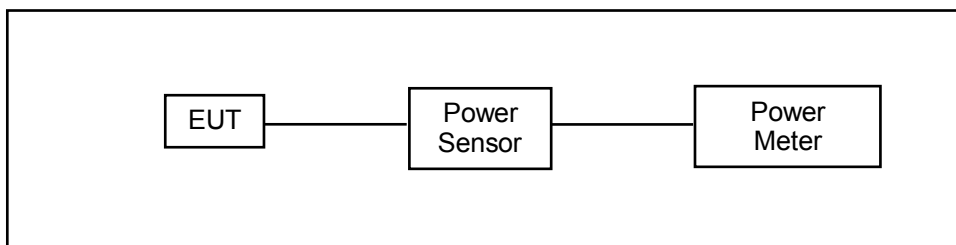

■ Test Procedure

The testing follows the Measurement Procedure of ANSI C63.10:2013 section 11.9.2.3.2 Method AVGPM.

The tests below are run with the EUT's transmitter set at high power in TX mode. The EUT is needed to force selection of output power level and channel number. While testing, EUT was set to transmit continuously. Remove the Subjective device's antenna and connect the RF output port to power sensor.

4.4. 6 dB RF Bandwidth Measurement

■ **Limit**

6 dB RF Bandwidth: Systems using digital modulation techniques may operate in the 2400–2483.5 MHz bands. The minimum 6 dB band-width shall be at least 500 kHz.

■ **Test Setup**

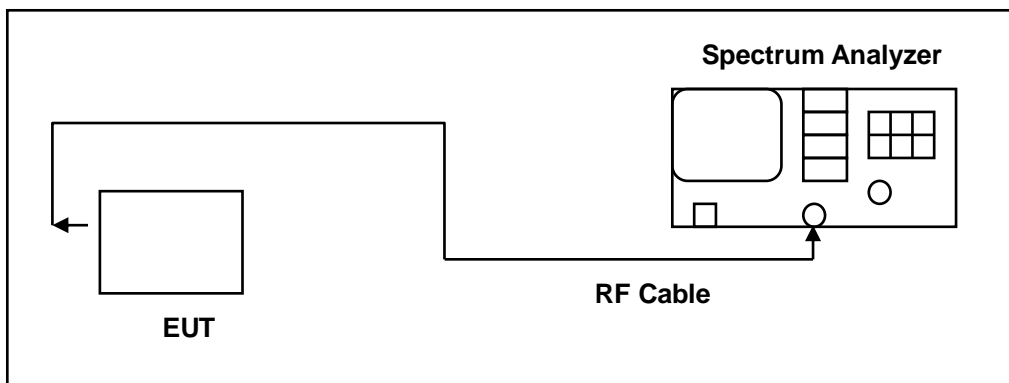

■ **Test Procedure**

The EUT tested to DTS test procedure of ANSI C63.10:2013 section 11.8.2 option2 for compliance to FCC 47CFR 15.247 requirements.

6 dB RF Bandwidth: The antenna port of the EUT was connected to the input of a spectrum analyzer. Analyzer RBW was set to 100 kHz. For each RF output channel investigated, the spectrum analyzer center frequency was set to the channel carrier. A peak output reading was taken, a DISPLAY line was drawn 6 dB lower than peak level. The 6 dB bandwidth was determined from where the channel output spectrum intersected the display line.

The test was performed at 3 channels (Channel low, middle, high)

4.5. Maximum Power Spectral Density Measurement

■ Limit

For digitally modulated systems, the power spectral density conducted from the intentional radiator to the antenna shall not be greater than 8 dBm in any 3 kHz band during any time interval of continuous transmission.

IEEE 802.11b / IEEE 802.11g / IEEE 802.11n 2.4 GHz 20 MHz (256QAM) /

IEEE 802.11n 2.4 GHz 40 MHz (256QAM)

* Directional Gain = $10 \cdot \log\{[10^{G1/20} + 10^{G2/20} + \dots + 10^{Gn/20}]^2 / NANT\}$ = 5.07 dBi < 6 dBi;

■ Test Setup

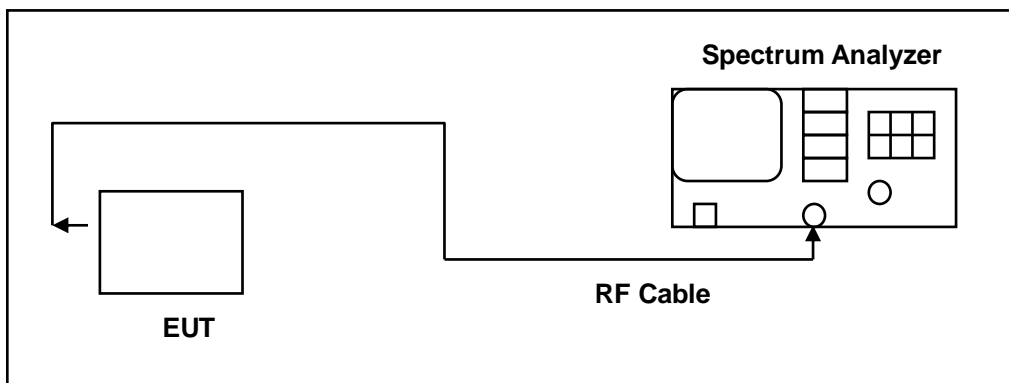

■ Test Procedure

The EUT tested to DTS test procedure of ANSI C63.10:2013 section 11.10.2 Method PKPSD for compliance to FCC 47CFR 15.247 requirements.

1. Set analyzer center frequency to DTS channel center frequency.
2. Set the span to 1.5 times the DTS bandwidth.
3. Set the RBW to: $3 \text{ kHz} \leq \text{RBW} \leq 100 \text{ kHz}$.
4. Set the VBW $\geq 3 \times \text{RBW}$.
5. Detector = peak.
6. Sweep time = auto couple.
7. Trace mode = max hold.
8. Allow trace to fully stabilize.
9. Use the peak marker function to determine the maximum amplitude level within the RBW.
10. If measured value exceeds limit, reduce RBW (no less than 3 kHz) and repeat.

4.6. Out of Band Conducted Emissions Measurement

■ **Limit**

In any 100 kHz bandwidth outside the frequency band in which the spread spectrum or digitally modulated intentional radiator is operating, the radio frequency power that is produced by the intentional radiator shall be at least 30 dB below that in the 100 kHz bandwidth within the band that contains the highest level of the desired power

■ **Test Setup**

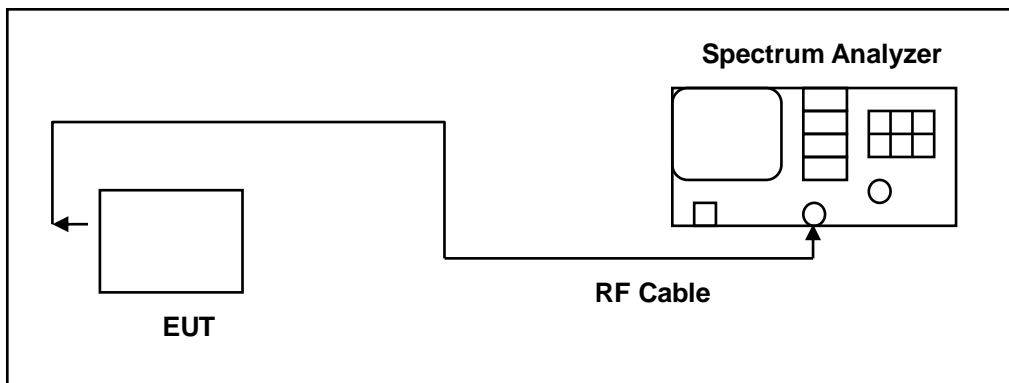

■ **Test Procedure**

In any 100 kHz bandwidth outside the EUT pass band, the RF power produced by the modulation products of the spreading sequence, the information sequence, and the carrier frequency shall be at least 30 dB below that of the maximum in-band 100 kHz emission, antenna output of the EUT was coupled directly to spectrum analyzer; if an external attenuator and/or cable was used, these losses are compensated for with the analyzer OFFSET function. All other types of emissions from the EUT shall meet the general limits for radiated frequencies outside the pass band. The test was performed at 3 channels.



4.7. Antenna Measurement

■ Limit

For intentional device, according to 15.203, an intentional radiator shall be designed to ensure that no antenna other than that furnished by the responsible party shall be used with the device.

And According to 15.247 (b), if transmitting antennas of directional gain greater than 6 dBi are used, the power shall be reduced by the amount in dB that the directional gain of the antenna exceeds 6 dBi.

■ Antenna Description

See section 2 – antenna information.

■ Directional Gain Calculated

For Maximum Conducted Output Power

Operate Freq. Band	Directional Gain (dBi)
IEEE 802.11b	2.06
IEEE 802.11g	2.06
IEEE 802.11n 2.4 GHz 20 MHz (64QAM)	5.07
IEEE 802.11n 2.4 GHz 40 MHz (64QAM)	5.07
IEEE 802.11n 2.4 GHz 20 MHz (256QAM)	5.07
IEEE 802.11n 2.4 GHz 40 MHz (256QAM)	5.07

For Maximum Power Density

Operate Freq. Band	Directional Gain (dBi)
IEEE 802.11b	5.07
IEEE 802.11g	5.07
IEEE 802.11n 2.4 GHz 20 MHz (256QAM)	5.07
IEEE 802.11n 2.4 GHz 40 MHz (256QAM)	5.07

5 Test Results

Annex A. Conducted Emission

Standard:	FCC Part 15.247	Line:	L1
Test item:	Conducted Emission	Power:	AC 120 V/60 Hz
Mode:	Mode 1	Temp.(°C)/Hum.(%RH):	26(°C)/60 %RH
Description:			

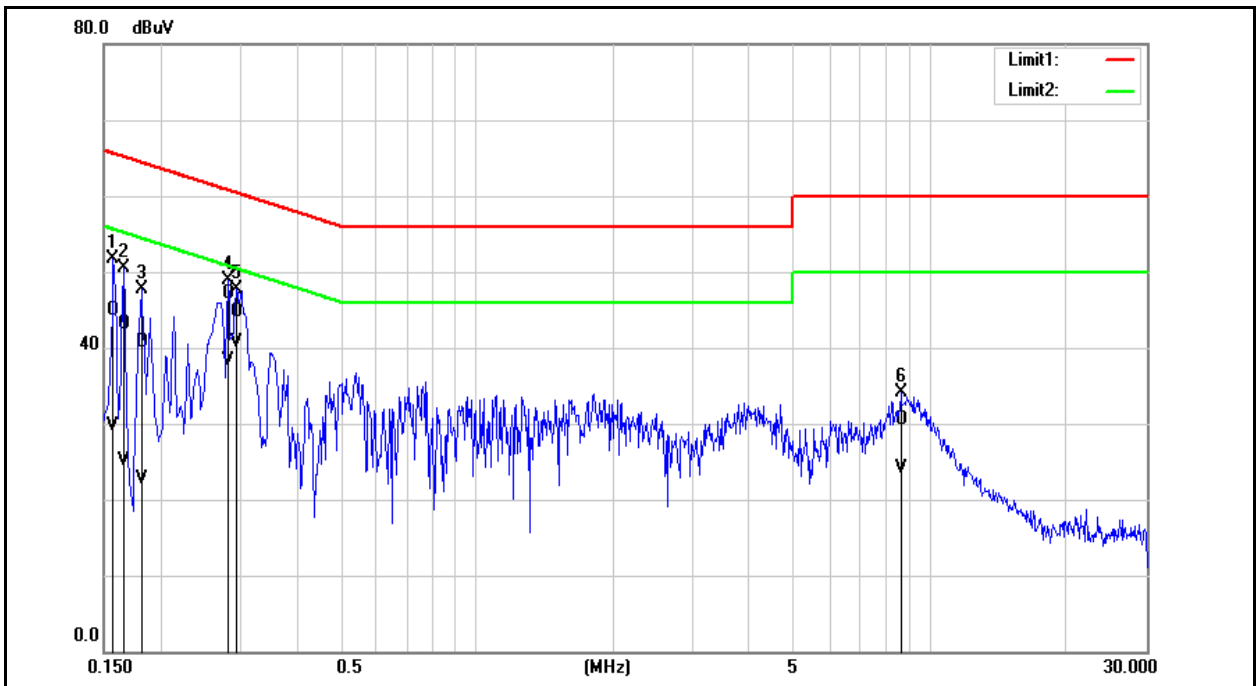

No.	Frequency (MHz)	QP reading (dBuV)	AVG reading (dBuV)	Correction factor (dB)	QP result (dBuV)	AVG result (dBuV)	QP limit (dBuV)	AVG limit (dBuV)	QP margin (dB)	AVG margin (dB)	Remark
1	0.1580	35.29	20.08	9.65	44.94	29.73	65.57	55.57	-20.63	-25.84	Pass
2	0.1660	33.45	15.54	9.65	43.10	25.19	65.16	55.16	-22.06	-29.97	Pass
3	0.1820	31.12	13.06	9.64	40.76	22.70	64.39	54.39	-23.63	-31.69	Pass
4	0.2820	37.46	28.69	9.65	47.11	38.34	60.76	50.76	-13.65	-12.42	Pass
5	0.2940	35.13	31.11	9.65	44.78	40.76	60.41	50.41	-15.63	-9.65	Pass
6	8.6100	20.62	14.22	9.88	30.50	24.10	60.00	50.00	-29.50	-25.90	Pass

Note: 1. Result (dBuV) = Correction factor (dB) + Reading(dBuV).

2. Correction factor (dB) = Cable loss (dB) + L.I.S.N. factor (dB).



Standard:	FCC Part 15.247	Line:	N
Test item:	Conducted Emission	Power:	AC 120 V/60 Hz
Mode:	Mode 1	Temp.(°C)/Hum.(%RH):	26(°C)/60 %RH
Description:			

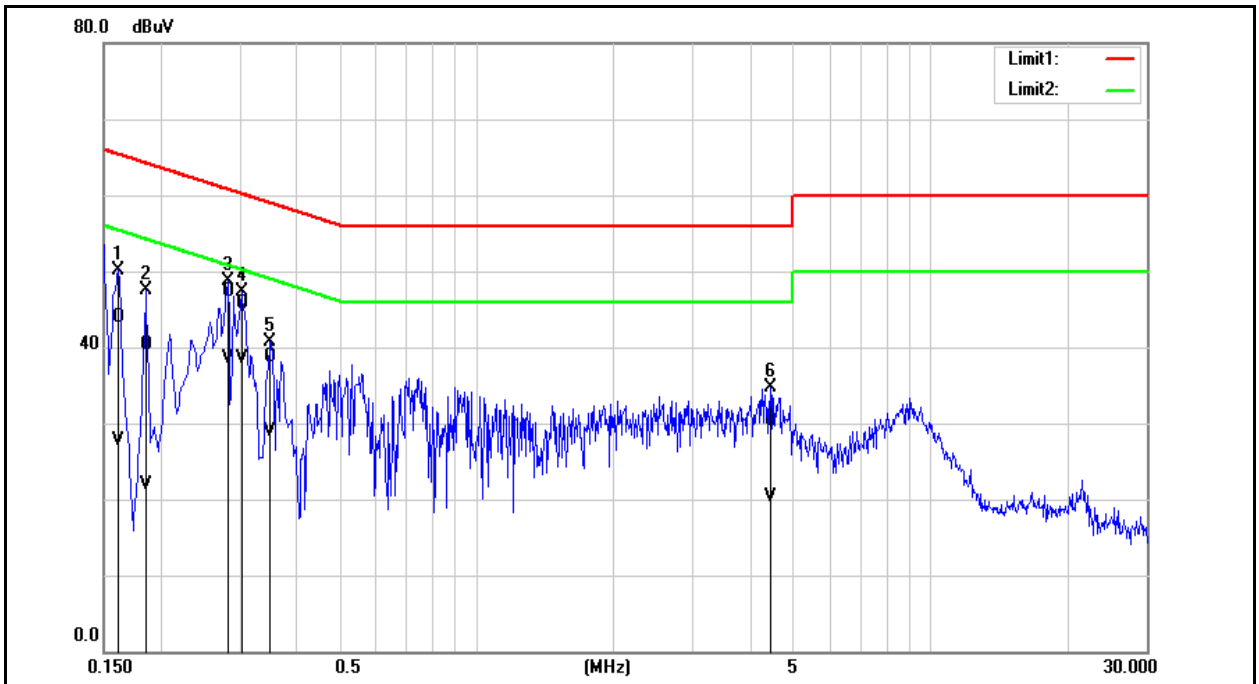

No.	Frequency (MHz)	QP reading (dBuV)	AVG reading (dBuV)	Correction factor (dB)	QP result (dBuV)	AVG result (dBuV)	QP limit (dBuV)	AVG limit (dBuV)	QP margin (dB)	AVG margin (dB)	Remark
1	0.1620	34.22	17.96	9.68	43.90	27.64	65.36	55.36	-21.46	-27.72	Pass
2	0.1860	30.68	12.22	9.67	40.35	21.89	64.21	54.21	-23.86	-32.32	Pass
3	0.2820	37.66	28.75	9.68	47.34	38.43	60.76	50.76	-13.42	-12.33	Pass
4	0.3020	35.93	28.86	9.68	45.61	38.54	60.19	50.19	-14.58	-11.65	Pass
5	0.3500	29.05	19.27	9.68	38.73	28.95	58.96	48.96	-20.23	-20.01	Pass
6	4.4460	20.47	10.57	9.82	30.29	20.39	56.00	46.00	-25.71	-25.61	Pass

Note: 1. Result (dBuV) = Correction factor (dB) + Reading(dBuV).
2. Correction factor (dB) = Cable loss (dB) + L.I.S.N. factor (dB).

Annex B. Conducted Test Results

Maximum Conducted Output Power Measurement

ANT-0					
Test Mode	Frequency (MHz)	Data Rate	Average Output Power		
			Measurement Results		Limit
			dBm	W	dBm
Mode 2	2412	1 M	15.47	0.035	≤ 30
	2437		16.33	0.043	≤ 30
	2462		11.55	0.014	≤ 30
Mode 3	2412	6 M	15.94	0.039	≤ 30
	2437		19.63	0.092	≤ 30
	2462		14.10	0.026	≤ 30
Mode 4	2412	13 M	14.88	0.031	≤ 30
	2437		19.56	0.090	≤ 30
	2462		14.77	0.030	≤ 30
Mode 5	2422	27 M	12.99	0.020	≤ 30
	2437		15.91	0.039	≤ 30
	2452		12.13	0.016	≤ 30
Mode 6	2412	13 M	15.07	0.032	≤ 30
	2437		19.70	0.093	≤ 30
	2462		14.89	0.031	≤ 30
Mode 7	2422	27 M	13.11	0.020	≤ 30
	2437		16.03	0.040	≤ 30
	2452		12.28	0.017	≤ 30

Note: The relevant measured result has the offset with cable loss already.



ANT-1					
Test Mode	Frequency (MHz)	Data Rate	Average Output Power		
			Measurement Results		Limit
			dBm	W	dBm
Mode 2	2412	1 M	14.90	0.031	≤ 30
	2437		14.91	0.031	≤ 30
	2462		11.02	0.013	≤ 30
Mode 3	2412	6 M	14.82	0.030	≤ 30
	2437		18.79	0.076	≤ 30
	2462		13.15	0.021	≤ 30
Mode 4	2412	13 M	13.75	0.024	≤ 30
	2437		18.67	0.074	≤ 30
	2462		14.03	0.025	≤ 30
Mode 5	2422	27 M	11.89	0.015	≤ 30
	2437		14.98	0.031	≤ 30
	2452		11.30	0.013	≤ 30
Mode 6	2412	13 M	13.87	0.024	≤ 30
	2437		18.86	0.077	≤ 30
	2462		14.15	0.026	≤ 30
Mode 7	2422	27 M	12.04	0.016	≤ 30
	2437		15.14	0.033	≤ 30
	2452		11.41	0.014	≤ 30

Note: The relevant measured result has the offset with cable loss already.



ANT-0+1					
Test Mode	Frequency (MHz)	Data Rate	Average Output Power		
			Measurement Results		Limit
			dBm	W	dBm
Mode 2	2412	1 M	18.20	0.066	≤ 30
	2437		18.69	0.074	≤ 30
	2462		14.30	0.027	≤ 30
Mode 3	2412	6 M	18.43	0.070	≤ 30
	2437		22.24	0.168	≤ 30
	2462		16.66	0.046	≤ 30
Mode 4	2412	13 M	17.36	0.054	≤ 30
	2437		22.15	0.164	≤ 30
	2462		17.43	0.055	≤ 30
Mode 5	2422	27 M	15.49	0.035	≤ 30
	2437		18.48	0.070	≤ 30
	2452		14.75	0.030	≤ 30
Mode 6	2412	13 M	17.52	0.057	≤ 30
	2437		22.31	0.170	≤ 30
	2462		17.55	0.057	≤ 30
Mode 7	2422	27 M	15.62	0.036	≤ 30
	2437		18.62	0.073	≤ 30
	2452		14.88	0.031	≤ 30

Note: The relevant measured result has the offset with cable loss already.



6 dB RF Bandwidth Measurement

Test Mode	Frequency (MHz)	Measurement (kHz)		Limit (kHz)
		ANT-0	ANT-1	
Mode 2	2412	8106	8099	≥ 500
	2437	8102	8099	≥ 500
	2462	8102	8098	≥ 500
Mode 3	2412	16350	16390	≥ 500
	2437	16110	16380	≥ 500
	2462	16370	16400	≥ 500
Mode 6	2412	17580	17590	≥ 500
	2437	17580	17580	≥ 500
	2462	17600	17600	≥ 500
Mode 7	2422	35180	35190	≥ 500
	2437	35180	35190	≥ 500
	2452	35180	35190	≥ 500



■ Test Graphs

Mode 2: IEEE 802.11b Continuous TX mode_ANT-0

2412 MHz



2437 MHz



2462 MHz





Mode 3: IEEE 802.11g Continuous TX mode_ANT-0

2412 MHz

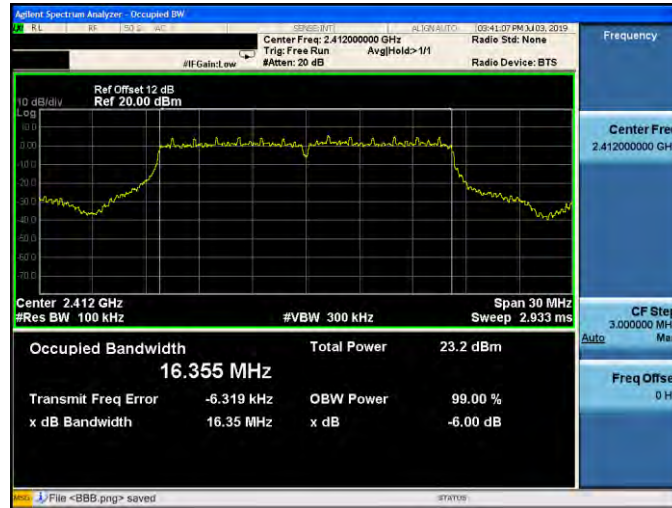

2437 MHz

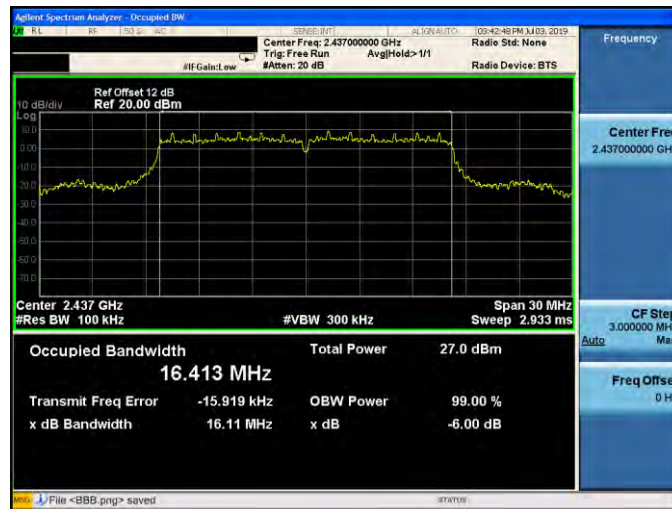

2462 MHz

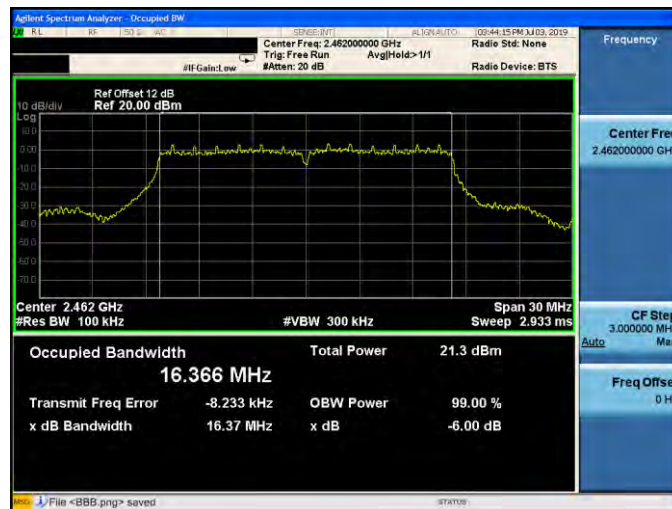



Mode 6: IEEE 802.11n 2.4 GHz 20 MHz (256QAM) Continuous TX mode_ANT-0

2412 MHz

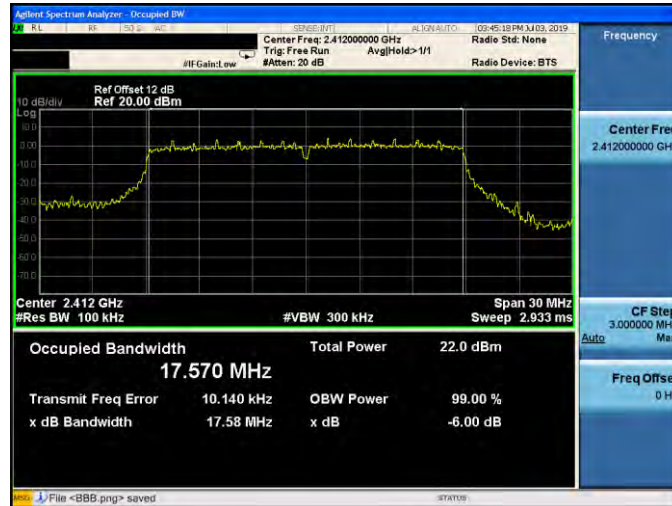

2437 MHz



2462 MHz





Mode 7: IEEE 802.11n 2.4 GHz 40 MHz (256QAM) Continuous TX mode_ANT-0

2422 MHz

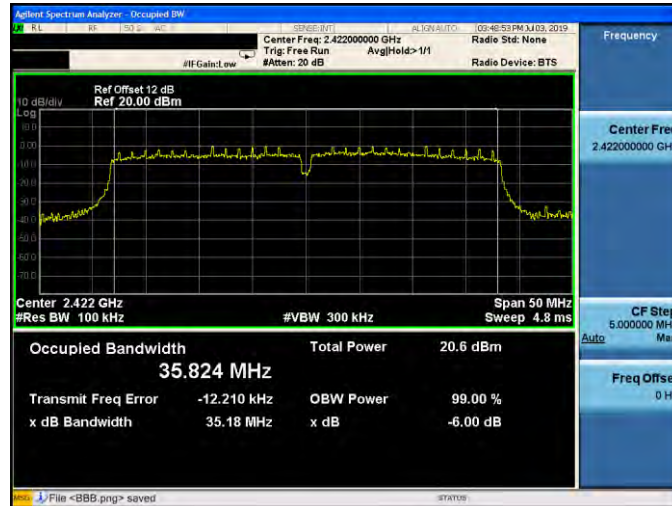

2437 MHz

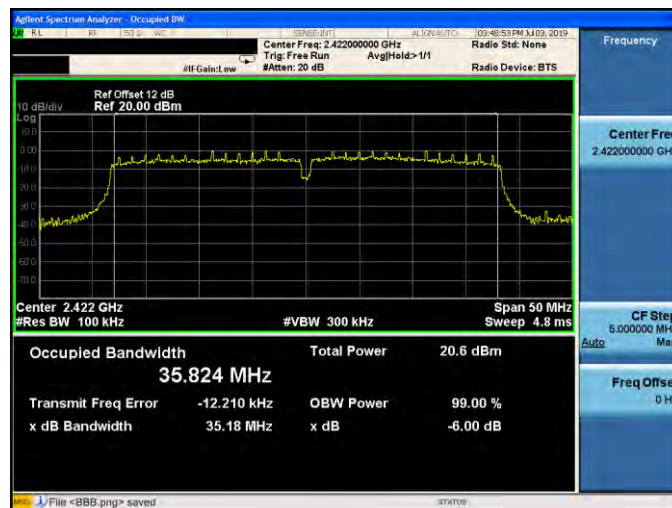

2452 MHz

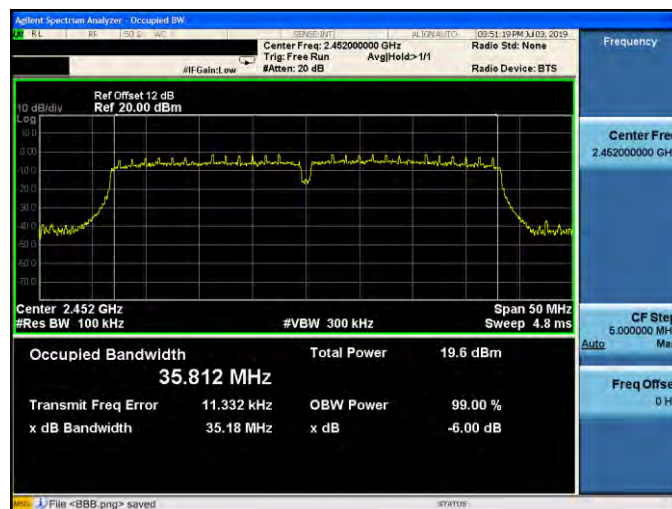



Mode 2: IEEE 802.11b Continuous TX mode_ANT-1

2412 MHz



2437 MHz



2462 MHz





Mode 3: IEEE 802.11g Continuous TX mode_ANT-1

2412 MHz



2437 MHz

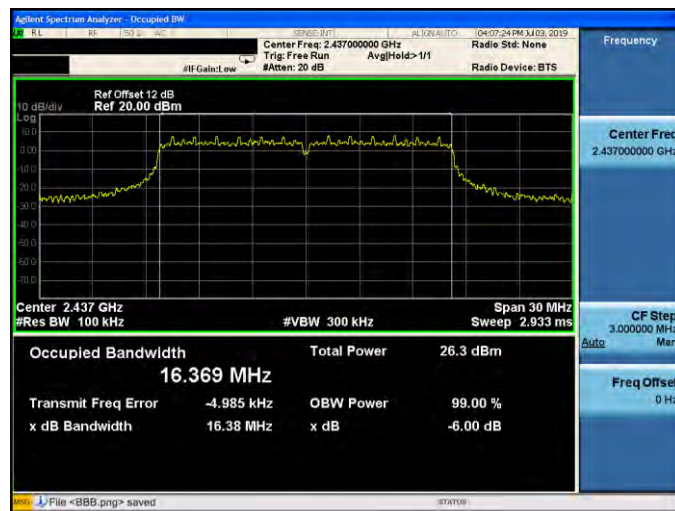

2462 MHz

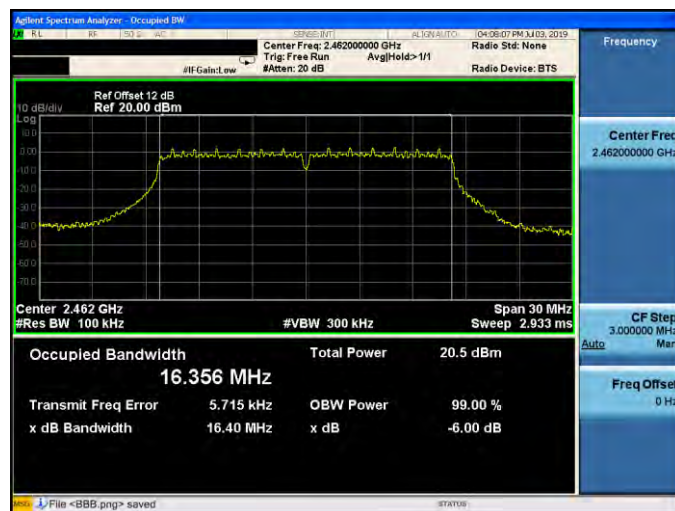



Mode 6: IEEE 802.11n 2.4 GHz 20 MHz (256QAM) Continuous TX mode_ANT-1

2412 MHz

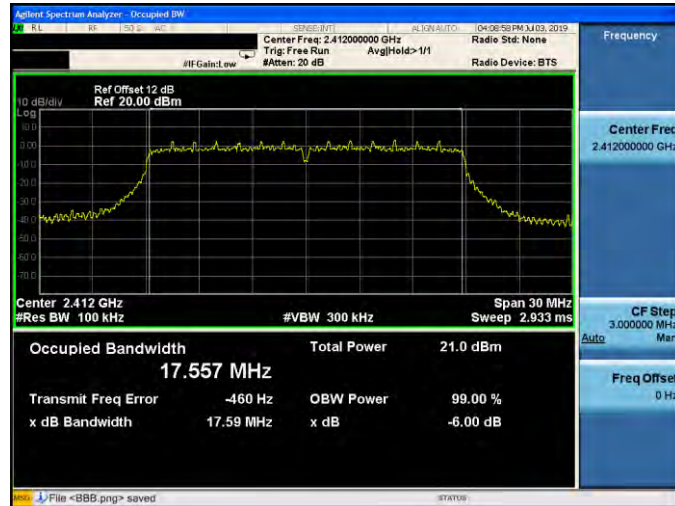

2437 MHz



2462 MHz

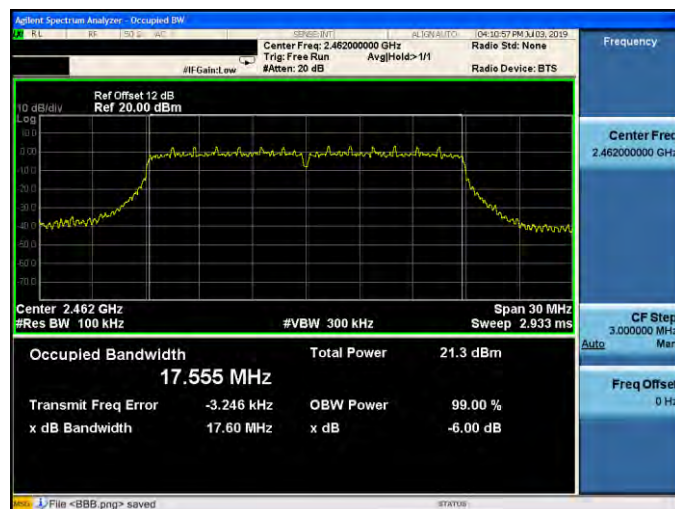



Mode 7: IEEE 802.11n 2.4 GHz 40 MHz (256QAM) Continuous TX mode_ANT-1

2422 MHz

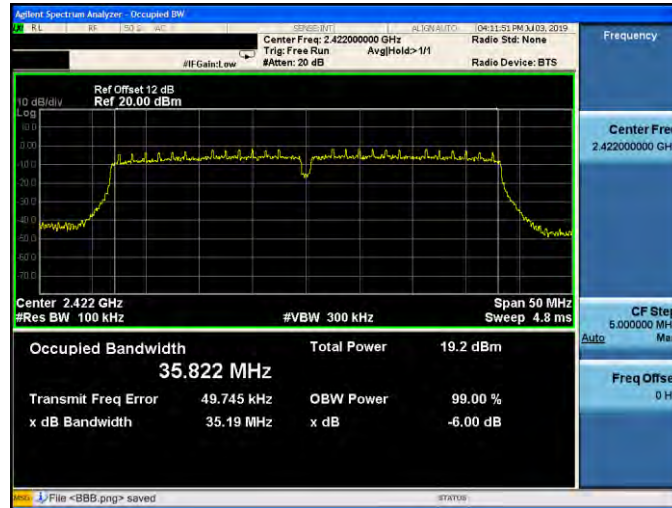

2437 MHz

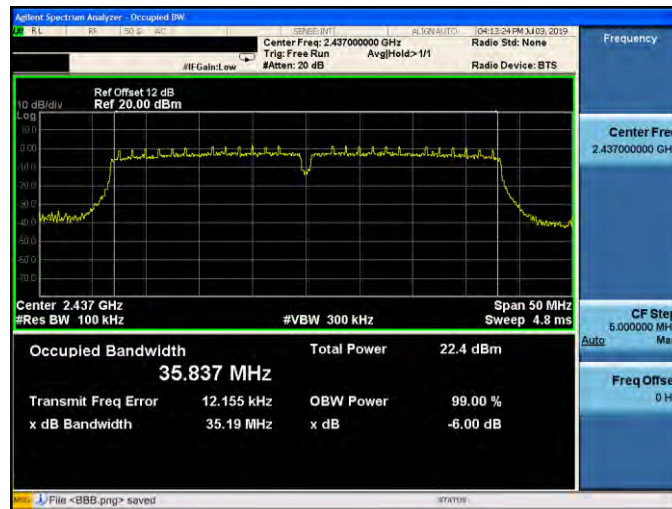

2452 MHz





Maximum Power Spectral Density Measurement

Test Mode	Frequency (MHz)	Measurement (dBm/3 kHz)			Limit (dBm/ 3 kHz)
		ANT-0	ANT-1	ANT-0+1	
Mode 2	2412	-8.855	-8.783	-5.809	≤ 8
	2437	-7.735	-8.071	-4.889	≤ 8
	2462	-12.618	-12.562	-9.580	≤ 8
Mode 3	2412	-11.249	-12.495	-8.817	≤ 8
	2437	-7.212	-8.370	-4.742	≤ 8
	2462	-13.457	-14.297	-10.846	≤ 8
Mode 6	2412	-12.313	-13.768	-9.970	≤ 8
	2437	-7.215	-8.623	-4.852	≤ 8
	2462	-12.155	-13.267	-9.665	≤ 8
Mode 7	2422	-15.760	-16.820	-13.247	≤ 8
	2437	-13.029	-13.908	-10.436	≤ 8
	2452	-16.617	-17.380	-13.971	≤ 8



Mode 2: IEEE 802.11b Continuous TX mode_ANT-0

2412 MHz

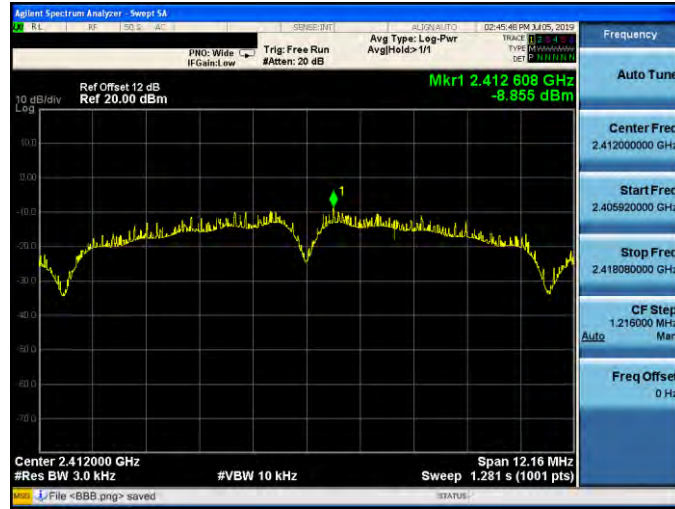

2437 MHz



2462 MHz





Mode 6: IEEE 802.11n 2.4 GHz 20 MHz (256QAM) Continuous TX mode_ANT-0

2412 MHz

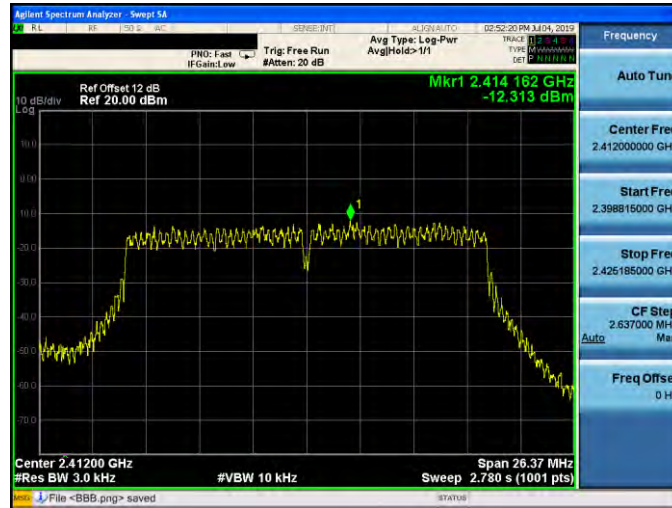

2437 MHz

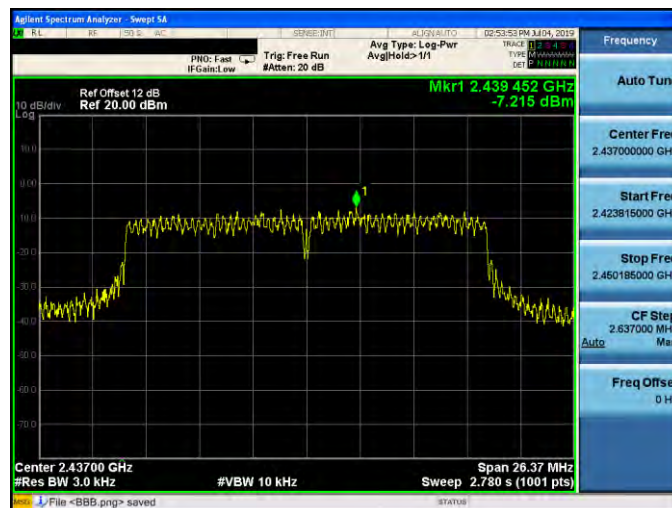

2462 MHz

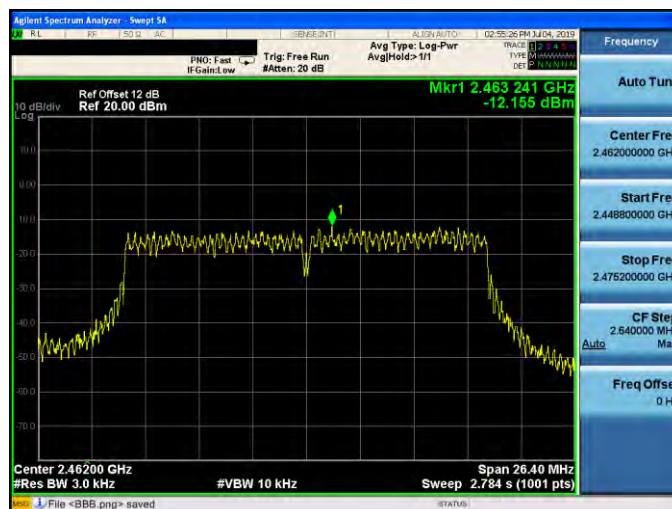



Mode 7: IEEE 802.11n 2.4 GHz 40 MHz (256QAM) Continuous TX mode_ANT-0

2422 MHz

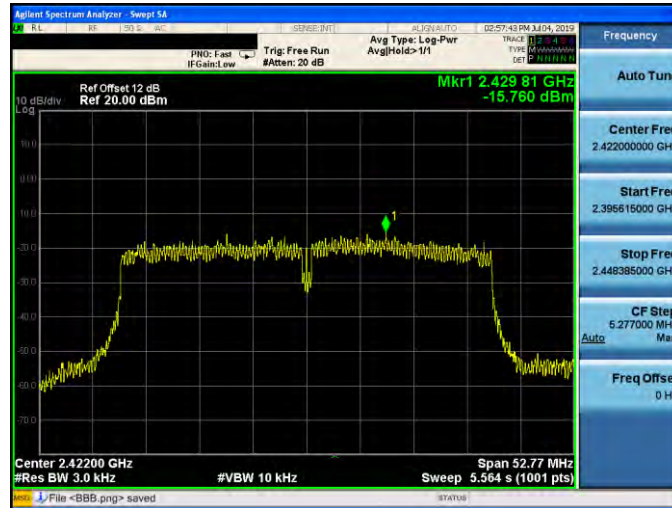

2437 MHz

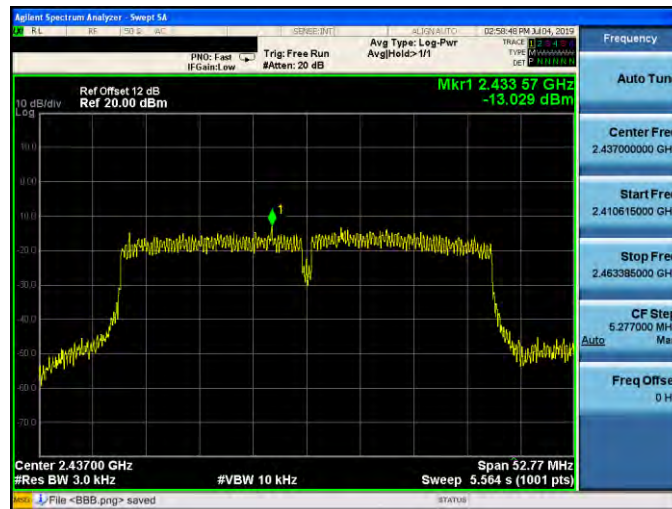

2452 MHz

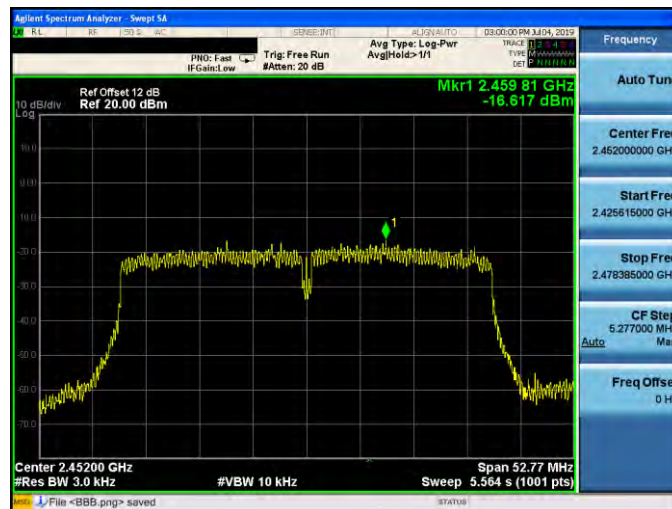



Mode 2: IEEE 802.11b Continuous TX mode_ANT-1

2412 MHz



2437 MHz



2462 MHz





Mode 3: IEEE 802.11g Continuous TX mode_ANT-1

2412 MHz

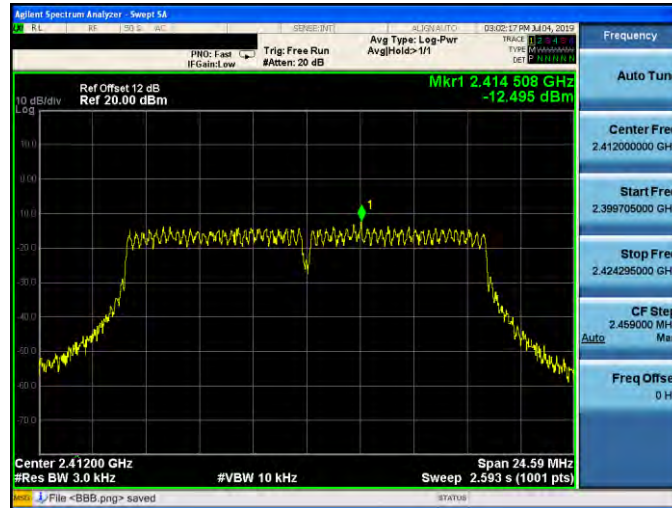

2437 MHz

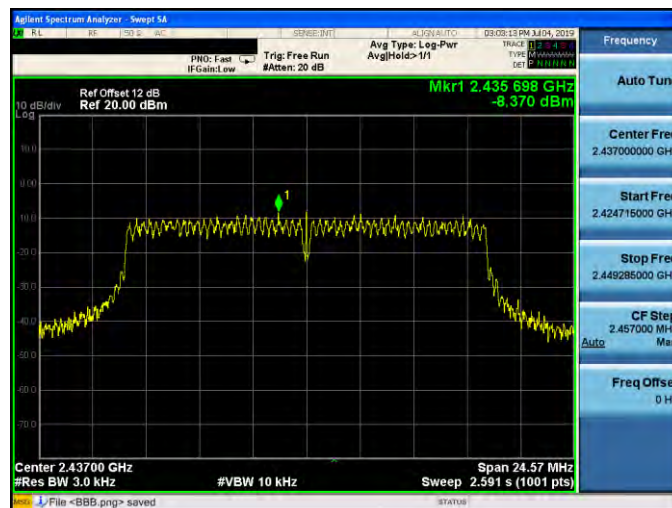

2462 MHz

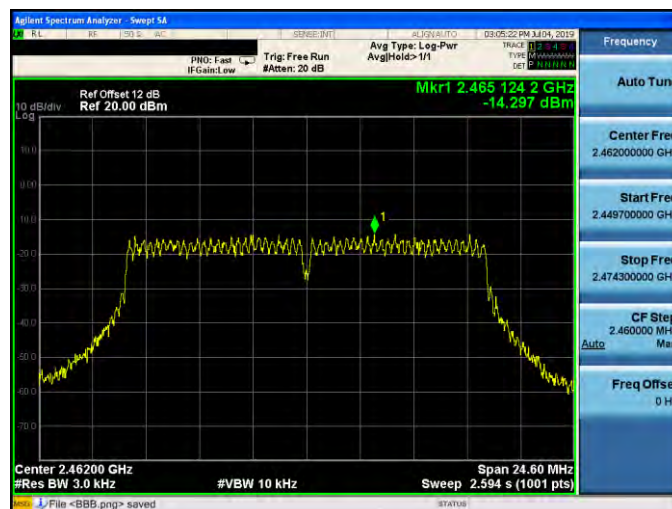



Mode 6: IEEE 802.11n 2.4 GHz 20 MHz (256QAM) Continuous TX mode_ANT-1

2412 MHz

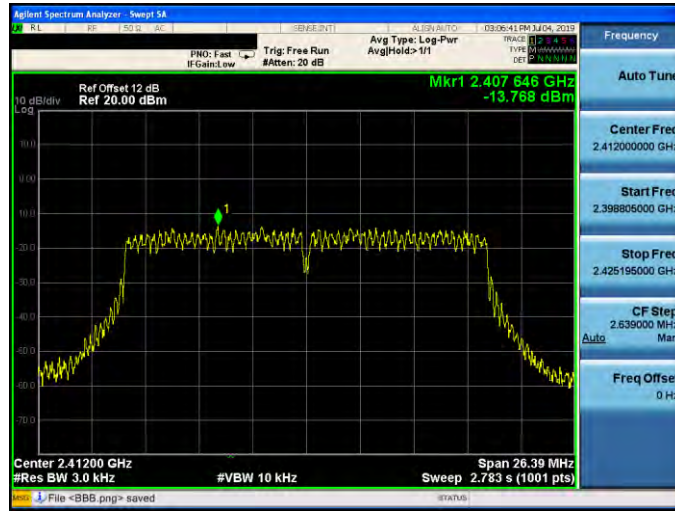

2437 MHz

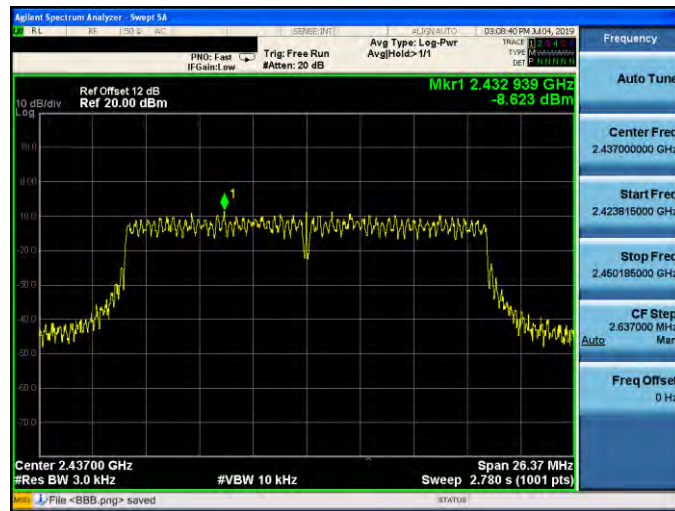

2462 MHz

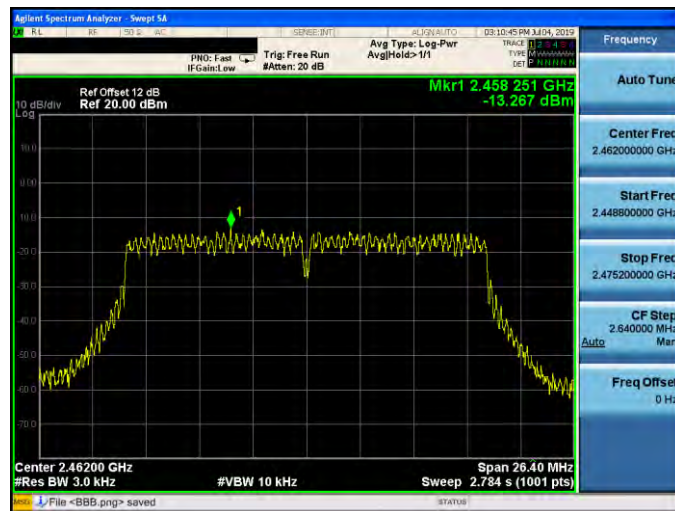



Mode 7: IEEE 802.11n 2.4 GHz 40 MHz (256QAM) Continuous TX mode_ANT-1

2422 MHz

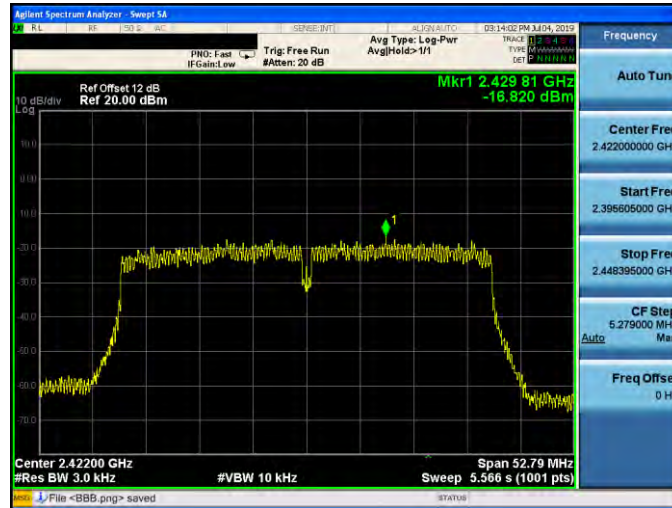

2437 MHz

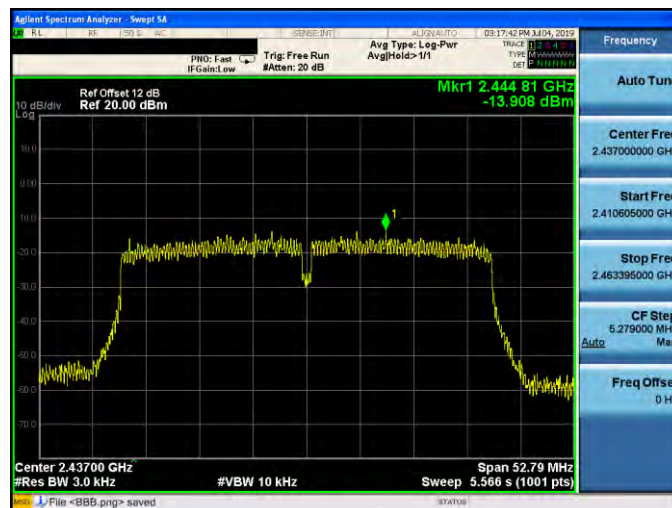

2452 MHz

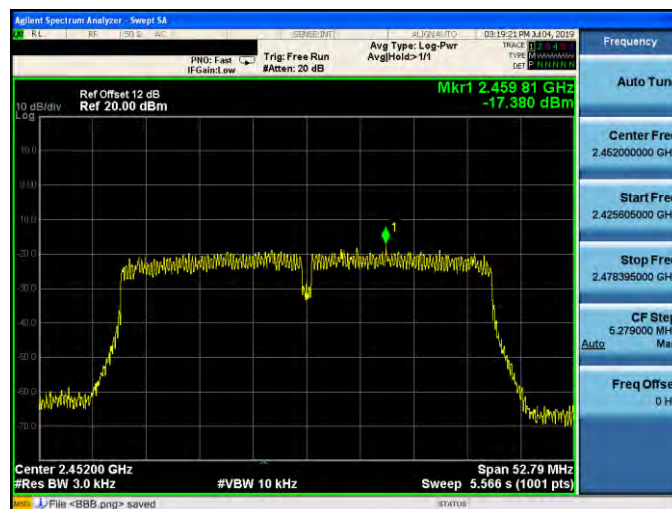



Out of Band Conducted Emissions Measurement

■ Test Graphs

Reference level

Mode 2: IEEE 802.11b Continuous TX mode_ANT-0

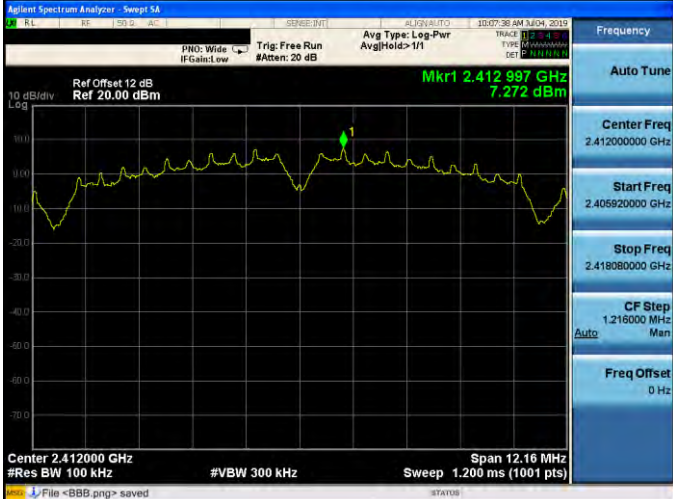
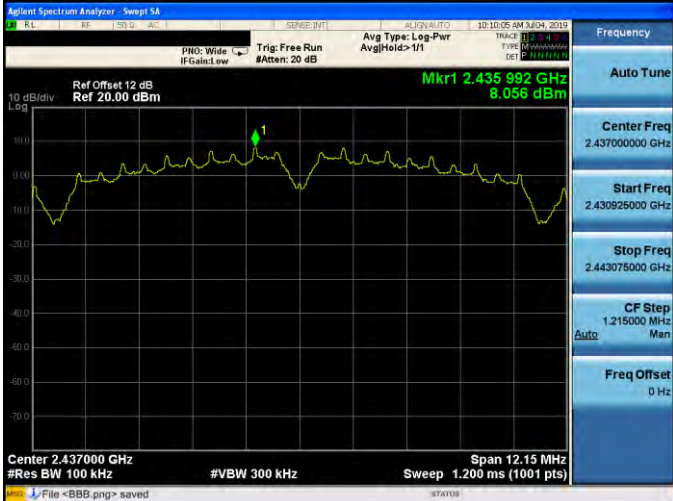
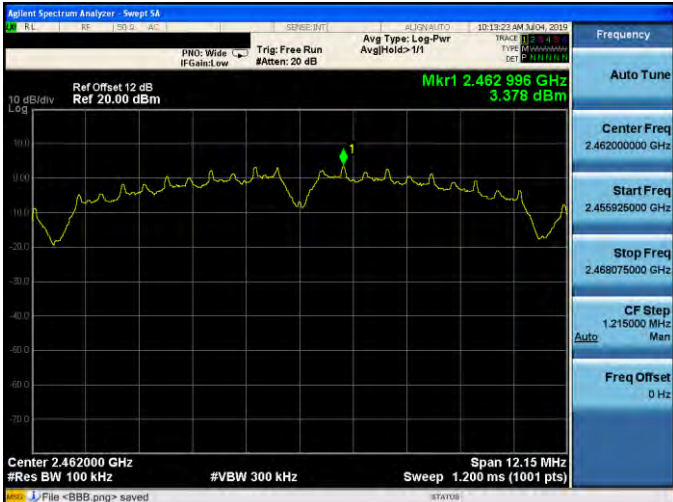
2412 MHz	 <p>Agilent Spectrum Analyzer - Swept SA</p> <p>Ref Offset 12 dB Ref 20.00 dBm</p> <p>Mkr1 2.412 997 GHz 7.272 dBm</p> <p>Center 2.412000 GHz #Res BW 100 kHz #VBW 300 kHz Sweep 1.200 ms (1001 pts)</p> <p>Frequency</p> <p>Auto Tune</p> <p>Center Freq 2.412000000 GHz</p> <p>Start Freq 2.406920000 GHz</p> <p>Stop Freq 2.418080000 GHz</p> <p>CF Step 1.216000 MHz Auto Man</p> <p>Freq Offset 0 Hz</p>
2437 MHz	 <p>Agilent Spectrum Analyzer - Swept SA</p> <p>Ref Offset 12 dB Ref 20.00 dBm</p> <p>Mkr1 2.435 992 GHz 8.056 dBm</p> <p>Center 2.437000 GHz #Res BW 100 kHz #VBW 300 kHz Sweep 1.200 ms (1001 pts)</p> <p>Frequency</p> <p>Auto Tune</p> <p>Center Freq 2.437000000 GHz</p> <p>Start Freq 2.430925000 GHz</p> <p>Stop Freq 2.443075000 GHz</p> <p>CF Step 1.215000 MHz Auto Man</p> <p>Freq Offset 0 Hz</p>
2462 MHz	 <p>Agilent Spectrum Analyzer - Swept SA</p> <p>Ref Offset 12 dB Ref 20.00 dBm</p> <p>Mkr1 2.462 996 GHz 3.378 dBm</p> <p>Center 2.462000 GHz #Res BW 100 kHz #VBW 300 kHz Sweep 1.200 ms (1001 pts)</p> <p>Frequency</p> <p>Auto Tune</p> <p>Center Freq 2.462000000 GHz</p> <p>Start Freq 2.456925000 GHz</p> <p>Stop Freq 2.468075000 GHz</p> <p>CF Step 1.215000 MHz Auto Man</p> <p>Freq Offset 0 Hz</p>



Mode 3: IEEE 802.11g Continuous TX mode_ANT-0

2412 MHz

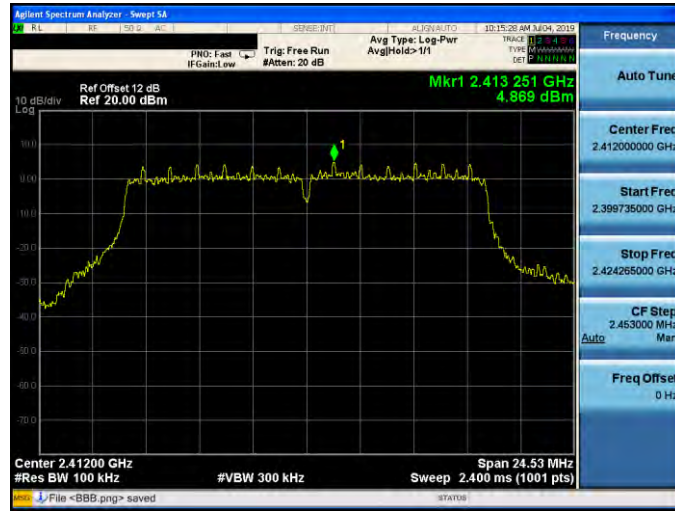

2437 MHz



2462 MHz

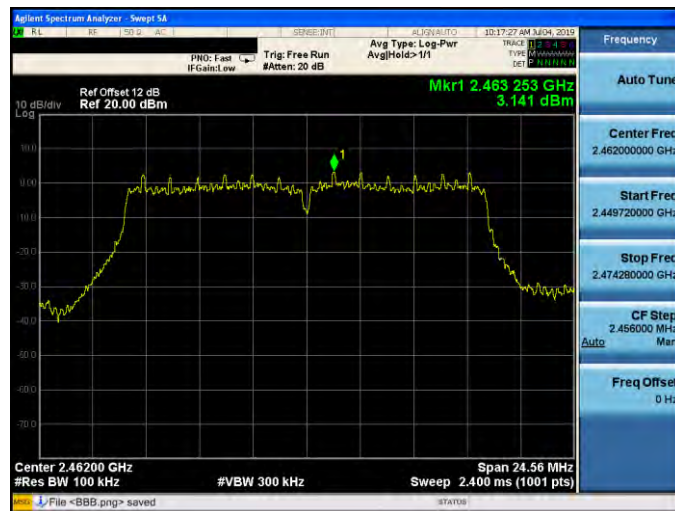



Mode 6: IEEE 802.11n 2.4 GHz 20 MHz (256QAM) Continuous TX mode_ANT-0

2412 MHz



2437 MHz

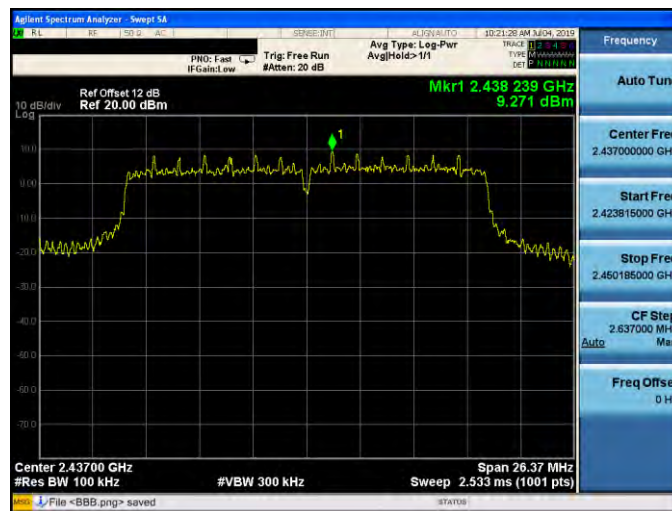

2462 MHz

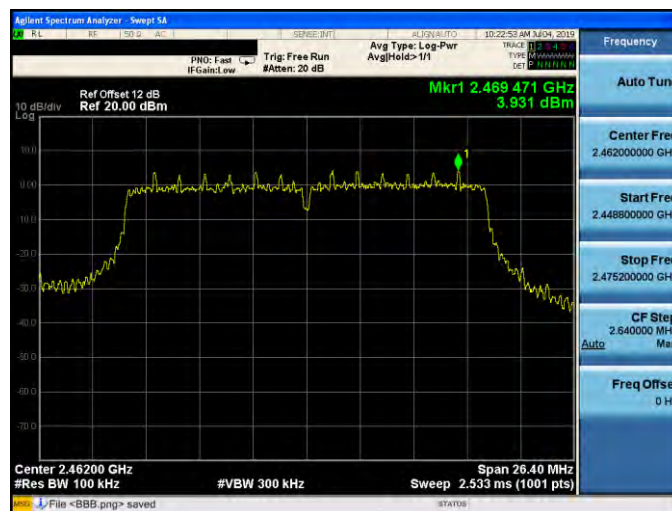



Mode 7: IEEE 802.11n 2.4 GHz 40 MHz (256QAM) Continuous TX mode_ANT-0

2422 MHz

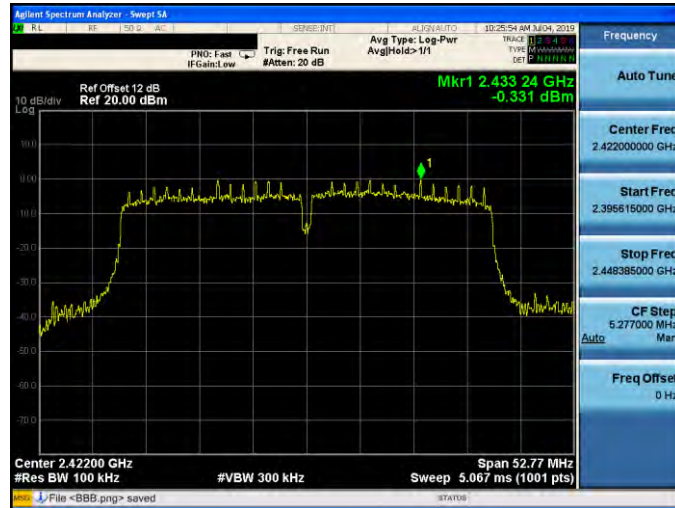

2437 MHz

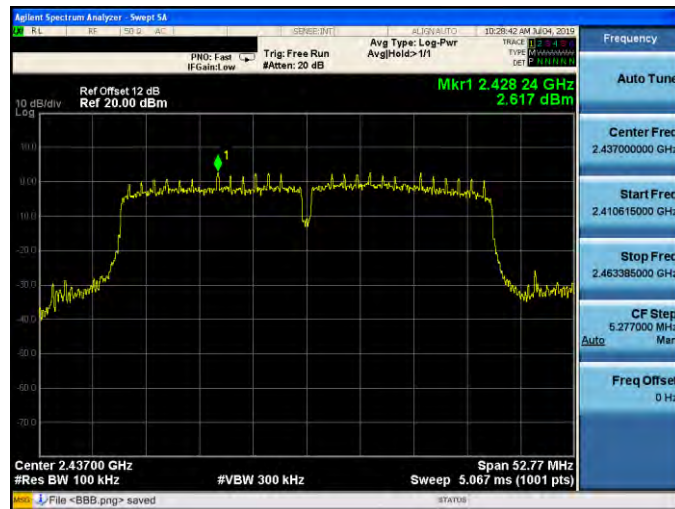

2452 MHz

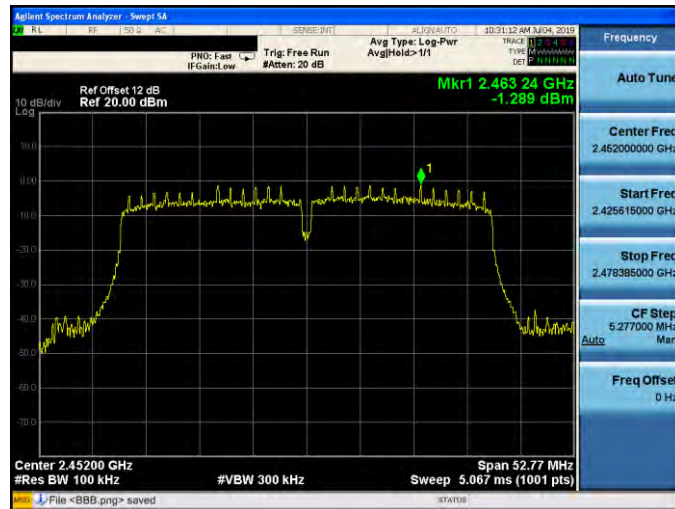



Mode 2: IEEE 802.11b Continuous TX mode_ANT-1

2412 MHz

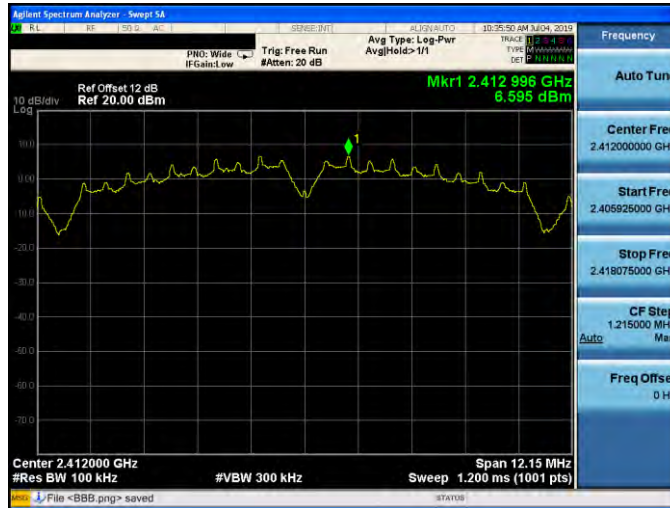

2437 MHz

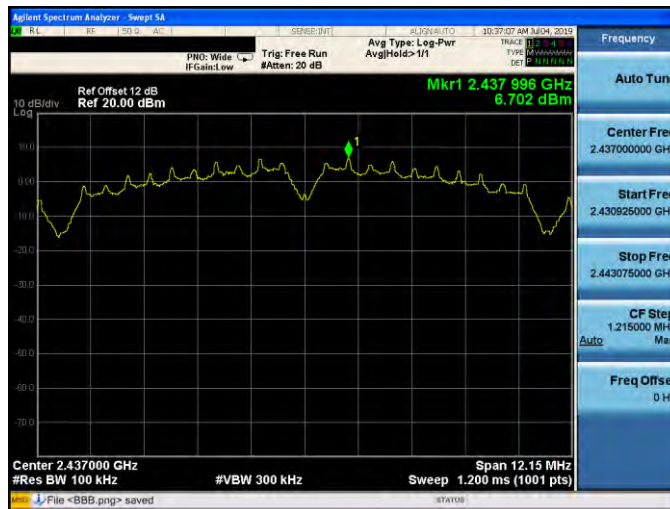

2462 MHz





Mode 3: IEEE 802.11g Continuous TX mode_ANT-1

2412 MHz

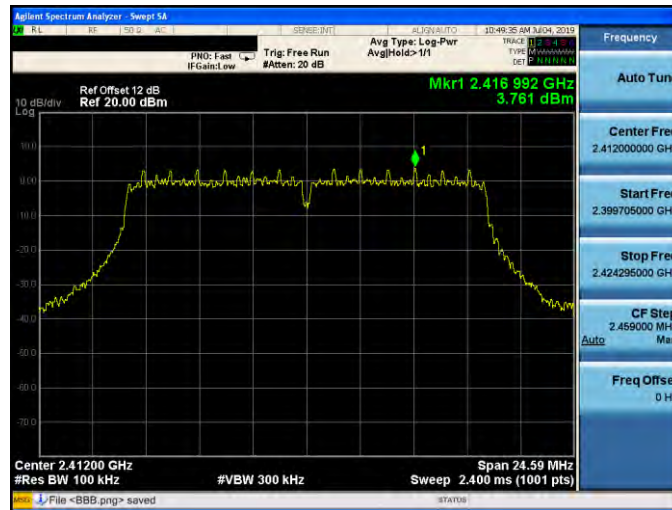

2437 MHz

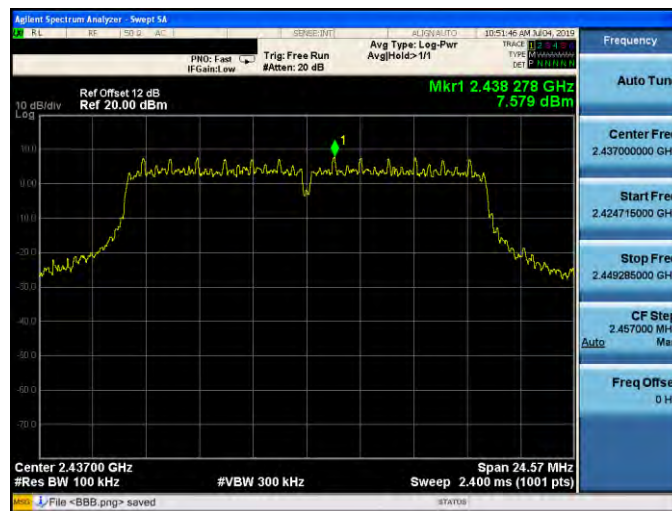

2462 MHz





Mode 6: IEEE 802.11n 2.4 GHz 20 MHz (256QAM) Continuous TX mode_ANT-1

2412 MHz

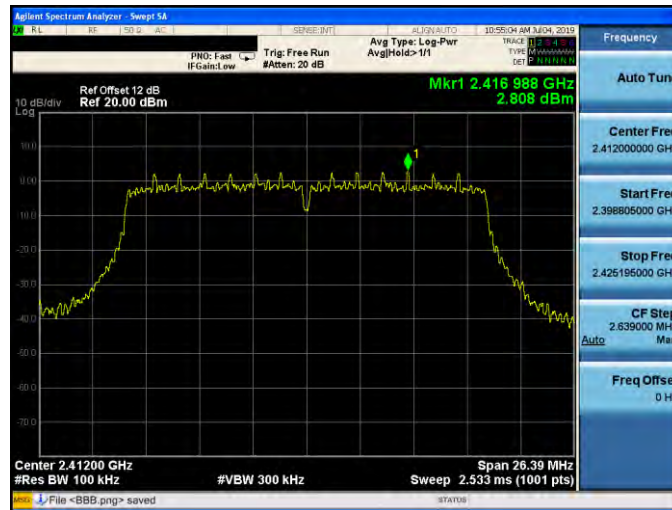

2437 MHz

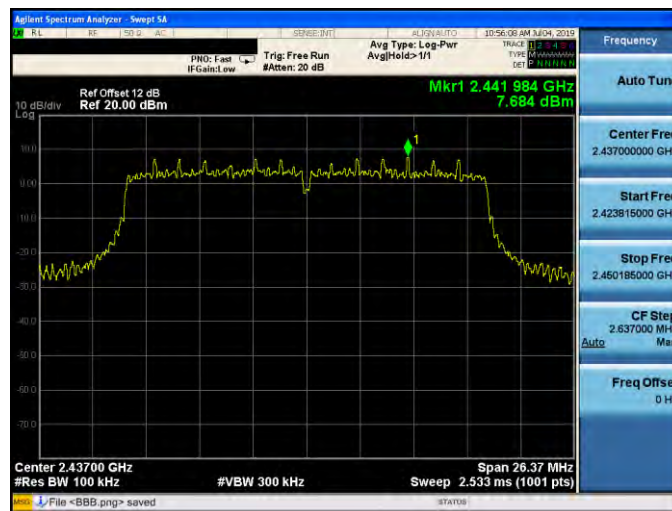

2462 MHz

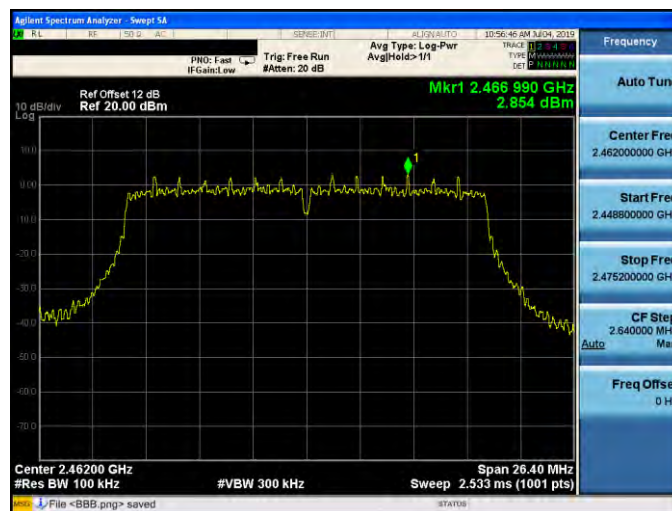



Mode 7: IEEE 802.11n 2.4 GHz 40 MHz (256QAM) Continuous TX mode_ANT-1

2422 MHz

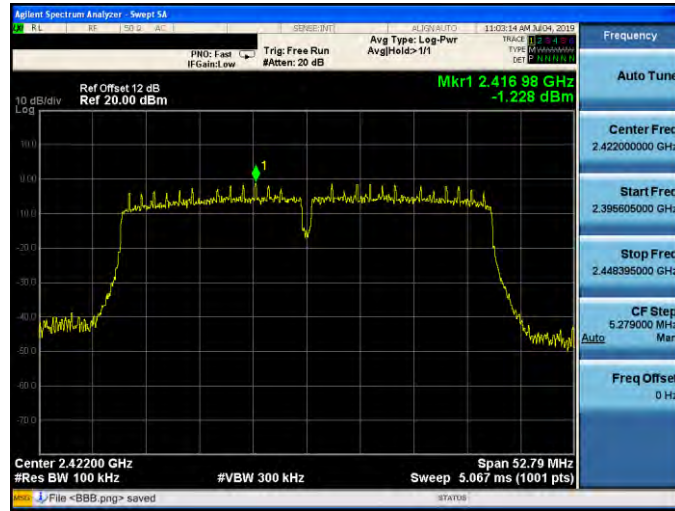

2437 MHz



2452 MHz





Out of Band Conducted Emissions

Mode 2: IEEE 802.11b Continuous TX mode_ANT-0

2412 MHz

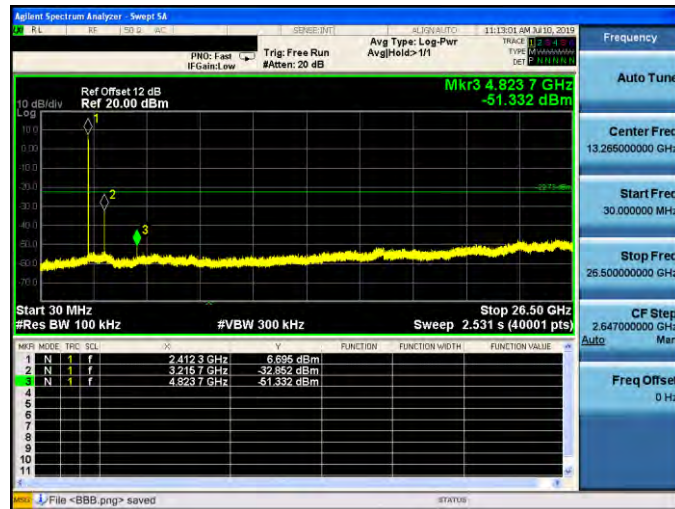

2437 MHz

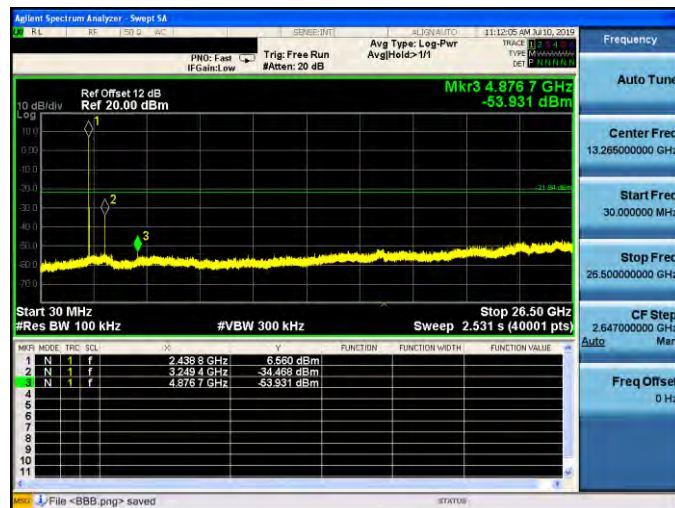

2462 MHz

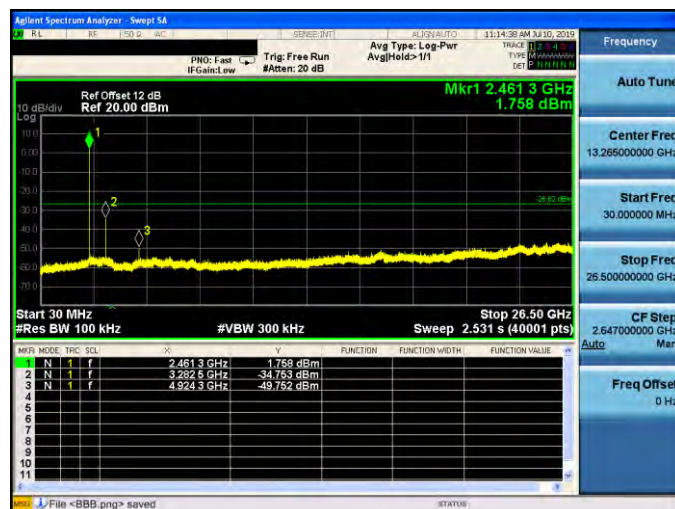



Mode 3: IEEE 802.11g Continuous TX mode_ANT-0

2412 MHz

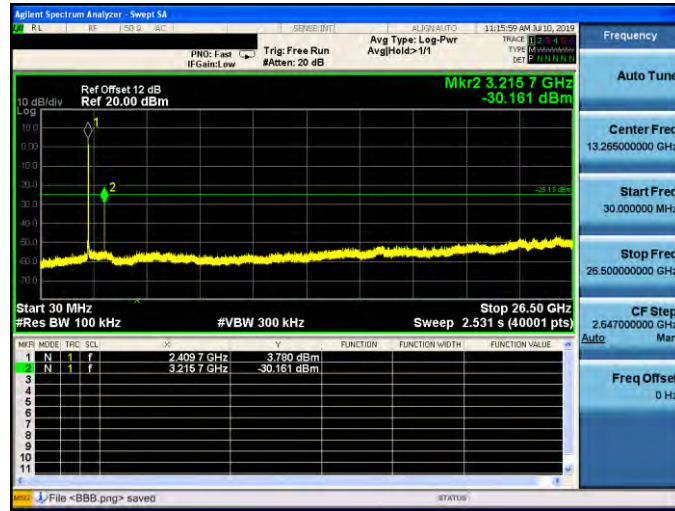

2437 MHz

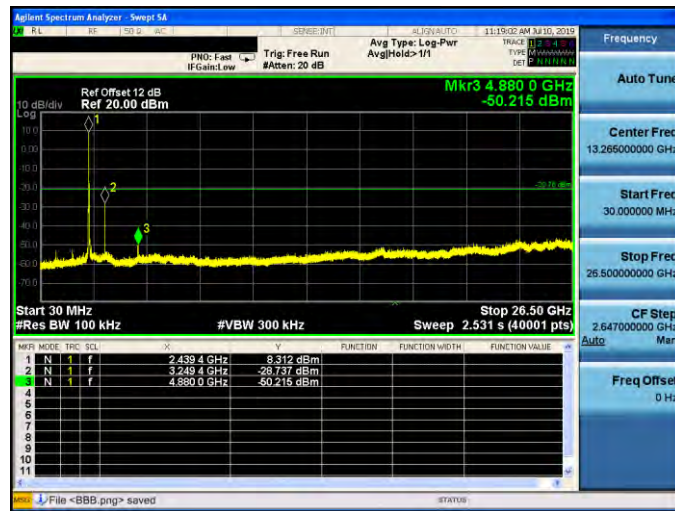

2462 MHz

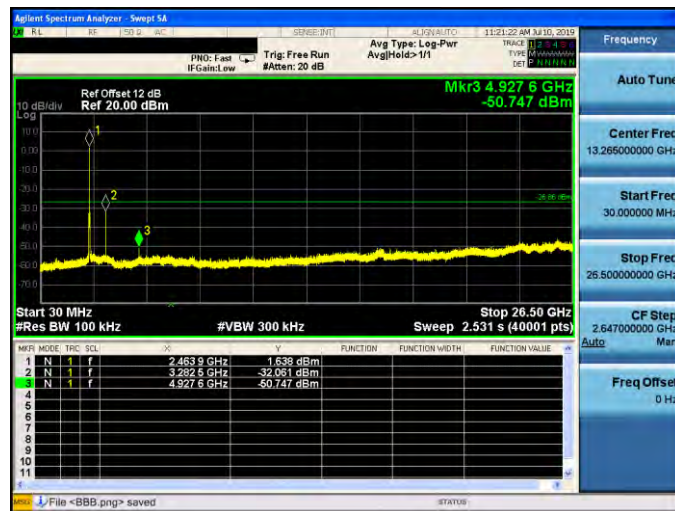



Mode 6: IEEE 802.11n 2.4 GHz 20 MHz (256QAM) Continuous TX mode_ANT-0

2412 MHz

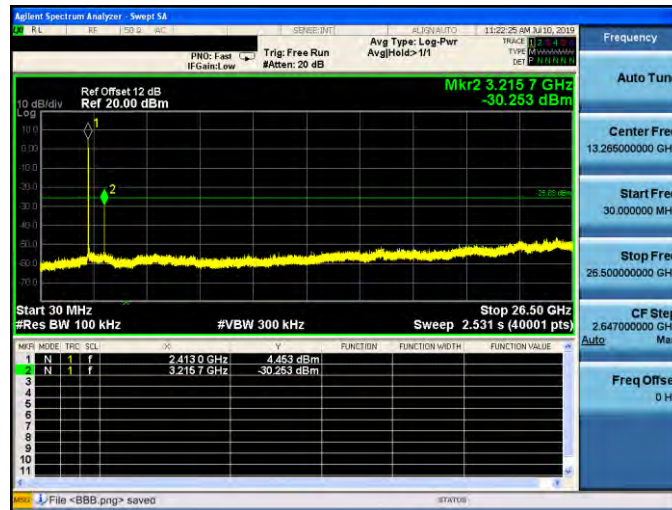

2437 MHz

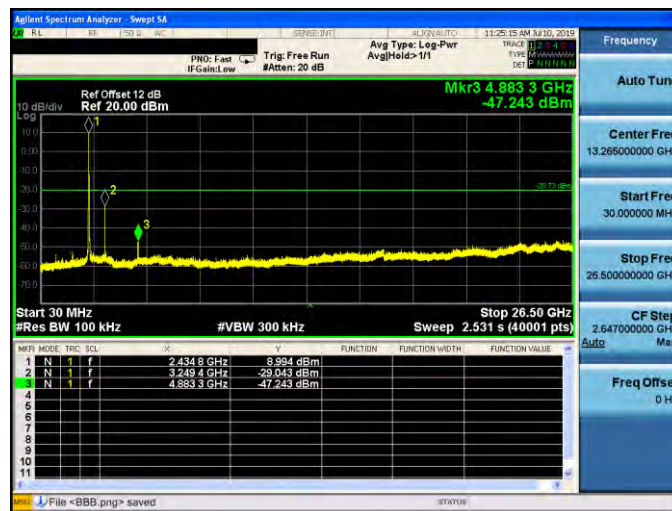

2462 MHz

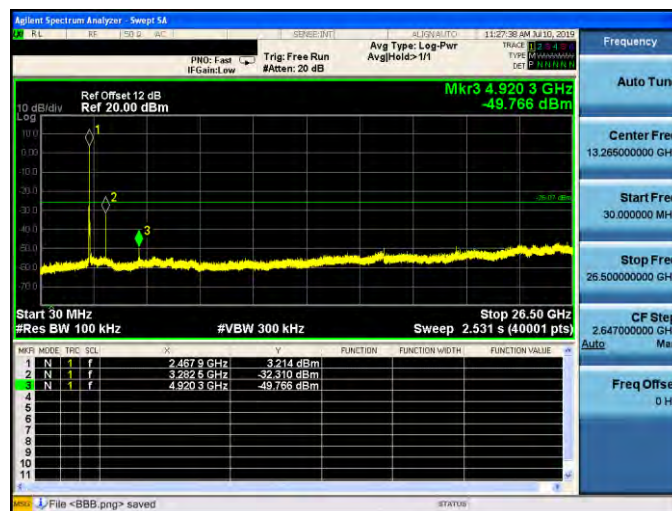



Mode 7: IEEE 802.11n 2.4 GHz 40 MHz (256QAM) Continuous TX mode_ANT-0

2422 MHz

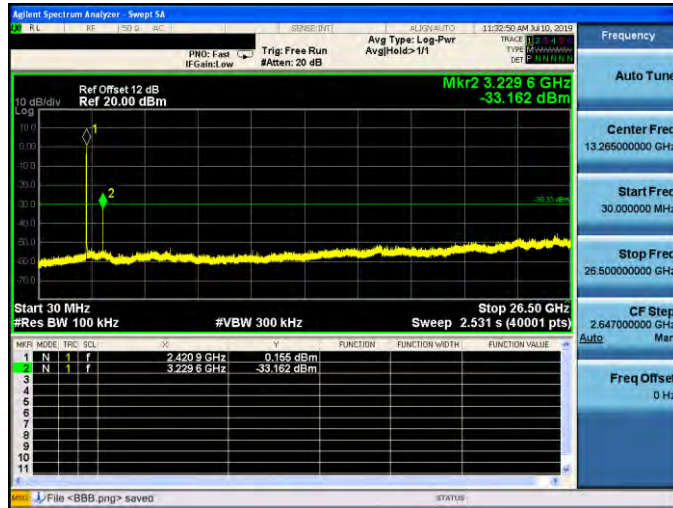

2437 MHz

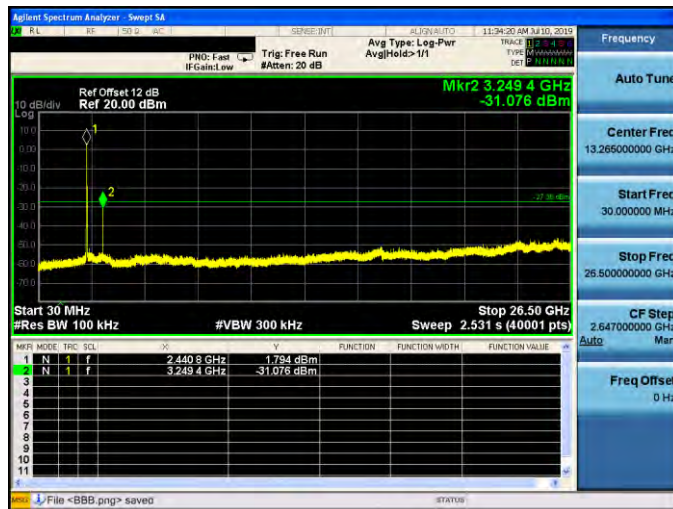

2452 MHz

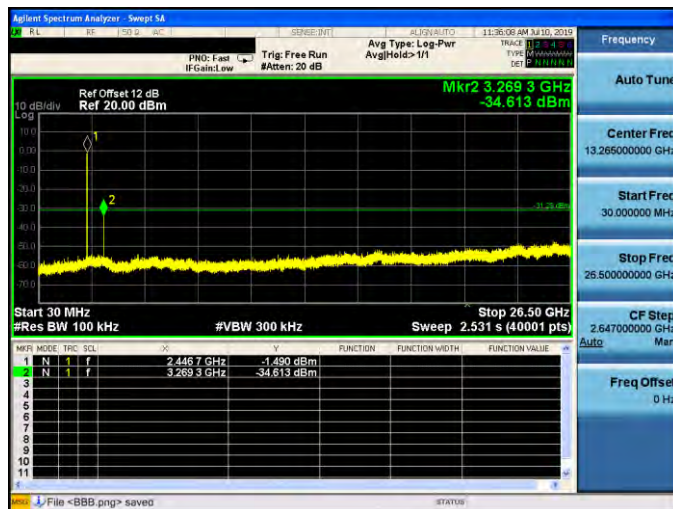



Mode 2: IEEE 802.11b Continuous TX mode_ANT-1

2412 MHz

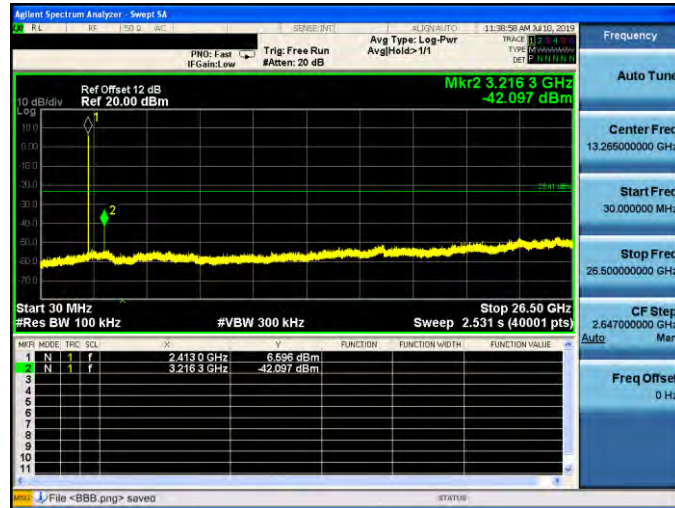

2437 MHz

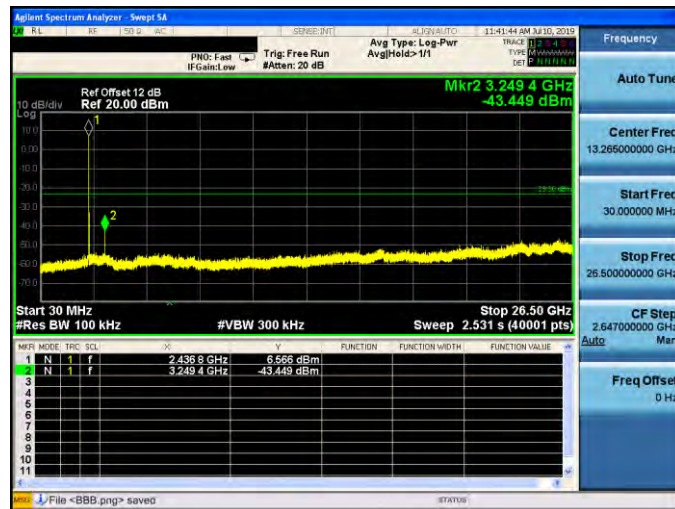

2462 MHz

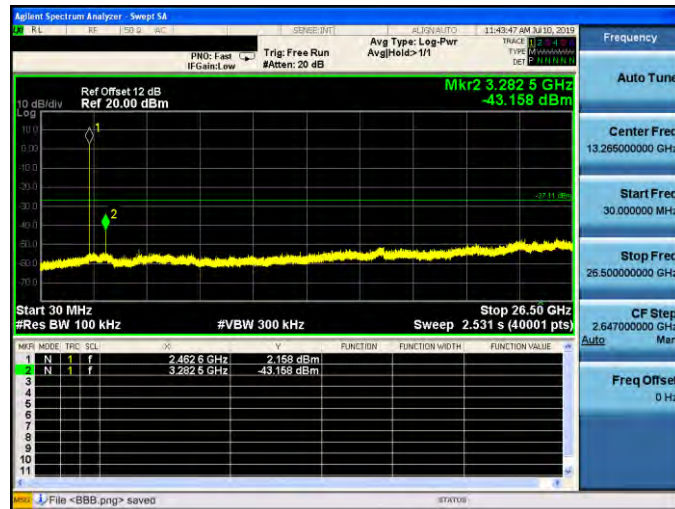



Mode 3: IEEE 802.11g Continuous TX mode_ANT-1

2412 MHz



2437 MHz

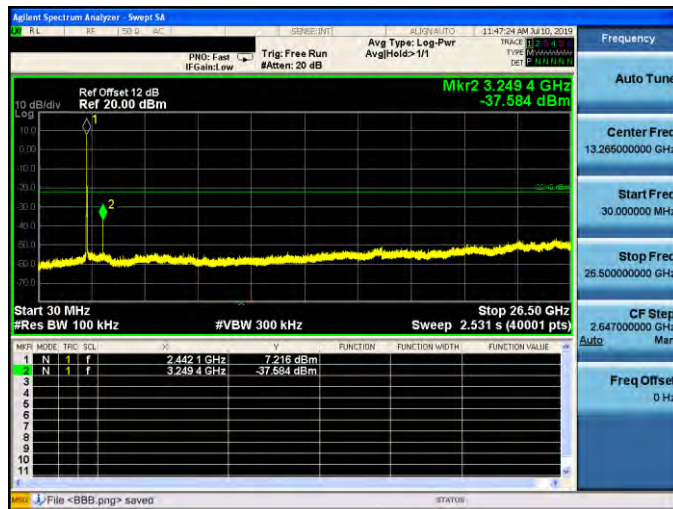

2462 MHz

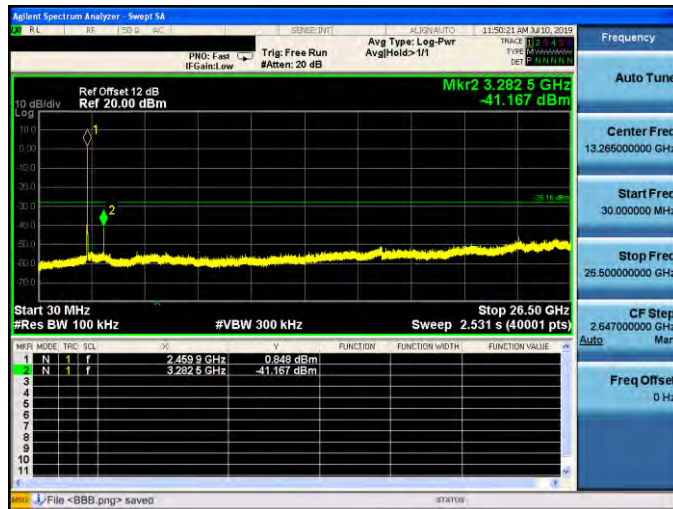



Mode 6: IEEE 802.11n 2.4 GHz 20 MHz (256QAM) Continuous TX mode_ANT-1

2412 MHz

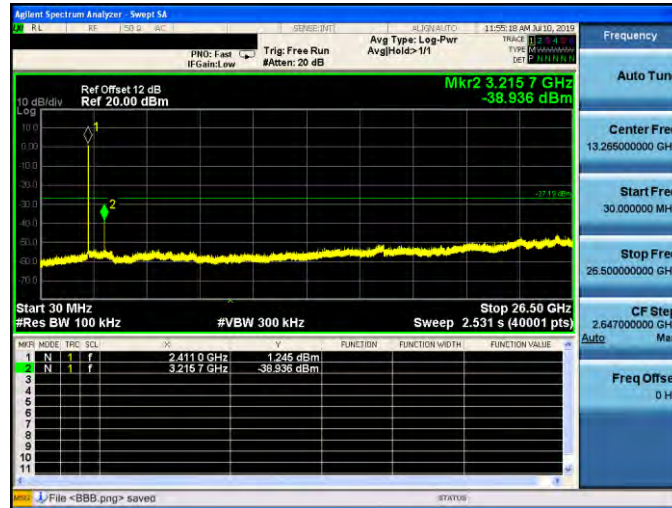

2437 MHz

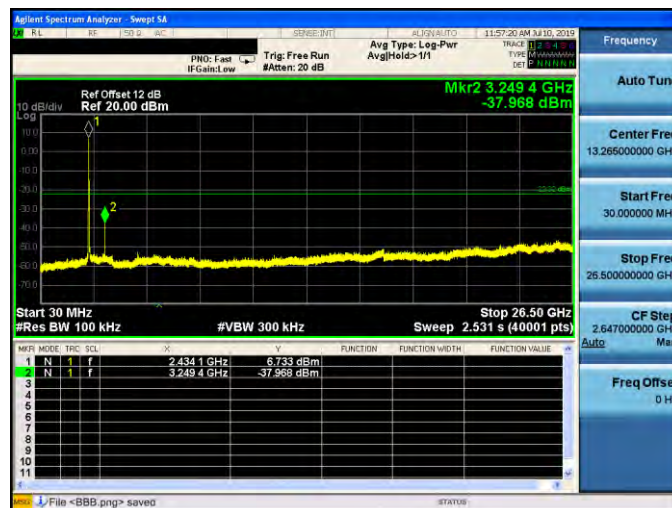

2462 MHz

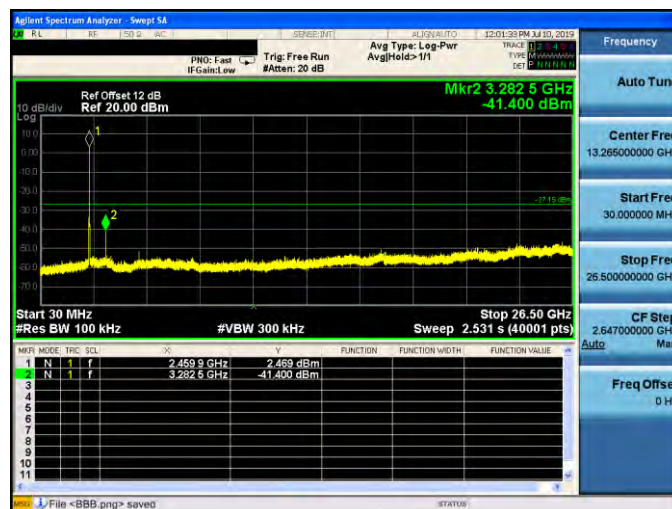



Mode 7: IEEE 802.11n 2.4 GHz 40 MHz (256QAM) Continuous TX mode_ANT-1

2422 MHz

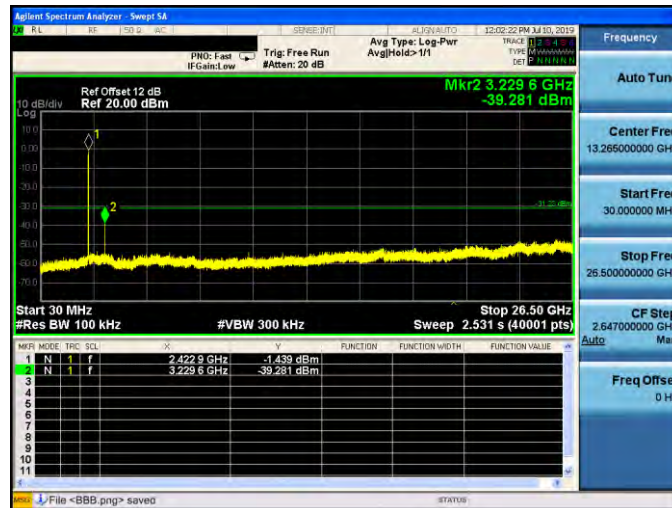

2437 MHz

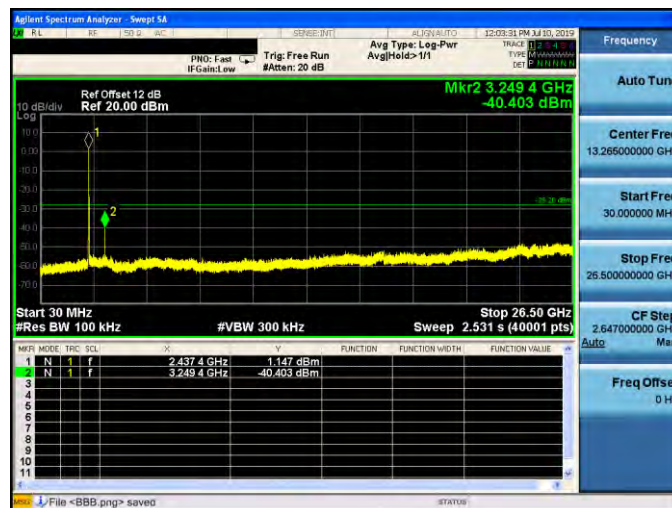

2452 MHz

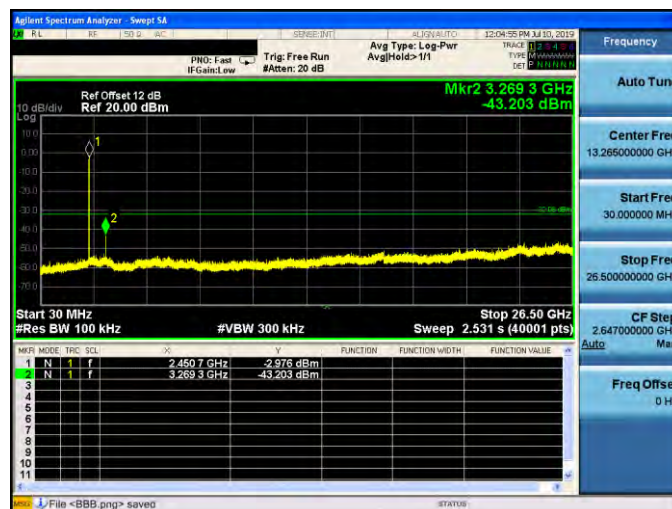

Conducted Band Edge

Mode 2: IEEE 802.11b Continuous TX mode_ANT-0

2412 MHz

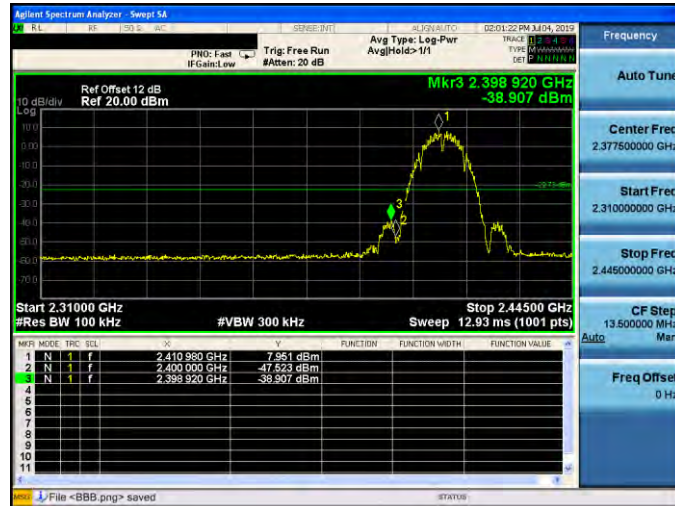

2462 MHz

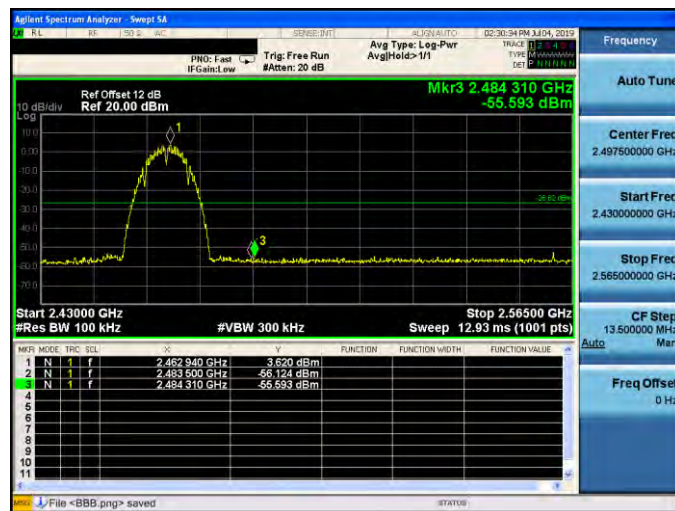

Mode 3: IEEE 802.11g Continuous TX mode_ANT-0

2412 MHz



2462 MHz





Mode 6: IEEE 802.11n 2.4 GHz 20 MHz (256QAM) Continuous TX mode_ANT-0

2412 MHz



2462 MHz





Mode 7: IEEE 802.11n 2.4 GHz 40 MHz (256QAM) Continuous TX mode_ANT-0

2422 MHz



2452 MHz



Mode 2: IEEE 802.11b Continuous TX mode_ANT-1

2412 MHz

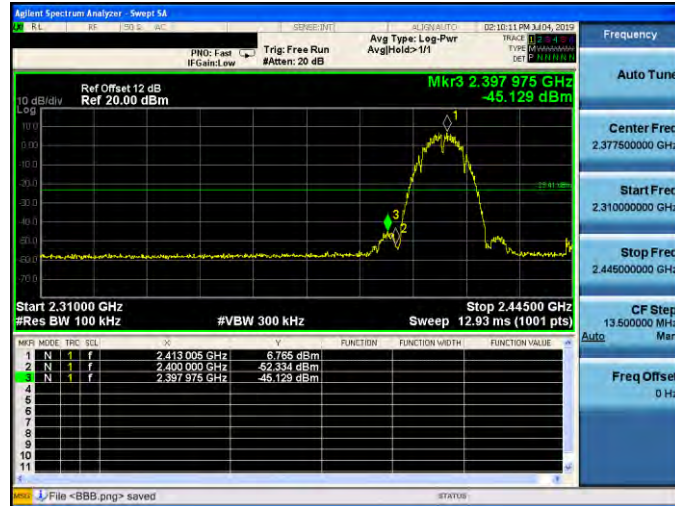

2462 MHz

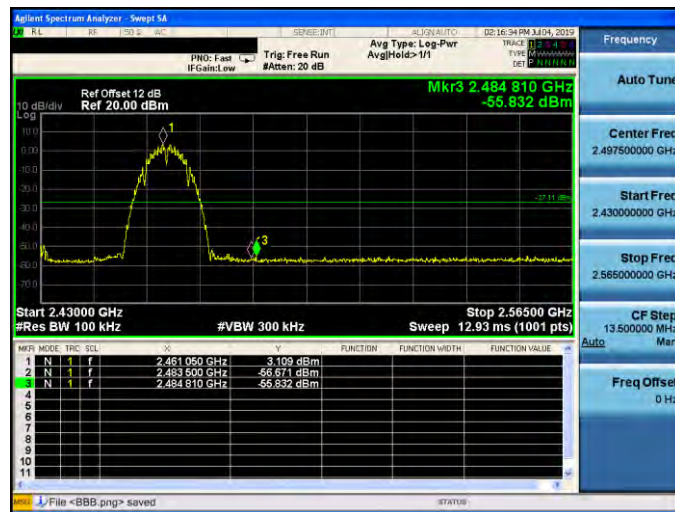

Mode 3: IEEE 802.11g Continuous TX mode_ANT-1

2412 MHz

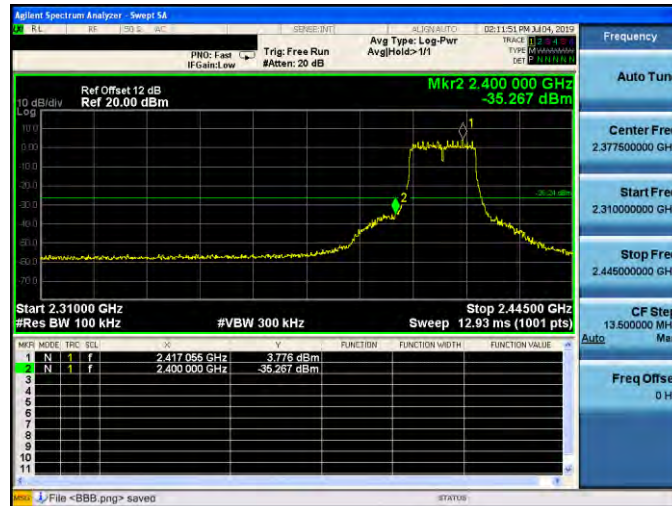

2462 MHz

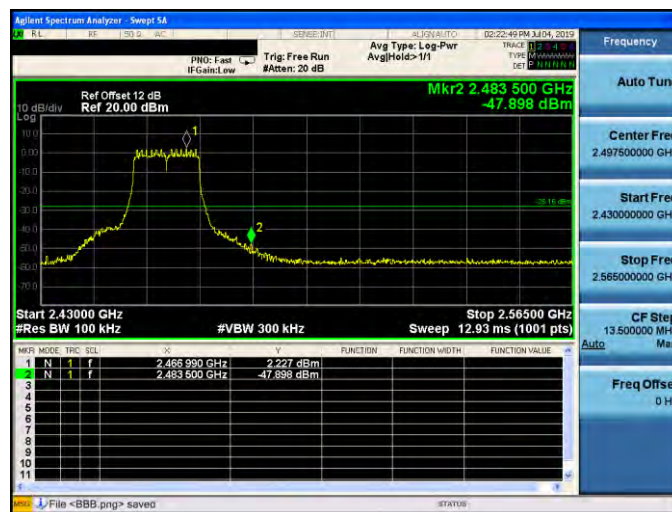

Mode 6: IEEE 802.11n 2.4 GHz 20 MHz (256QAM) Continuous TX mode_ANT-1

2412 MHz

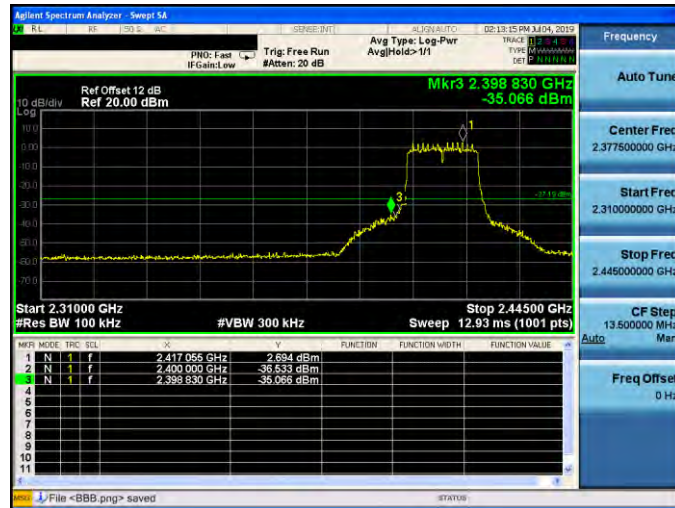

2462 MHz

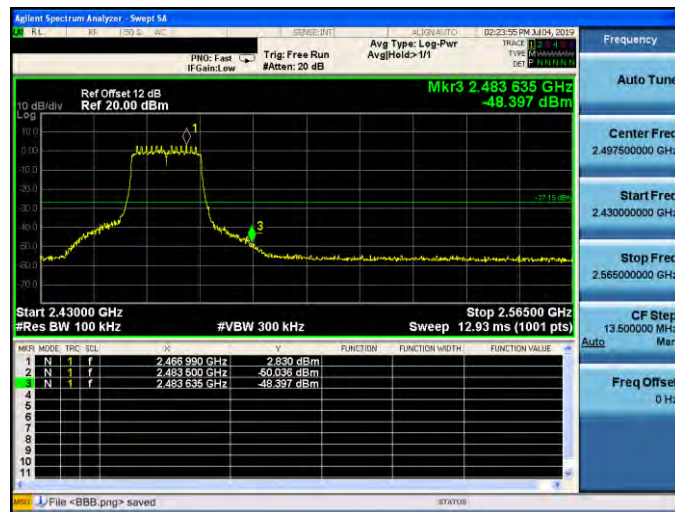

Annex C. Radiated Emission Measurement

Harmonic

Below 1 GHz

Standard:	FCC Part 15.247	Test Distance:	3 m
Test item:	Harmonic	Power:	AC 120 V/60 Hz
Frequency:	2437 MHz	Temp.(°C)/Hum.(%RH):	26(°C)/60 %RH
Mode:	Mode 3		

Frequency (MHz)	Reading (dBuV)	Correct Factor (dB/m)	Result (dBuV/m)	Limit (dBuV/m)	Margin (dB)	Remark	Ant.Polar. H / V
95.9600	51.61	-11.58	40.03	43.50	-3.47	QP	H
120.2100	48.83	-8.44	40.39	43.50	-3.11	QP	H
146.4000	44.61	-6.05	38.56	43.50	-4.94	QP	H
168.7100	46.14	-6.01	40.13	43.50	-3.37	QP	H
231.7600	49.74	-7.11	42.63	46.00	-3.37	QP	H
325.8500	48.60	-3.61	44.99	46.00	-1.01	QP	H
72.6800	46.63	-9.29	37.34	40.00	-2.66	QP	V
96.9300	48.07	-11.46	36.61	43.50	-6.89	QP	V
168.7100	44.46	-6.01	38.45	43.50	-5.05	QP	V
224.9700	50.56	-7.39	43.17	46.00	-2.83	QP	V
321.9700	46.25	-3.67	42.58	46.00	-3.42	QP	V
552.8300	34.90	0.62	35.52	46.00	-10.48	QP	V

Note:1.Result (dBuV/m) = Correct Factor (dB/m) + Reading(dBuV).

Example: 40.03 = -11.58 + 51.61.

2.Correction factor (dB/m) = Antenna Factor (dB/m) + Cable loss (dB) – Pre-Amplifier gain (dB).

3.When the peak results are less than average limit, so not need to evaluate the average.



Above 1 GHz

Standard:	FCC Part 15.247	Test Distance:	3 m
Test item:	Harmonic	Power:	AC 120 V/60 Hz
Frequency:	2412 MHz	Temp.(°C)/Hum.(%RH):	26(°C)/60 %RH
Mode:	Mode 2		
Ant.Polar.:	Horizontal		

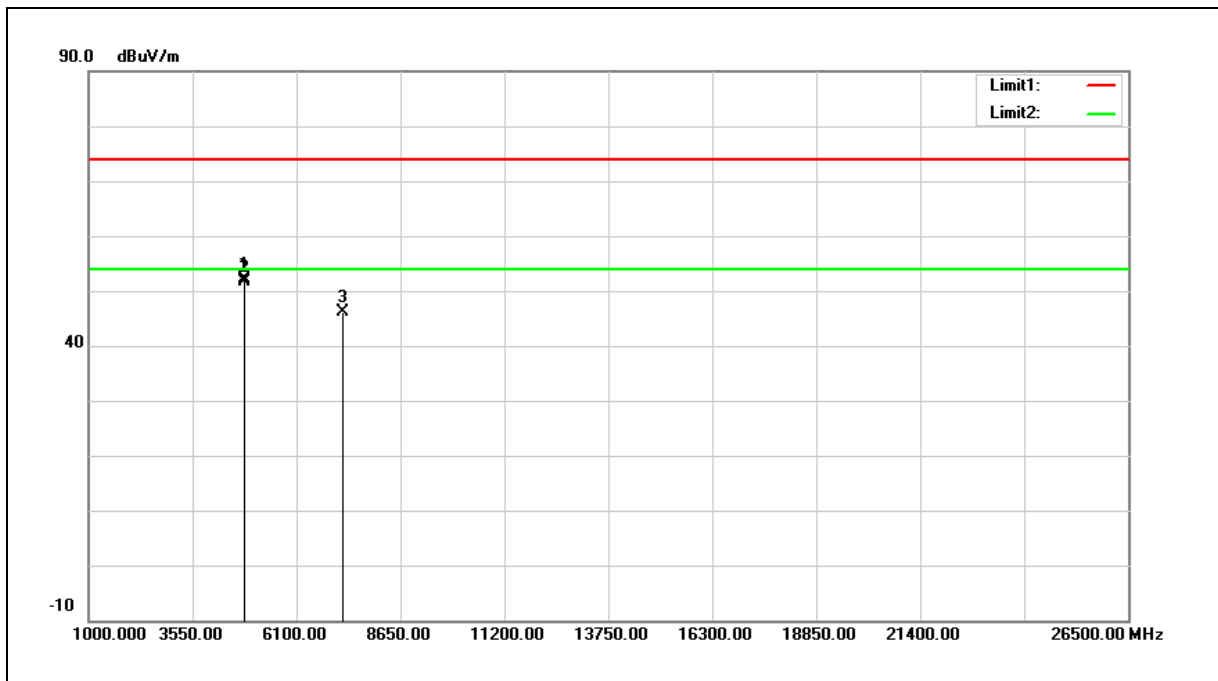

No.	Frequency (MHz)	Reading (dBuV)	Correct Factor (dB/m)	Result (dBuV/m)	Limit (dBuV/m)	Margin (dB)	Remark
1	4824.000	46.48	5.57	52.05	74.00	-21.95	peak
2	4824.000	46.11	5.57	51.68	54.00	-2.32	AVG
3	7236.000	34.05	11.98	46.03	74.00	-27.97	peak

Note:1.Result (dBuV/m) = Correct Factor (dB/m) + Reading(dBuV).

Example: 52.05 = 5.57 + 46.48

2.Correction factor (dB/m) = Antenna Factor (dB/m) + Cable loss (dB) – Pre-Amplifier gain (dB).

3. When the peak results are less than average limit, so not need to evaluate the average.



Standard:	FCC Part 15.247	Test Distance:	3 m
Test item:	Harmonic	Power:	AC 120 V/60 Hz
Frequency:	2412 MHz	Temp.(°C)/Hum.(%RH):	26(°C)/60 %RH
Mode:	Mode 2		
Ant.Polar.:	Vertical		

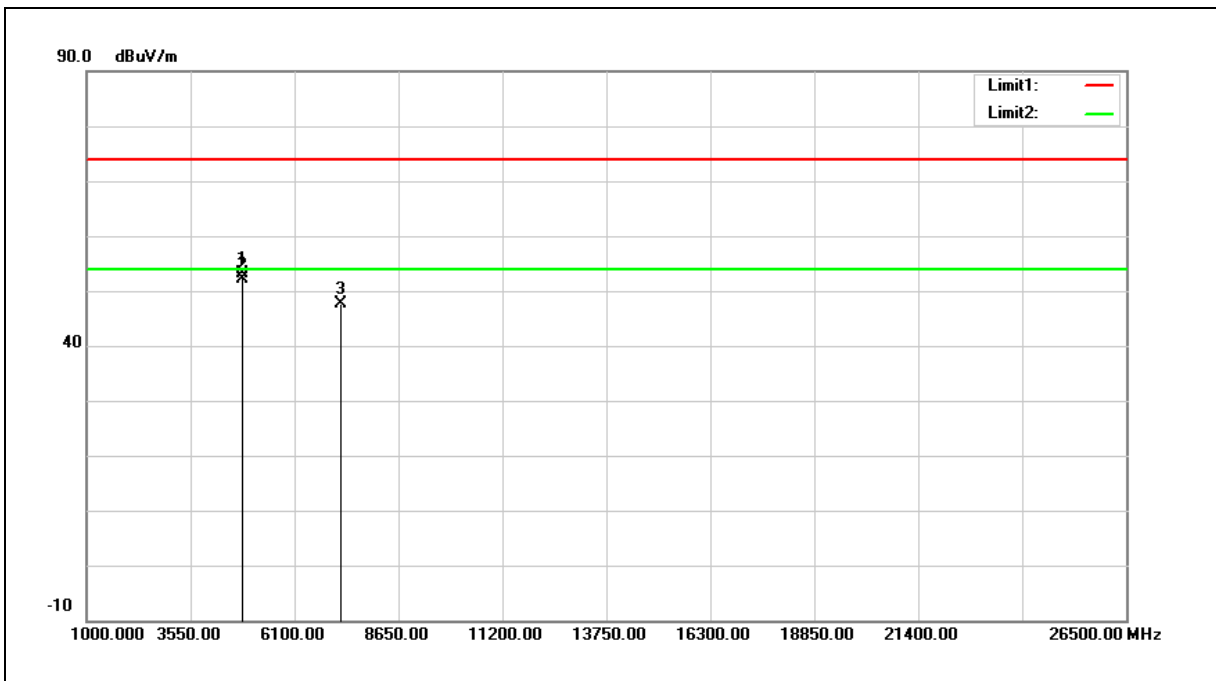

No.	Frequency (MHz)	Reading (dBuV)	Correct Factor (dB/m)	Result (dBuV/m)	Limit (dBuV/m)	Margin (dB)	Remark
1	4824.000	47.66	5.57	53.23	74.00	-20.77	peak
2	4824.000	46.56	5.57	52.13	54.00	-1.87	AVG
3	7236.000	35.58	11.98	47.56	74.00	-26.44	peak

Note:1.Result (dBuV/m) = Correct Factor (dB/m) + Reading(dBuV).

Example: 53.23 = 5.57 + 47.66

2.Correction factor (dB/m) = Antenna Factor (dB/m) + Cable loss (dB) – Pre-Amplifier gain (dB).

3. When the peak results are less than average limit, so not need to evaluate the average.



Standard:	FCC Part 15.247	Test Distance:	3 m
Test item:	Harmonic	Power:	AC 120 V/60 Hz
Frequency:	2437 MHz	Temp.(°C)/Hum.(%RH):	26(°C)/60 %RH
Mode:	Mode 2		
Ant.Polar.:	Horizontal		

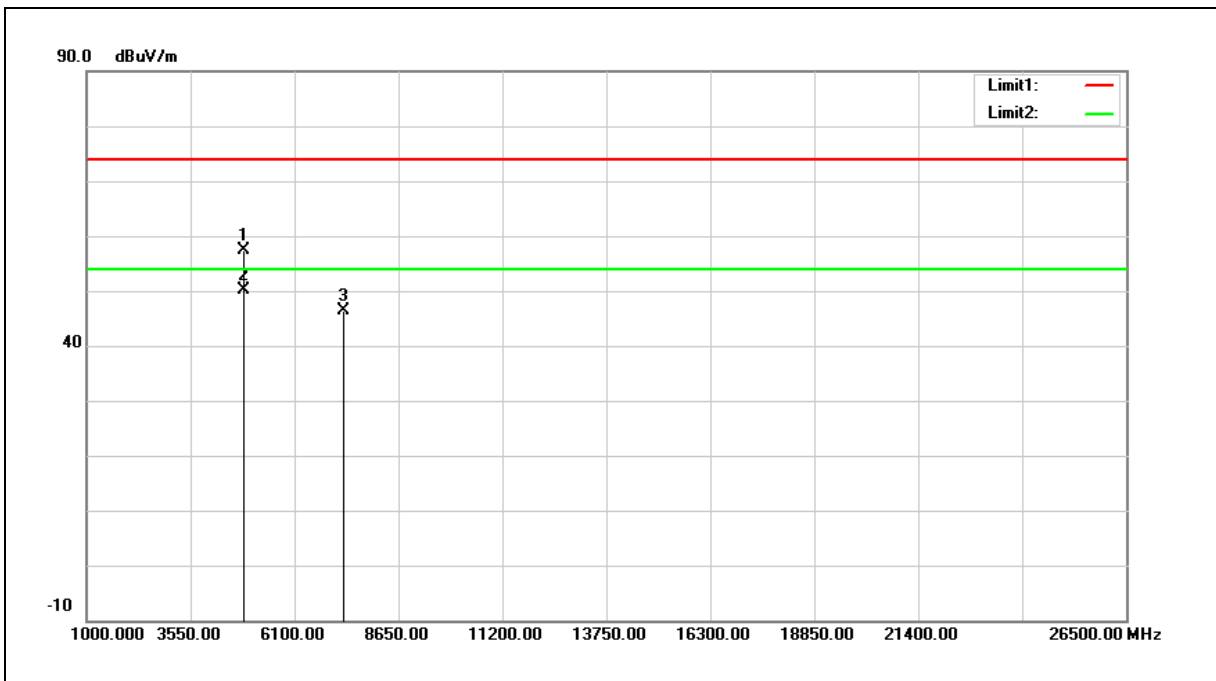

No.	Frequency (MHz)	Reading (dBuV)	Correct Factor (dB/m)	Result (dBuV/m)	Limit (dBuV/m)	Margin (dB)	Remark
1	4874.000	51.75	5.67	57.42	74.00	-16.58	peak
2	4874.000	44.34	5.67	50.01	54.00	-3.99	AVG
3	7311.000	34.22	12.15	46.37	74.00	-27.63	peak

Note:1.Result (dBuV/m) = Correct Factor (dB/m) + Reading(dBuV).

2.Correction factor (dB/m) = Antenna Factor (dB/m) + Cable loss (dB) – Pre-Amplifier gain (dB).

3. When the peak results are less than average limit, so not need to evaluate the average.



Standard:	FCC Part 15.247	Test Distance:	3 m
Test item:	Harmonic	Power:	AC 120 V/60 Hz
Frequency:	2437 MHz	Temp.(°C)/Hum.(%RH):	26(°C)/60 %RH
Mode:	Mode 2		
Ant.Polar.:	Vertical		

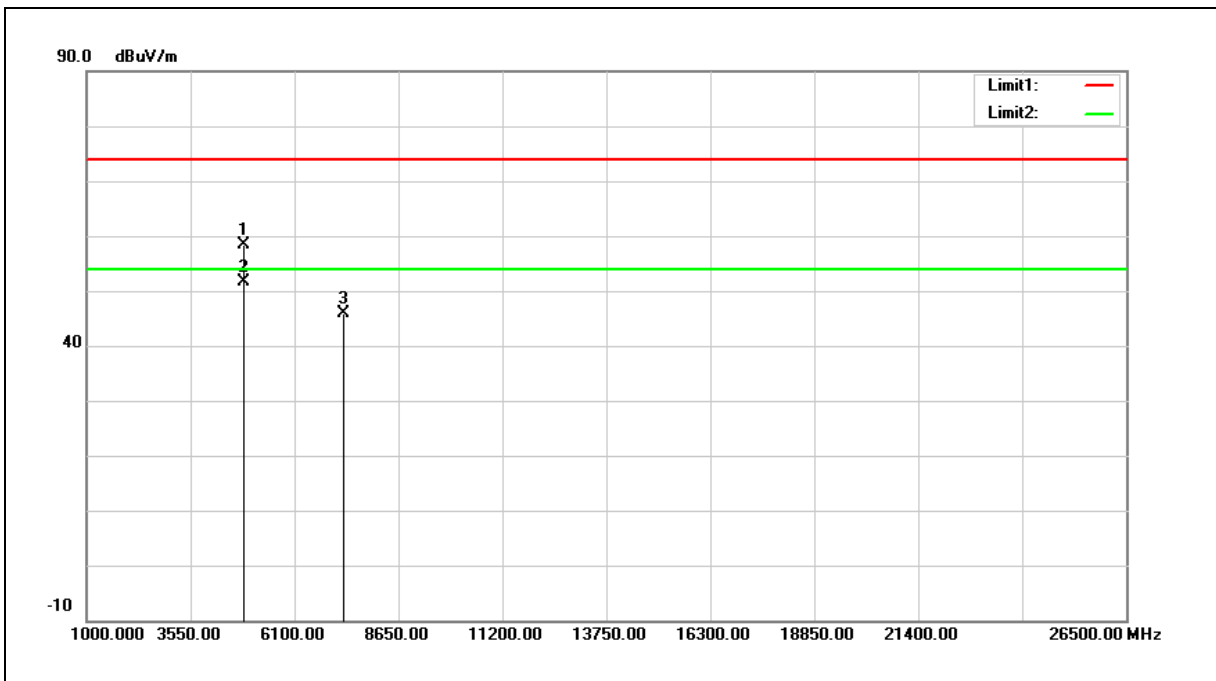

No.	Frequency (MHz)	Reading (dBuV)	Correct Factor (dB/m)	Result (dBuV/m)	Limit (dBuV/m)	Margin (dB)	Remark
1	4874.000	52.80	5.67	58.47	74.00	-15.53	peak
2	4874.000	46.02	5.67	51.69	54.00	-2.31	AVG
3	7311.000	33.77	12.15	45.92	74.00	-28.08	peak

Note:1.Result (dBuV/m) = Correct Factor (dB/m) + Reading(dBuV).

2.Correction factor (dB/m) = Antenna Factor (dB/m) + Cable loss (dB) – Pre-Amplifier gain (dB).

3. When the peak results are less than average limit, so not need to evaluate the average.



Standard:	FCC Part 15.247	Test Distance:	3 m
Test item:	Harmonic	Power:	AC 120 V/60 Hz
Frequency:	2462 MHz	Temp.(°C)/Hum.(%RH):	26(°C)/60 %RH
Mode:	Mode 2		
Ant.Polar.:	Horizontal		

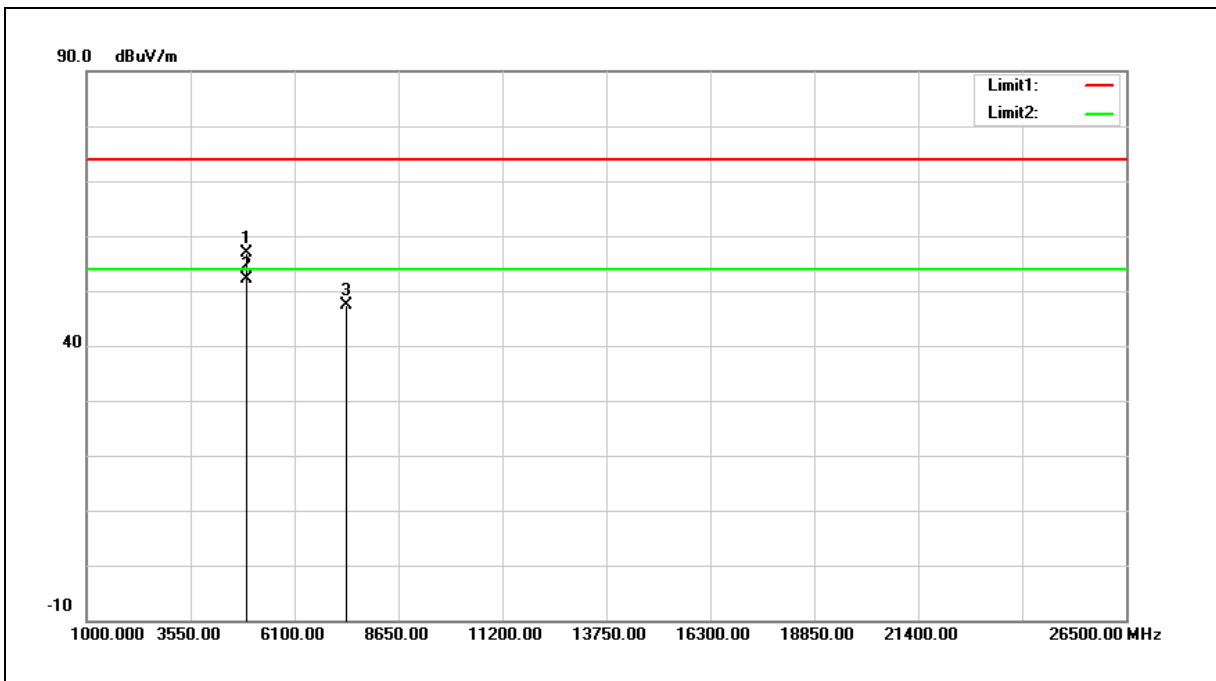

No.	Frequency (MHz)	Reading (dBuV)	Correct Factor (dB/m)	Result (dBuV/m)	Limit (dBuV/m)	Margin (dB)	Remark
1	4924.000	51.10	5.77	56.87	74.00	-17.13	peak
2	4924.000	46.38	5.77	52.15	54.00	-1.85	AVG
3	7386.000	34.94	12.33	47.27	74.00	-26.73	peak

Note:1.Result (dBuV/m) = Correct Factor (dB/m) + Reading(dBuV).

2.Correction factor (dB/m) = Antenna Factor (dB/m) + Cable loss (dB) – Pre-Amplifier gain (dB).

3. When the peak results are less than average limit, so not need to evaluate the average.



Standard:	FCC Part 15.247	Test Distance:	3 m
Test item:	Harmonic	Power:	AC 120 V/60 Hz
Frequency:	2462 MHz	Temp.(°C)/Hum.(%RH):	26(°C)/60 %RH
Mode:	Mode 2		
Ant.Polar.:	Vertical		

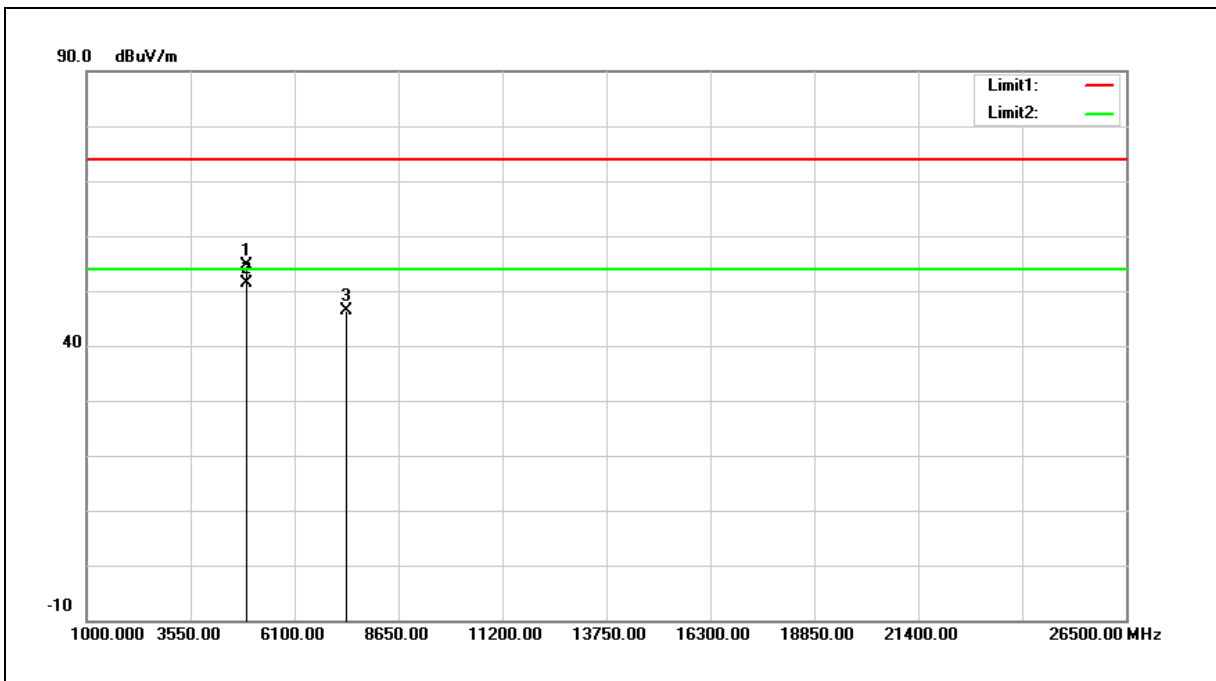

No.	Frequency (MHz)	Reading (dBuV)	Correct Factor (dB/m)	Result (dBuV/m)	Limit (dBuV/m)	Margin (dB)	Remark
1	4924.000	48.98	5.77	54.75	74.00	-19.25	peak
2	4924.000	45.64	5.77	51.41	54.00	-2.59	AVG
3	7386.000	34.05	12.33	46.38	74.00	-27.62	peak

Note:1.Result (dBuV/m) = Correct Factor (dB/m) + Reading(dBuV).

2.Correction factor (dB/m) = Antenna Factor (dB/m) + Cable loss (dB) – Pre-Amplifier gain (dB).

3. When the peak results are less than average limit, so not need to evaluate the average.



Standard:	FCC Part 15.247	Test Distance:	3 m
Test item:	Harmonic	Power:	AC 120 V/60 Hz
Frequency:	2412 MHz	Temp.(°C)/Hum.(%RH):	26(°C)/60 %RH
Mode:	Mode 3		
Ant.Polar.:	Horizontal		

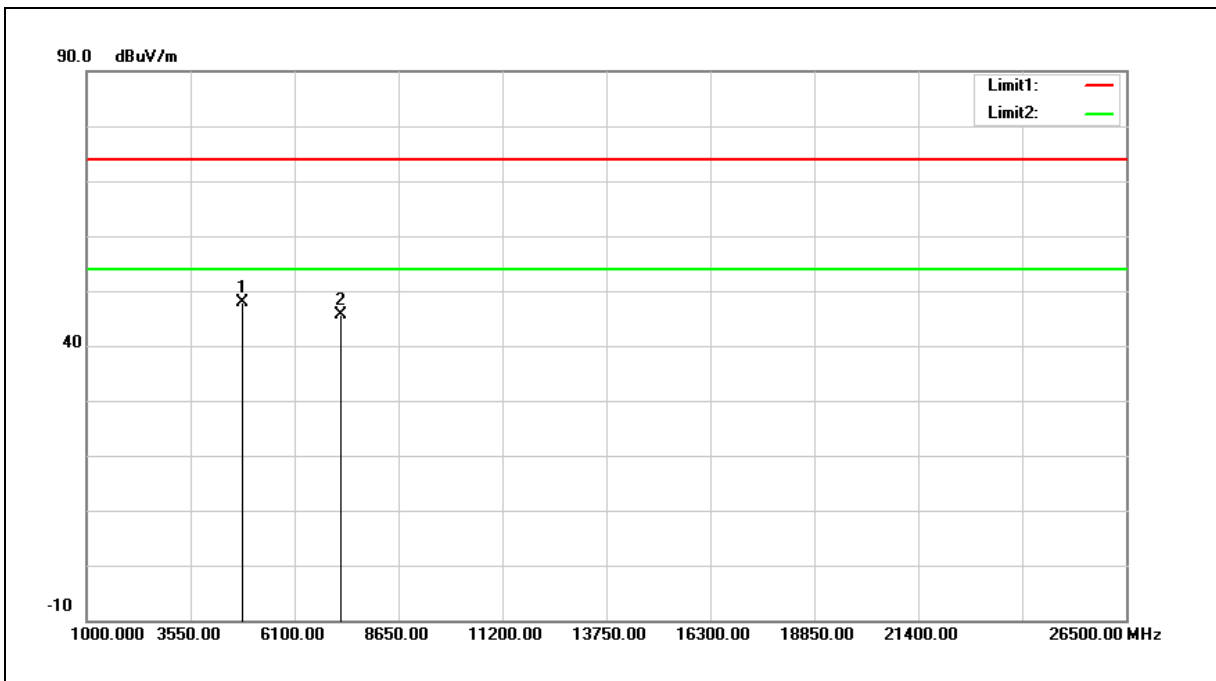

No.	Frequency (MHz)	Reading (dBuV)	Correct Factor (dB/m)	Result (dBuV/m)	Limit (dBuV/m)	Margin (dB)	Remark
1	4824.000	42.32	5.57	47.89	74.00	-26.11	peak
2	7236.000	33.63	11.98	45.61	74.00	-28.39	peak

- Note:1.Result (dBuV/m) = Correct Factor (dB/m) + Reading(dBuV).
 2.Correction factor (dB/m) = Antenna Factor (dB/m) + Cable loss (dB) – Pre-Amplifier gain (dB).
 3. When the peak results are less than average limit, so not need to evaluate the average.



Standard:	FCC Part 15.247	Test Distance:	3 m
Test item:	Harmonic	Power:	AC 120 V/60 Hz
Frequency:	2412 MHz	Temp.(°C)/Hum.(%RH):	26(°C)/60 %RH
Mode:	Mode 3		
Ant.Polar.:	Vertical		

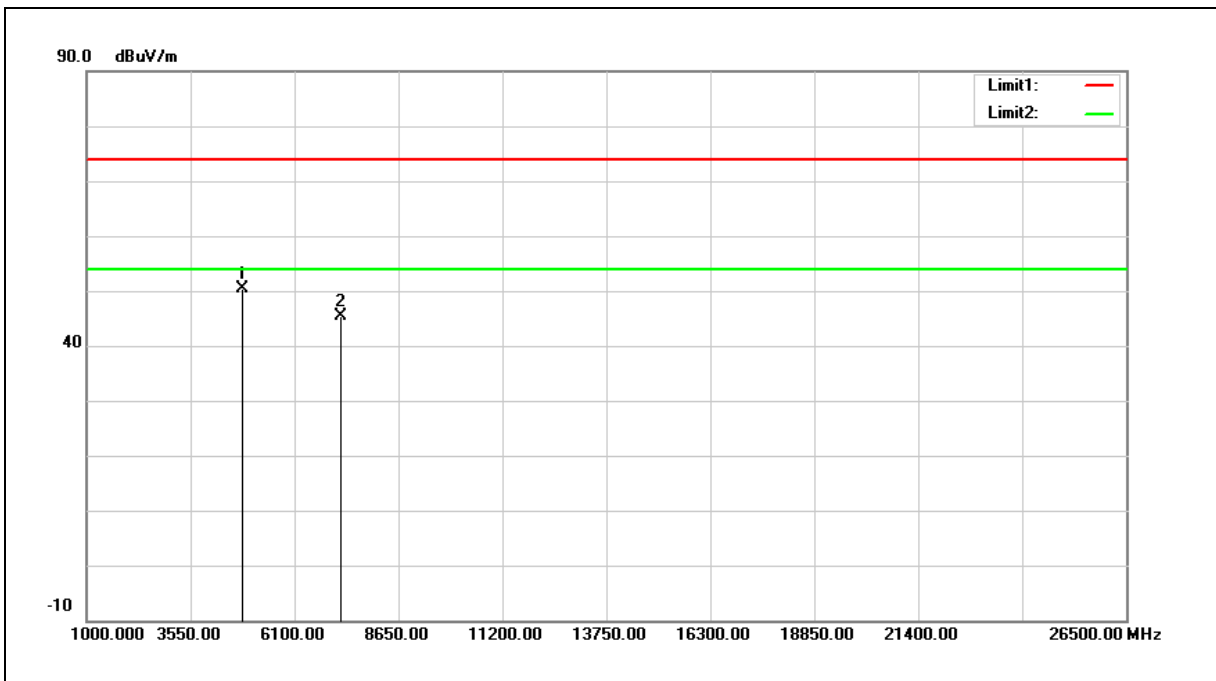

No.	Frequency (MHz)	Reading (dBuV)	Correct Factor (dB/m)	Result (dBuV/m)	Limit (dBuV/m)	Margin (dB)	Remark
1	4824.000	44.74	5.57	50.31	74.00	-23.69	peak
2	7236.000	33.51	11.98	45.49	74.00	-28.51	peak

- Note:1.Result (dBuV/m) = Correct Factor (dB/m) + Reading(dBuV).
 2.Correction factor (dB/m) = Antenna Factor (dB/m) + Cable loss (dB) – Pre-Amplifier gain (dB).
 3. When the peak results are less than average limit, so not need to evaluate the average.



Standard:	FCC Part 15.247	Test Distance:	3 m
Test item:	Harmonic	Power:	AC 120 V/60 Hz
Frequency:	2437 MHz	Temp.(°C)/Hum.(%RH):	26(°C)/60 %RH
Mode:	Mode 3		
Ant.Polar.:	Horizontal		

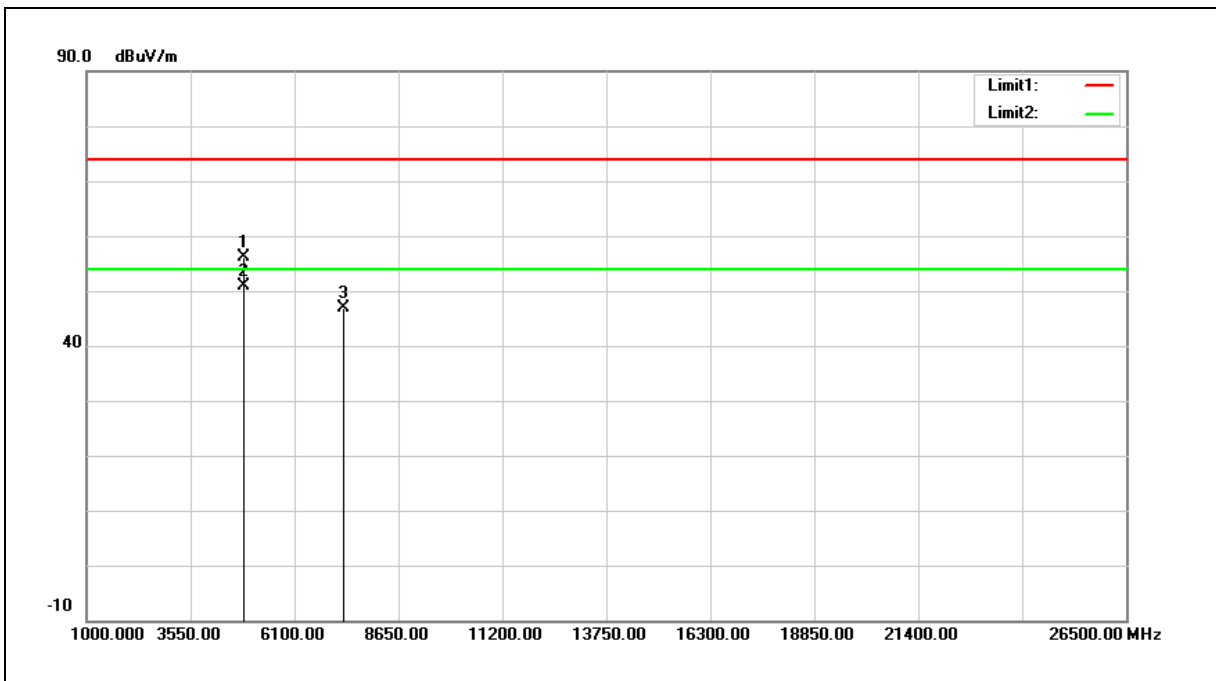

No.	Frequency (MHz)	Reading (dBuV)	Correct Factor (dB/m)	Result (dBuV/m)	Limit (dBuV/m)	Margin (dB)	Remark
1	4874.000	50.49	5.67	56.16	74.00	-17.84	peak
2	4874.000	45.19	5.67	50.86	54.00	-3.14	AVG
3	7311.000	34.77	12.15	46.92	74.00	-27.08	peak

Note:1.Result (dBuV/m) = Correct Factor (dB/m) + Reading(dBuV).

2.Correction factor (dB/m) = Antenna Factor (dB/m) + Cable loss (dB) – Pre-Amplifier gain (dB).

3. When the peak results are less than average limit, so not need to evaluate the average.



Standard:	FCC Part 15.247	Test Distance:	3 m
Test item:	Harmonic	Power:	AC 120 V/60 Hz
Frequency:	2437 MHz	Temp.(°C)/Hum.(%RH):	26(°C)/60 %RH
Mode:	Mode 3		
Ant.Polar.:	Vertical		

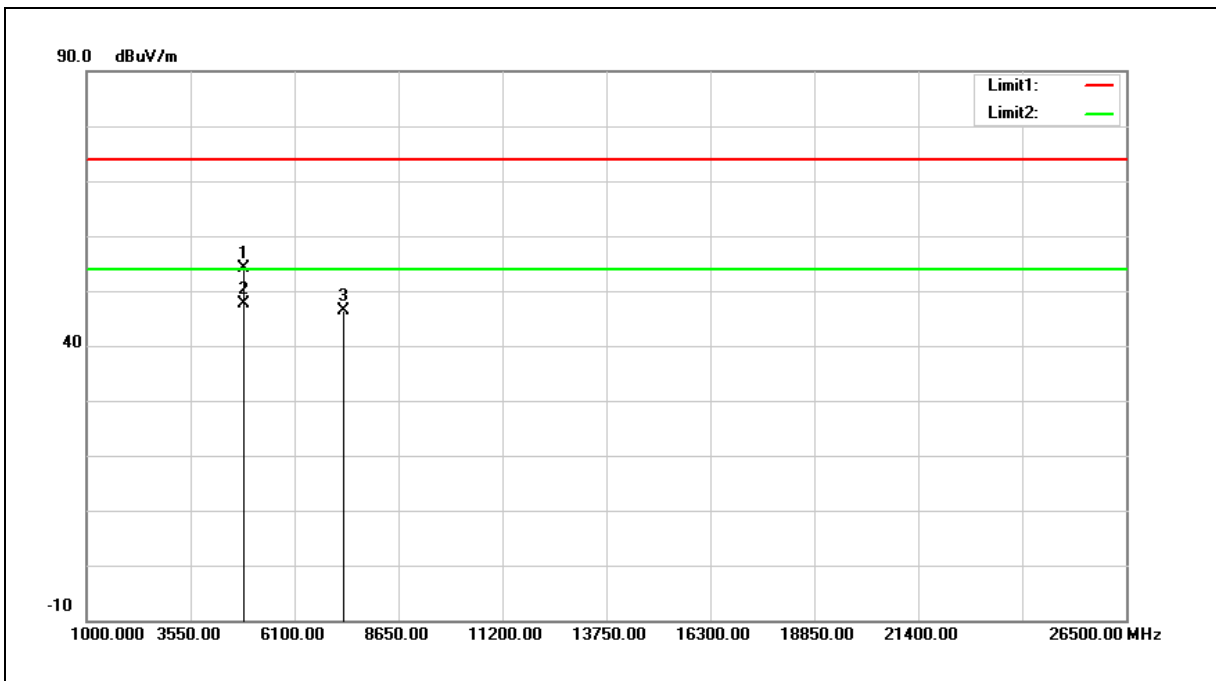

No.	Frequency (MHz)	Reading (dBuV)	Correct Factor (dB/m)	Result (dBuV/m)	Limit (dBuV/m)	Margin (dB)	Remark
1	4874.000	48.36	5.67	54.03	74.00	-19.97	peak
2	4874.000	41.95	5.67	47.62	54.00	-6.38	AVG
3	7311.000	34.33	12.15	46.48	74.00	-27.52	peak

Note:1.Result (dBuV/m) = Correct Factor (dB/m) + Reading(dBuV).

2.Correction factor (dB/m) = Antenna Factor (dB/m) + Cable loss (dB) – Pre-Amplifier gain (dB).

3. When the peak results are less than average limit, so not need to evaluate the average.



Standard:	FCC Part 15.247	Test Distance:	3 m
Test item:	Harmonic	Power:	AC 120 V/60 Hz
Frequency:	2462 MHz	Temp.(°C)/Hum.(%RH):	26(°C)/60 %RH
Mode:	Mode 3		
Ant.Polar.:	Horizontal		

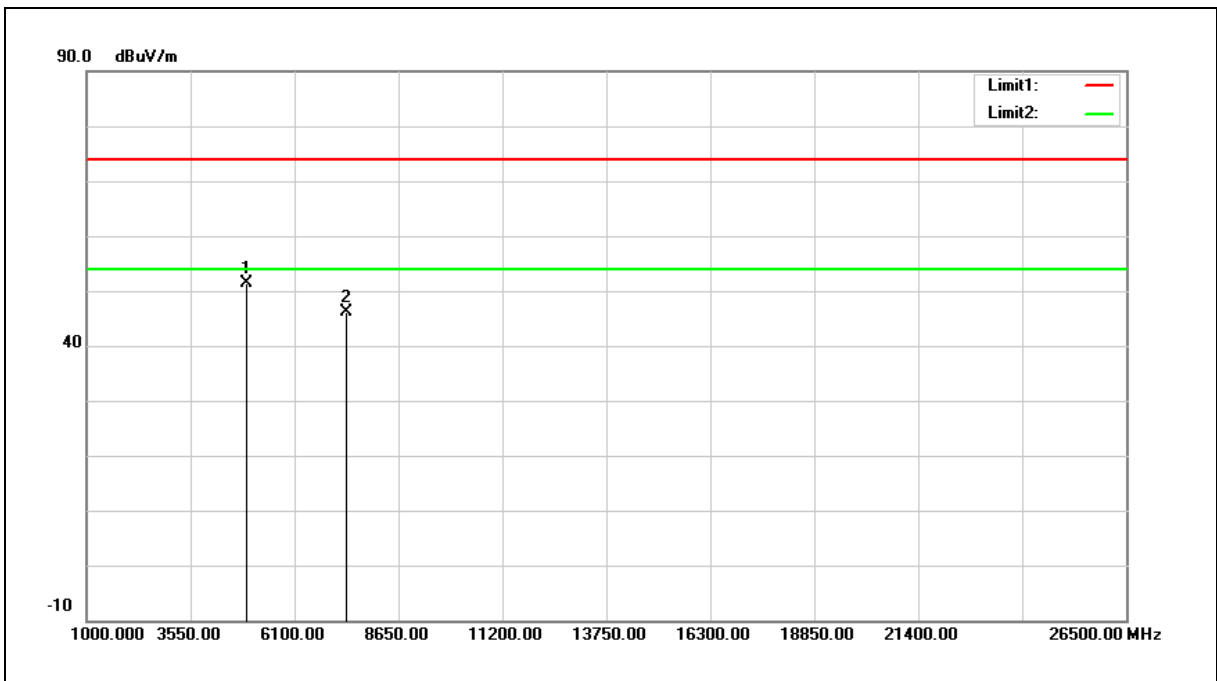

No.	Frequency (MHz)	Reading (dBuV)	Correct Factor (dB/m)	Result (dBuV/m)	Limit (dBuV/m)	Margin (dB)	Remark
1	4924.000	45.69	5.77	51.46	74.00	-22.54	peak
2	7386.000	33.88	12.33	46.21	74.00	-27.79	peak

Note:1.Result (dBuV/m) = Correct Factor (dB/m) + Reading(dBuV).

2.Correction factor (dB/m) = Antenna Factor (dB/m) + Cable loss (dB) – Pre-Amplifier gain (dB).

3. When the peak results are less than average limit, so not need to evaluate the average.



Standard:	FCC Part 15.247	Test Distance:	3 m
Test item:	Harmonic	Power:	AC 120 V/60 Hz
Frequency:	2462 MHz	Temp.(°C)/Hum.(%RH):	26(°C)/60 %RH
Mode:	Mode 3		
Ant.Polar.:	Vertical		

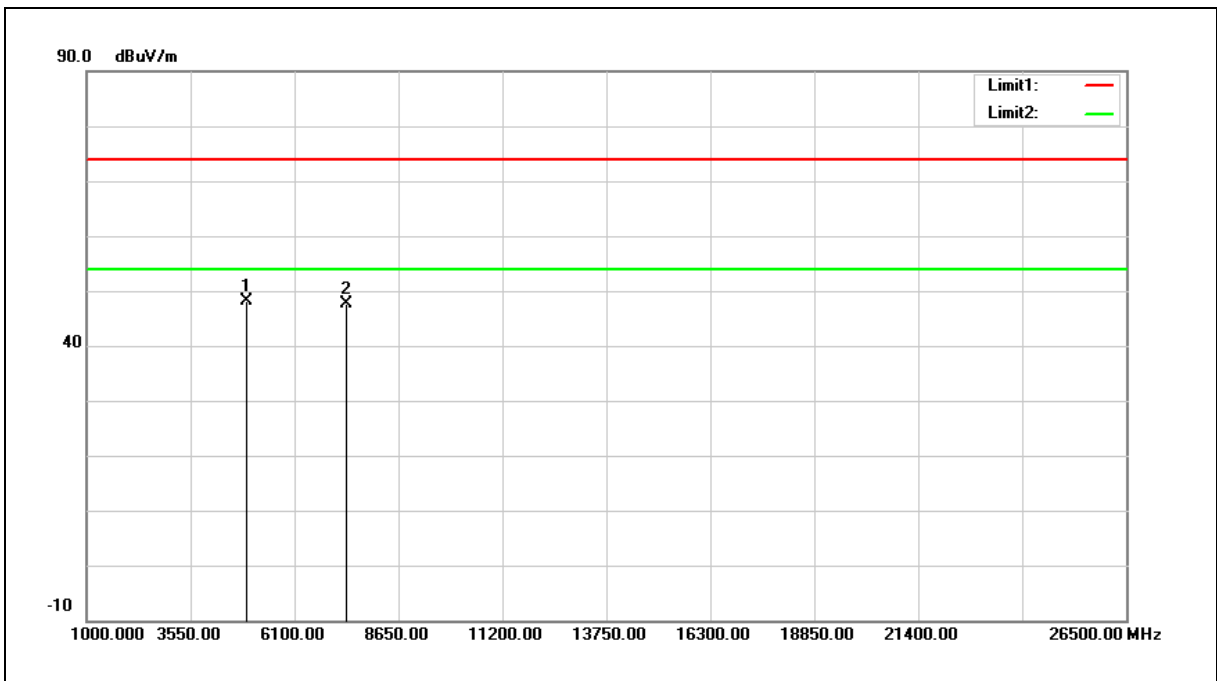

No.	Frequency (MHz)	Reading (dBuV)	Correct Factor (dB/m)	Result (dBuV/m)	Limit (dBuV/m)	Margin (dB)	Remark
1	4924.000	42.38	5.77	48.15	74.00	-25.85	peak
2	7386.000	35.21	12.33	47.54	74.00	-26.46	peak

Note:1.Result (dBuV/m) = Correct Factor (dB/m) + Reading(dBuV).

2.Correction factor (dB/m) = Antenna Factor (dB/m) + Cable loss (dB) – Pre-Amplifier gain (dB).

3. When the peak results are less than average limit, so not need to evaluate the average.



Standard:	FCC Part 15.247	Test Distance:	3 m
Test item:	Harmonic	Power:	AC 120 V/60 Hz
Frequency:	2412 MHz	Temp.(°C)/Hum.(%RH):	26(°C)/60 %RH
Mode:	Mode 6		
Ant.Polar.:	Horizontal		

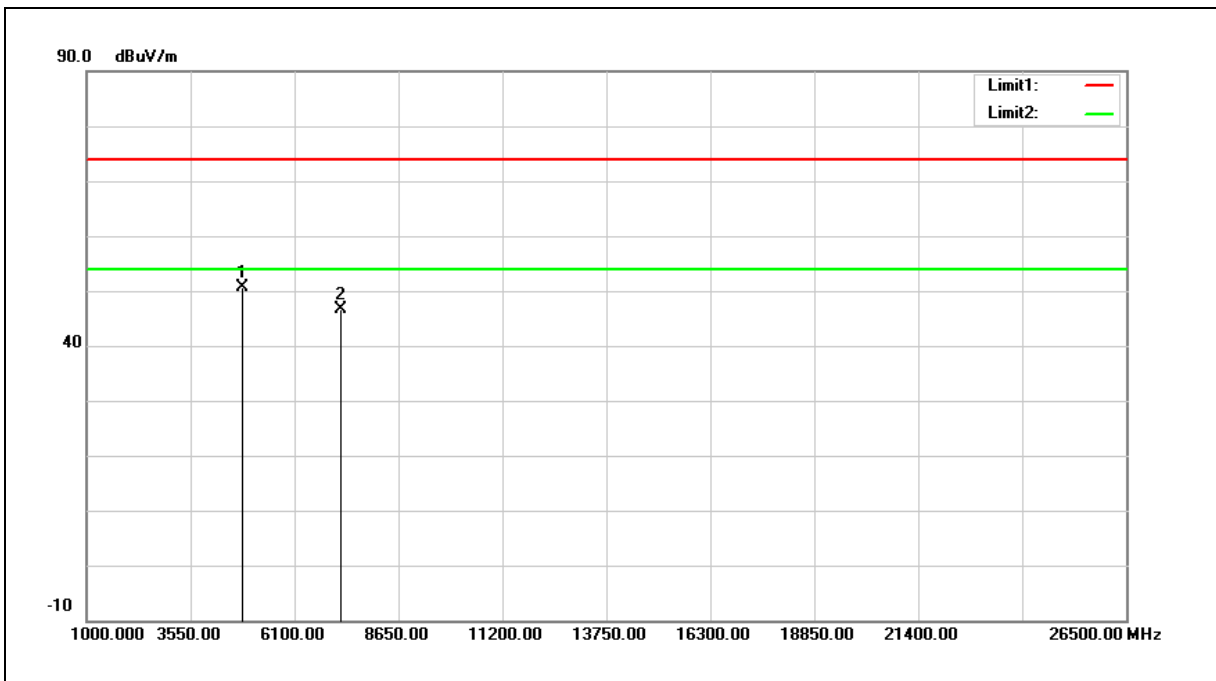

No.	Frequency (MHz)	Reading (dBuV)	Correct Factor (dB/m)	Result (dBuV/m)	Limit (dBuV/m)	Margin (dB)	Remark
1	4824.000	45.12	5.57	50.69	74.00	-23.31	peak
2	7236.000	34.67	11.98	46.65	74.00	-27.35	peak

Note:1.Result (dBuV/m) = Correct Factor (dB/m) + Reading(dBuV).

2.Correction factor (dB/m) = Antenna Factor (dB/m) + Cable loss (dB) – Pre-Amplifier gain (dB).

3. When the peak results are less than average limit, so not need to evaluate the average.



Standard:	FCC Part 15.247	Test Distance:	3 m
Test item:	Harmonic	Power:	AC 120 V/60 Hz
Frequency:	2412 MHz	Temp.(°C)/Hum.(%RH):	26(°C)/60 %RH
Mode:	Mode 6		
Ant.Polar.:	Vertical		

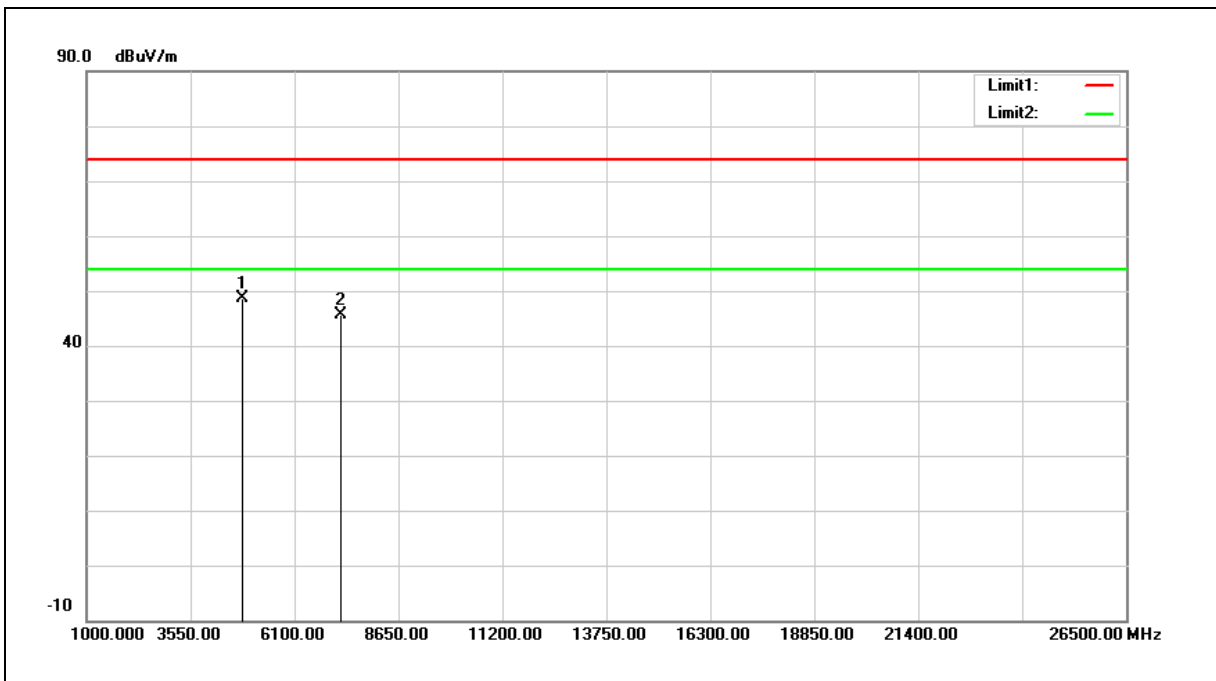

No.	Frequency (MHz)	Reading (dBuV)	Correct Factor (dB/m)	Result (dBuV/m)	Limit (dBuV/m)	Margin (dB)	Remark
1	4824.000	43.04	5.57	48.61	74.00	-25.39	peak
2	7236.000	33.70	11.98	45.68	74.00	-28.32	peak

- Note:1.Result (dBuV/m) = Correct Factor (dB/m) + Reading(dBuV).
 2.Correction factor (dB/m) = Antenna Factor (dB/m) + Cable loss (dB) – Pre-Amplifier gain (dB).
 3. When the peak results are less than average limit, so not need to evaluate the average.



Standard:	FCC Part 15.247	Test Distance:	3 m
Test item:	Harmonic	Power:	AC 120 V/60 Hz
Frequency:	2437 MHz	Temp.(°C)/Hum.(%RH):	26(°C)/60 %RH
Mode:	Mode 6		
Ant.Polar.:	Horizontal		

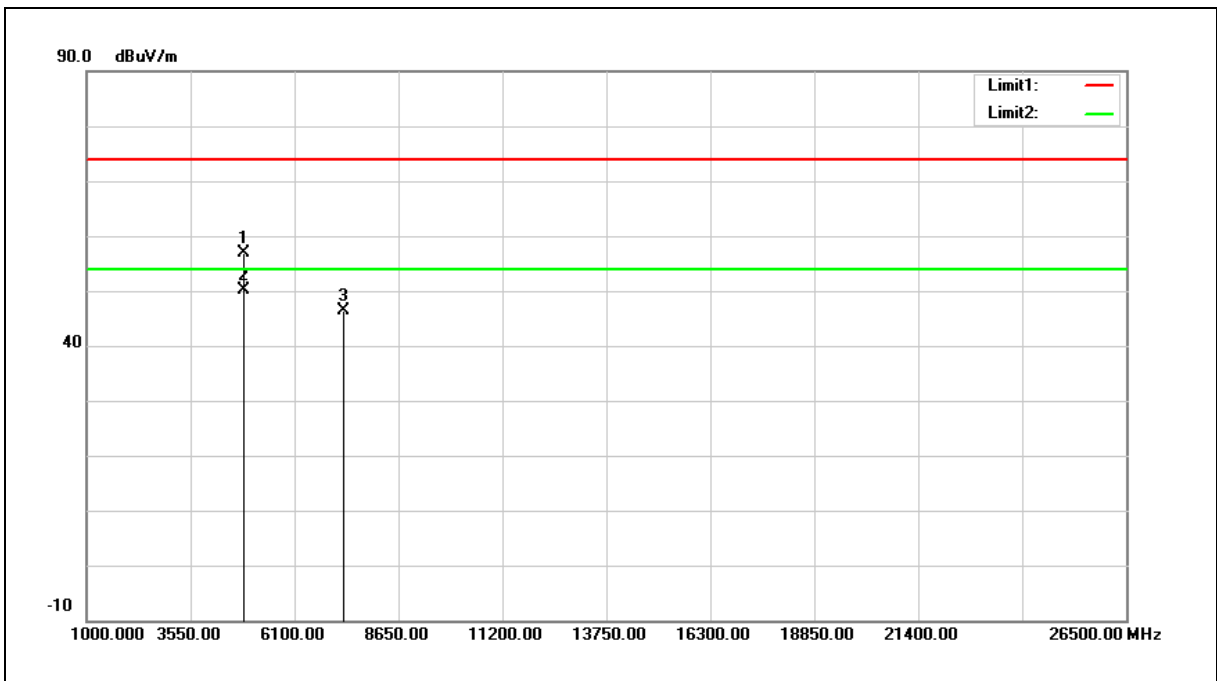

No.	Frequency (MHz)	Reading (dBuV)	Correct Factor (dB/m)	Result (dBuV/m)	Limit (dBuV/m)	Margin (dB)	Remark
1	4874.000	51.30	5.67	56.97	74.00	-17.03	peak
2	4874.000	44.54	5.67	50.21	54.00	-3.79	AVG
3	7311.000	34.17	12.15	46.32	74.00	-27.68	peak

Note:1.Result (dBuV/m) = Correct Factor (dB/m) + Reading(dBuV).

2.Correction factor (dB/m) = Antenna Factor (dB/m) + Cable loss (dB) – Pre-Amplifier gain (dB).

3. When the peak results are less than average limit, so not need to evaluate the average.



Standard:	FCC Part 15.247	Test Distance:	3 m
Test item:	Harmonic	Power:	AC 120 V/60 Hz
Frequency:	2437 MHz	Temp.(°C)/Hum.(%RH):	26(°C)/60 %RH
Mode:	Mode 6		
Ant.Polar.:	Vertical		

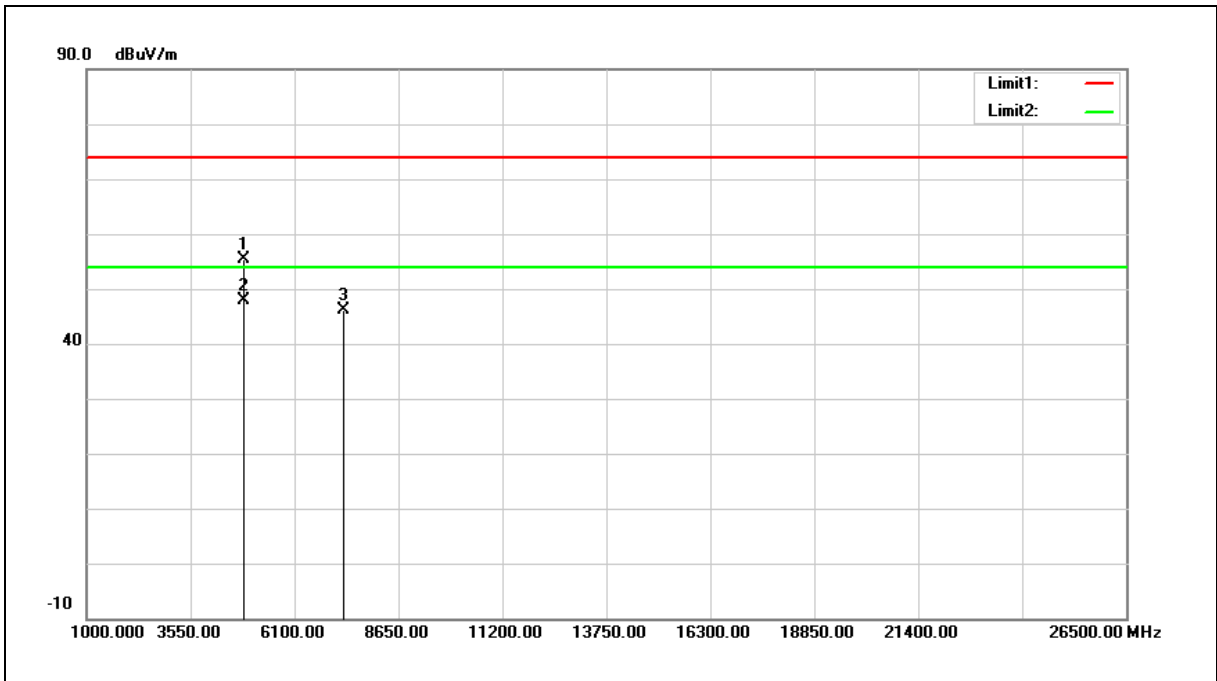

No.	Frequency (MHz)	Reading (dBuV)	Correct Factor (dB/m)	Result (dBuV/m)	Limit (dBuV/m)	Margin (dB)	Remark
1	4874.000	49.69	5.67	55.36	74.00	-18.64	peak
2	4874.000	42.28	5.67	47.95	54.00	-6.05	AVG
3	7311.000	33.93	12.15	46.08	74.00	-27.92	peak

Note:1.Result (dBuV/m) = Correct Factor (dB/m) + Reading(dBuV).

2.Correction factor (dB/m) = Antenna Factor (dB/m) + Cable loss (dB) – Pre-Amplifier gain (dB).

3. When the peak results are less than average limit, so not need to evaluate the average.



Standard:	FCC Part 15.247	Test Distance:	3 m
Test item:	Harmonic	Power:	AC 120 V/60 Hz
Frequency:	2462 MHz	Temp.(°C)/Hum.(%RH):	26(°C)/60 %RH
Mode:	Mode 6		
Ant.Polar.:	Horizontal		

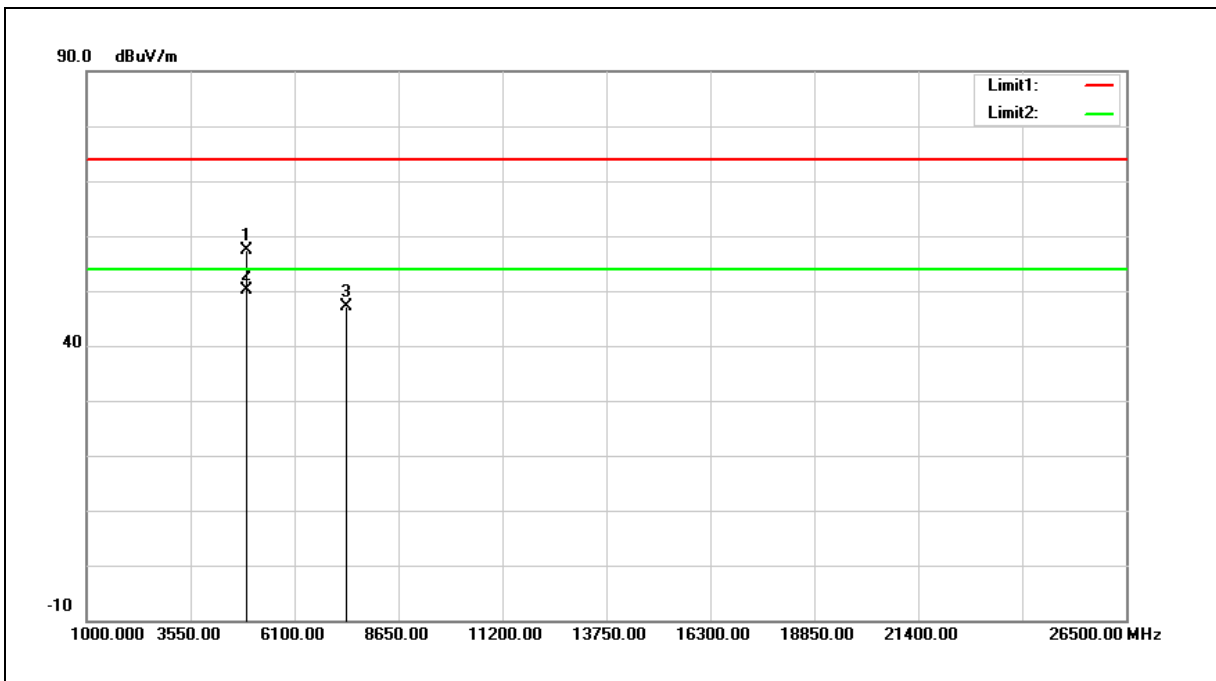

No.	Frequency (MHz)	Reading (dBuV)	Correct Factor (dB/m)	Result (dBuV/m)	Limit (dBuV/m)	Margin (dB)	Remark
1	4924.000	51.49	5.77	57.26	74.00	-16.74	peak
2	4924.000	44.48	5.77	50.25	54.00	-3.75	AVG
3	7386.000	34.72	12.33	47.05	74.00	-26.95	peak

Note:1.Result (dBuV/m) = Correct Factor (dB/m) + Reading(dBuV).

2.Correction factor (dB/m) = Antenna Factor (dB/m) + Cable loss (dB) – Pre-Amplifier gain (dB).

3. When the peak results are less than average limit, so not need to evaluate the average.



Standard:	FCC Part 15.247	Test Distance:	3 m
Test item:	Harmonic	Power:	AC 120 V/60 Hz
Frequency:	2462 MHz	Temp.(°C)/Hum.(%RH):	26(°C)/60 %RH
Mode:	Mode 6		
Ant.Polar.:	Vertical		

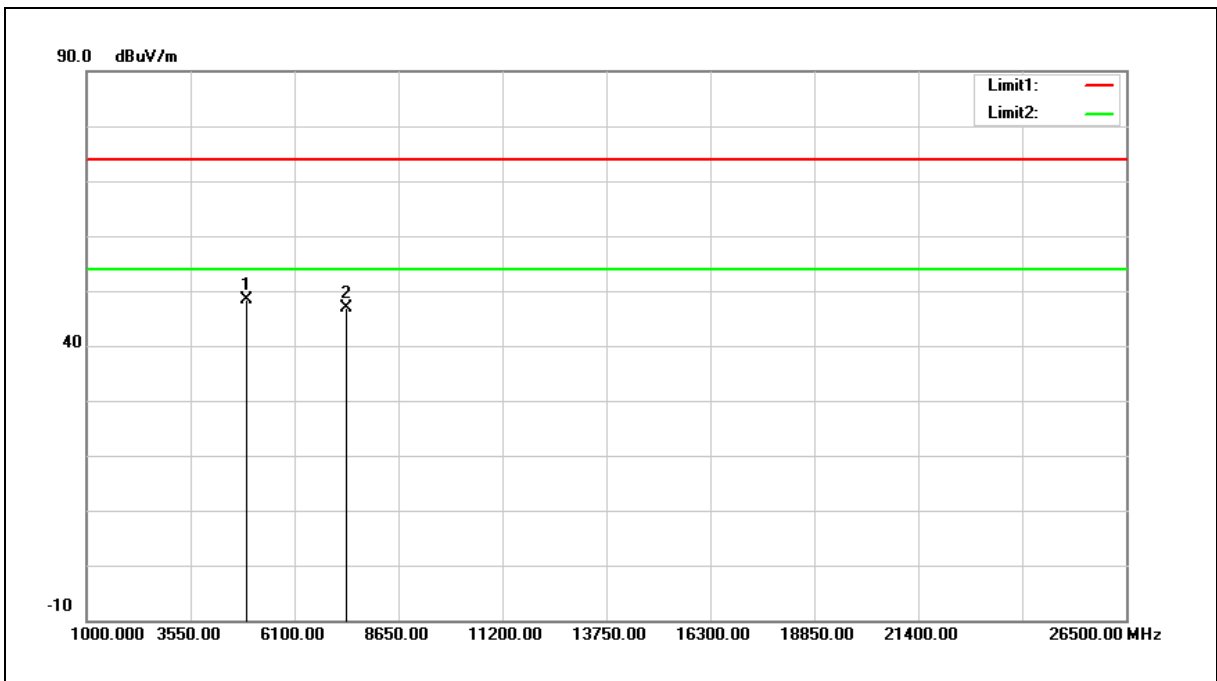

No.	Frequency (MHz)	Reading (dBuV)	Correct Factor (dB/m)	Result (dBuV/m)	Limit (dBuV/m)	Margin (dB)	Remark
1	4924.000	42.59	5.77	48.36	74.00	-25.64	peak
2	7386.000	34.58	12.33	46.91	74.00	-27.09	peak

Note:1.Result (dBuV/m) = Correct Factor (dB/m) + Reading(dBuV).

2.Correction factor (dB/m) = Antenna Factor (dB/m) + Cable loss (dB) – Pre-Amplifier gain (dB).

3. When the peak results are less than average limit, so not need to evaluate the average.



Standard:	FCC Part 15.247	Test Distance:	3 m
Test item:	Harmonic	Power:	AC 120 V/60 Hz
Frequency:	2422 MHz	Temp.(°C)/Hum.(%RH):	26(°C)/60 %RH
Mode:	Mode 7		
Ant.Polar.:	Horizontal		

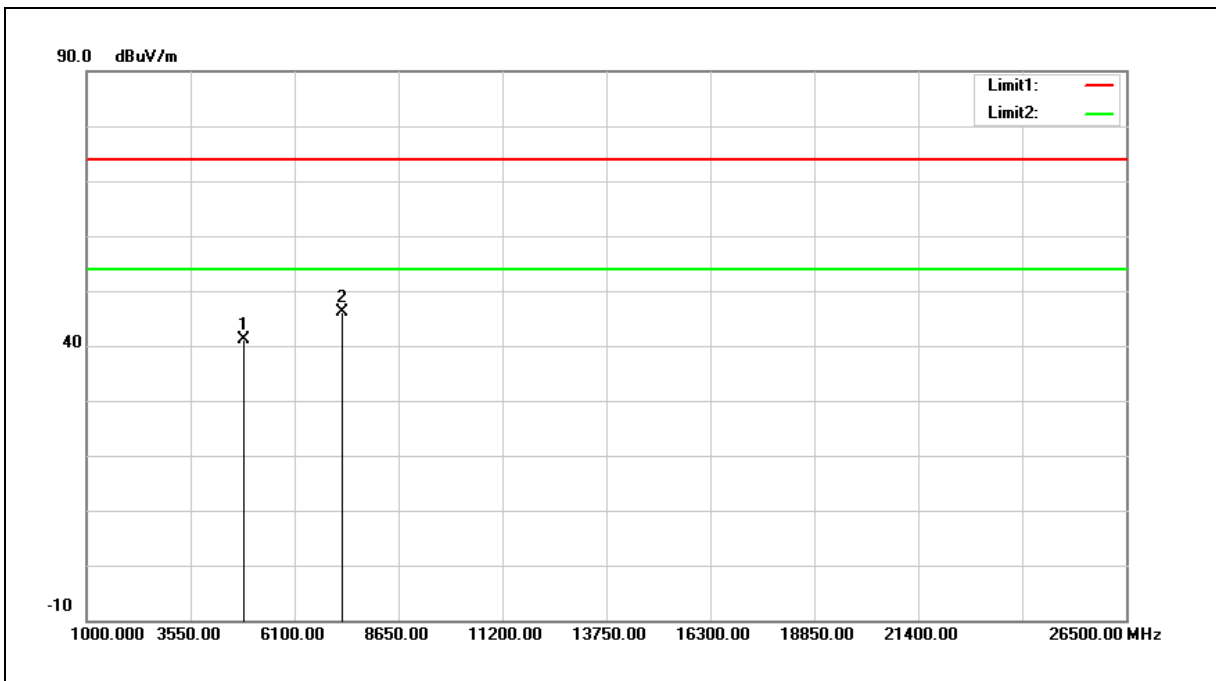

No.	Frequency (MHz)	Reading (dBuV)	Correct Factor (dB/m)	Result (dBuV/m)	Limit (dBuV/m)	Margin (dB)	Remark
1	4844.000	35.43	5.62	41.05	74.00	-32.95	peak
2	7266.000	34.09	12.04	46.13	74.00	-27.87	peak

Note:1.Result (dBuV/m) = Correct Factor (dB/m) + Reading(dBuV).

2.Correction factor (dB/m) = Antenna Factor (dB/m) + Cable loss (dB) – Pre-Amplifier gain (dB).

3. When the peak results are less than average limit, so not need to evaluate the average.



Standard:	FCC Part 15.247	Test Distance:	3 m
Test item:	Harmonic	Power:	AC 120 V/60 Hz
Frequency:	2422 MHz	Temp.(°C)/Hum.(%RH):	26(°C)/60 %RH
Mode:	Mode 7		
Ant.Polar.:	Vertical		

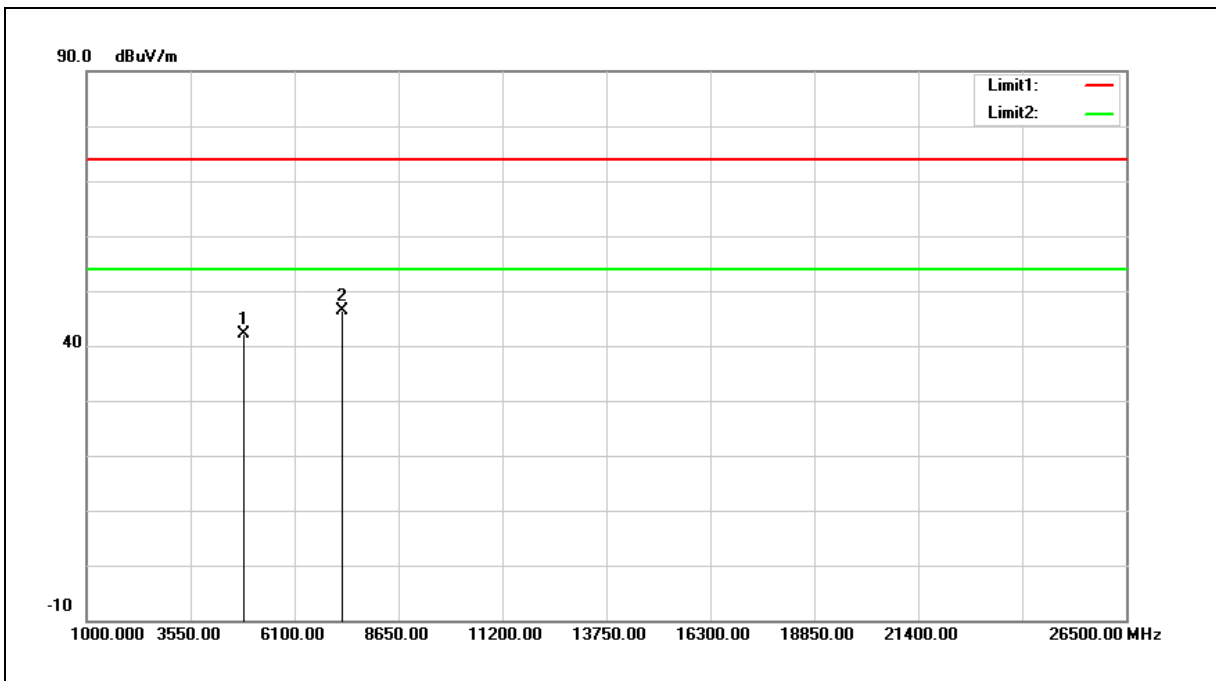

No.	Frequency (MHz)	Reading (dBuV)	Correct Factor (dB/m)	Result (dBuV/m)	Limit (dBuV/m)	Margin (dB)	Remark
1	4844.000	36.45	5.62	42.07	74.00	-31.93	peak
2	7266.000	34.33	12.04	46.37	74.00	-27.63	peak

Note:1.Result (dBuV/m) = Correct Factor (dB/m) + Reading(dBuV).

2.Correction factor (dB/m) = Antenna Factor (dB/m) + Cable loss (dB) – Pre-Amplifier gain (dB).

3. When the peak results are less than average limit, so not need to evaluate the average.



Standard:	FCC Part 15.247	Test Distance:	3 m
Test item:	Harmonic	Power:	AC 120 V/60 Hz
Frequency:	2437 MHz	Temp.(°C)/Hum.(%RH):	26(°C)/60 %RH
Mode:	Mode 7		
Ant.Polar.:	Horizontal		

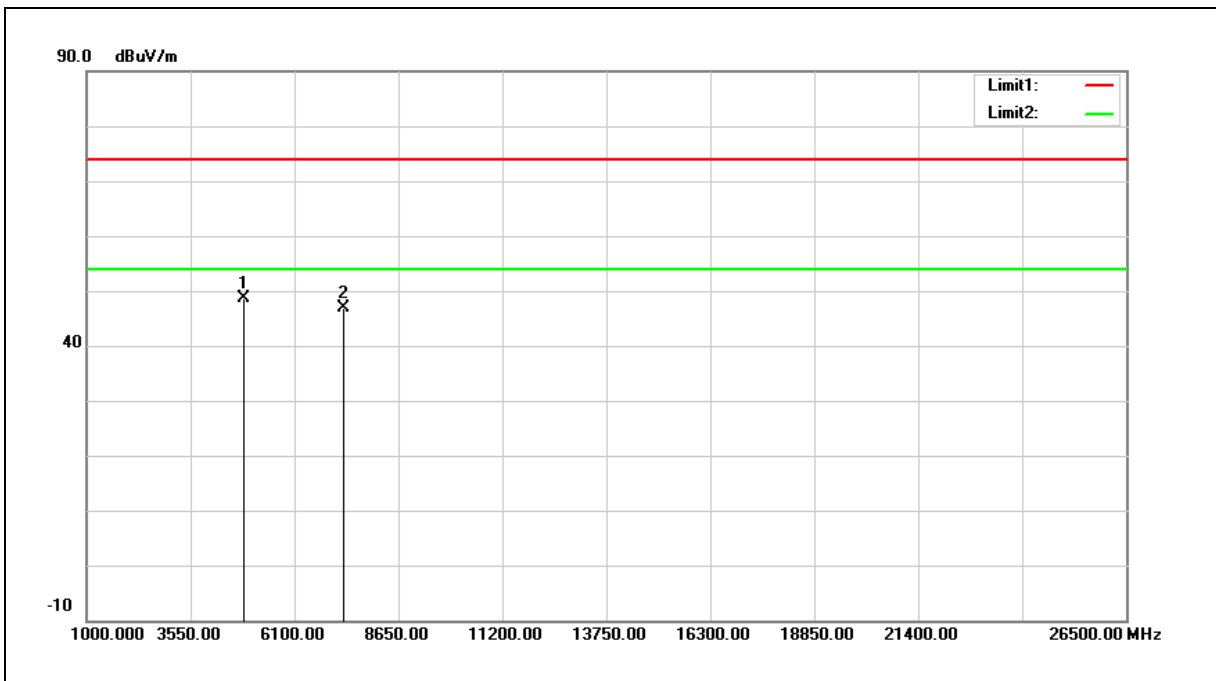

No.	Frequency (MHz)	Reading (dBuV)	Correct Factor (dB/m)	Result (dBuV/m)	Limit (dBuV/m)	Margin (dB)	Remark
1	4874.000	42.87	5.67	48.54	74.00	-25.46	peak
2	7311.000	34.68	12.15	46.83	74.00	-27.17	peak

- Note:1.Result (dBuV/m) = Correct Factor (dB/m) + Reading(dBuV).
- 2.Correction factor (dB/m) = Antenna Factor (dB/m) + Cable loss (dB) – Pre-Amplifier gain (dB).
3. When the peak results are less than average limit, so not need to evaluate the average.



Standard:	FCC Part 15.247	Test Distance:	3 m
Test item:	Harmonic	Power:	AC 120 V/60 Hz
Frequency:	2437 MHz	Temp.(°C)/Hum.(%RH):	26(°C)/60 %RH
Mode:	Mode 7		
Ant.Polar.:	Vertical		

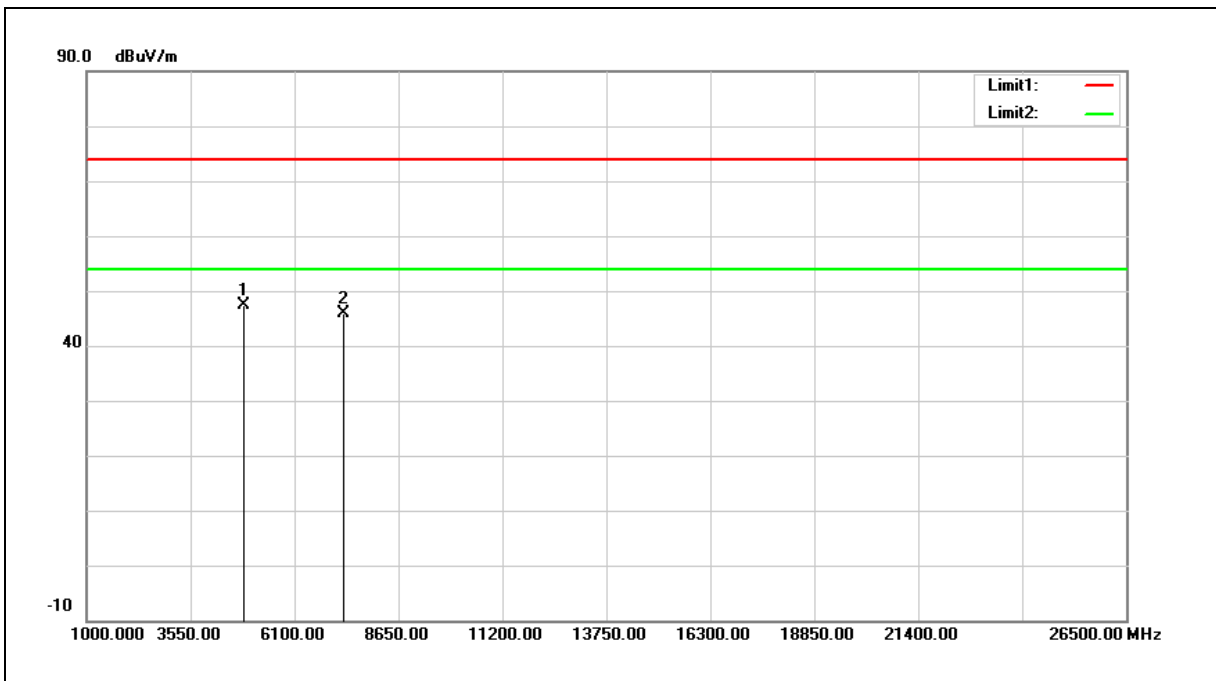

No.	Frequency (MHz)	Reading (dBuV)	Correct Factor (dB/m)	Result (dBuV/m)	Limit (dBuV/m)	Margin (dB)	Remark
1	4874.000	41.67	5.67	47.34	74.00	-26.66	peak
2	7311.000	33.75	12.15	45.90	74.00	-28.10	peak

Note:1.Result (dBuV/m) = Correct Factor (dB/m) + Reading(dBuV).

2.Correction factor (dB/m) = Antenna Factor (dB/m) + Cable loss (dB) – Pre-Amplifier gain (dB).

3. When the peak results are less than average limit, so not need to evaluate the average.



Standard:	FCC Part 15.247	Test Distance:	3 m
Test item:	Harmonic	Power:	AC 120 V/60 Hz
Frequency:	2452 MHz	Temp.(°C)/Hum.(%RH):	26(°C)/60 %RH
Mode:	Mode 7		
Ant.Polar.:	Horizontal		

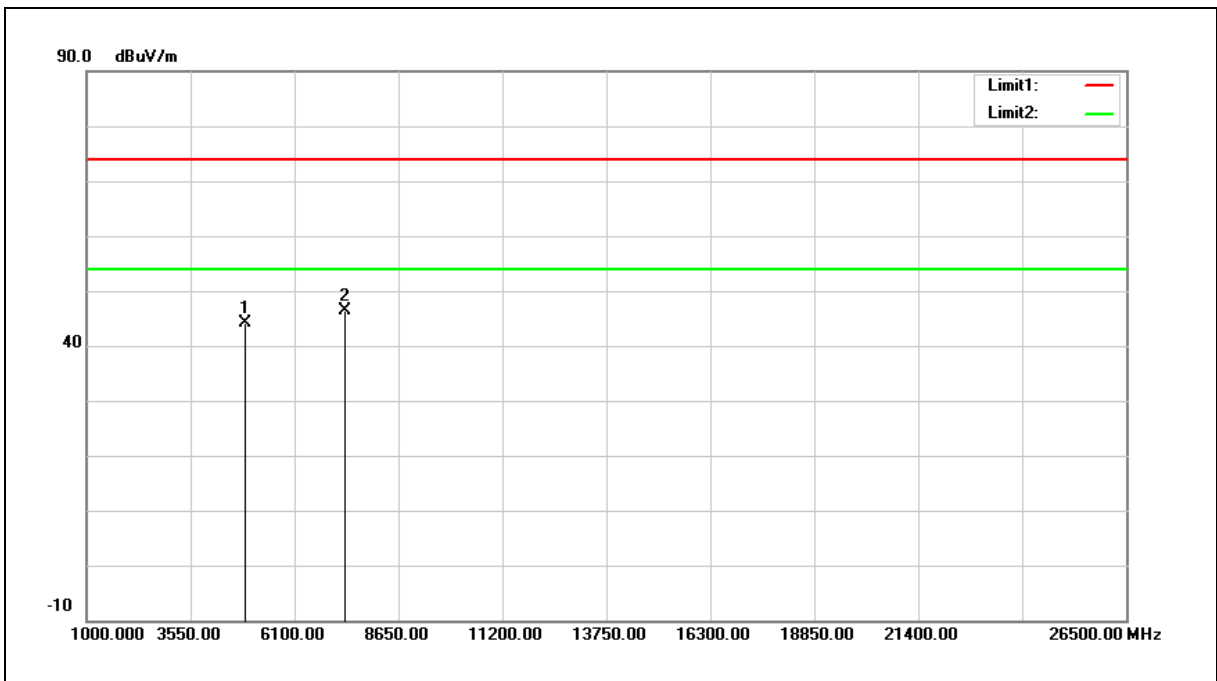

No.	Frequency (MHz)	Reading (dBuV)	Correct Factor (dB/m)	Result (dBuV/m)	Limit (dBuV/m)	Margin (dB)	Remark
1	4904.000	38.42	5.73	44.15	74.00	-29.85	peak
2	7356.000	34.21	12.25	46.46	74.00	-27.54	peak

Note:1.Result (dBuV/m) = Correct Factor (dB/m) + Reading(dBuV).

2.Correction factor (dB/m) = Antenna Factor (dB/m) + Cable loss (dB) – Pre-Amplifier gain (dB).

3. When the peak results are less than average limit, so not need to evaluate the average.



Standard:	FCC Part 15.247	Test Distance:	3 m
Test item:	Harmonic	Power:	AC 120 V/60 Hz
Frequency:	2452 MHz	Temp.(°C)/Hum.(%RH):	26(°C)/60 %RH
Mode:	Mode 7		
Ant.Polar.:	Vertical		

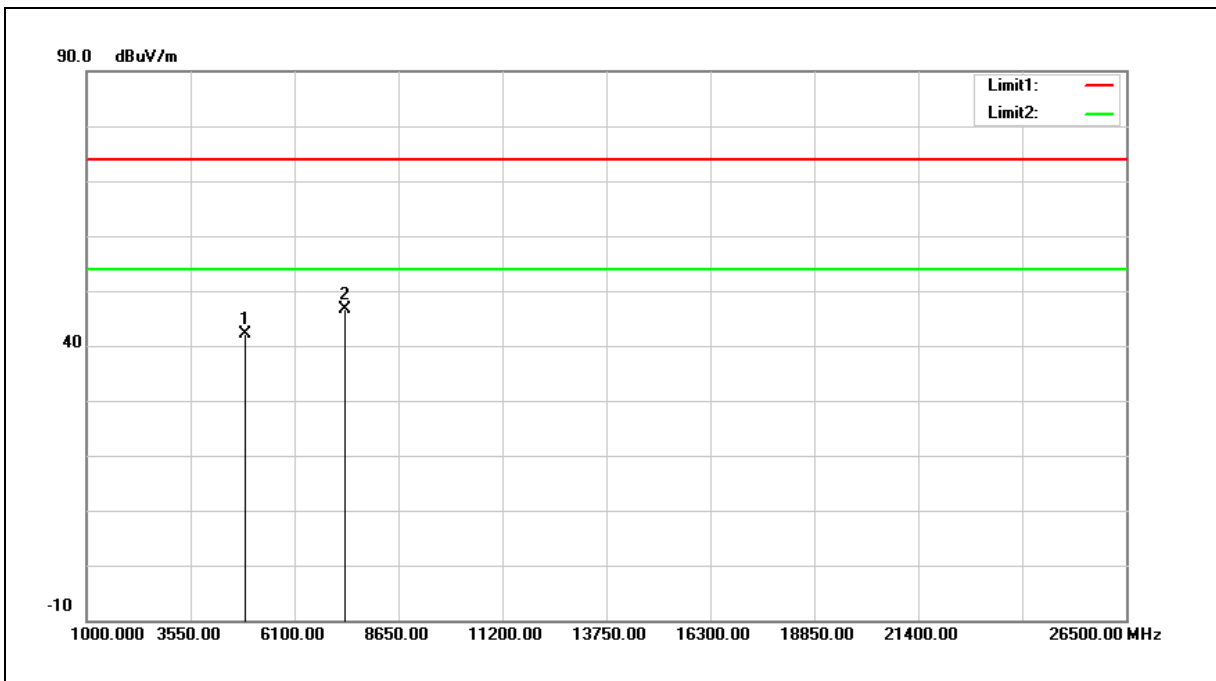

No.	Frequency (MHz)	Reading (dBuV)	Correct Factor (dB/m)	Result (dBuV/m)	Limit (dBuV/m)	Margin (dB)	Remark
1	4904.000	36.36	5.73	42.09	74.00	-31.91	peak
2	7356.000	34.30	12.25	46.55	74.00	-27.45	peak

Note:1.Result (dBuV/m) = Correct Factor (dB/m) + Reading(dBuV).

2.Correction factor (dB/m) = Antenna Factor (dB/m) + Cable loss (dB) – Pre-Amplifier gain (dB).

3. When the peak results are less than average limit, so not need to evaluate the average.



Standard:	FCC Part 15.247	Test Distance:	3 m
Test item:	Transmitter Unwanted Emissions	Power:	AC 120 V/60 Hz
Frequency:	Simultaneous Transmitting	Temp.(°C)/Hum.(%RH):	26(°C)/60 %RH
Mode:	(WLAN 2.4 GHz + 5 GHz)		
Ant.Polar.:	Horizontal		

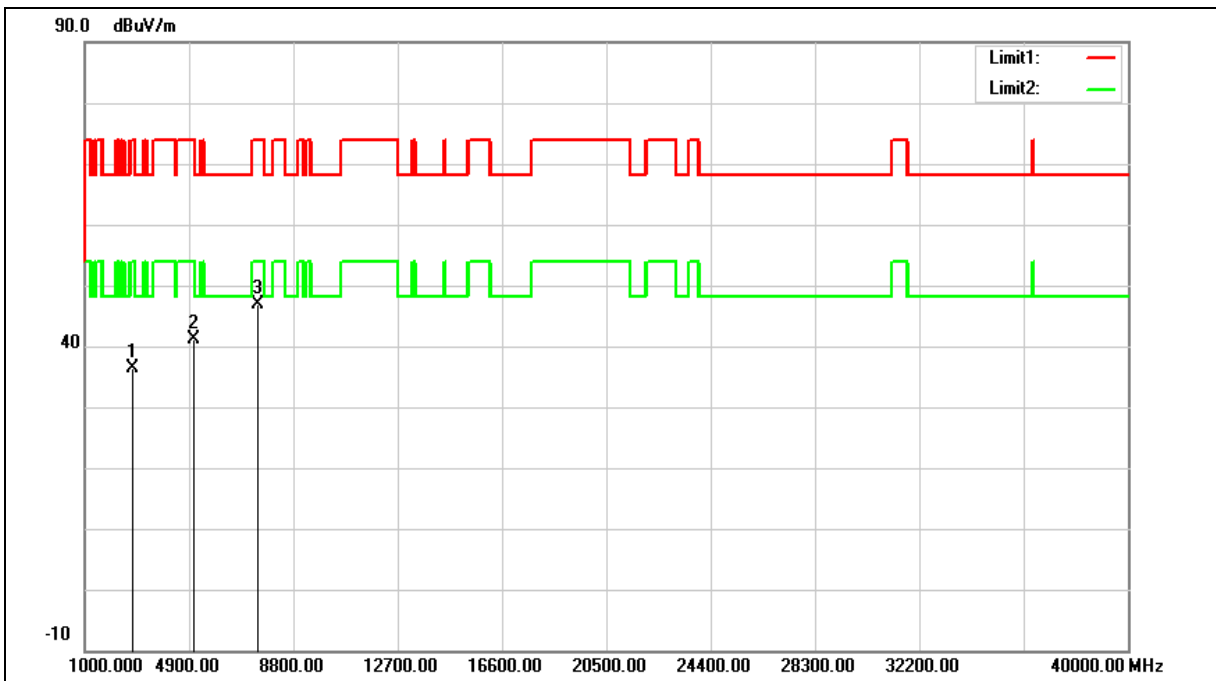

No.	Frequency (MHz)	Reading (dBuV)	Correct Factor (dB/m)	Result (dBuV/m)	Limit (dBuV/m)	Margin (dB)	Remark
1	2768.000	36.07	0.21	36.28	74.00	-37.72	peak
2	5063.000	35.19	6.06	41.25	74.00	-32.75	peak
3	7460.000	34.31	12.50	46.81	74.00	-27.19	peak

Note:1.Result (dBuV/m) = Correct Factor (dB/m) + Reading(dBuV).

2.Correction factor (dB/m) = Antenna Factor (dB/m) + Cable loss (dB) – Pre-Amplifier gain (dB).

3. When the peak results are less than average limit, so not need to evaluate the average.

Standard:	FCC Part 15.247	Test Distance:	3 m
Test item:	Transmitter Unwanted Emissions	Power:	AC 120 V/60 Hz
Frequency:	Simultaneous Transmitting	Temp.(°C)/Hum.(%RH):	26(°C)/60 %RH
Mode:	(WLAN 2.4 GHz + 5 GHz)		
Ant.Polar.:	Vertical		

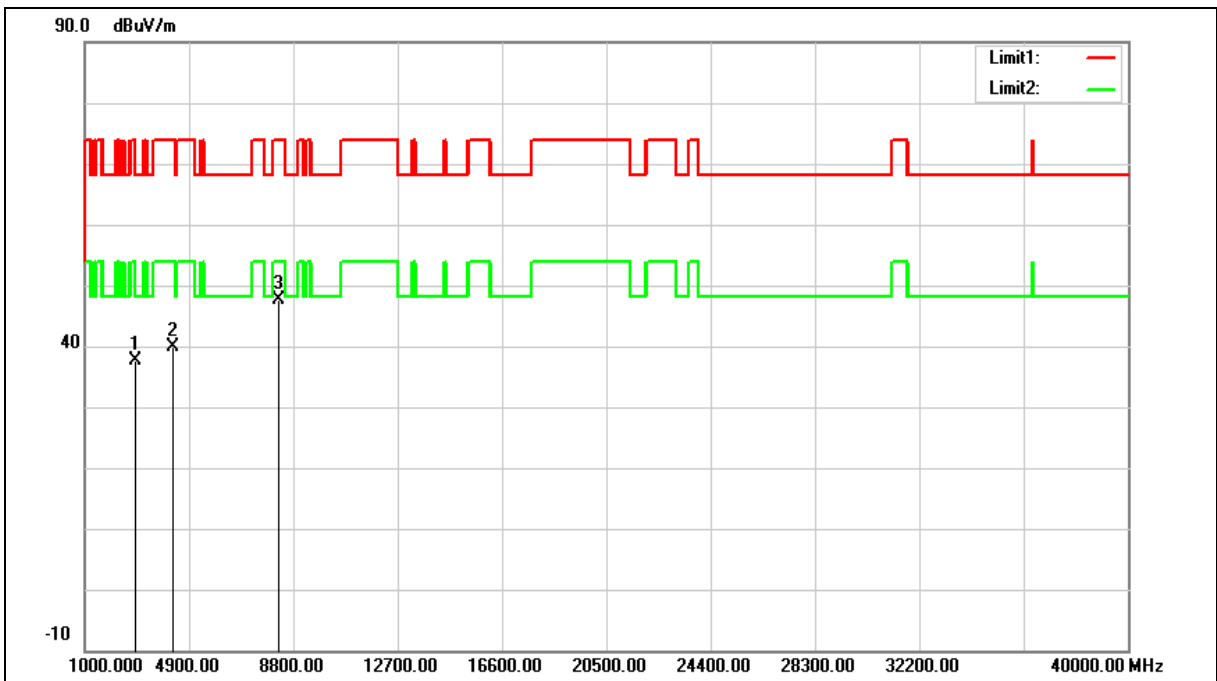

No.	Frequency (MHz)	Reading (dBuV)	Correct Factor (dB/m)	Result (dBuV/m)	Limit (dBuV/m)	Margin (dB)	Remark
1	2853.000	37.05	0.48	37.53	74.00	-36.47	peak
2	4281.000	35.75	4.19	39.94	74.00	-34.06	peak
3	8225.000	33.90	13.84	47.74	74.00	-26.26	peak

Note:1.Result (dBuV/m) = Correct Factor (dB/m) + Reading(dBuV).

2.Correction factor (dB/m) = Antenna Factor (dB/m) + Cable loss (dB) – Pre-Amplifier gain (dB).

3. When the peak results are less than average limit, so not need to evaluate the average.



Band Edge

Standard:	FCC Part 15.247	Test Distance:	3 m
Test item:	Band edge	Power:	AC 120 V/60 Hz
Frequency:	2412 MHz	Temp.(°C)/Hum.(%RH):	26(°C)/60 %RH
Mode:	Mode 2		
Ant.Polar.:	Horizontal		

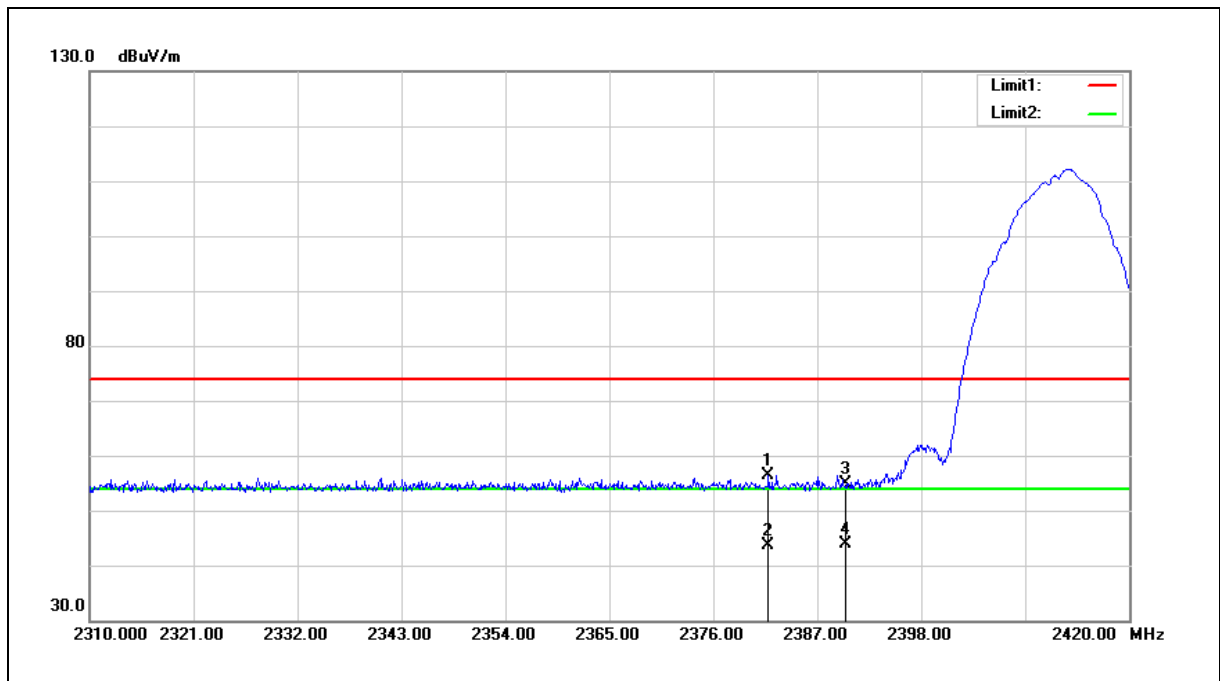

No.	Frequency (MHz)	Reading (dBuV)	Correct Factor (dB/m)	Result (dBuV/m)	Limit (dBuV/m)	Margin (dB)	Remark
1	2381.830	57.42	-1.08	56.34	74.00	-17.66	peak
2	2381.830	44.77	-1.08	43.69	54.00	-10.31	AVG
3	2390.000	55.93	-1.05	54.88	74.00	-19.12	peak
4	2390.000	44.87	-1.05	43.82	54.00	-10.18	AVG

- Note:1.Result (dBuV/m) = Correct Factor (dB/m) + Reading(dBuV).
 2.Correction factor (dB/m) = Antenna Factor (dB/m) + Cable loss (dB) – Pre-Amplifier gain (dB).
 3. When the peak results are less than average limit, so not need to evaluate the average.



Standard:	FCC Part 15.247	Test Distance:	3 m
Test item:	Band edge	Power:	AC 120 V/60 Hz
Frequency:	2412 MHz	Temp.(°C)/Hum.(%RH):	26(°C)/60 %RH
Mode:	Mode 2		
Ant.Polar.:	Vertical		

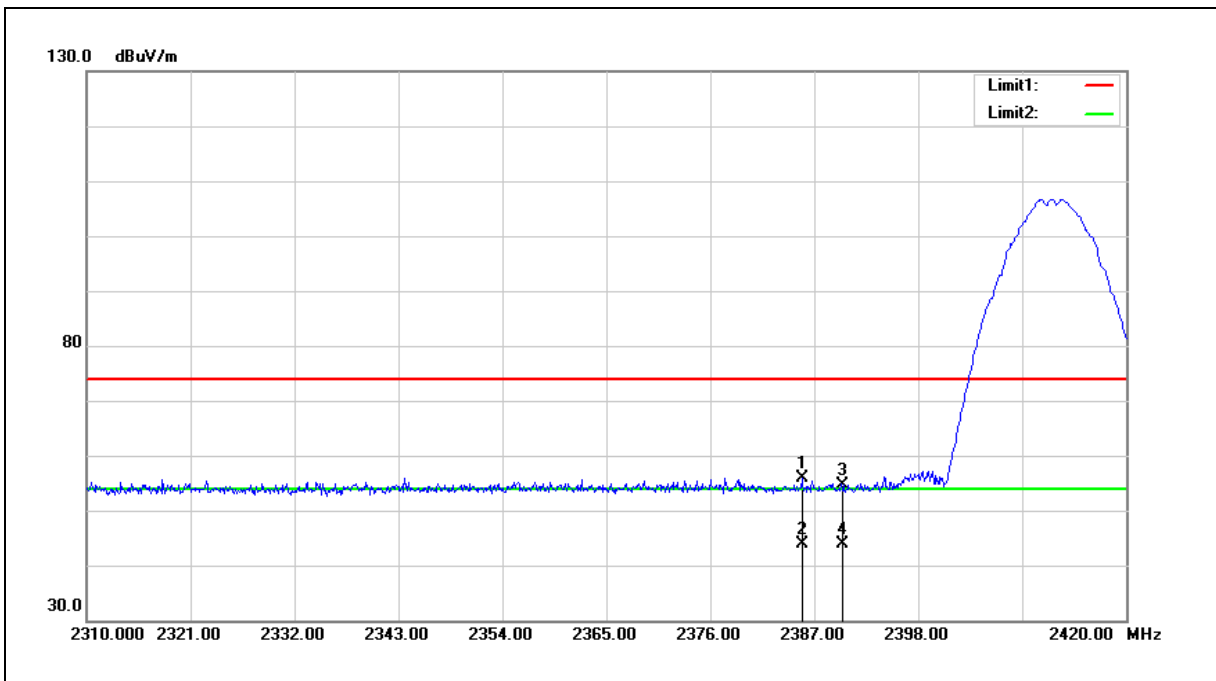

No.	Frequency (MHz)	Reading (dBuV)	Correct Factor (dB/m)	Result (dBuV/m)	Limit (dBuV/m)	Margin (dB)	Remark
1	2385.680	57.05	-1.07	55.98	74.00	-18.02	peak
2	2385.680	44.94	-1.07	43.87	54.00	-10.13	AVG
3	2390.000	55.75	-1.05	54.70	74.00	-19.30	peak
4	2390.000	44.93	-1.05	43.88	54.00	-10.12	AVG

Note:1.Result (dBuV/m) = Correct Factor (dB/m) + Reading(dBuV).

2.Correction factor (dB/m) = Antenna Factor (dB/m) + Cable loss (dB) – Pre-Amplifier gain (dB).

3. When the peak results are less than average limit, so not need to evaluate the average.



Standard:	FCC Part 15.247	Test Distance:	3 m
Test item:	Band edge	Power:	AC 120 V/60 Hz
Frequency:	2437 MHz	Temp.(°C)/Hum.(%RH):	26(°C)/60 %RH
Mode:	Mode 2		
Ant.Polar.:	Horizontal		

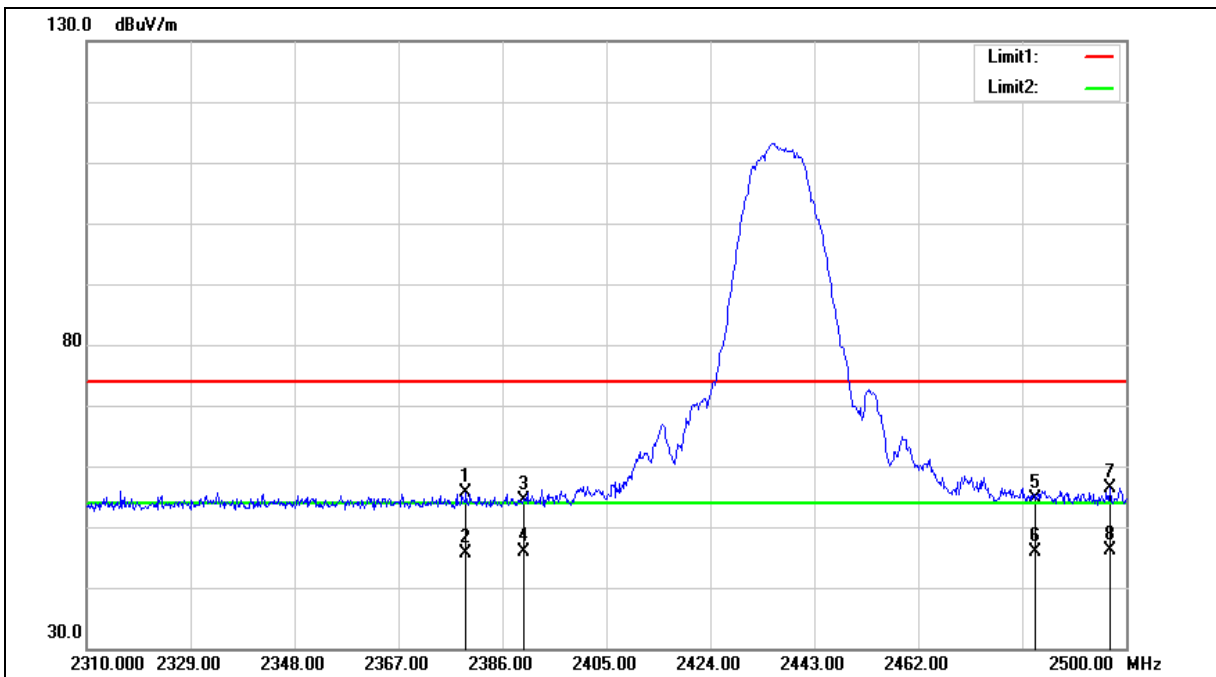



Standard:	FCC Part 15.247	Test Distance:	3 m
Test item:	Band edge	Power:	AC 120 V/60 Hz
Frequency:	2437 MHz	Temp.(°C)/Hum.(%RH):	26(°C)/60 %RH
Mode:	Mode 2		
Ant.Polar.:	Horizontal		

No.	Frequency (MHz)	Reading (dBuV)	Correct Factor (dB/m)	Result (dBuV/m)	Limit (dBuV/m)	Margin (dB)	Remark
1	2379.350	56.68	-1.08	55.60	74.00	-18.40	peak
2	2379.350	46.71	-1.08	45.63	54.00	-8.37	AVG
3	2390.000	55.31	-1.05	54.26	74.00	-19.74	peak
4	2390.000	46.91	-1.05	45.86	54.00	-8.14	AVG
5	2483.500	55.25	-0.70	54.55	74.00	-19.45	peak
6	2483.500	46.67	-0.70	45.97	54.00	-8.03	AVG
7	2497.150	57.03	-0.65	56.38	74.00	-17.62	peak
8	2497.150	46.69	-0.65	46.04	54.00	-7.96	AVG

Note:1.Result (dBuV/m) = Correct Factor (dB/m) + Reading(dBuV).

2.Correction factor (dB/m) = Antenna Factor (dB/m) + Cable loss (dB) – Pre-Amplifier gain (dB).

3. When the peak results are less than average limit, so not need to evaluate the average.



Standard:	FCC Part 15.247	Test Distance:	3 m
Test item:	Band edge	Power:	AC 120 V/60 Hz
Frequency:	2437 MHz	Temp.(°C)/Hum.(%RH):	26(°C)/60 %RH
Mode:	Mode 2		
Ant.Polar.:	Vertical		

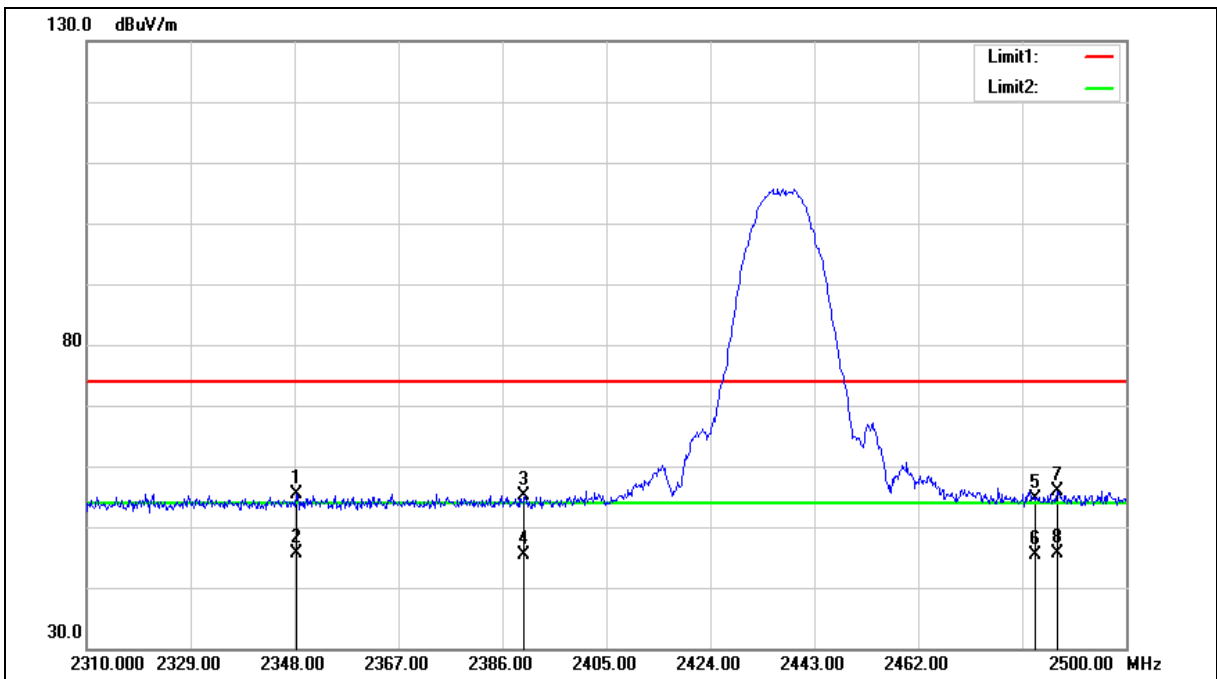



Standard:	FCC Part 15.247	Test Distance:	3 m
Test item:	Band edge	Power:	AC 120 V/60 Hz
Frequency:	2437 MHz	Temp.(°C)/Hum.(%RH):	26(°C)/60 %RH
Mode:	Mode 2		
Ant.Polar.:	Vertical		

No.	Frequency (MHz)	Reading (dBuV)	Correct Factor (dB/m)	Result (dBuV/m)	Limit (dBuV/m)	Margin (dB)	Remark
1	2348.380	56.68	-1.19	55.49	74.00	-18.51	peak
2	2348.380	46.74	-1.19	45.55	54.00	-8.45	AVG
3	2390.000	56.14	-1.05	55.09	74.00	-18.91	peak
4	2390.000	46.52	-1.05	45.47	54.00	-8.53	AVG
5	2483.500	55.37	-0.70	54.67	74.00	-19.33	peak
6	2483.500	46.09	-0.70	45.39	54.00	-8.61	AVG
7	2487.460	56.63	-0.69	55.94	74.00	-18.06	peak
8	2487.460	46.39	-0.69	45.70	54.00	-8.30	AVG

Note:1.Result (dBuV/m) = Correct Factor (dB/m) + Reading(dBuV).

2.Correction factor (dB/m) = Antenna Factor (dB/m) + Cable loss (dB) – Pre-Amplifier gain (dB).

3. When the peak results are less than average limit, so not need to evaluate the average.



Standard:	FCC Part 15.247	Test Distance:	3 m
Test item:	Band edge	Power:	AC 120 V/60 Hz
Frequency:	2462 MHz	Temp.(°C)/Hum.(%RH):	26(°C)/60 %RH
Mode:	Mode 2		
Ant.Polar.:	Horizontal		

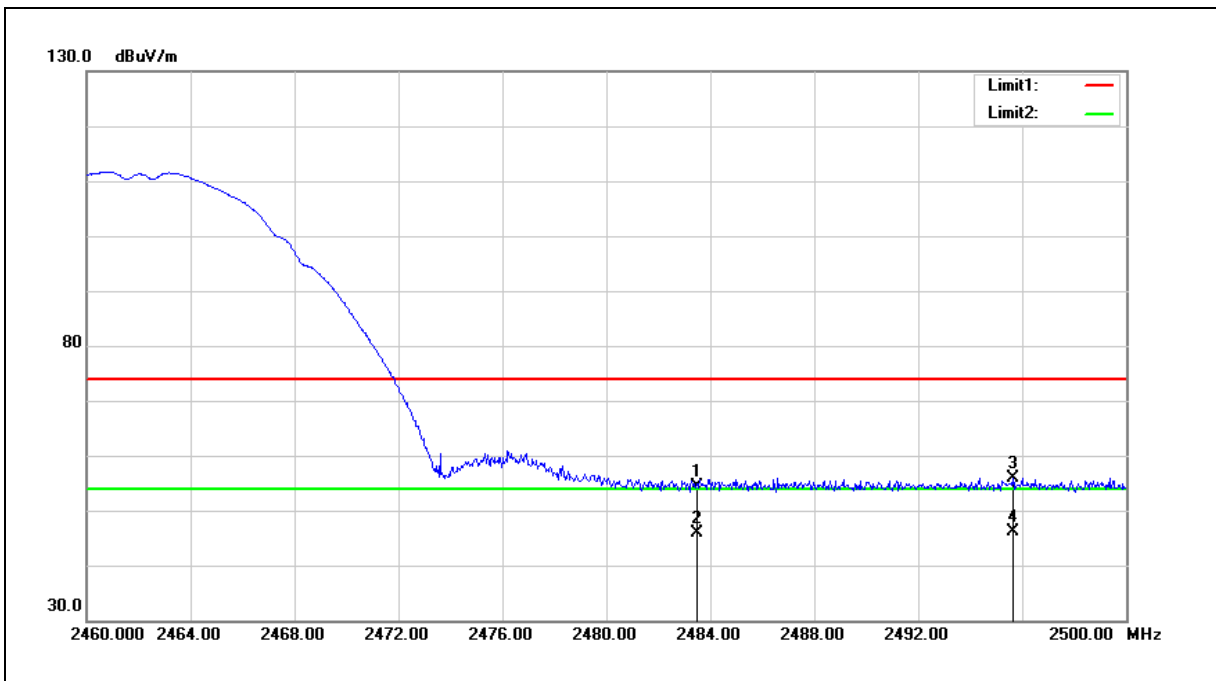

No.	Frequency (MHz)	Reading (dBuV)	Correct Factor (dB/m)	Result (dBuV/m)	Limit (dBuV/m)	Margin (dB)	Remark
1	2483.500	55.01	-0.70	54.31	74.00	-19.69	peak
2	2483.500	46.47	-0.70	45.77	54.00	-8.23	AVG
3	2495.640	56.54	-0.66	55.88	74.00	-18.12	peak
4	2495.640	46.68	-0.66	46.02	54.00	-7.98	AVG

Note:1.Result (dBuV/m) = Correct Factor (dB/m) + Reading(dBuV).

2.Correction factor (dB/m) = Antenna Factor (dB/m) + Cable loss (dB) – Pre-Amplifier gain (dB).

3. When the peak results are less than average limit, so not need to evaluate the average.



Standard:	FCC Part 15.247	Test Distance:	3 m
Test item:	Band edge	Power:	AC 120 V/60 Hz
Frequency:	2462 MHz	Temp.(°C)/Hum.(%RH):	26(°C)/60 %RH
Mode:	Mode 2		
Ant.Polar.:	Vertical		

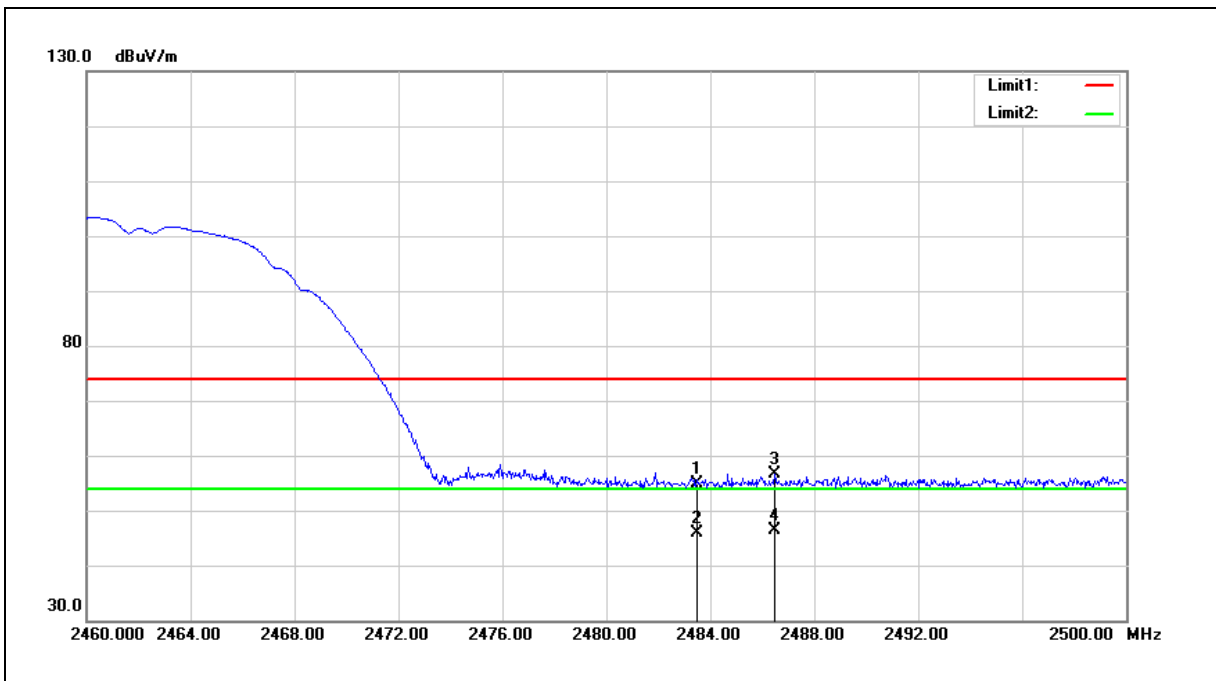

No.	Frequency (MHz)	Reading (dBuV)	Correct Factor (dB/m)	Result (dBuV/m)	Limit (dBuV/m)	Margin (dB)	Remark
1	2483.500	55.54	-0.70	54.84	74.00	-19.16	peak
2	2483.500	46.52	-0.70	45.82	54.00	-8.18	AVG
3	2486.480	57.30	-0.70	56.60	74.00	-17.40	peak
4	2486.480	46.96	-0.70	46.26	54.00	-7.74	AVG

- Note:1.Result (dBuV/m) = Correct Factor (dB/m) + Reading(dBuV).
- 2.Correction factor (dB/m) = Antenna Factor (dB/m) + Cable loss (dB) – Pre-Amplifier gain (dB).
3. When the peak results are less than average limit, so not need to evaluate the average.



Standard:	FCC Part 15.247	Test Distance:	3 m
Test item:	Band edge	Power:	AC 120 V/60 Hz
Frequency:	2412 MHz	Temp.(°C)/Hum.(%RH):	26(°C)/60 %RH
Mode:	Mode 3		
Ant.Polar.:	Horizontal		

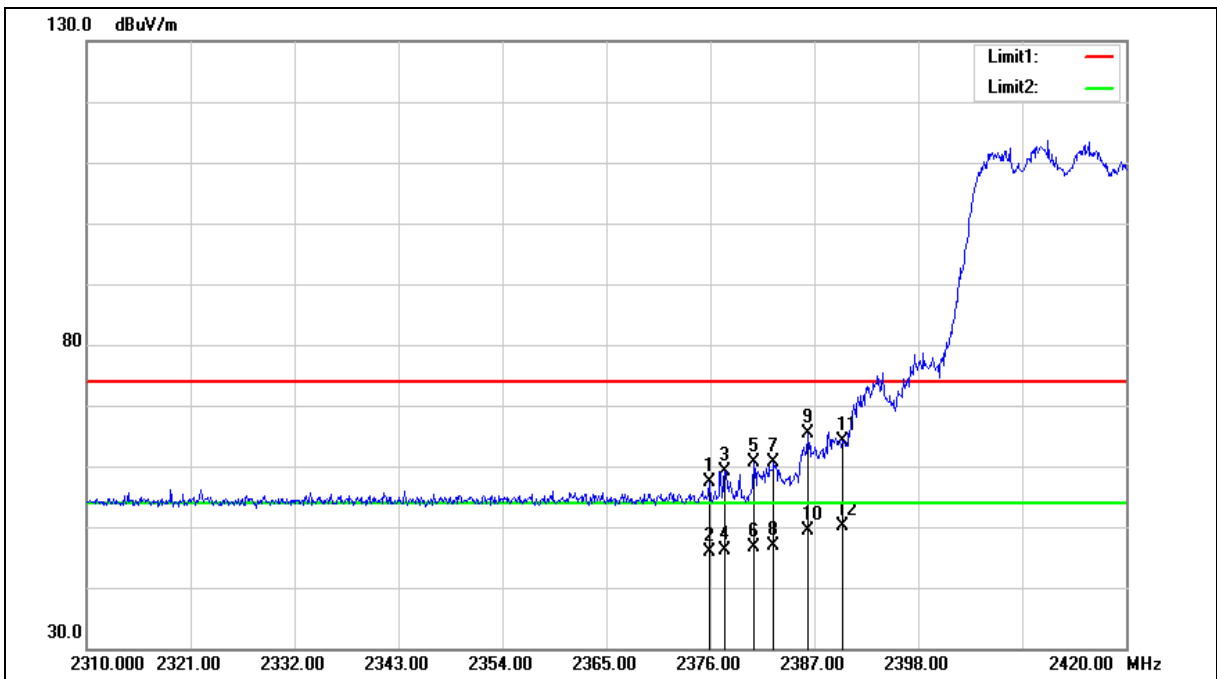



Standard:	FCC Part 15.247	Test Distance:	3 m
Test item:	Band edge	Power:	AC 120 V/60 Hz
Frequency:	2412 MHz	Temp.(°C)/Hum.(%RH):	26(°C)/60 %RH
Mode:	Mode 3		
Ant.Polar.:	Horizontal		

No.	Frequency (MHz)	Reading (dBuV)	Correct Factor (dB/m)	Result (dBuV/m)	Limit (dBuV/m)	Margin (dB)	Remark
1	2375.890	58.42	-1.10	57.32	74.00	-16.68	peak
2	2375.890	47.08	-1.10	45.98	54.00	-8.02	AVG
3	2377.540	60.32	-1.10	59.22	74.00	-14.78	peak
4	2377.540	47.26	-1.10	46.16	54.00	-7.84	AVG
5	2380.620	61.64	-1.08	60.56	74.00	-13.44	peak
6	2380.620	47.80	-1.08	46.72	54.00	-7.28	AVG
7	2382.710	61.64	-1.07	60.57	74.00	-13.43	peak
8	2382.710	47.83	-1.07	46.76	54.00	-7.24	AVG
9	2386.340	66.45	-1.07	65.38	74.00	-8.62	peak
10	2386.340	50.34	-1.07	49.27	54.00	-4.73	AVG
11	2390.000	65.22	-1.05	64.17	74.00	-9.83	peak
12	2390.000	51.24	-1.05	50.19	54.00	-3.81	AVG

Note:1.Result (dBuV/m) = Correct Factor (dB/m) + Reading(dBuV).

2.Correction factor (dB/m) = Antenna Factor (dB/m) + Cable loss (dB) – Pre-Amplifier gain (dB).

3. When the peak results are less than average limit, so not need to evaluate the average.



Standard:	FCC Part 15.247	Test Distance:	3 m
Test item:	Band edge	Power:	AC 120 V/60 Hz
Frequency:	2412 MHz	Temp.(°C)/Hum.(%RH):	26(°C)/60 %RH
Mode:	Mode 3		
Ant.Polar.:	Vertical		

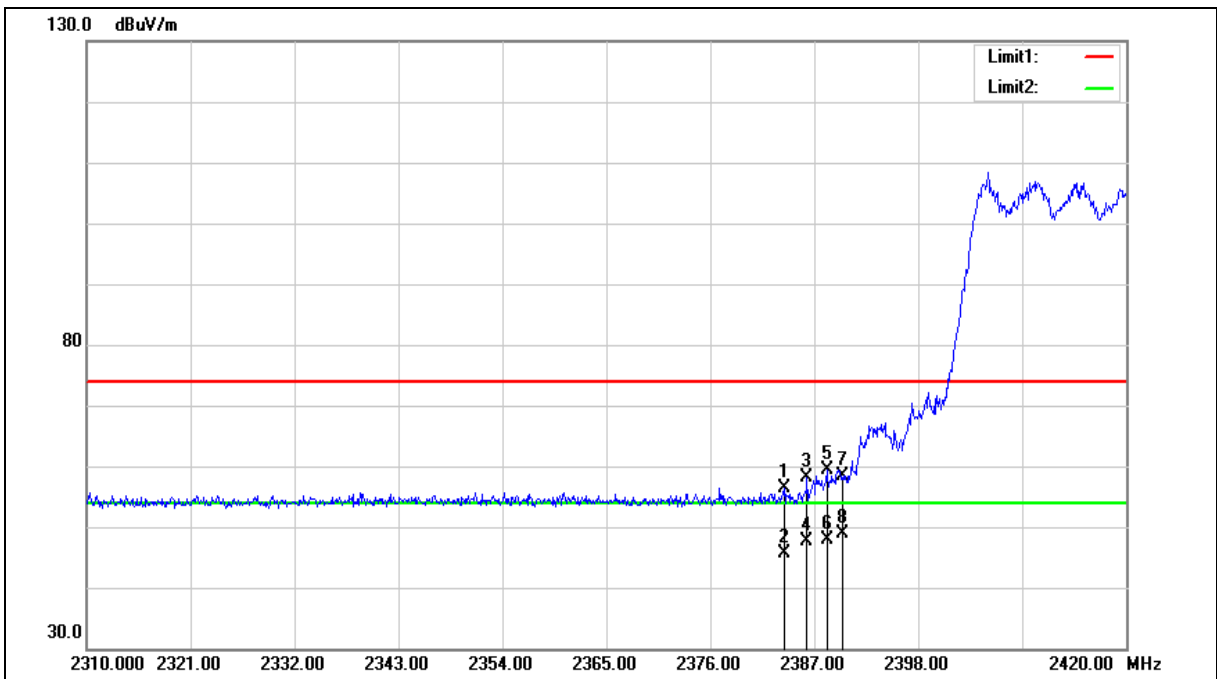



Standard:	FCC Part 15.247	Test Distance:	3 m
Test item:	Band edge	Power:	AC 120 V/60 Hz
Frequency:	2412 MHz	Temp.(°C)/Hum.(%RH):	26(°C)/60 %RH
Mode:	Mode 3		
Ant.Polar.:	Vertical		

No.	Frequency (MHz)	Reading (dBuV)	Correct Factor (dB/m)	Result (dBuV/m)	Limit (dBuV/m)	Margin (dB)	Remark
1	2383.810	57.37	-1.07	56.30	74.00	-17.70	peak
2	2383.810	46.74	-1.07	45.67	54.00	-8.33	AVG
3	2386.230	59.11	-1.07	58.04	74.00	-15.96	peak
4	2386.230	48.67	-1.07	47.60	54.00	-6.40	AVG
5	2388.320	60.53	-1.05	59.48	74.00	-14.52	peak
6	2388.320	48.84	-1.05	47.79	54.00	-6.21	AVG
7	2390.000	59.32	-1.05	58.27	74.00	-15.73	peak
8	2390.000	49.96	-1.05	48.91	54.00	-5.09	AVG

Note:1.Result (dBuV/m) = Correct Factor (dB/m) + Reading(dBuV).

2.Correction factor (dB/m) = Antenna Factor (dB/m) + Cable loss (dB) – Pre-Amplifier gain (dB).

3. When the peak results are less than average limit, so not need to evaluate the average.



Standard:	FCC Part 15.247	Test Distance:	3 m
Test item:	Band edge	Power:	AC 120 V/60 Hz
Frequency:	2437 MHz	Temp.(°C)/Hum.(%RH):	26(°C)/60 %RH
Mode:	Mode 3		
Ant.Polar.:	Horizontal		

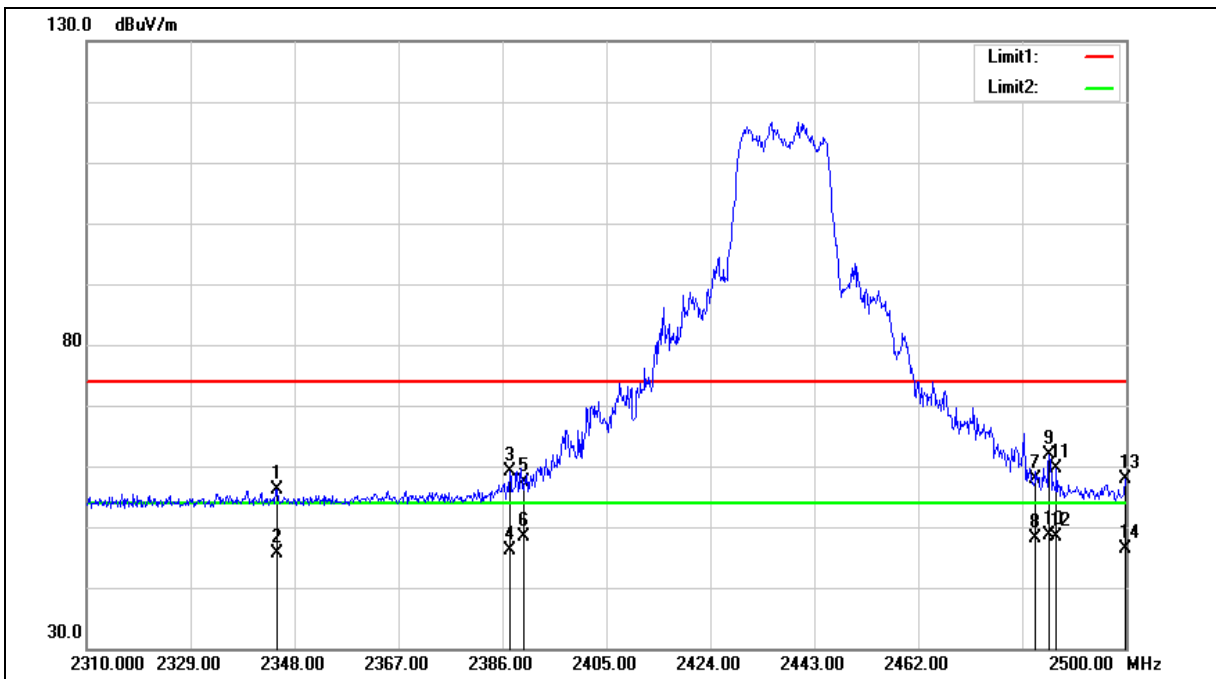



Standard:	FCC Part 15.247	Test Distance:	3 m
Test item:	Band edge	Power:	AC 120 V/60 Hz
Frequency:	2437 MHz	Temp.(°C)/Hum.(%RH):	26(°C)/60 %RH
Mode:	Mode 3		
Ant.Polar.:	Horizontal		

No.	Frequency (MHz)	Reading (dBUV)	Correct Factor (dB/m)	Result (dBUV/m)	Limit (dBUV/m)	Margin (dB)	Remark
1	2344.770	57.39	-1.21	56.18	74.00	-17.82	peak
2	2344.770	46.87	-1.21	45.66	54.00	-8.34	AVG
3	2387.330	60.23	-1.06	59.17	74.00	-14.83	peak
4	2387.330	47.16	-1.06	46.10	54.00	-7.90	AVG
5	2390.000	58.37	-1.05	57.32	74.00	-16.68	peak
6	2390.000	49.53	-1.05	48.48	54.00	-5.52	AVG
7	2483.500	58.68	-0.70	57.98	74.00	-16.02	peak
8	2483.500	48.90	-0.70	48.20	54.00	-5.80	AVG
9	2485.940	62.50	-0.70	61.80	74.00	-12.20	peak
10	2485.940	49.27	-0.70	48.57	54.00	-5.43	AVG
11	2487.270	60.21	-0.69	59.52	74.00	-14.48	peak
12	2487.270	49.10	-0.69	48.41	54.00	-5.59	AVG
13	2499.810	58.61	-0.64	57.97	74.00	-16.03	peak
14	2499.810	47.02	-0.64	46.38	54.00	-7.62	AVG

Note:1.Result (dBUV/m) = Correct Factor (dB/m) + Reading(dBUV).

2.Correction factor (dB/m) = Antenna Factor (dB/m) + Cable loss (dB) – Pre-Amplifier gain (dB).

3. When the peak results are less than average limit, so not need to evaluate the average.



Standard:	FCC Part 15.247	Test Distance:	3 m
Test item:	Band edge	Power:	AC 120 V/60 Hz
Frequency:	2437 MHz	Temp.(°C)/Hum.(%RH):	26(°C)/60 %RH
Mode:	Mode 3		
Ant.Polar.:	Vertical		

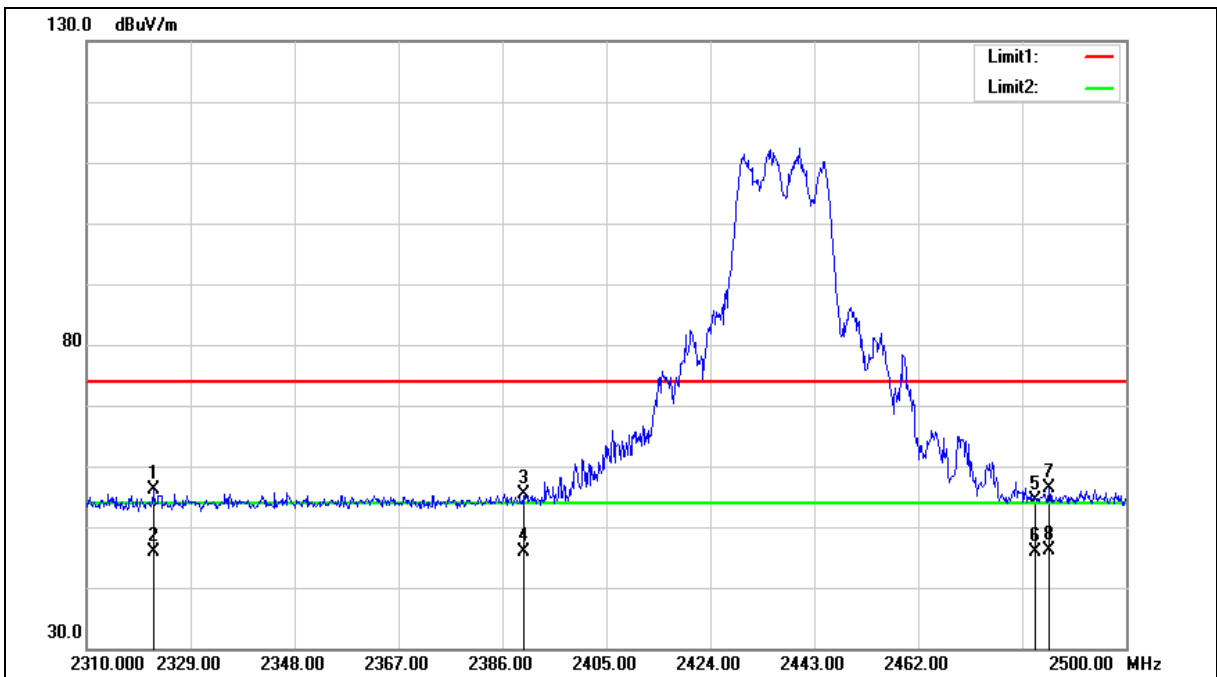



Standard:	FCC Part 15.247	Test Distance:	3 m
Test item:	Band edge	Power:	AC 120 V/60 Hz
Frequency:	2437 MHz	Temp.(°C)/Hum.(%RH):	26(°C)/60 %RH
Mode:	Mode 3		
Ant.Polar.:	Vertical		

No.	Frequency (MHz)	Reading (dBuV)	Correct Factor (dB/m)	Result (dBuV/m)	Limit (dBuV/m)	Margin (dB)	Remark
1	2322.350	57.54	-1.29	56.25	74.00	-17.75	peak
2	2322.350	47.28	-1.29	45.99	54.00	-8.01	AVG
3	2390.000	56.31	-1.05	55.26	74.00	-18.74	peak
4	2390.000	47.00	-1.05	45.95	54.00	-8.05	AVG
5	2483.500	55.18	-0.70	54.48	74.00	-19.52	peak
6	2483.500	46.57	-0.70	45.87	54.00	-8.13	AVG
7	2485.940	56.97	-0.70	56.27	74.00	-17.73	peak
8	2485.940	46.73	-0.70	46.03	54.00	-7.97	AVG

Note:1.Result (dBuV/m) = Correct Factor (dB/m) + Reading(dBuV).

2.Correction factor (dB/m) = Antenna Factor (dB/m) + Cable loss (dB) – Pre-Amplifier gain (dB).

3. When the peak results are less than average limit, so not need to evaluate the average.



Standard:	FCC Part 15.247	Test Distance:	3 m
Test item:	Band edge	Power:	AC 120 V/60 Hz
Frequency:	2462 MHz	Temp.(°C)/Hum.(%RH):	26(°C)/60 %RH
Mode:	Mode 3		
Ant.Polar.:	Horizontal		

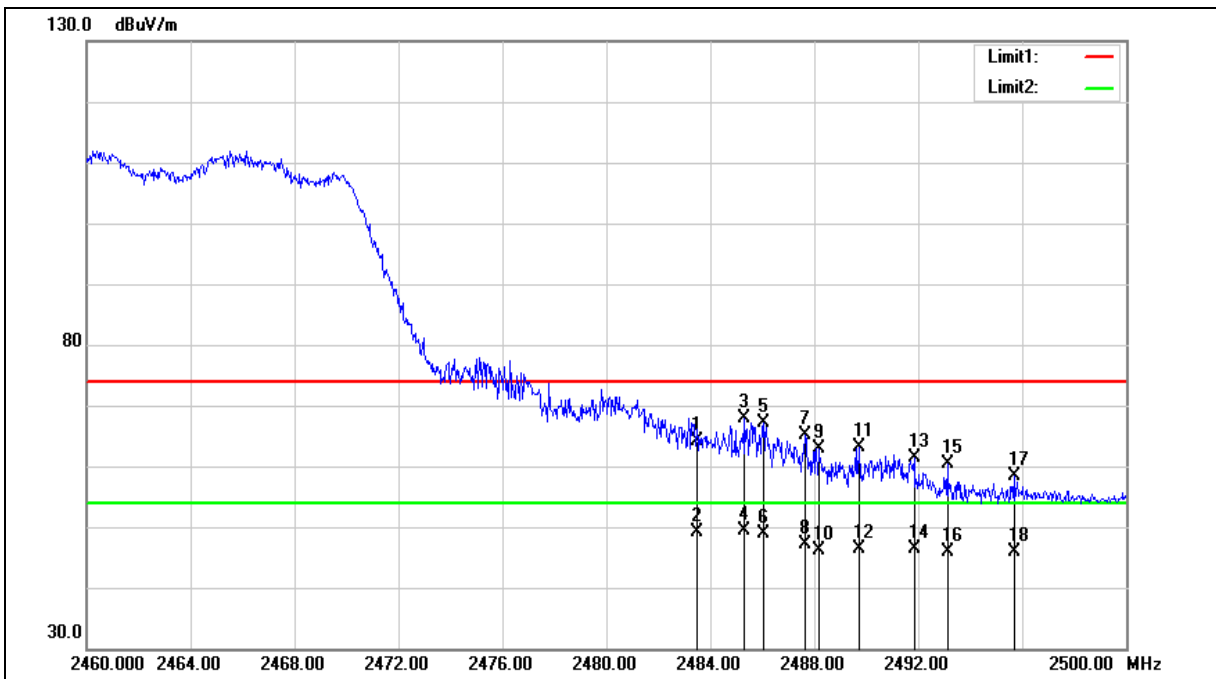



Standard:	FCC Part 15.247	Test Distance:	3 m
Test item:	Band edge	Power:	AC 120 V/60 Hz
Frequency:	2462 MHz	Temp.(°C)/Hum.(%RH):	26(°C)/60 %RH
Mode:	Mode 3		
Ant.Polar.:	Horizontal		

No.	Frequency (MHz)	Reading (dBuV)	Correct Factor (dB/m)	Result (dBuV/m)	Limit (dBuV/m)	Margin (dB)	Remark
1	2483.500	64.84	-0.70	64.14	74.00	-9.86	peak
2	2483.500	49.94	-0.70	49.24	54.00	-4.76	AVG
3	2485.320	68.52	-0.70	67.82	74.00	-6.18	peak
4	2485.320	50.16	-0.70	49.46	54.00	-4.54	AVG
5	2486.040	67.73	-0.70	67.03	74.00	-6.97	peak
6	2486.040	49.62	-0.70	48.92	54.00	-5.08	AVG
7	2487.640	65.83	-0.68	65.15	74.00	-8.85	peak
8	2487.640	47.92	-0.68	47.24	54.00	-6.76	AVG
9	2488.160	63.67	-0.68	62.99	74.00	-11.01	peak
10	2488.160	46.88	-0.68	46.20	54.00	-7.80	AVG
11	2489.720	63.75	-0.68	63.07	74.00	-10.93	peak
12	2489.720	46.99	-0.68	46.31	54.00	-7.69	AVG
13	2491.840	62.11	-0.67	61.44	74.00	-12.56	peak
14	2491.840	46.96	-0.67	46.29	54.00	-7.71	AVG
15	2493.120	61.01	-0.67	60.34	74.00	-13.66	peak
16	2493.120	46.54	-0.67	45.87	54.00	-8.13	AVG
17	2495.680	59.06	-0.66	58.40	74.00	-15.60	peak
18	2495.680	46.44	-0.66	45.78	54.00	-8.22	AVG

Note:1.Result (dBuV/m) = Correct Factor (dB/m) + Reading(dBuV).

2.Correction factor (dB/m) = Antenna Factor (dB/m) + Cable loss (dB) – Pre-Amplifier gain (dB).

3. When the peak results are less than average limit, so not need to evaluate the average.



Standard:	FCC Part 15.247	Test Distance:	3 m
Test item:	Band edge	Power:	AC 120 V/60 Hz
Frequency:	2462 MHz	Temp.(°C)/Hum.(%RH):	26(°C)/60 %RH
Mode:	Mode 3		
Ant.Polar.:	Vertical		

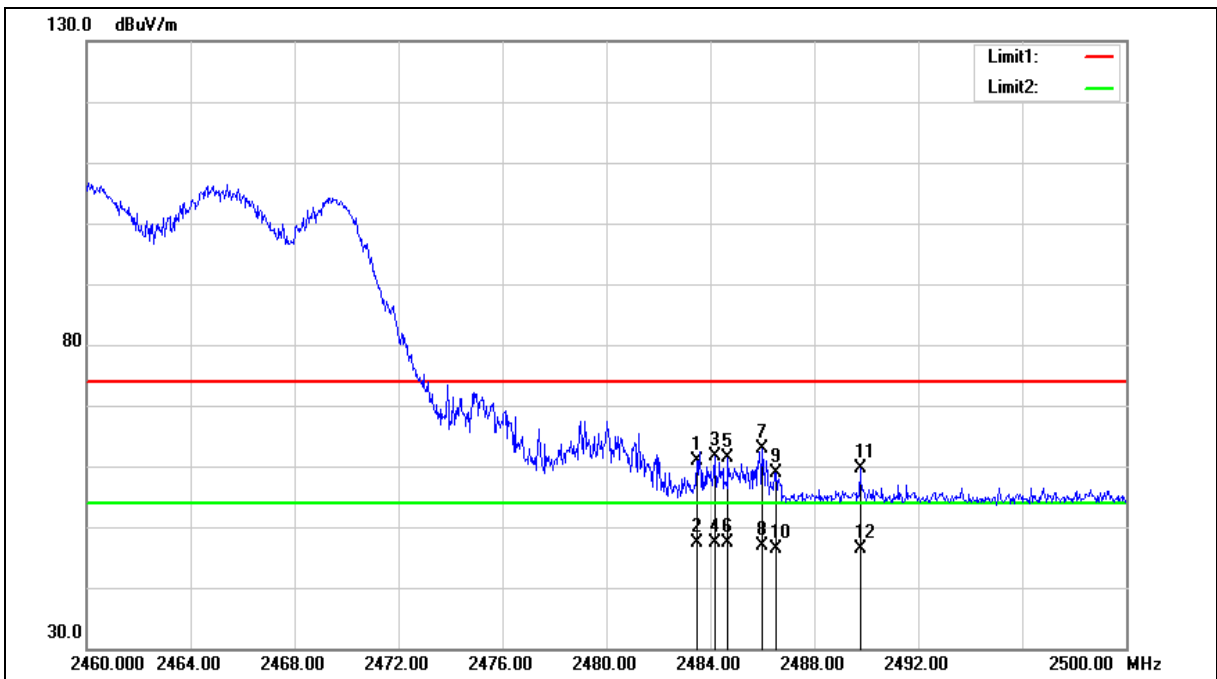



Standard:	FCC Part 15.247	Test Distance:	3 m
Test item:	Band edge	Power:	AC 120 V/60 Hz
Frequency:	2462 MHz	Temp.(°C)/Hum.(%RH):	26(°C)/60 %RH
Mode:	Mode 3		
Ant.Polar.:	Vertical		

No.	Frequency (MHz)	Reading (dBuV)	Correct Factor (dB/m)	Result (dBuV/m)	Limit (dBuV/m)	Margin (dB)	Remark
1	2483.500	61.61	-0.70	60.91	74.00	-13.09	peak
2	2483.500	48.09	-0.70	47.39	54.00	-6.61	AVG
3	2484.160	62.33	-0.70	61.63	74.00	-12.37	peak
4	2484.160	48.12	-0.70	47.42	54.00	-6.58	AVG
5	2484.680	62.08	-0.70	61.38	74.00	-12.62	peak
6	2484.680	48.15	-0.70	47.45	54.00	-6.55	AVG
7	2486.000	63.65	-0.70	62.95	74.00	-11.05	peak
8	2486.000	47.59	-0.70	46.89	54.00	-7.11	AVG
9	2486.520	59.70	-0.70	59.00	74.00	-15.00	peak
10	2486.520	47.06	-0.70	46.36	54.00	-7.64	AVG
11	2489.760	60.19	-0.68	59.51	74.00	-14.49	peak
12	2489.760	47.17	-0.68	46.49	54.00	-7.51	AVG

Note:1.Result (dBuV/m) = Correct Factor (dB/m) + Reading(dBuV).

2.Correction factor (dB/m) = Antenna Factor (dB/m) + Cable loss (dB) – Pre-Amplifier gain (dB).

3. When the peak results are less than average limit, so not need to evaluate the average.



Standard:	FCC Part 15.247	Test Distance:	3 m
Test item:	Band edge	Power:	AC 120 V/60 Hz
Frequency:	2412 MHz	Temp.(°C)/Hum.(%RH):	26(°C)/60 %RH
Mode:	Mode 6		
Ant.Polar.:	Horizontal		

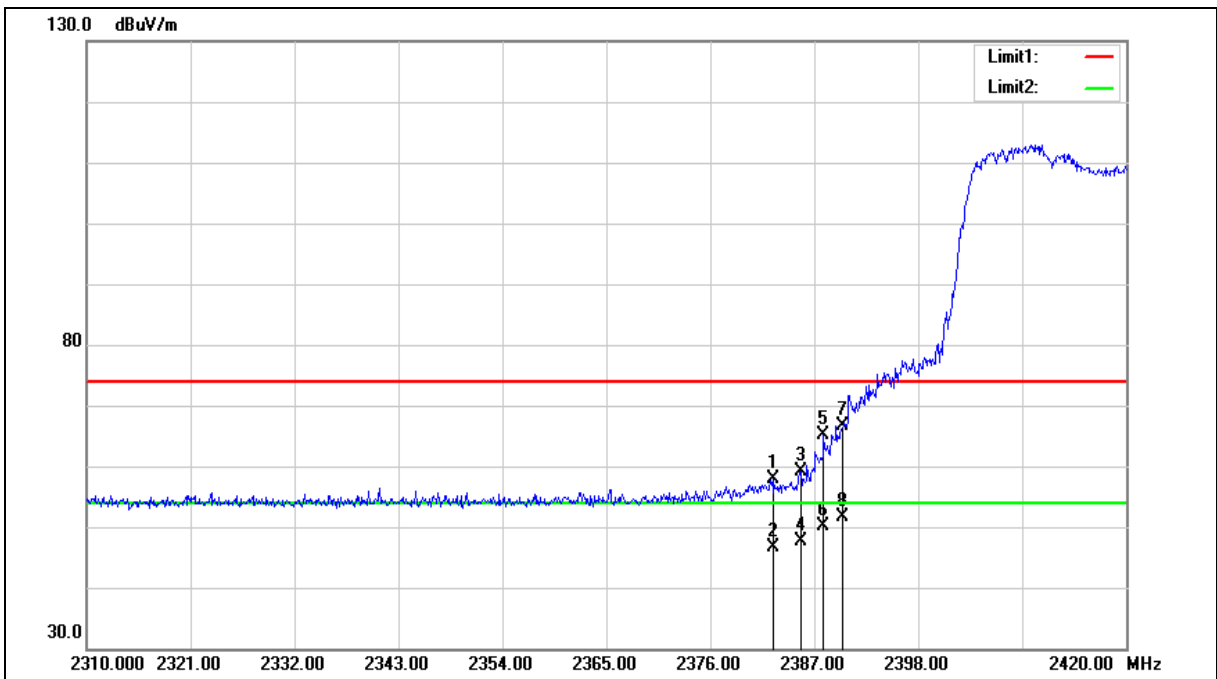



Standard:	FCC Part 15.247	Test Distance:	3 m
Test item:	Band edge	Power:	AC 120 V/60 Hz
Frequency:	2412 MHz	Temp.(°C)/Hum.(%RH):	26(°C)/60 %RH
Mode:	Mode 6		
Ant.Polar.:	Horizontal		

No.	Frequency (MHz)	Reading (dBuV)	Correct Factor (dB/m)	Result (dBuV/m)	Limit (dBuV/m)	Margin (dB)	Remark
1	2382.600	58.94	-1.08	57.86	74.00	-16.14	peak
2	2382.600	47.63	-1.08	46.55	54.00	-7.45	AVG
3	2385.570	60.26	-1.07	59.19	74.00	-14.81	peak
4	2385.570	48.74	-1.07	47.67	54.00	-6.33	AVG
5	2387.990	66.30	-1.05	65.25	74.00	-8.75	peak
6	2387.990	51.11	-1.05	50.06	54.00	-3.94	AVG
7	2390.000	67.78	-1.05	66.73	74.00	-7.27	peak
8	2390.000	52.76	-1.05	51.71	54.00	-2.29	AVG

Note:1.Result (dBuV/m) = Correct Factor (dB/m) + Reading(dBuV).

2.Correction factor (dB/m) = Antenna Factor (dB/m) + Cable loss (dB) – Pre-Amplifier gain (dB).

3. When the peak results are less than average limit, so not need to evaluate the average.



Standard:	FCC Part 15.247	Test Distance:	3 m
Test item:	Band edge	Power:	AC 120 V/60 Hz
Frequency:	2412 MHz	Temp.(°C)/Hum.(%RH):	26(°C)/60 %RH
Mode:	Mode 6		
Ant.Polar.:	Vertical		

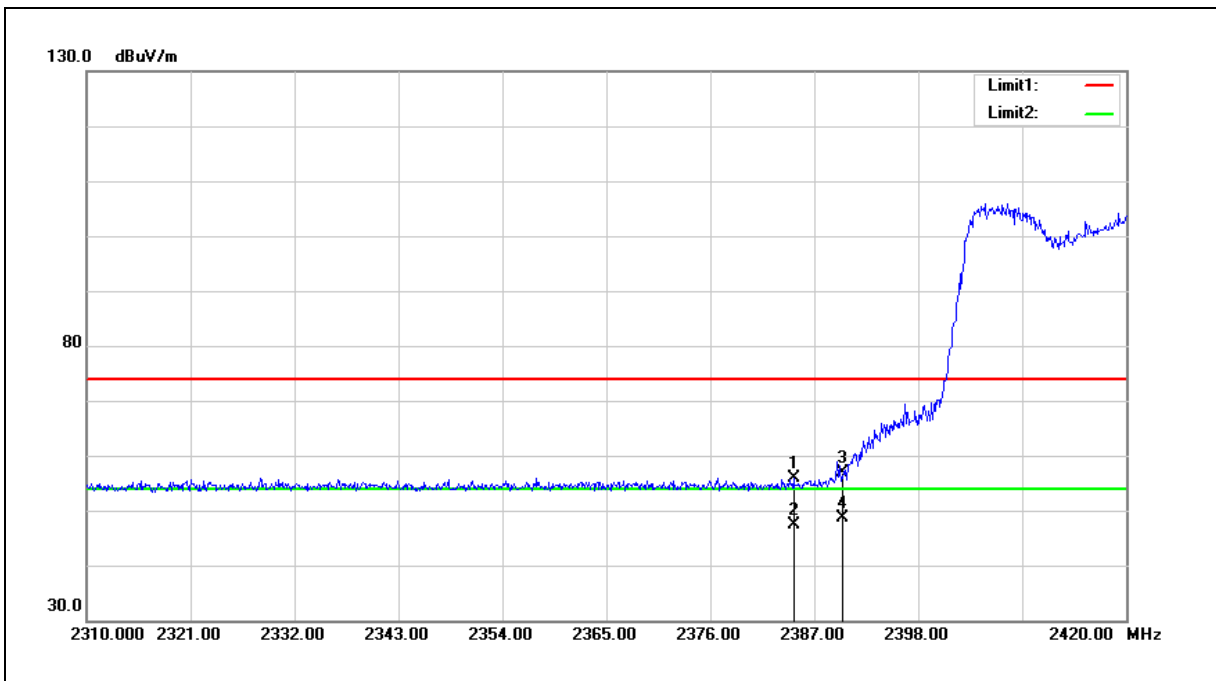

No.	Frequency (MHz)	Reading (dBuV)	Correct Factor (dB/m)	Result (dBuV/m)	Limit (dBuV/m)	Margin (dB)	Remark
1	2384.800	56.96	-1.07	55.89	74.00	-18.11	peak
2	2384.800	48.40	-1.07	47.33	54.00	-6.67	AVG
3	2390.000	57.92	-1.05	56.87	74.00	-17.13	peak
4	2390.000	49.80	-1.05	48.75	54.00	-5.25	AVG

Note:1.Result (dBuV/m) = Correct Factor (dB/m) + Reading(dBuV).

2.Correction factor (dB/m) = Antenna Factor (dB/m) + Cable loss (dB) – Pre-Amplifier gain (dB).

3. When the peak results are less than average limit, so not need to evaluate the average.



Standard:	FCC Part 15.247	Test Distance:	3 m
Test item:	Band edge	Power:	AC 120 V/60 Hz
Frequency:	2437 MHz	Temp.(°C)/Hum.(%RH):	26(°C)/60 %RH
Mode:	Mode 6		
Ant.Polar.:	Horizontal		

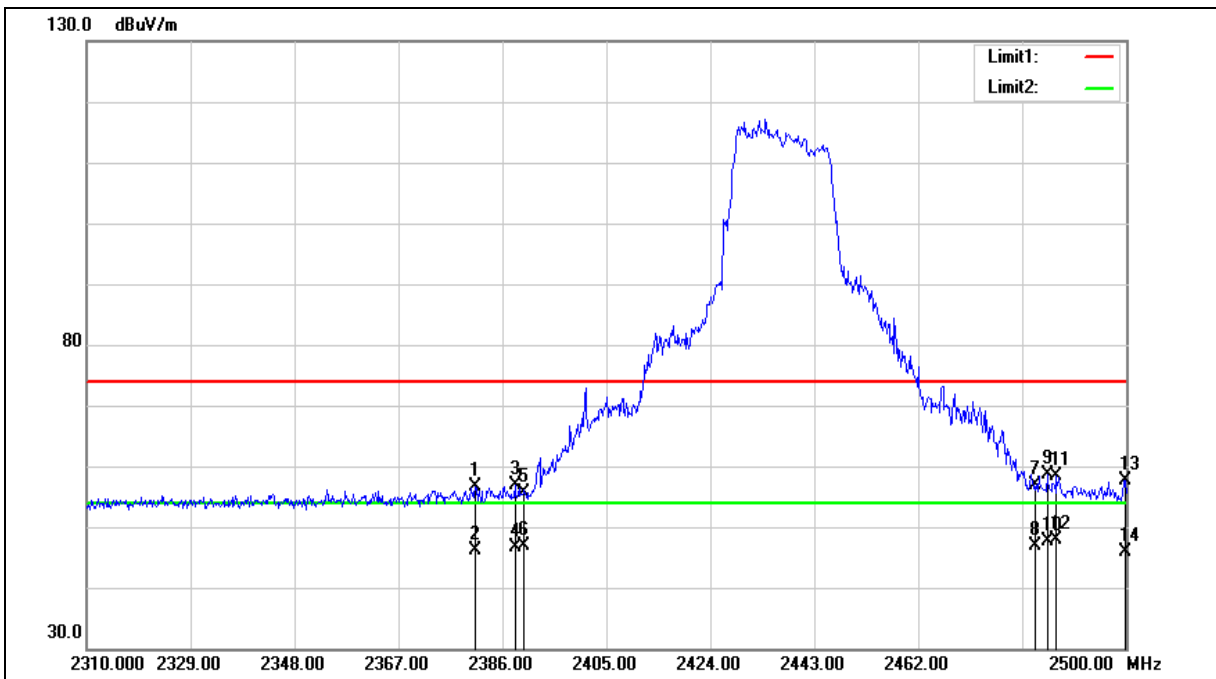



Standard:	FCC Part 15.247	Test Distance:	3 m
Test item:	Band edge	Power:	AC 120 V/60 Hz
Frequency:	2437 MHz	Temp.(°C)/Hum.(%RH):	26(°C)/60 %RH
Mode:	Mode 6		
Ant.Polar.:	Horizontal		

No.	Frequency (MHz)	Reading (dBUV)	Correct Factor (dB/m)	Result (dBUV/m)	Limit (dBUV/m)	Margin (dB)	Remark
1	2381.060	57.64	-1.08	56.56	74.00	-17.44	peak
2	2381.060	47.33	-1.08	46.25	54.00	-7.75	AVG
3	2388.280	57.97	-1.05	56.92	74.00	-17.08	peak
4	2388.280	47.79	-1.05	46.74	54.00	-7.26	AVG
5	2390.000	56.78	-1.05	55.73	74.00	-18.27	peak
6	2390.000	47.91	-1.05	46.86	54.00	-7.14	AVG
7	2483.500	57.53	-0.70	56.83	74.00	-17.17	peak
8	2483.500	47.56	-0.70	46.86	54.00	-7.14	AVG
9	2485.560	59.21	-0.70	58.51	74.00	-15.49	peak
10	2485.560	48.30	-0.70	47.60	54.00	-6.40	AVG
11	2487.270	59.16	-0.69	58.47	74.00	-15.53	peak
12	2487.270	48.56	-0.69	47.87	54.00	-6.13	AVG
13	2499.810	58.23	-0.64	57.59	74.00	-16.41	peak
14	2499.810	46.59	-0.64	45.95	54.00	-8.05	AVG

Note:1.Result (dBUV/m) = Correct Factor (dB/m) + Reading(dBUV).

2.Correction factor (dB/m) = Antenna Factor (dB/m) + Cable loss (dB) – Pre-Amplifier gain (dB).

3. When the peak results are less than average limit, so not need to evaluate the average.



Standard:	FCC Part 15.247	Test Distance:	3 m
Test item:	Band edge	Power:	AC 120 V/60 Hz
Frequency:	2437 MHz	Temp.(°C)/Hum.(%RH):	26(°C)/60 %RH
Mode:	Mode 6		
Ant.Polar.:	Vertical		

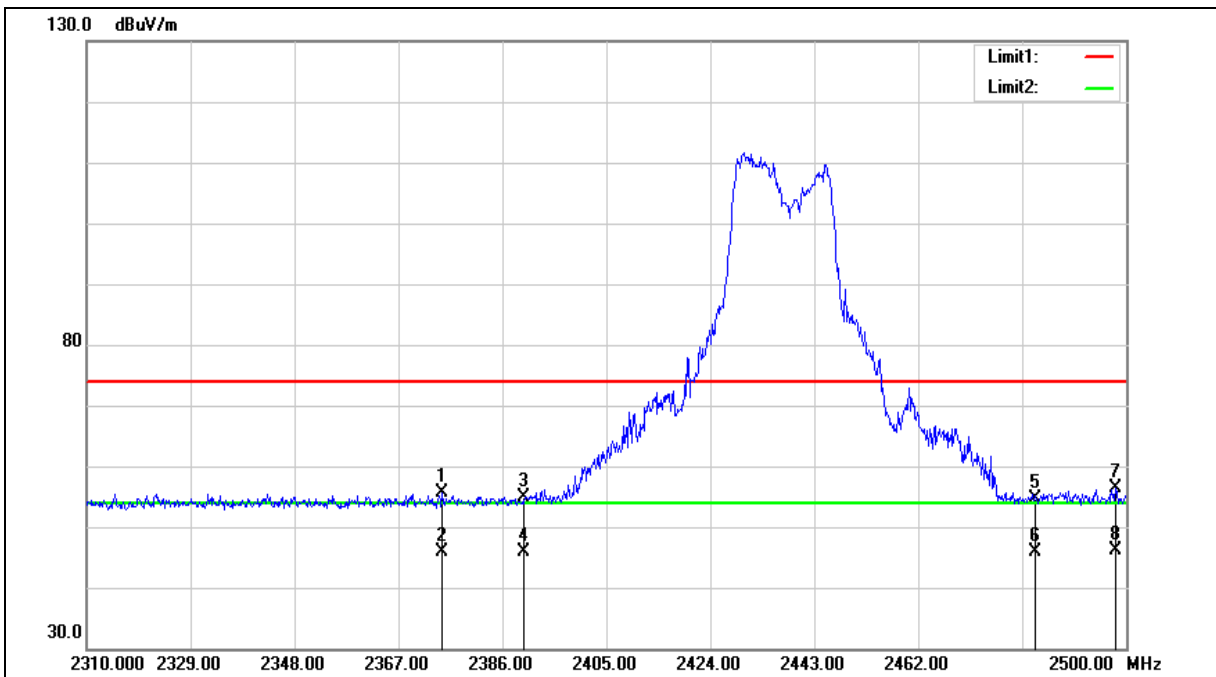



Standard:	FCC Part 15.247	Test Distance:	3 m
Test item:	Band edge	Power:	AC 120 V/60 Hz
Frequency:	2437 MHz	Temp.(°C)/Hum.(%RH):	26(°C)/60 %RH
Mode:	Mode 6		
Ant.Polar.:	Vertical		

No.	Frequency (MHz)	Reading (dBuV)	Correct Factor (dB/m)	Result (dBuV/m)	Limit (dBuV/m)	Margin (dB)	Remark
1	2374.980	56.61	-1.10	55.51	74.00	-18.49	peak
2	2374.980	46.90	-1.10	45.80	54.00	-8.20	AVG
3	2390.000	55.94	-1.05	54.89	74.00	-19.11	peak
4	2390.000	47.01	-1.05	45.96	54.00	-8.04	AVG
5	2483.500	55.33	-0.70	54.63	74.00	-19.37	peak
6	2483.500	46.58	-0.70	45.88	54.00	-8.12	AVG
7	2498.100	57.09	-0.64	56.45	74.00	-17.55	peak
8	2498.100	46.69	-0.64	46.05	54.00	-7.95	AVG

Note:1.Result (dBuV/m) = Correct Factor (dB/m) + Reading(dBuV).

2.Correction factor (dB/m) = Antenna Factor (dB/m) + Cable loss (dB) – Pre-Amplifier gain (dB).

3. When the peak results are less than average limit, so not need to evaluate the average.



Standard:	FCC Part 15.247	Test Distance:	3 m
Test item:	Band edge	Power:	AC 120 V/60 Hz
Frequency:	2462 MHz	Temp.(°C)/Hum.(%RH):	26(°C)/60 %RH
Mode:	Mode 6		
Ant.Polar.:	Horizontal		

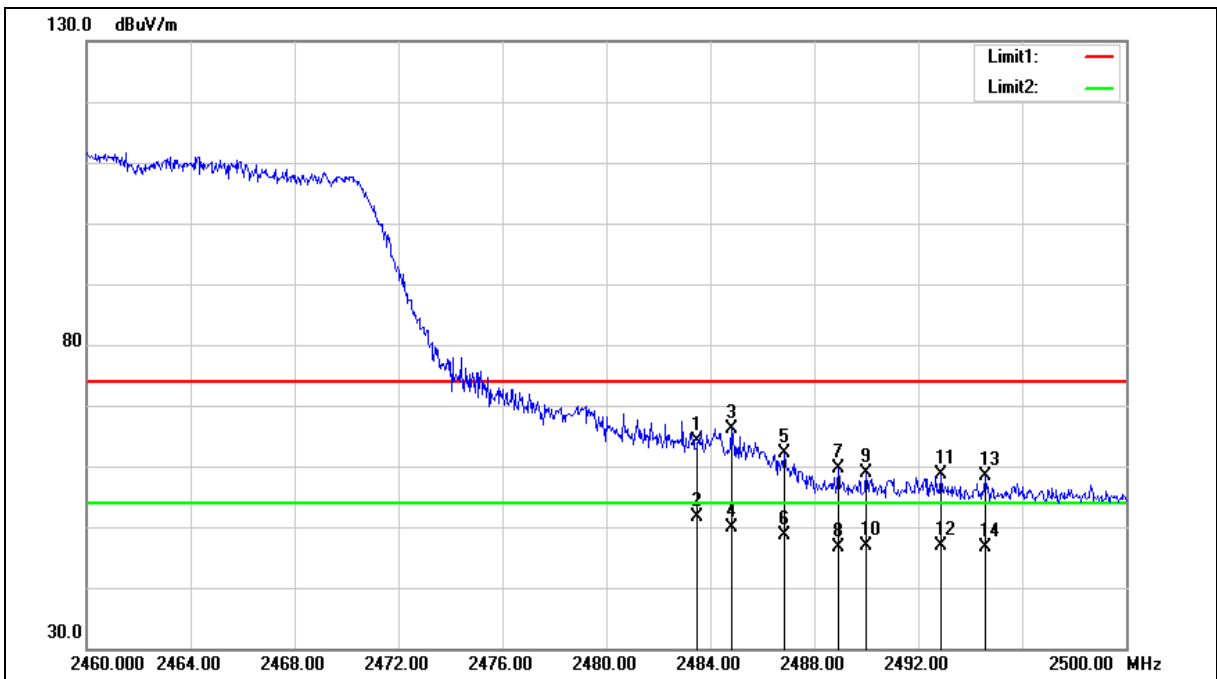



Standard:	FCC Part 15.247	Test Distance:	3 m
Test item:	Band edge	Power:	AC 120 V/60 Hz
Frequency:	2462 MHz	Temp.(°C)/Hum.(%RH):	26(°C)/60 %RH
Mode:	Mode 6		
Ant.Polar.:	Horizontal		

No.	Frequency (MHz)	Reading (dBUV)	Correct Factor (dB/m)	Result (dBUV/m)	Limit (dBUV/m)	Margin (dB)	Remark
1	2483.500	64.72	-0.70	64.02	74.00	-9.98	peak
2	2483.500	52.25	-0.70	51.55	54.00	-2.45	AVG
3	2484.800	66.95	-0.70	66.25	74.00	-7.75	peak
4	2484.800	50.57	-0.70	49.87	54.00	-4.13	AVG
5	2486.840	62.93	-0.69	62.24	74.00	-11.76	peak
6	2486.840	49.33	-0.69	48.64	54.00	-5.36	AVG
7	2488.920	60.27	-0.68	59.59	74.00	-14.41	peak
8	2488.920	47.31	-0.68	46.63	54.00	-7.37	AVG
9	2490.000	59.67	-0.68	58.99	74.00	-15.01	peak
10	2490.000	47.50	-0.68	46.82	54.00	-7.18	AVG
11	2492.880	59.38	-0.67	58.71	74.00	-15.29	peak
12	2492.880	47.49	-0.67	46.82	54.00	-7.18	AVG
13	2494.560	58.99	-0.66	58.33	74.00	-15.67	peak
14	2494.560	47.36	-0.66	46.70	54.00	-7.30	AVG

Note:1.Result (dBUV/m) = Correct Factor (dB/m) + Reading(dBUV).

2.Correction factor (dB/m) = Antenna Factor (dB/m) + Cable loss (dB) – Pre-Amplifier gain (dB).

3. When the peak results are less than average limit, so not need to evaluate the average.



Standard:	FCC Part 15.247	Test Distance:	3 m
Test item:	Band edge	Power:	AC 120 V/60 Hz
Frequency:	2462 MHz	Temp.(°C)/Hum.(%RH):	26(°C)/60 %RH
Mode:	Mode 6		
Ant.Polar.:	Vertical		

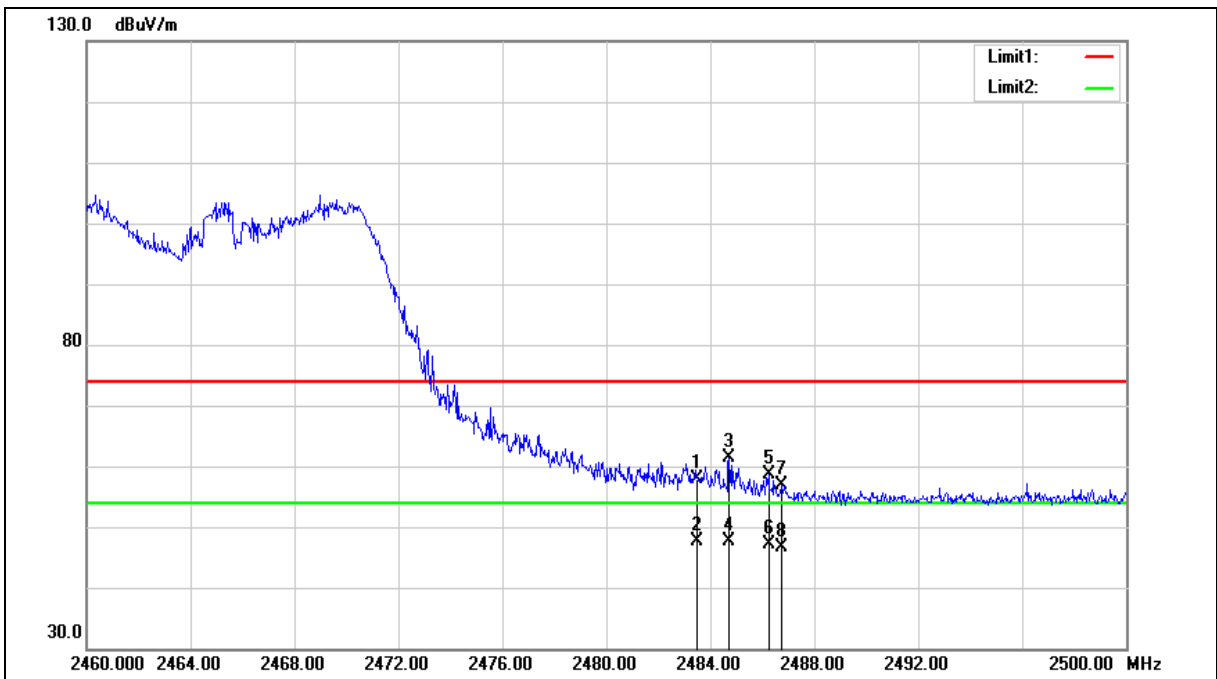



Standard:	FCC Part 15.247	Test Distance:	3 m
Test item:	Band edge	Power:	AC 120 V/60 Hz
Frequency:	2462 MHz	Temp.(°C)/Hum.(%RH):	26(°C)/60 %RH
Mode:	Mode 6		
Ant.Polar.:	Vertical		

No.	Frequency (MHz)	Reading (dBuV)	Correct Factor (dB/m)	Result (dBuV/m)	Limit (dBuV/m)	Margin (dB)	Remark
1	2483.500	58.56	-0.70	57.86	74.00	-16.14	peak
2	2483.500	48.34	-0.70	47.64	54.00	-6.36	AVG
3	2484.720	62.06	-0.70	61.36	74.00	-12.64	peak
4	2484.720	48.44	-0.70	47.74	54.00	-6.26	AVG
5	2486.240	59.39	-0.70	58.69	74.00	-15.31	peak
6	2486.240	47.71	-0.70	47.01	54.00	-6.99	AVG
7	2486.760	57.65	-0.69	56.96	74.00	-17.04	peak
8	2486.760	47.44	-0.69	46.75	54.00	-7.25	AVG

Note:1.Result (dBuV/m) = Correct Factor (dB/m) + Reading(dBuV).

2.Correction factor (dB/m) = Antenna Factor (dB/m) + Cable loss (dB) – Pre-Amplifier gain (dB).

3. When the peak results are less than average limit, so not need to evaluate the average.



Standard:	FCC Part 15.247	Test Distance:	3 m
Test item:	Band edge	Power:	AC 120 V/60 Hz
Frequency:	2422 MHz	Temp.(°C)/Hum.(%RH):	26(°C)/60 %RH
Mode:	Mode 7		
Ant.Polar.:	Horizontal		

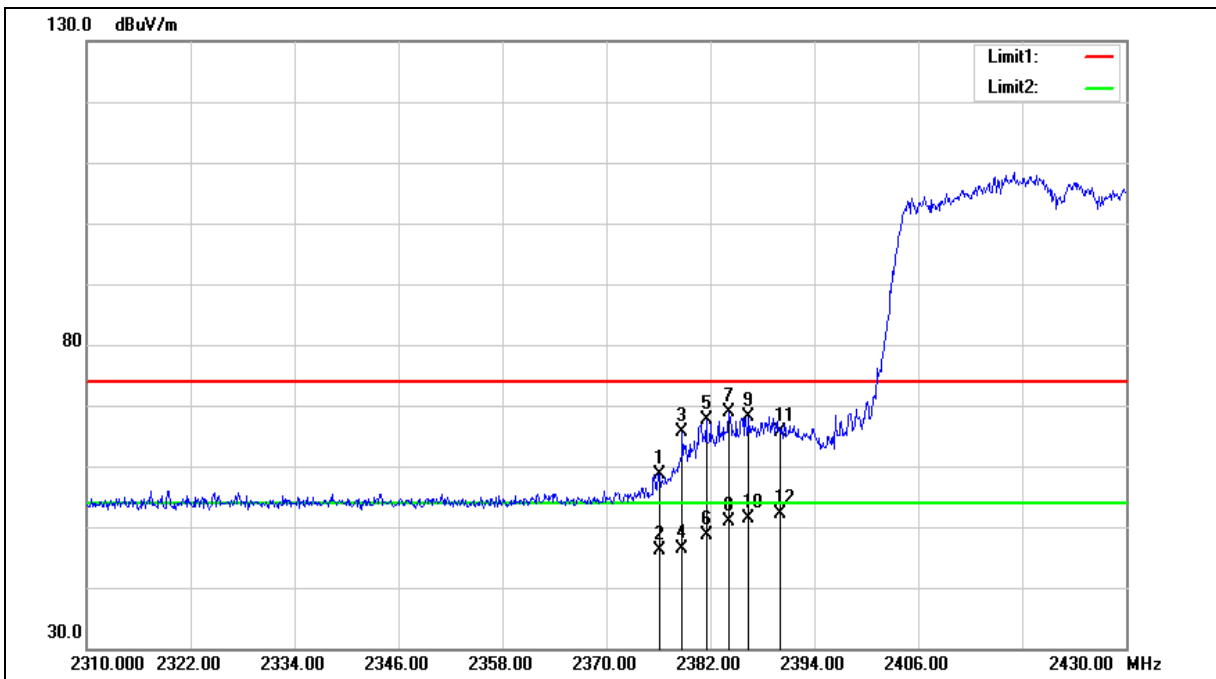



Standard:	FCC Part 15.247	Test Distance:	3 m
Test item:	Band edge	Power:	AC 120 V/60 Hz
Frequency:	2422 MHz	Temp.(°C)/Hum.(%RH):	26(°C)/60 %RH
Mode:	Mode 7		
Ant.Polar.:	Horizontal		

No.	Frequency (MHz)	Reading (dBuV)	Correct Factor (dB/m)	Result (dBuV/m)	Limit (dBuV/m)	Margin (dB)	Remark
1	2376.120	59.82	-1.10	58.72	74.00	-15.28	peak
2	2376.120	47.17	-1.10	46.07	54.00	-7.93	AVG
3	2378.760	66.64	-1.10	65.54	74.00	-8.46	peak
4	2378.760	47.51	-1.10	46.41	54.00	-7.59	AVG
5	2381.520	68.61	-1.08	67.53	74.00	-6.47	peak
6	2381.520	49.66	-1.08	48.58	54.00	-5.42	AVG
7	2384.160	69.96	-1.07	68.89	74.00	-5.11	peak
8	2384.160	51.84	-1.07	50.77	54.00	-3.23	AVG
9	2386.440	69.15	-1.07	68.08	74.00	-5.92	peak
10	2386.440	52.54	-1.07	51.47	54.00	-2.53	AVG
11	2390.000	66.67	-1.05	65.62	74.00	-8.38	peak
12	2390.000	53.17	-1.05	52.12	54.00	-1.88	AVG

Note:1.Result (dBuV/m) = Correct Factor (dB/m) + Reading(dBuV).

2.Correction factor (dB/m) = Antenna Factor (dB/m) + Cable loss (dB) – Pre-Amplifier gain (dB).

3. When the peak results are less than average limit, so not need to evaluate the average.



Standard:	FCC Part 15.247	Test Distance:	3 m
Test item:	Band edge	Power:	AC 120 V/60 Hz
Frequency:	2422 MHz	Temp.(°C)/Hum.(%RH):	26(°C)/60 %RH
Mode:	Mode 7		
Ant.Polar.:	Vertical		

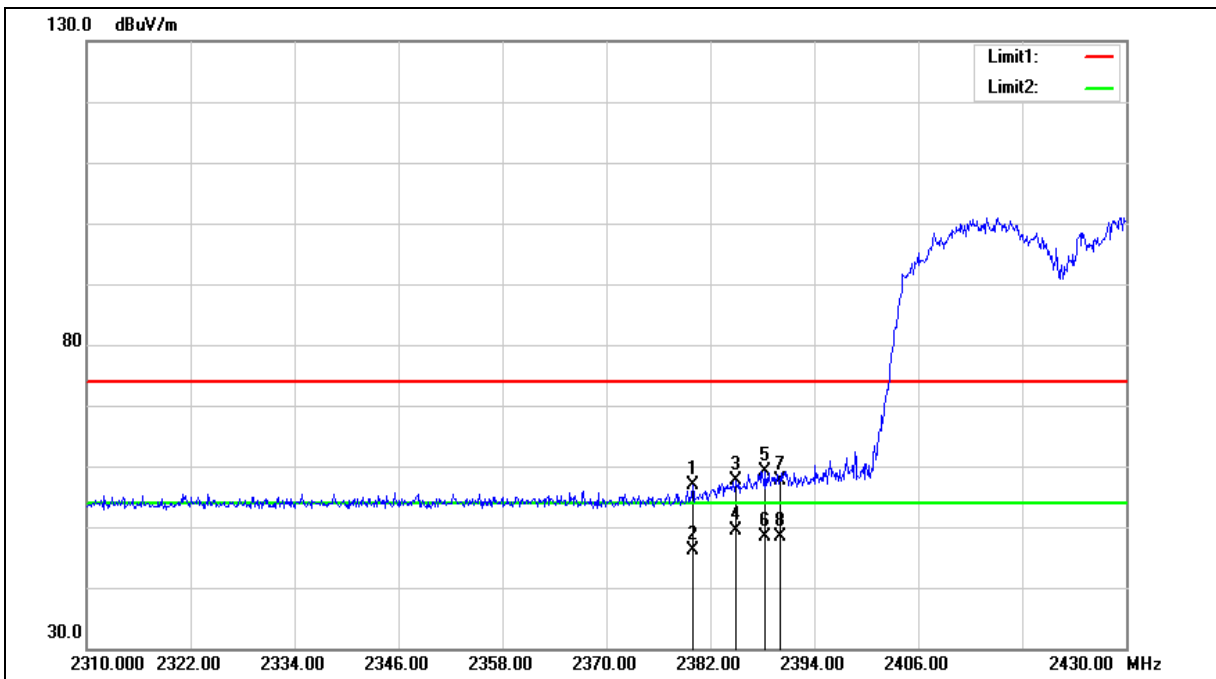



Standard:	FCC Part 15.247	Test Distance:	3 m
Test item:	Band edge	Power:	AC 120 V/60 Hz
Frequency:	2422 MHz	Temp.(°C)/Hum.(%RH):	26(°C)/60 %RH
Mode:	Mode 7		
Ant.Polar.:	Vertical		

No.	Frequency (MHz)	Reading (dBuV)	Correct Factor (dB/m)	Result (dBuV/m)	Limit (dBuV/m)	Margin (dB)	Remark
1	2379.960	58.00	-1.08	56.92	74.00	-17.08	peak
2	2379.960	47.15	-1.08	46.07	54.00	-7.93	AVG
3	2384.880	58.75	-1.07	57.68	74.00	-16.32	peak
4	2384.880	50.44	-1.07	49.37	54.00	-4.63	AVG
5	2388.360	60.25	-1.05	59.20	74.00	-14.80	peak
6	2388.360	49.45	-1.05	48.40	54.00	-5.60	AVG
7	2390.000	58.61	-1.05	57.56	74.00	-16.44	peak
8	2390.000	49.52	-1.05	48.47	54.00	-5.53	AVG

Note:1.Result (dBuV/m) = Correct Factor (dB/m) + Reading(dBuV).

2.Correction factor (dB/m) = Antenna Factor (dB/m) + Cable loss (dB) – Pre-Amplifier gain (dB).

3. When the peak results are less than average limit, so not need to evaluate the average.



Standard:	FCC Part 15.247	Test Distance:	3 m
Test item:	Band edge	Power:	AC 120 V/60 Hz
Frequency:	2437 MHz	Temp.(°C)/Hum.(%RH):	26(°C)/60 %RH
Mode:	Mode 7		
Ant.Polar.:	Horizontal		

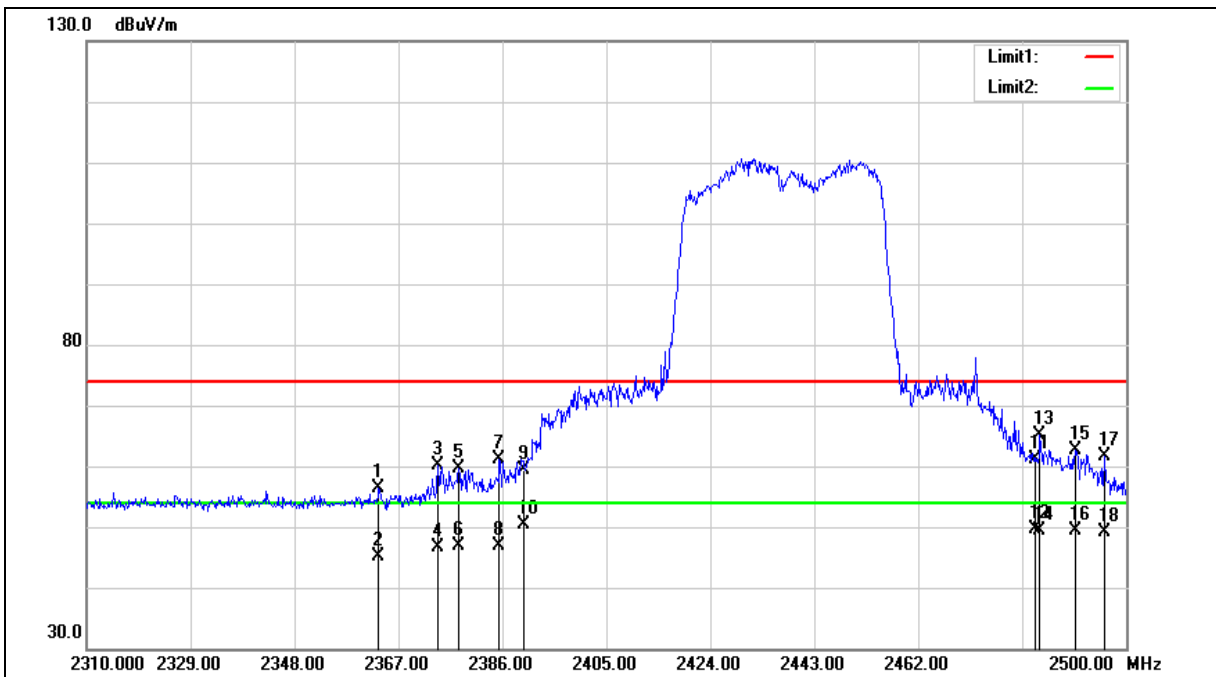



Standard:	FCC Part 15.247	Test Distance:	3 m
Test item:	Band edge	Power:	AC 120 V/60 Hz
Frequency:	2437 MHz	Temp.(°C)/Hum.(%RH):	26(°C)/60 %RH
Mode:	Mode 7		
Ant.Polar.:	Horizontal		

No.	Frequency (MHz)	Reading (dBuV)	Correct Factor (dB/m)	Result (dBuV/m)	Limit (dBuV/m)	Margin (dB)	Remark
1	2363.390	57.54	-1.14	56.40	74.00	-17.60	peak
2	2363.390	46.36	-1.14	45.22	54.00	-8.78	AVG
3	2374.220	61.29	-1.10	60.19	74.00	-13.81	peak
4	2374.220	47.62	-1.10	46.52	54.00	-7.48	AVG
5	2378.020	60.68	-1.10	59.58	74.00	-14.42	peak
6	2378.020	47.95	-1.10	46.85	54.00	-7.15	AVG
7	2385.430	62.11	-1.07	61.04	74.00	-12.96	peak
8	2385.430	48.01	-1.07	46.94	54.00	-7.06	AVG
9	2390.000	60.38	-1.05	59.33	74.00	-14.67	peak
10	2390.000	51.32	-1.05	50.27	54.00	-3.73	AVG
11	2483.500	61.71	-0.70	61.01	74.00	-12.99	peak
12	2483.500	50.36	-0.70	49.66	54.00	-4.34	AVG
13	2484.230	65.85	-0.70	65.15	74.00	-8.85	peak
14	2484.230	50.13	-0.70	49.43	54.00	-4.57	AVG
15	2490.690	63.24	-0.67	62.57	74.00	-11.43	peak
16	2490.690	49.99	-0.67	49.32	54.00	-4.68	AVG
17	2496.010	62.17	-0.65	61.52	74.00	-12.48	peak
18	2496.010	49.89	-0.65	49.24	54.00	-4.76	AVG

Note:1.Result (dBuV/m) = Correct Factor (dB/m) + Reading(dBuV).

2.Correction factor (dB/m) = Antenna Factor (dB/m) + Cable loss (dB) – Pre-Amplifier gain (dB).

3. When the peak results are less than average limit, so not need to evaluate the average.



Standard:	FCC Part 15.247	Test Distance:	3 m
Test item:	Band edge	Power:	AC 120 V/60 Hz
Frequency:	2437 MHz	Temp.(°C)/Hum.(%RH):	26(°C)/60 %RH
Mode:	Mode 7		
Ant.Polar.:	Vertical		

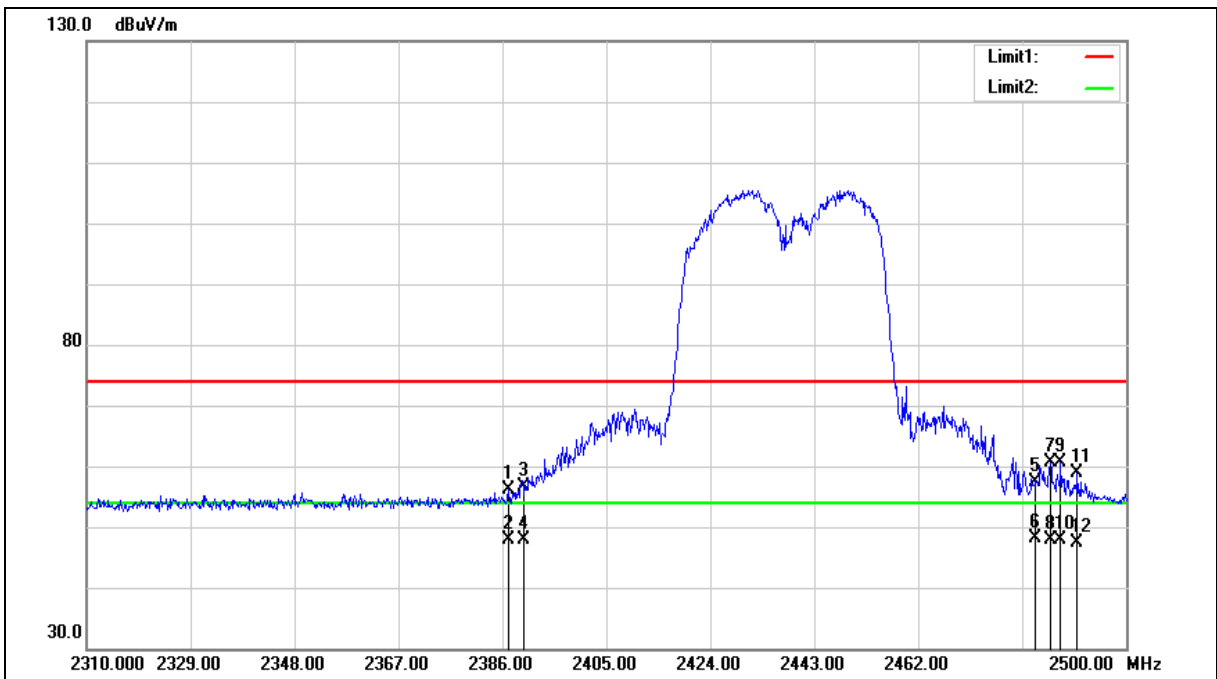



Standard:	FCC Part 15.247	Test Distance:	3 m
Test item:	Band edge	Power:	AC 120 V/60 Hz
Frequency:	2437 MHz	Temp.(°C)/Hum.(%RH):	26(°C)/60 %RH
Mode:	Mode 7		
Ant.Polar.:	Vertical		

No.	Frequency (MHz)	Reading (dBuV)	Correct Factor (dB/m)	Result (dBuV/m)	Limit (dBuV/m)	Margin (dB)	Remark
1	2387.140	57.12	-1.06	56.06	74.00	-17.94	peak
2	2387.140	48.92	-1.06	47.86	54.00	-6.14	AVG
3	2390.000	57.74	-1.05	56.69	74.00	-17.31	peak
4	2390.000	48.96	-1.05	47.91	54.00	-6.09	AVG
5	2483.500	58.05	-0.70	57.35	74.00	-16.65	peak
6	2483.500	48.95	-0.70	48.25	54.00	-5.75	AVG
7	2486.130	61.40	-0.70	60.70	74.00	-13.30	peak
8	2486.130	48.65	-0.70	47.95	54.00	-6.05	AVG
9	2488.030	61.33	-0.68	60.65	74.00	-13.35	peak
10	2488.030	48.46	-0.68	47.78	54.00	-6.22	AVG
11	2491.070	59.43	-0.67	58.76	74.00	-15.24	peak
12	2491.070	48.09	-0.67	47.42	54.00	-6.58	AVG

Note:1.Result (dBuV/m) = Correct Factor (dB/m) + Reading(dBuV).

2.Correction factor (dB/m) = Antenna Factor (dB/m) + Cable loss (dB) – Pre-Amplifier gain (dB).

3. When the peak results are less than average limit, so not need to evaluate the average.



Standard:	FCC Part 15.247	Test Distance:	3 m
Test item:	Band edge	Power:	AC 120 V/60 Hz
Frequency:	2452 MHz	Temp.(°C)/Hum.(%RH):	26(°C)/60 %RH
Mode:	Mode 7		
Ant.Polar.:	Horizontal		

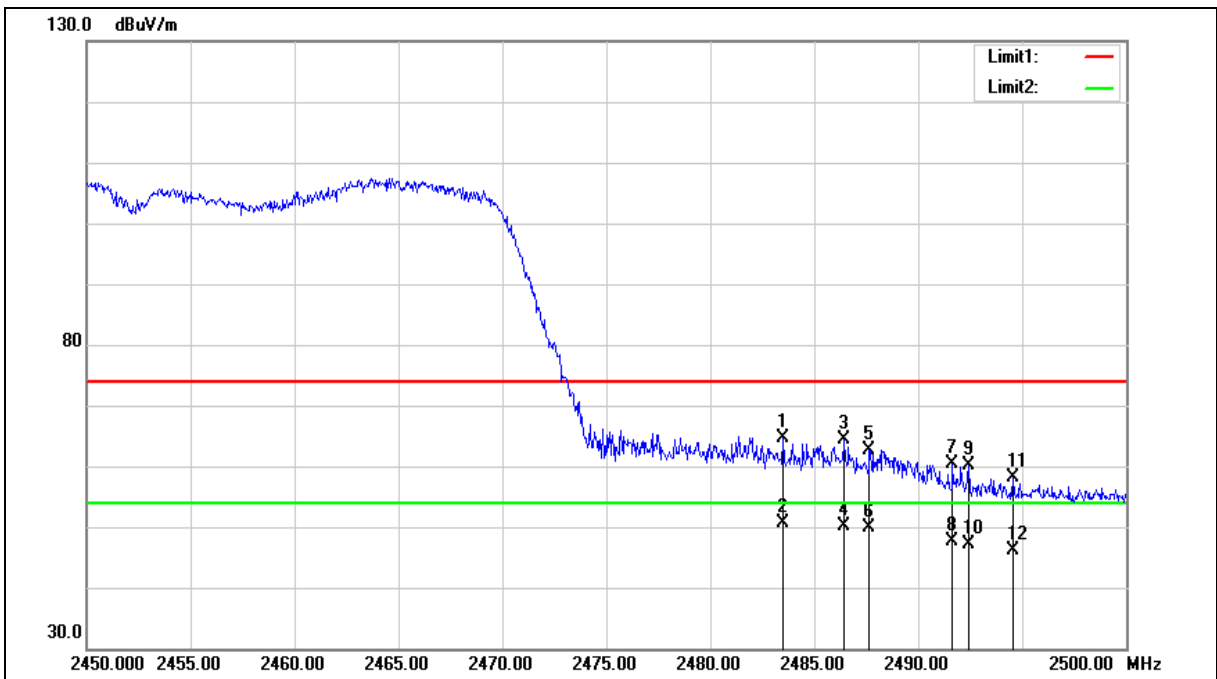



Standard:	FCC Part 15.247	Test Distance:	3 m
Test item:	Band edge	Power:	AC 120 V/60 Hz
Frequency:	2452 MHz	Temp.(°C)/Hum.(%RH):	26(°C)/60 %RH
Mode:	Mode 7		
Ant.Polar.:	Horizontal		

No.	Frequency (MHz)	Reading (dBuV)	Correct Factor (dB/m)	Result (dBuV/m)	Limit (dBuV/m)	Margin (dB)	Remark
1	2483.500	65.32	-0.70	64.62	74.00	-9.38	peak
2	2483.500	51.21	-0.70	50.51	54.00	-3.49	AVG
3	2486.450	65.03	-0.70	64.33	74.00	-9.67	peak
4	2486.450	50.81	-0.70	50.11	54.00	-3.89	AVG
5	2487.650	63.31	-0.68	62.63	74.00	-11.37	peak
6	2487.650	50.44	-0.68	49.76	54.00	-4.24	AVG
7	2491.650	61.09	-0.67	60.42	74.00	-13.58	peak
8	2491.650	48.20	-0.67	47.53	54.00	-6.47	AVG
9	2492.400	60.80	-0.67	60.13	74.00	-13.87	peak
10	2492.400	47.71	-0.67	47.04	54.00	-6.96	AVG
11	2494.550	58.75	-0.66	58.09	74.00	-15.91	peak
12	2494.550	46.75	-0.66	46.09	54.00	-7.91	AVG

Note:1.Result (dBuV/m) = Correct Factor (dB/m) + Reading(dBuV).

2.Correction factor (dB/m) = Antenna Factor (dB/m) + Cable loss (dB) – Pre-Amplifier gain (dB).

3. When the peak results are less than average limit, so not need to evaluate the average.



Standard:	FCC Part 15.247	Test Distance:	3 m
Test item:	Band edge	Power:	AC 120 V/60 Hz
Frequency:	2452 MHz	Temp.(°C)/Hum.(%RH):	26(°C)/60 %RH
Mode:	Mode 7		
Ant.Polar.:	Vertical		

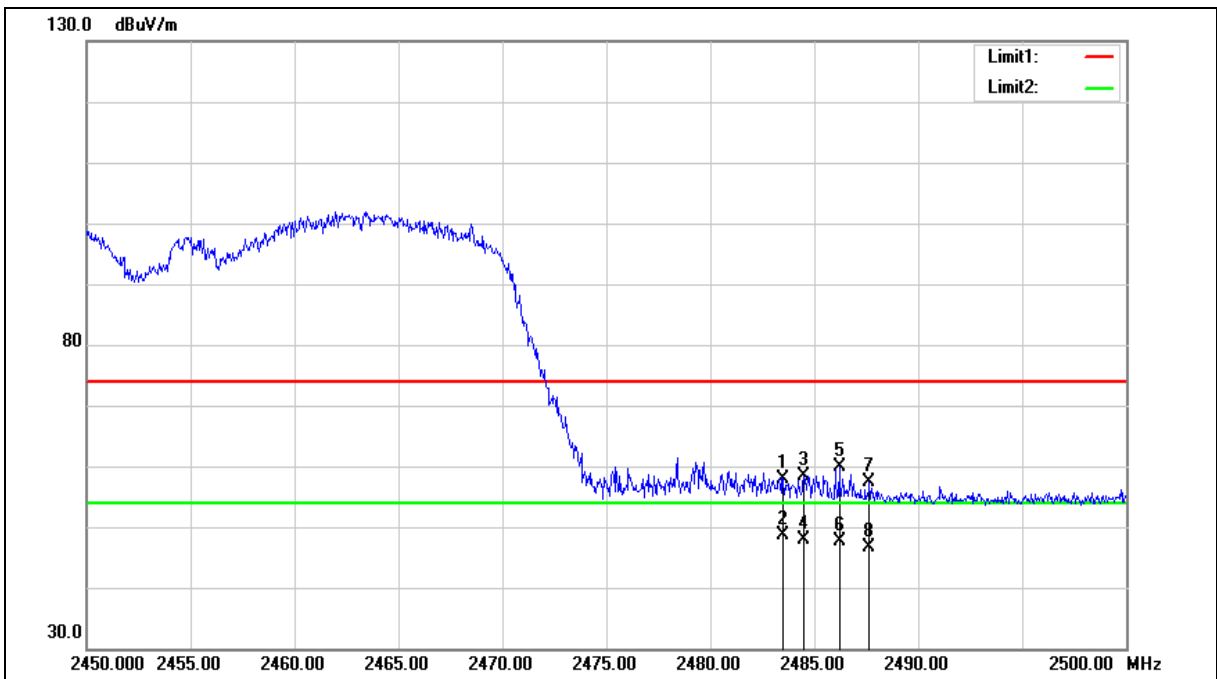



Standard:	FCC Part 15.247	Test Distance:	3 m
Test item:	Band edge	Power:	AC 120 V/60 Hz
Frequency:	2452 MHz	Temp.(°C)/Hum.(%RH):	26(°C)/60 %RH
Mode:	Mode 7		
Ant.Polar.:	Vertical		

No.	Frequency (MHz)	Reading (dBuV)	Correct Factor (dB/m)	Result (dBuV/m)	Limit (dBuV/m)	Margin (dB)	Remark
1	2483.500	58.52	-0.70	57.82	74.00	-16.18	peak
2	2483.500	49.27	-0.70	48.57	54.00	-5.43	AVG
3	2484.500	59.12	-0.70	58.42	74.00	-15.58	peak
4	2484.500	48.52	-0.70	47.82	54.00	-6.18	AVG
5	2486.200	60.70	-0.70	60.00	74.00	-14.00	peak
6	2486.200	48.30	-0.70	47.60	54.00	-6.40	AVG
7	2487.650	57.99	-0.68	57.31	74.00	-16.69	peak
8	2487.650	47.23	-0.68	46.55	54.00	-7.45	AVG

Note:1.Result (dBuV/m) = Correct Factor (dB/m) + Reading(dBuV).

2.Correction factor (dB/m) = Antenna Factor (dB/m) + Cable loss (dB) – Pre-Amplifier gain (dB).

3. When the peak results are less than average limit, so not need to evaluate the average.

--- END---