

MAX BR1 Mini Core

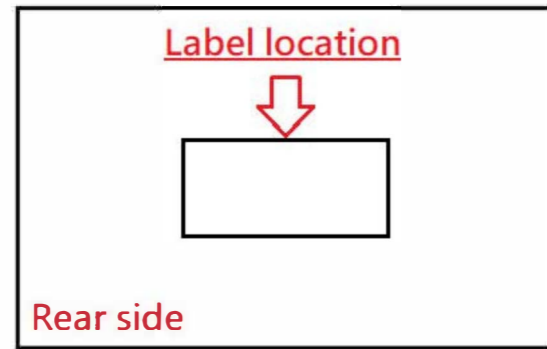

R1.00(4X)

64.00

39.00

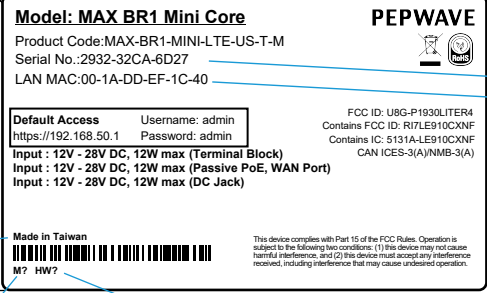

database: "Serial"

database: "LAN MAC"

(checking: ends at 0)

database: "Country of Origin"

database:"CM code:"

database:"Hardware Version"

database: "barcode"

(checking: serial without hyphen)

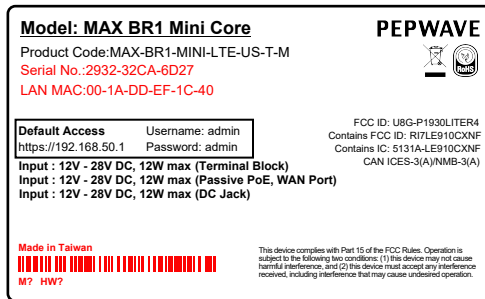
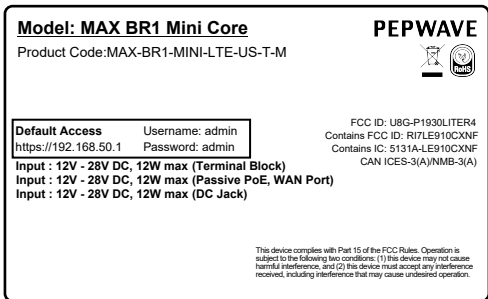

RED COLOR=ONLINE PRINTING

# PISMOLABS

## COPYRIGHT

THE COPYRIGHT & INTELLECTUAL PROPERTY OF THIS DRAWING IS VESTED IN: PISMOLABS LIMITED

## GENERAL NOTES

\* DENOTES A DIMENSION ON CENTRE LINE WITH A POSITIONAL TOLERANCE OF 50% OF THE DIMENSION TOLERANCE

ALL DIMENSIONS ARE IN MM

ALL DIMENSIONS SHOWN THUS (XX.XX) ARE REFERENCE DIMENSIONS ONLY

DO NOT SCALE FROM THIS DRAWING IF IN DOUBT-ASK

THIRD ANGLE PROJECTION



## GENERAL TOLERANCES

UNLESS OTHERWISE STATED

LINEAR : 0.2

ANGULAR : 0.5°

## MATERIAL

## FINISH

SCALE 1:1

DWN DATE

ISS	DATE	DWN	CHANGE MADE / REF

TITLE	
MAX-BR1-MINI-LTE-US-T-M	Rev3
PRODUCT LABEL	

DRAWING No.
02-140007-00
SHEET OF PRO ENGINEER

- NOTE:
- MATERIAL:消銀龍, t=0.05mm, T=0.025, 壓克力背膠
  - COLOR:
    - 底色為材質原色
    - 未標示部份印刷黑色
  - TEMPERATURE RESISTANT = 80 DEGREE CELSIUS
  - ADHESIVE THICKNESS=0.024+/-0.003mm
  - 背貼物: ABS膠塑 / 板金 (表面有噴漆處理)
  - 卷狀出貨
  - 出貨的12碼長度的SN,用30\*10mm的空白貼紙,其設置以狹窄條寬用"2";調整間距的default為0.
  - 文字需距離標籤邊緣1.5mm~2mm

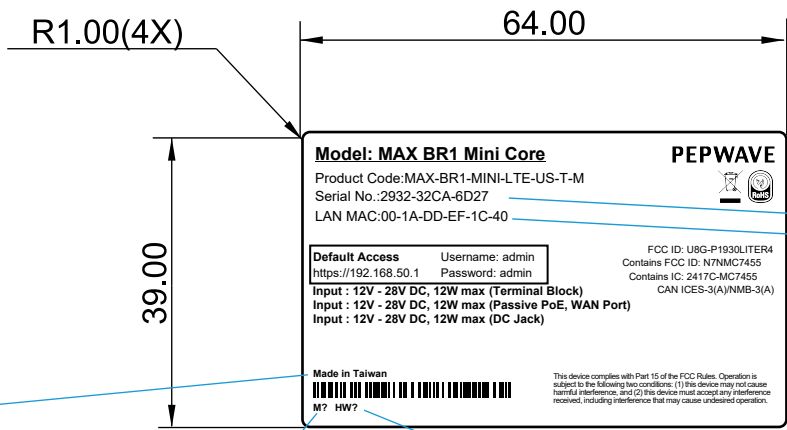

database: "Country of Origin"

database: "CM code:"

database: "Hardware Version"

database: "barcode"  
(checking: serial without hyphen)

database: "Serial"  
database: "LAN MAC"  
(checking: ends at 0)

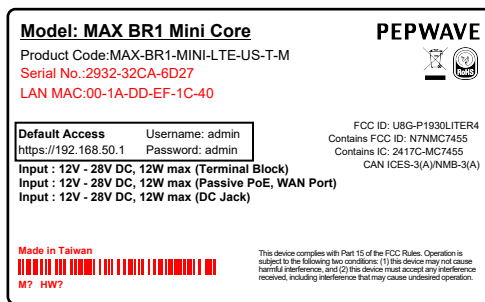
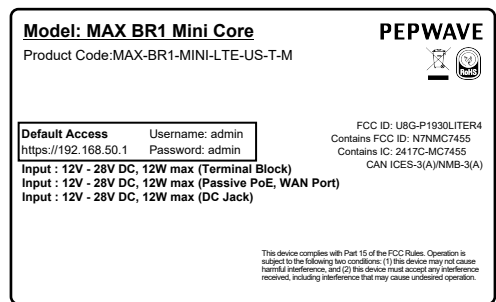

RED COLOR=ONLINE PRINTING

NOTE:

- 1) MATERIAL:消銀龍, t=0.05mm, T=0.025, 壓克力背膠
- 2) COLOR:
  - a. 底色為材質原色
  - b. 未標示部份印刷黑色
- 3) TEMPERATURE RESISTANT = 80 DEGREE CELSIUS
- 4) ADHESIVE THICKNESS=0.024+/-0.003mm
- 5) 背貼物: ABS膠塑 / 板金 (表面有噴漆處理)
- 6) 卷狀出貨
- 7) 出貨的12碼長度的SN,用30\*10mm的空白貼紙, 其設置以狹窄條寬用"2"; 調整間距的default為0.
- 8) 文字需距離標籤邊緣 1.5mm~2mm

# PISMOLABS

**COPYRIGHT**  
THE COPYRIGHT & INTELLECTUAL PROPERTY OF THIS DRAWING IS VESTED IN: PISMOLABS LIMITED

**GENERAL NOTES**  
\* DENOTES A DIMENSION ON CENTRE LINE WITH A POSITIONAL TOLERANCE OF 50% OF THE DIMENSION TOLERANCE  
ALL DIMENSIONS ARE IN MM  
ALL DIMENSIONS SHOWN THIS (XX.XX) ARE REFERENCE DIMENSIONS ONLY  
DO NOT SCALE FROM THIS DRAWING IF IN DOUBT-ASK

**GENERAL TOLERANCES**  
UNLESS OTHERWISE STATED  
LINEAR : 0.2  
ANGULAR : 0.5~

**MATERIAL**

**FINISH**

**SCALE**  
1:1

DWN				DATE			
ISS	DATE	DWN	CHANGE MADE / REF				

**TITLE**  
MAX-BR1-MINI-LTE-US-T-M  
PRODUCT LABEL

Rev3

**DRAWING No.**  
**02-140007-00**  
SHEET OF PRO ENGINEER

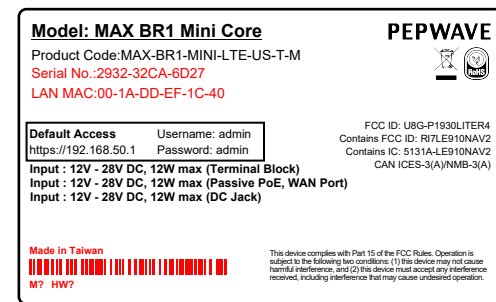
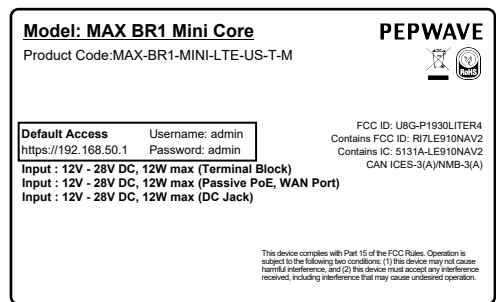
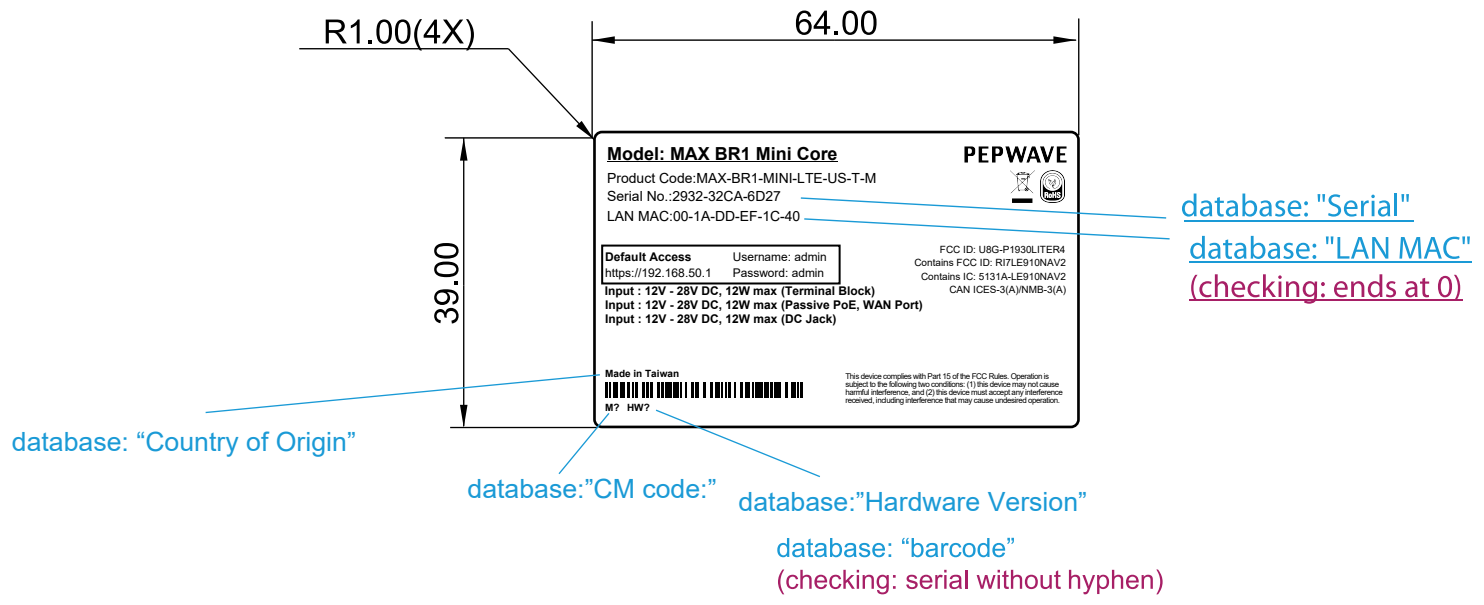

# PISMOLABS

**COPYRIGHT**  
THE COPYRIGHT & INTELLECTUAL PROPERTY OF THIS DRAWING IS VESTED IN: PISMOLABS LIMITED

**GENERAL NOTES**

- \* DENOTES A DIMENSION ON CENTRE LINE WITH A POSITIONAL TOLERANCE OF 50% OF THE DIMENSION TOLERANCE
- ALL DIMENSIONS ARE IN MM
- ALL DIMENSIONS SHOWN THUS (XX.XX) ARE REFERENCE DIMENSIONS ONLY
- DO NOT SCALE FROM THIS DRAWING IF IN DOUBT-ASK

THIRD ANGLE PROJECTION

**GENERAL TOLERANCES**

UNLESS OTHERWISE STATED

LINEAR : 0.2  
ANGULAR : 0.5°

**MATERIAL**

**FINISH**

**SCALE** 1:1

DWN  DATE

ISS	DATE	DWN	CHANGE MADE / REF

**TITLE**

MAX-BR1-MINI-LTE-US-T-M Rev3  
PRODUCT LABEL

DRAWING No.  
**02-140007-00**  
SHEET OF PRO ENGINEER

**NOTE:**

- 1) MATERIAL: 消銀龍, t=0.05mm, T=0.025, 壓克力背膠
- 2) COLOR:
  - a. 底色為材質原色
  - b. 未標示部份印刷黑色
- 3) TEMPERATURE RESISTANT = 80 DEGREE CELSIUS
- 4) ADHESIVE THICKNESS=0.024+/-0.003mm
- 5) 背貼物: ABS膠塑 / 板金 (表面有噴漆處理)
- 6) 卷狀出貨
- 7) 出貨的12碼長度的SN,用30\*10mm的空白貼紙, 其設置以狹窄條寬用"2"; 調整間距的default為0.
- 8) 文字需距離標籤邊緣1.5mm~2mm