

EMC Test Report

Applicant : Pismo Labs Technology Limited
Product Type : Pepwave / Peplink / Pismo Labs Wireless Product
Trade Name : peplink, PEPWAVE, Pismo
Model Number : SpeedFusion Engine
SFE-CAM-AB-LTEA-W
SFE-CAM-VM-LTEA-W
SFE-CAM
Pismo827
Pismo 827
Applicable Standard : FCC 47 CFR PART 15 SUBPART B
ANSI C63.4: 2014
Receive Date : Sep. 11, 2018
Test Period : Oct. 30 ~ Nov. 07, 2018
Issue Date : Dec. 05, 2018

Issue by

A Test Lab Techno Corp.
No. 140-1, Changan Street, Bade District,
Taoyuan City 33465, Taiwan (R.O.C)
Tel : +886-3-2710188 / Fax : +886-3-2710190



Taiwan Accreditation Foundation accreditation number: 1330

Test Firm MRA designation number: TW1062

Note: This report shall not be reproduced except in full, without the written approval of A Test Lab Techno Corp. This document may be altered or revised by A Test Lab Techno Corp. personnel only, and shall be noted in the revision section of the document. The client should not use it to claim product endorsement by TAF, or any government agencies. The test results in the report only apply to the tested sample.



Revision History

Rev.	Issue Date	Revisions	Revised By
00	Nov. 28, 2018	Initial Issue	Serene Yang
01	Dec. 05, 2018	Revised Report Information	Serene Yang

Verification of Compliance

Issued Date: Dec. 05, 2018

Applicant : Pismo Labs Technology Limited

Product Type : Pepwave / Peplink / Pismo Labs Wireless Product

Trade Name : peplink, PEPWAVE, Pismo

Model Number : SpeedFusion Engine
SFE-CAM-AB-LTEA-W
SFE-CAM-VM-LTEA-W
SFE-CAM
Pismo827
Pismo 827

EUT Rated Voltage : DC 12 V, 2 A

Test Voltage : 120 Vac / 60 Hz, 240 Vac / 60 Hz

Applicable Standard : FCC 47 CFR PART 15 SUBPART B
ANSI C63.4: 2014

Test Result : Complied

Performing Lab. : A Test Lab Techno Corp.
No. 140-1, Changan Street, Bade District,
Taoyuan City 33465, Taiwan (R.O.C)
Tel : +886-3-2710188 / Fax : +886-3-2710190
Taiwan Accreditation Foundation accreditation number: 1330
<http://www.atl-lab.com.tw/e-index.htm>



The above equipment has been tested by A Test Lab Techno Corp., and found compliance with the requirements set forth in the technical standards mentioned above. The results of testing in this report apply only to the product/system, which was tested. Other similar equipment will not necessarily produce the same results due to production tolerance and measurement uncertainties.

Approved By : Misty Wu Reviewed By : Terry Liao
(Manager) (Misty Wu) (Testing Engineer) (Terry Liao)



TABLE OF CONTENTS

1	General Information	5
1.1.	Summary of Test Result	5
1.2.	Testing Location	5
1.3.	Measurement Uncertainty	6
1.4.	Test Site Environment	6
2	EUT Description.....	7
3	Test Methodology.....	8
3.1.	Decision of Test Mode	8
3.2.	EUT Test Step	8
3.3.	Configuration of Test System Details	9
3.4.	Test Instruments.....	10
4	Measurement Procedure.....	12
4.1.	Conducted Emission	12
4.2.	Radiated Emission	14
5	Test Results	17
5.1.	Conducted Emission	17
5.2.	Radiated Emission	23

1 General Information

1.1. Summary of Test Result

Emission			
Standard	Item	Verdict	Remark
FCC 47 CFR PART 15 SUBPART B ANSI C63.4	Conducted Emission	PASS	Meet Class A limit
FCC 47 CFR PART 15 SUBPART B ANSI C63.4	Radiated Emission	PASS	Meet Class A limit

The test results of this report was related only to the tested sample(s) identified in this report.

1.2. Testing Location

Site Name: A Test Lab Techno Corp.

<http://www.atl-lab.com.tw/e-index.htm>

Site Address: No. 140-1, Changan Street, Bade District, Taoyuan City 33465, Taiwan (R.O.C)

Tel : +886-3-2710188

Fax : +886-3-2710190

1.3. Measurement Uncertainty

Test Item		Frequency Range	Uncertainty (dB)
Conducted Emission	AC Power Port	9 kHz ~ 150 kHz	2.7
		150 kHz ~ 30 MHz	2.7

Test Item	Test Site	Frequency Range	Uncertainty (dB)	
Radiated Emission	TE06	30 MHz ~ 1000 MHz	Horizontal	5.6
			Vertical	6.0
	TE01	1000 MHz ~ 6000 MHz		5.2
		6000 MHz ~ 18000 MHz		5.5
		18000 MHz ~ 26500 MHz		4.8
		26500 MHz ~ 40000 MHz		4.8
	TE09	1000 MHz ~ 6000 MHz		4.9
		6000 MHz ~ 18000 MHz		5.3
		18000 MHz ~ 26500 MHz		4.5
		26500 MHz ~ 40000 MHz		4.8

Note: The Vertical and Horizontal measurement uncertainty of 1 GHz to 40 GHz is evaluated and choose which polarity is worst value.

1.4. Test Site Environment

Test Item	Items	Required (IEC 60068-1)	Actual
Conducted Emission	Temperature (°C)	15-35	26
	Humidity (%RH)	25-75	60
	Barometric pressure (mbar)	860-1060	990
Radiated Emission	Temperature (°C)	15-35	26
	Humidity (%RH)	25-75	60
	Barometric pressure (mbar)	860-1060	990

2 EUT Description

Applicant	Pismo Labs Technology Limited A5, 5/F, HK Spinners Industrial Building, Phase 6, 481 Castle Peak Road, Cheung Sha Wan, Kowloon, Hong Kong			
Manufacturer	Pismo Labs Technology Limited Unit A5, 5/F, HK Spinners Industrial Building, Phase 6, 481 Castle Peak Road, Cheung Sha Wan, Kowloon, Hong Kong			
Product Type	Pepwave / Peplink / Pismo Labs Wireless Product			
Trade Name	peplink, PEPWAVE, Pismo			
Model Number	SpeedFusion Engine SFE-CAM-AB-LTEA-W SFE-CAM-VM-LTEA-W SFE-CAM Pismo827 Pismo 827			
Product Type / Trade Name / Models Different Description	Those model numbers differ from each other in selling region.			
I/O Ports	Refer to User Manual			
Highest Operating Frequency	5850 MHz			
Component List				
Power adapter	Trade Name	DVE	Model Number	DSA-24PFM-12 FUS
	I/P: 100-240 VAC, 50/60 Hz, 0.8 A			
	O/P: 12 VDC, 2 A			
Cable out: Shielded, 1.5 m with one core				

3 Test Methodology

3.1. Decision of Test Mode

3.1.1. The following test mode(s) were scanned during the preliminary test:

Pre-Test Mode	
Mode 1: LTE Band1 / Wi-Fi / GPS link mode (AC 120 V, 60 Hz)	
Mode 2: LTE Band1 / Wi-Fi / GPS link mode (AC 240 V, 60 Hz)	
Mode 3: WCDMA Band1 / Wi-Fi / GPS link mode (AC 240 V, 60 Hz)	

3.1.2. After the preliminary scan, the following test mode was final mode and found to produce the highest emission level.

Final Test Mode			
Emission	Conducted Emission		Mode 1 / Mode 2
	Radiated Emission	Below 1 GHz	Mode 1 / Mode 2
		Above 1 GHz	Mode 1 / Mode 2

The above highest emission mode of the configuration of the EUT and cable was chosen for all final test items.

3.2. EUT Test Step

1	Setup the EUT and simulators as shown on 3.3.
2	Turn on the power of all equipment.
3	The EUT Link to MT8820C for 4G.
4	The EUT Link to CMU200 for 3G.
5	The EUT Link to SMU200A for GPS.
6	The Notebook link to EUT by LAN.
7	The Notebook link to EUT by Wi-Fi.
8	Start to test till get the worst reading.

Measurement Software			
No.	Description	Software	Version
1	Conducted Emission	EZ EMC	1.1.4.3
2	Radiated Emission _ Below 1 GHz	EZ EMC	1.1.4.2
3	Radiated Emission _ Above 1 GHz	EZ EMC	1.1.4.4

3.3. Configuration of Test System Details

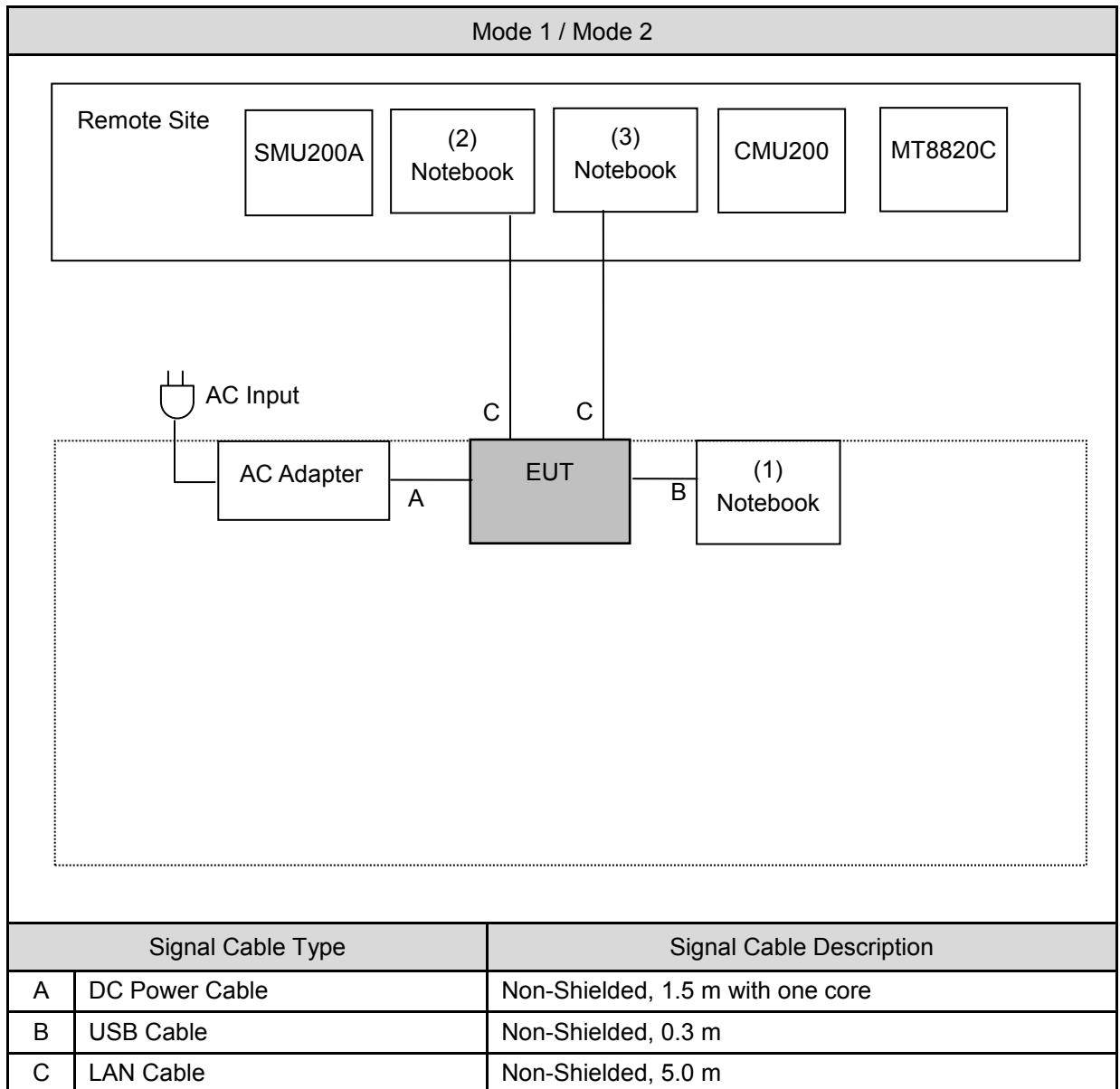

Devices Description					
Product	Manufacturer	Model Number	Serial Number	Power Cord	
(1)	Notebook	DELL	LATITUDE E5440	25627158361	Non-Shielded, 0.8 m
(2)	Notebook	DELL	LATITUDE E5440	6699565657	Non-Shielded, 0.8 m
(3)	Notebook	DELL	LATITUDE 7370	10811202626	Non-Shielded, 0.8 m



3.4. Test Instruments

Test Period : Oct. 30, 2018

Conducted Emission test site					
Equipment	Manufacturer	Model Number	Serial Number	Cal. Date	Cal. Period
Test Receiver	R&S	ESCI	100367	05/21/2018	1 year
LISN	R&S	ENV216	101040	04/11/2018	1 year
LISN	R&S	ENV216	101041	03/23/2018	1 year
Wireless COM.TEST.SET	R&S	CMU200	109369	12/01/2016	2 years
Radio Communication Analyzer	Anritsu	MT8820C	6201342039	12/10/2017	1 year
Signal Generator	R&S	SMU200A	102598	04/26/2018	1 year
Test Site	ATL	TE02	TE02	N.C.R.	-----

Test Period : Oct. 30, 2018

Radiated Emission - 10 Meter Chamber					
Equipment	Manufacturer	Model Number	Serial Number	Cal. Date	Cal. Period
Amplifier	EMCI	EMC9135	980298	10/24/2018	1 year
Amplifier	EMCI	EMC9135	980299	03/05/2018	1 year
Test Receiver	R&S	ESCI	100722	10/24/2018	1 year
Test Receiver	R&S	ESCI	101000	12/18/2017	1 year
Broadband Antenna	SCHWARZBECK MESS-ELEKTRONIK	VULB 9168	670	10/23/2018	1 year
Broadband Antenna	SCHWARZBECK MESS-ELEKTRONIK	VULB 9168	671	02/28/2018	1 year
Wireless COM.TEST.SET	R&S	CMU200	109369	12/01/2016	2 years
Radio Communication Analyzer	Anritsu	MT8820C	6201342039	12/10/2017	1 year
Signal Generator	R&S	SMU200A	102598	04/26/2018	1 year
Test Site	ATL	TE06	TE06	10/21/2018	1 year

Note: N.C.R. = No Calibration Request.



Test Period : Nov. 07, 2018

Radiated Emission - 3 Meter Chamber					
Equipment	Manufacturer	Model Number	Serial Number	Cal. Date	Cal. Period
EXA Spectrum Analyzer	Agilent	N9010A	MY48030518	11/04/2017	1 year
Amplifier	Agilent	8449B	3008A02456	03/13/2018	1 year
Double Ridged Horn Antenna (1~18 GHz)	ETS	3117	00152321	09/27/2018	1 year
Preamplifier	EMCI	EMC2654045	980028	08/23/2018	1 year
Horn Antenna (18~40 GHz)	ETS	3116	00086467	09/18/2018	1 year
Wireless COM.TEST.SET	R&S	CMU200	109369	12/01/2016	2 years
Radio Communication Analyzer	Anritsu	MT8820C	6201342039	12/10/2017	1 year
Signal Generator	R&S	SMU200A	102598	04/26/2018	1 year
Test Site	ATL	TE09	TE09	04/21/2018	1 year

Note: N.C.R. = No Calibration Request.

4 Measurement Procedure

4.1. Conducted Emission

■ Test Setup

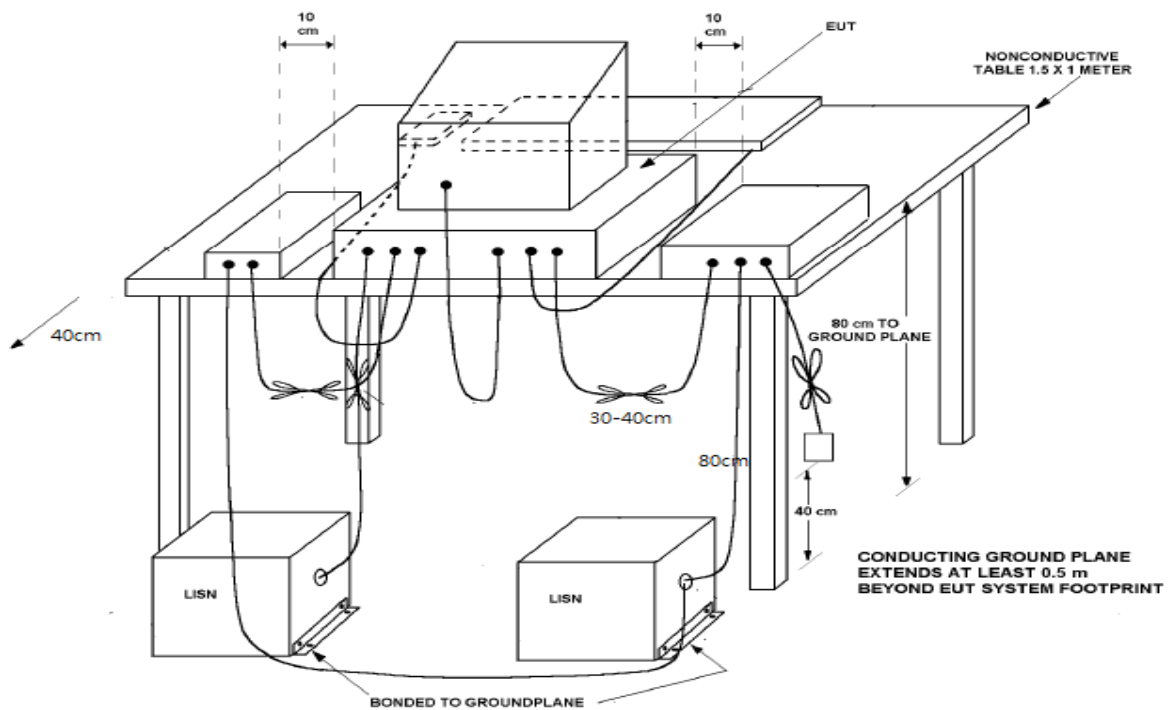
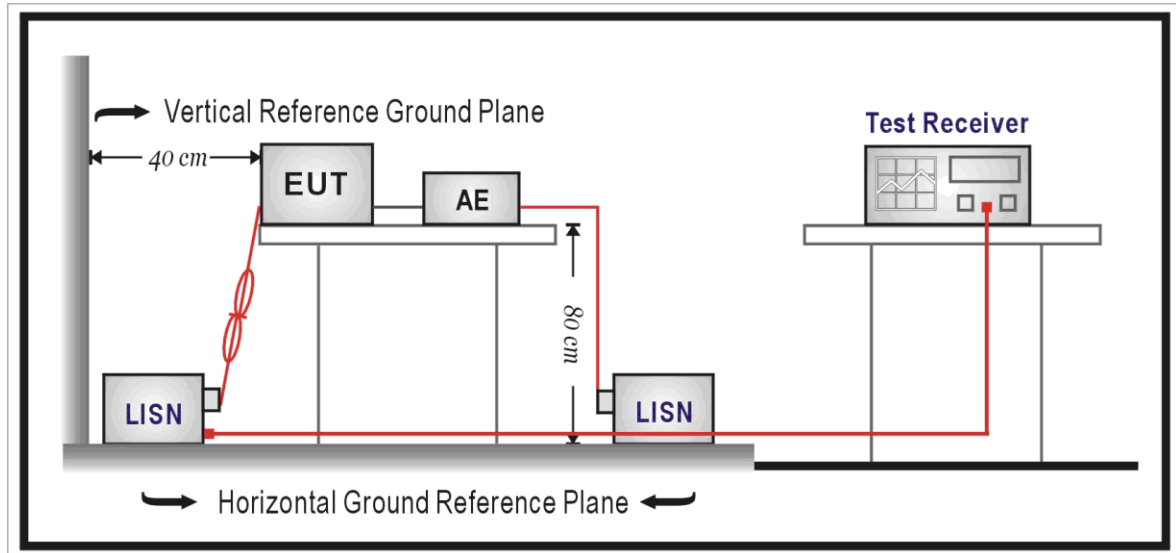

■ Test Procedure

The EUT and simulators are connected to the main power through a line impedance stabilization network (L.I.S.N.). This provides a 50 Ω // 50 μ H coupling impedance for the measuring equipment. The peripheral devices are also connected to the main power through a LISN that provides a 50 Ω // 50 μ H coupling impedance with 50ohm termination.

Tabletop device shall be placed on a non-conducting platform, of nominal size 1 m by 1.5 m, raised 80 cm above the reference ground plane. The wall of screened room shall be located 40cm to the rear of the EUT. Other surfaces of tabletop or floor standing EUT shall be at least 80cm from any other ground conducting surface including one or more LISNs. For floor-standing device shall be placed under the EUT with a 12 mm insulating material.

Conducted emissions were investigated over the frequency range from 0.15 MHz to 30 MHz using a resolution bandwidth of 9 kHz. The equipment under test (EUT) shall be meet the limits in section 4.1.1, as applicable, including the average limit and the quasi-peak limit when using respectively, an average detector and quasi-peak detector measured in accordance with the methods described of related standard. When all of peak value were complied with quasi-peak and average limit from 150 kHz to 30 MHz then quasi-peak and average measurement was unnecessary.

The AMN shall be placed 0,8 m from the boundary of the unit under test and bonded to a ground reference plane for AMNs mounted on top of the ground reference plane. This distance is between the closest points of the AMN and the EUT. All other units of the EUT and associated equipment shall be at least 0,8 m from the AMN. If the mains power cable is longer than 1m then the cable shall be folded back and forth at the centre of the lead to form a bundle no longer than 0.4 m. All of interconnecting cables that hang closer than 40 cm to the ground plane shall be folded back and forth in the center forming a bundle 30 cm to 40 cm long. All of EUT and AE shall be separate place more than 0.1 m. All 50 Ω ports of the LISN shall be resistively terminated into 50 Ω loads when not connected to the measuring instrument.

If the reading of the measuring receiver shows fluctuations close to the limit, the reading shall be observed for at least 15 s at each measurement frequency; the higher reading shall be recorded with the exception of any brief isolated high reading which shall be ignored.

4.2. Radiated Emission

■ Test Setup

Below 1 GHz

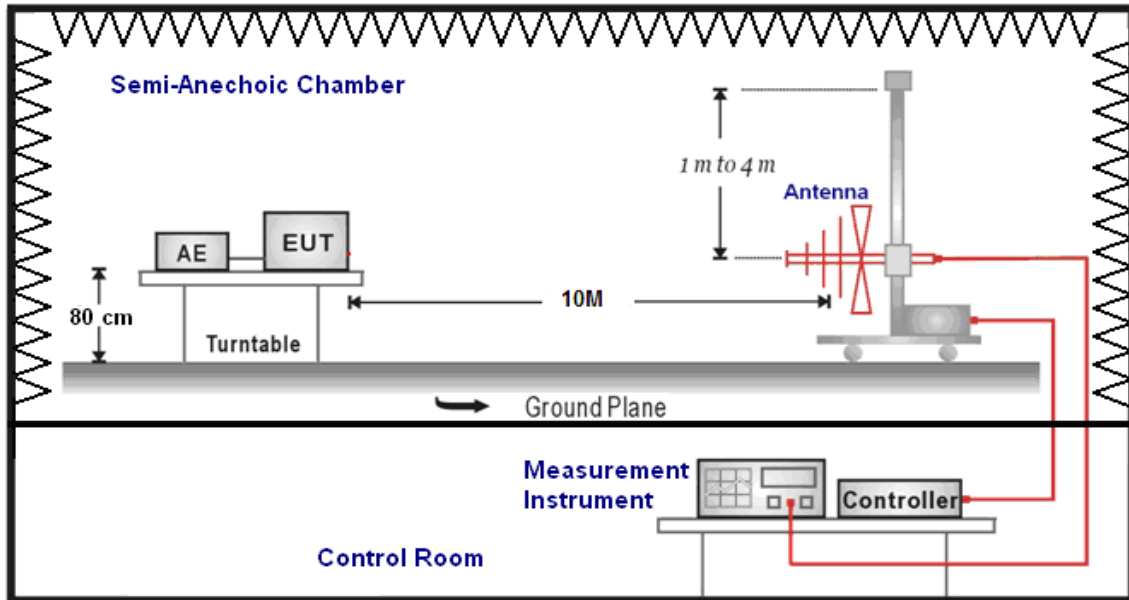

Above 1 GHz

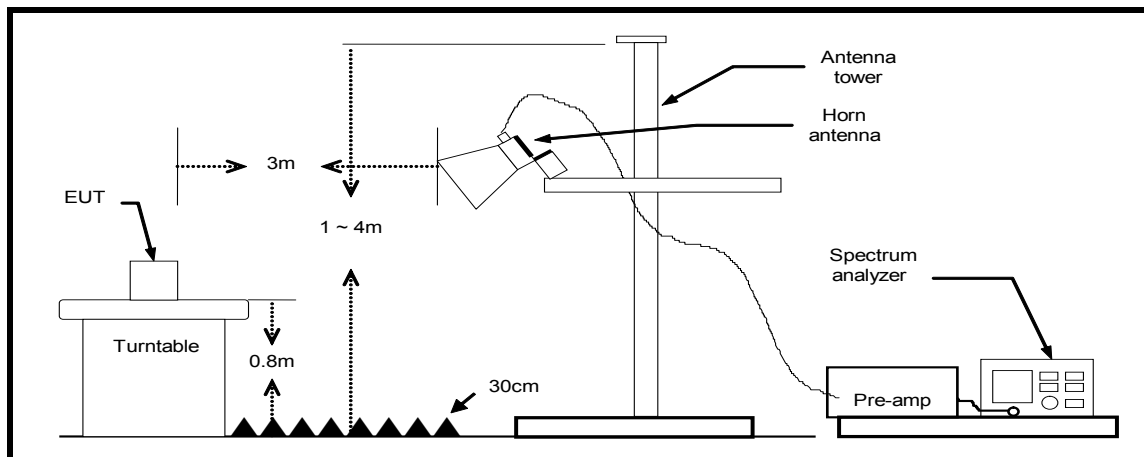

Test arrangement for radiated emissions of tabletop equipment.

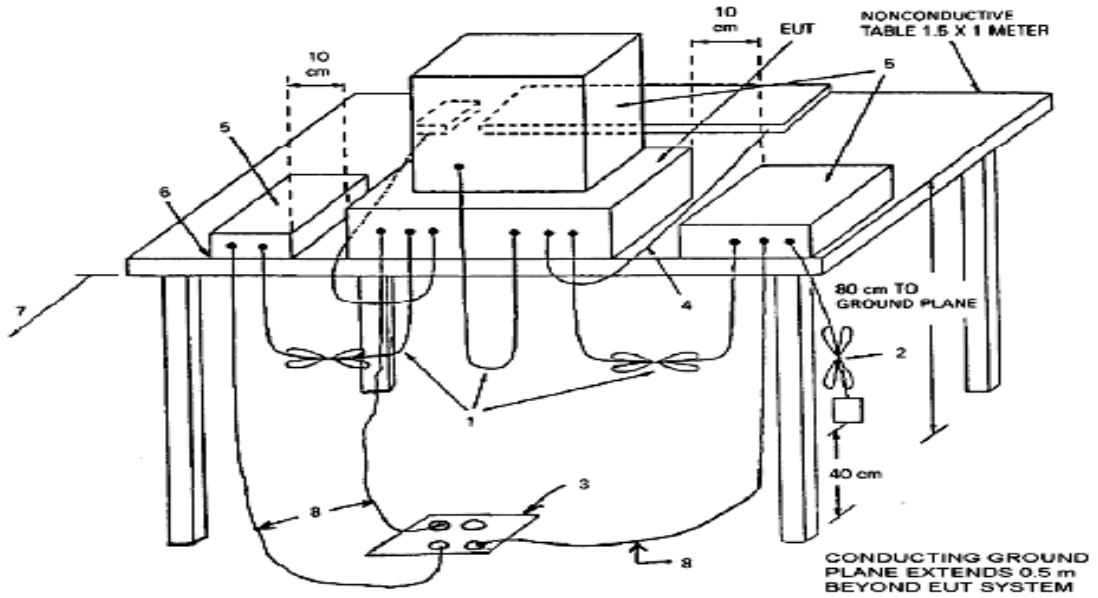

■ Test Procedure

Below 1 GHz

The EUT and its simulators are placed on a turn table which is 0.8 meter above ground. When the EUT is floor-standing equipment, it is placed on the ground plane which has a 12 mm non-conductive covering to insulate the EUT from the ground plane.

The turn table is 0.8 m height and 2.0 m wide x 1.0 m deep size. It can rotate 360 degrees to determine the position of the maximum emission level. The spacing between the each equipment was 10 cm. The mains cables are dropped to floor and are round to receptacle. Interconnecting cables of table top equipment that hang closer than 0.4 m to the ground plane are folded back and forth forming a bundle 0.3 m to 0.4 m long, hanging approximately in the middle between ground plane and table. The EUT was positioned such that the distance from antenna to the EUT was 10 meters and the receive antenna was moved from 1 m to 4 m to investigate maximum highest emission at least 6 points over the frequency range from 30 MHz to 1 GHz using a resolution bandwidth of 120 kHz and measured by the quasi-peak detector.

According to this standard paragraph 15.109, as an alternative to the radiated emission limits, digital devices may be shown to comply with the standards contained in Third Edition of the International Special Committee on Radio Interference (CISPR), Pub. 22, "Information Technology Equipment - Radio Disturbance Characteristics - Limits and Methods of Measurement".

Above 1 GHz

The Setup is same as Below 1 GHz placement. The turn table is 0.8 m height and 1.8 m wide x 1.0 m deep size. The turn table can rotate 360 degrees to determine the position of the maximum emission level. The EUT was positioned such that the distance from antenna to the EUT was 3 meter for above 1 GHz, the highest frequency performed according to internal source frequency of the EUT, the specification was below:

Highest frequency generated or used in the device or on which the device operates or tunes (MHz)	Upper frequency of measurement range (MHz)
Below 1.705	30
1.705 - 108	1000
108 - 500	2000
500 - 1000	5000
Above 1000	5th harmonic of the highest frequency or 40 GHz, whichever is lower

Absorber shall be spread between floor of a turn table and a receive antenna shown in 4.2.3. The antenna used boresight antenna master from 1 meter and 4 meters to find out the maximum emission level and find the highest emission at least 6 points. Both horizontal and vertical polarization of the antenna are set on measurement. In order to find the maximum emission, all of the interface cables must be manipulated on radiated measurement.

Radiated emissions were applied to above 1 GHz using a resolution bandwidth of 1 MHz and measured by the peak and average detector which antenna to the EUT distance was 3 meters. If the EUT was meet both limits and measurement with the average detector receiver is unnecessary.

5 Test Results

5.1. Conducted Emission

■ Limit

Frequency (MHz)	Class A (dBuV)		Class B (dBuV)	
	Quasi-peak	Average	Quasi-peak	Average
0.15 - 0.5	79	66	66 - 56	56 - 46
0.50 - 5.0	73	60	56	46
5.0 - 30.0	73	60	60	50

Note: (1) The lower limit shall apply at the transition frequencies.

(2) The limit decreases in line with the logarithm of the frequency in the range 0.15 to 0.50 MHz.

■ Test Result

Test Standard:	FCC Part 15B	Power Line:	L1
Test Mode:	Mode 1	Test Power:	AC 120 V / 60 Hz
Description:			

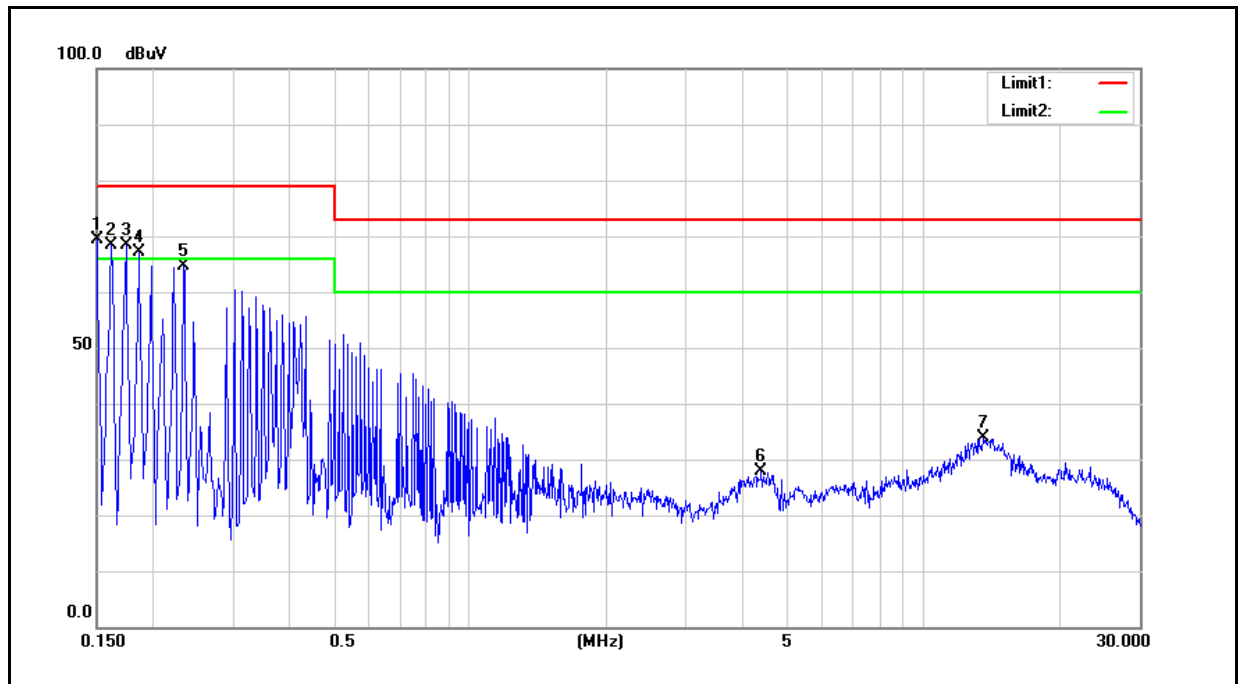

No.	Frequency (MHz)	QP reading (dBuV)	AVG reading (dBuV)	Correction factor (dB)	QP result (dBuV)	AVG result (dBuV)	QP limit (dBuV)	AVG limit (dBuV)	QP margin (dB)	AVG margin (dB)	Remark
1	0.1500	51.50	24.39	9.59	61.09	33.98	79.00	66.00	-17.91	-32.02	Pass
2	0.1620	52.08	24.13	9.60	61.68	33.73	79.00	66.00	-17.32	-32.27	Pass
3	0.1740	51.19	22.97	9.60	60.79	32.57	79.00	66.00	-18.21	-33.43	Pass
4	0.1860	50.19	21.88	9.60	59.79	31.48	79.00	66.00	-19.21	-34.52	Pass
5	0.2340	46.40	19.68	9.60	56.00	29.28	79.00	66.00	-23.00	-36.72	Pass
6	4.3980	13.83	7.68	9.74	23.57	17.42	73.00	60.00	-49.43	-42.58	Pass
7	13.5580	18.51	8.87	9.90	28.41	18.77	73.00	60.00	-44.59	-41.23	Pass

Note: 1. Result (dBuV) = Correction factor (dB) + Reading(dBuV).
 2. Correction factor (dB) = Cable loss (dB) + L.I.S.N. factor (dB).



Test Standard:	FCC Part 15B	Power Line:	N
Test Mode:	Mode 1	Test Power:	AC 120 V / 60 Hz
Description:			

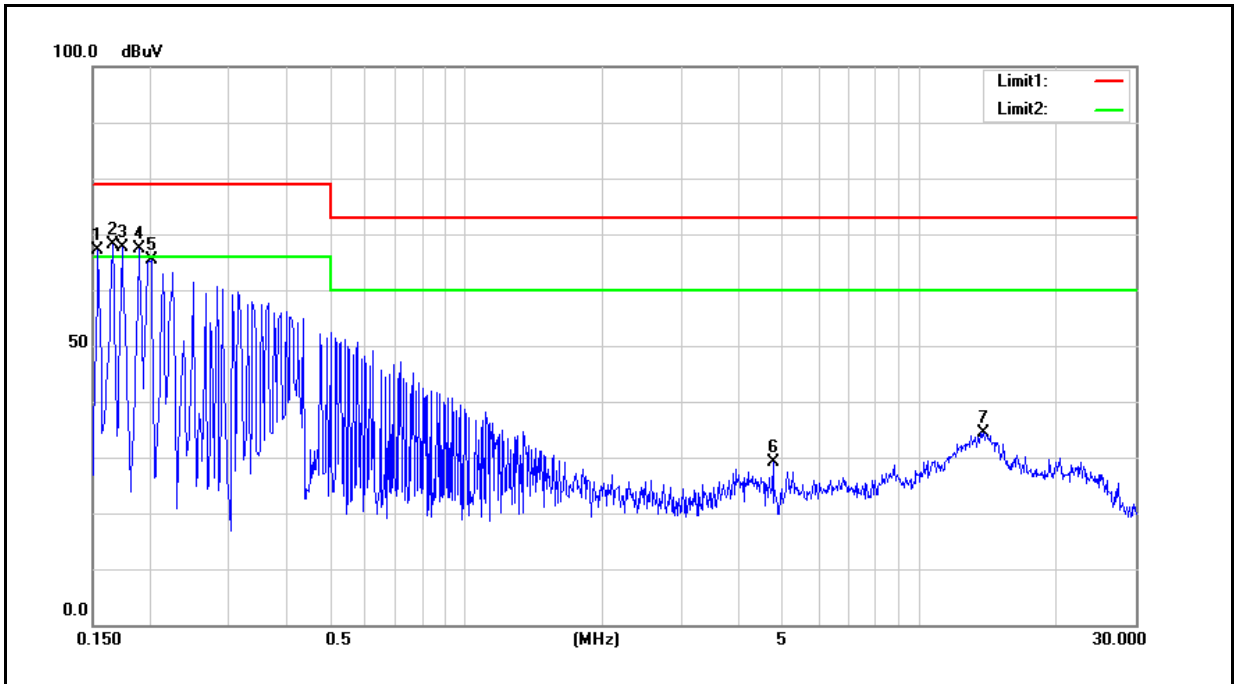

No.	Frequency (MHz)	QP reading (dBuV)	AVG reading (dBuV)	Correction factor (dB)	QP result (dBuV)	AVG result (dBuV)	QP limit (dBuV)	AVG limit (dBuV)	QP margin (dB)	AVG margin (dB)	Remark
1	0.1540	52.59	25.67	9.60	62.19	35.27	79.00	66.00	-16.81	-30.73	Pass
2	0.1660	51.94	23.75	9.60	61.54	33.35	79.00	66.00	-17.46	-32.65	Pass
3	0.1740	51.19	23.12	9.60	60.79	32.72	79.00	66.00	-18.21	-33.28	Pass
4	0.1900	50.08	21.89	9.60	59.68	31.49	79.00	66.00	-19.32	-34.51	Pass
5	0.2020	49.03	20.43	9.60	58.63	30.03	79.00	66.00	-20.37	-35.97	Pass
6	4.7660	10.56	3.44	9.76	20.32	13.20	73.00	60.00	-52.68	-46.80	Pass
7	13.8700	20.08	13.02	9.90	29.98	22.92	73.00	60.00	-43.02	-37.08	Pass

Note: 1. Result (dBuV) = Correction factor (dB) + Reading(dBuV).
 2. Correction factor (dB) = Cable loss (dB) + L.I.S.N. factor (dB).



Test Standard:	FCC Part 15B	Power Line:	L1
Test Mode:	Mode 2	Test Power:	AC 240 V / 60 Hz
Description:			

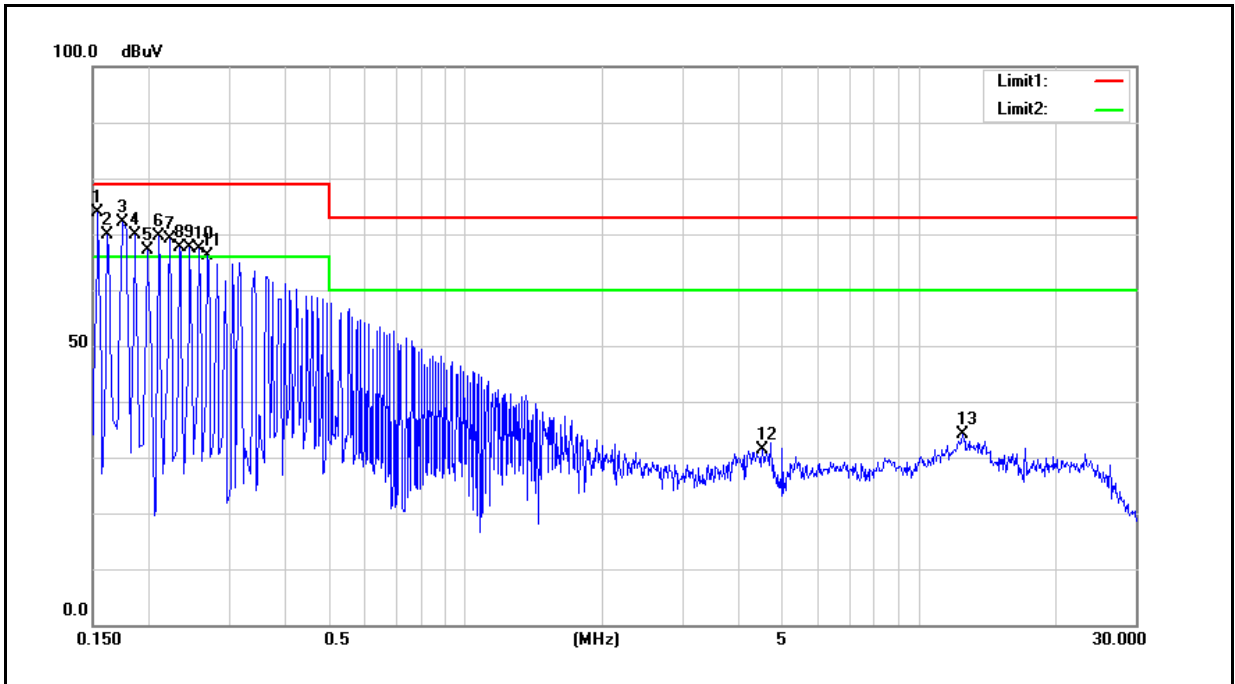



Test Standard:	FCC Part 15B	Power Line:	L1
Test Mode:	Mode 2	Test Power:	AC 240 V / 60 Hz
Description:			

No.	Frequency (MHz)	QP reading (dBuV)	AVG reading (dBuV)	Correction factor (dB)	QP result (dBuV)	AVG result (dBuV)	QP limit (dBuV)	AVG limit (dBuV)	QP margin (dB)	AVG margin (dB)	Remark
1	0.1540	56.31	27.57	9.60	65.91	37.17	79.00	66.00	-13.09	-28.83	Pass
2	0.1620	55.91	27.79	9.60	65.51	37.39	79.00	66.00	-13.49	-28.61	Pass
3	0.1750	55.16	26.40	9.60	64.76	36.00	79.00	66.00	-14.24	-30.00	Pass
4	0.1860	54.48	25.79	9.60	64.08	35.39	79.00	66.00	-14.92	-30.61	Pass
5	0.1980	53.41	25.51	9.60	63.01	35.11	79.00	66.00	-15.99	-30.89	Pass
6	0.2100	52.73	23.88	9.60	62.33	33.48	79.00	66.00	-16.67	-32.52	Pass
7	0.2220	51.65	23.78	9.60	61.25	33.38	79.00	66.00	-17.75	-32.62	Pass
8	0.2340	51.13	22.98	9.60	60.73	32.58	79.00	66.00	-18.27	-33.42	Pass
9	0.2460	51.27	23.54	9.60	60.87	33.14	79.00	66.00	-18.13	-32.86	Pass
10	0.2580	51.05	22.65	9.60	60.65	32.25	79.00	66.00	-18.35	-33.75	Pass
11	0.2700	50.35	21.94	9.60	59.95	31.54	79.00	66.00	-19.05	-34.46	Pass
12	4.5180	16.55	9.37	9.74	26.29	19.11	73.00	60.00	-46.71	-40.89	Pass
13	12.5140	18.05	8.01	9.89	27.94	17.90	73.00	60.00	-45.06	-42.10	Pass

Note: 1. Result (dBuV) = Correction factor (dB) + Reading(dBuV).

2. Correction factor (dB) = Cable loss (dB) + L.I.S.N. factor (dB).



Test Standard:	FCC Part 15B	Power Line:	N
Test Mode:	Mode 2	Test Power:	AC 240 V / 60 Hz
Description:			

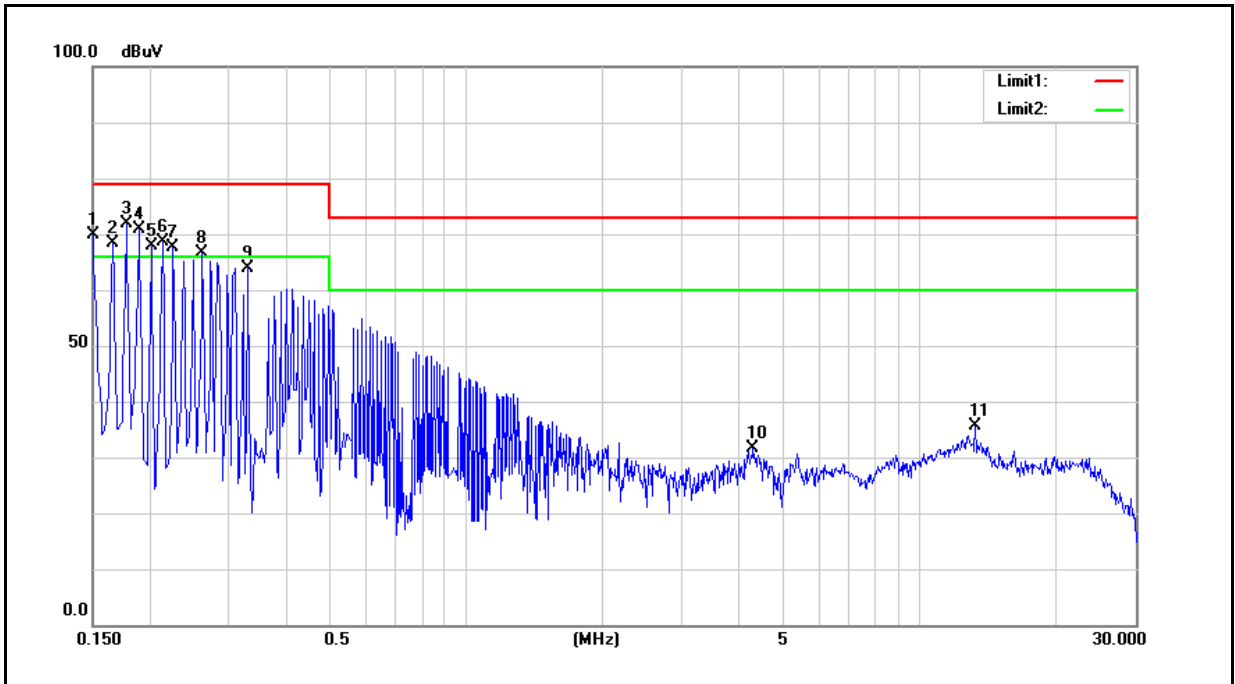

No.	Frequency (MHz)	QP reading (dBuV)	AVG reading (dBuV)	Correction factor (dB)	QP result (dBuV)	AVG result (dBuV)	QP limit (dBuV)	AVG limit (dBuV)	QP margin (dB)	AVG margin (dB)	Remark
1	0.1500	56.34	28.32	9.59	65.93	37.91	79.00	66.00	-13.07	-28.09	Pass
2	0.1660	55.36	28.04	9.60	64.96	37.64	79.00	66.00	-14.04	-28.36	Pass
3	0.1780	54.63	25.95	9.60	64.23	35.55	79.00	66.00	-14.77	-30.45	Pass
4	0.1900	54.27	26.44	9.60	63.87	36.04	79.00	66.00	-15.13	-29.96	Pass
5	0.2020	54.18	25.07	9.60	63.78	34.67	79.00	66.00	-15.22	-31.33	Pass
6	0.2140	52.85	23.99	9.60	62.45	33.59	79.00	66.00	-16.55	-32.41	Pass
7	0.2260	51.93	23.50	9.60	61.53	33.10	79.00	66.00	-17.47	-32.90	Pass
8	0.2620	50.07	22.20	9.60	59.67	31.80	79.00	66.00	-19.33	-34.20	Pass
9	0.3300	47.04	19.72	9.59	56.63	29.31	79.00	66.00	-22.37	-36.69	Pass
10	4.2980	16.85	9.80	9.74	26.59	19.54	73.00	60.00	-46.41	-40.46	Pass
11	13.3180	18.33	10.60	9.90	28.23	20.50	73.00	60.00	-44.77	-39.50	Pass

Note: 1. Result (dBuV) = Correction factor (dB) + Reading(dBuV).
 2. Correction factor (dB) = Cable loss (dB) + L.I.S.N. factor (dB).

5.2. Radiated Emission

■ Limit

Under 1 GHz test shall not exceed following value

FCC 47 CFR PART 15 SUBPART B				
Frequency range (MHz)	Class A		Class B	
	Distance (m)	dBuV/m	Distance (m)	dBuV/m
30 to 88	10	39	3	40
88 to 216	10	43.5	3	43.5
216 to 960	10	46.4	3	46
Above 960	10	49.5	3	54

CISPR 22				
Frequency range (MHz)	Class A		Class B	
	Distance (m)	dBuV/m	Distance (m)	dBuV/m
30 to 230	10	40	10	30
230 to 1000	10	47	10	37

Above 1 GHz test shall not exceed following value

Frequency (MHz)	dBuV/m (Distance 3 m)			
	Class A		Class B	
	Average	Peak	Average	Peak
1000 ~ 40000	60	80	54	74

- Remark:
1. The tighter limit shall apply at the edge between two frequency bands.
 2. Distance refers to the distance in meters between the measuring instrument antenna and the closed point of any part of the device or system.
 3. RF Voltage (dBuV/m) = 20 log RF Voltage (uV/m)
 4. Peak detector limit is corresponding to 20 dB above the maximum permitted average limit.

According to FCC Part 15.33 (b), for an unintentional radiator, including a digital device, the spectrum shall be investigated from the lowest radio frequency signal generated or used in the device, without going below the lowest frequency for which a radiated emission limit is specified, up to the frequency shown in the following table:

Highest frequency generated or used in the device or in which the device operated or tunes (MHz)	Upper frequency of measurement range (MHz)
Below 1.75	30
1.75-108	1000
108-500	2000
500-1000	5000
Above 1000	5th harmonic of the highest frequency or 40 GHz, whichever is lower

■ Test Result

Test Standard:	FCC Part 15B (limit use CISPR 22)	Test Distance:	10 m
Test Mode:	Mode 1	Test Power:	AC 120 V / 60 Hz
Measurement Range:	30 MHz~1 GHz	Ant.Polar.:	Horizontal

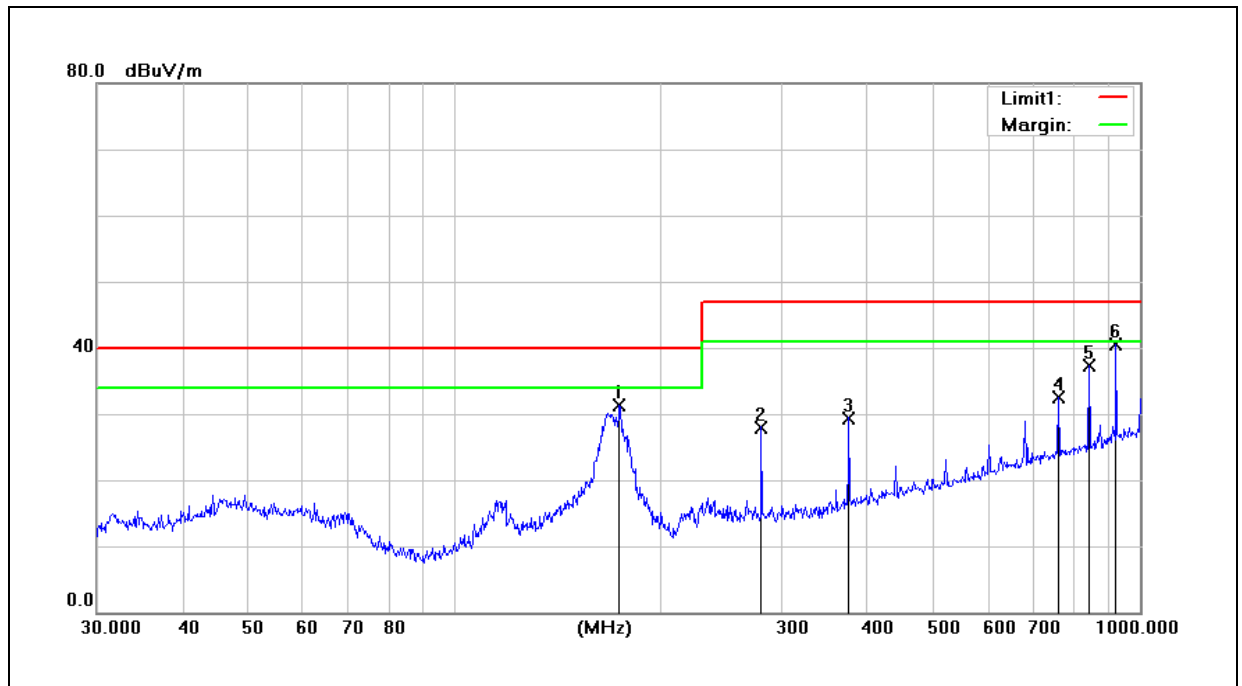

No.	Frequency (MHz)	Reading (dBuV)	Correct Factor (dB/m)	Result (dBuV/m)	Limit (dBuV/m)	Margin (dB)	Height (cm)	Degree (°)	Remark
1	173.8135	47.91	-16.61	31.30	40.00	-8.70	400	336	QP
2	280.0237	43.61	-15.61	28.00	47.00	-19.00	400	343	QP
3	375.9385	42.81	-13.41	29.40	47.00	-17.60	200	355	QP
4	760.7036	38.43	-5.93	32.50	47.00	-14.50	100	45	QP
5	842.1296	42.46	-5.16	37.30	47.00	-9.70	100	359	QP
6	922.5157	44.58	-3.98	40.60	47.00	-6.40	100	38	QP

Note: 1. Result (dBuV/m) = Correction factor (dB/m) + Reading(dBuV).

Example: 31.30 = -16.61 + 47.91

2. Correction factor (dB/m) = Antenna Factor (dB/m) + Cable loss (dB) – Pre-Amplifier gain (dB).



Test Standard:	FCC Part 15B (limit use CISPR 22)	Test Distance:	10 m
Test Mode:	Mode 1	Test Power:	AC 120 V / 60 Hz
Measurement Range:	30 MHz~1 GHz	Ant.Polar.:	Vertical

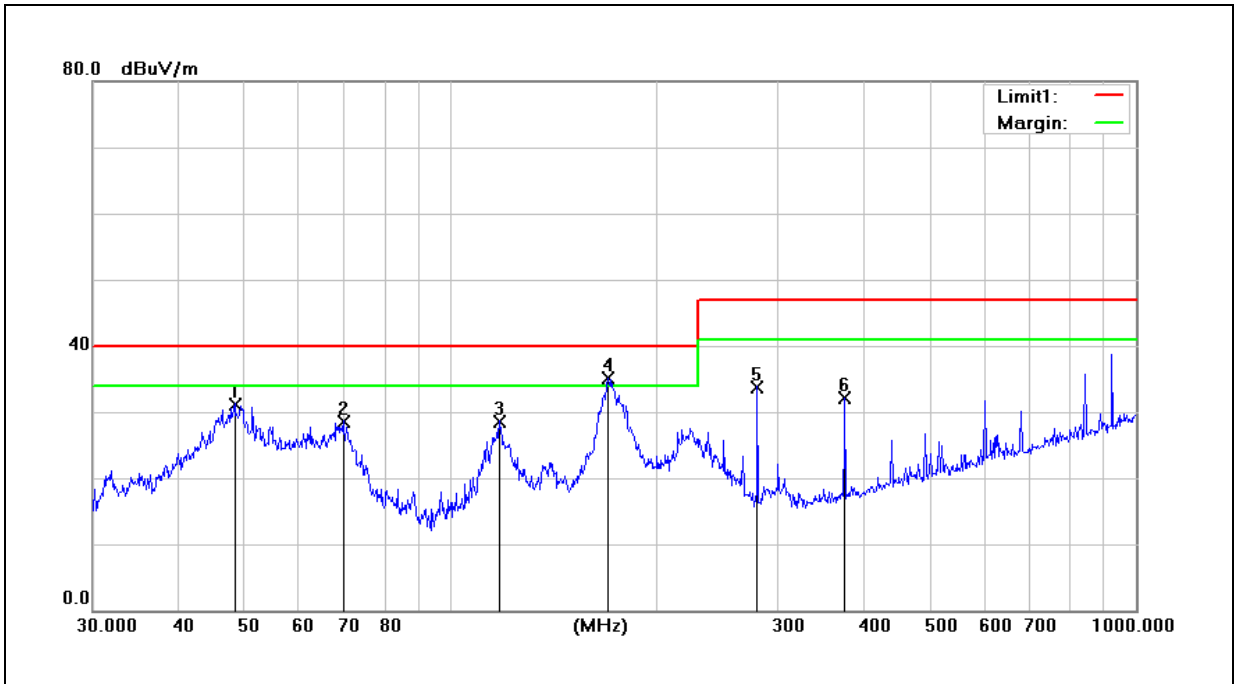

No.	Frequency (MHz)	Reading (dBuV)	Correct Factor (dB/m)	Result (dBuV/m)	Limit (dBuV/m)	Margin (dB)	Height (cm)	Degree (°)	Remark
1	48.3318	47.01	-15.81	31.20	40.00	-8.80	100	343	QP
2	69.6005	46.82	-18.22	28.60	40.00	-11.40	399	270	QP
3	117.7725	46.48	-17.88	28.60	40.00	-11.40	100	103	QP
4	169.5990	50.09	-14.99	35.10	40.00	-4.90	100	230	QP
5	280.0237	47.71	-13.91	33.80	47.00	-13.20	100	0	QP
6	375.9385	43.59	-11.49	32.10	47.00	-14.90	100	61	QP

Note: 1. Result (dBuV/m) = Correction factor (dB/m) + Reading(dBuV).

2. Correction factor (dB/m) = Antenna Factor (dB/m) + Cable loss (dB) – Pre-Amplifier gain (dB).

Test Standard:	FCC Part 15B (limit use CISPR 22)	Test Distance:	10 m
Test Mode:	Mode 2	Test Power:	AC 240 V / 60 Hz
Measurement Range:	30 MHz~1 GHz	Ant.Polar.:	Horizontal

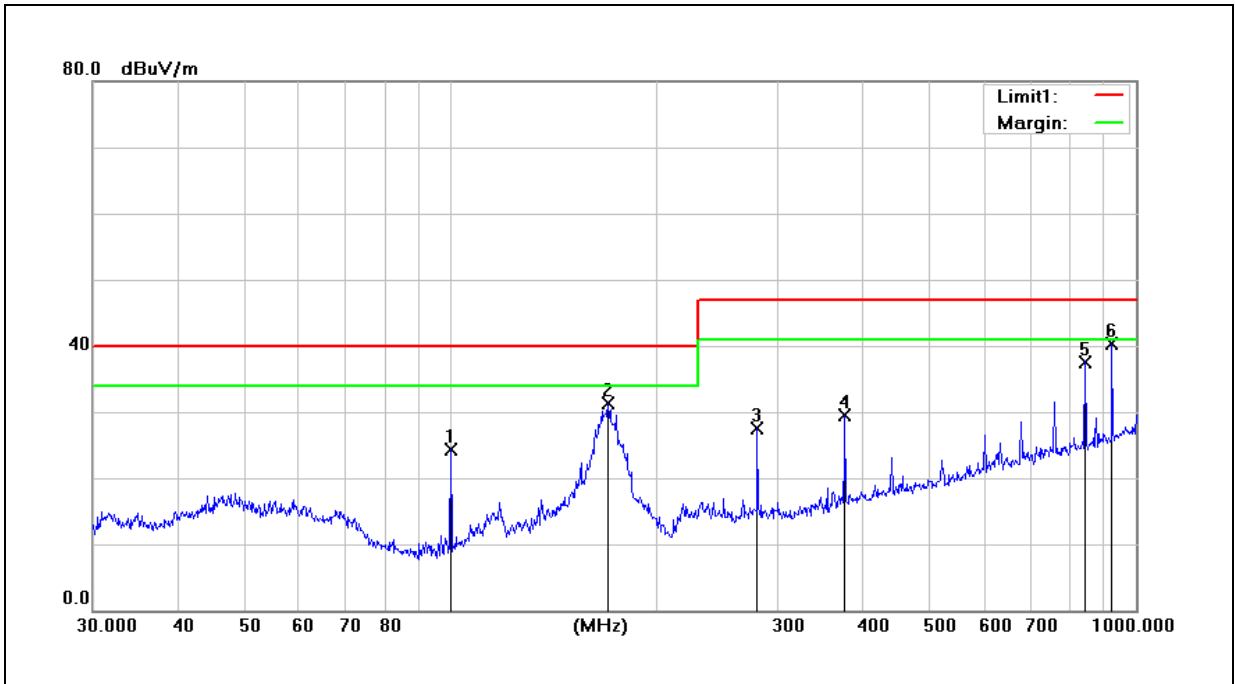

No.	Frequency (MHz)	Reading (dBuV)	Correct Factor (dB/m)	Result (dBuV/m)	Limit (dBuV/m)	Margin (dB)	Height (cm)	Degree (°)	Remark
1	99.8777	45.23	-20.93	24.30	40.00	-15.70	300	183	QP
2	169.5990	47.51	-16.21	31.30	40.00	-8.70	400	307	QP
3	280.0237	43.11	-15.61	27.50	47.00	-19.50	398	0	QP
4	375.9385	42.91	-13.41	29.50	47.00	-17.50	200	360	QP
5	842.1296	42.76	-5.16	37.60	47.00	-9.40	100	246	QP
6	922.5157	44.28	-3.98	40.30	47.00	-6.70	100	246	QP

Note: 1. Result (dBuV/m) = Correction factor (dB/m) + Reading(dBuV).

2. Correction factor (dB/m) = Antenna Factor (dB/m) + Cable loss (dB) – Pre-Amplifier gain (dB).

Test Standard:	FCC Part 15B (limit use CISPR 22)	Test Distance:	10 m
Test Mode:	Mode 2	Test Power:	AC 240 V / 60 Hz
Measurement Range:	30 MHz~1 GHz	Ant.Polar.:	Vertical

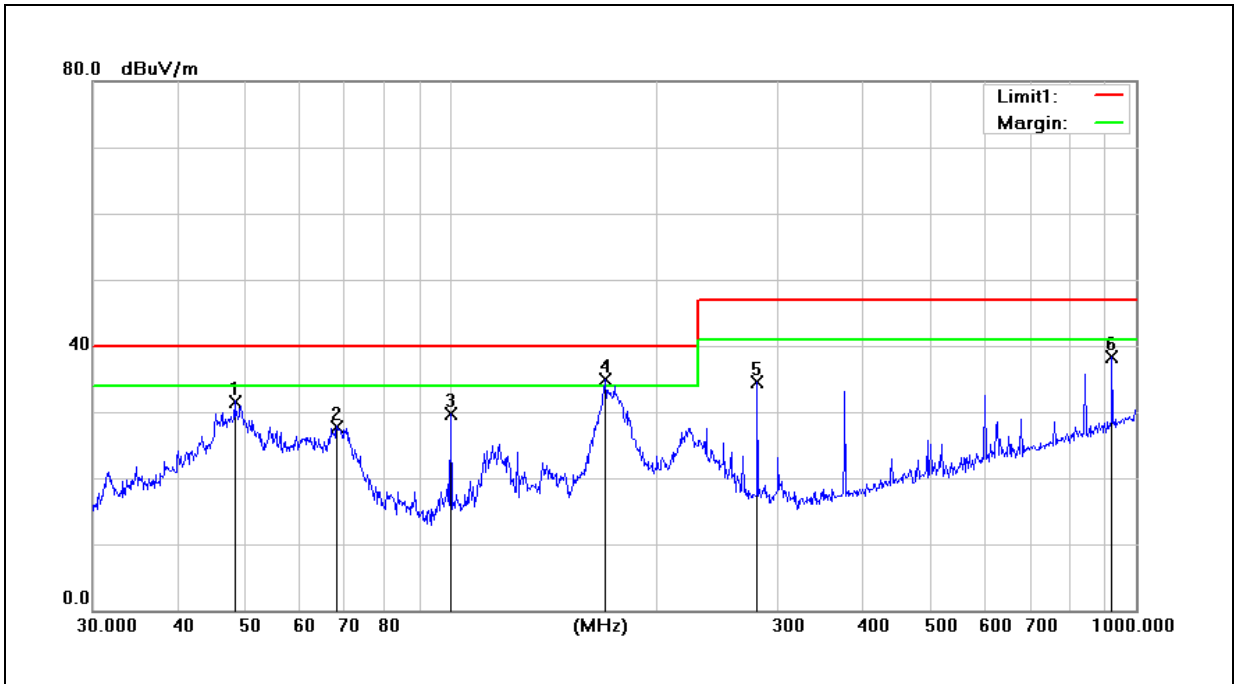

No.	Frequency (MHz)	Reading (dBuV)	Correct Factor (dB/m)	Result (dBuV/m)	Limit (dBuV/m)	Margin (dB)	Height (cm)	Degree (°)	Remark
1	48.3318	47.41	-15.81	31.60	40.00	-8.40	100	359	QP
2	68.1514	45.76	-17.96	27.80	40.00	-12.20	100	0	QP
3	99.8777	49.90	-20.20	29.70	40.00	-10.30	100	85	QP
4	167.8243	49.80	-14.90	34.90	40.00	-5.10	100	209	QP
5	280.0237	48.41	-13.91	34.50	47.00	-12.50	100	0	QP
6	922.5157	38.49	-0.19	38.30	47.00	-8.70	152	0	QP

Note: 1. Result (dBuV/m) = Correction factor (dB/m) + Reading(dBuV).

2. Correction factor (dB/m) = Antenna Factor (dB/m) + Cable loss (dB) – Pre-Amplifier gain (dB).



Test Standard:	FCC Part 15B	Test Distance:	3 m
Test Mode:	Mode 1	Test Power:	AC 120 V / 60 Hz
Measurement Range:	1 GHz~40 GHz	Ant.Polar.:	Horizontal

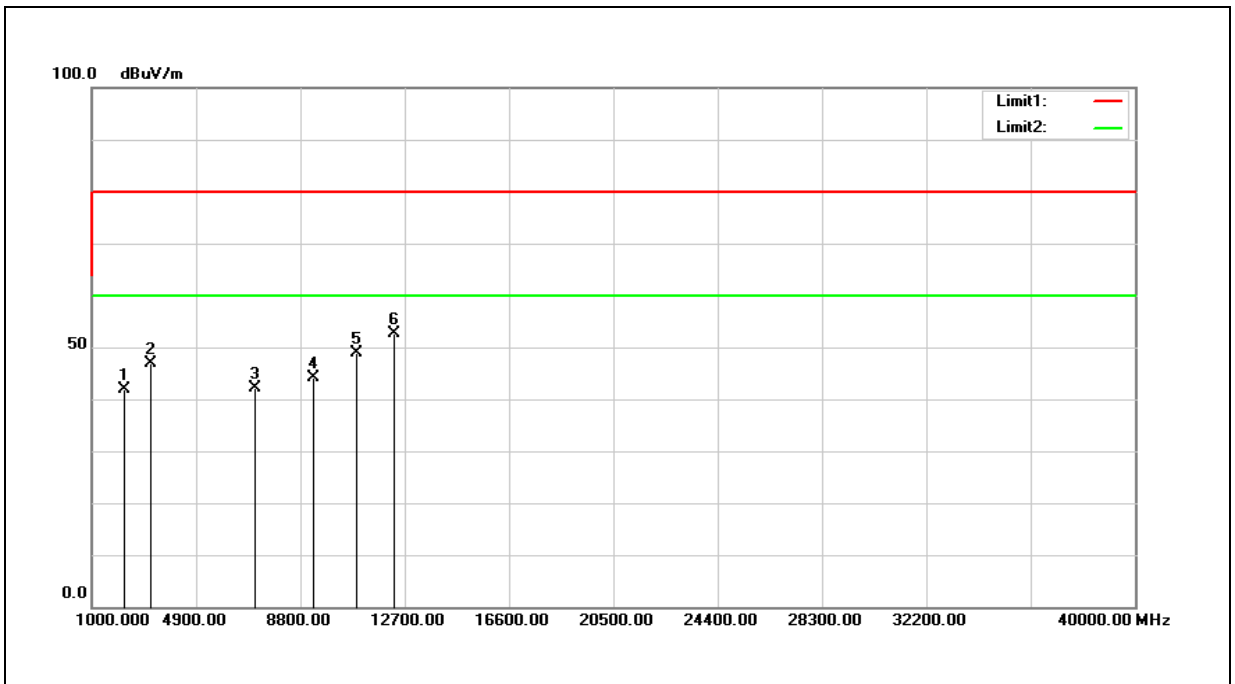

No.	Frequency (MHz)	Reading (dBuV)	Correct Factor (dB/m)	Result (dBuV/m)	Limit (dBuV/m)	Margin (dB)	Height (cm)	Degree (°)	Remark
1	2200.000	38.72	3.18	41.90	80.00	-38.10	100	321	peak
2	3184.000	42.30	4.69	46.99	80.00	-33.01	100	227	peak
3	7072.000	31.99	10.23	42.22	80.00	-37.78	200	8	peak
4	9268.000	33.08	11.00	44.08	80.00	-35.92	100	195	peak
5	10912.000	32.44	16.45	48.89	80.00	-31.11	200	198	peak
6	12304.000	33.11	19.49	52.60	80.00	-27.40	200	234	peak

Note: 1. Result (dBuV/m) = Correction factor (dB/m) + Reading(dBuV).

Example: 41.90 = 38.72 + 3.18

2. Correction factor (dB/m) = Antenna Factor (dB/m) + Cable loss (dB) – Pre-Amplifier gain (dB).



Test Standard:	FCC Part 15B	Test Distance:	3 m
Test Mode:	Mode 1	Test Power:	AC 120 V / 60 Hz
Measurement Range:	1 GHz~40 GHz	Ant.Polar.:	Vertical

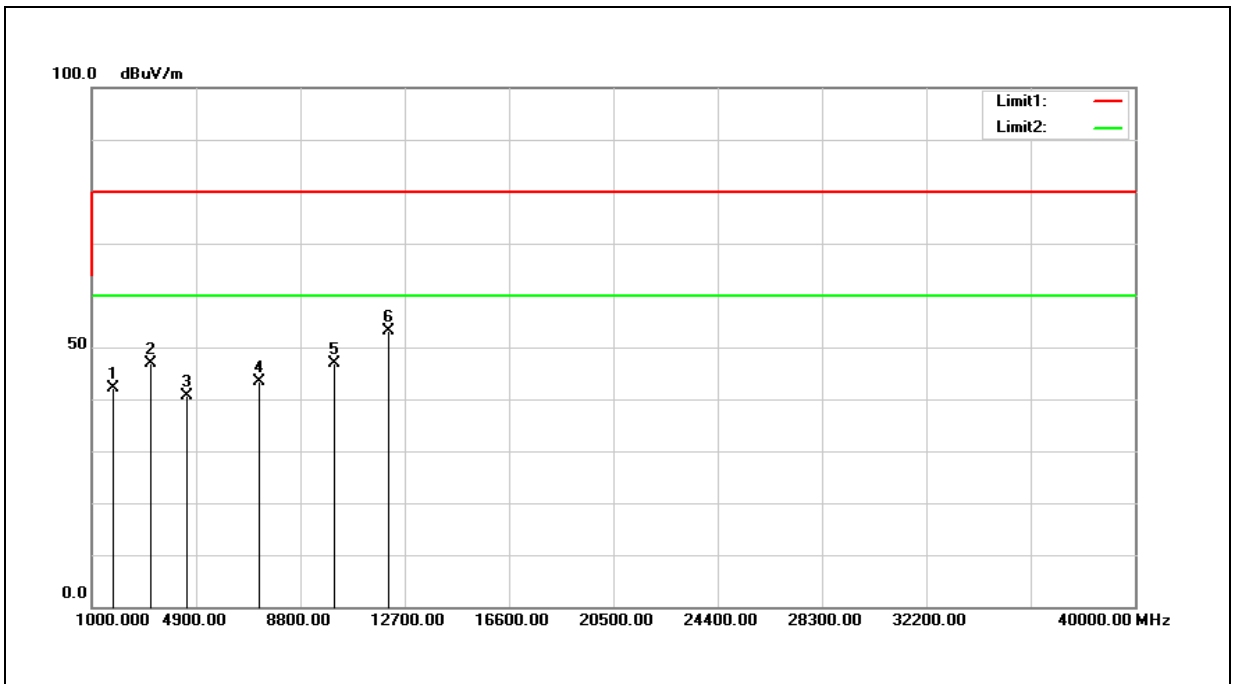

No.	Frequency (MHz)	Reading (dBuV)	Correct Factor (dB/m)	Result (dBuV/m)	Limit (dBuV/m)	Margin (dB)	Height (cm)	Degree (°)	Remark
1	1804.000	40.91	1.25	42.16	80.00	-37.84	100	0	peak
2	3184.000	42.29	4.69	46.98	80.00	-33.02	100	247	peak
3	4540.000	33.48	7.08	40.56	80.00	-39.44	100	165	peak
4	7240.000	33.16	10.21	43.37	80.00	-36.63	100	0	peak
5	10060.000	33.91	12.89	46.80	80.00	-33.20	100	274	peak
6	12064.000	34.35	18.86	53.21	80.00	-26.79	100	342	peak

Note: 1. Result (dBuV/m) = Correction factor (dB/m) + Reading(dBuV).

2. Correction factor (dB/m) = Antenna Factor (dB/m) + Cable loss (dB) – Pre-Amplifier gain (dB).



Test Standard:	FCC Part 15B	Test Distance:	3 m
Test Mode:	Mode 2	Test Power:	AC 240 V / 60 Hz
Measurement Range:	1 GHz~40 GHz	Ant.Polar.:	Horizontal

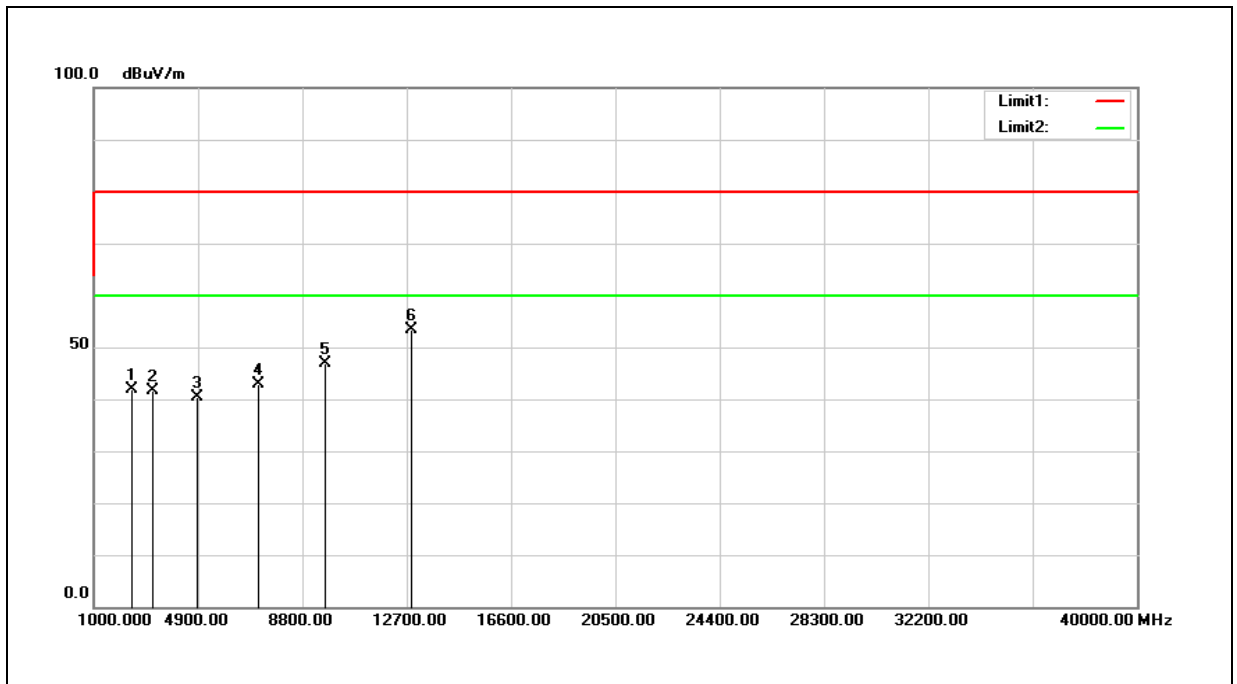

No.	Frequency (MHz)	Reading (dBuV)	Correct Factor (dB/m)	Result (dBuV/m)	Limit (dBuV/m)	Margin (dB)	Height (cm)	Degree (°)	Remark
1	2416.000	38.20	3.70	41.90	80.00	-38.10	100	0	peak
2	3196.000	36.96	4.69	41.65	80.00	-38.35	100	208	peak
3	4828.000	32.82	7.51	40.33	80.00	-39.67	178	0	peak
4	7156.000	32.73	10.22	42.95	80.00	-37.05	200	347	peak
5	9652.000	35.23	11.69	46.92	80.00	-33.08	100	360	peak
6	12868.000	32.69	20.63	53.32	80.00	-26.68	100	204	peak

Note: 1. Result (dBuV/m) = Correction factor (dB/m) + Reading(dBuV).

2. Correction factor (dB/m) = Antenna Factor (dB/m) + Cable loss (dB) – Pre-Amplifier gain (dB).

Test Standard:	FCC Part 15B	Test Distance:	3 m
Test Mode:	Mode 2	Test Power:	AC 240 V / 60 Hz
Measurement Range:	1 GHz~40 GHz	Ant.Polar.:	Vertical

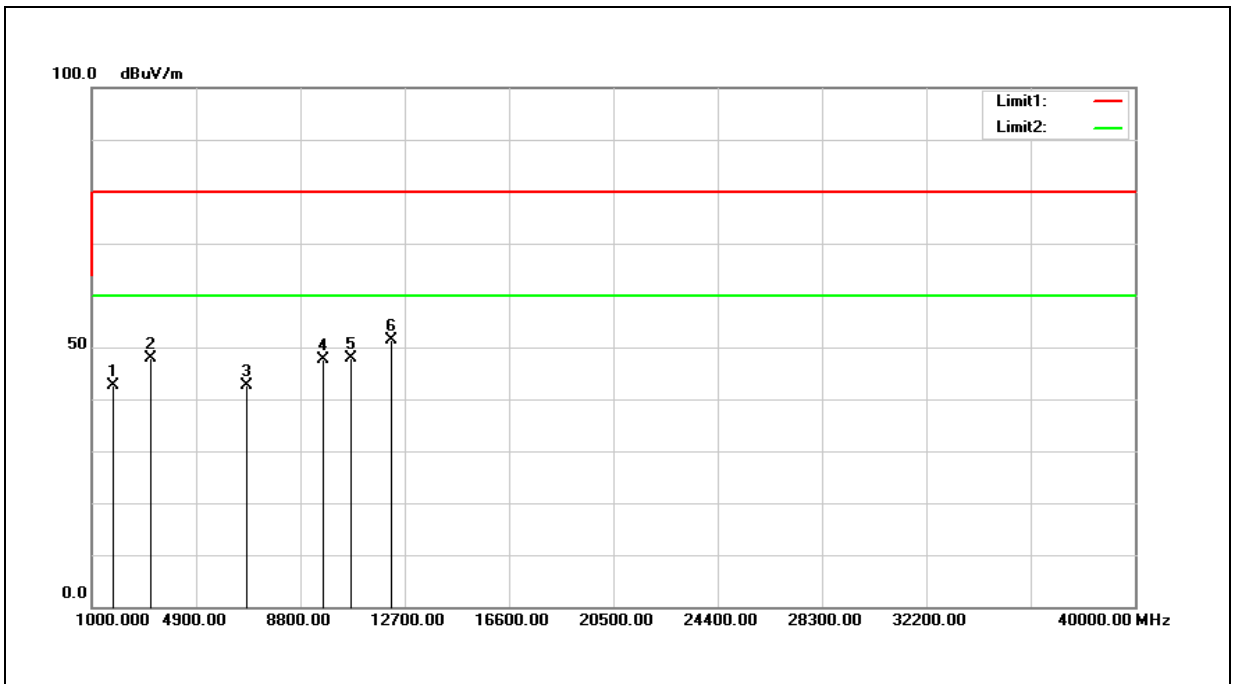

No.	Frequency (MHz)	Reading (dBuV)	Correct Factor (dB/m)	Result (dBuV/m)	Limit (dBuV/m)	Margin (dB)	Height (cm)	Degree (°)	Remark
1	1804.000	41.35	1.25	42.60	80.00	-37.40	100	358	peak
2	3196.000	43.15	4.69	47.84	80.00	-32.16	100	120	peak
3	6748.000	32.36	10.27	42.63	80.00	-37.37	100	0	peak
4	9652.000	35.93	11.69	47.62	80.00	-32.38	100	12	peak
5	10636.000	32.75	15.18	47.93	80.00	-32.07	100	333	peak
6	12172.000	32.22	19.15	51.37	80.00	-28.63	200	1	peak

Note: 1. Result (dBuV/m) = Correction factor (dB/m) + Reading(dBuV).

2. Correction factor (dB/m) = Antenna Factor (dB/m) + Cable loss (dB) – Pre-Amplifier gain (dB).