

FCC Test Report

Report No.: RF150713E08-1

FCC ID: U8G-P1813

Test Model: MAX Transit

Series Model: MAX transit Duo, MAX transit Quad, Pismo 813

Received Date: July 13, 2015

Test Date: July 20 to Aug. 26, 2015

Issued Date: Sep. 02, 2015

Applicant: Pismo Labs Technology Limited

Address: FLAT/RM A5, 5/F, HK SPINNERS IND BLDG PHASE 6, 481 CASTLE PEAK ROAD, CHEUNG SHA WAN, HONG KONG.

Issued By: Bureau Veritas Consumer Products Services (H.K.) Ltd., Taoyuan Branch Hsin Chu Laboratory

Lab Address: No. 81-1, Lu Liao Keng, 9th Ling, Wu Lung Tsuen, Chiung Lin Hsiang, Hsin Chu Hsien 307, Taiwan R.O.C.

Test Location (1): No. 81-1, Lu Liao Keng, 9th Ling, Wu Lung Tsuen, Chiung Lin Hsiang, Hsin Chu Hsien 307, Taiwan R.O.C.

Test Location (2): No. 49, Ln. 206, Wende Rd., Shangshan Tsuen, Chiung Lin Hsiang, Hsin Chu Hsien 307, Taiwan R.O.C.

Test Location (3): E-2, No.1, Li Hsin 1st Road, Hsinchu Science Park, Hsinchu City 300, Taiwan R.O.C.



This report is for your exclusive use. Any copying or replication of this report to or for any other person or entity, or use of our name or trademark, is permitted only with our prior written permission. This report sets forth our findings solely with respect to the test samples identified herein. The results set forth in this report are not indicative or representative of the quality or characteristics of the lot from which a test sample was taken or any similar or identical product unless specifically and expressly noted. Our report includes all of the tests requested by you and the results thereof based upon the information that you provided to us. You have 60 days from date of issuance of this report to notify us of any material error or omission caused by our negligence, provided, however, that such notice shall be in writing and shall specifically address the issue you wish to raise. A failure to raise such issue within the prescribed time shall constitute your unqualified acceptance of the completeness of this report, the tests conducted and the correctness of the report contents. Unless specific mention, the uncertainty of measurement has been explicitly taken into account to declare the compliance or non-compliance to the specification. The report must not be used by the client to claim product certification, approval, or endorsement by TAF or any government agencies.

Table of Contents

Release Control Record	4
1 Certificate of Conformity	5
2 Summary of Test Results	6
2.1 Measurement Uncertainty	6
2.2 Modification Record	6
3 General Information	7
3.1 General Description of EUT	7
3.2 Description of Test Modes	10
3.2.1 Test Mode Applicability and Tested Channel Detail.....	11
3.3 Duty Cycle of Test Signal	13
3.4 Description of Support Units	14
3.4.1 Configuration of System under Test	15
3.5 General Description of Applied Standard.....	17
4 Test Types and Results	18
4.1 Radiated Emission and Bandedge Measurement.....	18
4.1.1 Limits of Radiated Emission and Bandedge Measurement	18
4.1.2 Test Instruments	19
4.1.3 Test Procedure	21
4.1.4 Deviation from Test Standard	21
4.1.5 Test Setup.....	22
4.1.6 EUT Operating Condition	22
4.1.7 Test Results	23
4.2 Conducted Emission Measurement	42
4.2.1 Limits of Conducted Emission Measurement	42
4.2.2 Test Instruments	42
4.2.3 Test Procedure	44
4.2.4 Deviation from Test Standard	44
4.2.5 Test Setup.....	44
4.2.6 EUT Operating Condition	44
4.2.7 Test Results (Mode 1).....	45
4.2.8 Test Results (Mode 2).....	47
4.2.9 Test Results (Mode 3).....	49
4.2.10 Test Results (Mode 4).....	51
4.3 Transmit Power Measurement	53
4.3.1 Limits of Transmit Power Measurement	53
4.3.2 Test Setup.....	53
4.3.3 Test Instruments	53
4.3.4 Test Procedure	53
4.3.5 Deviation from Test Standard	53
4.3.6 EUT Operating Condition	53
4.3.7 Test Result.....	54
4.4 Peak Power Spectral Density Measurement	55
4.4.1 Limits of Peak Power Spectral Density Measurement	55
4.4.2 Test Setup.....	55
4.4.3 Test Instruments	55
4.4.4 Test Procedure	55
4.4.5 Deviation from Test Standard	56
4.4.6 EUT Operating Condition	56
4.4.7 Test Results	57
4.5 Frequency Stability Measurement	63
4.5.1 Limits of Frequency Stability Measurement	63
4.5.2 Test Setup.....	63
4.5.3 Test Instruments	63



4.5.4	Test Procedure	63
4.5.5	Deviation from Test Standard	63
4.5.6	EUT Operating Condition	63
4.5.7	Test Results	64
4.6	6dB Bandwidth Measurement	65
4.6.1	Limits of 6dB Bandwidth Measurement	65
4.6.2	Test Setup	65
4.6.3	Test Instruments	65
4.6.4	Test Procedure	65
4.6.5	Deviation from Test Standard	65
4.6.6	EUT Operating Condition	65
4.6.7	Test Results	66
5	Pictures of Test Arrangements	68
	Appendix – Information on the Testing Laboratories	69



A D T

Release Control Record

Issue No.	Description	Date Issued
RF150713E08-1	Original release.	Sep. 02, 2015



1 Certificate of Conformity

Product: Upgradable transportation WiFi hotspot

Brand: Pepwave / Peplink / Pismo

Test Model: MAX Transit

Series Model: MAX transit Duo, MAX transit Quad, Pismo 813

Sample Status: MASS-PRODUCTION

Applicant: Pismo Labs Technology Limited

Test Date: July 20 to Aug. 26, 2015

Standard: 47 CFR FCC Part 15, Subpart E (Section 15.407)
ANSI C63.10: 2013

The above equipment has been tested by **Bureau Veritas Consumer Products Services (H.K.) Ltd., Taoyuan Branch**, and found compliance with the requirement of the above standards. The test record, data evaluation & Equipment Under Test (EUT) configurations represented herein are true and accurate accounts of the measurements of the sample's EMC characteristics under the conditions specified in this report.

Prepared by :  , **Date:** Sep. 02, 2015
 Lori Chung / Specialist

Approved by :  , **Date:** Sep. 02, 2015
 May Chen / Manager

2 Summary of Test Results

47 CFR FCC Part 15, Subpart E (SECTION 15.407)			
FCC Clause	Test Item	Result	Remarks
15.407(b)(6)	AC Power Conducted Emissions	Pass	Meet the requirement of limit. Minimum passing margin is -1.66dB at 18.22844MHz.
15.407(b) (1/2/3/4/6)	Radiated Emissions & Band Edge Measurement	Pass	Meet the requirement of limit. Minimum passing margin is -0.1dB at 5863.00MHz & 10400.00MHz & 10480.00MHz & 5850.00MHz.
15.407(a)(1/2 /3)	Max Average Transmit Power	Pass	Meet the requirement of limit.
15.407(a)(1/2 /3)	Peak Power Spectral Density	Pass	Meet the requirement of limit.
15.407(e)	6dB bandwidth	Pass	Meet the requirement of limit. (U-NII-3 Band only)
15.407(g)	Frequency Stability	Pass	Meet the requirement of limit.
15.203	Antenna Requirement	Pass	Antenna connector is RP-SMA not a standard connector.

NOTE: The EUT was operating in 2400 ~ 2483.5MHz, 5150~5250MHz and 5725~5850MHz frequencies band. This report was recorded the RF parameters including 5150~5250MHz and 5725~5850MHz. For the 2400 ~ 2483.5MHz RF parameters was recorded in another test report.

2.1 Measurement Uncertainty

Where relevant, the following measurement uncertainty levels have been estimated for tests performed on the EUT as specified in CISPR 16-4-2:

Measurement	Frequency	Expanded Uncertainty (k=2) (±)
Conducted Emissions at mains ports	150kHz ~ 30MHz	2.86 dB
Radiated Emissions up to 1 GHz	30MHz ~ 1GHz	5.37 dB
Radiated Emissions above 1 GHz	1GHz ~ 6GHz	3.65 dB
	6GHz ~ 18GHz	3.88 dB
	18GHz ~ 40GHz	4.11 dB

2.2 Modification Record

There were no modifications required for compliance.

3 General Information

3.1 General Description of EUT

Product	Upgradable transportation WiFi hotspot
Brand	Pepwave / Peplink / Pismo
Test Model	MAX Transit
Series Model	MAX transit Duo, MAX transit Quad, Pismo 813
Status of EUT	MASS-PRODUCTION
Power Supply Rating	12-48Vdc from power adapter or 12-48Vdc from Terminal Block or 5Vdc from Micro USB
Modulation Type	CCK, DQPSK, DBPSK for DSSS 64QAM, 16QAM, QPSK, BPSK for OFDM 256QAM for OFDM in 11ac mode
Modulation Technology	DSSS, OFDM
Transfer Rate	802.11b: up to 11Mbps 802.11a: up to 54Mbps 802.11n: up to 300Mbps 802.11ac: up to 433.3Mbps
Operating Frequency	For 15.407 5.18 ~ 5.24GHz, 5.745 ~ 5.825GHz
	For 15.247 2.412 ~ 2.462GHz
Number of Channel	For 15.407 9 for 802.11a, 802.11n (HT20), 802.11ac (VHT20) 4 for 802.11n (HT40), 802.11ac (VHT40) 2 for 802.11ac (VHT80)
	For 15.247 (2.4GHz) 11 for 802.11b, 802.11g, 802.11n (HT20) 7 for 802.11n (HT40)
Output Power	For 15.407 802.11a: 252.981mW 802.11ac (VHT20): 239.957mW 802.11ac (VHT40): 132.781mW 802.11ac (VHT80): 14.61mW
	For 15.247 802.11b: 33.848mW 802.11g: 379.799mW 802.11n(HT20): 359.414mW 802.11n(HT40): 222.048mW
Antenna Type	Refer to Note
Antenna Connector	Refer to Note
Accessory Device	Adapter x 1 GPS x 1
Data Cable Supplied	NA

Note:

- The EUT has below model names which are identical to each other in all aspects except for the following table:

Product Name	Brand	Model Name	Difference
Upgradable transportation WiFi hotspot	Pepwave / Peplink / Pismo	MAX Transit	For marketing requirement
		MAX transit Duo	
		MAX transit Quad	
		Pismo 813	

From the above models, model: MAX Transit was selected as representative model for the test and its data was recorded in this report.

- There are WLAN (2.4GHz/5GHz), WWAN (2G/3G), LTE (4G) and GPS technology used for the EUT.
- The emission of the simultaneous operation (WLAN 2.4GHz & 5GHz & WWAN 2G) has been evaluated and no non-compliance was found.
- The antennas provided to the EUT, please refer to the following table:

For WLAN							
Antenna No.	Brand	Model	Ant. Gain (dBi)	Frequency range (GHz to GHz)	Antenna Type	Connector Type	
1	SmartAnt	SAA06-220690	3	2.4~2.4835	Dipole	RP-SMA	
			4~5.5	5.15~5.25			
			5~5.6	5.725~5.85			
For GPS							
Set	Brand	Model	Ant. Gain (dBi)	Frequency range (MHz)	Antenna Type	Connector Type	
1	Chang Hong	GPS-01	-1	1575.42 (\pm 1.023MHz)	Magnetic	R-SMA Male	
For LTE							
Set	Transmitter Circuit	Brand	Model	Ant. Gain (dBi)	Frequency range (MHz to MHz)	Antenna Type	Connector Type
1	Cellular Main	Pulse	SPDA24700/2700	2	698-960	Dipole	R-SMA Male
	Cellular Diversity / Aux				1710-2170 2500-2700		

- The EUT inside has one LTE module which FCC ID: N7NMC7355.

- The EUT must be supplied with a power adapter as following table:

Brand Name	Model No.	Spec.
Ten Pao	S024WM1200200	Input: 100-240V, 600mA, 50/60Hz Output: 12V, 2000mA DC output cable: Inshielded, 1.5m with 1 core

- The EUT was pre-tested under the following test modes :

Pre-test Mode	Power
Mode A	Power from Adapter
Mode B	Power from USB 1 & 2
Mode C	Power from USB 1
Mode D	Power from USB 2
Mode E	Power from (Terminal Block: 48Vdc)
Mode F	Power from (Terminal Block: 12Vdc)

- The worst radiated emissions were found in **Mode A**. Therefore only the test data of the modes were recorded in this report.
- For Conducted emission test, the Mode A, C, D&F were selected as representative mode for the test and their data were recorded in this report.

10. The EUT incorporates a MIMO function.

For 2.4GHz Band			
MODULATION MODE	DATA RATE (MCS)	TX & RX CONFIGURATION	
802.11b	1 ~ 11Mbps	2TX	2RX
802.11g	6 ~ 54Mbps	2TX	2RX
802.11n (HT20)	MCS 0~7	2TX	2RX
	MCS 8~15	2TX	2RX
802.11n (HT40)	MCS 0~7	2TX	2RX
	MCS 8~15	2TX	2RX
For 5GHz Band			
MODULATION MODE	DATA RATE (MCS)	TX & RX CONFIGURATION	
802.11a	6 ~ 54Mbps	2TX	2RX
802.11n (HT20)	MCS 0~7	2TX	2RX
	MCS 8~15	2TX	2RX
802.11n (HT40)	MCS 0~7	2TX	2RX
	MCS 8~15	2TX	2RX
802.11ac (VHT20)	MCS 0~8, Nss=1	2TX	2RX
	MCS 0~8, Nss=2	2TX	2RX
802.11ac (VHT40)	MCS 0~9, Nss=1	2TX	2RX
	MCS 0~9, Nss=2	2TX	2RX
802.11ac (VHT80)	MCS 0~9, Nss=1	2TX	2RX
	MCS 0~9, Nss=2	2TX	2RX

11. The above EUT information is declared by manufacturer and for more detailed features description, please refer to the manufacturer's specifications or user's manual.

3.2 Description of Test Modes

FOR 5180 ~ 5240MHz

4 channels are provided for 802.11a, 802.11n (HT20), 802.11ac (VHT20):

Channel	Frequency	Channel	Frequency
36	5180 MHz	44	5220 MHz
40	5200 MHz	48	5240 MHz

2 channels are provided for 802.11n (HT40), 802.11ac (VHT40):

Channel	Frequency	Channel	Frequency
38	5190 MHz	46	5230 MHz

1 channel is provided for 802.11ac (VHT80):

Channel	Frequency
42	5210MHz

FOR 5745 ~ 5825MHz:

5 channels are provided for 802.11a, 802.11n (HT20), 802.11ac (VHT20):

Channel	Frequency	Channel	Frequency
149	5745MHz	161	5805MHz
153	5765MHz	165	5825MHz
157	5785MHz		

2 channels are provided for 802.11n (HT40), 802.11ac (VHT40):

Channel	Frequency	Channel	Frequency
151	5755MHz	159	5795MHz

1 channel is provided for 802.11ac (VHT80):

Channel	Frequency
155	5775MHz

3.2.1 Test Mode Applicability and Tested Channel Detail

EUT CONFIGURE MODE	APPLICABLE TO				DESCRIPTION
	RE \geq 1G	RE $<$ 1G	PLC	APCM	
1	√	√	√	√	Power from Adapter
2	-	-	√	-	Power from USB 1
3	-	-	√	-	Power from USB 2
4	-	-	√	-	Power from Terminal Block

Where **RE \geq 1G**: Radiated Emission above 1GHz **RE $<$ 1G**: Radiated Emission below 1GHz
PLC: Power Line Conducted Emission **APCM**: Antenna Port Conducted Measurement

NOTE: 1. The EUT had been pre-tested on the positioned of each 2 axis. The worst case was found when positioned on **Wall-mount type**.
2. "-" means no effect.

Radiated Emission Test (Above 1GHz):

- Pre-Scan has been conducted to determine the worst-case mode from all possible combinations between available modulations, data rates and antenna ports (if EUT with antenna diversity architecture).
- Following channel(s) was (were) selected for the final test as listed below.

MODE	FREQ. BAND (MHz)	AVAILABLE CHANNEL	TESTED CHANNEL	MODULATION TECHNOLOGY	MODULATION TYPE	DATA RATE (Mbps)
802.11a	5180-5240	36 to 48	36, 40, 48	OFDM	BPSK	6
802.11ac (VHT20)		36 to 48	36, 40, 48	OFDM	BPSK	6.5
802.11ac (VHT40)		38 to 46	38, 46	OFDM	BPSK	13.5
802.11ac (VHT80)		42	42	OFDM	BPSK	29.3
802.11a	5745-5825	149 to 165	149, 157, 165	OFDM	BPSK	6
802.11ac (VHT20)		149 to 165	149, 157, 165	OFDM	BPSK	6.5
802.11ac (VHT40)		151 to 159	151, 159	OFDM	BPSK	13.5
802.11ac (VHT80)		155	155	OFDM	BPSK	29.3

Radiated Emission Test (Below 1GHz):

- Pre-Scan has been conducted to determine the worst-case mode from all possible combinations between available modulations, data rates and antenna ports (if EUT with antenna diversity architecture).
- Following channel(s) was (were) selected for the final test as listed below.

MODE	FREQ. BAND (MHz)	AVAILABLE CHANNEL	TESTED CHANNEL	MODULATION TECHNOLOGY	MODULATION TYPE	DATA RATE (Mbps)
802.11a	5745-5825	149 to 165	157	OFDM	BPSK	6

Power Line Conducted Emission Test:

- Pre-Scan has been conducted to determine the worst-case mode from all possible combinations between available modulations, data rates and antenna ports (if EUT with antenna diversity architecture).
- Following channel(s) was (were) selected for the final test as listed below.

MODE	FREQ. BAND (MHz)	AVAILABLE CHANNEL	TESTED CHANNEL	MODULATION TECHNOLOGY	MODULATION TYPE	DATA RATE (Mbps)
802.11a	5745-5825	149 to 165	157	OFDM	BPSK	6

Antenna Port Conducted Measurement:

- This item includes all test value of each mode, but only includes spectrum plot of worst value of each mode.
- Pre-Scan has been conducted to determine the worst-case mode from all possible combinations between available modulations, data rates and antenna ports (if EUT with antenna diversity architecture).
- Following channel(s) was (were) selected for the final test as listed below.

MODE	FREQ. BAND (MHz)	AVAILABLE CHANNEL	TESTED CHANNEL	MODULATION TECHNOLOGY	MODULATION TYPE	DATA RATE (Mbps)
802.11a	5180-5240	36 to 48	36, 40, 48	OFDM	BPSK	6
802.11ac (VHT20)		36 to 48	36, 40, 48	OFDM	BPSK	6.5
802.11ac (VHT40)		38 to 46	38, 46	OFDM	BPSK	13.5
802.11ac (VHT80)		42	42	OFDM	BPSK	29.3
802.11a	5745-5825	149 to 165	149, 157, 165	OFDM	BPSK	6
802.11ac (VHT20)		149 to 165	149, 157, 165	OFDM	BPSK	6.5
802.11ac (VHT40)		151 to 159	151, 159	OFDM	BPSK	13.5
802.11ac (VHT80)		155	155	OFDM	BPSK	29.3

Test Condition:

APPLICABLE TO	ENVIRONMENTAL CONDITIONS	INPUT POWER	TESTED BY
RE≥1G	24deg. C, 67%RH	120Vac, 60Hz	Tim Ho
RE<1G	25deg. C, 68%RH	120Vac, 60Hz	Weiwei Lo
PLC	27deg. C, 60%RH	120Vac, 60Hz	Timmy Hu
	25deg. C, 60%RH		Jyunchun Lin
	28deg. C, 56%RH		Wythe Lin
APCM	25deg. C, 60%RH	120Vac, 60Hz	Anderson Chen

3.3 Duty Cycle of Test Signal

Duty cycle of test signal is < 98%, duty factor shall be considered.

802.11a: Duty cycle = 2.027 ms/2.102 ms = 0.964, Duty factor = $10 * \log(1/0.964) = 0.16$

802.11ac (VHT20): Duty cycle = 1.907 ms/1.982 ms = 0.962, Duty factor = $10 * \log(1/0.962) = 0.17$

802.11ac (VHT40): Duty cycle = 0.935 ms/1.027 ms = 0.91, Duty factor = $10 * \log(1/0.91) = 0.41$

802.11ac (VHT80): Duty cycle = 1.132 ms/1.207 ms = 0.938, Duty factor = $10 * \log(1/0.938) = 0.28$

802.11a **802.11ac (VHT20)**

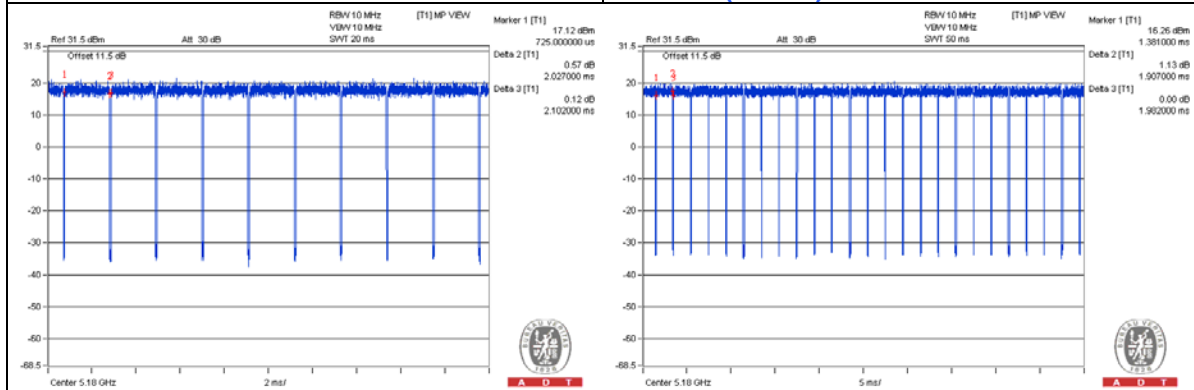

802.11ac (VHT40) **802.11ac (VHT80)**

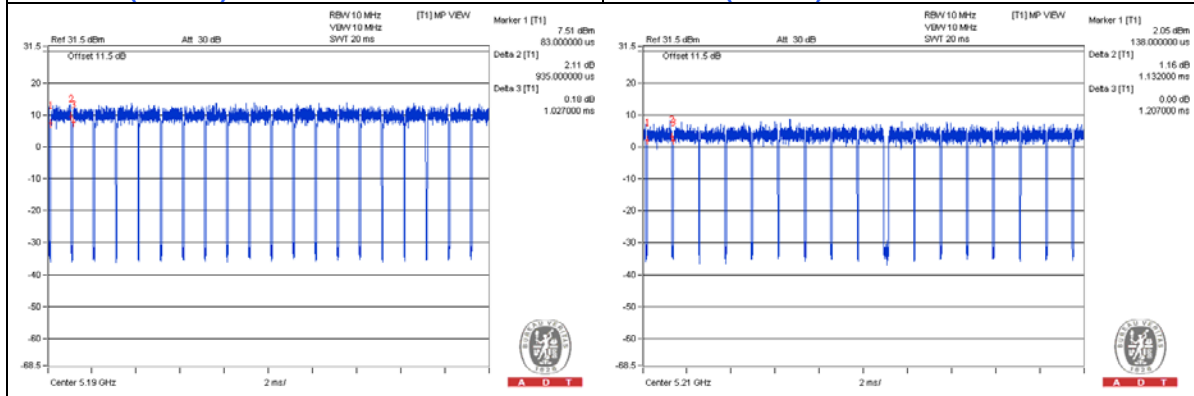

3.4 Description of Support Units

The EUT has been tested as an independent unit together with other necessary accessories or support units. The following support units or accessories were used to form a representative test configuration during the tests.

ID	Product	Brand	Model No.	Serial No.	FCC ID	Remarks
A.	NOTEBOOK COMPUTER	DELL	E6440	F9LYQ32	FCC DoC	Provided by Lab
B.	NOTEBOOK COMPUTER	DELL	E6420	482T3R1	FCC DoC	Provided by Lab
C.	Adapter	ASUS	ad876320	NA	NA	Provided by Lab

Note:

1. All power cords of the above support units are non-shielded (1.8m).

ID	Descriptions	Qty.	Length (m)	Shielding (Yes/No)	Cores (Qty.)	Remarks
1.	DC	1	2	No	0	Provided by Lab
2.	RJ45	1	10	No	0	Provided by Lab
3.	RJ45	1	10	No	0	Provided by Lab
4.	Earth	1	3	No	0	Provided by Lab
5.	RJ45	3	10	No	0	Provided by Lab
6.	DC	1	1.5	No	1	Supplied by Client
7.	Micro USB to USB	1	1	No	0	Provided by Lab
8.	Micro USB to USB	1	1	No	0	Provided by Lab

Note: The core(s) is(are) originally attached to the cable(s).

3.4.1 Configuration of System under Test
For conducted emission test Mode 2:

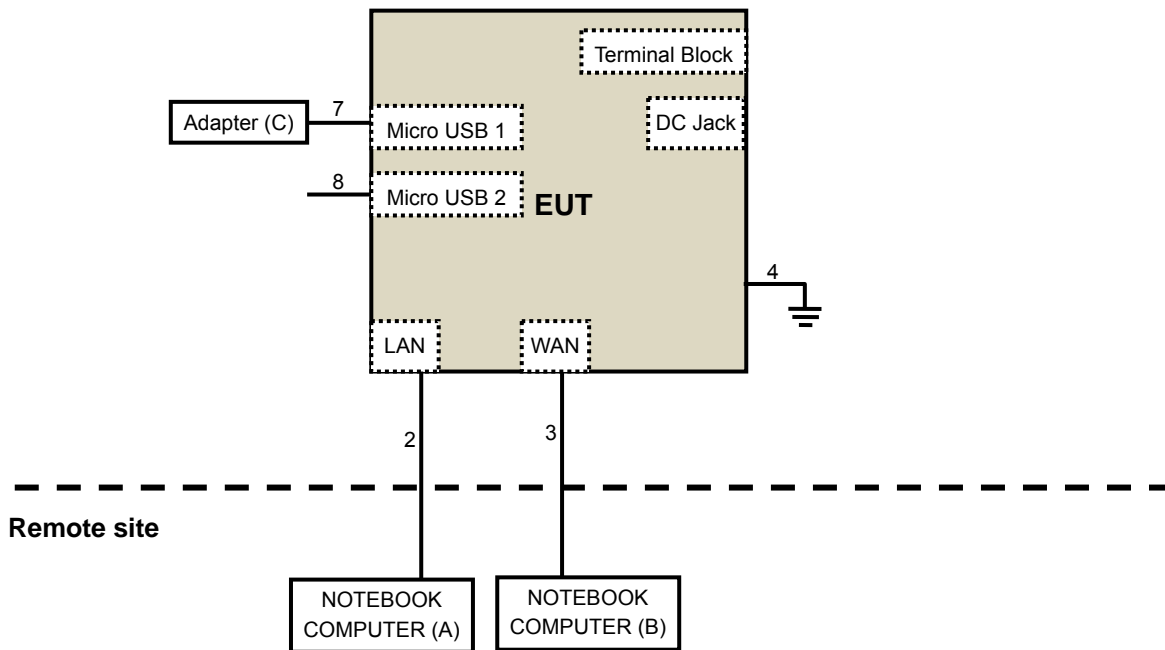

For conducted emission test Mode 3:

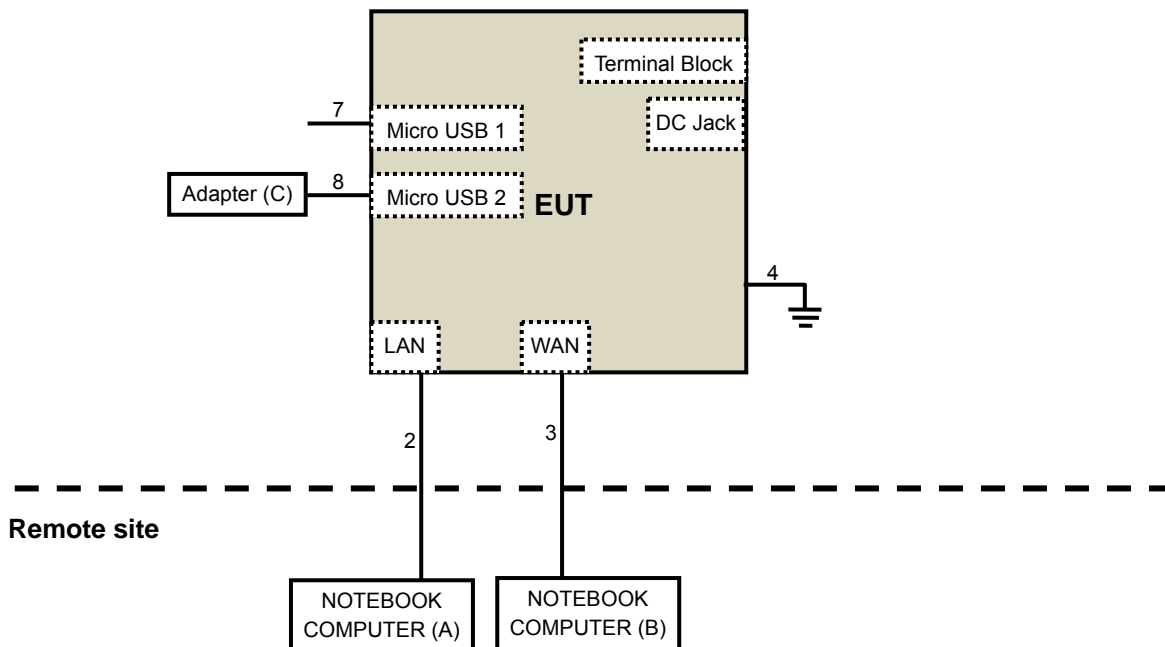

For conducted emission test Mode 4:

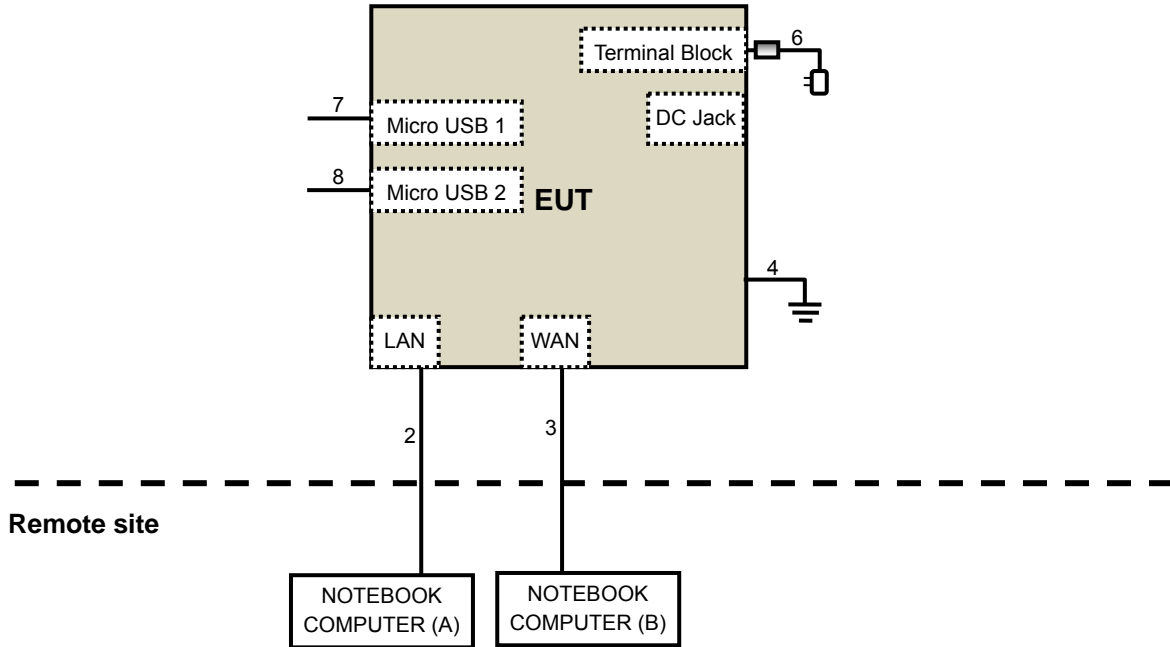

For conducted emission test Mode 1 & other test items:

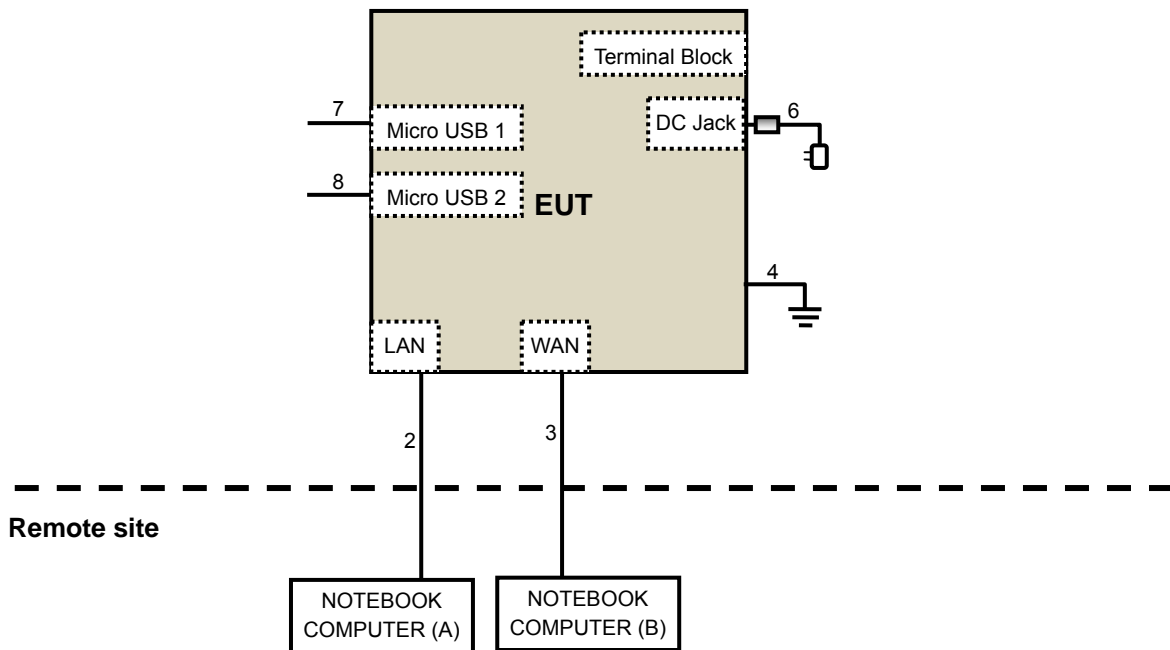

3.5 General Description of Applied Standard

The EUT is a RF Product. According to the specifications of the manufacturer, it must comply with the requirements of the following standards:

FCC Part 15, Subpart E (15.407)
789033 D02 General UNII Test Procedure New Rules v01
662911 D01 Multiple Transmitter Output v02r01
ANSI C63.10-2013

All test items have been performed and recorded as per the above standards.

NOTE: The EUT has been verified to comply with the requirements of FCC Part 15, Subpart B, Class B (DoC). The test report has been issued separately.

4 Test Types and Results

4.1 Radiated Emission and Bandedge Measurement

4.1.1 Limits of Radiated Emission and Bandedge Measurement

Radiated emissions which fall in the restricted bands must comply with the radiated emission limits specified as below table.

Frequencies (MHz)	Field Strength (microvolts/meter)	Measurement Distance (meters)
0.009 ~ 0.490	2400/F(kHz)	300
0.490 ~ 1.705	24000/F(kHz)	30
1.705 ~ 30.0	30	30
30 ~ 88	100	3
88 ~ 216	150	3
216 ~ 960	200	3
Above 960	500	3

NOTE:

1. The lower limit shall apply at the transition frequencies.
2. Emission level (dBuV/m) = 20 log Emission level (uV/m).
3. For frequencies above 1000MHz, the field strength limits are based on average detector, however, the peak field strength of any emission shall not exceed the maximum permitted average limits, specified above by more than 20dB under any condition of modulation.

LIMITS OF UNWANTED EMISSION OUT OF THE RESTRICTED BANDS

APPLICABLE TO	LIMIT	
789033 D02 General UNII Test Procedure New Rules v01	FIELD STRENGTH AT 3m	
	PK:74 (dBuV/m)	AV:54 (dBuV/m)
APPLICABLE TO	EIRP LIMIT	EQUIVALENT FIELD STRENGTH AT 3m
15.407(b)(1)	PK:-27 (dBm/MHz)	PK:68.2(dBuV/m)
15.407(b)(2)		
15.407(b)(3)		
15.407(b)(4)	PK:-27 (dBm/MHz) ^{*1} PK:-17 (dBm/MHz) ^{*2}	PK: 68.2(dBuV/m) ^{*1} PK:78.2 (dBuV/m) ^{*2}

NOTE: ^{*1} beyond 10MHz of the band edge ^{*2} within 10 MHz of band edge

The following formula is used to convert the equipment isotropic radiated power (eirp) to field strength:

$$E = \frac{1000000\sqrt{30P}}{3} \mu\text{V/m, where P is the eirp (Watts).}$$

4.1.2 Test Instruments

For above 1GHz test:

DESCRIPTION & MANUFACTURER	MODEL NO.	SERIAL NO.	CALIBRATED DATE	CALIBRATED UNTIL
Test Receiver Agilent	N9038A	MY51210105	July 24, 2015	July 23, 2016
Horn_Antenna AISI	AIH.8018	000032009111 0	Feb. 09, 2015	Feb. 08, 2016
Pre-Amplifier Agilent	8449B	3008A02578	June 23, 2015	June 22, 2016
RF Cable	NA	131205 131216 131217 SNMY23684/ 4	Jan. 16, 2015	Jan. 15, 2016
Spectrum Analyzer R&S	FSV40	100964	June 26, 2015	June 25, 2016
Pre-Amplifier SPACEK LABS	SLKka-48-6	9K16	Dec. 12, 2014	Dec. 11, 2015
Horn_Antenna SCHWARZBECK	BBHA 9170	9170-424	Feb. 05, 2015	Feb. 04, 2016
RF Cable	NA	329751/4 RF104-204	Dec. 11, 2014	Dec. 10, 2015
Software	ADT_Radiated _V8.7.07	NA	NA	NA
Antenna Tower & Turn Table CT	NA	NA	NA	NA
Power Meter Anritsu	ML2495A	1014008	Apr. 28, 2015	Apr. 27, 2016
Power Sensor Anritsu	MA2411B	0917122	Apr. 28, 2015	Apr. 27, 2016
SPECTRUM ANALYZER R&S	FSP 40	100060	May 08, 2015	May 07, 2016
Temperature & Humidity Chamber GIANTFORCE	GTH-150-40-S P-AR	MAA0812-00 8	Jan. 12, 2015	Jan. 11, 2016

Note:

1. The calibration interval of the above test instruments is 12 months and the calibrations are traceable to NML/ROC and NIST/USA.
2. The test was performed in 966 Chamber No. G.
3. The FCC Site Registration No. is 966073.
4. The VCCI Site Registration No. is G-137.
5. The CANADA Site Registration No. is IC 7450H-2.
6. Tested Date: Aug. 06 to 07, 2015

For below 1GHz test:

DESCRIPTION & MANUFACTURER	MODEL NO.	SERIAL NO.	CALIBRATED DATE	CALIBRATED UNTIL
Test Receiver Agilent	N9038A	MY51210202	Dec. 12, 2014	Dec. 11, 2015
Pre-Amplifier Mini-Circuits	ZFL-1000VH2 B	AMP-ZFL-03	Nov. 12, 2014	Nov. 11, 2015
Trilog Broadband Antenna SCHWARZBECK	VULB 9168	9168-360	Feb. 06, 2015	Feb. 05, 2016
RF Cable	8D-FB	CHGCAB-001 -1 CHGCAB-001 -2	Oct. 04, 2014	Oct. 03, 2015
	RF-141	CHGCAB-004	Oct. 04, 2014	Oct. 03, 2015
Software	ADT_Radiated _V8.7.07	NA	NA	NA
Antenna Tower & Turn Table CT	NA	NA	NA	NA

Note:

1. The calibration interval of the above test instruments is 12 months and the calibrations are traceable to NML/ROC and NIST/USA.
2. The test was performed in 966 Chamber No. G.
3. The FCC Site Registration No. is 966073.
4. The VCCI Site Registration No. is G-137.
5. The CANADA Site Registration No. is IC 7450H-2.
6. Tested Date: July 23, 2015

4.1.3 Test Procedure

- a. The EUT was placed on the top of a rotating table 0.8 meters (for below 1GHz) / 1.5 meters (for above 1GHz) above the ground at 3 meter chamber room for test. The table was rotated 360 degrees to determine the position of the highest radiation.
- b. The EUT was set 3 meters away from the interference-receiving antenna, which was mounted on the top of a variable-height antenna tower.
- c. The height of antenna is varied from one meter to four meters above the ground to determine the maximum value of the field strength. Both horizontal and vertical polarizations of the antenna are set to make the measurement.
- d. For each suspected emission, the EUT was arranged to its worst case and then the antenna was tuned to heights from 1 meter to 4 meters and the rotatable table was turned from 0 degrees to 360 degrees to find the maximum reading.
- e. The test-receiver system was set to quasi-peak detect function and specified bandwidth with maximum hold mode when the test frequency is below 1 GHz.
- f. The test-receiver system was set to peak and average detect function and specified bandwidth with maximum hold mode when the test frequency is above 1 GHz. If the peak reading value also meets average limit, measurement with the average detector is unnecessary.

Note:

1. The resolution bandwidth and video bandwidth of test receiver/spectrum analyzer is 120kHz for Quasi-peak detection (QP) at frequency below 1GHz.
2. The resolution bandwidth of test receiver/spectrum analyzer is 1 MHz and the video bandwidth is 3 MHz for Peak detection (PK) at frequency above 1GHz.
3. The resolution bandwidth of test receiver/spectrum analyzer is 1MHz and the video bandwidth is 3MHz for RMS Average (Duty cycle < 98%) for Average detection (AV) at frequency above 1GHz, then the measurement results was added to a correction factor ($10 \log(1/\text{duty cycle})$).
4. The resolution bandwidth of test receiver/spectrum analyzer is 1MHz and the video bandwidth is 10Hz (Duty cycle $\geq 98\%$) for Average detection (AV) at frequency above 1GHz.
5. All modes of operation were investigated and the worst-case emissions are reported.

4.1.4 Deviation from Test Standard

No deviation.

4.1.5 Test Setup

<Frequency Range below 1GHz>

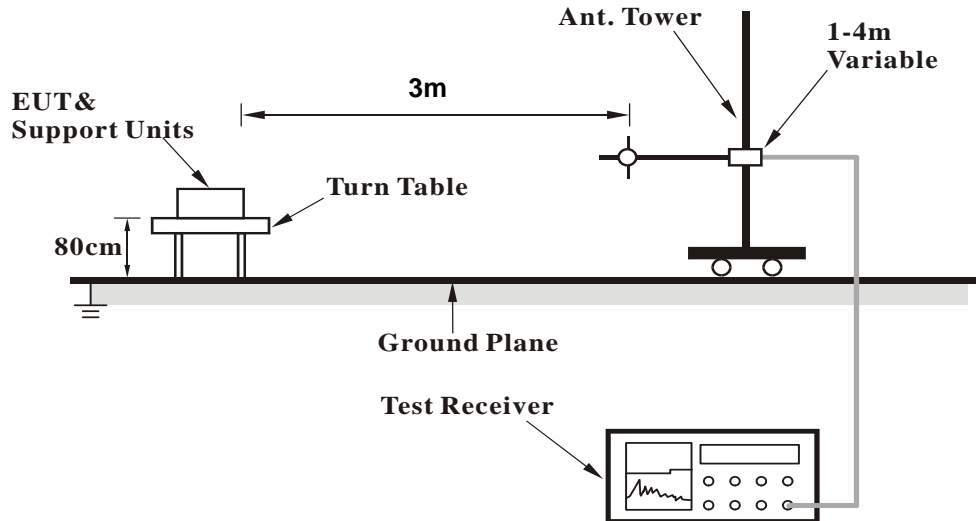

<Frequency Range above 1GHz>

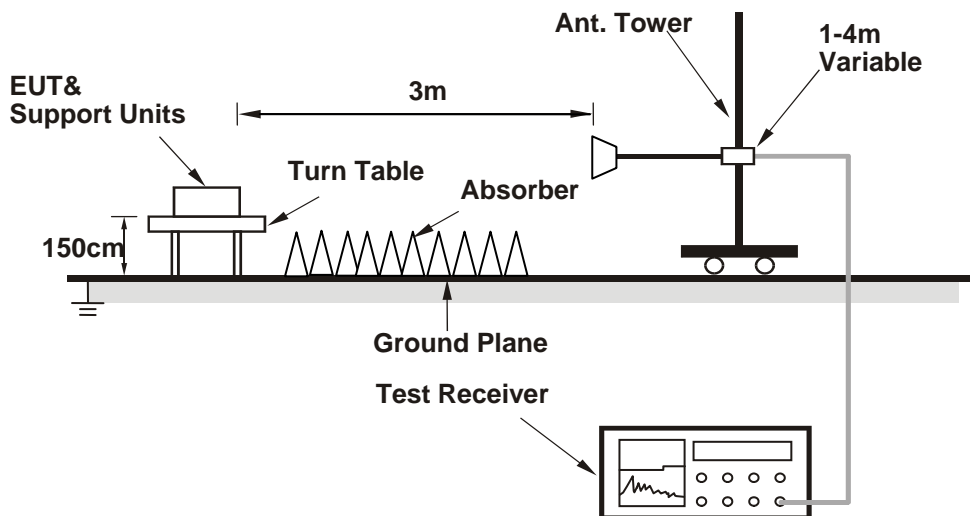

For the actual test configuration, please refer to the attached file (Test Setup Photo).

4.1.6 EUT Operating Condition

- a. Connect the EUT with the support units A & B (Notebook Computer) which is placed in remote site.
- b. Controlling software (artgui.exe [V2.3]) has been activated to set the EUT on specific status.

4.1.7 Test Results

Above 1GHz Data:

802.11a

CHANNEL	TX Channel 36	DETECTOR FUNCTION	Peak (PK)
FREQUENCY RANGE	1GHz ~ 40GHz		Average (AV)

ANTENNA POLARITY & TEST DISTANCE: HORIZONTAL AT 3 M

NO.	FREQ. (MHz)	EMISSION LEVEL (dBuV/m)	LIMIT (dBuV/m)	MARGIN (dB)	ANTENNA HEIGHT (m)	TABLE ANGLE (Degree)	RAW VALUE (dBuV)	CORRECTION FACTOR (dB/m)
1	5150.00	52.8 PK	74.0	-21.2	1.78 H	206	44.47	8.33
2	5150.00	41.2 AV	54.0	-12.8	1.78 H	206	32.87	8.33
3	*5180.00	102.8 PK			1.78 H	206	94.33	8.47
4	*5180.00	93.2 AV			1.78 H	206	84.73	8.47
5	#10360.00	61.1 PK	68.2	-7.1	2.21 H	211	46.60	14.50
6	15540.00	54.5 PK	74.0	-19.5	2.24 H	27	35.82	18.68
7	15540.00	43.0 AV	54.0	-11.0	2.24 H	27	24.32	18.68

ANTENNA POLARITY & TEST DISTANCE: VERTICAL AT 3 M

NO.	FREQ. (MHz)	EMISSION LEVEL (dBuV/m)	LIMIT (dBuV/m)	MARGIN (dB)	ANTENNA HEIGHT (m)	TABLE ANGLE (Degree)	RAW VALUE (dBuV)	CORRECTION FACTOR (dB/m)
1	5150.00	70.6 PK	74.0	-3.4	1.84 V	143	62.27	8.33
2	5150.00	53.5 AV	54.0	-0.5	1.84 V	143	45.17	8.33
3	*5180.00	116.3 PK			1.85 V	337	107.83	8.47
4	*5180.00	106.4 AV			1.85 V	337	97.93	8.47
5	#10360.00	67.6 PK	68.2	-0.6	2.06 V	344	53.10	14.50
6	15540.00	56.7 PK	74.0	-17.3	1.99 V	318	38.02	18.68
7	15540.00	45.3 AV	54.0	-8.7	1.99 V	318	26.62	18.68

REMARKS:

1. Emission Level(dBuV/m) = Raw Value(dBuV) + Correction Factor(dB/m)
2. Correction Factor(dB/m) = Antenna Factor(dB/m) + Cable Factor(dB) – Pre-Amplifier Factor(dB)
3. The other emission levels were very low against the limit.
4. Margin value = Emission Level – Limit value
5. " * ": Fundamental frequency.
6. " # ": The radiated frequency is out of the restricted band.



CHANNEL	TX Channel 40	DETECTOR FUNCTION	Peak (PK)
FREQUENCY RANGE	1GHz ~ 40GHz		Average (AV)

ANTENNA POLARITY & TEST DISTANCE: HORIZONTAL AT 3 M

NO.	FREQ. (MHz)	EMISSION LEVEL (dBuV/m)	LIMIT (dBuV/m)	MARGIN (dB)	ANTENNA HEIGHT (m)	TABLE ANGLE (Degree)	RAW VALUE (dBuV)	CORRECTION FACTOR (dB/m)
1	5150.00	52.5 PK	74.0	-21.5	1.75 H	195	44.17	8.33
2	5150.00	40.8 AV	54.0	-13.2	1.75 H	195	32.47	8.33
3	*5200.00	101.7 PK			1.75 H	195	93.16	8.54
4	*5200.00	92.2 AV			1.75 H	195	83.66	8.54
5	5350.00	53.1 PK	74.0	-20.9	1.75 H	195	44.30	8.80
6	5350.00	41.2 AV	54.0	-12.8	1.75 H	195	32.40	8.80
7	#10400.00	60.7 PK	68.2	-7.5	2.17 H	196	46.10	14.60
8	15600.00	53.9 PK	74.0	-20.1	2.24 H	21	35.00	18.90
9	15600.00	42.4 AV	54.0	-11.6	2.24 H	21	23.50	18.90

ANTENNA POLARITY & TEST DISTANCE: VERTICAL AT 3 M

NO.	FREQ. (MHz)	EMISSION LEVEL (dBuV/m)	LIMIT (dBuV/m)	MARGIN (dB)	ANTENNA HEIGHT (m)	TABLE ANGLE (Degree)	RAW VALUE (dBuV)	CORRECTION FACTOR (dB/m)
1	5150.00	52.6 PK	74.0	-21.4	1.89 V	351	44.27	8.33
2	5150.00	41.0 AV	54.0	-13.0	1.89 V	351	32.67	8.33
3	*5200.00	114.7 PK			1.89 V	351	106.16	8.54
4	*5200.00	105.0 AV			1.89 V	351	96.46	8.54
5	5350.00	52.3 PK	74.0	-21.7	1.89 V	351	43.50	8.80
6	5350.00	40.8 AV	54.0	-13.2	1.89 V	351	32.00	8.80
7	#10400.00	68.0 PK	68.2	-0.2	2.08 V	351	53.40	14.60
8	15600.00	57.1 PK	74.0	-16.9	2.08 V	316	38.20	18.90
9	15600.00	45.4 AV	54.0	-8.6	2.08 V	316	26.50	18.90

REMARKS:

1. Emission Level(dBuV/m) = Raw Value(dBuV) + Correction Factor(dB/m)
2. Correction Factor(dB/m) = Antenna Factor(dB/m) + Cable Factor(dB) – Pre-Amplifier Factor(dB)
3. The other emission levels were very low against the limit.
4. Margin value = Emission Level – Limit value
5. " * ": Fundamental frequency.
6. " # ": The radiated frequency is out of the restricted band.

CHANNEL	TX Channel 48	DETECTOR FUNCTION	Peak (PK)
FREQUENCY RANGE	1GHz ~ 40GHz		Average (AV)

ANTENNA POLARITY & TEST DISTANCE: HORIZONTAL AT 3 M

NO.	FREQ. (MHz)	EMISSION LEVEL (dBuV/m)	LIMIT (dBuV/m)	MARGIN (dB)	ANTENNA HEIGHT (m)	TABLE ANGLE (Degree)	RAW VALUE (dBuV)	CORRECTION FACTOR (dB/m)
1	5150.00	53.2 PK	74.0	-20.8	1.82 H	212	44.87	8.33
2	5150.00	41.1 AV	54.0	-12.9	1.82 H	212	32.77	8.33
3	*5240.00	102.1 PK			1.82 H	212	93.50	8.60
4	*5240.00	92.3 AV			1.82 H	212	83.70	8.60
5	5350.00	53.3 PK	74.0	-20.7	1.82 H	212	44.50	8.80
6	5350.00	41.5 AV	54.0	-12.5	1.82 H	212	32.70	8.80
7	#10480.00	61.4 PK	68.2	-6.8	2.22 H	204	46.93	14.47
8	15720.00	53.8 PK	74.0	-20.2	2.22 H	14	34.76	19.04
9	15720.00	42.5 AV	54.0	-11.5	2.22 H	14	23.46	19.04

ANTENNA POLARITY & TEST DISTANCE: VERTICAL AT 3 M

NO.	FREQ. (MHz)	EMISSION LEVEL (dBuV/m)	LIMIT (dBuV/m)	MARGIN (dB)	ANTENNA HEIGHT (m)	TABLE ANGLE (Degree)	RAW VALUE (dBuV)	CORRECTION FACTOR (dB/m)
1	5150.00	62.5 PK	74.0	-11.5	1.89 V	360	54.17	8.33
2	5150.00	46.2 AV	54.0	-7.8	1.89 V	360	37.87	8.33
3	*5240.00	114.5 PK			1.89 V	360	105.90	8.60
4	*5240.00	104.9 AV			1.89 V	360	96.30	8.60
5	5350.00	62.2 PK	74.0	-11.8	1.84 V	357	53.40	8.80
6	5350.00	46.0 AV	54.0	-8.0	1.84 V	357	37.20	8.80
7	#10480.00	67.8 PK	68.2	-0.4	2.04 V	345	53.33	14.47
8	15720.00	56.8 PK	74.0	-17.2	2.04 V	317	37.76	19.04
9	15720.00	45.2 AV	54.0	-8.8	2.04 V	317	26.16	19.04

REMARKS:

1. Emission Level(dBuV/m) = Raw Value(dBuV) + Correction Factor(dB/m)
2. Correction Factor(dB/m) = Antenna Factor(dB/m) + Cable Factor(dB) – Pre-Amplifier Factor(dB)
3. The other emission levels were very low against the limit.
4. Margin value = Emission Level – Limit value
5. " * ": Fundamental frequency.
6. " # ": The radiated frequency is out of the restricted band.

CHANNEL	TX Channel 149	DETECTOR FUNCTION	Peak (PK)
FREQUENCY RANGE	1GHz ~ 40GHz		Average (AV)

ANTENNA POLARITY & TEST DISTANCE: HORIZONTAL AT 3 M

NO.	FREQ. (MHz)	EMISSION LEVEL (dBuV/m)	LIMIT (dBuV/m)	MARGIN (dB)	ANTENNA HEIGHT (m)	TABLE ANGLE (Degree)	RAW VALUE (dBuV)	CORRECTION FACTOR (dB/m)
1	#5715.00	53.1 PK	74.0	-20.9	1.80 H	199	43.42	9.68
2	#5715.00	40.9 AV	54.0	-13.1	1.80 H	199	31.22	9.68
3	#5725.00	65.2 PK	78.2	-13.0	1.80 H	199	55.50	9.70
4	*5745.00	103.9 PK			1.80 H	199	94.14	9.76
5	*5745.00	94.2 AV			1.80 H	199	84.44	9.76
6	11490.00	55.0 PK	74.0	-19.0	1.85 H	155	40.14	14.86
7	11490.00	43.5 AV	54.0	-10.5	1.85 H	155	28.64	14.86
8	#17235.00	53.1 PK	74.0	-20.9	2.19 H	12	29.87	23.23
9	#17235.00	42.1 AV	54.0	-11.9	2.19 H	12	18.87	23.23

ANTENNA POLARITY & TEST DISTANCE: VERTICAL AT 3 M

NO.	FREQ. (MHz)	EMISSION LEVEL (dBuV/m)	LIMIT (dBuV/m)	MARGIN (dB)	ANTENNA HEIGHT (m)	TABLE ANGLE (Degree)	RAW VALUE (dBuV)	CORRECTION FACTOR (dB/m)
1	#5715.00	61.7 PK	74.0	-12.3	1.81 V	347	52.02	9.68
2	#5715.00	47.1 AV	54.0	-6.9	1.81 V	347	37.42	9.68
3	#5725.00	78.0 PK	78.2	-0.2	1.81 V	252	68.30	9.70
4	*5745.00	116.8 PK			1.79 V	343	107.04	9.76
5	*5745.00	107.3 AV			1.79 V	343	97.54	9.76
6	11490.00	59.4 PK	74.0	-14.6	1.84 V	314	44.54	14.86
7	11490.00	47.9 AV	54.0	-6.1	1.84 V	314	33.04	14.86
8	#17235.00	57.0 PK	74.0	-17.0	2.09 V	327	33.77	23.23
9	#17235.00	45.4 AV	54.0	-8.6	2.09 V	327	22.17	23.23

REMARKS:

1. Emission Level(dBuV/m) = Raw Value(dBuV) + Correction Factor(dB/m)
2. Correction Factor(dB/m) = Antenna Factor(dB/m) + Cable Factor(dB) – Pre-Amplifier Factor(dB)
3. The other emission levels were very low against the limit.
4. Margin value = Emission Level – Limit value
5. " * ": Fundamental frequency.
6. " # ": The radiated frequency is out of the restricted band.

CHANNEL	TX Channel 157	DETECTOR FUNCTION	Peak (PK)
FREQUENCY RANGE	1GHz ~ 40GHz		Average (AV)

ANTENNA POLARITY & TEST DISTANCE: HORIZONTAL AT 3 M

NO.	FREQ. (MHz)	EMISSION LEVEL (dBuV/m)	LIMIT (dBuV/m)	MARGIN (dB)	ANTENNA HEIGHT (m)	TABLE ANGLE (Degree)	RAW VALUE (dBuV)	CORRECTION FACTOR (dB/m)
1	#5715.00	52.7 PK	74.0	-21.3	1.81 H	208	43.02	9.68
2	#5715.00	40.9 AV	54.0	-13.1	1.81 H	208	31.22	9.68
3	#5725.00	64.5 PK	78.2	-13.7	1.81 H	208	54.80	9.70
4	*5785.00	111.3 PK			1.81 H	208	101.45	9.85
5	*5785.00	100.4 AV			1.81 H	208	90.55	9.85
6	#5850.00	65.1 PK	78.2	-13.1	1.81 H	208	55.18	9.92
7	#5863.00	52.8 PK	74.0	-21.2	1.81 H	208	42.87	9.93
8	#5863.00	40.8 AV	54.0	-13.2	1.81 H	208	30.87	9.93
9	11570.00	55.2 PK	74.0	-18.8	1.88 H	152	40.00	15.20
10	11570.00	43.4 AV	54.0	-10.6	1.88 H	152	28.20	15.20
11	#17355.00	52.9 PK	74.0	-21.1	2.23 H	18	29.34	23.56
12	#17355.00	42.2 AV	54.0	-11.8	2.23 H	18	18.64	23.56

ANTENNA POLARITY & TEST DISTANCE: VERTICAL AT 3 M

NO.	FREQ. (MHz)	EMISSION LEVEL (dBuV/m)	LIMIT (dBuV/m)	MARGIN (dB)	ANTENNA HEIGHT (m)	TABLE ANGLE (Degree)	RAW VALUE (dBuV)	CORRECTION FACTOR (dB/m)
1	#5715.00	53.0 PK	74.0	-21.0	1.84 V	355	43.32	9.68
2	#5715.00	41.1 AV	54.0	-12.9	1.84 V	355	31.42	9.68
3	#5725.00	78.0 PK	78.2	-0.2	1.72 V	342	68.30	9.70
4	*5785.00	123.7 PK			1.87 V	346	113.85	9.85
5	*5785.00	113.0 AV			1.87 V	346	103.15	9.85
6	#5850.00	77.9 PK	78.2	-0.3	1.77 V	351	67.98	9.92
7	#5863.00	73.9 PK	74.0	-0.1	1.77 V	0	63.97	9.93
8	#5863.00	50.0 AV	54.0	-4.0	1.77 V	0	40.07	9.93
9	11570.00	59.1 PK	74.0	-14.9	1.81 V	329	43.90	15.20
10	11570.00	47.6 AV	54.0	-6.4	1.81 V	329	32.40	15.20
11	#17355.00	57.1 PK	74.0	-16.9	2.10 V	313	33.54	23.56
12	#17355.00	45.7 AV	54.0	-8.3	2.10 V	313	22.14	23.56

REMARKS:

1. Emission Level(dBuV/m) = Raw Value(dBuV) + Correction Factor(dB/m)
2. Correction Factor(dB/m) = Antenna Factor(dB/m) + Cable Factor(dB) – Pre-Amplifier Factor(dB)
3. The other emission levels were very low against the limit.
4. Margin value = Emission Level – Limit value
5. " * ": Fundamental frequency.
6. " # ": The radiated frequency is out of the restricted band.

CHANNEL	TX Channel 165	DETECTOR FUNCTION	Peak (PK)
FREQUENCY RANGE	1GHz ~ 40GHz		Average (AV)

ANTENNA POLARITY & TEST DISTANCE: HORIZONTAL AT 3 M

NO.	FREQ. (MHz)	EMISSION LEVEL (dBuV/m)	LIMIT (dBuV/m)	MARGIN (dB)	ANTENNA HEIGHT (m)	TABLE ANGLE (Degree)	RAW VALUE (dBuV)	CORRECTION FACTOR (dB/m)
1	*5825.00	105.5 PK			1.79 H	198	95.59	9.91
2	*5825.00	95.6 AV			1.79 H	198	85.69	9.91
3	#5850.00	65.1 PK	78.2	-13.1	1.79 H	198	55.18	9.92
4	#5860.00	52.8 PK	74.0	-21.2	1.79 H	198	42.87	9.93
5	#5860.00	40.7 AV	54.0	-13.3	1.79 H	198	30.77	9.93
6	11650.00	54.7 PK	74.0	-19.3	1.79 H	163	39.30	15.40
7	11650.00	43.2 AV	54.0	-10.8	1.79 H	163	27.80	15.40
8	#17475.00	52.8 PK	74.0	-21.2	2.24 H	0	28.71	24.09
9	#17475.00	41.7 AV	54.0	-12.3	2.24 H	0	17.61	24.09

ANTENNA POLARITY & TEST DISTANCE: VERTICAL AT 3 M

NO.	FREQ. (MHz)	EMISSION LEVEL (dBuV/m)	LIMIT (dBuV/m)	MARGIN (dB)	ANTENNA HEIGHT (m)	TABLE ANGLE (Degree)	RAW VALUE (dBuV)	CORRECTION FACTOR (dB/m)
1	*5825.00	118.8 PK			2.16 V	345	108.89	9.91
2	*5825.00	108.7 AV			2.16 V	345	98.79	9.91
3	#5850.00	77.8 PK	78.2	-0.4	1.74 V	346	67.88	9.92
4	#5860.00	62.0 PK	74.0	-12.0	1.74 V	0	52.07	9.93
5	#5860.00	46.0 AV	54.0	-8.0	1.74 V	0	36.07	9.93
6	11650.00	59.6 PK	74.0	-14.4	1.82 V	335	44.20	15.40
7	11650.00	48.0 AV	54.0	-6.0	1.82 V	335	32.60	15.40
8	#17475.00	56.9 PK	74.0	-17.1	2.16 V	307	32.81	24.09
9	#17475.00	45.3 AV	54.0	-8.7	2.16 V	307	21.21	24.09

REMARKS:

1. Emission Level(dBuV/m) = Raw Value(dBuV) + Correction Factor(dB/m)
2. Correction Factor(dB/m) = Antenna Factor(dB/m) + Cable Factor(dB) – Pre-Amplifier Factor(dB)
3. The other emission levels were very low against the limit.
4. Margin value = Emission Level – Limit value
5. " * ": Fundamental frequency.
6. " # ": The radiated frequency is out of the restricted band.

802.11ac (VHT20)

CHANNEL	TX Channel 36	DETECTOR FUNCTION	Peak (PK)
FREQUENCY RANGE	1GHz ~ 40GHz		Average (AV)

ANTENNA POLARITY & TEST DISTANCE: HORIZONTAL AT 3 M								
NO.	FREQ. (MHz)	EMISSION LEVEL (dBuV/m)	LIMIT (dBuV/m)	MARGIN (dB)	ANTENNA HEIGHT (m)	TABLE ANGLE (Degree)	RAW VALUE (dBuV)	CORRECTION FACTOR (dB/m)
1	5150.00	52.7 PK	74.0	-21.3	1.82 H	205	44.37	8.33
2	5150.00	40.9 AV	54.0	-13.1	1.82 H	205	32.57	8.33
3	*5180.00	104.5 PK			1.82 H	205	96.03	8.47
4	*5180.00	94.5 AV			1.82 H	205	86.03	8.47
5	#10360.00	61.0 PK	74.0	-13.0	2.17 H	200	46.50	14.50
6	#10360.00	49.0 AV	54.0	-5.0	2.17 H	200	34.50	14.50
7	15540.00	54.1 PK	74.0	-19.9	2.26 H	41	35.42	18.68
8	15540.00	42.6 AV	54.0	-11.4	2.26 H	41	23.92	18.68

ANTENNA POLARITY & TEST DISTANCE: VERTICAL AT 3 M								
NO.	FREQ. (MHz)	EMISSION LEVEL (dBuV/m)	LIMIT (dBuV/m)	MARGIN (dB)	ANTENNA HEIGHT (m)	TABLE ANGLE (Degree)	RAW VALUE (dBuV)	CORRECTION FACTOR (dB/m)
1	5150.00	65.6 PK	74.0	-8.4	2.16 V	304	57.27	8.33
2	5150.00	53.5 AV	54.0	-0.5	2.16 V	304	45.17	8.33
3	*5180.00	117.1 PK			2.04 V	344	108.63	8.47
4	*5180.00	107.1 AV			2.04 V	344	98.63	8.47
5	#10360.00	59.3 PK	74.0	-14.7	1.82 V	329	44.80	14.50
6	#10360.00	47.8 AV	54.0	-6.2	1.82 V	329	33.30	14.50
7	15540.00	57.2 PK	74.0	-16.8	2.13 V	301	38.52	18.68
8	15540.00	45.4 AV	54.0	-8.6	2.13 V	301	26.72	18.68

REMARKS:

1. Emission Level(dBuV/m) = Raw Value(dBuV) + Correction Factor(dB/m)
2. Correction Factor(dB/m) = Antenna Factor(dB/m) + Cable Factor(dB) – Pre-Amplifier Factor(dB)
3. The other emission levels were very low against the limit.
4. Margin value = Emission Level – Limit value
5. " * ": Fundamental frequency.
6. " # ": The radiated frequency is out of the restricted band.

CHANNEL	TX Channel 40	DETECTOR FUNCTION	Peak (PK)
FREQUENCY RANGE	1GHz ~ 40GHz		Average (AV)

ANTENNA POLARITY & TEST DISTANCE: HORIZONTAL AT 3 M

NO.	FREQ. (MHz)	EMISSION LEVEL (dBuV/m)	LIMIT (dBuV/m)	MARGIN (dB)	ANTENNA HEIGHT (m)	TABLE ANGLE (Degree)	RAW VALUE (dBuV)	CORRECTION FACTOR (dB/m)
1	5150.00	53.3 PK	74.0	-20.7	1.77 H	213	44.97	8.33
2	5150.00	41.5 AV	54.0	-12.5	1.77 H	213	33.17	8.33
3	*5200.00	104.7 PK			1.77 H	213	96.16	8.54
4	*5200.00	94.9 AV			1.77 H	213	86.36	8.54
5	#10400.00	54.6 PK	68.2	-13.6	2.23 H	205	40.00	14.60
6	15600.00	54.7 PK	74.0	-19.3	2.21 H	35	35.80	18.90
7	15600.00	43.0 AV	54.0	-11.0	2.21 H	35	24.10	18.90

ANTENNA POLARITY & TEST DISTANCE: VERTICAL AT 3 M

NO.	FREQ. (MHz)	EMISSION LEVEL (dBuV/m)	LIMIT (dBuV/m)	MARGIN (dB)	ANTENNA HEIGHT (m)	TABLE ANGLE (Degree)	RAW VALUE (dBuV)	CORRECTION FACTOR (dB/m)
1	5150.00	53.2 PK	74.0	-20.8	1.85 V	350	44.87	8.33
2	5150.00	41.4 AV	54.0	-12.6	1.85 V	350	33.07	8.33
3	*5200.00	117.8 PK			2.00 V	356	109.26	8.54
4	*5200.00	108.0 AV			2.00 V	356	99.46	8.54
5	#10400.00	68.1 PK	68.2	-0.1	2.05 V	351	53.50	14.60
6	15600.00	57.5 PK	74.0	-16.5	2.17 V	306	38.60	18.90
7	15600.00	45.6 AV	54.0	-8.4	2.17 V	306	26.70	18.90

REMARKS:

1. Emission Level(dBuV/m) = Raw Value(dBuV) + Correction Factor(dB/m)
2. Correction Factor(dB/m) = Antenna Factor(dB/m) + Cable Factor(dB) – Pre-Amplifier Factor(dB)
3. The other emission levels were very low against the limit.
4. Margin value = Emission Level – Limit value
5. " * ": Fundamental frequency.
6. " # ": The radiated frequency is out of the restricted band.

CHANNEL	TX Channel 48	DETECTOR FUNCTION	Peak (PK)
FREQUENCY RANGE	1GHz ~ 40GHz		Average (AV)

ANTENNA POLARITY & TEST DISTANCE: HORIZONTAL AT 3 M

NO.	FREQ. (MHz)	EMISSION LEVEL (dBuV/m)	LIMIT (dBuV/m)	MARGIN (dB)	ANTENNA HEIGHT (m)	TABLE ANGLE (Degree)	RAW VALUE (dBuV)	CORRECTION FACTOR (dB/m)
1	5150.00	53.3 PK	74.0	-20.7	1.80 H	213	44.97	8.33
2	5150.00	41.5 AV	54.0	-12.5	1.80 H	213	33.17	8.33
3	*5240.00	105.2 PK			1.80 H	213	96.60	8.60
4	*5240.00	95.2 AV			1.80 H	213	86.60	8.60
5	5350.00	53.3 PK	74.0	-20.7	1.80 H	213	44.50	8.80
6	5350.00	41.4 AV	54.0	-12.6	1.80 H	213	32.60	8.80
7	#10480.00	55.4 PK	68.2	-12.8	2.15 H	204	40.93	14.47
8	15720.00	54.4 PK	74.0	-19.6	2.20 H	30	35.36	19.04
9	15720.00	42.7 AV	54.0	-11.3	2.20 H	30	23.66	19.04

ANTENNA POLARITY & TEST DISTANCE: VERTICAL AT 3 M

NO.	FREQ. (MHz)	EMISSION LEVEL (dBuV/m)	LIMIT (dBuV/m)	MARGIN (dB)	ANTENNA HEIGHT (m)	TABLE ANGLE (Degree)	RAW VALUE (dBuV)	CORRECTION FACTOR (dB/m)
1	5150.00	52.6 PK	74.0	-21.4	1.92 V	360	44.27	8.33
2	5150.00	41.2 AV	54.0	-12.8	1.92 V	360	32.87	8.33
3	*5240.00	117.8 PK			2.02 V	360	109.20	8.60
4	*5240.00	108.0 AV			2.02 V	360	99.40	8.60
5	5350.00	52.5 PK	74.0	-21.5	1.89 V	340	43.70	8.80
6	5350.00	41.0 AV	54.0	-13.0	1.89 V	340	32.20	8.80
7	#10480.00	68.1 PK	68.2	-0.1	2.03 V	356	53.63	14.47
8	15720.00	57.6 PK	74.0	-16.4	2.18 V	299	38.56	19.04
9	15720.00	45.6 AV	54.0	-8.4	2.18 V	299	26.56	19.04

REMARKS:

1. Emission Level(dBuV/m) = Raw Value(dBuV) + Correction Factor(dB/m)
2. Correction Factor(dB/m) = Antenna Factor(dB/m) + Cable Factor(dB) – Pre-Amplifier Factor(dB)
3. The other emission levels were very low against the limit.
4. Margin value = Emission Level – Limit value
5. " * ": Fundamental frequency.
6. " # ": The radiated frequency is out of the restricted band.

CHANNEL	TX Channel 149	DETECTOR FUNCTION	Peak (PK)
FREQUENCY RANGE	1GHz ~ 40GHz		Average (AV)

ANTENNA POLARITY & TEST DISTANCE: HORIZONTAL AT 3 M

NO.	FREQ. (MHz)	EMISSION LEVEL (dBuV/m)	LIMIT (dBuV/m)	MARGIN (dB)	ANTENNA HEIGHT (m)	TABLE ANGLE (Degree)	RAW VALUE (dBuV)	CORRECTION FACTOR (dB/m)
1	#5715.00	53.2 PK	74.0	-20.8	1.82 H	218	43.52	9.68
2	#5715.00	41.4 AV	54.0	-12.6	1.82 H	218	31.72	9.68
3	#5725.00	64.9 PK	78.2	-13.3	1.82 H	218	55.20	9.70
4	*5745.00	104.6 PK			1.82 H	218	94.84	9.76
5	*5745.00	94.8 AV			1.82 H	218	85.04	9.76
6	11490.00	55.5 PK	74.0	-18.5	1.83 H	159	40.64	14.86
7	11490.00	43.8 AV	54.0	-10.2	1.83 H	159	28.94	14.86
8	#17235.00	53.5 PK	74.0	-20.5	2.17 H	0	30.27	23.23
9	#17235.00	42.4 AV	54.0	-11.6	2.17 H	0	19.17	23.23

ANTENNA POLARITY & TEST DISTANCE: VERTICAL AT 3 M

NO.	FREQ. (MHz)	EMISSION LEVEL (dBuV/m)	LIMIT (dBuV/m)	MARGIN (dB)	ANTENNA HEIGHT (m)	TABLE ANGLE (Degree)	RAW VALUE (dBuV)	CORRECTION FACTOR (dB/m)
1	#5715.00	66.8 PK	74.0	-7.2	1.82 V	346	57.12	9.68
2	#5715.00	50.8 AV	54.0	-3.2	1.82 V	346	41.12	9.68
3	#5725.00	77.4 PK	78.2	-0.8	1.99 V	292	67.70	9.70
4	*5745.00	117.0 PK			1.91 V	349	107.24	9.76
5	*5745.00	107.4 AV			1.91 V	349	97.64	9.76
6	11490.00	58.7 PK	74.0	-15.3	1.84 V	316	43.84	14.86
7	11490.00	47.5 AV	54.0	-6.5	1.84 V	316	32.64	14.86
8	#17235.00	56.5 PK	74.0	-17.5	2.10 V	307	33.27	23.23
9	#17235.00	45.0 AV	54.0	-9.0	2.10 V	307	21.77	23.23

REMARKS:

1. Emission Level(dBuV/m) = Raw Value(dBuV) + Correction Factor(dB/m)
2. Correction Factor(dB/m) = Antenna Factor(dB/m) + Cable Factor(dB) – Pre-Amplifier Factor(dB)
3. The other emission levels were very low against the limit.
4. Margin value = Emission Level – Limit value
5. " * ": Fundamental frequency.
6. " # ": The radiated frequency is out of the restricted band.

CHANNEL	TX Channel 157	DETECTOR FUNCTION	Peak (PK)
FREQUENCY RANGE	1GHz ~ 40GHz		Average (AV)

ANTENNA POLARITY & TEST DISTANCE: HORIZONTAL AT 3 M

NO.	FREQ. (MHz)	EMISSION LEVEL (dBuV/m)	LIMIT (dBuV/m)	MARGIN (dB)	ANTENNA HEIGHT (m)	TABLE ANGLE (Degree)	RAW VALUE (dBuV)	CORRECTION FACTOR (dB/m)
1	#5715.00	53.1 PK	74.0	-20.9	1.82 H	200	43.42	9.68
2	#5715.00	41.0 AV	54.0	-13.0	1.82 H	200	31.32	9.68
3	#5725.00	65.3 PK	78.2	-12.9	1.82 H	200	55.60	9.70
4	*5785.00	111.2 PK			1.82 H	200	101.35	9.85
5	*5785.00	100.3 AV			1.82 H	200	90.45	9.85
6	#5850.00	65.5 PK	78.2	-12.7	1.82 H	200	55.58	9.92
7	#5860.00	52.9 PK	74.0	-21.1	1.82 H	200	42.97	9.93
8	#5860.00	41.2 AV	54.0	-12.8	1.82 H	200	31.27	9.93
9	11570.00	54.8 PK	74.0	-19.2	1.86 H	157	39.60	15.20
10	11570.00	43.4 AV	54.0	-10.6	1.86 H	157	28.20	15.20
11	#17355.00	53.1 PK	74.0	-20.9	2.15 H	6	29.54	23.56
12	#17355.00	41.9 AV	54.0	-12.1	2.15 H	6	18.34	23.56

ANTENNA POLARITY & TEST DISTANCE: VERTICAL AT 3 M

NO.	FREQ. (MHz)	EMISSION LEVEL (dBuV/m)	LIMIT (dBuV/m)	MARGIN (dB)	ANTENNA HEIGHT (m)	TABLE ANGLE (Degree)	RAW VALUE (dBuV)	CORRECTION FACTOR (dB/m)
1	#5715.00	68.8 PK	74.0	-5.2	1.80 V	350	59.12	9.68
2	#5715.00	51.6 AV	54.0	-2.4	1.80 V	350	41.92	9.68
3	#5725.00	77.9 PK	78.2	-0.3	1.95 V	343	68.20	9.70
4	*5785.00	123.5 PK			1.91 V	356	113.65	9.85
5	*5785.00	112.9 AV			1.91 V	356	103.05	9.85
6	#5850.00	78.1 PK	78.2	-0.1	1.89 V	356	68.18	9.92
7	#5860.00	69.2 PK	74.0	-4.8	1.78 V	349	59.27	9.93
8	#5860.00	49.3 AV	54.0	-4.7	1.78 V	349	39.37	9.93
9	11570.00	62.1 PK	74.0	-11.9	2.04 V	195	46.90	15.20
10	11570.00	50.4 AV	54.0	-3.6	2.04 V	195	35.20	15.20
11	#17355.00	56.6 PK	74.0	-17.4	2.12 V	295	33.04	23.56
12	#17355.00	45.1 AV	54.0	-8.9	2.12 V	295	21.54	23.56

REMARKS:

1. Emission Level(dBuV/m) = Raw Value(dBuV) + Correction Factor(dB/m)
2. Correction Factor(dB/m) = Antenna Factor(dB/m) + Cable Factor(dB) – Pre-Amplifier Factor(dB)
3. The other emission levels were very low against the limit.
4. Margin value = Emission Level – Limit value
5. " * ": Fundamental frequency.
6. " # ": The radiated frequency is out of the restricted band.

CHANNEL	TX Channel 165	DETECTOR FUNCTION	Peak (PK)
FREQUENCY RANGE	1GHz ~ 40GHz		Average (AV)

ANTENNA POLARITY & TEST DISTANCE: HORIZONTAL AT 3 M

NO.	FREQ. (MHz)	EMISSION LEVEL (dBuV/m)	LIMIT (dBuV/m)	MARGIN (dB)	ANTENNA HEIGHT (m)	TABLE ANGLE (Degree)	RAW VALUE (dBuV)	CORRECTION FACTOR (dB/m)
1	*5825.00	106.7 PK			1.74 H	203	96.79	9.91
2	*5825.00	97.0 AV			1.74 H	203	87.09	9.91
3	#5850.00	65.0 PK	78.2	-13.2	1.74 H	203	55.08	9.92
4	#5860.00	52.5 PK	74.0	-21.5	1.74 H	203	42.57	9.93
5	#5860.00	40.8 AV	54.0	-13.2	1.74 H	203	30.87	9.93
6	11650.00	55.4 PK	74.0	-18.6	1.83 H	145	40.00	15.40
7	11650.00	44.0 AV	54.0	-10.0	1.83 H	145	28.60	15.40
8	#17475.00	52.7 PK	74.0	-21.3	2.17 H	12	28.61	24.09
9	#17475.00	41.8 AV	54.0	-12.2	2.17 H	12	17.71	24.09

ANTENNA POLARITY & TEST DISTANCE: VERTICAL AT 3 M

NO.	FREQ. (MHz)	EMISSION LEVEL (dBuV/m)	LIMIT (dBuV/m)	MARGIN (dB)	ANTENNA HEIGHT (m)	TABLE ANGLE (Degree)	RAW VALUE (dBuV)	CORRECTION FACTOR (dB/m)
1	*5825.00	119.5 PK			1.80 V	353	109.59	9.91
2	*5825.00	109.6 AV			1.80 V	353	99.69	9.91
3	#5850.00	77.9 PK	78.2	-0.3	1.80 V	335	67.98	9.92
4	#5860.00	62.4 PK	74.0	-11.6	1.80 V	353	52.47	9.93
5	#5860.00	46.8 AV	54.0	-7.2	1.80 V	353	36.87	9.93
6	11650.00	59.4 PK	74.0	-14.6	1.83 V	321	44.00	15.40
7	11650.00	48.0 AV	54.0	-6.0	1.83 V	321	32.60	15.40
8	#17475.00	56.9 PK	74.0	-17.1	2.09 V	297	32.81	24.09
9	#17475.00	45.1 AV	54.0	-8.9	2.09 V	297	21.01	24.09

REMARKS:

1. Emission Level(dBuV/m) = Raw Value(dBuV) + Correction Factor(dB/m)
2. Correction Factor(dB/m) = Antenna Factor(dB/m) + Cable Factor(dB) – Pre-Amplifier Factor(dB)
3. The other emission levels were very low against the limit.
4. Margin value = Emission Level – Limit value
5. " * ": Fundamental frequency.
6. " # ": The radiated frequency is out of the restricted band.

802.11ac (VHT40)

CHANNEL	TX Channel 38	DETECTOR FUNCTION	Peak (PK)
FREQUENCY RANGE	1GHz ~ 40GHz		Average (AV)

ANTENNA POLARITY & TEST DISTANCE: HORIZONTAL AT 3 M

NO.	FREQ. (MHz)	EMISSION LEVEL (dBuV/m)	LIMIT (dBuV/m)	MARGIN (dB)	ANTENNA HEIGHT (m)	TABLE ANGLE (Degree)	RAW VALUE (dBuV)	CORRECTION FACTOR (dB/m)
1	5150.00	53.3 PK	74.0	-20.7	1.74 H	211	44.97	8.33
2	5150.00	41.1 AV	54.0	-12.9	1.74 H	211	32.77	8.33
3	*5190.00	97.1 PK			1.74 H	211	88.60	8.50
4	*5190.00	86.7 AV			1.74 H	211	78.20	8.50
5	5350.00	53.5 PK	74.0	-20.5	1.74 H	211	44.70	8.80
6	5350.00	41.3 AV	54.0	-12.7	1.74 H	211	32.50	8.80
7	#10380.00	60.6 PK	74.0	-13.4	2.23 H	196	46.05	14.55
8	#10380.00	48.9 AV	54.0	-5.1	2.23 H	196	34.35	14.55
9	15570.00	54.7 PK	74.0	-19.3	2.19 H	28	35.91	18.79
10	15570.00	43.3 AV	54.0	-10.7	2.19 H	28	24.51	18.79

ANTENNA POLARITY & TEST DISTANCE: VERTICAL AT 3 M

NO.	FREQ. (MHz)	EMISSION LEVEL (dBuV/m)	LIMIT (dBuV/m)	MARGIN (dB)	ANTENNA HEIGHT (m)	TABLE ANGLE (Degree)	RAW VALUE (dBuV)	CORRECTION FACTOR (dB/m)
1	5150.00	69.1 PK	74.0	-4.9	1.80 V	360	60.77	8.33
2	5150.00	53.4 AV	54.0	-0.6	1.80 V	360	45.07	8.33
3	*5190.00	110.4 PK			1.80 V	336	101.90	8.50
4	*5190.00	100.2 AV			1.80 V	336	91.70	8.50
5	5350.00	56.8 PK	74.0	-17.2	1.80 V	333	48.00	8.80
6	5350.00	44.3 AV	54.0	-9.7	1.80 V	333	35.50	8.80
7	#10380.00	59.7 PK	74.0	-14.3	1.77 V	339	45.15	14.55
8	#10380.00	48.1 AV	54.0	-5.9	1.77 V	339	33.55	14.55
9	15570.00	56.8 PK	74.0	-17.2	2.10 V	310	38.01	18.79
10	15570.00	45.0 AV	54.0	-9.0	2.10 V	310	26.21	18.79

REMARKS:

1. Emission Level(dBuV/m) = Raw Value(dBuV) + Correction Factor(dB/m)
2. Correction Factor(dB/m) = Antenna Factor(dB/m) + Cable Factor(dB) – Pre-Amplifier Factor(dB)
3. The other emission levels were very low against the limit.
4. Margin value = Emission Level – Limit value
5. " * ": Fundamental frequency.
6. " # ": The radiated frequency is out of the restricted band.

CHANNEL	TX Channel 46	DETECTOR FUNCTION	Peak (PK)
FREQUENCY RANGE	1GHz ~ 40GHz		Average (AV)

ANTENNA POLARITY & TEST DISTANCE: HORIZONTAL AT 3 M

NO.	FREQ. (MHz)	EMISSION LEVEL (dBuV/m)	LIMIT (dBuV/m)	MARGIN (dB)	ANTENNA HEIGHT (m)	TABLE ANGLE (Degree)	RAW VALUE (dBuV)	CORRECTION FACTOR (dB/m)
1	5150.00	52.4 PK	74.0	-21.6	1.76 H	206	44.07	8.33
2	5150.00	40.6 AV	54.0	-13.4	1.76 H	206	32.27	8.33
3	*5230.00	103.9 PK			1.76 H	206	95.31	8.59
4	*5230.00	93.6 AV			1.76 H	206	85.01	8.59
5	5350.00	52.3 PK	74.0	-21.7	1.76 H	206	43.50	8.80
6	5350.00	40.6 AV	54.0	-13.4	1.76 H	206	31.80	8.80
7	#10460.00	54.5 PK	68.2	-13.7	2.20 H	214	39.99	14.51
8	15690.00	54.6 PK	74.0	-19.4	2.29 H	30	35.63	18.97
9	15690.00	43.3 AV	54.0	-10.7	2.29 H	30	24.33	18.97

ANTENNA POLARITY & TEST DISTANCE: VERTICAL AT 3 M

NO.	FREQ. (MHz)	EMISSION LEVEL (dBuV/m)	LIMIT (dBuV/m)	MARGIN (dB)	ANTENNA HEIGHT (m)	TABLE ANGLE (Degree)	RAW VALUE (dBuV)	CORRECTION FACTOR (dB/m)
1	5150.00	66.4 PK	74.0	-7.6	1.70 V	143	58.07	8.33
2	5150.00	53.1 AV	54.0	-0.9	1.70 V	143	44.77	8.33
3	*5230.00	117.3 PK			1.92 V	344	108.71	8.59
4	*5230.00	106.8 AV			1.92 V	344	98.21	8.59
5	5350.00	61.0 PK	74.0	-13.0	1.77 V	337	52.20	8.80
6	5350.00	46.4 AV	54.0	-7.6	1.77 V	337	37.60	8.80
7	#10460.00	67.6 PK	68.2	-0.6	2.13 V	192	53.09	14.51
8	15690.00	56.9 PK	74.0	-17.1	2.17 V	290	37.93	18.97
9	15690.00	45.1 AV	54.0	-8.9	2.17 V	290	26.13	18.97

REMARKS:

1. Emission Level(dBuV/m) = Raw Value(dBuV) + Correction Factor(dB/m)
2. Correction Factor(dB/m) = Antenna Factor(dB/m) + Cable Factor(dB) – Pre-Amplifier Factor(dB)
3. The other emission levels were very low against the limit.
4. Margin value = Emission Level – Limit value
5. " * ": Fundamental frequency.
6. " # ": The radiated frequency is out of the restricted band.

CHANNEL	TX Channel 151	DETECTOR FUNCTION	Peak (PK)
FREQUENCY RANGE	1GHz ~ 40GHz		Average (AV)

ANTENNA POLARITY & TEST DISTANCE: HORIZONTAL AT 3 M

NO.	FREQ. (MHz)	EMISSION LEVEL (dBuV/m)	LIMIT (dBuV/m)	MARGIN (dB)	ANTENNA HEIGHT (m)	TABLE ANGLE (Degree)	RAW VALUE (dBuV)	CORRECTION FACTOR (dB/m)
1	#5715.00	53.0 PK	74.0	-21.0	1.80 H	191	43.32	9.68
2	#5715.00	41.0 AV	54.0	-13.0	1.80 H	191	31.32	9.68
3	#5725.00	59.0 PK	78.2	-19.2	1.80 H	191	49.30	9.70
4	*5755.00	96.2 PK			1.80 H	191	86.43	9.77
5	*5755.00	85.9 AV			1.80 H	191	76.13	9.77
6	11510.00	55.4 PK	74.0	-18.6	1.80 H	145	40.55	14.85
7	11510.00	44.0 AV	54.0	-10.0	1.80 H	145	29.15	14.85
8	#17265.00	53.1 PK	74.0	-20.9	2.21 H	7	29.87	23.23
9	#17265.00	42.0 AV	54.0	-12.0	2.21 H	7	18.77	23.23

ANTENNA POLARITY & TEST DISTANCE: VERTICAL AT 3 M

NO.	FREQ. (MHz)	EMISSION LEVEL (dBuV/m)	LIMIT (dBuV/m)	MARGIN (dB)	ANTENNA HEIGHT (m)	TABLE ANGLE (Degree)	RAW VALUE (dBuV)	CORRECTION FACTOR (dB/m)
1	#5715.00	67.9 PK	74.0	-6.1	1.89 V	344	58.22	9.68
2	#5715.00	53.4 AV	54.0	-0.6	1.89 V	344	43.72	9.68
3	#5725.00	72.0 PK	78.2	-6.2	2.01 V	268	62.30	9.70
4	*5755.00	109.1 PK			2.03 V	354	99.33	9.77
5	*5755.00	98.8 AV			2.03 V	354	89.03	9.77
6	11510.00	59.9 PK	74.0	-14.1	1.81 V	321	45.05	14.85
7	11510.00	48.3 AV	54.0	-5.7	1.81 V	321	33.45	14.85
8	#17265.00	57.3 PK	74.0	-16.7	2.15 V	287	34.07	23.23
9	#17265.00	45.4 AV	54.0	-8.6	2.15 V	287	22.17	23.23

REMARKS:

1. Emission Level(dBuV/m) = Raw Value(dBuV) + Correction Factor(dB/m)
2. Correction Factor(dB/m) = Antenna Factor(dB/m) + Cable Factor(dB) – Pre-Amplifier Factor(dB)
3. The other emission levels were very low against the limit.
4. Margin value = Emission Level – Limit value
5. " * ": Fundamental frequency.
6. " # ": The radiated frequency is out of the restricted band.

CHANNEL	TX Channel 159	DETECTOR FUNCTION	Peak (PK)
FREQUENCY RANGE	1GHz ~ 40GHz		Average (AV)

ANTENNA POLARITY & TEST DISTANCE: HORIZONTAL AT 3 M

NO.	FREQ. (MHz)	EMISSION LEVEL (dBuV/m)	LIMIT (dBuV/m)	MARGIN (dB)	ANTENNA HEIGHT (m)	TABLE ANGLE (Degree)	RAW VALUE (dBuV)	CORRECTION FACTOR (dB/m)
1	#5715.00	53.0 PK	74.0	-21.0	1.73 H	198	43.32	9.68
2	#5715.00	41.3 AV	54.0	-12.7	1.73 H	198	31.62	9.68
3	*5795.00	102.3 PK			1.73 H	198	92.42	9.88
4	*5795.00	91.9 AV			1.73 H	198	82.02	9.88
5	#5850.00	58.4 PK	78.2	-19.8	1.73 H	198	48.48	9.92
6	#5860.00	53.0 PK	74.0	-21.0	1.73 H	198	43.07	9.93
7	#5860.00	41.4 AV	54.0	-12.6	1.73 H	198	31.47	9.93
8	11590.00	54.6 PK	74.0	-19.4	1.85 H	144	39.29	15.31
9	11590.00	43.3 AV	54.0	-10.7	1.85 H	144	27.99	15.31
10	#17385.00	52.5 PK	74.0	-21.5	2.15 H	4	28.74	23.76
11	#17385.00	41.8 AV	54.0	-12.2	2.15 H	4	18.04	23.76

ANTENNA POLARITY & TEST DISTANCE: VERTICAL AT 3 M

NO.	FREQ. (MHz)	EMISSION LEVEL (dBuV/m)	LIMIT (dBuV/m)	MARGIN (dB)	ANTENNA HEIGHT (m)	TABLE ANGLE (Degree)	RAW VALUE (dBuV)	CORRECTION FACTOR (dB/m)
1	#5715.00	66.8 PK	74.0	-7.2	1.91 V	343	57.12	9.68
2	#5715.00	49.7 AV	54.0	-4.3	1.91 V	343	40.02	9.68
3	*5795.00	115.7 PK			2.10 V	359	105.82	9.88
4	*5795.00	105.1 AV			2.10 V	359	95.22	9.88
5	#5850.00	71.3 PK	78.2	-6.9	1.95 V	354	61.38	9.92
6	#5860.00	69.2 PK	74.0	-4.8	2.13 V	351	59.27	9.93
7	#5860.00	53.2 AV	54.0	-0.8	2.13 V	351	43.27	9.93
8	11590.00	59.2 PK	74.0	-14.8	1.77 V	329	43.89	15.31
9	11590.00	47.7 AV	54.0	-6.3	1.77 V	329	32.39	15.31
10	#17385.00	56.7 PK	74.0	-17.3	2.14 V	305	32.94	23.76
11	#17385.00	45.0 AV	54.0	-9.0	2.14 V	305	21.24	23.76

REMARKS:

1. Emission Level(dBuV/m) = Raw Value(dBuV) + Correction Factor(dB/m)
2. Correction Factor(dB/m) = Antenna Factor(dB/m) + Cable Factor(dB) – Pre-Amplifier Factor(dB)
3. The other emission levels were very low against the limit.
4. Margin value = Emission Level – Limit value
5. " * ": Fundamental frequency.
6. " # ": The radiated frequency is out of the restricted band.

802.11ac (VHT80)

CHANNEL	TX Channel 42	DETECTOR FUNCTION	Peak (PK)
FREQUENCY RANGE	1GHz ~ 40GHz		Average (AV)

ANTENNA POLARITY & TEST DISTANCE: HORIZONTAL AT 3 M

NO.	FREQ. (MHz)	EMISSION LEVEL (dBuV/m)	LIMIT (dBuV/m)	MARGIN (dB)	ANTENNA HEIGHT (m)	TABLE ANGLE (Degree)	RAW VALUE (dBuV)	CORRECTION FACTOR (dB/m)
1	5150.00	53.5 PK	74.0	-20.5	1.72 H	205	45.17	8.33
2	5150.00	41.4 AV	54.0	-12.6	1.72 H	205	33.07	8.33
3	*5210.00	92.5 PK			1.72 H	205	83.95	8.55
4	*5210.00	82.3 AV			1.72 H	205	73.75	8.55
5	5350.00	52.8 PK	74.0	-21.2	1.72 H	205	44.00	8.80
6	5350.00	40.7 AV	54.0	-13.3	1.72 H	205	31.90	8.80
7	#10420.00	54.9 PK	74.0	-19.1	1.86 H	168	40.33	14.57
8	#10420.00	43.4 AV	54.0	-10.6	1.86 H	168	28.83	14.57
9	15630.00	52.7 PK	74.0	-21.3	2.23 H	5	33.77	18.93
10	15630.00	41.7 AV	54.0	-12.3	2.23 H	5	22.77	18.93

ANTENNA POLARITY & TEST DISTANCE: VERTICAL AT 3 M

NO.	FREQ. (MHz)	EMISSION LEVEL (dBuV/m)	LIMIT (dBuV/m)	MARGIN (dB)	ANTENNA HEIGHT (m)	TABLE ANGLE (Degree)	RAW VALUE (dBuV)	CORRECTION FACTOR (dB/m)
1	5150.00	67.4 PK	74.0	-6.6	1.96 V	359	59.07	8.33
2	5150.00	53.5 AV	54.0	-0.5	1.96 V	359	45.17	8.33
3	*5210.00	104.9 PK			1.81 V	337	96.35	8.55
4	*5210.00	95.0 AV			1.81 V	337	86.45	8.55
5	5350.00	52.7 PK	74.0	-21.3	1.94 V	348	43.90	8.80
6	5350.00	40.9 AV	54.0	-13.1	1.94 V	348	32.10	8.80
7	#10420.00	59.2 PK	74.0	-14.8	1.84 V	342	44.63	14.57
8	#10420.00	47.5 AV	54.0	-6.5	1.84 V	342	32.93	14.57
9	15630.00	57.5 PK	74.0	-16.5	2.14 V	298	38.57	18.93
10	15630.00	45.5 AV	54.0	-8.5	2.14 V	298	26.57	18.93

REMARKS:

- Emission Level(dBuV/m) = Raw Value(dBuV) + Correction Factor(dB/m)
- Correction Factor(dB/m) = Antenna Factor(dB/m) + Cable Factor(dB) – Pre-Amplifier Factor(dB)
- The other emission levels were very low against the limit.
- Margin value = Emission Level – Limit value
- " * ": Fundamental frequency.
- " # ": The radiated frequency is out of the restricted band.

CHANNEL	TX Channel 155	DETECTOR FUNCTION	Peak (PK)
FREQUENCY RANGE	1GHz ~ 40GHz		Average (AV)

ANTENNA POLARITY & TEST DISTANCE: HORIZONTAL AT 3 M

NO.	FREQ. (MHz)	EMISSION LEVEL (dBuV/m)	LIMIT (dBuV/m)	MARGIN (dB)	ANTENNA HEIGHT (m)	TABLE ANGLE (Degree)	RAW VALUE (dBuV)	CORRECTION FACTOR (dB/m)
1	#5715.00	53.0 PK	74.0	-21.0	1.81 H	212	43.32	9.68
2	#5715.00	41.2 AV	54.0	-12.8	1.81 H	212	31.52	9.68
3	#5725.00	59.6 PK	78.2	-18.6	1.81 H	212	49.90	9.70
4	*5775.00	90.4 PK			1.81 H	212	80.57	9.83
5	*5775.00	80.2 AV			1.81 H	212	70.37	9.83
6	#5850.00	58.7 PK	78.2	-19.5	1.81 H	212	48.78	9.92
7	#5860.00	52.8 PK	74.0	-21.2	1.81 H	212	42.87	9.93
8	#5860.00	40.7 AV	54.0	-13.3	1.81 H	212	30.77	9.93
9	11550.00	55.3 PK	74.0	-18.7	1.79 H	151	40.21	15.09
10	11550.00	44.0 AV	54.0	-10.0	1.79 H	151	28.91	15.09
11	#17325.00	52.9 PK	74.0	-21.1	2.17 H	11	29.52	23.38
12	#17325.00	41.8 AV	54.0	-12.2	2.17 H	11	18.42	23.38

ANTENNA POLARITY & TEST DISTANCE: VERTICAL AT 3 M

NO.	FREQ. (MHz)	EMISSION LEVEL (dBuV/m)	LIMIT (dBuV/m)	MARGIN (dB)	ANTENNA HEIGHT (m)	TABLE ANGLE (Degree)	RAW VALUE (dBuV)	CORRECTION FACTOR (dB/m)
1	#5715.00	67.8 PK	74.0	-6.2	1.81 V	338	58.12	9.68
2	#5715.00	53.8 AV	54.0	-0.2	1.81 V	338	44.12	9.68
3	#5725.00	73.1 PK	78.2	-5.1	1.65 V	348	63.40	9.70
4	*5775.00	103.7 PK			1.73 V	345	93.87	9.83
5	*5775.00	93.4 AV			1.73 V	345	83.57	9.83
6	#5850.00	59.0 PK	78.2	-19.2	2.15 V	347	49.08	9.92
7	#5860.00	58.8 PK	74.0	-15.2	2.15 V	347	48.87	9.93
8	#5860.00	44.4 AV	54.0	-9.6	2.15 V	347	34.47	9.93
9	11550.00	58.7 PK	74.0	-15.3	1.77 V	322	43.61	15.09
10	11550.00	47.5 AV	54.0	-6.5	1.77 V	322	32.41	15.09
11	#17325.00	57.7 PK	74.0	-16.3	2.13 V	299	34.32	23.38
12	#17325.00	45.7 AV	54.0	-8.3	2.13 V	299	22.32	23.38

REMARKS:

1. Emission Level(dBuV/m) = Raw Value(dBuV) + Correction Factor(dB/m)
2. Correction Factor(dB/m) = Antenna Factor(dB/m) + Cable Factor(dB) – Pre-Amplifier Factor(dB)
3. The other emission levels were very low against the limit.
4. Margin value = Emission Level – Limit value
5. " * ": Fundamental frequency.
6. " # ": The radiated frequency is out of the restricted band.

Below 1GHz Data:
802.11a

CHANNEL	TX Channel 157	DETECTOR FUNCTION	Quasi-Peak (QP)
FREQUENCY RANGE	Below 1GHz		

ANTENNA POLARITY & TEST DISTANCE: HORIZONTAL AT 3 M

NO.	FREQ. (MHz)	EMISSION LEVEL (dBuV/m)	LIMIT (dBuV/m)	MARGIN (dB)	ANTENNA HEIGHT (m)	TABLE ANGLE (Degree)	RAW VALUE (dBuV)	CORRECTION FACTOR (dB/m)
1	105.90	29.1 QP	43.5	-14.4	1.50 H	272	45.57	-16.50
2	199.99	28.6 QP	43.5	-14.9	1.50 H	287	44.56	-15.93
3	250.00	28.0 QP	46.0	-18.0	1.50 H	94	41.94	-13.92
4	374.98	42.5 QP	46.0	-3.5	1.00 H	226	52.29	-9.78
5	680.00	39.5 QP	46.0	-6.5	1.00 H	212	42.50	-3.02
6	840.00	37.2 QP	46.0	-8.8	1.50 H	261	37.26	-0.09

ANTENNA POLARITY & TEST DISTANCE: VERTICAL AT 3 M

NO.	FREQ. (MHz)	EMISSION LEVEL (dBuV/m)	LIMIT (dBuV/m)	MARGIN (dB)	ANTENNA HEIGHT (m)	TABLE ANGLE (Degree)	RAW VALUE (dBuV)	CORRECTION FACTOR (dB/m)
1	187.48	26.7 QP	43.5	-16.9	1.00 V	317	41.88	-15.23
2	250.00	26.2 QP	46.0	-19.8	1.50 V	211	40.15	-13.92
3	400.01	28.7 QP	46.0	-17.3	1.50 V	267	37.98	-9.27
4	466.69	30.1 QP	46.0	-15.9	1.00 V	271	37.48	-7.38
5	625.00	34.3 QP	46.0	-11.7	1.50 V	192	37.94	-3.68
6	720.01	29.3 QP	46.0	-16.7	1.50 V	247	31.73	-2.45

REMARKS:

1. Emission Level(dBuV/m) = Raw Value(dBuV) + Correction Factor(dB/m)
2. Correction Factor(dB/m) = Antenna Factor(dB/m) + Cable Factor(dB) – Pre-Amplifier Factor(dB)
3. The other emission levels were very low against the limit.
4. Margin value = Emission Level – Limit value

4.2 Conducted Emission Measurement

4.2.1 Limits of Conducted Emission Measurement

Frequency (MHz)	Conducted Limit (dBuV)	
	Quasi-peak	Average
0.15 - 0.5	66 - 56	56 - 46
0.50 - 5.0	56	46
5.0 - 30.0	60	50

Note: 1. The lower limit shall apply at the transition frequencies.

2. The limit decreases in line with the logarithm of the frequency in the range of 0.15 to 0.50MHz.

4.2.2 Test Instruments

For Mode 1~3 test:

DESCRIPTION & MANUFACTURER	MODEL NO.	SERIAL NO.	CALIBRATED DATE	CALIBRATED UNTIL
Test Receiver R&S	ESCS 30	100375	May 06, 2015	May 05, 2016
Line-Impedance Stabilization Network (for EUT) SCHWARZBECK	NSLK-8127	8127-522	Sep. 15, 2014	Sep. 14, 2015
Line-Impedance Stabilization Network (for Peripheral) R&S	ENV216	100072	June 11, 2015	June 10, 2016
RF Cable	5D-FB	COCCAB-001	Mar. 09, 2015	Mar. 08, 2016
50 ohms Terminator	N/A	EMC-03	Sep. 22, 2014	Sep. 21, 2015
50 ohms Terminator	N/A	EMC-02	Sep. 30, 2014	Sep. 29, 2015
Software BVADT	BVADT_Cond_ V7.3.7.3	NA	NA	NA

Note:

1. The calibration interval of the above test instruments are 12 months and the calibrations are traceable to NML/ROC and NIST/USA.
2. The test was performed in Shielded Room No. C.
3. The VCCI Con C Registration No. is C-3611.
4. Tested Date: July 20 to Aug. 10, 2015

For Mode 4 test:

DESCRIPTION & MANUFACTURER	MODEL NO.	SERIAL NO.	CALIBRATED DATE	CALIBRATED UNTIL
Test Receiver R&S	ESCS 30	100287	Apr. 17, 2015	Apr. 16, 2016
Line-Impedance Stabilization Network (for EUT) SCHWARZBECK	NSLK-8127	8127-523	Sep. 29, 2014	Sep. 28, 2015
RF Cable	5D-FB	COACAB-001	May 25, 2015	May 24, 2016
50 ohms Terminator	50	3	Oct. 17, 2014	Oct. 16, 2015
50 ohms Terminator	N/A	EMC-04	Oct. 21, 2014	Oct. 20, 2015
Software BVADT	BVADT_Cond_ V7.3.7.3	NA	NA	NA
Line-Impedance Stabilization Network (for Peripheral) R&S	ENV216	100071	Nov. 10, 2014	Nov. 09, 2015

Note:

1. The calibration interval of the above test instruments are 12 months and the calibrations are traceable to NML/ROC and NIST/USA.
2. The test was performed in Shielded Room No. A.
3. The VCCI Con A Registration No. is C-817.
4. Tested Date: Aug. 26, 2015

4.2.3 Test Procedure

- a. The EUT was placed 0.4 meters from the conducting wall of the shielded room with EUT being connected to the power mains through a line impedance stabilization network (LISN). Other support units were connected to the power mains through another LISN. The two LISNs provide 50 ohm/ 50uH of coupling impedance for the measuring instrument.
- b. Both lines of the power mains connected to the EUT were checked for maximum conducted interference.
- c. The frequency range from 150kHz to 30MHz was searched. Emission levels under (Limit - 20dB) was not recorded.

NOTE: All modes of operation were investigated and the worst-case emissions are reported.

4.2.4 Deviation from Test Standard

No deviation.

4.2.5 Test Setup

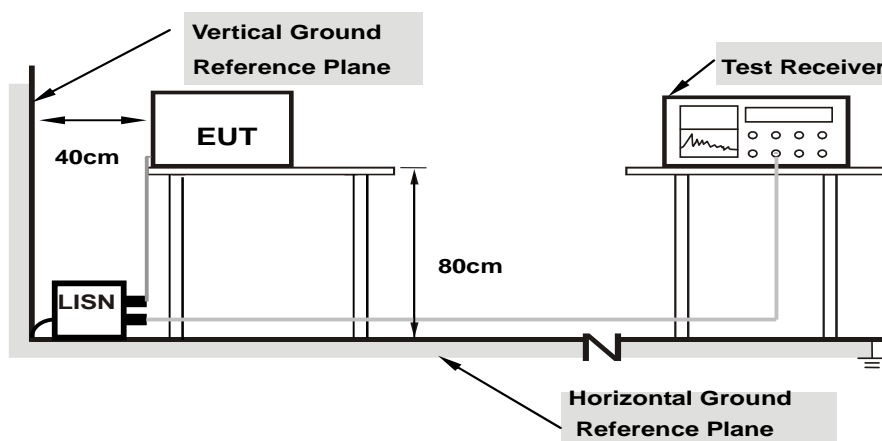

Note: 1.Support units were connected to second LISN.

For the actual test configuration, please refer to the attached file (Test Setup Photo).

4.2.6 EUT Operating Condition

Same as 4.1.6.

4.2.7 Test Results (Mode 1)

Phase	Line (L)	Detector Function	Quasi-Peak (QP) / Average (AV)
-------	----------	-------------------	--------------------------------

No	Freq. [MHz]	Corr.	Reading Value		Emission Level		Limit		Margin	
		Factor	[dB (uV)]		[dB (uV)]		[dB (uV)]		(dB)	
	(dB)	Q.P.	AV.	Q.P.	AV.	Q.P.	AV.	Q.P.	AV.	
1	0.16562	0.14	54.92	45.34	55.06	45.48	65.18	55.18	-10.11	-9.69
2	0.20859	0.15	48.10	41.84	48.25	41.99	63.26	53.26	-15.01	-11.27
3	0.40781	0.17	42.42	40.06	42.59	40.23	57.69	47.69	-15.10	-7.46
4	18.22844	1.04	49.42	47.30	50.46	48.34	60.00	50.00	-9.54	-1.66
5	19.05094	1.07	48.50	46.26	49.57	47.33	60.00	50.00	-10.43	-2.67
6	19.88356	1.11	46.90	44.56	48.01	45.67	60.00	50.00	-11.99	-4.33

REMARKS:

1. Q.P. and AV. are abbreviations of quasi-peak and average individually.
2. The emission levels of other frequencies were very low against the limit.
3. Margin value = Emission level - Limit value
4. Correction factor = Insertion loss + Cable loss
5. Emission Level = Correction Factor + Reading Value.

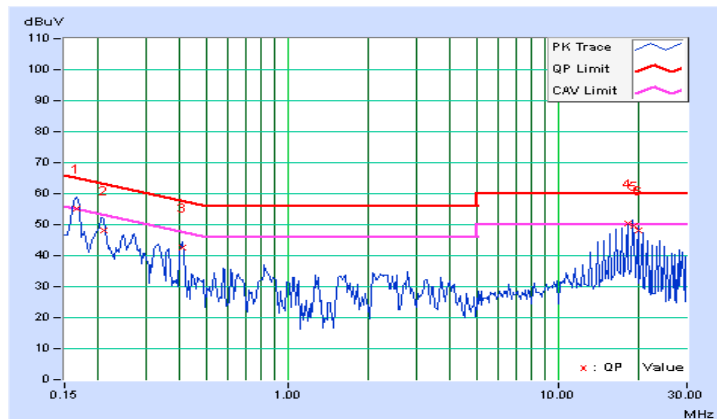

Phase	Neutral (N)	Detector Function	Quasi-Peak (QP) / Average (AV)
-------	-------------	-------------------	--------------------------------

No	Freq. [MHz]	Corr.	Reading Value		Emission Level		Limit		Margin	
		Factor	[dB (uV)]		[dB (uV)]		[dB (uV)]		(dB)	
	(dB)	Q.P.	AV.	Q.P.	AV.	Q.P.	AV.	Q.P.	AV.	
1	0.16562	0.14	55.14	45.28	55.28	45.42	65.18	55.18	-9.89	-9.75
2	0.20172	0.15	50.02	43.96	50.17	44.11	63.54	53.54	-13.37	-9.43
3	0.40781	0.19	42.80	40.18	42.99	40.37	57.69	47.69	-14.70	-7.32
4	18.22094	1.15	49.24	43.42	50.39	44.57	60.00	50.00	-9.61	-5.43
5	19.04969	1.19	48.46	46.04	49.65	47.23	60.00	50.00	-10.35	-2.77
6	19.88531	1.22	47.50	45.06	48.72	46.28	60.00	50.00	-11.28	-3.72

REMARKS:

1. Q.P. and AV. are abbreviations of quasi-peak and average individually.
2. The emission levels of other frequencies were very low against the limit.
3. Margin value = Emission level - Limit value
4. Correction factor = Insertion loss + Cable loss
5. Emission Level = Correction Factor + Reading Value.

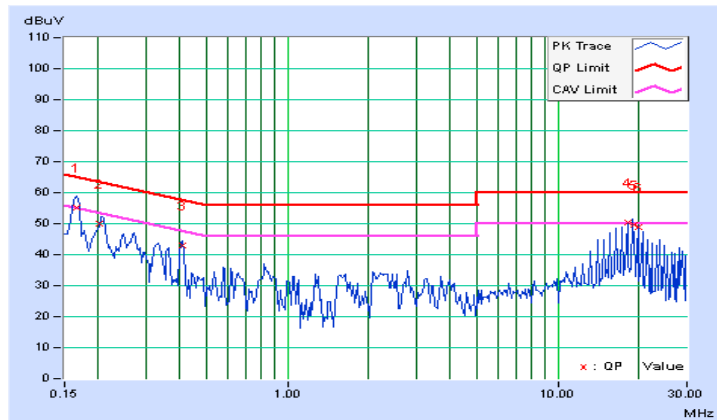

4.2.8 Test Results (Mode 2)

Phase	Line (L)	Detector Function	Quasi-Peak (QP) / Average (AV)
-------	----------	-------------------	--------------------------------

No	Freq. [MHz]	Corr.	Reading Value		Emission Level		Limit		Margin	
		Factor	[dB (uV)]		[dB (uV)]		[dB (uV)]		(dB)	
	(dB)	Q.P.	AV.	Q.P.	AV.	Q.P.	AV.	Q.P.	AV.	
1	0.18125	0.15	41.32	31.68	41.47	31.83	64.43	54.43	-22.96	-22.60
2	0.31016	0.16	41.70	29.40	41.86	29.56	59.97	49.97	-18.11	-20.41
3	0.88828	0.19	38.38	23.80	38.57	23.99	56.00	46.00	-17.43	-22.01
4	2.20313	0.27	36.18	21.82	36.45	22.09	56.00	46.00	-19.55	-23.91
5	4.35547	0.40	39.52	26.10	39.92	26.50	56.00	46.00	-16.08	-19.50
6	12.83594	0.84	33.10	23.16	33.94	24.00	60.00	50.00	-26.06	-26.00

REMARKS:

1. Q.P. and AV. are abbreviations of quasi-peak and average individually.
2. The emission levels of other frequencies were very low against the limit.
3. Margin value = Emission level - Limit value
4. Correction factor = Insertion loss + Cable loss
5. Emission Level = Correction Factor + Reading Value.

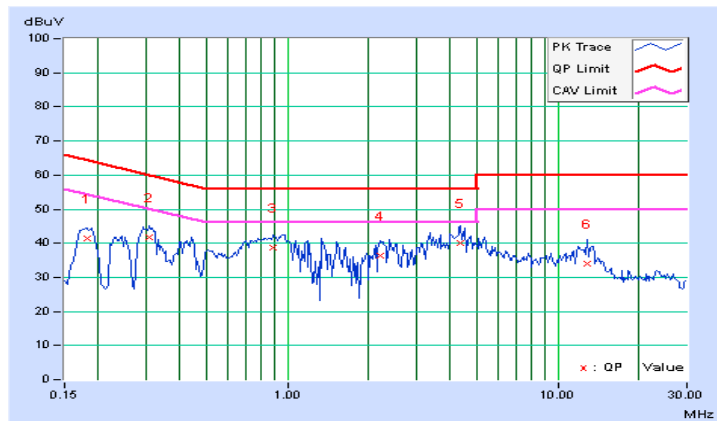

Phase	Neutral (N)	Detector Function	Quasi-Peak (QP) / Average (AV)
-------	-------------	-------------------	--------------------------------

No	Freq. [MHz]	Corr.	Reading Value		Emission Level		Limit		Margin	
		Factor (dB)	[dB (uV)]		[dB (uV)]		[dB (uV)]		(dB)	
			Q.P.	AV.	Q.P.	AV.	Q.P.	AV.	Q.P.	AV.
1	0.18097	0.15	41.40	29.66	41.55	29.81	64.44	54.44	-22.89	-24.63
2	0.31016	0.17	37.96	25.38	38.13	25.55	59.97	49.97	-21.83	-24.41
3	0.90000	0.23	35.30	20.66	35.53	20.89	56.00	46.00	-20.47	-25.11
4	2.17188	0.31	34.06	19.80	34.37	20.11	56.00	46.00	-21.63	-25.89
5	4.32031	0.44	36.80	23.46	37.24	23.90	56.00	46.00	-18.76	-22.10
6	12.55078	0.90	34.14	24.86	35.04	25.76	60.00	50.00	-24.96	-24.24

REMARKS:

1. Q.P. and AV. are abbreviations of quasi-peak and average individually.
2. The emission levels of other frequencies were very low against the limit.
3. Margin value = Emission level - Limit value
4. Correction factor = Insertion loss + Cable loss
5. Emission Level = Correction Factor + Reading Value.

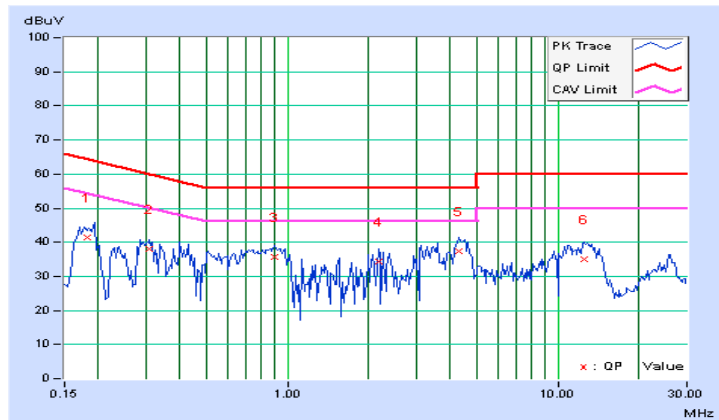

4.2.9 Test Results (Mode 3)

Phase	Line (L)	Detector Function	Quasi-Peak (QP) / Average (AV)
-------	----------	-------------------	--------------------------------

No	Freq. [MHz]	Corr.	Reading Value		Emission Level		Limit		Margin	
		Factor	[dB (uV)]		[dB (uV)]		[dB (uV)]		(dB)	
	(dB)	Q.P.	AV.	Q.P.	AV.	Q.P.	AV.	Q.P.	AV.	
1	0.18516	0.15	41.34	31.22	41.49	31.37	64.25	54.25	-22.76	-22.88
2	0.31159	0.16	41.54	28.94	41.70	29.10	59.93	49.93	-18.23	-20.83
3	0.88047	0.19	37.76	22.68	37.95	22.87	56.00	46.00	-18.05	-23.13
4	2.25781	0.28	36.74	22.94	37.02	23.22	56.00	46.00	-18.98	-22.78
5	4.22656	0.39	39.70	26.48	40.09	26.87	56.00	46.00	-15.91	-19.13
6	12.23047	0.82	32.54	23.26	33.36	24.08	60.00	50.00	-26.64	-25.92

REMARKS:

1. Q.P. and AV. are abbreviations of quasi-peak and average individually.
2. The emission levels of other frequencies were very low against the limit.
3. Margin value = Emission level - Limit value
4. Correction factor = Insertion loss + Cable loss
5. Emission Level = Correction Factor + Reading Value.

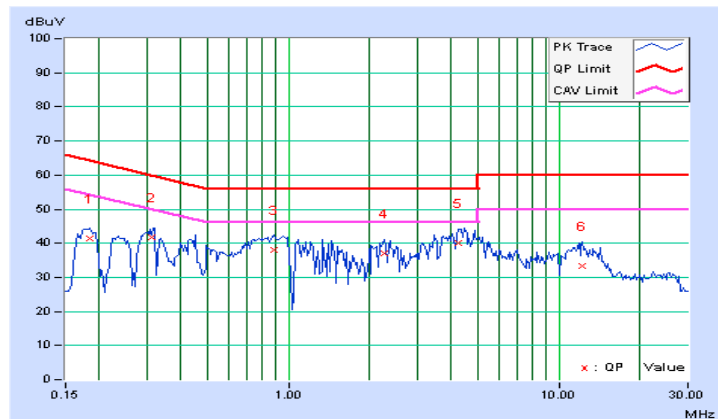

Phase	Neutral (N)	Detector Function	Quasi-Peak (QP) / Average (AV)
-------	-------------	-------------------	--------------------------------

No	Freq. [MHz]	Corr.	Reading Value		Emission Level		Limit		Margin	
		Factor	[dB (uV)]		[dB (uV)]		[dB (uV)]		(dB)	
		(dB)	Q.P.	AV.	Q.P.	AV.	Q.P.	AV.	Q.P.	AV.
1	0.18125	0.15	40.64	29.12	40.79	29.27	64.43	54.43	-23.64	-25.16
2	0.30234	0.17	37.06	24.26	37.23	24.43	60.18	50.18	-22.95	-25.75
3	0.74375	0.22	34.26	20.34	34.48	20.56	56.00	46.00	-21.52	-25.44
4	3.28906	0.38	34.88	21.04	35.26	21.42	56.00	46.00	-20.74	-24.58
5	4.28516	0.44	36.92	23.42	37.36	23.86	56.00	46.00	-18.64	-22.14
6	12.80859	0.91	34.02	24.58	34.93	25.49	60.00	50.00	-25.07	-24.51

REMARKS:

1. Q.P. and AV. are abbreviations of quasi-peak and average individually.
2. The emission levels of other frequencies were very low against the limit.
3. Margin value = Emission level - Limit value
4. Correction factor = Insertion loss + Cable loss
5. Emission Level = Correction Factor + Reading Value.

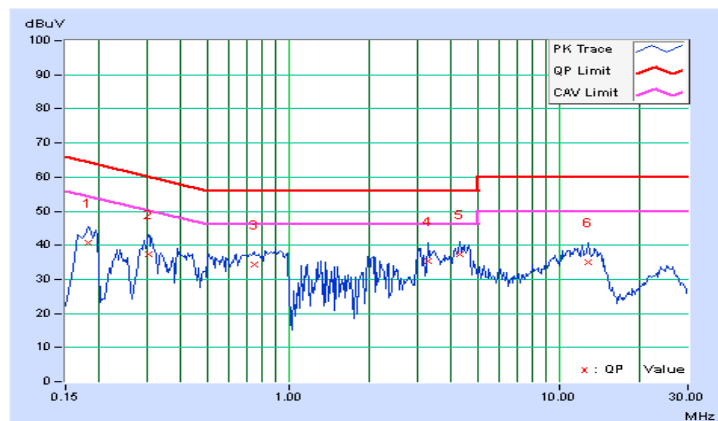

4.2.10 Test Results (Mode 4)

Phase	Line (L)	Detector Function	Quasi-Peak (QP) / Average (AV)
-------	----------	-------------------	--------------------------------

No	Freq. [MHz]	Corr.	Reading Value		Emission Level		Limit		Margin	
		Factor	[dB (uV)]		[dB (uV)]		[dB (uV)]		(dB)	
	(dB)	Q.P.	AV.	Q.P.	AV.	Q.P.	AV.	Q.P.	AV.	
1	0.18125	0.10	53.68	44.22	53.78	44.32	64.43	54.43	-10.65	-10.11
2	0.22812	0.11	44.36	36.26	44.47	36.37	62.52	52.52	-18.05	-16.15
3	0.40522	0.16	41.58	39.12	41.74	39.28	57.75	47.75	-16.01	-8.47
4	4.19922	0.35	40.84	39.14	41.19	39.49	56.00	46.00	-14.81	-6.51
5	5.88241	0.40	43.06	40.80	43.46	41.20	60.00	50.00	-16.54	-8.80
6	10.92816	0.56	36.28	31.82	36.84	32.38	60.00	50.00	-23.16	-17.62

REMARKS:

1. Q.P. and AV. are abbreviations of quasi-peak and average individually.
2. The emission levels of other frequencies were very low against the limit.
3. Margin value = Emission level - Limit value
4. Correction factor = Insertion loss + Cable loss
5. Emission Level = Correction Factor + Reading Value.

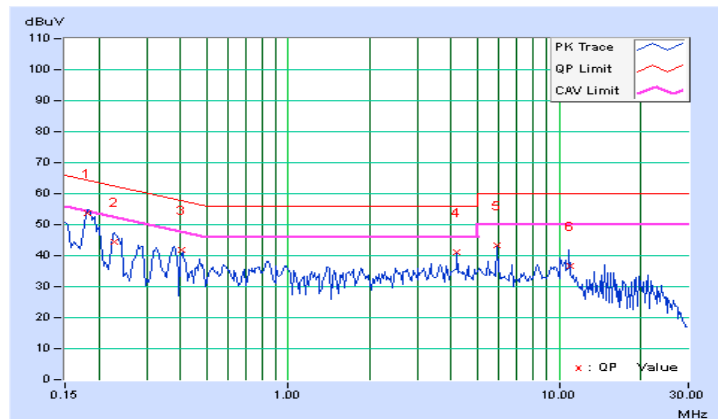

Phase	Neutral (N)	Detector Function	Quasi-Peak (QP) / Average (AV)
-------	-------------	-------------------	--------------------------------

No	Freq. [MHz]	Corr.	Reading Value		Emission Level		Limit		Margin	
		Factor	[dB (uV)]		[dB (uV)]		[dB (uV)]		(dB)	
		(dB)	Q.P.	AV.	Q.P.	AV.	Q.P.	AV.	Q.P.	AV.
1	0.15391	0.09	44.06	18.50	44.15	18.59	65.79	55.79	-21.64	-37.20
2	0.18125	0.09	53.08	43.36	53.17	43.45	64.43	54.43	-11.25	-10.97
3	0.22422	0.11	44.18	33.98	44.29	34.09	62.66	52.66	-18.38	-18.58
4	0.40713	0.15	39.50	35.98	39.65	36.13	57.71	47.71	-18.06	-11.58
5	4.20463	0.32	40.36	39.28	40.68	39.60	56.00	46.00	-15.32	-6.40
6	5.88531	0.37	43.44	41.34	43.81	41.71	60.00	50.00	-16.19	-8.29

REMARKS:

1. Q.P. and AV. are abbreviations of quasi-peak and average individually.
2. The emission levels of other frequencies were very low against the limit.
3. Margin value = Emission level - Limit value
4. Correction factor = Insertion loss + Cable loss
5. Emission Level = Correction Factor + Reading Value.

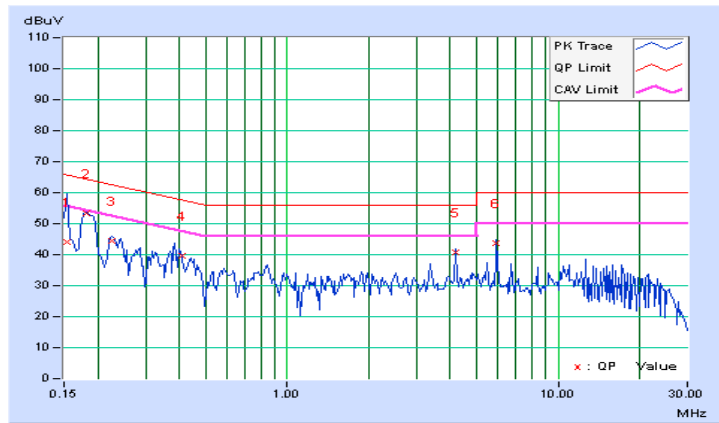

4.3 Transmit Power Measurement

4.3.1 Limits of Transmit Power Measurement

Operation Band	EUT Category		LIMIT
U-NII-1		Outdoor Access Point	1 Watt (30 dBm) (Max. e.i.r.p \leq 125mW(21 dBm) at any elevation angle above 30 degrees as measured from the horizon)
		Fixed point-to-point Access Point	1 Watt (30 dBm)
	√	Indoor Access Point	1 Watt (30 dBm)
		Mobile and Portable client device	250mW (24 dBm)
U-NII-2A			250mW (24 dBm) or 11 dBm+10 log B*
U-NII-2C			250mW (24 dBm) or 11 dBm+10 log B*
U-NII-3	√		1 Watt (30 dBm)

*B is the 26 dB emission bandwidth in megahertz

Per KDB 662911 Method of conducted output power measurement on IEEE 802.11 devices,

Array Gain = 0 dB (i.e., no array gain) for $N_{ANT} \leq 4$;

Array Gain = 0 dB (i.e., no array gain) for channel widths ≥ 40 MHz for any N_{ANT} ;

Array Gain = $5 \log(N_{ANT}/N_{SS})$ dB or 3 dB, whichever is less for 20-MHz channel widths with $N_{ANT} \geq 5$.

For power measurements on all other devices: Array Gain = $10 \log(N_{ANT}/N_{SS})$ dB.

4.3.2 Test Setup

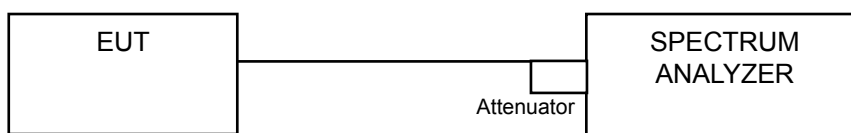

4.3.3 Test Instruments

Refer to section 4.1.2 to get information of above instrument.

4.3.4 Test Procedure

Method PM is used to perform output power measurement, trigger and gating function of wide band power meter is enabled to measure max output power of TX on burst. Duty factor is not added to measured value.

4.3.5 Deviation from Test Standard

No deviation.

4.3.6 EUT Operating Condition

The software provided by client to enable the EUT under transmission condition continuously at lowest, middle and highest channel frequencies individually.

4.3.7 Test Result

POWER OUTPUT:

802.11a

Chan.	Chan. Freq. (MHz)	Maximum Conducted Power (dBm)		Total Power (mW)	Total Power (dBm)	Limit (dBm)	Pass / Fail
		Chain 0	Chain 1				
36	5180	16.73	15.59	83.322	19.21	30	Pass
40	5200	17.80	16.16	101.561	20.07	30	Pass
48	5240	18.78	16.60	121.218	20.84	30	Pass
149	5745	14.48	12.52	45.919	16.62	30	Pass
157	5785	21.80	20.07	252.981	24.03	30	Pass
165	5825	17.44	15.50	90.944	19.59	30	Pass

802.11ac (VHT20)

Chan.	Chan. Freq. (MHz)	Maximum Conducted Power (dBm)		Total Power (mW)	Total Power (dBm)	Limit (dBm)	Pass / Fail
		Chain 0	Chain 1				
36	5180	15.64	14.55	65.154	18.14	30	Pass
40	5200	17.38	15.75	92.286	19.65	30	Pass
48	5240	18.32	16.33	110.874	20.45	30	Pass
149	5745	14.31	12.36	44.196	16.45	30	Pass
157	5785	21.53	19.90	239.957	23.80	30	Pass
165	5825	17.38	15.43	89.616	19.52	30	Pass

802.11ac (VHT40)

Chan.	Chan. Freq. (MHz)	Maximum Conducted Power (dBm)		Total Power (mW)	Total Power (dBm)	Limit (dBm)	Pass / Fail
		Chain 0	Chain 1				
38	5190	11.81	10.84	27.305	14.36	30	Pass
46	5230	18.89	17.43	132.781	21.23	30	Pass
151	5755	9.43	7.95	15.007	11.76	30	Pass
159	5795	17.41	15.94	94.345	19.75	30	Pass

802.11ac (VHT80)

Chan.	Chan. Freq. (MHz)	Maximum Conducted Power (dBm)		Total Power (mW)	Total Power (dBm)	Limit (dBm)	Pass / Fail
		Chain 0	Chain 1				
42	5210	9.28	7.88	14.61	11.65	30	Pass
155	5775	5.77	4.41	6.537	8.15	30	Pass

4.4 Peak Power Spectral Density Measurement

4.4.1 Limits of Peak Power Spectral Density Measurement

Operation Band	EUT Category		LIMIT
U-NII-1		Outdoor Access Point	17dBm/ MHz
		Fixed point-to-point Access Point	
	√	Indoor Access Point	
		Mobile and Portable client device	11dBm/ MHz
U-NII-2A			11dBm/ MHz
U-NII-2C			11dBm/ MHz
U-NII-3	√		30dBm/ 500kHz

4.4.2 Test Setup

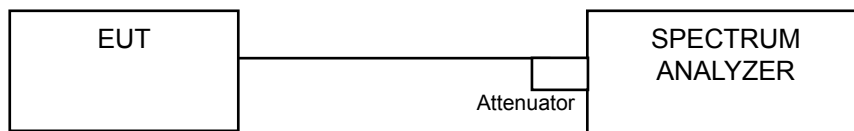

4.4.3 Test Instruments

Refer to section 4.1.2 to get information of above instrument.

4.4.4 Test Procedure

For U-NII-1 band:

Using method SA-2

1. Set span to encompass the entire emission bandwidth (EBW) of the signal.
2. Set RBW = 1 MHz, Set VBW ≥ 3 MHz, Detector = RMS
3. Sweep time = auto, trigger set to “free run”.
4. Trace average at least 100 traces in power averaging mode.
5. Record the max value and add 10 log (1/duty cycle)

For U-NII-3:

1. Set span to encompass the entire emission bandwidth (EBW) of the signal.
2. Set RBW = 300 kHz, Set VBW ≥ 1 MHz, Detector = RMS
3. Use the peak marker function to determine the maximum power level in any 300 kHz band segment within the fundamental EBW.
4. Scale the observed power level to an equivalent value in 500 kHz by adjusting (reducing) the measured power by a bandwidth correction factor (BWCF) where $BWCF = 10\log(500\text{ kHz}/300\text{kHz})$
5. Sweep time = auto, trigger set to “free run”.
6. Trace average at least 100 traces in power averaging mode.
7. Record the max value and add 10 log (1/duty cycle)

4.4.5 Deviation from Test Standard

No deviation.

4.4.6 EUT Operating Condition

Same as Item 4.3.6.

4.4.7 Test Results

For U-NII-1 Band 802.11a

Chan.	Chan. Freq. (MHz)	PSD w/o duty factor (dBm)		Duty Factor (dB)	Total PSD with Duty Factor (dBm)	MAX. Limit (dBm)	Pass / Fail
		Chain 0	Chain 1				
36	5180	1.71	3.77	0.16	6.03	14.49	Pass
40	5200	2.66	4.89	0.16	7.09	14.49	Pass
48	5240	3.07	5.77	0.16	7.80	14.49	Pass

Note: 1. Method a) of power density measurement of KDB 662911 is using for calculating total power density. Total power density is summing entire spectra across corresponding frequency bins on the various outputs by computer.

2. Directional gain = $5.5\text{dBi} + 10\log(2) = 8.51\text{dBi} > 6\text{dBi}$, so the power density limit shall be reduced to $17-(8.51-6) = 14.49\text{dBm}$.

3. Refer to section 3.3 for duty cycle spectrum plot.

802.11ac (VHT20)

Chan.	Chan. Freq. (MHz)	PSD w/o duty factor (dBm)		Duty Factor (dB)	Total PSD with Duty Factor (dBm)	MAX. Limit (dBm)	Pass / Fail
		Chain 0	Chain 1				
36	5180	0.62	2.01	0.17	4.55	14.49	Pass
40	5200	1.72	3.81	0.17	6.07	14.49	Pass
48	5240	2.40	5.04	0.17	7.10	14.49	Pass

Note: 1. Method a) of power density measurement of KDB 662911 is using for calculating total power density. Total power density is summing entire spectra across corresponding frequency bins on the various outputs by computer.

2. Directional gain = $5.5\text{dBi} + 10\log(2) = 8.51\text{dBi} > 6\text{dBi}$, so the power density limit shall be reduced to $17-(8.51-6) = 14.49\text{dBm}$.

3. Refer to section 3.3 for duty cycle spectrum plot.

802.11ac (VHT40)

Chan.	Chan. Freq. (MHz)	PSD w/o duty factor (dBm)		Duty Factor (dB)	Total PSD with Duty Factor (dBm)	MAX. Limit (dBm)	Pass / Fail
		Chain 0	Chain 1				
38	5190	-6.04	-4.68	0.41	-1.89	14.49	Pass
46	5230	0.24	2.96	0.41	5.23	14.49	Pass

- Note: 1. Method a) of power density measurement of KDB 662911 is using for calculating total power density. Total power density is summing entire spectra across corresponding frequency bins on the various outputs by computer.
2. Directional gain = $5.5\text{dBi} + 10\log(2) = 8.51\text{dBi} > 6\text{dBi}$, so the power density limit shall be reduced to $17-(8.51-6) = 14.49\text{dBm}$.
3. Refer to section 3.3 for duty cycle spectrum plot.

802.11ac (VHT80):

Chan.	Chan. Freq. (MHz)	PSD w/o duty factor (dBm)		Duty Factor (dB)	Total PSD with Duty Factor (dBm)	MAX. Limit (dBm)	Pass / Fail
		Chain 0	Chain 1				
42	5210	-11.79	-10.32	0.28	-7.71	14.49	Pass

- Note: 1. Method a) of power density measurement of KDB 662911 is using for calculating total power density. Total power density is summing entire spectra across corresponding frequency bins on the various outputs by computer.
2. Directional gain = $5.5\text{dBi} + 10\log(2) = 8.51\text{dBi} > 6\text{dBi}$, so the power density limit shall be reduced to $17-(8.51-6) = 14.49\text{dBm}$.
3. Refer to section 3.3 for duty cycle spectrum plot.

SPECTRUM PLOT OF WORST VALUE

802.11a – Chain 1: CH 48

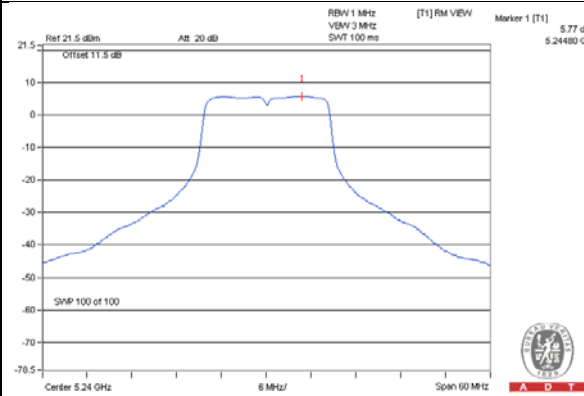

802.11ac (VHT20) – Chain 1: CH 48

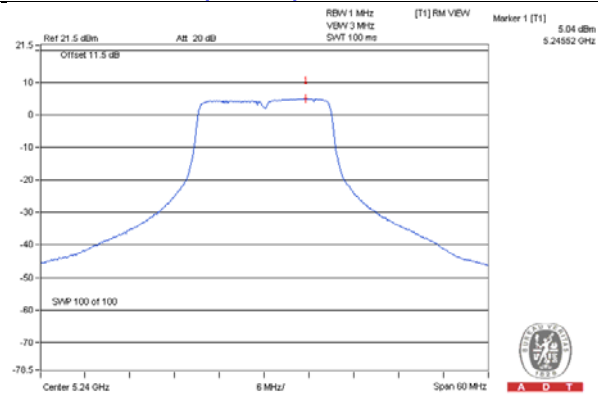

802.11ac (VHT40) – Chain 1: CH 46

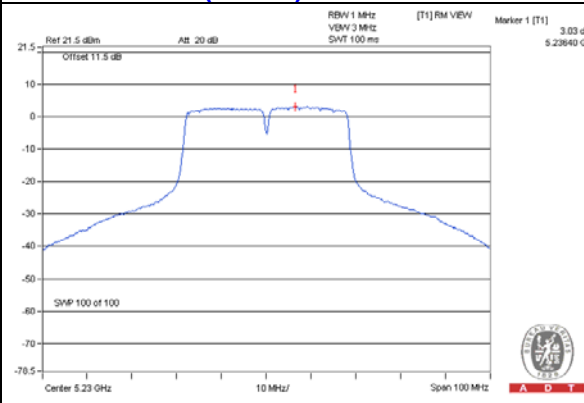

802.11ac (VHT80) – Chain 1: CH 42

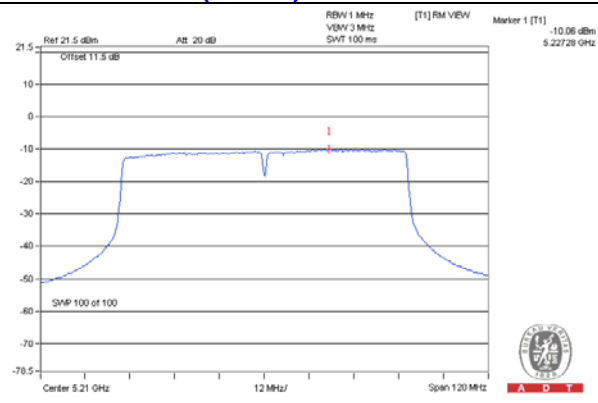

For U-NII-3 Band

802.11a

TX chain	Chan.	Chan. Freq. (MHz)	PSD W/O Duty Factor		10 log (N=2) dB	Duty Factor (dB)	Total PSD With Duty Factor (dBm/500kHz)	Limit (dBm/500kHz)	Pass /Fail
			(dBm/300kHz)	(dBm/500kHz)					
0	149	5745	-8.36	-6.14	3.01	0.16	-2.97	26.99	Pass
	157	5785	-0.59	1.63	3.01	0.16	4.80	26.99	Pass
	165	5825	-4.85	-2.63	3.01	0.16	0.54	26.99	Pass
1	149	5745	-6.79	-4.57	3.01	0.16	-1.40	26.99	Pass
	157	5785	-0.01	2.21	3.01	0.16	5.38	26.99	Pass
	165	5825	-3.42	-1.20	3.01	0.16	1.97	26.99	Pass

- Note: 1. Method a) of power density measurement of KDB 662911 is using for calculating total power density. Total power density is summing entire spectra across corresponding frequency bins on the various outputs by computer.
2. Directional gain = 6dBi + 10log(2) = 9.01dBi > 6dBi , so the power density limit shall be reduced to 30-(9.01-6) = 26.99dBm.
3. Refer to section 3.3 for duty cycle spectrum plot.

802.11ac (VHT20)

TX chain	Chan.	Chan. Freq. (MHz)	PSD W/O Duty Factor		10 log (N=2) dB	Duty Factor (dB)	Total PSD With Duty Factor (dBm/500kHz)	Limit (dBm/500kHz)	Pass /Fail
			(dBm/300kHz)	(dBm/500kHz)					
0	149	5745	-8.67	-6.45	3.01	0.17	-3.27	26.99	Pass
	157	5785	-0.93	1.29	3.01	0.17	4.47	26.99	Pass
	165	5825	-5.53	-3.31	3.01	0.17	-0.13	26.99	Pass
1	149	5745	-7.40	-5.18	3.01	0.17	-2.00	26.99	Pass
	157	5785	-0.47	1.75	3.01	0.17	4.93	26.99	Pass
	165	5825	-3.73	-1.51	3.01	0.17	1.67	26.99	Pass

- Note: 1. Method a) of power density measurement of KDB 662911 is using for calculating total power density. Total power density is summing entire spectra across corresponding frequency bins on the various outputs by computer.
2. Directional gain = 6dBi + 10log(2) = 9.01dBi > 6dBi , so the power density limit shall be reduced to 30-(9.01-6) = 26.99dBm.
3. Refer to section 3.3 for duty cycle spectrum plot.

802.11ac (VHT40)

TX chain	Chan.	Chan. Freq. (MHz)	PSD W/O Duty Factor		10 log (N=2) dB	Duty Factor (dB)	Total PSD With Duty Factor (dBm/500kHz)	Limit (dBm/500kHz)	Pass /Fail
			(dBm/300kHz)	(dBm/500kHz)					
0	151	5755	-16.53	-14.31	3.01	0.41	-10.89	26.99	Pass
	159	5795	-8.07	-5.85	3.01	0.41	-2.43	26.99	Pass
1	151	5755	-15.78	-13.56	3.01	0.41	-10.14	26.99	Pass
	159	5795	-6.99	-4.77	3.01	0.41	-1.35	26.99	Pass

Note: 1. Method a) of power density measurement of KDB 662911 is using for calculating total power density. Total power density is summing entire spectra across corresponding frequency bins on the various outputs by computer.

2. Directional gain = $6\text{dBi} + 10\log(2) = 9.01\text{dBi} > 6\text{dBi}$, so the power density limit shall be reduced to $30-(9.01-6) = 26.99\text{dBm}$.

3. Refer to section 3.3 for duty cycle spectrum plot.

802.11ac (VHT80)

TX chain	Chan.	Chan. Freq. (MHz)	PSD W/O Duty Factor		10 log (N=2) dB	Duty Factor (dB)	Total PSD With Duty Factor (dBm/500kHz)	Limit (dBm/500kHz)	Pass /Fail
			(dBm/300kHz)	(dBm/500kHz)					
0	155	5775	-22.80	-20.58	3.01	0.28	-17.29	26.99	Pass
1	155	5775	-22.16	-19.94	3.01	0.28	-16.65	26.99	Pass

Note: 1. Method a) of power density measurement of KDB 662911 is using for calculating total power density. Total power density is summing entire spectra across corresponding frequency bins on the various outputs by computer.

2. Directional gain = $6\text{dBi} + 10\log(2) = 9.01\text{dBi} > 6\text{dBi}$, so the power density limit shall be reduced to $30-(9.01-6) = 26.99\text{dBm}$.

3. Refer to section 3.3 for duty cycle spectrum plot.

SPECTRUM PLOT OF WORST VALUE

802.11a – Chain 1: CH 157

802.11ac (VHT20) – Chain 1: CH 157

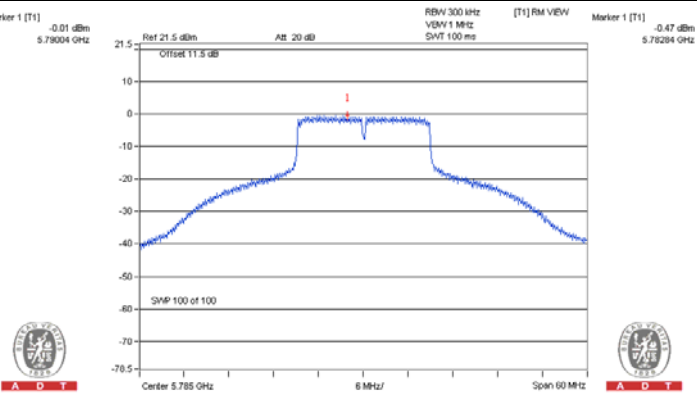
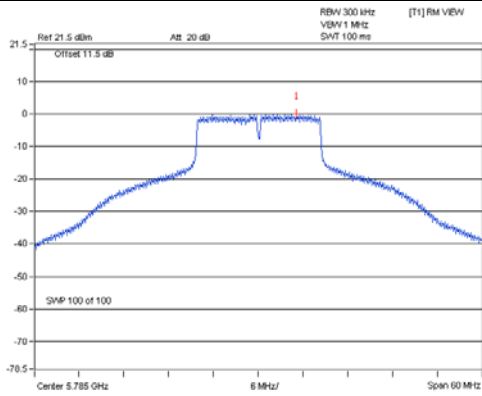

802.11ac (VHT40) – Chain 1: CH 159

802.11ac (VHT80) – Chain 1: CH 155

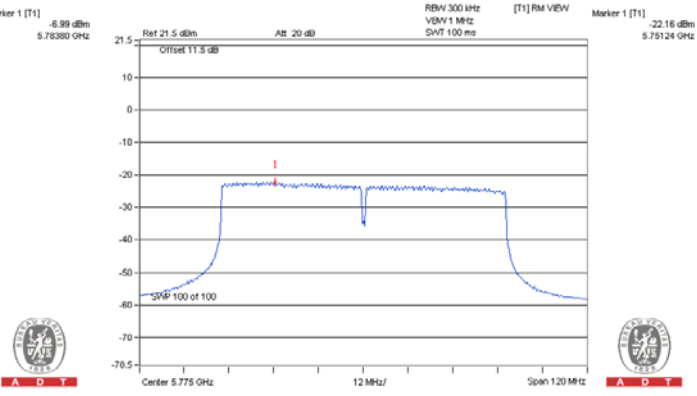
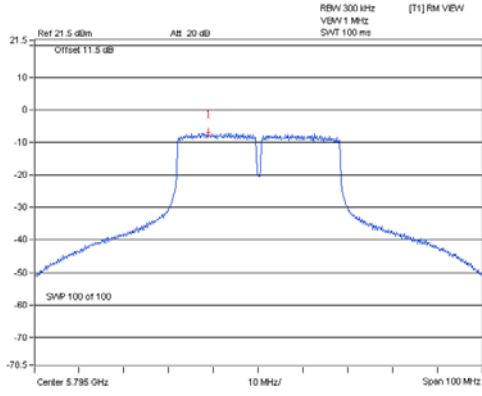

4.5 Frequency Stability Measurement

4.5.1 Limits of Frequency Stability Measurement

The frequency of the carrier signal shall be maintained within band of operation

4.5.2 Test Setup

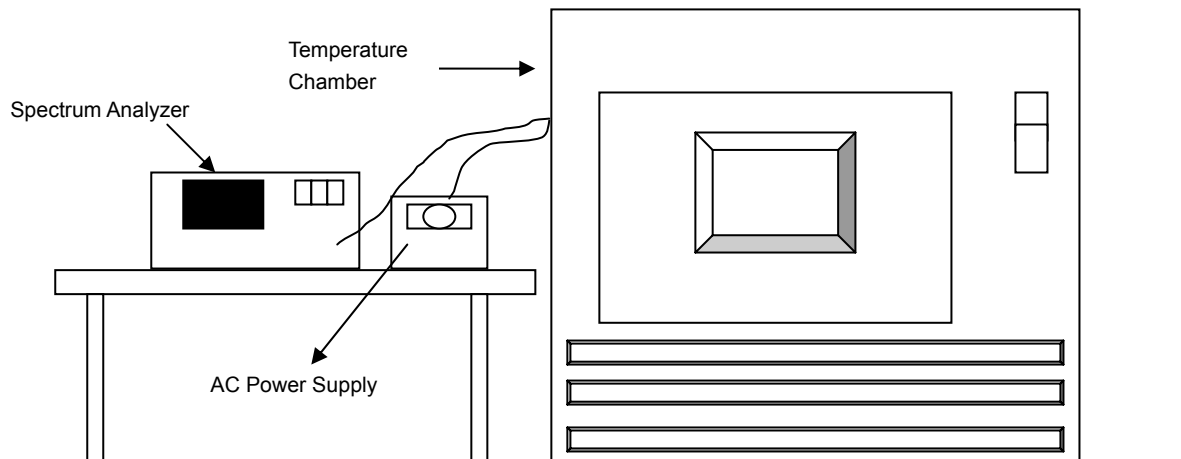

4.5.3 Test Instruments

Refer to section 4.1.2 to get information of above instrument.

4.5.4 Test Procedure

- The EUT was placed inside the environmental test chamber and powered by nominal AC voltage.
- Turn the EUT on and couple its output to a spectrum analyzer.
- Turn the EUT off and set the chamber to the highest temperature specified.
- Allow sufficient time (approximately 30 min) for the temperature of the chamber to stabilize, turn the EUT on and measure the operating frequency after 2, 5, and 10 minutes.
- Repeat step 2 and 3 with the temperature chamber set to the lowest temperature.
- The test chamber was allowed to stabilize at +20 degree C for a minimum of 30 minutes. The supply voltage was then adjusted on the EUT from 85% to 115% and the frequency record.

4.5.5 Deviation from Test Standard

No deviation.

4.5.6 EUT Operating Condition

Set the EUT transmit at un-modulation mode to test frequency stability.

4.5.7 Test Results

FREQUENCY STABILITY VERSUS TEMP.									
OPERATING FREQUENCY: 5180MHz									
TEMP. (°C)	POWER SUPPLY (Vac)	0 MINUTE		2 MINUTE		5 MINUTE		10 MINUTE	
		Measured Frequency (MHz)	Frequency Drift (%)	Measured Frequency (MHz)	Frequency Drift (%)	Measured Frequency (MHz)	Frequency Drift (%)	Measured Frequency (MHz)	Frequency Drift (%)
50	120	5179.9941	-0.00011	5179.9918	-0.00016	5179.9925	-0.00014	5179.992	-0.00015
40	120	5179.9941	-0.00011	5179.9965	-0.00007	5179.9968	-0.00006	5179.9985	-0.00003
30	120	5180.0101	0.00019	5180.0078	0.00015	5180.0081	0.00016	5180.0074	0.00014
20	120	5180.0214	0.00041	5180.0205	0.00040	5180.0187	0.00036	5180.019	0.00037
10	120	5180.0101	0.00019	5180.0095	0.00018	5180.0078	0.00015	5180.0113	0.00022
0	120	5180.0123	0.00024	5180.0139	0.00027	5180.0137	0.00026	5180.0109	0.00021
-10	120	5179.9837	-0.00031	5179.9856	-0.00028	5179.9858	-0.00027	5179.9843	-0.00030
-20	120	5179.9821	-0.00035	5179.9804	-0.00038	5179.9794	-0.00040	5179.9824	-0.00034
-30	120	5180.0191	0.00037	5180.0197	0.00038	5180.0195	0.00038	5180.0188	0.00036

FREQUENCY STABILITY VERSUS VOLTAGE									
OPERATING FREQUENCY: 5180MHz									
TEMP. (°C)	POWER SUPPLY (Vac)	0 MINUTE		2 MINUTE		5 MINUTE		10 MINUTE	
		Measured Frequency (MHz)	Frequency Drift (%)	Measured Frequency (MHz)	Frequency Drift (%)	Measured Frequency (MHz)	Frequency Drift (%)	Measured Frequency (MHz)	Frequency Drift (%)
20	138	5180.0207	0.00040	5180.0204	0.00039	5180.0179	0.00035	5180.0186	0.00036
	120	5180.0214	0.00041	5180.0205	0.00040	5180.0187	0.00036	5180.019	0.00037
	102	5180.0211	0.00041	5180.0214	0.00041	5180.0195	0.00038	5180.0189	0.00036

4.6 6dB Bandwidth Measurement

4.6.1 Limits of 6dB Bandwidth Measurement

The minimum of 6dB Bandwidth Measurement is 0.5MHz.

4.6.2 Test Setup

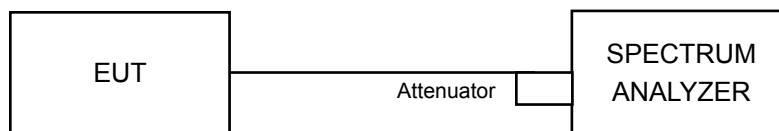

4.6.3 Test Instruments

Refer to section 4.1.2 to get information of above instrument.

4.6.4 Test Procedure

MEASUREMENT PROCEDURE REF

- Set resolution bandwidth (RBW) = 100kHz
- Set the video bandwidth (VBW) $\geq 3 \times$ RBW, Detector = Peak.
- Trace mode = max hold.
- Sweep = auto couple.
- Measure the maximum width of the emission that is constrained by the frequencies associated with the two amplitude points (upper and lower) that are attenuated by 6 dB relative to the maximum level measured in the fundamental emission

4.6.5 Deviation from Test Standard

No deviation.

4.6.6 EUT Operating Condition

The software provided by client to enable the EUT under transmission condition continuously at lowest, middle and highest channel frequencies individually.

4.6.7 Test Results

802.11a

Channel	Frequency (MHz)	6dB Bandwidth (MHz)		Minimum Limit (MHz)	Pass / Fail
		Chain 0	Chain 1		
149	5745	16.42	16.39	0.5	Pass
157	5785	16.36	16.34	0.5	Pass
165	5825	16.37	16.36	0.5	Pass

802.11ac (VHT20)

Channel	Frequency (MHz)	6dB Bandwidth (MHz)		Minimum Limit (MHz)	Pass / Fail
		Chain 0	Chain 1		
149	5745	17.60	17.24	0.5	Pass
157	5785	16.66	17.58	0.5	Pass
165	5825	17.38	17.59	0.5	Pass

802.11ac (VHT40)

Channel	Frequency (MHz)	6dB Bandwidth (MHz)		Minimum Limit (MHz)	Pass / Fail
		Chain 0	Chain 1		
151	5755	35.80	35.93	0.5	Pass
159	5795	35.81	36.11	0.5	Pass

802.11ac (VHT80)

Channel	Frequency (MHz)	6dB Bandwidth (MHz)		Minimum Limit (MHz)	Pass / Fail
		Chain 0	Chain 1		
155	5775	74.64	73.59	0.5	Pass

SPECTRUM PLOT OF WORST VALUE

802.11a – Chain 1: CH 157

802.11a (VHT20) – Chain 0: CH 157

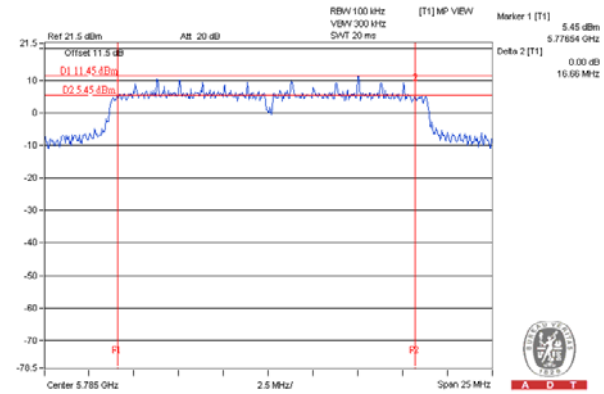
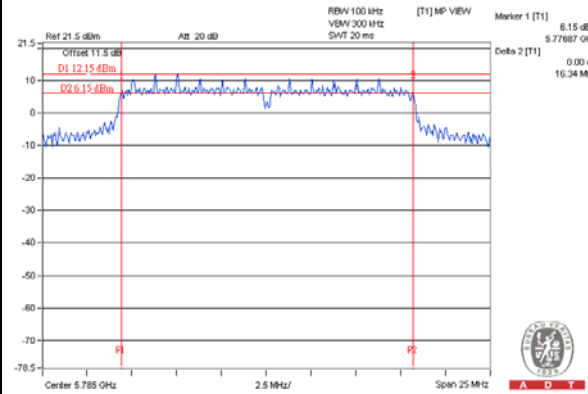

802.11ac (VHT40) – Chain 0: CH 151

802.11ac (VHT80) – Chain 1: CH 155

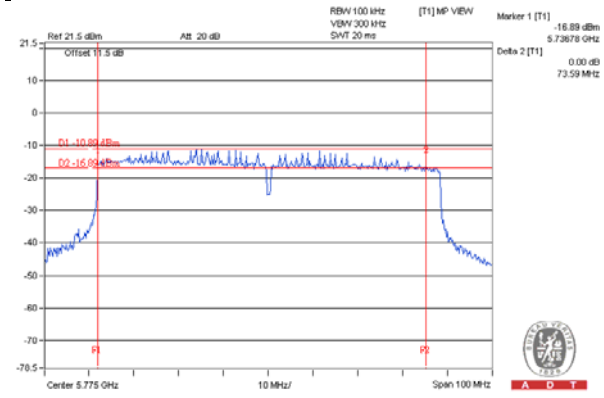
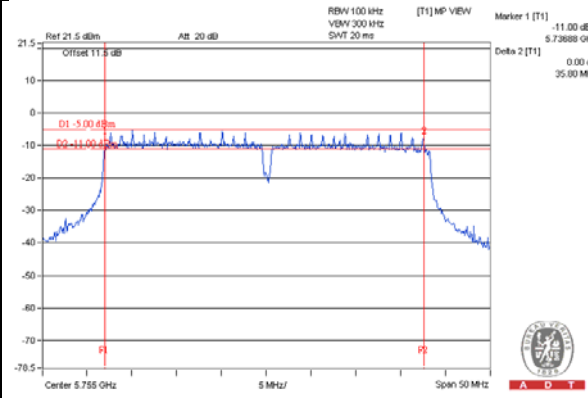

5 Pictures of Test Arrangements

Please refer to the attached file (Test Setup Photo).



Appendix – Information on the Testing Laboratories

We, Bureau Veritas Consumer Products Services (H.K.) Ltd., Taoyuan Branch, were founded in 1988 to provide our best service in EMC, Radio, Telecom and Safety consultation. Our laboratories are accredited and approved according to ISO/IEC 17025.

If you have any comments, please feel free to contact us at the following:

Linko EMC/RF Lab

Tel: 886-2-26052180

Fax: 886-2-26051924

Hsin Chu EMC/RF Lab/Telecom Lab

Tel: 886-3-5935343

Fax: 886-3-5935342

Hwa Ya EMC/RF/Safety

Tel: 886-3-3183232

Fax: 886-3-3270892

Email: service.adt@tw.bureauveritas.com

Web Site: www.bureauveritas-adt.com

The address and road map of all our labs can be found in our web site also.

--- END ---