

FCC Test Report

Report No.: RF150713E08

FCC ID: U8G-P1813

Test Model: MAX Transit

Series Model: MAX transit Duo, MAX transit Quad, Pismo 813

Received Date: July 13, 2015

Test Date: July 20 to Aug. 26, 2015

Issued Date: Sep. 02, 2015

Applicant: Pismo Labs Technology Limited

Address: FLAT/RM A5, 5/F, HK SPINNERS IND BLDG PHASE 6, 481 CASTLE PEAK ROAD, CHEUNG SHA WAN, HONG KONG.

Issued By: Bureau Veritas Consumer Products Services (H.K.) Ltd., Taoyuan Branch Hsin Chu Laboratory

Lab Address: No. 81-1, Lu Liao Keng, 9th Ling, Wu Lung Tsuen, Chiung Lin Hsiang, Hsin Chu Hsien 307, Taiwan R.O.C.

Test Location (1): No. 81-1, Lu Liao Keng, 9th Ling, Wu Lung Tsuen, Chiung Lin Hsiang, Hsin Chu Hsien 307, Taiwan R.O.C.

Test Location (2): No. 49, Ln. 206, Wende Rd., Shangshan Tsuen, Chiung Lin Hsiang, Hsin Chu Hsien 307, Taiwan R.O.C.

Test Location (3): E-2, No.1, Li Hsin 1st Road, Hsinchu Science Park 300, Hsinchu City, Taiwan R.O.C.



This report is for your exclusive use. Any copying or replication of this report to or for any other person or entity, or use of our name or trademark, is permitted only with our prior written permission. This report sets forth our findings solely with respect to the test samples identified herein. The results set forth in this report are not indicative or representative of the quality or characteristics of the lot from which a test sample was taken or any similar or identical product unless specifically and expressly noted. Our report includes all of the tests requested by you and the results thereof based upon the information that you provided to us. You have 60 days from date of issuance of this report to notify us of any material error or omission caused by our negligence, provided, however, that such notice shall be in writing and shall specifically address the issue you wish to raise. A failure to raise such issue within the prescribed time shall constitute your unqualified acceptance of the completeness of this report, the tests conducted and the correctness of the report contents. Unless specific mention, the uncertainty of measurement has been explicitly taken into account to declare the compliance or non-compliance to the specification. The report must not be used by the client to claim product certification, approval, or endorsement by TAF or any government agencies.

Table of Contents

Release Control Record	4
1 Certificate of Conformity	5
2 Summary of Test Results	6
2.1 Measurement Uncertainty.....	6
2.2 Modification Record.....	6
3 General Information	7
3.1 General Description of EUT.....	7
3.2 Description of Test Modes.....	10
3.2.1 Test Mode Applicability and Tested Channel Detail.....	11
3.3 Duty Cycle of Test Signal.....	13
3.4 Description of Support Units.....	14
3.4.1 Configuration of System under Test.....	15
3.5 General Description of Applied Standards.....	17
4 Test Types and Results	18
4.1 Radiated Emission and Bandedge Measurement.....	18
4.1.1 Limits of Radiated Emission and Bandedge Measurement.....	18
4.1.2 Test Instruments.....	19
4.1.3 Test Procedures.....	21
4.1.4 Deviation from Test Standard.....	21
4.1.5 Test Setup.....	22
4.1.6 EUT Operating Conditions.....	22
4.1.7 Test Results.....	23
4.2 Conducted Emission Measurement.....	36
4.2.1 Limits of Conducted Emission Measurement.....	36
4.2.2 Test Instruments.....	36
4.2.3 Test Procedures.....	38
4.2.4 Deviation from Test Standard.....	38
4.2.5 Test Setup.....	38
4.2.6 EUT Operating Conditions.....	38
4.2.7 Test Results (Mode 1).....	39
4.2.8 Test Results (Mode 2).....	41
4.2.9 Test Results (Mode 3).....	43
4.2.10 Test Results (Mode 4).....	45
4.3 6dB Bandwidth Measurement.....	47
4.3.1 Limits of 6dB Bandwidth Measurement.....	47
4.3.2 Test Setup.....	47
4.3.3 Test Instruments.....	47
4.3.4 Test Procedure.....	47
4.3.5 Deviation from Test Standard.....	47
4.3.6 EUT Operating Conditions.....	47
4.3.7 Test Result.....	48
4.4 Conducted Output Power Measurement.....	50
4.4.1 Limits of Conducted Output Power Measurement.....	50
4.4.2 Test Setup.....	50
4.4.3 Test Instruments.....	50
4.4.4 Test Procedures.....	50
4.4.5 Deviation from Test Standard.....	50
4.4.6 EUT Operating Conditions.....	50
4.4.7 Test Results.....	51
4.5 Power Spectral Density Measurement.....	53
4.5.1 Limits of Power Spectral Density Measurement.....	53
4.5.2 Test Setup.....	53
4.5.3 Test Procedure.....	53



4.5.4	Deviation from Test Standard	53
4.5.5	EUT Operating Condition	53
4.5.6	Test Results	54
4.6	Conducted Out of Band Emission Measurement.....	56
4.6.1	Limits of Conducted Out of Band Emission Measurement	56
4.6.2	Test Setup.....	56
4.6.3	Test Instruments	56
4.6.4	Test Procedure	56
4.6.5	Deviation from Test Standard	56
4.6.6	EUT Operating Condition	56
4.6.7	Test Results	56
5	Pictures of Test Arrangements.....	65
	Appendix – Information on the Testing Laboratories	66



A D T

Release Control Record

Issue No.	Description	Date Issued
RF150713E08	Original release.	Sep. 02, 2015



A D T

1 Certificate of Conformity

Product: Upgradable transportation WiFi hotspot

Brand: Pepwave / Peplink / Pismo

Test Model: MAX Transit

Series Model: MAX transit Duo, MAX transit Quad, Pismo 813

Sample Status: MASS-PRODUCTION

Applicant: Pismo Labs Technology Limited

Test Date: July 20 to Aug. 26, 2015

Standards: 47 CFR FCC Part 15, Subpart C (Section 15.247)
ANSI C63.10: 2013

The above equipment has been tested by **Bureau Veritas Consumer Products Services (H.K.) Ltd., Taoyuan Branch**, and found compliance with the requirement of the above standards. The test record, data evaluation & Equipment Under Test (EUT) configurations represented herein are true and accurate accounts of the measurements of the sample's EMC characteristics under the conditions specified in this report.

Prepared by :  , **Date:** Sep. 02, 2015
Lori Chung / Specialist

Approved by :  , **Date:** Sep. 02, 2015
May Chen / Manager

2 Summary of Test Results

47 CFR FCC Part 15, Subpart C (SECTION 15.247)			
FCC Clause	Test Item	Result	Remarks
15.207	AC Power Conducted Emission	Pass	Meet the requirement of limit. Minimum passing margin is -1.29dB at 18.20569MHz.
15.205 / 15.209 / 15.247(d)	Radiated Emissions and Band Edge Measurement	Pass	Meet the requirement of limit. Minimum passing margin is -0.1dB at 4924.00MHz, 2483.50MHz & 2390.00MHz.
15.247(d)	Antenna Port Emission	Pass	Meet the requirement of limit.
15.247(a)(2)	6dB bandwidth	Pass	Meet the requirement of limit.
15.247(b)	Conducted power	Pass	Meet the requirement of limit.
15.247(e)	Power Spectral Density	Pass	Meet the requirement of limit.
15.203	Antenna Requirement	Pass	Antenna connector is RP-SMA not a standard connector.

NOTE: The EUT was operating in 2400 ~ 2483.5MHz, 5150~5250MHz and 5725~5850MHz frequencies band. This report was recorded the RF parameters including 2400 ~ 2483.5MHz. For the 5150~5250MHz and 5725~5850MHz RF parameters was recorded in another test report.

2.1 Measurement Uncertainty

Where relevant, the following measurement uncertainty levels have been estimated for tests performed on the EUT as specified in CISPR 16-4-2:

Measurement	Frequency	Expanded Uncertainty (k=2) (\pm)
Conducted Emissions at mains ports	150kHz ~ 30MHz	2.86 dB
Radiated Emissions up to 1 GHz	30MHz ~ 1GHz	5.37 dB
Radiated Emissions above 1 GHz	1GHz ~ 6GHz	3.65 dB
	6GHz ~ 18GHz	3.88 dB
	18GHz ~ 40GHz	4.11 dB

2.2 Modification Record

There were no modifications required for compliance.

3 General Information

3.1 General Description of EUT

Product	Upgradable transportation WiFi hotspot
Brand	Pepwave / Peplink / Pismo
Test Model	MAX Transit
Series Model	MAX transit Duo, MAX transit Quad, Pismo 813
Status of EUT	MASS-PRODUCTION
Power Supply Rating	12-48Vdc from power adapter or 12-48Vdc from Terminal Block or 5Vdc from Micro USB
Modulation Type	CCK, DQPSK, DBPSK for DSSS 64QAM, 16QAM, QPSK, BPSK for OFDM 256QAM for OFDM in 11ac mode
Modulation Technology	DSSS, OFDM
Transfer Rate	802.11b: up to 11Mbps 802.11a: up to 54Mbps 802.11n: up to 300Mbps 802.11ac: up to 433.3Mbps
Operating Frequency	For 15.407 5.18 ~ 5.24GHz, 5.745 ~ 5.825GHz
	For 15.247 2.412 ~ 2.462GHz
Number of Channel	For 15.407 9 for 802.11a, 802.11n (HT20), 802.11ac (VHT20) 4 for 802.11n (HT40), 802.11ac (VHT40) 2 for 802.11ac (VHT80)
	For 15.247 (2.4GHz) 11 for 802.11b, 802.11g, 802.11n (HT20) 7 for 802.11n (HT40)
Output Power	For 15.407 802.11a: 252.981mW 802.11ac (VHT20): 239.957mW 802.11ac (VHT40): 132.781mW 802.11ac (VHT80): 14.61mW
	For 15.247 802.11b: 33.848mW 802.11g: 379.799mW 802.11n(HT20): 359.414mW 802.11n(HT40): 222.048mW
Antenna Type	Refer to Note
Antenna Connector	Refer to Note
Accessory Device	Adapter x 1 GPS x 1
Data Cable Supplied	NA

Note:

- The EUT has below model names which are identical to each other in all aspects except for the following table:

Product Name	Brand	Model Name	Difference
Upgradable transportation WiFi hotspot	Pepwave / Peplink / Pismo	MAX Transit	For marketing requirement
		MAX transit Duo	
		MAX transit Quad	
		Pismo 813	

From the above models, model: MAX Transit was selected as representative model for the test and its data was recorded in this report.

- There are WLAN (2.4GHz/5GHz), WWAN (2G/3G), LTE (4G) and GPS technology used for the EUT.
- The emission of the simultaneous operation (WLAN 2.4GHz & 5GHz & WWAN 2G) has been evaluated and no non-compliance was found.
- The antennas provided to the EUT, please refer to the following table:

For WLAN							
Antenna No.	Brand	Model	Ant. Gain (dBi)	Frequency range (GHz to GHz)	Antenna Type	Connector Type	
1	SmartAnt	SAA06-220690	3	2.4~2.4835	Dipole	RP-SMA	
			4~5.5	5.15~5.25			
			5.5~6	5.725~5.85			
For GPS							
Set	Brand	Model	Ant. Gain (dBi)	Frequency range (MHz)	Antenna Type	Connector Type	
1	Chang Hong	GPS-01	-1	1575.42 (±1.023MHz)	Magnetic	R-SMA Male	
For LTE							
Set	Transmitter Circuit	Brand	Model	Ant. Gain (dBi)	Frequency range (MHz to MHz)	Antenna Type	Connector Type
1	Cellular Main	Pulse	SPDA24700/2700	2	698-960	Dipole	R-SMA Male
	Cellular Diversity / Aux				1710-2170 2500-2700		

- The EUT inside has one LTE module which FCC ID: N7NMC7355.

- The EUT must be supplied with a power adapter as following table:

Brand Name	Model No.	Spec.
Ten Pao	S024WM1200200	Input: 100-240V, 600mA, 50/60Hz Output: 12V, 2000mA DC output cable: unshielded, 1.5m with 1 core

- The EUT was pre-tested under the following test modes :

Pre-test Mode	Power
Mode A	Power from Adapter
Mode B	Power from USB 1 & 2
Mode C	Power from USB 1
Mode D	Power from USB 2
Mode E	Power from (Terminal Block: 48Vdc)
Mode F	Power from (Terminal Block: 12Vdc)

The worst radiated emissions were found in **Mode A**. Therefore only the test data of the modes were recorded in this report.

For Conducted emission test, the Mode A, C, D&F were selected as representative mode for the test and their data were recorded in this report.

8. The EUT incorporates a MIMO function.

For 2.4GHz Band			
MODULATION MODE	DATA RATE (MCS)	TX & RX CONFIGURATION	
802.11b	1 ~ 11Mbps	2TX	2RX
802.11g	6 ~ 54Mbps	2TX	2RX
802.11n (HT20)	MCS 0~7	2TX	2RX
	MCS 8~15	2TX	2RX
802.11n (HT40)	MCS 0~7	2TX	2RX
	MCS 8~15	2TX	2RX
For 5GHz Band			
MODULATION MODE	DATA RATE (MCS)	TX & RX CONFIGURATION	
802.11a	6 ~ 54Mbps	2TX	2RX
802.11n (HT20)	MCS 0~7	2TX	2RX
	MCS 8~15	2TX	2RX
802.11n (HT40)	MCS 0~7	2TX	2RX
	MCS 8~15	2TX	2RX
802.11ac (VHT20)	MCS 0~8, Nss=1	2TX	2RX
	MCS 0~8, Nss=2	2TX	2RX
802.11ac (VHT40)	MCS 0~9, Nss=1	2TX	2RX
	MCS 0~9, Nss=2	2TX	2RX
802.11ac (VHT80)	MCS 0~9, Nss=1	2TX	2RX
	MCS 0~9, Nss=2	2TX	2RX

9. The above EUT information is declared by manufacturer and for more detailed features description, please refer to the manufacturer's specifications or user's manual.

3.2 Description of Test Modes

11 channels are provided for 802.11b, 802.11g and 802.11n (HT20):

Channel	Frequency	Channel	Frequency
1	2412MHz	7	2442MHz
2	2417MHz	8	2447MHz
3	2422MHz	9	2452MHz
4	2427MHz	10	2457MHz
5	2432MHz	11	2462MHz
6	2437MHz		

7 channels are provided for 802.11n (HT40):

Channel	Frequency	Channel	Frequency
3	2422MHz	7	2442MHz
4	2427MHz	8	2447MHz
5	2432MHz	9	2452MHz
6	2437MHz		

3.2.1 Test Mode Applicability and Tested Channel Detail

EUT CONFIGURE MODE	APPLICABLE TO				DESCRIPTION
	RE \geq 1G	RE $<$ 1G	PLC	APCM	
1	√	√	√	√	Power from Adapter
2	-	-	√	-	Power from USB 1
3	-	-	√	-	Power from USB 2
4	-	-	√	-	Power from Terminal Block

Where **RE \geq 1G**: Radiated Emission above 1GHz & Bandedge Measurement
RE $<$ 1G: Radiated Emission below 1GHz
PLC: Power Line Conducted Emission
APCM: Antenna Port Conducted Measurement

NOTE: 1. The EUT had been pre-tested on the positioned of each 2 axis. The worst case was found when positioned on **Wall-mount type**.

2. "-" means no effect.

Radiated Emission Test (Above 1GHz):

- Pre-Scan has been conducted to determine the worst-case mode from all possible combinations between available modulations, data rates and antenna ports (if EUT with antenna diversity architecture).
- Following channel(s) was (were) selected for the final test as listed below.

MODE	AVAILABLE CHANNEL	TESTED CHANNEL	MODULATION TECHNOLOGY	MODULATION TYPE	DATA RATE (Mbps)
802.11b	1 to 11	1, 6, 11	DSSS	DBPSK	1
802.11g	1 to 11	1, 6, 11	OFDM	BPSK	6
802.11n (HT20)	1 to 11	1, 6, 11	OFDM	BPSK	6.5
802.11n (HT40)	3 to 9	3, 6, 9	OFDM	BPSK	13.5

Radiated Emission Test (Below 1GHz):

- Pre-Scan has been conducted to determine the worst-case mode from all possible combinations between available modulations, data rates and antenna ports (if EUT with antenna diversity architecture).
- Following channel(s) was (were) selected for the final test as listed below.

MODE	AVAILABLE CHANNEL	TESTED CHANNEL	MODULATION TECHNOLOGY	MODULATION TYPE	DATA RATE (Mbps)
802.11g	1 to 11	6	OFDM	BPSK	6

Power Line Conducted Emission Test:

- Pre-Scan has been conducted to determine the worst-case mode from all possible combinations between available modulations, data rates and antenna ports (if EUT with antenna diversity architecture).
- Following channel(s) was (were) selected for the final test as listed below.

MODE	AVAILABLE CHANNEL	TESTED CHANNEL	MODULATION TECHNOLOGY	MODULATION TYPE	DATA RATE (Mbps)
802.11g	1 to 11	6	OFDM	BPSK	6

Antenna Port Conducted Measurement:

- This item includes all test value of each mode, but only includes spectrum plot of worst value of each mode.
- Pre-Scan has been conducted to determine the worst-case mode from all possible combinations between available modulations, data rates and antenna ports (if EUT with antenna diversity architecture).
- Following channel(s) was (were) selected for the final test as listed below.

MODE	AVAILABLE CHANNEL	TESTED CHANNEL	MODULATION TECHNOLOGY	MODULATION TYPE	DATA RATE (Mbps)
802.11b	1 to 11	1, 6, 11	DSSS	DBPSK	1
802.11g	1 to 11	1, 6, 11	OFDM	BPSK	6
802.11n (HT20)	1 to 11	1, 6, 11	OFDM	BPSK	6.5
802.11n (HT40)	3 to 9	3, 6, 9	OFDM	BPSK	13.5

Test Condition:

APPLICABLE TO	ENVIRONMENTAL CONDITIONS	INPUT POWER	TESTED BY
RE\geq1G	24deg. C, 67%RH	120Vac, 60Hz	Weiwei Lo
RE$<$1G	25deg. C, 68%RH	120Vac, 60Hz	Weiwei Lo
PLC	27deg. C, 60%RH	120Vac, 60Hz	Timmy Hu
	25deg. C, 60%RH		Jyunchun Lin
	28deg. C, 56%RH		Wythe Lin
APCM	25deg. C, 60%RH	120Vac, 60Hz	Anderson Chen

3.3 Duty Cycle of Test Signal

Duty cycle of test signal is 100 %, duty factor is not required.

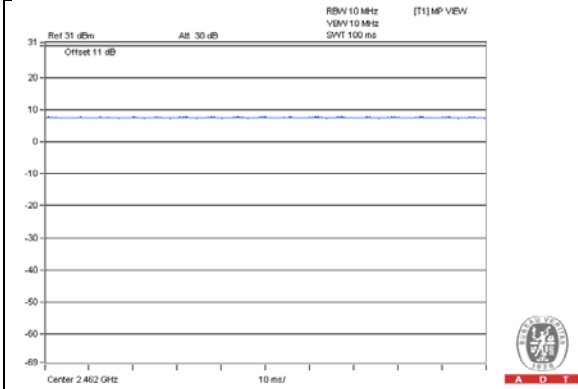
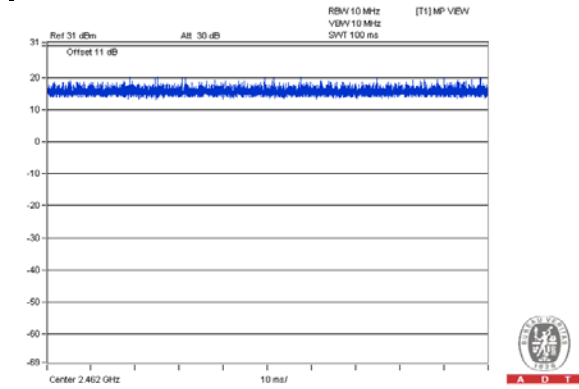
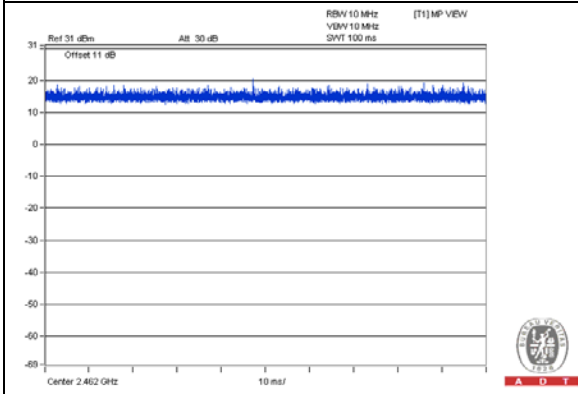
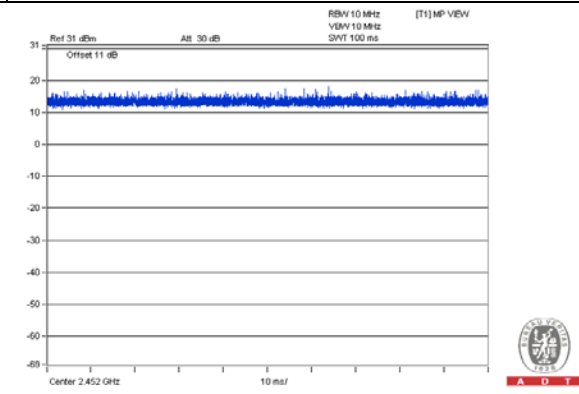
802.11b**802.11g****802.11n (HT20)****802.11n (HT40)**

3.4 Description of Support Units

The EUT has been tested as an independent unit together with other necessary accessories or support units. The following support units or accessories were used to form a representative test configuration during the tests.

ID	Product	Brand	Model No.	Serial No.	FCC ID	Remarks
A.	NOTEBOOK COMPUTER	DELL	E6440	F9LYQ32	FCC DoC	Provided by Lab
B.	NOTEBOOK COMPUTER	DELL	E6420	482T3R1	FCC DoC	Provided by Lab
C.	Adapter	ASUS	ad876320	NA	NA	Provided by Lab

Note:

1. All power cords of the above support units are non-shielded (1.8m).

ID	Descriptions	Qty.	Length (m)	Shielding (Yes/No)	Cores (Qty.)	Remarks
1.	DC	1	2	No	0	Provided by Lab
2.	RJ45	1	10	No	0	Provided by Lab
3.	RJ45	1	10	No	0	Provided by Lab
4.	Earth	1	3	No	0	Provided by Lab
5.	RJ45	3	10	No	0	Provided by Lab
6.	DC	1	1.5	No	1	Supplied by Client
7.	Micro USB to USB	1	1	No	0	Provided by Lab
8.	Micro USB to USB	1	1	No	0	Provided by Lab

Note: The core(s) is(are) originally attached to the cable(s).

3.4.1 Configuration of System under Test

For conducted emission test Mode 2:

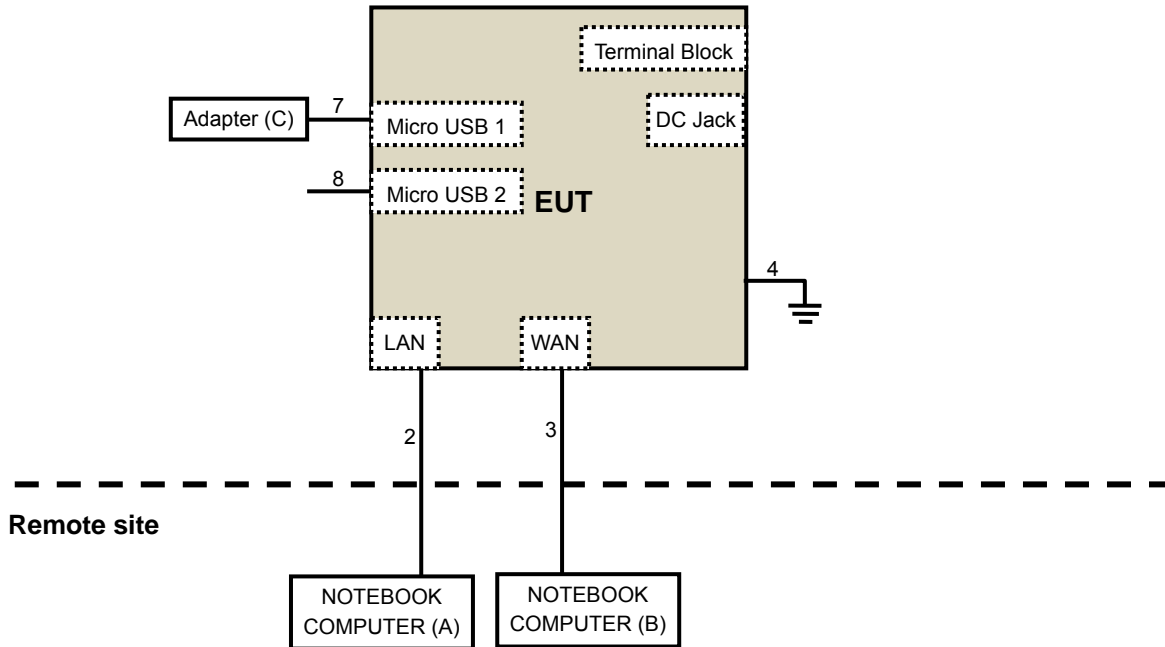

For conducted emission test Mode 3:

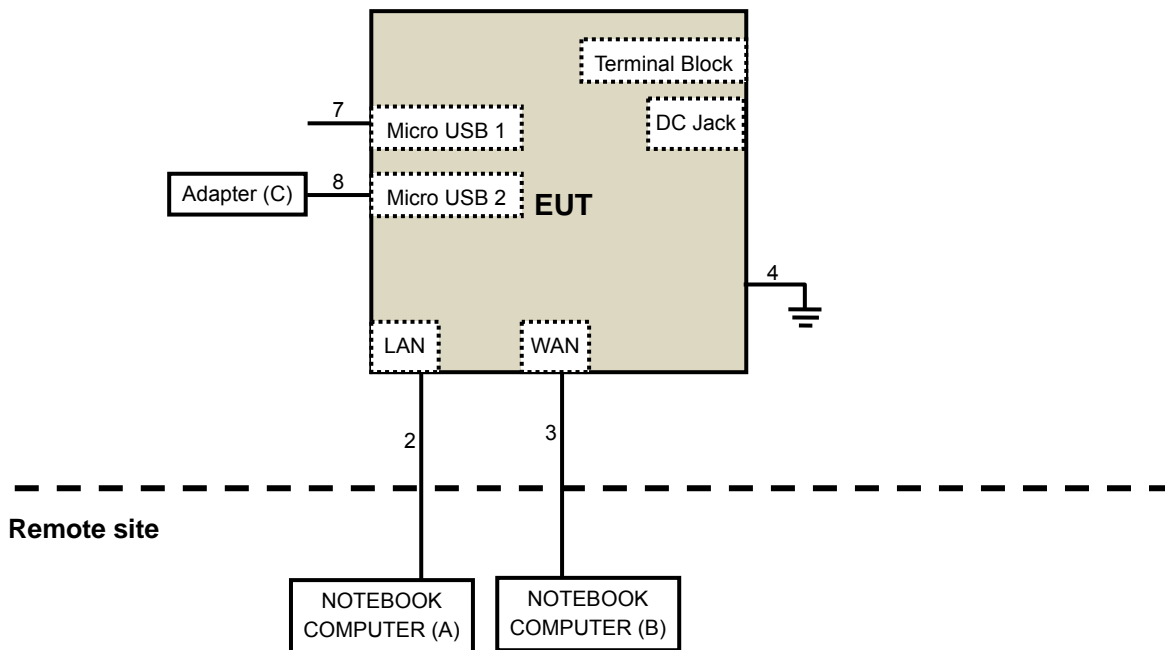

For conducted emission test Mode 4:

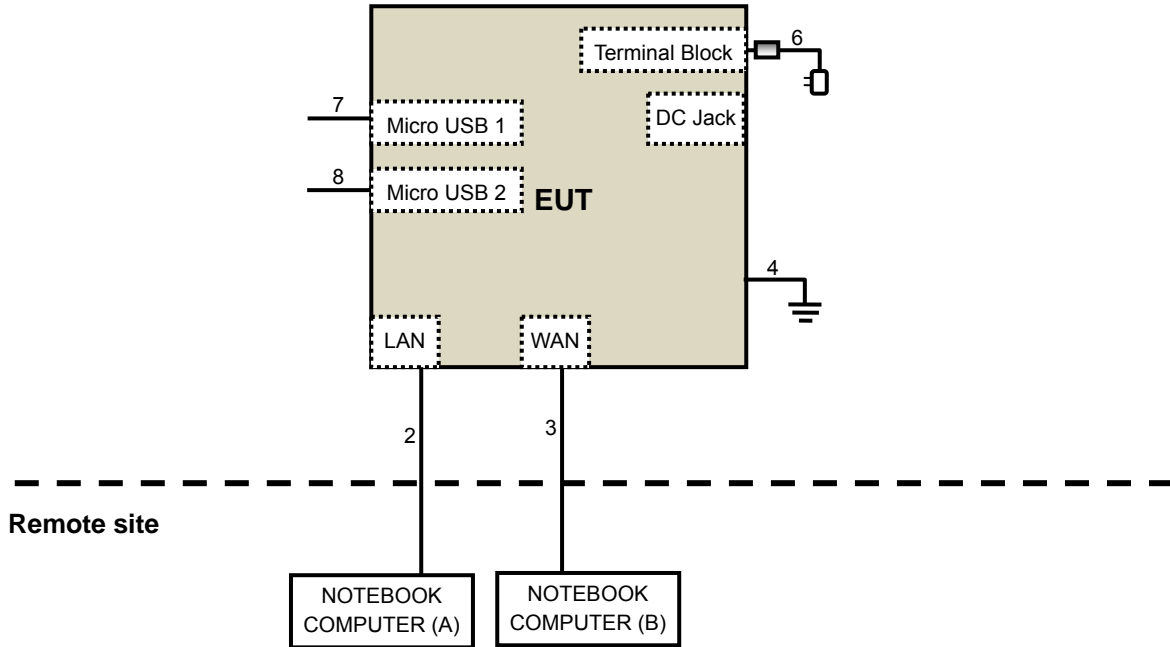

For conducted emission test Mode 1 & other test items:

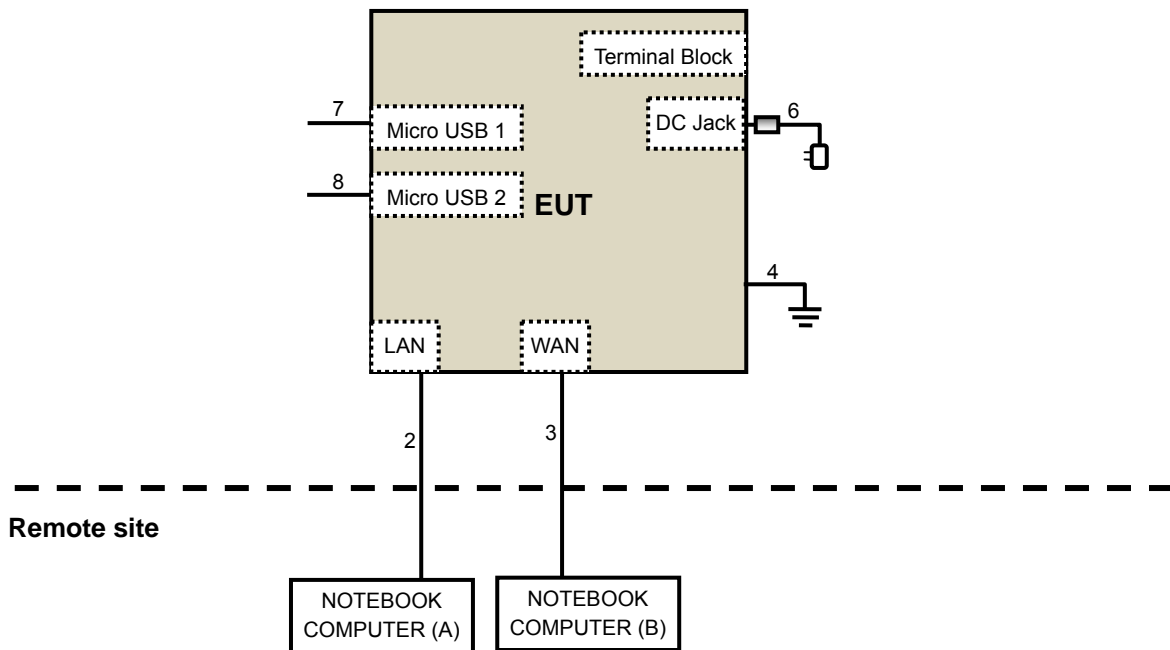

3.5 General Description of Applied Standards

The EUT is a RF Product. According to the specifications of the manufacturer, it must comply with the requirements of the following standards:

FCC Part 15, Subpart C (15.247)
558074 D01 DTS Meas Guidance v03r03
662911 D01 Multiple Transmitter Output v02r01
ANSI C63.10-2013

All test items have been performed and recorded as per the above standards.

4 Test Types and Results

4.1 Radiated Emission and Bandedge Measurement

4.1.1 Limits of Radiated Emission and Bandedge Measurement

Radiated emissions which fall in the restricted bands must comply with the radiated emission limits specified as below table. Other emissions shall be at least 20dB below the highest level of the desired power:

Frequencies (MHz)	Field Strength (microvolts/meter)	Measurement Distance (meters)
0.009 ~ 0.490	2400/F(kHz)	300
0.490 ~ 1.705	24000/F(kHz)	30
1.705 ~ 30.0	30	30
30 ~ 88	100	3
88 ~ 216	150	3
216 ~ 960	200	3
Above 960	500	3

NOTE:

1. The lower limit shall apply at the transition frequencies.
2. Emission level (dBuV/m) = 20 log Emission level (uV/m).
3. For frequencies above 1000MHz, the field strength limits are based on average detector, however, the peak field strength of any emission shall not exceed the maximum permitted average limits, specified above by more than 20dB under any condition of modulation.

4.1.2 Test Instruments

For above 1GHz test:

DESCRIPTION & MANUFACTURER	MODEL NO.	SERIAL NO.	CALIBRATED DATE	CALIBRATED UNTIL
Test Receiver Agilent	N9038A	MY51210105	July 24, 2015	July 23, 2016
Horn_Antenna AISI	AIH.8018	000032009111 0	Feb. 09, 2015	Feb. 08, 2016
Pre-Amplifier Agilent	8449B	3008A02578	June 23, 2015	June 22, 2016
RF Cable	NA	131205 131216 131217 SNMY23684/ 4	Jan. 16, 2015	Jan. 15, 2016
Spectrum Analyzer R&S	FSV40	100964	June 26, 2015	June 25, 2016
Pre-Amplifier SPACEK LABS	SLKKa-48-6	9K16	Dec. 12, 2014	Dec. 11, 2015
Horn_Antenna SCHWARZBECK	BBHA 9170	9170-424	Feb. 05, 2015	Feb. 04, 2016
RF Cable	NA	329751/4 RF104-204	Dec. 11, 2014	Dec. 10, 2015
Software	ADT_Radiated _V8.7.07	NA	NA	NA
Antenna Tower & Turn Table CT	NA	NA	NA	NA
Power Meter Anritsu	ML2495A	1014008	Apr. 28, 2015	Apr. 27, 2016
Power Sensor Anritsu	MA2411B	0917122	Apr. 28, 2015	Apr. 27, 2016
SPECTRUM ANALYZER R&S	FSP 40	100060	May 08, 2015	May 07, 2016

Note:

1. The calibration interval of the above test instruments is 12 months and the calibrations are traceable to NML/ROC and NIST/USA.
2. The test was performed in 966 Chamber No. G.
3. The FCC Site Registration No. is 966073.
4. The VCCI Site Registration No. is G-137.
5. The CANADA Site Registration No. is IC 7450H-2.
6. Tested Date: Aug. 06 to 07, 2015

For below 1GHz test:

DESCRIPTION & MANUFACTURER	MODEL NO.	SERIAL NO.	CALIBRATED DATE	CALIBRATED UNTIL
Test Receiver Agilent	N9038A	MY51210202	Dec. 12, 2014	Dec. 11, 2015
Pre-Amplifier Mini-Circuits	ZFL-1000VH2 B	AMP-ZFL-03	Nov. 12, 2014	Nov. 11, 2015
Trilog Broadband Antenna SCHWARZBECK	VULB 9168	9168-360	Feb. 06, 2015	Feb. 05, 2016
RF Cable	8D-FB	CHGCAB-001 -1 CHGCAB-001 -2	Oct. 04, 2014	Oct. 03, 2015
	RF-141	CHGCAB-004	Oct. 04, 2014	Oct. 03, 2015
Software	ADT_Radiated _V8.7.07	NA	NA	NA
Antenna Tower & Turn Table CT	NA	NA	NA	NA

Note:

1. The calibration interval of the above test instruments is 12 months and the calibrations are traceable to NML/ROC and NIST/USA.
2. The test was performed in 966 Chamber No. G.
3. The FCC Site Registration No. is 966073.
4. The VCCI Site Registration No. is G-137.
5. The CANADA Site Registration No. is IC 7450H-2.
6. Tested Date: July 23, 2015

4.1.3 Test Procedures

- a. The EUT was placed on the top of a rotating table 0.8 meters (for below 1GHz) / 1.5 meters (for above 1GHz) above the ground at 3 meter chamber room for test. The table was rotated 360 degrees to determine the position of the highest radiation.
- b. The EUT was set 3 meters away from the interference-receiving antenna, which was mounted on the top of a variable-height antenna tower.
- c. The height of antenna is varied from one meter to four meters above the ground to determine the maximum value of the field strength. Both horizontal and vertical polarizations of the antenna are set to make the measurement.
- d. For each suspected emission, the EUT was arranged to its worst case and then the antenna was tuned to heights from 1 meter to 4 meters and the rotatable table was turned from 0 degrees to 360 degrees to find the maximum reading.
- e. The test-receiver system was set to quasi-peak detect function and specified bandwidth with maximum hold mode when the test frequency is below 1 GHz.
- f. The test-receiver system was set to peak and average detect function and specified bandwidth with maximum hold mode when the test frequency is above 1 GHz. If the peak reading value also meets average limit, measurement with the average detector is unnecessary.

Note:

1. The resolution bandwidth and video bandwidth of test receiver/spectrum analyzer is 120kHz for Quasi-peak detection (QP) at frequency below 1GHz.
2. The resolution bandwidth of test receiver/spectrum analyzer is 1 MHz and the video bandwidth is 3 MHz for Peak detection (PK) at frequency above 1GHz.
3. The resolution bandwidth of test receiver/spectrum analyzer is 1MHz and the video bandwidth is 3MHz for RMS Average (Duty cycle < 98%) for Average detection (AV) at frequency above 1GHz, then the measurement results was added to a correction factor ($10 \log(1/\text{duty cycle})$).
4. The resolution bandwidth of test receiver/spectrum analyzer is 1MHz and the video bandwidth is 10Hz (Duty cycle $\geq 98\%$) for Average detection (AV) at frequency above 1GHz.
5. All modes of operation were investigated and the worst-case emissions are reported.

4.1.4 Deviation from Test Standard

No deviation.

4.1.5 Test Setup

<Frequency Range below 1GHz>

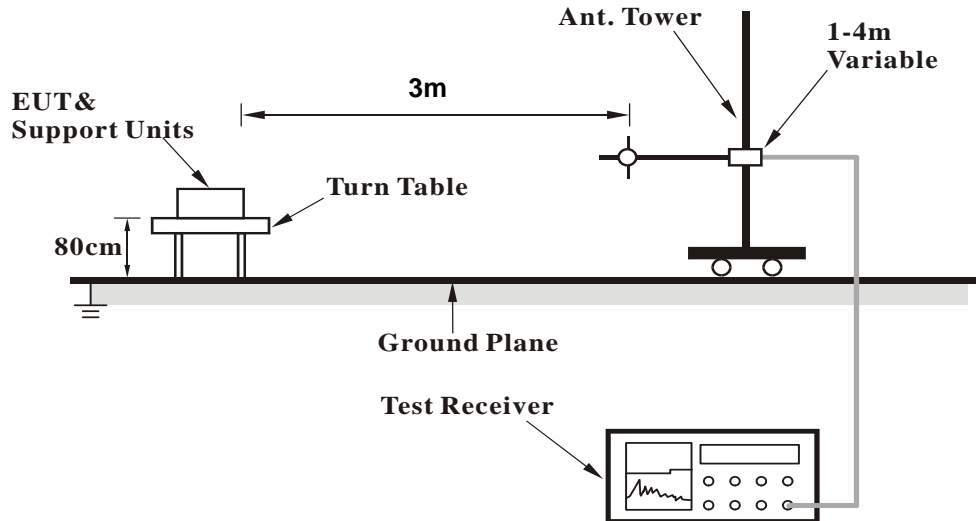

<Frequency Range above 1GHz>

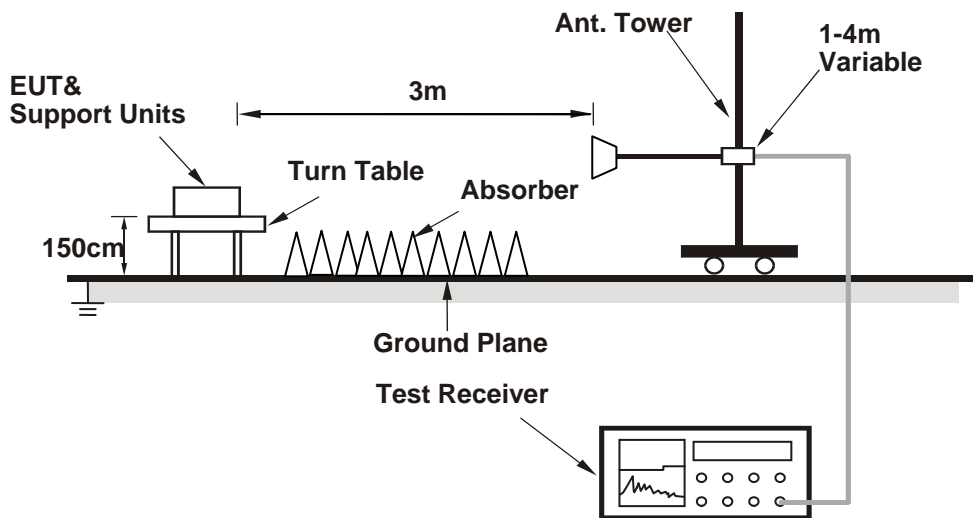

For the actual test configuration, please refer to the attached file (Test Setup Photo).

4.1.6 EUT Operating Conditions

- a. Connect the EUT with the support units A & B (Notebook Computer) which is placed in remote site.
- b. Controlling software (artgui.exe [V2.3]) has been activated to set the EUT on specific status.

4.1.7 Test Results

Above 1GHz Data:

802.11b

CHANNEL	TX Channel 1	DETECTOR FUNCTION	Peak (PK)
FREQUENCY RANGE	1GHz ~ 25GHz		Average (AV)

ANTENNA POLARITY & TEST DISTANCE: HORIZONTAL AT 3 M

NO.	FREQ. (MHz)	EMISSION LEVEL (dBuV/m)	LIMIT (dBuV/m)	MARGIN (dB)	ANTENNA HEIGHT (m)	TABLE ANGLE (Degree)	RAW VALUE (dBuV)	CORRECTION FACTOR (dB/m)
1	2390.00	45.8 PK	74.0	-28.2	1.20 H	163	47.23	-1.43
2	2390.00	34.2 AV	54.0	-19.8	1.20 H	163	35.63	-1.43
3	*2412.00	92.8 PK			2.03 H	226	94.18	-1.38
4	*2412.00	84.7 AV			2.03 H	226	86.08	-1.38
5	4824.00	48.6 PK	74.0	-25.4	1.42 H	252	41.51	7.09
6	4824.00	39.0 AV	54.0	-15.0	1.42 H	252	31.91	7.09

ANTENNA POLARITY & TEST DISTANCE: VERTICAL AT 3 M

NO.	FREQ. (MHz)	EMISSION LEVEL (dBuV/m)	LIMIT (dBuV/m)	MARGIN (dB)	ANTENNA HEIGHT (m)	TABLE ANGLE (Degree)	RAW VALUE (dBuV)	CORRECTION FACTOR (dB/m)
1	2390.00	57.7 PK	74.0	-16.3	1.81 V	97	59.13	-1.43
2	2390.00	48.4 AV	54.0	-5.6	1.81 V	97	49.83	-1.43
3	*2412.00	104.1 PK			1.80 V	92	105.48	-1.38
4	*2412.00	100.5 AV			1.80 V	92	101.88	-1.38
5	4824.00	56.1 PK	74.0	-17.9	1.55 V	270	49.01	7.09
6	4824.00	53.5 AV	54.0	-0.5	1.55 V	270	46.41	7.09

REMARKS:

1. Emission Level(dBuV/m) = Raw Value(dBuV) + Correction Factor(dB/m)
2. Correction Factor(dB/m) = Antenna Factor(dB/m) + Cable Factor(dB) – Pre-Amplifier Factor(dB)
3. The other emission levels were very low against the limit.
4. Margin value = Emission Level – Limit value
5. " * ": Fundamental frequency.

CHANNEL	TX Channel 6	DETECTOR FUNCTION	Peak (PK)
FREQUENCY RANGE	1GHz ~ 25GHz		Average (AV)

ANTENNA POLARITY & TEST DISTANCE: HORIZONTAL AT 3 M

NO.	FREQ. (MHz)	EMISSION LEVEL (dBuV/m)	LIMIT (dBuV/m)	MARGIN (dB)	ANTENNA HEIGHT (m)	TABLE ANGLE (Degree)	RAW VALUE (dBuV)	CORRECTION FACTOR (dB/m)
1	*2437.00	88.5 PK			2.07 H	233	89.82	-1.32
2	*2437.00	84.7 AV			2.07 H	233	86.02	-1.32
3	4874.00	48.7 PK	74.0	-25.3	1.32 H	274	41.45	7.25
4	4874.00	40.0 AV	54.0	-14.0	1.32 H	274	32.75	7.25
5	7311.00	54.1 PK	74.0	-19.9	1.07 H	238	39.65	14.45
6	7311.00	42.0 AV	54.0	-12.0	1.07 H	238	27.55	14.45

ANTENNA POLARITY & TEST DISTANCE: VERTICAL AT 3 M

NO.	FREQ. (MHz)	EMISSION LEVEL (dBuV/m)	LIMIT (dBuV/m)	MARGIN (dB)	ANTENNA HEIGHT (m)	TABLE ANGLE (Degree)	RAW VALUE (dBuV)	CORRECTION FACTOR (dB/m)
1	*2437.00	103.5 PK			1.78 V	270	104.82	-1.32
2	*2437.00	99.8 AV			1.78 V	270	101.12	-1.32
3	4874.00	56.5 PK	74.0	-17.5	2.26 V	261	49.25	7.25
4	4874.00	53.7 AV	54.0	-0.3	2.26 V	261	46.45	7.25
5	7311.00	53.7 PK	74.0	-20.3	2.26 V	261	39.25	14.45
6	7311.00	41.5 AV	54.0	-12.5	2.26 V	261	27.05	14.45

REMARKS:

1. Emission Level(dBuV/m) = Raw Value(dBuV) + Correction Factor(dB/m)
2. Correction Factor(dB/m) = Antenna Factor(dB/m) + Cable Factor(dB) – Pre-Amplifier Factor(dB)
3. The other emission levels were very low against the limit.
4. Margin value = Emission Level – Limit value
5. " * ": Fundamental frequency.



CHANNEL	TX Channel 11	DETECTOR FUNCTION	Peak (PK)
FREQUENCY RANGE	1GHz ~ 25GHz		Average (AV)

ANTENNA POLARITY & TEST DISTANCE: HORIZONTAL AT 3 M

NO.	FREQ. (MHz)	EMISSION LEVEL (dBuV/m)	LIMIT (dBuV/m)	MARGIN (dB)	ANTENNA HEIGHT (m)	TABLE ANGLE (Degree)	RAW VALUE (dBuV)	CORRECTION FACTOR (dB/m)
1	*2462.00	86.5 PK			1.97 H	215	87.76	-1.26
2	*2462.00	82.4 AV			1.97 H	215	83.66	-1.26
3	2483.50	51.2 PK	74.0	-22.8	1.97 H	215	52.41	-1.21
4	2483.50	42.1 AV	54.0	-11.9	1.97 H	215	43.31	-1.21
5	4924.00	48.6 PK	74.0	-25.4	1.31 H	287	41.15	7.45
6	4924.00	40.1 AV	54.0	-13.9	1.31 H	287	32.65	7.45
7	7386.00	50.2 PK	74.0	-23.8	1.00 H	245	35.68	14.52
8	7386.00	37.2 AV	54.0	-16.8	1.00 H	245	22.68	14.52

ANTENNA POLARITY & TEST DISTANCE: VERTICAL AT 3 M

NO.	FREQ. (MHz)	EMISSION LEVEL (dBuV/m)	LIMIT (dBuV/m)	MARGIN (dB)	ANTENNA HEIGHT (m)	TABLE ANGLE (Degree)	RAW VALUE (dBuV)	CORRECTION FACTOR (dB/m)
1	*2462.00	101.2 PK			2.00 V	274	102.46	-1.26
2	*2462.00	97.4 AV			2.00 V	274	98.66	-1.26
3	2483.50	56.4 PK	74.0	-17.6	1.86 V	82	57.61	-1.21
4	2483.50	47.6 AV	54.0	-6.4	1.86 V	82	48.81	-1.21
5	4924.00	56.6 PK	74.0	-17.4	2.17 V	256	49.15	7.45
6	4924.00	53.9 AV	54.0	-0.1	2.17 V	256	46.45	7.45
7	7386.00	53.9 PK	74.0	-20.1	2.17 V	256	39.38	14.52
8	7386.00	41.8 AV	54.0	-12.2	2.17 V	256	27.28	14.52

REMARKS:

1. Emission Level(dBuV/m) = Raw Value(dBuV) + Correction Factor(dB/m)
2. Correction Factor(dB/m) = Antenna Factor(dB/m) + Cable Factor(dB) – Pre-Amplifier Factor(dB)
3. The other emission levels were very low against the limit.
4. Margin value = Emission Level – Limit value
5. " * ": Fundamental frequency.

802.11g

CHANNEL	TX Channel 1	DETECTOR FUNCTION	Peak (PK)
FREQUENCY RANGE	1GHz ~ 25GHz		Average (AV)

ANTENNA POLARITY & TEST DISTANCE: HORIZONTAL AT 3 M								
NO.	FREQ. (MHz)	EMISSION LEVEL (dBuV/m)	LIMIT (dBuV/m)	MARGIN (dB)	ANTENNA HEIGHT (m)	TABLE ANGLE (Degree)	RAW VALUE (dBuV)	CORRECTION FACTOR (dB/m)
1	2390.00	51.3 PK	74.0	-22.7	2.06 H	217	52.73	-1.43
2	2390.00	42.0 AV	54.0	-12.0	2.06 H	217	43.43	-1.43
3	*2412.00	93.2 PK			2.06 H	217	94.58	-1.38
4	*2412.00	82.4 AV			2.06 H	217	83.78	-1.38
5	4824.00	48.6 PK	74.0	-25.4	1.33 H	265	41.51	7.09
6	4824.00	39.8 AV	54.0	-14.2	1.33 H	265	32.71	7.09

ANTENNA POLARITY & TEST DISTANCE: VERTICAL AT 3 M								
NO.	FREQ. (MHz)	EMISSION LEVEL (dBuV/m)	LIMIT (dBuV/m)	MARGIN (dB)	ANTENNA HEIGHT (m)	TABLE ANGLE (Degree)	RAW VALUE (dBuV)	CORRECTION FACTOR (dB/m)
1	2390.00	73.6 PK	74.0	-0.4	1.49 V	157	75.03	-1.43
2	2390.00	43.8 AV	54.0	-10.2	1.49 V	157	45.23	-1.43
3	*2412.00	108.0 PK			1.80 V	273	109.38	-1.38
4	*2412.00	97.4 AV			1.80 V	273	98.78	-1.38
5	4824.00	47.9 PK	74.0	-26.1	2.16 V	264	40.81	7.09
6	4824.00	39.7 AV	54.0	-14.3	2.16 V	264	32.61	7.09

REMARKS:

1. Emission Level(dBuV/m) = Raw Value(dBuV) + Correction Factor(dB/m)
2. Correction Factor(dB/m) = Antenna Factor(dB/m) + Cable Factor(dB) – Pre-Amplifier Factor(dB)
3. The other emission levels were very low against the limit.
4. Margin value = Emission Level – Limit value
5. " * ": Fundamental frequency.



CHANNEL	TX Channel 6	DETECTOR FUNCTION	Peak (PK)
FREQUENCY RANGE	1GHz ~ 25GHz		Average (AV)

ANTENNA POLARITY & TEST DISTANCE: HORIZONTAL AT 3 M

NO.	FREQ. (MHz)	EMISSION LEVEL (dBuV/m)	LIMIT (dBuV/m)	MARGIN (dB)	ANTENNA HEIGHT (m)	TABLE ANGLE (Degree)	RAW VALUE (dBuV)	CORRECTION FACTOR (dB/m)
1	2390.00	68.1 PK	74.0	-5.9	2.01 H	215	69.53	-1.43
2	2390.00	45.7 AV	54.0	-8.3	2.01 H	215	47.13	-1.43
3	*2437.00	99.7 PK			2.01 H	215	101.02	-1.32
4	*2437.00	88.0 AV			2.01 H	215	89.32	-1.32
5	2483.50	65.0 PK	74.0	-9.0	2.01 H	215	66.21	-1.21
6	2483.50	41.9 AV	54.0	-12.1	2.01 H	215	43.11	-1.21
7	4874.00	48.6 PK	74.0	-25.4	1.30 H	274	41.35	7.25
8	4874.00	39.8 AV	54.0	-14.2	1.30 H	274	32.55	7.25
9	7311.00	54.2 PK	74.0	-19.8	1.07 H	223	39.75	14.45
10	7311.00	42.4 AV	54.0	-11.6	1.07 H	223	27.95	14.45

ANTENNA POLARITY & TEST DISTANCE: VERTICAL AT 3 M

NO.	FREQ. (MHz)	EMISSION LEVEL (dBuV/m)	LIMIT (dBuV/m)	MARGIN (dB)	ANTENNA HEIGHT (m)	TABLE ANGLE (Degree)	RAW VALUE (dBuV)	CORRECTION FACTOR (dB/m)
1	2390.00	73.8 PK	74.0	-0.2	2.19 V	157	75.23	-1.43
2	2390.00	51.2 AV	54.0	-2.8	2.19 V	157	52.63	-1.43
3	*2437.00	114.1 PK			1.71 V	94	115.42	-1.32
4	*2437.00	102.7 AV			1.71 V	94	104.02	-1.32
5	2483.50	70.7 PK	74.0	-3.3	2.19 V	157	71.91	-1.21
6	2483.50	47.3 AV	54.0	-6.7	2.19 V	157	48.51	-1.21
7	4874.00	48.5 PK	74.0	-25.5	2.14 V	263	41.25	7.25
8	4874.00	40.0 AV	54.0	-14.0	2.14 V	263	32.75	7.25
9	7311.00	54.0 PK	74.0	-20.0	2.22 V	264	39.55	14.45
10	7311.00	41.5 AV	54.0	-12.5	2.22 V	264	27.05	14.45

REMARKS:

1. Emission Level(dBuV/m) = Raw Value(dBuV) + Correction Factor(dB/m)
2. Correction Factor(dB/m) = Antenna Factor(dB/m) + Cable Factor(dB) – Pre-Amplifier Factor(dB)
3. The other emission levels were very low against the limit.
4. Margin value = Emission Level – Limit value
5. " * ": Fundamental frequency.



CHANNEL	TX Channel 11	DETECTOR FUNCTION	Peak (PK)
FREQUENCY RANGE	1GHz ~ 25GHz		Average (AV)

ANTENNA POLARITY & TEST DISTANCE: HORIZONTAL AT 3 M

NO.	FREQ. (MHz)	EMISSION LEVEL (dBuV/m)	LIMIT (dBuV/m)	MARGIN (dB)	ANTENNA HEIGHT (m)	TABLE ANGLE (Degree)	RAW VALUE (dBuV)	CORRECTION FACTOR (dB/m)
1	*2462.00	95.0 PK			2.04 H	241	96.26	-1.26
2	*2462.00	83.5 AV			2.04 H	241	84.76	-1.26
3	2483.50	69.0 PK	74.0	-5.0	2.04 H	241	70.21	-1.21
4	2483.50	44.8 AV	54.0	-9.2	2.04 H	241	46.01	-1.21
5	4924.00	48.4 PK	74.0	-25.6	1.30 H	277	40.95	7.45
6	4924.00	39.5 AV	54.0	-14.5	1.30 H	277	32.05	7.45
7	7386.00	54.4 PK	74.0	-19.6	1.11 H	251	39.88	14.52
8	7386.00	42.3 AV	54.0	-11.7	1.11 H	251	27.78	14.52

ANTENNA POLARITY & TEST DISTANCE: VERTICAL AT 3 M

NO.	FREQ. (MHz)	EMISSION LEVEL (dBuV/m)	LIMIT (dBuV/m)	MARGIN (dB)	ANTENNA HEIGHT (m)	TABLE ANGLE (Degree)	RAW VALUE (dBuV)	CORRECTION FACTOR (dB/m)
1	*2462.00	110.1 PK			1.56 V	37	111.36	-1.26
2	*2462.00	98.9 AV			1.56 V	37	100.16	-1.26
3	2483.50	73.9 PK	74.0	-0.1	1.79 V	37	75.11	-1.21
4	2483.50	49.8 AV	54.0	-4.2	1.79 V	37	51.01	-1.21
5	4924.00	48.8 PK	74.0	-25.2	2.14 V	259	41.35	7.45
6	4924.00	40.1 AV	54.0	-13.9	2.14 V	259	32.65	7.45
7	7386.00	53.6 PK	74.0	-20.4	2.22 V	252	39.08	14.52
8	7386.00	41.0 AV	54.0	-13.0	2.22 V	252	26.48	14.52

REMARKS:

1. Emission Level(dBuV/m) = Raw Value(dBuV) + Correction Factor(dB/m)
2. Correction Factor(dB/m) = Antenna Factor(dB/m) + Cable Factor(dB) – Pre-Amplifier Factor(dB)
3. The other emission levels were very low against the limit.
4. Margin value = Emission Level – Limit value
5. " * ": Fundamental frequency.

802.11n (HT20)

CHANNEL	TX Channel 1	DETECTOR FUNCTION	Peak (PK)
FREQUENCY RANGE	1GHz ~ 25GHz		Average (AV)

ANTENNA POLARITY & TEST DISTANCE: HORIZONTAL AT 3 M

NO.	FREQ. (MHz)	EMISSION LEVEL (dBuV/m)	LIMIT (dBuV/m)	MARGIN (dB)	ANTENNA HEIGHT (m)	TABLE ANGLE (Degree)	RAW VALUE (dBuV)	CORRECTION FACTOR (dB/m)
1	2390.00	71.0 PK	74.0	-3.0	1.98 H	212	72.43	-1.43
2	2390.00	41.5 AV	54.0	-12.5	1.98 H	212	42.93	-1.43
3	*2412.00	91.8 PK			1.98 H	212	93.18	-1.38
4	*2412.00	81.1 AV			1.98 H	212	82.48	-1.38
5	4824.00	48.6 PK	74.0	-25.4	1.35 H	289	41.51	7.09
6	4824.00	40.0 AV	54.0	-14.0	1.35 H	289	32.91	7.09

ANTENNA POLARITY & TEST DISTANCE: VERTICAL AT 3 M

NO.	FREQ. (MHz)	EMISSION LEVEL (dBuV/m)	LIMIT (dBuV/m)	MARGIN (dB)	ANTENNA HEIGHT (m)	TABLE ANGLE (Degree)	RAW VALUE (dBuV)	CORRECTION FACTOR (dB/m)
1	2390.00	73.1 PK	74.0	-0.9	1.50 V	107	74.53	-1.43
2	2390.00	43.5 AV	54.0	-10.5	1.50 V	107	44.93	-1.43
3	*2412.00	107.2 PK			1.58 V	157	108.58	-1.38
4	*2412.00	96.4 AV			1.58 V	157	97.78	-1.38
5	4824.00	48.9 PK	74.0	-25.1	2.08 V	256	41.81	7.09
6	4824.00	40.4 AV	54.0	-13.6	2.08 V	256	33.31	7.09

REMARKS:

1. Emission Level(dBuV/m) = Raw Value(dBuV) + Correction Factor(dB/m)
2. Correction Factor(dB/m) = Antenna Factor(dB/m) + Cable Factor(dB) – Pre-Amplifier Factor(dB)
3. The other emission levels were very low against the limit.
4. Margin value = Emission Level – Limit value
5. " * ": Fundamental frequency.

CHANNEL	TX Channel 6	DETECTOR FUNCTION	Peak (PK)
FREQUENCY RANGE	1GHz ~ 25GHz		Average (AV)

ANTENNA POLARITY & TEST DISTANCE: HORIZONTAL AT 3 M

NO.	FREQ. (MHz)	EMISSION LEVEL (dBuV/m)	LIMIT (dBuV/m)	MARGIN (dB)	ANTENNA HEIGHT (m)	TABLE ANGLE (Degree)	RAW VALUE (dBuV)	CORRECTION FACTOR (dB/m)
1	2390.00	69.0 PK	74.0	-5.0	2.09 H	223	70.43	-1.43
2	2390.00	42.5 AV	54.0	-11.5	2.09 H	223	43.93	-1.43
3	*2437.00	95.3 PK			2.09 H	223	96.62	-1.32
4	*2437.00	84.0 AV			2.09 H	223	85.32	-1.32
5	2483.50	69.4 PK	74.0	-4.6	2.09 H	223	70.61	-1.21
6	2483.50	41.2 AV	54.0	-12.8	2.09 H	223	42.41	-1.21
7	4874.00	49.3 PK	74.0	-24.7	1.31 H	272	42.05	7.25
8	4874.00	40.4 AV	54.0	-13.6	1.31 H	272	33.15	7.25
9	7311.00	54.0 PK	74.0	-20.0	1.02 H	253	39.55	14.45
10	7311.00	42.1 AV	54.0	-11.9	1.02 H	253	27.65	14.45

ANTENNA POLARITY & TEST DISTANCE: VERTICAL AT 3 M

NO.	FREQ. (MHz)	EMISSION LEVEL (dBuV/m)	LIMIT (dBuV/m)	MARGIN (dB)	ANTENNA HEIGHT (m)	TABLE ANGLE (Degree)	RAW VALUE (dBuV)	CORRECTION FACTOR (dB/m)
1	2390.00	73.9 PK	74.0	-0.1	1.89 V	136	75.33	-1.43
2	2390.00	47.3 AV	54.0	-6.7	1.89 V	136	48.73	-1.43
3	*2437.00	110.3 PK			1.89 V	136	111.62	-1.32
4	*2437.00	98.7 AV			1.89 V	136	100.02	-1.32
5	2483.50	69.3 PK	74.0	-4.7	1.80 V	136	70.51	-1.21
6	2483.50	41.3 AV	54.0	-12.7	1.80 V	136	42.51	-1.21
7	4874.00	48.4 PK	74.0	-25.6	2.13 V	273	41.15	7.25
8	4874.00	39.7 AV	54.0	-14.3	2.13 V	273	32.45	7.25
9	7311.00	53.9 PK	74.0	-20.1	2.21 V	276	39.45	14.45
10	7311.00	41.2 AV	54.0	-12.8	2.21 V	276	26.75	14.45

REMARKS:

1. Emission Level(dBuV/m) = Raw Value(dBuV) + Correction Factor(dB/m)
2. Correction Factor(dB/m) = Antenna Factor(dB/m) + Cable Factor(dB) – Pre-Amplifier Factor(dB)
3. The other emission levels were very low against the limit.
4. Margin value = Emission Level – Limit value
5. " * ": Fundamental frequency.



CHANNEL	TX Channel 11	DETECTOR FUNCTION	Peak (PK)
FREQUENCY RANGE	1GHz ~ 25GHz		Average (AV)

ANTENNA POLARITY & TEST DISTANCE: HORIZONTAL AT 3 M

NO.	FREQ. (MHz)	EMISSION LEVEL (dBuV/m)	LIMIT (dBuV/m)	MARGIN (dB)	ANTENNA HEIGHT (m)	TABLE ANGLE (Degree)	RAW VALUE (dBuV)	CORRECTION FACTOR (dB/m)
1	*2462.00	94.3 PK			2.08 H	226	95.56	-1.26
2	*2462.00	83.3 AV			2.08 H	226	84.56	-1.26
3	2483.50	68.1 PK	74.0	-5.9	2.08 H	226	69.31	-1.21
4	2483.50	47.0 AV	54.0	-7.0	2.08 H	226	48.21	-1.21
5	4924.00	48.0 PK	74.0	-26.0	1.35 H	274	40.55	7.45
6	4924.00	39.6 AV	54.0	-14.4	1.35 H	274	32.15	7.45
7	7386.00	54.6 PK	74.0	-19.4	1.12 H	229	40.08	14.52
8	7386.00	42.3 AV	54.0	-11.7	1.12 H	229	27.78	14.52

ANTENNA POLARITY & TEST DISTANCE: VERTICAL AT 3 M

NO.	FREQ. (MHz)	EMISSION LEVEL (dBuV/m)	LIMIT (dBuV/m)	MARGIN (dB)	ANTENNA HEIGHT (m)	TABLE ANGLE (Degree)	RAW VALUE (dBuV)	CORRECTION FACTOR (dB/m)
1	*2462.00	109.2 PK			1.52 V	41	110.46	-1.26
2	*2462.00	98.3 AV			1.52 V	41	99.56	-1.26
3	2483.50	73.3 PK	74.0	-0.7	1.31 V	156	74.51	-1.21
4	2483.50	52.1 AV	54.0	-1.9	1.31 V	156	53.31	-1.21
5	4924.00	48.6 PK	74.0	-25.4	2.17 V	271	41.15	7.45
6	4924.00	40.2 AV	54.0	-13.8	2.17 V	271	32.75	7.45
7	7386.00	53.6 PK	74.0	-20.4	2.18 V	249	39.08	14.52
8	7386.00	41.3 AV	54.0	-12.7	2.18 V	249	26.78	14.52

REMARKS:

1. Emission Level(dBuV/m) = Raw Value(dBuV) + Correction Factor(dB/m)
2. Correction Factor(dB/m) = Antenna Factor(dB/m) + Cable Factor(dB) – Pre-Amplifier Factor(dB)
3. The other emission levels were very low against the limit.
4. Margin value = Emission Level – Limit value
5. " * ": Fundamental frequency.

802.11n (HT40)

CHANNEL	TX Channel 3	DETECTOR FUNCTION	Peak (PK)
FREQUENCY RANGE	1GHz ~ 25GHz		Average (AV)

ANTENNA POLARITY & TEST DISTANCE: HORIZONTAL AT 3 M								
NO.	FREQ. (MHz)	EMISSION LEVEL (dBuV/m)	LIMIT (dBuV/m)	MARGIN (dB)	ANTENNA HEIGHT (m)	TABLE ANGLE (Degree)	RAW VALUE (dBuV)	CORRECTION FACTOR (dB/m)
1	2390.00	68.5 PK	74.0	-5.5	1.98 H	242	69.93	-1.43
2	2390.00	42.4 AV	54.0	-11.6	1.98 H	242	43.83	-1.43
3	*2422.00	87.6 PK			1.98 H	242	88.96	-1.36
4	*2422.00	75.3 AV			1.98 H	242	76.66	-1.36
5	4844.00	48.7 PK	74.0	-25.3	1.32 H	282	41.55	7.15
6	4844.00	39.8 AV	54.0	-14.2	1.32 H	282	32.65	7.15
7	7266.00	54.0 PK	74.0	-20.0	1.05 H	226	39.43	14.57
8	7266.00	41.6 AV	54.0	-12.4	1.05 H	226	27.03	14.57

ANTENNA POLARITY & TEST DISTANCE: VERTICAL AT 3 M								
NO.	FREQ. (MHz)	EMISSION LEVEL (dBuV/m)	LIMIT (dBuV/m)	MARGIN (dB)	ANTENNA HEIGHT (m)	TABLE ANGLE (Degree)	RAW VALUE (dBuV)	CORRECTION FACTOR (dB/m)
1	2390.00	73.9 PK	74.0	-0.1	1.85 V	202	75.33	-1.43
2	2390.00	47.6 AV	54.0	-6.4	1.85 V	202	49.03	-1.43
3	*2422.00	102.8 PK			1.61 V	174	104.16	-1.36
4	*2422.00	90.6 AV			1.61 V	174	91.96	-1.36
5	4844.00	48.7 PK	74.0	-25.3	2.08 V	257	41.55	7.15
6	4844.00	40.3 AV	54.0	-13.7	2.08 V	257	33.15	7.15
7	7266.00	53.2 PK	74.0	-20.8	2.27 V	255	38.63	14.57
8	7266.00	41.0 AV	54.0	-13.0	2.27 V	255	26.43	14.57

REMARKS:

1. Emission Level(dBuV/m) = Raw Value(dBuV) + Correction Factor(dB/m)
2. Correction Factor(dB/m) = Antenna Factor(dB/m) + Cable Factor(dB) – Pre-Amplifier Factor(dB)
3. The other emission levels were very low against the limit.
4. Margin value = Emission Level – Limit value
5. " * ": Fundamental frequency.

CHANNEL	TX Channel 6	DETECTOR FUNCTION	Peak (PK)
FREQUENCY RANGE	1GHz ~ 25GHz		Average (AV)

ANTENNA POLARITY & TEST DISTANCE: HORIZONTAL AT 3 M

NO.	FREQ. (MHz)	EMISSION LEVEL (dBuV/m)	LIMIT (dBuV/m)	MARGIN (dB)	ANTENNA HEIGHT (m)	TABLE ANGLE (Degree)	RAW VALUE (dBuV)	CORRECTION FACTOR (dB/m)
1	2390.00	68.9 PK	74.0	-5.1	1.97 H	233	70.33	-1.43
2	2390.00	41.0 AV	54.0	-13.0	1.97 H	233	42.43	-1.43
3	*2437.00	91.3 PK			1.97 H	233	92.62	-1.32
4	*2437.00	80.0 AV			1.97 H	233	81.32	-1.32
5	2483.50	65.8 PK	74.0	-8.2	1.97 H	233	67.01	-1.21
6	2483.50	41.2 AV	54.0	-12.8	1.97 H	233	42.41	-1.21
7	4874.00	48.2 PK	74.0	-25.8	1.30 H	274	40.95	7.25
8	4874.00	39.6 AV	54.0	-14.4	1.30 H	274	32.35	7.25
9	7311.00	54.0 PK	74.0	-20.0	1.04 H	226	39.55	14.45
10	7311.00	42.2 AV	54.0	-11.8	1.04 H	226	27.75	14.45

ANTENNA POLARITY & TEST DISTANCE: VERTICAL AT 3 M

NO.	FREQ. (MHz)	EMISSION LEVEL (dBuV/m)	LIMIT (dBuV/m)	MARGIN (dB)	ANTENNA HEIGHT (m)	TABLE ANGLE (Degree)	RAW VALUE (dBuV)	CORRECTION FACTOR (dB/m)
1	2390.00	73.9 PK	74.0	-0.1	1.47 V	156	75.33	-1.43
2	2390.00	45.8 AV	54.0	-8.2	1.47 V	156	47.23	-1.43
3	*2437.00	106.1 PK			1.47 V	156	107.42	-1.32
4	*2437.00	94.7 AV			1.47 V	156	96.02	-1.32
5	2483.50	70.5 PK	74.0	-3.5	1.47 V	156	71.71	-1.21
6	2483.50	46.0 AV	54.0	-8.0	1.47 V	156	47.21	-1.21
7	4874.00	48.5 PK	74.0	-25.5	2.11 V	264	41.25	7.25
8	4874.00	39.9 AV	54.0	-14.1	2.11 V	264	32.65	7.25
9	7311.00	54.3 PK	74.0	-19.7	2.25 V	277	39.85	14.45
10	7311.00	41.5 AV	54.0	-12.5	2.25 V	277	27.05	14.45

REMARKS:

1. Emission Level(dBuV/m) = Raw Value(dBuV) + Correction Factor(dB/m)
2. Correction Factor(dB/m) = Antenna Factor(dB/m) + Cable Factor(dB) – Pre-Amplifier Factor(dB)
3. The other emission levels were very low against the limit.
4. Margin value = Emission Level – Limit value
5. " * ": Fundamental frequency.

CHANNEL	TX Channel 9	DETECTOR FUNCTION	Peak (PK)
FREQUENCY RANGE	1GHz ~ 25GHz		Average (AV)

ANTENNA POLARITY & TEST DISTANCE: HORIZONTAL AT 3 M

NO.	FREQ. (MHz)	EMISSION LEVEL (dBuV/m)	LIMIT (dBuV/m)	MARGIN (dB)	ANTENNA HEIGHT (m)	TABLE ANGLE (Degree)	RAW VALUE (dBuV)	CORRECTION FACTOR (dB/m)
1	*2452.00	90.0 PK			2.06 H	217	91.28	-1.28
2	*2452.00	78.5 AV			2.06 H	217	79.78	-1.28
3	2483.50	67.8 PK	74.0	-6.2	2.06 H	217	69.01	-1.21
4	2483.50	45.5 AV	54.0	-8.5	2.06 H	217	46.71	-1.21
5	4904.00	48.9 PK	74.0	-25.1	1.26 H	272	41.54	7.36
6	4904.00	40.2 AV	54.0	-13.8	1.26 H	272	32.84	7.36
7	7356.00	53.9 PK	74.0	-20.1	1.13 H	224	39.40	14.50
8	7356.00	41.6 AV	54.0	-12.4	1.13 H	224	27.10	14.50

ANTENNA POLARITY & TEST DISTANCE: VERTICAL AT 3 M

NO.	FREQ. (MHz)	EMISSION LEVEL (dBuV/m)	LIMIT (dBuV/m)	MARGIN (dB)	ANTENNA HEIGHT (m)	TABLE ANGLE (Degree)	RAW VALUE (dBuV)	CORRECTION FACTOR (dB/m)
1	*2452.00	105.4 PK			1.50 V	163	106.68	-1.28
2	*2452.00	94.1 AV			1.50 V	163	95.38	-1.28
3	2483.50	73.2 PK	74.0	-0.8	1.64 V	338	74.41	-1.21
4	2483.50	50.7 AV	54.0	-3.3	1.64 V	338	51.91	-1.21
5	4904.00	48.7 PK	74.0	-25.3	2.18 V	256	41.34	7.36
6	4904.00	40.0 AV	54.0	-14.0	2.18 V	256	32.64	7.36
7	7356.00	53.7 PK	74.0	-20.3	2.23 V	249	39.20	14.50
8	7356.00	41.4 AV	54.0	-12.6	2.23 V	249	26.90	14.50

REMARKS:

1. Emission Level(dBuV/m) = Raw Value(dBuV) + Correction Factor(dB/m)
2. Correction Factor(dB/m) = Antenna Factor(dB/m) + Cable Factor(dB) – Pre-Amplifier Factor(dB)
3. The other emission levels were very low against the limit.
4. Margin value = Emission Level – Limit value
5. " * ": Fundamental frequency.

Below 1GHz Data:

802.11g

CHANNEL	TX Channel 6	DETECTOR FUNCTION	Quasi-Peak (QP)
FREQUENCY RANGE	Below 1GHz		

ANTENNA POLARITY & TEST DISTANCE: HORIZONTAL AT 3 M

NO.	FREQ. (MHz)	EMISSION LEVEL (dBuV/m)	LIMIT (dBuV/m)	MARGIN (dB)	ANTENNA HEIGHT (m)	TABLE ANGLE (Degree)	RAW VALUE (dBuV)	CORRECTION FACTOR (dB/m)
1	49.59	35.6 QP	40.0	-4.4	1.50 H	250	48.68	-13.11
2	280.02	36.0 QP	46.0	-10.0	1.00 H	140	48.59	-12.56
3	374.98	42.5 QP	46.0	-3.5	1.00 H	226	52.29	-9.78
4	440.02	34.9 QP	46.0	-11.1	2.00 H	260	42.73	-7.87
5	560.01	37.7 QP	46.0	-8.3	1.50 H	223	43.18	-5.49
6	760.02	37.0 QP	46.0	-9.0	1.00 H	147	37.99	-0.99

ANTENNA POLARITY & TEST DISTANCE: VERTICAL AT 3 M

NO.	FREQ. (MHz)	EMISSION LEVEL (dBuV/m)	LIMIT (dBuV/m)	MARGIN (dB)	ANTENNA HEIGHT (m)	TABLE ANGLE (Degree)	RAW VALUE (dBuV)	CORRECTION FACTOR (dB/m)
1	147.76	28.8 QP	43.5	-14.7	1.00 V	182	41.61	-12.84
2	199.99	33.8 QP	43.5	-9.7	1.00 V	175	49.77	-15.93
3	280.02	35.1 QP	46.0	-10.9	1.50 V	136	47.69	-12.56
4	359.99	40.1 QP	46.0	-5.9	1.00 V	192	50.45	-10.37
5	520.00	40.0 QP	46.0	-6.0	1.50 V	186	46.36	-6.32
6	760.02	37.0 QP	46.0	-9.1	1.00 V	184	37.94	-0.99

REMARKS:

1. Emission Level(dBuV/m) = Raw Value(dBuV) + Correction Factor(dB/m)
2. Correction Factor(dB/m) = Antenna Factor(dB/m) + Cable Factor(dB) – Pre-Amplifier Factor(dB)
3. The other emission levels were very low against the limit.
4. Margin value = Emission Level – Limit value

4.2 Conducted Emission Measurement

4.2.1 Limits of Conducted Emission Measurement

Frequency (MHz)	Conducted Limit (dBuV)	
	Quasi-peak	Average
0.15 - 0.5	66 - 56	56 - 46
0.50 - 5.0	56	46
5.0 - 30.0	60	50

Note: 1. The lower limit shall apply at the transition frequencies.

2. The limit decreases in line with the logarithm of the frequency in the range of 0.15 to 0.50MHz.

4.2.2 Test Instruments

For Mode 1~3 test:

DESCRIPTION & MANUFACTURER	MODEL NO.	SERIAL NO.	CALIBRATED DATE	CALIBRATED UNTIL
Test Receiver R&S	ESCS 30	100375	May 06, 2015	May 05, 2016
Line-Impedance Stabilization Network (for EUT) SCHWARZBECK	NSLK-8127	8127-522	Sep. 15, 2014	Sep. 14, 2015
Line-Impedance Stabilization Network (for Peripheral) R&S	ENV216	100072	June 11, 2015	June 10, 2016
RF Cable	5D-FB	COCCAB-001	Mar. 09, 2015	Mar. 08, 2016
50 ohms Terminator	N/A	EMC-03	Sep. 22, 2014	Sep. 21, 2015
50 ohms Terminator	N/A	EMC-02	Sep. 30, 2014	Sep. 29, 2015
Software BVADT	BVADT_Cond_ V7.3.7.3	NA	NA	NA

Note:

1. The calibration interval of the above test instruments are 12 months and the calibrations are traceable to NML/ROC and NIST/USA.
2. The test was performed in Shielded Room No. C.
3. The VCCI Con C Registration No. is C-3611.
4. Tested Date: July 20 to Aug. 10, 2015

For Mode 4 test:

DESCRIPTION & MANUFACTURER	MODEL NO.	SERIAL NO.	CALIBRATED DATE	CALIBRATED UNTIL
Test Receiver R&S	ESCS 30	100287	Apr. 17, 2015	Apr. 16, 2016
Line-Impedance Stabilization Network (for EUT) SCHWARZBECK	NSLK-8127	8127-523	Sep. 29, 2014	Sep. 28, 2015
RF Cable	5D-FB	COACAB-001	May 25, 2015	May 24, 2016
50 ohms Terminator	50	3	Oct. 17, 2014	Oct. 16, 2015
50 ohms Terminator	N/A	EMC-04	Oct. 21, 2014	Oct. 20, 2015
Software BVADT	BVADT_Cond_ V7.3.7.3	NA	NA	NA
Line-Impedance Stabilization Network (for Peripheral) R&S	ENV216	100071	Nov. 10, 2014	Nov. 09, 2015

Note:

1. The calibration interval of the above test instruments are 12 months and the calibrations are traceable to NML/ROC and NIST/USA.
2. The test was performed in Shielded Room No. A.
3. The VCCI Con A Registration No. is C-817.
4. Tested Date: Aug. 26, 2015

4.2.3 Test Procedures

- The EUT was placed 0.4 meters from the conducting wall of the shielded room with EUT being connected to the power mains through a line impedance stabilization network (LISN). Other support units were connected to the power mains through another LISN. The two LISNs provide 50 ohm/ 50uH of coupling impedance for the measuring instrument.
- Both lines of the power mains connected to the EUT were checked for maximum conducted interference.
- The frequency range from 150kHz to 30MHz was searched. Emission levels under (Limit - 20dB) was not recorded.

NOTE: The resolution bandwidth and video bandwidth of test receiver is 9kHz for quasi-peak detection (QP) and average detection (AV) at frequency 0.15MHz-30MHz.

4.2.4 Deviation from Test Standard

No deviation.

4.2.5 Test Setup

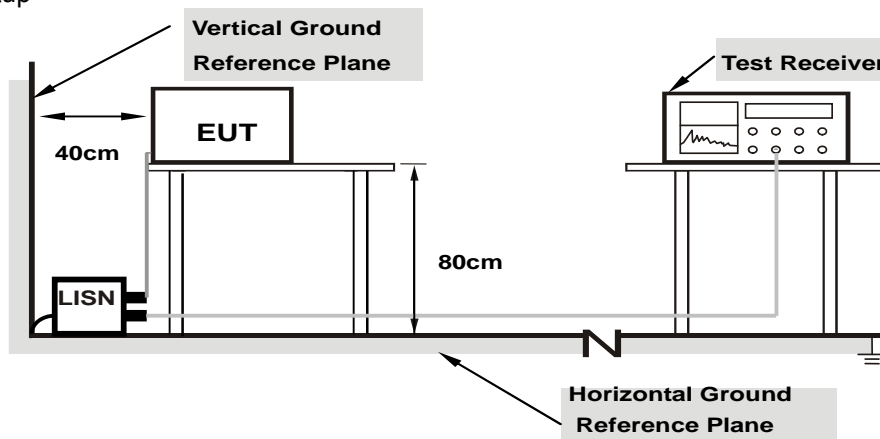

Note: 1.Support units were connected to second LISN.

For the actual test configuration, please refer to the attached file (Test Setup Photo).

4.2.6 EUT Operating Conditions

Same as 4.1.6.

4.2.7 Test Results (Mode 1)

Phase	Line (L)	Detector Function	Quasi-Peak (QP) / Average (AV)
-------	----------	-------------------	--------------------------------

No	Freq. [MHz]	Corr.	Reading Value		Emission Level		Limit		Margin	
		Factor (dB)	[dB (uV)]		[dB (uV)]		[dB (uV)]		(dB)	
			Q.P.	AV.	Q.P.	AV.	Q.P.	AV.	Q.P.	AV.
1	0.16187	0.14	57.62	47.42	57.76	47.56	65.37	55.37	-7.61	-7.81
2	0.20322	0.15	51.24	45.08	51.39	45.23	63.48	53.48	-12.09	-8.25
3	0.40781	0.17	42.54	39.94	42.71	40.11	57.69	47.69	-14.98	-7.58
4	16.52984	0.98	47.46	45.98	48.44	46.96	60.00	50.00	-11.56	-3.04
5	18.12694	1.04	49.38	47.32	50.42	48.36	60.00	50.00	-9.58	-1.64
6	18.93944	1.07	48.74	44.38	49.81	45.45	60.00	50.00	-10.19	-4.55

REMARKS:

1. Q.P. and AV. are abbreviations of quasi-peak and average individually.
2. The emission levels of other frequencies were very low against the limit.
3. Margin value = Emission level - Limit value
4. Correction factor = Insertion loss + Cable loss
5. Emission Level = Correction Factor + Reading Value.

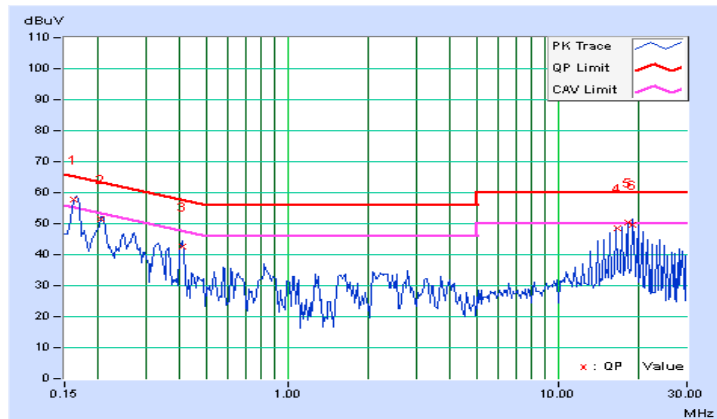

Phase	Neutral (N)	Detector Function	Quasi-Peak (QP) / Average (AV)
-------	-------------	-------------------	--------------------------------

No	Freq. [MHz]	Corr.	Reading Value		Emission Level		Limit		Margin	
		Factor	[dB (uV)]		[dB (uV)]		[dB (uV)]		(dB)	
	(dB)	Q.P.	AV.	Q.P.	AV.	Q.P.	AV.	Q.P.	AV.	
1	0.16562	0.14	55.80	46.30	55.94	46.44	65.18	55.18	-9.23	-8.73
2	0.20469	0.15	49.24	41.80	49.39	41.95	63.42	53.42	-14.03	-11.47
3	0.40781	0.19	42.54	40.06	42.73	40.25	57.69	47.69	-14.96	-7.44
4	18.20569	1.15	49.68	47.56	50.83	48.71	60.00	50.00	-9.17	-1.29
5	19.02844	1.19	48.80	46.66	49.99	47.85	60.00	50.00	-10.01	-2.15
6	19.84906	1.22	46.22	41.38	47.44	42.60	60.00	50.00	-12.56	-7.40

REMARKS:

1. Q.P. and AV. are abbreviations of quasi-peak and average individually.
2. The emission levels of other frequencies were very low against the limit.
3. Margin value = Emission level - Limit value
4. Correction factor = Insertion loss + Cable loss
5. Emission Level = Correction Factor + Reading Value.

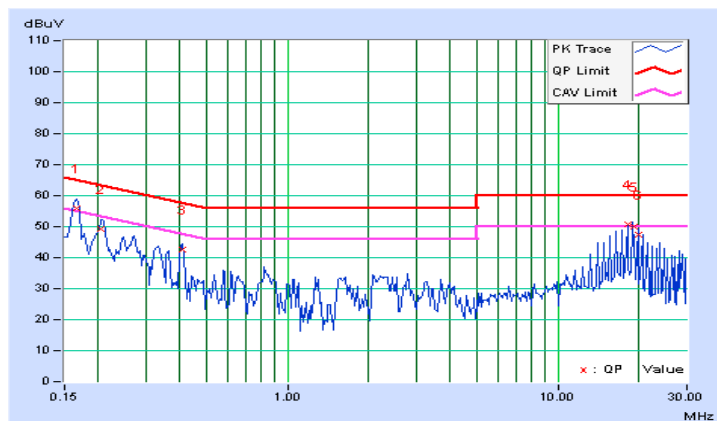

4.2.8 Test Results (Mode 2)

Phase	Line (L)	Detector Function	Quasi-Peak (QP) / Average (AV)
-------	----------	-------------------	--------------------------------

No	Freq. [MHz]	Corr.	Reading Value		Emission Level		Limit		Margin	
		Factor	[dB (uV)]		[dB (uV)]		[dB (uV)]		(dB)	
	(dB)	Q.P.	AV.	Q.P.	AV.	Q.P.	AV.	Q.P.	AV.	
1	0.18553	0.15	40.56	31.28	40.71	31.43	64.23	54.23	-23.53	-22.81
2	0.31797	0.16	40.26	27.00	40.42	27.16	59.76	49.76	-19.34	-22.60
3	0.97422	0.20	37.84	21.94	38.04	22.14	56.00	46.00	-17.96	-23.86
4	2.43359	0.29	35.32	22.96	35.61	23.25	56.00	46.00	-20.39	-22.75
5	4.45313	0.41	38.92	25.78	39.33	26.19	56.00	46.00	-16.67	-19.81
6	11.56250	0.80	31.58	22.56	32.38	23.36	60.00	50.00	-27.62	-26.64

REMARKS:

1. Q.P. and AV. are abbreviations of quasi-peak and average individually.
2. The emission levels of other frequencies were very low against the limit.
3. Margin value = Emission level - Limit value
4. Correction factor = Insertion loss + Cable loss
5. Emission Level = Correction Factor + Reading Value.

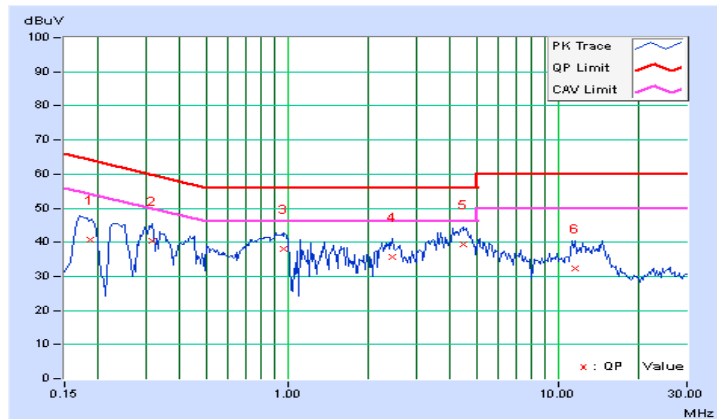

Phase	Neutral (N)	Detector Function	Quasi-Peak (QP) / Average (AV)
-------	-------------	-------------------	--------------------------------

No	Freq. [MHz]	Corr.	Reading Value		Emission Level		Limit		Margin	
		Factor	[dB (uV)]		[dB (uV)]		[dB (uV)]		(dB)	
	(dB)	Q.P.	AV.	Q.P.	AV.	Q.P.	AV.	Q.P.	AV.	
1	0.18344	0.15	41.56	29.70	41.71	29.85	64.33	54.33	-22.62	-24.48
2	0.32188	0.17	37.72	21.00	37.89	21.17	59.66	49.66	-21.76	-28.48
3	0.89609	0.23	35.78	21.44	36.01	21.67	56.00	46.00	-19.99	-24.33
4	2.17969	0.31	33.82	19.76	34.13	20.07	56.00	46.00	-21.87	-25.93
5	4.33984	0.44	36.22	23.12	36.66	23.56	56.00	46.00	-19.34	-22.44
6	12.58984	0.90	34.32	24.92	35.22	25.82	60.00	50.00	-24.78	-24.18

REMARKS:

1. Q.P. and AV. are abbreviations of quasi-peak and average individually.
2. The emission levels of other frequencies were very low against the limit.
3. Margin value = Emission level - Limit value
4. Correction factor = Insertion loss + Cable loss
5. Emission Level = Correction Factor + Reading Value.

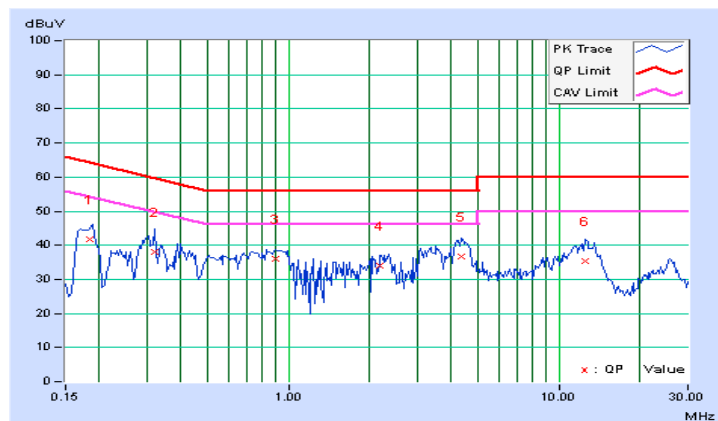

4.2.9 Test Results (Mode 3)

Phase	Line (L)	Detector Function	Quasi-Peak (QP) / Average (AV)
-------	----------	-------------------	--------------------------------

No	Freq. [MHz]	Corr.	Reading Value		Emission Level		Limit		Margin	
		Factor	[dB (uV)]		[dB (uV)]		[dB (uV)]		(dB)	
	(dB)	Q.P.	AV.	Q.P.	AV.	Q.P.	AV.	Q.P.	AV.	
1	0.18125	0.15	41.50	31.62	41.65	31.77	64.43	54.43	-22.78	-22.66
2	0.31016	0.16	41.58	28.96	41.74	29.12	59.97	49.97	-18.23	-20.85
3	0.95078	0.20	38.96	25.02	39.16	25.22	56.00	46.00	-16.84	-20.78
4	2.28516	0.28	36.46	22.94	36.74	23.22	56.00	46.00	-19.26	-22.78
5	4.48828	0.41	39.22	25.94	39.63	26.35	56.00	46.00	-16.37	-19.65
6	12.64453	0.84	32.80	23.22	33.64	24.06	60.00	50.00	-26.36	-25.94

REMARKS:

1. Q.P. and AV. are abbreviations of quasi-peak and average individually.
2. The emission levels of other frequencies were very low against the limit.
3. Margin value = Emission level - Limit value
4. Correction factor = Insertion loss + Cable loss
5. Emission Level = Correction Factor + Reading Value.

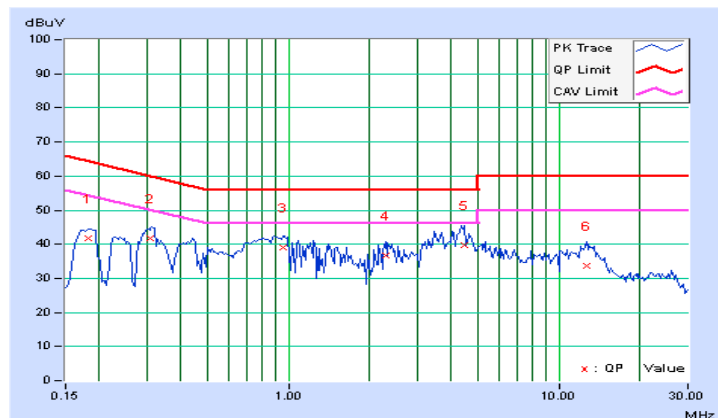

Phase	Neutral (N)	Detector Function	Quasi-Peak (QP) / Average (AV)
-------	-------------	-------------------	--------------------------------

No	Freq. [MHz]	Corr.	Reading Value		Emission Level		Limit		Margin	
		Factor	[dB (uV)]		[dB (uV)]		[dB (uV)]		(dB)	
	(dB)	Q.P.	AV.	Q.P.	AV.	Q.P.	AV.	Q.P.	AV.	
1	0.18125	0.15	40.66	29.06	40.81	29.21	64.43	54.43	-23.62	-25.22
2	0.29453	0.17	36.48	23.78	36.65	23.95	60.40	50.40	-23.75	-26.45
3	0.81797	0.22	33.64	17.92	33.86	18.14	56.00	46.00	-22.14	-27.86
4	2.05078	0.30	31.82	17.58	32.12	17.88	56.00	46.00	-23.88	-28.12
5	4.22266	0.43	35.42	21.84	35.85	22.27	56.00	46.00	-20.15	-23.73
6	12.52734	0.90	33.24	23.66	34.14	24.56	60.00	50.00	-25.86	-25.44

REMARKS:

1. Q.P. and AV. are abbreviations of quasi-peak and average individually.
2. The emission levels of other frequencies were very low against the limit.
3. Margin value = Emission level - Limit value
4. Correction factor = Insertion loss + Cable loss
5. Emission Level = Correction Factor + Reading Value.

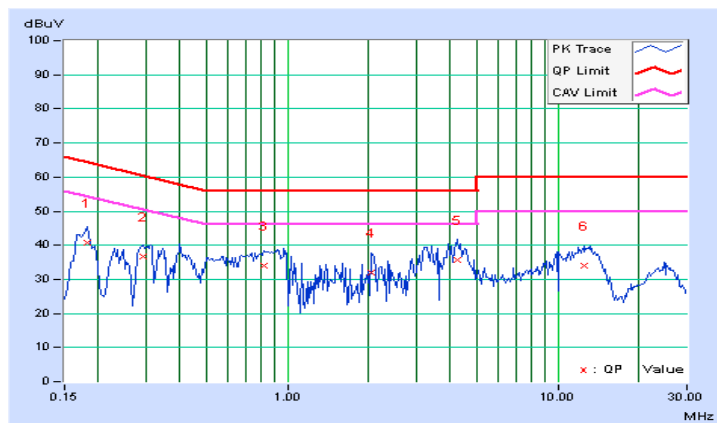

4.2.10 Test Results (Mode 4)

Phase	Line (L)	Detector Function	Quasi-Peak (QP) / Average (AV)
-------	----------	-------------------	--------------------------------

No	Freq. [MHz]	Corr.	Reading Value		Emission Level		Limit		Margin	
		Factor (dB)	[dB (uV)]		[dB (uV)]		[dB (uV)]		(dB)	
		Q.P.	AV.	Q.P.	AV.	Q.P.	AV.	Q.P.	AV.	
1	0.18200	0.10	54.52	45.52	54.62	45.62	64.39	54.39	-9.78	-8.78
2	0.22812	0.11	44.92	37.90	45.03	38.01	62.52	52.52	-17.49	-14.51
3	0.40391	0.16	40.54	35.46	40.70	35.62	57.77	47.77	-17.07	-12.15
4	0.83359	0.21	33.18	27.50	33.39	27.71	56.00	46.00	-22.61	-18.29
5	4.19675	0.35	40.80	39.06	41.15	39.41	56.00	46.00	-14.85	-6.59
6	5.87503	0.40	42.62	40.50	43.02	40.90	60.00	50.00	-16.98	-9.10

REMARKS:

1. Q.P. and AV. are abbreviations of quasi-peak and average individually.
2. The emission levels of other frequencies were very low against the limit.
3. Margin value = Emission level - Limit value
4. Correction factor = Insertion loss + Cable loss
5. Emission Level = Correction Factor + Reading Value.

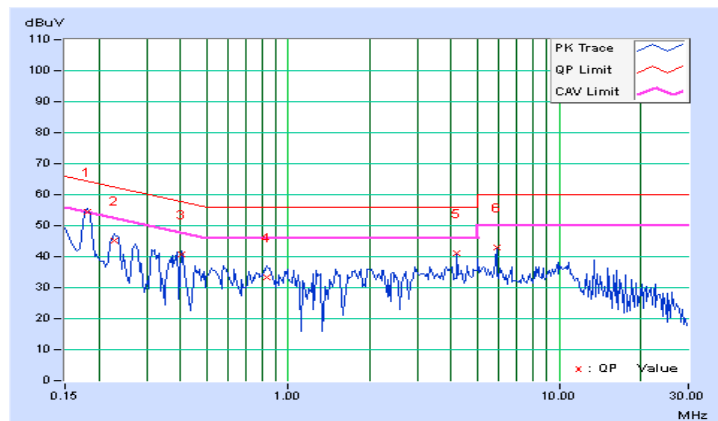

Phase	Neutral (N)	Detector Function	Quasi-Peak (QP) / Average (AV)
-------	-------------	-------------------	--------------------------------

No	Freq. [MHz]	Corr.	Reading Value		Emission Level		Limit		Margin	
		Factor	[dB (uV)]		[dB (uV)]		[dB (uV)]		(dB)	
		(dB)	Q.P.	AV.	Q.P.	AV.	Q.P.	AV.	Q.P.	AV.
1	0.18125	0.09	52.90	44.44	52.99	44.53	64.43	54.43	-11.43	-9.89
2	0.22812	0.11	44.98	37.12	45.09	37.23	62.52	52.52	-17.43	-15.29
3	0.36316	0.14	35.80	30.06	35.94	30.20	58.66	48.66	-22.72	-18.46
4	0.84141	0.19	32.22	31.14	32.41	31.33	56.00	46.00	-23.59	-14.67
5	4.20313	0.32	40.42	39.12	40.74	39.44	56.00	46.00	-15.26	-6.56
6	5.88281	0.37	41.98	40.42	42.35	40.79	60.00	50.00	-17.65	-9.21

REMARKS:

1. Q.P. and AV. are abbreviations of quasi-peak and average individually.
2. The emission levels of other frequencies were very low against the limit.
3. Margin value = Emission level - Limit value
4. Correction factor = Insertion loss + Cable loss
5. Emission Level = Correction Factor + Reading Value.

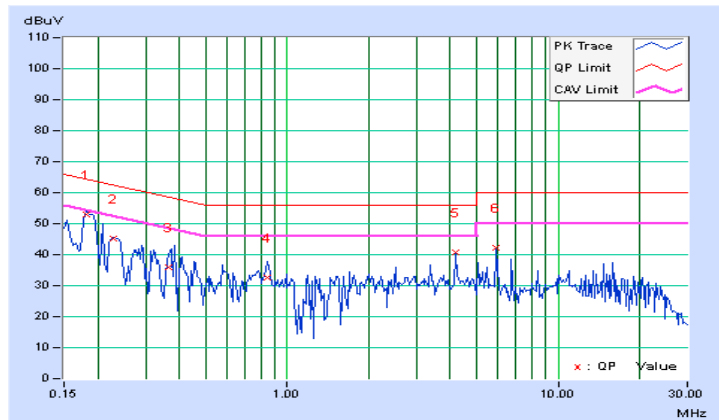

4.3 6dB Bandwidth Measurement

4.3.1 Limits of 6dB Bandwidth Measurement

The minimum of 6dB Bandwidth Measurement is 0.5 MHz.

4.3.2 Test Setup

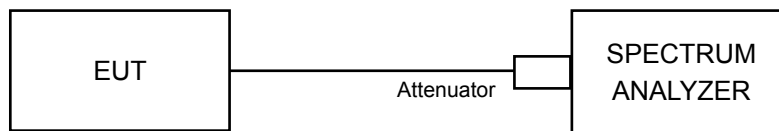

4.3.3 Test Instruments

Refer to section 4.1.2 to get information of above instrument.

4.3.4 Test Procedure

- a. Set resolution bandwidth (RBW) = 100kHz
- b. Set the video bandwidth (VBW) $\geq 3 \times$ RBW, Detector = Peak.
- c. Trace mode = max hold.
- d. Sweep = auto couple.
- e. Measure the maximum width of the emission that is constrained by the frequencies associated with the two amplitude points (upper and lower) that are attenuated by 6 dB relative to the maximum level measured in the fundamental emission

4.3.5 Deviation from Test Standard

No deviation.

4.3.6 EUT Operating Conditions

The software provided by client to enable the EUT under transmission condition continuously at lowest, middle and highest channel frequencies individually.

4.3.7 Test Result

802.11b

Channel	Frequency (MHz)	6dB Bandwidth (MHz)		Minimum Limit (MHz)	Pass / Fail
		Chain 0	Chain 1		
1	2412	10.12	10.13	0.5	Pass
6	2437	10.11	10.12	0.5	Pass
11	2462	11.09	10.62	0.5	Pass

802.11g

Channel	Frequency (MHz)	6dB Bandwidth (MHz)		Minimum Limit (MHz)	Pass / Fail
		Chain 0	Chain 1		
1	2412	16.54	16.53	0.5	Pass
6	2437	16.53	16.54	0.5	Pass
11	2462	16.52	16.51	0.5	Pass

802.11n (HT20)

Channel	Frequency (MHz)	6dB Bandwidth (MHz)		Minimum Limit (MHz)	Pass / Fail
		Chain 0	Chain 1		
1	2412	17.81	17.75	0.5	Pass
6	2437	17.76	17.77	0.5	Pass
11	2462	17.78	17.72	0.5	Pass

802.11n (HT40)

Channel	Frequency (MHz)	6dB Bandwidth (MHz)		Minimum Limit (MHz)	Pass / Fail
		Chain 0	Chain 1		
3	2422	36.67	36.64	0.5	Pass
6	2437	36.50	36.44	0.5	Pass
9	2452	25.79	27.47	0.5	Pass

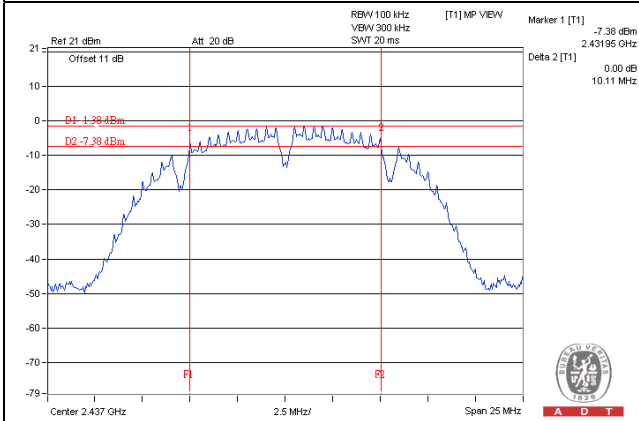
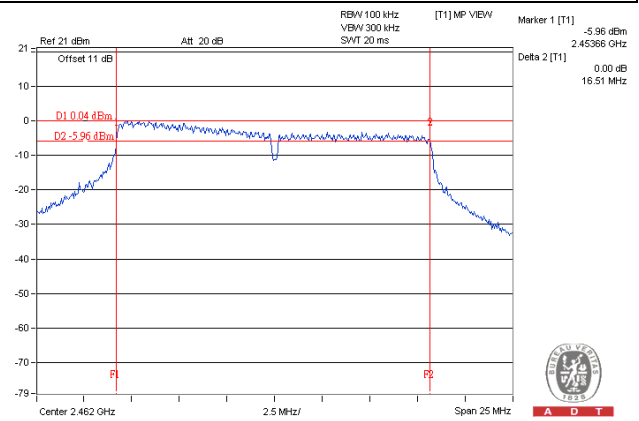
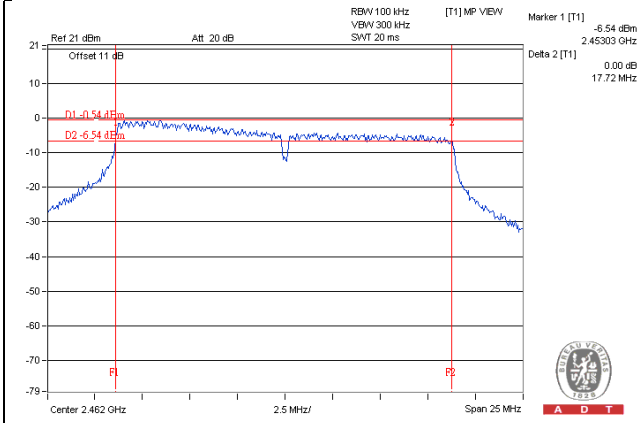
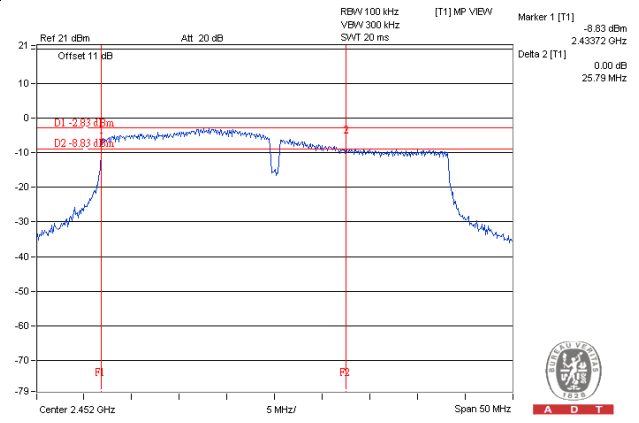
Spectrum Plot of Worst Value**802.11b – Chain 0: CH 6****802.11g – Chain 1: CH 11****802.11n (HT20) – Chain 1: CH 11****802.11n (HT40) – Chain 0: CH 9**

4.4 Conducted Output Power Measurement

4.4.1 Limits of Conducted Output Power Measurement

For systems using digital modulation in the 2400–2483.5 MHz bands: 1 Watt (30dBm)

Per KDB 662911 D01 Multiple Transmitter Output Method of conducted output power measurement on IEEE 802.11 devices,

Array Gain = 0 dB (i.e., no array gain) for $NANT \leq 4$;

Array Gain = 0 dB (i.e., no array gain) for channel widths ≥ 40 MHz for any NANT;

Array Gain = $5 \log(NANT/NSS)$ dB or 3 dB, whichever is less for 20-MHz channel widths with $NANT \geq 5$.

For power measurements on all other devices: Array Gain = $10 \log(NANT/NSS)$ dB.

4.4.2 Test Setup

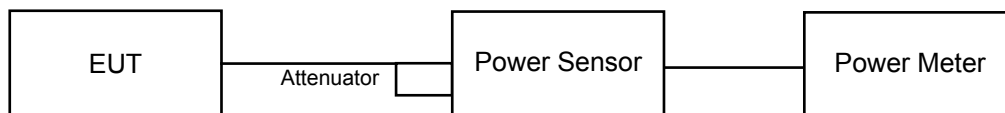

4.4.3 Test Instruments

Refer to section 4.1.2 to get information of above instrument.

4.4.4 Test Procedures

A peak / average power sensor was used on the output port of the EUT. A power meter was used to read the response of the peak / average power sensor. Record the power level.

4.4.5 Deviation from Test Standard

No deviation.

4.4.6 EUT Operating Conditions

Same as Item 4.3.6.

4.4.7 Test Results

FOR PEAK POWER

802.11b

Chan.	Freq. (MHz)	Peak Power (dBm)		Total Power (mW)	Total Power (dBm)	Limit (dBm)	Pass / Fail
		Chain 0	Chain 1				
1	2412	12.30	12.27	33.848	15.30	30	Pass
6	2437	8.74	8.43	14.448	11.60	30	Pass
11	2462	7.10	7.31	10.512	10.22	30	Pass

802.11g

Chan.	Freq. (MHz)	Peak Power (dBm)		Total Power (mW)	Total Power (dBm)	Limit (dBm)	Pass / Fail
		Chain 0	Chain 1				
1	2412	19.56	19.22	173.925	22.40	30	Pass
6	2437	22.74	22.83	379.799	25.80	30	Pass
11	2462	19.84	19.94	195.011	22.90	30	Pass

802.11n (HT20)

Chan.	Freq. (MHz)	Peak Power (dBm)		Total Power (mW)	Total Power (dBm)	Limit (dBm)	Pass / Fail
		Chain 0	Chain 1				
1	2412	18.38	18.30	136.473	21.35	30	Pass
6	2437	22.47	22.62	359.414	25.56	30	Pass
11	2462	19.38	19.61	178.107	22.51	30	Pass

802.11n (HT40)

Chan.	Freq. (MHz)	Peak Power (dBm)		Total Power (mW)	Total Power (dBm)	Limit (dBm)	Pass / Fail
		Chain 0	Chain 1				
3	2422	17.55	17.64	114.961	20.61	30	Pass
6	2437	20.64	20.26	222.048	23.46	30	Pass
9	2452	19.81	19.77	190.561	22.80	30	Pass

FOR AVERAGE POWER
802.11b

Chan.	Frequency (MHz)	Avg. Power (dBm)		Total Power (mW)	Total Power (dBm)
		Chain 0	Chain 1		
1	2412	10.27	10.01	20.664	13.15
6	2437	6.89	6.57	9.426	9.74
11	2462	5.01	5.66	6.851	8.36

802.11g

Chan.	Frequency (MHz)	Avg. Power (dBm)		Total Power (mW)	Total Power (dBm)
		Chain 0	Chain 1		
1	2412	11.22	11.19	26.395	14.22
6	2437	14.56	14.96	59.909	17.77
11	2462	12.37	12.65	35.666	15.52

802.11n (HT20)

Chan.	Frequency (MHz)	Avg. Power (dBm)		Total Power (mW)	Total Power (dBm)
		Chain 0	Chain 1		
1	2412	10.72	10.54	23.127	13.64
6	2437	14.52	14.84	58.793	17.69
11	2462	11.70	11.92	30.351	14.82

802.11n (HT40)

Chan.	Frequency (MHz)	Avg. Power (dBm)		Total Power (mW)	Total Power (dBm)
		Chain 0	Chain 1		
3	2422	9.50	9.73	18.310	12.63
6	2437	13.19	13.18	41.642	16.20
9	2452	12.57	12.35	35.251	15.47

4.5 Power Spectral Density Measurement

4.5.1 Limits of Power Spectral Density Measurement

The Maximum of Power Spectral Density Measurement is 8dBm.

4.5.2 Test Setup

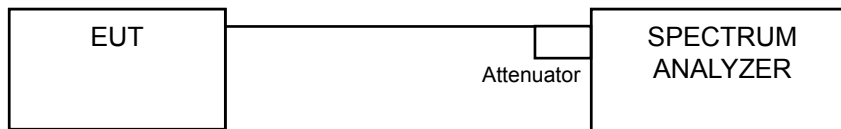

TEST INSTRUMENTS

Refer to section 4.1.2 to get information of above instrument.

4.5.3 Test Procedure

- Set analyzer center frequency to DTS channel center frequency.
- Set the span to 1.5 times the DTS bandwidth.
- Set the RBW to: $3 \text{ kHz} \leq \text{RBW} \leq 100 \text{ kHz}$.
- Set the VBW $\geq 3 \times \text{RBW}$.
- Detector = peak.
- Sweep time = auto couple.
- Trace mode = max hold.
- Allow trace to fully stabilize.
- Use the peak marker function to determine the maximum amplitude level within the RBW.

4.5.4 Deviation from Test Standard

No deviation.

4.5.5 EUT Operating Condition

Same as Item 4.3.6

4.5.6 Test Results

802.11b

TX chain	Channel	Freq. (MHz)	PSD (dBm)	10 log (N=2) dB	Total PSD (dBm)	Limit (dBm)	Pass /Fail
0	1	2412	-13.37	3.01	-10.36	7.99	Pass
	6	2437	-16.58	3.01	-13.57	7.99	Pass
	11	2462	-18.57	3.01	-15.56	7.99	Pass
1	1	2412	-12.78	3.01	-9.77	7.99	Pass
	6	2437	-16.57	3.01	-13.56	7.99	Pass
	11	2462	-18.12	3.01	-15.11	7.99	Pass

NOTE: Directional gain = $3\text{dBi} + 10\log(2) = 6.01\text{dBi} > 6\text{dBi}$, so the power density limit shall be reduced to $8-(6.01-6) = 7.99\text{dBm}$.

802.11g

TX chain	Channel	Freq. (MHz)	PSD (dBm)	10 log (N=2) dB	Total PSD (dBm)	Limit (dBm)	Pass /Fail
0	1	2412	-13.88	3.01	-10.87	7.99	Pass
	6	2437	-9.31	3.01	-6.30	7.99	Pass
	11	2462	-12.54	3.01	-9.53	7.99	Pass
1	1	2412	-13.29	3.01	-10.28	7.99	Pass
	6	2437	-8.24	3.01	-5.23	7.99	Pass
	11	2462	-12.84	3.01	-9.83	7.99	Pass

NOTE: Directional gain = $3\text{dBi} + 10\log(2) = 6.01\text{dBi} > 6\text{dBi}$, so the power density limit shall be reduced to $8-(6.01-6) = 7.99\text{dBm}$.

802.11n (HT20)

TX chain	Channel	Freq. (MHz)	PSD (dBm)	10 log (N=2) dB	Total PSD (dBm)	Limit (dBm)	Pass /Fail
0	1	2412	-14.27	3.01	-11.26	7.99	Pass
	6	2437	-9.84	3.01	-6.83	7.99	Pass
	11	2462	-14.02	3.01	-11.01	7.99	Pass
1	1	2412	-13.37	3.01	-10.36	7.99	Pass
	6	2437	-9.67	3.01	-6.66	7.99	Pass
	11	2462	-12.58	3.01	-9.57	7.99	Pass

NOTE: Directional gain = $3\text{dBi} + 10\log(2) = 6.01\text{dBi} > 6\text{dBi}$, so the power density limit shall be reduced to $8-(6.01-6) = 7.99\text{dBm}$.

802.11n (HT40)

TX chain	Channel	Freq. (MHz)	PSD (dBm)	10 log (N=2) dB	Total PSD (dBm)	Limit (dBm)	Pass /Fail
0	3	2422	-18.83	3.01	-15.82	7.99	Pass
	6	2437	-15.47	3.01	-12.46	7.99	Pass
	9	2452	-15.19	3.01	-12.18	7.99	Pass
1	3	2422	-18.76	3.01	-15.75	7.99	Pass
	6	2437	-14.15	3.01	-11.14	7.99	Pass
	9	2452	-14.19	3.01	-11.18	7.99	Pass

NOTE: Directional gain = 3dBi + 10log(2) = 6.01dBi > 6dBi , so the power density limit shall be reduced to 8-(6.01-6) = 7.99dBm.

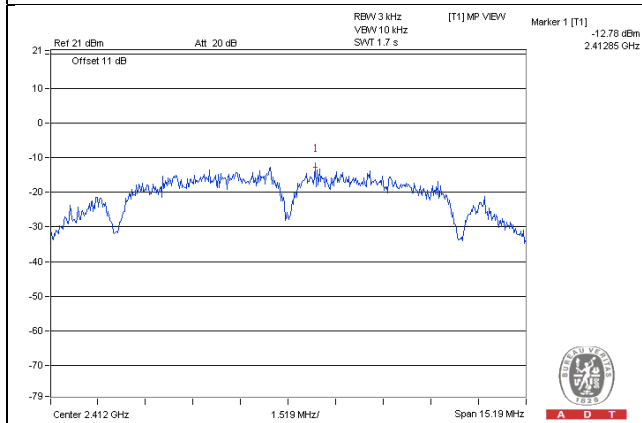
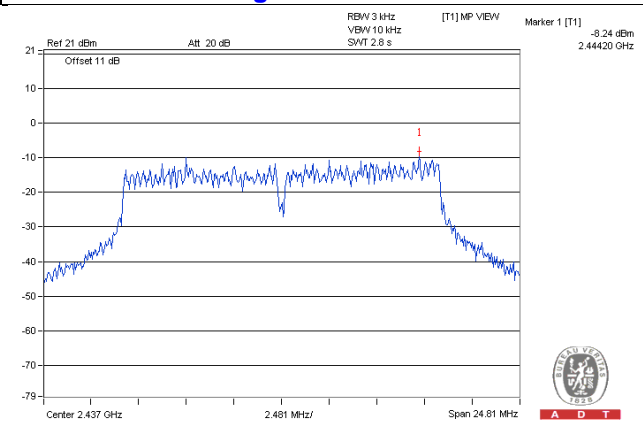
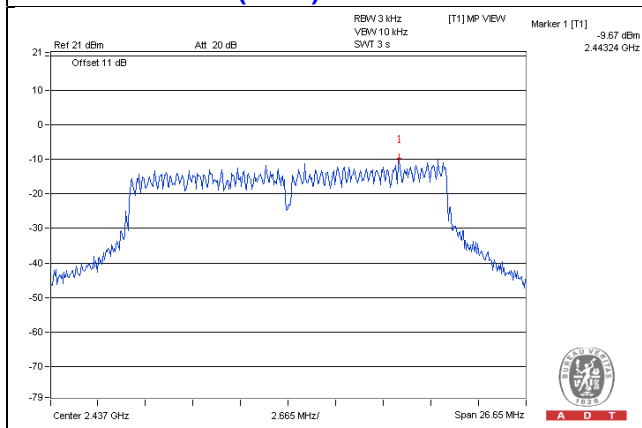
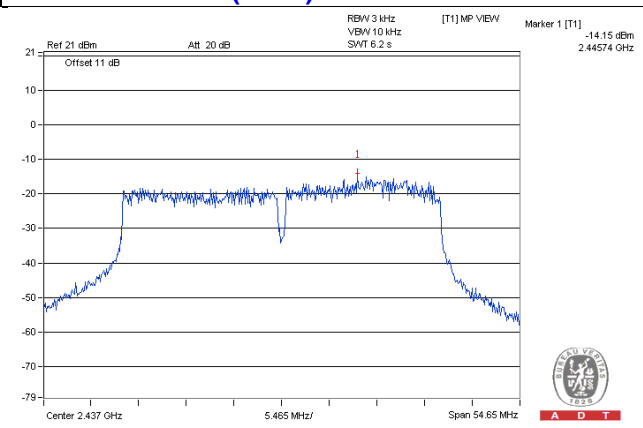
Spectrum Plot of Worst Value
802.11b – Chain 1: CH 1

802.11g – Chain 1: CH 6

802.11n (HT20) – Chain 1: CH 6

802.11n (HT40) – Chain 1: CH 6

4.6 Conducted Out of Band Emission Measurement

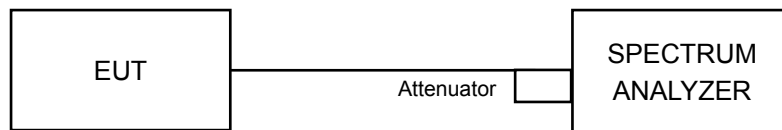
4.6.1 Limits of Conducted Out of Band Emission Measurement

Below 20dB of the highest emission level of operating band (in 100kHz Resolution Bandwidth).

4.6.2 Test Setup



4.6.3 Test Instruments

Refer to section 4.1.2 to get information of above instrument.

4.6.4 Test Procedure

MEASUREMENT PROCEDURE REF

1. Set the RBW = 100 kHz.
2. Set the VBW \geq 300 kHz.
3. Detector = peak.
4. Sweep time = auto couple.
5. Trace mode = max hold.
6. Allow trace to fully stabilize.
7. Use the peak marker function to determine the maximum power level in any 100 kHz band segment within the fundamental EBW.

MEASUREMENT PROCEDURE OOB

1. Set RBW = 100 kHz.
2. Set VBW \geq 300 kHz.
3. Detector = peak.
4. Sweep = auto couple.
5. Trace Mode = max hold.
6. Allow trace to fully stabilize.
7. Use the peak marker function to determine the maximum amplitude level.

4.6.5 Deviation from Test Standard

No deviation.

4.6.6 EUT Operating Condition

Same as Item 4.3.6

4.6.7 Test Results

The spectrum plots are attached on the following pages. D1 line indicates the highest level, and D2 line indicates the 20dB offset below D1. It shows compliance with the requirement.

802.11b
Chain 0

CH 1

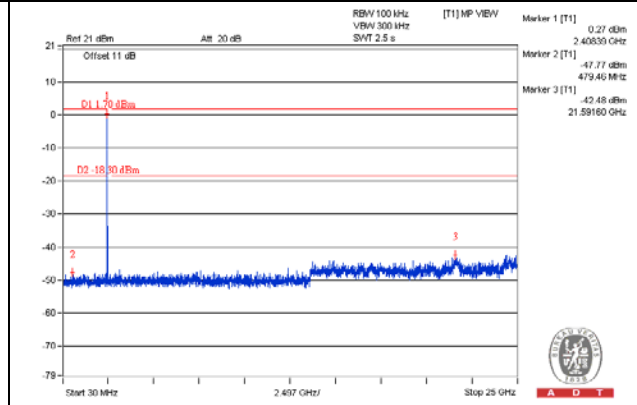
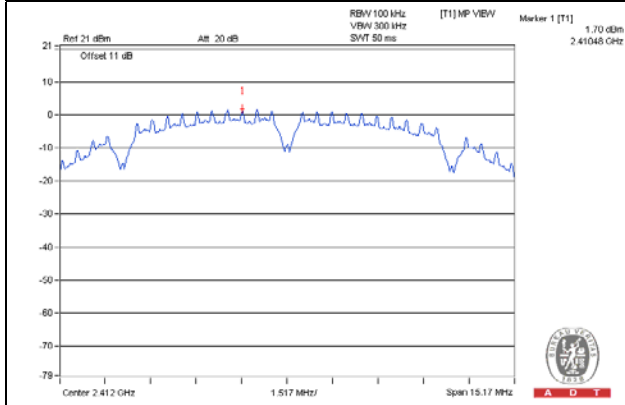

CH 6

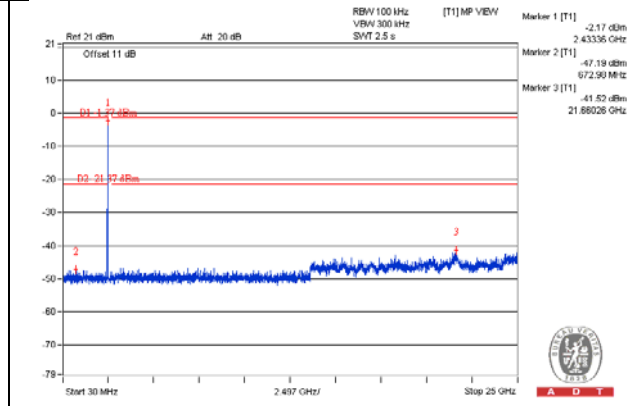
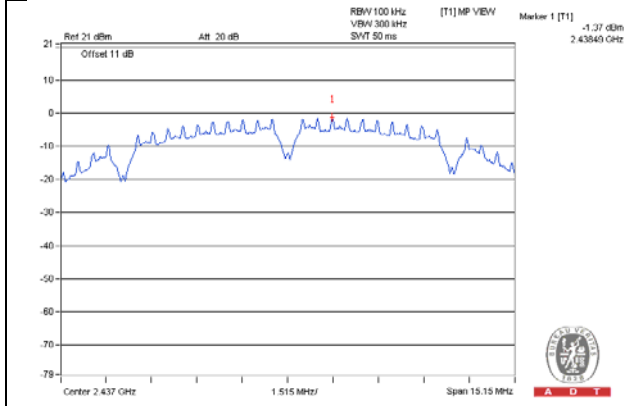

CH 11

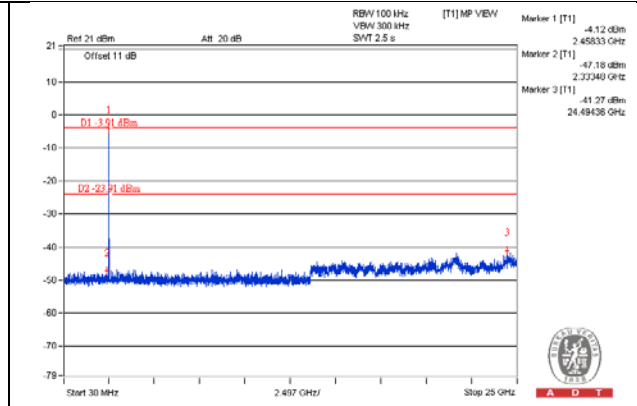
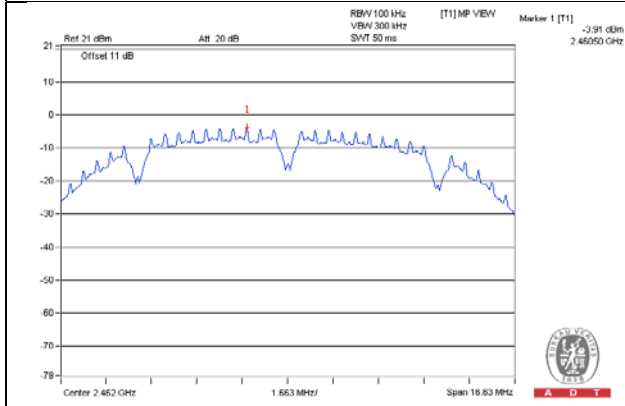

CH 1 Band edge

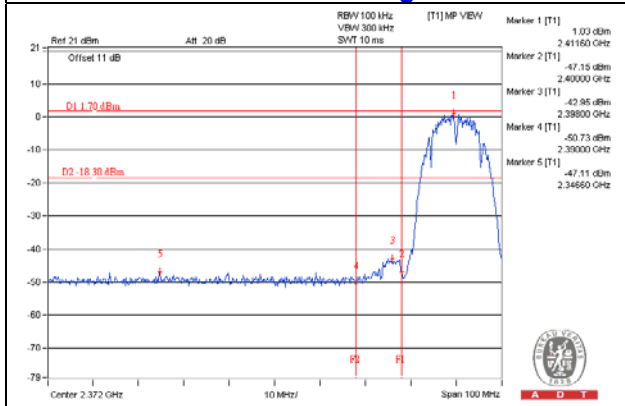

CH 11 Band edge

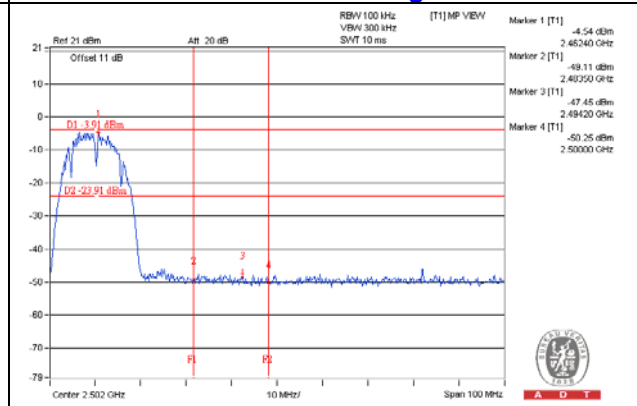

Chain 1

CH 1

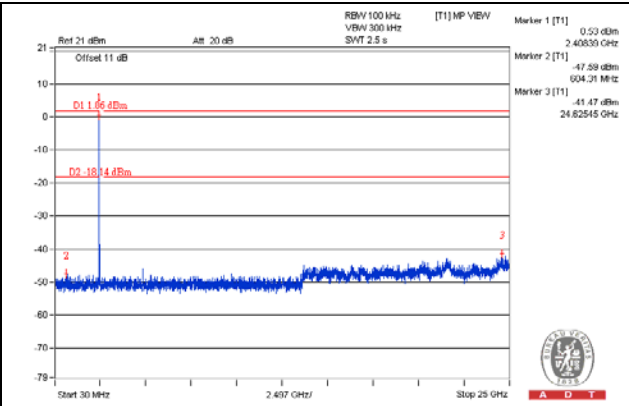
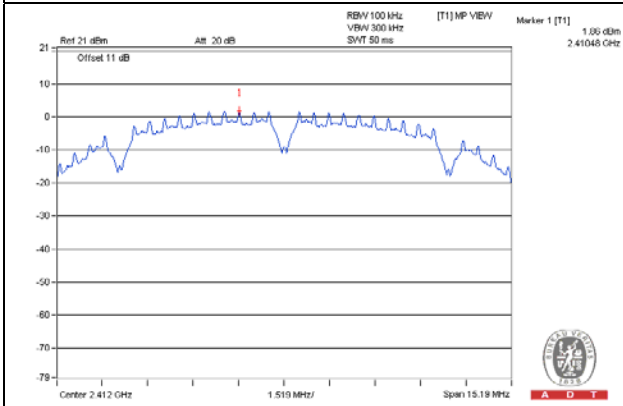

CH 6

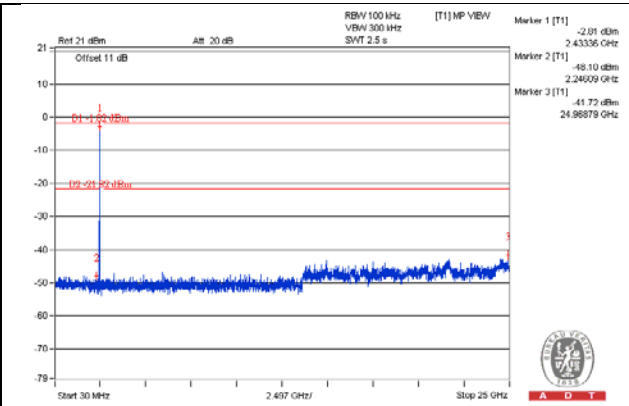
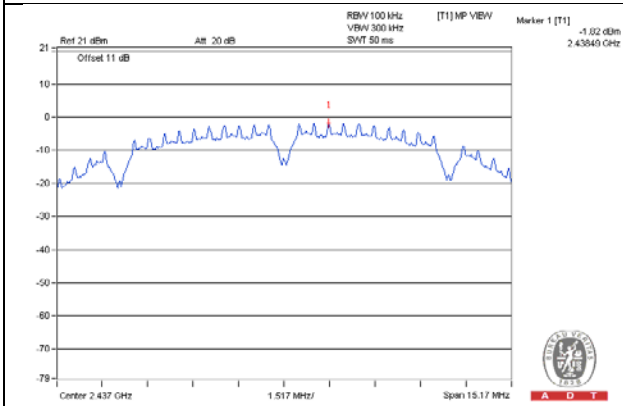

CH 11

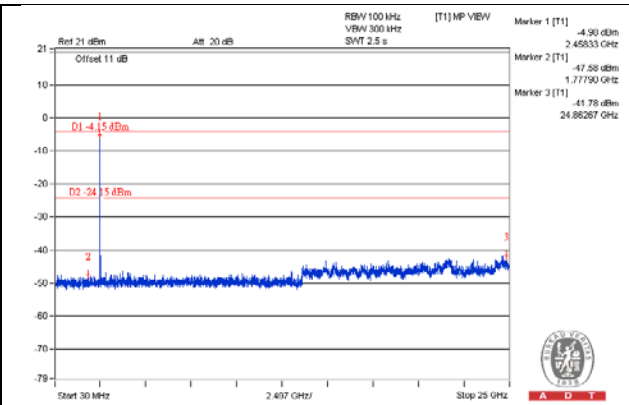
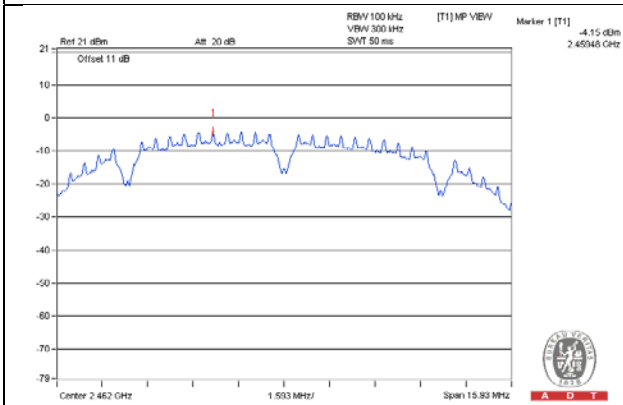

CH 1 Band edge

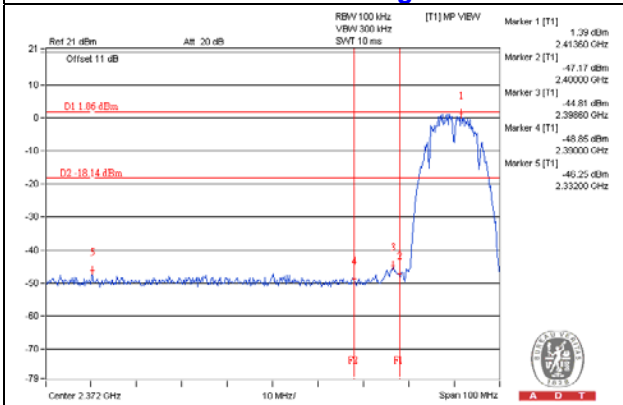

CH 11 Band edge

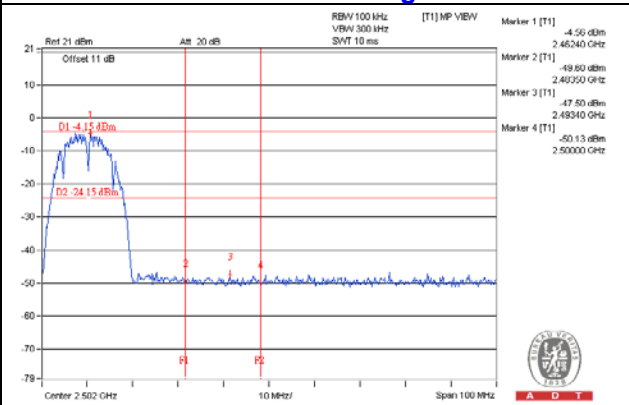

802.11g
Chain 0

CH 1

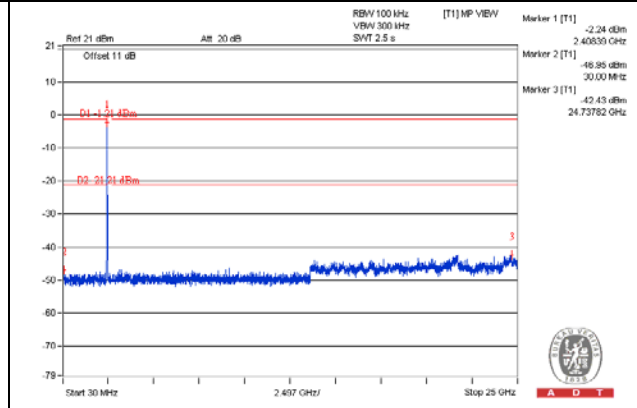
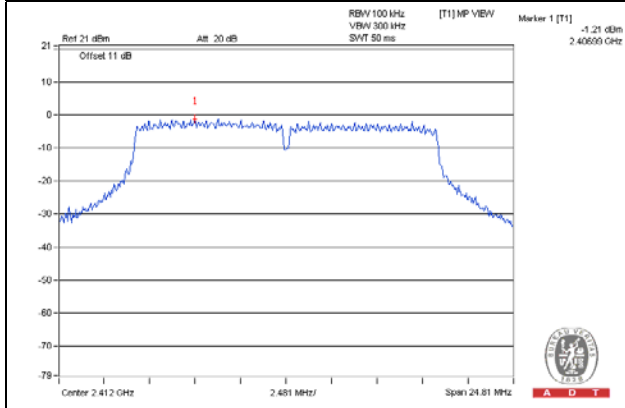

CH 6

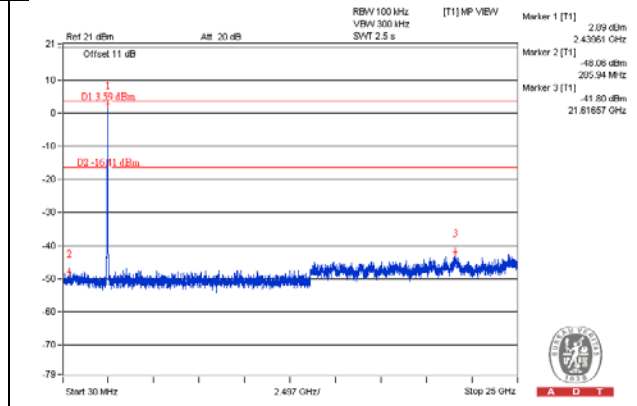
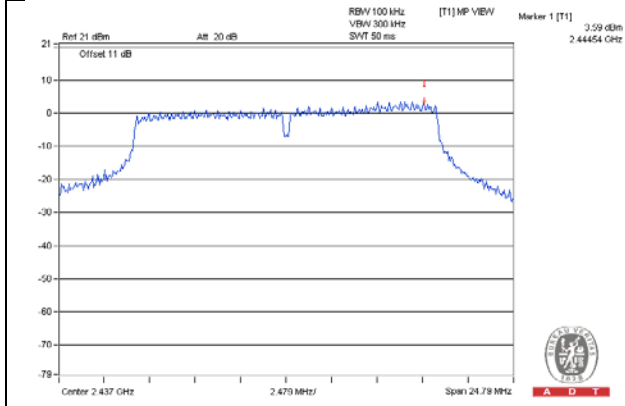

CH 11

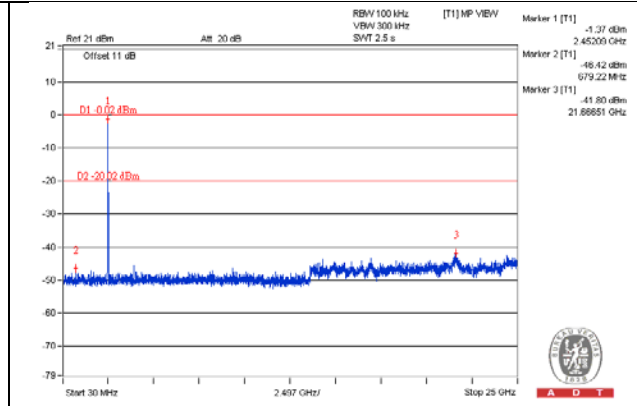
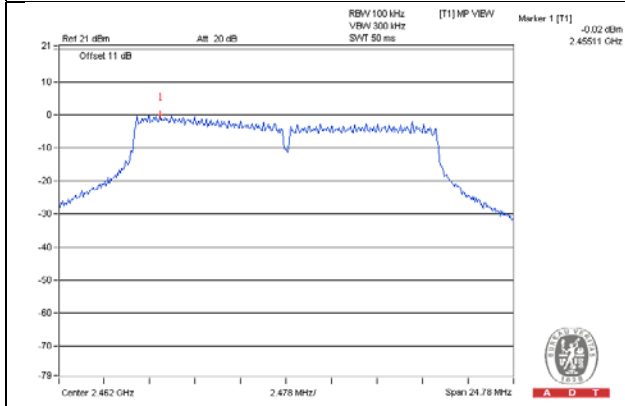

CH 1 Band edge

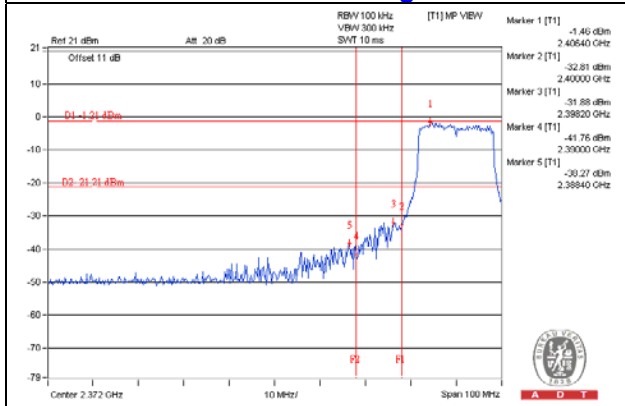

CH 11 Band edge

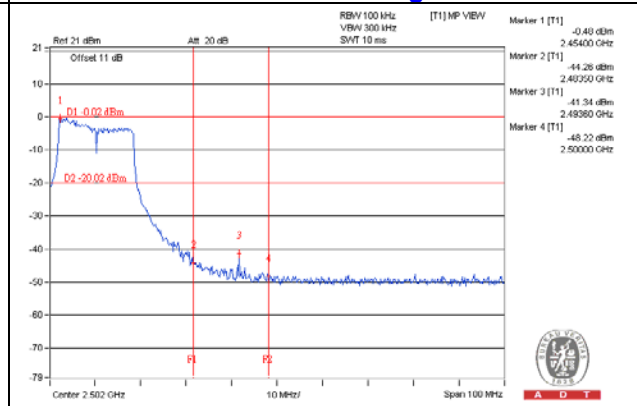

Chain 1

CH 1

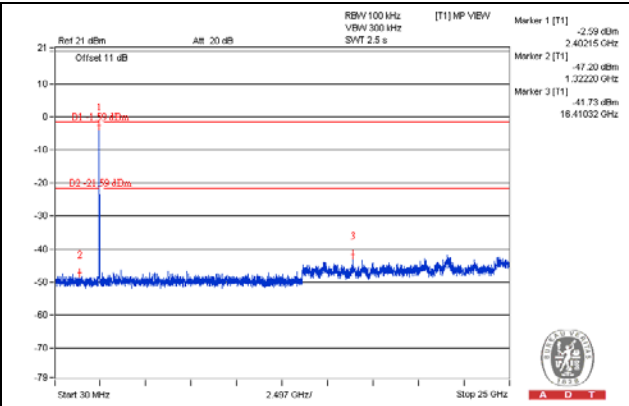
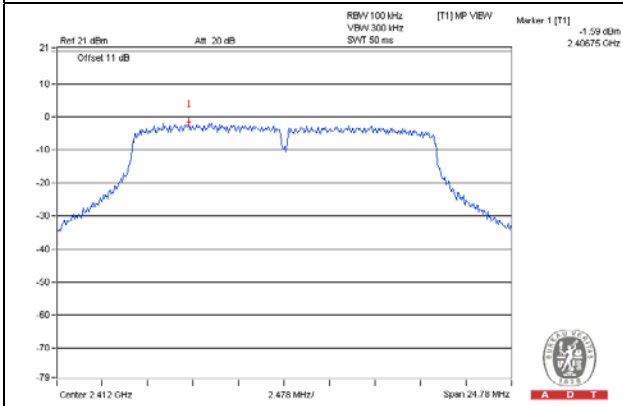

CH 6

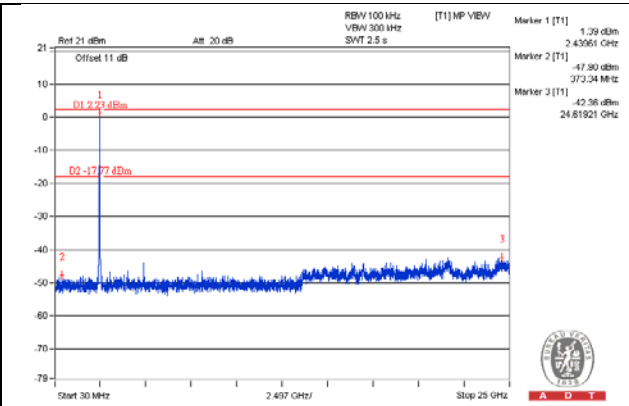
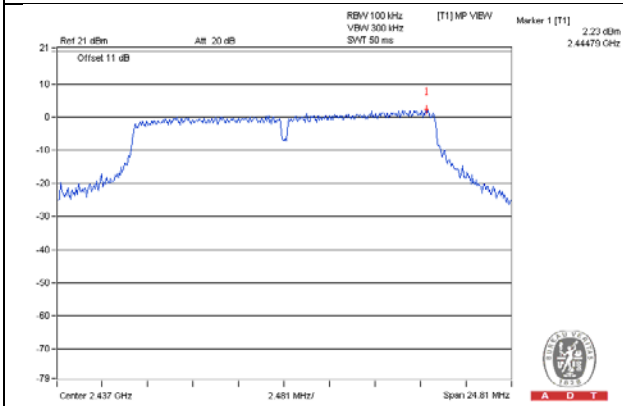

CH 11

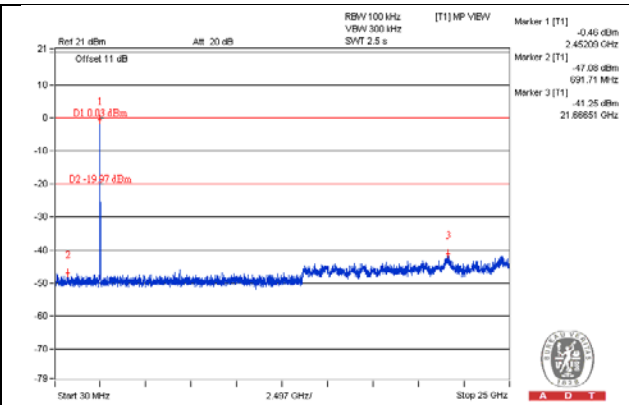
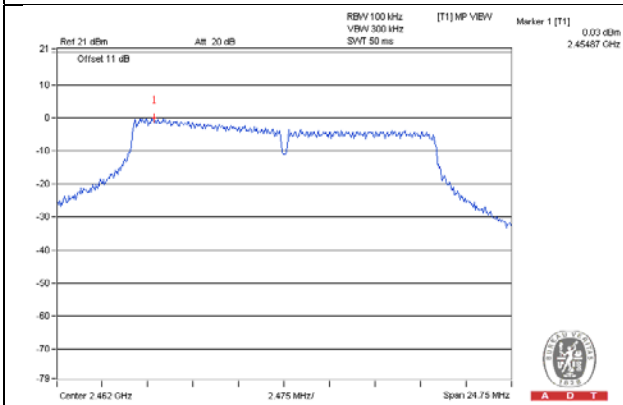

CH 1 Band edge

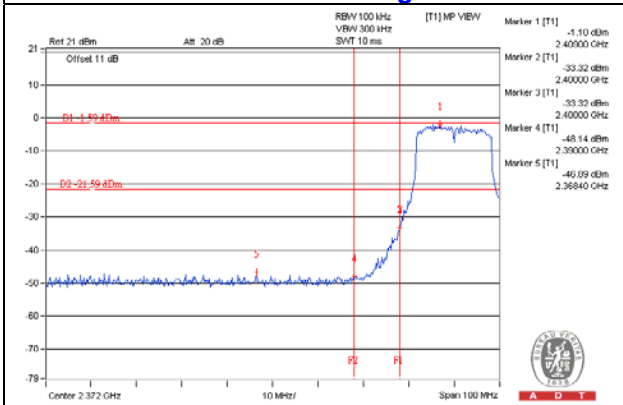

CH 11 Band edge

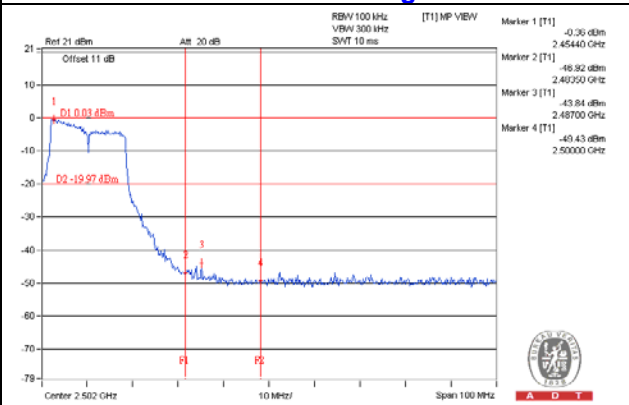

802.11n (HT20)

Chain 0

CH 1

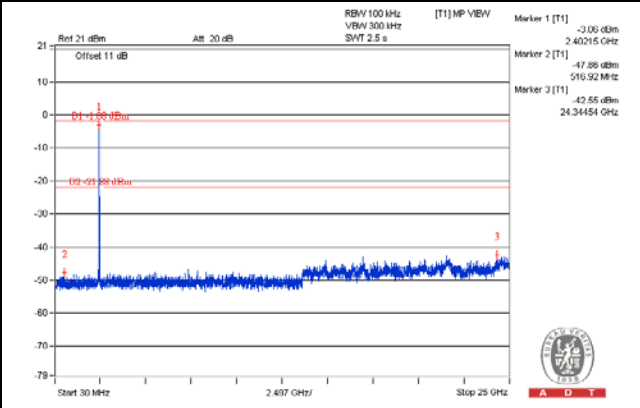
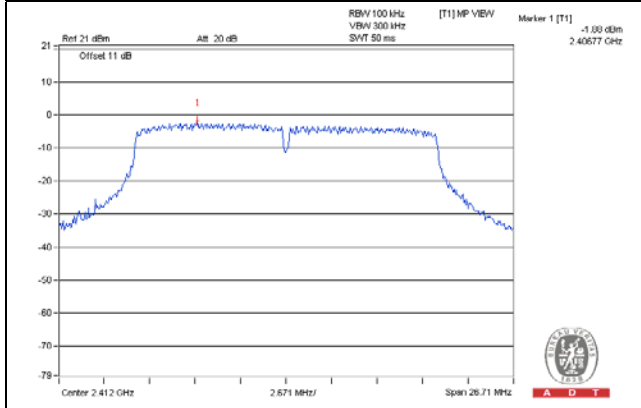

CH 6

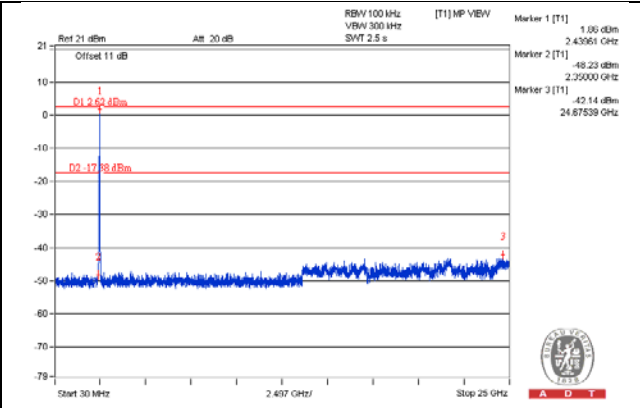
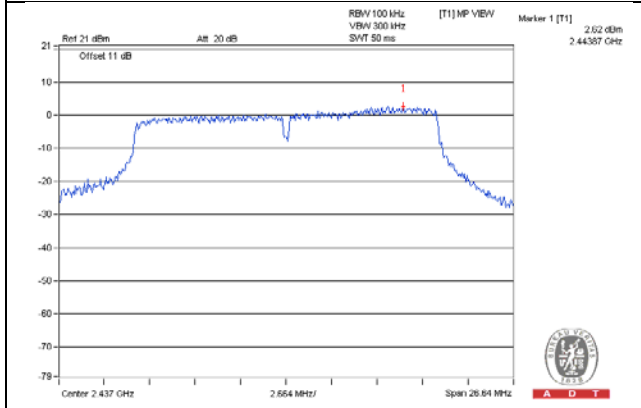

CH 11

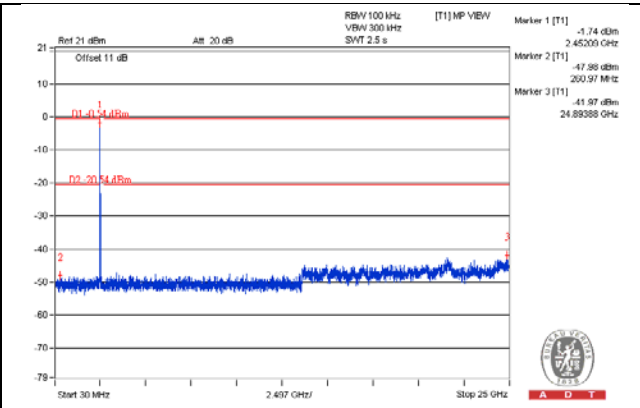
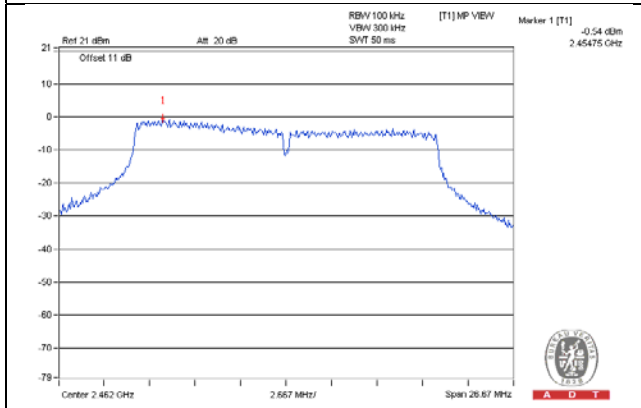

CH 1 Band edge

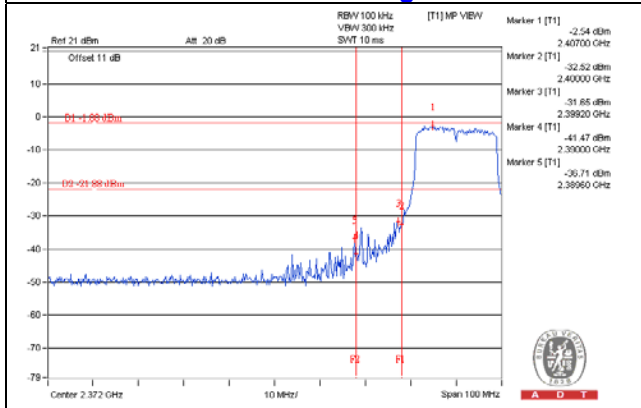

CH 11 Band edge

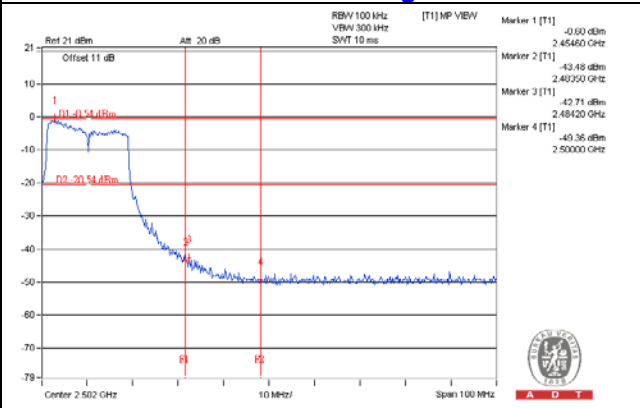

Chain 1

CH 1

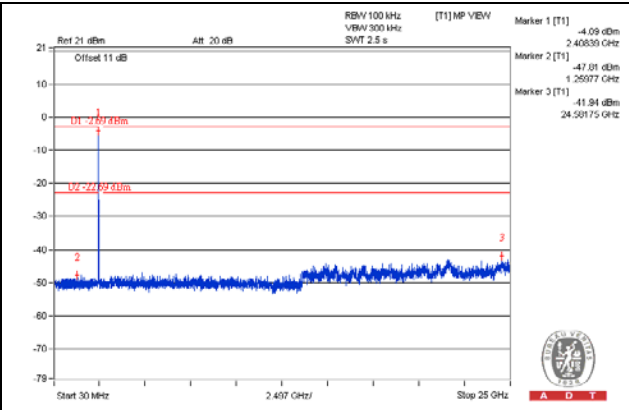
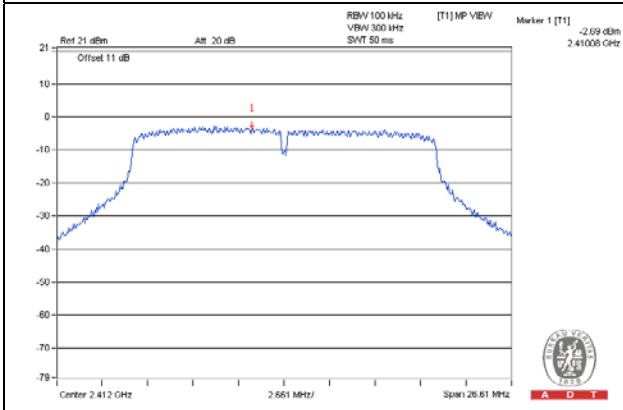

CH 6

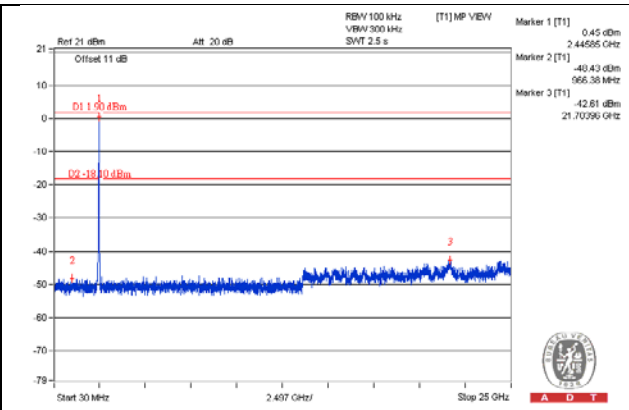
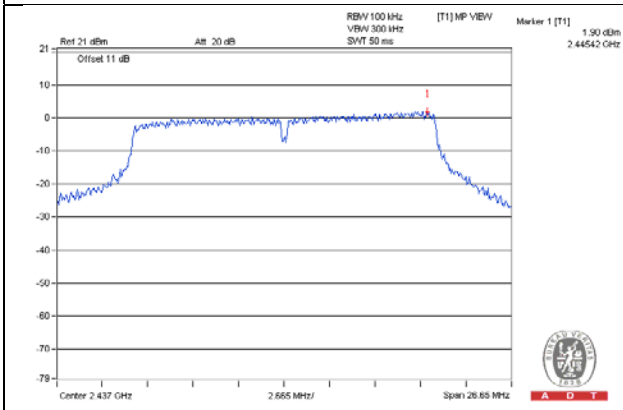

CH 11

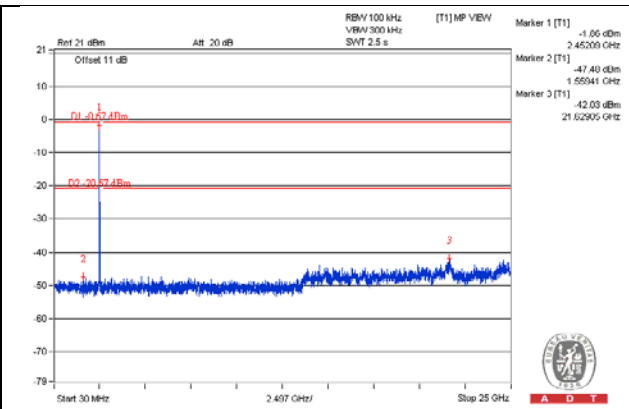
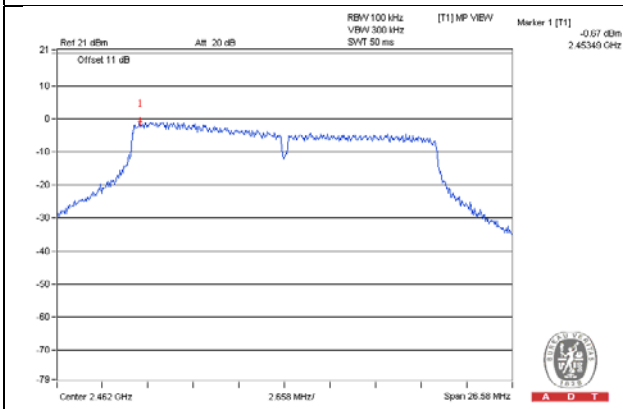

CH 1 Band edge

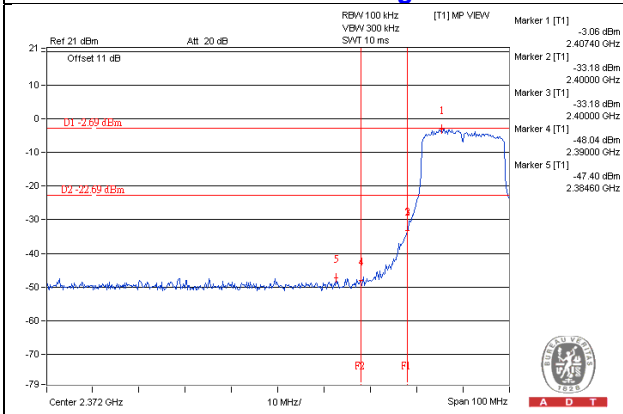

CH 11 Band edge

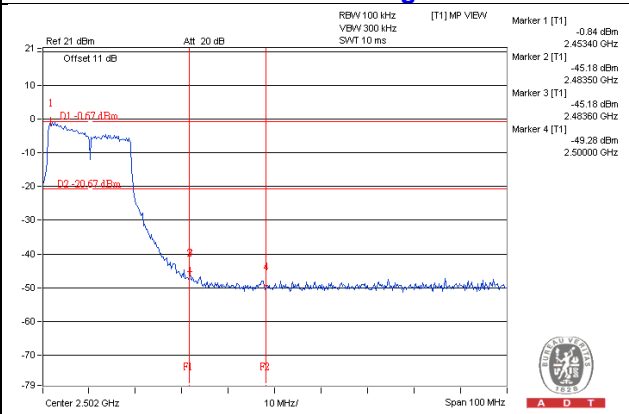

802.11n (HT40)

Chain 0

CH 3

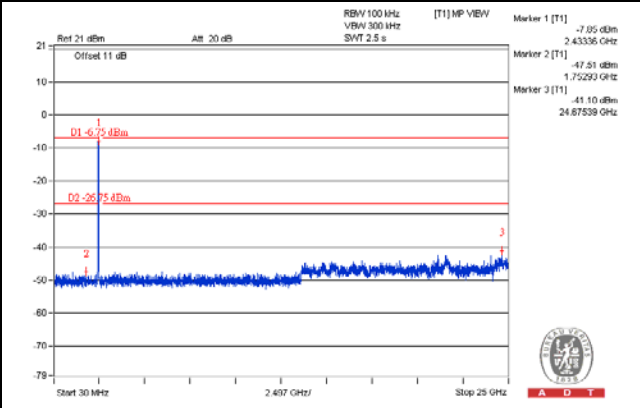
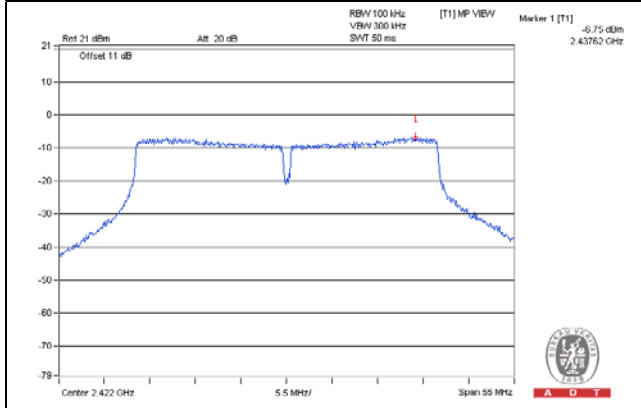

CH 6

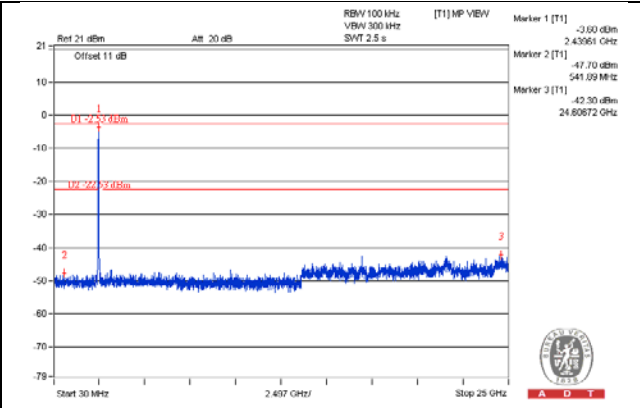
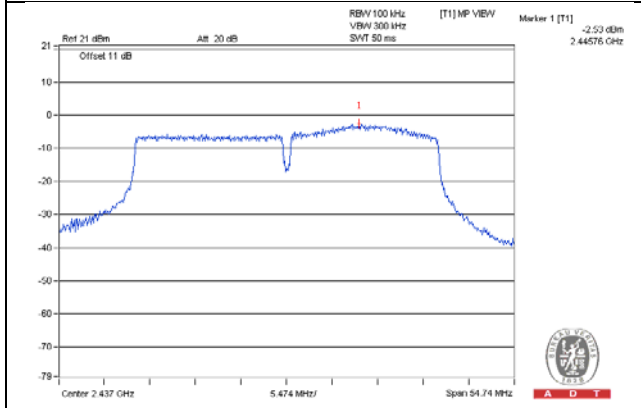

CH 9

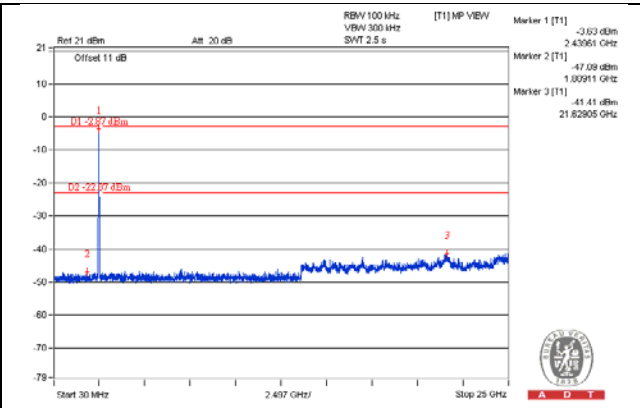
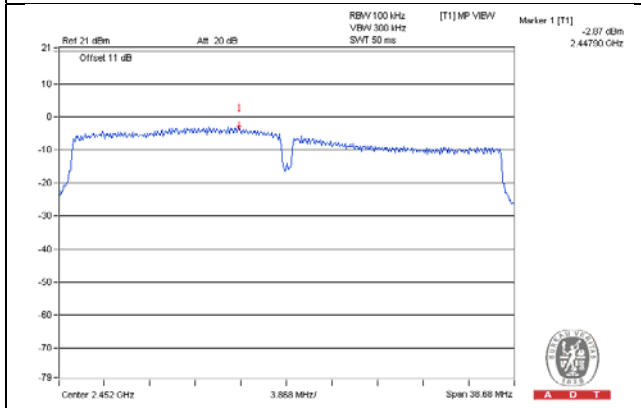

CH 3 Band edge

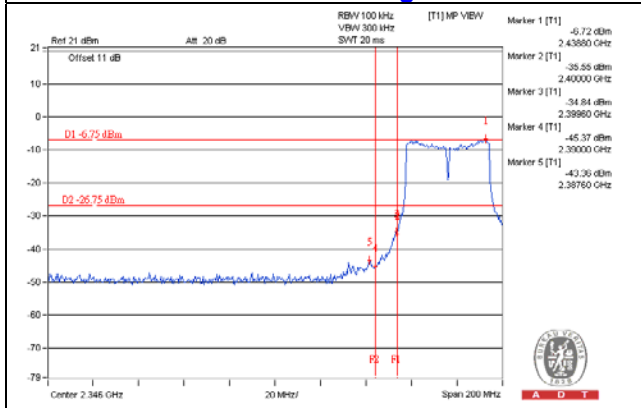

CH 9 Band edge

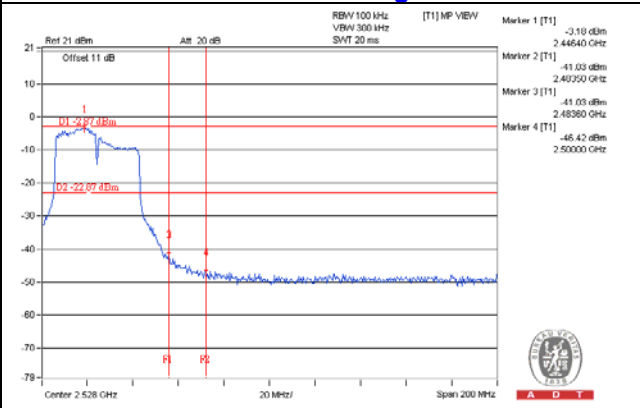

Chain 1

CH 3

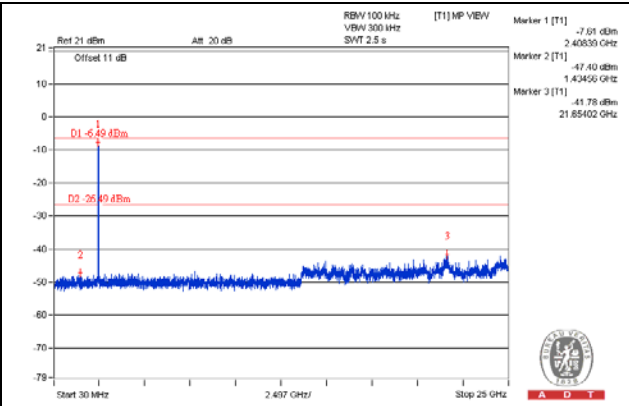
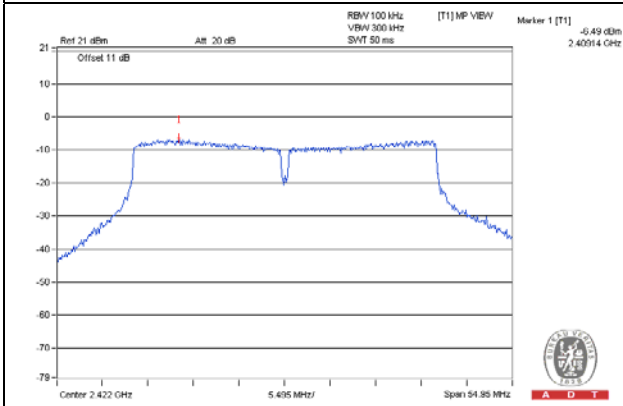

CH 6

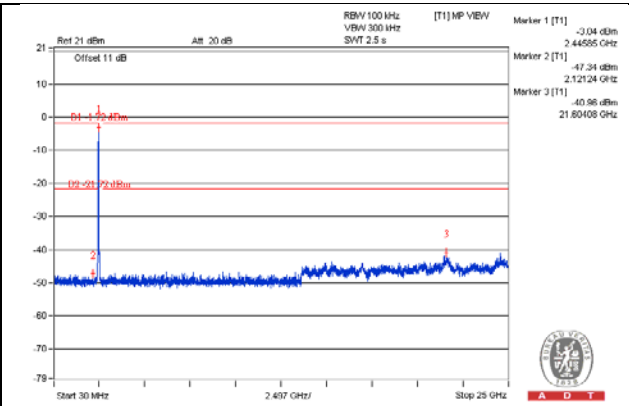
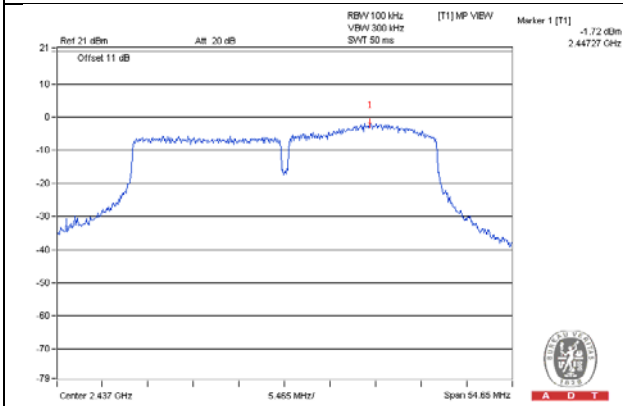

CH 9

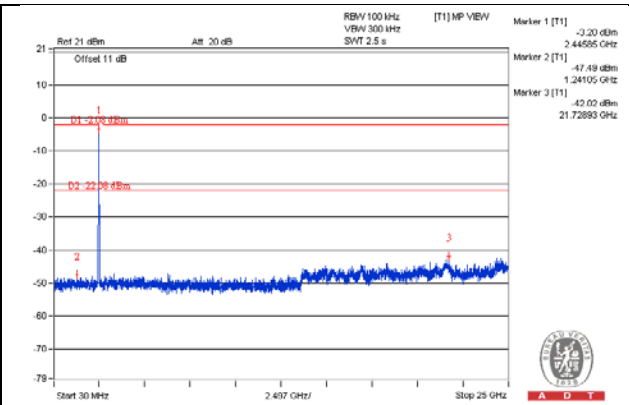
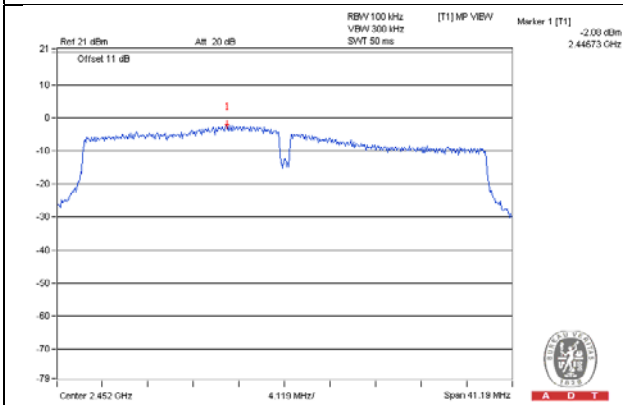

CH 3 Band edge

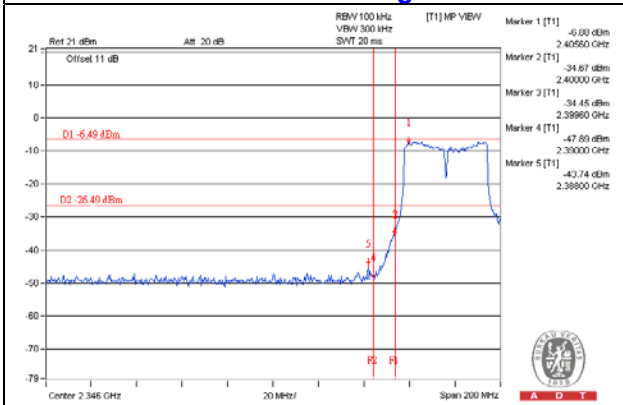

CH 9 Band edge

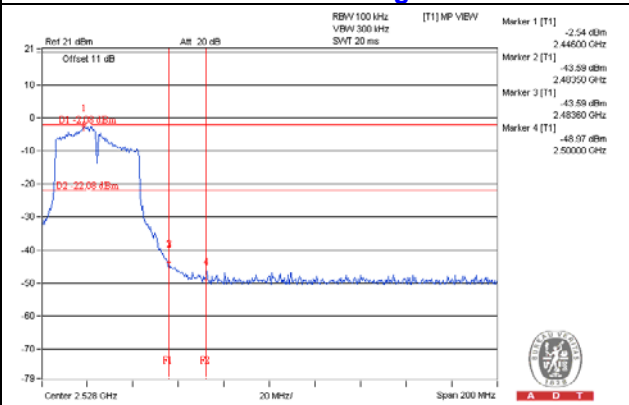

5 Pictures of Test Arrangements

Please refer to the attached file (Test Setup Photo).

Appendix – Information on the Testing Laboratories

We, Bureau Veritas Consumer Products Services (H.K.) Ltd., Taoyuan Branch, were founded in 1988 to provide our best service in EMC, Radio, Telecom and Safety consultation. Our laboratories are accredited and approved according to ISO/IEC 17025.

If you have any comments, please feel free to contact us at the following:

Linko EMC/RF Lab

Tel: 886-2-26052180

Fax: 886-2-26051924

Hsin Chu EMC/RF/Telecom Lab

Tel: 886-3-5935343

Fax: 886-3-5935342

Hwa Ya EMC/RF/Safety Lab

Tel: 886-3-3183232

Fax: 886-3-3270892

Email: service.adt@tw.bureauveritas.com

Web Site: www.bureauveritas-adt.com

The address and road map of all our labs can be found in our web site also.

--- END ---