

FCC Test Report

Report No.: FD160923E02E

FCC ID: U8G-P1811ACPRO

Test Model: Balance 30 Pro

Series Model: Peplink Balance 30 Pro, BPL-031-LTEA-W-T, Pismo 811AC, B30 Pro

Received Date: Mar. 20, 2019

Test Date: Mar. 28 to June 10, 2019

Issued Date: June 13, 2019

Applicant: PISMO LABS TECHNOLOGY LIMITED

Address: A8, 5/F, HK Spinners Industrial Building, Phase 6, 481 Castle Peak Road, Cheung Sha Wan, Hong Kong

Issued By: Bureau Veritas Consumer Products Services (H.K.) Ltd., Taoyuan Branch Hsin Chu Laboratory

Lab Address: E-2, No.1, Li Hsin 1st Road, Hsinchu Science Park, Hsinchu City 300, Taiwan R.O.C.

Test Location (1): E-2, No.1, Li Hsin 1st Road, Hsinchu Science Park, Hsinchu City 300, Taiwan R.O.C.

Test Location (2): No. 49, Ln. 206, Wende Rd., Shangshan Tsuen, Chiung Lin Hsiang, Hsin Chu Hsien 307, Taiwan R.O.C.

FCC Registration / 810758 / TW1085 for Test Location (1) /

Designation Number: 960022 / TW1058 for Test Location (2)



This report is for your exclusive use. Any copying or replication of this report to or for any other person or entity, or use of our name or trademark, is permitted only with our prior written permission. This report sets forth our findings solely with respect to the test samples identified herein. The results set forth in this report are not indicative or representative of the quality or characteristics of the lot from which a test sample was taken or any similar or identical product unless specifically and expressly noted. Our report includes all of the tests requested by you and the results thereof based upon the information that you provided to us. You have 60 days from date of issuance of this report to notify us of any material error or omission caused by our negligence, provided, however, that such notice shall be in writing and shall specifically address the issue you wish to raise. A failure to raise such issue within the prescribed time shall constitute your unqualified acceptance of the completeness of this report, the tests conducted and the correctness of the report contents. Unless specifically mentioned, the uncertainty of measurement has been explicitly taken into account to declare the compliance or non-compliance to the specification. The report must not be used by the client to claim product certification, approval, or endorsement by TAF or any government agencies.

Table of Contents

Release Control Record	3
1 Certificate of Conformity	4
2 Summary of Test Results	5
2.1 Measurement Uncertainty	5
2.2 Modification Record	5
3 General Information	6
3.1 Description of EUT	6
3.2 Features of EUT	7
3.3 Operating Modes of EUT and Determination of Worst Case Operating Mode	8
3.4 Test Program Used and Operation Descriptions.....	9
3.5 Primary Clock Frequencies of Internal Source	9
4 Configuration and Connections with EUT	10
4.1 Connection Diagram of EUT and Peripheral Devices	10
4.2 Configuration of Peripheral Devices and Cable Connections	12
5 Conducted Emissions at Mains Ports	13
5.1 Limits	13
5.2 Test Instruments	13
5.3 Test Arrangement	15
5.4 Supplementary Information	15
5.5 Test Results (Mode 1)	16
5.6 Test Results (Mode 2)	18
6 Radiated Emissions up to 1 GHz	20
6.1 Limits	20
6.2 Test Instruments	21
6.3 Test Arrangement	23
6.4 Supplementary Information	23
6.5 Test Results (Mode 1)	24
6.6 Test Results (Mode 2)	26
7 Radiated Emissions above 1 GHz	28
7.1 Limits	28
7.2 Test Instruments	29
7.3 Test Arrangement	31
7.4 Supplementary Information	31
7.5 Test Results (Mode 1)	32
7.6 Test Results (Mode 2)	34
8 Pictures of Test Arrangements	36
Appendix – Information of the Testing Laboratories	37



Release Control Record

Issue No.	Description	Date Issued
FD160923E02E	Original release.	June 13, 2019

1 Certificate of Conformity

Product: PEPWAVE / peplink Wireless Product

Brand: PEPWAVE / peplink

Test Model: Balance 30 Pro

Series Model: Peplink Balance 30 Pro, BPL-031-LTEA-W-T, Pismo 811AC, B30 Pro

Sample Status: PROTOTYPE SAMPLE

Applicant: PISMO LABS TECHNOLOGY LIMITED

Test Date: Mar. 28 to June 10, 2019

Standards: 47 CFR FCC Part 15, Subpart B, Class A
ICES-003:2016 Issue 6 updated Apr. 2019, Class A
ANSI C63.4:2014

The above equipment has been tested by **Bureau Veritas Consumer Products Services (H.K.) Ltd., Taoyuan Branch**, and found compliance with the requirement of the above standards. The test record, data evaluation & Equipment Under Test (EUT) configurations represented herein are true and accurate accounts of the measurements of the sample's EMC characteristics under the conditions specified in this report.

Prepared by : Phoenix Huang, **Date:** June 13, 2019
Phoenix Huang / Specialist

Approved by : Ken Lu, **Date:** June 13, 2019
Ken Lu / Manager

2 Summary of Test Results

47 CFR FCC Part 15, Subpart B / ICES-003:2016 Issue 6 updated Apr. 2019, Class A

ANSI C63.4:2014

FCC Clause	ICES-003 Clause	Test Item	Result/Remarks	Verdict
15.107	6.1	AC Power Line Conducted Emissions	Minimum passing Class A margin is -23.15 dB at 0.95859 MHz	Pass
15.109	6.2.1	Radiated Emissions up to 1 GHz	Minimum passing Class A margin is -0.87 dB at 117.51 MHz	Pass
	6.2.2	Radiated Emissions above 1 GHz	Minimum passing Class A margin is -11.96 dB at 6946.70 MHz	Pass

Note: Determining compliance based on the results of the compliance measurement, not taking into account measurement instrumentation uncertainty.

2.1 Measurement Uncertainty

Where relevant, the following measurement uncertainty levels have been estimated for tests performed on the EUT:

Measurement	Frequency	Expanded Uncertainty (k=2) (\pm)
Conducted Emissions at mains ports	150kHz ~ 30MHz	1.8 dB
Radiated Emissions up to 1 GHz	30MHz ~ 1GHz	4.0 dB
Radiated Emissions above 1 GHz	1GHz ~ 6GHz	4.7 dB
	6GHz ~ 18GHz	5.2 dB
	18GHz ~ 40GHz	5.3 dB

2.2 Modification Record

There were no modifications required for compliance.

3 General Information

3.1 Description of EUT

Product	PEPWAVE / peplink Wireless Product
Brand	PEPWAVE / peplink
Test Model	Balance 30 Pro
Series Model	Peplink Balance 30 Pro, BPL-031-LTEA-W-T, Pismo 811AC, B30 Pro
Sample Status	PROTOTYPE SAMPLE
Operating Software	NA
Power Supply Rating	12Vdc from power adapter
Accessory Device	Adapter x 1
Data Cable Supplied	NA

Note:

1. There are WLAN, WWAN(LTE) technology used for the EUT.
2. EUT contains two WiFi chip as same model, this chip model support dual band operation, but it will be locked to single band operation by firmware. One chip is supported 2.4GHz, other is supported 5GHz.
3. EUT could be applied with a plug in USB cellular device.
4. EUT inside has one WWAN(LTE) module which FCC ID: N7NMC7455.
5. Simultaneously transmission condition.

Condition	Technology			
1	WLAN (2.4GHz)	WLAN (5GHz)	WWAN(LTE) module (FCC ID: N7NMC7455)	-
2	WLAN (2.4GHz)	WLAN (5GHz)	WWAN(LTE) module (FCC ID: N7NMC7455)	3G/LTE (USB cellular device)

6. The EUT has below model names, which are identical to each other in all aspects except for the following:

Brand	Model	Difference
PEPWAVE / peplink	Balance 30 Pro	For marketing requirement
	Peplink Balance 30 Pro	
	BPL-031-LTEA-W-T	
	Pismo 811AC	
	B30 Pro	

From the above models, model: **Balance 30 Pro** was selected as representative model for the test and its data are recorded in this report.

7. The EUT must be supplied with a power adapter as following table:

Adapter 1		
Brand	Model No.	Spec.
DVE	DSA-36PFH-12 FUS 120300AN	Input: 100-240Vac, 50/60Hz, 1A Output: 12Vdc, 3A DC output cable (Unshielded, 1.5m)
Adapter 2 (Only for test not for sale)		
Model No.	Spec.	
STD-26021	Input: 100-240Vac, 47-63Hz, 1.6A AC input cable (Unshielded, 1.5m with one core) Output: 56Vdc, 2.15A DC output cable (Unshielded, 1.5m)	

8. The antennas provided to the EUT, please refer to the following table:

For WLAN						
Antenna No.	Brand	Model	Antenna Net Gain (dBi)	Frequency Range (MHz)	Antenna Type	Connector Type
2.4GHz	Master Wave Technology Co., Ltd	98614PRSX000	2.44	2400 ~ 2500	Dipole	R-SMA
5GHz			4.10	5150 ~ 5350	Dipole	R-SMA
			4.73	5725 ~ 5850		
For WWAN(LTE)						
Brand	Model	Antenna Net Gain(dBi)	Frequency Range (MHz)	Antenna Type	Connector Type	
Master Wave Technology Co., Ltd	98642ZSAX001	2.5	1920~1980	Dipole	SMA	
		1.82	880~915			
		1.48	1710~1785			
		3.42	2500~2570			
		2	832~862			
		3.52	2570~2620			
		3.02	2300~2400			
		2.39	1850~1910			
		1.69	699~716			
		2.12	777~787			
		2.39	1850~1915			
		3.52	2496~2690			

9. The EUT incorporates a MIMO function.

2.4GHz Band		
MODULATION MODE	TX & RX CONFIGURATION	
802.11b	2TX	2RX
802.11g	2TX	2RX
802.11n (HT20)	2TX	2RX
802.11n (HT40)	2TX	2RX
5GHz Band		
MODULATION MODE	TX & RX CONFIGURATION	
802.11a	2TX	2RX
802.11n (HT20)	2TX	2RX
802.11n (HT40)	2TX	2RX
802.11ac (VHT20)	2TX	2RX
802.11ac (VHT40)	2TX	2RX
802.11ac (VHT80)	2TX	2RX

10. The above EUT information is declared by manufacturer and for more detailed features description, please refer to the manufacturer's specifications or user's manual.

3.2 Features of EUT

The tests reported herein were performed according to the method specified by PISMO LABS TECHNOLOGY LIMITED, for detailed feature description, please refer to the manufacturer's specifications or user's manual.

3.3 Operating Modes of EUT and Determination of Worst Case Operating Mode

For radiated emission test: EUT has been pre-tested under following test modes, and test mode A was the worst cases for final test.

Mode	Test Condition					
	Radiated emission test					
	Adapter	LAN	WAN 1	WAN 2	LTE / 3G	Arrangement
A	Adapter 1 (DVE)	1000Mbps (without PoE)	1000Mbps	1000Mbps	LTE	Horizontal Placement
B	Adapter 1 (DVE)	1000Mbps (without PoE)	1000Mbps	1000Mbps	LTE	Vertical Placement
C	Adapter 1 (DVE)	1000Mbps (without PoE)	1000Mbps	1000Mbps	3G	Horizontal Placement
D	Adapter 1 (DVE)	100Mbps (without PoE)	100Mbps	100Mbps	LTE	Horizontal Placement
E	Adapter 1 (DVE)	10Mbps (without PoE)	10Mbps	10Mbps	LTE	Horizontal Placement

Note: The test configurations are defined by the applicant requirement.

Test modes are presented in the report as below.

Mode	Test Condition					
	Adapter Brand	LAN	WAN 1	WAN 2	LTE / 3G	Arrangement
1	Adapter 1 (DVE)	1000Mbps (without PoE)	1000Mbps	1000Mbps	LTE	Horizontal Placement
2	Adapter 2 (TECH)	1000Mbps (with PoE)	1000Mbps	1000Mbps	LTE	Horizontal Placement

3.4 Test Program Used and Operation Descriptions

Mode 1

1. Turn on the power of all equipment.
2. Support units A ~ C (Laptop) run "TfGen.exe" program to communicate with EUT via UTP cables.
3. Support units D ~ E (Laptop) run "Ping.exe" program to communicate with EUT via wireless.
4. EUT link support unit G (CMU200) with 3G.
5. EUT link support unit H (MT8820C) with 4G.

Mode2

1. Turn on the power of all equipment.
2. Support units A ~ C, M, N, O (Laptop) run "TfGen.exe" program to communicate with EUT via UTP cables.
3. Support units D ~ E (Laptop) run "Ping.exe" program to communicate with EUT via wireless.
4. EUT link support unit G (CMU200) with 3G.
5. EUT link support unit H (MT8820C) with 4G.

3.5 Primary Clock Frequencies of Internal Source

The EUT is provided by PISMO LABS TECHNOLOGY LIMITED, for detailed internal source, please refer to the manufacturer's specifications.

4 Configuration and Connections with EUT

4.1 Connection Diagram of EUT and Peripheral Devices

Mode 1

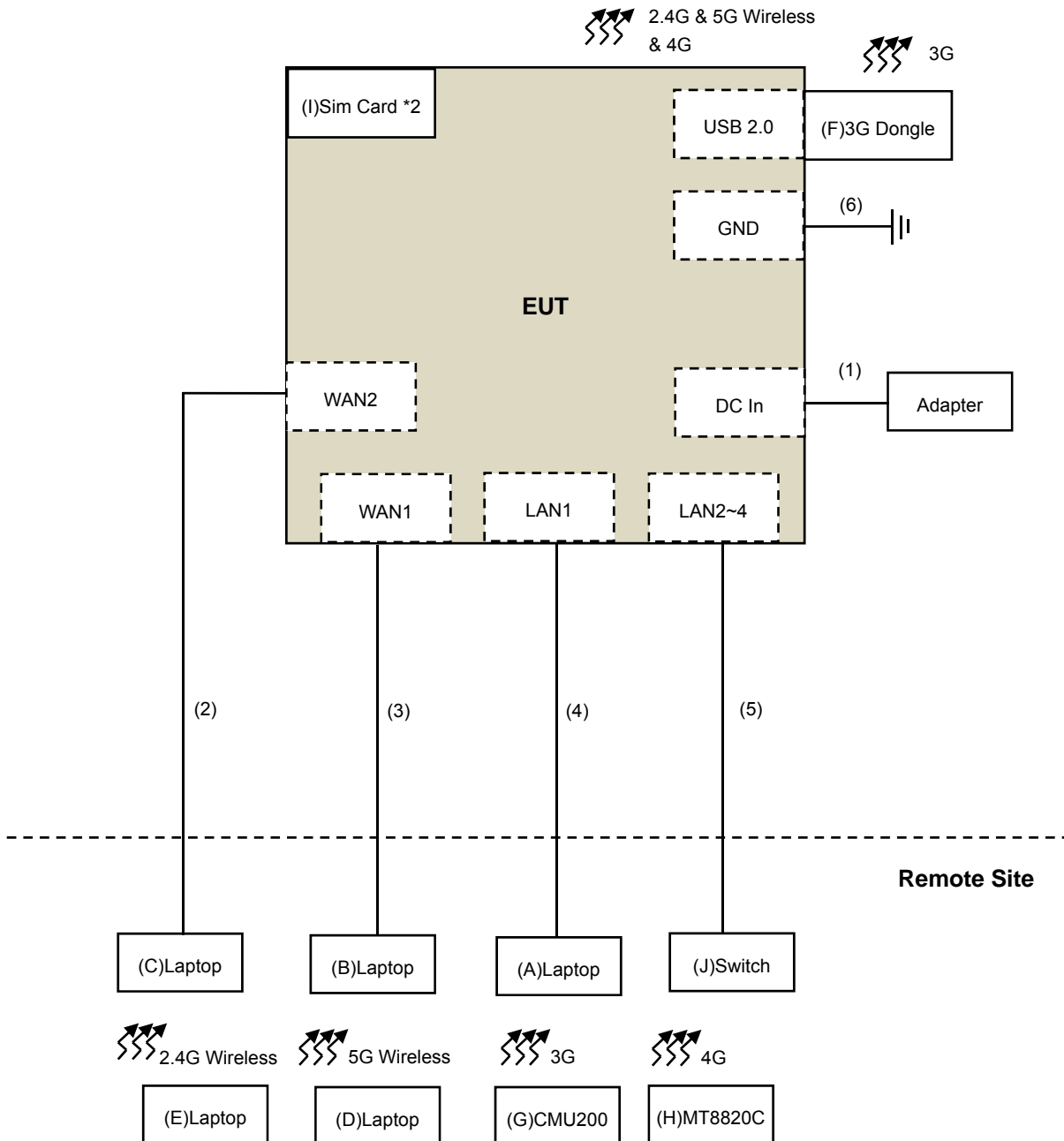

Mode2

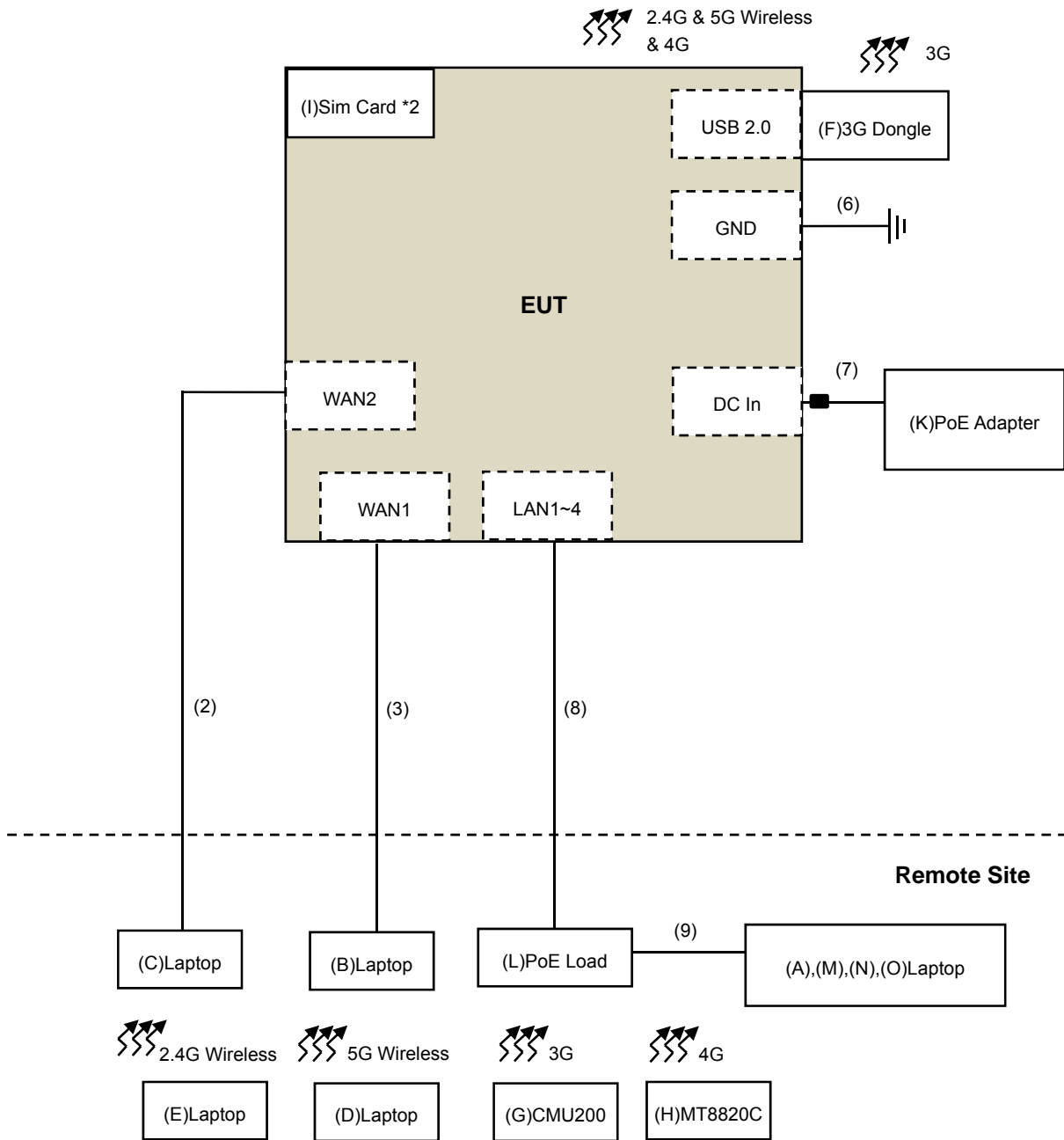

4.2 Configuration of Peripheral Devices and Cable Connections

ID	Product	Brand	Model No.	Serial No.	FCC ID	Remarks
A.	Laptop	DELL	PP32LA	HSLB32S	FCC DoC	Provided by Lab
B.	Laptop	DELL	PP27L	6YLB32S	FCC DoC	Provided by Lab
C.	Laptop	DELL	PP32LA	DSL32S	FCC DoC	Provided by Lab
D.	Laptop	DELL	E5440	BDC7F12	FCC DoC	Provided by Lab
E.	Laptop	DELL	E5420	CHHYLQ1	NA	Provided by Lab
F.	3G Dongle	at&t	NA	NA	NA	Supplied by client
G.	CMU200	R&S	CMU200	121040	NA	Provided by Lab
H.	MT8820C	Anritsu	MT8820C	6201127458	NA	Provided by Lab
I.	Sim Card *2	NA	NA	NA	NA	Provided by Lab
J.	Switch	NA	NA	NA	NA	Provided by Lab
K.	PoE Adaptor	TECH	STD-26021	NA	NA	Supplied by client
L.	PoE Load	NA	NA	NA	NA	Provided by Lab
M.	Laptop	DELL	P70F	JJY07L2	FCC DoC	Provided by Lab
N.	Laptop	DELL	P70F	1KY07L2	FCC DoC	Provided by Lab
O.	Laptop	DELL	E5430	4N1SKV1	FCC DoC	Provided by Lab

Note:

1. All power cords of the above support units are non-shielded (1.8m).

ID	Descriptions	Qty.	Length (m)	Shielding (Yes/No)	Cores (Qty.)	Remarks
1.	DC Power Cable	1	1.5	No	0	Supplied by client
2.	Cat 5e Cable	1	10	No	0	Provided by Lab
3.	Cat 5e Cable	1	10	No	0	Provided by Lab
4.	Cat 5e Cable	1	10	No	0	Provided by Lab
5.	Cat 5e Cable	3	10	No	0	Provided by Lab
6.	GND Cable	1	1.8	No	0	Provided by Lab
7.	DC Power Cable	1	1.5	No	1	Supplied by client
8.	Cat 5e Cable	4	10	No	0	Provided by Lab
9.	Cat 5e Cable	4	3	No	0	Provided by Lab

Note: The cores is originally attached to the cable.

5 Conducted Emissions at Mains Ports

5.1 Limits

Frequency (MHz)	Class A (dBuV)		Class B (dBuV)	
	Quasi-peak	Average	Quasi-peak	Average
0.15 - 0.5	79	66	66 - 56	56 - 46
0.50 - 5.0	73	60	56	46
5.0 - 30.0	73	60	60	50

Notes: 1. The lower limit shall apply at the transition frequencies.
 2. The limit decreases linearly with the logarithm of the frequency in the range of 0.15 to 0.50 MHz.

5.2 Test Instruments

For Mode 1:

DESCRIPTION & MANUFACTURER	MODEL NO.	SERIAL NO.	CALIBRATED DATE	CALIBRATED UNTIL
Test Receiver R&S	ESCS 30	100287	Apr. 19, 2018	Apr. 18, 2019
Line-Impedance Stabilization Network (for EUT) SCHWARZBECK	NSLK-8127	8127-523	Oct. 19, 2018	Oct. 18, 2019
Line-Impedance Stabilization Network (for Peripheral) R&S	ENV216	100071	Nov. 05, 2018	Nov. 04, 2019
RF Cable	5D-FB	COACAB-001	Mar. 14, 2019	Mar. 13, 2020
10 dB PAD EMEC	STI02-2200-10	002	Mar. 14, 2019	Mar. 13, 2020
50 ohms Terminator	N/A	EMC-04	Nov. 14, 2018	Nov. 13, 2019
50 ohms Terminator	N/A	EMC-01	Oct. 04, 2018	Oct. 03, 2019
Software BVADT	BVADT_Cond_ V7.3.7.4	NA	NA	NA

Note:

1. The calibration interval of the above test instruments are 12 months and the calibrations are traceable to NML/ROC and NIST/USA.
2. The test was performed in Conducted Room D
3. The VCCI Con D Registration No. is C-20005.
4. Tested Date: Mar. 28, 2019

For Mode 2:

DESCRIPTION & MANUFACTURER	MODEL NO.	SERIAL NO.	CALIBRATED DATE	CALIBRATED UNTIL
Test Receiver R&S	ESCS 30	100375	May 15, 2019	May 14, 2020
Line-Impedance Stabilization Network (for EUT) SCHWARZBECK	NSLK-8127	8127-522	Sep. 03, 2018	Sep. 02, 2019
Line-Impedance Stabilization Network (for Peripheral) R&S	ENV 216	100072	June 04, 2018	June 03, 2019
RF Cable	5D-FB	COACAB-002	Feb. 22, 2019	Feb. 21, 2020
10 dB PAD EMEC	STI02-2200-10	004	Mar. 14, 2019	Mar. 13, 2020
50 ohms Terminator	N/A	EMC-03	Sep. 25, 2018	Sep. 24, 2019
50 ohms Terminator	N/A	EMC-02	Sep. 12, 2018	Sep. 11, 2019
Software BVADT	BVADT_Cond_ V7.3.7.4	NA	NA	NA

Note:

1. The calibration interval of the above test instruments are 12 months and the calibrations are traceable to NML/ROC and NIST/USA.
2. The test was performed in Conducted Room C
- 3 The VCCI Con C Registration No. is C-13611.
- 4 Tested Date: May 22, 2019

5.3 Test Arrangement

- The EUT was placed 0.4 meters from the conducting wall of the shielded room with EUT being connected to the power mains through a line impedance stabilization network (LISN). Other support units were connected to the power mains through another LISN. The two LISNs provide 50 Ohm/ 50uH of coupling impedance for the measuring instrument.
- Both lines of the power mains connected to the EUT were checked for maximum conducted interference.
- The test results of conducted emissions at mains ports are recorded of six worst margins for quasi-peak (mandatory) [and average (if necessary)] values against the limits at frequencies of interest unless the margin is 20 dB or greater.

Note: The resolution bandwidth and video bandwidth of test receiver is 9kHz for quasi-peak detection (QP) and average detection (AV) at frequency 0.15MHz-30MHz.

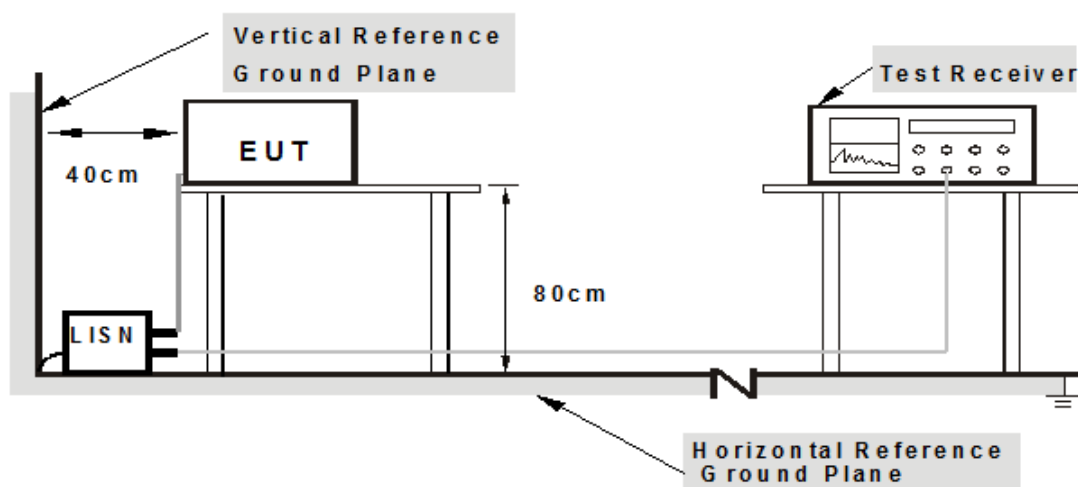

Note: 1. Support units were connected to second LISN.

5.4 Supplementary Information

There is not any deviation from the test standards for the test method.

5.5 Test Results (Mode 1)

Frequency Range	150kHz ~ 30MHz	Detector Function & Resolution Bandwidth	Quasi-Peak (QP) / Average (AV), 9kHz
Input Power	120Vac, 60Hz	Environmental Conditions	23°C, 71%RH
Tested by	Jeff Fan		
Test Mode	Mode 1		

Phase Of Power : Line (L)										
No	Frequency (MHz)	Correction Factor (dB)	Reading Value (dBuV)		Emission Level (dBuV)		Limit (dBuV)		Margin (dB)	
			Q.P.	AV.	Q.P.	AV.	Q.P.	AV.	Q.P.	AV.
1	0.15391	9.76	41.12	22.31	50.88	32.07	79.00	66.00	-28.12	-33.93
2	0.18125	9.75	35.62	17.37	45.37	27.12	79.00	66.00	-33.63	-38.88
3	0.20078	9.74	31.84	15.67	41.58	25.41	79.00	66.00	-37.42	-40.59
4	0.43906	9.74	21.99	12.98	31.73	22.72	79.00	66.00	-47.27	-43.28
5	2.87109	9.81	16.79	9.83	26.60	19.64	73.00	60.00	-46.40	-40.36
6	3.73438	9.82	16.77	10.56	26.59	20.38	73.00	60.00	-46.41	-39.62

Remarks:

1. Q.P. and AV. are abbreviations of quasi-peak and average individually.
2. The emission levels of other frequencies were very low against the limit.
3. Margin value = Emission level – Limit value
4. Correction factor = Insertion loss + Cable loss
5. Emission Level = Correction Factor + Reading Value

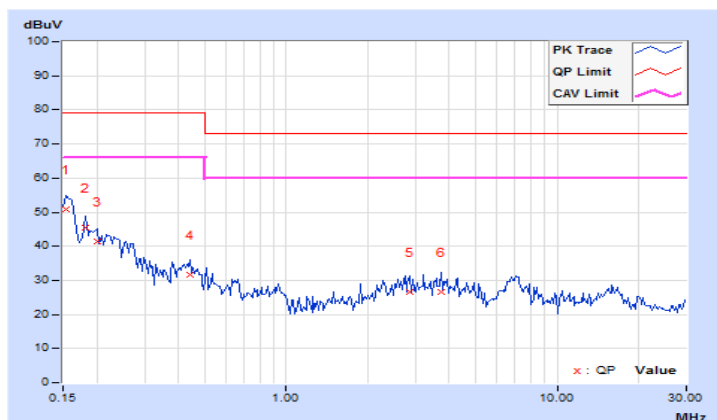

Frequency Range	150kHz ~ 30MHz	Detector Function & Resolution Bandwidth	Quasi-Peak (QP) / Average (AV), 9kHz
Input Power	120Vac, 60Hz	Environmental Conditions	23°C, 71%RH
Tested by	Jeff Fan		
Test Mode	Mode 1		

Phase Of Power : Neutral (N)										
No	Frequency (MHz)	Correction Factor (dB)	Reading Value (dBuV)		Emission Level (dBuV)		Limit (dBuV)		Margin (dB)	
			Q.P.	AV.	Q.P.	AV.	Q.P.	AV.	Q.P.	AV.
1	0.15000	9.75	42.45	25.34	52.20	35.09	79.00	66.00	-26.80	-30.91
2	0.16953	9.74	36.86	18.01	46.60	27.75	79.00	66.00	-32.40	-38.25
3	0.24375	9.73	29.13	13.02	38.86	22.75	79.00	66.00	-40.14	-43.25
4	0.43906	9.74	26.03	17.36	35.77	27.10	79.00	66.00	-43.23	-38.90
5	2.82031	9.81	16.20	8.62	26.01	18.43	73.00	60.00	-46.99	-41.57
6	15.67188	10.09	15.73	6.02	25.82	16.11	73.00	60.00	-47.18	-43.89

Remarks:

1. Q.P. and AV. are abbreviations of quasi-peak and average individually.
2. The emission levels of other frequencies were very low against the limit.
3. Margin value = Emission level – Limit value
4. Correction factor = Insertion loss + Cable loss
5. Emission Level = Correction Factor + Reading Value

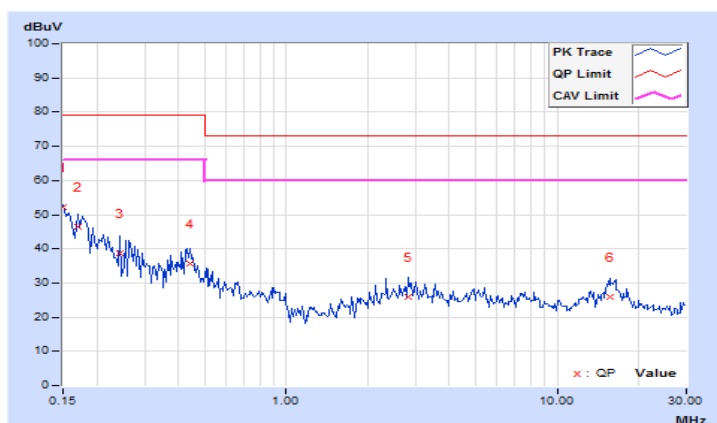

5.6 Test Results (Mode 2)

Frequency Range	150kHz ~ 30MHz	Detector Function & Resolution Bandwidth	Quasi-Peak (QP) / Average (AV), 9kHz
Input Power (System)	120Vac, 60Hz	Environmental Conditions	24°C, 73%RH
Tested by	Yuhan Lin		
Test Mode	Mode 2		

Phase Of Power : Line (L)										
No	Frequency (MHz)	Correction Factor (dB)	Reading Value (dBuV)		Emission Level (dBuV)		Limit (dBuV)		Margin (dB)	
			Q.P.	AV.	Q.P.	AV.	Q.P.	AV.	Q.P.	AV.
1	0.17734	10.02	34.85	28.80	44.87	38.82	79.00	66.00	-34.13	-27.18
2	0.21641	10.02	29.44	22.26	39.46	32.28	79.00	66.00	-39.54	-33.72
3	0.26328	10.03	32.23	26.26	42.26	36.29	79.00	66.00	-36.74	-29.71
4	0.43516	10.04	28.70	26.46	38.74	36.50	79.00	66.00	-40.26	-29.50
5	0.52109	10.05	29.31	26.66	39.36	36.71	73.00	60.00	-33.64	-23.29
6	0.70078	10.07	27.70	22.79	37.77	32.86	73.00	60.00	-35.23	-27.14

Remarks:

1. Q.P. and AV. are abbreviations of quasi-peak and average individually.
2. The emission levels of other frequencies were very low against the limit.
3. Margin value = Emission level – Limit value
4. Correction factor = Insertion loss + Cable loss
5. Emission Level = Correction Factor + Reading Value

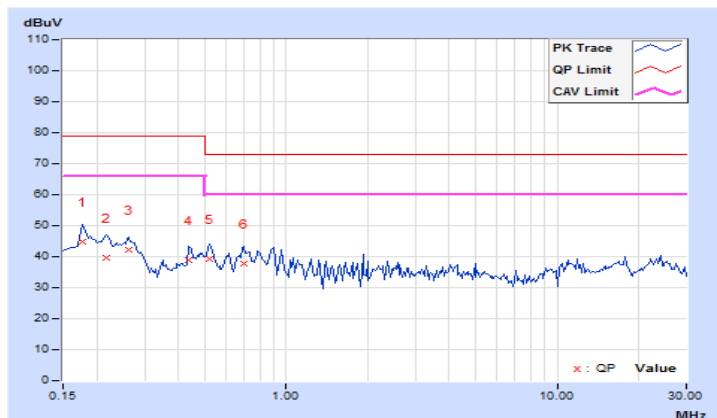

Frequency Range	150kHz ~ 30MHz	Detector Function & Resolution Bandwidth	Quasi-Peak (QP) / Average (AV), 9kHz
Input Power (System)	120Vac, 60Hz	Environmental Conditions	24°C, 73%RH
Tested by	Yuhan Lin		
Test Mode	Mode 2		

Phase Of Power : Neutral (N)										
No	Frequency (MHz)	Correction Factor (dB)	Reading Value (dBuV)		Emission Level (dBuV)		Limit (dBuV)		Margin (dB)	
			Q.P.	AV.	Q.P.	AV.	Q.P.	AV.	Q.P.	AV.
1	0.18125	10.02	31.92	24.40	41.94	34.42	79.00	66.00	-37.06	-31.58
2	0.26328	10.03	33.08	26.04	43.11	36.07	79.00	66.00	-35.89	-29.93
3	0.51328	10.05	28.98	21.89	39.03	31.94	73.00	60.00	-33.97	-28.06
4	0.70078	10.06	28.69	23.67	38.75	33.73	73.00	60.00	-34.25	-26.27
5	0.78672	10.07	27.30	22.79	37.37	32.86	73.00	60.00	-35.63	-27.14
6	0.95859	10.08	29.05	26.77	39.13	36.85	73.00	60.00	-33.87	-23.15

Remarks:

1. Q.P. and AV. are abbreviations of quasi-peak and average individually.
2. The emission levels of other frequencies were very low against the limit.
3. Margin value = Emission level – Limit value
4. Correction factor = Insertion loss + Cable loss
5. Emission Level = Correction Factor + Reading Value

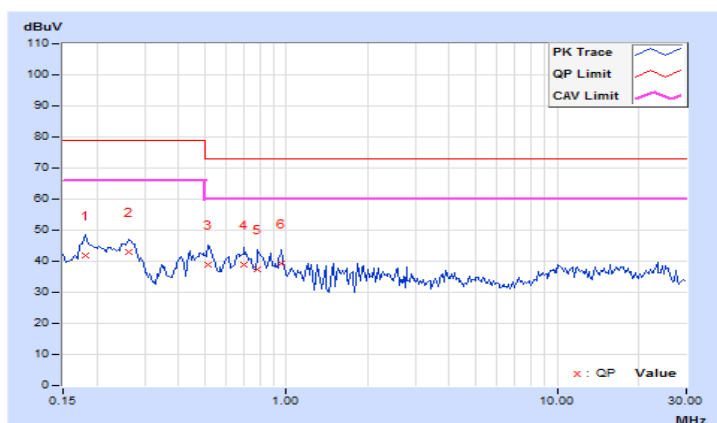

6 Radiated Emissions up to 1 GHz

6.1 Limits

Emissions radiated outside of the specified bands, shall be according to the general radiated limits as following:

Radiated Emissions Limits at 10 meters (dB μ V/m)				
Frequencies (MHz)	FCC 15B / ICES-003, Class A	FCC 15B / ICES-003, Class B	CISPR 22, Class A	CISPR 22, Class B
30-88	39	29.5	40	30
88-216	43.5	33.1		
216-230	46.4	35.6		
230-960			47	37
960-1000	49.5	43.5		

Radiated Emissions Limits at 3 meters (dB μ V/m)				
Frequencies (MHz)	FCC 15B / ICES-003, Class A	FCC 15B / ICES-003, Class B	CISPR 22, Class A	CISPR 22, Class B
30-88	49.5	40	50.5	40.5
88-216	54	43.5		
216-230	56.9	46		
230-960			57.5	47.5
960-1000	60	54		

- Notes:
1. The lower limit shall apply at the transition frequencies.
 2. Emission level (dB μ V/m) = 20 log Emission level (uV/m).
 3. QP detector shall be applied if not specified.

6.2 Test Instruments

For Mode 1:

DESCRIPTION & MANUFACTURER	MODEL NO.	SERIAL NO.	CALIBRATED DATE	CALIBRATED UNTIL
Test Receiver Agilent	N9038A	MY50010125	Apr. 12, 2018	Apr. 11, 2019
	N9038A	MY50010132	June 06, 2018	June 05, 2019
Pre-Amplifier Sonoma	310N	352925	Aug. 27, 2018	Aug. 26, 2019
	310N	352926	Aug. 27, 2018	Aug. 26, 2019
Trilog Broadband Antenna SCHWARZBECK	VULB 9168	9168-359	Nov. 22, 2018	Nov. 21, 2019
	VULB 9168	9168-358	Nov. 21, 2018	Nov. 20, 2019
Fixed attenuator Mini-Circuits	UNAT-5+	CHF-001	Sep. 05, 2018	Sep. 04, 2019
	UNAT-5+	CHF-002	Sep. 05, 2018	Sep. 04, 2019
RF Cable	8D-FB	CHFCAB-001-1 CHFCAB-001-3 CHFCAB-001-4	Sep. 17, 2018	Sep. 16, 2019
		CHFCAB-002-1 CHFCAB-002-3 CHFCAB-002-4	Sep. 17, 2018	Sep. 16, 2019
Software BVADT	ADT_Radiated_V 8.7.08	NA	NA	NA
Antenna Tower & Turn Table CT	NA	NA	NA	NA

Note:

1. The calibration interval of the above test instruments are 12 months and the calibrations are traceable to NML/ROC and NIST/USA.
2. The test was performed in Chamber F room
3. The VCCI Site Registration No. is R-13252.
4. Tested Date: Mar. 29, 2019

For Mode 2:

DESCRIPTION & MANUFACTURER	MODEL NO.	SERIAL NO.	CALIBRATED DATE	CALIBRATED UNTIL
Test Receiver Agilent	N9038A	MY50010125	Apr. 11, 2019	Apr. 10, 2020
Test Receiver R&S	ESR3	102528	Feb. 22, 2019	Feb. 21, 2020
Pre-Amplifier Sonoma	310N	352925	Aug. 27, 2018	Aug. 26, 2019
	310N	352926	Aug. 27, 2018	Aug. 26, 2019
Trilog Broadband Antenna SCHWARZBECK	VULB 9168	9168-359	Nov. 22, 2018	Nov. 21, 2019
	VULB 9168	9168-358	Nov. 21, 2018	Nov. 20, 2019
Fixed attenuator Mini-Circuits	UNAT-5+	CHF-001	Sep. 05, 2018	Sep. 04, 2019
	UNAT-5+	CHF-002	Sep. 05, 2018	Sep. 04, 2019
RF Cable	8D-FB	CHFCAB-001-1 CHFCAB-001-3 CHFCAB-001-4	Sep. 17, 2018	Sep. 16, 2019
		CHFCAB-002-1 CHFCAB-002-3 CHFCAB-002-4	Sep. 17, 2018	Sep. 16, 2019
Software BVADT	ADT_Radiated_V 8.7.08	NA	NA	NA
Antenna Tower & Turn Table CT	NA	NA	NA	NA

Note:

1. The calibration interval of the above test instruments are 12 months and the calibrations are traceable to NML/ROC and NIST/USA.
2. The test was performed in Chamber F room
3. The VCCI Site Registration No. is R-13252.
4. Tested Date: June 10, 2019

6.3 Test Arrangement

- The EUT was placed on the top of a rotating table 0.8 meters above the ground at an accredited test facility. The table was rotated 360 degrees to determine the position of the highest radiation.
- The EUT was set 10 meters away from the interference-receiving antenna, which was mounted on the top of a variable-height antenna tower.
- The antenna is a broadband antenna, and its height is varied from one meter to four meters above the ground to determine the maximum value of the field strength. Both horizontal and vertical polarizations of the antenna are set to make the measurement.
- For each suspected emission, the EUT was arranged to its worst case and then the antenna was tuned to heights from 1 meter to 4 meters and the rotatable table was turned from 0 degrees to 360 degrees to find the maximum reading.
- The test-receiver system was set to quasi-peak detect function and specified bandwidth with maximum hold mode when the test frequency is up to 1 GHz.

Note: The resolution bandwidth and video bandwidth of test receiver/spectrum analyzer is 120kHz for quasi-peak detection (QP) at frequency up to 1GHz.

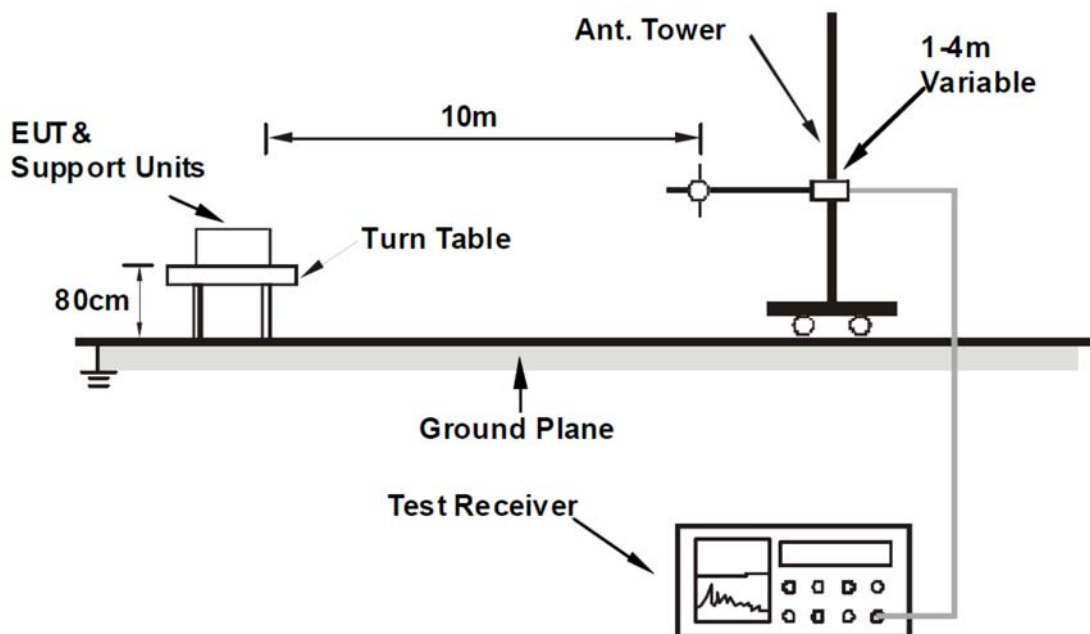

For the actual test configuration, please refer to the related Item – Photographs of the Test Configuration.

6.4 Supplementary Information

There is not any deviation from the test standards for the test method.

6.5 Test Results (Mode 1)

Frequency Range	30MHz ~ 1GHz	Detector Function & Resolution Bandwidth	Quasi-Peak (QP), 120kHz
Input Power	120Vac, 60Hz	Environmental Conditions	26°C, 76%RH
Tested by	Eagle Chen		
Test Mode	Mode 1		

Antenna Polarity & Test Distance : Horizontal at 10 m								
No	Frequency (MHz)	Emission Level (dBuV/m)	Limit (dBuV/m)	Margin (dB)	Antenna Height (m)	Table Angle (Degree)	Raw Value (dBuV)	Correction Factor (dB/m)
1	157.51	31.20 QP	40.00	-8.80	4.00 H	108	43.58	-12.38
2	199.99	30.91 QP	40.00	-9.09	4.00 H	25	45.72	-14.81
3	239.96	37.80 QP	47.00	-9.20	3.00 H	80	51.12	-13.32
4	375.03	39.27 QP	47.00	-7.73	2.00 H	242	48.32	-9.05
5	520.00	38.93 QP	47.00	-8.07	2.00 H	185	44.38	-5.45
6	599.97	38.83 QP	47.00	-8.17	2.00 H	185	42.41	-3.58
7	899.99	42.93 QP	47.00	-4.07	1.00 H	264	40.80	2.13
8	1000.00	45.44 QP	47.00	-1.56	1.33 H	203	41.33	4.11

Remarks:

1. Emission Level(dBuV/m) = Raw Value(dBuV) + Correction Factor(dB/m)
2. Correction Factor(dB/m) = Antenna Factor (dB/m) + Cable Factor (dB) – Pre-Amplifier Factor (dB)
3. The other emission levels were very low against the limit.
4. Margin value = Emission level – Limit value

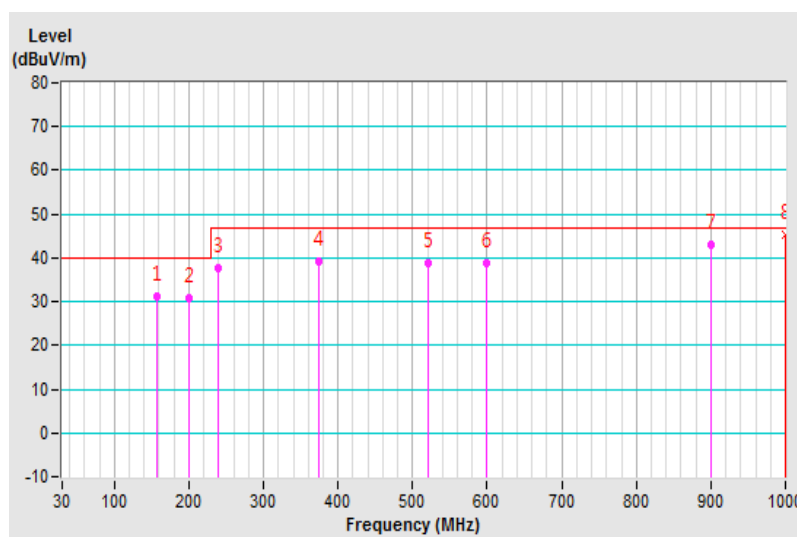

Frequency Range	30MHz ~ 1GHz	Detector Function & Resolution Bandwidth	Quasi-Peak (QP), 120kHz
Input Power	120Vac, 60Hz	Environmental Conditions	26°C, 76%RH
Tested by	Eagle Chen		
Test Mode	Mode 1		

Antenna Polarity & Test Distance : Vertical at 10 m								
No	Frequency (MHz)	Emission Level (dBuV/m)	Limit (dBuV/m)	Margin (dB)	Antenna Height (m)	Table Angle (Degree)	Raw Value (dBuV)	Correction Factor (dB/m)
1	64.24	28.40 QP	40.00	-11.60	1.00 V	306	42.28	-13.88
2	152.51	33.99 QP	40.00	-6.01	1.58 V	344	46.07	-12.08
3	300.00	35.56 QP	47.00	-11.44	1.00 V	95	46.29	-10.73
4	375.03	36.13 QP	47.00	-10.87	4.00 V	209	44.71	-8.58
5	520.00	37.79 QP	47.00	-9.21	1.00 V	145	42.65	-4.86
6	625.00	38.16 QP	47.00	-8.84	3.00 V	333	40.60	-2.44
7	899.99	36.11 QP	47.00	-10.89	4.00 V	296	33.94	2.17
8	1000.00	40.89 QP	47.00	-6.11	2.00 V	352	36.44	4.45

Remarks:

1. Emission Level(dBuV/m) = Raw Value(dBuV) + Correction Factor(dB/m)
2. Correction Factor(dB/m) = Antenna Factor (dB/m) + Cable Factor (dB) – Pre-Amplifier Factor (dB)
3. The other emission levels were very low against the limit.
4. Margin value = Emission level – Limit value

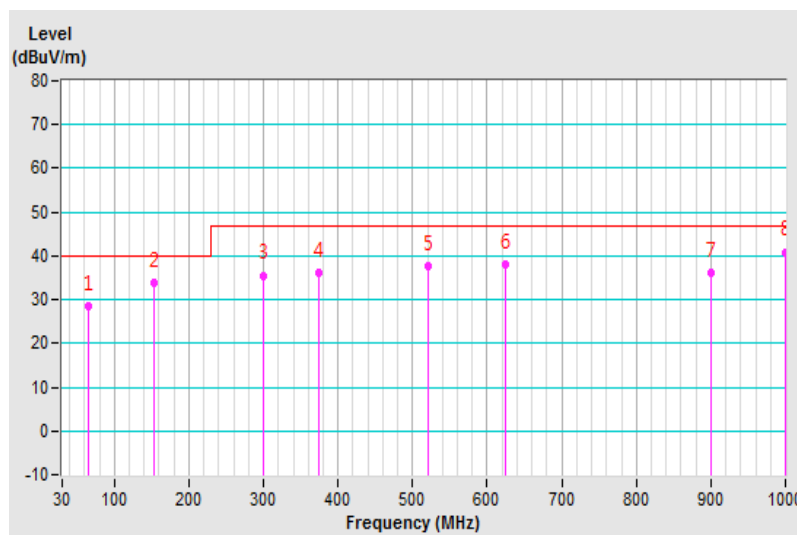

6.6 Test Results (Mode 2)

Frequency Range	30MHz ~ 1GHz	Detector Function & Resolution Bandwidth	Quasi-Peak (QP), 120kHz
Input Power (System)	120Vac, 60Hz	Environmental Conditions	25°C, 66%RH
Tested by	Bear Lee		
Test Mode	Mode 2		

Antenna Polarity & Test Distance : Horizontal at 10 m								
No	Frequency (MHz)	Emission Level (dBuV/m)	Limit (dBuV/m)	Margin (dB)	Antenna Height (m)	Table Angle (Degree)	Raw Value (dBuV)	Correction Factor (dB/m)
1	117.49	28.75 QP	40.00	-11.25	3.00 H	93	43.51	-14.76
2	172.54	29.59 QP	40.00	-10.41	4.00 H	34	42.63	-13.04
3	240.00	32.99 QP	47.00	-14.01	4.00 H	314	46.31	-13.32
4	375.03	33.74 QP	47.00	-13.26	3.00 H	109	42.79	-9.05
5	500.01	33.68 QP	47.00	-13.32	2.00 H	165	39.58	-5.90
6	899.99	37.58 QP	47.00	-9.42	1.00 H	231	35.45	2.13
7	999.99	42.50 QP	47.00	-4.50	1.00 H	246	38.39	4.11

Remarks:

1. Emission Level(dBuV/m) = Raw Value(dBuV) + Correction Factor(dB/m)
2. Correction Factor(dB/m) = Antenna Factor (dB/m) + Cable Factor (dB) – Pre-Amplifier Factor (dB)
3. The other emission levels were very low against the limit.
4. Margin value = Emission level – Limit value

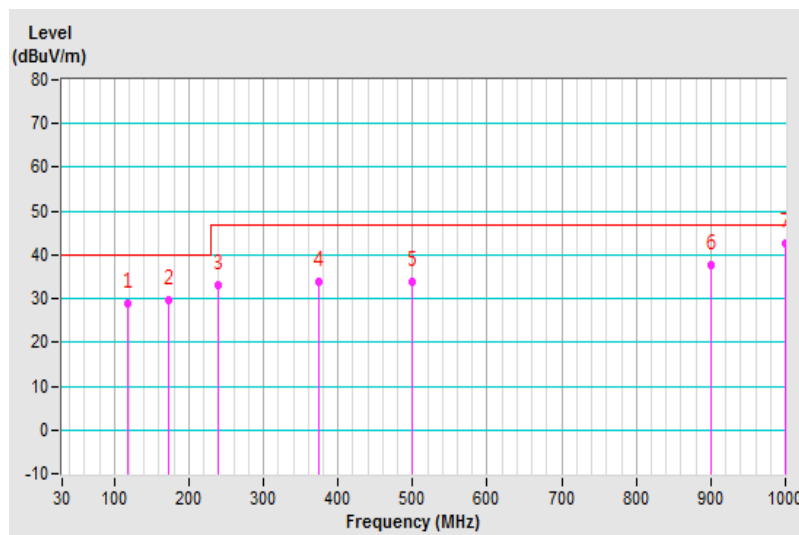

Frequency Range	30MHz ~ 1GHz	Detector Function & Resolution Bandwidth	Quasi-Peak (QP), 120kHz
Input Power (System)	120Vac, 60Hz	Environmental Conditions	25°C, 66%RH
Tested by	Bear Lee		
Test Mode	Mode 2		

Antenna Polarity & Test Distance : Vertical at 10 m								
No	Frequency (MHz)	Emission Level (dBuV/m)	Limit (dBuV/m)	Margin (dB)	Antenna Height (m)	Table Angle (Degree)	Raw Value (dBuV)	Correction Factor (dB/m)
1	32.57	33.11 QP	40.00	-6.89	1.00 V	159	47.46	-14.35
2	117.51	39.13 QP	40.00	-0.87	1.42 V	1	53.54	-14.41
3	172.49	33.86 QP	40.00	-6.14	2.00 V	8	46.63	-12.77
4	240.00	34.42 QP	47.00	-12.58	1.00 V	67	47.32	-12.90
5	300.00	35.72 QP	47.00	-11.28	1.00 V	70	46.45	-10.73
6	500.01	31.26 QP	47.00	-15.74	4.00 V	334	36.53	-5.27
7	999.99	40.72 QP	47.00	-6.28	2.00 V	332	36.27	4.45

Remarks:

1. Emission Level(dBuV/m) = Raw Value(dBuV) + Correction Factor(dB/m)
2. Correction Factor(dB/m) = Antenna Factor (dB/m) + Cable Factor (dB) – Pre-Amplifier Factor (dB)
3. The other emission levels were very low against the limit.
4. Margin value = Emission level – Limit value

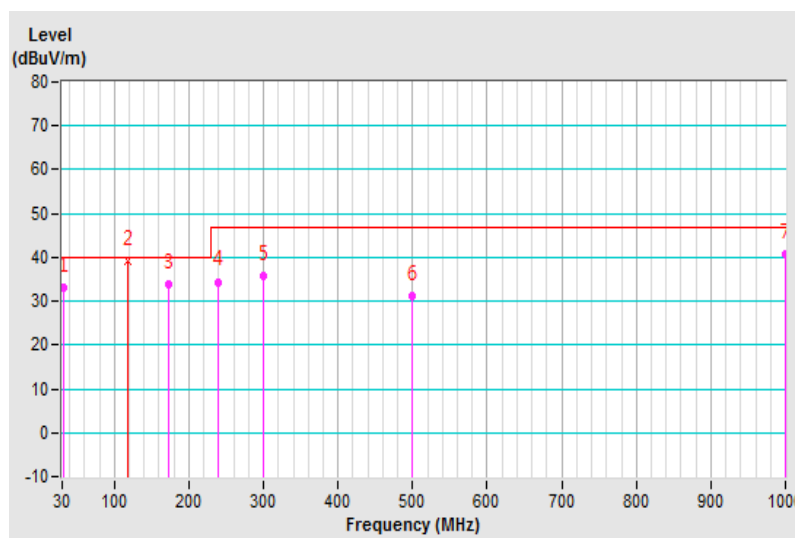

7 Radiated Emissions above 1 GHz

7.1 Limits

Emissions radiated outside of the specified bands, shall be according to the general radiated limits as following:

Radiated Emissions Limits at 10 meters (dB μ V/m)				
Frequencies (MHz)	FCC 15B / ICES-003, Class A	FCC 15B / ICES-003, Class B	CISPR 22, Class A	CISPR 22, Class B
1000-3000	Avg: 49.5	Avg: 43.5	Not defined	Not defined
Above 3000	Peak: 69.5	Peak: 63.5	Not defined	Not defined

Radiated Emissions Limits at 3 meters (dB μ V/m)				
Frequencies (MHz)	FCC 15B / ICES-003, Class A	FCC 15B / ICES-003, Class B	CISPR 22, Class A	CISPR 22, Class B
1000-3000	Avg: 60	Avg: 54	Avg: 56	Avg: 50
	Peak: 80	Peak: 74	Peak: 76	Peak: 70
Above 3000			Avg: 60	Avg: 54
			Peak: 80	Peak: 74

- Notes:
1. The lower limit shall apply at the transition frequencies.
 2. Emission level (dB μ V/m) = 20 log Emission level (uV/m).
 3. As shown in 15.35(b), for frequencies above 1000MHz, the field strength limits are based on average detector, however, the peak field strength of any emission shall not exceed the maximum permitted average limits, specified above by more than 20dB under any condition of modulation.

Frequency Range (For unintentional radiators)

Highest frequency generated or used in the device or on which the device operates or tunes (MHz)	Upper frequency of measurement range (MHz)
Below 1.705	30
1.705-108	1000
108-500	2000
500-1000	5000
Above 1000	5th harmonic of the highest frequency or 40GHz, whichever is lower

7.2 Test Instruments

For Mode 1:

DESCRIPTION & MANUFACTURER	MODEL NO.	SERIAL NO.	CALIBRATED DATE	CALIBRATED UNTIL
Test Receiver Agilent	N9038A	MY50010125	Apr. 16, 2018	Apr. 15, 2019
Pre-Amplifier Agilent	8449B	3008A01975	Feb. 21, 2019	Feb. 20, 2020
Horn Antenna SCHWARZBECK	BBHA 9120D	D123	Nov. 25, 2018	Nov. 24, 2019
RF Coaxial Cable	EMC104-SM- SM-11000	170209	Mar. 05, 2019	Mar. 04, 2020
RF Coaxial Cable	EMC104-SM- SM-6000	170207	Mar. 05, 2019	Mar. 04, 2020
RF Coaxial Cable	EMC104-SM- SM-2500	170206	Mar. 05, 2019	Mar. 04, 2020
Spectrum Analyzer Agilent	E4446A	MY48250253	Aug. 01, 2018	July 31, 2019
Pre-Amplifier SPACEK LABS	SLKka-48-6	9K16	Dec. 04, 2018	Dec. 03, 2019
Horn Antenna SCHWARZBECK	BBHA 9170	9170-424	Nov. 25, 2018	Nov. 24, 2019
RF Cable	SUCOFLEX 102	36432/2 36443/2	Jan. 10, 2019	Jan. 09, 2020
Software BVADT	ADT_Radiated_ V8.7.08	NA	NA	NA
Antenna Tower & Turn Table CT	NA	NA	NA	NA
Fix tool for Boresight antenna tower	BAF-01	5	NA	NA

Note:

1. The calibration interval of the above test instruments are 12 months and the calibrations are traceable to NML/ROC and NIST/USA.
2. The test was performed in Chamber F room
3. Tested Date: Mar. 29, 2019

For Mode 2:

DESCRIPTION & MANUFACTURER	MODEL NO.	SERIAL NO.	CALIBRATED DATE	CALIBRATED UNTIL
Test Receiver Agilent	N9038A	MY50010125	Apr. 11, 2019	Apr. 10, 2020
Pre-Amplifier Agilent	8449B	3008A01975	Feb. 21, 2019	Feb. 20, 2020
Horn Antenna SCHWARZBECK	BBHA 9120D	D123	Nov. 25, 2018	Nov. 24, 2019
RF Coaxial Cable	EMC104-SM- SM-11000	170209	Mar. 05, 2019	Mar. 04, 2020
RF Coaxial Cable	EMC104-SM- SM-6000	170207	Mar. 05, 2019	Mar. 04, 2020
RF Coaxial Cable	EMC104-SM- SM-2500	170206	Mar. 05, 2019	Mar. 04, 2020
Spectrum Analyzer Agilent	E4446A	MY48250253	Aug. 01, 2018	July 31, 2019
Pre-Amplifier SPACEK LABS	SLKKa-48-6	9K16	Dec. 04, 2018	Dec. 03, 2019
Horn Antenna SCHWARZBECK	BBHA 9170	9170-424	Nov. 25, 2018	Nov. 24, 2019
RF Cable	SUCOFLEX 102	36432/2 36443/2	Jan. 10, 2019	Jan. 09, 2020
Software BVADT	ADT_Radiated_ V8.7.08	NA	NA	NA
Antenna Tower & Turn Table CT	NA	NA	NA	NA
Fix tool for Boresight antenna tower	BAF-01	5	NA	NA

Note:

1. The calibration interval of the above test instruments are 12 months and the calibrations are traceable to NML/ROC and NIST/USA.
2. The test was performed in Chamber F room
3. Tested Date: June 10, 2019

7.3 Test Arrangement

- The EUT was placed on the top of a rotating table 0.8 meters above the ground at an accredited chamber room. The table was rotated 360 degrees to determine the position of the highest radiation.
- The EUT was set 3 meters away from the interference-receiving antenna, which was mounted on the top of a variable-height antenna tower.
- The height of antenna can be varied from one meter to four meters, the height of adjustment depends on the EUT height and the antenna 3dB beamwidth both, to detect the maximum value of the field strength. Both horizontal and vertical polarizations of the antenna are set to make the measurement.
- For each suspected emission, the EUT was arranged to its worst case and then the antenna was tuned to heights and the rotatable table was turned from 0 degrees to 360 degrees to find the maximum reading.
- The spectrum analyzer system was set to peak and average detects function and specified bandwidth with maximum hold mode when the test frequency is above 1 GHz.

Note: The resolution bandwidth of test receiver/spectrum analyzer is 1MHz and video bandwidth is 3MHz for Peak detection (PK) at frequency above 1GHz. The resolution bandwidth of test receiver/spectrum analyzer is 1 MHz for Average detection (AV) at frequency above 1GHz.

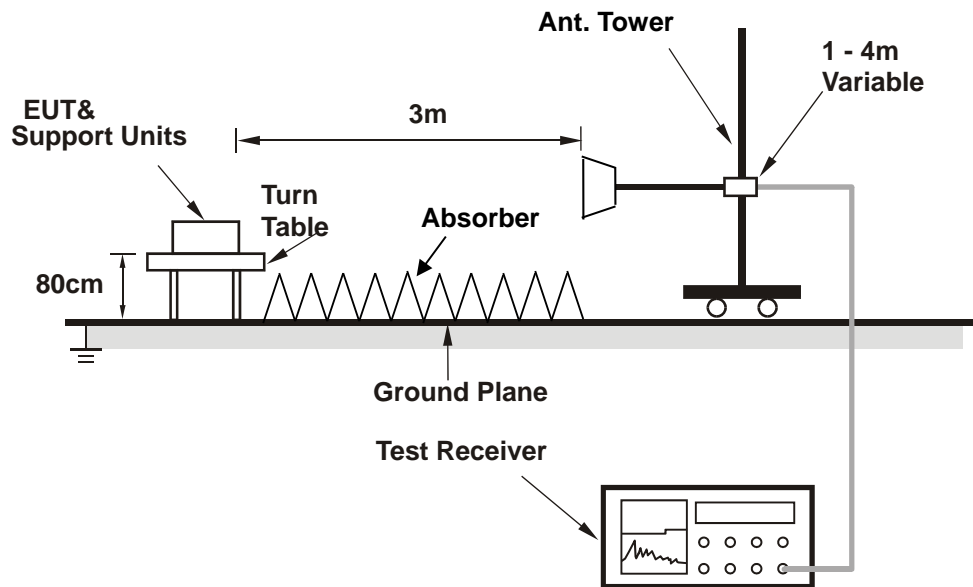

The test arrangement is in accordance with ANSI 63.4:2014. For the actual test configuration, please refer to the related item – Photographs of the Test Configuration.

7.4 Supplementary Information

There is not any deviation from the test standards for the test method.

7.5 Test Results (Mode 1)

Frequency Range	1GHz ~ 29.5GHz	Detector Function & Resolution Bandwidth	Peak (PK) / Average (AV), 1MHz
Input Power	120Vac, 60Hz	Environmental Conditions	25°C, 67%RH
Tested by	Eagle Chen		
Test Mode	Mode 1		

Antenna Polarity & Test Distance : Horizontal at 3 m								
No	Frequency (MHz)	Emission Level (dBuV/m)	Limit (dBuV/m)	Margin (dB)	Antenna Height (m)	Table Angle (Degree)	Raw Value (dBuV)	Correction Factor (dB/m)
1	1000.42	51.36 PK	80.00	-28.64	1.00 H	134	57.85	-6.49
2	1000.42	38.41 AV	60.00	-21.59	1.00 H	164	44.90	-6.49
3	1200.05	47.08 PK	80.00	-32.92	1.00 H	276	51.45	-4.37
4	1200.05	46.05 AV	60.00	-13.95	1.00 H	278	50.42	-4.37
5	2433.53	45.89 PK	80.00	-34.11	1.00 H	198	45.15	0.74
6	2433.53	28.71 AV	60.00	-31.29	1.00 H	360	27.97	0.74
7	4177.73	42.19 PK	80.00	-37.81	1.00 H	266	36.32	5.87
8	4177.73	28.89 AV	60.00	-31.11	1.00 H	360	23.02	5.87
9	5265.30	44.52 PK	80.00	-35.48	1.00 H	60	35.78	8.74
10	5265.30	30.84 AV	60.00	-29.16	1.00 H	322	22.10	8.74
11	6946.65	59.87 PK	80.00	-20.13	1.00 H	8	46.22	13.65
12	6946.65	46.59 AV	60.00	-13.41	1.00 H	204	32.94	13.65

Remarks:

1. Emission Level(dBuV/m) = Raw Value(dBuV) + Correction Factor(dB/m)
2. Correction Factor(dB/m) = Antenna Factor (dB/m) + Cable Factor (dB) – Pre-Amplifier Factor (dB)
3. The other emission levels were very low against the limit.
4. Margin value = Emission level – Limit value

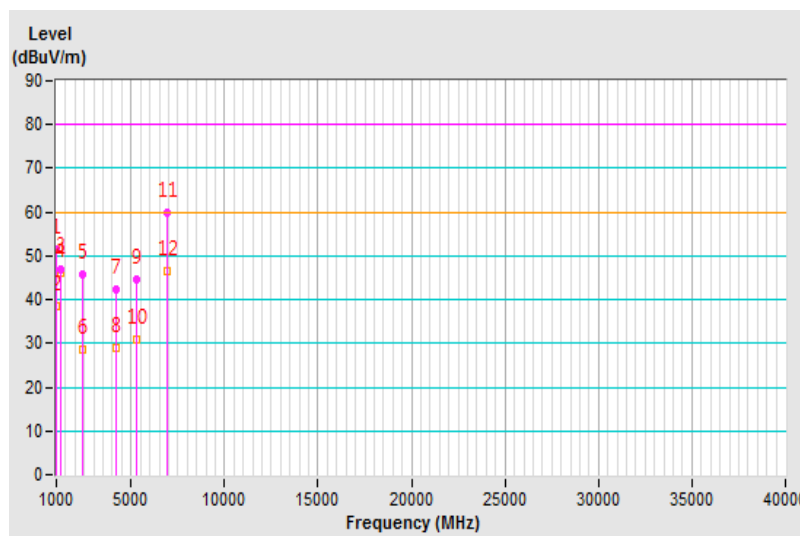

Frequency Range	1GHz ~ 29.5GHz	Detector Function & Resolution Bandwidth	Peak (PK) / Average (AV), 1MHz
Input Power	120Vac, 60Hz	Environmental Conditions	25°C, 67%RH
Tested by	Eagle Chen		
Test Mode	Mode 1		

Antenna Polarity & Test Distance : Vertical at 3 m								
No	Frequency (MHz)	Emission Level (dBuV/m)	Limit (dBuV/m)	Margin (dB)	Antenna Height (m)	Table Angle (Degree)	Raw Value (dBuV)	Correction Factor (dB/m)
1	1000.11	44.93 PK	80.00	-35.07	1.00 V	24	51.42	-6.49
2	1000.11	35.00 AV	60.00	-25.00	1.00 V	226	41.49	-6.49
3	1200.02	47.74 PK	80.00	-32.26	1.00 V	104	52.11	-4.37
4	1200.02	45.67 AV	60.00	-14.33	1.00 V	104	50.04	-4.37
5	2432.68	46.63 PK	80.00	-33.37	1.00 V	265	45.88	0.75
6	2432.68	29.70 AV	60.00	-30.30	1.00 V	1	28.95	0.75
7	3249.33	45.74 PK	80.00	-34.26	1.00 V	359	42.61	3.13
8	3249.33	43.89 AV	60.00	-16.11	1.00 V	108	40.76	3.13
9	5173.07	54.21 PK	80.00	-25.79	1.00 V	149	44.98	9.23
10	5173.07	30.76 AV	60.00	-29.24	1.00 V	44	21.53	9.23
11	6946.70	62.30 PK	80.00	-17.70	1.00 V	48	48.65	13.65
12	6946.70	48.04 AV	60.00	-11.96	1.00 V	240	34.39	13.65

Remarks:

1. Emission Level(dBuV/m) = Raw Value(dBuV) + Correction Factor(dB/m)
2. Correction Factor(dB/m) = Antenna Factor (dB/m) + Cable Factor (dB) – Pre-Amplifier Factor (dB)
3. The other emission levels were very low against the limit.
4. Margin value = Emission level – Limit value

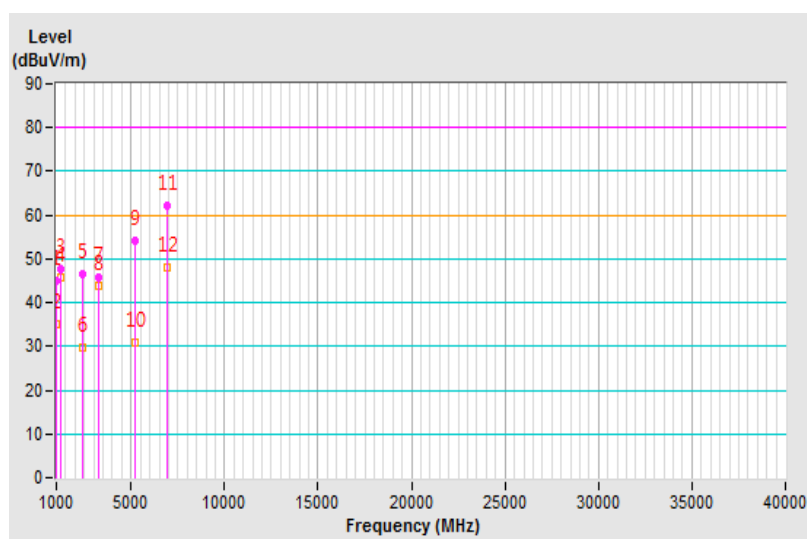

7.6 Test Results (Mode 2)

Frequency Range	1GHz ~ 29.5GHz	Detector Function & Resolution Bandwidth	Peak (PK) / Average (AV), 1MHz
Input Power (System)	120Vac, 60Hz	Environmental Conditions	23°C, 64%RH
Tested by	Leon Wu		
Test Mode	Mode 2		

Antenna Polarity & Test Distance : Horizontal at 3 m								
No	Frequency (MHz)	Emission Level (dBuV/m)	Limit (dBuV/m)	Margin (dB)	Antenna Height (m)	Table Angle (Degree)	Raw Value (dBuV)	Correction Factor (dB/m)
1	1666.40	43.27 PK	80.00	-36.73	1.00 H	131	47.02	-3.75
2	1666.40	38.99 AV	60.00	-21.01	1.00 H	235	42.74	-3.75
3	2468.80	47.18 PK	80.00	-32.82	1.00 H	87	46.65	0.53
4	2468.80	33.12 AV	60.00	-26.88	1.00 H	156	32.59	0.53
5	3215.95	46.82 PK	80.00	-33.18	1.00 H	197	43.81	3.01
6	3215.95	41.49 AV	60.00	-18.51	1.00 H	348	38.48	3.01
7	4166.25	49.38 PK	80.00	-30.62	1.00 H	198	42.21	7.17
8	4166.25	36.49 AV	60.00	-23.51	1.00 H	147	29.32	7.17
9	5174.35	56.82 PK	80.00	-23.18	1.00 H	154	47.05	9.77
10	5174.35	38.00 AV	60.00	-22.00	1.00 H	267	28.23	9.77
11	7038.40	57.95 PK	80.00	-22.05	1.00 H	54	41.25	16.70
12	7038.40	45.68 AV	60.00	-14.32	1.00 H	80	28.98	16.70

Remarks:

1. Emission Level(dBuV/m) = Raw Value(dBuV) + Correction Factor(dB/m)
2. Correction Factor(dB/m) = Antenna Factor (dB/m) + Cable Factor (dB) – Pre-Amplifier Factor (dB)
3. The other emission levels were very low against the limit.
4. Margin value = Emission level – Limit value

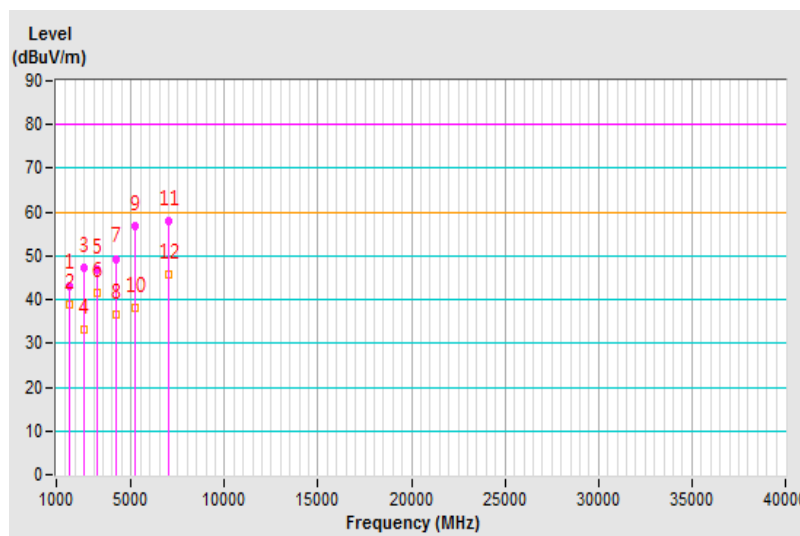

Frequency Range	1GHz ~ 29.5GHz	Detector Function & Resolution Bandwidth	Peak (PK) / Average (AV), 1MHz
Input Power (System)	120Vac, 60Hz	Environmental Conditions	23°C, 64%RH
Tested by	Leon Wu		
Test Mode	Mode 2		

Antenna Polarity & Test Distance : Vertical at 3 m								
No	Frequency (MHz)	Emission Level (dBuV/m)	Limit (dBuV/m)	Margin (dB)	Antenna Height (m)	Table Angle (Degree)	Raw Value (dBuV)	Correction Factor (dB/m)
1	1667.25	52.19 PK	80.00	-27.81	1.00 V	166	55.93	-3.74
2	1667.25	34.12 AV	60.00	-25.88	1.00 V	0	37.86	-3.74
3	2416.10	46.02 PK	80.00	-33.98	1.00 V	335	45.50	0.52
4	2416.10	32.25 AV	60.00	-27.75	1.00 V	360	31.73	0.52
5	3215.95	49.48 PK	80.00	-30.52	1.00 V	121	46.47	3.01
6	3215.95	47.72 AV	60.00	-12.28	1.00 V	0	44.71	3.01
7	4979.70	51.17 PK	80.00	-28.83	1.00 V	295	41.45	9.72
8	4979.70	39.41 AV	60.00	-20.59	1.00 V	127	29.69	9.72
9	5612.95	54.52 PK	80.00	-25.48	1.00 V	360	42.42	12.10
10	5612.95	41.20 AV	60.00	-18.80	1.00 V	265	29.10	12.10
11	6902.40	58.97 PK	80.00	-21.03	1.00 V	36	42.33	16.64
12	6902.40	45.45 AV	60.00	-14.55	1.00 V	156	28.81	16.64

Remarks:

1. Emission Level(dBuV/m) = Raw Value(dBuV) + Correction Factor(dB/m)
2. Correction Factor(dB/m) = Antenna Factor (dB/m) + Cable Factor (dB) – Pre-Amplifier Factor (dB)
3. The other emission levels were very low against the limit.
4. Margin value = Emission level – Limit value

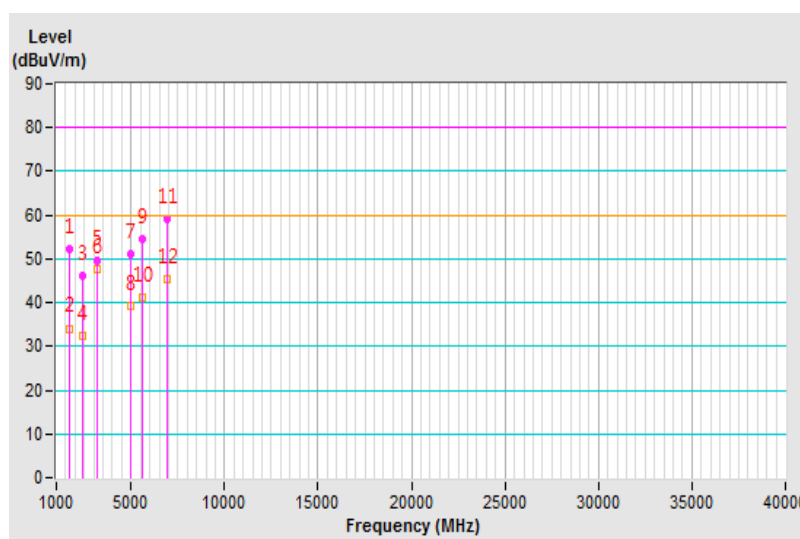

8 Pictures of Test Arrangements

Please refer to the attached file (Test Setup Photo).

Appendix – Information of the Testing Laboratories

We, Bureau Veritas Consumer Products Services (H.K.) Ltd., Taoyuan Branch, were founded in 1988 to provide our best service in EMC, Radio, Telecom and Safety consultation. Our laboratories are FCC recognized accredited test firms and accredited according to ISO/IEC 17025.

If you have any comments, please feel free to contact us at the following:

Lin Kou EMC/RF Lab

Tel: 886-2-26052180

Fax: 886-2-26051924

Hsin Chu EMC/RF/Telecom Lab

Tel: 886-3-6668565

Fax: 886-3-6668323

Hwa Ya EMC/RF/Safety Lab

Tel: 886-3-3183232

Fax: 886-3-3270892

Email: service.adt@tw.bureauveritas.com

Web Site: www.bureauveritas-adt.com

The address and road map of all our labs can be found in our web site also.

--- END ---