

## FCC Test Report

**Report No.:** RF160923E02A-1

**FCC ID:** U8G-P1811AC

**Test Model:** MAX HD2 LTE

**Series Model:** MAX HD2 LTEA

**Received Date:** Sep. 23, 2016

**Test Date:** Nov. 01 to 04, 2016

**Issued Date:** Nov. 14, 2016

**Applicant:** Pismo Labs Technology Limited

**Address:** FLAT/RM A5, 5/F, HK SPINNERS IND BLDG PHASE 6, 481 CASTLE PEAK ROAD, CHEUNG SHA WAN, HONG KONG.

**Issued By:** Bureau Veritas Consumer Products Services (H.K.) Ltd., Taoyuan Branch  
Hsin Chu Laboratory

**Lab Address:** E-2, No.1, Li Hsin 1st Road, Hsinchu Science Park, Hsinchu City 300,  
Taiwan R.O.C.

**Test Location (1):** E-2, No.1, Li Hsin 1st Road, Hsinchu Science Park, Hsinchu City 300,  
Taiwan R.O.C.

**Test Location (2):** No. 49, Ln. 206, Wende Rd., Shangshan Tsuen, Chiung Lin Hsiang, Hsin  
Chu Hsien 307, Taiwan R.O.C.



This report is for your exclusive use. Any copying or replication of this report to or for any other person or entity, or use of our name or trademark, is permitted only with our prior written permission. This report sets forth our findings solely with respect to the test samples identified herein. The results set forth in this report are not indicative or representative of the quality or characteristics of the lot from which a test sample was taken or any similar or identical product unless specifically and expressly noted. Our report includes all of the tests requested by you and the results thereof based upon the information that you provided to us. You have 60 days from date of issuance of this report to notify us of any material error or omission caused by our negligence, provided, however, that such notice shall be in writing and shall specifically address the issue you wish to raise. A failure to raise such issue within the prescribed time shall constitute your unqualified acceptance of the completeness of this report, the tests conducted and the correctness of the report contents. Unless specific mention, the uncertainty of measurement has been explicitly taken into account to declare the compliance or non-compliance to the specification. The report must not be used by the client to claim product certification, approval, or endorsement by TAF or any government agencies.

## Table of Contents

<b>Release Control Record</b> .....	<b>4</b>
<b>1 Certificate of Conformity</b> .....	<b>5</b>
<b>2 Summary of Test Results</b> .....	<b>6</b>
2.1 Measurement Uncertainty .....	6
2.2 Modification Record .....	6
<b>3 General Information</b> .....	<b>7</b>
3.1 General Description of EUT .....	7
3.2 Description of Test Modes .....	11
3.2.1 Test Mode Applicability and Tested Channel Detail .....	12
3.3 Duty Cycle of Test Signal .....	14
3.4 Description of Support Units .....	15
3.4.1 Configuration of System under Test .....	16
3.5 General Description of Applied Standard .....	17
<b>4 Test Types and Results</b> .....	<b>18</b>
4.1 Radiated Emission and Bandedge Measurement .....	18
4.1.1 Limits of Radiated Emission and Bandedge Measurement .....	18
4.1.2 Test Instruments .....	19
4.1.3 Test Procedure .....	21
4.1.4 Deviation from Test Standard .....	21
4.1.5 Test Setup .....	22
4.1.6 EUT Operating Condition .....	23
4.1.7 Test Results .....	24
4.2 Conducted Emission Measurement .....	43
4.2.1 Limits of Conducted Emission Measurement .....	43
4.2.2 Test Instruments .....	43
4.2.3 Test Procedure .....	44
4.2.4 Deviation from Test Standard .....	44
4.2.5 Test Setup .....	44
4.2.6 EUT Operating Condition .....	44
4.2.7 Test Results .....	45
4.3 Transmit Power Measurement .....	47
4.3.1 Limits of Transmit Power Measurement .....	47
4.3.2 Test Setup .....	47
4.3.3 Test Instruments .....	47
4.3.4 Test Procedure .....	47
4.3.5 Deviation from Test Standard .....	47
4.3.6 EUT Operating Condition .....	47
4.3.7 Test Result .....	48
4.4 Occupied Bandwidth Measurement .....	50
4.4.1 Test Setup .....	50
4.4.2 Test Instruments .....	50
4.4.3 Test Procedure .....	50
4.4.4 Test Results .....	51
4.5 Peak Power Spectral Density Measurement .....	55
4.5.1 Limits of Peak Power Spectral Density Measurement .....	55
4.5.2 Test Setup .....	55
4.5.3 Test Instruments .....	55
4.5.4 Test Procedure .....	55
4.5.5 Deviation from Test Standard .....	56
4.5.6 EUT Operating Condition .....	56
4.5.7 Test Results .....	57
4.6 Frequency Stability Measurement .....	63
4.6.1 Limits of Frequency Stability Measurement .....	63

4.6.2	Test Setup.....	63
4.6.3	Test Instruments .....	63
4.6.4	Test Procedure .....	63
4.6.5	Deviation from Test Standard .....	63
4.6.6	EUT Operating Condition .....	63
4.6.7	Test Results .....	64
4.7	6dB Bandwidth Measurement .....	65
4.7.1	Limits of 6dB Bandwidth Measurement.....	65
4.7.2	Test Setup.....	65
4.7.3	Test Instruments .....	65
4.7.4	Test Procedure .....	65
4.7.5	Deviation from Test Standard .....	65
4.7.6	EUT Operating Condition .....	65
4.7.7	Test Results .....	66
<b>5</b>	<b>Pictures of Test Arrangements.....</b>	<b>68</b>
	<b>Annex A- Radiated Out of Band Emission (OOBE) Measurement (For U-NII-3 band) .....</b>	<b>69</b>
	<b>Appendix – Information on the Testing Laboratories .....</b>	<b>72</b>

### Release Control Record

Issue No.	Description	Date Issued
RF160923E02A-1	Original release.	Nov. 14, 2016

## 1 Certificate of Conformity

**Product:** Pepwave / Peplink / Pismo Labs Wireless Product  
**Brand:** Pepwave  
**Test Model:** MAX HD2 LTE  
**Series Model:** MAX HD2 LTEA  
**Sample Status:** ENGINEERING SAMPLE  
**Applicant:** Pismo Labs Technology Limited  
**Test Date:** Nov. 01 to 04, 2016  
**Standard:** 47 CFR FCC Part 15, Subpart E (Section 15.407)  
ANSI C63.10: 2013

The above equipment has been tested by **Bureau Veritas Consumer Products Services (H.K.) Ltd., Taoyuan Branch**, and found compliance with the requirement of the above standards. The test record, data evaluation & Equipment Under Test (EUT) configurations represented herein are true and accurate accounts of the measurements of the sample's EMC characteristics under the conditions specified in this report.

**Prepared by :** Wendy Wu , **Date:** Nov. 14, 2016  
Wendy Wu / Specialist

**Approved by :** May Chen , **Date:** Nov. 14, 2016  
May Chen / Manager

## 2 Summary of Test Results

47 CFR FCC Part 15, Subpart E (Section 15.407)			
FCC Clause	Test Item	Result	Remarks
15.407(b)(6)	AC Power Conducted Emissions	Pass	Meet the requirement of limit. Minimum passing margin is -8.43dB at 0.15000MHz.
15.407(b) (1/2/3/4(i/ii)/6)	Radiated Emissions & Band Edge Measurement*	Pass	Meet the requirement of limit. Minimum passing margin is -0.1dB at 5649.27MHz.
15.407(a)(1/2/3)	Max Average Transmit Power	Pass	Meet the requirement of limit.
---	Occupied Bandwidth Measurement	-	Reference only.
15.407(a)(1/2/3)	Peak Power Spectral Density	Pass	Meet the requirement of limit.
15.407(e)	6dB bandwidth	Pass	Meet the requirement of limit. (U-NII-3 Band only)
15.407(g)	Frequency Stability	Pass	Meet the requirement of limit.
15.203	Antenna Requirement	Pass	Antenna connector is R-SMA not a standard connector.

\*For U-NII-3 band compliance with rule part 15.407(b)(4)(i), the OOB test plots were recorded in Annex A.

### 2.1 Measurement Uncertainty

Where relevant, the following measurement uncertainty levels have been estimated for tests performed on the EUT as specified in CISPR 16-4-2:

Measurement	Frequency	Expanded Uncertainty (k=2) (±)
Conducted Emissions at mains ports	150kHz ~ 30MHz	1.83 dB
Radiated Emissions up to 1 GHz	30MHz ~ 1GHz	5.34 dB
Radiated Emissions above 1 GHz	1GHz ~ 6GHz	3.41 dB
	6GHz ~ 18GHz	3.49 dB
	18GHz ~ 40GHz	3.30 dB

### 2.2 Modification Record

There were no modifications required for compliance.

### 3 General Information

#### 3.1 General Description of EUT

Product	Pepwave / Peplink / Pismo Labs Wireless Product
Brand	Pepwave
Test Model	MAX HD2 LTE
Series Model	MAX HD2 LTEA
Status of EUT	ENGINEERING SAMPLE
Power Supply Rating	12Vdc from power adapter
Modulation Type	CCK, DQPSK, DBPSK for DSSS 64QAM, 16QAM, QPSK, BPSK for OFDM 256QAM for OFDM in 11ac mode only
Modulation Technology	DSSS, OFDM
Transfer Rate	802.11b: up to 11Mbps 802.11a/g: up to 54Mbps 802.11n: up to 300Mbps 802.11ac: up to 866.7Mbps
Operating Frequency	<b>2.4GHz:</b> 2.412GHz ~ 2.462GHz <b>5GHz:</b> 5.18GHz ~ 5.24GHz, 5.745GHz ~ 5.825GHz
Number of Channel	<b>2.4GHz:</b> 802.11b, 802.11g, 802.11n (HT20): 11 802.11n (HT40): 7 <b>5GHz:</b> 802.11a, 802.11n (HT20), 802.11ac (VHT20): 9 802.11n (HT40), 802.11ac (VHT40): 4 802.11ac (VHT80): 2
Output Power	<b>2.4GHz:</b> 988.867mW <b>5GHz:</b> <b>5.18GHz ~ 5.24GHz:</b> 197.885mW <b>5.745GHz ~ 5.825GHz:</b> 264.424mW
Antenna Type	Refer to Note
Antenna Connector	Refer to Note
Accessory Device	Adapter x 1
Data Cable Supplied	NA

Note:

1. The EUT has below model names, which are identical to each other in all aspects except for the following:

Product name	Brand	Model	Difference	Purpose	Hardware/Software
Pepwave	Pepwave	MAX HD2 LTE	(1) MAX HD2 LTE contains two N7NMC7355 modules. (2) MAX HD2 LTEA contain two N7NMC7455 modules	For marketing requirement	All of hardware and software are identical.
		MAX HD2 LTEA			
Peplink		MAX HD2 LTE			
		MAX HD2 LTEA			
Pismo Labs Wireless		MAX HD2 LTE			
Product		MAX HD2 LTEA			

From the above models, model: **MAX HD2 LTE** was selected as representative model for the test and its data was recorded in this report.

- There are WLAN, GPS, WWAN(LTE) technology used for the EUT.
- EUT contains two WiFi chip as same model, this chip model support dual band operation, but it will be locked to single band operation by firmware. One chip is supported 2.4GHz, other is supported 5GHz.
- EUT contains two same certified module which FCC ID: N7NMC7455 or N7NMC7355.
- EUT could be applied with a plug in USB cellular device.
- Simultaneously transmission condition.

Condition	Technology				
1	WLAN (2.4GHz)	WLAN (5GHz)	WWAN(LTE) module (FCC ID: N7NMC7355)	WWAN(LTE) module (FCC ID: N7NMC7355)	-
2	WLAN (2.4GHz)	WLAN (5GHz)	WWAN(LTE) module (FCC ID: N7NMC7355)	WWAN(LTE) module (FCC ID: N7NMC7355)	3G/LTE (USB cellular device)
3	WLAN (2.4GHz)	WLAN (5GHz)	WWAN(LTE) module (FCC ID: N7NMC7455)	WWAN(LTE) module (FCC ID: N7NMC7455)	-
4	WLAN (2.4GHz)	WLAN (5GHz)	WWAN(LTE) module (FCC ID: N7NMC7455)	WWAN(LTE) module (FCC ID: N7NMC7455)	3G/LTE (USB cellular device)

**Note:** The emission of the simultaneous operation has been evaluated and no non-compliance was found.

7. The EUT must be supplied with a power adapter as following table:

Brand	Model No.	Spec.
ADAPTER TECH.	ATS036T-W120V	Input: 100-240Vac, 50-60Hz, 1A Output: 12Vdc, 3A DC output cable (Unshielded, 1.5m)



8. The antennas provided to the EUT, please refer to the following table:

For WLAN							
Antenna No.	Brand	Model	Antenna Net Gain(dBi)	Frequency range	Antenna Type	Connector Type	Cable Length (mm)
WAN(2.4G)-1	SmartAnt	SAA06-220690	3	2400 ~ 2500 MHz	Dipole	R-SMA	150
WAN(2.4G)-2	SmartAnt	SAA06-220690	3	2400 ~ 2500 MHz	Dipole	R-SMA	150
AP(5G)-1	SmartAnt	SAA06-220690	5.5	5150 ~ 5350 MHz	Dipole	R-SMA	260
			6	5350 ~ 5875 MHz			260
AP(5G)-2	SmartAnt	SAA06-220690	5.5	5150 ~ 5350 MHz	Dipole	R-SMA	260
			6	5350 ~ 5875 MHz			260
For GPS							
Antenna No.	Brand	Model	Antenna Net Gain(dBi)	Frequency range	Antenna Type	Connector Type	
1	MASTER WAVE TECHNOLOGY CO., LTD.	98335KSAF000	4.5 ±0.5	1575.42 MHz	Magnetic	SMA	
For WWAN(LTE)							
Antenna No.	Brand	Model	Antenna Net Gain(dBi)	Frequency range	Antenna Type	Connector Type	
Cellular 1 Main	MASTER WAVE TECHNOLOGY CO., LTD.	98619ZSAX025	1.99	699~960 MHz	Dipole	SMA	
Cellular 1 Diversity/Aux			4	1575~2170 MHz			
Cellular 2 Main			1	2300~2320 MHz			
Cellular 1 Diversity/Aux			2.8	2325~2690 MHz			

9. The EUT incorporates a MIMO function.

2.4GHz Band			
MODULATION MODE	DATA RATE (MCS)	TX & RX CONFIGURATION	
802.11b	1 ~ 11Mbps	2TX	2RX
802.11g	6 ~ 54Mbps	2TX	2RX
802.11n (HT20)	MCS 0~7	2TX	2RX
	MCS 8~15	2TX	2RX
802.11n (HT40)	MCS 0~7	2TX	2RX
	MCS 8~15	2TX	2RX
5GHz Band			
MODULATION MODE	DATA RATE (MCS)	TX & RX CONFIGURATION	
802.11a	6 ~ 54Mbps	2TX	2RX
802.11n (HT20)	MCS 0~7	2TX	2RX
	MCS 8~15	2TX	2RX
802.11n (HT40)	MCS 0~7	2TX	2RX
	MCS 8~15	2TX	2RX
802.11ac (VHT20)	MCS0~8 Nss=1	2TX	2RX
	MCS0~8 Nss=2	2TX	2RX
802.11ac (VHT40)	MCS0~9 Nss=1	2TX	2RX
	MCS0~9 Nss=2	2TX	2RX
802.11ac (VHT80)	MCS0~9 Nss=1	2TX	2RX
	MCS0~9 Nss=2	2TX	2RX

Note:

1. The modulation and bandwidth are similar for 802.11n mode for 20MHz (40MHz) and 802.11ac mode for 20MHz (40MHz), therefore investigated worst case to representative mode in test report. (Final test mode refer section 3.2.1)

10. The above EUT information is declared by manufacturer and for more detailed features description, please refer to the manufacturer's specifications or user's manual.

### 3.2 Description of Test Modes

#### FOR 5180 ~ 5240MHz

4 channels are provided for 802.11a, 802.11n (HT20), 802.11ac (VHT20):

Channel	Frequency	Channel	Frequency
36	5180MHz	44	5220MHz
40	5200MHz	48	5240MHz

2 channels are provided for 802.11n (HT40), 802.11ac (VHT40):

Channel	Frequency	Channel	Frequency
38	5190MHz	46	5230MHz

1 channel is provided for 802.11ac (VHT80):

Channel	Frequency
42	5210MHz

#### FOR 5745 ~ 5825MHz:

5 channels are provided for 802.11a, 802.11n (HT20), 802.11ac (VHT20):

Channel	Frequency	Channel	Frequency
149	5745MHz	161	5805MHz
153	5765MHz	165	5825MHz
157	5785MHz		

2 channels are provided for 802.11n (HT40), 802.11ac (VHT40):

Channel	Frequency	Channel	Frequency
151	5755MHz	159	5795MHz

1 channel is provided for 802.11ac (VHT80):

Channel	Frequency
155	5775MHz

### 3.2.1 Test Mode Applicability and Tested Channel Detail

EUT Configure Mode	Applicable To				Description
	RE $\geq$ 1G	RE<1G	PLC	APCM	
-	√	√	√	√	-

Where **RE $\geq$ 1G**: Radiated Emission above 1GHz      **RE<1G**: Radiated Emission below 1GHz  
**PLC**: Power Line Conducted Emission      **APCM**: Antenna Port Conducted Measurement

**NOTE:**

1. The EUT had been pre-tested on the positioned of each 2 axis. The worst case was found when positioned on **Y-plane**.

#### **Radiated Emission Test (Above 1GHz):**

- Pre-Scan has been conducted to determine the worst-case mode from all possible combinations between available modulations, data rates and antenna ports (if EUT with antenna diversity architecture).
- Following channel(s) was (were) selected for the final test as listed below.

Mode	FREQ. Band (MHz)	Available Channel	Tested Channel	Modulation Technology	Modulation Type	Data Rate (Mbps)
802.11a	5180-5240	36 to 48	36, 40, 48	OFDM	BPSK	6
802.11ac (VHT20)		36 to 48	36, 40, 48	OFDM	BPSK	6.5
802.11ac (VHT40)		38 to 46	38, 46	OFDM	BPSK	13.5
802.11ac (VHT80)		42	42	OFDM	BPSK	29.3
802.11a	5745-5825	149 to 165	149, 157, 165	OFDM	BPSK	6
802.11ac (VHT20)		149 to 165	149, 157, 165	OFDM	BPSK	6.5
802.11ac (VHT40)		151 to 159	151, 159	OFDM	BPSK	13.5
802.11ac (VHT80)		155	155	OFDM	BPSK	29.3

#### **Radiated Emission Test (Below 1GHz):**

- Pre-Scan has been conducted to determine the worst-case mode from all possible combinations between available modulations, data rates and antenna ports (if EUT with antenna diversity architecture).
- Following channel(s) was (were) selected for the final test as listed below.

Mode	FREQ. Band (MHz)	Available Channel	Tested Channel	Modulation Technology	Modulation Type	Data Rate (Mbps)
802.11ac (VHT20)	5745-5825	149 to 165	157	OFDM	BPSK	6.5

#### **Power Line Conducted Emission Test:**

- Pre-Scan has been conducted to determine the worst-case mode from all possible combinations between available modulations, data rates and antenna ports (if EUT with antenna diversity architecture).
- Following channel(s) was (were) selected for the final test as listed below.

Mode	FREQ. Band (MHz)	Available Channel	Tested Channel	Modulation Technology	Modulation Type	Data Rate (Mbps)
802.11ac (VHT20)	5745-5825	149 to 165	157	OFDM	BPSK	6.5

### Antenna Port Conducted Measurement:

- This item includes all test value of each mode, but only includes spectrum plot of worst value of each mode.
- Pre-Scan has been conducted to determine the worst-case mode from all possible combinations between available modulations, data rates and antenna ports (if EUT with antenna diversity architecture).
- Following channel(s) was (were) selected for the final test as listed below.

Mode	FREQ. Band (MHz)	Available Channel	Tested Channel	Modulation Technology	Modulation Type	Data Rate (Mbps)
802.11a	5180-5240	36 to 48	36, 40, 48	OFDM	BPSK	6
802.11ac (VHT20)		36 to 48	36, 40, 48	OFDM	BPSK	6.5
802.11ac (VHT40)		38 to 46	38, 46	OFDM	BPSK	13.5
802.11ac (VHT80)		42	42	OFDM	BPSK	29.3
802.11a	5745-5825	149 to 165	149, 157, 165	OFDM	BPSK	6
802.11ac (VHT20)		149 to 165	149, 157, 165	OFDM	BPSK	6.5
802.11ac (VHT40)		151 to 159	151, 159	OFDM	BPSK	13.5
802.11ac (VHT80)		155	155	OFDM	BPSK	29.3

### Test Condition:

APPLICABLE TO	ENVIRONMENTAL CONDITIONS	INPUT POWER	TESTED BY
RE $\geq$ 1G	21deg. C, 69%RH	120Vac, 60Hz	Jyunchun Lin
RE<1G	21deg. C, 67%RH	120Vac, 60Hz	Gary Cheng
PLC	25deg. C, 69%RH	120Vac, 60Hz	Eagle Chen
APCM	25deg. C, 60%RH	120Vac, 60Hz	Gary Cheng

### 3.3 Duty Cycle of Test Signal

If duty cycle of test signal is < 98%, duty factor shall be considered.

**802.11a**: Duty cycle =  $2.027\text{ms}/2.104\text{ ms} = 0.963$ , Duty factor =  $10 * \log( 1/0.963) = 0.16$

**802.11ac (VHT20)**: Duty cycle =  $1.898\text{ ms}/1.98\text{ ms} = 0.959$ , Duty factor =  $10 * \log( 1/0.959) = 0.18$

**802.11ac (VHT40)**: Duty cycle =  $0.935\text{ ms}/1.028\text{ ms} = 0.91$ , Duty factor =  $10 * \log( 1/0.91) = 0.41$

**802.11ac (VHT80)**: Duty cycle =  $1.136\text{ ms}/1.204\text{ ms} = 0.949$ , Duty factor =  $10 * \log( 1/0.949) = 0.25$

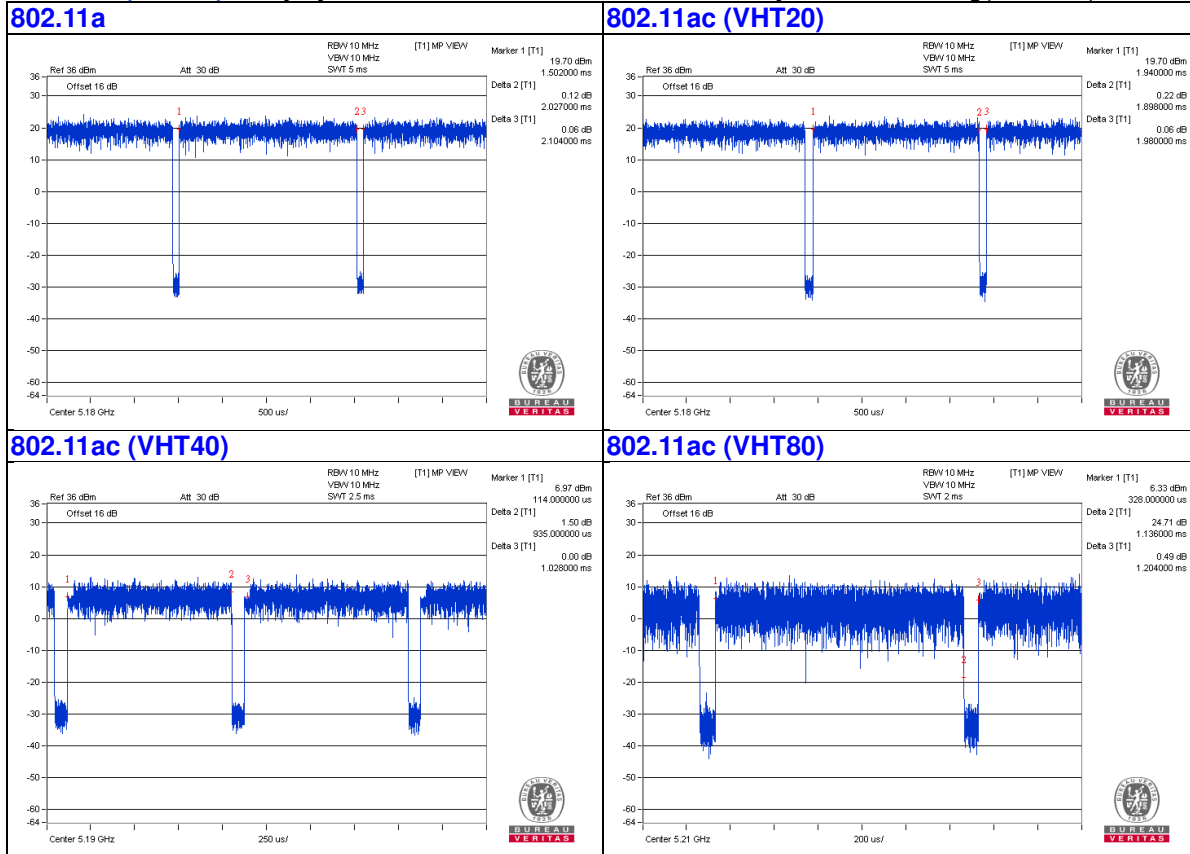

### 3.4 Description of Support Units

The EUT has been tested as an independent unit together with other necessary accessories or support units. The following support units or accessories were used to form a representative test configuration during the tests.

ID	Product	Brand	Model No.	Serial No.	FCC ID	Remarks
A.	Laptop	DELL	E6420	482T3R1	FCC DoC	Provided by Lab
B.	HUB	ZyXEL	NBG4115	S090A4200153	FCC DoC	Provided by Lab
C.	3G / LTE Wireless Dongle	D-LINK	DWM-221	RD271F8000411	KA2WM221B1	Provided by Lab
D.	SIM Card A	R&S	CRT-Z3	NA	NA	Provided by Lab
E.	SIM Card B	R&S	CRT-Z3	NA	NA	Provided by Lab

Note:

1. All power cords of the above support units are non-shielded (1.8m).

ID	Descriptions	Qty.	Length (m)	Shielding (Yes/No)	Cores (Qty.)	Remarks
1.	GPS Antenna Cable	1	5	No	0	Supplied by Client
2.	RJ-45 Cable	1	10	No	0	Provided by Lab
3.	RJ-45 Cable	3	3	No	0	Provided by Lab
4.	RJ-45 Cable	2	3	No	0	Provided by Lab
5.	DC Cable	1	1.5	No	0	Supplied by Client
6.	Ground wire	1	1.5	No	0	Provided by Lab

### 3.4.1 Configuration of System under Test

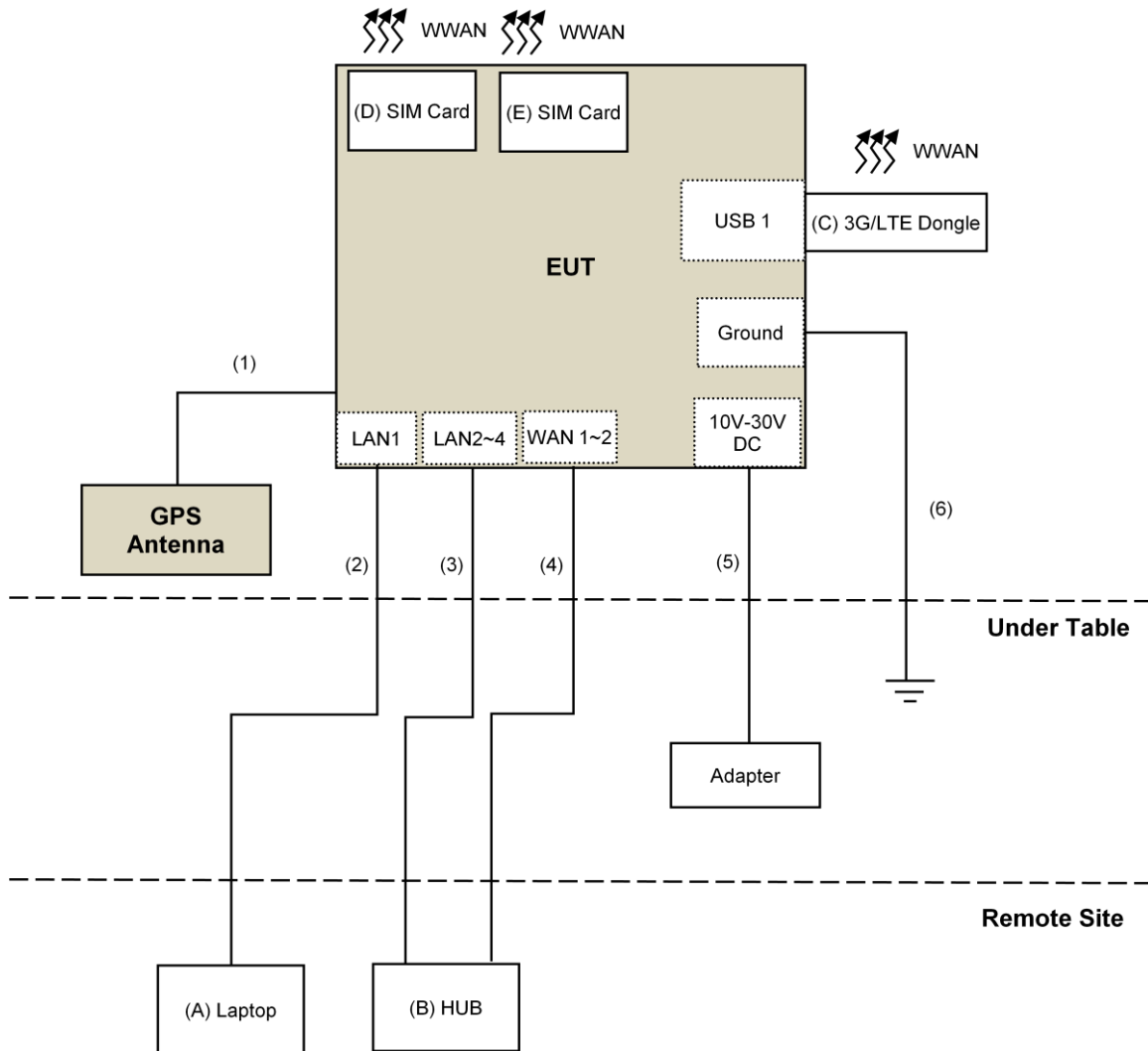



### 3.5 General Description of Applied Standard

The EUT is a RF Product. According to the specifications of the manufacturer, it must comply with the requirements of the following standards:

**FCC Part 15, Subpart E (15.407)**  
**KDB 789033 D02 General UNII Test Procedure New Rules v01r03**  
**KDB 662911 D01 Multiple Transmitter Output v02r01**  
**ANSI C63.10-2013**

All test items have been performed and recorded as per the above standards.

## 4 Test Types and Results

### 4.1 Radiated Emission and Bandedge Measurement

#### 4.1.1 Limits of Radiated Emission and Bandedge Measurement

Radiated emissions which fall in the restricted bands must comply with the radiated emission limits specified as below table.

Frequencies (MHz)	Field Strength (microvolts/meter)	Measurement Distance (meters)
0.009 ~ 0.490	2400/F(kHz)	300
0.490 ~ 1.705	24000/F(kHz)	30
1.705 ~ 30.0	30	30
30 ~ 88	100	3
88 ~ 216	150	3
216 ~ 960	200	3
Above 960	500	3

#### NOTE:

1. The lower limit shall apply at the transition frequencies.
2. Emission level (dBuV/m) = 20 log Emission level (uV/m).
3. For frequencies above 1000MHz, the field strength limits are based on average detector, however, the peak field strength of any emission shall not exceed the maximum permitted average limits, specified above by more than 20dB under any condition of modulation.

Limits of unwanted emission out of the restricted bands

Applicable To		Limit	
789033 D02 General UNII Test Procedure New Rules v01r03		Field Strength at 3m	
		PK:74 (dBμV/m)	AV:54 (dBμV/m)
Frequency Band	Applicable To	EIRP Limit	Equivalent Field Strength at 3m
5150~5250 MHz	15.407(b)(1)	PK:-27 (dBm/MHz)	PK:68.2(dBμV/m)
5250~5350 MHz	15.407(b)(2)		
5470~5725 MHz	15.407(b)(3)		
5725~5850 MHz	<input checked="" type="checkbox"/> 15.407(b)(4)(i)	PK:-27 (dBm/MHz) <sup>*1</sup> PK:10 (dBm/MHz) <sup>*2</sup> PK:15.6 (dBm/MHz) <sup>*3</sup> PK:27 (dBm/MHz) <sup>*4</sup>	PK: 68.2(dBμV/m) <sup>*1</sup> PK:105.2 (dBμV/m) <sup>*2</sup> PK: 110.8(dBμV/m) <sup>*3</sup> PK:122.2 (dBμV/m) <sup>*4</sup>
	<input type="checkbox"/> 15.407(b)(4)(ii)	Emission limits in section 15.247(d)	
<sup>*1</sup> beyond 75 MHz or more above of the band edge.		<sup>*2</sup> below the band edge increasing linearly to 10 dBm/MHz at 25 MHz above.	
<sup>*3</sup> below the band edge increasing linearly to a level of 15.6 dBm/MHz at 5 MHz above.		<sup>*4</sup> from 5 MHz above or below the band edge increasing linearly to a level of 27 dBm/MHz at the band edge.	

#### Note:

The following formula is used to convert the equipment isotropic radiated power (eirp) to field strength:

$$E = \frac{1000000\sqrt{30P}}{3} \mu\text{V/m, where P is the eirp (Watts).}$$

## 4.1.2 Test Instruments

DESCRIPTION & MANUFACTURER	MODEL NO.	SERIAL NO.	CALIBRATED DATE	CALIBRATED UNTIL
Test Receiver Keysight	N9038A	MY54450088	July 20, 2016	July 19, 2017
Pre-Amplifier <sup>(*)</sup> EMCI	EMC001340	980142	Jan. 20, 2016	Jan. 19, 2018
Loop Antenna <sup>(*)</sup> Electro-Metrics	EM-6879	264	Dec. 16, 2014	Dec. 15, 2016
RF Cable	NA	LOOPCAB-001 LOOPCAB-002	Jan. 18, 2016	Jan. 17, 2017
Pre-Amplifier Mini-Circuits	ZFL-1000VH2B	AMP-ZFL-01	Nov. 11, 2015	Nov. 10, 2016
Trilog Broadband Antenna SCHWARZBECK	VULB 9168	9168-406	Jan. 04, 2016	Jan. 03, 2017
RF Cable	8D	966-4-1 966-4-2 966-4-3	Apr. 02, 2016	Apr. 01, 2017
Fixed attenuator Mini-Circuits	UNAT-5+	PAD-3m-4-01	Oct. 05, 2016	Oct. 04, 2017
Horn_Antenna SCHWARZBECK	BBHA 9120D	9120D-783	Jan. 19, 2016	Jan. 18, 2017
Pre-Amplifier Agilent	8449B	3008A01922	Sep. 18, 2016	Sep. 17, 2017
RF Cable	EMC104-SM-SM-2000 EMC104-SM-SM-5000 EMC104-SM-SM-5000	150318 150323 150324	Mar. 30, 2016	Mar. 29, 2017
Pre-Amplifier EMCI	EMC184045	980143	Jan. 15, 2016	Jan. 14, 2017
Horn_Antenna SCHWARZBECK	BBHA 9170	BBHA9170608	Jan. 08, 2016	Jan. 07, 2017
RF Cable	SUCOFLEX 102	36432/2 36441/2	Jan. 16, 2016	Jan. 15, 2017
Software	ADT_Radiated_V8.7.08	NA	NA	NA
Antenna Tower & Turn Table Max-Full	MF-7802	MF780208410	NA	NA
Boresight Antenna Fixture	FBA-01	FBA-SIP02	NA	NA
Spectrum Analyzer R&S	FSP40	100060	May 11, 2016	May 10, 2017
Power meter Anritsu	ML2495A	1014008	May 5, 2016	May 4, 2017
Power sensor Anritsu	MA2411B	0917122	May 5, 2016	May 4, 2017
AC Power Source Extech Electronics	6205	1440452	NA	NA
Temperature & Humidity Chamber Giant Force	GTH-150-40-SP-AR	MAA0812-008	Jan. 15, 2016	Jan. 14, 2017
Digital Multimeter FLUKE	87III	73680266	Nov. 10, 2015	Nov. 09, 2016

**Note:**

1. The calibration interval of the above test instruments is 12 months and the calibrations are traceable to NML/ROC and NIST/USA.
2. \*The calibration interval of the above test instruments is 24 months and the calibrations are traceable to NML/ROC and NIST/USA.
3. The test was performed in 966 Chamber No. 4.
4. The FCC Site Registration No. is 292998
5. The CANADA Site Registration No. is 20331-2
- 6 Loop antenna was used for all emissions below 30 MHz.
7. Tested Date: Nov. 01 to 04, 2016

#### 4.1.3 Test Procedure

##### **For Radiated emission below 30MHz**

- a. The EUT was placed on the top of a rotating table 0.8 meters above the ground at a 3 meter chamber room. The table was rotated 360 degrees to determine the position of the highest radiation.
- b. The EUT was set 3 meters away from the interference-receiving antenna, which was mounted on the top of a variable-height antenna tower.
- c. Both X and Y axes of the antenna are set to make the measurement.
- d. For each suspected emission, the EUT was arranged to its worst case and the rotatable table was turned from 0 degrees to 360 degrees to find the maximum reading.
- e. The test-receiver system was set to Quasi-Peak Detect Function and Specified Bandwidth with Maximum Hold Mode.

##### **NOTE:**

1. The resolution bandwidth and video bandwidth of test receiver/spectrum analyzer is 9kHz at frequency below 30MHz.

##### **For Radiated emission above 30MHz**

- a. The EUT was placed on the top of a rotating table 0.8 meters (for 30MHz ~ 1GHz) / 1.5 meters (for above 1GHz) above the ground at 3 meter chamber room for test. The table was rotated 360 degrees to determine the position of the highest radiation.
- b. The EUT was set 3 meters away from the interference-receiving antenna, which was mounted on the top of a variable-height antenna tower.
- c. The height of antenna is varied from one meter to four meters above the ground to determine the maximum value of the field strength. Both horizontal and vertical polarizations of the antenna are set to make the measurement.
- d. For each suspected emission, the EUT was arranged to its worst case and then the antenna was tuned to heights from 1 meter to 4 meters and the rotatable table was turned from 0 degrees to 360 degrees to find the maximum reading.
- e. The test-receiver system was set to quasi-peak detect function and specified bandwidth with maximum hold mode when the test frequency is below 1 GHz.
- f. The test-receiver system was set to peak and average detect function and specified bandwidth with maximum hold mode when the test frequency is above 1 GHz. If the peak reading value also meets average limit, measurement with the average detector is unnecessary.

##### **Note:**

1. The resolution bandwidth and video bandwidth of test receiver/spectrum analyzer is 120kHz for Quasi-peak detection (QP) at frequency below 1GHz.
2. The resolution bandwidth of test receiver/spectrum analyzer is 1 MHz and the video bandwidth is 3 MHz for Peak detection (PK) at frequency above 1GHz.
3. The resolution bandwidth of test receiver/spectrum analyzer is 1MHz and the video bandwidth is  $\geq 1/T$  (Duty cycle < 98%) or 10Hz (Duty cycle  $\geq 98\%$ ) for Average detection (AV) at frequency above 1GHz.
4. All modes of operation were investigated and the worst-case emissions are reported.

#### 4.1.4 Deviation from Test Standard

No deviation.

#### 4.1.5 Test Setup

##### For Radiated emission below 30MHz

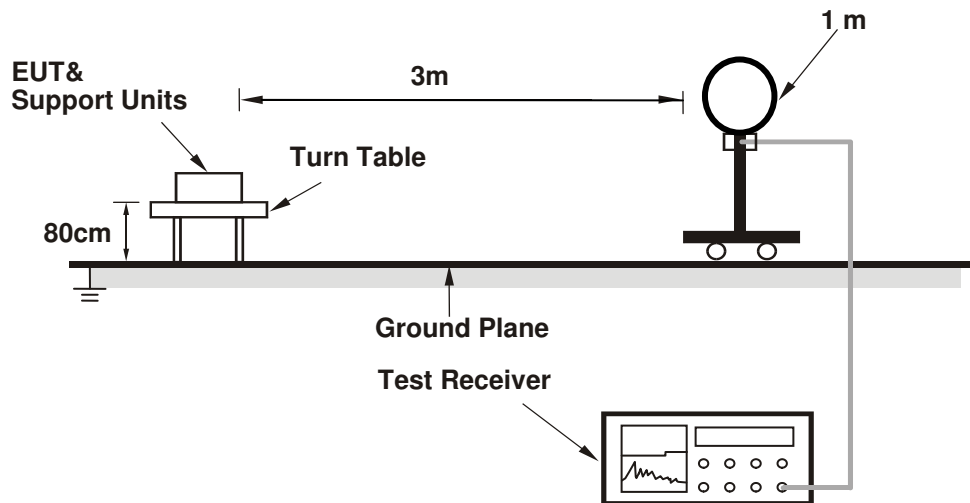

##### For Radiated emission 30MHz to 1GHz

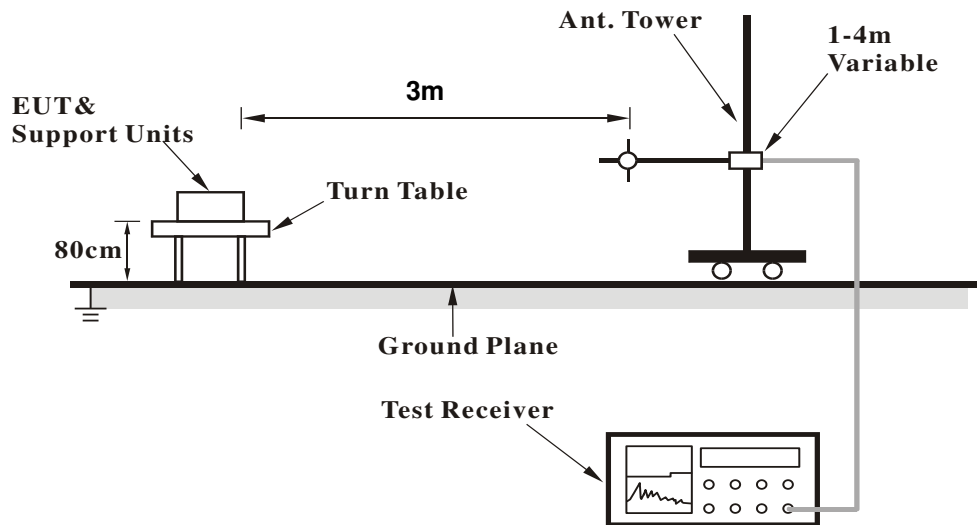

### For Radiated emission above 1GHz

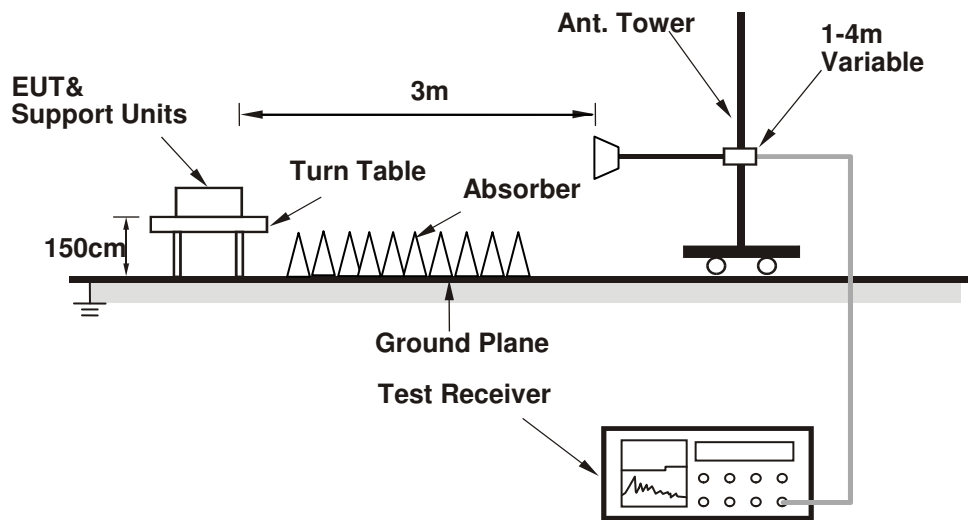

For the actual test configuration, please refer to the attached file (Test Setup Photo).

#### 4.1.6 EUT Operating Condition

- a. Connected the EUT with the Laptop which is placed on remote site.
- b. Controlling software (artgui.exe[art2\_ver\_4\_9\_575\_5\_cs\_u3\_bin]) has been activated to set the EUT on specific status.

4.1.7 Test Results

Above 1GHz Data:

802.11a

<b>CHANNEL</b>	TX Channel 36	<b>DETECTOR FUNCTION</b>	Peak (PK)
<b>FREQUENCY RANGE</b>	1GHz ~ 40GHz		Average (AV)

**ANTENNA POLARITY & TEST DISTANCE: HORIZONTAL AT 3 M**

NO.	FREQ. (MHz)	EMISSION LEVEL (dBuV/m)	LIMIT (dBuV/m)	MARGIN (dB)	ANTENNA HEIGHT (m)	TABLE ANGLE (Degree)	RAW VALUE (dBuV)	CORRECTION FACTOR (dB/m)
1	5150.00	53.5 PK	74.0	-20.5	3.60 H	54	52.0	1.5
2	5150.00	39.6 AV	54.0	-14.4	3.60 H	54	38.1	1.5
3	*5180.00	97.0 PK			3.60 H	54	95.4	1.6
4	*5180.00	87.3 AV			3.60 H	54	85.7	1.6
5	#10360.00	59.3 PK	74.0	-14.7	1.52 H	45	47.8	11.5
6	#10360.00	47.1 AV	54.0	-6.9	1.52 H	45	35.6	11.5
7	15540.00	55.5 PK	74.0	-18.5	1.52 H	311	42.4	13.1
8	15540.00	43.2 AV	54.0	-10.8	1.52 H	311	30.1	13.1

**ANTENNA POLARITY & TEST DISTANCE: VERTICAL AT 3 M**

NO.	FREQ. (MHz)	EMISSION LEVEL (dBuV/m)	LIMIT (dBuV/m)	MARGIN (dB)	ANTENNA HEIGHT (m)	TABLE ANGLE (Degree)	RAW VALUE (dBuV)	CORRECTION FACTOR (dB/m)
1	5150.00	63.5 PK	74.0	-10.5	2.26 V	200	62.0	1.5
2	5150.00	49.5 AV	54.0	-4.5	2.26 V	200	48.0	1.5
3	*5180.00	113.6 PK			2.26 V	200	112.0	1.6
4	*5180.00	103.8 AV			2.26 V	200	102.2	1.6
5	#10360.00	63.4 PK	74.0	-10.6	1.54 V	174	51.9	11.5
6	#10360.00	51.3 AV	54.0	-2.7	1.54 V	174	39.8	11.5
7	15540.00	59.7 PK	74.0	-14.3	3.14 V	197	46.6	13.1
8	15540.00	47.0 AV	54.0	-7.0	3.14 V	197	33.9	13.1

**REMARKS:**

1. Emission Level(dBuV/m) = Raw Value(dBuV) + Correction Factor(dB/m)
2. Correction Factor(dB/m) = Antenna Factor(dB/m) + Cable Factor(dB) – Pre-Amplifier Factor(dB)
3. The other emission levels were very low against the limit.
4. Margin value = Emission Level – Limit value
5. " \* ": Fundamental frequency.
6. " # ": The radiated frequency is out of the restricted band.



<b>CHANNEL</b>	TX Channel 40	<b>DETECTOR FUNCTION</b>	Peak (PK)
<b>FREQUENCY RANGE</b>	1GHz ~ 40GHz		Average (AV)

**ANTENNA POLARITY & TEST DISTANCE: HORIZONTAL AT 3 M**

NO.	FREQ. (MHz)	EMISSION LEVEL (dBuV/m)	LIMIT (dBuV/m)	MARGIN (dB)	ANTENNA HEIGHT (m)	TABLE ANGLE (Degree)	RAW VALUE (dBuV)	CORRECTION FACTOR (dB/m)
1	5150.00	57.4 PK	74.0	-16.6	3.52 H	50	55.9	1.5
2	5150.00	44.2 AV	54.0	-9.8	3.52 H	50	42.7	1.5
3	*5200.00	104.1 PK			3.52 H	50	102.4	1.7
4	*5200.00	93.6 AV			3.52 H	50	91.9	1.7
5	#10400.00	61.4 PK	74.0	-12.6	1.58 H	57	49.8	11.6
6	#10400.00	49.4 AV	54.0	-4.6	1.58 H	57	37.8	11.6
7	15600.00	57.3 PK	74.0	-16.7	1.52 H	302	44.2	13.1
8	15600.00	45.4 AV	54.0	-8.6	1.52 H	302	32.3	13.1

**ANTENNA POLARITY & TEST DISTANCE: VERTICAL AT 3 M**

NO.	FREQ. (MHz)	EMISSION LEVEL (dBuV/m)	LIMIT (dBuV/m)	MARGIN (dB)	ANTENNA HEIGHT (m)	TABLE ANGLE (Degree)	RAW VALUE (dBuV)	CORRECTION FACTOR (dB/m)
1	5150.00	67.0 PK	74.0	-7.0	2.26 V	186	65.5	1.5
2	5150.00	53.0 AV	54.0	-1.0	2.26 V	186	51.5	1.5
3	*5200.00	120.6 PK			2.26 V	186	118.9	1.7
4	*5200.00	110.1 AV			2.26 V	186	108.4	1.7
5	#10400.00	66.7 PK	74.0	-7.3	1.57 V	178	55.1	11.6
6	#10400.00	53.5 AV	54.0	-0.5	1.57 V	178	41.9	11.6
7	15600.00	62.3 PK	74.0	-11.7	3.20 V	182	49.2	13.1
8	15600.00	49.8 AV	54.0	-4.2	3.20 V	182	36.7	13.1

**REMARKS:**

1. Emission Level(dBuV/m) = Raw Value(dBuV) + Correction Factor(dB/m)
2. Correction Factor(dB/m) = Antenna Factor(dB/m) + Cable Factor(dB) – Pre-Amplifier Factor(dB)
3. The other emission levels were very low against the limit.
4. Margin value = Emission Level – Limit value
5. " \* ": Fundamental frequency.
6. " # ": The radiated frequency is out of the restricted band.

<b>CHANNEL</b>	TX Channel 48	<b>DETECTOR FUNCTION</b>	Peak (PK)
<b>FREQUENCY RANGE</b>	1GHz ~ 40GHz		Average (AV)

**ANTENNA POLARITY & TEST DISTANCE: HORIZONTAL AT 3 M**

NO.	FREQ. (MHz)	EMISSION LEVEL (dBuV/m)	LIMIT (dBuV/m)	MARGIN (dB)	ANTENNA HEIGHT (m)	TABLE ANGLE (Degree)	RAW VALUE (dBuV)	CORRECTION FACTOR (dB/m)
1	*5240.00	97.0 PK			3.66 H	49	95.4	1.6
2	*5240.00	87.2 AV			3.66 H	49	85.6	1.6
3	5350.00	47.2 PK	74.0	-26.8	3.66 H	49	45.3	1.9
4	5350.00	34.5 AV	54.0	-19.5	3.66 H	49	32.6	1.9
5	#10480.00	59.7 PK	74.0	-14.3	1.54 H	34	47.7	12.0
6	#10480.00	47.3 AV	54.0	-6.7	1.54 H	34	35.3	12.0
7	15720.00	55.2 PK	74.0	-18.8	1.47 H	320	42.0	13.2
8	15720.00	42.7 AV	54.0	-11.3	1.47 H	320	29.5	13.2

**ANTENNA POLARITY & TEST DISTANCE: VERTICAL AT 3 M**

NO.	FREQ. (MHz)	EMISSION LEVEL (dBuV/m)	LIMIT (dBuV/m)	MARGIN (dB)	ANTENNA HEIGHT (m)	TABLE ANGLE (Degree)	RAW VALUE (dBuV)	CORRECTION FACTOR (dB/m)
1	*5240.00	115.8 PK			2.26 V	186	114.2	1.6
2	*5240.00	106.0 AV			2.26 V	186	104.4	1.6
3	5350.00	57.0 PK	74.0	-17.0	2.26 V	186	55.1	1.9
4	5350.00	44.3 AV	54.0	-9.7	2.26 V	186	42.4	1.9
5	#10480.00	63.6 PK	74.0	-10.4	1.53 V	166	51.6	12.0
6	#10480.00	51.3 AV	54.0	-2.7	1.53 V	166	39.3	12.0
7	15720.00	59.8 PK	74.0	-14.2	3.15 V	196	46.6	13.2
8	15720.00	47.1 AV	54.0	-6.9	3.15 V	196	33.9	13.2

**REMARKS:**

1. Emission Level(dBuV/m) = Raw Value(dBuV) + Correction Factor(dB/m)
2. Correction Factor(dB/m) = Antenna Factor(dB/m) + Cable Factor(dB) – Pre-Amplifier Factor(dB)
3. The other emission levels were very low against the limit.
4. Margin value = Emission Level – Limit value
5. " \* ": Fundamental frequency.
6. " # ": The radiated frequency is out of the restricted band.

<b>CHANNEL</b>	TX Channel 149	<b>DETECTOR FUNCTION</b>	Peak (PK)
<b>FREQUENCY RANGE</b>	1GHz ~ 40GHz		Average (AV)

**ANTENNA POLARITY & TEST DISTANCE: HORIZONTAL AT 3 M**

NO.	FREQ. (MHz)	EMISSION LEVEL (dBuV/m)	LIMIT (dBuV/m)	MARGIN (dB)	ANTENNA HEIGHT (m)	TABLE ANGLE (Degree)	RAW VALUE (dBuV)	CORRECTION FACTOR (dB/m)
1	#5593.23	61.9 PK	68.2	-6.3	3.55 H	56	59.6	2.3
2	*5745.00	104.8 PK			3.55 H	56	102.1	2.7
3	*5745.00	95.2 AV			3.55 H	56	92.5	2.7
4	#5978.93	61.4 PK	68.2	-6.8	3.55 H	56	58.2	3.2
5	7660.00	43.6 PK	74.0	-30.4	3.00 H	100	35.4	8.2
6	7660.00	38.5 AV	54.0	-15.5	3.00 H	100	30.3	8.2
7	11490.00	57.3 PK	74.0	-16.7	1.47 H	42	43.9	13.4
8	11490.00	45.6 AV	54.0	-8.4	1.47 H	42	32.2	13.4
9	#17235.00	58.4 PK	74.0	-15.6	1.48 H	326	40.1	18.3
10	#17235.00	46.3 AV	54.0	-7.7	1.48 H	326	28.0	18.3

**ANTENNA POLARITY & TEST DISTANCE: VERTICAL AT 3 M**

NO.	FREQ. (MHz)	EMISSION LEVEL (dBuV/m)	LIMIT (dBuV/m)	MARGIN (dB)	ANTENNA HEIGHT (m)	TABLE ANGLE (Degree)	RAW VALUE (dBuV)	CORRECTION FACTOR (dB/m)
1	#5616.02	63.1 PK	68.2	-5.1	1.85 V	181	60.6	2.5
2	*5745.00	121.5 PK			1.85 V	181	118.8	2.7
3	*5745.00	112.0 AV			1.85 V	181	109.3	2.7
4	#5953.27	62.4 PK	68.2	-5.8	1.85 V	181	59.4	3.0
5	7660.00	53.8 PK	74.0	-20.2	1.51 V	211	45.6	8.2
6	7660.00	48.5 AV	54.0	-5.5	1.51 V	211	40.3	8.2
7	11490.00	64.5 PK	74.0	-9.5	2.05 V	360	51.1	13.4
8	11490.00	52.0 AV	54.0	-2.0	2.05 V	360	38.6	13.4
9	#17235.00	57.2 PK	74.0	-16.8	2.02 V	342	38.9	18.3
10	#17235.00	45.2 AV	54.0	-8.8	2.02 V	342	26.9	18.3

**REMARKS:**

1. Emission Level(dBuV/m) = Raw Value(dBuV) + Correction Factor(dB/m)
2. Correction Factor(dB/m) = Antenna Factor(dB/m) + Cable Factor(dB) – Pre-Amplifier Factor(dB)
3. The other emission levels were very low against the limit.
4. Margin value = Emission Level – Limit value
5. " \* ": Fundamental frequency.
6. " # ": The radiated frequency is out of the restricted band.

<b>CHANNEL</b>	TX Channel 157	<b>DETECTOR FUNCTION</b>	Peak (PK)
<b>FREQUENCY RANGE</b>	1GHz ~ 40GHz		Average (AV)

**ANTENNA POLARITY & TEST DISTANCE: HORIZONTAL AT 3 M**

NO.	FREQ. (MHz)	EMISSION LEVEL (dBuV/m)	LIMIT (dBuV/m)	MARGIN (dB)	ANTENNA HEIGHT (m)	TABLE ANGLE (Degree)	RAW VALUE (dBuV)	CORRECTION FACTOR (dB/m)
1	#5600.82	60.3 PK	68.2	-7.9	3.56 H	49	57.9	2.4
2	*5785.00	105.2 PK			3.56 H	49	102.5	2.7
3	*5785.00	95.5 AV			3.56 H	49	92.8	2.7
4	#5994.60	61.3 PK	68.2	-6.9	3.56 H	49	58.0	3.3
5	11570.00	57.2 PK	74.0	-16.8	1.46 H	40	44.1	13.1
6	11570.00	45.3 AV	54.0	-8.7	1.46 H	40	32.2	13.1
7	#17355.00	58.0 PK	74.0	-16.0	1.48 H	323	39.2	18.8
8	#17355.00	45.9 AV	54.0	-8.1	1.48 H	323	27.1	18.8

**ANTENNA POLARITY & TEST DISTANCE: VERTICAL AT 3 M**

NO.	FREQ. (MHz)	EMISSION LEVEL (dBuV/m)	LIMIT (dBuV/m)	MARGIN (dB)	ANTENNA HEIGHT (m)	TABLE ANGLE (Degree)	RAW VALUE (dBuV)	CORRECTION FACTOR (dB/m)
1	#5581.82	62.8 PK	68.2	-5.4	1.85 V	189	60.5	2.3
2	*5785.00	122.0 PK			1.85 V	189	119.3	2.7
3	*5785.00	112.0 AV			1.85 V	189	109.3	2.7
4	#5929.52	60.9 PK	68.2	-7.3	1.85 V	189	58.0	2.9
5	11570.00	64.5 PK	74.0	-9.5	2.04 V	359	51.4	13.1
6	11570.00	51.9 AV	54.0	-2.1	2.04 V	359	38.8	13.1
7	#17355.00	56.8 PK	74.0	-17.2	2.04 V	340	38.0	18.8
8	#17355.00	44.9 AV	54.0	-9.1	2.04 V	340	26.1	18.8

**REMARKS:**

1. Emission Level(dBuV/m) = Raw Value(dBuV) + Correction Factor(dB/m)
2. Correction Factor(dB/m) = Antenna Factor(dB/m) + Cable Factor(dB) – Pre-Amplifier Factor(dB)
3. The other emission levels were very low against the limit.
4. Margin value = Emission Level – Limit value
5. " \* ": Fundamental frequency.
6. " # ": The radiated frequency is out of the restricted band.

<b>CHANNEL</b>	TX Channel 165	<b>DETECTOR FUNCTION</b>	Peak (PK)
<b>FREQUENCY RANGE</b>	1GHz ~ 40GHz		Average (AV)

**ANTENNA POLARITY & TEST DISTANCE: HORIZONTAL AT 3 M**

NO.	FREQ. (MHz)	EMISSION LEVEL (dBuV/m)	LIMIT (dBuV/m)	MARGIN (dB)	ANTENNA HEIGHT (m)	TABLE ANGLE (Degree)	RAW VALUE (dBuV)	CORRECTION FACTOR (dB/m)
1	#5606.52	62.8 PK	68.2	-5.4	3.60 H	55	60.3	2.5
2	*5825.00	104.6 PK			3.60 H	55	101.9	2.7
3	*5825.00	95.3 AV			3.60 H	55	92.6	2.7
4	#5948.05	63.1 PK	68.2	-5.1	3.60 H	55	60.1	3.0
5	#7766.67	49.5 PK	74.0	-24.5	1.51 H	192	41.3	8.2
6	#7766.67	39.5 AV	54.0	-14.5	1.51 H	192	31.3	8.2
7	11650.00	57.2 PK	74.0	-16.8	1.51 H	35	44.1	13.1
8	11650.00	45.6 AV	54.0	-8.4	1.51 H	35	32.5	13.1
9	#17475.00	58.9 PK	74.0	-15.1	1.51 H	323	39.7	19.2
10	#17475.00	46.6 AV	54.0	-7.4	1.51 H	323	27.4	19.2

**ANTENNA POLARITY & TEST DISTANCE: VERTICAL AT 3 M**

NO.	FREQ. (MHz)	EMISSION LEVEL (dBuV/m)	LIMIT (dBuV/m)	MARGIN (dB)	ANTENNA HEIGHT (m)	TABLE ANGLE (Degree)	RAW VALUE (dBuV)	CORRECTION FACTOR (dB/m)
1	#5641.68	62.1 PK	68.2	-6.1	1.85 V	188	59.6	2.5
2	*5825.00	121.8 PK			1.85 V	188	119.1	2.7
3	*5825.00	111.8 AV			1.85 V	188	109.1	2.7
4	#5949.00	61.4 PK	68.2	-6.8	1.85 V	188	58.4	3.0
5	#7766.67	54.2 PK	74.0	-19.8	1.63 V	197	46.0	8.2
6	#7766.67	49.2 AV	54.0	-4.8	1.63 V	197	41.0	8.2
7	11650.00	60.2 PK	74.0	-13.8	2.59 V	163	47.1	13.1
8	11650.00	49.2 AV	54.0	-4.8	2.59 V	163	36.1	13.1
9	#17475.00	56.9 PK	74.0	-17.1	2.03 V	334	37.7	19.2
10	#17475.00	44.7 AV	54.0	-9.3	2.03 V	334	25.5	19.2

**REMARKS:**

- Emission Level(dBuV/m) = Raw Value(dBuV) + Correction Factor(dB/m)
- Correction Factor(dB/m) = Antenna Factor(dB/m) + Cable Factor(dB) – Pre-Amplifier Factor(dB)
- The other emission levels were very low against the limit.
- Margin value = Emission Level – Limit value
- " \* ": Fundamental frequency.
- " # ": The radiated frequency is out of the restricted band.

**802.11ac (VHT20)**

<b>CHANNEL</b>	TX Channel 36	<b>DETECTOR FUNCTION</b>	Peak (PK)
<b>FREQUENCY RANGE</b>	1GHz ~ 40GHz		Average (AV)

**ANTENNA POLARITY & TEST DISTANCE: HORIZONTAL AT 3 M**

NO.	FREQ. (MHz)	EMISSION LEVEL (dBuV/m)	LIMIT (dBuV/m)	MARGIN (dB)	ANTENNA HEIGHT (m)	TABLE ANGLE (Degree)	RAW VALUE (dBuV)	CORRECTION FACTOR (dB/m)
1	5150.00	53.5 PK	74.0	-20.5	3.66 H	55	52.0	1.5
2	5150.00	39.9 AV	54.0	-14.1	3.66 H	55	38.4	1.5
3	*5180.00	97.3 PK			3.66 H	55	95.7	1.6
4	*5180.00	87.4 AV			3.66 H	55	85.8	1.6
5	#10360.00	59.1 PK	74.0	-14.9	1.53 H	32	47.6	11.5
6	#10360.00	46.9 AV	54.0	-7.1	1.53 H	32	35.4	11.5
7	15540.00	55.4 PK	74.0	-18.6	1.54 H	314	42.3	13.1
8	15540.00	42.8 AV	54.0	-11.2	1.54 H	314	29.7	13.1

**ANTENNA POLARITY & TEST DISTANCE: VERTICAL AT 3 M**

NO.	FREQ. (MHz)	EMISSION LEVEL (dBuV/m)	LIMIT (dBuV/m)	MARGIN (dB)	ANTENNA HEIGHT (m)	TABLE ANGLE (Degree)	RAW VALUE (dBuV)	CORRECTION FACTOR (dB/m)
1	5150.00	65.4 PK	74.0	-8.6	2.26 V	187	63.9	1.5
2	5150.00	49.6 AV	54.0	-4.4	2.26 V	187	48.1	1.5
3	*5180.00	113.1 PK			2.26 V	187	111.5	1.6
4	*5180.00	103.5 AV			2.26 V	187	101.9	1.6
5	#10360.00	63.4 PK	74.0	-10.6	1.57 V	166	51.9	11.5
6	#10360.00	51.0 AV	54.0	-3.0	1.57 V	166	39.5	11.5
7	15540.00	59.4 PK	74.0	-14.6	3.11 V	185	46.3	13.1
8	15540.00	46.8 AV	54.0	-7.2	3.11 V	185	33.7	13.1

**REMARKS:**

- Emission Level(dBuV/m) = Raw Value(dBuV) + Correction Factor(dB/m)
- Correction Factor(dB/m) = Antenna Factor(dB/m) + Cable Factor(dB) – Pre-Amplifier Factor(dB)
- The other emission levels were very low against the limit.
- Margin value = Emission Level – Limit value
- " \* ": Fundamental frequency.
- " # ": The radiated frequency is out of the restricted band.

<b>CHANNEL</b>	TX Channel 40	<b>DETECTOR FUNCTION</b>	Peak (PK)
<b>FREQUENCY RANGE</b>	1GHz ~ 40GHz		Average (AV)

**ANTENNA POLARITY & TEST DISTANCE: HORIZONTAL AT 3 M**

NO.	FREQ. (MHz)	EMISSION LEVEL (dBuV/m)	LIMIT (dBuV/m)	MARGIN (dB)	ANTENNA HEIGHT (m)	TABLE ANGLE (Degree)	RAW VALUE (dBuV)	CORRECTION FACTOR (dB/m)
1	5150.00	57.8 PK	74.0	-16.2	3.49 H	63	56.3	1.5
2	5150.00	44.6 AV	54.0	-9.4	3.49 H	63	43.1	1.5
3	*5200.00	104.5 PK			3.49 H	63	102.8	1.7
4	*5200.00	93.7 AV			3.49 H	63	92.0	1.7
5	#10400.00	61.6 PK	74.0	-12.4	1.58 H	54	50.0	11.6
6	#10400.00	49.6 AV	54.0	-4.4	1.58 H	54	38.0	11.6
7	15600.00	56.8 PK	74.0	-17.2	1.49 H	290	43.7	13.1
8	15600.00	45.1 AV	54.0	-8.9	1.49 H	290	32.0	13.1

**ANTENNA POLARITY & TEST DISTANCE: VERTICAL AT 3 M**

NO.	FREQ. (MHz)	EMISSION LEVEL (dBuV/m)	LIMIT (dBuV/m)	MARGIN (dB)	ANTENNA HEIGHT (m)	TABLE ANGLE (Degree)	RAW VALUE (dBuV)	CORRECTION FACTOR (dB/m)
1	5150.00	67.9 PK	74.0	-6.1	2.26 V	186	66.4	1.5
2	5150.00	53.5 AV	54.0	-0.5	2.26 V	186	52.0	1.5
3	*5200.00	119.5 PK			2.26 V	186	117.8	1.7
4	*5200.00	109.5 AV			2.26 V	186	107.8	1.7
5	#10400.00	66.9 PK	74.0	-7.1	1.60 V	182	55.3	11.6
6	#10400.00	53.5 AV	54.0	-0.5	1.60 V	182	41.9	11.6
7	15600.00	62.9 PK	74.0	-11.1	3.17 V	177	49.8	13.1
8	15600.00	50.2 AV	54.0	-3.8	3.17 V	177	37.1	13.1

**REMARKS:**

1. Emission Level(dBuV/m) = Raw Value(dBuV) + Correction Factor(dB/m)
2. Correction Factor(dB/m) = Antenna Factor(dB/m) + Cable Factor(dB) – Pre-Amplifier Factor(dB)
3. The other emission levels were very low against the limit.
4. Margin value = Emission Level – Limit value
5. " \* ": Fundamental frequency.
6. " # ": The radiated frequency is out of the restricted band.

<b>CHANNEL</b>	TX Channel 48	<b>DETECTOR FUNCTION</b>	Peak (PK)
<b>FREQUENCY RANGE</b>	1GHz ~ 40GHz		Average (AV)

**ANTENNA POLARITY & TEST DISTANCE: HORIZONTAL AT 3 M**

NO.	FREQ. (MHz)	EMISSION LEVEL (dBuV/m)	LIMIT (dBuV/m)	MARGIN (dB)	ANTENNA HEIGHT (m)	TABLE ANGLE (Degree)	RAW VALUE (dBuV)	CORRECTION FACTOR (dB/m)
1	*5240.00	97.1 PK			3.64 H	50	95.5	1.6
2	*5240.00	87.2 AV			3.64 H	50	85.6	1.6
3	5350.00	47.4 PK	74.0	-26.6	3.64 H	50	45.5	1.9
4	5350.00	34.6 AV	54.0	-19.4	3.64 H	50	32.7	1.9
5	#10480.00	59.7 PK	74.0	-14.3	1.59 H	19	47.7	12.0
6	#10480.00	47.1 AV	54.0	-6.9	1.59 H	19	35.1	12.0
7	15720.00	55.2 PK	74.0	-18.8	1.47 H	311	42.0	13.2
8	15720.00	42.9 AV	54.0	-11.1	1.47 H	311	29.7	13.2

**ANTENNA POLARITY & TEST DISTANCE: VERTICAL AT 3 M**

NO.	FREQ. (MHz)	EMISSION LEVEL (dBuV/m)	LIMIT (dBuV/m)	MARGIN (dB)	ANTENNA HEIGHT (m)	TABLE ANGLE (Degree)	RAW VALUE (dBuV)	CORRECTION FACTOR (dB/m)
1	*5240.00	115.6 PK			2.26 V	186	114.0	1.6
2	*5240.00	106.1 AV			2.26 V	186	104.5	1.6
3	5350.00	56.8 PK	74.0	-17.2	2.26 V	186	54.9	1.9
4	5350.00	44.5 AV	54.0	-9.5	2.26 V	186	42.6	1.9
5	#10480.00	63.9 PK	74.0	-10.1	1.49 V	153	51.9	12.0
6	#10480.00	51.7 AV	54.0	-2.3	1.49 V	153	39.7	12.0
7	15720.00	60.0 PK	74.0	-14.0	3.13 V	203	46.8	13.2
8	15720.00	47.6 AV	54.0	-6.4	3.13 V	203	34.4	13.2

**REMARKS:**

1. Emission Level(dBuV/m) = Raw Value(dBuV) + Correction Factor(dB/m)
2. Correction Factor(dB/m) = Antenna Factor(dB/m) + Cable Factor(dB) – Pre-Amplifier Factor(dB)
3. The other emission levels were very low against the limit.
4. Margin value = Emission Level – Limit value
5. " \* ": Fundamental frequency.
6. " # ": The radiated frequency is out of the restricted band.



<b>CHANNEL</b>	TX Channel 149	<b>DETECTOR FUNCTION</b>	Peak (PK)
<b>FREQUENCY RANGE</b>	1GHz ~ 40GHz		Average (AV)

**ANTENNA POLARITY & TEST DISTANCE: HORIZONTAL AT 3 M**

NO.	FREQ. (MHz)	EMISSION LEVEL (dBuV/m)	LIMIT (dBuV/m)	MARGIN (dB)	ANTENNA HEIGHT (m)	TABLE ANGLE (Degree)	RAW VALUE (dBuV)	CORRECTION FACTOR (dB/m)
1	#5629.80	60.3 PK	68.2	-7.9	3.57 H	45	57.8	2.5
2	*5745.00	104.9 PK			3.57 H	45	102.2	2.7
3	*5745.00	95.3 AV			3.57 H	45	92.6	2.7
4	#6021.68	61.1 PK	68.2	-7.1	3.57 H	45	57.8	3.3
5	11490.00	57.1 PK	74.0	-16.9	1.44 H	48	43.7	13.4
6	11490.00	45.7 AV	54.0	-8.3	1.44 H	48	32.3	13.4
7	#17235.00	58.6 PK	74.0	-15.4	1.46 H	330	40.3	18.3
8	#17235.00	46.4 AV	54.0	-7.6	1.46 H	330	28.1	18.3

**ANTENNA POLARITY & TEST DISTANCE: VERTICAL AT 3 M**

NO.	FREQ. (MHz)	EMISSION LEVEL (dBuV/m)	LIMIT (dBuV/m)	MARGIN (dB)	ANTENNA HEIGHT (m)	TABLE ANGLE (Degree)	RAW VALUE (dBuV)	CORRECTION FACTOR (dB/m)
1	#5576.60	62.7 PK	68.2	-5.5	1.91 V	185	60.4	2.3
2	*5745.00	122.5 PK			1.91 V	185	119.8	2.7
3	*5745.00	111.6 AV			1.91 V	185	108.9	2.7
4	#5939.50	61.1 PK	68.2	-7.1	1.91 V	185	58.2	2.9
5	11490.00	64.3 PK	74.0	-9.7	2.10 V	358	50.9	13.4
6	11490.00	51.6 AV	54.0	-2.4	2.10 V	358	38.2	13.4
7	#17235.00	57.2 PK	74.0	-16.8	2.00 V	328	38.9	18.3
8	#17235.00	45.0 AV	54.0	-9.0	2.00 V	328	26.7	18.3

**REMARKS:**

1. Emission Level(dBuV/m) = Raw Value(dBuV) + Correction Factor(dB/m)
2. Correction Factor(dB/m) = Antenna Factor(dB/m) + Cable Factor(dB) – Pre-Amplifier Factor(dB)
3. The other emission levels were very low against the limit.
4. Margin value = Emission Level – Limit value
5. " \* ": Fundamental frequency.
6. " # ": The radiated frequency is out of the restricted band.

<b>CHANNEL</b>	TX Channel 157	<b>DETECTOR FUNCTION</b>	Peak (PK)
<b>FREQUENCY RANGE</b>	1GHz ~ 40GHz		Average (AV)

**ANTENNA POLARITY & TEST DISTANCE: HORIZONTAL AT 3 M**

NO.	FREQ. (MHz)	EMISSION LEVEL (dBuV/m)	LIMIT (dBuV/m)	MARGIN (dB)	ANTENNA HEIGHT (m)	TABLE ANGLE (Degree)	RAW VALUE (dBuV)	CORRECTION FACTOR (dB/m)
1	#5575.18	61.6 PK	68.2	-6.6	3.52 H	47	59.3	2.3
2	*5785.00	104.9 PK			3.52 H	47	102.2	2.7
3	*5785.00	95.1 AV			3.52 H	47	92.4	2.7
4	#5971.80	61.2 PK	68.2	-7.0	3.52 H	47	58.2	3.0
5	11570.00	57.2 PK	74.0	-16.8	1.43 H	29	44.1	13.1
6	11570.00	45.8 AV	54.0	-8.2	1.43 H	29	32.7	13.1
7	#17355.00	58.1 PK	74.0	-15.9	1.50 H	323	39.3	18.8
8	#17355.00	45.9 AV	54.0	-8.1	1.50 H	323	27.1	18.8

**ANTENNA POLARITY & TEST DISTANCE: VERTICAL AT 3 M**

NO.	FREQ. (MHz)	EMISSION LEVEL (dBuV/m)	LIMIT (dBuV/m)	MARGIN (dB)	ANTENNA HEIGHT (m)	TABLE ANGLE (Degree)	RAW VALUE (dBuV)	CORRECTION FACTOR (dB/m)
1	#5553.32	63.9 PK	68.2	-4.3	1.91 V	185	61.6	2.3
2	*5785.00	122.3 PK			1.91 V	185	119.6	2.7
3	*5785.00	112.1 AV			1.91 V	185	109.4	2.7
4	#5934.75	61.7 PK	68.2	-6.5	1.91 V	185	58.8	2.9
5	11570.00	64.9 PK	74.0	-9.1	2.04 V	360	51.8	13.1
6	11570.00	52.1 AV	54.0	-1.9	2.04 V	360	39.0	13.1
7	#17355.00	57.0 PK	74.0	-17.0	2.02 V	326	38.2	18.8
8	#17355.00	45.1 AV	54.0	-8.9	2.02 V	326	26.3	18.8

**REMARKS:**

1. Emission Level(dBuV/m) = Raw Value(dBuV) + Correction Factor(dB/m)
2. Correction Factor(dB/m) = Antenna Factor(dB/m) + Cable Factor(dB) – Pre-Amplifier Factor(dB)
3. The other emission levels were very low against the limit.
4. Margin value = Emission Level – Limit value
5. " \* ": Fundamental frequency.
6. " # ": The radiated frequency is out of the restricted band.

<b>CHANNEL</b>	TX Channel 165	<b>DETECTOR FUNCTION</b>	Peak (PK)
<b>FREQUENCY RANGE</b>	1GHz ~ 40GHz		Average (AV)

**ANTENNA POLARITY & TEST DISTANCE: HORIZONTAL AT 3 M**

NO.	FREQ. (MHz)	EMISSION LEVEL (dBuV/m)	LIMIT (dBuV/m)	MARGIN (dB)	ANTENNA HEIGHT (m)	TABLE ANGLE (Degree)	RAW VALUE (dBuV)	CORRECTION FACTOR (dB/m)
1	#5591.32	60.8 PK	68.2	-7.4	3.51 H	69	58.5	2.3
2	*5825.00	104.7 PK			3.51 H	69	102.0	2.7
3	*5825.00	94.8 AV			3.51 H	69	92.1	2.7
4	#5991.75	61.5 PK	68.2	-6.7	3.51 H	69	58.2	3.3
5	11650.00	57.3 PK	74.0	-16.7	1.52 H	49	44.2	13.1
6	11650.00	45.8 AV	54.0	-8.2	1.52 H	49	32.7	13.1
7	#17475.00	58.4 PK	74.0	-15.6	1.45 H	323	39.2	19.2
8	#17475.00	46.3 AV	54.0	-7.7	1.45 H	323	27.1	19.2

**ANTENNA POLARITY & TEST DISTANCE: VERTICAL AT 3 M**

NO.	FREQ. (MHz)	EMISSION LEVEL (dBuV/m)	LIMIT (dBuV/m)	MARGIN (dB)	ANTENNA HEIGHT (m)	TABLE ANGLE (Degree)	RAW VALUE (dBuV)	CORRECTION FACTOR (dB/m)
1	#5595.12	62.0 PK	68.2	-6.2	1.92 V	176	59.7	2.3
2	*5825.00	122.1 PK			1.92 V	176	119.4	2.7
3	*5825.00	111.8 AV			1.92 V	176	109.1	2.7
4	#5936.18	62.0 PK	68.2	-6.2	1.92 V	176	59.1	2.9
5	11650.00	64.6 PK	74.0	-9.4	2.00 V	360	51.5	13.1
6	11650.00	52.0 AV	54.0	-2.0	2.00 V	360	38.9	13.1
7	#17475.00	57.2 PK	74.0	-16.8	1.97 V	330	38.0	19.2
8	#17475.00	45.3 AV	54.0	-8.7	1.97 V	330	26.1	19.2

**REMARKS:**

1. Emission Level(dBuV/m) = Raw Value(dBuV) + Correction Factor(dB/m)
2. Correction Factor(dB/m) = Antenna Factor(dB/m) + Cable Factor(dB) – Pre-Amplifier Factor(dB)
3. The other emission levels were very low against the limit.
4. Margin value = Emission Level – Limit value
5. " \* ": Fundamental frequency.
6. " # ": The radiated frequency is out of the restricted band.

**802.11ac (VHT40)**

<b>CHANNEL</b>	TX Channel 38	<b>DETECTOR FUNCTION</b>	Peak (PK)
<b>FREQUENCY RANGE</b>	1GHz ~ 40GHz		Average (AV)

**ANTENNA POLARITY & TEST DISTANCE: HORIZONTAL AT 3 M**

NO.	FREQ. (MHz)	EMISSION LEVEL (dBuV/m)	LIMIT (dBuV/m)	MARGIN (dB)	ANTENNA HEIGHT (m)	TABLE ANGLE (Degree)	RAW VALUE (dBuV)	CORRECTION FACTOR (dB/m)
1	5150.00	60.2 PK	74.0	-13.8	3.50 H	54	58.7	1.5
2	5150.00	45.1 AV	54.0	-8.9	3.50 H	54	43.6	1.5
3	*5190.00	91.0 PK			3.50 H	54	89.3	1.7
4	*5190.00	83.3 AV			3.50 H	54	81.6	1.7
5	5350.00	52.3 PK	74.0	-21.7	3.50 H	54	50.4	1.9
6	5350.00	40.1 AV	54.0	-13.9	3.50 H	54	38.2	1.9
7	#10380.00	57.3 PK	74.0	-16.7	1.60 H	20	45.8	11.5
8	#10380.00	45.4 AV	54.0	-8.6	1.60 H	20	33.9	11.5
9	15570.00	53.2 PK	74.0	-20.8	1.45 H	306	40.1	13.1
10	15570.00	40.4 AV	54.0	-13.6	1.45 H	306	27.3	13.1

**ANTENNA POLARITY & TEST DISTANCE: VERTICAL AT 3 M**

NO.	FREQ. (MHz)	EMISSION LEVEL (dBuV/m)	LIMIT (dBuV/m)	MARGIN (dB)	ANTENNA HEIGHT (m)	TABLE ANGLE (Degree)	RAW VALUE (dBuV)	CORRECTION FACTOR (dB/m)
1	5150.00	64.0 PK	74.0	-10.0	2.26 V	183	62.5	1.5
2	5150.00	49.5 AV	54.0	-4.5	2.26 V	183	48.0	1.5
3	*5190.00	109.5 PK			2.26 V	183	107.8	1.7
4	*5190.00	99.8 AV			2.26 V	183	98.1	1.7
5	5350.00	56.5 PK	74.0	-17.5	2.26 V	183	54.6	1.9
6	5350.00	44.6 AV	54.0	-9.4	2.26 V	183	42.7	1.9
7	#10380.00	61.5 PK	74.0	-12.5	1.49 V	164	50.0	11.5
8	#10380.00	49.4 AV	54.0	-4.6	1.49 V	164	37.9	11.5
9	15570.00	57.3 PK	74.0	-16.7	3.15 V	190	44.2	13.1
10	15570.00	45.5 AV	54.0	-8.5	3.15 V	190	32.4	13.1

**REMARKS:**

- Emission Level(dBuV/m) = Raw Value(dBuV) + Correction Factor(dB/m)
- Correction Factor(dB/m) = Antenna Factor(dB/m) + Cable Factor(dB) – Pre-Amplifier Factor(dB)
- The other emission levels were very low against the limit.
- Margin value = Emission Level – Limit value
- " \* ": Fundamental frequency.
- " # ": The radiated frequency is out of the restricted band.

<b>CHANNEL</b>	TX Channel 46	<b>DETECTOR FUNCTION</b>	Peak (PK)
<b>FREQUENCY RANGE</b>	1GHz ~ 40GHz		Average (AV)

**ANTENNA POLARITY & TEST DISTANCE: HORIZONTAL AT 3 M**

NO.	FREQ. (MHz)	EMISSION LEVEL (dBuV/m)	LIMIT (dBuV/m)	MARGIN (dB)	ANTENNA HEIGHT (m)	TABLE ANGLE (Degree)	RAW VALUE (dBuV)	CORRECTION FACTOR (dB/m)
1	*5230.00	100.0 PK			3.44 H	56	98.4	1.6
2	*5230.00	89.6 AV			3.44 H	56	88.0	1.6
3	5350.00	57.3 PK	74.0	-16.7	3.44 H	56	55.4	1.9
4	5350.00	44.3 AV	54.0	-9.7	3.44 H	56	42.4	1.9
5	#10460.00	57.7 PK	74.0	-16.3	1.62 H	17	45.8	11.9
6	#10460.00	45.6 AV	54.0	-8.4	1.62 H	17	33.7	11.9
7	15690.00	53.4 PK	74.0	-20.6	1.42 H	309	40.1	13.3
8	15690.00	40.4 AV	54.0	-13.6	1.42 H	309	27.1	13.3

**ANTENNA POLARITY & TEST DISTANCE: VERTICAL AT 3 M**

NO.	FREQ. (MHz)	EMISSION LEVEL (dBuV/m)	LIMIT (dBuV/m)	MARGIN (dB)	ANTENNA HEIGHT (m)	TABLE ANGLE (Degree)	RAW VALUE (dBuV)	CORRECTION FACTOR (dB/m)
1	*5230.00	116.2 PK			2.26 V	184	114.6	1.6
2	*5230.00	106.1 AV			2.26 V	184	104.5	1.6
3	5350.00	61.3 PK	74.0	-12.7	2.26 V	184	59.4	1.9
4	5350.00	48.1 AV	54.0	-5.9	2.26 V	184	46.2	1.9
5	#10460.00	61.4 PK	74.0	-12.6	1.49 V	151	49.5	11.9
6	#10460.00	49.6 AV	54.0	-4.4	1.49 V	151	37.7	11.9
7	15690.00	57.6 PK	74.0	-16.4	3.19 V	200	44.3	13.3
8	15690.00	45.5 AV	54.0	-8.5	3.19 V	200	32.2	13.3

**REMARKS:**

1. Emission Level(dBuV/m) = Raw Value(dBuV) + Correction Factor(dB/m)
2. Correction Factor(dB/m) = Antenna Factor(dB/m) + Cable Factor(dB) – Pre-Amplifier Factor(dB)
3. The other emission levels were very low against the limit.
4. Margin value = Emission Level – Limit value
5. " \* ": Fundamental frequency.
6. " # ": The radiated frequency is out of the restricted band.

<b>CHANNEL</b>	TX Channel 151	<b>DETECTOR FUNCTION</b>	Peak (PK)
<b>FREQUENCY RANGE</b>	1GHz ~ 40GHz		Average (AV)

**ANTENNA POLARITY & TEST DISTANCE: HORIZONTAL AT 3 M**

NO.	FREQ. (MHz)	EMISSION LEVEL (dBuV/m)	LIMIT (dBuV/m)	MARGIN (dB)	ANTENNA HEIGHT (m)	TABLE ANGLE (Degree)	RAW VALUE (dBuV)	CORRECTION FACTOR (dB/m)
1	#5614.12	64.7 PK	68.2	-3.5	3.50 H	60	62.2	2.5
2	*5755.00	105.2 PK			3.50 H	60	102.5	2.7
3	*5755.00	93.6 AV			3.50 H	60	90.9	2.7
4	#5951.37	63.9 PK	68.2	-4.3	3.50 H	60	60.9	3.0
5	11510.00	54.4 PK	74.0	-19.6	1.57 H	39	41.0	13.4
6	11510.00	42.2 AV	54.0	-11.8	1.57 H	39	28.8	13.4
7	#17265.00	56.1 PK	74.0	-17.9	1.51 H	319	37.8	18.3
8	#17265.00	43.2 AV	54.0	-10.8	1.51 H	319	24.9	18.3

**ANTENNA POLARITY & TEST DISTANCE: VERTICAL AT 3 M**

NO.	FREQ. (MHz)	EMISSION LEVEL (dBuV/m)	LIMIT (dBuV/m)	MARGIN (dB)	ANTENNA HEIGHT (m)	TABLE ANGLE (Degree)	RAW VALUE (dBuV)	CORRECTION FACTOR (dB/m)
1	#5649.27	68.1 PK	68.2	-0.1	1.92 V	182	65.6	2.5
2	*5755.00	121.3 PK			1.92 V	182	118.6	2.7
3	*5755.00	109.7 AV			1.92 V	182	107.0	2.7
4	#5940.93	62.5 PK	68.2	-5.7	1.92 V	182	59.6	2.9
5	11510.00	62.1 PK	74.0	-11.9	2.00 V	360	48.7	13.4
6	11510.00	49.4 AV	54.0	-4.6	2.00 V	360	36.0	13.4
7	#17265.00	54.7 PK	74.0	-19.3	1.99 V	320	36.4	18.3
8	#17265.00	41.3 AV	54.0	-12.7	1.99 V	320	23.0	18.3

**REMARKS:**

1. Emission Level(dBuV/m) = Raw Value(dBuV) + Correction Factor(dB/m)
2. Correction Factor(dB/m) = Antenna Factor(dB/m) + Cable Factor(dB) – Pre-Amplifier Factor(dB)
3. The other emission levels were very low against the limit.
4. Margin value = Emission Level – Limit value
5. " \* ": Fundamental frequency.
6. " # ": The radiated frequency is out of the restricted band.

<b>CHANNEL</b>	TX Channel 159	<b>DETECTOR FUNCTION</b>	Peak (PK)
<b>FREQUENCY RANGE</b>	1GHz ~ 40GHz		Average (AV)

**ANTENNA POLARITY & TEST DISTANCE: HORIZONTAL AT 3 M**

NO.	FREQ. (MHz)	EMISSION LEVEL (dBuV/m)	LIMIT (dBuV/m)	MARGIN (dB)	ANTENNA HEIGHT (m)	TABLE ANGLE (Degree)	RAW VALUE (dBuV)	CORRECTION FACTOR (dB/m)
1	#5596.07	63.4 PK	68.2	-4.8	3.53 H	75	61.1	2.3
2	*5795.00	105.6 PK			3.53 H	75	102.9	2.7
3	*5795.00	93.8 AV			3.53 H	75	91.1	2.7
4	#5996.02	64.2 PK	68.2	-4.0	3.53 H	75	60.9	3.3
5	11590.00	54.8 PK	74.0	-19.2	1.57 H	35	41.8	13.0
6	11590.00	42.6 AV	54.0	-11.4	1.57 H	35	29.6	13.0
7	#17385.00	56.2 PK	74.0	-17.8	1.54 H	324	37.2	19.0
8	#17385.00	43.5 AV	54.0	-10.5	1.54 H	324	24.5	19.0

**ANTENNA POLARITY & TEST DISTANCE: VERTICAL AT 3 M**

NO.	FREQ. (MHz)	EMISSION LEVEL (dBuV/m)	LIMIT (dBuV/m)	MARGIN (dB)	ANTENNA HEIGHT (m)	TABLE ANGLE (Degree)	RAW VALUE (dBuV)	CORRECTION FACTOR (dB/m)
1	#5647.37	64.0 PK	68.2	-4.2	1.92 V	181	61.5	2.5
2	*5795.00	120.6 PK			1.92 V	181	117.9	2.7
3	*5795.00	109.6 AV			1.92 V	181	106.9	2.7
4	#5932.85	67.7 PK	68.2	-0.5	1.92 V	181	64.8	2.9
5	11590.00	62.1 PK	74.0	-11.9	2.00 V	360	49.1	13.0
6	11590.00	49.5 AV	54.0	-4.5	2.00 V	360	36.5	13.0
7	#17385.00	54.6 PK	74.0	-19.4	2.03 V	315	35.6	19.0
8	#17385.00	41.0 AV	54.0	-13.0	2.03 V	315	22.0	19.0

**REMARKS:**

1. Emission Level(dBuV/m) = Raw Value(dBuV) + Correction Factor(dB/m)
2. Correction Factor(dB/m) = Antenna Factor(dB/m) + Cable Factor(dB) – Pre-Amplifier Factor(dB)
3. The other emission levels were very low against the limit.
4. Margin value = Emission Level – Limit value
5. " \* ": Fundamental frequency.
6. " # ": The radiated frequency is out of the restricted band.

**802.11ac (VHT80)**

<b>CHANNEL</b>	TX Channel 42	<b>DETECTOR FUNCTION</b>	Peak (PK)
<b>FREQUENCY RANGE</b>	1GHz ~ 40GHz		Average (AV)

**ANTENNA POLARITY & TEST DISTANCE: HORIZONTAL AT 3 M**

NO.	FREQ. (MHz)	EMISSION LEVEL (dBuV/m)	LIMIT (dBuV/m)	MARGIN (dB)	ANTENNA HEIGHT (m)	TABLE ANGLE (Degree)	RAW VALUE (dBuV)	CORRECTION FACTOR (dB/m)
1	5150.00	62.4 PK	74.0	-11.6	3.48 H	51	60.9	1.5
2	5150.00	49.2 AV	54.0	-4.8	3.48 H	51	47.7	1.5
3	*5210.00	91.6 PK			3.48 H	51	89.9	1.7
4	*5210.00	83.7 AV			3.48 H	51	82.0	1.7
5	5350.00	55.2 PK	74.0	-18.8	3.48 H	51	53.3	1.9
6	5350.00	43.2 AV	54.0	-10.8	3.48 H	51	41.3	1.9
7	#10420.00	55.1 PK	74.0	-18.9	1.64 H	18	43.4	11.7
8	#10420.00	43.4 AV	54.0	-10.6	1.64 H	18	31.7	11.7
9	15630.00	51.3 PK	74.0	-22.7	1.49 H	306	38.1	13.2
10	15630.00	38.4 AV	54.0	-15.6	1.49 H	306	25.2	13.2

**ANTENNA POLARITY & TEST DISTANCE: VERTICAL AT 3 M**

NO.	FREQ. (MHz)	EMISSION LEVEL (dBuV/m)	LIMIT (dBuV/m)	MARGIN (dB)	ANTENNA HEIGHT (m)	TABLE ANGLE (Degree)	RAW VALUE (dBuV)	CORRECTION FACTOR (dB/m)
1	5150.00	66.6 PK	74.0	-7.4	2.26 V	184	65.1	1.5
2	5150.00	53.3 AV	54.0	-0.7	2.26 V	184	51.8	1.5
3	*5210.00	107.9 PK			2.26 V	184	106.2	1.7
4	*5210.00	97.6 AV			2.26 V	184	95.9	1.7
5	5350.00	59.5 PK	74.0	-14.5	2.26 V	184	57.6	1.9
6	5350.00	47.9 AV	54.0	-6.1	2.26 V	184	46.0	1.9
7	#10420.00	59.4 PK	74.0	-14.6	1.50 V	174	47.7	11.7
8	#10420.00	47.5 AV	54.0	-6.5	1.50 V	174	35.8	11.7
9	15630.00	55.4 PK	74.0	-18.6	3.17 V	183	42.2	13.2
10	15630.00	43.2 AV	54.0	-10.8	3.17 V	183	30.0	13.2

**REMARKS:**

1. Emission Level(dBuV/m) = Raw Value(dBuV) + Correction Factor(dB/m)
2. Correction Factor(dB/m) = Antenna Factor(dB/m) + Cable Factor(dB) – Pre-Amplifier Factor(dB)
3. The other emission levels were very low against the limit.
4. Margin value = Emission Level – Limit value
5. " \* ": Fundamental frequency.
6. " # ": The radiated frequency is out of the restricted band.



<b>CHANNEL</b>	TX Channel 155	<b>DETECTOR FUNCTION</b>	Peak (PK)
<b>FREQUENCY RANGE</b>	1GHz ~ 40GHz		Average (AV)

**ANTENNA POLARITY & TEST DISTANCE: HORIZONTAL AT 3 M**

NO.	FREQ. (MHz)	EMISSION LEVEL (dBuV/m)	LIMIT (dBuV/m)	MARGIN (dB)	ANTENNA HEIGHT (m)	TABLE ANGLE (Degree)	RAW VALUE (dBuV)	CORRECTION FACTOR (dB/m)
1	#5549.00	59.8 PK	74.0	-14.2	3.52 H	54	57.5	2.3
2	#5549.00	49.4 AV	54.0	-4.6	3.52 H	54	47.1	2.3
3	#5648.32	62.4 PK	68.2	-5.8	3.52 H	54	59.9	2.5
4	*5775.00	97.5 PK			3.52 H	54	94.8	2.7
5	*5775.00	87.7 AV			3.52 H	54	85.0	2.7
6	#5940.45	62.9 PK	68.2	-5.3	3.52 H	54	60.0	2.9
7	#6026.00	57.2 PK	74.0	-16.8	3.52 H	54	53.8	3.4
8	#6026.00	48.9 AV	54.0	-5.1	3.52 H	54	45.5	3.4
9	11550.00	52.2 PK	74.0	-21.8	1.54 H	20	39.0	13.2
10	11550.00	40.5 AV	54.0	-13.5	1.54 H	20	27.3	13.2
11	#17325.00	53.3 PK	74.0	-20.7	1.55 H	316	34.7	18.6
12	#17325.00	41.6 AV	54.0	-12.4	1.55 H	316	23.0	18.6

**ANTENNA POLARITY & TEST DISTANCE: VERTICAL AT 3 M**

NO.	FREQ. (MHz)	EMISSION LEVEL (dBuV/m)	LIMIT (dBuV/m)	MARGIN (dB)	ANTENNA HEIGHT (m)	TABLE ANGLE (Degree)	RAW VALUE (dBuV)	CORRECTION FACTOR (dB/m)
1	#5549.00	64.4 PK	74.0	-9.6	1.69 V	357	62.1	2.3
2	#5549.00	53.6 AV	54.0	-0.4	1.69 V	357	51.3	2.3
3	#5615.55	65.2 PK	68.2	-3.0	1.69 V	357	62.7	2.5
4	#5630.75	66.1 PK	68.2	-2.1	1.69 V	357	63.6	2.5
5	#5691.55	85.4 PK	99.0	-13.6	1.69 V	357	82.7	2.7
6	*5775.00	113.6 PK			1.69 V	357	110.9	2.7
7	*5775.00	103.8 AV			1.69 V	357	101.1	2.7
8	#5932.37	65.4 PK	68.2	-2.8	1.69 V	357	62.5	2.9
9	#5952.32	62.6 PK	68.2	-5.6	1.69 V	357	59.6	3.0
10	#6026.00	61.8 PK	74.0	-12.2	1.69 V	357	58.4	3.4
11	#6026.00	53.1 AV	54.0	-0.9	1.69 V	357	49.7	3.4
12	11550.00	59.3 PK	74.0	-14.7	1.96 V	360	46.1	13.2
13	11550.00	47.2 AV	54.0	-6.8	1.96 V	360	34.0	13.2
14	#17325.00	52.4 PK	74.0	-21.6	2.01 V	330	33.8	18.6
15	#17325.00	39.6 AV	54.0	-14.4	2.01 V	330	21.0	18.6

**REMARKS:**

1. Emission Level(dBuV/m) = Raw Value(dBuV) + Correction Factor(dB/m)
2. Correction Factor(dB/m) = Antenna Factor(dB/m) + Cable Factor(dB) – Pre-Amplifier Factor(dB)
3. The other emission levels were very low against the limit.
4. Margin value = Emission Level – Limit value
5. " \* ": Fundamental frequency.
6. " # ": The radiated frequency is out of the restricted band.

**Below 1GHz Data:**

**802.11ac (VHT20)**

<b>CHANNEL</b>	TX Channel 157	<b>DETECTOR FUNCTION</b>	Quasi-Peak (QP)
<b>FREQUENCY RANGE</b>	9kHz ~ 1GHz		

**ANTENNA POLARITY & TEST DISTANCE: HORIZONTAL AT 3 M**

NO.	FREQ. (MHz)	EMISSION LEVEL (dBuV/m)	LIMIT (dBuV/m)	MARGIN (dB)	ANTENNA HEIGHT (m)	TABLE ANGLE (Degree)	RAW VALUE (dBuV)	CORRECTION FACTOR (dB/m)
1	35.77	33.6 QP	40.0	-6.4	1.00 H	110	43.2	-9.6
2	146.10	35.3 QP	43.5	-8.2	1.00 H	310	43.9	-8.6
3	239.90	38.6 QP	46.0	-7.4	1.50 H	130	48.9	-10.3
4	359.90	37.8 QP	46.0	-8.2	1.50 H	310	44.3	-6.5
5	625.00	39.8 QP	46.0	-6.2	1.50 H	40	39.8	0.0
6	750.00	39.4 QP	46.0	-6.6	1.00 H	320	37.5	1.9

**ANTENNA POLARITY & TEST DISTANCE: VERTICAL AT 3 M**

NO.	FREQ. (MHz)	EMISSION LEVEL (dBuV/m)	LIMIT (dBuV/m)	MARGIN (dB)	ANTENNA HEIGHT (m)	TABLE ANGLE (Degree)	RAW VALUE (dBuV)	CORRECTION FACTOR (dB/m)
1	42.70	36.9 QP	40.0	-3.1	1.00 V	350	45.8	-8.9
2	240.00	39.8 QP	46.0	-6.2	1.20 V	105	50.1	-10.3
3	360.00	39.4 QP	46.0	-6.6	1.50 V	101	45.9	-6.5
4	520.00	42.3 QP	46.0	-3.7	1.00 V	144	44.6	-2.3
5	625.00	42.8 QP	46.0	-3.2	1.00 V	300	42.8	0.0
6	1000.00	46.6 QP	54.0	-7.4	1.00 V	160	41.7	4.9

**REMARKS:**

1. Emission Level(dBuV/m) = Raw Value(dBuV) + Correction Factor(dB/m)
2. Correction Factor(dB/m) = Antenna Factor(dB/m) + Cable Factor(dB) – Pre-Amplifier Factor(dB)
3. The other emission levels were very low against the limit.
4. Margin value = Emission Level – Limit value

## 4.2 Conducted Emission Measurement

### 4.2.1 Limits of Conducted Emission Measurement

Frequency (MHz)	Conducted Limit (dBuV)	
	Quasi-peak	Average
0.15 - 0.5	66 - 56	56 - 46
0.50 - 5.0	56	46
5.0 - 30.0	60	50

Note: 1. The lower limit shall apply at the transition frequencies.

2. The limit decreases in line with the logarithm of the frequency in the range of 0.15 to 0.50MHz.

### 4.2.2 Test Instruments

DESCRIPTION & MANUFACTURER	MODEL NO.	SERIAL NO.	CALIBRATED DATE	CALIBRATED UNTIL
Test Receiver R&S	ESCS 30	100375	May 09, 2016	May 08, 2017
Line-Impedance Stabilization Network (for EUT) SCHWARZBECK	NSLK-8127	8127-522	Aug. 31, 2016	Aug. 30, 2017
Line-Impedance Stabilization Network (for Peripheral ) R&S	ENV216	100072	June 13, 2016	June 12, 2017
RF Cable	5D-FB	COACAB-002	Mar. 04, 2016	Mar. 03, 2017
10 dB PAD Mini-Circuits	HAT-10+	CONATT-003	Sep. 13, 2016	Sep. 12, 2017
50 ohms Terminator	N/A	EMC-03	Sep. 29, 2016	Sep. 28, 2017
50 ohms Terminator	N/A	EMC-02	Sep. 29, 2016	Sep. 28, 2017
Software BVADT	BVADT_Cond_ V7.3.7.4	NA	NA	NA

**Note:**

1. The calibration interval of the above test instruments are 12 months and the calibrations are traceable to NML/ROC and NIST/USA.
2. The test was performed in Shielded Room No. C.
- 3 The VCCI Con C Registration No. is C-3611.
- 4 Tested Date: Nov. 01, 2016

#### 4.2.3 Test Procedure

- The EUT was placed 0.4 meters from the conducting wall of the shielded room with EUT being connected to the power mains through a line impedance stabilization network (LISN). Other support units were connected to the power mains through another LISN. The two LISNs provide 50 ohm/ 50uH of coupling impedance for the measuring instrument.
- Both lines of the power mains connected to the EUT were checked for maximum conducted interference.
- The frequency range from 150kHz to 30MHz was searched. Emission levels under (Limit - 20dB) was not recorded.

**NOTE:** All modes of operation were investigated and the worst-case emissions are reported.

#### 4.2.4 Deviation from Test Standard

No deviation.

#### 4.2.5 Test Setup

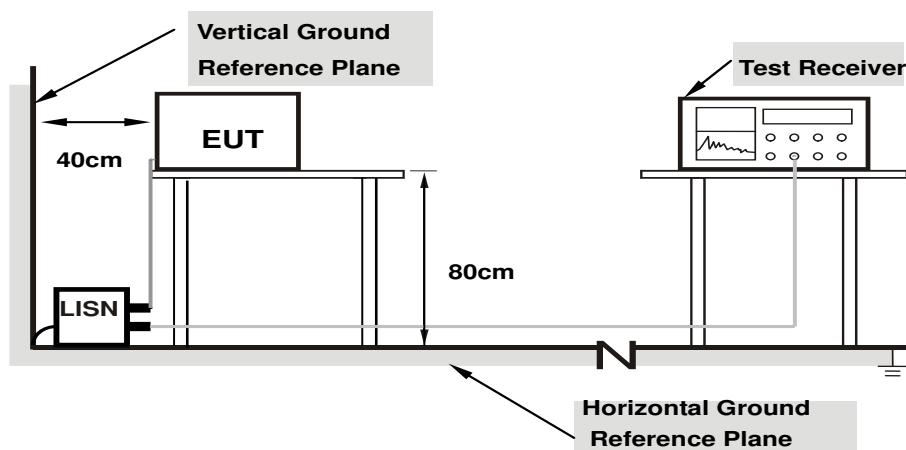

**Note: 1.Support units were connected to second LISN.**

For the actual test configuration, please refer to the attached file (Test Setup Photo).

#### 4.2.6 EUT Operating Condition

Same as 4.1.6.

#### 4.2.7 Test Results

Phase	Line (L)	Detector Function	Quasi-Peak (QP) / Average (AV)
-------	----------	-------------------	--------------------------------

No	Freq. [MHz]	Corr.	Reading Value		Emission Level		Limit		Margin	
		Factor (dB)	[dB (uV)]		[dB (uV)]		[dB (uV)]		(dB)	
			Q.P.	AV.	Q.P.	AV.	Q.P.	AV.	Q.P.	AV.
1	0.15000	10.14	47.08	34.47	57.22	44.61	66.00	56.00	-8.78	-11.39
2	0.18906	10.12	41.12	29.69	51.24	39.81	64.08	54.08	-12.84	-14.27
3	0.22812	10.12	35.03	22.34	45.15	32.46	62.52	52.52	-17.37	-20.06
4	0.35313	10.11	25.04	13.23	35.15	23.34	58.89	48.89	-23.74	-25.55
5	0.56797	10.11	27.68	21.91	37.79	32.02	56.00	46.00	-18.21	-13.98
6	13.21094	10.56	26.30	19.74	36.86	30.30	60.00	50.00	-23.14	-19.70

#### REMARKS:

1. Q.P. and AV. are abbreviations of quasi-peak and average individually.
2. The emission levels of other frequencies were very low against the limit.
3. Margin value = Emission level - Limit value
4. Correction factor = Insertion loss + Cable loss
5. Emission Level = Correction Factor + Reading Value.

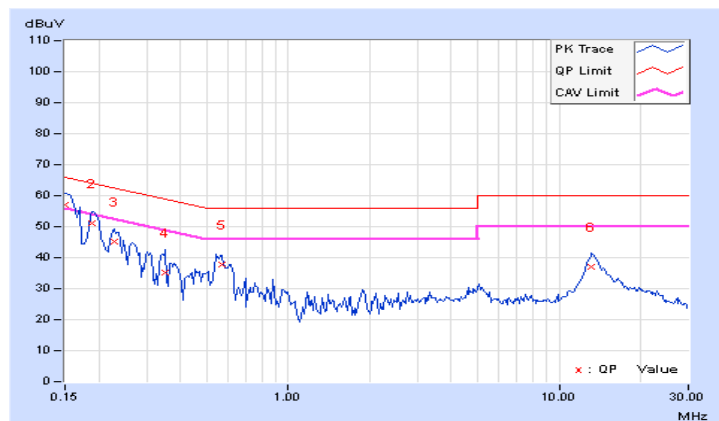

Phase	Neutral (N)	Detector Function	Quasi-Peak (QP) / Average (AV)
-------	-------------	-------------------	--------------------------------

No	Freq.	Corr.	Reading Value		Emission Level		Limit		Margin	
	[MHz]	Factor	[dB (uV)]		[dB (uV)]		[dB (uV)]		(dB)	
		(dB)	Q.P.	AV.	Q.P.	AV.	Q.P.	AV.	Q.P.	AV.
<b>1</b>	<b>0.15000</b>	<b>10.19</b>	<b>47.38</b>	<b>35.80</b>	<b>57.57</b>	<b>45.99</b>	<b>66.00</b>	<b>56.00</b>	<b>-8.43</b>	<b>-10.01</b>
2	0.18906	10.10	40.51	28.71	50.61	38.81	64.08	54.08	-13.47	-15.27
3	0.23203	10.07	33.95	22.54	44.02	32.61	62.38	52.38	-18.36	-19.77
4	0.34531	10.08	27.96	19.45	38.04	29.53	59.07	49.07	-21.03	-19.54
5	0.55234	10.12	26.46	16.48	36.58	26.60	56.00	46.00	-19.42	-19.40
6	13.33984	10.61	26.33	19.72	36.94	30.33	60.00	50.00	-23.06	-19.67

**REMARKS:**

1. Q.P. and AV. are abbreviations of quasi-peak and average individually.
2. The emission levels of other frequencies were very low against the limit.
3. Margin value = Emission level - Limit value
4. Correction factor = Insertion loss + Cable loss
5. Emission Level = Correction Factor + Reading Value.

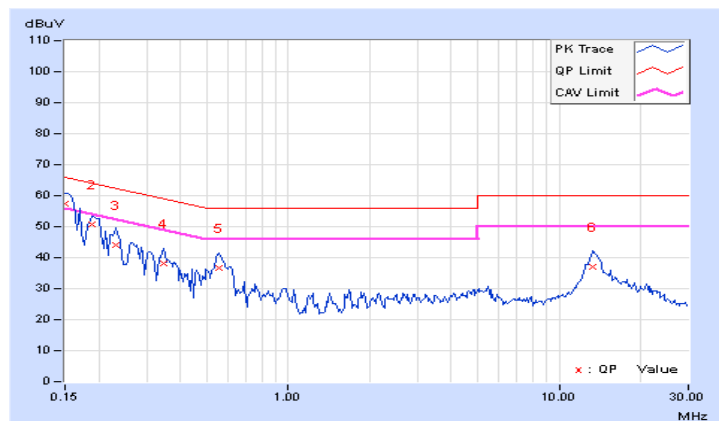

### 4.3 Transmit Power Measurement

#### 4.3.1 Limits of Transmit Power Measurement

Operation Band	EUT Category		Limit
U-NII-1		Outdoor Access Point	1 Watt (30 dBm) (Max. e.i.r.p $\leq$ 125mW(21 dBm) at any elevation angle above 30 degrees as measured from the horizon)
		Fixed point-to-point Access Point	1 Watt (30 dBm)
	√	Indoor Access Point	1 Watt (30 dBm)
		Mobile and Portable client device	250mW (24 dBm)
U-NII-2A			250mW (24 dBm) or 11 dBm+10 log B*
U-NII-2C			250mW (24 dBm) or 11 dBm+10 log B*
U-NII-3	√		1 Watt (30 dBm)

\*B is the 26 dB emission bandwidth in megahertz

Per KDB 662911 Method of conducted output power measurement on IEEE 802.11 devices,

Array Gain = 0 dB (i.e., no array gain) for  $N_{ANT} \leq 4$ ;

Array Gain = 0 dB (i.e., no array gain) for channel widths  $\geq 40$  MHz for any  $N_{ANT}$ ;

Array Gain =  $5 \log(N_{ANT}/N_{SS})$  dB or 3 dB, whichever is less for 20-MHz channel widths with  $N_{ANT} \geq 5$ .

For power measurements on all other devices: Array Gain =  $10 \log(N_{ANT}/N_{SS})$  dB.

#### 4.3.2 Test Setup

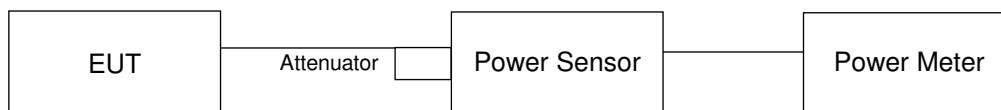

#### 4.3.3 Test Instruments

Refer to section 4.1.2 to get information of above instrument.

#### 4.3.4 Test Procedure

Method PM is used to perform output power measurement, trigger and gating function of wide band power meter is enabled to measure max output power of TX on burst. Duty factor is not added to measured value.

#### 4.3.5 Deviation from Test Standard

No deviation.

#### 4.3.6 EUT Operating Condition

The software provided by client to enable the EUT under transmission condition continuously at lowest, middle and highest channel frequencies individually.

## 4.3.7 Test Result

## 802.11a

CHAN.	FREQ. (MHz)	Maximum Conducted Power (dBm)		Total Power (mW)	Total Power (dBm)	Power Limit (dBm)	Pass/Fail
		CHAIN 0	CHAIN 1				
36	5180	17.62	8.38	64.697	18.11	30	Pass
40	5200	21.95	16.15	197.885	22.96	30	Pass
48	5240	18.84	10.85	88.722	19.48	30	Pass
149	5745	21.74	20.56	263.042	24.20	30	Pass
157	5785	21.57	20.22	248.745	23.96	30	Pass
165	5825	21.51	20.47	253.008	24.03	30	Pass

## 802.11ac (VHT20)

CHAN.	FREQ. (MHz)	Maximum Conducted Power (dBm)		Total Power (mW)	Total Power (dBm)	Power Limit (dBm)	Pass/Fail
		CHAIN 0	CHAIN 1				
36	5180	17.33	7.92	60.269	17.80	30	Pass
40	5200	21.75	16.16	190.929	22.81	30	Pass
48	5240	18.66	10.61	84.959	19.29	30	Pass
149	5745	21.71	20.52	260.972	24.17	30	Pass
157	5785	21.78	20.56	264.424	24.22	30	Pass
165	5825	21.53	20.69	259.453	24.14	30	Pass

## 802.11ac (VHT40)

CHAN.	FREQ. (MHz)	Maximum Conducted Power (dBm)		Total Power (mW)	Total Power (dBm)	Power Limit (dBm)	Pass/Fail
		CHAIN 0	CHAIN 1				
38	5190	12.24	9.71	26.103	14.17	30	Pass
46	5230	13.79	11.35	37.579	15.75	30	Pass
151	5755	20.70	20.61	232.57	23.67	30	Pass
159	5795	20.45	19.97	210.229	23.23	30	Pass



802.11ac (VHT80)

CHAN.	CHAN. FREQ. (MHz)	Maximum Conducted Power (dBm)		Total Power (mW)	Total Power (dBm)	Power Limit (dBm)	Pass/Fail
		CHAIN 0	CHAIN 1				
42	5210	11.70	9.09	22.901	13.60	30	Pass
155	5775	18.62	17.14	124.539	20.95	30	Pass

## 4.4 Occupied Bandwidth Measurement

### 4.4.1 Test Setup



### 4.4.2 Test Instruments

Refer to section 4.1.2 to get information of above instrument.

### 4.4.3 Test Procedure

The transmitter output was connected to the spectrum analyzer through an attenuator. The bandwidth of the fundamental frequency was measured by spectrum analyzer with resolution bandwidth in the range of 1% to 5% of the anticipated emission bandwidth, and a video bandwidth at least 3x the resolution bandwidth and set the detector to SAMPLE. The width of a frequency band such that, below the lower and above the upper frequency limits, the mean powers emitted are each equal to a specified percentage 0.5 %of the total mean power of a given emission.

#### 4.4.4 Test Results

##### 802.11a

Channel	Channel Frequency (MHz)	Occupied Bandwidth (MHz)	
		CHAIN 0	CHAIN 1
36	5180	16.80	16.68
40	5200	17.04	16.68
48	5240	16.80	16.68
149	5745	17.88	17.28
157	5785	19.08	17.28
165	5825	19.68	17.28

##### 802.11ac (VHT20)

Channel	Channel Frequency (MHz)	Occupied Bandwidth (MHz)	
		CHAIN 0	CHAIN 1
36	5180	17.88	17.88
40	5200	18.12	17.88
48	5240	16.80	17.88
149	5745	19.20	18.24
157	5785	19.56	18.24
165	5825	20.40	18.36

##### 802.11ac (VHT40)

Channel	Channel Frequency (MHz)	Occupied Bandwidth (MHz)	
		CHAIN 0	CHAIN 1
38	5190	36.96	36.72
46	5230	36.72	36.48
151	5755	37.20	37.20
159	5795	38.16	37.44

##### 802.11ac (VHT80)

Channel	Channel Frequency (MHz)	Occupied Bandwidth (MHz)	
		CHAIN 0	CHAIN 1
42	5210	75.84	75.84
155	5775	81.12	77.28

### Spectrum Plot of Worst Value

**802.11a\_Chain0 / CH165**

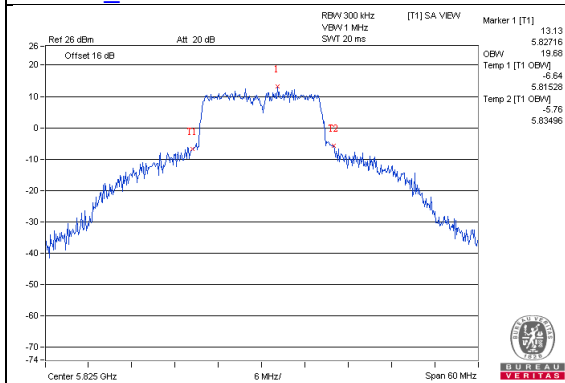

**802.11ac (VHT20)\_Chain0 / CH165**

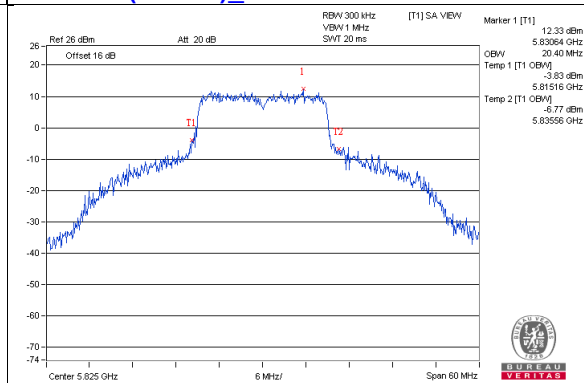

**802.11ac (VHT40)\_Chain0 / CH159**

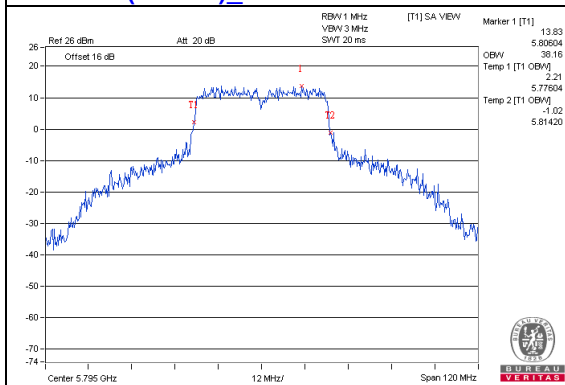

**802.11ac (VHT80)\_Chain0 / CH155**

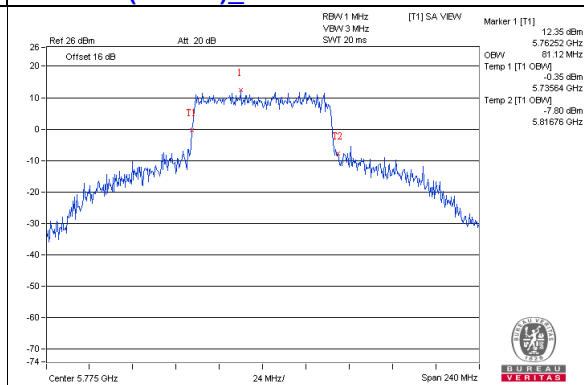

### Spectrum Plot for near by DFS band (DFS is required, if 99% OCP straddle into U-NII-2A band)

**802.11a\_Chain0 / CH48**

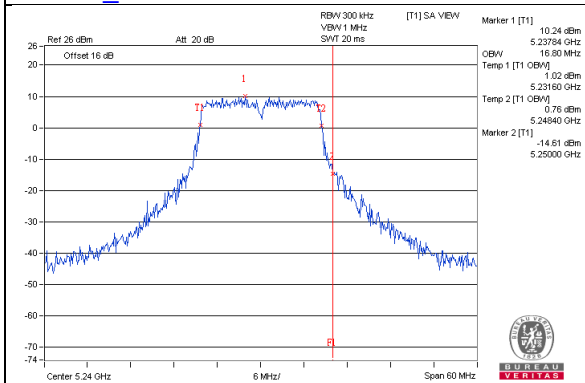

**802.11a\_Chain1 / CH48**

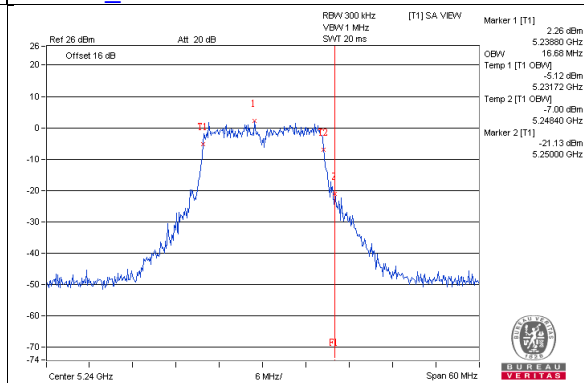

**802.11ac(VHT20)\_Chain0 / CH48**

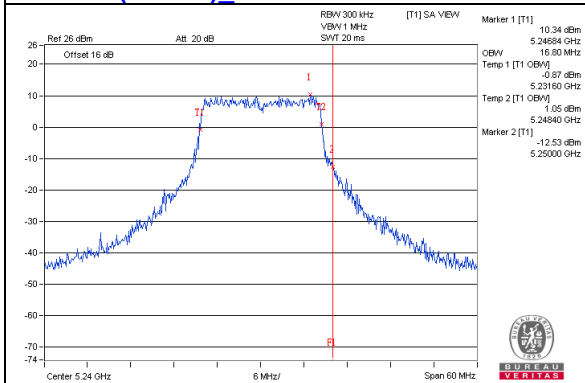

**802.11ac(VHT20)\_Chain1 / CH48**

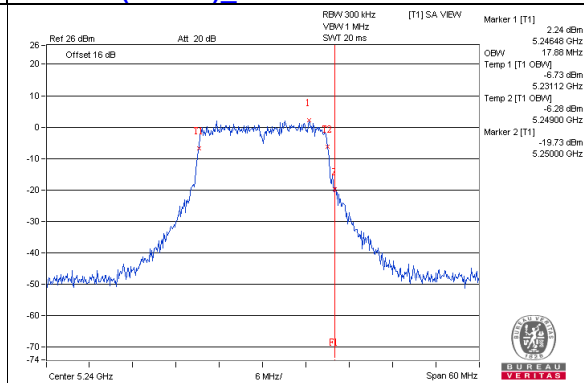

**802.11ac(VHT40)\_Chain0 / CH46**

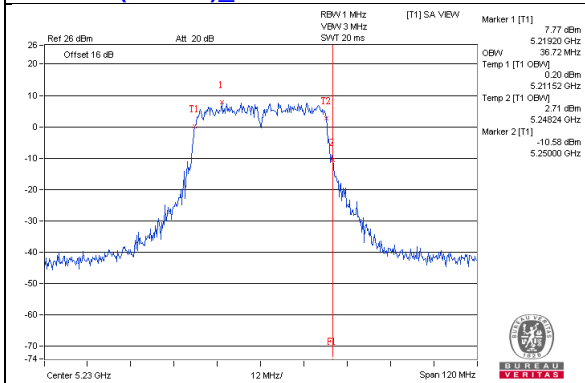

**802.11ac(VHT40)\_Chain1 / CH46**

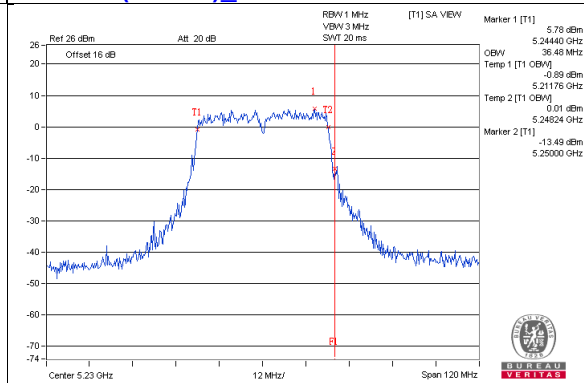

**802.11ac(VHT80)\_Chain0 / CH42**

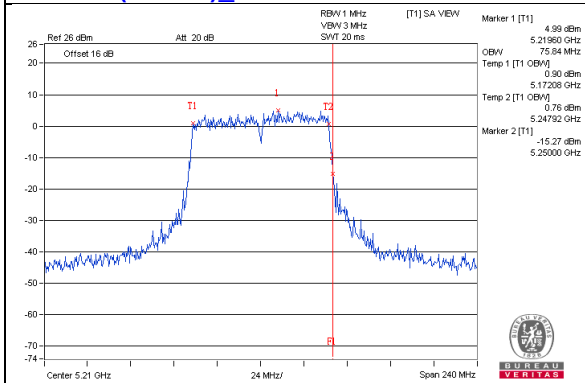

**802.11ac(VHT80)\_Chain1 / CH42**

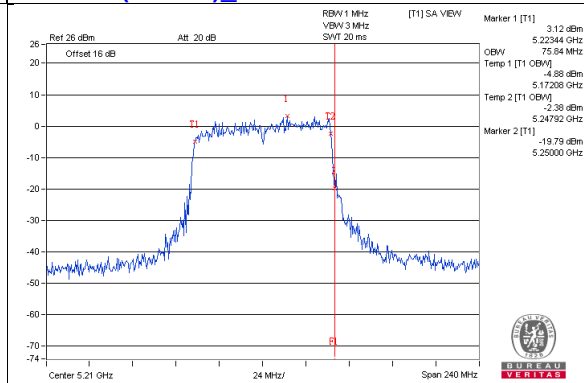

### Spectrum Plot for near by DFS band (DFS is required, if 99% OCP straddle into U-NII-2C band)

**802.11a\_Chain0 / CH149**

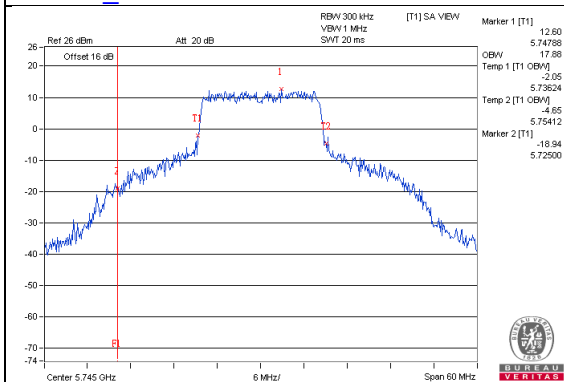

**802.11a\_Chain1 / CH149**

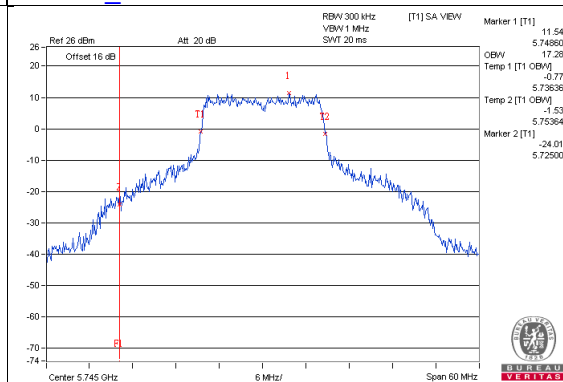

**802.11ac(VHT20)\_Chain0 / CH149**

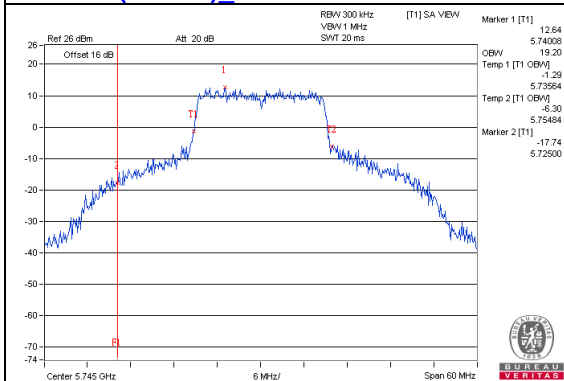

**802.11ac(VHT20)\_Chain1 / CH149**

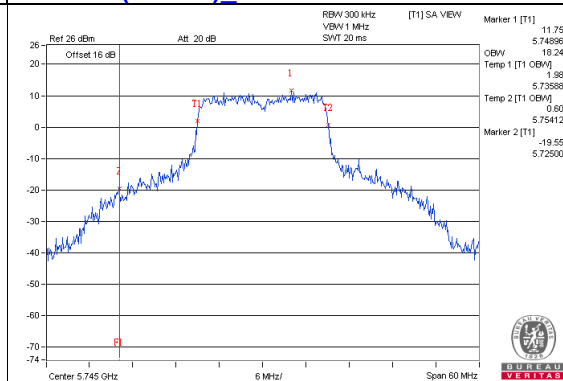

**802.11ac(VHT40)\_Chain0 / CH151**

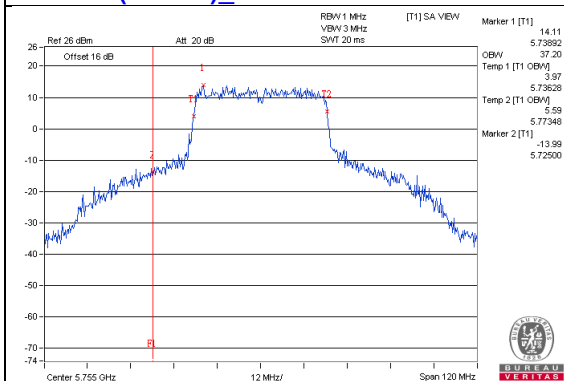

**802.11ac(VHT40)\_Chain1 / CH151**

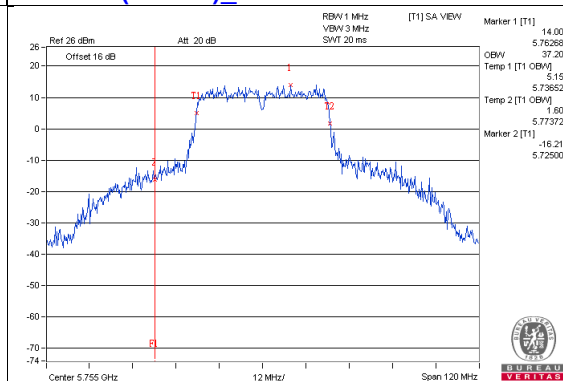

**802.11ac(VHT80)\_Chain0 / CH155**

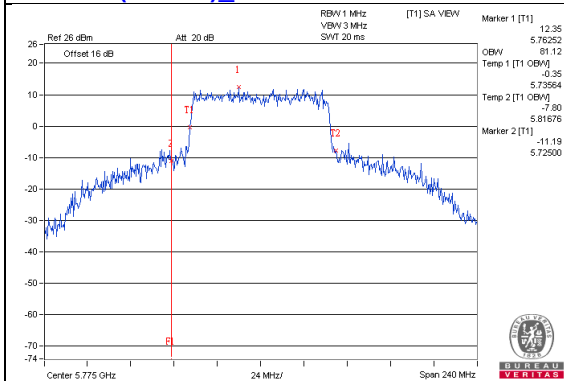

**802.11ac(VHT80)\_Chain1 / CH155**

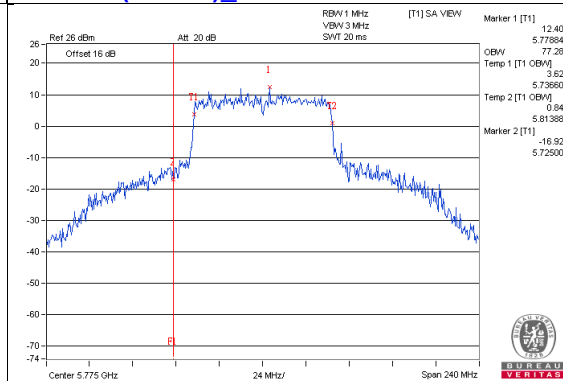

## 4.5 Peak Power Spectral Density Measurement

### 4.5.1 Limits of Peak Power Spectral Density Measurement

Operation Band	EUT Category		Limit
U-NII-1		Outdoor Access Point	17dBm/ MHz
		Fixed point-to-point Access Point	
	√	Indoor Access Point	
		Mobile and Portable client device	11dBm/ MHz
U-NII-2A			11dBm/ MHz
U-NII-2C			11dBm/ MHz
U-NII-3		√	30dBm/ 500kHz

### 4.5.2 Test Setup

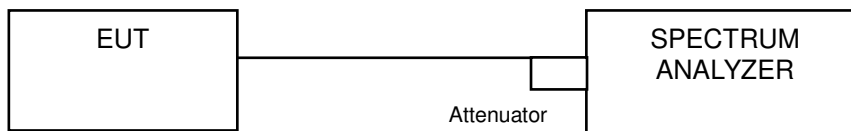

### 4.5.3 Test Instruments

Refer to section 4.1.2 to get information of above instrument.

### 4.5.4 Test Procedure

#### For U-NII-1:

Using method SA-2

1. Set span to encompass the entire emission bandwidth (EBW) of the signal.
2. Set RBW = 1 MHz, Set VBW ≥ 3 MHz, Detector = RMS
3. Sweep time = auto, trigger set to “free run”.
4. Trace average at least 100 traces in power averaging mode.
5. Record the max value and add 10 log (1/duty cycle)

#### For U-NII-3:

1. Set span to encompass the entire emission bandwidth (EBW) of the signal.
2. Set RBW = 300 kHz, Set VBW ≥ 1 MHz, Detector = RMS
3. Use the peak marker function to determine the maximum power level in any 300 kHz band segment within the fundamental EBW.
4. Scale the observed power level to an equivalent value in 500 kHz by adjusting (reducing) the measured power by a bandwidth correction factor (BWCF) where  $BWCF = 10\log(500\text{ kHz}/300\text{kHz})$
5. Sweep time = auto, trigger set to “free run”.
6. Trace average at least 100 traces in power averaging mode.
7. Record the max value and add 10 log (1/duty cycle)

#### 4.5.5 Deviation from Test Standard

No deviation.

#### 4.5.6 EUT Operating Condition

Same as Item 4.3.6.



#### 4.5.7 Test Results

##### For U-NII-1:

##### 802.11a

Chan.	Chan. Freq. (MHz)	PSD W/O Duty Factor (dBm)		Duty Factor (dB)	Total PSD With Duty Factor (dBm)	MAX. Limit (dBm)	Pass / Fail
		Chain 0	Chain 1				
36	5180	4.68	-6.00	0.16	5.20	14.49	Pass
40	5200	8.74	3.21	0.16	9.97	14.49	Pass
48	5240	6.13	-3.50	0.16	6.74	14.49	Pass

- Note:**
- Method a) of power density measurement of KDB 662911 is using for calculating total power density. Total power density is summing entire spectra across corresponding frequency bins on the various outputs by computer.
  - Directional gain =  $5.5\text{dBi} + 10\log(2) = 8.51\text{dBi} > 6\text{dBi}$  , so the power density limit shall be reduced to  $17 - (8.51 - 6) = 14.49\text{dBm}$ .
  - Refer to section 3.3 for duty cycle spectrum plot.

##### 802.11ac (VHT20)

Chan.	Chan. Freq. (MHz)	PSD W/O Duty Factor (dBm)		Duty Factor (dB)	Total PSD With Duty Factor (dBm)	MAX. Limit (dBm)	Pass / Fail
		Chain 0	Chain 1				
36	5180	4.46	-6.01	0.18	5.02	14.49	Pass
40	5200	8.48	2.24	0.18	9.59	14.49	Pass
48	5240	6.22	-2.60	0.18	6.94	14.49	Pass

- Note:**
- Method a) of power density measurement of KDB 662911 is using for calculating total power density. Total power density is summing entire spectra across corresponding frequency bins on the various outputs by computer.
  - Directional gain =  $5.5\text{dBi} + 10\log(2) = 8.51\text{dBi} > 6\text{dBi}$  , so the power density limit shall be reduced to  $17 - (8.51 - 6) = 14.49\text{dBm}$ .
  - Refer to section 3.3 for duty cycle spectrum plot.

### 802.11ac (VHT40)

Chan.	Chan. Freq. (MHz)	PSD W/O Duty Factor (dBm)		Duty Factor (dB)	Total PSD With Duty Factor (dBm)	MAX. Limit (dBm)	Pass / Fail
		Chain 0	Chain 1				
38	5190	-3.64	-8.02	0.41	-1.88	14.49	Pass
46	5230	-1.94	-5.76	0.41	-0.02	14.49	Pass

- Note:**
- Method a) of power density measurement of KDB 662911 is using for calculating total power density. Total power density is summing entire spectra across corresponding frequency bins on the various outputs by computer.
  - Directional gain =  $5.5\text{dBi} + 10\log(2) = 8.51\text{dBi} > 6\text{dBi}$  , so the power density limit shall be reduced to  $17 - (8.51 - 6) = 14.49\text{dBm}$ .
  - Refer to section 3.3 for duty cycle spectrum plot.

### 802.11ac (VHT80)

Chan.	Chan. Freq. (MHz)	PSD W/O Duty Factor (dBm)		Duty Factor (dB)	Total PSD With Duty Factor (dBm)	MAX. Limit (dBm)	Pass / Fail
		Chain 0	Chain 1				
42	5210	-4.82	-6.97	0.25	-2.50	14.49	Pass

- Note:**
- Method a) of power density measurement of KDB 662911 is using for calculating total power density. Total power density is summing entire spectra across corresponding frequency bins on the various outputs by computer.
  - Directional gain =  $5.5\text{dBi} + 10\log(2) = 8.51\text{dBi} > 6\text{dBi}$  , so the power density limit shall be reduced to  $17 - (8.51 - 6) = 14.49\text{dBm}$ .
  - Refer to section 3.3 for duty cycle spectrum plot.

### Spectrum Plot of Worst Value

**802.11a\_Chain 0 / CH40**

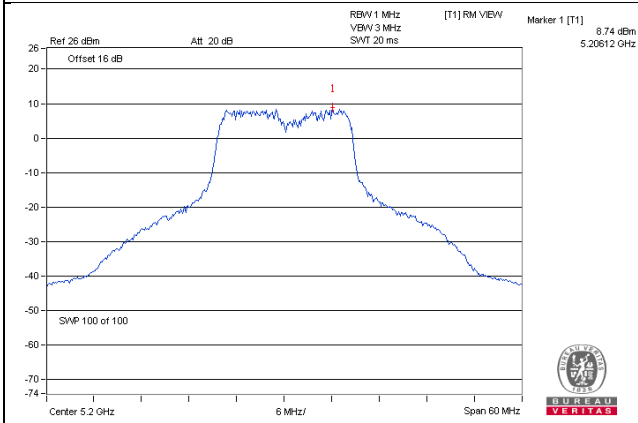

**802.11ac (VHT20)\_Chain 0 / CH40**

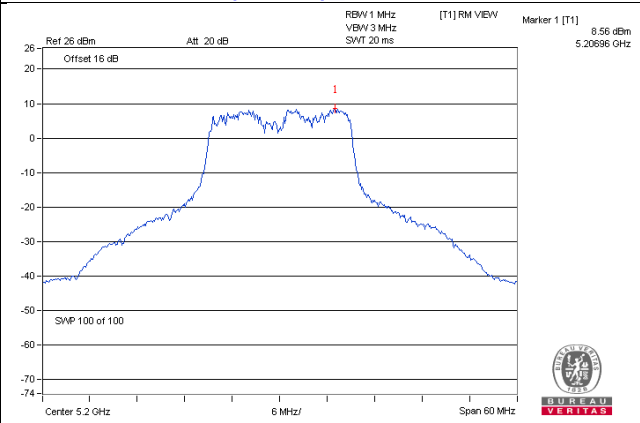

**802.11ac (VHT40)\_Chain 0 / CH46**

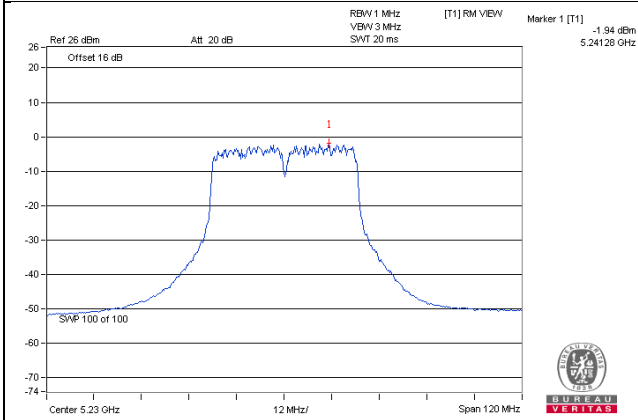

**802.11ac (VHT80)\_Chain 0 / CH42**

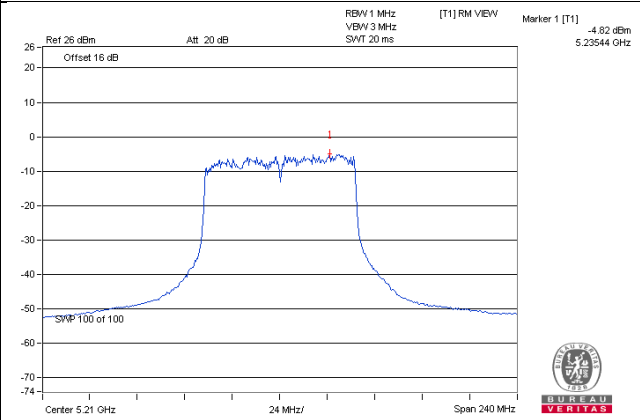

**For U-NII-3:**
**802.11a**

TX chain	Chan.	Chan. Freq. (MHz)	PSD W/O Duty Factor		10 log (N=2) dB	Duty Factor (dB)	Total PSD With Duty Factor (dBm/500kHz)	Limit (dBm/500kHz)	Pass /Fail
			(dBm/300kHz)	(dBm/500kHz)					
0	149	5745	0.32	2.54	3.01	0.16	5.71	26.99	Pass
	157	5785	-0.29	1.93	3.01	0.16	5.10	26.99	Pass
	165	5825	-0.31	1.91	3.01	0.16	5.08	26.99	Pass
1	149	5745	-1.03	1.19	3.01	0.16	4.36	26.99	Pass
	157	5785	-1.54	0.68	3.01	0.16	3.85	26.99	Pass
	165	5825	-1.19	1.03	3.01	0.16	4.20	26.99	Pass

Note: 1. Directional gain =  $6\text{dBi} + 10\log(2) = 9.01\text{dBi} > 6\text{dBi}$  , so the power density limit shall be reduced to  $30 - (9.01 - 6) = 26.99\text{dBm}$ .

2. Refer to section 3.3 for duty cycle spectrum plot.

**802.11ac (VHT20)**

TX chain	Chan.	Chan. Freq. (MHz)	PSD W/O Duty Factor		10 log (N=2) dB	Duty Factor (dB)	Total PSD With Duty Factor (dBm/500kHz)	Limit (dBm/500kHz)	Pass /Fail
			(dBm/300kHz)	(dBm/500kHz)					
0	149	5745	-0.45	1.77	3.01	0.18	4.96	26.99	Pass
	157	5785	-0.25	1.97	3.01	0.18	5.16	26.99	Pass
	165	5825	-0.56	1.66	3.01	0.18	4.85	26.99	Pass
1	149	5745	-1.72	0.50	3.01	0.18	3.69	26.99	Pass
	157	5785	-2.05	0.17	3.01	0.18	3.36	26.99	Pass
	165	5825	-1.56	0.66	3.01	0.18	3.85	26.99	Pass

Note: 1. Directional gain =  $6\text{dBi} + 10\log(2) = 9.01\text{dBi} > 6\text{dBi}$  , so the power density limit shall be reduced to  $30 - (9.01 - 6) = 26.99\text{dBm}$ .

2. Refer to section 3.3 for duty cycle spectrum plot.

### 802.11ac (VHT40)

TX chain	Chan.	Chan. Freq. (MHz)	PSD W/O Duty Factor		10 log (N=2) dB	Duty Factor (dB)	Total PSD With Duty Factor (dBm/500kHz)	Limit (dBm/500kHz)	Pass /Fail
			(dBm/300kHz)	(dBm/500kHz)					
0	151	5755	-4.99	-2.77	3.01	0.41	0.65	26.99	Pass
	159	5795	-4.88	-2.66	3.01	0.41	0.76	26.99	Pass
1	151	5755	-5.02	-2.80	3.01	0.41	0.62	26.99	Pass
	159	5795	-5.06	-2.84	3.01	0.41	0.58	26.99	Pass

Note: 1. Directional gain =  $6\text{dBi} + 10\log(2) = 9.01\text{dBi} > 6\text{dBi}$  , so the power density limit shall be reduced to  $30-(9.01-6) = 26.99\text{dBm}$ .

2. Refer to section 3.3 for duty cycle spectrum plot.

### 802.11ac (VHT80)

TX chain	Chan.	Chan. Freq. (MHz)	PSD W/O Duty Factor		10 log (N=2) dB	Duty Factor (dB)	Total PSD With Duty Factor (dBm/500kHz)	Limit (dBm/500kHz)	Pass /Fail
			(dBm/300kHz)	(dBm/500kHz)					
0	155	5775	-6.78	-4.56	3.01	0.25	-1.30	26.99	Pass
1	155	5775	-7.71	-5.49	3.01	0.25	-2.23	26.99	Pass

Note: 1. Directional gain =  $6\text{dBi} + 10\log(2) = 9.01\text{dBi} > 6\text{dBi}$  , so the power density limit shall be reduced to  $30-(9.01-6) = 26.99\text{dBm}$ .

2. Refer to section 3.3 for duty cycle spectrum plot.

Spectrum Plot of Worst Value

802.11a – Chain 0: CH 149

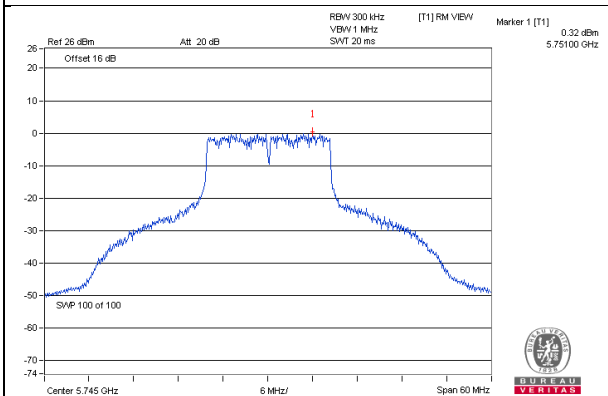

802.11ac (VHT20) – Chain 0: CH 165

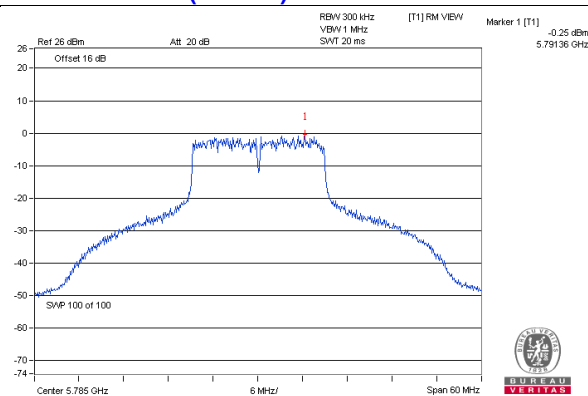

802.11ac (VHT40) – Chain 0: CH 159

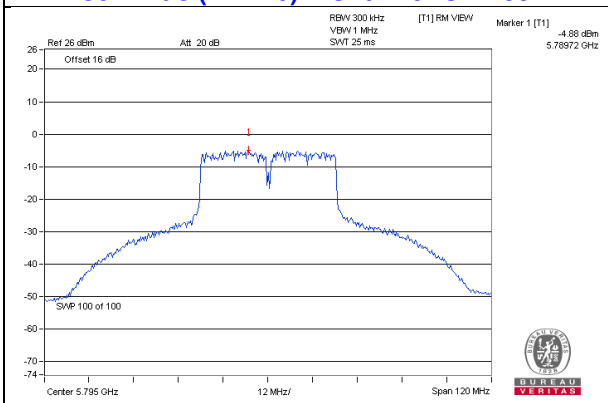

802.11ac (VHT80) – Chain 0: CH 155

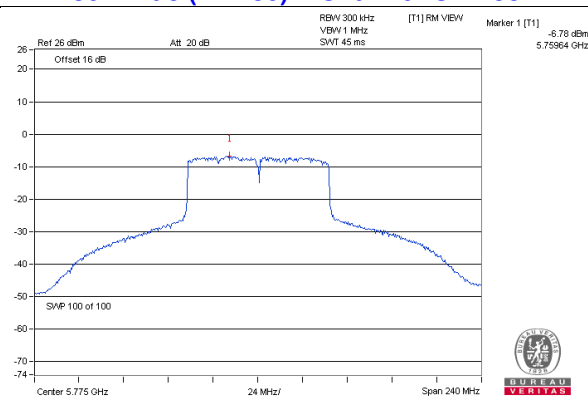

## 4.6 Frequency Stability Measurement

### 4.6.1 Limits of Frequency Stability Measurement

The frequency of the carrier signal shall be maintained within band of operation

### 4.6.2 Test Setup

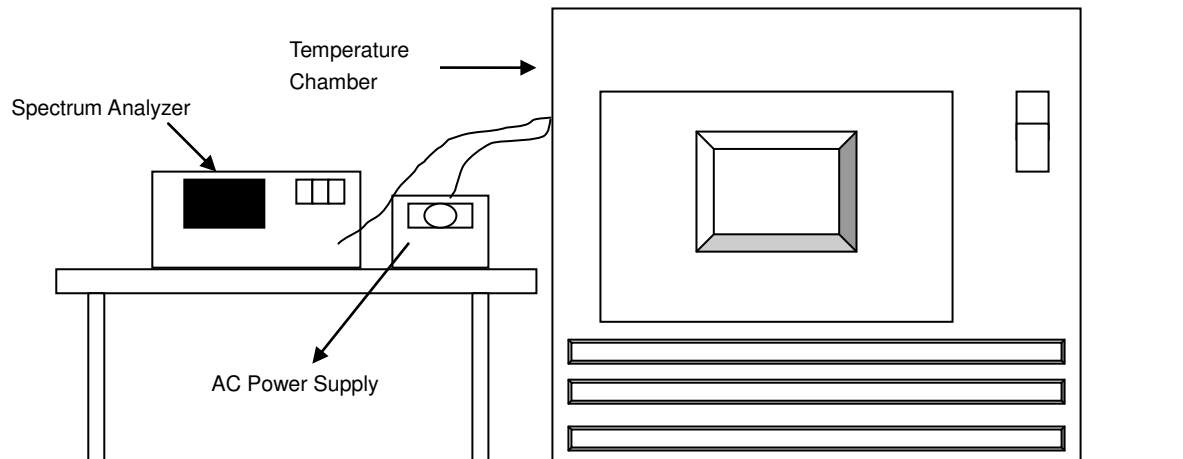

### 4.6.3 Test Instruments

Refer to section 4.1.2 to get information of above instrument.

### 4.6.4 Test Procedure

- The EUT was placed inside the environmental test chamber and powered by nominal AC voltage.
- Turn the EUT on and couple its output to a spectrum analyzer.
- Turn the EUT off and set the chamber to the highest temperature specified.
- Allow sufficient time (approximately 30 min) for the temperature of the chamber to stabilize, turn the EUT on and measure the operating frequency after 2, 5, and 10 Minutes.
- Repeat step 2 and 3 with the temperature chamber set to the lowest temperature.
- The test chamber was allowed to stabilize at +20 degree C for a minimum of 30 Minutes. The supply voltage was then adjusted on the EUT from 85% to 115% and the frequency record.

### 4.6.5 Deviation from Test Standard

No deviation.

### 4.6.6 EUT Operating Condition

Set the EUT transmit at un-modulation mode to test frequency stability.

## 4.6.7 Test Results

Frequency Stability Versus Temp.									
Operating Frequency: 5180 MHz									
TEMP. (°C)	Power Supply (Vac)	0 Minute		2 Minute		5 Minute		10 Minute	
		Measured Frequency (MHz)	Pass/Fail	Measured Frequency (MHz)	Pass/Fail	Measured Frequency (MHz)	Pass/Fail	Measured Frequency (MHz)	Pass/Fail
50	120	5179.9871	Pass	5179.9856	Pass	5179.989	Pass	5179.9872	Pass
40	120	5180.0199	Pass	5180.018	Pass	5180.0206	Pass	5180.0174	Pass
30	120	5180.0091	Pass	5180.0077	Pass	5180.0084	Pass	5180.0087	Pass
20	120	5180.0258	Pass	5180.023	Pass	5180.0253	Pass	5180.0245	Pass
10	120	5179.9766	Pass	5179.9783	Pass	5179.9796	Pass	5179.9771	Pass
0	120	5179.9798	Pass	5179.981	Pass	5179.9806	Pass	5179.9779	Pass
-10	120	5180.0058	Pass	5180.0057	Pass	5180.0089	Pass	5180.0085	Pass
-20	120	5179.9995	Pass	5180.0022	Pass	5180	Pass	5179.9979	Pass
-30	120	5179.9815	Pass	5179.9831	Pass	5179.9792	Pass	5179.9826	Pass

Frequency Stability Versus Voltage									
Operating Frequency: 5180 MHz									
TEMP. (°C)	Power Supply (Vac)	0 Minute		2 Minute		5 Minute		10 Minute	
		Measured Frequency (MHz)	Pass/Fail	Measured Frequency (MHz)	Pass/Fail	Measured Frequency (MHz)	Pass/Fail	Measured Frequency (MHz)	Pass/Fail
20	138	5180.0262	Pass	5180.023	Pass	5180.0253	Pass	5180.025	Pass
	120	5180.0258	Pass	5180.023	Pass	5180.0253	Pass	5180.0245	Pass
	102	5180.026	Pass	5180.0238	Pass	5180.0244	Pass	5180.0246	Pass



## 4.7 6dB Bandwidth Measurement

### 4.7.1 Limits of 6dB Bandwidth Measurement

The minimum of 6dB Bandwidth Measurement is 0.5MHz.

### 4.7.2 Test Setup

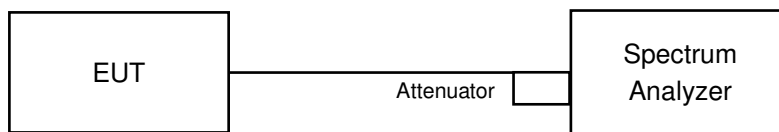

### 4.7.3 Test Instruments

Refer to section 4.1.2 to get information of above instrument.

### 4.7.4 Test Procedure

#### MEASUREMENT PROCEDURE REF

- Set resolution bandwidth (RBW) = 100kHz
- Set the video bandwidth (VBW)  $\geq 3 \times$  RBW, Detector = Peak.
- Trace mode = max hold.
- Sweep = auto couple.
- Measure the maximum width of the emission that is constrained by the frequencies associated with the two amplitude points (upper and lower) that are attenuated by 6 dB relative to the maximum level measured in the fundamental emission

### 4.7.5 Deviation from Test Standard

No deviation.

### 4.7.6 EUT Operating Condition

The software provided by client to enable the EUT under transmission condition continuously at lowest, middle and highest channel frequencies individually.

#### 4.7.7 Test Results

##### 802.11a

Channel	Frequency (MHz)	6dB Bandwidth (MHz)		Minimum Limit (MHz)	Pass / Fail
		Chain 0	Chain 1		
149	5745	16.37	16.40	0.5	PASS
157	5785	16.39	16.37	0.5	PASS
165	5825	16.39	16.36	0.5	PASS

##### 802.11ac (VHT20)

Channel	Frequency (MHz)	6dB Bandwidth (MHz)		Minimum Limit (MHz)	Pass / Fail
		Chain 0	Chain 1		
149	5745	17.62	16.98	0.5	PASS
157	5785	17.61	17.61	0.5	PASS
165	5825	17.59	17.60	0.5	PASS

##### 802.11ac (VHT40)

Channel	Frequency (MHz)	6dB Bandwidth (MHz)		Minimum Limit (MHz)	Pass / Fail
		Chain 0	Chain 1		
151	5755	36.40	35.81	0.5	PASS
159	5795	36.40	36.13	0.5	PASS

##### 802.11ac (VHT80)

Channel	Frequency (MHz)	6dB Bandwidth (MHz)		Minimum Limit (MHz)	Pass / Fail
		Chain 0	Chain 1		
155	5775	72.93	73.33	0.5	PASS

Spectrum Plot of Worst Value

802.11a\_Chain 1 / CH165

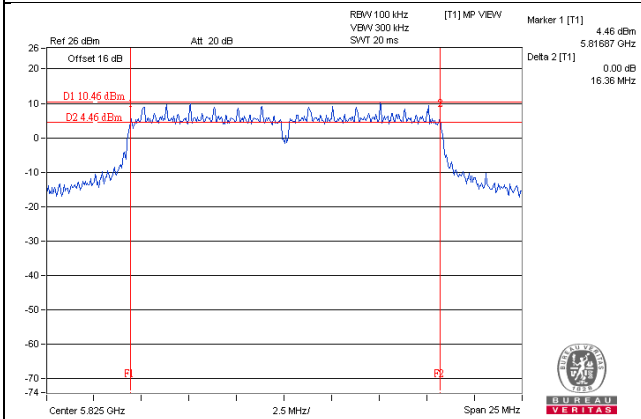

802.11ac (VHT20)\_Chain 1 / CH149

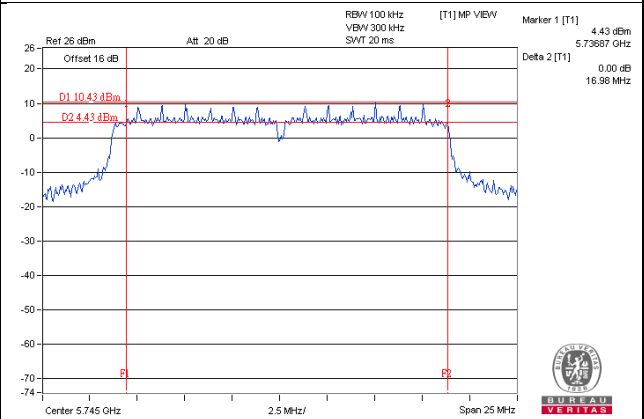

802.11ac (VHT40)\_Chain 1 / CH151

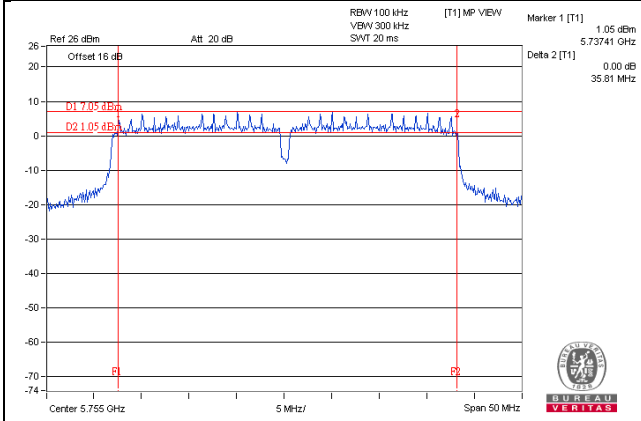

802.11ac (VHT80)\_Chain 0 / CH155

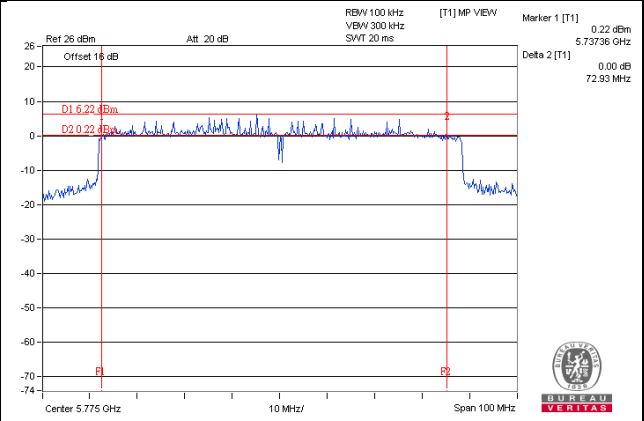

## 5 Pictures of Test Arrangements

Please refer to the attached file (Test Setup Photo).

### Annex A- Radiated Out of Band Emission (OOBE) Measurement (For U-NII-3 band)

802.11a

**CH 149 5745 MHz**

**Horizontal**

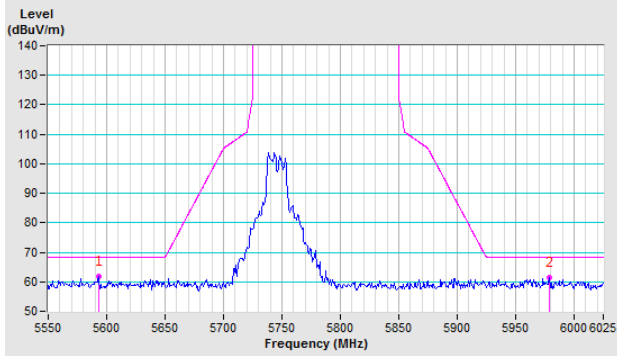

**Vertical**

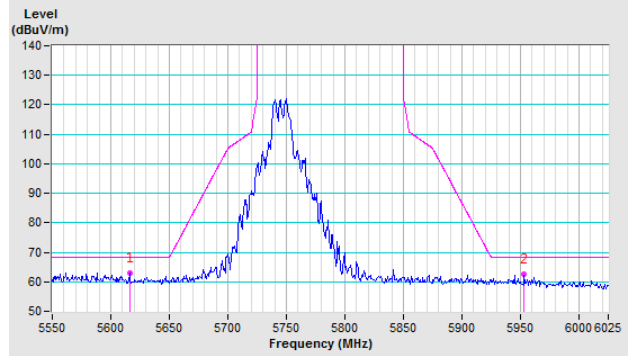

**CH 157 5785 MHz**

**Horizontal**

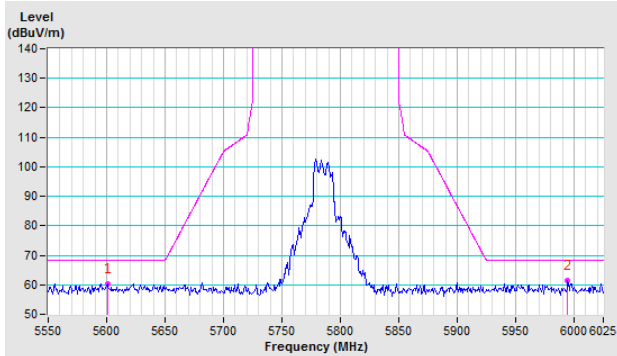

**Vertical**

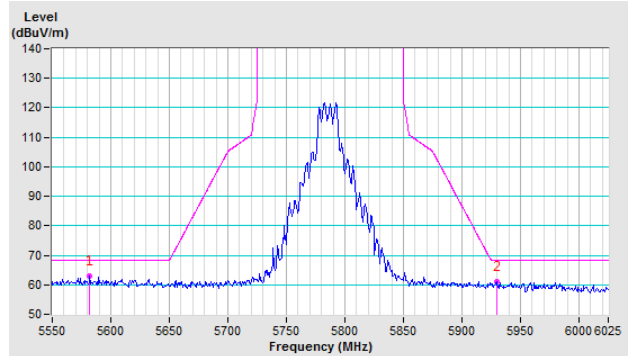

**CH 165 5825 MHz**

**Horizontal**

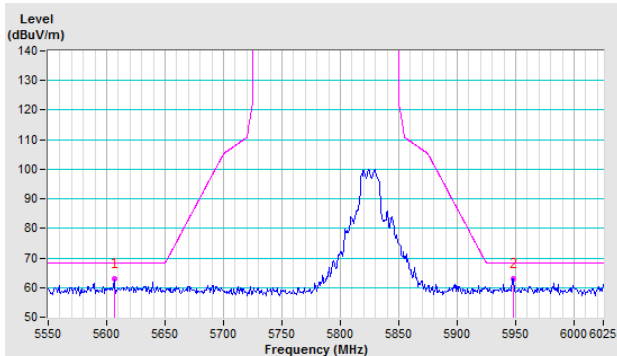

**Vertical**

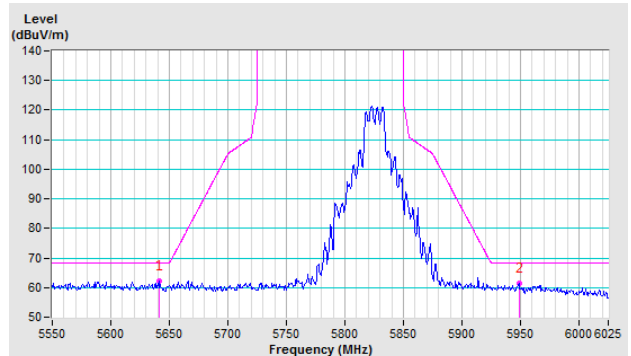

802.11ac (VHT20)

CH 149 5745 MHz

Horizontal

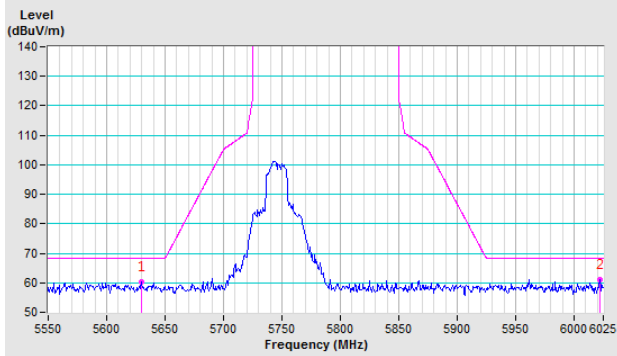

Vertical

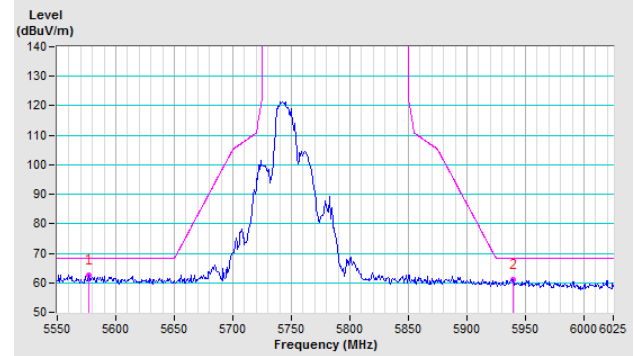

CH 157 5785 MHz

Horizontal

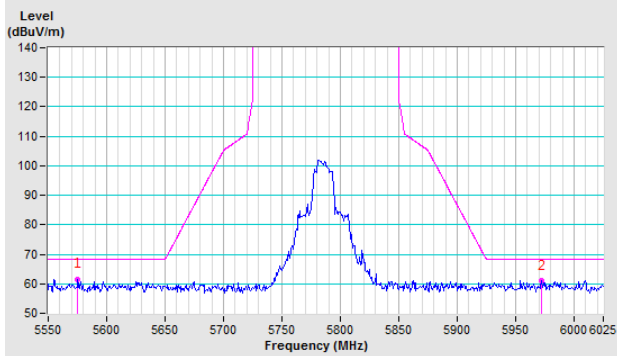

Vertical

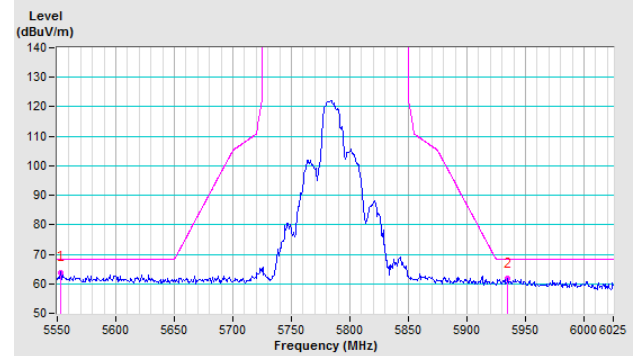

CH 165 5825 MHz

Horizontal

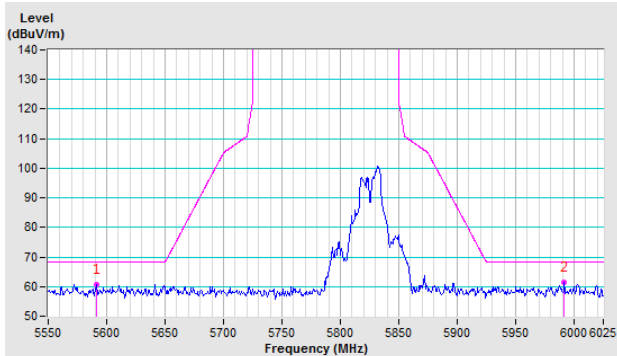

Vertical

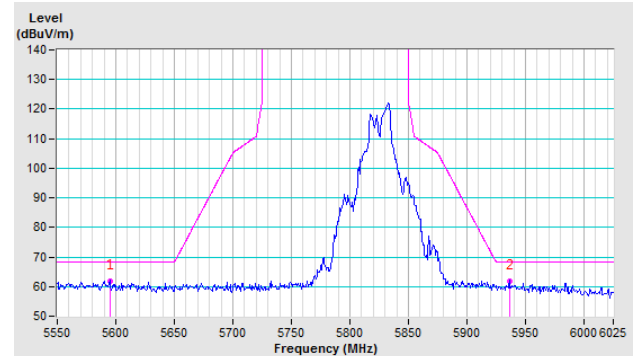

### 802.11ac (VHT40)

**CH 151 5755 MHz**

**Horizontal**

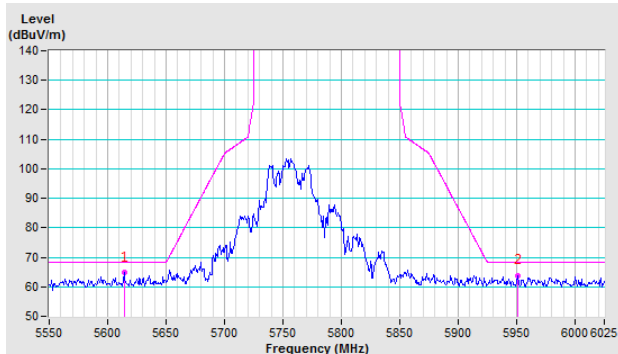

**Vertical**

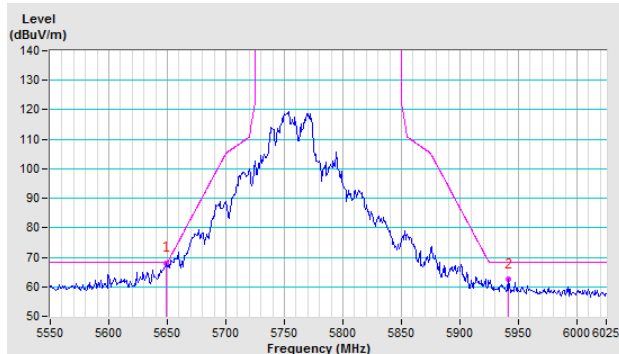

**CH 159 5795 MHz**

**Horizontal**

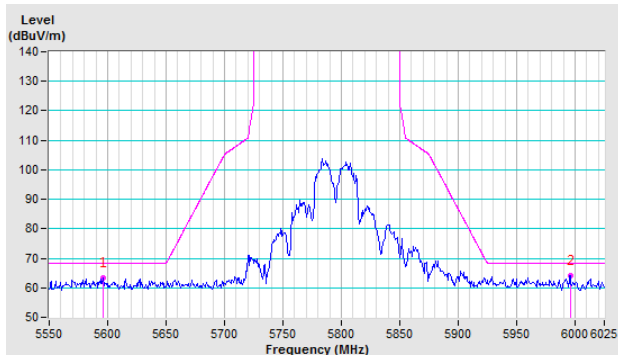

**Vertical**

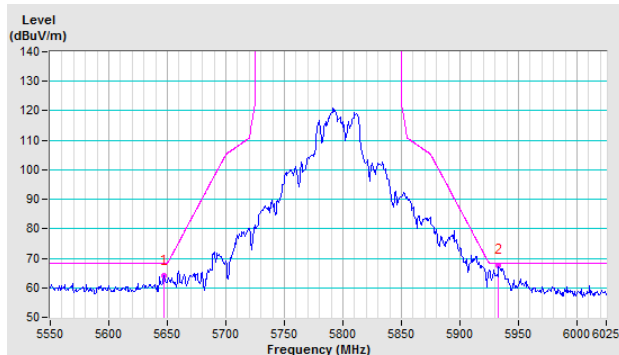

### 802.11ac (VHT80)

**CH 155 5775 MHz**

**Horizontal**

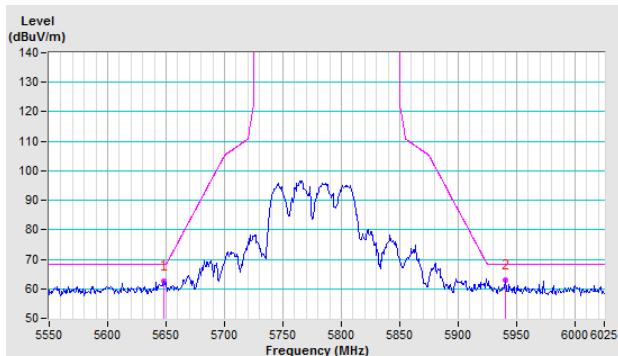

**Vertical**

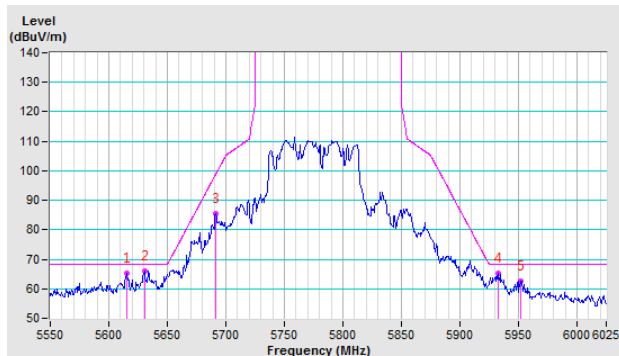

## Appendix – Information on the Testing Laboratories

We, Bureau Veritas Consumer Products Services (H.K.) Ltd., Taoyuan Branch, were founded in 1988 to provide our best service in EMC, Radio, Telecom and Safety consultation. Our laboratories are accredited and approved according to ISO/IEC 17025.

If you have any comments, please feel free to contact us at the following:

**Linko EMC/RF Lab**

Tel: 886-2-26052180

Fax: 886-2-26051924

**Hsin Chu EMC/RF/Telecom Lab**

Tel: 886-3-6668565

Fax: 886-3-6668323

**Hwa Ya EMC/RF/Safety Lab**

Tel: 886-3-3183232

Fax: 886-3-3270892

**Email:** [service.adt@tw.bureauveritas.com](mailto:service.adt@tw.bureauveritas.com)

**Web Site:** [www.bureauveritas-adt.com](http://www.bureauveritas-adt.com)

The address and road map of all our labs can be found in our web site also.

--- END ---