

## FCC Test Report

**Report No.:** RF150825E05-1

**FCC ID:** U8G-P1811

**Test Model:** MAX 700

**Series Model:** Pismo 811

**Received Date:** Aug. 25, 2015

**Test Date:** Sep. 08 to 14, 2015

**Issued Date:** Sep. 25, 2015

**Applicant:** Pismo Labs Technology Limited

**Address:** FLAT/RM A5, 5/F, HK SPINNERS IND BLDG PHASE 6, 481 CASTLE PEAK ROAD, CHEUNG SHA WAN, HONG KONG.

**Issued By:** Bureau Veritas Consumer Products Services (H.K.) Ltd., Taoyuan Branch Hsin Chu Laboratory

**Lab Address:** No. 81-1, Lu Liao Keng, 9th Ling, Wu Lung Tsuen, Chiung Lin Hsiang, Hsin Chu Hsien 307, Taiwan R.O.C.

**Test Location (1):** No. 81-1, Lu Liao Keng, 9th Ling, Wu Lung Tsuen, Chiung Lin Hsiang, Hsin Chu Hsien 307, Taiwan R.O.C.

**Test Location (2):** No. 49, Ln. 206, Wende Rd., Shangshan Tsuen, Chiung Lin Hsiang, Hsin Chu Hsien 307, Taiwan R.O.C.

**Test Location (3):** E-2, No.1, Li Hsin 1st Road, Hsinchu Science Park, Hsinchu City 300, Taiwan R.O.C.



This report is for your exclusive use. Any copying or replication of this report to or for any other person or entity, or use of our name or trademark, is permitted only with our prior written permission. This report sets forth our findings solely with respect to the test samples identified herein. The results set forth in this report are not indicative or representative of the quality or characteristics of the lot from which a test sample was taken or any similar or identical product unless specifically and expressly noted. Our report includes all of the tests requested by you and the results thereof based upon the information that you provided to us. You have 60 days from date of issuance of this report to notify us of any material error or omission caused by our negligence, provided, however, that such notice shall be in writing and shall specifically address the issue you wish to raise. A failure to raise such issue within the prescribed time shall constitute your unqualified acceptance of the completeness of this report, the tests conducted and the correctness of the report contents. Unless specific mention, the uncertainty of measurement has been explicitly taken into account to declare the compliance or non-compliance to the specification. The report must not be used by the client to claim product certification, approval, or endorsement by TAF or any government agencies.

**Table of Contents**

<b>Release Control Record</b> .....	<b>4</b>
<b>1 Certificate of Conformity</b> .....	<b>5</b>
<b>2 Summary of Test Results</b> .....	<b>6</b>
2.1 Measurement Uncertainty.....	6
2.2 Modification Record.....	6
<b>3 General Information</b> .....	<b>7</b>
3.1 General Description of EUT.....	7
3.2 Description of Test Modes.....	10
3.2.1 Test Mode Applicability and Tested Channel Detail.....	11
3.3 Duty Cycle of Test Signal.....	13
3.4 Description of Support Units.....	14
3.4.1 Configuration of System under Test.....	15
3.5 General Description of Applied Standard.....	17
<b>4 Test Types and Results</b> .....	<b>18</b>
4.1 Radiated Emission and Bandedge Measurement.....	18
4.1.1 Limits of Radiated Emission and Bandedge Measurement.....	18
4.1.2 Test Instruments.....	19
4.1.3 Test Procedures.....	20
4.1.4 Deviation from Test Standard.....	20
4.1.5 Test Setup.....	21
4.1.6 EUT Operating Conditions.....	21
4.1.7 Test Results.....	22
4.2 Conducted Emission Measurement.....	41
4.2.1 Limits of Conducted Emission Measurement.....	41
4.2.2 Test Instruments.....	41
4.2.3 Test Procedures.....	42
4.2.4 Deviation from Test Standard.....	42
4.2.5 Test Setup.....	42
4.2.6 EUT Operating Conditions.....	42
4.2.7 Test Results (Mode 1).....	43
4.2.8 Test Results (Mode 2).....	45
4.3 Transmit Power Measurement.....	47
4.3.1 Limits of Transmit Power Measurement.....	47
4.3.2 Test Setup.....	47
4.3.3 Test Instruments.....	47
4.3.4 Test Procedures.....	47
4.3.5 Deviation from Test Standard.....	48
4.3.6 EUT Operating Conditions.....	48
4.3.7 Test Results.....	49
4.4 Peak Power Spectral Density Measurement.....	50
4.4.1 Limits of Peak Power Spectral Density Measurement.....	50
4.4.2 Test Setup.....	50
4.4.3 Test Instruments.....	50
4.4.4 Test Procedures.....	51
4.4.5 Deviation from Test Standard.....	51
4.4.6 EUT Operating Conditions.....	51
4.4.7 Test Results.....	52
4.5 Frequency Stability Measurement.....	57
4.5.1 Limits of Frequency Stability Measurement.....	57
4.5.2 Test Setup.....	57
4.5.3 Test Instruments.....	57
4.5.4 Test Procedures.....	57
4.5.5 Deviation from Test Standard.....	57



4.5.6 EUT Operating Conditions.....	57
4.5.7 Test Results .....	58
4.6 6dB Bandwidth Measurement.....	59
4.6.1 Limits of 6dB Bandwidth Measurement.....	59
4.6.2 Test Setup.....	59
4.6.3 Test Instruments .....	59
4.6.4 Test Procedures.....	59
4.6.5 Deviation from Test Standard .....	59
4.6.6 EUT Operating Conditions.....	59
4.6.7 Test Results .....	60
<b>5 Pictures of Test Arrangements.....</b>	<b>62</b>
<b>Appendix – Information on the Testing Laboratories .....</b>	<b>63</b>



A D T

### Release Control Record

Issue No.	Description	Date Issued
RF150825E05-1	Original release.	Sep. 25, 2015



## 1 Certificate of Conformity

**Product:** Pepwave / Peplink / Pismo Wireless Product

**Brand:** Pepwave / Peplink / Pismo

**Test Model:** MAX 700

**Series Model:** Pismo 811

**Sample Status:** ENGINEERING SAMPLE

**Applicant:** Pismo Labs Technology Limited

**Test Date:** Sep. 08 to 14, 2015

**Standard:** 47 CFR FCC Part 15, Subpart E (Section 15.407)  
ANSI C63.10: 2013

The above equipment has been tested by **Bureau Veritas Consumer Products Services (H.K.) Ltd., Taoyuan Branch**, and found compliance with the requirement of the above standards. The test record, data evaluation & Equipment Under Test (EUT) configurations represented herein are true and accurate accounts of the measurements of the sample's EMC characteristics under the conditions specified in this report.

**Prepared by :** Phoenix Huang , **Date:** Sep. 25, 2015  
Phoenix Huang / Specialist

**Approved by :** May Chen , **Date:** Sep. 25, 2015  
May Chen / Manager

## 2 Summary of Test Results

47 CFR FCC Part 15, Subpart E (SECTION 15.407)			
FCC Clause	Test Item	Result	Remarks
15.407(b)(6)	AC Power Conducted Emissions	Pass	Meet the requirement of limit. Minimum passing margin is -5.50dB at 0.47422MHz.
15.407(b) (1/2/3/4/6)	Radiated Emissions & Band Edge Measurement	Pass	Meet the requirement of limit. Minimum passing margin is -0.1dB at 5725.00MHz, 5850.00MHz.
15.407(a)(1/2 /3)	Max Average Transmit Power	Pass	Meet the requirement of limit.
15.407(a)(1/2 /3)	Peak Power Spectral Density	Pass	Meet the requirement of limit.
15.407(e)	6dB bandwidth	Pass	Meet the requirement of limit. (U-NII-3 Band only)
15.407(g)	Frequency Stability	Pass	Meet the requirement of limit.
15.203	Antenna Requirement	Pass	Antenna connector is RP-SMA not a standard connector.

**NOTE:** 1. The EUT was operating in 2.4 ~ 2.4835GHz, 5.15~5.25GHz and 5.725~5.85GHz frequencies band. This report was recorded the RF parameters including 5.15~5.25GHz and 5.725~5.85GHz. For the 2.4 ~ 2.4835GHz RF parameters was recorded in another test report.

### 2.1 Measurement Uncertainty

Where relevant, the following measurement uncertainty levels have been estimated for tests performed on the EUT as specified in CISPR 16-4-2:

Measurement	Frequency	Expanded Uncertainty (k=2) (±)
Conducted Emissions at mains ports	150kHz ~ 30MHz	2.86 dB
Radiated Emissions up to 1 GHz	30MHz ~ 1GHz	5.37 dB
Radiated Emissions above 1 GHz	1GHz ~ 6GHz	3.65 dB
	6GHz ~ 18GHz	3.88 dB
	18GHz ~ 40GHz	4.11 dB

### 2.2 Modification Record

There were no modifications required for compliance.

### 3 General Information

#### 3.1 General Description of EUT

Product	Pepwave / Peplink / Pismo Wireless Product
Brand	Pepwave / Peplink / Pismo
Test Model	MAX 700
Series Model	Pismo 811
Status of EUT	ENGINEERING SAMPLE
Power Supply Rating	12Vdc from power adapter or 12-48Vdc from Terminal block
Modulation Type	CCK, DQPSK, DBPSK for DSSS 64QAM, 16QAM, QPSK, BPSK for OFDM 256QAM for OFDM in 11ac mode only
Modulation Technology	DSSS, OFDM
Transfer Rate	802.11b: up to 11Mbps 802.11a/g: up to 54Mbps 802.11n: up to 300Mbps 802.11ac: up to 866.7Mbps
Operating Frequency	<b>2.4GHz:</b> 2.412GHz ~ 2.462GHz <b>5GHz:</b> 5.18GHz ~ 5.24GHz, 5.745GHz ~ 5.825GHz
Number of Channel	<b>2.4GHz:</b> 802.11b, 802.11g, 802.11n (HT20): 11 802.11n (HT40): 7 <b>5GHz:</b> 802.11a, 802.11n (HT20), 802.11ac (VHT20): 9 802.11n (HT40), 802.11ac (VHT40): 4 802.11ac (VHT80): 2
Output Power	<b>2.4GHz:</b> 802.11b: 797.576mW 802.11g: 838.62mW 802.11n (HT20): 889.322mW 802.11n (HT40): 151.881mW <b>5GHz:</b> 802.11a: 176.644mW 802.11ac (VHT20): 172.549mW 802.11ac (VHT40): 235.977mW 802.11ac (VHT80): 43.321mW
Antenna Type	Refer to Note
Antenna Connector	Refer to Note
Accessory Device	Adapter x 1
Data Cable Supplied	NA

**Note:**

1. The EUT could be applied with four Cellular USB Dongles, therefore emission tests are added for simultaneously transmit between WLAN and Cellular USB Dongles. The emission tests have been performed at the worst channel of all WLAN and Cellular USB Dongles, the emission of the simultaneous operation (WLAN & Cellular USB Dongles) has been evaluated and no non-compliance found. < Cellular USB Dongle only for test, not for sale >
2. The EUT has different model names, which are identical to each other in all aspects except for the following table:

Product Name	Brand Name	Model No.	Description
Pepwave / Peplink / Pismo Wireless Product	Pepwave / Peplink / Pismo	MAX 700	For marketing requirement
		Pismo 811	

From the above models, model: **MAX 700** was selected as representative model for the test and its data was recorded in this report.

3. The EUT must be supplied with a power adapter and as the following table:

Brand	Model No.	Spec.
Ten Pao	S024WM1200200	AC input: 100-240V, 600mA, 50/60Hz DC output: 12V, 2000mA DC output cable: 1.5m, unshielded with one core

4. The antennas provided to the EUT, please refer to the following table:

For WIFI 1							
No.	Transmitter Circuit	Brand	Model	Ant. Gain (dBi) <Excluding cable loss>	Frequency range (GHz to GHz)	Antenna Type	Connector Type
1	Chain (0)	SmartAnt	SAA06-220690	3	2.4~2.4835	Dipole	RP-SMA
				4~5.5	5.15~5.25		
				5.5~6	5.725~5.85		
2	Chain (1)	SmartAnt	SAA06-220690	3	2.4~2.4835	Dipole	RP-SMA
				4~5.5	5.15~5.25		
				5.5~6	5.725~5.85		
For WIFI 2							
No.	Transmitter Circuit	Brand	Model	Ant. Gain (dBi) <Excluding cable loss>	Frequency range (GHz to GHz)	Antenna Type	Connector Type
3	Chain (0)	SmartAnt	SAA06-220690	3	2.4~2.4835	Dipole	RP-SMA
				4~5.5	5.15~5.25		
				5.5~6	5.725~5.85		
4	Chain (1)	SmartAnt	SAA06-220690	3	2.4~2.4835	Dipole	RP-SMA
				4~5.5	5.15~5.25		
				5.5~6	5.725~5.85		



5. The EUT incorporates a MIMO function.

<b>For 2.4GHz Band</b>			
<b>MODULATION MODE</b>	<b>DATA RATE (MCS)</b>	<b>TX &amp; RX CONFIGURATION</b>	
<b>802.11b</b>	1 ~ 11Mbps	2TX	2RX
<b>802.11g</b>	6 ~ 54Mbps	2TX	2RX
<b>802.11n (HT20) &amp; 802.11n (HT40)</b>	MCS 0~7	2TX	2RX
	MCS 8~15	2TX	2RX
<b>For 5GHz Band</b>			
<b>MODULATION MODE</b>	<b>DATA RATE (MCS)</b>	<b>TX &amp; RX CONFIGURATION</b>	
<b>802.11a</b>	6 ~ 54Mbps	2TX	2RX
<b>802.11n (HT20) &amp; 802.11n (HT40)</b>	MCS 0~7	2TX	2RX
	MCS 8~15	2TX	2RX
<b>802.11ac (VHT20)</b>	MCS0~8 Nss= 1	2TX	2RX
	MCS0~8 Nss= 2	2TX	2RX
<b>802.11ac (VHT40) &amp; 802.11ac (VHT80)</b>	MCS0~9 Nss= 1	2TX	2RX
	MCS0~9 Nss= 2	2TX	2RX

Note: 1. The modulation and bandwidth are similar for 802.11n mode for 20MHz (40MHz) and 802.11ac mode for 20MHz (40MHz), therefore investigated worst case to representative mode in test report. (Final test mode refer section 3.2.1)

6. The EUT was pre-tested under the following test modes :

Pre-test Mode	Power
Mode A	Power from Terminal Block (24Vdc)
Mode B	Power from Terminal Block (12Vdc)
<b>Mode C</b>	<b>Power from Adapter</b>

Note: The worst radiated emissions were found in **Mode C**. Therefore only the test data of the modes were recorded in this report.

7. The above EUT information is declared by manufacturer and for more detailed features description, please refer to the manufacturer's specifications or user's manual.

### 3.2 Description of Test Modes

#### FOR 5180 ~ 5240MHz

4 channels are provided for 802.11a, 802.11n (HT20), 802.11ac (VHT20):

Channel	Frequency	Channel	Frequency
36	5180 MHz	44	5220 MHz
40	5200 MHz	48	5240 MHz

2 channels are provided for 802.11n (HT40), 802.11ac (VHT40):

Channel	Frequency	Channel	Frequency
38	5190 MHz	46	5230 MHz

1 channel is provided for 802.11ac (VHT80):

Channel	Frequency
42	5210MHz

#### FOR 5745 ~ 5825MHz:

5 channels are provided for 802.11a, 802.11n (HT20), 802.11ac (VHT20):

Channel	Frequency	Channel	Frequency
149	5745MHz	161	5805MHz
153	5765MHz	165	5825MHz
157	5785MHz		

2 channels are provided for 802.11n (HT40), 802.11ac (VHT40):

Channel	Frequency	Channel	Frequency
151	5755MHz	159	5795MHz

1 channel is provided for 802.11ac (VHT80):

Channel	Frequency
155	5775MHz

### 3.2.1 Test Mode Applicability and Tested Channel Detail

EUT CONFIGURE MODE	APPLICABLE TO				DESCRIPTION
	RE≥1G	RE<1G	PLC	APCM	
1	√	√	√	√	Power from Adapter
2	-	-	√	-	Power from Terminal Block (24Vdc)

Where **RE≥1G**: Radiated Emission above 1GHz      **RE<1G**: Radiated Emission below 1GHz  
**PLC**: Power Line Conducted Emission      **APCM**: Antenna Port Conducted Measurement

**NOTE:**

1. The EUT had been pre-tested on the positioned of each 3 axis. The worst case was found when positioned on **Z-plane**.
2. "-" means no effect.

**Radiated Emission Test (Above 1GHz):**

- Pre-Scan has been conducted to determine the worst-case mode from all possible combinations between available modulations, data rates and antenna ports (if EUT with antenna diversity architecture).
- Following channel(s) was (were) selected for the final test as listed below.

MODE	FREQ. BAND (MHz)	AVAILABLE CHANNEL	TESTED CHANNEL	MODULATION TECHNOLOGY	MODULATION TYPE	DATA RATE (Mbps)
802.11a	5180-5240	36 to 48	36, 40, 48	OFDM	BPSK	6
802.11n (HT20)		36 to 48	36, 40, 48	OFDM	BPSK	6.5
802.11n (HT40)		38 to 46	38, 46	OFDM	BPSK	13.5
802.11ac (VHT80)		42	42	OFDM	BPSK	29.3
802.11a	5745-5825	149 to 165	149, 157, 165	OFDM	BPSK	6
802.11n (HT20)		149 to 165	149, 157, 165	OFDM	BPSK	6.5
802.11n (HT40)		151 to 159	151, 159	OFDM	BPSK	13.5
802.11ac (VHT80)		155	155	OFDM	BPSK	29.3

**Radiated Emission Test (Below 1GHz):**

- Pre-Scan has been conducted to determine the worst-case mode from all possible combinations between available modulations, data rates and antenna ports (if EUT with antenna diversity architecture).
- Following channel(s) was (were) selected for the final test as listed below.

MODE	FREQ. BAND (MHz)	AVAILABLE CHANNEL	TESTED CHANNEL	MODULATION TECHNOLOGY	MODULATION TYPE	DATA RATE (Mbps)
802.11ac (VHT40)	5180-5240, 5745-5825	38 to 46, 151 to 159	46	OFDM	BPSK	13.5

**Power Line Conducted Emission Test:**

- Pre-Scan has been conducted to determine the worst-case mode from all possible combinations between available modulations, data rates and antenna ports (if EUT with antenna diversity architecture).
- Following channel(s) was (were) selected for the final test as listed below.

MODE	FREQ. BAND (MHz)	AVAILABLE CHANNEL	TESTED CHANNEL	MODULATION TECHNOLOGY	MODULATION TYPE	DATA RATE (Mbps)
802.11ac (VHT40)	5180-5240, 5745-5825	38 to 46, 151 to 159	46	OFDM	BPSK	13.5

**Antenna Port Conducted Measurement:**

- This item includes all test value of each mode, but only includes spectrum plot of worst value of each mode.
- Pre-Scan has been conducted to determine the worst-case mode from all possible combinations between available modulations, data rates and antenna ports (if EUT with antenna diversity architecture).
- Following channel(s) was (were) selected for the final test as listed below.

MODE	FREQ. BAND (MHz)	AVAILABLE CHANNEL	TESTED CHANNEL	MODULATION TECHNOLOGY	MODULATION TYPE	DATA RATE (Mbps)
802.11a	5180-5240	36 to 48	36, 40, 48	OFDM	BPSK	6
802.11n (HT20)		36 to 48	36, 40, 48	OFDM	BPSK	6.5
802.11n (HT40)		38 to 46	38, 46	OFDM	BPSK	13.5
802.11ac (VHT80)		42	42	OFDM	BPSK	29.3
802.11a	5745-5825	149 to 165	149, 157, 165	OFDM	BPSK	6
802.11n (HT20)		149 to 165	149, 157, 165	OFDM	BPSK	6.5
802.11n (HT40)		151 to 159	151, 159	OFDM	BPSK	13.5
802.11ac (VHT80)		155	155	OFDM	BPSK	29.3

**Test Condition:**

APPLICABLE TO	ENVIRONMENTAL CONDITIONS	INPUT POWER	TESTED BY
<b>RE<math>\geq</math>1G</b>	24deg. C, 72%RH	120Vac, 60Hz	Weiwei Lo
	24deg. C, 74%RH	120Vac, 60Hz	Weiwei Lo
<b>RE<math>&lt;</math>1G</b>	24deg. C, 65%RH	120Vac, 60Hz	Weiwei Lo
<b>PLC</b>	25deg. C, 60%RH	120Vac, 60Hz	Timmy Hu
<b>APCM</b>	25deg. C, 60%RH	120Vac, 60Hz	Anderson Chen

### 3.3 Duty Cycle of Test Signal

If duty cycle of test signal is  $\geq 98\%$ , duty factor is not required.  
 If duty cycle of test signal is  $< 98\%$ , duty factor shall be considered.

**802.11a:** Duty cycle =  $5.357 \text{ ms} / 5.457 \text{ ms} = 0.982$

**802.11ac (VHT20):** Duty cycle =  $4.981 \text{ ms} / 5.081 \text{ ms} = 0.98$

**802.11ac (VHT40):** Duty cycle =  $2.41 \text{ ms} / 2.487 \text{ ms} = 0.969$ , Duty factor =  $10 * \log(1/0.969) = 0.14$

**802.11ac (VHT80):** Duty cycle =  $0.371 \text{ ms} / 0.44 \text{ ms} = 0.843$ , Duty factor =  $10 * \log(1/0.843) = 0.74$

**802.11a** **802.11ac (VHT20)**

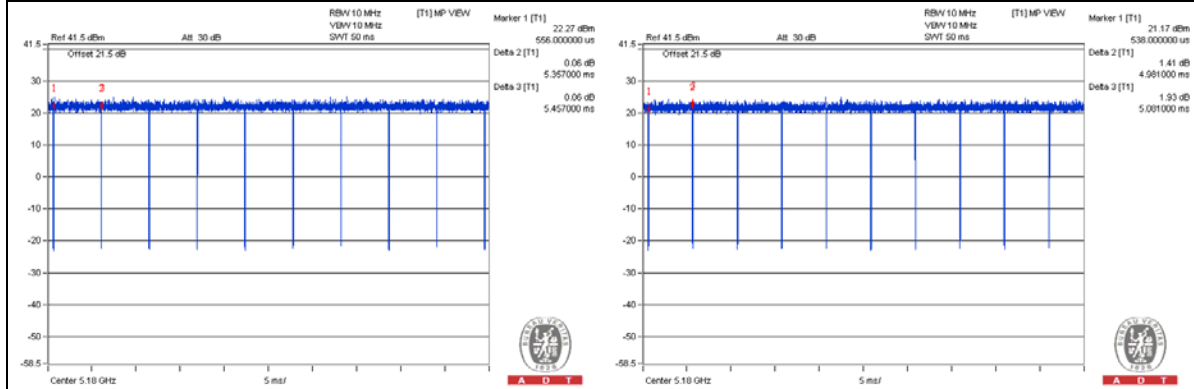

**802.11ac (VHT40)** **802.11ac (VHT80)**

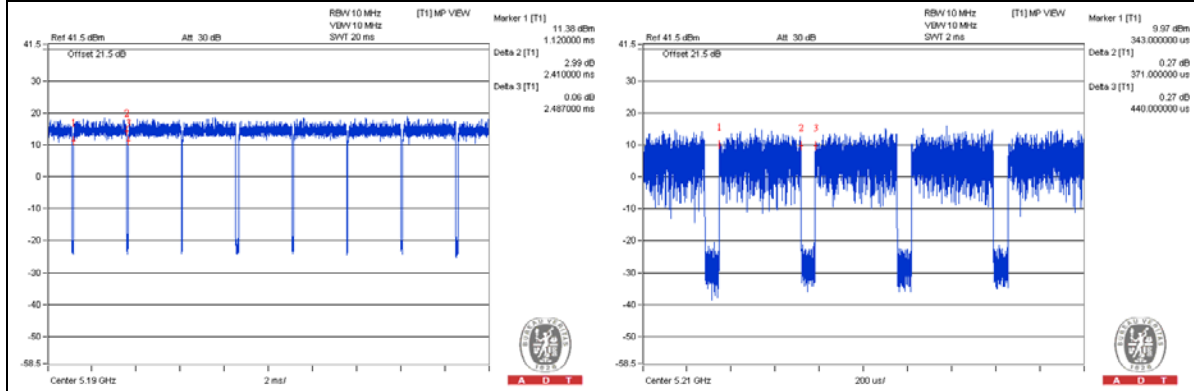

### 3.4 Description of Support Units

The EUT has been tested as an independent unit together with other necessary accessories or support units. The following support units or accessories were used to form a representative test configuration during the tests.

ID	Product	Brand	Model No.	Serial No.	FCC ID	Remarks
A.	Notebook Computer	DELL	E5430	HYV4VY1	FCC DoC	Provided by Lab
B.	Notebook Computer	DELL	E6420	482T3R1	FCC DoC	Provided by Lab
C.	HUB	ZyXEL	ES-116P	S060H02000215	FCC DoC	Provided by Lab
D.	3G Dongle	at&t	QUALCOMM 3G	NA	N7NMC8781U	Provided by Lab
E.	3G Dongle	at&t	QUALCOMM 3G	NA	N7NMC8781U	Provided by Lab
F.	3G Dongle	at&t	QUALCOMM 3G	NA	N7NMC8781U	Provided by Lab
G.	3G Dongle	at&t	QUALCOMM 3G	NA	N7NMC8781U	Provided by Lab
H.	DC Power Supply	Topward	6603D	795551	NA	Provided by Lab

Note:

1. All power cords of the above support units are non-shielded (1.8m).

ID	Descriptions	Qty.	Length (m)	Shielding (Yes/No)	Cores (Qty.)	Remarks
1.	DC	1	1.5	No	1	Supplied by Client
2.	RJ-45	1	10	No	0	Provided by Lab
3.	RJ-45	1	10	No	0	Provided by Lab
4.	RJ-45	1	10	No	0	Provided by Lab
5.	RJ-45	3	10	No	0	Provided by Lab
6.	GND	1	1.8	No	0	Provided by Lab
7.	DC	1	1.5	No	0	Provided by Lab

Note: The core(s) is(are) originally attached to the cable(s).

### 3.4.1 Configuration of System under Test

#### For Radiated Emission, Conducted Emission test: (Mode 1)

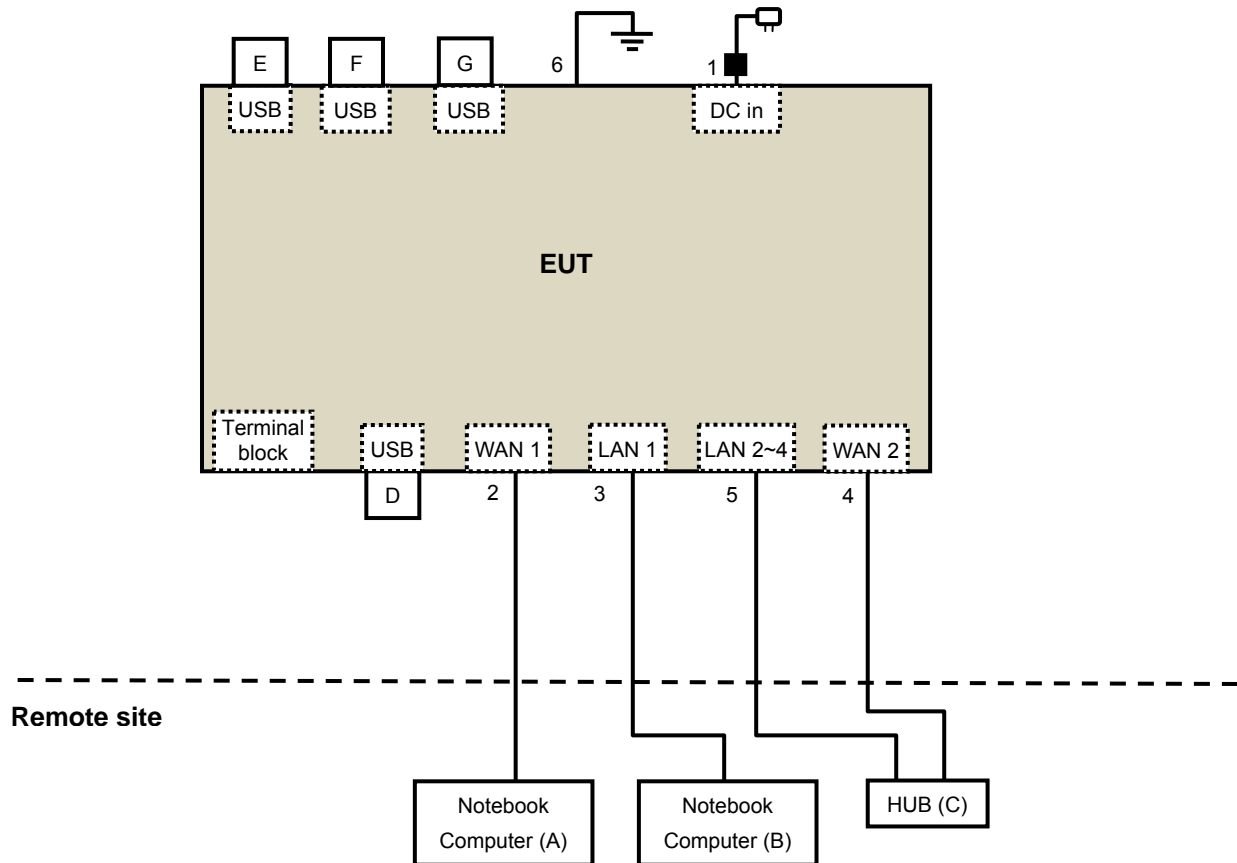

**Note:** Support units D~G are 3G Dongles.

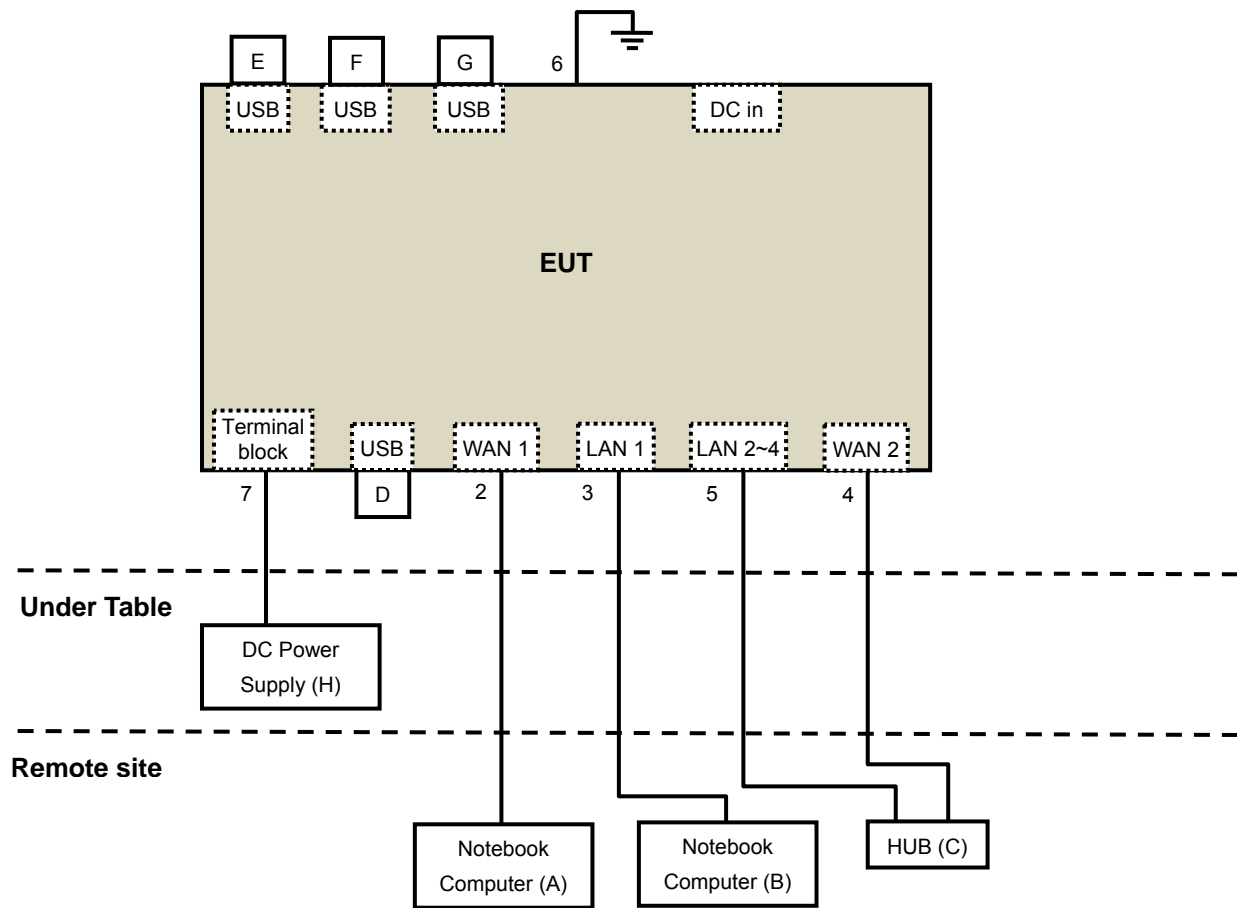
**For Conducted Emission test: (Mode 2)**

**Note:** Support units D~G are 3G Dongles.



### 3.5 General Description of Applied Standard

The EUT is a RF Product. According to the specifications of the manufacturer, it must comply with the requirements of the following standards:

**FCC Part 15, Subpart E (15.407)**

**789033 D02 General UNII Test Procedure New Rules v01**

**662911 D01 Multiple Transmitter Output v02r01**

**ANSI C63.10-2013**

All test items have been performed and recorded as per the above standards.

## 4 Test Types and Results

### 4.1 Radiated Emission and Bandedge Measurement

#### 4.1.1 Limits of Radiated Emission and Bandedge Measurement

Radiated emissions which fall in the restricted bands must comply with the radiated emission limits specified as below table.

Frequencies (MHz)	Field Strength (microvolts/meter)	Measurement Distance (meters)
0.009 ~ 0.490	2400/F(kHz)	300
0.490 ~ 1.705	24000/F(kHz)	30
1.705 ~ 30.0	30	30
30 ~ 88	100	3
88 ~ 216	150	3
216 ~ 960	200	3
Above 960	500	3

**NOTE:**

1. The lower limit shall apply at the transition frequencies.
2. Emission level (dBuV/m) = 20 log Emission level (uV/m).
3. For frequencies above 1000MHz, the field strength limits are based on average detector, however, the peak field strength of any emission shall not exceed the maximum permitted average limits, specified above by more than 20dB under any condition of modulation.

**LIMITS OF UNWANTED EMISSION OUT OF THE RESTRICTED BANDS**

APPLICABLE TO	LIMIT	
789033 D02 General UNII Test Procedure New Rules v01	FIELD STRENGTH AT 3m	
	PK:74 (dBuV/m)	AV:54 (dBuV/m)
APPLICABLE TO	EIRP LIMIT	EQUIVALENT FIELD STRENGTH AT 3m
15.407(b)(1)	PK:-27 (dBm/MHz)	PK:68.2(dBuV/m)
15.407(b)(2)		
15.407(b)(3)		
15.407(b)(4)	PK:-27 (dBm/MHz) <sup>*1</sup> PK:-17 (dBm/MHz) <sup>*2</sup>	PK:68.2 (dBuV/m) <sup>*1</sup> PK:78.2 (dBuV/m) <sup>*2</sup>

**NOTE:** <sup>\*1</sup> beyond 10MHz of the band edge <sup>\*2</sup> within 10 MHz of band edge

The following formula is used to convert the equipment isotropic radiated power (eirp) to field strength:

$$E = \frac{1000000\sqrt{30P}}{3} \mu\text{V/m, where P is the eirp (Watts).$$

#### 4.1.2 Test Instruments

DESCRIPTION & MANUFACTURER	MODEL NO.	SERIAL NO.	CALIBRATED DATE	CALIBRATED UNTIL
Test Receiver Agilent	N9038A	MY51210105	July 24, 2015	July 23, 2016
Pre-Amplifier Mini-Circuits	ZFL-1000VH2 B	AMP-ZFL-03	Nov. 12, 2014	Nov. 11, 2015
Trilog Broadband Antenna SCHWARZBECK	VULB 9168	9168-360	Feb. 06, 2015	Feb. 05, 2016
RF Cable	8D-FB	CHGCAB-001 -1 CHGCAB-001 -2	Oct. 04, 2014	Oct. 03, 2015
	RF-141	CHGCAB-004	Oct. 04, 2014	Oct. 03, 2015
Horn_Antenna AISI	AIH.8018	000032009111 0	Feb. 09, 2015	Feb. 08, 2016
Pre-Amplifier Agilent	8449B	3008A02578	June 23, 2015	June 22, 2016
RF Cable	NA	131205 131216 131217 SNMY23684/ 4	Jan. 16, 2015	Jan. 15, 2016
Spectrum Analyzer R&S	FSV40	100964	June 26, 2015	June 25, 2016
Pre-Amplifier SPACEK LABS	SLKKa-48-6	9K16	Dec. 12, 2014	Dec. 11, 2015
Horn_Antenna SCHWARZBECK	BBHA 9170	9170-424	Feb. 05, 2015	Feb. 04, 2016
RF Cable	NA	329751/4 RF104-204	Dec. 11, 2014	Dec. 10, 2015
Software	ADT_Radiated _V8.7.07	NA	NA	NA
Antenna Tower & Turn Table CT	NA	NA	NA	NA
Spectrum Analyzer R&S	FSP 40	100060	May 08, 2015	May 07, 2016
Power meter Anritsu	ML2495A	1014008	Apr. 28, 2015	Apr. 27, 2016
Power sensor Anritsu	MA2411B	0917122	Apr. 28, 2015	Apr. 27, 2016

**Note:**

1. The calibration interval of the above test instruments is 12 months and the calibrations are traceable to NML/ROC and NIST/USA.
2. The test was performed in 966 Chamber No. G.
3. The FCC Site Registration No. is 966073.
4. The VCCI Site Registration No. is G-137.
5. The CANADA Site Registration No. is IC 7450H-2.
6. Tested Date: Sep. 11 to 14, 2015

#### 4.1.3 Test Procedures

- a. The EUT was placed on the top of a rotating table 0.8 meters (for below 1GHz) / 1.5 meters (for above 1GHz) above the ground at 3 meter chamber room for test. The table was rotated 360 degrees to determine the position of the highest radiation.
- b. The EUT was set 3 meters away from the interference-receiving antenna, which was mounted on the top of a variable-height antenna tower.
- c. The height of antenna is varied from one meter to four meters above the ground to determine the maximum value of the field strength. Both horizontal and vertical polarizations of the antenna are set to make the measurement.
- d. For each suspected emission, the EUT was arranged to its worst case and then the antenna was tuned to heights from 1 meter to 4 meters and the rotatable table was turned from 0 degrees to 360 degrees to find the maximum reading.
- e. The test-receiver system was set to quasi-peak detect function and specified bandwidth with maximum hold mode when the test frequency is below 1 GHz.
- f. The test-receiver system was set to peak and average detect function and specified bandwidth with maximum hold mode when the test frequency is above 1 GHz. If the peak reading value also meets average limit, measurement with the average detector is unnecessary.

**Note:**

1. The resolution bandwidth and video bandwidth of test receiver/spectrum analyzer is 120kHz for Quasi-peak detection (QP) at frequency below 1GHz.
2. The resolution bandwidth of test receiver/spectrum analyzer is 1 MHz and the video bandwidth is 3 MHz for Peak detection (PK) at frequency above 1GHz.
3. The resolution bandwidth of test receiver/spectrum analyzer is 1MHz and the video bandwidth is 3MHz for RMS Average (Duty cycle < 98%) for Average detection (AV) at frequency above 1GHz, then the measurement results was added to a correction factor ( $10 \log(1/\text{duty cycle})$ ).
4. The resolution bandwidth of test receiver/spectrum analyzer is 1MHz and the video bandwidth is 10Hz (Duty cycle  $\geq 98\%$ ) for Average detection (AV) at frequency above 1GHz.
5. All modes of operation were investigated and the worst-case emissions are reported.

#### 4.1.4 Deviation from Test Standard

No deviation.

#### 4.1.5 Test Setup

##### <Frequency Range below 1GHz>

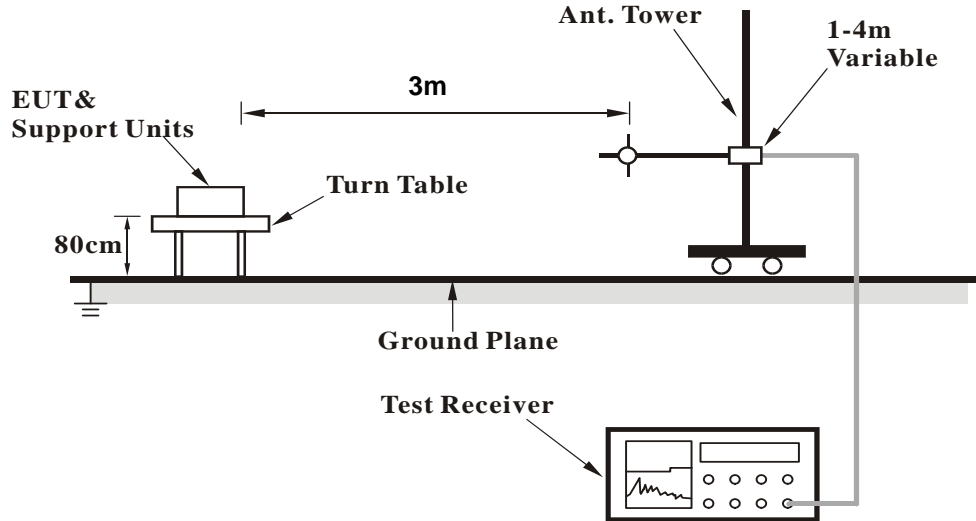

##### <Frequency Range above 1GHz>

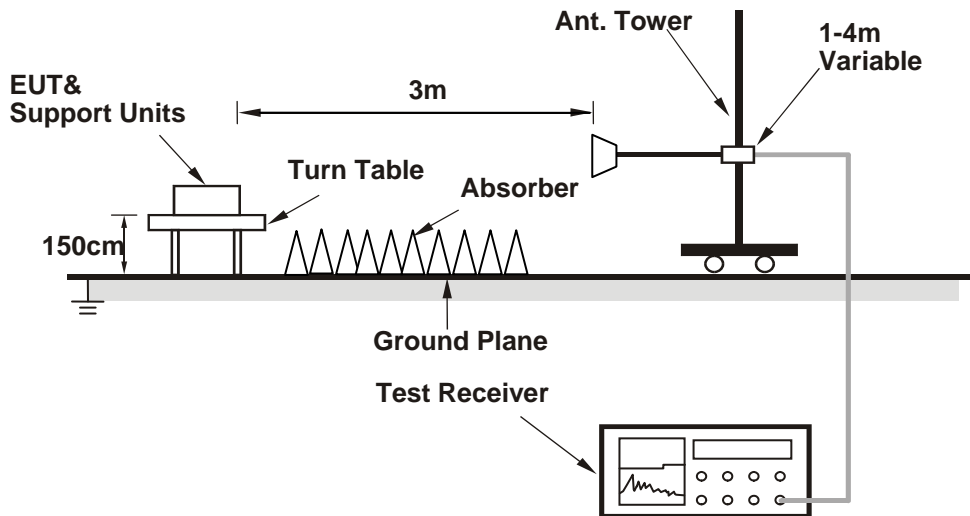

For the actual test configuration, please refer to the attached file (Test Setup Photo).

#### 4.1.6 EUT Operating Conditions

1. Placed the EUT on the testing table.
2. Connect the EUT with the support unit A (Notebook Computer) which is placed in remote site.
3. The communication partner run test program "artgui.exe V2.3" to enable EUT under transmission/receiving condition continuously at specific channel frequency.

4.1.7 Test Results

Above 1GHz Data

802.11a

<b>CHANNEL</b>	TX Channel 36	<b>DETECTOR FUNCTION</b>	Peak (PK)
<b>FREQUENCY RANGE</b>	1GHz ~ 40GHz		Average (AV)

**ANTENNA POLARITY & TEST DISTANCE: HORIZONTAL AT 3 M**

NO.	FREQ. (MHz)	EMISSION LEVEL (dBuV/m)	LIMIT (dBuV/m)	MARGIN (dB)	ANTENNA HEIGHT (m)	TABLE ANGLE (Degree)	RAW VALUE (dBuV)	CORRECTION FACTOR (dB/m)
1	5150.00	53.6 PK	74.0	-20.4	1.90 H	310	43.63	9.97
2	5150.00	40.2 AV	54.0	-13.8	1.90 H	310	30.23	9.97
3	*5180.00	99.6 PK			1.90 H	310	89.44	10.16
4	*5180.00	88.3 AV			1.90 H	310	78.14	10.16
5	#10360.00	55.0 PK	74.0	-19.0	1.52 H	139	38.02	16.98
6	#10360.00	43.0 AV	54.0	-11.0	1.52 H	139	26.02	16.98
7	15540.00	56.1 PK	74.0	-17.9	1.58 H	150	34.17	21.93
8	15540.00	41.9 AV	54.0	-12.1	1.58 H	150	19.97	21.93

**ANTENNA POLARITY & TEST DISTANCE: VERTICAL AT 3 M**

NO.	FREQ. (MHz)	EMISSION LEVEL (dBuV/m)	LIMIT (dBuV/m)	MARGIN (dB)	ANTENNA HEIGHT (m)	TABLE ANGLE (Degree)	RAW VALUE (dBuV)	CORRECTION FACTOR (dB/m)
1	5150.00	70.6 PK	74.0	-3.4	1.91 V	360	60.63	9.97
2	5150.00	53.6 AV	54.0	-0.4	1.91 V	360	43.63	9.97
3	*5180.00	118.3 PK			1.91 V	360	108.14	10.16
4	*5180.00	106.5 AV			1.91 V	360	96.34	10.16
5	#10360.00	57.0 PK	74.0	-17.0	1.76 V	199	40.02	16.98
6	#10360.00	45.0 AV	54.0	-9.0	1.76 V	199	28.02	16.98
7	15540.00	52.1 PK	74.0	-21.9	1.79 V	198	30.17	21.93
8	15540.00	42.1 AV	54.0	-11.9	1.79 V	198	20.17	21.93

**REMARKS:**

1. Emission Level(dBuV/m) = Raw Value(dBuV) + Correction Factor(dB/m)
2. Correction Factor(dB/m) = Antenna Factor(dB/m) + Cable Factor(dB) – Pre-Amplifier Factor(dB)
3. The other emission levels were very low against the limit.
4. Margin value = Emission Level – Limit value
5. " \* ": Fundamental frequency.
6. " # ": The radiated frequency is out of the restricted band.

<b>CHANNEL</b>	TX Channel 40	<b>DETECTOR FUNCTION</b>	Peak (PK)
<b>FREQUENCY RANGE</b>	1GHz ~ 40GHz		Average (AV)

**ANTENNA POLARITY & TEST DISTANCE: HORIZONTAL AT 3 M**

NO.	FREQ. (MHz)	EMISSION LEVEL (dBuV/m)	LIMIT (dBuV/m)	MARGIN (dB)	ANTENNA HEIGHT (m)	TABLE ANGLE (Degree)	RAW VALUE (dBuV)	CORRECTION FACTOR (dB/m)
1	5150.00	51.7 PK	74.0	-22.3	1.89 H	331	41.73	9.97
2	5150.00	40.5 AV	54.0	-13.5	1.89 H	331	30.53	9.97
3	*5200.00	104.6 PK			1.91 H	316	94.34	10.26
4	*5200.00	93.2 AV			1.91 H	316	82.94	10.26
5	#10400.00	60.2 PK	74.0	-13.8	1.71 H	217	43.14	17.06
6	#10400.00	46.0 AV	54.0	-8.0	1.71 H	217	28.94	17.06
7	15600.00	61.2 PK	74.0	-12.8	1.77 H	186	38.92	22.28
8	15600.00	47.8 AV	54.0	-6.2	1.77 H	186	25.52	22.28

**ANTENNA POLARITY & TEST DISTANCE: VERTICAL AT 3 M**

NO.	FREQ. (MHz)	EMISSION LEVEL (dBuV/m)	LIMIT (dBuV/m)	MARGIN (dB)	ANTENNA HEIGHT (m)	TABLE ANGLE (Degree)	RAW VALUE (dBuV)	CORRECTION FACTOR (dB/m)
1	5150.00	68.1 PK	74.0	-5.9	1.87 V	360	58.13	9.97
2	5150.00	51.4 AV	54.0	-2.6	1.87 V	360	41.43	9.97
3	*5200.00	122.8 PK			1.87 V	360	112.54	10.26
4	*5200.00	111.1 AV			1.87 V	360	100.84	10.26
5	#10400.00	67.4 PK	74.0	-6.6	1.80 V	0	50.34	17.06
6	#10400.00	53.4 AV	54.0	-0.6	1.80 V	0	36.34	17.06
7	15600.00	61.1 PK	74.0	-12.9	1.93 V	22	38.82	22.28
8	15600.00	48.8 AV	54.0	-5.2	1.93 V	22	26.52	22.28

**REMARKS:**

1. Emission Level(dBuV/m) = Raw Value(dBuV) + Correction Factor(dB/m)
2. Correction Factor(dB/m) = Antenna Factor(dB/m) + Cable Factor(dB) – Pre-Amplifier Factor(dB)
3. The other emission levels were very low against the limit.
4. Margin value = Emission Level – Limit value
5. " \* ": Fundamental frequency.
6. " # ": The radiated frequency is out of the restricted band.

<b>CHANNEL</b>	TX Channel 48	<b>DETECTOR FUNCTION</b>	Peak (PK)
<b>FREQUENCY RANGE</b>	1GHz ~ 40GHz		Average (AV)

**ANTENNA POLARITY & TEST DISTANCE: HORIZONTAL AT 3 M**

NO.	FREQ. (MHz)	EMISSION LEVEL (dBuV/m)	LIMIT (dBuV/m)	MARGIN (dB)	ANTENNA HEIGHT (m)	TABLE ANGLE (Degree)	RAW VALUE (dBuV)	CORRECTION FACTOR (dB/m)
1	*5240.00	104.9 PK			1.92 H	300	94.57	10.33
2	*5240.00	93.4 AV			1.92 H	300	83.07	10.33
3	5350.00	52.2 PK	74.0	-21.8	1.92 H	325	41.65	10.55
4	5350.00	40.7 AV	54.0	-13.3	1.92 H	325	30.15	10.55
5	#10480.00	60.1 PK	74.0	-13.9	1.76 H	210	43.37	16.73
6	#10480.00	45.7 AV	54.0	-8.3	1.76 H	210	28.97	16.73
7	15720.00	61.0 PK	74.0	-13.0	1.76 H	198	38.37	22.63
8	15720.00	47.8 AV	54.0	-6.2	1.76 H	198	25.17	22.63

**ANTENNA POLARITY & TEST DISTANCE: VERTICAL AT 3 M**

NO.	FREQ. (MHz)	EMISSION LEVEL (dBuV/m)	LIMIT (dBuV/m)	MARGIN (dB)	ANTENNA HEIGHT (m)	TABLE ANGLE (Degree)	RAW VALUE (dBuV)	CORRECTION FACTOR (dB/m)
1	*5240.00	122.1 PK			1.98 V	360	111.77	10.33
2	*5240.00	110.3 AV			1.98 V	360	99.97	10.33
3	5350.00	68.7 PK	74.0	-5.3	1.90 V	359	58.15	10.55
4	5350.00	51.8 AV	54.0	-2.2	1.90 V	359	41.25	10.55
5	#10480.00	67.8 PK	74.0	-6.2	1.83 V	0	51.07	16.73
6	#10480.00	53.6 AV	54.0	-0.4	1.83 V	0	36.87	16.73
7	15720.00	61.1 PK	74.0	-12.9	1.92 V	11	38.47	22.63
8	15720.00	48.8 AV	54.0	-5.2	1.92 V	11	26.17	22.63

**REMARKS:**

1. Emission Level(dBuV/m) = Raw Value(dBuV) + Correction Factor(dB/m)
2. Correction Factor(dB/m) = Antenna Factor(dB/m) + Cable Factor(dB) – Pre-Amplifier Factor(dB)
3. The other emission levels were very low against the limit.
4. Margin value = Emission Level – Limit value
5. " \* ": Fundamental frequency.
6. " # ": The radiated frequency is out of the restricted band.



<b>CHANNEL</b>	TX Channel 149	<b>DETECTOR FUNCTION</b>	Peak (PK)
<b>FREQUENCY RANGE</b>	1GHz ~ 40GHz		Average (AV)

ANTENNA POLARITY & TEST DISTANCE: HORIZONTAL AT 3 M								
NO.	FREQ. (MHz)	EMISSION LEVEL (dBuV/m)	LIMIT (dBuV/m)	MARGIN (dB)	ANTENNA HEIGHT (m)	TABLE ANGLE (Degree)	RAW VALUE (dBuV)	CORRECTION FACTOR (dB/m)
1	#5715.00	48.1 PK	74.0	-25.9	1.55 H	122	36.57	11.53
2	#5715.00	36.3 AV	54.0	-17.7	1.55 H	122	24.77	11.53
3	#5725.00	61.1 PK	78.2	-17.1	1.65 H	221	49.55	11.55
4	*5745.00	96.9 PK			1.87 H	211	85.27	11.63
5	*5745.00	85.9 AV			1.87 H	211	74.27	11.63
6	11490.00	54.3 PK	74.0	-19.7	1.57 H	150	37.00	17.30
7	11490.00	42.6 AV	54.0	-11.4	1.57 H	150	25.30	17.30
8	#17235.00	56.0 PK	74.0	-18.0	1.54 H	155	29.19	26.81
9	#17235.00	42.0 AV	54.0	-12.0	1.54 H	155	15.19	26.81

ANTENNA POLARITY & TEST DISTANCE: VERTICAL AT 3 M								
NO.	FREQ. (MHz)	EMISSION LEVEL (dBuV/m)	LIMIT (dBuV/m)	MARGIN (dB)	ANTENNA HEIGHT (m)	TABLE ANGLE (Degree)	RAW VALUE (dBuV)	CORRECTION FACTOR (dB/m)
1	#5715.00	65.1 PK	74.0	-8.9	1.80 V	355	53.57	11.53
2	#5715.00	49.5 AV	54.0	-4.5	1.80 V	355	37.97	11.53
3	#5725.00	78.1 PK	78.2	-0.1	1.80 V	355	66.55	11.55
4	*5745.00	115.2 PK			1.80 V	355	103.57	11.63
5	*5745.00	103.9 AV			1.80 V	355	92.27	11.63
6	11490.00	56.9 PK	74.0	-17.1	1.82 V	195	39.60	17.30
7	11490.00	44.7 AV	54.0	-9.3	1.82 V	195	27.40	17.30
8	#17235.00	52.1 PK	74.0	-21.9	1.84 V	212	25.29	26.81
9	#17235.00	42.0 AV	54.0	-12.0	1.84 V	212	15.19	26.81

**REMARKS:**

1. Emission Level(dBuV/m) = Raw Value(dBuV) + Correction Factor(dB/m)
2. Correction Factor(dB/m) = Antenna Factor(dB/m) + Cable Factor(dB) – Pre-Amplifier Factor(dB)
3. The other emission levels were very low against the limit.
4. Margin value = Emission Level – Limit value
5. " \* ": Fundamental frequency.
6. " # ": The radiated frequency is out of the restricted band.

<b>CHANNEL</b>	TX Channel 157	<b>DETECTOR FUNCTION</b>	Peak (PK)
<b>FREQUENCY RANGE</b>	1GHz ~ 40GHz		Average (AV)

**ANTENNA POLARITY & TEST DISTANCE: HORIZONTAL AT 3 M**

NO.	FREQ. (MHz)	EMISSION LEVEL (dBuV/m)	LIMIT (dBuV/m)	MARGIN (dB)	ANTENNA HEIGHT (m)	TABLE ANGLE (Degree)	RAW VALUE (dBuV)	CORRECTION FACTOR (dB/m)
1	#5725.00	46.6 PK	78.2	-31.6	1.44 H	211	35.05	11.55
2	*5785.00	104.8 PK			1.90 H	303	93.06	11.74
3	*5785.00	93.4 AV			1.90 H	303	81.66	11.74
4	#5850.00	44.0 PK	78.2	-34.2	1.23 H	332	32.25	11.75
5	11570.00	60.1 PK	74.0	-13.9	1.76 H	218	42.19	17.91
6	11570.00	45.9 AV	54.0	-8.1	1.76 H	218	27.99	17.91
7	#17355.00	61.0 PK	74.0	-13.0	1.73 H	208	33.86	27.14
8	#17355.00	47.6 AV	54.0	-6.4	1.73 H	208	20.46	27.14

**ANTENNA POLARITY & TEST DISTANCE: VERTICAL AT 3 M**

NO.	FREQ. (MHz)	EMISSION LEVEL (dBuV/m)	LIMIT (dBuV/m)	MARGIN (dB)	ANTENNA HEIGHT (m)	TABLE ANGLE (Degree)	RAW VALUE (dBuV)	CORRECTION FACTOR (dB/m)
1	#5725.00	63.6 PK	78.2	-14.6	1.76 V	360	52.05	11.55
2	*5785.00	119.8 PK			1.76 V	360	108.06	11.74
3	*5785.00	108.1 AV			1.76 V	360	96.36	11.74
4	#5850.00	61.0 PK	78.2	-17.2	1.76 V	360	49.25	11.75
5	11570.00	67.5 PK	74.0	-6.5	1.83 V	2	49.59	17.91
6	11570.00	53.4 AV	54.0	-0.6	1.83 V	2	35.49	17.91
7	#17355.00	60.4 PK	74.0	-13.6	1.95 V	12	33.26	27.14
8	#17355.00	48.2 AV	54.0	-5.8	1.95 V	12	21.06	27.14

**REMARKS:**

1. Emission Level(dBuV/m) = Raw Value(dBuV) + Correction Factor(dB/m)
2. Correction Factor(dB/m) = Antenna Factor(dB/m) + Cable Factor(dB) – Pre-Amplifier Factor(dB)
3. The other emission levels were very low against the limit.
4. Margin value = Emission Level – Limit value
5. " \* ": Fundamental frequency.
6. " # ": The radiated frequency is out of the restricted band.

<b>CHANNEL</b>	TX Channel 165	<b>DETECTOR FUNCTION</b>	Peak (PK)
<b>FREQUENCY RANGE</b>	1GHz ~ 40GHz		Average (AV)

**ANTENNA POLARITY & TEST DISTANCE: HORIZONTAL AT 3 M**

NO.	FREQ. (MHz)	EMISSION LEVEL (dBuV/m)	LIMIT (dBuV/m)	MARGIN (dB)	ANTENNA HEIGHT (m)	TABLE ANGLE (Degree)	RAW VALUE (dBuV)	CORRECTION FACTOR (dB/m)
1	*5825.00	100.0 PK			1.86 H	314	88.22	11.78
2	*5825.00	88.8 AV			1.86 H	314	77.02	11.78
3	#5850.00	60.7 PK	78.2	-17.5	1.55 H	144	48.95	11.75
4	#5860.00	49.3 PK	74.0	-24.7	1.52 H	122	37.55	11.75
5	#5860.00	36.9 AV	54.0	-17.1	1.52 H	122	25.15	11.75
6	11650.00	54.9 PK	74.0	-19.1	1.53 H	134	36.74	18.16
7	11650.00	42.6 AV	54.0	-11.4	1.53 H	134	24.44	18.16
8	#17475.00	55.9 PK	74.0	-18.1	1.62 H	142	27.98	27.92
9	#17475.00	41.5 AV	54.0	-12.5	1.62 H	142	13.58	27.92

**ANTENNA POLARITY & TEST DISTANCE: VERTICAL AT 3 M**

NO.	FREQ. (MHz)	EMISSION LEVEL (dBuV/m)	LIMIT (dBuV/m)	MARGIN (dB)	ANTENNA HEIGHT (m)	TABLE ANGLE (Degree)	RAW VALUE (dBuV)	CORRECTION FACTOR (dB/m)
1	*5825.00	118.1 PK			1.94 V	360	106.32	11.78
2	*5825.00	105.6 AV			1.94 V	360	93.82	11.78
3	#5850.00	77.7 PK	78.2	-0.5	1.94 V	360	65.95	11.75
4	#5860.00	66.3 PK	74.0	-7.7	1.94 V	360	54.55	11.75
5	#5860.00	50.1 AV	54.0	-3.9	1.94 V	360	38.35	11.75
6	11650.00	56.6 PK	74.0	-17.4	1.77 V	195	38.44	18.16
7	11650.00	44.9 AV	54.0	-9.1	1.77 V	195	26.74	18.16
8	#17475.00	51.6 PK	74.0	-22.4	1.78 V	194	23.68	27.92
9	#17475.00	41.9 AV	54.0	-12.1	1.78 V	194	13.98	27.92

**REMARKS:**

1. Emission Level(dBuV/m) = Raw Value(dBuV) + Correction Factor(dB/m)
2. Correction Factor(dB/m) = Antenna Factor(dB/m) + Cable Factor(dB) – Pre-Amplifier Factor(dB)
3. The other emission levels were very low against the limit.
4. Margin value = Emission Level – Limit value
5. " \* ": Fundamental frequency.
6. " # ": The radiated frequency is out of the restricted band.

**802.11ac (VHT20)**

<b>CHANNEL</b>	TX Channel 36	<b>DETECTOR FUNCTION</b>	Peak (PK)
<b>FREQUENCY RANGE</b>	1GHz ~ 40GHz		Average (AV)

<b>ANTENNA POLARITY &amp; TEST DISTANCE: HORIZONTAL AT 3 M</b>								
<b>NO.</b>	<b>FREQ. (MHz)</b>	<b>EMISSION LEVEL (dBuV/m)</b>	<b>LIMIT (dBuV/m)</b>	<b>MARGIN (dB)</b>	<b>ANTENNA HEIGHT (m)</b>	<b>TABLE ANGLE (Degree)</b>	<b>RAW VALUE (dBuV)</b>	<b>CORRECTION FACTOR (dB/m)</b>
1	5150.00	53.6 PK	74.0	-20.4	1.90 H	298	43.63	9.97
2	5150.00	40.2 AV	54.0	-13.8	1.90 H	298	30.23	9.97
3	*5180.00	99.8 PK			1.88 H	318	89.64	10.16
4	*5180.00	88.5 AV			1.88 H	318	78.34	10.16
5	#10360.00	55.3 PK	74.0	-18.7	1.46 H	132	38.32	16.98
6	#10360.00	43.5 AV	54.0	-10.5	1.46 H	132	26.52	16.98
7	15540.00	55.8 PK	74.0	-18.2	1.64 H	144	33.87	21.93
8	15540.00	41.8 AV	54.0	-12.2	1.64 H	144	19.87	21.93

<b>ANTENNA POLARITY &amp; TEST DISTANCE: VERTICAL AT 3 M</b>								
<b>NO.</b>	<b>FREQ. (MHz)</b>	<b>EMISSION LEVEL (dBuV/m)</b>	<b>LIMIT (dBuV/m)</b>	<b>MARGIN (dB)</b>	<b>ANTENNA HEIGHT (m)</b>	<b>TABLE ANGLE (Degree)</b>	<b>RAW VALUE (dBuV)</b>	<b>CORRECTION FACTOR (dB/m)</b>
1	5150.00	71.4 PK	74.0	-2.6	1.79 V	357	61.43	9.97
2	5150.00	53.4 AV	54.0	-0.6	1.79 V	357	43.43	9.97
3	*5180.00	118.8 PK			1.79 V	357	108.64	10.16
4	*5180.00	106.0 AV			1.79 V	357	95.84	10.16
5	#10360.00	57.3 PK	74.0	-16.7	1.81 V	211	40.32	16.98
6	#10360.00	45.2 AV	54.0	-8.8	1.81 V	211	28.22	16.98
7	15540.00	51.7 PK	74.0	-22.3	1.74 V	210	29.77	21.93
8	15540.00	42.0 AV	54.0	-12.0	1.74 V	210	20.07	21.93

**REMARKS:**

- Emission Level(dBuV/m) = Raw Value(dBuV) + Correction Factor(dB/m)
- Correction Factor(dB/m) = Antenna Factor(dB/m) + Cable Factor(dB) – Pre-Amplifier Factor(dB)
- The other emission levels were very low against the limit.
- Margin value = Emission Level – Limit value
- " \* ": Fundamental frequency.
- " # ": The radiated frequency is out of the restricted band.

<b>CHANNEL</b>	TX Channel 40	<b>DETECTOR FUNCTION</b>	Peak (PK)
<b>FREQUENCY RANGE</b>	1GHz ~ 40GHz		Average (AV)

**ANTENNA POLARITY & TEST DISTANCE: HORIZONTAL AT 3 M**

NO.	FREQ. (MHz)	EMISSION LEVEL (dBuV/m)	LIMIT (dBuV/m)	MARGIN (dB)	ANTENNA HEIGHT (m)	TABLE ANGLE (Degree)	RAW VALUE (dBuV)	CORRECTION FACTOR (dB/m)
1	*5200.00	104.1 PK			1.92 H	328	93.84	10.26
2	*5200.00	92.9 AV			1.92 H	328	82.64	10.26
3	#10400.00	59.8 PK	74.0	-14.2	1.67 H	233	42.74	17.06
4	#10400.00	45.7 AV	54.0	-8.3	1.67 H	233	28.64	17.06
5	15600.00	60.9 PK	74.0	-13.1	1.71 H	190	38.62	22.28
6	15600.00	47.4 AV	54.0	-6.6	1.71 H	190	25.12	22.28

**ANTENNA POLARITY & TEST DISTANCE: VERTICAL AT 3 M**

NO.	FREQ. (MHz)	EMISSION LEVEL (dBuV/m)	LIMIT (dBuV/m)	MARGIN (dB)	ANTENNA HEIGHT (m)	TABLE ANGLE (Degree)	RAW VALUE (dBuV)	CORRECTION FACTOR (dB/m)
1	*5200.00	121.4 PK			1.88 V	360	111.14	10.26
2	*5200.00	109.2 AV			1.88 V	360	98.94	10.26
3	#10400.00	67.4 PK	74.0	-6.6	1.70 V	12	50.34	17.06
4	#10400.00	53.4 AV	54.0	-0.6	1.70 V	12	36.34	17.06
5	15600.00	60.8 PK	74.0	-13.2	1.84 V	16	38.52	22.28
6	15600.00	48.4 AV	54.0	-5.6	1.84 V	16	26.12	22.28

**REMARKS:**

1. Emission Level(dBuV/m) = Raw Value(dBuV) + Correction Factor(dB/m)
2. Correction Factor(dB/m) = Antenna Factor(dB/m) + Cable Factor(dB) – Pre-Amplifier Factor(dB)
3. The other emission levels were very low against the limit.
4. Margin value = Emission Level – Limit value
5. " \* ": Fundamental frequency.
6. " # ": The radiated frequency is out of the restricted band.

<b>CHANNEL</b>	TX Channel 48	<b>DETECTOR FUNCTION</b>	Peak (PK)
<b>FREQUENCY RANGE</b>	1GHz ~ 40GHz		Average (AV)

**ANTENNA POLARITY & TEST DISTANCE: HORIZONTAL AT 3 M**

NO.	FREQ. (MHz)	EMISSION LEVEL (dBuV/m)	LIMIT (dBuV/m)	MARGIN (dB)	ANTENNA HEIGHT (m)	TABLE ANGLE (Degree)	RAW VALUE (dBuV)	CORRECTION FACTOR (dB/m)
1	*5240.00	105.1 PK			1.97 H	308	94.77	10.33
2	*5240.00	93.5 AV			1.97 H	308	83.17	10.33
3	5350.00	52.1 PK	74.0	-21.9	1.90 H	320	41.55	10.55
4	5350.00	40.8 AV	54.0	-13.2	1.90 H	320	30.25	10.55
5	#10480.00	60.2 PK	74.0	-13.8	1.74 H	198	43.47	16.73
6	#10480.00	45.6 AV	54.0	-8.4	1.74 H	198	28.87	16.73
7	15720.00	60.5 PK	74.0	-13.5	1.73 H	184	37.87	22.63
8	15720.00	47.4 AV	54.0	-6.6	1.73 H	184	24.77	22.63

**ANTENNA POLARITY & TEST DISTANCE: VERTICAL AT 3 M**

NO.	FREQ. (MHz)	EMISSION LEVEL (dBuV/m)	LIMIT (dBuV/m)	MARGIN (dB)	ANTENNA HEIGHT (m)	TABLE ANGLE (Degree)	RAW VALUE (dBuV)	CORRECTION FACTOR (dB/m)
1	*5240.00	123.0 PK			1.90 V	360	112.67	10.33
2	*5240.00	110.1 AV			1.90 V	360	99.77	10.33
3	5350.00	57.0 PK	74.0	-17.0	1.90 V	360	46.45	10.55
4	5350.00	44.1 AV	54.0	-9.9	1.90 V	360	33.55	10.55
5	#10480.00	67.7 PK	74.0	-6.3	1.71 V	23	50.97	16.73
6	#10480.00	53.4 AV	54.0	-0.6	1.71 V	23	36.67	16.73
7	15720.00	61.1 PK	74.0	-12.9	1.75 V	23	38.47	22.63
8	15720.00	48.8 AV	54.0	-5.2	1.75 V	23	26.17	22.63

**REMARKS:**

1. Emission Level(dBuV/m) = Raw Value(dBuV) + Correction Factor(dB/m)
2. Correction Factor(dB/m) = Antenna Factor(dB/m) + Cable Factor(dB) – Pre-Amplifier Factor(dB)
3. The other emission levels were very low against the limit.
4. Margin value = Emission Level – Limit value
5. " \* ": Fundamental frequency.
6. " # ": The radiated frequency is out of the restricted band.

<b>CHANNEL</b>	TX Channel 149	<b>DETECTOR FUNCTION</b>	Peak (PK)
<b>FREQUENCY RANGE</b>	1GHz ~ 40GHz		Average (AV)

ANTENNA POLARITY & TEST DISTANCE: HORIZONTAL AT 3 M								
NO.	FREQ. (MHz)	EMISSION LEVEL (dBuV/m)	LIMIT (dBuV/m)	MARGIN (dB)	ANTENNA HEIGHT (m)	TABLE ANGLE (Degree)	RAW VALUE (dBuV)	CORRECTION FACTOR (dB/m)
1	#5715.00	47.8 PK	74.0	-26.2	1.50 H	117	36.27	11.53
2	#5715.00	36.0 AV	54.0	-18.0	1.50 H	117	24.47	11.53
3	#5725.00	61.1 PK	78.2	-17.1	1.68 H	217	49.55	11.55
4	*5745.00	96.6 PK			1.83 H	202	84.97	11.63
5	*5745.00	85.4 AV			1.83 H	202	73.77	11.63
6	11490.00	54.7 PK	74.0	-19.3	1.53 H	135	37.40	17.30
7	11490.00	42.9 AV	54.0	-11.1	1.53 H	135	25.60	17.30
8	#17235.00	55.5 PK	74.0	-18.5	1.49 H	157	28.69	26.81
9	#17235.00	41.6 AV	54.0	-12.4	1.49 H	157	14.79	26.81

ANTENNA POLARITY & TEST DISTANCE: VERTICAL AT 3 M								
NO.	FREQ. (MHz)	EMISSION LEVEL (dBuV/m)	LIMIT (dBuV/m)	MARGIN (dB)	ANTENNA HEIGHT (m)	TABLE ANGLE (Degree)	RAW VALUE (dBuV)	CORRECTION FACTOR (dB/m)
1	#5715.00	67.6 PK	74.0	-6.4	1.92 V	352	56.07	11.53
2	#5715.00	49.6 AV	54.0	-4.4	1.92 V	352	38.07	11.53
3	#5725.00	77.8 PK	78.2	-0.4	1.92 V	352	66.25	11.55
4	*5745.00	116.0 PK			1.92 V	352	104.37	11.63
5	*5745.00	103.4 AV			1.92 V	352	91.77	11.63
6	11490.00	56.8 PK	74.0	-17.2	1.85 V	181	39.50	17.30
7	11490.00	44.5 AV	54.0	-9.5	1.85 V	181	27.20	17.30
8	#17235.00	51.7 PK	74.0	-22.3	1.80 V	222	24.89	26.81
9	#17235.00	41.7 AV	54.0	-12.3	1.80 V	222	14.89	26.81

**REMARKS:**

1. Emission Level(dBuV/m) = Raw Value(dBuV) + Correction Factor(dB/m)
2. Correction Factor(dB/m) = Antenna Factor(dB/m) + Cable Factor(dB) – Pre-Amplifier Factor(dB)
3. The other emission levels were very low against the limit.
4. Margin value = Emission Level – Limit value
5. " \* ": Fundamental frequency.
6. " # ": The radiated frequency is out of the restricted band.

<b>CHANNEL</b>	TX Channel 157	<b>DETECTOR FUNCTION</b>	Peak (PK)
<b>FREQUENCY RANGE</b>	1GHz ~ 40GHz		Average (AV)

**ANTENNA POLARITY & TEST DISTANCE: HORIZONTAL AT 3 M**

NO.	FREQ. (MHz)	EMISSION LEVEL (dBuV/m)	LIMIT (dBuV/m)	MARGIN (dB)	ANTENNA HEIGHT (m)	TABLE ANGLE (Degree)	RAW VALUE (dBuV)	CORRECTION FACTOR (dB/m)
1	*5785.00	105.1 PK			1.93 H	308	93.36	11.74
2	*5785.00	93.5 AV			1.93 H	308	81.76	11.74
3	11570.00	60.2 PK	74.0	-13.8	1.80 H	230	42.29	17.91
4	11570.00	45.8 AV	54.0	-8.2	1.80 H	230	27.89	17.91
5	#17355.00	60.8 PK	74.0	-13.2	1.71 H	223	33.66	27.14
6	#17355.00	47.6 AV	54.0	-6.4	1.71 H	223	20.46	27.14

**ANTENNA POLARITY & TEST DISTANCE: VERTICAL AT 3 M**

NO.	FREQ. (MHz)	EMISSION LEVEL (dBuV/m)	LIMIT (dBuV/m)	MARGIN (dB)	ANTENNA HEIGHT (m)	TABLE ANGLE (Degree)	RAW VALUE (dBuV)	CORRECTION FACTOR (dB/m)
1	*5785.00	119.4 PK			1.72 V	350	107.66	11.74
2	*5785.00	107.6 AV			1.72 V	350	95.86	11.74
3	11570.00	67.0 PK	74.0	-7.0	1.78 V	10	49.09	17.91
4	11570.00	53.1 AV	54.0	-0.9	1.78 V	10	35.19	17.91
5	#17355.00	60.6 PK	74.0	-13.4	1.92 V	0	33.46	27.14
6	#17355.00	48.4 AV	54.0	-5.6	1.92 V	0	21.26	27.14

**REMARKS:**

1. Emission Level(dBuV/m) = Raw Value(dBuV) + Correction Factor(dB/m)
2. Correction Factor(dB/m) = Antenna Factor(dB/m) + Cable Factor(dB) – Pre-Amplifier Factor(dB)
3. The other emission levels were very low against the limit.
4. Margin value = Emission Level – Limit value
5. " \* ": Fundamental frequency.
6. " # ": The radiated frequency is out of the restricted band.



<b>CHANNEL</b>	TX Channel 165	<b>DETECTOR FUNCTION</b>	Peak (PK)
<b>FREQUENCY RANGE</b>	1GHz ~ 40GHz		Average (AV)

**ANTENNA POLARITY & TEST DISTANCE: HORIZONTAL AT 3 M**

NO.	FREQ. (MHz)	EMISSION LEVEL (dBuV/m)	LIMIT (dBuV/m)	MARGIN (dB)	ANTENNA HEIGHT (m)	TABLE ANGLE (Degree)	RAW VALUE (dBuV)	CORRECTION FACTOR (dB/m)
1	*5825.00	99.7 PK			1.54 H	221	87.92	11.78
2	*5825.00	92.3 AV			1.54 H	221	80.52	11.78
3	#5850.00	60.3 PK	78.2	-17.9	1.56 H	136	48.55	11.75
4	#5860.00	49.7 PK	74.0	-24.3	1.57 H	123	37.95	11.75
5	#5860.00	37.1 AV	54.0	-16.9	1.57 H	123	25.35	11.75
6	11650.00	54.5 PK	74.0	-19.5	1.51 H	132	36.34	18.16
7	11650.00	42.4 AV	54.0	-11.6	1.51 H	132	24.24	18.16
8	#17475.00	55.6 PK	74.0	-18.4	1.64 H	156	27.68	27.92
9	#17475.00	41.3 AV	54.0	-12.7	1.64 H	156	13.38	27.92

**ANTENNA POLARITY & TEST DISTANCE: VERTICAL AT 3 M**

NO.	FREQ. (MHz)	EMISSION LEVEL (dBuV/m)	LIMIT (dBuV/m)	MARGIN (dB)	ANTENNA HEIGHT (m)	TABLE ANGLE (Degree)	RAW VALUE (dBuV)	CORRECTION FACTOR (dB/m)
1	*5825.00	117.9 PK			1.98 V	351	106.12	11.78
2	*5825.00	105.2 AV			1.98 V	351	93.42	11.78
3	#5850.00	78.1 PK	78.2	-0.1	1.98 V	351	66.35	11.75
4	#5860.00	63.3 PK	74.0	-10.7	1.98 V	351	51.55	11.75
5	#5860.00	49.1 AV	54.0	-4.9	1.98 V	351	37.35	11.75
6	11650.00	57.0 PK	74.0	-17.0	1.80 V	199	38.84	18.16
7	11650.00	45.2 AV	54.0	-8.8	1.80 V	199	27.04	18.16
8	#17475.00	51.8 PK	74.0	-22.2	1.76 V	199	23.88	27.92
9	#17475.00	42.0 AV	54.0	-12.0	1.76 V	199	14.08	27.92

**REMARKS:**

1. Emission Level(dBuV/m) = Raw Value(dBuV) + Correction Factor(dB/m)
2. Correction Factor(dB/m) = Antenna Factor(dB/m) + Cable Factor(dB) – Pre-Amplifier Factor(dB)
3. The other emission levels were very low against the limit.
4. Margin value = Emission Level – Limit value
5. " \* ": Fundamental frequency.
6. " # ": The radiated frequency is out of the restricted band.

**802.11ac (VHT40)**

<b>CHANNEL</b>	TX Channel 38	<b>DETECTOR FUNCTION</b>	Peak (PK)
<b>FREQUENCY RANGE</b>	1GHz ~ 40GHz		Average (AV)

**ANTENNA POLARITY & TEST DISTANCE: HORIZONTAL AT 3 M**

NO.	FREQ. (MHz)	EMISSION LEVEL (dBuV/m)	LIMIT (dBuV/m)	MARGIN (dB)	ANTENNA HEIGHT (m)	TABLE ANGLE (Degree)	RAW VALUE (dBuV)	CORRECTION FACTOR (dB/m)
1	5150.00	53.5 PK	74.0	-20.5	1.59 H	111	43.53	9.97
2	5150.00	40.5 AV	54.0	-13.5	1.59 H	111	30.53	9.97
3	*5190.00	94.9 PK			1.58 H	107	84.70	10.20
4	*5190.00	82.7 AV			1.58 H	107	72.50	10.20
5	5350.00	43.4 PK	74.0	-30.6	1.57 H	108	32.85	10.55
6	5350.00	32.2 AV	54.0	-21.8	1.57 H	108	21.65	10.55
7	#10380.00	54.6 PK	74.0	-19.4	1.48 H	140	37.58	17.02
8	#10380.00	42.7 AV	54.0	-11.3	1.48 H	140	25.68	17.02
9	15570.00	55.8 PK	74.0	-18.2	1.68 H	145	33.70	22.10
10	15570.00	41.3 AV	54.0	-12.7	1.68 H	145	19.20	22.10

**ANTENNA POLARITY & TEST DISTANCE: VERTICAL AT 3 M**

NO.	FREQ. (MHz)	EMISSION LEVEL (dBuV/m)	LIMIT (dBuV/m)	MARGIN (dB)	ANTENNA HEIGHT (m)	TABLE ANGLE (Degree)	RAW VALUE (dBuV)	CORRECTION FACTOR (dB/m)
1	5150.00	68.3 PK	74.0	-5.7	1.88 V	360	58.33	9.97
2	5150.00	53.6 AV	54.0	-0.4	1.88 V	360	43.63	9.97
3	*5190.00	111.6 PK			1.88 V	360	101.40	10.20
4	*5190.00	98.8 AV			1.88 V	360	88.60	10.20
5	5350.00	58.1 PK	74.0	-15.9	1.88 V	360	47.55	10.55
6	5350.00	43.5 AV	54.0	-10.5	1.88 V	360	32.95	10.55
7	#10380.00	56.7 PK	74.0	-17.3	1.78 V	208	39.68	17.02
8	#10380.00	44.9 AV	54.0	-9.1	1.78 V	208	27.88	17.02
9	15570.00	51.5 PK	74.0	-22.5	1.82 V	189	29.40	22.10
10	15570.00	41.7 AV	54.0	-12.3	1.82 V	189	19.60	22.10

**REMARKS:**

- Emission Level(dBuV/m) = Raw Value(dBuV) + Correction Factor(dB/m)
- Correction Factor(dB/m) = Antenna Factor(dB/m) + Cable Factor(dB) – Pre-Amplifier Factor(dB)
- The other emission levels were very low against the limit.
- Margin value = Emission Level – Limit value
- " \* ": Fundamental frequency.
- " # ": The radiated frequency is out of the restricted band.

<b>CHANNEL</b>	TX Channel 46	<b>DETECTOR FUNCTION</b>	Peak (PK)
<b>FREQUENCY RANGE</b>	1GHz ~ 40GHz		Average (AV)

**ANTENNA POLARITY & TEST DISTANCE: HORIZONTAL AT 3 M**

NO.	FREQ. (MHz)	EMISSION LEVEL (dBuV/m)	LIMIT (dBuV/m)	MARGIN (dB)	ANTENNA HEIGHT (m)	TABLE ANGLE (Degree)	RAW VALUE (dBuV)	CORRECTION FACTOR (dB/m)
1	5150.00	55.3 PK	74.0	-18.7	1.61 H	119	45.33	9.97
2	5150.00	42.5 AV	54.0	-11.5	1.61 H	119	32.53	9.97
3	*5230.00	102.4 PK			1.60 H	138	92.08	10.32
4	*5230.00	89.5 AV			1.60 H	138	79.18	10.32
5	5350.00	43.7 PK	74.0	-30.3	1.58 H	131	33.15	10.55
6	5350.00	30.0 AV	54.0	-24.0	1.58 H	131	19.45	10.55
7	#10460.00	54.4 PK	74.0	-19.6	1.51 H	134	37.58	16.82
8	#10460.00	42.4 AV	54.0	-11.6	1.51 H	134	25.58	16.82
9	15690.00	55.3 PK	74.0	-18.7	1.67 H	152	32.78	22.52
10	15690.00	41.1 AV	54.0	-12.9	1.67 H	152	18.58	22.52

**ANTENNA POLARITY & TEST DISTANCE: VERTICAL AT 3 M**

NO.	FREQ. (MHz)	EMISSION LEVEL (dBuV/m)	LIMIT (dBuV/m)	MARGIN (dB)	ANTENNA HEIGHT (m)	TABLE ANGLE (Degree)	RAW VALUE (dBuV)	CORRECTION FACTOR (dB/m)
1	5150.00	70.3 PK	74.0	-3.7	1.87 V	360	60.33	9.97
2	5150.00	53.8 AV	54.0	-0.2	1.87 V	360	43.83	9.97
3	*5230.00	118.9 PK			1.87 V	360	108.58	10.32
4	*5230.00	105.7 AV			1.87 V	360	95.38	10.32
5	5350.00	60.6 PK	74.0	-13.4	1.87 V	360	50.05	10.55
6	5350.00	46.2 AV	54.0	-7.8	1.87 V	360	35.65	10.55
7	#10460.00	56.8 PK	74.0	-17.2	1.86 V	189	39.98	16.82
8	#10460.00	45.1 AV	54.0	-8.9	1.86 V	189	28.28	16.82
9	15690.00	52.3 PK	74.0	-21.7	1.76 V	197	29.78	22.52
10	15690.00	42.4 AV	54.0	-11.6	1.76 V	197	19.88	22.52

**REMARKS:**

1. Emission Level(dBuV/m) = Raw Value(dBuV) + Correction Factor(dB/m)
2. Correction Factor(dB/m) = Antenna Factor(dB/m) + Cable Factor(dB) – Pre-Amplifier Factor(dB)
3. The other emission levels were very low against the limit.
4. Margin value = Emission Level – Limit value
5. " \* ": Fundamental frequency.
6. " # ": The radiated frequency is out of the restricted band.

<b>CHANNEL</b>	TX Channel 151	<b>DETECTOR FUNCTION</b>	Peak (PK)
<b>FREQUENCY RANGE</b>	1GHz ~ 40GHz		Average (AV)

**ANTENNA POLARITY & TEST DISTANCE: HORIZONTAL AT 3 M**

NO.	FREQ. (MHz)	EMISSION LEVEL (dBuV/m)	LIMIT (dBuV/m)	MARGIN (dB)	ANTENNA HEIGHT (m)	TABLE ANGLE (Degree)	RAW VALUE (dBuV)	CORRECTION FACTOR (dB/m)
1	#5715.00	55.4 PK	74.0	-18.6	1.53 H	138	43.87	11.53
2	#5715.00	42.5 AV	54.0	-11.5	1.53 H	138	30.97	11.53
3	#5725.00	62.1 PK	78.2	-16.1	1.53 H	121	50.55	11.55
4	*5755.00	94.5 PK			1.56 H	110	82.86	11.64
5	*5755.00	82.5 AV			1.56 H	110	70.86	11.64
6	11510.00	54.3 PK	74.0	-19.7	1.53 H	132	37.00	17.30
7	11510.00	42.4 AV	54.0	-11.6	1.53 H	132	25.10	17.30
8	#17265.00	56.1 PK	74.0	-17.9	1.69 H	164	29.39	26.71
9	#17265.00	41.8 AV	54.0	-12.2	1.69 H	164	15.09	26.71

**ANTENNA POLARITY & TEST DISTANCE: VERTICAL AT 3 M**

NO.	FREQ. (MHz)	EMISSION LEVEL (dBuV/m)	LIMIT (dBuV/m)	MARGIN (dB)	ANTENNA HEIGHT (m)	TABLE ANGLE (Degree)	RAW VALUE (dBuV)	CORRECTION FACTOR (dB/m)
1	#5715.00	70.3 PK	74.0	-3.7	1.81 V	354	58.77	11.53
2	#5715.00	53.8 AV	54.0	-0.2	1.81 V	354	42.27	11.53
3	#5725.00	77.1 PK	78.2	-1.1	1.81 V	354	65.55	11.55
4	*5755.00	111.1 PK			1.81 V	354	99.46	11.64
5	*5755.00	98.2 AV			1.81 V	354	86.56	11.64
6	11510.00	56.8 PK	74.0	-17.2	1.80 V	215	39.50	17.30
7	11510.00	45.3 AV	54.0	-8.7	1.80 V	215	28.00	17.30
8	#17265.00	52.1 PK	74.0	-21.9	1.82 V	186	25.39	26.71
9	#17265.00	42.3 AV	54.0	-11.7	1.82 V	186	15.59	26.71

**REMARKS:**

1. Emission Level(dBuV/m) = Raw Value(dBuV) + Correction Factor(dB/m)
2. Correction Factor(dB/m) = Antenna Factor(dB/m) + Cable Factor(dB) – Pre-Amplifier Factor(dB)
3. The other emission levels were very low against the limit.
4. Margin value = Emission Level – Limit value
5. " \* ": Fundamental frequency.
6. " # ": The radiated frequency is out of the restricted band.

<b>CHANNEL</b>	TX Channel 159	<b>DETECTOR FUNCTION</b>	Peak (PK)
<b>FREQUENCY RANGE</b>	1GHz ~ 40GHz		Average (AV)

**ANTENNA POLARITY & TEST DISTANCE: HORIZONTAL AT 3 M**

NO.	FREQ. (MHz)	EMISSION LEVEL (dBuV/m)	LIMIT (dBuV/m)	MARGIN (dB)	ANTENNA HEIGHT (m)	TABLE ANGLE (Degree)	RAW VALUE (dBuV)	CORRECTION FACTOR (dB/m)
1	*5795.00	99.5 PK			1.55 H	110	87.72	11.78
2	*5795.00	86.4 AV			1.55 H	110	74.62	11.78
3	#5850.00	50.3 PK	78.2	-27.9	1.52 H	110	38.55	11.75
4	#5860.00	56.1 PK	74.0	-17.9	1.54 H	117	44.35	11.75
5	#5860.00	42.5 AV	54.0	-11.5	1.54 H	117	30.75	11.75
6	11590.00	54.2 PK	74.0	-19.8	1.53 H	147	36.09	18.11
7	11590.00	42.0 AV	54.0	-12.0	1.53 H	147	23.89	18.11
8	#17385.00	56.0 PK	74.0	-18.0	1.62 H	158	28.55	27.45
9	#17385.00	41.4 AV	54.0	-12.6	1.62 H	158	13.95	27.45

**ANTENNA POLARITY & TEST DISTANCE: VERTICAL AT 3 M**

NO.	FREQ. (MHz)	EMISSION LEVEL (dBuV/m)	LIMIT (dBuV/m)	MARGIN (dB)	ANTENNA HEIGHT (m)	TABLE ANGLE (Degree)	RAW VALUE (dBuV)	CORRECTION FACTOR (dB/m)
1	*5795.00	115.6 PK			1.78 V	353	103.82	11.78
2	*5795.00	102.5 AV			1.78 V	353	90.72	11.78
3	#5850.00	67.5 PK	78.2	-10.7	1.78 V	353	55.75	11.75
4	#5860.00	71.1 PK	74.0	-2.9	1.78 V	353	59.35	11.75
5	#5860.00	53.8 AV	54.0	-0.2	1.78 V	353	42.05	11.75
6	11590.00	56.6 PK	74.0	-17.4	1.75 V	214	38.49	18.11
7	11590.00	44.8 AV	54.0	-9.2	1.75 V	214	26.69	18.11
8	#17385.00	51.5 PK	74.0	-22.5	1.81 V	190	24.05	27.45
9	#17385.00	41.9 AV	54.0	-12.1	1.81 V	190	14.45	27.45

**REMARKS:**

1. Emission Level(dBuV/m) = Raw Value(dBuV) + Correction Factor(dB/m)
2. Correction Factor(dB/m) = Antenna Factor(dB/m) + Cable Factor(dB) – Pre-Amplifier Factor(dB)
3. The other emission levels were very low against the limit.
4. Margin value = Emission Level – Limit value
5. " \* ": Fundamental frequency.
6. " # ": The radiated frequency is out of the restricted band.

**802.11ac (VHT80)**

<b>CHANNEL</b>	TX Channel 42	<b>DETECTOR FUNCTION</b>	Peak (PK)
<b>FREQUENCY RANGE</b>	1GHz ~ 40GHz		Average (AV)

**ANTENNA POLARITY & TEST DISTANCE: HORIZONTAL AT 3 M**

NO.	FREQ. (MHz)	EMISSION LEVEL (dBuV/m)	LIMIT (dBuV/m)	MARGIN (dB)	ANTENNA HEIGHT (m)	TABLE ANGLE (Degree)	RAW VALUE (dBuV)	CORRECTION FACTOR (dB/m)
1	5150.00	60.0 PK	74.0	-14.0	1.57 H	127	50.03	9.97
2	5150.00	38.1 AV	54.0	-15.9	1.57 H	127	28.13	9.97
3	*5210.00	93.0 PK			1.55 H	120	82.73	10.27
4	*5210.00	73.8 AV			1.55 H	120	63.53	10.27
5	5350.00	45.5 PK	74.0	-28.5	1.58 H	107	34.95	10.55
6	5350.00	32.4 AV	54.0	-21.6	1.58 H	107	21.85	10.55
7	#10420.00	55.0 PK	74.0	-19.0	1.47 H	129	38.02	16.98
8	#10420.00	42.5 AV	54.0	-11.5	1.47 H	129	25.52	16.98
9	15630.00	55.5 PK	74.0	-18.5	1.64 H	152	33.13	22.37
10	15630.00	41.6 AV	54.0	-12.4	1.64 H	152	19.23	22.37

**ANTENNA POLARITY & TEST DISTANCE: VERTICAL AT 3 M**

NO.	FREQ. (MHz)	EMISSION LEVEL (dBuV/m)	LIMIT (dBuV/m)	MARGIN (dB)	ANTENNA HEIGHT (m)	TABLE ANGLE (Degree)	RAW VALUE (dBuV)	CORRECTION FACTOR (dB/m)
1	5150.00	73.2 PK	74.0	-0.8	1.82 V	360	63.23	9.97
2	5150.00	48.5 AV	54.0	-5.5	1.82 V	360	38.53	9.97
3	*5210.00	108.0 PK			1.82 V	360	97.73	10.27
4	*5210.00	88.2 AV			1.82 V	360	77.93	10.27
5	5350.00	58.9 PK	74.0	-15.1	1.82 V	360	48.35	10.55
6	5350.00	42.8 AV	54.0	-11.2	1.82 V	360	32.25	10.55
7	#10420.00	56.3 PK	74.0	-17.7	1.80 V	222	39.32	16.98
8	#10420.00	44.4 AV	54.0	-9.6	1.80 V	222	27.42	16.98
9	15630.00	51.2 PK	74.0	-22.8	1.85 V	190	28.83	22.37
10	15630.00	41.7 AV	54.0	-12.3	1.85 V	190	19.33	22.37

**REMARKS:**

- Emission Level(dBuV/m) = Raw Value(dBuV) + Correction Factor(dB/m)
- Correction Factor(dB/m) = Antenna Factor(dB/m) + Cable Factor(dB) – Pre-Amplifier Factor(dB)
- The other emission levels were very low against the limit.
- Margin value = Emission Level – Limit value
- " \* ": Fundamental frequency.
- " # ": The radiated frequency is out of the restricted band.

<b>CHANNEL</b>	TX Channel 155	<b>DETECTOR FUNCTION</b>	Peak (PK)
<b>FREQUENCY RANGE</b>	1GHz ~ 40GHz		Average (AV)

<b>ANTENNA POLARITY &amp; TEST DISTANCE: HORIZONTAL AT 3 M</b>								
NO.	FREQ. (MHz)	EMISSION LEVEL (dBuV/m)	LIMIT (dBuV/m)	MARGIN (dB)	ANTENNA HEIGHT (m)	TABLE ANGLE (Degree)	RAW VALUE (dBuV)	CORRECTION FACTOR (dB/m)
1	#5715.00	61.0 PK	74.0	-13.0	1.50 H	119	49.47	11.53
2	#5715.00	38.6 AV	54.0	-15.4	1.50 H	119	27.07	11.53
3	#5725.00	65.6 PK	78.2	-12.6	1.57 H	118	54.05	11.55
4	*5775.00	93.6 PK			1.51 H	101	81.88	11.72
5	*5775.00	72.5 AV			1.51 H	101	60.78	11.72
6	#5850.00	61.6 PK	78.2	-16.6	1.60 H	126	49.85	11.75
7	#5860.00	60.8 PK	74.0	-13.2	1.58 H	110	49.05	11.75
8	#5860.00	37.4 AV	54.0	-16.6	1.58 H	110	25.65	11.75
9	11550.00	54.8 PK	74.0	-19.2	1.50 H	136	37.09	17.71
10	11550.00	42.6 AV	54.0	-11.4	1.50 H	136	24.89	17.71
11	#17325.00	55.2 PK	74.0	-18.8	1.62 H	163	28.35	26.85
12	#17325.00	41.2 AV	54.0	-12.8	1.62 H	163	14.35	26.85

<b>ANTENNA POLARITY &amp; TEST DISTANCE: VERTICAL AT 3 M</b>								
NO.	FREQ. (MHz)	EMISSION LEVEL (dBuV/m)	LIMIT (dBuV/m)	MARGIN (dB)	ANTENNA HEIGHT (m)	TABLE ANGLE (Degree)	RAW VALUE (dBuV)	CORRECTION FACTOR (dB/m)
1	#5715.00	73.8 PK	74.0	-0.2	1.98 V	360	62.27	11.53
2	#5715.00	48.2 AV	54.0	-5.8	1.98 V	360	36.67	11.53
3	#5725.00	78.1 PK	78.2	-0.1	1.98 V	360	66.55	11.55
4	*5775.00	107.7 PK			1.98 V	360	95.98	11.72
5	*5775.00	86.1 AV			1.98 V	360	74.38	11.72
6	#5850.00	74.7 PK	78.2	-3.5	1.98 V	360	62.95	11.75
7	#5860.00	73.8 PK	74.0	-0.2	1.98 V	360	62.05	11.75
8	#5860.00	47.6 AV	54.0	-6.4	1.98 V	360	35.85	11.75
9	11550.00	56.7 PK	74.0	-17.3	1.74 V	215	38.99	17.71
10	11550.00	44.7 AV	54.0	-9.3	1.74 V	215	26.99	17.71
11	#17325.00	51.3 PK	74.0	-22.7	1.85 V	195	24.45	26.85
12	#17325.00	41.4 AV	54.0	-12.6	1.85 V	195	14.55	26.85

**REMARKS:**

1. Emission Level(dBuV/m) = Raw Value(dBuV) + Correction Factor(dB/m)
2. Correction Factor(dB/m) = Antenna Factor(dB/m) + Cable Factor(dB) – Pre-Amplifier Factor(dB)
3. The other emission levels were very low against the limit.
4. Margin value = Emission Level – Limit value
5. " \* ": Fundamental frequency.
6. " # ": The radiated frequency is out of the restricted band.

**Below 1GHz Data**
**802.11ac (VHT40)**

<b>CHANNEL</b>	TX Channel 46	<b>DETECTOR FUNCTION</b>	Quasi-Peak (QP)
<b>FREQUENCY RANGE</b>	Below 1GHz		

**ANTENNA POLARITY & TEST DISTANCE: HORIZONTAL AT 3 M**

NO.	FREQ. (MHz)	EMISSION LEVEL (dBuV/m)	LIMIT (dBuV/m)	MARGIN (dB)	ANTENNA HEIGHT (m)	TABLE ANGLE (Degree)	RAW VALUE (dBuV)	CORRECTION FACTOR (dB/m)
1	240.01	43.5 QP	46.0	-2.5	1.20 H	80	57.93	-14.44
2	300.01	39.7 QP	46.0	-6.3	1.50 H	360	51.77	-12.04
3	375.01	40.8 QP	46.0	-5.2	1.60 H	242	50.75	-9.97
4	499.97	41.3 QP	46.0	-4.7	1.00 H	360	48.13	-6.83
5	680.01	42.2 QP	46.0	-3.8	1.40 H	56	45.19	-3.03
6	750.00	39.7 QP	46.0	-6.3	1.50 H	145	40.93	-1.21

**ANTENNA POLARITY & TEST DISTANCE: VERTICAL AT 3 M**

NO.	FREQ. (MHz)	EMISSION LEVEL (dBuV/m)	LIMIT (dBuV/m)	MARGIN (dB)	ANTENNA HEIGHT (m)	TABLE ANGLE (Degree)	RAW VALUE (dBuV)	CORRECTION FACTOR (dB/m)
1	37.57	35.1 QP	40.0	-4.9	1.30 V	304	48.86	-13.76
2	240.01	43.3 QP	46.0	-2.7	1.20 V	9	57.70	-14.44
3	333.32	39.7 QP	46.0	-6.3	2.00 V	306	50.78	-11.09
4	374.94	42.2 QP	46.0	-3.8	1.10 V	60	52.17	-9.98
5	724.95	40.4 QP	46.0	-5.6	1.40 V	19	42.73	-2.37
6	749.98	37.4 QP	46.0	-8.6	1.50 V	187	38.64	-1.21

**REMARKS:**

1. Emission Level(dBuV/m) = Raw Value(dBuV) + Correction Factor(dB/m)
2. Correction Factor(dB/m) = Antenna Factor(dB/m) + Cable Factor(dB) – Pre-Amplifier Factor(dB)
3. The other emission levels were very low against the limit.
4. Margin value = Emission Level – Limit value



## 4.2 Conducted Emission Measurement

### 4.2.1 Limits of Conducted Emission Measurement

Frequency (MHz)	Conducted Limit (dBuV)	
	Quasi-peak	Average
0.15 - 0.5	66 - 56	56 - 46
0.50 - 5.0	56	46
5.0 - 30.0	60	50

Note: 1. The lower limit shall apply at the transition frequencies.

2. The limit decreases in line with the logarithm of the frequency in the range of 0.15 to 0.50MHz.

### 4.2.2 Test Instruments

DESCRIPTION & MANUFACTURER	MODEL NO.	SERIAL NO.	CALIBRATED DATE	CALIBRATED UNTIL
Test Receiver R&S	ESCS 30	100375	May 06, 2015	May 05, 2016
Line-Impedance Stabilization Network (for EUT) SCHWARZBECK	NSLK-8127	8127-522	Sep. 01, 2015	Aug. 31, 2016
Line-Impedance Stabilization Network (for Peripheral ) R&S	ENV216	100072	June 11, 2015	June 10, 2016
RF Cable	5D-FB	COCCAB-001	Mar. 09, 2015	Mar. 08, 2016
50 ohms Terminator	N/A	EMC-03	Sep. 22, 2014	Sep. 21, 2015
50 ohms Terminator	N/A	EMC-02	Sep. 30, 2014	Sep. 29, 2015
Software BVADT	BVADT_Cond_ V7.3.7.3	NA	NA	NA

**Note:**

1. The calibration interval of the above test instruments are 12 months and the calibrations are traceable to NML/ROC and NIST/USA.
2. The test was performed in Shielded Room No. C.
- 3 The VCCI Con C Registration No. is C-3611.
- 4 Tested Date: Sep. 08 to 10, 2015

4.2.3 Test Procedures

- a. The EUT was placed 0.4 meters from the conducting wall of the shielded room with EUT being connected to the power mains through a line impedance stabilization network (LISN). Other support units were connected to the power mains through another LISN. The two LISNs provide 50 ohm/ 50uH of coupling impedance for the measuring instrument.
- b. Both lines of the power mains connected to the EUT were checked for maximum conducted interference.
- c. The frequency range from 150kHz to 30MHz was searched. Emission levels under (Limit - 20dB) was not recorded.

**NOTE:** All modes of operation were investigated and the worst-case emissions are reported.

4.2.4 Deviation from Test Standard

No deviation.

4.2.5 Test Setup

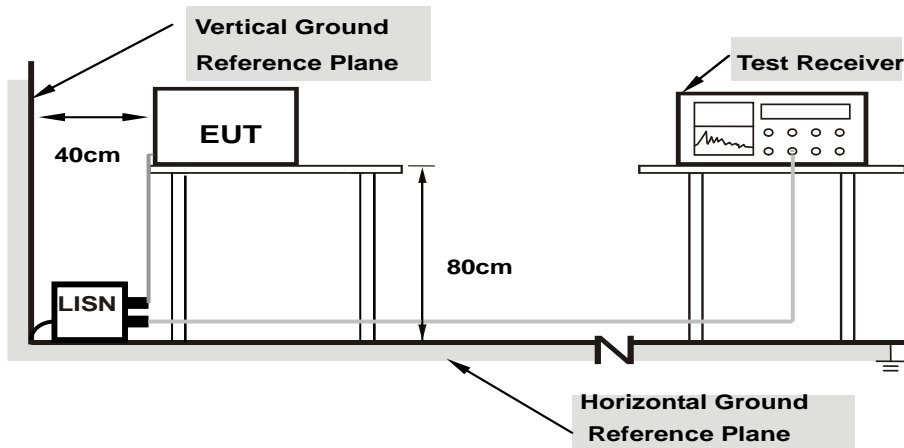

**Note: 1.Support units were connected to second LISN.**

For the actual test configuration, please refer to the attached file (Test Setup Photo).

4.2.6 EUT Operating Conditions

Same as 4.1.6.

4.2.7 Test Results (Mode 1)

Phase	Line (L)	Detector Function	Quasi-Peak (QP) / Average (AV)
-------	----------	-------------------	--------------------------------

No	Frequency (MHz)	Correction Factor (dB)	Reading Value (dBuV)		Emission Level (dBuV)		Limit (dBuV)		Margin (dB)	
			Q.P.	AV.	Q.P.	AV.	Q.P.	AV.	Q.P.	AV.
1	0.17734	0.21	49.80	44.55	50.01	44.76	64.61	54.61	-14.60	-9.85
2	0.29453	0.22	42.24	36.49	42.46	36.71	60.40	50.40	-17.94	-13.69
3	0.47422	0.24	40.52	35.87	40.76	36.11	56.44	46.44	-15.68	-10.33
4	0.67344	0.25	37.99	31.02	38.24	31.27	56.00	46.00	-17.76	-14.73
5	0.83750	0.27	36.44	27.63	36.71	27.90	56.00	46.00	-19.29	-18.10
6	10.27734	0.84	34.13	27.46	34.97	28.30	60.00	50.00	-25.03	-21.70

Remarks:

1. Q.P. and AV. are abbreviations of quasi-peak and average individually.
2. The emission levels of other frequencies were very low against the limit.
3. Margin value = Emission level – Limit value
4. Correction factor = Insertion loss + Cable loss
5. Emission Level = Correction Factor + Reading Value

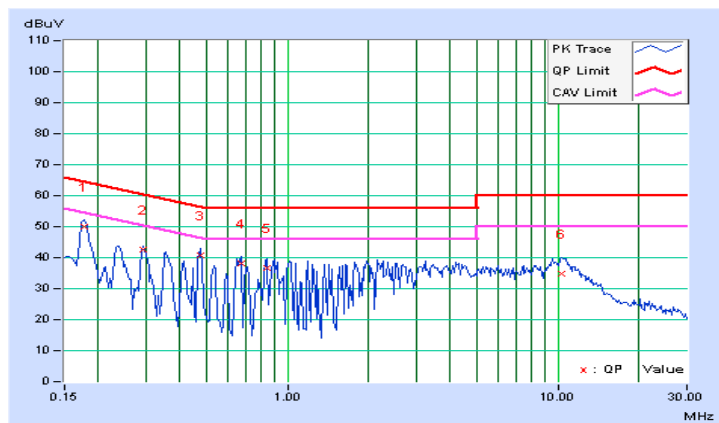

Phase	Neutral (N)	Detector Function	Quasi-Peak (QP) / Average (AV)
-------	-------------	-------------------	--------------------------------

No	Frequency (MHz)	Correction Factor (dB)	Reading Value (dBuV)		Emission Level (dBuV)		Limit (dBuV)		Margin (dB)	
			Q.P.	AV.	Q.P.	AV.	Q.P.	AV.	Q.P.	AV.
1	0.17499	0.24	52.32	44.85	52.56	45.09	64.72	54.72	-12.16	-9.63
2	0.18125	0.25	50.94	43.13	51.19	43.38	64.43	54.43	-13.24	-11.05
3	0.29453	0.28	44.67	41.90	44.95	42.18	60.40	50.40	-15.44	-8.21
<b>4</b>	<b>0.47422</b>	<b>0.30</b>	<b>43.91</b>	<b>40.63</b>	<b>44.21</b>	<b>40.93</b>	<b>56.44</b>	<b>46.44</b>	<b>-12.22</b>	<b>-5.50</b>
5	0.82969	0.33	40.06	34.12	40.39	34.45	56.00	46.00	-15.61	-11.55
6	10.40234	0.87	40.40	33.85	41.27	34.72	60.00	50.00	-18.73	-15.28

**Remarks:**

1. Q.P. and AV. are abbreviations of quasi-peak and average individually.
2. The emission levels of other frequencies were very low against the limit.
3. Margin value = Emission level – Limit value
4. Correction factor = Insertion loss + Cable loss
5. Emission Level = Correction Factor + Reading Value

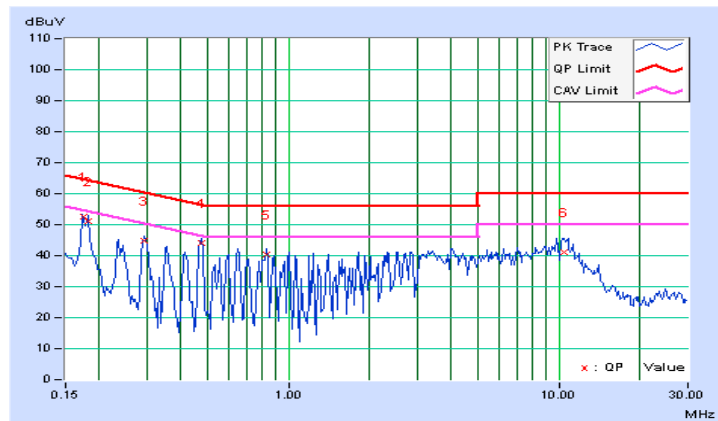

#### 4.2.8 Test Results (Mode 2)

Phase	Line (L)	Detector Function	Quasi-Peak (QP) / Average (AV)
-------	----------	-------------------	--------------------------------

No	Frequency (MHz)	Correction Factor (dB)	Reading Value (dBuV)		Emission Level (dBuV)		Limit (dBuV)		Margin (dB)	
			Q.P.	AV.	Q.P.	AV.	Q.P.	AV.	Q.P.	AV.
1	0.16172	0.20	50.65	21.05	50.85	21.25	65.38	55.38	-14.52	-34.12
2	0.19297	0.21	48.97	21.18	49.18	21.39	63.91	53.91	-14.73	-32.52
3	0.23594	0.21	44.59	18.94	44.80	19.15	62.24	52.24	-17.43	-33.08
4	0.31016	0.22	43.12	13.32	43.34	13.54	59.97	49.97	-16.63	-36.43
5	0.34922	0.22	44.54	14.34	44.76	14.56	58.98	48.98	-14.22	-34.42
6	0.42344	0.23	42.63	18.78	42.86	19.01	57.38	47.38	-14.52	-28.37
7	0.49375	0.24	39.86	11.94	40.10	12.18	56.10	46.10	-16.01	-33.93
8	0.65000	0.25	35.84	9.02	36.09	9.27	56.00	46.00	-19.91	-36.73

**Remarks:**

1. Q.P. and AV. are abbreviations of quasi-peak and average individually.
2. The emission levels of other frequencies were very low against the limit.
3. Margin value = Emission level – Limit value
4. Correction factor = Insertion loss + Cable loss
5. Emission Level = Correction Factor + Reading Value

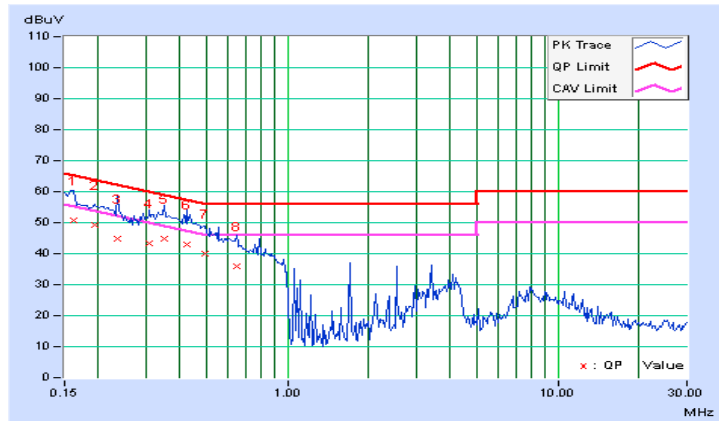

Phase	Neutral (N)	Detector Function	Quasi-Peak (QP) / Average (AV)
-------	-------------	-------------------	--------------------------------

No	Frequency (MHz)	Correction Factor (dB)	Reading Value (dBuV)		Emission Level (dBuV)		Limit (dBuV)		Margin (dB)	
			Q.P.	AV.	Q.P.	AV.	Q.P.	AV.	Q.P.	AV.
1	0.15781	0.23	51.03	21.72	51.26	21.95	65.58	55.58	-14.32	-33.63
2	0.18906	0.26	49.06	21.07	49.32	21.33	64.08	54.08	-14.76	-32.75
3	0.30234	0.29	43.75	14.88	44.04	15.17	60.18	50.18	-16.14	-35.01
4	0.32578	0.29	42.23	12.51	42.52	12.80	59.56	49.56	-17.04	-36.76
5	0.34922	0.29	40.90	13.52	41.19	13.81	58.98	48.98	-17.79	-35.17
6	0.43516	0.30	40.16	11.90	40.46	12.20	57.15	47.15	-16.69	-34.95
7	0.48203	0.31	36.59	8.19	36.90	8.50	56.30	46.30	-19.41	-37.81

**Remarks:**

1. Q.P. and AV. are abbreviations of quasi-peak and average individually.
2. The emission levels of other frequencies were very low against the limit.
3. Margin value = Emission level – Limit value
4. Correction factor = Insertion loss + Cable loss
5. Emission Level = Correction Factor + Reading Value

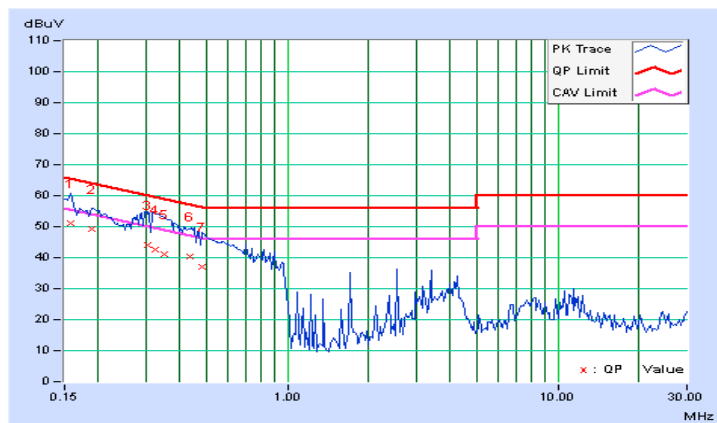

### 4.3 Transmit Power Measurement

#### 4.3.1 Limits of Transmit Power Measurement

Operation Band	EUT Category		LIMIT
U-NII-1		Outdoor Access Point	1 Watt (30 dBm) (Max. e.i.r.p $\leq$ 125mW(21 dBm) at any elevation angle above 30 degrees as measured from the horizon)
		Fixed point-to-point Access Point	1 Watt (30 dBm)
		Indoor Access Point	1 Watt (30 dBm)
	√	Mobile and Portable client device	250mW (24 dBm)
U-NII-2A			250mW (24 dBm) or 11 dBm+10 log B*
U-NII-2C			250mW (24 dBm) or 11 dBm+10 log B*
U-NII-3	√		1 Watt (30 dBm)

\*B is the 26 dB emission bandwidth in megahertz

Per KDB 662911 D01 Multiple Transmitter Output v02r01 Method of conducted output power measurement on IEEE 802.11 devices,

Array Gain = 0 dB (i.e., no array gain) for  $N_{ANT} \leq 4$ ;

Array Gain = 0 dB (i.e., no array gain) for channel widths  $\geq 40$  MHz for any  $N_{ANT}$ ;

Array Gain =  $5 \log(N_{ANT}/N_{SS})$  dB or 3 dB, whichever is less for 20-MHz channel widths with  $N_{ANT} \geq 5$ .

For power measurements on all other devices: Array Gain =  $10 \log(N_{ANT}/N_{SS})$  dB.

#### 4.3.2 Test Setup

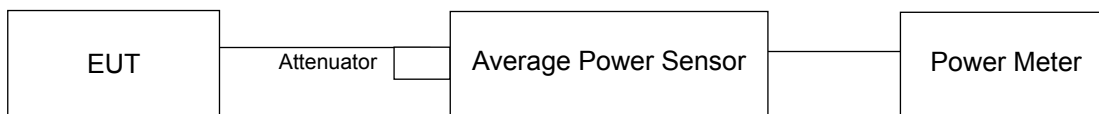

#### 4.3.3 Test Instruments

Refer to section 4.1.2 to get information of above instrument.

#### 4.3.4 Test Procedures

Method PM is used to perform output power measurement, trigger and gating function of wide band power meter is enabled to measure max output power of TX on burst. Duty factor is not added to measured value.

#### 4.3.5 Deviation from Test Standard

No deviation.

#### 4.3.6 EUT Operating Conditions

The software provided by client to enable the EUT under transmission condition continuously at lowest, middle and highest channel frequencies individually.



#### 4.3.7 Test Results

##### 802.11a

Chan.	Chan. Freq. (MHz)	Average Power (dBm)		Total Power (mW)	Total Power (dBm)	Limit (dBm)	Pass / Fail
		Chain 0	Chain 1				
36	5180	18.25	16.16	108.139	20.34	24	Pass
40	5200	19.46	17.11	139.712	21.45	24	Pass
48	5240	19.55	17.00	140.276	21.47	24	Pass
149	5745	16.15	12.43	58.708	17.69	30	Pass
157	5785	20.28	18.45	176.644	22.47	30	Pass
165	5825	17.76	15.86	98.252	19.92	30	Pass

##### 802.11ac (VHT20)

Chan.	Chan. Freq. (MHz)	Average Power (dBm)		Total Power (mW)	Total Power (dBm)	Limit (dBm)	Pass / Fail
		Chain 0	Chain 1				
36	5180	19.23	16.12	124.679	20.96	24	Pass
40	5200	19.46	16.12	129.234	21.11	24	Pass
48	5240	19.52	16.23	131.512	21.19	24	Pass
149	5745	15.60	12.49	54.05	17.33	30	Pass
157	5785	20.19	18.33	172.549	22.37	30	Pass
165	5825	17.36	15.22	87.716	19.43	30	Pass

##### 802.11ac (VHT40)

Chan.	Chan. Freq. (MHz)	Average Power (dBm)		Total Power (mW)	Total Power (dBm)	Limit (dBm)	Pass / Fail
		Chain 0	Chain 1				
38	5190	15.66	12.22	53.485	17.28	24	Pass
46	5230	21.29	20.06	235.977	23.73	24	Pass
151	5755	13.79	11.24	37.238	15.71	30	Pass
159	5795	18.26	16.61	112.802	20.52	30	Pass

##### 802.11ac (VHT80)

Chan.	Chan. Freq. (MHz)	Average Power (dBm)		Total Power (mW)	Total Power (dBm)	Limit (dBm)	Pass / Fail
		Chain 0	Chain 1				
42	5210	12.56	10.98	30.561	14.85	24	Pass
155	5775	14.12	12.43	43.321	16.37	30	Pass

#### 4.4 Peak Power Spectral Density Measurement

##### 4.4.1 Limits of Peak Power Spectral Density Measurement

Operation Band	EUT Category		LIMIT
U-NII-1		Outdoor Access Point	17dBm/ MHz
		Fixed point-to-point Access Point	
		Indoor Access Point	
	√	Mobile and Portable client device	11dBm/ MHz
U-NII-2A			11dBm/ MHz
U-NII-2C			11dBm/ MHz
U-NII-3		√	30dBm/ 500kHz

##### 4.4.2 Test Setup

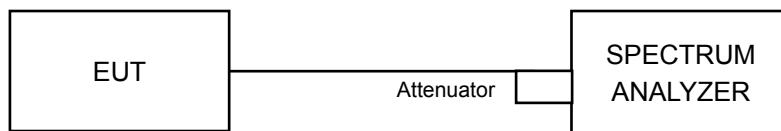

##### 4.4.3 Test Instruments

Refer to section 4.1.2 to get information of above instrument.

#### 4.4.4 Test Procedures

##### **For 802.11a, 802.11ac (VHT20):**

###### **For U-NII-1**

Using method SA-1

- a. Set span to encompass the entire emission bandwidth (EBW) of the signal.
- b. Set RBW = 1 MHz, Set VBW  $\geq$  3 MHz, Detector = RMS
- c. Sweep time = auto, trigger set to "free run".
- d. Trace average at least 100 traces in power averaging mode.
- e. Record the max value

###### **For U-NII-3:**

- a. Set span to encompass the entire emission bandwidth (EBW) of the signal.
- b. Set RBW = 300 kHz, Set VBW  $\geq$  1 MHz, Detector = RMS
- c. Use the peak marker function to determine the maximum power level in any 300 kHz band segment within the fundamental EBW.
- d. Scale the observed power level to an equivalent value in 500 kHz by adjusting (reducing) the measured power by a bandwidth correction factor (BWCF) where  $BWCF = 10\log(500\text{ kHz}/300\text{kHz})$
- e. Sweep time = auto, trigger set to "free run".
- f. Trace average at least 100 traces in power averaging mode.
- g. Record the max value

##### **For 802.11ac (VHT40) & 802.11ac (VHT80):**

###### **For U-NII-1**

Using method SA-2

- a. Set span to encompass the entire emission bandwidth (EBW) of the signal.
- b. Set RBW = 1 MHz, Set VBW  $\geq$  3 MHz, Detector = RMS
- c. Sweep time = auto, trigger set to "free run".
- d. Trace average at least 100 traces in power averaging mode.
- e. Record the max value and add  $10\log(1/\text{duty cycle})$

###### **For U-NII-3:**

- a. Set span to encompass the entire emission bandwidth (EBW) of the signal.
- b. Set RBW = 300 kHz, Set VBW  $\geq$  1 MHz, Detector = RMS
- c. Use the peak marker function to determine the maximum power level in any 300 kHz band segment within the fundamental EBW.
- d. Scale the observed power level to an equivalent value in 500 kHz by adjusting (reducing) the measured power by a bandwidth correction factor (BWCF) where  $BWCF = 10\log(500\text{ kHz}/300\text{kHz})$
- e. Sweep time = auto, trigger set to "free run".
- f. Trace average at least 100 traces in power averaging mode.
- g. Record the max value and add  $10\log(1/\text{duty cycle})$

#### 4.4.5 Deviation from Test Standard

No deviation.

#### 4.4.6 EUT Operating Conditions

Same as Item 4.3.6.

#### 4.4.7 Test Results

##### For U-NII-1:

##### 802.11a

Chan.	Chan. Freq. (MHz)	PSD (dBm)		Total Power Density (dBm)	MAX. Limit (dBm)	Pass / Fail
		Chain 0	Chain 1			
36	5180	4.16	2.43	6.39	8.49	Pass
40	5200	5.16	4.81	8.00	8.49	Pass
48	5240	5.79	4.41	8.16	8.49	Pass

- Note:**
- Method a) of power density measurement of KDB 662911 is using for calculating total power density. Total power density is summing entire spectra across corresponding frequency bins on the various outputs by computer.
  - 5150~5250MHz: Directional gain =  $5.5\text{dBi} + 10\log(2) = 8.51\text{dBi} > 6\text{dBi}$  , so the power density limit shall be reduced to  $11-(8.51-6) = 8.49\text{dBm}$ .

##### 802.11ac (VHT20)

Chan.	Chan. Freq. (MHz)	PSD (dBm)		Total Power Density (dBm)	MAX. Limit (dBm)	Pass / Fail
		Chain 0	Chain 1			
36	5180	5.49	1.44	6.93	8.49	Pass
40	5200	5.06	3.16	7.22	8.49	Pass
48	5240	5.21	3.37	7.40	8.49	Pass

- Note:**
- Method a) of power density measurement of KDB 662911 is using for calculating total power density. Total power density is summing entire spectra across corresponding frequency bins on the various outputs by computer.
  - 5150~5250MHz: Directional gain =  $5.5\text{dBi} + 10\log(2) = 8.51\text{dBi} > 6\text{dBi}$  , so the power density limit shall be reduced to  $11-(8.51-6) = 8.49\text{dBm}$ .

**802.11ac (VHT40)**

Chan.	Chan. Freq. (MHz)	PSD W/O Duty Factor (dBm)		Duty Factor (dB)	Total PSD With Duty Factor (dBm)	MAX. Limit (dBm)	Pass / Fail
		Chain 0	Chain 1				
38	5190	-1.07	-4.91	0.14	0.57	8.49	Pass
46	5230	5.03	3.88	0.14	7.64	8.49	Pass

- Note:**
- Method a) of power density measurement of KDB 662911 is using for calculating total power density. Total power density is summing entire spectra across corresponding frequency bins on the various outputs by computer.
  - 5150~5250MHz: Directional gain = 5.5dBi + 10log(2) = 8.51dBi > 6dBi , so the power density limit shall be reduced to 11-(8.51-6) = 8.49dBm.
  - Refer to section 3.3 for duty cycle spectrum plot.

**802.11ac (VHT80)**

Chan.	Chan. Freq. (MHz)	PSD W/O Duty Factor (dBm)		Duty Factor (dB)	Total PSD With Duty Factor (dBm)	MAX. Limit (dBm)	Pass / Fail
		Chain 0	Chain 1				
42	5210	-3.54	-4.50	0.74	-0.24	8.49	Pass

- Note:**
- Method a) of power density measurement of KDB 662911 is using for calculating total power density. Total power density is summing entire spectra across corresponding frequency bins on the various outputs by computer.
  - 5150~5250MHz: Directional gain = 5.5dBi + 10log(2) = 8.51dBi > 6dBi , so the power density limit shall be reduced to 11-(8.51-6) = 8.49dBm.
  - Refer to section 3.3 for duty cycle spectrum plot.

Spectrum Plot of Worst Value

802.11a\_Chain 0 / CH48

802.11ac (VHT20)\_Chain 0 / CH36

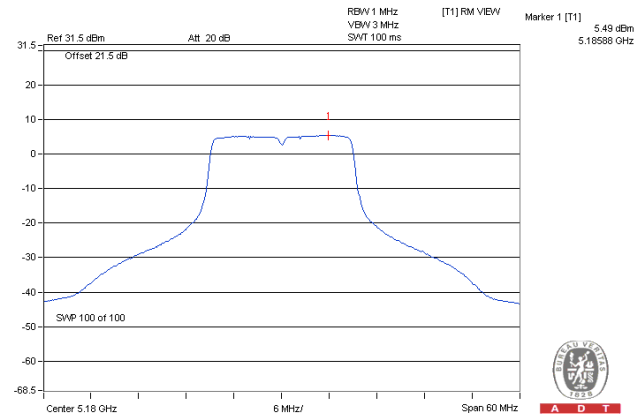
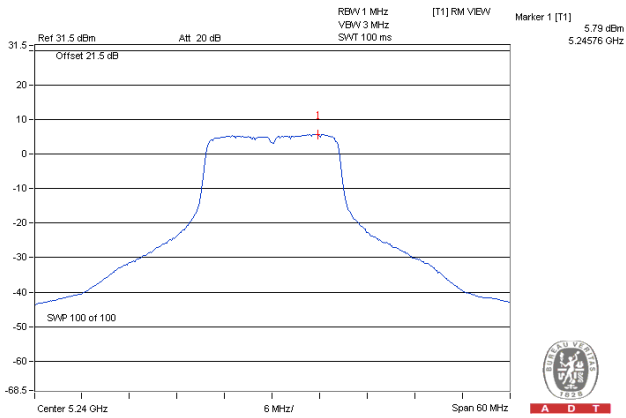

802.11ac (VHT40)\_Chain 0 / CH46

802.11ac (VHT80)\_Chain 0 / CH42

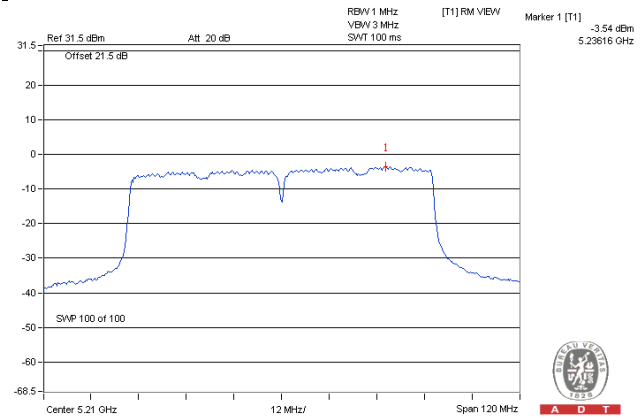
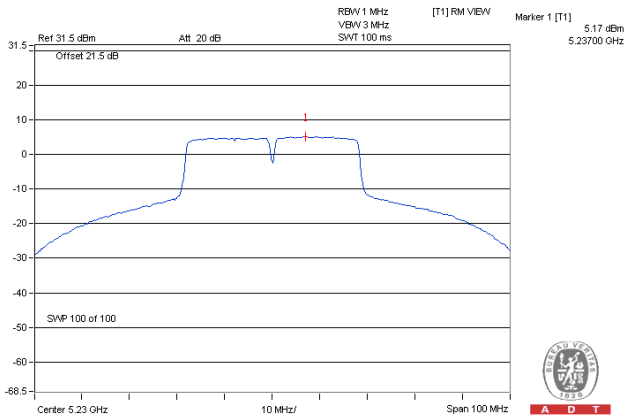

**For U-NII-3:**
**802.11a**

TX chain	Chan.	Chan. Freq. (MHz)	PSD		10 log (N=2) dB	Total PSD (dBm/500kHz)	Limit (dBm/500kHz)	Pass /Fail
			(dBm/300kHz)	(dBm/500kHz)				
0	149	5745	-4.68	-2.46	3.01	0.55	27.24	Pass
	157	5785	0.13	2.35	3.01	5.36	27.24	Pass
	165	5825	-2.28	-0.06	3.01	2.95	27.24	Pass
1	149	5745	-9.70	-7.48	3.01	-4.47	27.24	Pass
	157	5785	-2.68	-0.46	3.01	2.55	27.24	Pass
	165	5825	-6.32	-4.10	3.01	-1.09	27.24	Pass

**Note:** 1. 5725~5850MHz: Directional gain = 6dBi + 10log(2) = 8.76dBi > 6dB, so the power density limit shall be reduced to 30-(8.76-6) = 27.24dBm.

**802.11ac (VHT20)**

TX chain	Chan.	Chan. Freq. (MHz)	PSD		10 log (N=2) dB	Total PSD (dBm/500kHz)	Limit (dBm/500kHz)	Pass /Fail
			(dBm/300kHz)	(dBm/500kHz)				
0	149	5745	-4.84	-2.62	3.01	0.39	27.24	Pass
	157	5785	-0.08	2.14	3.01	5.15	27.24	Pass
	165	5825	-2.90	-0.68	3.01	2.33	27.24	Pass
1	149	5745	-10.06	-7.84	3.01	-4.83	27.24	Pass
	157	5785	-2.98	-0.76	3.01	2.25	27.24	Pass
	165	5825	-7.04	-4.82	3.01	-1.81	27.24	Pass

**Note:** 1. 5725~5850MHz: Directional gain = 6dBi + 10log(2) = 8.76dBi > 6dB, so the power density limit shall be reduced to 30-(8.76-6) = 27.24dBm.

**802.11ac (VHT40)**

TX chain	Chan.	Chan. Freq. (MHz)	PSD W/O Duty Factor		10 log (N=2) dB	Duty Factor (dB)	Total PSD With Duty Factor (dBm/500kHz)	Limit (dBm/500kHz)	Pass /Fail
			(dBm/300kHz)	(dBm/500kHz)					
0	151	5755	-9.26	-7.04	3.01	0.14	-3.89	27.24	Pass
	159	5795	-5.66	-3.44	3.01	0.14	-0.29	27.24	Pass
1	151	5755	-14.69	-12.47	3.01	0.14	-9.32	27.24	Pass
	159	5795	-9.01	-6.79	3.01	0.14	-3.64	27.24	Pass

**Note:** 1. 5725~5850MHz: Directional gain = 6dBi + 10log(2) = 8.76dBi > 6dB, so the power density limit shall be reduced to 30-(8.76-6) = 27.24dBm.

2. Refer to section 3.3 for duty cycle spectrum plot.

**802.11ac (VHT80)**

TX chain	Chan.	Chan. Freq. (MHz)	PSD W/O Duty Factor		10 log (N=2) dB	Duty Factor (dB)	Total PSD With Duty Factor (dBm/500kHz)	Limit (dBm/500kHz)	Pass /Fail
			(dBm/300kHz)	(dBm/500kHz)					
0	155	5775	-13.85	-11.63	3.01	0.74	-7.88	27.24	Pass
1	155	5775	-16.70	-14.48	3.01	0.74	-10.73	27.24	Pass

- Note:**
- 5725~5850MHz: Directional gain = 6dBi + 10log(2) = 8.76dBi > 6dB, so the power density limit shall be reduced to 30-(8.76-6) = 27.24dBm.
  - Refer to section 3.3 for duty cycle spectrum plot.

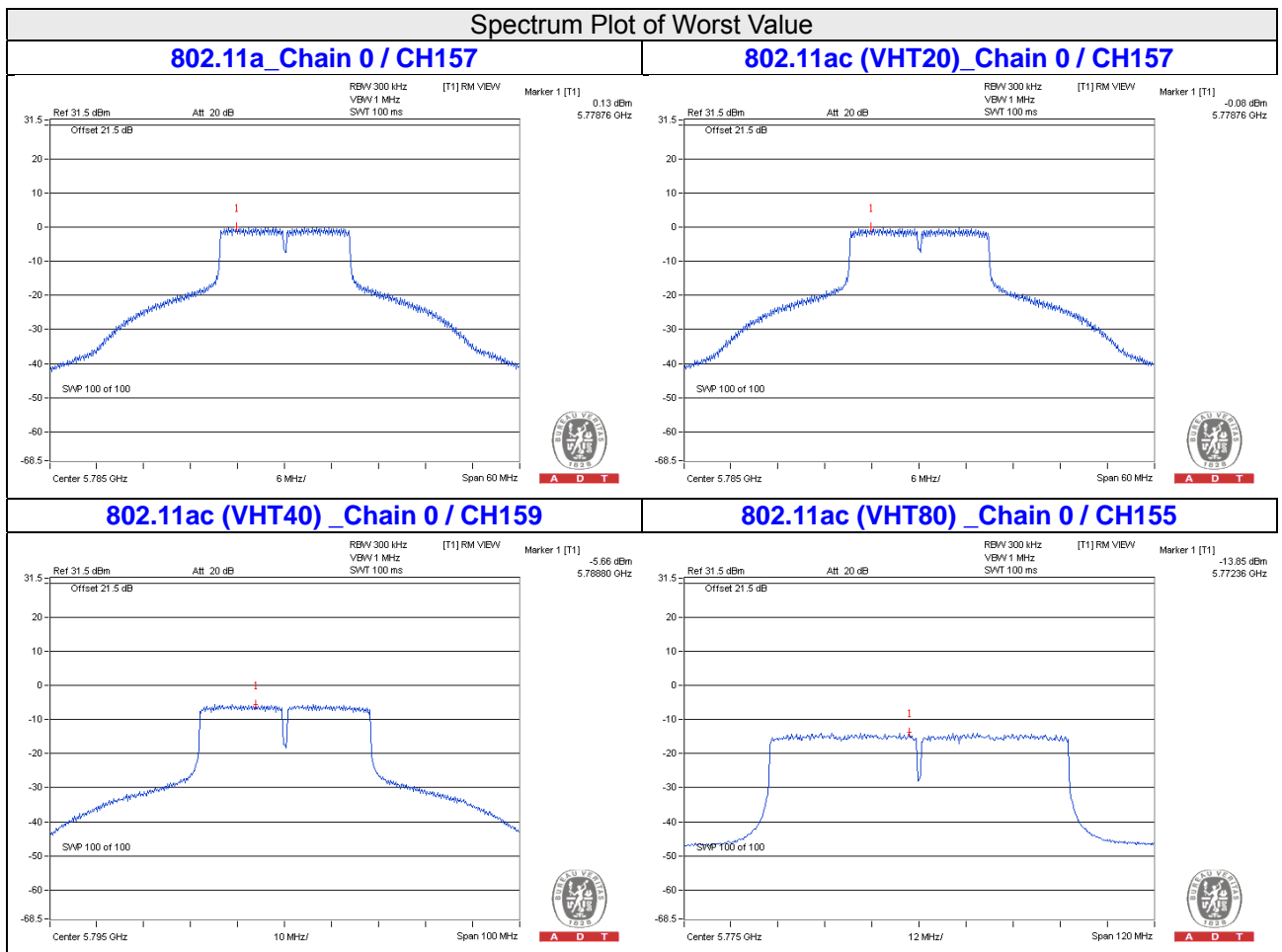



## 4.5 Frequency Stability Measurement

### 4.5.1 Limits of Frequency Stability Measurement

The frequency of the carrier signal shall be maintained within band of operation

### 4.5.2 Test Setup

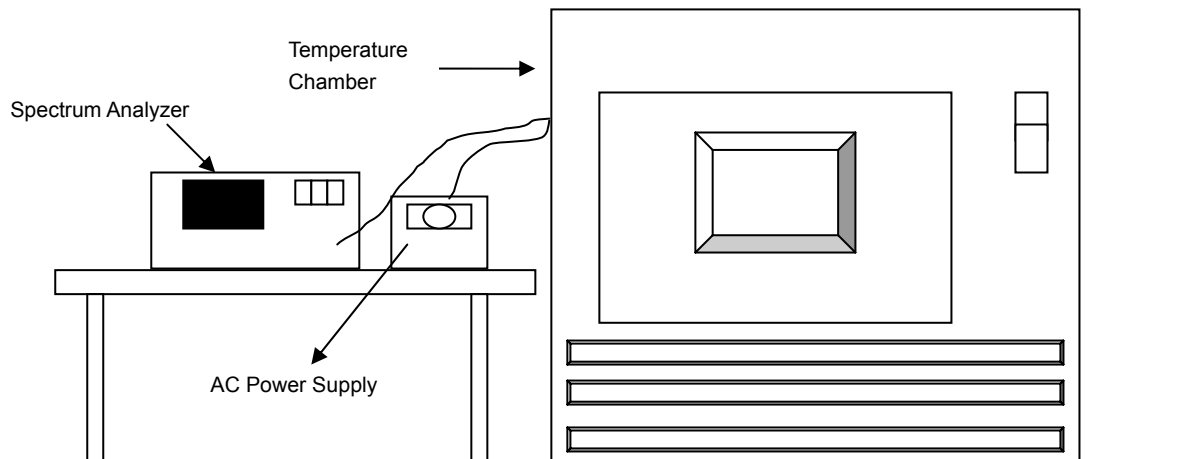

### 4.5.3 Test Instruments

Refer to section 4.1.2 to get information of above instrument.

### 4.5.4 Test Procedures

- The EUT was placed inside the environmental test chamber and powered by nominal AC voltage.
- Turn the EUT on and couple its output to a spectrum analyzer.
- Turn the EUT off and set the chamber to the highest temperature specified.
- Allow sufficient time (approximately 30 min) for the temperature of the chamber to stabilize, turn the EUT on and measure the operating frequency after 2, 5, and 10 minutes.
- Repeat step 2 and 3 with the temperature chamber set to the lowest temperature.
- The test chamber was allowed to stabilize at +20 degree C for a minimum of 30 minutes. The supply voltage was then adjusted on the EUT from 85% to 115% and the frequency record.

### 4.5.5 Deviation from Test Standard

No deviation.

### 4.5.6 EUT Operating Conditions

Set the EUT transmit at un-modulation mode to test frequency stability.

#### 4.5.7 Test Results

Frequency Stability Versus Temp.									
Operating Frequency: 5180MHz									
Temp. (°C)	Power Supply (Vac)	0 Minute		2 Minute		5 Minute		10 Minute	
		Measured Frequency (MHz)	Frequency Drift (%)	Measured Frequency (MHz)	Frequency Drift (%)	Measured Frequency (MHz)	Frequency Drift (%)	Measured Frequency (MHz)	Frequency Drift (%)
50	120	5180.0026	0.00005	5180.0034	0.00007	5180.0042	0.00008	5180.0012	0.00002
40	120	5179.9917	-0.00016	5179.9923	-0.00015	5179.9907	-0.00018	5179.9892	-0.00021
30	120	5180.0221	0.00043	5180.0171	0.00033	5180.0219	0.00042	5180.0185	0.00036
20	120	5179.9929	-0.00014	5179.9946	-0.00010	5179.9906	-0.00018	5179.9914	-0.00017
10	120	5180.0179	0.00035	5180.0199	0.00038	5180.0197	0.00038	5180.0165	0.00032
0	120	5179.9796	-0.00039	5179.9773	-0.00044	5179.9815	-0.00036	5179.9773	-0.00044
-10	120	5180.0191	0.00037	5180.0156	0.00030	5180.018	0.00035	5180.0154	0.00030
-20	120	5180.0019	0.00004	5180.0028	0.00005	5179.9995	-0.00001	5180.0033	0.00006
-30	120	5180.0168	0.00032	5180.0193	0.00037	5180.0175	0.00034	5180.0194	0.00037

Frequency Stability Versus Temp.									
Operating Frequency: 5180MHz									
Temp. (°C)	Power Supply (Vac)	0 Minute		2 Minute		5 Minute		10 Minute	
		Measured Frequency (MHz)	Frequency Drift (%)	Measured Frequency (MHz)	Frequency Drift (%)	Measured Frequency (MHz)	Frequency Drift (%)	Measured Frequency (MHz)	Frequency Drift (%)
20	138	5179.9934	-0.00013	5179.9952	-0.00009	5179.9915	-0.00016	5179.9912	-0.00017
	120	5179.9929	-0.00014	5179.9946	-0.00010	5179.9906	-0.00018	5179.9914	-0.00017
	102	5179.9928	-0.00014	5179.9939	-0.00012	5179.9916	-0.00016	5179.9905	-0.00018

## 4.6 6dB Bandwidth Measurement

### 4.6.1 Limits of 6dB Bandwidth Measurement

The minimum of 6dB Bandwidth Measurement is 0.5MHz.

### 4.6.2 Test Setup

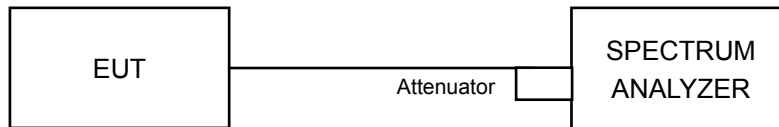

### 4.6.3 Test Instruments

Refer to section 4.1.2 to get information of above instrument.

### 4.6.4 Test Procedures

#### MEASUREMENT PROCEDURE REF

- Set resolution bandwidth (RBW) = 100kHz
- Set the video bandwidth (VBW)  $\geq 3 \times$  RBW, Detector = Peak.
- Trace mode = max hold.
- Sweep = auto couple.
- Measure the maximum width of the emission that is constrained by the frequencies associated with the two amplitude points (upper and lower) that are attenuated by 6 dB relative to the maximum level measured in the fundamental emission

### 4.6.5 Deviation from Test Standard

No deviation.

### 4.6.6 EUT Operating Conditions

The software provided by client to enable the EUT under transmission condition continuously at lowest, middle and highest channel frequencies individually.

#### 4.6.7 Test Results

##### 802.11a

Channel	Frequency (MHz)	6dB Bandwidth (MHz)		Minimum Limit (MHz)	Pass / Fail
		Chain 0	Chain 1		
149	5745	16.41	16.39	0.5	Pass
157	5785	16.37	16.40	0.5	Pass
165	5825	16.38	16.40	0.5	Pass

##### 802.11ac (VHT20)

Channel	Frequency (MHz)	6dB Bandwidth (MHz)		Minimum Limit (MHz)	Pass / Fail
		Chain 0	Chain 1		
149	5745	17.62	17.63	0.5	Pass
157	5785	17.61	17.63	0.5	Pass
165	5825	17.61	17.62	0.5	Pass

##### 802.11ac (VHT40)

Channel	Frequency (MHz)	6dB Bandwidth (MHz)		Minimum Limit (MHz)	Pass / Fail
		Chain 0	Chain 1		
151	5755	36.32	36.34	0.5	Pass
159	5795	36.23	36.44	0.5	Pass

##### 802.11ac (VHT80)

Channel	Frequency (MHz)	6dB Bandwidth (MHz)		Minimum Limit (MHz)	Pass / Fail
		Chain 0	Chain 1		
155	5775	76.56	76.61	0.5	Pass

Spectrum Plot of Worst Value

802.11a\_Chain 0 / CH157

802.11ac (VHT20)\_Chain 0 / CH157

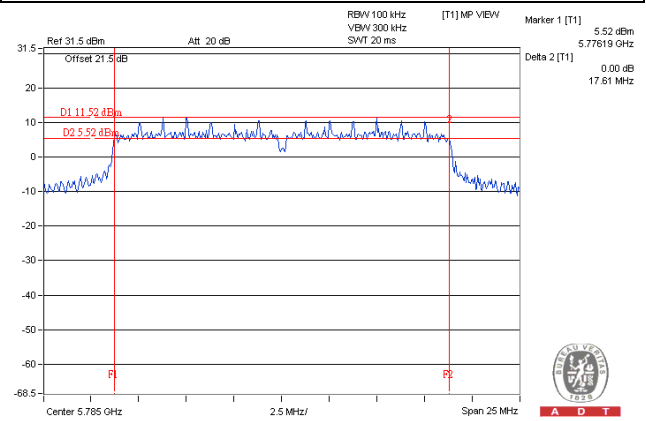
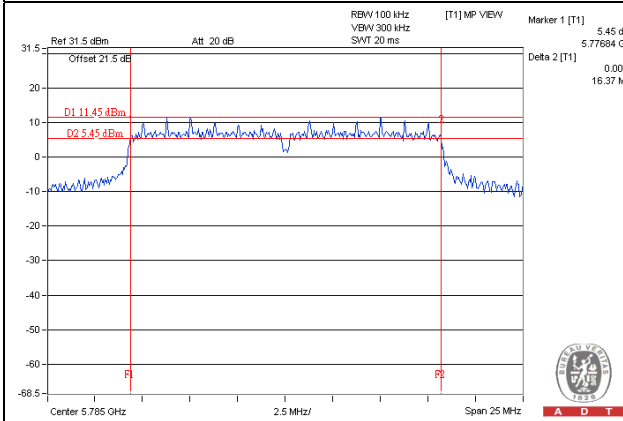

802.11ac (VHT40)\_Chain 0 / CH159

802.11ac (VHT80)\_Chain 0 / CH155

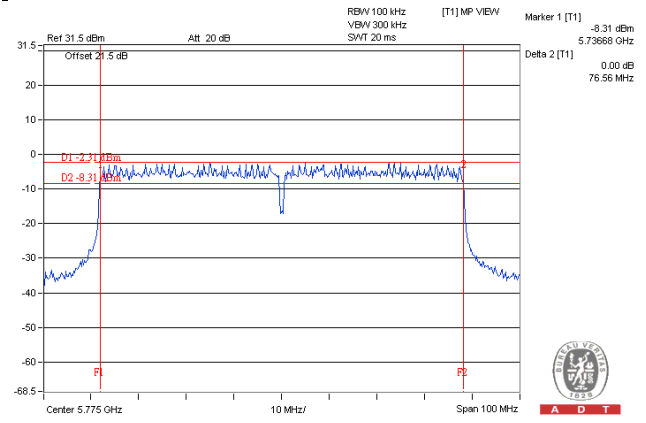
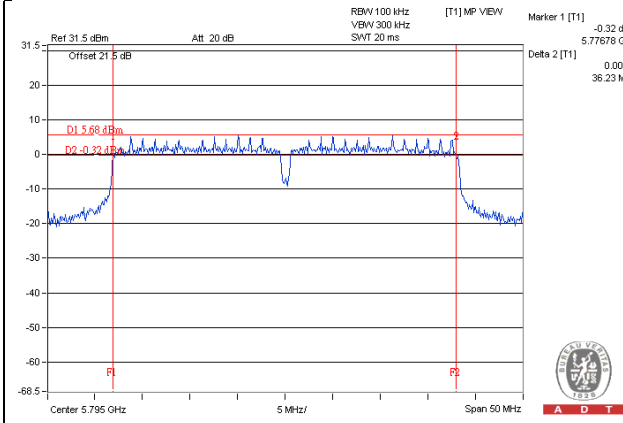

## 5 Pictures of Test Arrangements

Please refer to the attached file (Test Setup Photo).



## Appendix – Information on the Testing Laboratories

We, Bureau Veritas Consumer Products Services (H.K.) Ltd., Taoyuan Branch, were founded in 1988 to provide our best service in EMC, Radio, Telecom and Safety consultation. Our laboratories are accredited and approved according to ISO/IEC 17025.

If you have any comments, please feel free to contact us at the following:

**Linko EMC/RF Lab**

Tel: 886-2-26052180

Fax: 886-2-26051924

**Hsin Chu EMC/RF Lab/Telecom Lab**

Tel: 886-3-5935343

Fax: 886-3-5935342

**Hwa Ya EMC/RF/Safety**

Tel: 886-3-3183232

Fax: 886-3-3270892

**Email:** [service.adt@tw.bureauveritas.com](mailto:service.adt@tw.bureauveritas.com)

**Web Site:** [www.bureauveritas-adt.com](http://www.bureauveritas-adt.com)

The address and road map of all our labs can be found in our web site also.

--- END ---