



FCC TEST REPORT (15.247)

REPORT NO.: RF121224E05

MODEL NO.: MAX OTG (Refer to 3.1 for more details)

FCC ID: U8G-P1375

RECEIVED: Feb. 02, 2013

TESTED: Feb. 02 and Dec. 21 to 26, 2013

ISSUED: Jan. 03, 2014

APPLICANT: Pismo Labs Technology Limited

ADDRESS: FLAT/RM A5, 5/F, HK SPINNERS IND
BLDG PHASE 6, 481 CASTLE PEAK
ROAD, CHEUNG SHA WAN, HONG KONG.

ISSUED BY: Bureau Veritas Consumer Products Services
(H.K.) Ltd., Taoyuan Branch Hsin Chu Laboratory

LAB ADDRESS : No. 81-1, Lu Liao Keng, 9th Ling, Wu Lung Tsuen,
Chiung Lin Hsiang, Hsin Chu Hsien 307, Taiwan,
R.O.C.

TEST LOCATION (1): No. 81-1, Lu Liao Keng, 9th Ling, Wu Lung Tsuen,
Chiung Lin Hsiang, Hsin Chu Hsien 307, Taiwan,
R.O.C.

TEST LOCATION (2): No. 49, Ln. 206, Wende Rd., Shangshan Tsuen,
Chiung Lin Hsiang, Hsin Chu Hsien 307, Taiwan,
R.O.C.

This report should not be used by the client to claim product certification, approval, or endorsement by TAF or any government agencies.



This report is for your exclusive use. Any copying or replication of this report to or for any other person or entity, or use of our name or trademark, is permitted only with our prior written permission. This report sets forth our findings solely with respect to the test samples identified herein. The results set forth in this report are not indicative or representative of the quality or characteristics of the lot from which a test sample was taken or any similar or identical product unless specifically and expressly noted. Our report includes all of the tests requested by you and the results thereof based upon the information that you provided to us. You have 60 days from date of issuance of this report to notify us of any material error or omission caused by our negligence, provided, however, that such notice shall be in writing and shall specifically address the issue you wish to raise. A failure to raise such issue within the prescribed time shall constitute your unqualified acceptance of the completeness of this report, the tests conducted and the correctness of the report contents. Unless specific mention, the uncertainty of measurement has been explicitly taken into account to declare the compliance or non-compliance to the specification



A D T

Table of Contents

RELEASE CONTROL RECORD	5
1. CERTIFICATION	6
2. SUMMARY OF TEST RESULTS	7
2.1 MEASUREMENT UNCERTAINTY	8
3. GENERAL INFORMATION	9
3.1 GENERAL DESCRIPTION OF EUT	9
3.2 DESCRIPTION OF TEST MODES	12
3.2.1 TEST MODE APPLICABILITY AND TESTED CHANNEL DETAIL	13
3.3 GENERAL DESCRIPTION OF APPLIED STANDARDS	16
3.4 DUTY CYCLE OF TEST SIGNAL	17
3.5 DESCRIPTION OF SUPPORT UNITS	19
3.6 CONFIGURATION OF SYSTEM UNDER TEST	20
4. TEST TYPES AND RESULTS (FOR 2.4GHz, 2.400 ~ 2.4835GHz Band)	21
4.1 CONDUCTED EMISSION MEASUREMENT	21
4.1.1 LIMITS OF CONDUCTED EMISSION MEASUREMENT	21
4.1.2 TEST INSTRUMENTS	21
4.1.3 TEST PROCEDURES	22
4.1.4 DEVIATION FROM TEST STANDARD	22
4.1.5 TEST SETUP	22
4.1.6 EUT OPERATING CONDITIONS	23
4.1.7 TEST RESULTS	24
4.2 RADIATED EMISSION AND BANDEDGE MEASUREMENT	26
4.2.1 LIMITS OF RADIATED EMISSION AND BANDEDGE MEASUREMENT	26
4.2.2 TEST INSTRUMENTS	27
4.2.3 TEST PROCEDURES	29
4.2.4 DEVIATION FROM TEST STANDARD	29
4.2.5 TEST SETUP	30
4.2.6 EUT OPERATING CONDITIONS	30
4.2.7 TEST RESULTS	31
4.3 6dB BANDWIDTH MEASUREMENT	44
4.3.1 LIMITS OF 6dB BANDWIDTH MEASUREMENT	44
4.3.2 TEST INSTRUMENTS	44
4.3.3 TEST PROCEDURE	44
4.3.4 DEVIATION FROM TEST STANDARD	44
4.3.5 TEST SETUP	44
4.3.6 EUT OPERATING CONDITIONS	45
4.3.7 TEST RESULTS	46
4.4 CONDUCTED OUTPUT POWER MEASUREMENT	48
4.4.1 LIMITS OF MAXIMUM PEAK OUTPUT POWER MEASUREMENT	48
4.4.2 INSTRUMENTS	48
4.4.3 TEST PROCEDURES	48
4.4.4 DEVIATION FROM TEST STANDARD	49
4.4.5 TEST SETUP	49
4.4.6 EUT OPERATING CONDITIONS	49
4.4.7 TEST RESULTS	50
4.5 AVERAGE OUTPUT POWER	51
4.5.1 FOR REFERENCE	51
4.5.2 TEST INSTRUMENTS	51
4.5.3 TEST PROCEDURES	51
4.5.4 TEST SETUP	51



A D T

4.5.5	EUT OPERATING CONDITIONS	51
4.5.6	TEST RESULTS	52
4.6	POWER SPECTRAL DENSITY MEASUREMENT	53
4.6.1	LIMITS OF POWER SPECTRAL DENSITY MEASUREMENT	53
4.6.2	TEST INSTRUMENTS.....	53
4.6.3	TEST PROCEDURE.....	53
4.6.4	DEVIATION FROM TEST STANDARD	53
4.6.5	TEST SETUP	53
4.6.6	EUT OPERATING CONDITION.....	53
4.6.7	TEST RESULTS	54
4.7	CONDUCTED OUT-BAND EMISSION MEASUREMENT.....	56
4.7.1	LIMITS OF CONDUCTED OUT-BAND EMISSION MEASUREMENT.....	56
4.7.2	TEST INSTRUMENTS.....	56
4.7.3	TEST PROCEDURE.....	56
4.7.4	DEVIATION FROM TEST STANDARD	57
4.7.5	TEST SETUP	57
4.7.6	EUT OPERATING CONDITION.....	57
4.7.7	TEST RESULTS	57
5.	TEST TYPES AND RESULTS (FOR 5GHz, 5.725~5.850GHz Band).....	62
5.1	CONDUCTED EMISSION MEASUREMENT	62
5.1.1	LIMITS OF CONDUCTED EMISSION MEASUREMENT	62
5.1.2	TEST INSTRUMENTS.....	62
5.1.3	TEST PROCEDURES	63
5.1.4	DEVIATION FROM TEST STANDARD	63
5.1.5	TEST SETUP	63
5.1.6	EUT OPERATING CONDITIONS	64
5.1.7	TEST RESULTS	65
5.2	RADIATED AND BANDEDGE EMISSION MEASUREMENT	67
5.2.1	LIMITS OF RADIATED AND BANDEDGE EMISSION MEASUREMENT.....	67
5.2.2	TEST INSTRUMENTS.....	68
5.2.3	TEST PROCEDURES	70
5.2.4	DEVIATION FROM TEST STANDARD	70
5.2.5	TEST SETUP	71
5.2.6	EUT OPERATING CONDITIONS	71
5.2.7	TEST RESULTS	72
5.3	6dB BANDWIDTH MEASUREMENT	81
5.3.1	LIMITS OF 6dB BANDWIDTH MEASUREMENT	81
5.3.2	TEST INSTRUMENTS.....	81
5.3.3	TEST PROCEDURE.....	81
5.3.4	DEVIATION FROM TEST STANDARD	81
5.3.5	TEST SETUP	81
5.3.6	EUT OPERATING CONDITIONS	81
5.3.7	TEST RESULTS	82
5.4	CONDUCTED OUTPUT POWER MEASUREMENT	84
5.4.1	LIMITS OF CONDUCTED OUTPUT POWER MEASUREMENT	84
5.4.2	INSTRUMENTS.....	84
5.4.3	TEST PROCEDURES	84
5.4.4	DEVIATION FROM TEST STANDARD	84
5.4.5	TEST SETUP	84
5.4.6	EUT OPERATING CONDITIONS	84
5.4.7	TEST RESULTS	86
5.5	AVERAGE OUTPUT POWER.....	87



A D T

5.5.1	FOR REFERENCE	87
5.5.2	TEST INSTRUMENTS.....	87
5.5.3	TEST PROCEDURES	87
5.5.4	TEST SETUP	87
5.5.5	EUT OPERATING CONDITIONS	87
5.5.6	TEST RESULTS	88
5.6	POWER SPECTRAL DENSITY MEASUREMENT.....	89
5.6.1	LIMITS OF POWER SPECTRAL DENSITY MEASUREMENT	89
5.6.2	TEST INSTRUMENTS.....	89
5.6.3	TEST PROCEDURE.....	89
5.6.4	DEVIATION FROM TEST STANDARD	89
5.6.5	TEST SETUP	89
5.6.6	EUT OPERATING CONDITION.....	89
5.6.7	TEST RESULTS	90
5.7	CONDUCTED OUT-BAND EMISSION MEASUREMENT.....	92
5.7.1	LIMITS OF CONDUCTED OUT-BAND EMISSION MEASUREMENT.....	92
5.7.2	TEST INSTRUMENTS.....	92
5.7.3	TEST PROCEDURE.....	92
5.7.4	DEVIATION FROM TEST STANDARD	93
5.7.5	TEST SETUP	93
5.7.6	EUT OPERATING CONDITION.....	93
5.7.7	TEST RESULTS	93
6.	PHOTOGRAPHS OF THE TEST CONFIGURATION.....	97
7.	INFORMATION ON THE TESTING LABORATORIES	98
8.	APPENDIX A - MODIFICATIONS RECORDERS FOR ENGINEERING CHANGES TO THE EUT BY THE LAB.....	99



A D T

RELEASE CONTROL RECORD

ISSUE NO.	REASON FOR CHANGE	DATE ISSUED
RF121224E05	Original release	Jan. 03, 2014



A D T

1. CERTIFICATION

PRODUCT: Pepwave / Peplink / Pismo Wireless Product
BRAND NAME: Peplink / Pepwave / Pismo
MODEL NO.: MAX OTG (Refer to 3.1 for more details)
TEST SAMPLE: ENGINEERING SAMPLE
APPLICANT: Pismo Labs Technology Limited
TESTED: Feb. 02 and Dec. 21 to 26, 2013
STANDARDS: **FCC Part 15, Subpart C (Section 15.247)**
ANSI C63.10-2009

The above equipment (Model: MAX OTG) has been tested by **Bureau Veritas Consumer Products Services (H.K.) Ltd., Taoyuan Branch**, and found compliance with the requirement of the above standards. The test record, data evaluation & Equipment Under Test (EUT) configurations represented herein are true and accurate accounts of the measurements of the sample's EMC characteristics under the conditions specified in this report.

PREPARED BY :  , **DATE:** Jan. 03, 2014
(Elsie Hsu, Specialist)

APPROVED BY :  , **DATE:** Jan. 03, 2014
(May Chen, Manager)



A D T

2. SUMMARY OF TEST RESULTS

The EUT has been tested according to the following specifications:

For 2.4GHz, 2400~2483.5MHz Band

APPLIED STANDARD: FCC PART 15, SUBPART C (SECTION 15.247)			
STANDARD SECTION	TEST TYPE	RESULT	REMARK
15.207	AC Power Conducted Emission	PASS	Meet the requirement of limit. Minimum passing margin is - 10.22dB at 0.45609MHz
15.247(d) 15.209	Radiated Emissions	PASS	Meet the requirement of limit. Minimum passing margin is - 0.1dB at 2390MHz
15.247(d)	Band Edge Measurement	PASS	Meet the requirement of limit.
15.247(a)(2)	6dB bandwidth	PASS	Meet the requirement of limit.
15.247(b)	Conducted output power	PASS	Meet the requirement of limit.
15.247(e)	Power Spectral Density	PASS	Meet the requirement of limit.
15.203	Antenna Requirement	PASS	No antenna connector is used.

For 5GHz, 5725~5850MHz Band

APPLIED STANDARD: FCC PART 15, SUBPART C (SECTION 15.247)			
STANDARD SECTION	TEST TYPE	RESULT	REMARK
15.207	AC Power Conducted Emission	PASS	Meet the requirement of limit. Minimum passing margin is -10.35dB at 0.45097MHz
15.247(d) 15.209	Radiated Emissions	PASS	Meet the requirement of limit. Minimum passing margin is -0.20dB at 11570MHz
15.247(d)	Band Edge Measurement	PASS	Meet the requirement of limit.
15.247(a)(2)	6dB bandwidth	PASS	Meet the requirement of limit.
15.247(b)	Conducted output power	PASS	Meet the requirement of limit.
15.247(e)	Power Spectral Density	PASS	Meet the requirement of limit.
15.203	Antenna Requirement	PASS	Antenna connector is I-PEX not a standard connector.

NOTE: The EUT was operating in 2.400 ~ 2.4835GHz, 5.15~5.25GHz and 5.725~5.850GHz frequencies band. This report was recorded the RF parameters including 2.400 ~ 2.4835GHz and 5.725~5.850GHz. For the 5.15~5.25GHz RF parameters was recorded in another test report.



A D T

2.1 MEASUREMENT UNCERTAINTY

Where relevant, the following measurement uncertainty levels have been estimated for tests performed on the EUT as specified in CISPR 16-4-2:

This uncertainty represents an expanded uncertainty expressed at approximately the 95% confidence level using a coverage factor of $k=2$.

Measurement	Value
Conducted emissions	2.98 dB
Radiated emissions (30MHz-1GHz)	5.37 dB
Radiated emissions (1GHz -6GHz)	3.72 dB
Radiated emissions (6GHz -18GHz)	4.00 dB
Radiated emissions (18GHz -40GHz)	4.11 dB



A D T

3. GENERAL INFORMATION

3.1 GENERAL DESCRIPTION OF EUT

PRODUCT	Pepwave / Peplink / Pismo Wireless Product
MODEL NO.	MAX OTG (Refer to NOTE for more details)
POWER SUPPLY	DC 12V from power adapter
MODULATION TYPE	CCK, DQPSK, DBPSK for DSSS 64QAM, 16QAM, QPSK, BPSK for OFDM
MODULATION TECHNOLOGY	DSSS,OFDM
TRANSFER RATE	802.11b: up to 11Mbps 802.11a/g: up to 54Mbps 802.11n: up to 150Mbps
OPERATING FREQUENCY	For 15.407 5GHz: 5.18 ~ 5.24GHz For 15.247 2.4GHz: 2.412 ~ 2.462GHz 5GHz: 5.745 ~ 5.825GHz
NUMBER OF CHANNEL	For 15.407 4 for 802.11a, 802.11n (HT20) 2 for 802.11n (HT40) For 15.247 (2.4GHz) 11 for 802.11b, 802.11g, 802.11n (HT20) 7 for 802.11n (HT40) For 15.247 (5GHz) 5 for 802.11a, 802.11n (HT20) 2 for 802.11n (HT40)



MAXIMUM OUTPUT POWER	<p>For 15.407 802.11a: 46.132mW 802.11n (HT20): 46.345mW 802.11n (HT40): 42.855mW</p> <p>For 15.247 (2.4GHz) 802.11b: 347.536mW 802.11g: 948.418mW 802.11n (HT20): 937.562mW 802.11n (HT40): 403.645mW</p> <p>For 15.247 (5GHz) 802.11a: 85.507mW 802.11n (HT20): 81.846mW 802.11n (HT40): 73.961mW</p>
ANTENNA TYPE	Please see NOTE
DATA CABLE	NA
I/O PORTS	Refer to user's manual
ASSOCIATED DEVICES	Adapter x 1

NOTE:

1. The EUT is a 2.4GHz & 5GHz WLAN device.
2. The EUT has twelve model names which are identical to each other in all aspects except for the following table:

Brand	Model Name	Description
Pepwave / Peplink / Pismo	MAX On-The-Go	For marketing purposes
	MAX OTG	
	Pismo735	
	MAX Make-It	
	Balance	
	MAX	
	Device Connector	
	AP One	
	MAX Connector	
	Air Connector	
	Air Switch	
	Pismo935	

From the above models, model: **MAX OTG** was selected as representative model for the test and its data was recorded in this report.



3. There is a antenna provided to this EUT, please refer to the following table:

Brand	Antenna Type	Gain(dBi) Include cable loss	Connector	Cable length (mm)	Frequency range (MHz to MHz)
SmartAnt	Embedded	0.83	I-PEX	20	2400~2500
		3.49			5150~5875

4. The EUT must be supplied with a power adapter as following table:

Brand	Model No.	Spec.
Ten Pao	S024EM1200200	Input: 100-240V, 600mA, 50/60Hz Output: 12V, 2000mA DC output cable (unshielded, 1.5m with one core)

5. The EUT incorporates a SISO function.

MODULATION MODE	TX/RX FUNCTION
802.11b	1Tx/1Rx
802.11g	1Tx/1Rx
802.11n (HT20)	1Tx/1Rx
802.11n (HT40)	1Tx/1Rx

6. The EUT could be applied with four USB Cellular Modems, therefore emission tests are added for simultaneously transmit between WLAN and USB Cellular Modem. The emission tests have been performed at the worst channel of both WLAN and USB Cellular Modem, the spurious emission of the simultaneous operation (WLAN & USB Cellular Modem) has been evaluated and no non-compliance found. < USB Cellular Modem only for test, not for sale >

Brand name	Model name	FCC ID	Spec.	Testing mode
SIERRA WIRELESS	AirCard 881U	N7NMC8781U	3.5G USB WIRELESS DEVICE	GPRS ch128, 824.2MHz
SIERRA WIRELESS	AirCard 881U	N7NMC8781U	3.5G USB WIRELESS DEVICE	GPRS ch128, 824.2MHz
SIERRA WIRELESS	AirCard 881U	N7NMC8781U	3.5G USB WIRELESS DEVICE	GPRS ch128, 824.2MHz
SIERRA WIRELESS	AirCard 881U	N7NMC8781U	3.5G USB WIRELESS DEVICE	GPRS ch128, 824.2MHz

7. 2.4GHz and 5GHz technology cannot transmit at same time.

8. Spurious emission of the simultaneous operation (WiFi & 3G Device) has been evaluated and no non-compliance was found.

9. When the EUT operating in 802.11n, the software operation, which is defined by manufacturer, MCS (Modulation and Coding Schemes) from 0 to 7.

10. For more detailed product features, please refer to manufacturer's specification or user's manual.



A D T

3.2 DESCRIPTION OF TEST MODES

Operated in 2400 ~ 2483.5MHz band:

11 channels are provided for 802.11b, 802.11g, 802.11n (HT20):

CHANNEL	FREQUENCY	CHANNEL	FREQUENCY
1	2412MHz	7	2442MHz
2	2417MHz	8	2447MHz
3	2422MHz	9	2452MHz
4	2427MHz	10	2457MHz
5	2432MHz	11	2462MHz
6	2437MHz		

7 channels are provided for 802.11n (HT40):

CHANNEL	FREQUENCY	CHANNEL	FREQUENCY
3	2422MHz	7	2442MHz
4	2427MHz	8	2447MHz
5	2432MHz	9	2452MHz
6	2437MHz		

Operated in 5725 ~ 5850MHz band:

5 channels are provided for 802.11a, 802.11n (HT20):

CHANNEL	FREQUENCY	CHANNEL	FREQUENCY
149	5745 MHz	161	5805 MHz
153	5765 MHz	165	5825 MHz
157	5785 MHz		

2 channels are provided for 802.11n (HT40):

CHANNEL	FREQUENCY
151	5755 MHz
159	5795 MHz

3.2.1 TEST MODE APPLICABILITY AND TESTED CHANNEL DETAIL

EUT CONFIGURE MODE	APPLICABLE TO					DESCRIPTION
	PLC	RE < 1G	RE ≥ 1G	APCM	OB	
-	√	√	√	√	√	-

Where **PLC**: Power Line Conducted Emission **RE < 1G**: Radiated Emission below 1GHz
RE ≥ 1G: Radiated Emission above 1GHz **APCM**: Antenna Port Conducted Measurement
OB: Conducted Out-Band Emission Measurement

NOTE: 1. The EUT had been pre-tested on the positioned of each 2 axis. The worst case was found when positioned on Y-plane.

POWER LINE CONDUCTED EMISSION TEST:

- Pre-Scan has been conducted to determine the worst-case mode from all possible combinations between available modulations, data rates and antenna ports (if EUT with antenna diversity architecture).
- Following channel(s) was (were) selected for the final test as listed below.

MODE	AVAILABLE CHANNEL	TESTED CHANNEL	MODULATION TECHNOLOGY	MODULATION TYPE	DATA RATE (Mbps)
802.11g	1 to 11	6	OFDM	BPSK	6
802.11a	149 to 165	165	OFDM	BPSK	6

RADIATED EMISSION TEST (BELOW 1 GHz):

- Pre-Scan has been conducted to determine the worst-case mode from all possible combinations between available modulations, data rates and antenna ports (if EUT with antenna diversity architecture).
- Following channel(s) was (were) selected for the final test as listed below.

MODE	AVAILABLE CHANNEL	TESTED CHANNEL	MODULATION TECHNOLOGY	MODULATION TYPE	DATA RATE (Mbps)
802.11g	1 to 11	6	OFDM	BPSK	6
802.11a	149 to 165	165	OFDM	BPSK	6

RADIATED EMISSION TEST (ABOVE 1 GHz):

- Pre-Scan has been conducted to determine the worst-case mode from all possible combinations between available modulations, data rates and antenna ports (if EUT with antenna diversity architecture).
- Following channel(s) was (were) selected for the final test as listed below.

MODE	AVAILABLE CHANNEL	TESTED CHANNEL	MODULATION TECHNOLOGY	MODULATION TYPE	DATA RATE (Mbps)
802.11b	1 to 11	1, 6, 11	DSSS	DBPSK	1
802.11g	1 to 11	1, 6, 11	OFDM	BPSK	6
For 2.4 GHz 802.11n (HT20)	1 to 11	1, 6, 11	OFDM	BPSK	6.5
For 2.4 GHz 802.11n (HT40)	3 to 9	3, 6, 9	OFDM	BPSK	13.5
802.11a	149 to 165	149, 157, 165	OFDM	BPSK	6
For 5 GHz 802.11n (HT20)	149 to 165	149, 157, 165	OFDM	BPSK	6.5
For 5 GHz 802.11n (HT40)	151 to 159	151, 159	OFDM	BPSK	13.5

ANTENNA PORT CONDUCTED MEASUREMENT:

- Pre-Scan has been conducted to determine the worst-case mode from all possible combinations between available modulations, data rates and antenna ports (if EUT with antenna diversity architecture).
- Following channel(s) was (were) selected for the final test as listed below.

MODE	AVAILABLE CHANNEL	TESTED CHANNEL	MODULATION TECHNOLOGY	MODULATION TYPE	DATA RATE (Mbps)
802.11b	1 to 11	1, 6, 11	DSSS	DBPSK	1
802.11g	1 to 11	1, 6, 11	OFDM	BPSK	6
For 2.4 GHz 802.11n (HT20)	1 to 11	1, 6, 11	OFDM	BPSK	6.5
For 2.4 GHz 802.11n (HT40)	3 to 9	3, 6, 9	OFDM	BPSK	13.5
802.11a	149 to 165	149, 157, 165	OFDM	BPSK	6
For 5 GHz 802.11n (HT20)	149 to 165	149, 157, 165	OFDM	BPSK	6.5
For 5 GHz 802.11n (HT40)	151 to 159	151, 159	OFDM	BPSK	13.5



A D T

CONDUCTED OUT-BAND EMISSION MEASUREMENT:

- Pre-Scan has been conducted to determine the worst-case mode from all possible combinations between available modulations, data rates and antenna ports (if EUT with antenna diversity architecture).
- Following channel(s) was (were) selected for the final test as listed below.

MODE	AVAILABLE CHANNEL	TESTED CHANNEL	MODULATION TECHNOLOGY	MODULATION TYPE	DATA RATE (Mbps)
802.11b	1 to 11	1, 6, 11	DSSS	DBPSK	1
802.11g	1 to 11	1, 6, 11	OFDM	BPSK	6
For 2.4 GHz 802.11n (HT20)	1 to 11	1, 6, 11	OFDM	BPSK	6.5
For 2.4 GHz 802.11n (HT40)	3 to 9	3, 6, 9	OFDM	BPSK	13.5
802.11a	149 to 165	149, 157, 165	OFDM	BPSK	6
For 5 GHz 802.11n (HT20)	149 to 165	149, 157, 165	OFDM	BPSK	6.5
For 5 GHz 802.11n (HT40)	151 to 159	151, 159	OFDM	BPSK	13.5

TEST CONDITION:

APPLICABLE TO	ENVIRONMENTAL CONDITIONS	INPUT POWER	TESTED BY
PLC	21deg. C, 69%RH	120Vac, 60Hz	Scott Chen
RE<1G	19deg. C, 71%RH	120Vac, 60Hz	Chilin Lee
RE ³ 1G	24deg. C, 66%RH	120Vac, 60Hz	Andy Ho
APCM	25deg. C, 60%RH	120Vac, 60Hz	Nelson Teng
OB	25deg. C, 60%RH	120Vac, 60Hz	Nelson Teng

3.3 GENERAL DESCRIPTION OF APPLIED STANDARDS

The EUT is a RF product. According to the specifications of the manufacturer, it must comply with the requirements of the following standards:

FCC Part 15, Subpart C (15.247)

558074 D01 DTS Meas Guidance v03r01

ANSI C63.10-2009

All test items have been performed and recorded as per the above standards.



A D T

3.4 DUTY CYCLE OF TEST SIGNAL

For 2.4GHz

Duty cycle of test signal is 100 %, duty factor is not required.

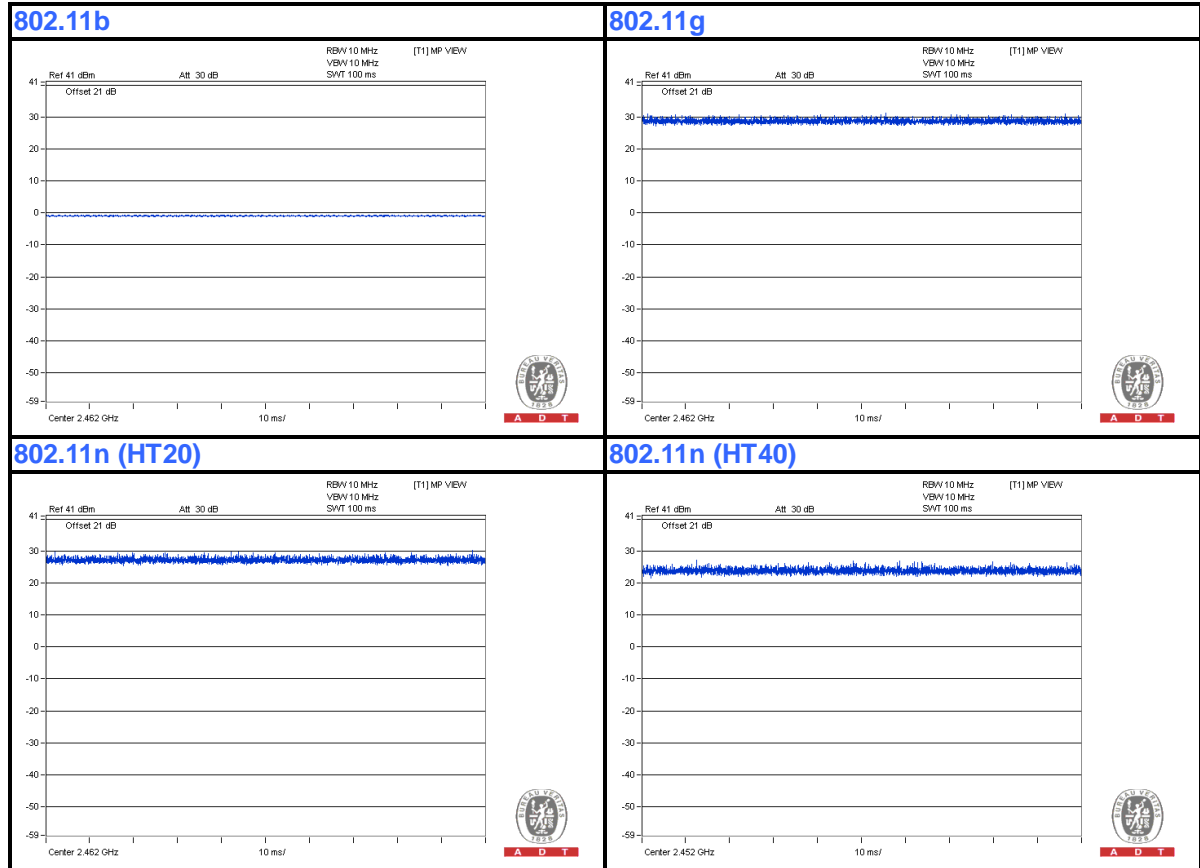



A D T

For 5GHz

Duty cycle of test signal is 100 %, duty factor is not required.





A D T

3.5 DESCRIPTION OF SUPPORT UNITS

The EUT has been tested as an independent unit together with other necessary accessories or support units. The following support units or accessories were used to form a representative test configuration during the tests.

NO.	PRODUCT	BRAND	MODEL NO.	SERIAL NO.	FCC ID
1	NOTEBOOK COMPUTER	DELL	PP32LA	FSLB32S	FCC DoC
2	NOTEBOOK COMPUTER	DELL	PP32LA	GSLB32S	FCC DoC
3	3G USB Dongle	SIERRA WIRELESS	AirCard 881U	K541629231210	N7NMC8781U
4	3G USB Dongle	SIERRA WIRELESS	AirCard 881U	K541629234810	N7NMC8781U
5	3G USB Dongle	SIERRA WIRELESS	AirCard 881U	K541629188210	N7NMC8781U
6	3G USB Dongle	SIERRA WIRELESS	AirCard 881U	K541629135910	N7NMC8781U

NO.	SIGNAL CABLE DESCRIPTION OF THE ABOVE SUPPORT UNITS
1	UTP cable (10m)
2	UTP cable (10m)
3	NA
4	NA
5	NA
6	NA

NOTE: All power cords of the above support units are non shielded (1.8m).

3.6 CONFIGURATION OF SYSTEM UNDER TEST

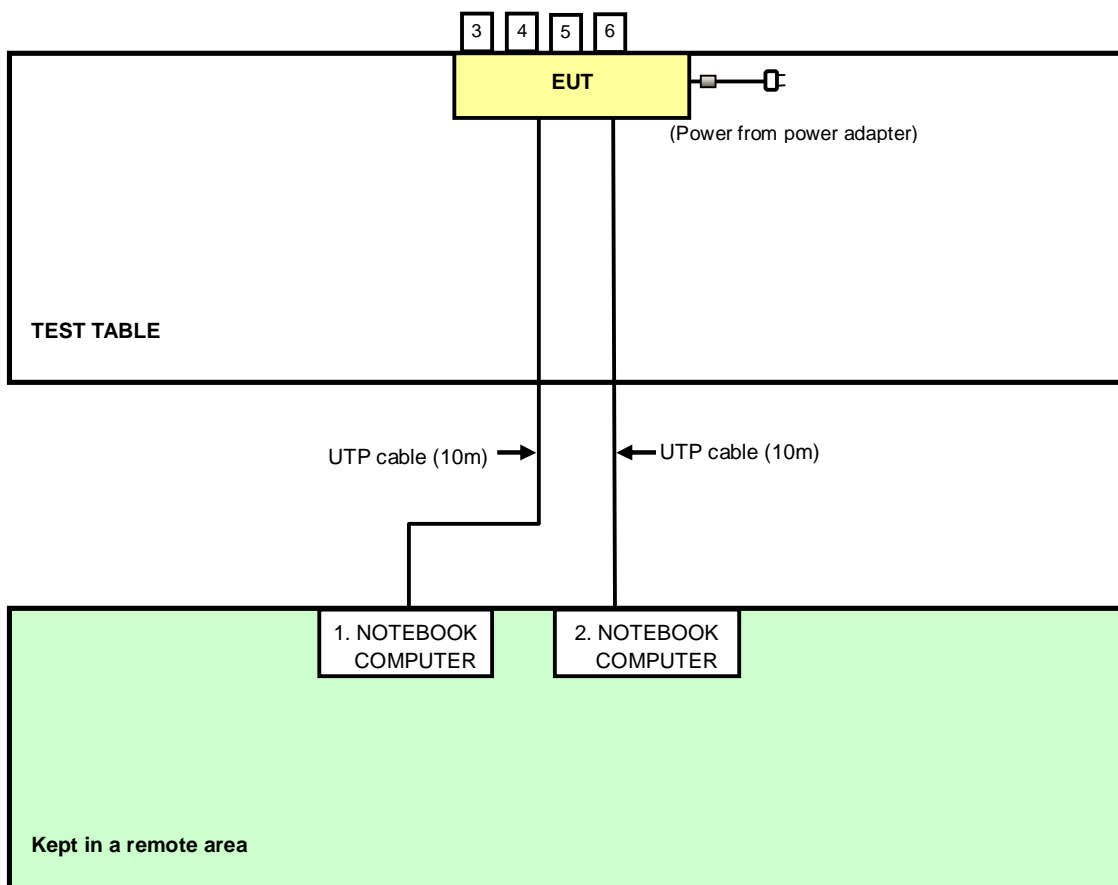

Note: Item 3 ~ 6 are 3G USB Dongles

4. TEST TYPES AND RESULTS (FOR 2.4GHz, 2.400 ~ 2.4835GHz Band)

4.1 CONDUCTED EMISSION MEASUREMENT

4.1.1 LIMITS OF CONDUCTED EMISSION MEASUREMENT

FREQUENCY OF EMISSION (MHz)	CONDUCTED LIMIT (dB μ V)	
	Quasi-peak	Average
0.15-0.5	66 to 56	56 to 46
0.5-5	56	46
5-30	60	50

- NOTE:**
1. The lower limit shall apply at the transition frequencies.
 2. The limit decreases in line with the logarithm of the frequency in the range of 0.15 to 0.50 MHz.

4.1.2 TEST INSTRUMENTS

DESCRIPTION & MANUFACTURER	MODEL NO.	SERIAL NO.	CALIBRATED DATE	CALIBRATED UNTIL
Test Receiver	ESCS 30	100375	Mar. 12, 2012	Mar. 11, 2013
Line-Impedance Stabilization Network (for EUT) SCHWARZBECK	NSLK8127	8127-522	Sep. 06, 2012	Sep. 05, 2013
Line-Impedance Stabilization Network (for Peripheral)	ENV216	100072	June 08, 2012	June 07, 2013
RF Cable (JYEBAO)	5DFB	COCCAB-001	Aug. 28, 2012	Aug. 27, 2013
50 ohms Terminator	50	EMC-3	Sep. 25, 2012	Sep. 24, 2013
Software ADT	BV ADT_Cond_V7.3.7.3	NA	NA	NA

Note:

1. The calibration interval of the above test instruments is 12 months and the calibrations are traceable to NML/ROC and NIST/USA.
2. The test was performed in Shielded Room No. C.
3. The VCCI Con C Registration No. is C-3611.
4. Tested Date: Feb. 22, 2013

4.1.3 TEST PROCEDURES

- a. The EUT was placed 0.4 meters from the conducting wall of the shielded room with EUT being connected to the power mains through a line impedance stabilization network (LISN). Other support units were connected to the power mains through another LISN.
- b. The two LISNs provide 50 ohm/ 50uH of coupling impedance for the measuring instrument.
- c. Both lines of the power mains connected to the EUT were checked for maximum conducted interference.
- d. The frequency range from 150kHz to 30MHz was searched. Emission levels under (Limit - 20dB) were not recorded.

NOTE:

1. The resolution bandwidth of test receiver is 9kHz for Quasi-peak detection (QP) & Average detection (AV).

4.1.4 DEVIATION FROM TEST STANDARD

No deviation

4.1.5 TEST SETUP

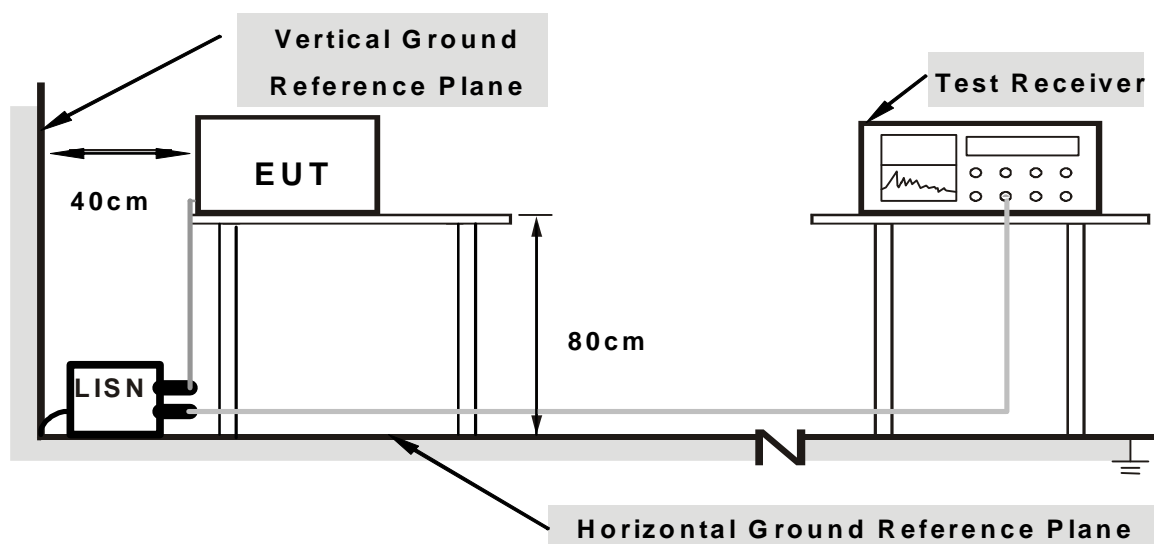

Note: 1. Support units were connected to second LISN.

For the actual test configuration, please refer to the related item – Photographs of the Test Configuration.



A D T

4.1.6 EUT OPERATING CONDITIONS

1. Placed the EUT on testing table.
2. Prepared computer system (support unit 1) to act as communication partner.
3. The communication partner ran test program “artgui.exe[v2.3]” to enable EUT under transmission/receiving condition continuously.

4.1.7 TEST RESULTS

PHASE	Line (L)	DETECTOR FUNCTION	Quasi-Peak (QP) / Average (AV)
--------------	----------	--------------------------	--------------------------------

No	Freq. [MHz]	Corr. Factor (dB)	Reading Value [dB (uV)]		Emission Level [dB (uV)]		Limit [dB (uV)]		Margin (dB)	
			Q.P.	AV.	Q.P.	AV.	Q.P.	AV.	Q.P.	AV.
			1	0.15000	0.11	53.64	42.94	53.75	43.05	66.00
2	0.18516	0.12	46.78	35.43	46.90	35.55	64.25	54.25	-17.35	-18.70
3	0.45859	0.18	41.21	36.29	41.39	36.47	56.72	46.72	-15.32	-10.24
4	4.80469	0.40	32.06	25.36	32.46	25.76	56.00	46.00	-23.54	-20.24
5	12.93750	0.92	31.85	27.66	32.77	28.58	60.00	50.00	-27.23	-21.42
6	21.66406	1.35	36.95	33.73	38.30	35.08	60.00	50.00	-21.70	-14.92

REMARKS:

1. Q.P. and AV. are abbreviations of quasi-peak and average individually.
2. The emission levels of other frequencies were very low against the limit.
3. Margin value = Emission Level – Limit value
4. Correction Factor = Insertion loss + Cable loss
5. Emission Level = Correction Factor + Reading Value

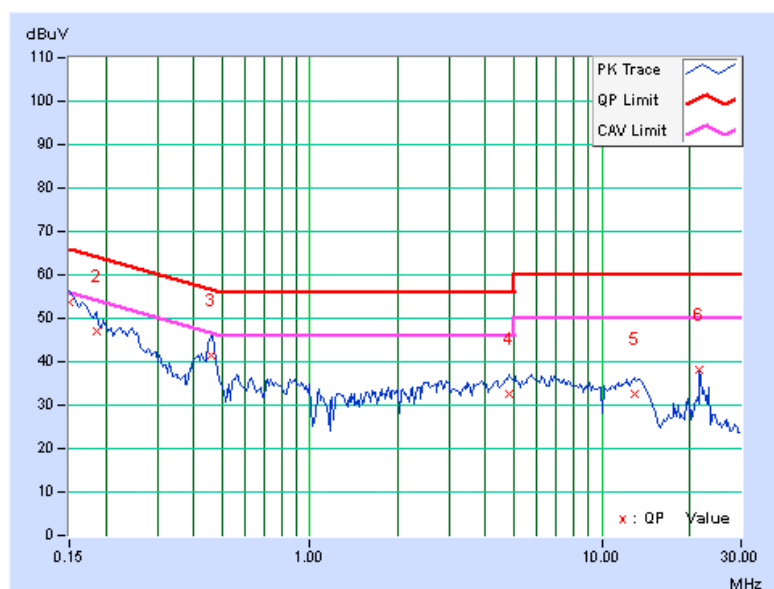

PHASE	Neutral (N)	DETECTOR FUNCTION	Quasi-Peak (QP) / Average (AV)
-------	-------------	-------------------	--------------------------------

No	Freq. [MHz]	Corr. Factor (dB)	Reading Value [dB (uV)]		Emission Level [dB (uV)]		Limit [dB (uV)]		Margin (dB)	
			Q.P.	AV.	Q.P.	AV.	Q.P.	AV.	Q.P.	AV.
	1	0.15000	0.09	53.03	42.12	53.12	42.21	66.00	56.00	-12.88
2	0.21250	0.12	44.98	32.55	45.10	32.67	63.11	53.11	-18.00	-20.43
3	0.45609	0.17	41.78	36.37	41.95	36.54	56.76	46.76	-14.81	-10.22
4	0.75547	0.19	31.69	26.84	31.88	27.03	56.00	46.00	-24.12	-18.97
5	3.68359	0.34	30.93	24.63	31.27	24.97	56.00	46.00	-24.73	-21.03
6	21.66406	1.02	37.03	34.28	38.05	35.30	60.00	50.00	-21.95	-14.70

REMARKS:

1. Q.P. and AV. are abbreviations of quasi-peak and average individually.
2. The emission levels of other frequencies were very low against the limit.
3. Margin value = Emission Level – Limit value
4. Correction Factor = Insertion loss + Cable loss
5. Emission Level = Correction Factor + Reading Value

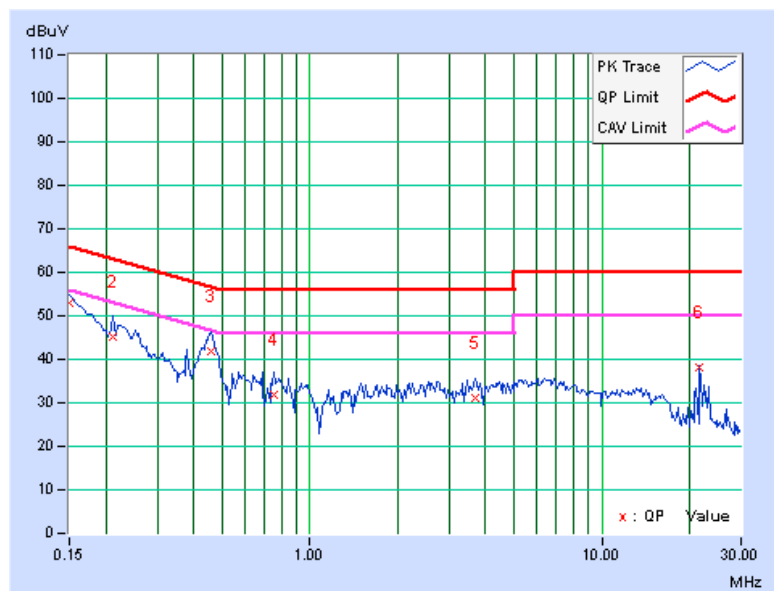



A D T

4.2 RADIATED EMISSION AND BANDEGE MEASUREMENT

4.2.1 LIMITS OF RADIATED EMISSION AND BANDEGE MEASUREMENT

Radiated emissions which fall in the restricted bands must comply with the radiated emission limits specified as below table. Other emissions shall be at least 20dB below the highest level of the desired power:

Frequencies (MHz)	Field strength (microvolts/meter)	Measurement distance (meters)
0.009-0.490	2400/F(kHz)	300
0.490-1.705	24000/F(kHz)	30
1.705-30.0	30	30
30-88	100	3
88-216	150	3
216-960	200	3
Above 960	500	3

NOTE:

1. The lower limit shall apply at the transition frequencies.
2. Emission level (dBuV/m) = 20 log Emission level (uV/m).
3. For frequencies above 1000MHz, the field strength limits are based on average detector, however, the peak field strength of any emission shall not exceed the maximum permitted average limits, specified above by more than 20dB.



A D T

4.2.2 TEST INSTRUMENTS

Below 1GHz test

DESCRIPTION & MANUFACTURER	MODEL NO.	SERIAL NO.	CALIBRATED DATE	CALIBRATED UNTIL
MXE EMI Receiver Agilent	N9038A	MY51210105	Jan. 29,2013	Jan. 28,2014
Pre-Amplifier Mini-Circuits	ZFL-1000VH2 B	AMP-ZFL-03	Nov. 13, 2013	Nov. 12, 2014
Trilog Broadband Antenna SCHWARZBECK	VULB 9168	9168-360	Mar. 19, 2013	Mar. 18, 2014
RF Cable	NA	CHGCAB_001	Oct. 05, 2013	Oct. 04, 2014
Spectrum Analyzer R&S	FSV40	100964	July 15, 2013	July 14, 2014
Horn_Antenna AISI	AIH.8018	000032009111 0	Nov. 18, 2013	Nov. 17, 2014
Pre-Amplifier Agilent	8449B	3008A02578	June 25, 2013	June 24, 2014
RF Cable	NA	RF104-201 RF104-203 RF104-204	Dec. 12, 2013	Dec. 11, 2014
Spectrum Analyzer Agilent	E4446A	MY48250253	Aug. 28, 2013	Aug. 27, 2014
Pre-Amplifier SPACEK LABS	SLKKa-48-6	9K16	Nov. 13, 2013	Nov. 12, 2014
Horn_Antenna SCHWARZBECK	BBHA 9170	9170-424	Oct. 08, 2013	Oct. 07, 2014
Software	ADT_Radiated _V8.7.07	NA	NA	NA
Antenna Tower & Turn Table CT	NA	NA	NA	NA

Note:

1. The calibration interval of the above test instruments is 12 months and the calibrations are traceable to NML/ROC and NIST/USA.
2. The horn antenna, preamplifier (model: 8449B) are used only for the measurement of emission frequency above 1GHz if tested.
- 3 The test was performed in 966 Chamber No. G.
4. The FCC Site Registration No. is 966073.
- 5 The VCCI Site Registration No. is G-137.
- 6 The CANADA Site Registration No. is IC 7450H-2.
- 7 Tested Date: Dec. 26, 2013



A D T

Above 1GHz test

DESCRIPTION & MANUFACTURER	MODEL NO.	SERIAL NO.	CALIBRATED DATE	CALIBRATED UNTIL
MXE EMI Receiver Agilent	N9038A	MY50010156	Jan. 16, 2013	Jan. 15, 2014
Pre-Amplifier Mini-Circuits	ZFL-1000VH2 B	AMP-ZFL-04	Nov. 13, 2013	Nov. 12, 2014
Trilog Broadband Antenna SCHWARZBECK	VULB 9168	9168-361	Mar. 25, 2013	Mar. 24, 2014
RF Cable	NA	CHHCAB_001	Oct. 06, 2013	Oct. 05, 2014
Horn_Antenna AISI	AIH.8018	0000220091110	Dec. 06, 2013	Dec. 05, 2014
Pre-Amplifier Agilent	8449B	3008A01923	Oct. 29, 2013	Oct. 28, 2014
RF Cable	NA	RF104-205 RF104-207 RF104-202	Dec. 26, 2012	Dec. 25, 2013
Spectrum Analyzer Agilent	E4446A	MY48250253	Aug. 28, 2013	Aug. 27, 2014
Pre-Amplifier SPACEK LABS	SLKKa-48-6	9K16	Nov. 13, 2013	Nov. 12, 2014
Horn_Antenna SCHWARZBECK	BBHA 9170	9170-424	Oct. 08, 2013	Oct. 07, 2014
Software	ADT_Radiated _V8.7.07	NA	NA	NA
Antenna Tower & Turn Table CT	NA	NA	NA	NA

Note:

1. The calibration interval of the above test instruments is 12 months and the calibrations are traceable to NML/ROC and NIST/USA.
2. The horn antenna, preamplifier (model: 8449B) are used only for the measurement of emission frequency above 1GHz if tested.
- 3 The test was performed in 966 Chamber No. H.
4. The FCC Site Registration No. is 797305.
- 5 The CANADA Site Registration No. is IC 7450H-3.
- 6 Tested Date: Dec. 21, 2013

4.2.3 TEST PROCEDURES

- a. The EUT was placed on the top of a rotating table 0.8 meters above the ground at 3 meter chamber room for test. The table was rotated 360 degrees to determine the position of the highest radiation.
- b. The EUT was set 3 meters away from the interference-receiving antenna, which was mounted on the top of a variable-height antenna tower.
- c. The height of antenna is varied from one meter to four meters above the ground to determine the maximum value of the field strength. Both horizontal and vertical polarizations of the antenna are set to make the measurement.
- d. For each suspected emission, the EUT was arranged to its worst case and then the antenna was tuned to heights from 1 meter to 4 meters and the rotatable table was turned from 0 degrees to 360 degrees to find the maximum reading.
- e. The test-receiver system was set to quasi-peak detect function and specified bandwidth with maximum hold mode when the test frequency is below 1 GHz.
- f. The test-receiver system was set to peak and average detect function and specified bandwidth with maximum hold mode when the test frequency is above 1 GHz. If the peak reading value also meets average limit, measurement with the average detector is unnecessary.

NOTE:

1. The resolution bandwidth and video bandwidth of test receiver/spectrum analyzer is 120kHz for Quasi-peak detection (QP) at frequency below 1GHz.
2. The resolution bandwidth of test receiver/spectrum analyzer is 1 MHz and the video bandwidth is 3 MHz for Peak detection (PK) at frequency above 1GHz.
3. The resolution bandwidth of test receiver/spectrum analyzer is 1 MHz and the video bandwidth is 10 Hz for Average detection (AV) at frequency above 1GHz.
4. All modes of operation were investigated and the worst-case emissions are reported.

4.2.4 DEVIATION FROM TEST STANDARD

No deviation

4.2.5 TEST SETUP

<Frequency Range below 1GHz>

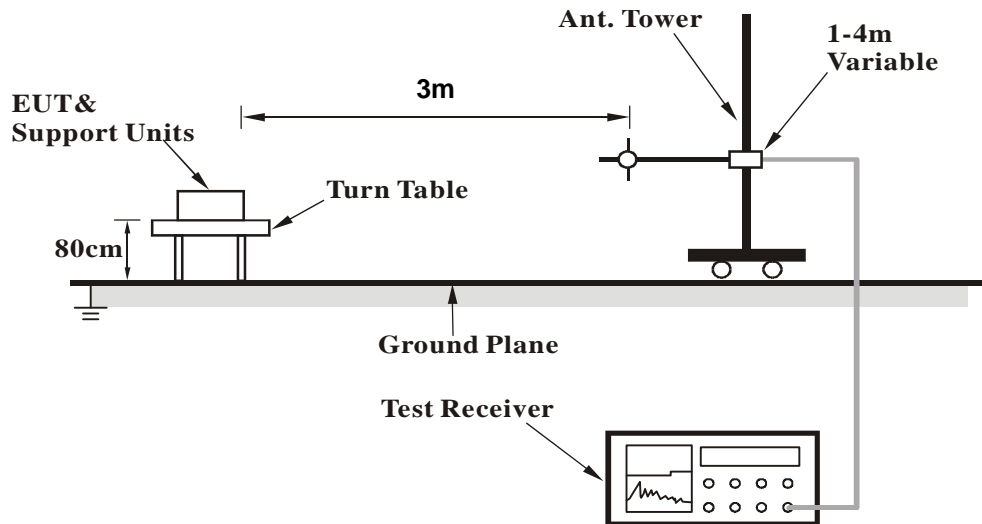

<Frequency Range above 1GHz>

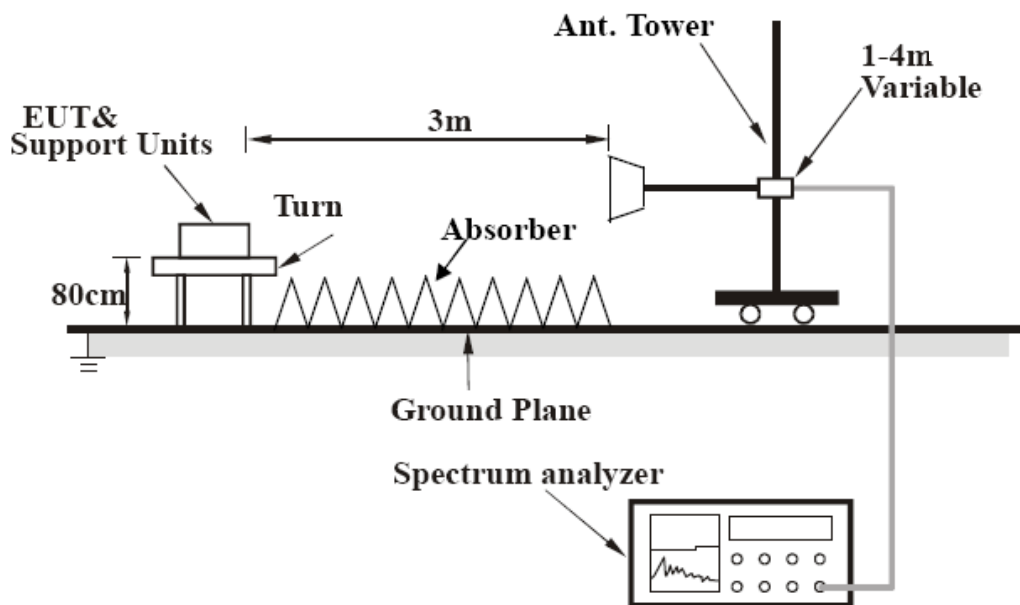

For the actual test configuration, please refer to the related item – Photographs of the Test Configuration.

4.2.6 EUT OPERATING CONDITIONS

Same as 4.1.6

4.2.7 TEST RESULTS

BELOW 1GHz WORST-CASE DATA

802.11g

CHANNEL	TX Channel 6	DETECTOR FUNCTION	Quasi-Peak (QP)
FREQUENCY RANGE	Below 1GHz		

ANTENNA POLARITY & TEST DISTANCE: HORIZONTAL AT 3 M								
NO.	FREQ. (MHz)	EMISSION LEVEL (dBuV/m)	LIMIT (dBuV/m)	MARGIN (dB)	ANTENNA HEIGHT (m)	TABLE ANGLE (Degree)	RAW VALUE (dBuV)	CORRECTION FACTOR (dB/m)
1	96.01	31.3 QP	43.5	-12.2	2.00 H	92	49.95	-18.65
2	204.02	38.2 QP	43.5	-5.3	1.00 H	89	54.62	-16.38
3	225.07	40.3 QP	46.0	-5.7	1.00 H	106	56.60	-16.33
4	294.42	35.8 QP	46.0	-10.2	1.00 H	360	48.49	-12.72
5	450.01	37.2 QP	46.0	-8.8	2.00 H	53	45.75	-8.54
6	675.00	34.6 QP	46.0	-11.4	1.00 H	185	38.61	-3.97
ANTENNA POLARITY & TEST DISTANCE: VERTICAL AT 3 M								
NO.	FREQ. (MHz)	EMISSION LEVEL (dBuV/m)	LIMIT (dBuV/m)	MARGIN (dB)	ANTENNA HEIGHT (m)	TABLE ANGLE (Degree)	RAW VALUE (dBuV)	CORRECTION FACTOR (dB/m)
1	49.84	35.9 QP	40.0	-4.1	1.00 V	87	49.61	-13.73
2	225.02	39.6 QP	46.0	-6.4	1.00 V	250	55.89	-16.33
3	240.05	37.4 QP	46.0	-8.7	1.00 V	245	52.11	-14.76
4	450.01	35.9 QP	46.0	-10.1	1.00 V	152	44.46	-8.54
5	675.00	36.1 QP	46.0	-9.9	1.50 V	185	40.10	-3.97
6	899.99	41.1 QP	46.0	-4.9	2.00 V	12	40.95	0.18

REMARKS:

1. Emission Level(dBuV/m) = Raw Value(dBuV) + Correction Factor(dB/m)
2. Correction Factor(dB/m) = Antenna Factor(dB/m) + Cable Factor(dB) – Pre-Amplifier Factor(dB)
3. The other emission levels were very low against the limit.
4. Margin value = Emission Level – Limit value



A D T

ABOVE 1GHz DATA

802.11b

CHANNEL	TX Channel 1	DETECTOR FUNCTION	Peak (PK)
FREQUENCY RANGE	1GHz ~ 25GHz		Average (AV)

ANTENNA POLARITY & TEST DISTANCE: HORIZONTAL AT 3 M

NO.	FREQ. (MHz)	EMISSION LEVEL (dBuV/m)	LIMIT (dBuV/m)	MARGIN (dB)	ANTENNA HEIGHT (m)	TABLE ANGLE (Degree)	RAW VALUE (dBuV)	CORRECTION FACTOR (dB/m)
1	2386.16	63.3 PK	74.0	-10.7	1.00 H	329	29.79	33.51
2	2386.16	46.7 AV	54.0	-7.3	1.00 H	329	13.19	33.51
3	*2412.00	110.0 PK			1.00 H	329	76.41	33.59
4	*2412.00	106.8 AV			1.00 H	329	73.21	33.59
5	4824.00	57.1 PK	74.0	-16.9	1.66 H	323	13.92	43.18
6	4824.00	53.6 AV	54.0	-0.4	1.66 H	323	10.42	43.18

ANTENNA POLARITY & TEST DISTANCE: VERTICAL AT 3 M

NO.	FREQ. (MHz)	EMISSION LEVEL (dBuV/m)	LIMIT (dBuV/m)	MARGIN (dB)	ANTENNA HEIGHT (m)	TABLE ANGLE (Degree)	RAW VALUE (dBuV)	CORRECTION FACTOR (dB/m)
1	2386.16	63.7 PK	74.0	-10.3	1.05 V	291	30.19	33.51
2	2386.16	50.1 AV	54.0	-3.9	1.05 V	291	16.59	33.51
3	*2412.00	106.7 PK			1.05 V	291	73.11	33.59
4	*2412.00	104.2 AV			1.05 V	291	70.61	33.59
5	4824.00	52.3 PK	74.0	-21.7	1.11 V	317	9.12	43.18
6	4824.00	45.6 AV	54.0	-8.4	1.11 V	317	2.42	43.18

REMARKS:

1. Emission Level(dBuV/m) = Raw Value(dBuV) + Correction Factor(dB/m)
2. Correction Factor(dB/m) = Antenna Factor(dB/m) + Cable Factor(dB) – Pre-Amplifier Factor(dB)
3. The other emission levels were very low against the limit.
4. Margin value = Emission Level – Limit value
5. " * ": Fundamental frequency.



A D T

CHANNEL	TX Channel 6	DETECTOR FUNCTION	Peak (PK)
FREQUENCY RANGE	1GHz ~ 25GHz		Average (AV)

ANTENNA POLARITY & TEST DISTANCE: HORIZONTAL AT 3 M

NO.	FREQ. (MHz)	EMISSION LEVEL (dBuV/m)	LIMIT (dBuV/m)	MARGIN (dB)	ANTENNA HEIGHT (m)	TABLE ANGLE (Degree)	RAW VALUE (dBuV)	CORRECTION FACTOR (dB/m)
1	*2437.00	109.9 PK			1.00 H	322	76.23	33.67
2	*2437.00	107.0 AV			1.00 H	322	73.33	33.67
3	4874.00	57.2 PK	74.0	-16.8	1.65 H	25	13.96	43.24
4	4874.00	53.3 AV	54.0	-0.7	1.65 H	25	10.06	43.24
5	7311.00	56.2 PK	74.0	-17.8	1.00 H	255	8.13	48.07
6	7311.00	43.2 AV	54.0	-10.8	1.00 H	255	-4.87	48.07

ANTENNA POLARITY & TEST DISTANCE: VERTICAL AT 3 M

NO.	FREQ. (MHz)	EMISSION LEVEL (dBuV/m)	LIMIT (dBuV/m)	MARGIN (dB)	ANTENNA HEIGHT (m)	TABLE ANGLE (Degree)	RAW VALUE (dBuV)	CORRECTION FACTOR (dB/m)
1	*2437.00	103.1 PK			1.00 V	317	69.43	33.67
2	*2437.00	99.8 AV			1.00 V	317	66.13	33.67
3	4874.00	52.9 PK	74.0	-21.1	1.08 V	326	9.66	43.24
4	4874.00	46.0 AV	54.0	-8.0	1.08 V	326	2.76	43.24
5	7311.00	56.7 PK	74.0	-17.3	1.04 V	190	8.63	48.07
6	7311.00	44.8 AV	54.0	-9.2	1.04 V	190	-3.27	48.07

REMARKS:

1. Emission Level(dBuV/m) = Raw Value(dBuV) + Correction Factor(dB/m)
2. Correction Factor(dB/m) = Antenna Factor(dB/m) + Cable Factor(dB) – Pre-Amplifier Factor(dB)
3. The other emission levels were very low against the limit.
4. Margin value = Emission Level – Limit value
5. " * ": Fundamental frequency.



A D T

CHANNEL	TX Channel 11	DETECTOR FUNCTION	Peak (PK)
FREQUENCY RANGE	1GHz ~ 25GHz		Average (AV)

ANTENNA POLARITY & TEST DISTANCE: HORIZONTAL AT 3 M

NO.	FREQ. (MHz)	EMISSION LEVEL (dBuV/m)	LIMIT (dBuV/m)	MARGIN (dB)	ANTENNA HEIGHT (m)	TABLE ANGLE (Degree)	RAW VALUE (dBuV)	CORRECTION FACTOR (dB/m)
1	*2462.00	110.1 PK			1.00 H	331	76.36	33.74
2	*2462.00	107.0 AV			1.00 H	331	73.26	33.74
3	2487.90	64.1 PK	74.0	-9.9	1.00 H	328	30.27	33.83
4	2487.90	47.2 AV	54.0	-6.8	1.00 H	328	13.37	33.83
5	4924.00	57.0 PK	74.0	-17.0	1.64 H	26	13.73	43.27
6	4924.00	53.8 AV	54.0	-0.2	1.64 H	26	10.53	43.27
7	7386.00	56.5 PK	74.0	-17.5	1.00 H	248	8.10	48.40
8	7386.00	44.1 AV	54.0	-9.9	1.00 H	248	-4.30	48.40

ANTENNA POLARITY & TEST DISTANCE: VERTICAL AT 3 M

NO.	FREQ. (MHz)	EMISSION LEVEL (dBuV/m)	LIMIT (dBuV/m)	MARGIN (dB)	ANTENNA HEIGHT (m)	TABLE ANGLE (Degree)	RAW VALUE (dBuV)	CORRECTION FACTOR (dB/m)
1	*2462.00	103.4 PK			1.00 V	304	69.66	33.74
2	*2462.00	99.9 AV			1.00 V	304	66.16	33.74
3	2487.90	56.2 PK	74.0	-17.8	1.00 V	304	22.37	33.83
4	2487.90	39.5 AV	54.0	-14.5	1.00 V	304	5.67	33.83
5	4924.00	52.7 PK	74.0	-21.3	1.12 V	317	9.43	43.27
6	4924.00	46.1 AV	54.0	-7.9	1.12 V	317	2.83	43.27
7	7386.00	56.7 PK	74.0	-17.3	1.00 V	188	8.30	48.40
8	7386.00	44.5 AV	54.0	-9.5	1.00 V	188	-3.90	48.40

REMARKS:

1. Emission Level(dBuV/m) = Raw Value(dBuV) + Correction Factor(dB/m)
2. Correction Factor(dB/m) = Antenna Factor(dB/m) + Cable Factor(dB) – Pre-Amplifier Factor(dB)
3. The other emission levels were very low against the limit.
4. Margin value = Emission Level – Limit value
5. " * ": Fundamental frequency.



A D T

802.11g

CHANNEL	TX Channel 1	DETECTOR FUNCTION	Peak (PK)
FREQUENCY RANGE	1GHz ~ 25GHz		Average (AV)

ANTENNA POLARITY & TEST DISTANCE: HORIZONTAL AT 3 M

NO.	FREQ. (MHz)	EMISSION LEVEL (dBuV/m)	LIMIT (dBuV/m)	MARGIN (dB)	ANTENNA HEIGHT (m)	TABLE ANGLE (Degree)	RAW VALUE (dBuV)	CORRECTION FACTOR (dB/m)
1	2390.00	69.0 PK	74.0	-5.0	1.00 H	325	35.47	33.53
2	2390.00	53.9 AV	54.0	-0.1	1.00 H	325	20.37	33.53
3	*2412.00	113.7 PK			1.00 H	325	80.11	33.59
4	*2412.00	102.1 AV			1.00 H	325	68.51	33.59
5	4824.00	58.1 PK	74.0	-15.9	1.00 H	6	14.92	43.18
6	4824.00	44.7 AV	54.0	-9.3	1.00 H	6	1.52	43.18

ANTENNA POLARITY & TEST DISTANCE: VERTICAL AT 3 M

NO.	FREQ. (MHz)	EMISSION LEVEL (dBuV/m)	LIMIT (dBuV/m)	MARGIN (dB)	ANTENNA HEIGHT (m)	TABLE ANGLE (Degree)	RAW VALUE (dBuV)	CORRECTION FACTOR (dB/m)
1	2390.00	66.1 PK	74.0	-7.9	1.01 V	277	32.57	33.53
2	2390.00	50.0 AV	54.0	-4.0	1.01 V	277	16.47	33.53
3	*2412.00	108.1 PK			1.01 V	277	74.51	33.59
4	*2412.00	97.6 AV			1.01 V	277	64.01	33.59
5	4824.00	50.8 PK	74.0	-23.2	1.02 V	304	7.62	43.18
6	4824.00	38.5 AV	54.0	-15.5	1.02 V	304	-4.68	43.18

REMARKS:

1. Emission Level(dBuV/m) = Raw Value(dBuV) + Correction Factor(dB/m)
2. Correction Factor(dB/m) = Antenna Factor(dB/m) + Cable Factor(dB) – Pre-Amplifier Factor(dB)
3. The other emission levels were very low against the limit.
4. Margin value = Emission Level – Limit value
5. " * " : Fundamental frequency.



A D T

CHANNEL	TX Channel 6	DETECTOR FUNCTION	Peak (PK)
FREQUENCY RANGE	1GHz ~ 25GHz		Average (AV)

ANTENNA POLARITY & TEST DISTANCE: HORIZONTAL AT 3 M

NO.	FREQ. (MHz)	EMISSION LEVEL (dBuV/m)	LIMIT (dBuV/m)	MARGIN (dB)	ANTENNA HEIGHT (m)	TABLE ANGLE (Degree)	RAW VALUE (dBuV)	CORRECTION FACTOR (dB/m)
1	2390.00	69.3 PK	74.0	-4.7	1.00 H	329	35.77	33.53
2	2390.00	46.9 AV	54.0	-7.1	1.00 H	329	13.37	33.53
3	*2437.00	120.3 PK			1.00 H	329	86.63	33.67
4	*2437.00	108.9 AV			1.00 H	329	75.23	33.67
5	2483.50	61.7 PK	74.0	-12.3	1.00 H	329	27.89	33.81
6	2483.50	43.2 AV	54.0	-10.8	1.00 H	329	9.39	33.81
7	4874.00	58.1 PK	74.0	-15.9	1.00 H	6	14.86	43.24
8	4874.00	44.7 AV	54.0	-9.3	1.00 H	6	1.46	43.24
9	7311.00	60.7 PK	74.0	-13.3	1.44 H	13	12.63	48.07
10	7311.00	47.8 AV	54.0	-6.2	1.44 H	13	-0.27	48.07

ANTENNA POLARITY & TEST DISTANCE: VERTICAL AT 3 M

NO.	FREQ. (MHz)	EMISSION LEVEL (dBuV/m)	LIMIT (dBuV/m)	MARGIN (dB)	ANTENNA HEIGHT (m)	TABLE ANGLE (Degree)	RAW VALUE (dBuV)	CORRECTION FACTOR (dB/m)
1	2390.00	66.6 PK	74.0	-7.4	1.00 V	263	33.07	33.53
2	2390.00	43.8 AV	54.0	-10.2	1.00 V	263	10.27	33.53
3	*2437.00	113.5 PK			1.00 V	263	79.83	33.67
4	*2437.00	103.9 AV			1.00 V	263	70.23	33.67
5	2483.50	57.9 PK	74.0	-16.1	1.00 V	263	24.09	33.81
6	2483.50	40.0 AV	54.0	-14.0	1.00 V	263	6.19	33.81
7	4874.00	55.3 PK	74.0	-18.7	1.00 V	337	12.06	43.24
8	4874.00	43.1 AV	54.0	-10.9	1.00 V	337	-0.14	43.24
9	7311.00	60.5 PK	74.0	-13.5	1.28 V	62	12.43	48.07
10	7311.00	47.3 AV	54.0	-6.7	1.28 V	62	-0.77	48.07

REMARKS:

1. Emission Level(dBuV/m) = Raw Value(dBuV) + Correction Factor(dB/m)
2. Correction Factor(dB/m) = Antenna Factor(dB/m) + Cable Factor(dB) – Pre-Amplifier Factor(dB)
3. The other emission levels were very low against the limit.
4. Margin value = Emission Level – Limit value
5. " * ": Fundamental frequency.



A D T

CHANNEL	TX Channel 11	DETECTOR FUNCTION	Peak (PK)
FREQUENCY RANGE	1GHz ~ 25GHz		Average (AV)

ANTENNA POLARITY & TEST DISTANCE: HORIZONTAL AT 3 M

NO.	FREQ. (MHz)	EMISSION LEVEL (dBuV/m)	LIMIT (dBuV/m)	MARGIN (dB)	ANTENNA HEIGHT (m)	TABLE ANGLE (Degree)	RAW VALUE (dBuV)	CORRECTION FACTOR (dB/m)
1	2390.00	60.5 PK	74.0	-13.5	1.00 H	326	26.97	33.53
2	2390.00	44.3 AV	54.0	-9.7	1.00 H	326	10.77	33.53
3	*2462.00	114.5 PK			1.00 H	326	80.76	33.74
4	*2462.00	103.9 AV			1.00 H	326	70.16	33.74
5	2483.50	71.2 PK	74.0	-2.8	1.00 H	326	37.39	33.81
6	2483.50	52.4 AV	54.0	-1.6	1.00 H	326	18.59	33.81
7	4924.00	53.1 PK	74.0	-20.9	1.00 H	30	9.83	43.27
8	4924.00	40.1 AV	54.0	-13.9	1.00 H	30	-3.17	43.27
9	7386.00	56.8 PK	74.0	-17.2	1.00 H	250	8.40	48.40
10	7386.00	43.9 AV	54.0	-10.1	1.00 H	250	-4.50	48.40

ANTENNA POLARITY & TEST DISTANCE: VERTICAL AT 3 M

NO.	FREQ. (MHz)	EMISSION LEVEL (dBuV/m)	LIMIT (dBuV/m)	MARGIN (dB)	ANTENNA HEIGHT (m)	TABLE ANGLE (Degree)	RAW VALUE (dBuV)	CORRECTION FACTOR (dB/m)
1	2390.00	51.7 PK	74.0	-22.3	1.00 V	264	18.17	33.53
2	2390.00	37.1 AV	54.0	-16.9	1.00 V	264	3.57	33.53
3	*2462.00	108.1 PK			1.00 V	264	74.36	33.74
4	*2462.00	97.4 AV			1.00 V	264	63.66	33.74
5	2483.50	64.9 PK	74.0	-9.1	1.00 V	264	31.09	33.81
6	2483.50	46.0 AV	54.0	-8.0	1.00 V	264	12.19	33.81
7	4924.00	51.2 PK	74.0	-22.8	1.00 V	318	7.93	43.27
8	4924.00	39.0 AV	54.0	-15.0	1.00 V	318	-4.27	43.27
9	7386.00	56.6 PK	74.0	-17.4	1.00 V	206	8.20	48.40
10	7386.00	43.9 AV	54.0	-10.1	1.00 V	206	-4.50	48.40

REMARKS:

1. Emission Level(dBuV/m) = Raw Value(dBuV) + Correction Factor(dB/m)
2. Correction Factor(dB/m) = Antenna Factor(dB/m) + Cable Factor(dB) – Pre-Amplifier Factor(dB)
3. The other emission levels were very low against the limit.
4. Margin value = Emission Level – Limit value
5. " * ": Fundamental frequency.



A D T

802.11n (HT20)

CHANNEL	TX Channel 1	DETECTOR FUNCTION	Peak (PK)
FREQUENCY RANGE	1GHz ~ 25GHz		Average (AV)

ANTENNA POLARITY & TEST DISTANCE: HORIZONTAL AT 3 M

NO.	FREQ. (MHz)	EMISSION LEVEL (dBuV/m)	LIMIT (dBuV/m)	MARGIN (dB)	ANTENNA HEIGHT (m)	TABLE ANGLE (Degree)	RAW VALUE (dBuV)	CORRECTION FACTOR (dB/m)
1	2390.00	72.8 PK	74.0	-1.2	1.00 H	323	39.27	33.53
2	2390.00	53.1 AV	54.0	-0.9	1.00 H	323	19.57	33.53
3	*2412.00	111.6 PK			1.00 H	323	78.01	33.59
4	*2412.00	100.3 AV			1.00 H	323	66.71	33.59
5	4824.00	52.9 PK	74.0	-21.1	1.00 H	34	9.72	43.18
6	4824.00	40.0 AV	54.0	-14.0	1.00 H	34	-3.18	43.18

ANTENNA POLARITY & TEST DISTANCE: VERTICAL AT 3 M

NO.	FREQ. (MHz)	EMISSION LEVEL (dBuV/m)	LIMIT (dBuV/m)	MARGIN (dB)	ANTENNA HEIGHT (m)	TABLE ANGLE (Degree)	RAW VALUE (dBuV)	CORRECTION FACTOR (dB/m)
1	2390.00	66.2 PK	74.0	-7.8	1.05 V	263	32.67	33.53
2	2390.00	50.1 AV	54.0	-3.9	1.05 V	263	16.57	33.53
3	*2412.00	107.9 PK			1.05 V	263	74.31	33.59
4	*2412.00	97.4 AV			1.05 V	263	63.81	33.59
5	4824.00	51.5 PK	74.0	-22.5	1.02 V	323	8.32	43.18
6	4824.00	38.8 AV	54.0	-15.2	1.02 V	323	-4.38	43.18

REMARKS:

1. Emission Level(dBuV/m) = Raw Value(dBuV) + Correction Factor(dB/m)
2. Correction Factor(dB/m) = Antenna Factor(dB/m) + Cable Factor(dB) – Pre-Amplifier Factor(dB)
3. The other emission levels were very low against the limit.
4. Margin value = Emission Level – Limit value
5. " * " : Fundamental frequency.



A D T

CHANNEL	TX Channel 6	DETECTOR FUNCTION	Peak (PK)
FREQUENCY RANGE	1GHz ~ 25GHz		Average (AV)

ANTENNA POLARITY & TEST DISTANCE: HORIZONTAL AT 3 M

NO.	FREQ. (MHz)	EMISSION LEVEL (dBuV/m)	LIMIT (dBuV/m)	MARGIN (dB)	ANTENNA HEIGHT (m)	TABLE ANGLE (Degree)	RAW VALUE (dBuV)	CORRECTION FACTOR (dB/m)
1	2390.00	73.1 PK	74.0	-0.9	1.00 H	328	39.57	33.53
2	2390.00	46.5 AV	54.0	-7.5	1.00 H	328	12.97	33.53
3	*2437.00	116.3 PK			1.00 H	328	82.63	33.67
4	*2437.00	104.7 AV			1.00 H	328	71.03	33.67
5	2483.50	68.6 PK	74.0	-5.4	1.00 H	328	34.79	33.81
6	2483.50	43.2 AV	54.0	-10.8	1.00 H	328	9.39	33.81
7	4874.00	58.7 PK	74.0	-15.3	1.00 H	54	15.46	43.24
8	4874.00	45.0 AV	54.0	-9.0	1.00 H	54	1.76	43.24
9	7311.00	61.1 PK	74.0	-12.9	1.40 H	217	13.03	48.07
10	7311.00	48.2 AV	54.0	-5.8	1.40 H	217	0.13	48.07

ANTENNA POLARITY & TEST DISTANCE: VERTICAL AT 3 M

NO.	FREQ. (MHz)	EMISSION LEVEL (dBuV/m)	LIMIT (dBuV/m)	MARGIN (dB)	ANTENNA HEIGHT (m)	TABLE ANGLE (Degree)	RAW VALUE (dBuV)	CORRECTION FACTOR (dB/m)
1	2390.00	69.7 PK	74.0	-4.3	1.03 V	247	36.17	33.53
2	2390.00	43.4 AV	54.0	-10.6	1.03 V	247	9.87	33.53
3	*2437.00	112.1 PK			1.03 V	247	78.43	33.67
4	*2437.00	101.5 AV			1.03 V	247	67.83	33.67
5	2483.50	65.4 PK	74.0	-8.6	1.03 V	247	31.59	33.81
6	2483.50	39.7 AV	54.0	-14.3	1.03 V	247	5.89	33.81
7	4874.00	54.6 PK	74.0	-19.4	1.05 V	327	11.36	43.24
8	4874.00	42.7 AV	54.0	-11.3	1.05 V	327	-0.54	43.24
9	7311.00	60.2 PK	74.0	-13.8	1.33 V	74	12.13	48.07
10	7311.00	47.0 AV	54.0	-7.0	1.33 V	74	-1.07	48.07

REMARKS:

1. Emission Level(dBuV/m) = Raw Value(dBuV) + Correction Factor(dB/m)
2. Correction Factor(dB/m) = Antenna Factor(dB/m) + Cable Factor(dB) – Pre-Amplifier Factor(dB)
3. The other emission levels were very low against the limit.
4. Margin value = Emission Level – Limit value
5. " * ": Fundamental frequency.



A D T

CHANNEL	TX Channel 11	DETECTOR FUNCTION	Peak (PK)
FREQUENCY RANGE	1GHz ~ 25GHz		Average (AV)

ANTENNA POLARITY & TEST DISTANCE: HORIZONTAL AT 3 M

NO.	FREQ. (MHz)	EMISSION LEVEL (dBuV/m)	LIMIT (dBuV/m)	MARGIN (dB)	ANTENNA HEIGHT (m)	TABLE ANGLE (Degree)	RAW VALUE (dBuV)	CORRECTION FACTOR (dB/m)
1	*2462.00	114.1 PK			1.00 H	325	80.36	33.74
2	*2462.00	102.5 AV			1.00 H	325	68.76	33.74
3	2483.50	73.1 PK	74.0	-0.9	1.00 H	325	39.29	33.81
4	2483.50	53.4 AV	54.0	-0.6	1.00 H	325	19.59	33.81
5	4924.00	53.1 PK	74.0	-20.9	1.02 H	21	9.83	43.27
6	4924.00	40.3 AV	54.0	-13.7	1.02 H	21	-2.97	43.27
7	7386.00	56.8 PK	74.0	-17.2	1.12 H	257	8.40	48.40
8	7386.00	43.8 AV	54.0	-10.2	1.12 H	257	-4.60	48.40

ANTENNA POLARITY & TEST DISTANCE: VERTICAL AT 3 M

NO.	FREQ. (MHz)	EMISSION LEVEL (dBuV/m)	LIMIT (dBuV/m)	MARGIN (dB)	ANTENNA HEIGHT (m)	TABLE ANGLE (Degree)	RAW VALUE (dBuV)	CORRECTION FACTOR (dB/m)
1	*2462.00	108.2 PK			1.02 V	255	74.46	33.74
2	*2462.00	97.5 AV			1.02 V	255	63.76	33.74
3	2483.50	66.5 PK	74.0	-7.5	1.02 V	255	32.69	33.81
4	2483.50	50.3 AV	54.0	-3.7	1.02 V	255	16.49	33.81
5	4924.00	51.0 PK	74.0	-23.0	1.03 V	331	7.73	43.27
6	4924.00	38.6 AV	54.0	-15.4	1.03 V	331	-4.67	43.27
7	7386.00	56.6 PK	74.0	-17.4	1.04 V	219	8.20	48.40
8	7386.00	43.8 AV	54.0	-10.2	1.04 V	219	-4.60	48.40

REMARKS:

1. Emission Level(dBuV/m) = Raw Value(dBuV) + Correction Factor(dB/m)
2. Correction Factor(dB/m) = Antenna Factor(dB/m) + Cable Factor(dB) – Pre-Amplifier Factor(dB)
3. The other emission levels were very low against the limit.
4. Margin value = Emission Level – Limit value
5. " * ": Fundamental frequency.



802.11n (HT40)

CHANNEL	TX Channel 3	DETECTOR FUNCTION	Peak (PK)
FREQUENCY RANGE	1GHz ~ 25GHz		Average (AV)

ANTENNA POLARITY & TEST DISTANCE: HORIZONTAL AT 3 M

NO.	FREQ. (MHz)	EMISSION LEVEL (dBuV/m)	LIMIT (dBuV/m)	MARGIN (dB)	ANTENNA HEIGHT (m)	TABLE ANGLE (Degree)	RAW VALUE (dBuV)	CORRECTION FACTOR (dB/m)
1	2390.00	71.1 PK	74.0	-2.9	1.00 H	327	37.57	33.53
2	2390.00	53.5 AV	54.0	-0.5	1.00 H	327	19.97	33.53
3	*2422.00	106.1 PK			1.00 H	327	72.48	33.62
4	*2422.00	94.1 AV			1.00 H	327	60.48	33.62
5	4844.00	52.8 PK	74.0	-21.2	1.06 H	19	9.60	43.20
6	4844.00	39.8 AV	54.0	-14.2	1.06 H	19	-3.40	43.20
7	7266.00	56.8 PK	74.0	-17.2	1.07 H	261	8.89	47.91
8	7266.00	43.9 AV	54.0	-10.1	1.07 H	261	-4.01	47.91

ANTENNA POLARITY & TEST DISTANCE: VERTICAL AT 3 M

NO.	FREQ. (MHz)	EMISSION LEVEL (dBuV/m)	LIMIT (dBuV/m)	MARGIN (dB)	ANTENNA HEIGHT (m)	TABLE ANGLE (Degree)	RAW VALUE (dBuV)	CORRECTION FACTOR (dB/m)
1	2390.00	65.8 PK	74.0	-8.2	1.10 V	278	32.27	33.53
2	2390.00	49.9 AV	54.0	-4.1	1.10 V	278	16.37	33.53
3	*2422.00	102.5 PK			1.10 V	278	68.88	33.62
4	*2422.00	91.2 AV			1.10 V	278	57.58	33.62
5	4844.00	50.0 PK	74.0	-24.0	1.01 V	349	6.80	43.20
6	4844.00	37.8 AV	54.0	-16.2	1.01 V	349	-5.40	43.20
7	7266.00	56.9 PK	74.0	-17.1	1.04 V	247	8.99	47.91
8	7266.00	44.2 AV	54.0	-9.8	1.04 V	247	-3.71	47.91

REMARKS:

1. Emission Level(dBuV/m) = Raw Value(dBuV) + Correction Factor(dB/m)
2. Correction Factor(dB/m) = Antenna Factor(dB/m) + Cable Factor(dB) – Pre-Amplifier Factor(dB)
3. The other emission levels were very low against the limit.
4. Margin value = Emission Level – Limit value
5. " * ": Fundamental frequency.



A D T

CHANNEL	TX Channel 6	DETECTOR FUNCTION	Peak (PK)
FREQUENCY RANGE	1GHz ~ 25GHz		Average (AV)

ANTENNA POLARITY & TEST DISTANCE: HORIZONTAL AT 3 M

NO.	FREQ. (MHz)	EMISSION LEVEL (dBuV/m)	LIMIT (dBuV/m)	MARGIN (dB)	ANTENNA HEIGHT (m)	TABLE ANGLE (Degree)	RAW VALUE (dBuV)	CORRECTION FACTOR (dB/m)
1	2390.00	72.9 PK	74.0	-1.1	1.00 H	349	39.37	33.53
2	2390.00	53.5 AV	54.0	-0.5	1.00 H	349	19.97	33.53
3	*2437.00	109.6 PK			1.00 H	349	75.93	33.67
4	*2437.00	97.8 AV			1.00 H	349	64.13	33.67
5	2483.50	69.2 PK	74.0	-4.8	1.00 H	349	35.39	33.81
6	2483.50	48.8 AV	54.0	-5.2	1.00 H	349	14.99	33.81
7	4874.00	53.0 PK	74.0	-21.0	1.00 H	30	9.76	43.24
8	4874.00	40.0 AV	54.0	-14.0	1.00 H	30	-3.24	43.24
9	7311.00	57.0 PK	74.0	-17.0	1.16 H	250	8.93	48.07
10	7311.00	44.0 AV	54.0	-10.0	1.16 H	250	-4.07	48.07

ANTENNA POLARITY & TEST DISTANCE: VERTICAL AT 3 M

NO.	FREQ. (MHz)	EMISSION LEVEL (dBuV/m)	LIMIT (dBuV/m)	MARGIN (dB)	ANTENNA HEIGHT (m)	TABLE ANGLE (Degree)	RAW VALUE (dBuV)	CORRECTION FACTOR (dB/m)
1	2390.00	69.4 PK	74.0	-4.6	1.12 V	271	35.87	33.53
2	2390.00	50.2 AV	54.0	-3.8	1.12 V	271	16.67	33.53
3	*2437.00	105.0 PK			1.12 V	271	71.33	33.67
4	*2437.00	93.7 AV			1.12 V	271	60.03	33.67
5	2483.50	65.6 PK	74.0	-8.4	1.12 V	271	31.79	33.81
6	2483.50	45.5 AV	54.0	-8.5	1.12 V	271	11.69	33.81
7	4874.00	54.3 PK	74.0	-19.7	1.10 V	321	11.06	43.24
8	4874.00	42.3 AV	54.0	-11.7	1.10 V	321	-0.94	43.24
9	7311.00	59.9 PK	74.0	-14.1	1.35 V	80	11.83	48.07
10	7311.00	46.8 AV	54.0	-7.2	1.35 V	80	-1.27	48.07

REMARKS:

1. Emission Level(dBuV/m) = Raw Value(dBuV) + Correction Factor(dB/m)
2. Correction Factor(dB/m) = Antenna Factor(dB/m) + Cable Factor(dB) – Pre-Amplifier Factor(dB)
3. The other emission levels were very low against the limit.
4. Margin value = Emission Level – Limit value
5. " * ": Fundamental frequency.



A D T

CHANNEL	TX Channel 9	DETECTOR FUNCTION	Peak (PK)
FREQUENCY RANGE	1GHz ~ 25GHz		Average (AV)

ANTENNA POLARITY & TEST DISTANCE: HORIZONTAL AT 3 M

NO.	FREQ. (MHz)	EMISSION LEVEL (dBuV/m)	LIMIT (dBuV/m)	MARGIN (dB)	ANTENNA HEIGHT (m)	TABLE ANGLE (Degree)	RAW VALUE (dBuV)	CORRECTION FACTOR (dB/m)
1	*2452.00	108.5 PK			1.04 H	349	74.79	33.71
2	*2452.00	97.1 AV			1.04 H	349	63.39	33.71
3	2483.50	73.8 PK	74.0	-0.2	1.04 H	349	39.99	33.81
4	2483.50	50.4 AV	54.0	-3.6	1.04 H	349	16.59	33.81
5	4904.00	53.3 PK	74.0	-20.7	1.10 H	9	10.03	43.27
6	4904.00	40.1 AV	54.0	-13.9	1.10 H	9	-3.17	43.27
7	7356.00	57.1 PK	74.0	-16.9	1.11 H	257	8.83	48.27
8	7356.00	44.1 AV	54.0	-9.9	1.11 H	257	-4.17	48.27

ANTENNA POLARITY & TEST DISTANCE: VERTICAL AT 3 M

NO.	FREQ. (MHz)	EMISSION LEVEL (dBuV/m)	LIMIT (dBuV/m)	MARGIN (dB)	ANTENNA HEIGHT (m)	TABLE ANGLE (Degree)	RAW VALUE (dBuV)	CORRECTION FACTOR (dB/m)
1	*2452.00	104.6 PK			1.08 V	272	70.89	33.71
2	*2452.00	93.6 AV			1.08 V	272	59.89	33.71
3	2483.50	66.0 PK	74.0	-8.0	1.08 V	272	32.19	33.81
4	2483.50	50.1 AV	54.0	-3.9	1.08 V	272	16.29	33.81
5	4904.00	50.7 PK	74.0	-23.3	1.04 V	336	7.43	43.27
6	4904.00	38.2 AV	54.0	-15.8	1.04 V	336	-5.07	43.27
7	7356.00	56.9 PK	74.0	-17.1	1.01 V	231	8.63	48.27
8	7356.00	44.0 AV	54.0	-10.0	1.01 V	231	-4.27	48.27

REMARKS:

1. Emission Level(dBuV/m) = Raw Value(dBuV) + Correction Factor(dB/m)
2. Correction Factor(dB/m) = Antenna Factor(dB/m) + Cable Factor(dB) – Pre-Amplifier Factor(dB)
3. The other emission levels were very low against the limit.
4. Margin value = Emission Level – Limit value
5. " * ": Fundamental frequency.

4.3 6dB BANDWIDTH MEASUREMENT

4.3.1 LIMITS OF 6dB BANDWIDTH MEASUREMENT

The minimum of 6dB Bandwidth Measurement is 0.5 MHz.

4.3.2 TEST INSTRUMENTS

DESCRIPTION & MANUFACTURER	MODEL NO.	SERIAL NO.	CALIBRATED DATE	CALIBRATED UNTIL
Spectrum Analyzer R&S	FSP 40	100036	Jan. 21, 2013	Jan. 20, 2014

Note:

1. The calibration interval of the above test instruments is 12 months and the calibrations are traceable to NML/ROC and NIST/USA.
2. Tested date : Dec. 24, 2013

4.3.3 TEST PROCEDURE

1. Set resolution bandwidth (RBW) = 100kHz
2. Set the video bandwidth (VBW) $\geq 3 \times$ RBW, Detector = Peak.
3. Trace mode = max hold.
4. Sweep = auto couple.
5. Measure the maximum width of the emission that is constrained by the frequencies associated with the two amplitude points (upper and lower) that are attenuated by 6 dB relative to the maximum level measured in the fundamental emission

4.3.4 DEVIATION FROM TEST STANDARD

No deviation

4.3.5 TEST SETUP

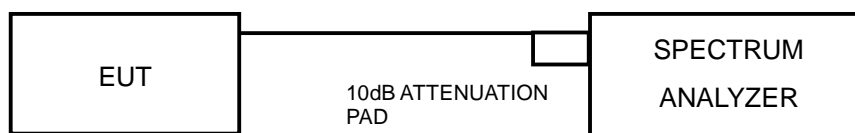

4.3.6 EUT OPERATING CONDITIONS

The software provided by client to enable the EUT under transmission condition continuously at lowest, middle and highest channel frequencies individually.



A D T

4.3.7 TEST RESULTS

802.11b

CHANNEL	FREQUENCY (MHz)	6dB BANDWIDTH (MHz)	MINIMUM LIMIT (MHz)	PASS / FAIL
1	2412	10.10	0.5	PASS
6	2437	10.15	0.5	PASS
11	2462	10.62	0.5	PASS

802.11g

CHANNEL	FREQUENCY (MHz)	6dB BANDWIDTH (MHz)	MINIMUM LIMIT (MHz)	PASS / FAIL
1	2412	15.68	0.5	PASS
6	2437	16.14	0.5	PASS
11	2462	15.81	0.5	PASS

802.11n (HT20)

CHANNEL	FREQUENCY (MHz)	6dB BANDWIDTH (MHz)	MINIMUM LIMIT (MHz)	PASS / FAIL
1	2412	16.57	0.5	PASS
6	2437	17.02	0.5	PASS
11	2462	16.44	0.5	PASS

802.11n (HT40)

CHANNEL	FREQUENCY (MHz)	6dB BANDWIDTH (MHz)	MINIMUM LIMIT (MHz)	PASS / FAIL
3	2422	35.57	0.5	PASS
6	2437	32.69	0.5	PASS
9	2452	26.46	0.5	PASS



A D T

SPECTRUM PLOT OF WORST VALUE

802.11b / CH1

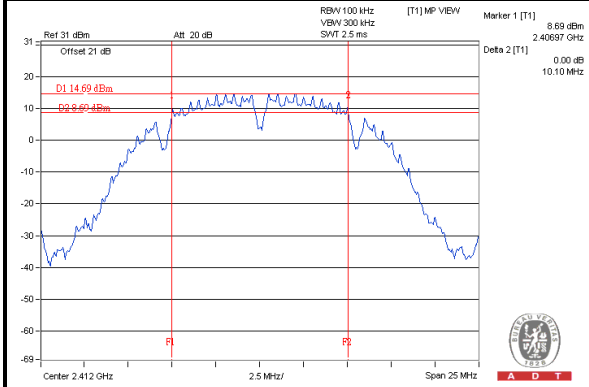

802.11g / CH1

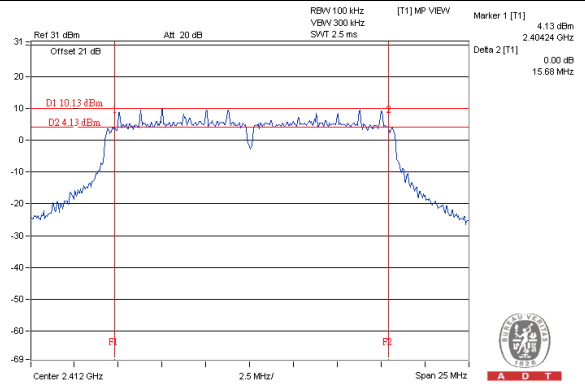

802.11n (HT20) / CH11

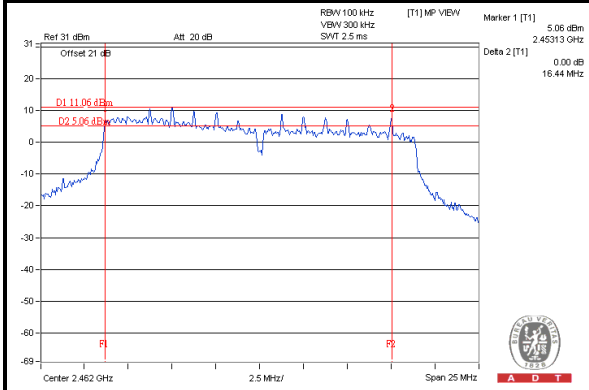

802.11n (HT40) / CH9

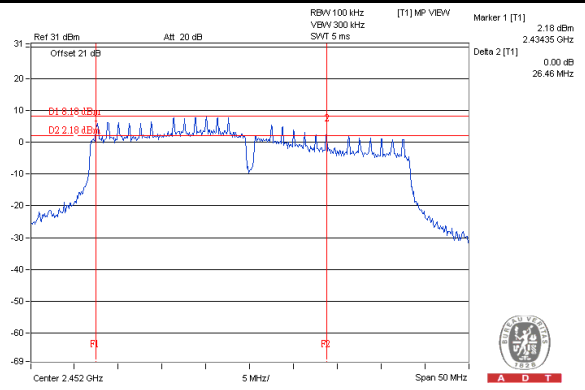

4.4 CONDUCTED OUTPUT POWER MEASUREMENT

4.4.1 LIMITS OF MAXIMUM PEAK OUTPUT POWER MEASUREMENT

For systems using digital modulation in the 2400–2483.5 MHz bands: 1 Watt (30dBm)

4.4.2 INSTRUMENTS

DESCRIPTION & MANUFACTURER	MODEL NO.	SERIAL NO.	CALIBRATED DATE	CALIBRATED UNTIL
Power Meter	ML2495A	1014008	Apr. 23, 2013	Apr. 22, 2014
Power Sensor	MA2411B	0917122	Apr. 23, 2013	Apr. 22, 2014

Note:

1. The calibration interval of the above test instruments is 12 months and the calibrations are traceable to NML/ROC and NIST/USA.
2. Tested date : Dec. 24, 2013

4.4.3 TEST PROCEDURES

The peak power sensor was used on the output port of the EUT. A power meter was used to read the response of the peak power sensor. Record the peak power level.

4.4.4 DEVIATION FROM TEST STANDARD

No deviation.

4.4.5 TEST SETUP

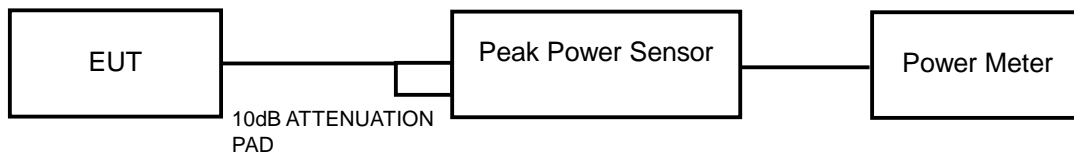

4.4.6 EUT OPERATING CONDITIONS

Same as Item 4.3.6



A D T

4.4.7 TEST RESULTS

802.11b

CHANNEL	FREQUENCY (MHz)	PEAK POWER (mW)	PEAK POWER (dBm)	LIMIT (dBm)	PASS/FAIL
1	2412	347.536	25.41	30	PASS
6	2437	260.016	24.15	30	PASS
11	2462	251.768	24.01	30	PASS

802.11g

CHANNEL	FREQUENCY (MHz)	PEAK POWER (mW)	PEAK POWER (dBm)	LIMIT (dBm)	PASS/FAIL
1	2412	534.564	27.28	30	PASS
6	2437	948.418	29.77	30	PASS
11	2462	668.344	28.25	30	PASS

802.11n (HT20)

CHANNEL	FREQUENCY (MHz)	PEAK POWER (mW)	PEAK POWER (dBm)	LIMIT (dBm)	PASS/FAIL
1	2412	456.037	26.59	30	PASS
6	2437	937.562	29.72	30	PASS
11	2462	592.925	27.73	30	PASS

802.11n (HT40)

CHANNEL	FREQUENCY (MHz)	PEAK POWER (mW)	PEAK POWER (dBm)	LIMIT (dBm)	PASS/FAIL
3	2422	186.638	22.71	30	PASS
6	2437	402.717	26.05	30	PASS
9	2452	403.645	26.06	30	PASS



A D T

4.5 AVERAGE OUTPUT POWER

4.5.1 FOR REFERENCE.

4.5.2 TEST INSTRUMENTS

DESCRIPTION & MANUFACTURER	MODEL NO.	SERIAL NO.	CALIBRATED DATE	CALIBRATED UNTIL
Power Meter	ML2495A	1014008	Apr. 23, 2013	Apr. 22, 2014
Power Sensor	MA2411B	0917122	Apr. 23, 2013	Apr. 22, 2014

Note:

1. The calibration interval of the above test instruments is 12 months and the calibrations are traceable to NML/ROC and NIST/USA.
2. Tested date : Dec. 24, 2013

4.5.3 TEST PROCEDURES

Method PM is used to perform output power measurement, trigger and gating function of wide band power meter is enabled to measure max output power of TX on burst. Duty factor is not added to measured value.

4.5.4 TEST SETUP

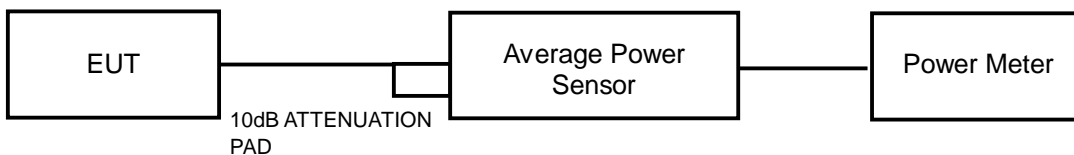

4.5.5 EUT OPERATING CONDITIONS

Same as Item 4.3.6



A D T

4.5.6 TEST RESULTS

802.11b

CHAN.	FREQUENCY (MHz)	AVERAGE POWER (mW)	AVERAGE POWER (dBm)
1	2412	224.905	23.52
6	2437	174.582	22.42
11	2462	174.181	22.41

802.11g

CHAN.	FREQUENCY (MHz)	AVERAGE POWER (mW)	AVERAGE POWER (dBm)
1	2412	121.060	20.83
6	2437	192.309	22.84
11	2462	172.187	22.36

802.11n (HT20)

CHAN.	FREQUENCY (MHz)	AVERAGE POWER (mW)	AVERAGE POWER (dBm)
1	2412	106.414	20.27
6	2437	190.546	22.80
11	2462	148.252	21.71

802.11n (HT40)

CHAN.	FREQUENCY (MHz)	AVERAGE POWER (mW)	AVERAGE POWER (dBm)
3	2422	46.452	16.67
6	2437	111.173	20.46
9	2452	108.643	20.36

4.6 POWER SPECTRAL DENSITY MEASUREMENT

4.6.1 LIMITS OF POWER SPECTRAL DENSITY MEASUREMENT

The Maximum of Power Spectral Density Measurement is 8dBm.

4.6.2 TEST INSTRUMENTS

DESCRIPTION & MANUFACTURER	MODEL NO.	SERIAL NO.	CALIBRATED DATE	CALIBRATED UNTIL
Spectrum Analyzer R&S	FSP 40	100036	Jan. 21, 2013	Jan. 20, 2014

Note:

1. The calibration interval of the above test instruments is 12 months and the calibrations are traceable to NML/ROC and NIST/USA.
2. Tested date : Dec. 24, 2013

4.6.3 TEST PROCEDURE

1. Set the RBW = 3 kHz, VBW =10 kHz, Detector = peak.
2. Sweep time = auto couple, Trace mode = max hold, allow trace to fully stabilize.
3. Use the peak marker function to determine the maximum amplitude level.

4.6.4 DEVIATION FROM TEST STANDARD

No deviation

4.6.5 TEST SETUP

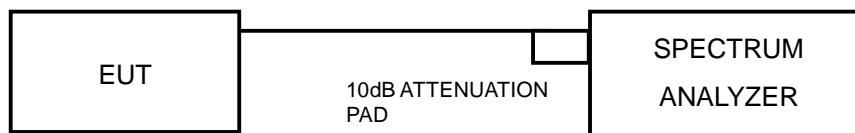

4.6.6 EUT OPERATING CONDITION

Same as Item 4.3.6



A D T

4.6.7 TEST RESULTS

802.11b

Channel	FREQUENCY (MHz)	PSD (dBm)	LIMIT (dBm)	PASS /FAIL
1	2412	-0.71	8	PASS
6	2437	-2.45	8	PASS
11	2462	-2.81	8	PASS

802.11g

Channel	FREQUENCY (MHz)	PSD (dBm)	LIMIT (dBm)	PASS /FAIL
1	2412	-5.47	8	PASS
6	2437	-1.58	8	PASS
11	2462	-3.05	8	PASS

802.11n (HT20)

Channel	FREQUENCY (MHz)	PSD (dBm)	LIMIT (dBm)	PASS /FAIL
1	2412	-7.23	8	PASS
6	2437	-2.32	8	PASS
11	2462	-4.32	8	PASS

802.11n (HT40)

Channel	FREQUENCY (MHz)	PSD (dBm)	LIMIT (dBm)	PASS /FAIL
3	2422	-11.70	8	PASS
6	2437	-7.80	8	PASS
9	2452	-7.89	8	PASS



A D T

SPECTRUM PLOT OF WORST VALUE

802.11b / CH1

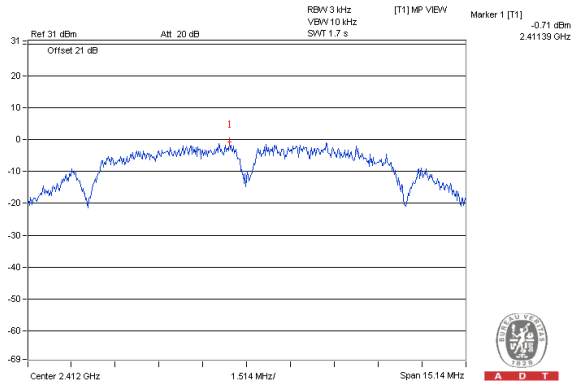

802.11g / CH 6

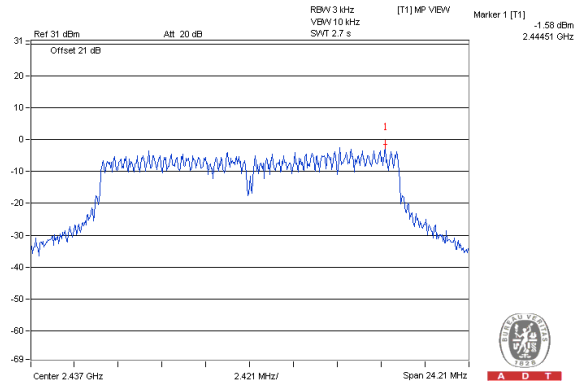

802.11n (HT20) / CH6

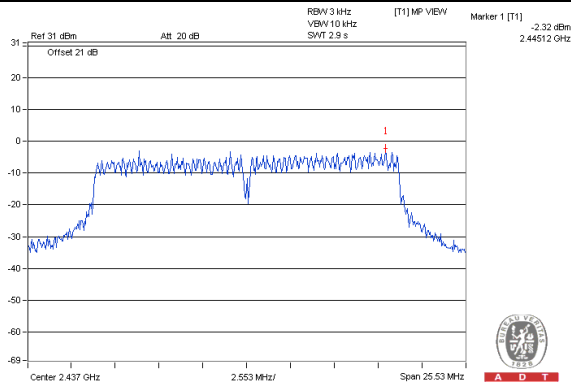

802.11n (HT40) / CH6

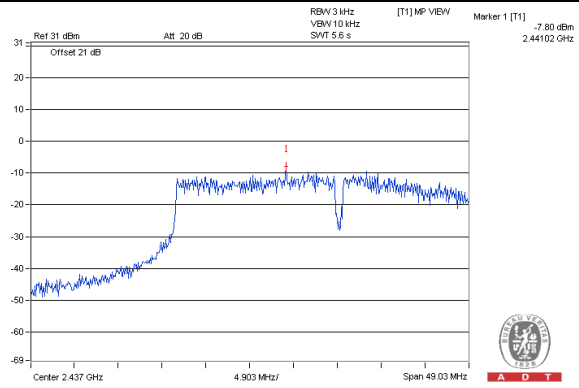



A D T

4.7 CONDUCTED OUT-BAND EMISSION MEASUREMENT

4.7.1 LIMITS OF CONDUCTED OUT-BAND EMISSION MEASUREMENT

Below 20dB of the highest emission level of operating band (in 100kHz Resolution Bandwidth).

4.7.2 TEST INSTRUMENTS

DESCRIPTION & MANUFACTURER	MODEL NO.	SERIAL NO.	CALIBRATED DATE	CALIBRATED UNTIL
Spectrum Analyzer R&S	FSP 40	100036	Jan. 21, 2013	Jan. 20, 2014

Note:

1. The calibration interval of the above test instruments is 12 months and the calibrations are traceable to NML/ROC and NIST/USA.
2. Tested date : Dec. 24, 2013

4.7.3 TEST PROCEDURE

Measurement Procedure - Reference Level

1. Set the RBW = 100 kHz.
2. Set the VBW \geq 300 kHz.
3. Detector = peak.
4. Sweep time = auto couple.
5. Trace mode = max hold.
6. Allow trace to fully stabilize.
7. Use the peak marker function to determine the maximum power level in any 100 kHz band segment within the fundamental EBW.

Measurement Procedure –Unwanted Emission Level

1. Set RBW = 100 kHz.
2. Set VBW \geq 300 kHz.
3. Set span to encompass the spectrum to be examined
4. Detector = peak.
5. Trace Mode = max hold.
6. Sweep = auto couple.

4.7.4 DEVIATION FROM TEST STANDARD

No deviation

4.7.5 TEST SETUP

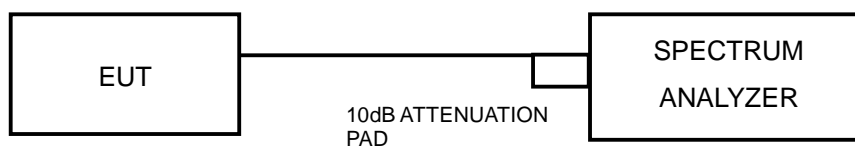

4.7.6 EUT OPERATING CONDITION

Same as Item 4.3.6

4.7.7 TEST RESULTS

The spectrum plots are attached on the following pages. D1 line indicates the highest level, and D2 line indicates the 20dB offset below D1. It shows compliance with the requirement.



A D T

802.11b:

CH 1

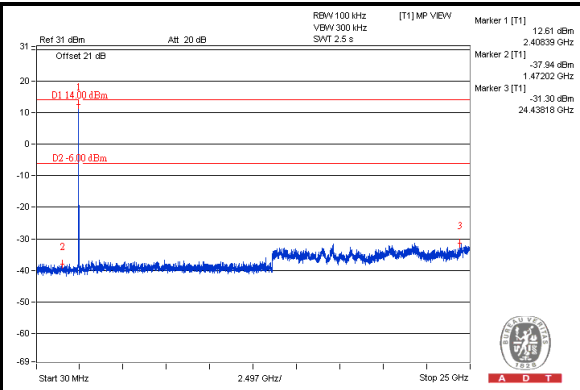
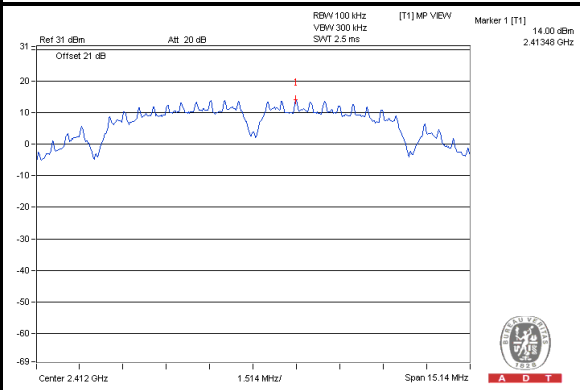

CH 6

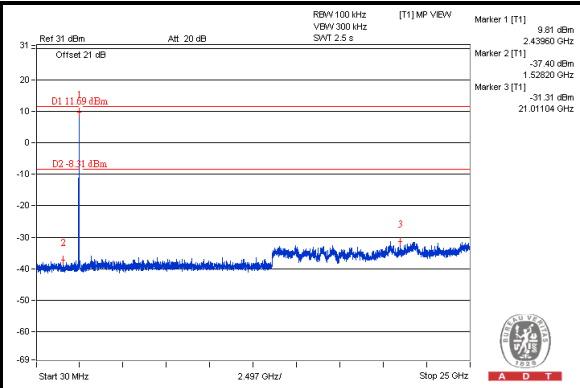
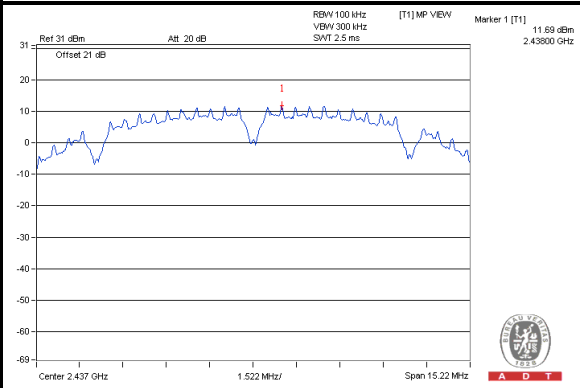

CH 11

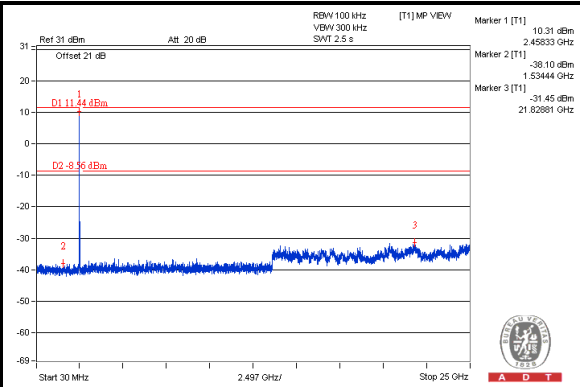
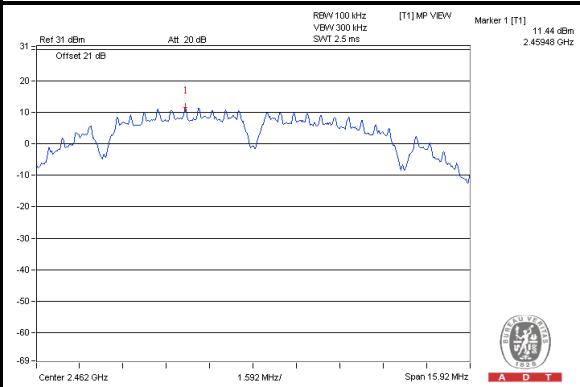

CH 1 Band edge

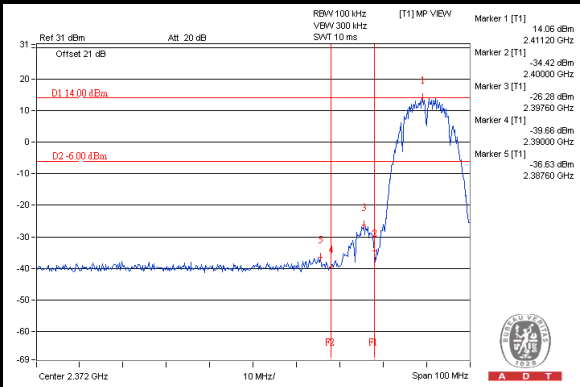

CH 11 Band edge

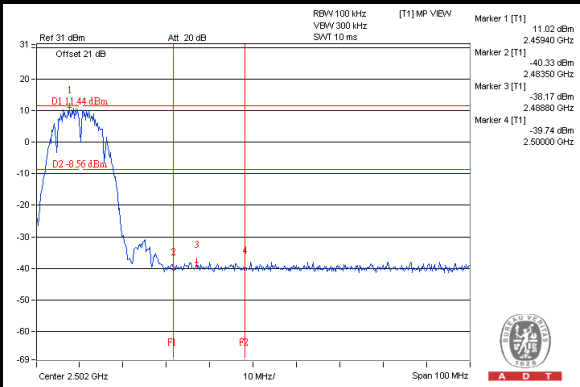



A D T

802.11g:

CH 1

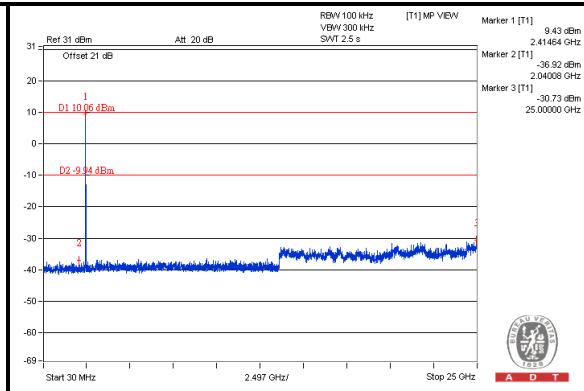
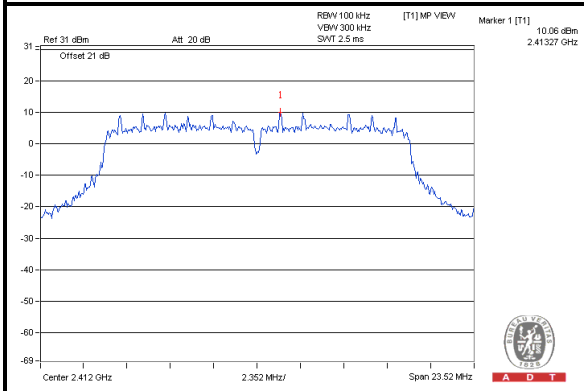

CH 6

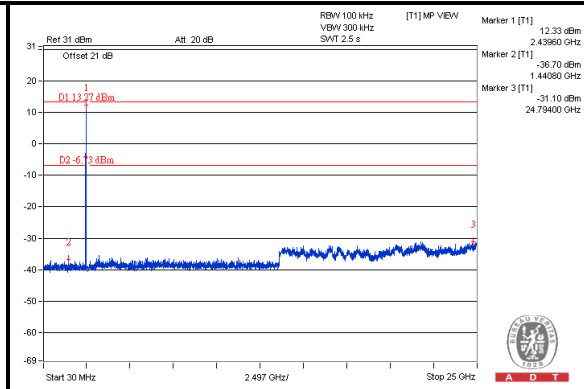
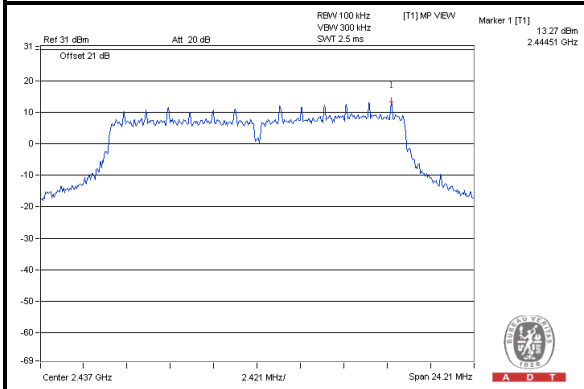

CH 11

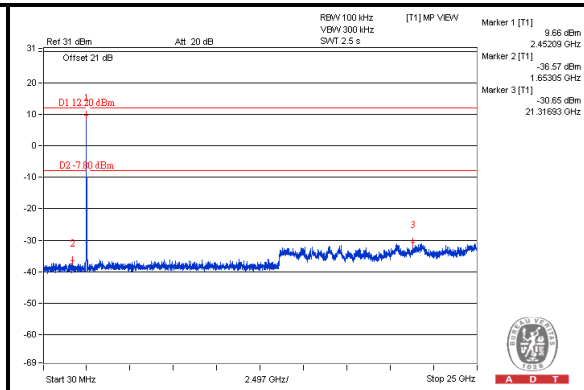
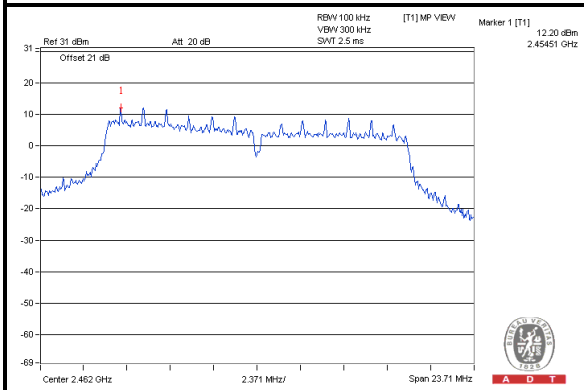

CH 1 Band edge

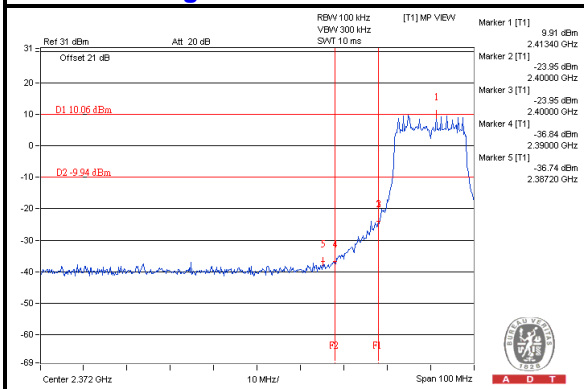

CH 11 Band edge

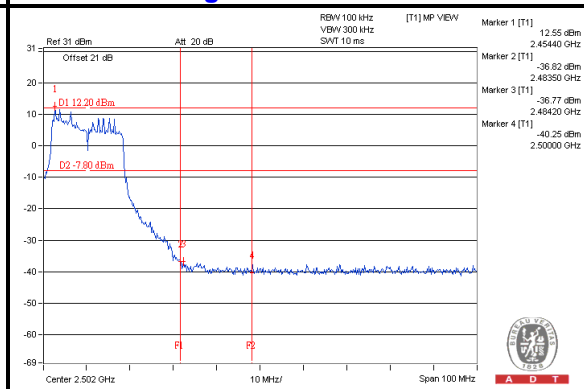



A D T

802.11n (HT20):

CH 1

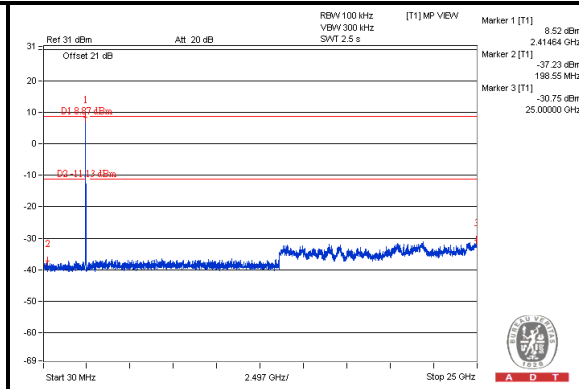
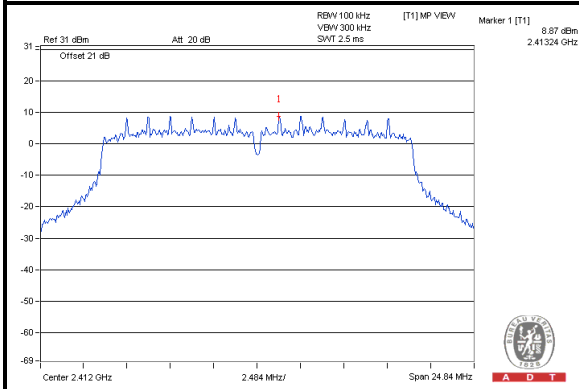

CH 6

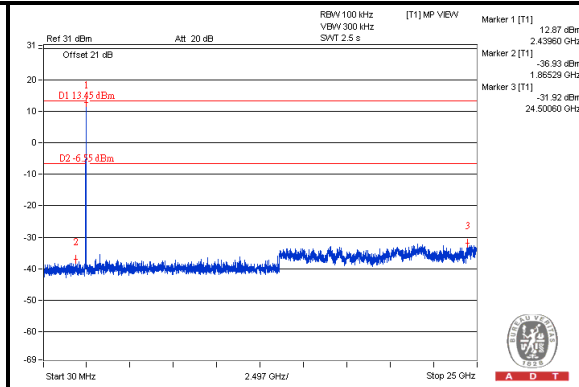
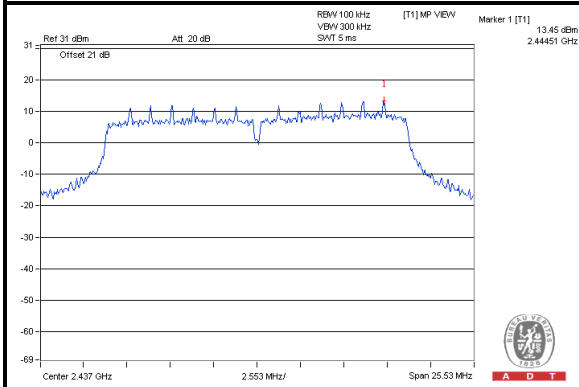

CH 11

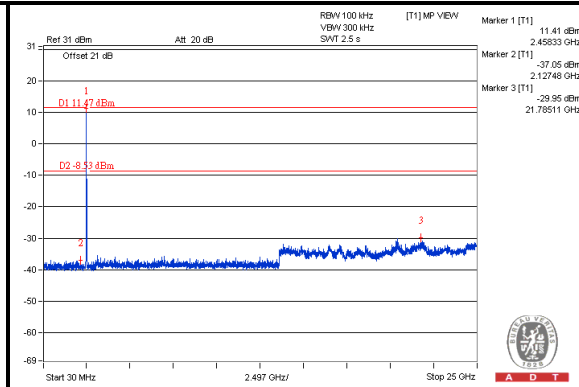
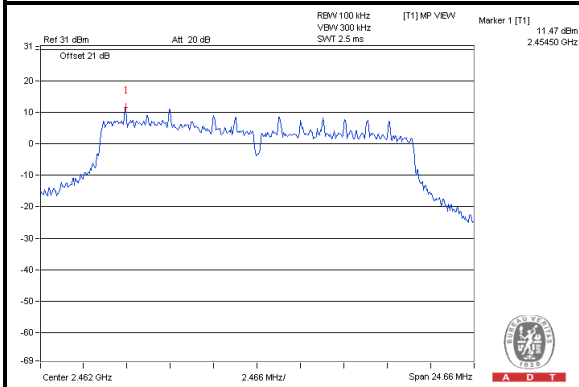

CH 1 Band edge

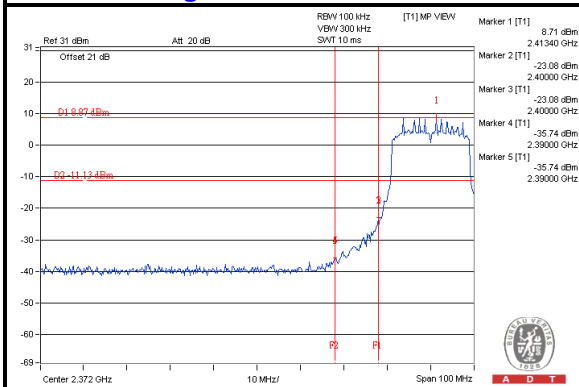

CH 11 Band edge

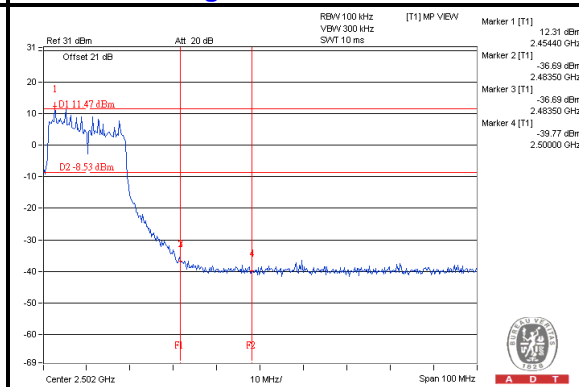



A D T

802.11n (HT40):

CH 3

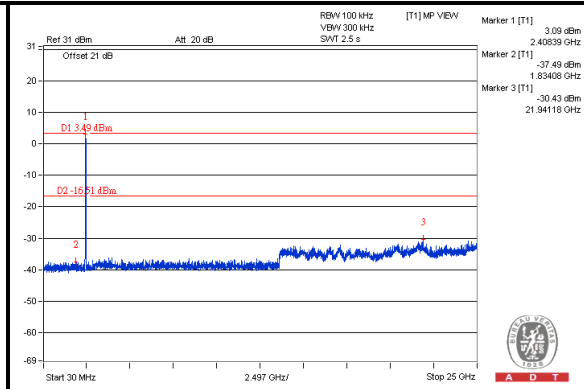
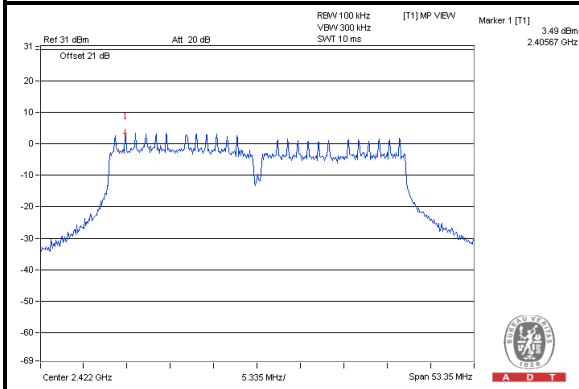

CH 6

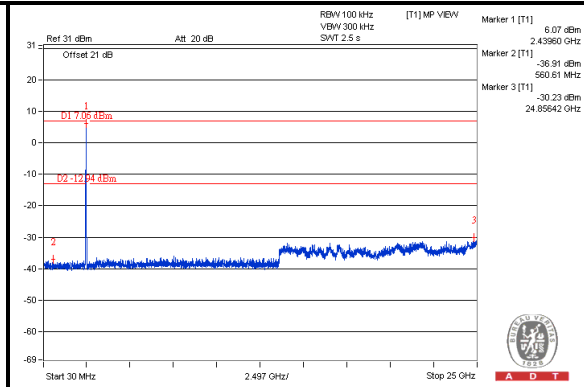
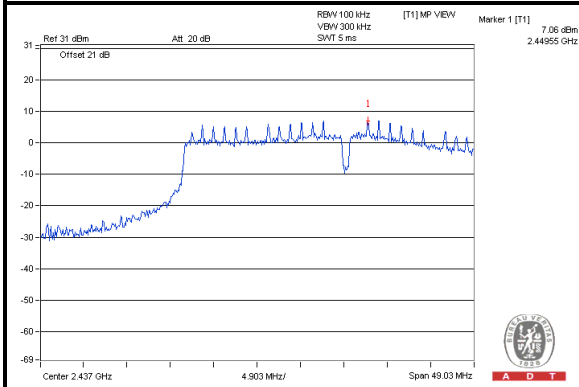

CH 9

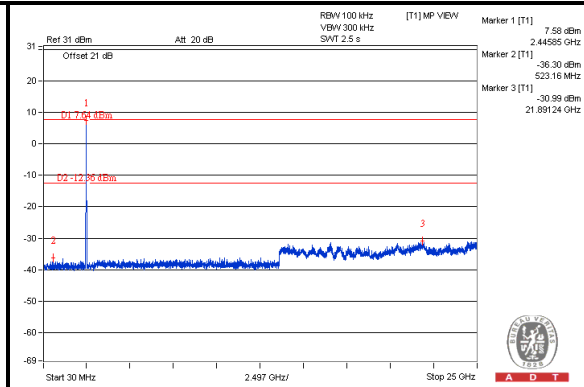
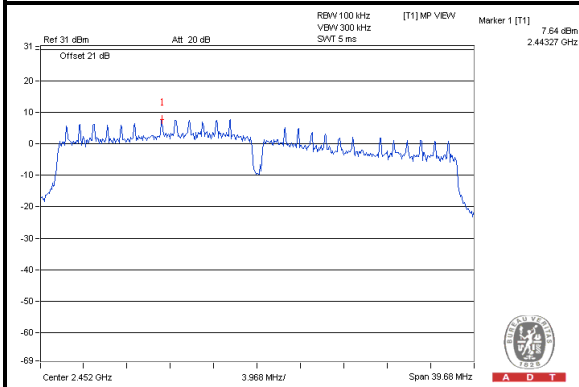

CH 3 Band edge

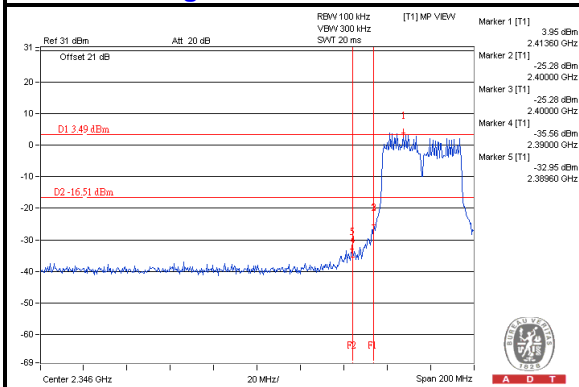

CH 9 Band edge

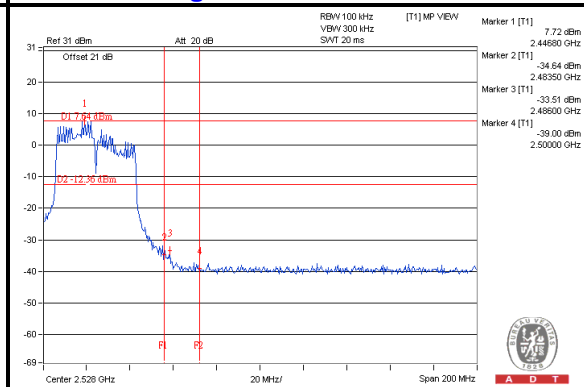



A D T

5. TEST TYPES AND RESULTS (FOR 5GHz, 5.725~5.850GHz Band)

5.1 CONDUCTED EMISSION MEASUREMENT

5.1.1 LIMITS OF CONDUCTED EMISSION MEASUREMENT

FREQUENCY OF EMISSION (MHz)	CONDUCTED LIMIT (dB μ V)	
	Quasi-peak	Average
0.15-0.5	66 to 56	56 to 46
0.5-5	56	46
5-30	60	50

- NOTE:**
1. The lower limit shall apply at the transition frequencies.
 2. The limit decreases in line with the logarithm of the frequency in the range of 0.15 to 0.50 MHz.

5.1.2 TEST INSTRUMENTS

DESCRIPTION & MANUFACTURER	MODEL NO.	SERIAL NO.	CALIBRATED DATE	CALIBRATED UNTIL
Test Receiver	ESCS 30	100375	Mar. 12, 2012	Mar.11, 2013
Line-Impedance Stabilization Network (for EUT) SCHWARZBECK	NSLK8127	8127-522	Sep. 06, 2012	Sep. 05, 2013
Line-Impedance Stabilization Network (for Peripheral)	ENV216	100072	June 08,2012	June 07,2013
RF Cable (JYEBAO)	5DFB	COCCAB-001	Aug. 28, 2012	Aug. 27, 2013
50 ohms Terminator	50	EMC-3	Sep. 25, 2012	Sep. 24, 2013
Software ADT	BV ADT_Cond_V7.3.7.3	NA	NA	NA

Note:

1. The calibration interval of the above test instruments is 12 months and the calibrations are traceable to NML/ROC and NIST/USA.
2. The test was performed in Shielded Room No. C.
3. The VCCI Con C Registration No. is C-3611.
4. Tested Date: Feb. 22, 2013

5.1.3 TEST PROCEDURES

- a. The EUT was placed 0.4 meters from the conducting wall of the shielded room with EUT being connected to the power mains through a line impedance stabilization network (LISN). Other support units were connected to the power mains through another LISN.
- b. The two LISNs provide 50 ohm/ 50uH of coupling impedance for the measuring instrument.
- c. Both lines of the power mains connected to the EUT were checked for maximum conducted interference.
- d. The frequency range from 150kHz to 30MHz was searched. Emission levels under (Limit – 20dB) were not recorded.

NOTE:

1. The resolution bandwidth of test receiver is 9kHz for Quasi-peak detection (QP) & Average detection (AV).

5.1.4 DEVIATION FROM TEST STANDARD

No deviation

5.1.5 TEST SETUP

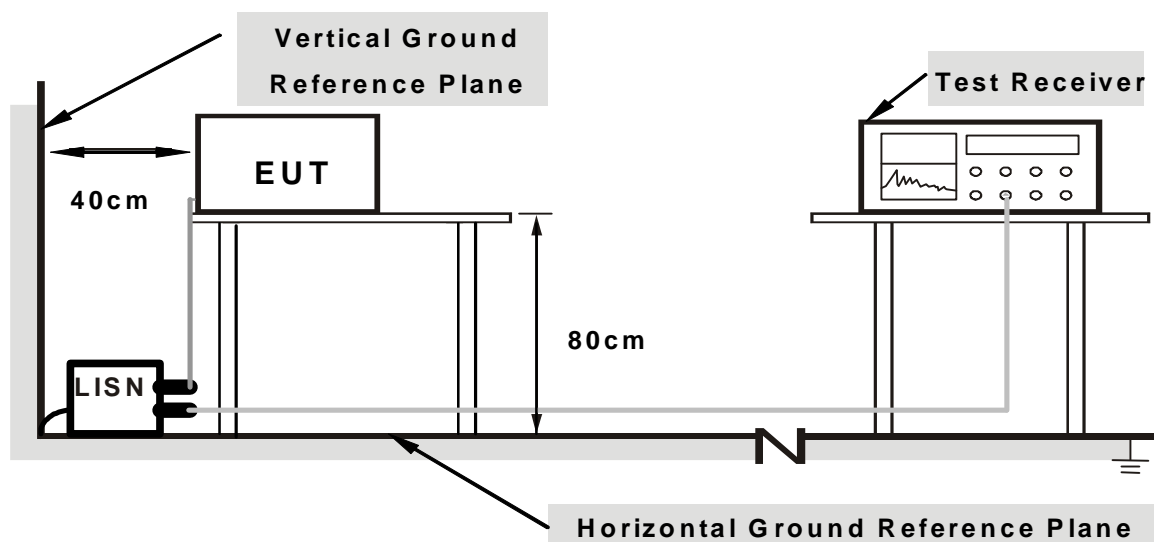

Note: 1.Support units were connected to second LISN.

For the actual test configuration, please refer to the related item – Photographs of the Test Configuration.

5.1.6 EUT OPERATING CONDITIONS

Same as the 4.1.6

5.1.7 TEST RESULTS

PHASE	Line (L)	DETECTOR FUNCTION	Quasi-Peak (QP) / Average (AV)
--------------	----------	--------------------------	--------------------------------

No	Freq. [MHz]	Corr. Factor (dB)	Reading Value [dB (uV)]		Emission Level [dB (uV)]		Limit [dB (uV)]		Margin (dB)	
			Q.P.	AV.	Q.P.	AV.	Q.P.	AV.	Q.P.	AV.
			1	0.15000	0.11	52.99	41.74	53.10	41.85	66.00
2	0.22812	0.14	43.35	33.26	43.49	33.40	62.52	52.52	-19.03	-19.12
3	0.45078	0.18	42.10	36.05	42.28	36.23	56.86	46.86	-14.58	-10.63
4	6.40234	0.51	32.64	27.00	33.15	27.51	60.00	50.00	-26.85	-22.49
5	13.16016	0.93	32.18	27.98	33.11	28.91	60.00	50.00	-26.89	-21.09
6	21.66016	1.35	33.08	31.09	34.43	32.44	60.00	50.00	-25.57	-17.56

REMARKS:

1. Q.P. and AV. are abbreviations of quasi-peak and average individually.
2. The emission levels of other frequencies were very low against the limit.
3. Margin value = Emission Level – Limit value
4. Correction Factor = Insertion loss + Cable loss
5. Emission Level = Correction Factor + Reading Value

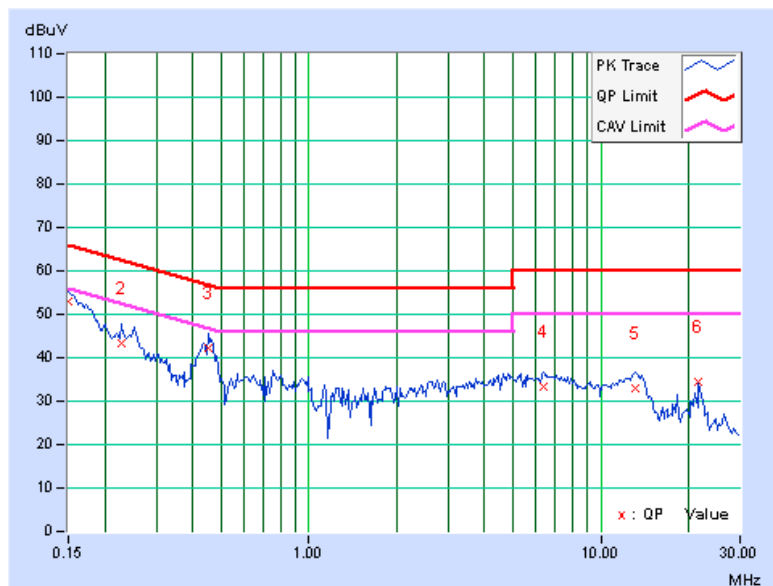

PHASE	Neutral (N)	DETECTOR FUNCTION	Quasi-Peak (QP) / Average (AV)
--------------	-------------	--------------------------	--------------------------------

No	Freq. [MHz]	Corr. Factor (dB)	Reading Value [dB (uV)]		Emission Level [dB (uV)]		Limit [dB (uV)]		Margin (dB)	
			Q.P.	AV.	Q.P.	AV.	Q.P.	AV.	Q.P.	AV.
	1	0.15000	0.09	53.11	42.19	53.20	42.28	66.00	56.00	-12.80
2	0.19687	0.12	44.55	33.00	44.67	33.12	63.74	53.74	-19.07	-20.62
3	0.45097	0.17	42.12	36.33	42.29	36.50	56.86	46.86	-14.56	-10.35
4	1.73438	0.24	30.92	24.18	31.16	24.42	56.00	46.00	-24.84	-21.58
5	5.66406	0.44	31.69	25.06	32.13	25.50	60.00	50.00	-27.87	-24.50
6	21.66406	1.02	35.57	32.76	36.59	33.78	60.00	50.00	-23.41	-16.22

REMARKS:

1. Q.P. and AV. are abbreviations of quasi-peak and average individually.
2. The emission levels of other frequencies were very low against the limit.
3. Margin value = Emission Level – Limit value
4. Correction Factor = Insertion loss + Cable loss
5. Emission Level = Correction Factor + Reading Value

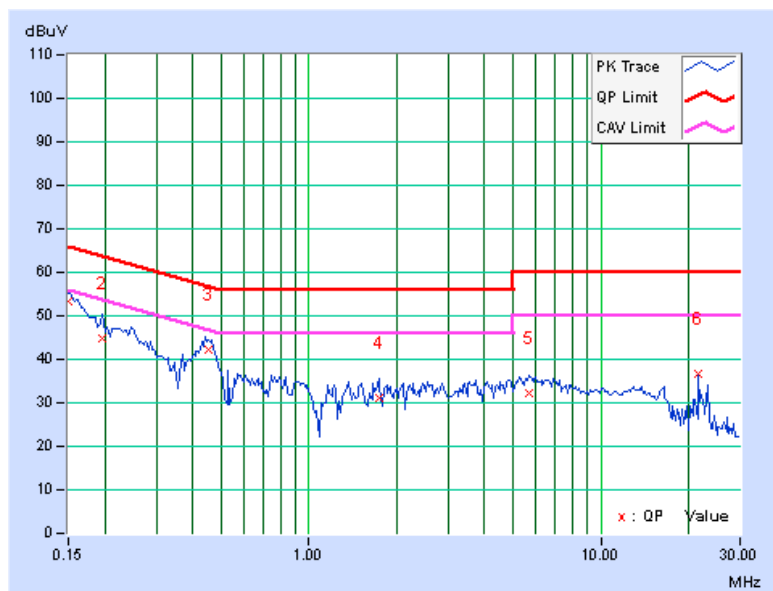



A D T

5.2 RADIATED AND BANDEGE EMISSION MEASUREMENT

5.2.1 LIMITS OF RADIATED AND BANDEGE EMISSION MEASUREMENT

Radiated emissions which fall in the restricted bands must comply with the radiated emission limits specified as below table. Other emissions shall be at least 20dB below the highest level of the desired power:

Frequencies (MHz)	Field strength (microvolts/meter)	Measurement distance (meters)
0.009-0.490	2400/F(kHz)	300
0.490-1.705	24000/F(kHz)	30
1.705-30.0	30	30
30-88	100	3
88-216	150	3
216-960	200	3
Above 960	500	3

NOTE:

1. The lower limit shall apply at the transition frequencies.
2. Emission level (dBuV/m) = 20 log Emission level (uV/m).
3. For frequencies above 1000MHz, the field strength limits are based on average detector, however, the peak field strength of any emission shall not exceed the maximum permitted average limits, specified above by more than 20dB.



A D T

5.2.2 TEST INSTRUMENTS

Below 1GHz test

DESCRIPTION & MANUFACTURER	MODEL NO.	SERIAL NO.	CALIBRATED DATE	CALIBRATED UNTIL
MXE EMI Receiver Agilent	N9038A	MY51210105	Jan. 29,2013	Jan. 28,2014
Pre-Amplifier Mini-Circuits	ZFL-1000VH2 B	AMP-ZFL-03	Nov. 13, 2013	Nov. 12, 2014
Trilog Broadband Antenna SCHWARZBECK	VULB 9168	9168-360	Mar. 19, 2013	Mar. 18, 2014
RF Cable	NA	CHGCAB_001	Oct. 05, 2013	Oct. 04, 2014
Spectrum Analyzer R&S	FSV40	100964	July 15, 2013	July 14, 2014
Horn_Antenna AISI	AIH.8018	000032009111 0	Nov. 18, 2013	Nov. 17, 2014
Pre-Amplifier Agilent	8449B	3008A02578	June 25, 2013	June 24, 2014
RF Cable	NA	RF104-201 RF104-203 RF104-204	Dec. 12, 2013	Dec. 11, 2014
Spectrum Analyzer Agilent	E4446A	MY48250253	Aug. 28, 2013	Aug. 27, 2014
Pre-Amplifier SPACEK LABS	SLKKa-48-6	9K16	Nov. 13, 2013	Nov. 12, 2014
Horn_Antenna SCHWARZBECK	BBHA 9170	9170-424	Oct. 08, 2013	Oct. 07, 2014
Software	ADT_Radiated _V8.7.07	NA	NA	NA
Antenna Tower & Turn Table CT	NA	NA	NA	NA

Note:

1. The calibration interval of the above test instruments is 12 months and the calibrations are traceable to NML/ROC and NIST/USA.
2. The horn antenna, preamplifier (model: 8449B) are used only for the measurement of emission frequency above 1GHz if tested.
- 3 The test was performed in 966 Chamber No. G.
4. The FCC Site Registration No. is 966073.
- 5 The VCCI Site Registration No. is G-137.
- 6 The CANADA Site Registration No. is IC 7450H-2.
- 7 Tested Date: Dec. 26, 2013



A D T

Above 1GHz test

DESCRIPTION & MANUFACTURER	MODEL NO.	SERIAL NO.	CALIBRATED DATE	CALIBRATED UNTIL
MXE EMI Receiver Agilent	N9038A	MY50010156	Jan. 16, 2013	Jan. 15, 2014
Pre-Amplifier Mini-Circuits	ZFL-1000VH2 B	AMP-ZFL-04	Nov. 13, 2013	Nov. 12, 2014
Trilog Broadband Antenna SCHWARZBECK	VULB 9168	9168-361	Mar. 25, 2013	Mar. 24, 2014
RF Cable	NA	CHHCAB_001	Oct. 06, 2013	Oct. 05, 2014
Horn_Antenna AISI	AIH.8018	0000220091110	Dec. 06, 2013	Dec. 05, 2014
Pre-Amplifier Agilent	8449B	3008A01923	Oct. 29, 2013	Oct. 28, 2014
RF Cable	NA	RF104-205 RF104-207 RF104-202	Dec. 26, 2012	Dec. 25, 2013
Spectrum Analyzer Agilent	E4446A	MY48250253	Aug. 28, 2013	Aug. 27, 2014
Pre-Amplifier SPACEK LABS	SLKka-48-6	9K16	Nov. 13, 2013	Nov. 12, 2014
Horn_Antenna SCHWARZBECK	BBHA 9170	9170-424	Oct. 08, 2013	Oct. 07, 2014
Software	ADT_Radiated _V8.7.07	NA	NA	NA
Antenna Tower & Turn Table CT	NA	NA	NA	NA

Note:

1. The calibration interval of the above test instruments is 12 months and the calibrations are traceable to NML/ROC and NIST/USA.
2. The horn antenna, preamplifier (model: 8449B) are used only for the measurement of emission frequency above 1GHz if tested.
- 3 The test was performed in 966 Chamber No. H.
4. The FCC Site Registration No. is 797305.
- 5 The CANADA Site Registration No. is IC 7450H-3.
- 6 Tested Date: Dec. 21, 2013

5.2.3 TEST PROCEDURES

- a. The EUT was placed on the top of a rotating table 0.8 meters above the ground at 3 meter chamber room for test. The table was rotated 360 degrees to determine the position of the highest radiation.
- b. The EUT was set 3 meters away from the interference-receiving antenna, which was mounted on the top of a variable-height antenna tower.
- c. The height of antenna is varied from one meter to four meters above the ground to determine the maximum value of the field strength. Both horizontal and vertical polarizations of the antenna are set to make the measurement.
- d. For each suspected emission, the EUT was arranged to its worst case and then the antenna was tuned to heights from 1 meter to 4 meters and the rotatable table was turned from 0 degrees to 360 degrees to find the maximum reading.
- e. The test-receiver system was set to quasi-peak detect function and specified bandwidth with maximum hold mode when the test frequency is below 1 GHz.
- f. The test-receiver system was set to peak and average detect function and specified bandwidth with maximum hold mode when the test frequency is above 1 GHz. If the peak reading value also meets average limit, measurement with the average detector is unnecessary.

NOTE:

1. The resolution bandwidth and video bandwidth of test receiver/spectrum analyzer is 120kHz for Quasi-peak detection (QP) at frequency below 1GHz.
2. The resolution bandwidth of test receiver/spectrum analyzer is 1 MHz and the video bandwidth is 3 MHz for Peak detection (PK) at frequency above 1GHz.
3. The resolution bandwidth of test receiver/spectrum analyzer is 1 MHz and the video bandwidth is 10 Hz for Average detection (AV) at frequency above 1GHz.
4. All modes of operation were investigated and the worst-case emissions are reported.

5.2.4 DEVIATION FROM TEST STANDARD

No deviation

5.2.5 TEST SETUP

<Frequency Range below 1GHz>

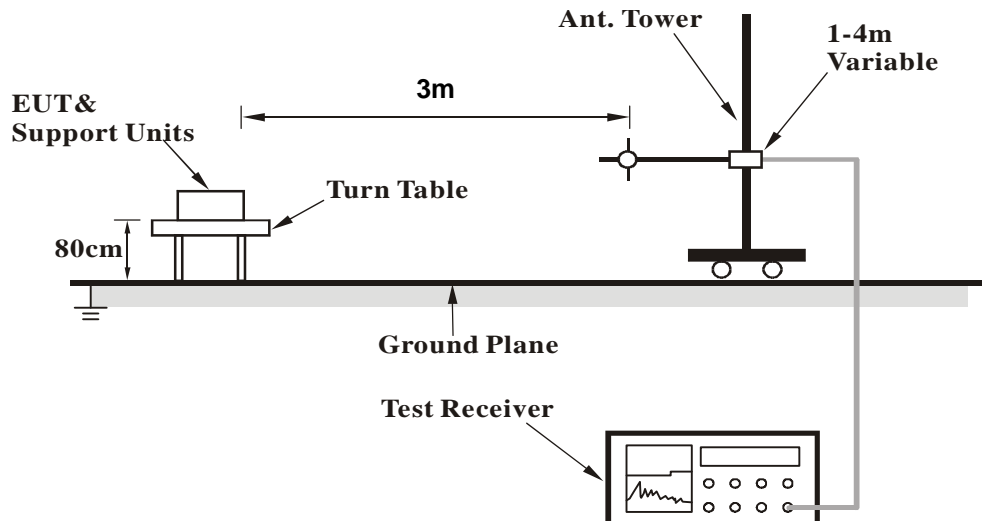

<Frequency Range above 1GHz>

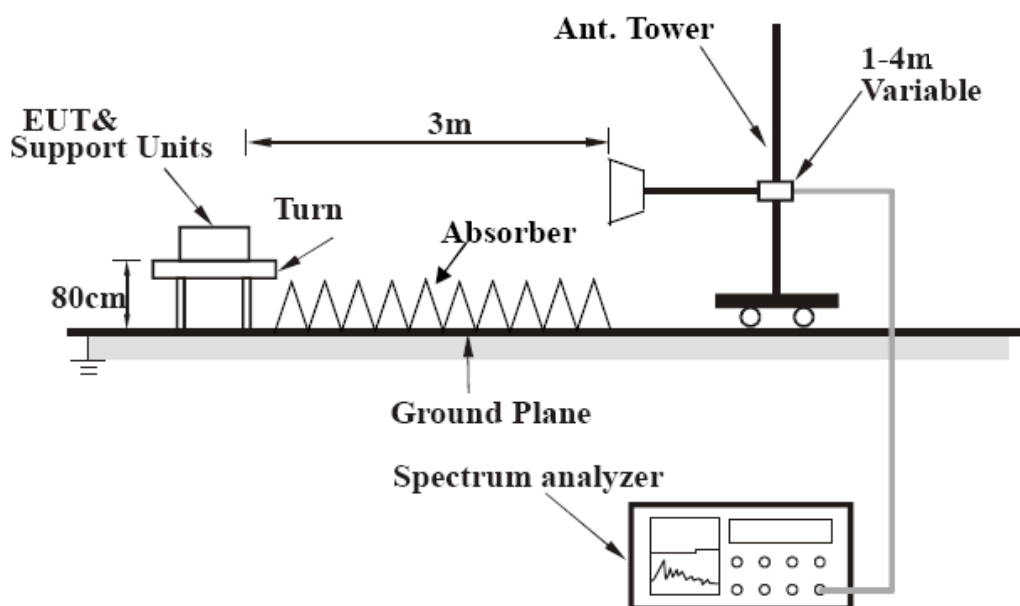

For the actual test configuration, please refer to the related item – Photographs of the Test Configuration.

5.2.6 EUT OPERATING CONDITIONS

Same as the 4.1.6



A D T

5.2.7 TEST RESULTS

BELOW 1GHz WORST-CASE DATA

802.11a

CHANNEL	TX Channel 165	DETECTOR FUNCTION	Quasi-Peak (QP)
FREQUENCY RANGE	Below 1GHz		

ANTENNA POLARITY & TEST DISTANCE: HORIZONTAL AT 3 M

NO.	FREQ. (MHz)	EMISSION LEVEL (dBuV/m)	LIMIT (dBuV/m)	MARGIN (dB)	ANTENNA HEIGHT (m)	TABLE ANGLE (Degree)	RAW VALUE (dBuV)	CORRECTION FACTOR (dB/m)
1	101.88	29.4 QP	43.5	-14.1	2.00 H	281	47.01	-17.64
2	225.07	39.2 QP	46.0	-6.8	2.00 H	124	55.53	-16.33
3	311.64	36.6 QP	46.0	-9.4	1.00 H	6	48.65	-12.03
4	396.03	39.2 QP	46.0	-6.8	2.00 H	246	49.16	-9.98
5	450.01	38.9 QP	46.0	-7.1	2.00 H	236	47.41	-8.54
6	675.00	39.3 QP	46.0	-6.7	1.00 H	102	43.29	-3.97

ANTENNA POLARITY & TEST DISTANCE: VERTICAL AT 3 M

NO.	FREQ. (MHz)	EMISSION LEVEL (dBuV/m)	LIMIT (dBuV/m)	MARGIN (dB)	ANTENNA HEIGHT (m)	TABLE ANGLE (Degree)	RAW VALUE (dBuV)	CORRECTION FACTOR (dB/m)
1	73.17	33.3 QP	40.0	-6.7	1.00 V	360	49.60	-16.28
2	115.41	29.7 QP	43.5	-13.8	1.00 V	275	45.40	-15.67
3	225.02	32.6 QP	46.0	-13.4	1.50 V	89	48.97	-16.33
4	389.77	34.7 QP	46.0	-11.4	1.00 V	360	44.72	-10.07
5	450.01	37.9 QP	46.0	-8.2	1.00 V	242	46.39	-8.54
6	675.05	35.1 QP	46.0	-10.9	1.50 V	150	39.09	-3.97

REMARKS:

1. Emission Level(dBuV/m) = Raw Value(dBuV) + Correction Factor(dB/m)
2. Correction Factor(dB/m) = Antenna Factor(dB/m) + Cable Factor(dB) – Pre-Amplifier Factor(dB)
3. The other emission levels were very low against the limit.
4. Margin value = Emission Level – Limit value



ABOVE 1GHz DATA

802.11a

CHANNEL	TX Channel 149	DETECTOR FUNCTION	Peak (PK)
FREQUENCY RANGE	1GHz ~ 40GHz		Average (AV)

ANTENNA POLARITY & TEST DISTANCE: HORIZONTAL AT 3 M								
NO.	FREQ. (MHz)	EMISSION LEVEL (dBuV/m)	LIMIT (dBuV/m)	MARGIN (dB)	ANTENNA HEIGHT (m)	TABLE ANGLE (Degree)	RAW VALUE (dBuV)	CORRECTION FACTOR (dB/m)
1	5460.00	55.7 PK	74.0	-18.3	1.00 H	294	11.62	44.08
2	5460.00	44.3 AV	54.0	-9.7	1.00 H	294	0.22	44.08
3	*5745.00	103.5 PK			1.27 H	341	59.02	44.48
4	*5745.00	92.6 AV			1.27 H	341	48.12	44.48
5	11490.00	64.1 PK	74.0	-9.9	1.26 H	48	12.48	51.62
6	11490.00	53.2 AV	54.0	-0.8	1.26 H	48	1.58	51.62

ANTENNA POLARITY & TEST DISTANCE: VERTICAL AT 3 M								
NO.	FREQ. (MHz)	EMISSION LEVEL (dBuV/m)	LIMIT (dBuV/m)	MARGIN (dB)	ANTENNA HEIGHT (m)	TABLE ANGLE (Degree)	RAW VALUE (dBuV)	CORRECTION FACTOR (dB/m)
1	5460.00	55.6 PK	74.0	-18.4	1.00 V	27	11.52	44.08
2	5460.00	44.3 AV	54.0	-9.7	1.00 V	27	0.22	44.08
3	*5745.00	99.7 PK			1.19 V	311	55.22	44.48
4	*5745.00	89.1 AV			1.19 V	311	44.62	44.48
5	11490.00	54.3 PK	74.0	-19.7	1.00 V	245	2.68	51.62
6	11490.00	42.3 AV	54.0	-11.7	1.00 V	245	-9.32	51.62

REMARKS:

1. Emission Level(dBuV/m) = Raw Value(dBuV) + Correction Factor(dB/m)
2. Correction Factor(dB/m) = Antenna Factor(dB/m) + Cable Factor(dB) – Pre-Amplifier Factor(dB)
3. The other emission levels were very low against the limit.
4. Margin value = Emission Level – Limit value
5. " * ": Fundamental frequency.
6. The limit value is defined as per 15.247.

CHANNEL	TX Channel 157	DETECTOR FUNCTION	Peak (PK)
FREQUENCY RANGE	1GHz ~ 40GHz		Average (AV)

ANTENNA POLARITY & TEST DISTANCE: HORIZONTAL AT 3 M

NO.	FREQ. (MHz)	EMISSION LEVEL (dBuV/m)	LIMIT (dBuV/m)	MARGIN (dB)	ANTENNA HEIGHT (m)	TABLE ANGLE (Degree)	RAW VALUE (dBuV)	CORRECTION FACTOR (dB/m)
1	*5785.00	104.0 PK			1.28 H	340	59.48	44.52
2	*5785.00	93.5 AV			1.28 H	340	48.98	44.52
3	11570.00	66.3 PK	74.0	-7.7	1.26 H	52	14.81	51.49
4	11570.00	53.8 AV	54.0	-0.2	1.26 H	52	2.31	51.49

ANTENNA POLARITY & TEST DISTANCE: VERTICAL AT 3 M

NO.	FREQ. (MHz)	EMISSION LEVEL (dBuV/m)	LIMIT (dBuV/m)	MARGIN (dB)	ANTENNA HEIGHT (m)	TABLE ANGLE (Degree)	RAW VALUE (dBuV)	CORRECTION FACTOR (dB/m)
1	*5785.00	99.1 PK			1.24 V	287	54.58	44.52
2	*5785.00	89.0 AV			1.24 V	287	44.48	44.52
3	11570.00	54.9 PK	74.0	-19.1	1.06 V	250	3.41	51.49
4	11570.00	42.7 AV	54.0	-11.3	1.06 V	250	-8.79	51.49

REMARKS:

1. Emission Level(dBuV/m) = Raw Value(dBuV) + Correction Factor(dB/m)
2. Correction Factor(dB/m) = Antenna Factor(dB/m) + Cable Factor(dB) – Pre-Amplifier Factor(dB)
3. The other emission levels were very low against the limit.
4. Margin value = Emission Level – Limit value
5. " * ": Fundamental frequency.
6. The limit value is defined as per 15.247.

CHANNEL	TX Channel 165	DETECTOR FUNCTION	Peak (PK)
FREQUENCY RANGE	1GHz ~ 40GHz		Average (AV)

ANTENNA POLARITY & TEST DISTANCE: HORIZONTAL AT 3 M

NO.	FREQ. (MHz)	EMISSION LEVEL (dBuV/m)	LIMIT (dBuV/m)	MARGIN (dB)	ANTENNA HEIGHT (m)	TABLE ANGLE (Degree)	RAW VALUE (dBuV)	CORRECTION FACTOR (dB/m)
1	*5825.00	105.2 PK			1.24 H	338	60.61	44.59
2	*5825.00	93.4 AV			1.24 H	338	48.81	44.59
3	11650.00	66.4 PK	74.0	-7.6	1.27 H	50	14.99	51.41
4	11650.00	53.5 AV	54.0	-0.5	1.27 H	50	2.09	51.41

ANTENNA POLARITY & TEST DISTANCE: VERTICAL AT 3 M

NO.	FREQ. (MHz)	EMISSION LEVEL (dBuV/m)	LIMIT (dBuV/m)	MARGIN (dB)	ANTENNA HEIGHT (m)	TABLE ANGLE (Degree)	RAW VALUE (dBuV)	CORRECTION FACTOR (dB/m)
1	*5825.00	99.2 PK			1.25 V	297	54.61	44.59
2	*5825.00	88.9 AV			1.25 V	297	44.31	44.59
3	11650.00	55.0 PK	74.0	-19.0	1.11 V	240	3.59	51.41
4	11650.00	42.9 AV	54.0	-11.1	1.11 V	240	-8.51	51.41

REMARKS:

1. Emission Level(dBuV/m) = Raw Value(dBuV) + Correction Factor(dB/m)
2. Correction Factor(dB/m) = Antenna Factor(dB/m) + Cable Factor(dB) – Pre-Amplifier Factor(dB)
3. The other emission levels were very low against the limit.
4. Margin value = Emission Level – Limit value
5. " * ": Fundamental frequency.
6. The limit value is defined as per 15.247.



A D T

802.11n (HT20)

CHANNEL	TX Channel 149	DETECTOR FUNCTION	Peak (PK)
FREQUENCY RANGE	1GHz ~ 40GHz		Average (AV)

ANTENNA POLARITY & TEST DISTANCE: HORIZONTAL AT 3 M								
NO.	FREQ. (MHz)	EMISSION LEVEL (dBuV/m)	LIMIT (dBuV/m)	MARGIN (dB)	ANTENNA HEIGHT (m)	TABLE ANGLE (Degree)	RAW VALUE (dBuV)	CORRECTION FACTOR (dB/m)
1	*5745.00	103.7 PK			1.26 H	328	59.22	44.48
2	*5745.00	92.5 AV			1.26 H	328	48.02	44.48
3	11490.00	63.9 PK	74.0	-10.1	1.26 H	47	12.28	51.62
4	11490.00	53.2 AV	54.0	-0.8	1.26 H	47	1.58	51.62
ANTENNA POLARITY & TEST DISTANCE: VERTICAL AT 3 M								
NO.	FREQ. (MHz)	EMISSION LEVEL (dBuV/m)	LIMIT (dBuV/m)	MARGIN (dB)	ANTENNA HEIGHT (m)	TABLE ANGLE (Degree)	RAW VALUE (dBuV)	CORRECTION FACTOR (dB/m)
1	*5745.00	99.9 PK			1.23 V	324	55.42	44.48
2	*5745.00	89.3 AV			1.23 V	324	44.82	44.48
3	11490.00	54.6 PK	74.0	-19.4	1.00 V	256	2.98	51.62
4	11490.00	42.4 AV	54.0	-11.6	1.00 V	256	-9.22	51.62

REMARKS:

1. Emission Level(dBuV/m) = Raw Value(dBuV) + Correction Factor(dB/m)
2. Correction Factor(dB/m) = Antenna Factor(dB/m) + Cable Factor(dB) – Pre-Amplifier Factor(dB)
3. The other emission levels were very low against the limit.
4. Margin value = Emission Level – Limit value
5. " * ": Fundamental frequency.
6. The limit value is defined as per 15.247.



A D T

CHANNEL	TX Channel 157	DETECTOR FUNCTION	Peak (PK)
FREQUENCY RANGE	1GHz ~ 40GHz		Average (AV)

ANTENNA POLARITY & TEST DISTANCE: HORIZONTAL AT 3 M

NO.	FREQ. (MHz)	EMISSION LEVEL (dBuV/m)	LIMIT (dBuV/m)	MARGIN (dB)	ANTENNA HEIGHT (m)	TABLE ANGLE (Degree)	RAW VALUE (dBuV)	CORRECTION FACTOR (dB/m)
1	*5785.00	104.2 PK			1.26 H	350	59.68	44.52
2	*5785.00	93.8 AV			1.26 H	350	49.28	44.52
3	11570.00	66.3 PK	74.0	-7.7	1.24 H	48	14.81	51.49
4	11570.00	53.7 AV	54.0	-0.3	1.24 H	48	2.21	51.49

ANTENNA POLARITY & TEST DISTANCE: VERTICAL AT 3 M

NO.	FREQ. (MHz)	EMISSION LEVEL (dBuV/m)	LIMIT (dBuV/m)	MARGIN (dB)	ANTENNA HEIGHT (m)	TABLE ANGLE (Degree)	RAW VALUE (dBuV)	CORRECTION FACTOR (dB/m)
1	*5785.00	99.5 PK			1.21 V	271	54.98	44.52
2	*5785.00	89.5 AV			1.21 V	271	44.98	44.52
3	11570.00	55.4 PK	74.0	-18.6	1.03 V	253	3.91	51.49
4	11570.00	42.9 AV	54.0	-11.1	1.03 V	253	-8.59	51.49

REMARKS:

1. Emission Level(dBuV/m) = Raw Value(dBuV) + Correction Factor(dB/m)
2. Correction Factor(dB/m) = Antenna Factor(dB/m) + Cable Factor(dB) – Pre-Amplifier Factor(dB)
3. The other emission levels were very low against the limit.
4. Margin value = Emission Level – Limit value
5. " * ": Fundamental frequency.
6. The limit value is defined as per 15.247.



A D T

CHANNEL	TX Channel 165	DETECTOR FUNCTION	Peak (PK)
FREQUENCY RANGE	1GHz ~ 40GHz		Average (AV)

ANTENNA POLARITY & TEST DISTANCE: HORIZONTAL AT 3 M

NO.	FREQ. (MHz)	EMISSION LEVEL (dBuV/m)	LIMIT (dBuV/m)	MARGIN (dB)	ANTENNA HEIGHT (m)	TABLE ANGLE (Degree)	RAW VALUE (dBuV)	CORRECTION FACTOR (dB/m)
1	*5825.00	105.1 PK			1.23 H	349	60.51	44.59
2	*5825.00	93.1 AV			1.23 H	349	48.51	44.59
3	11650.00	66.6 PK	74.0	-7.4	1.26 H	48	15.19	51.41
4	11650.00	53.6 AV	54.0	-0.4	1.26 H	48	2.19	51.41

ANTENNA POLARITY & TEST DISTANCE: VERTICAL AT 3 M

NO.	FREQ. (MHz)	EMISSION LEVEL (dBuV/m)	LIMIT (dBuV/m)	MARGIN (dB)	ANTENNA HEIGHT (m)	TABLE ANGLE (Degree)	RAW VALUE (dBuV)	CORRECTION FACTOR (dB/m)
1	*5825.00	98.8 PK			1.27 V	289	54.21	44.59
2	*5825.00	88.4 AV			1.27 V	289	43.81	44.59
3	11650.00	55.2 PK	74.0	-18.8	1.05 V	234	3.79	51.41
4	11650.00	42.9 AV	54.0	-11.1	1.05 V	234	-8.51	51.41

REMARKS:

1. Emission Level(dBuV/m) = Raw Value(dBuV) + Correction Factor(dB/m)
2. Correction Factor(dB/m) = Antenna Factor(dB/m) + Cable Factor(dB) – Pre-Amplifier Factor(dB)
3. The other emission levels were very low against the limit.
4. Margin value = Emission Level – Limit value
5. " * ": Fundamental frequency.
6. The limit value is defined as per 15.247.

802.11n (HT40)

CHANNEL	TX Channel 151	DETECTOR FUNCTION	Peak (PK)
FREQUENCY RANGE	1GHz ~ 40GHz		Average (AV)

ANTENNA POLARITY & TEST DISTANCE: HORIZONTAL AT 3 M								
NO.	FREQ. (MHz)	EMISSION LEVEL (dBuV/m)	LIMIT (dBuV/m)	MARGIN (dB)	ANTENNA HEIGHT (m)	TABLE ANGLE (Degree)	RAW VALUE (dBuV)	CORRECTION FACTOR (dB/m)
1	*5755.00	101.8 PK			1.37 H	338	57.31	44.49
2	*5755.00	92.0 AV			1.37 H	338	47.51	44.49
3	11510.00	66.2 PK	74.0	-7.8	1.25 H	48	14.59	51.61
4	11510.00	53.6 AV	54.0	-0.4	1.25 H	48	1.99	51.61
ANTENNA POLARITY & TEST DISTANCE: VERTICAL AT 3 M								
NO.	FREQ. (MHz)	EMISSION LEVEL (dBuV/m)	LIMIT (dBuV/m)	MARGIN (dB)	ANTENNA HEIGHT (m)	TABLE ANGLE (Degree)	RAW VALUE (dBuV)	CORRECTION FACTOR (dB/m)
1	*5755.00	96.8 PK			1.27 V	296	52.31	44.49
2	*5755.00	87.1 AV			1.27 V	296	42.61	44.49
3	11510.00	61.2 PK	74.0	-12.8	1.00 V	242	9.59	51.61
4	11510.00	48.6 AV	54.0	-5.4	1.00 V	242	-3.01	51.61

REMARKS:

1. Emission Level(dBuV/m) = Raw Value(dBuV) + Correction Factor(dB/m)
2. Correction Factor(dB/m) = Antenna Factor(dB/m) + Cable Factor(dB) – Pre-Amplifier Factor(dB)
3. The other emission levels were very low against the limit.
4. Margin value = Emission Level – Limit value
5. " * ": Fundamental frequency.
6. The limit value is defined as per 15.247.



A D T

CHANNEL	TX Channel 159	DETECTOR FUNCTION	Peak (PK)
FREQUENCY RANGE	1GHz ~ 40GHz		Average (AV)

ANTENNA POLARITY & TEST DISTANCE: HORIZONTAL AT 3 M

NO.	FREQ. (MHz)	EMISSION LEVEL (dBuV/m)	LIMIT (dBuV/m)	MARGIN (dB)	ANTENNA HEIGHT (m)	TABLE ANGLE (Degree)	RAW VALUE (dBuV)	CORRECTION FACTOR (dB/m)
1	*5795.00	103.5 PK			1.03 H	335	58.96	44.54
2	*5795.00	92.5 AV			1.03 H	335	47.96	44.54
3	11590.00	63.3 PK	74.0	-10.7	1.26 H	50	11.86	51.44
4	11590.00	53.5 AV	54.0	-0.5	1.26 H	50	2.06	51.44

ANTENNA POLARITY & TEST DISTANCE: VERTICAL AT 3 M

NO.	FREQ. (MHz)	EMISSION LEVEL (dBuV/m)	LIMIT (dBuV/m)	MARGIN (dB)	ANTENNA HEIGHT (m)	TABLE ANGLE (Degree)	RAW VALUE (dBuV)	CORRECTION FACTOR (dB/m)
1	*5795.00	99.2 PK			1.33 V	297	54.66	44.54
2	*5795.00	88.0 AV			1.33 V	297	43.46	44.54
3	11590.00	55.2 PK	74.0	-18.8	1.00 V	338	3.76	51.44
4	11590.00	42.1 AV	54.0	-11.9	1.00 V	338	-9.34	51.44

REMARKS:

1. Emission Level(dBuV/m) = Raw Value(dBuV) + Correction Factor(dB/m)
2. Correction Factor(dB/m) = Antenna Factor(dB/m) + Cable Factor(dB) – Pre-Amplifier Factor(dB)
3. The other emission levels were very low against the limit.
4. Margin value = Emission Level – Limit value
5. " * ": Fundamental frequency.
6. The limit value is defined as per 15.247.

5.3 6dB BANDWIDTH MEASUREMENT

5.3.1 LIMITS OF 6dB BANDWIDTH MEASUREMENT

The minimum of 6dB Bandwidth Measurement is 0.5 MHz.

5.3.2 TEST INSTRUMENTS

DESCRIPTION & MANUFACTURER	MODEL NO.	SERIAL NO.	CALIBRATED DATE	CALIBRATED UNTIL
Spectrum Analyzer R&S	FSP 40	100036	Jan. 21, 2013	Jan. 20, 2014

Note:

1. The calibration interval of the above test instruments is 12 months and the calibrations are traceable to NML/ROC and NIST/USA.
2. Tested date : Dec. 24, 2013

5.3.3 TEST PROCEDURE

1. Set resolution bandwidth (RBW) = 100kHz
2. Set the video bandwidth (VBW) $\geq 3 \times$ RBW, Detector = Peak.
3. Trace mode = max hold.
4. Sweep = auto couple.
5. Measure the maximum width of the emission that is constrained by the frequencies associated with the two amplitude points (upper and lower) that are attenuated by 6 dB relative to the maximum level measured in the fundamental emission

5.3.4 DEVIATION FROM TEST STANDARD

No deviation

5.3.5 TEST SETUP

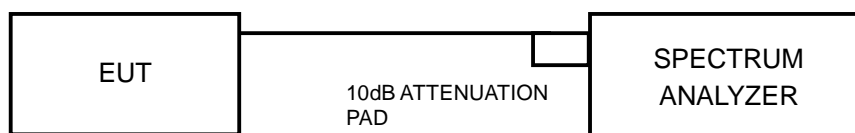

5.3.6 EUT OPERATING CONDITIONS

The software provided by client to enable the EUT under transmission condition continuously at lowest, middle and highest channel frequencies individually.



A D T

5.3.7 TEST RESULTS

802.11a

CHANNEL	FREQUENCY (MHz)	6dB BANDWIDTH (MHz)	MINIMUM LIMIT (MHz)	PASS / FAIL
149	5745	16.10	0.5	PASS
157	5785	16.12	0.5	PASS
165	5825	16.13	0.5	PASS

802.11n (HT20)

CHANNEL	FREQUENCY (MHz)	6dB BANDWIDTH (MHz)	MINIMUM LIMIT (MHz)	PASS / FAIL
149	5745	16.94	0.5	PASS
157	5785	16.96	0.5	PASS
165	5825	16.05	0.5	PASS

802.11n (HT40)

CHANNEL	FREQUENCY (MHz)	6dB BANDWIDTH (MHz)	MINIMUM LIMIT (MHz)	PASS / FAIL
151	5755	35.29	0.5	PASS
159	5795	35.59	0.5	PASS



A D T

SPECTRUM PLOT OF WORST VALUE

802.11a / CH149

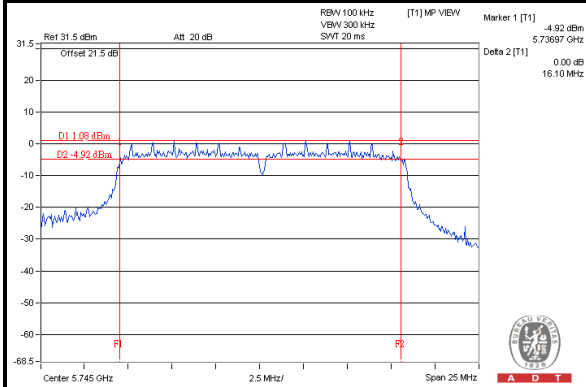

802.11n (HT20) / CH165

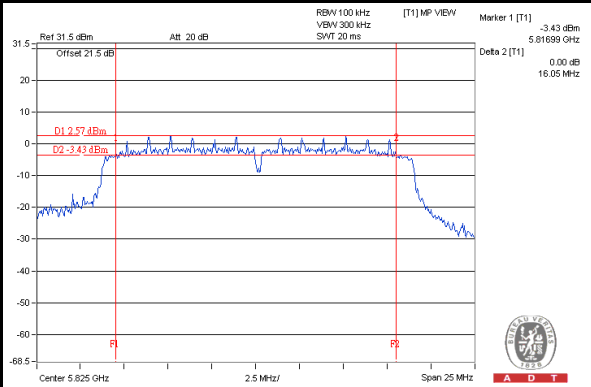

802.11n (HT40) / CH151

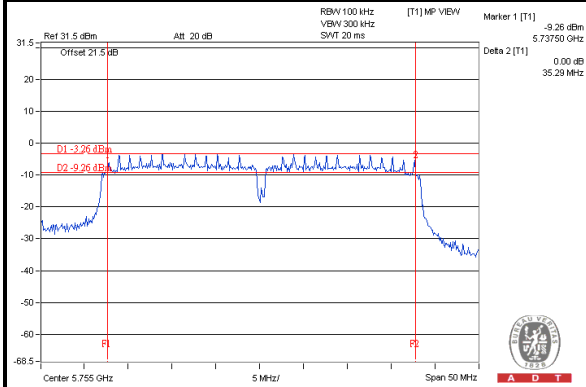



A D T

5.4 CONDUCTED OUTPUT POWER MEASUREMENT

5.4.1 LIMITS OF CONDUCTED OUTPUT POWER MEASUREMENT

For systems using digital modulation in the 5725 –5850 MHz band: 1 Watt (30dBm)

5.4.2 INSTRUMENTS

DESCRIPTION & MANUFACTURER	MODEL NO.	SERIAL NO.	CALIBRATED DATE	CALIBRATED UNTIL
Power Meter	ML2495A	1014008	Apr. 23, 2013	Apr. 22, 2014
Power Sensor	MA2411B	0917122	Apr. 23, 2013	Apr. 22, 2014

Note:

1. The calibration interval of the above test instruments is 12 months and the calibrations are traceable to NML/ROC and NIST/USA.
2. Tested date : Dec. 24, 2013

5.4.3 TEST PROCEDURES

The peak power sensor was used on the output port of the EUT. A power meter was used to read the response of the peak power sensor. Record the peak power level.

5.4.4 DEVIATION FROM TEST STANDARD

No deviation.

5.4.5 TEST SETUP

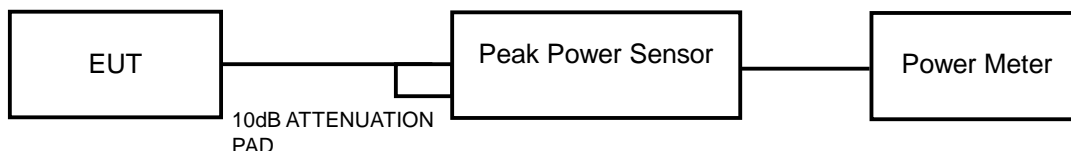

5.4.6 EUT OPERATING CONDITIONS

Same as Item 5.3.6



A D T



A D T

5.4.7 TEST RESULTS

802.11a

CHANNEL	FREQUENCY (MHz)	PEAK POWER (mW)	PEAK POWER (dBm)	LIMIT (dBm)	PASS/FAIL
149	5745	69.183	18.40	30	PASS
157	5785	72.277	18.59	30	PASS
165	5825	85.507	19.32	30	PASS

802.11n (HT20)

CHANNEL	FREQUENCY (MHz)	PEAK POWER (mW)	PEAK POWER (dBm)	LIMIT (dBm)	PASS/FAIL
149	5745	59.841	17.77	30	PASS
157	5785	81.846	19.13	30	PASS
165	5825	73.451	18.66	30	PASS

802.11n (HT40)

CHANNEL	FREQUENCY (MHz)	PEAK POWER (mW)	PEAK POWER (dBm)	LIMIT (dBm)	PASS/FAIL
151	5755	58.210	17.65	30	PASS
159	5795	73.961	18.69	30	PASS

5.5 AVERAGE OUTPUT POWER

5.5.1 FOR REFERENCE.

5.5.2 TEST INSTRUMENTS

DESCRIPTION & MANUFACTURER	MODEL NO.	SERIAL NO.	CALIBRATED DATE	CALIBRATED UNTIL
Power Meter	ML2495A	1014008	Apr. 23, 2013	Apr. 22, 2014
Power Sensor	MA2411B	0917122	Apr. 23, 2013	Apr. 22, 2014

Note:

1. The calibration interval of the above test instruments is 12 months and the calibrations are traceable to NML/ROC and NIST/USA.
2. Tested date : Dec. 24, 2013

5.5.3 TEST PROCEDURES

Method PM is used to perform output power measurement, trigger and gating function of wide band power meter is enabled to measure max output power of TX on burst. Duty factor is not added to measured value.

5.5.4 TEST SETUP

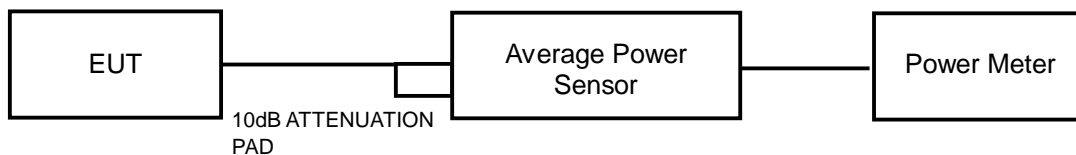

5.5.5 EUT OPERATING CONDITIONS

Same as Item 4.3.6



A D T

5.5.6 TEST RESULTS

802.11a

CHAN.	FREQUENCY (MHz)	AVERAGE POWER (mW)	AVERAGE POWER (dBm)
149	5745	15.668	11.95
157	5785	19.815	12.97
165	5825	24.378	13.87

802.11n (HT20)

CHAN.	FREQUENCY (MHz)	AVERAGE POWER (mW)	AVERAGE POWER (dBm)
149	5745	14.322	11.56
157	5785	22.029	13.43
165	5825	22.336	13.49

802.11n (HT40)

CHAN.	FREQUENCY (MHz)	AVERAGE POWER (mW)	AVERAGE POWER (dBm)
151	5755	12.912	11.11
159	5795	28.054	14.48

5.6 POWER SPECTRAL DENSITY MEASUREMENT

5.6.1 LIMITS OF POWER SPECTRAL DENSITY MEASUREMENT

The Maximum of Power Spectral Density Measurement is 8dBm.

5.6.2 TEST INSTRUMENTS

DESCRIPTION & MANUFACTURER	MODEL NO.	SERIAL NO.	CALIBRATED DATE	CALIBRATED UNTIL
Spectrum Analyzer R&S	FSP 40	100036	Jan. 21, 2013	Jan. 20, 2014

Note:

1. The calibration interval of the above test instruments is 12 months and the calibrations are traceable to NML/ROC and NIST/USA.
2. Tested date : Dec. 24, 2013

5.6.3 TEST PROCEDURE

1. Set the RBW = 3 kHz, VBW =10 kHz, Detector = peak.
2. Sweep time = auto couple, Trace mode = max hold, allow trace to fully stabilize.
3. Use the peak marker function to determine the maximum amplitude level.

5.6.4 DEVIATION FROM TEST STANDARD

No deviation

5.6.5 TEST SETUP

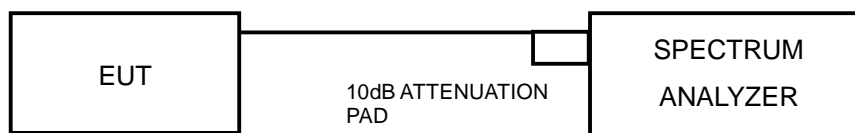

5.6.6 EUT OPERATING CONDITION

Same as Item 4.3.6



A D T

5.6.7 TEST RESULTS

802.11a

Channel	FREQUENCY (MHz)	PSD (dBm)	LIMIT (dBm)	PASS /FAIL
149	5745	-13.75	8	PASS
157	5785	-12.62	8	PASS
165	5825	-11.33	8	PASS

802.11n (HT20)

Channel	FREQUENCY (MHz)	PSD (dBm)	LIMIT (dBm)	PASS /FAIL
149	5745	-15.55	8	PASS
157	5785	-13.60	8	PASS
165	5825	-12.30	8	PASS

802.11n (HT40)

Channel	FREQUENCY (MHz)	PSD (dBm)	LIMIT (dBm)	PASS /FAIL
151	5755	-17.56	8	PASS
159	5795	-15.48	8	PASS



A D T

SPECTRUM PLOT OF WORST VALUE

802.11a / CH165

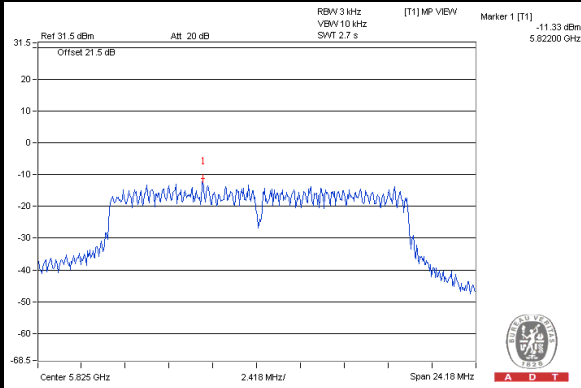

802.11n (HT20) / CH165

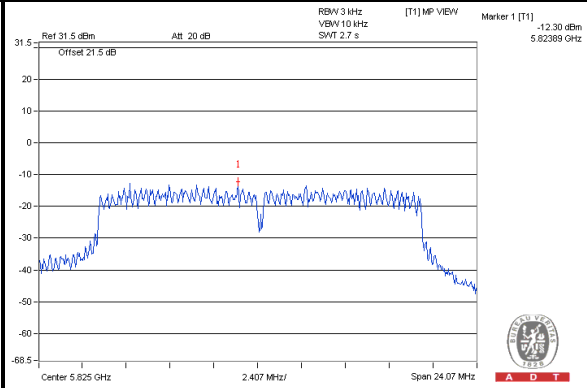

802.11n (HT40) / CH159

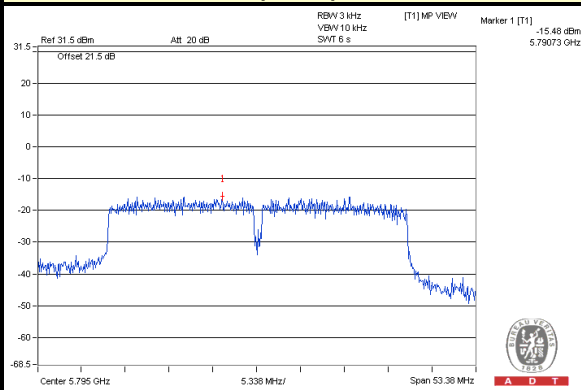



A D T

5.7 CONDUCTED OUT-BAND EMISSION MEASUREMENT

5.7.1 LIMITS OF CONDUCTED OUT-BAND EMISSION MEASUREMENT

Below 20dB of the highest emission level of operating band (in 100kHz Resolution Bandwidth).

5.7.2 TEST INSTRUMENTS

DESCRIPTION & MANUFACTURER	MODEL NO.	SERIAL NO.	CALIBRATED DATE	CALIBRATED UNTIL
Spectrum Analyzer R&S	FSP 40	100036	Jan. 21, 2013	Jan. 20, 2014

Note:

1. The calibration interval of the above test instruments is 12 months and the calibrations are traceable to NML/ROC and NIST/USA.
2. Tested date : Dec. 24, 2013

5.7.3 TEST PROCEDURE

Measurement Procedure - Reference Level

1. Set the RBW = 100 kHz.
2. Set the VBW \geq 300 kHz.
3. Detector = peak.
4. Sweep time = auto couple.
5. Trace mode = max hold.
6. Allow trace to fully stabilize.
7. Use the peak marker function to determine the maximum power level in any 100 kHz band segment within the fundamental EBW.

Measurement Procedure –Unwanted Emission Level

1. Set RBW = 100 kHz.
2. Set VBW \geq 300 kHz.
3. Set span to encompass the spectrum to be examined
4. Detector = peak.
5. Trace Mode = max hold.
6. Sweep = auto couple.

5.7.4 DEVIATION FROM TEST STANDARD

No deviation

5.7.5 TEST SETUP

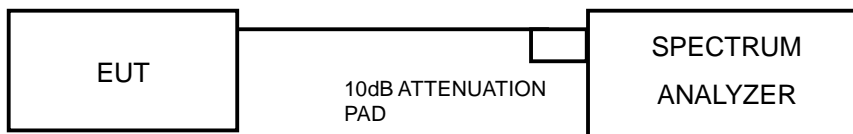

5.7.6 EUT OPERATING CONDITION

Same as Item 4.3.6

5.7.7 TEST RESULTS

The spectrum plots are attached on the following pages. D1 line indicates the highest level, and D2 line indicates the 20dB offset below D1. It shows compliance with the requirement.



A D T

802.11a

CH 149

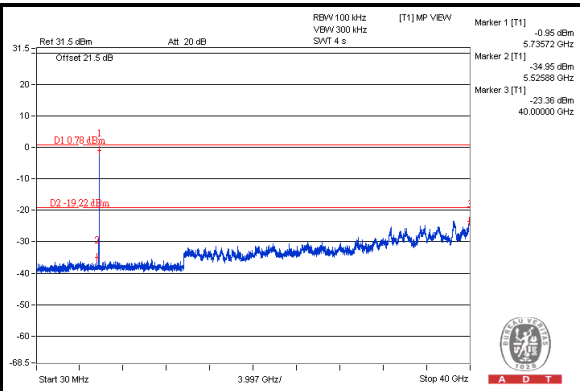
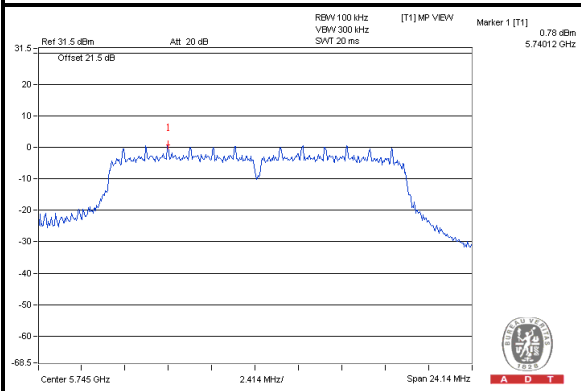

CH 157

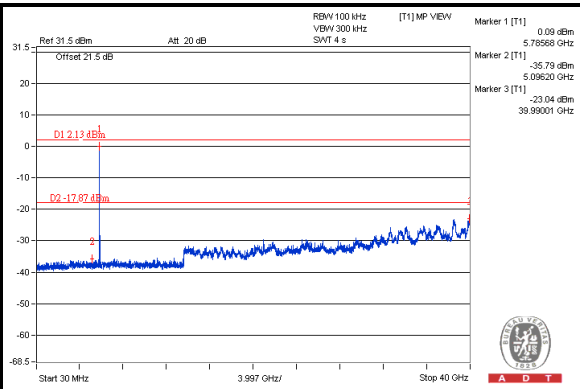
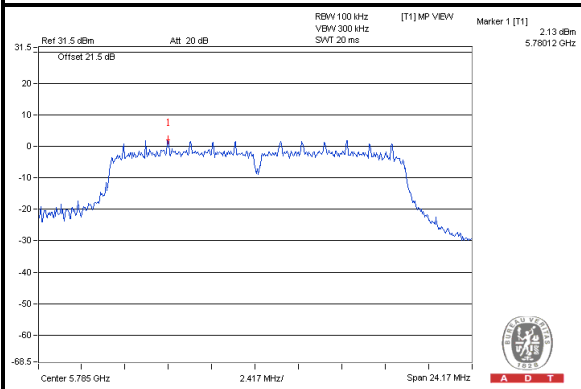

CH 165

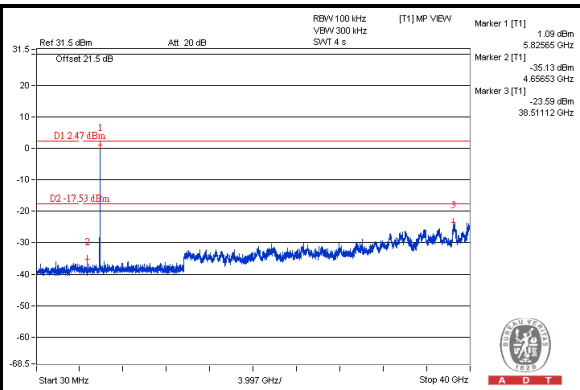
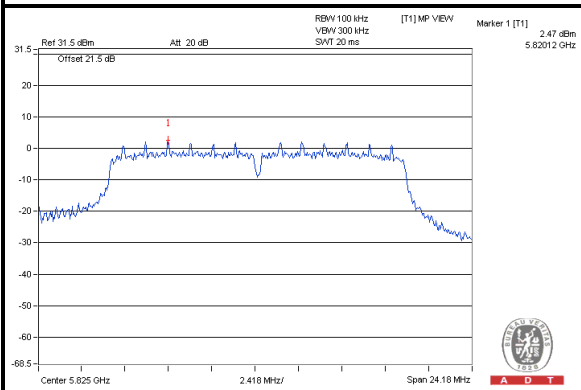

CH 149 Band edge

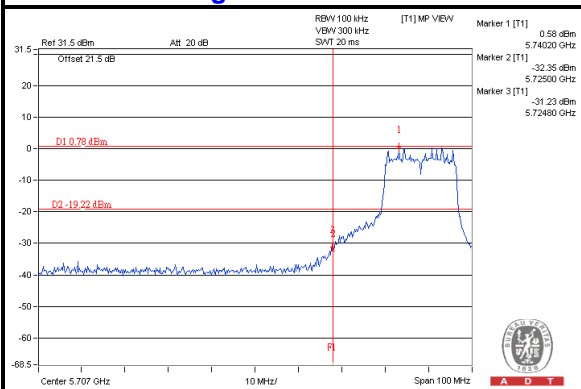

CH 165 Band edge

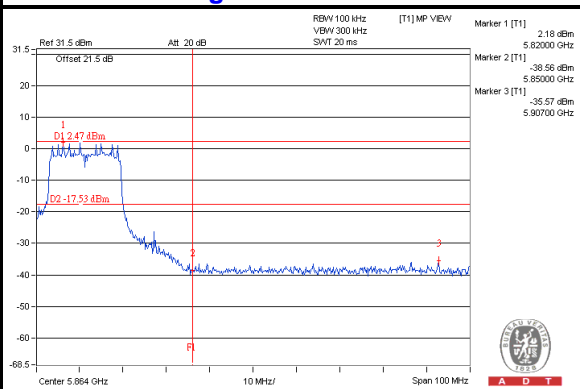



A D T

802.11n (HT20):

CH 149

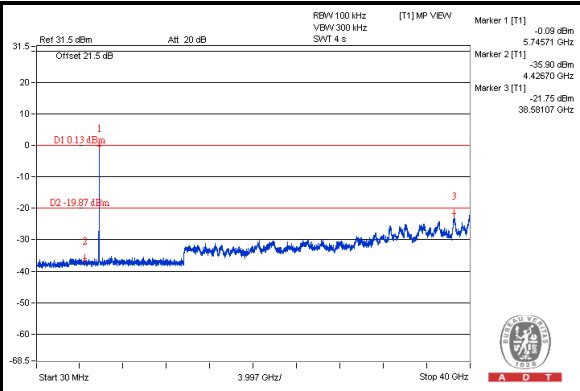
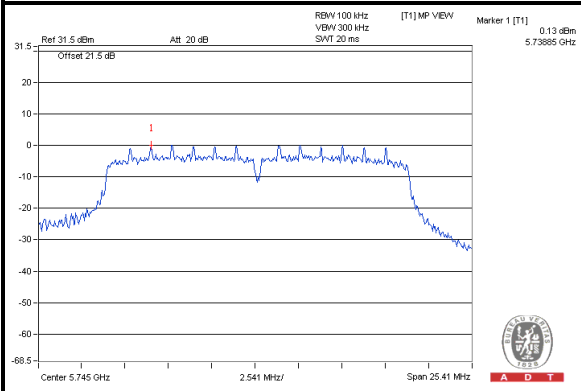

CH 157

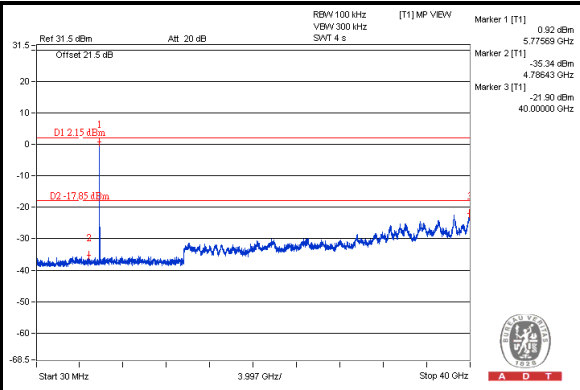
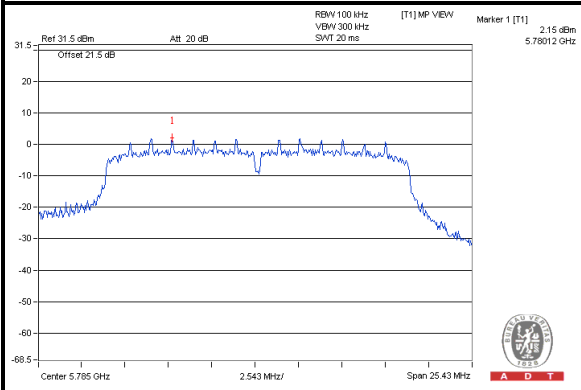

CH 165

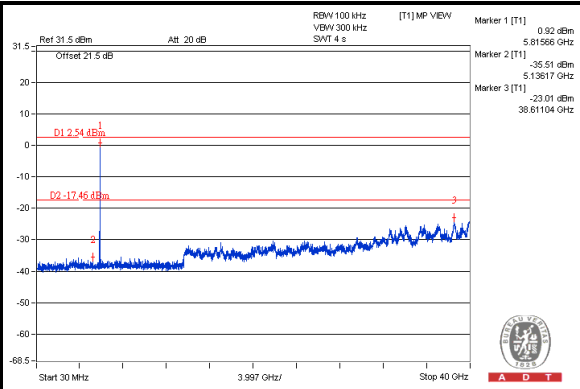
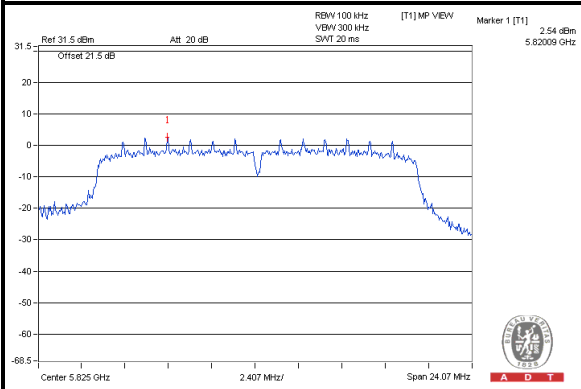

CH 149 Band edge

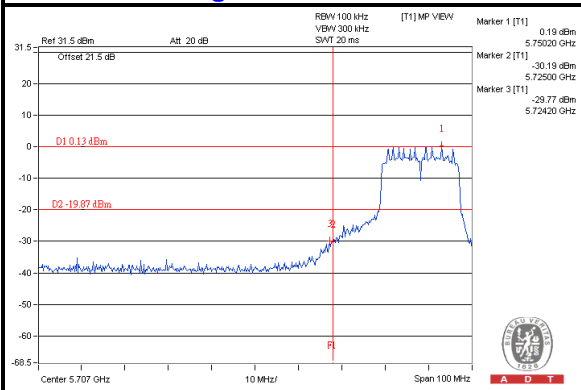

CH 165 Band edge

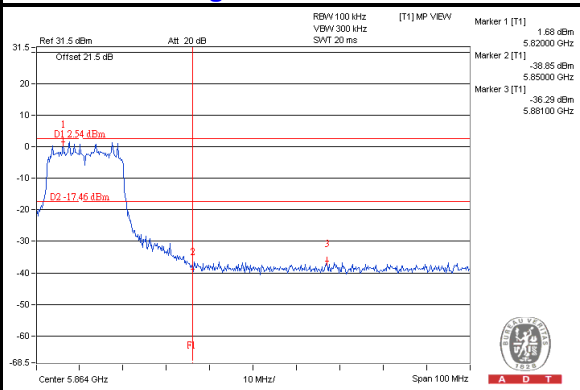



A D T

802.11n (HT40):

CH 151

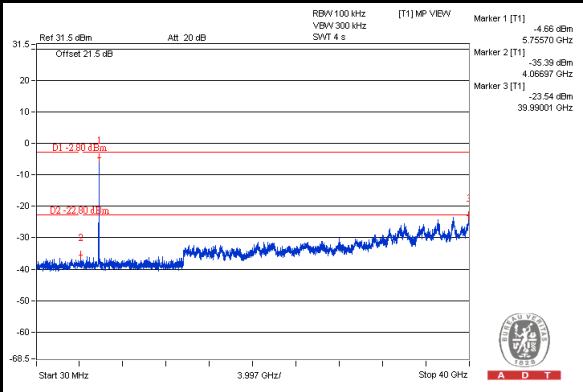
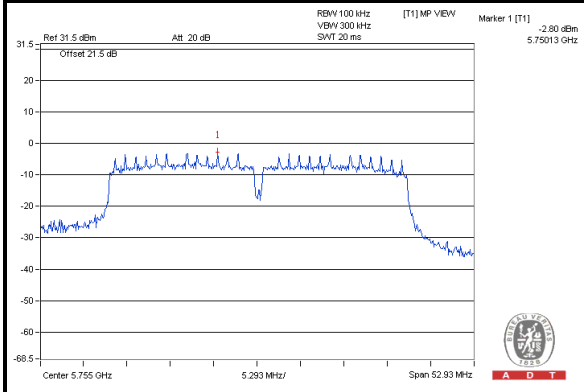

CH 159

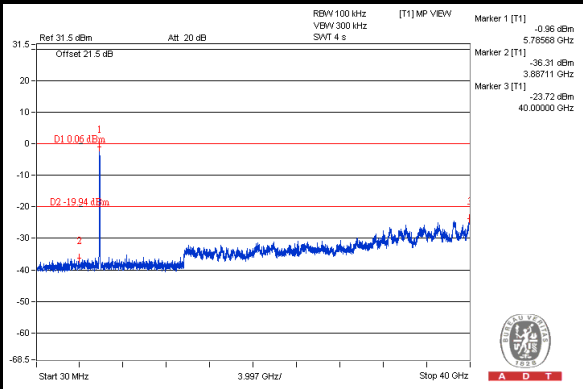
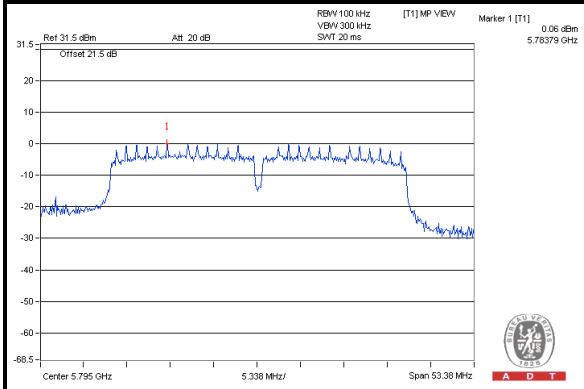

CH 151 Band edge

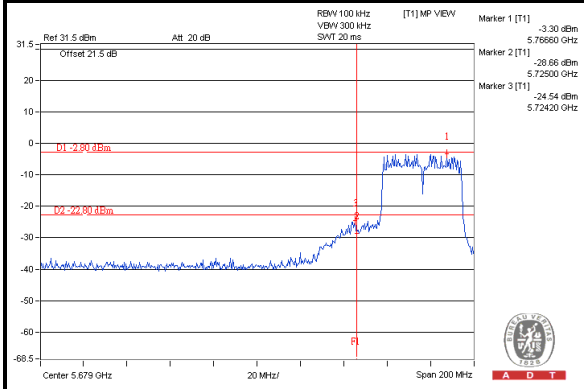

CH 159 Band edge

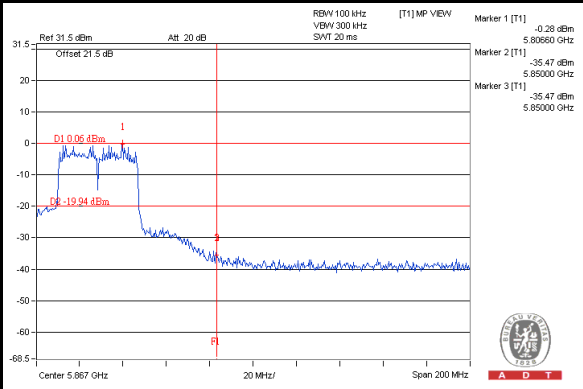

6. PHOTOGRAPHS OF THE TEST CONFIGURATION

Please refer to the attached file (Test Setup Photo).



A D T

7. INFORMATION ON THE TESTING LABORATORIES

We, Bureau Veritas Consumer Products Services (H.K.) Ltd., Taoyuan Branch, were founded in 1988 to provide our best service in EMC, Radio, Telecom and Safety consultation. Our laboratories are accredited and approved according to ISO/IEC 17025.

If you have any comments, please feel free to contact us at the following:

Linko EMC/RF Lab:

Tel: 886-2-26052180

Fax: 886-2-26052943

Hsin Chu EMC/RF Lab:

Tel: 886-3-5935343

Fax: 886-3-5935342

Hwa Ya EMC/RF/Safety/Telecom Lab:

Tel: 886-3-3183232

Fax: 886-3-3270892

Email: service.adt@tw.bureauveritas.com

Web Site: www.bureauveritas-adt.com

The address and road map of all our labs can be found in our web site also.



A D T

8. APPENDIX A - MODIFICATIONS RECORDERS FOR ENGINEERING CHANGES TO THE EUT BY THE LAB

No modifications were made to the EUT by the lab during the test.

--- END ---