

FCC Test Report

Report No.: RF150504E01

FCC ID: U8G-P1093

Test Model: MAX BR1 Slim LTE

Series Model: MAX BR1 Slim, MAX BR1, Pismo 930 Mini, Pismo 930, MAX

Received Date: May 04, 2015

Test Date: May 14 to 19, 2015

Issued Date: June 11, 2015

Applicant: Pismo Labs Technology Limited

Address: FLAT/RM A5, 5/F, HK SPINNERS IND BLDG PHASE 6, 481 CASTLE PEAK ROAD, CHEUNG SHA WAN, HONG KONG.

Issued By: Bureau Veritas Consumer Products Services (H.K.) Ltd., Taoyuan Branch Hsin Chu Laboratory

Lab Address: No. 81-1, Lu Liao Keng, 9th Ling, Wu Lung Tsuen, Chiung Lin Hsiang, Hsin Chu Hsien 307, Taiwan R.O.C.

Test Location (1): No. 81-1, Lu Liao Keng, 9th Ling, Wu Lung Tsuen, Chiung Lin Hsiang, Hsin Chu Hsien 307, Taiwan R.O.C.

Test Location (2): No. 49, Ln. 206, Wende Rd., Shangshan Tsuen, Chiung Lin Hsiang, Hsin Chu Hsien 307, Taiwan R.O.C.



This report is for your exclusive use. Any copying or replication of this report to or for any other person or entity, or use of our name or trademark, is permitted only with our prior written permission. This report sets forth our findings solely with respect to the test samples identified herein. The results set forth in this report are not indicative or representative of the quality or characteristics of the lot from which a test sample was taken or any similar or identical product unless specifically and expressly noted. Our report includes all of the tests requested by you and the results thereof based upon the information that you provided to us. You have 60 days from date of issuance of this report to notify us of any material error or omission caused by our negligence, provided, however, that such notice shall be in writing and shall specifically address the issue you wish to raise. A failure to raise such issue within the prescribed time shall constitute your unqualified acceptance of the completeness of this report, the tests conducted and the correctness of the report contents. Unless specific mention, the uncertainty of measurement has been explicitly taken into account to declare the compliance or non-compliance to the specification. The report must not be used by the client to claim product certification, approval, or endorsement by TAF or any government agencies.

Table of Contents

Release Control Record	4
1 Certificate of Conformity	5
2 Summary of Test Results	6
2.1 Measurement Uncertainty	6
2.2 Modification Record	6
3 General Information	7
3.1 General Description of EUT	7
3.2 Description of Test Modes	9
3.2.1 Test Mode Applicability and Tested Channel Detail	10
3.3 Duty Cycle of Test Signal	12
3.4 Description of Support Units	13
3.4.1 Configuration of System under Test	14
3.5 General Description of Applied Standards	16
4 Test Types and Results	17
4.1 Radiated Emission and Bandedge Measurement	17
4.1.1 Limits of Radiated Emission and Bandedge Measurement	17
4.1.2 Test Instruments	18
4.1.3 Test Procedures	19
4.1.4 Deviation from Test Standard	19
4.1.5 Test Setup	20
4.1.6 EUT Operating Conditions	20
4.1.7 Test Results	21
4.2 Conducted Emission Measurement	34
4.2.1 Limits of Conducted Emission Measurement	34
4.2.2 Test Instruments	34
4.2.3 Test Procedures	35
4.2.4 Deviation from Test Standard	35
4.2.5 Test Setup	35
4.2.6 EUT Operating Conditions	35
4.2.7 Test Results (Mode 1)	36
4.2.8 Test Results (Mode 2)	38
4.2.9 Test Results (Mode 3)	40
4.3 6dB Bandwidth Measurement	42
4.3.1 Limits of 6dB Bandwidth Measurement	42
4.3.2 Test Setup	42
4.3.3 Test Instruments	42
4.3.4 Test Procedures	42
4.3.5 Deviation from Test Standard	42
4.3.6 EUT Operating Conditions	42
4.3.7 Test Result	43
4.4 Conducted Output Power Measurement	45
4.4.1 Limits of Conducted Output Power Measurement	45
4.4.2 Test Setup	45
4.4.3 Test Instruments	45
4.4.4 Test Procedures	45
4.4.5 Deviation from Test Standard	45
4.4.6 EUT Operating Conditions	45
4.4.7 Test Results	46
4.5 Power Spectral Density Measurement	48
4.5.1 Limits of Power Spectral Density Measurement	48
4.5.2 Test Setup	48
4.5.3 Test Instruments	48
4.5.4 Test Procedures	48



4.5.5	Deviation from Test Standard	48
4.5.6	EUT Operating Conditions.....	48
4.5.7	Test Results	49
4.6	Conducted Out of Band Emission Measurement	51
4.6.1	Limits of Conducted Out of Band Emission Measurement.....	51
4.6.2	Test Setup.....	51
4.6.3	Test Instruments	51
4.6.4	Test Procedures.....	51
4.6.5	Deviation from Test Standard	51
4.6.6	EUT Operating Conditions.....	51
4.6.7	Test Results	51
5	Pictures of Test Arrangements.....	56
	Appendix – Information on the Testing Laboratories	57



A D T

Release Control Record

Issue No.	Description	Date Issued
RF150504E01	Original release.	June 11, 2015



1 Certificate of Conformity

Product: Pepwave / Peplink / Pismo Wireless Product

Brand: Pepwave / Peplink / Pismo

Test Model: MAX BR1 Slim LTE

Series Model: MAX BR1 Slim, MAX BR1, Pismo 930 Mini, Pismo 930, MAX

Sample Status: MASS-PRODUCTION

Applicant: Pismo Labs Technology Limited

Test Date: May 14 to 19, 2015

Standards: 47 CFR FCC Part 15, Subpart C (Section 15.247)
ANSI C63.10:2009

The above equipment has been tested by **Bureau Veritas Consumer Products Services (H.K.) Ltd., Taoyuan Branch**, and found compliance with the requirement of the above standards. The test record, data evaluation & Equipment Under Test (EUT) configurations represented herein are true and accurate accounts of the measurements of the sample's EMC characteristics under the conditions specified in this report.

Prepared by :  , **Date:** June 11, 2015
Lori Chung / Specialist

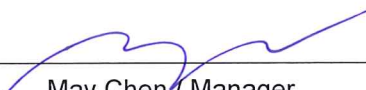
Approved by :  , **Date:** June 11, 2015
May Chen / Manager

2 Summary of Test Results

47 CFR FCC Part 15, Subpart C (SECTION 15.247)			
FCC Clause	Test Item	Result	Remarks
15.207	AC Power Conducted Emission	PASS	Meet the requirement of limit. Minimum passing margin is -9.96dB at 23.12806MHz.
15.205 / 15.209 / 15.247(d)	Radiated Emissions and Band Edge Measurement	PASS	Meet the requirement of limit. Minimum passing margin is -0.1dB at 2390.00MHz.
15.247(d)	Antenna Port Emission	PASS	Meet the requirement of limit.
15.247(a)(2)	6dB bandwidth	PASS	Meet the requirement of limit.
15.247(b)	Conducted power	PASS	Meet the requirement of limit.
15.247(e)	Power Spectral Density	PASS	Meet the requirement of limit.
15.203	Antenna Requirement	PASS	Antenna connector is Reverse SMA not a standard connector.

2.1 Measurement Uncertainty

Where relevant, the following measurement uncertainty levels have been estimated for tests performed on the EUT as specified in CISPR 16-4-2:

Measurement	Frequency	Expanded Uncertainty (k=2) (±)
Conducted Emissions at mains ports	150kHz ~ 30MHz	2.86 dB
Radiated Emissions up to 1 GHz	30MHz ~ 1GHz	5.37 dB
Radiated Emissions above 1 GHz	1GHz ~ 6GHz	3.65 dB
	6GHz ~ 18GHz	3.88 dB
	18GHz ~ 40GHz	4.11 dB

2.2 Modification Record

There were no modifications required for compliance.

3 General Information

3.1 General Description of EUT

Product	Pepwave / Peplink / Pismo Wireless Product
Brand	Pepwave / Peplink / Pismo
Test Model	MAX BR1 Slim LTE
Series Model	MAX BR1 Slim, MAX BR1, Pismo 930 Mini, Pismo 930, MAX
Status of EUT	MASS-PRODUCTION
Power Supply Rating	DC 5V, 2A from Micro USB or DC 12V-24V from Terminal Block
Modulation Type	CCK, DQPSK, DBPSK for DSSS 64QAM, 16QAM, QPSK, BPSK for OFDM
Modulation Technology	DSSS, OFDM
Transfer Rate	802.11b: up to 11Mbps 802.11g: up to 54Mbps 802.11n: up to 150Mbps
Operating Frequency	2.412 ~ 2.462GHz
Number of Channel	11 for 802.11b, 802.11g, 802.11n (HT20) 7 for 802.11n (HT40)
Output Power	802.11b: 269.774mW 802.11g: 446.684mW 802.11n (HT20): 431.519mW 802.11n (HT40): 238.232mW
Antenna Type	Refer to Note
Antenna Connector	Refer to Note
Accessory Device	NA
Data Cable Supplied	NA

Note:

- The EUT has below model names which are identical to each other in all aspects except for the following table:

Product Name	Brand	Model Name	Difference
Pepwave / Peplink / Pismo Wireless Product	Pepwave / Peplink / Pismo	MAX BR1 Slim LTE	For marketing requirement
		MAX BR1 Slim	
		MAX BR1	
		Pismo 930 Mini	
		Pismo 930	
		MAX	

From the above models, model: MAX BR1 Slim LTE was selected as representative model for the test and its data was recorded in this report.

- There are WLAN-2.4GHz, 3G, LTE and GPS technology used for the EUT, and it can't transmit at same time.

3. The antennas provided to the EUT, please refer to the following table:

For WLAN							
Set	Brand	Model	Ant. Gain (dBi)	Frequency range (GHz to GHz)	Antenna Type	Connector Type	
1	WNC	9E.XCI15.001	5.1	2.4~2.5	Dipole	Reverse SMA	
For GPS							
Set	Brand	Model	Ant. Gain (dBi)	Frequency range (MHz)	Antenna Type	Connector Type	
1	Chang Hong	GPS-01	-1	1575.42 (±1.023MHz)	Magnetic	R-SMA Male	
For LTE							
Set	Transmitter Circuit	Brand	Model	Ant. Gain (dBi)	Frequency range (MHz to MHz)	Antenna Type	Connector Type
1	Cellular Main	Pulse	SPDA24700/2700	2	698-960	Dipole	SMA Male
	Cellular Diversity / Aux				1710-2170 2500-2700	Dipole	SMA Male

4. The EUT incorporates a SISO function.

MODULATION MODE	DATA RATE (MCS)	TX & RX CONFIGURATION	
802.11b	1 ~ 11Mbps	1TX	1RX
802.11g	6 ~ 54Mbps	1TX	1RX
802.11n (HT20)	MCS 0~7	1TX	1RX
802.11n (HT40)	MCS 0~7	1TX	1RX

5. The EUT inside has one LTE module which FCC ID: N7NMC7355.

6. The EUT was pre-tested under the following test modes :

Pre-test Mode	Power
Mode A	Power from Adapter (Micro USB 1)
Mode B	Power from Adapter (Micro USB 2)
Mode C	Power from Adapter (Micro USB 1 & 2)

The worst radiated emissions were found in **Mode C**. Therefore only the test data of the modes were recorded in this report.

7. The above EUT information is declared by manufacturer and for more detailed features description, please refer to the manufacturer's specifications or user's manual.

3.2 Description of Test Modes

11 channels are provided for 802.11b, 802.11g and 802.11n (HT20):

Channel	Frequency	Channel	Frequency
1	2412MHz	7	2442MHz
2	2417MHz	8	2447MHz
3	2422MHz	9	2452MHz
4	2427MHz	10	2457MHz
5	2432MHz	11	2462MHz
6	2437MHz		

7 channels are provided for 802.11n (HT40):

Channel	Frequency	Channel	Frequency
3	2422MHz	7	2442MHz
4	2427MHz	8	2447MHz
5	2432MHz	9	2452MHz
6	2437MHz		

3.2.1 Test Mode Applicability and Tested Channel Detail

EUT CONFIGURE MODE	APPLICABLE TO				DESCRIPTION
	RE \geq 1G	RE<1G	PLC	APCM	
1	-	-	√	-	Power from Adapter (Micro USB 1)
2	-	-	√	-	Power from Adapter (Micro USB 2)
3	-	-	√	-	Power from DC power supply (Terminal Block)
4	√	√	-	√	Power from Adapter (Micro USB 1 & 2)

Where RE \geq 1G: Radiated Emission above 1GHz & Bandedge Measurement

RE<1G: Radiated Emission below 1GHz

PLC: Power Line Conducted Emission

APCM: Antenna Port Conducted Measurement

NOTE: The EUT had been pre-tested on the positioned of each 2 axis. The worst case was found when positioned on **X-plane**.

NOTE: "-" means no effect.

Radiated Emission Test (Above 1GHz):

- Pre-Scan has been conducted to determine the worst-case mode from all possible combinations between available modulations, data rates and antenna ports (if EUT with antenna diversity architecture).
- Following channel(s) was (were) selected for the final test as listed below.

MODE	AVAILABLE CHANNEL	TESTED CHANNEL	MODULATION TECHNOLOGY	MODULATION TYPE	DATA RATE (Mbps)
802.11b	1 to 11	1, 6, 11	DSSS	DBPSK	1
802.11g	1 to 11	1, 6, 11	OFDM	BPSK	6
802.11n (HT20)	1 to 11	1, 6, 11	OFDM	BPSK	6.5
802.11n (HT40)	3 to 9	3, 6, 9	OFDM	BPSK	13.5

Radiated Emission Test (Below 1GHz):

- Pre-Scan has been conducted to determine the worst-case mode from all possible combinations between available modulations, data rates and antenna ports (if EUT with antenna diversity architecture).
- Following channel(s) was (were) selected for the final test as listed below.

MODE	AVAILABLE CHANNEL	TESTED CHANNEL	MODULATION TECHNOLOGY	MODULATION TYPE	DATA RATE (Mbps)
802.11g	1 to 11	6	OFDM	BPSK	6

Power Line Conducted Emission Test:

- Pre-Scan has been conducted to determine the worst-case mode from all possible combinations between available modulations, data rates and antenna ports (if EUT with antenna diversity architecture).
- Following channel(s) was (were) selected for the final test as listed below.

MODE	AVAILABLE CHANNEL	TESTED CHANNEL	MODULATION TECHNOLOGY	MODULATION TYPE	DATA RATE (Mbps)
802.11g	1 to 11	6	OFDM	BPSK	6

Antenna Port Conducted Measurement:

- This item includes all test value of each mode, but only includes spectrum plot of worst value of each mode.
- Pre-Scan has been conducted to determine the worst-case mode from all possible combinations between available modulations, data rates and antenna ports (if EUT with antenna diversity architecture).
- Following channel(s) was (were) selected for the final test as listed below.

MODE	AVAILABLE CHANNEL	TESTED CHANNEL	MODULATION TECHNOLOGY	MODULATION TYPE	DATA RATE (Mbps)
802.11b	1 to 11	1, 6, 11	DSSS	DBPSK	1
802.11g	1 to 11	1, 6, 11	OFDM	BPSK	6
802.11n (HT20)	1 to 11	1, 6, 11	OFDM	BPSK	6.5
802.11n (HT40)	3 to 9	3, 6, 9	OFDM	BPSK	13.5

Test Condition:

APPLICABLE TO	ENVIRONMENTAL CONDITIONS	INPUT POWER (System)	TESTED BY
RE \geq 1G	24deg. C, 73%RH	120Vac, 60Hz	Weiwei Lo
RE<1G	25deg. C, 74%RH	120Vac, 60Hz	Jason Huang
PLC	25deg. C, 70%RH	120Vac, 60Hz	Mike Hsieh
APCM	25deg. C, 60%RH	120Vac, 60Hz	Gary Cheng

3.3 Duty Cycle of Test Signal

Duty cycle of test signal is 100 %, duty factor is not required.

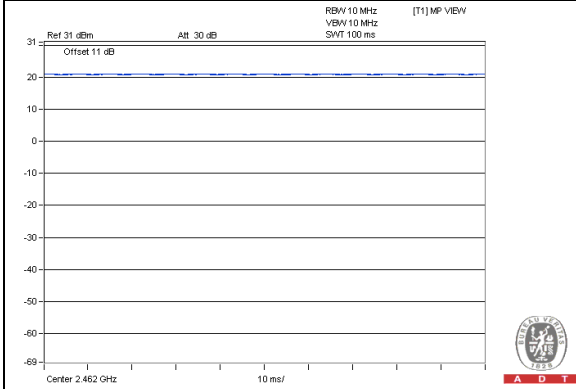
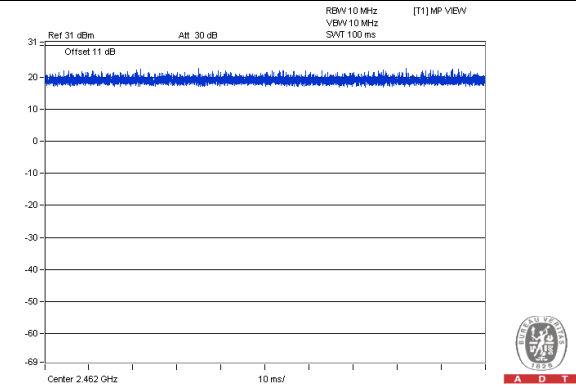
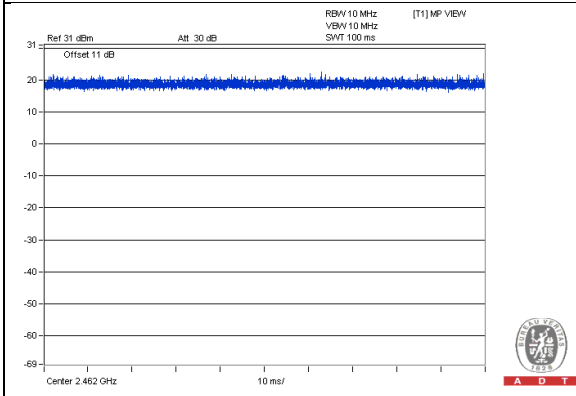
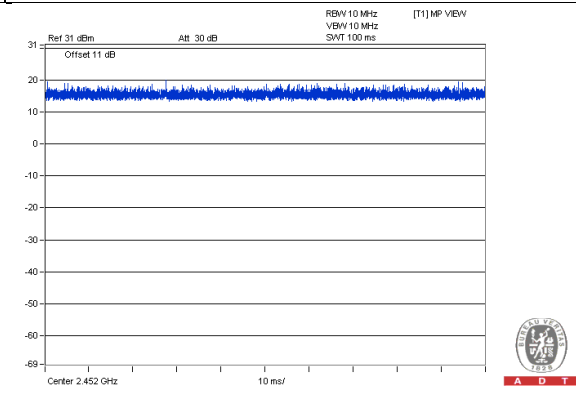
802.11b**802.11g****802.11n (HT20)****802.11n (HT40)**

3.4 Description of Support Units

The EUT has been tested as an independent unit together with other necessary accessories or support units. The following support units or accessories were used to form a representative test configuration during the tests.

ID	Product	Brand	Model No.	Serial No.	FCC ID	Remarks
A.	Adapter	Nicelink	US-T12B(W)	NA	NA	Provided by Lab
B.	Adapter	TOPCOM	TC-68	NA	NA	Provided by Lab
C.	DC power supply	GOOD WILL INSTRUMENT CO., LTD.	GPC-3030D	7700087	NA	Provided by Lab
D.	NOTEBOOK COMPUTER	DELL	PP18L	12252644560	FCC DoC	Provided by Lab
E.	HUB	Linksys	SD208	NA	NA	Provided by Lab

Note:

1. All power cords of the above support units are non-shielded (1.8m).

ID	Descriptions	Qty.	Length (m)	Shielding (Yes/No)	Cores (Qty.)	Remarks
1.	USB	1	1	Yes	0	Provided by Lab
2.	USB	1	1	Yes	0	Provided by Lab
3.	DC	1	3	No	0	Provided by Lab
4.	RJ45	1	10	No	0	Provided by Lab
5.	RJ45	1	10	No	0	Provided by Lab
6.	Earth	1	3	No	0	Provided by Lab

3.4.1 Configuration of System under Test

For conducted emission test Mode 1:

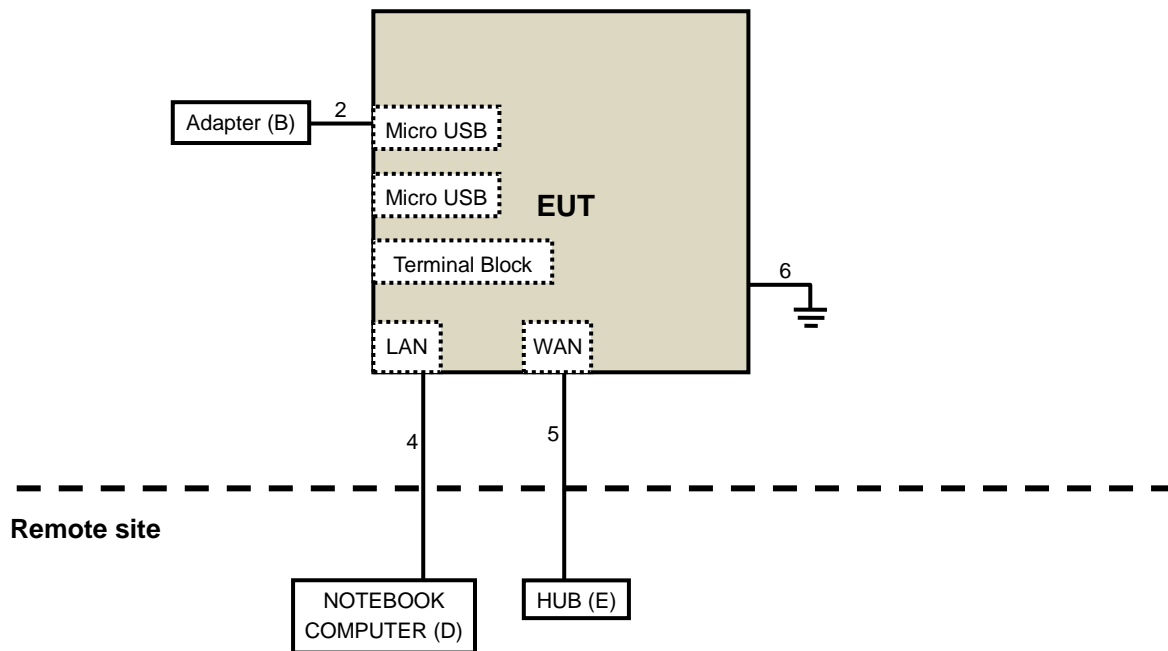

For conducted emission test Mode 2:

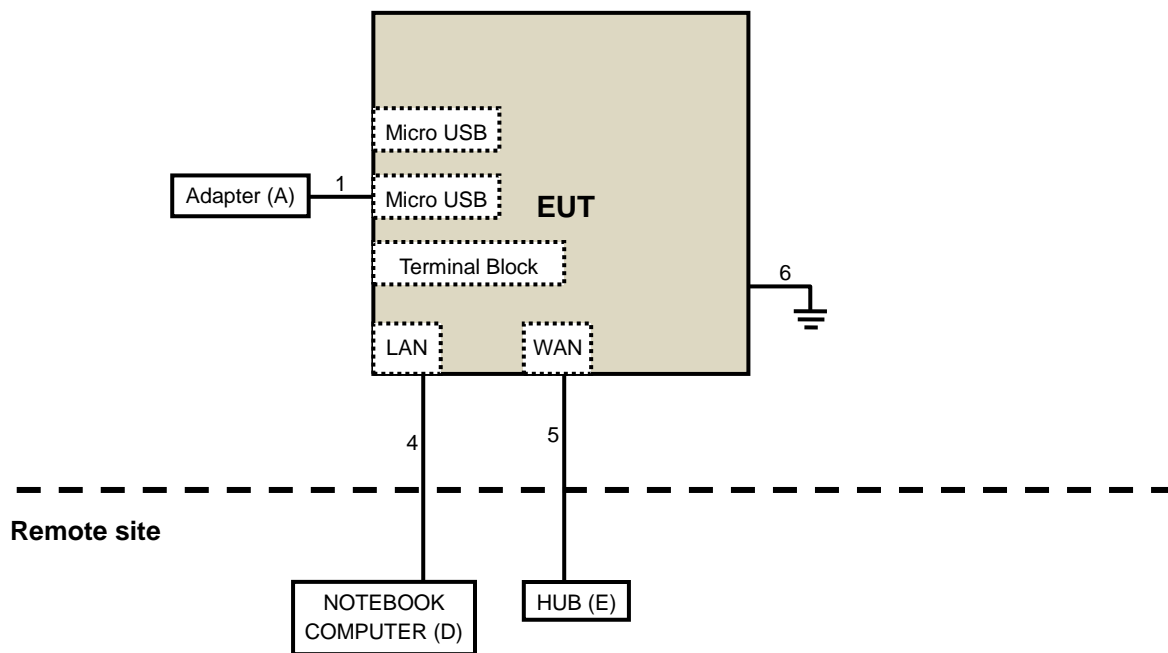

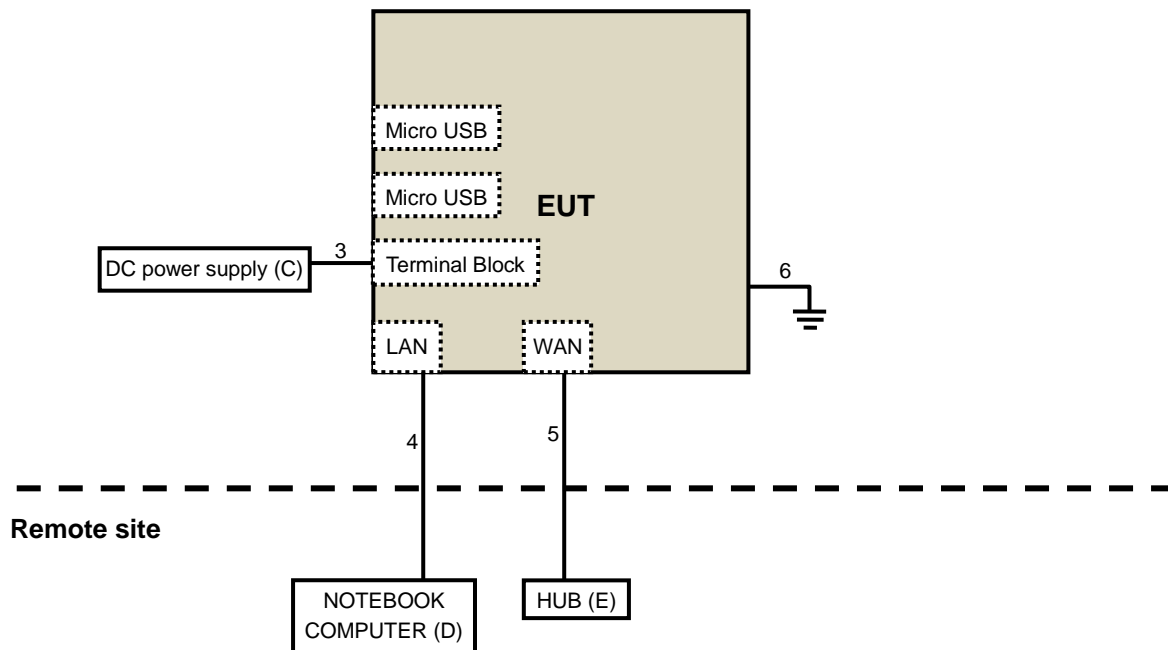
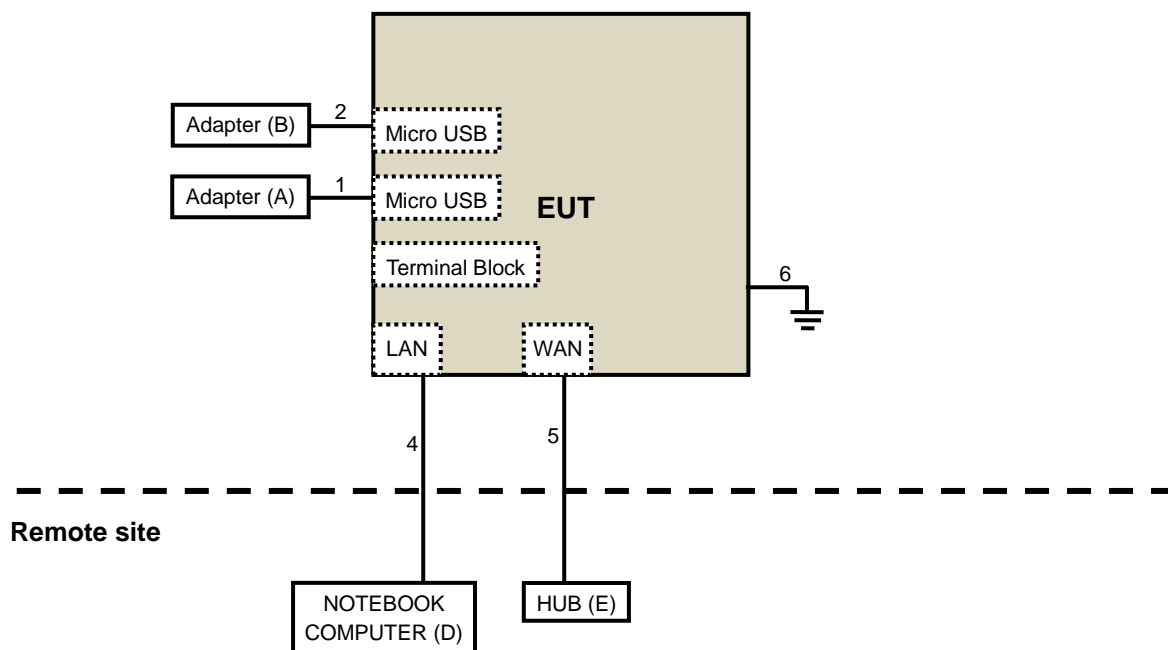
For conducted emission test Mode 3:**For other test items:**

3.5 General Description of Applied Standards

The EUT is a RF Product. According to the specifications of the manufacturer, it must comply with the requirements of the following standards:

FCC Part 15, Subpart C (15.247)
558074 D01 DTS Meas Guidance v03r02
ANSI C63.10-2009

All test items have been performed and recorded as per the above standards.

NOTE: The EUT has been verified to comply with the requirements of FCC Part 15, Subpart B, Class B (DoC). The test report has been issued separately.

4 Test Types and Results

4.1 Radiated Emission and Bandedge Measurement

4.1.1 Limits of Radiated Emission and Bandedge Measurement

Radiated emissions which fall in the restricted bands must comply with the radiated emission limits specified as below table. Other emissions shall be at least 20dB below the highest level of the desired power:

Frequencies (MHz)	Field Strength (microvolts/meter)	Measurement Distance (meters)
0.009 ~ 0.490	2400/F(kHz)	300
0.490 ~ 1.705	24000/F(kHz)	30
1.705 ~ 30.0	30	30
30 ~ 88	100	3
88 ~ 216	150	3
216 ~ 960	200	3
Above 960	500	3

NOTE:

1. The lower limit shall apply at the transition frequencies.
2. Emission level (dBuV/m) = 20 log Emission level (uV/m).
3. For frequencies above 1000MHz, the field strength limits are based on average detector, however, the peak field strength of any emission shall not exceed the maximum permitted average limits, specified above by more than 20dB under any condition of modulation.

4.1.2 Test Instruments

DESCRIPTION & MANUFACTURER	MODEL NO.	SERIAL NO.	CALIBRATED DATE	CALIBRATED UNTIL
Test Receiver Agilent	N9038A	MY51210105	July 21, 2014	July 20, 2015
Pre-Amplifier Mini-Circuits	ZFL-1000VH2 B	AMP-ZFL-03	Nov. 12, 2014	Nov. 11, 2015
Trilog Broadband Antenna SCHWARZBECK	VULB 9168	9168-360	Feb. 06, 2015	Feb. 05, 2016
RF Cable	NA	CHGCAB_001	Oct. 04, 2014	Oct. 03, 2015
Horn_Antenna AISI	AIH.8018	0000320091110	Feb. 09, 2015	Feb. 08, 2016
Pre-Amplifier Agilent	8449B	3008A02578	June 24, 2014	June 23, 2015
RF Cable	NA	131205 131216 131217 SNMY23684/4	Jan. 16, 2015	Jan. 15, 2016
Spectrum Analyzer R&S	FSV40	100964	July 05, 2014	July 04, 2015
Pre-Amplifier SPACEK LABS	SLKKa-48-6	9K16	Dec. 12, 2014	Dec. 11, 2015
Horn_Antenna SCHWARZBECK	BBHA 9170	9170-424	Feb. 05, 2015	Feb. 04, 2016
RF Cable	NA	329751/4 RF104-204	Dec. 11, 2014	Dec. 10, 2015
Antenna Tower & Turn Table CT	NA	NA	NA	NA
Power Meter Anritsu	ML2495A	0824006	May 22, 2014	May 21, 2015
Power Sensor Anritsu	MA2411B	0738172	May 22, 2014	May 21, 2015
SPECTRUM ANALYZER R&S	FSP 40	100060	May 08, 2015	May 07, 2016

Note:

1. The calibration interval of the above test instruments is 12 months and the calibrations are traceable to NML/ROC and NIST/USA.
2. The horn antenna, preamplifier (model: 8449B) are used only for the measurement of emission frequency above 1GHz if tested.
3. The test was performed in 966 Chamber No. G.
4. The FCC Site Registration No. is 966073.
5. The VCCI Site Registration No. is G-137.
6. The CANADA Site Registration No. is IC 7450H-2.
7. Tested Date: May 14 to 19, 2015

4.1.3 Test Procedures

- a. The EUT was placed on the top of a rotating table 0.8 meters above the ground at 3 meter chamber room for test. The table was rotated 360 degrees to determine the position of the highest radiation.
- b. The EUT was set 3 meters away from the interference-receiving antenna, which was mounted on the top of a variable-height antenna tower.
- c. The height of antenna is varied from one meter to four meters above the ground to determine the maximum value of the field strength. Both horizontal and vertical polarizations of the antenna are set to make the measurement.
- d. For each suspected emission, the EUT was arranged to its worst case and then the antenna was tuned to heights from 1 meter to 4 meters and the rotatable table was turned from 0 degrees to 360 degrees to find the maximum reading.
- e. The test-receiver system was set to quasi-peak detect function and specified bandwidth with maximum hold mode when the test frequency is below 1 GHz.
- f. The test-receiver system was set to peak and average detect function and specified bandwidth with maximum hold mode when the test frequency is above 1 GHz. If the peak reading value also meets average limit, measurement with the average detector is unnecessary.

Note:

1. For emission measurements above 1 GHz, the EUT shall be placed at a height of 1.5 m above the ground at 3 meter chamber room for test
2. The resolution bandwidth and video bandwidth of test receiver/spectrum analyzer is 120kHz for Quasi-peak detection (QP) at frequency below 1GHz.
3. The resolution bandwidth of test receiver/spectrum analyzer is 1 MHz and the video bandwidth is 3 MHz for Peak detection (PK) at frequency above 1GHz.
4. The resolution bandwidth of test receiver/spectrum analyzer is 1MHz and the video bandwidth is 3MHz for RMS Average (Duty cycle < 98%) for Average detection (AV) at frequency above 1GHz, then the measurement results was added to a correction factor ($10 \log(1/\text{duty cycle})$).
5. The resolution bandwidth of test receiver/spectrum analyzer is 1MHz and the video bandwidth is 10Hz (Duty cycle $\geq 98\%$) for Average detection (AV) at frequency above 1GHz.
6. All modes of operation were investigated and the worst-case emissions are reported.

4.1.4 Deviation from Test Standard

No deviation.

4.1.5 Test Setup

<Frequency Range below 1GHz>

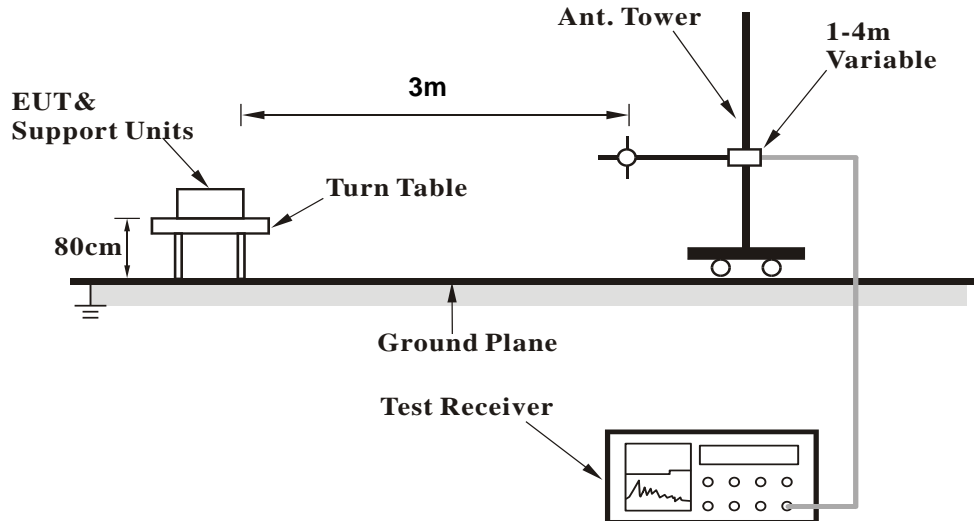

<Frequency Range above 1GHz>

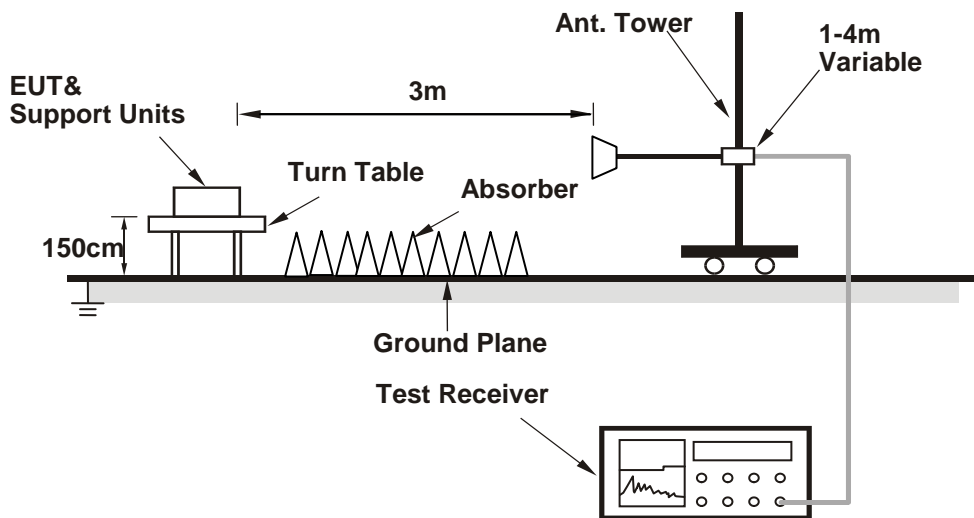

For the actual test configuration, please refer to the attached file (Test Setup Photo).

4.1.6 EUT Operating Conditions

- a. Connect the EUT with the support unit D (Notebook Computer) which is placed in remote site.
- b. Controlling software (artgui.exe [Ver2.25]) has been activated to set the EUT on specific status.

4.1.7 Test Results

Above 1GHz Data:

802.11b

CHANNEL	TX Channel 1	DETECTOR FUNCTION	Peak (PK)
FREQUENCY RANGE	1GHz ~ 25GHz		Average (AV)

ANTENNA POLARITY & TEST DISTANCE: HORIZONTAL AT 3 M

NO.	FREQ. (MHz)	EMISSION LEVEL (dBuV/m)	LIMIT (dBuV/m)	MARGIN (dB)	ANTENNA HEIGHT (m)	TABLE ANGLE (Degree)	RAW VALUE (dBuV)	CORRECTION FACTOR (dB/m)
1	2390.00	54.1 PK	74.0	-19.9	1.20 H	155	54.26	-0.16
2	2390.00	44.6 AV	54.0	-9.4	1.20 H	155	44.76	-0.16
3	*2412.00	97.5 PK			1.20 H	155	97.60	-0.10
4	*2412.00	94.6 AV			1.20 H	155	94.70	-0.10
5	4824.00	48.1 PK	74.0	-25.9	1.50 H	12	39.34	8.76
6	4824.00	35.5 AV	54.0	-18.5	1.50 H	12	26.74	8.76

ANTENNA POLARITY & TEST DISTANCE: VERTICAL AT 3 M

NO.	FREQ. (MHz)	EMISSION LEVEL (dBuV/m)	LIMIT (dBuV/m)	MARGIN (dB)	ANTENNA HEIGHT (m)	TABLE ANGLE (Degree)	RAW VALUE (dBuV)	CORRECTION FACTOR (dB/m)
1	2390.00	66.0 PK	74.0	-8.0	1.76 V	206	66.16	-0.16
2	2390.00	53.1 AV	54.0	-0.9	1.76 V	206	53.26	-0.16
3	*2412.00	107.8 PK			1.76 V	206	107.90	-0.10
4	*2412.00	105.4 AV			1.76 V	206	105.50	-0.10
5	4824.00	48.6 PK	74.0	-25.4	1.81 V	320	39.84	8.76
6	4824.00	36.2 AV	54.0	-17.8	1.81 V	320	27.44	8.76

REMARKS:

1. Emission Level(dBuV/m) = Raw Value(dBuV) + Correction Factor(dB/m)
2. Correction Factor(dB/m) = Antenna Factor(dB/m) + Cable Factor(dB) – Pre-Amplifier Factor(dB)
3. The other emission levels were very low against the limit.
4. Margin value = Emission Level – Limit value
5. " * ": Fundamental frequency.

CHANNEL	TX Channel 6	DETECTOR FUNCTION	Peak (PK)
FREQUENCY RANGE	1GHz ~ 25GHz		Average (AV)

ANTENNA POLARITY & TEST DISTANCE: HORIZONTAL AT 3 M

NO.	FREQ. (MHz)	EMISSION LEVEL (dBuV/m)	LIMIT (dBuV/m)	MARGIN (dB)	ANTENNA HEIGHT (m)	TABLE ANGLE (Degree)	RAW VALUE (dBuV)	CORRECTION FACTOR (dB/m)
1	2390.00	54.5 PK	74.0	-19.5	1.28 H	176	54.66	-0.16
2	2390.00	45.4 AV	54.0	-8.6	1.28 H	176	45.56	-0.16
3	*2437.00	113.4 PK			1.31 H	176	113.43	-0.03
4	*2437.00	100.1 AV			1.31 H	176	100.13	-0.03
5	2483.50	60.1 PK	74.0	-13.9	1.38 H	176	59.99	0.11
6	2483.50	43.4 AV	54.0	-10.6	1.38 H	176	43.29	0.11
7	4874.00	48.3 PK	74.0	-25.7	1.53 H	115	39.39	8.91
8	4874.00	36.3 AV	54.0	-17.7	1.53 H	115	27.39	8.91
9	7311.00	56.1 PK	74.0	-17.9	1.55 H	127	39.65	16.45
10	7311.00	43.8 AV	54.0	-10.2	1.55 H	127	27.35	16.45

ANTENNA POLARITY & TEST DISTANCE: VERTICAL AT 3 M

NO.	FREQ. (MHz)	EMISSION LEVEL (dBuV/m)	LIMIT (dBuV/m)	MARGIN (dB)	ANTENNA HEIGHT (m)	TABLE ANGLE (Degree)	RAW VALUE (dBuV)	CORRECTION FACTOR (dB/m)
1	2390.00	66.4 PK	74.0	-7.6	1.63 V	185	66.56	-0.16
2	2390.00	53.7 AV	54.0	-0.3	1.63 V	185	53.86	-0.16
3	*2437.00	115.3 PK			1.63 V	185	115.33	-0.03
4	*2437.00	112.7 AV			1.63 V	185	112.73	-0.03
5	2483.50	64.8 PK	74.0	-9.2	1.63 V	185	64.69	0.11
6	2483.50	47.2 AV	54.0	-6.8	1.63 V	185	47.09	0.11
7	4874.00	48.2 PK	74.0	-25.8	1.55 V	72	39.29	8.91
8	4874.00	36.5 AV	54.0	-17.5	1.55 V	72	27.59	8.91
9	7311.00	56.0 PK	74.0	-18.0	1.53 V	84	39.55	16.45
10	7311.00	43.6 AV	54.0	-10.4	1.53 V	84	27.15	16.45

REMARKS:

1. Emission Level(dBuV/m) = Raw Value(dBuV) + Correction Factor(dB/m)
2. Correction Factor(dB/m) = Antenna Factor(dB/m) + Cable Factor(dB) – Pre-Amplifier Factor(dB)
3. The other emission levels were very low against the limit.
4. Margin value = Emission Level – Limit value
5. " * ": Fundamental frequency.



CHANNEL	TX Channel 11	DETECTOR FUNCTION	Peak (PK)
FREQUENCY RANGE	1GHz ~ 25GHz		Average (AV)

ANTENNA POLARITY & TEST DISTANCE: HORIZONTAL AT 3 M

NO.	FREQ. (MHz)	EMISSION LEVEL (dBuV/m)	LIMIT (dBuV/m)	MARGIN (dB)	ANTENNA HEIGHT (m)	TABLE ANGLE (Degree)	RAW VALUE (dBuV)	CORRECTION FACTOR (dB/m)
1	*2462.00	100.3 PK			1.26 H	138	100.25	0.05
2	*2462.00	95.4 AV			1.26 H	138	95.35	0.05
3	2483.50	63.2 PK	74.0	-10.8	1.17 H	123	63.09	0.11
4	2483.50	45.3 AV	54.0	-8.7	1.17 H	123	45.19	0.11
5	4924.00	48.4 PK	74.0	-25.6	1.47 H	2	39.31	9.09
6	4924.00	35.7 AV	54.0	-18.3	1.47 H	2	26.61	9.09
7	7386.00	55.1 PK	74.0	-18.9	1.34 H	54	38.50	16.60
8	7386.00	43.4 AV	54.0	-10.6	1.34 H	54	26.80	16.60

ANTENNA POLARITY & TEST DISTANCE: VERTICAL AT 3 M

NO.	FREQ. (MHz)	EMISSION LEVEL (dBuV/m)	LIMIT (dBuV/m)	MARGIN (dB)	ANTENNA HEIGHT (m)	TABLE ANGLE (Degree)	RAW VALUE (dBuV)	CORRECTION FACTOR (dB/m)
1	*2462.00	110.6 PK			1.44 V	360	110.55	0.05
2	*2462.00	107.6 AV			1.44 V	360	107.55	0.05
3	4924.00	46.6 PK	74.0	-27.4	1.69 V	198	37.51	9.09
4	4924.00	34.2 AV	54.0	-19.8	1.69 V	198	25.11	9.09
5	7386.00	53.2 PK	74.0	-20.8	1.69 V	312	36.60	16.60
6	7386.00	41.0 AV	54.0	-13.0	1.69 V	312	24.40	16.60

REMARKS:

1. Emission Level(dBuV/m) = Raw Value(dBuV) + Correction Factor(dB/m)
2. Correction Factor(dB/m) = Antenna Factor(dB/m) + Cable Factor(dB) – Pre-Amplifier Factor(dB)
3. The other emission levels were very low against the limit.
4. Margin value = Emission Level – Limit value
5. " * ": Fundamental frequency.

802.11g

CHANNEL	TX Channel 1	DETECTOR FUNCTION	Peak (PK)
FREQUENCY RANGE	1GHz ~ 25GHz		Average (AV)

ANTENNA POLARITY & TEST DISTANCE: HORIZONTAL AT 3 M								
NO.	FREQ. (MHz)	EMISSION LEVEL (dBuV/m)	LIMIT (dBuV/m)	MARGIN (dB)	ANTENNA HEIGHT (m)	TABLE ANGLE (Degree)	RAW VALUE (dBuV)	CORRECTION FACTOR (dB/m)
1	2390.00	63.2 PK	74.0	-10.8	1.28 H	231	63.36	-0.16
2	2390.00	47.3 AV	54.0	-6.7	1.28 H	231	47.46	-0.16
3	*2412.00	100.2 PK			1.28 H	231	100.30	-0.10
4	*2412.00	90.2 AV			1.28 H	231	90.30	-0.10
5	4824.00	46.5 PK	74.0	-27.5	1.78 H	43	37.74	8.76
6	4824.00	36.4 AV	54.0	-17.6	1.78 H	43	27.64	8.76

ANTENNA POLARITY & TEST DISTANCE: VERTICAL AT 3 M								
NO.	FREQ. (MHz)	EMISSION LEVEL (dBuV/m)	LIMIT (dBuV/m)	MARGIN (dB)	ANTENNA HEIGHT (m)	TABLE ANGLE (Degree)	RAW VALUE (dBuV)	CORRECTION FACTOR (dB/m)
1	2390.00	70.0 PK	74.0	-4.0	1.80 V	208	70.16	-0.16
2	2390.00	53.8 AV	54.0	-0.2	1.80 V	208	53.96	-0.16
3	*2412.00	110.4 PK			1.80 V	209	110.50	-0.10
4	*2412.00	99.3 AV			1.80 V	209	99.40	-0.10
5	4824.00	48.2 PK	74.0	-25.8	1.34 V	201	39.44	8.76
6	4824.00	38.5 AV	54.0	-15.5	1.34 V	201	29.74	8.76

REMARKS:

1. Emission Level(dBuV/m) = Raw Value(dBuV) + Correction Factor(dB/m)
2. Correction Factor(dB/m) = Antenna Factor(dB/m) + Cable Factor(dB) – Pre-Amplifier Factor(dB)
3. The other emission levels were very low against the limit.
4. Margin value = Emission Level – Limit value
5. " * ": Fundamental frequency.

CHANNEL	TX Channel 6	DETECTOR FUNCTION	Peak (PK)
FREQUENCY RANGE	1GHz ~ 25GHz		Average (AV)

ANTENNA POLARITY & TEST DISTANCE: HORIZONTAL AT 3 M

NO.	FREQ. (MHz)	EMISSION LEVEL (dBuV/m)	LIMIT (dBuV/m)	MARGIN (dB)	ANTENNA HEIGHT (m)	TABLE ANGLE (Degree)	RAW VALUE (dBuV)	CORRECTION FACTOR (dB/m)
1	2390.00	64.2 PK	74.0	-9.8	1.24 H	213	64.36	-0.16
2	2390.00	45.4 AV	54.0	-8.6	1.24 H	213	45.56	-0.16
3	*2437.00	108.1 PK			1.24 H	213	108.13	-0.03
4	*2437.00	99.2 AV			1.24 H	213	99.23	-0.03
5	2483.50	65.6 PK	74.0	-8.4	1.24 H	213	65.49	0.11
6	2483.50	44.2 AV	54.0	-9.8	1.24 H	213	44.09	0.11
7	4874.00	48.3 PK	74.0	-25.7	1.44 H	0	39.39	8.91
8	4874.00	35.8 AV	54.0	-18.2	1.44 H	0	26.89	8.91
9	7311.00	55.1 PK	74.0	-18.9	1.36 H	54	38.65	16.45
10	7311.00	43.6 AV	54.0	-10.4	1.36 H	54	27.15	16.45

ANTENNA POLARITY & TEST DISTANCE: VERTICAL AT 3 M

NO.	FREQ. (MHz)	EMISSION LEVEL (dBuV/m)	LIMIT (dBuV/m)	MARGIN (dB)	ANTENNA HEIGHT (m)	TABLE ANGLE (Degree)	RAW VALUE (dBuV)	CORRECTION FACTOR (dB/m)
1	2390.00	73.6 PK	74.0	-0.4	1.71 V	109	73.76	-0.16
2	2390.00	53.5 AV	54.0	-0.5	1.71 V	109	53.66	-0.16
3	*2437.00	118.3 PK			1.65 V	110	118.33	-0.03
4	*2437.00	107.1 AV			1.65 V	110	107.13	-0.03
5	2483.50	72.2 PK	74.0	-1.8	1.65 V	110	72.09	0.11
6	2483.50	53.0 AV	54.0	-1.0	1.65 V	110	52.89	0.11
7	4874.00	47.3 PK	74.0	-26.7	1.69 V	187	38.39	8.91
8	4874.00	34.7 AV	54.0	-19.3	1.69 V	187	25.79	8.91
9	7311.00	53.9 PK	74.0	-20.1	1.67 V	292	37.45	16.45
10	7311.00	41.4 AV	54.0	-12.6	1.67 V	292	24.95	16.45

REMARKS:

1. Emission Level(dBuV/m) = Raw Value(dBuV) + Correction Factor(dB/m)
2. Correction Factor(dB/m) = Antenna Factor(dB/m) + Cable Factor(dB) – Pre-Amplifier Factor(dB)
3. The other emission levels were very low against the limit.
4. Margin value = Emission Level – Limit value
5. " * ": Fundamental frequency.

CHANNEL	TX Channel 11	DETECTOR FUNCTION	Peak (PK)
FREQUENCY RANGE	1GHz ~ 25GHz		Average (AV)

ANTENNA POLARITY & TEST DISTANCE: HORIZONTAL AT 3 M

NO.	FREQ. (MHz)	EMISSION LEVEL (dBuV/m)	LIMIT (dBuV/m)	MARGIN (dB)	ANTENNA HEIGHT (m)	TABLE ANGLE (Degree)	RAW VALUE (dBuV)	CORRECTION FACTOR (dB/m)
1	*2462.00	103.4 PK			1.35 H	342	103.35	0.05
2	*2462.00	90.5 AV			1.35 H	342	90.45	0.05
3	2483.50	63.2 PK	74.0	-10.8	1.34 H	342	63.09	0.11
4	2483.50	46.4 AV	54.0	-7.6	1.34 H	342	46.29	0.11
5	4924.00	48.1 PK	74.0	-25.9	1.48 H	0	39.01	9.09
6	4924.00	35.7 AV	54.0	-18.3	1.48 H	0	26.61	9.09
7	7386.00	55.4 PK	74.0	-18.6	1.30 H	40	38.80	16.60
8	7386.00	43.8 AV	54.0	-10.2	1.30 H	40	27.20	16.60

ANTENNA POLARITY & TEST DISTANCE: VERTICAL AT 3 M

NO.	FREQ. (MHz)	EMISSION LEVEL (dBuV/m)	LIMIT (dBuV/m)	MARGIN (dB)	ANTENNA HEIGHT (m)	TABLE ANGLE (Degree)	RAW VALUE (dBuV)	CORRECTION FACTOR (dB/m)
1	*2462.00	111.0 PK			1.60 V	141	110.95	0.05
2	*2462.00	99.1 AV			1.60 V	141	99.05	0.05
3	2483.50	70.2 PK	74.0	-3.8	1.60 V	141	70.09	0.11
4	2483.50	53.5 AV	54.0	-0.5	1.60 V	141	53.39	0.11
5	4924.00	47.0 PK	74.0	-27.0	1.63 V	197	37.91	9.09
6	4924.00	34.4 AV	54.0	-19.6	1.63 V	197	25.31	9.09
7	7386.00	53.1 PK	74.0	-20.9	1.70 V	304	36.50	16.60
8	7386.00	41.0 AV	54.0	-13.0	1.70 V	304	24.40	16.60

REMARKS:

1. Emission Level(dBuV/m) = Raw Value(dBuV) + Correction Factor(dB/m)
2. Correction Factor(dB/m) = Antenna Factor(dB/m) + Cable Factor(dB) – Pre-Amplifier Factor(dB)
3. The other emission levels were very low against the limit.
4. Margin value = Emission Level – Limit value
5. " * ": Fundamental frequency.

802.11n (HT20)

CHANNEL	TX Channel 1	DETECTOR FUNCTION	Peak (PK)
FREQUENCY RANGE	1GHz ~ 25GHz		Average (AV)

ANTENNA POLARITY & TEST DISTANCE: HORIZONTAL AT 3 M								
NO.	FREQ. (MHz)	EMISSION LEVEL (dBuV/m)	LIMIT (dBuV/m)	MARGIN (dB)	ANTENNA HEIGHT (m)	TABLE ANGLE (Degree)	RAW VALUE (dBuV)	CORRECTION FACTOR (dB/m)
1	2390.00	61.5 PK	74.0	-12.5	1.46 H	311	61.66	-0.16
2	2390.00	42.6 AV	54.0	-11.4	1.46 H	311	42.76	-0.16
3	*2412.00	101.5 PK			1.46 H	311	101.60	-0.10
4	*2412.00	91.2 AV			1.46 H	311	91.30	-0.10
5	4824.00	48.5 PK	74.0	-25.5	1.45 H	121	39.74	8.76
6	4824.00	35.9 AV	54.0	-18.1	1.45 H	121	27.14	8.76

ANTENNA POLARITY & TEST DISTANCE: VERTICAL AT 3 M								
NO.	FREQ. (MHz)	EMISSION LEVEL (dBuV/m)	LIMIT (dBuV/m)	MARGIN (dB)	ANTENNA HEIGHT (m)	TABLE ANGLE (Degree)	RAW VALUE (dBuV)	CORRECTION FACTOR (dB/m)
1	2390.00	69.6 PK	74.0	-4.4	1.75 V	222	69.76	-0.16
2	2390.00	53.4 AV	54.0	-0.6	1.75 V	222	53.56	-0.16
3	*2412.00	109.8 PK			1.80 V	203	109.90	-0.10
4	*2412.00	98.9 AV			1.80 V	203	99.00	-0.10
5	4824.00	47.0 PK	74.0	-27.0	1.64 V	203	38.24	8.76
6	4824.00	34.5 AV	54.0	-19.5	1.64 V	203	25.74	8.76

REMARKS:

1. Emission Level(dBuV/m) = Raw Value(dBuV) + Correction Factor(dB/m)
2. Correction Factor(dB/m) = Antenna Factor(dB/m) + Cable Factor(dB) – Pre-Amplifier Factor(dB)
3. The other emission levels were very low against the limit.
4. Margin value = Emission Level – Limit value
5. " * ": Fundamental frequency.

CHANNEL	TX Channel 6	DETECTOR FUNCTION	Peak (PK)
FREQUENCY RANGE	1GHz ~ 25GHz		Average (AV)

ANTENNA POLARITY & TEST DISTANCE: HORIZONTAL AT 3 M

NO.	FREQ. (MHz)	EMISSION LEVEL (dBuV/m)	LIMIT (dBuV/m)	MARGIN (dB)	ANTENNA HEIGHT (m)	TABLE ANGLE (Degree)	RAW VALUE (dBuV)	CORRECTION FACTOR (dB/m)
1	2390.00	63.5 PK	74.0	-10.5	1.48 H	174	63.66	-0.16
2	2390.00	43.7 AV	54.0	-10.3	1.48 H	174	43.86	-0.16
3	*2437.00	106.0 PK			1.48 H	174	106.03	-0.03
4	*2437.00	98.5 AV			1.48 H	174	98.53	-0.03
5	2483.50	62.4 PK	74.0	-11.6	1.48 H	174	62.29	0.11
6	2483.50	43.1 AV	54.0	-10.9	1.48 H	174	42.99	0.11
7	4874.00	48.8 PK	74.0	-25.2	1.49 H	10	39.89	8.91
8	4874.00	36.1 AV	54.0	-17.9	1.49 H	10	27.19	8.91
9	7311.00	53.6 PK	74.0	-20.4	1.36 H	69	37.15	16.45
10	7311.00	41.9 AV	54.0	-12.1	1.36 H	69	25.45	16.45

ANTENNA POLARITY & TEST DISTANCE: VERTICAL AT 3 M

NO.	FREQ. (MHz)	EMISSION LEVEL (dBuV/m)	LIMIT (dBuV/m)	MARGIN (dB)	ANTENNA HEIGHT (m)	TABLE ANGLE (Degree)	RAW VALUE (dBuV)	CORRECTION FACTOR (dB/m)
1	2390.00	73.5 PK	74.0	-0.5	1.73 V	119	73.66	-0.16
2	2390.00	53.2 AV	54.0	-0.8	1.73 V	119	53.36	-0.16
3	*2437.00	117.5 PK			1.63 V	116	117.53	-0.03
4	*2437.00	106.1 AV			1.63 V	116	106.13	-0.03
5	2483.50	72.7 PK	74.0	-1.3	1.60 V	111	72.59	0.11
6	2483.50	53.5 AV	54.0	-0.5	1.60 V	111	53.39	0.11
7	4874.00	47.0 PK	74.0	-27.0	1.68 V	200	38.09	8.91
8	4874.00	34.4 AV	54.0	-19.6	1.68 V	200	25.49	8.91
9	7311.00	53.7 PK	74.0	-20.3	1.67 V	298	37.25	16.45
10	7311.00	41.5 AV	54.0	-12.5	1.67 V	298	25.05	16.45

REMARKS:

1. Emission Level(dBuV/m) = Raw Value(dBuV) + Correction Factor(dB/m)
2. Correction Factor(dB/m) = Antenna Factor(dB/m) + Cable Factor(dB) – Pre-Amplifier Factor(dB)
3. The other emission levels were very low against the limit.
4. Margin value = Emission Level – Limit value
5. " * ": Fundamental frequency.

CHANNEL	TX Channel 11	DETECTOR FUNCTION	Peak (PK)
FREQUENCY RANGE	1GHz ~ 25GHz		Average (AV)

ANTENNA POLARITY & TEST DISTANCE: HORIZONTAL AT 3 M

NO.	FREQ. (MHz)	EMISSION LEVEL (dBuV/m)	LIMIT (dBuV/m)	MARGIN (dB)	ANTENNA HEIGHT (m)	TABLE ANGLE (Degree)	RAW VALUE (dBuV)	CORRECTION FACTOR (dB/m)
1	*2462.00	102.4 PK			1.32 H	243	102.35	0.05
2	*2462.00	91.2 AV			1.32 H	243	91.15	0.05
3	2483.50	65.7 PK	74.0	-8.3	1.32 H	243	65.59	0.11
4	2483.50	45.5 AV	54.0	-8.5	1.32 H	243	45.39	0.11
5	4924.00	48.6 PK	74.0	-25.4	1.52 H	212	39.51	9.09
6	4924.00	36.1 AV	54.0	-17.9	1.52 H	212	27.01	9.09
7	7386.00	55.7 PK	74.0	-18.3	1.40 H	124	39.10	16.60
8	7386.00	43.8 AV	54.0	-10.2	1.40 H	124	27.20	16.60

ANTENNA POLARITY & TEST DISTANCE: VERTICAL AT 3 M

NO.	FREQ. (MHz)	EMISSION LEVEL (dBuV/m)	LIMIT (dBuV/m)	MARGIN (dB)	ANTENNA HEIGHT (m)	TABLE ANGLE (Degree)	RAW VALUE (dBuV)	CORRECTION FACTOR (dB/m)
1	*2462.00	111.2 PK			1.63 V	156	111.15	0.05
2	*2462.00	99.5 AV			1.63 V	156	99.45	0.05
3	2483.50	70.1 PK	74.0	-3.9	1.63 V	153	69.99	0.11
4	2483.50	53.6 AV	54.0	-0.4	1.63 V	153	53.49	0.11
5	4924.00	46.6 PK	74.0	-27.4	1.70 V	192	37.51	9.09
6	4924.00	33.9 AV	54.0	-20.1	1.70 V	192	24.81	9.09
7	7386.00	53.5 PK	74.0	-20.5	1.71 V	298	36.90	16.60
8	7386.00	41.0 AV	54.0	-13.0	1.71 V	298	24.40	16.60

REMARKS:

1. Emission Level(dBuV/m) = Raw Value(dBuV) + Correction Factor(dB/m)
2. Correction Factor(dB/m) = Antenna Factor(dB/m) + Cable Factor(dB) – Pre-Amplifier Factor(dB)
3. The other emission levels were very low against the limit.
4. Margin value = Emission Level – Limit value
5. " * ": Fundamental frequency.

802.11n (HT40)

CHANNEL	TX Channel 3	DETECTOR FUNCTION	Peak (PK)
FREQUENCY RANGE	1GHz ~ 25GHz		Average (AV)

ANTENNA POLARITY & TEST DISTANCE: HORIZONTAL AT 3 M								
NO.	FREQ. (MHz)	EMISSION LEVEL (dBuV/m)	LIMIT (dBuV/m)	MARGIN (dB)	ANTENNA HEIGHT (m)	TABLE ANGLE (Degree)	RAW VALUE (dBuV)	CORRECTION FACTOR (dB/m)
1	2390.00	64.8 PK	74.0	-9.2	1.18 H	158	64.96	-0.16
2	2390.00	44.8 AV	54.0	-9.2	1.18 H	158	44.96	-0.16
3	*2422.00	95.1 PK			1.18 H	158	95.18	-0.08
4	*2422.00	86.4 AV			1.18 H	158	86.48	-0.08
5	4844.00	47.7 PK	74.0	-26.3	1.42 H	221	38.88	8.82
6	4844.00	35.2 AV	54.0	-18.8	1.42 H	221	26.38	8.82
7	7266.00	55.4 PK	74.0	-18.6	1.32 H	41	38.79	16.61
8	7266.00	43.7 AV	54.0	-10.3	1.32 H	41	27.09	16.61

ANTENNA POLARITY & TEST DISTANCE: VERTICAL AT 3 M								
NO.	FREQ. (MHz)	EMISSION LEVEL (dBuV/m)	LIMIT (dBuV/m)	MARGIN (dB)	ANTENNA HEIGHT (m)	TABLE ANGLE (Degree)	RAW VALUE (dBuV)	CORRECTION FACTOR (dB/m)
1	2390.00	70.1 PK	74.0	-3.9	1.62 V	117	70.26	-0.16
2	2390.00	53.9 AV	54.0	-0.1	1.62 V	117	54.06	-0.16
3	*2422.00	104.5 PK			1.68 V	112	104.58	-0.08
4	*2422.00	93.6 AV			1.68 V	112	93.68	-0.08
5	4844.00	47.6 PK	74.0	-26.4	1.68 V	210	38.78	8.82
6	4844.00	34.7 AV	54.0	-19.3	1.68 V	210	25.88	8.82
7	7266.00	53.6 PK	74.0	-20.4	1.65 V	313	36.99	16.61
8	7266.00	41.2 AV	54.0	-12.8	1.65 V	313	24.59	16.61

REMARKS:

1. Emission Level(dBuV/m) = Raw Value(dBuV) + Correction Factor(dB/m)
2. Correction Factor(dB/m) = Antenna Factor(dB/m) + Cable Factor(dB) – Pre-Amplifier Factor(dB)
3. The other emission levels were very low against the limit.
4. Margin value = Emission Level – Limit value
5. " * ": Fundamental frequency.

CHANNEL	TX Channel 6	DETECTOR FUNCTION	Peak (PK)
FREQUENCY RANGE	1GHz ~ 25GHz		Average (AV)

ANTENNA POLARITY & TEST DISTANCE: HORIZONTAL AT 3 M

NO.	FREQ. (MHz)	EMISSION LEVEL (dBuV/m)	LIMIT (dBuV/m)	MARGIN (dB)	ANTENNA HEIGHT (m)	TABLE ANGLE (Degree)	RAW VALUE (dBuV)	CORRECTION FACTOR (dB/m)
1	2390.00	65.1 PK	74.0	-8.9	1.24 H	154	65.26	-0.16
2	2390.00	42.8 AV	54.0	-11.2	1.24 H	154	42.96	-0.16
3	*2437.00	98.6 PK			1.24 H	154	98.63	-0.03
4	*2437.00	90.2 AV			1.24 H	154	90.23	-0.03
5	2483.50	62.2 PK	74.0	-11.8	1.24 H	154	62.09	0.11
6	2483.50	41.6 AV	54.0	-12.4	1.24 H	154	41.49	0.11
7	4874.00	45.2 PK	74.0	-28.8	1.45 H	153	36.29	8.91
8	4874.00	35.7 AV	54.0	-18.3	1.45 H	153	26.79	8.91
9	7311.00	55.5 PK	74.0	-18.5	1.33 H	49	39.05	16.45
10	7311.00	43.6 AV	54.0	-10.4	1.33 H	49	27.15	16.45

ANTENNA POLARITY & TEST DISTANCE: VERTICAL AT 3 M

NO.	FREQ. (MHz)	EMISSION LEVEL (dBuV/m)	LIMIT (dBuV/m)	MARGIN (dB)	ANTENNA HEIGHT (m)	TABLE ANGLE (Degree)	RAW VALUE (dBuV)	CORRECTION FACTOR (dB/m)
1	2390.00	70.9 PK	74.0	-3.1	1.62 V	111	71.06	-0.16
2	2390.00	53.2 AV	54.0	-0.8	1.62 V	111	53.36	-0.16
3	*2437.00	108.9 PK			1.62 V	111	108.93	-0.03
4	*2437.00	97.3 AV			1.62 V	111	97.33	-0.03
5	2483.50	66.8 PK	74.0	-7.2	1.66 V	112	66.69	0.11
6	2483.50	50.5 AV	54.0	-3.5	1.66 V	112	50.39	0.11
7	4874.00	46.9 PK	74.0	-27.1	1.73 V	205	37.99	8.91
8	4874.00	34.3 AV	54.0	-19.7	1.73 V	205	25.39	8.91
9	7311.00	53.3 PK	74.0	-20.7	1.64 V	300	36.85	16.45
10	7311.00	41.0 AV	54.0	-13.0	1.64 V	300	24.55	16.45

REMARKS:

1. Emission Level(dBuV/m) = Raw Value(dBuV) + Correction Factor(dB/m)
2. Correction Factor(dB/m) = Antenna Factor(dB/m) + Cable Factor(dB) – Pre-Amplifier Factor(dB)
3. The other emission levels were very low against the limit.
4. Margin value = Emission Level – Limit value
5. " * ": Fundamental frequency.



CHANNEL	TX Channel 9	DETECTOR FUNCTION	Peak (PK)
FREQUENCY RANGE	1GHz ~ 25GHz		Average (AV)

ANTENNA POLARITY & TEST DISTANCE: HORIZONTAL AT 3 M

NO.	FREQ. (MHz)	EMISSION LEVEL (dBuV/m)	LIMIT (dBuV/m)	MARGIN (dB)	ANTENNA HEIGHT (m)	TABLE ANGLE (Degree)	RAW VALUE (dBuV)	CORRECTION FACTOR (dB/m)
1	*2452.00	98.2 PK			1.21 H	158	98.18	0.02
2	*2452.00	85.5 AV			1.21 H	158	85.48	0.02
3	2483.50	60.2 PK	74.0	-13.8	1.21 H	158	60.09	0.11
4	2483.50	45.7 AV	54.0	-8.3	1.21 H	158	45.59	0.11
5	4904.00	48.3 PK	74.0	-25.7	1.43 H	54	39.29	9.01
6	4904.00	35.3 AV	54.0	-18.7	1.43 H	54	26.29	9.01
7	7356.00	55.1 PK	74.0	-18.9	1.38 H	56	38.55	16.55
8	7356.00	43.5 AV	54.0	-10.5	1.38 H	56	26.95	16.55

ANTENNA POLARITY & TEST DISTANCE: VERTICAL AT 3 M

NO.	FREQ. (MHz)	EMISSION LEVEL (dBuV/m)	LIMIT (dBuV/m)	MARGIN (dB)	ANTENNA HEIGHT (m)	TABLE ANGLE (Degree)	RAW VALUE (dBuV)	CORRECTION FACTOR (dB/m)
1	*2452.00	107.2 PK			1.74 V	112	107.18	0.02
2	*2452.00	96.7 AV			1.74 V	112	96.68	0.02
3	2483.50	70.6 PK	74.0	-3.4	1.74 V	112	70.49	0.11
4	2483.50	53.2 AV	54.0	-0.8	1.74 V	112	53.09	0.11
5	4904.00	46.9 PK	74.0	-27.1	1.64 V	184	37.89	9.01
6	4904.00	34.1 AV	54.0	-19.9	1.64 V	184	25.09	9.01
7	7356.00	53.4 PK	74.0	-20.6	1.72 V	297	36.85	16.55
8	7356.00	41.4 AV	54.0	-12.6	1.72 V	297	24.85	16.55

REMARKS:

1. Emission Level(dBuV/m) = Raw Value(dBuV) + Correction Factor(dB/m)
2. Correction Factor(dB/m) = Antenna Factor(dB/m) + Cable Factor(dB) – Pre-Amplifier Factor(dB)
3. The other emission levels were very low against the limit.
4. Margin value = Emission Level – Limit value
5. " * ": Fundamental frequency.

Below 1GHz Data:

802.11g

CHANNEL	TX Channel 6	DETECTOR FUNCTION	Quasi-Peak (QP)
FREQUENCY RANGE	Below 1GHz		

ANTENNA POLARITY & TEST DISTANCE: HORIZONTAL AT 3 M

NO.	FREQ. (MHz)	EMISSION LEVEL (dBuV/m)	LIMIT (dBuV/m)	MARGIN (dB)	ANTENNA HEIGHT (m)	TABLE ANGLE (Degree)	RAW VALUE (dBuV)	CORRECTION FACTOR (dB/m)
1	116.43	36.2 QP	43.5	-7.3	1.00 H	86	51.51	-15.30
2	182.63	33.8 QP	43.5	-9.7	1.00 H	335	48.60	-14.79
3	217.65	38.9 QP	46.0	-7.1	1.50 H	251	54.74	-15.82
4	267.02	34.0 QP	46.0	-12.0	1.50 H	210	47.26	-13.29
5	328.03	32.1 QP	46.0	-13.9	2.00 H	21	43.25	-11.14
6	904.41	32.1 QP	46.0	-13.9	1.50 H	4	31.25	0.89

ANTENNA POLARITY & TEST DISTANCE: VERTICAL AT 3 M

NO.	FREQ. (MHz)	EMISSION LEVEL (dBuV/m)	LIMIT (dBuV/m)	MARGIN (dB)	ANTENNA HEIGHT (m)	TABLE ANGLE (Degree)	RAW VALUE (dBuV)	CORRECTION FACTOR (dB/m)
1	37.37	34.2 QP	40.0	-5.8	1.50 V	343	48.02	-13.79
2	86.02	35.6 QP	40.0	-4.4	1.50 V	360	54.28	-18.69
3	108.81	33.0 QP	43.5	-10.5	1.00 V	85	49.09	-16.07
4	219.83	34.4 QP	46.0	-11.6	1.50 V	176	50.11	-15.75
5	270.71	32.6 QP	46.0	-13.4	1.50 V	280	45.68	-13.07
6	361.74	33.7 QP	46.0	-12.3	1.50 V	2	44.11	-10.43

REMARKS:

1. Emission Level(dBuV/m) = Raw Value(dBuV) + Correction Factor(dB/m)
2. Correction Factor(dB/m) = Antenna Factor(dB/m) + Cable Factor(dB) – Pre-Amplifier Factor(dB)
3. The other emission levels were very low against the limit.
4. Margin value = Emission Level – Limit value

4.2 Conducted Emission Measurement

4.2.1 Limits of Conducted Emission Measurement

Frequency (MHz)	Conducted Limit (dBuV)	
	Quasi-peak	Average
0.15 - 0.5	66 - 56	56 - 46
0.50 - 5.0	56	46
5.0 - 30.0	60	50

Note: 1. The lower limit shall apply at the transition frequencies.

2. The limit decreases in line with the logarithm of the frequency in the range of 0.15 to 0.50MHz.

4.2.2 Test Instruments

DESCRIPTION & MANUFACTURER	MODEL NO.	SERIAL NO.	CALIBRATED DATE	CALIBRATED UNTIL
Test Receiver ROHDE & SCHWARZ	ESCS 30	100375	May 06, 2015	May 05, 2016
Line-Impedance Stabilization Network (for EUT) SCHWARZBECK	NSLK-8127	8127-522	Sep. 15, 2014	Sep. 14, 2015
Line-Impedance Stabilization Network (for Peripheral) ROHDE & SCHWARZ	ENV216	100071	Nov. 10, 2014	Nov. 09, 2015
RF Cable (JYEBAO)	5D-FB	COCCAB-001	Mar. 09, 2015	Mar. 08, 2016
50 ohms Terminator	N/A	EMC-03	Sep. 22, 2014	Sep. 21, 2015
50 ohms Terminator	N/A	EMC-02	Sep. 30, 2014	Sep. 29, 2015
Software ADT	BV ADT_Cond_V7.3.7.3	NA	NA	NA

Note:

1. The calibration interval of the above test instruments is 12 months and the calibrations are traceable to NML/ROC and NIST/USA.
2. The test was performed in Shielded Room No. C.
3. The VCCI Con C Registration No. is C-3611.
4. Tested Date: May 18, 2015

4.2.3 Test Procedures

- a. The EUT was placed 0.4 meters from the conducting wall of the shielded room with EUT being connected to the power mains through a line impedance stabilization network (LISN). Other support units were connected to the power mains through another LISN. The two LISNs provide 50 ohm/ 50uH of coupling impedance for the measuring instrument.
- b. Both lines of the power mains connected to the EUT were checked for maximum conducted interference.
- c. The frequency range from 150kHz to 30MHz was searched. Emission levels under (Limit - 20dB) was not recorded.

NOTE: The resolution bandwidth and video bandwidth of test receiver is 9kHz for quasi-peak detection (QP) and average detection (AV) at frequency 0.15MHz-30MHz.

4.2.4 Deviation from Test Standard

No deviation.

4.2.5 Test Setup

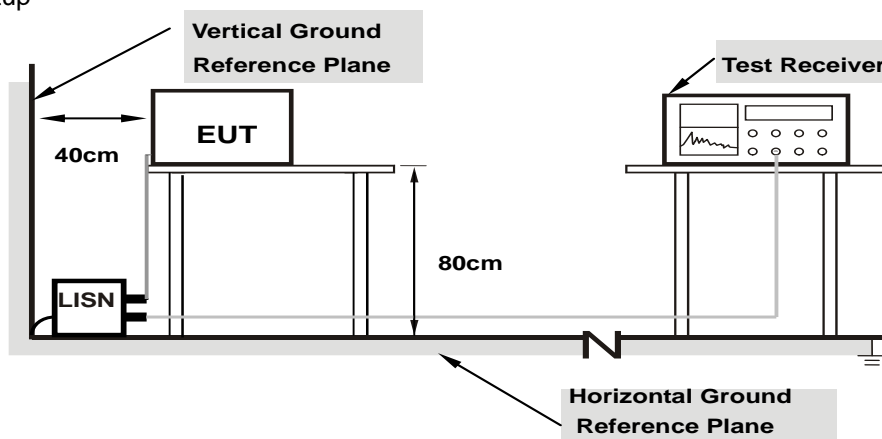

Note: 1.Support units were connected to second LISN.

For the actual test configuration, please refer to the attached file (Test Setup Photo).

4.2.6 EUT Operating Conditions

Same as 4.1.6.

4.2.7 Test Results (Mode 1)

Phase	Line (L)	Detector Function	Quasi-Peak (QP) / Average (AV)
-------	----------	-------------------	--------------------------------

No	Freq. [MHz]	Corr. Factor	Reading Value [dB (uV)]		Emission Level [dB (uV)]		Limit [dB (uV)]		Margin (dB)	
		(dB)	Q.P.	AV.	Q.P.	AV.	Q.P.	AV.	Q.P.	AV.
	1	0.15000	0.08	41.72	30.98	41.80	31.06	66.00	56.00	-24.20
2	0.32578	0.10	36.15	29.35	36.25	29.45	59.56	49.56	-23.31	-20.11
3	2.61328	0.19	27.04	18.11	27.23	18.30	56.00	46.00	-28.77	-27.70
4	5.55078	0.28	29.07	18.55	29.35	18.83	60.00	50.00	-30.65	-31.17
5	24.34766	0.80	39.03	37.02	39.83	37.82	60.00	50.00	-20.17	-12.18
6	29.23438	0.90	38.15	37.51	39.05	38.41	60.00	50.00	-20.95	-11.59

REMARKS:

1. Q.P. and AV. are abbreviations of quasi-peak and average individually.
2. The emission levels of other frequencies were very low against the limit.
3. Margin value = Emission level - Limit value
4. Correction factor = Insertion loss + Cable loss
5. Emission Level = Correction Factor + Reading Value.

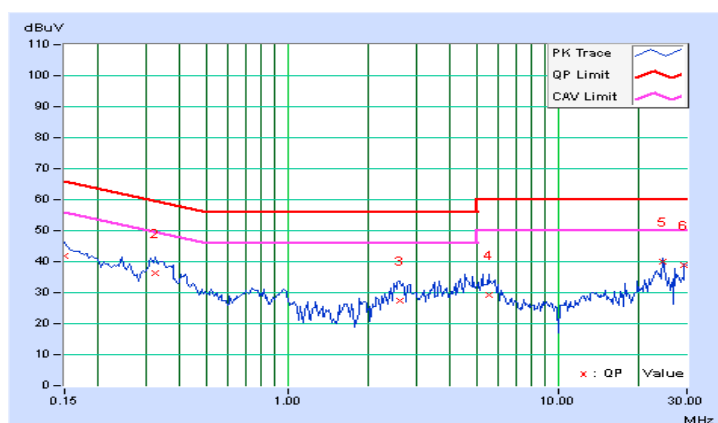

Phase	Neutral (N)	Detector Function	Quasi-Peak (QP) / Average (AV)
-------	-------------	-------------------	--------------------------------

No	Freq. [MHz]	Corr.	Reading Value		Emission Level		Limit		Margin	
		Factor	[dB (uV)]		[dB (uV)]		[dB (uV)]		(dB)	
	(dB)	Q.P.	AV.	Q.P.	AV.	Q.P.	AV.	Q.P.	AV.	
1	0.15000	0.08	41.34	30.75	41.42	30.83	66.00	56.00	-24.58	-25.17
2	0.32969	0.09	31.72	25.64	31.81	25.73	59.46	49.46	-27.65	-23.73
3	2.55078	0.19	27.02	16.39	27.21	16.58	56.00	46.00	-28.79	-29.42
4	5.76953	0.30	31.60	19.84	31.90	20.14	60.00	50.00	-28.10	-29.86
5	12.68750	0.54	29.35	20.99	29.89	21.53	60.00	50.00	-30.11	-28.47
6	23.12806	0.82	44.84	39.22	45.66	40.04	60.00	50.00	-14.34	-9.96

REMARKS:

1. Q.P. and AV. are abbreviations of quasi-peak and average individually.
2. The emission levels of other frequencies were very low against the limit.
3. Margin value = Emission level - Limit value
4. Correction factor = Insertion loss + Cable loss
5. Emission Level = Correction Factor + Reading Value.

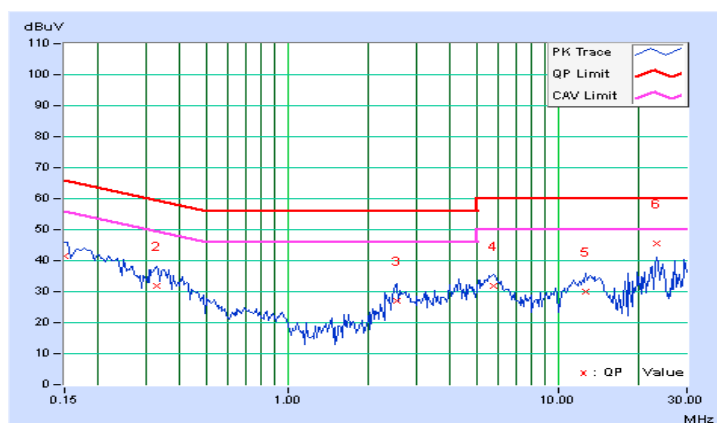

4.2.8 Test Results (Mode 2)

Phase	Line (L)	Detector Function	Quasi-Peak (QP) / Average (AV)
-------	----------	-------------------	--------------------------------

No	Freq. [MHz]	Corr. Factor	Reading Value [dB (uV)]		Emission Level [dB (uV)]		Limit [dB (uV)]		Margin (dB)	
		(dB)	Q.P.	AV.	Q.P.	AV.	Q.P.	AV.	Q.P.	AV.
	1	0.15000	0.08	42.07	31.14	42.15	31.22	66.00	56.00	-23.85
2	0.32969	0.10	36.31	29.83	36.41	29.93	59.46	49.46	-23.05	-19.53
3	0.75547	0.12	24.98	18.58	25.10	18.70	56.00	46.00	-30.90	-27.30
4	2.78906	0.19	26.56	18.48	26.75	18.67	56.00	46.00	-29.25	-27.33
5	5.48438	0.28	29.02	19.01	29.30	19.29	60.00	50.00	-30.70	-30.71
6	24.34766	0.80	39.13	35.77	39.93	36.57	60.00	50.00	-20.07	-13.43

REMARKS:

1. Q.P. and AV. are abbreviations of quasi-peak and average individually.
2. The emission levels of other frequencies were very low against the limit.
3. Margin value = Emission level - Limit value
4. Correction factor = Insertion loss + Cable loss
5. Emission Level = Correction Factor + Reading Value.

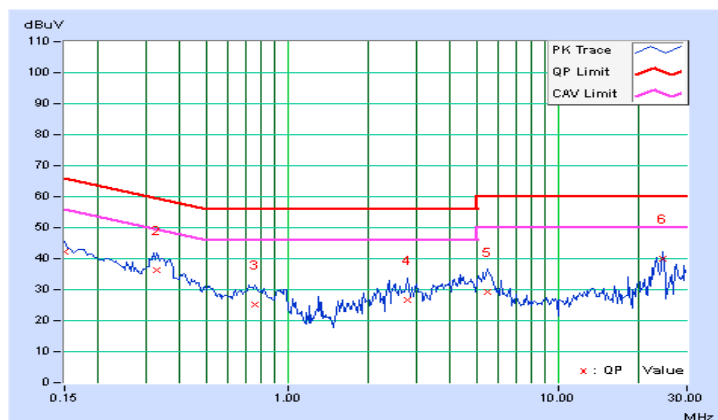

Phase	Neutral (N)	Detector Function	Quasi-Peak (QP) / Average (AV)
-------	-------------	-------------------	--------------------------------

No	Freq. [MHz]	Corr.	Reading Value		Emission Level		Limit		Margin	
		Factor	[dB (uV)]		[dB (uV)]		[dB (uV)]		(dB)	
		(dB)	Q.P.	AV.	Q.P.	AV.	Q.P.	AV.	Q.P.	AV.
1	0.15000	0.08	40.86	29.38	40.94	29.46	66.00	56.00	-25.06	-26.54
2	0.33750	0.09	31.74	25.30	31.83	25.39	59.26	49.26	-27.43	-23.87
3	2.67188	0.19	27.36	15.94	27.55	16.13	56.00	46.00	-28.45	-29.87
4	5.29688	0.28	29.53	18.45	29.81	18.73	60.00	50.00	-30.19	-31.27
5	13.35547	0.55	29.31	20.97	29.86	21.52	60.00	50.00	-30.14	-28.48
6	23.06641	0.81	37.32	34.50	38.13	35.31	60.00	50.00	-21.87	-14.69

REMARKS:

1. Q.P. and AV. are abbreviations of quasi-peak and average individually.
2. The emission levels of other frequencies were very low against the limit.
3. Margin value = Emission level - Limit value
4. Correction factor = Insertion loss + Cable loss
5. Emission Level = Correction Factor + Reading Value.

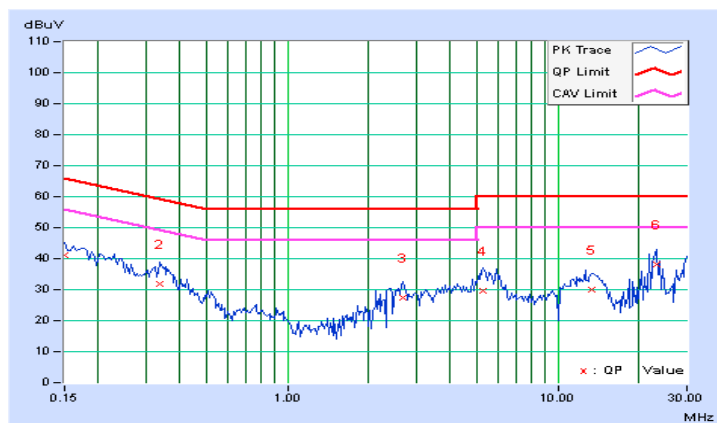

4.2.9 Test Results (Mode 3)

Phase	Line (L)	Detector Function	Quasi-Peak (QP) / Average (AV)
-------	----------	-------------------	--------------------------------

No	Freq. [MHz]	Corr. Factor	Reading Value [dB (uV)]		Emission Level [dB (uV)]		Limit [dB (uV)]		Margin (dB)	
		(dB)	Q.P.	AV.	Q.P.	AV.	Q.P.	AV.	Q.P.	AV.
	1	0.16172	0.08	25.67	16.81	25.75	16.89	65.38	55.38	-39.62
2	0.34141	0.10	25.64	17.49	25.74	17.59	59.17	49.17	-33.43	-31.58
3	0.82188	0.12	31.57	24.48	31.69	24.60	56.00	46.00	-24.31	-21.40
4	2.76563	0.19	34.00	10.69	34.19	10.88	56.00	46.00	-21.81	-35.12
5	11.89453	0.50	33.27	29.13	33.77	29.63	60.00	50.00	-26.23	-20.37
6	29.23438	0.90	35.49	35.04	36.39	35.94	60.00	50.00	-23.61	-14.06

REMARKS:

1. Q.P. and AV. are abbreviations of quasi-peak and average individually.
2. The emission levels of other frequencies were very low against the limit.
3. Margin value = Emission level - Limit value
4. Correction factor = Insertion loss + Cable loss
5. Emission Level = Correction Factor + Reading Value.

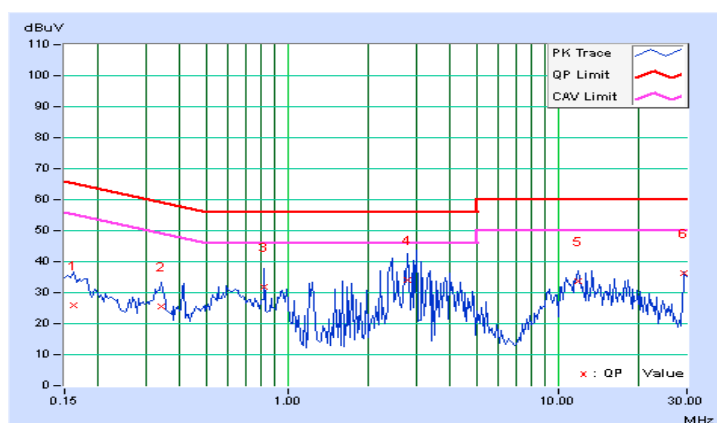

Phase	Neutral (N)	Detector Function	Quasi-Peak (QP) / Average (AV)
-------	-------------	-------------------	--------------------------------

No	Freq. [MHz]	Corr.	Reading Value		Emission Level		Limit		Margin	
		Factor	[dB (uV)]		[dB (uV)]		[dB (uV)]		(dB)	
	(dB)	Q.P.	AV.	Q.P.	AV.	Q.P.	AV.	Q.P.	AV.	
1	0.15000	0.08	27.99	16.48	28.07	16.56	66.00	56.00	-37.93	-39.44
2	0.82578	0.12	35.64	28.17	35.76	28.29	56.00	46.00	-20.24	-17.71
3	2.56641	0.19	36.49	10.64	36.68	10.83	56.00	46.00	-19.32	-35.17
4	4.14453	0.24	31.52	22.98	31.76	23.22	56.00	46.00	-24.24	-22.78
5	11.89063	0.51	32.66	21.19	33.17	21.70	60.00	50.00	-26.83	-28.30
6	29.23438	0.96	35.82	35.30	36.78	36.26	60.00	50.00	-23.22	-13.74

REMARKS:

1. Q.P. and AV. are abbreviations of quasi-peak and average individually.
2. The emission levels of other frequencies were very low against the limit.
3. Margin value = Emission level - Limit value
4. Correction factor = Insertion loss + Cable loss
5. Emission Level = Correction Factor + Reading Value.

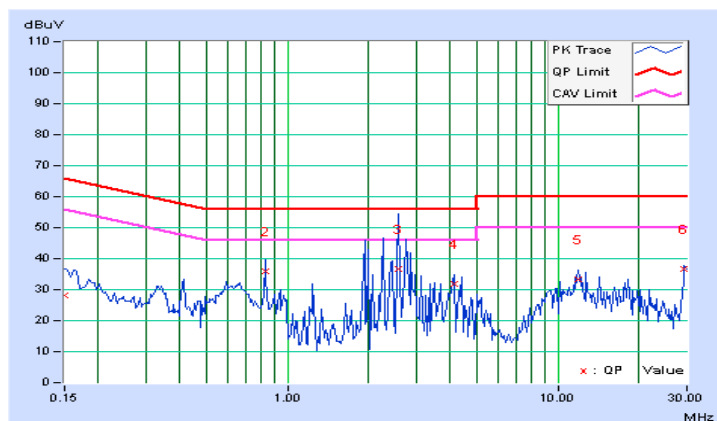

4.3 6dB Bandwidth Measurement

4.3.1 Limits of 6dB Bandwidth Measurement

The minimum of 6dB Bandwidth Measurement is 0.5 MHz.

4.3.2 Test Setup

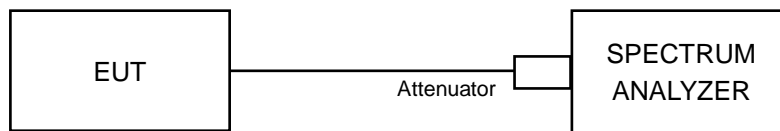

4.3.3 Test Instruments

Refer to section 4.1.2 to get information of above instrument.

4.3.4 Test Procedures

- a. Set resolution bandwidth (RBW) = 100kHz
- b. Set the video bandwidth (VBW) $\geq 3 \times$ RBW, Detector = Peak.
- c. Trace mode = max hold.
- d. Sweep = auto couple.
- e. Measure the maximum width of the emission that is constrained by the frequencies associated with the two amplitude points (upper and lower) that are attenuated by 6 dB relative to the maximum level measured in the fundamental emission

4.3.5 Deviation from Test Standard

No deviation.

4.3.6 EUT Operating Conditions

The software provided by client to enable the EUT under transmission condition continuously at lowest, middle and highest channel frequencies individually.

4.3.7 Test Result

802.11b

Channel	Frequency (MHz)	6dB Bandwidth (MHz)	Minimum Limit (MHz)	Pass / Fail
1	2412	10.14	0.5	PASS
6	2437	10.08	0.5	PASS
11	2462	10.11	0.5	PASS

802.11g

Channel	Frequency (MHz)	6dB Bandwidth (MHz)	Minimum Limit (MHz)	Pass / Fail
1	2412	16.36	0.5	PASS
6	2437	16.11	0.5	PASS
11	2462	16.36	0.5	PASS

802.11n (HT20)

Channel	Frequency (MHz)	6dB Bandwidth (MHz)	Minimum Limit (MHz)	Pass / Fail
1	2412	17.57	0.5	Pass
6	2437	16.57	0.5	Pass
11	2462	17.24	0.5	Pass

802.11n (HT40)

Channel	Frequency (MHz)	6dB Bandwidth (MHz)	Minimum Limit (MHz)	Pass / Fail
3	2422	35.88	0.5	Pass
6	2437	35.48	0.5	Pass
9	2452	35.87	0.5	Pass

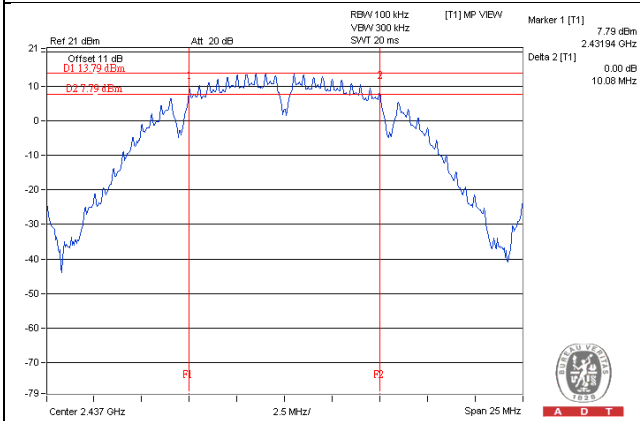
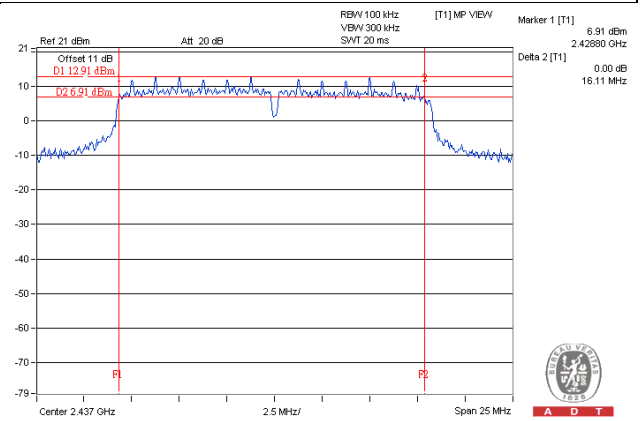
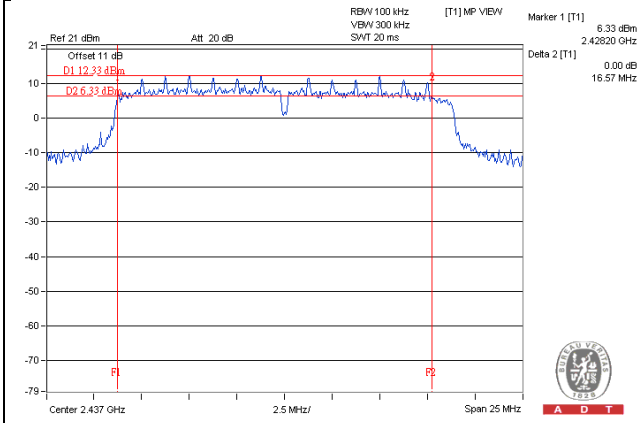
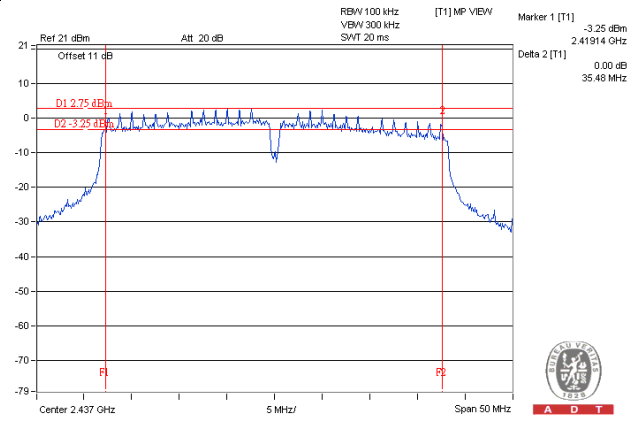
Spectrum Plot of Worst Value**802.11b: CH 6****802.11g: CH 6****802.11n (HT20): CH 6****802.11n (HT40): CH 6**

4.4 Conducted Output Power Measurement

4.4.1 Limits of Conducted Output Power Measurement

For systems using digital modulation in the 2400–2483.5 MHz bands: 1 Watt (30dBm)

4.4.2 Test Setup

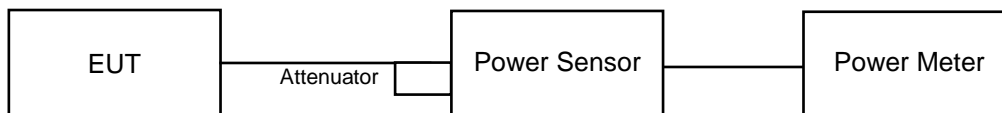

4.4.3 Test Instruments

Refer to section 4.1.2 to get information of above instrument.

4.4.4 Test Procedures

A peak / average power sensor was used on the output port of the EUT. A power meter was used to read the response of the peak / average power sensor. Record the power level.

4.4.5 Deviation from Test Standard

No deviation.

4.4.6 EUT Operating Conditions

Same as Item 4.3.6.

4.4.7 Test Results

FOR PEAK POWER

802.11b

Channel	Frequency (MHz)	Peak Power (mW)	Peak Power (dBm)	Limit (dBm)	Pass/Fail
1	2412	80.353	19.05	30	Pass
6	2437	269.774	24.31	30	Pass
11	2462	97.499	19.89	30	Pass

802.11g

Channel	Frequency (MHz)	Peak Power (mW)	Peak Power (dBm)	Limit (dBm)	Pass/Fail
1	2412	227.51	23.57	30	Pass
6	2437	446.684	26.50	30	Pass
11	2462	207.014	23.16	30	Pass

802.11n (HT20)

Channel	Frequency (MHz)	Peak Power (mW)	Peak Power (dBm)	Limit (dBm)	Pass/Fail
1	2412	199.986	23.01	30	Pass
6	2437	431.519	26.35	30	Pass
11	2462	212.814	23.28	30	Pass

802.11n (HT40)

Channel	Frequency (MHz)	Peak Power (mW)	Peak Power (dBm)	Limit (dBm)	Pass/Fail
3	2422	87.902	19.44	30	Pass
6	2437	238.232	23.77	30	Pass
9	2452	144.877	21.61	30	Pass

FOR AVERAGE POWER
802.11b

Channel	Frequency (MHz)	Average Power (mW)	Average Power (dBm)
1	2412	46.881	16.71
6	2437	170.216	22.31
11	2462	60.954	17.85

802.11g

Channel	Frequency (MHz)	Average Power (mW)	Average Power (dBm)
1	2412	33.963	15.31
6	2437	204.644	23.11
11	2462	32.285	15.09

802.11n (HT20)

Channel	Frequency (MHz)	Average Power (mW)	Average Power (dBm)
1	2412	28.576	14.56
6	2437	170.216	22.31
11	2462	31.261	14.95

802.11n (HT40)

Channel	Frequency (MHz)	Average Power (mW)	Average Power (dBm)
3	2422	19.099	12.81
6	2437	41.783	16.21
9	2452	22.439	13.51

4.5 Power Spectral Density Measurement

4.5.1 Limits of Power Spectral Density Measurement

The Maximum of Power Spectral Density Measurement is 8dBm.

4.5.2 Test Setup

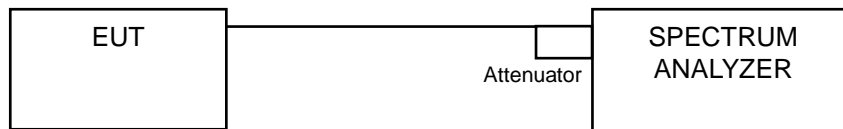

4.5.3 Test Instruments

Refer to section 4.1.2 to get information of above instrument.

4.5.4 Test Procedures

- a. Set analyzer center frequency to DTS channel center frequency.
- b. Set the span to 1.5 times the DTS bandwidth.
- c. Set the RBW to: $3 \text{ kHz} \leq \text{RBW} \leq 100 \text{ kHz}$.
- d. Set the VBW $\geq 3 \times \text{RBW}$.
- e. Detector = peak.
- f. Sweep time = auto couple.
- g. Trace mode = max hold.
- h. Allow trace to fully stabilize.
- i. Use the peak marker function to determine the maximum amplitude level within the RBW.

4.5.5 Deviation from Test Standard

No deviation.

4.5.6 EUT Operating Conditions

Same as Item 4.3.6

4.5.7 Test Results

802.11b

Channel	Freq. (MHz)	PSD (dBm)	Limit (dBm)	Pass /Fail
1	2412	-7.18	8	Pass
6	2437	-1.53	8	Pass
11	2462	-7.29	8	Pass

802.11g

Channel	Freq. (MHz)	PSD (dBm)	Limit (dBm)	Pass /Fail
1	2412	-11.52	8	Pass
6	2437	-0.47	8	Pass
11	2462	-10.05	8	Pass

802.11n (HT20)

Channel	Freq. (MHz)	PSD (dBm)	Limit (dBm)	Pass /Fail
1	2412	-11.78	8	Pass
6	2437	-3.19	8	Pass
11	2462	-10.81	8	Pass

802.11n (HT40)

Channel	Freq. (MHz)	PSD (dBm)	Limit (dBm)	PASS /FAIL
3	2422	-15.83	8	PASS
6	2437	-11.97	8	PASS
9	2452	-13.36	8	PASS

Spectrum Plot of Worst Value

802.11b: CH 6

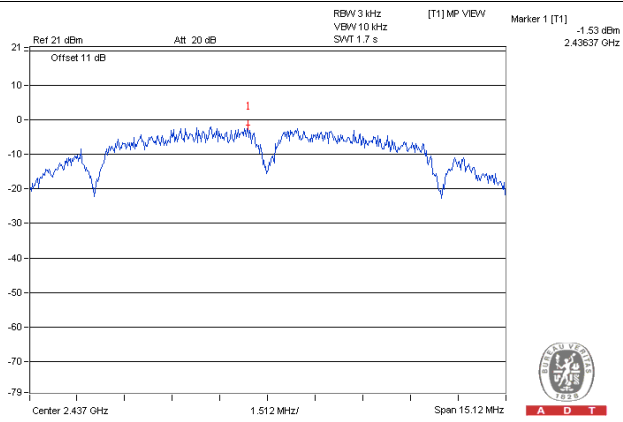

802.11g: CH 6

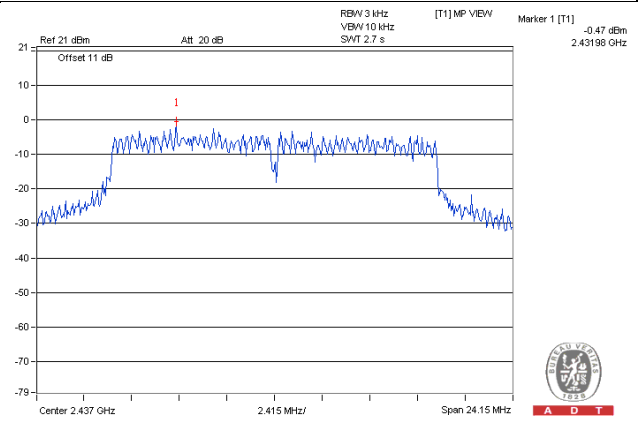

802.11n (HT20): CH 6

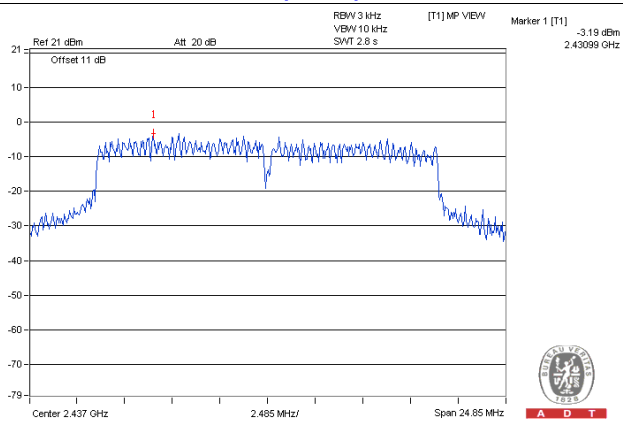

802.11n (HT40): CH 6

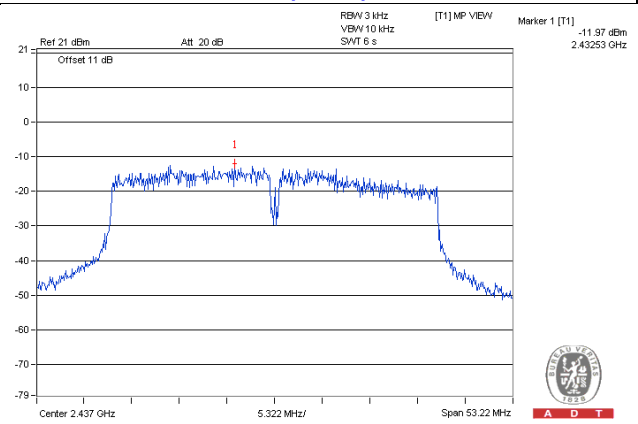

4.6 Conducted Out of Band Emission Measurement

4.6.1 Limits of Conducted Out of Band Emission Measurement

Below 20dB of the highest emission level of operating band (in 100kHz Resolution Bandwidth).

4.6.2 Test Setup

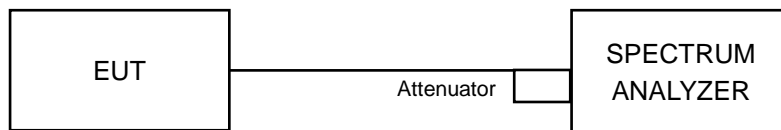

4.6.3 Test Instruments

Refer to section 4.1.2 to get information of above instrument.

4.6.4 Test Procedures

MEASUREMENT PROCEDURE REF

1. Set the RBW = 100 kHz.
2. Set the VBW \geq 300 kHz.
3. Detector = peak.
4. Sweep time = auto couple.
5. Trace mode = max hold.
6. Allow trace to fully stabilize.
7. Use the peak marker function to determine the maximum power level in any 100 kHz band segment within the fundamental EBW.

MEASUREMENT PROCEDURE OOB

1. Set RBW = 100 kHz.
2. Set VBW \geq 300 kHz.
3. Detector = peak.
4. Sweep = auto couple.
5. Trace Mode = max hold.
6. Allow trace to fully stabilize.
7. Use the peak marker function to determine the maximum amplitude level.

4.6.5 Deviation from Test Standard

No deviation.

4.6.6 EUT Operating Conditions

Same as Item 4.3.6

4.6.7 Test Results

The spectrum plots are attached on the following pages. D1 line indicates the highest level, and D2 line indicates the 20dB offset below D1. It shows compliance with the requirement.

802.11b

CH 1

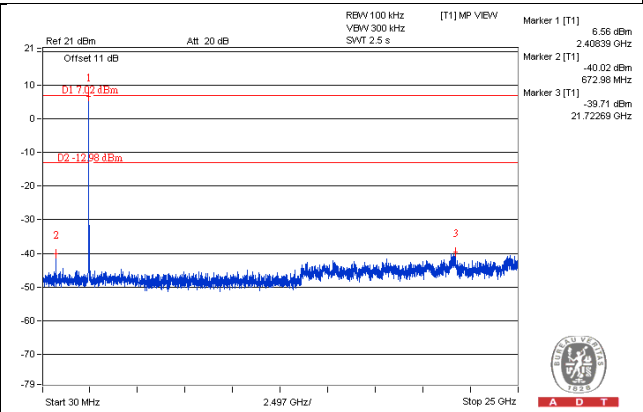
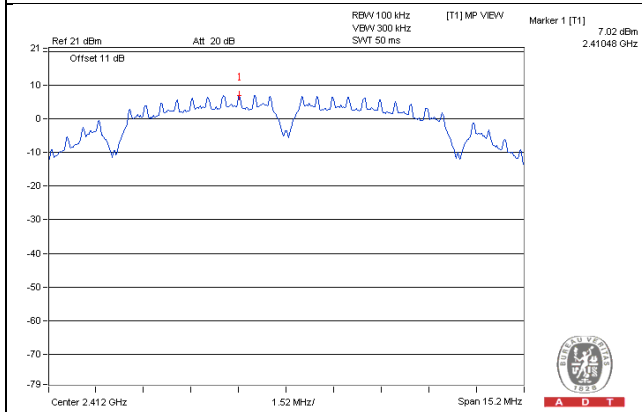

CH 6

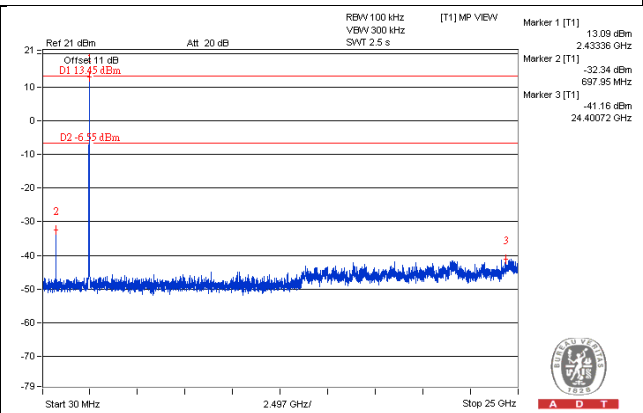
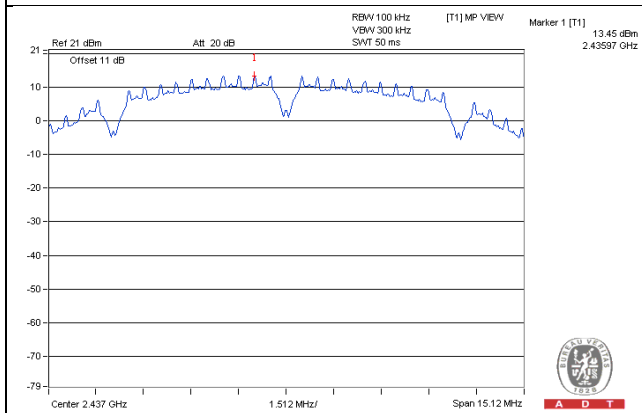

CH 11

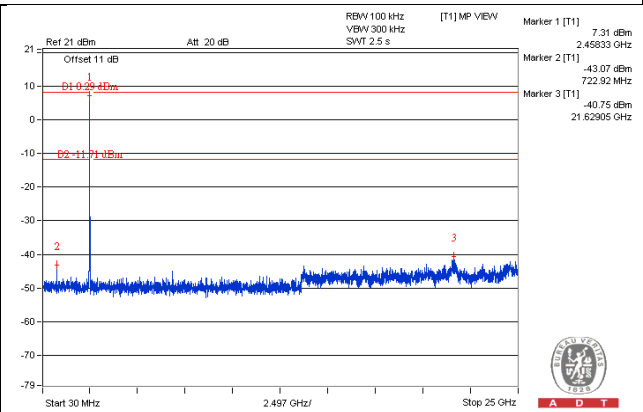
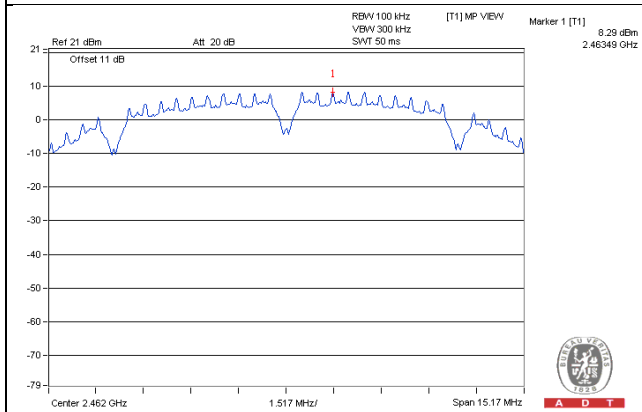

CH 1 Band edge

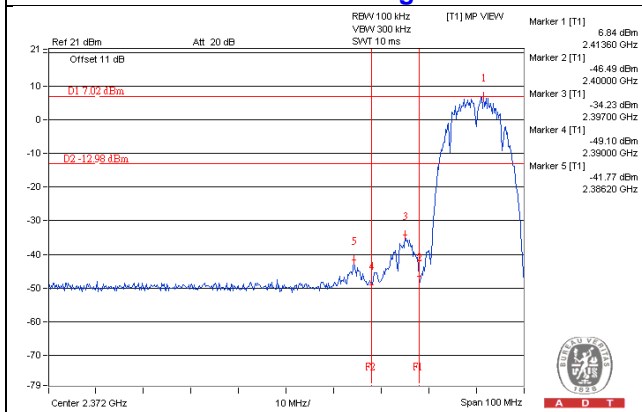

CH 11 Band edge

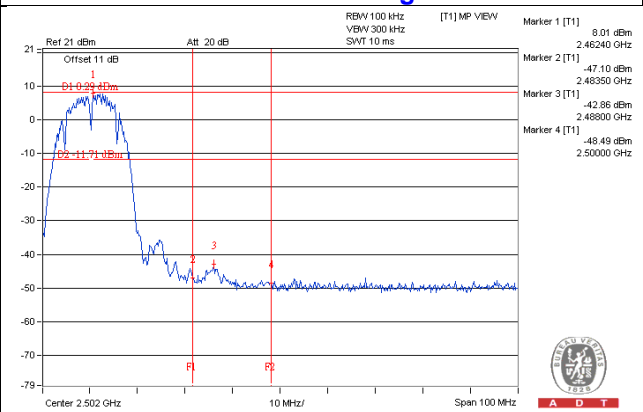

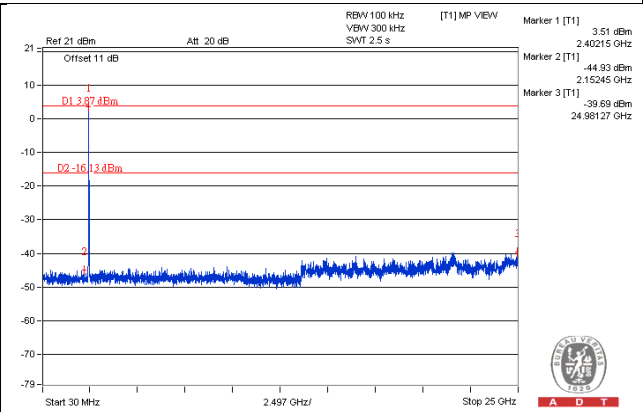
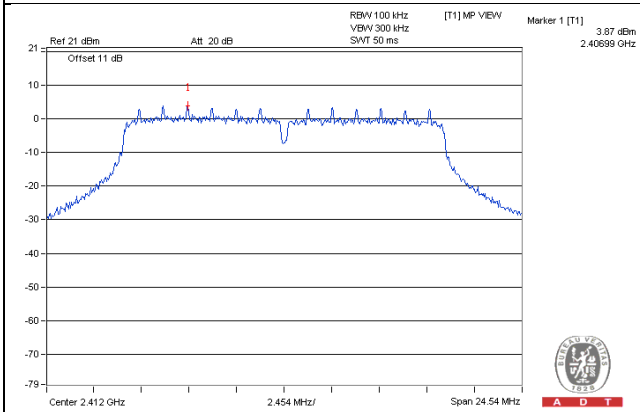
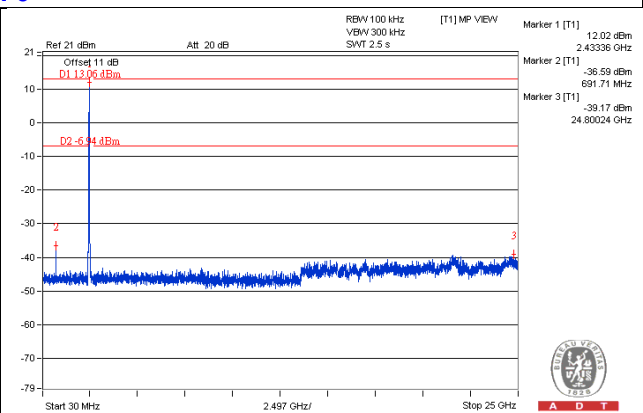
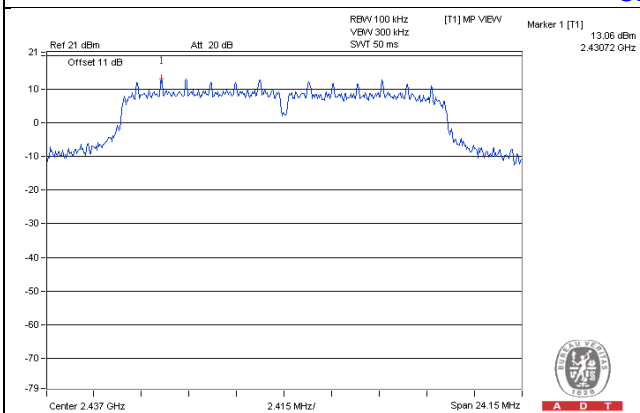
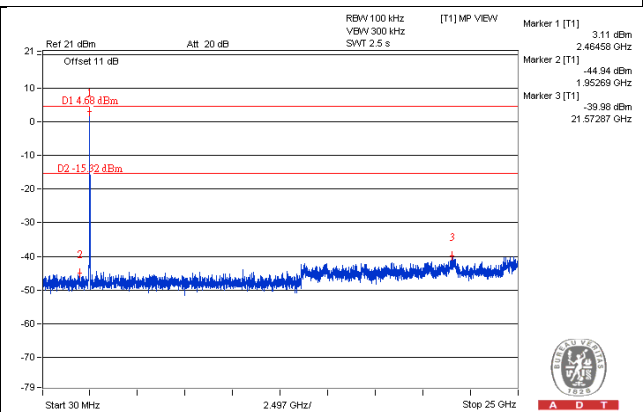
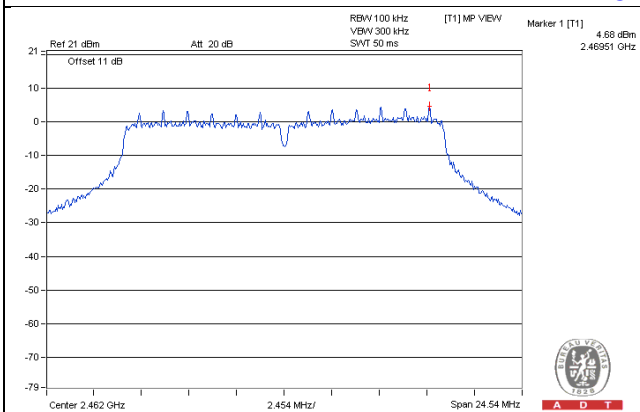
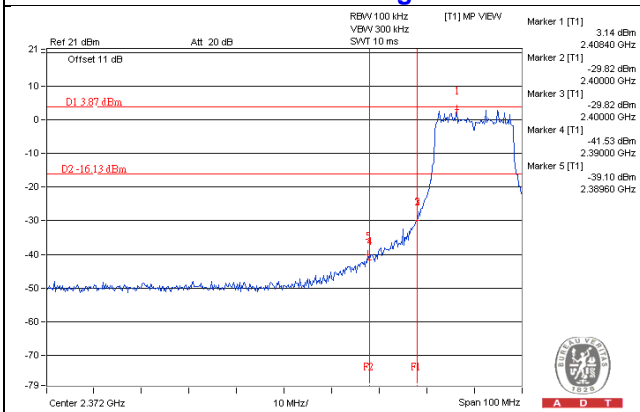
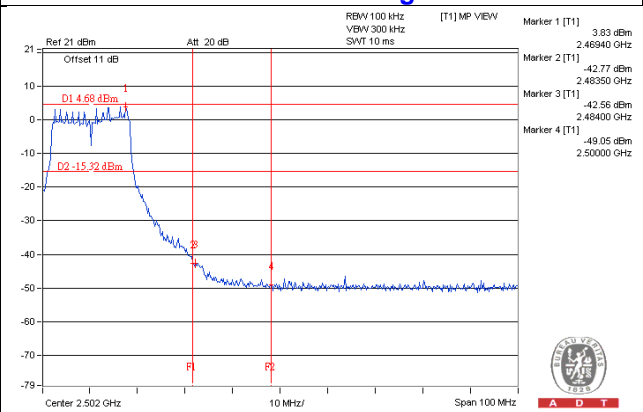
802.11g
CH 1

CH 6

CH 11

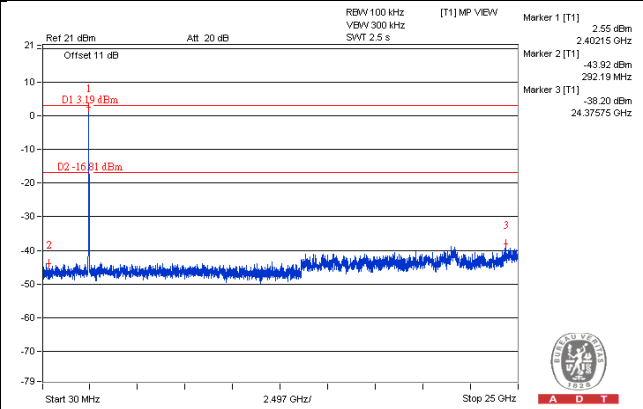
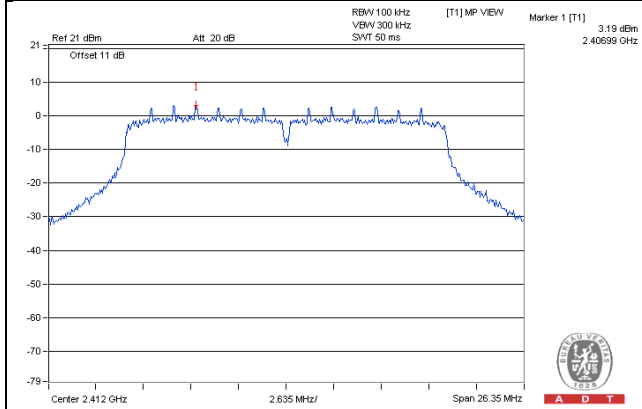
CH 1 Band edge

CH 11 Band edge

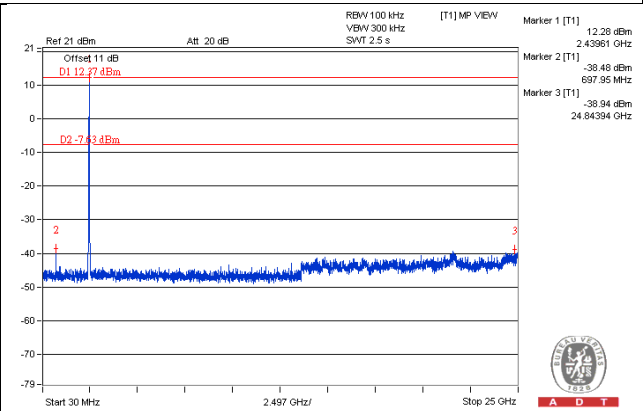
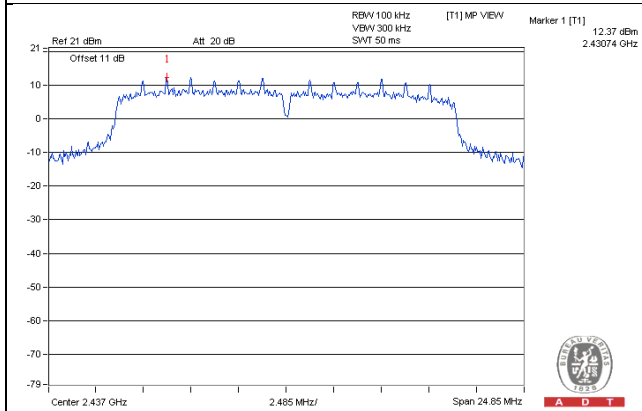
802.11n (HT20)

CH 1



CH 6



CH 11

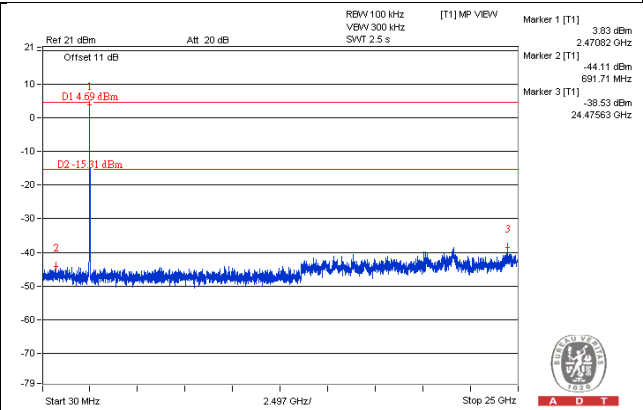
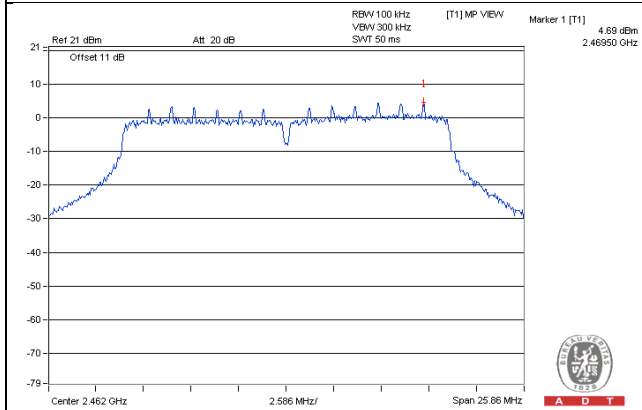

CH 1 Band edge

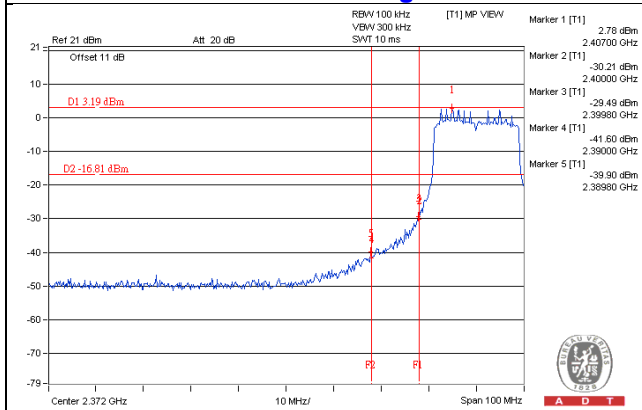

CH 11 Band edge

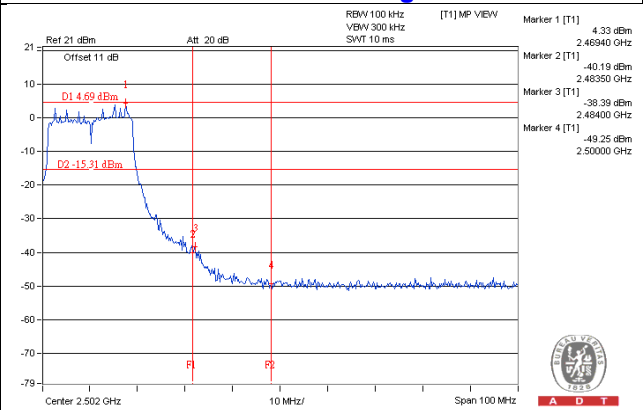

802.11n (HT40)

CH 3

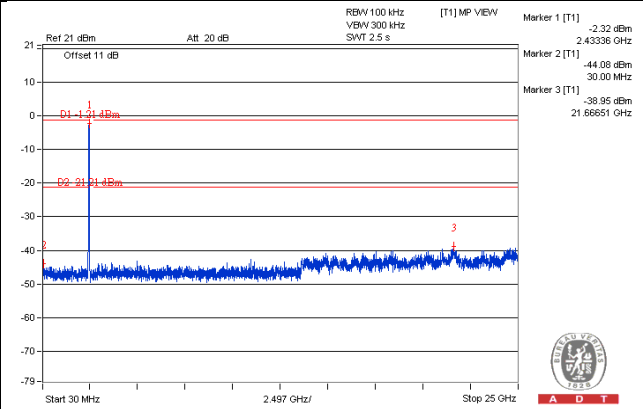
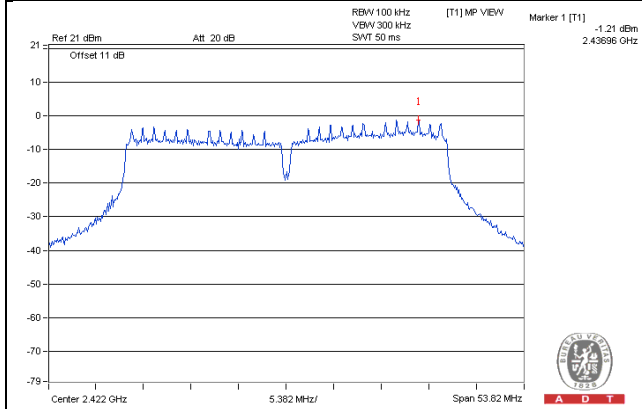

CH 6

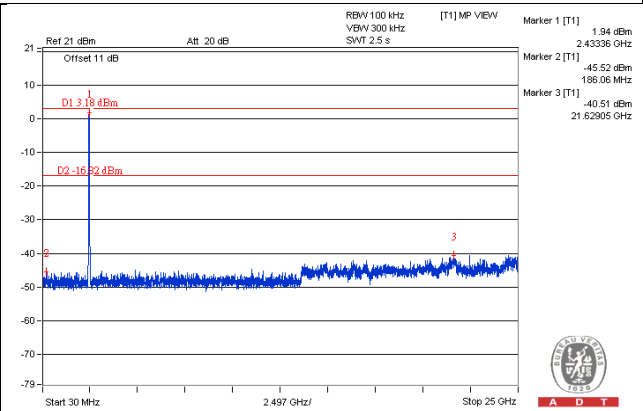
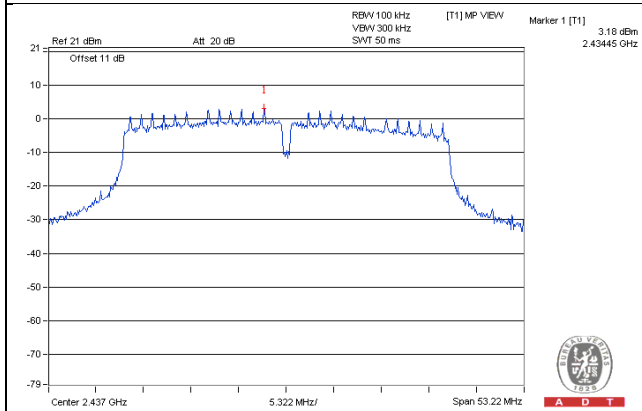

CH 9

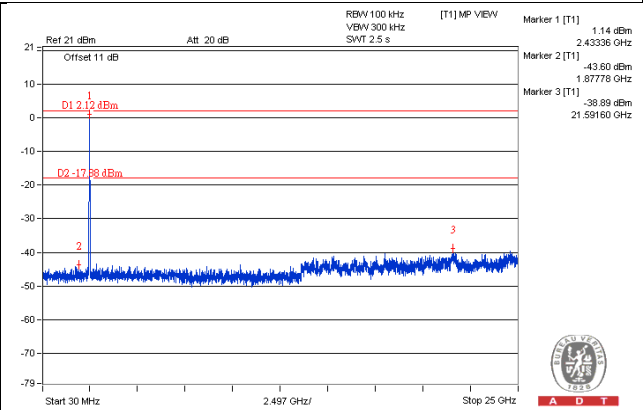
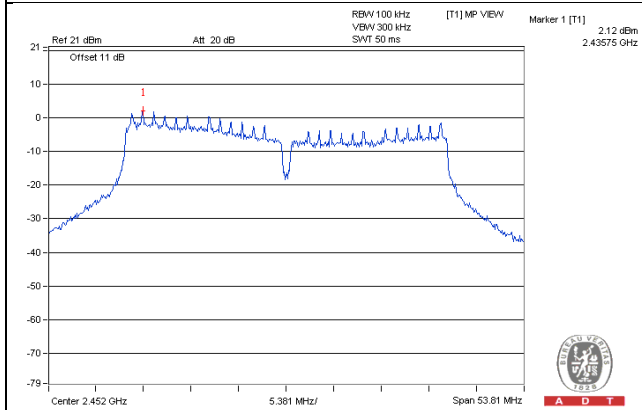

CH 3 Band edge

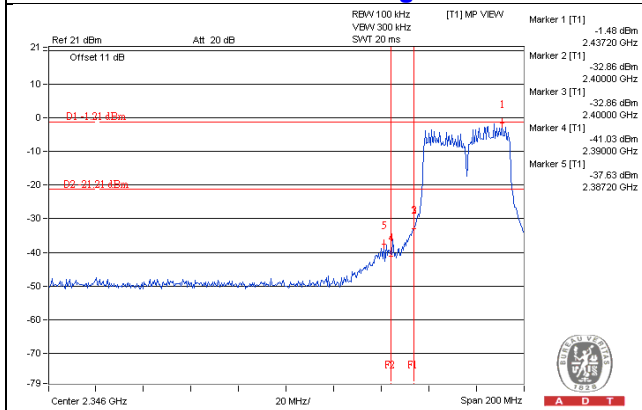

CH 9 Band edge

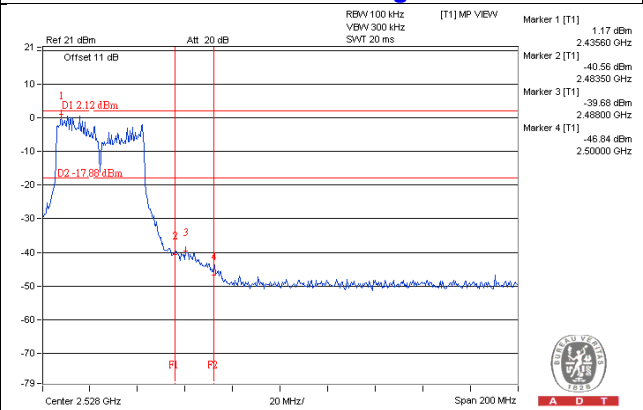

5 Pictures of Test Arrangements

Please refer to the attached file (Test Setup Photo).



Appendix – Information on the Testing Laboratories

We, Bureau Veritas Consumer Products Services (H.K.) Ltd., Taoyuan Branch, were founded in 1988 to provide our best service in EMC, Radio, Telecom and Safety consultation. Our laboratories are accredited and approved according to ISO/IEC 17025.

If you have any comments, please feel free to contact us at the following:

Linko EMC/RF Lab

Tel: 886-2-26052180

Fax: 886-2-26051924

Hsin Chu EMC/RF/Telecom Lab

Tel: 886-3-5935343

Fax: 886-3-5935342

Hwa Ya EMC/RF/Safety Lab

Tel: 886-3-3183232

Fax: 886-3-3270892

Email: service.adt@tw.bureauveritas.com

Web Site: www.bureauveritas-adt.com

The address and road map of all our labs can be found in our web site also.

--- END ---