

# FCC REPORT

## Certification

**Applicant Name:**  
GS Instech Co., Ltd.**Address:**  
70, Gilpa-ro 71beon-gil, Nam-gu, Inchen, Korea**Date of Issue:**  
September 19, 2018**Location of test lab:**  
HCT CO., LTD.,  
74, Seoicheon-ro 578beon-gil, Majang-myeon,  
Icheon-si, Gyeonggi-do, 17383, Rep. of KOREA**Report No.:** HCT-RF-1809-FC080-R1**FCC ID:** U88-PSELITE37A**APPLICANT:** GS Instech Co., Ltd.**Model:** PS-ELITE7837A**EUT Type:** Public Safety Repeater**Frequency Range:**

	Downlink (MHz)	Uplink (MHz)
PS Narrowband	769~775	799~805
NPSPAC	851~854	806~809
PS B/ILT SMR	854~861	809~816

**Output Power:** 37 dBm (Downlink) / 33 dBm (Uplink)**Date of Test:** September 07, 2018 ~ September 13, 2018**FCC Rule Parts:** CFR 47 Part 2, Part 90

The measurements shown in this report were made in accordance with the procedures indicated, and the emissions from this equipment were found to be within the limits applicable. I assume full responsibility for the accuracy and completeness of these measurements, and for the qualifications of all persons taking them. It is further stated that upon the basis of the measurements made, the equipment tested is capable of operation in accordance with the requirements of the FCC Rules under normal use and maintenance.

**Report prepared by : A Ram Han**  
Engineer of telecommunication testing center**Approved by : Jong Seok Lee**  
Manager of telecommunication testing center

This report only responds to the tested sample and may not be reproduced, except in full, without written approval of the HCT Co., Ltd.

## Version

TEST REPORT NO.	DATE	DESCRIPTION
HCT-RF-1809-FC080	September 17, 2018	- First Approval Report
HCT-RF-1809-FC080-R1	September 19, 2018	- Corrected typos on page 11.

# Table of Contents

1. GENERAL INFORMATION .....	4
1.1. APPLICANT INFORMATION .....	4
1.2. PRODUCT INFORMATION .....	4
1.3. TEST INFORMATION.....	4
2. FACILITIES AND ACCREDITATIONS.....	5
2.1. FACILITIES .....	5
2.2. EQUIPMENT.....	5
3. TEST SPECIFICATIONS .....	6
3.1. STANDARDS.....	6
3.2. ADDITIONAL DESCRIPTIONS ABOUT TEST .....	7
3.3. MEASUREMENTUNCERTAINTY .....	9
3.4. STANDARDS ENVIRONMENTAL TEST CONDITIONS.....	9
3.5. TEST DIAGRAMS .....	10
4. TEST EQUIPMENTS .....	11
5. AGC THRESHOLD.....	12
6. OUT-OF-BAND REJECTION .....	14
7. OCCUPIED BANDWIDTH .....	18
8. INTPUT-VERSUS-OUTPUT SIGNAL COMPARISON .....	41
9. INPUT/OUTPUT POWER AND AMPLIFIER/BOOSTER GAIN .....	62
10. NOISE FIGURE .....	67
11. OUT-OF-BAND/OUT-OF-BLOCK EMISSIONS AND SPURIOUS EMISSIONS .....	69
12. RADIATED SPURIOUS EMISSIONS .....	85
13. Annex A_EUT AND TEST SETUP PHOTO .....	87

## 1. GENERAL INFORMATION

### 1.1. APPLICANT INFORMATION

Company Name	GS Instech Co., Ltd.
Company Address	70, Gilpa-ro 71beon-gil, Nam-gu, Inchen, Korea

### 1.2. PRODUCT INFORMATION

EUT Type	Public Safety Repeater		
Power Supply	AC 110 ~ 125 V		
Frequency Range		Downlink (MHz)	Uplink (MHz)
	PS Narrowband	769~775	799~805
	NPSPAC	851~854	806~809
	PS B/ILT SMR	854~861	809~816
Tx Output Power	37 dBm (Downlink) / 33 dBm (Uplink)		
Antenna Specification	Manufacturer does not provide an antenna.		

### 1.3. TEST INFORMATION

FCC Rule Parts	CFR 47 Part 2, Part 90
Measurement Standards	KDB 935210 D05 v01r02, ANSI C63.26-2015
Test Location	HCT CO., LTD. 74, Seoicheon-ro 578beon-gil, Majang-myeon, Icheon-si, Gyeonggi-do, 17383, Rep. of KOREA

## **2. FACILITIES AND ACCREDITATIONS**

### **2.1. FACILITIES**

The SAC(Semi-Anechoic Chamber) and conducted measurement facility used to collect the radiated data are located at the 74, Seoicheon-ro 578beon-gil, Majang-myeon, Icheon-si, Gyeonggi-do, 17383, Rep. of KOREA.

The site is constructed in conformance with the requirements of ANSI C63.4. (Version :2014) and CISPR Publication 22.

Detailed description of test facility was submitted to the Commission and accepted dated April 02, 2018 (Registration Number: KR0032).

### **2.2. EQUIPMENT**

Radiated emissions are measured with one or more of the following types of Linearly polarized antennas: tuned dipole, bi-conical, log periodic, bi-log, and/or ridged waveguide, horn. Spectrum analyzers with pre-selectors and quasi-peak detectors are used to perform radiated measurements.

Calibrated wideband preamplifiers, coaxial cables, and coaxial attenuators are also used for making measurements.

All receiving equipment conforms to CISPR Publication 16-1, "Radio Interference Measuring Apparatus and Measurement Methods."

### 3. TEST SPECIFICATIONS

#### 3.1. STANDARDS

The following tests were conducted on a sample of the equipment for the purpose of demonstrating compliance with FCC Part 2, Part 90

Description	Reference	Results
AGC threshold	KDB 935210 D05 v01r02 4.2	Compliant
Out-of-band rejection	KDB 935210 D05 v01r02 4.3	Compliant
Occupied bandwidth	§2.1049, §90.219(e)(4)(ii)	Compliant
Input-versus-output signal comparison	§90.210, §90.219(e)(4)(iii)	Compliant
Input/output power and amplifier/booster gain	§2.1046, §90.219(e)(1), §90.541 §90.542 §90.635	Compliant
Noise figure	§90.219(e)(2)	Compliant
Out-of-band/out-of-block and spurious emissions	§2.1051, §90.219(e)(3), 90.543	Compliant
Spurious emissions radiated	§2.1053	Compliant

### 3.2. ADDITIONAL DESCRIPTIONS ABOUT TEST

Except for the following cases, EUT was tested under normal operating conditions.

- : Out-of-band rejection test requires maximum gain condition without AGC
- : Noise figure test requires any AGC circuitry be disabled over the duration of the measurement.

The test was generally based on the method of KDB 935210 D05 v01r02 and only followed ANSI C63.26-2015 if there was no test method in KDB standard.

EUT supports following digitally modulated signals.

- : P25 Phase 1 (12.5 kHz) and Phase 2 (6.25 kHz) signals are supported in PS narrowband, NPSAC and PS B/ILT SMR band.

Below channels greater than 12.5 kHz in EUT specification are not tested because it could consist of a combination of P25 Phase 1 and P25 Phase 2 signals.

Channelizing	P25 Phase 1 (12.5 kHz) combinations	P25 Phase 2 (6.25 kHz) combinations
25 kHz	n = 2	n = 4
50 kHz	n = 4	n = 8
75 kHz	n = 6	n = 12

The frequency stability measurement has been omitted in accordance with section 4.8 of KDB 935210 D05 v01r02.

- : It can be confirmed through occupied bandwidth and input-versus-output signal comparison test that EUT does not alter the input signal.

The tests results included actual loss value for attenuator and cable combination as shown in the table below.

<b>Correction factor table</b>			
<b>Frequency (MHz)</b>	<b>Factor (dB)</b>	<b>Frequency (MHz)</b>	<b>Factor (dB)</b>
50	28.557	2500	30.907
100	28.572	3000	31.414
200	28.704	3500	31.526
300	29.063	4000	31.977
400	29.182	4500	31.872
500	29.310	5000	32.31
600	29.368	5500	32.722
700	29.501	6000	32.659
750	29.568	6500	33.824
800	29.586	7000	33.462
850	29.612	7500	34.047
900	29.608	8000	33.754
1000	29.615	8500	34.102
1500	30.177	9000	34.915
2000	30.469		



### 3.3. MEASUREMENT UNCERTAINTY

The value of the measurement uncertainty for the each item.

Description	Reference	Results
AGC threshold	-	±0.87 dB
Out-of-band rejection		±0.58 MHz
Occupied Bandwidth	OBW > 5 MHz	±0.58 MHz
	OBW ≤ 25 kHz	±0.16 kHz
Input-versus-output signal comparison	-	±0.87 dB
Input/output power and amplifier/booster gain	-	±0.87 dB
Noise figure	-	±0.67 dB
Out-of-band/out-of-block and spurious emissions	-	±1.08 dB
Spurious emissions radiated	f ≤ 1 GHz	±4.80 dB
	f > 1 GHz	±6.07 dB

\* Coverage factor  $k = 2$ , Confidence levels of 95 %

### 3.4. STANDARDS ENVIRONMENTAL TEST CONDITIONS

Temperature	+15 °C to +35 °C
Relative humidity	30 % to 60 %
Air pressure	860 mbar to 1 060 mbar

### 3.5. TEST DIAGRAMS

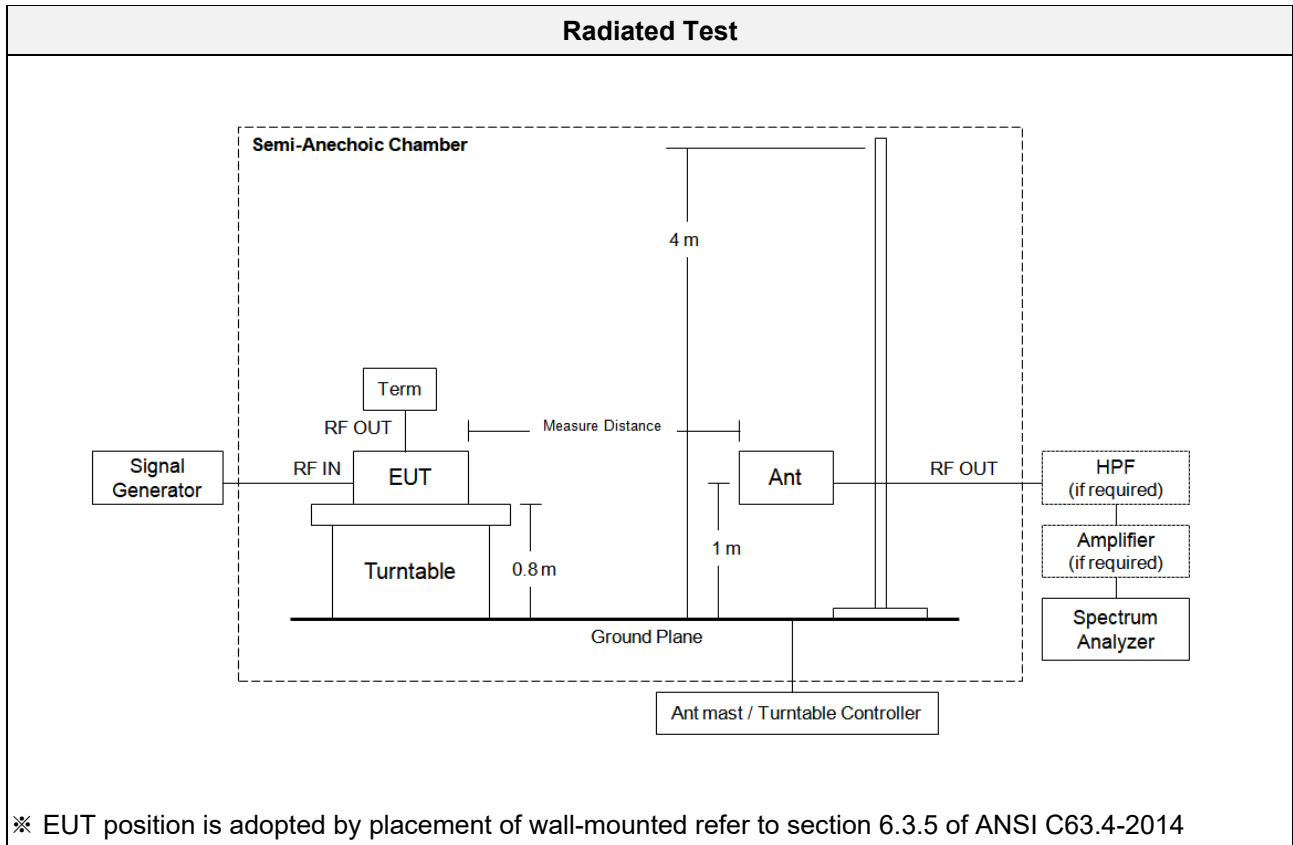
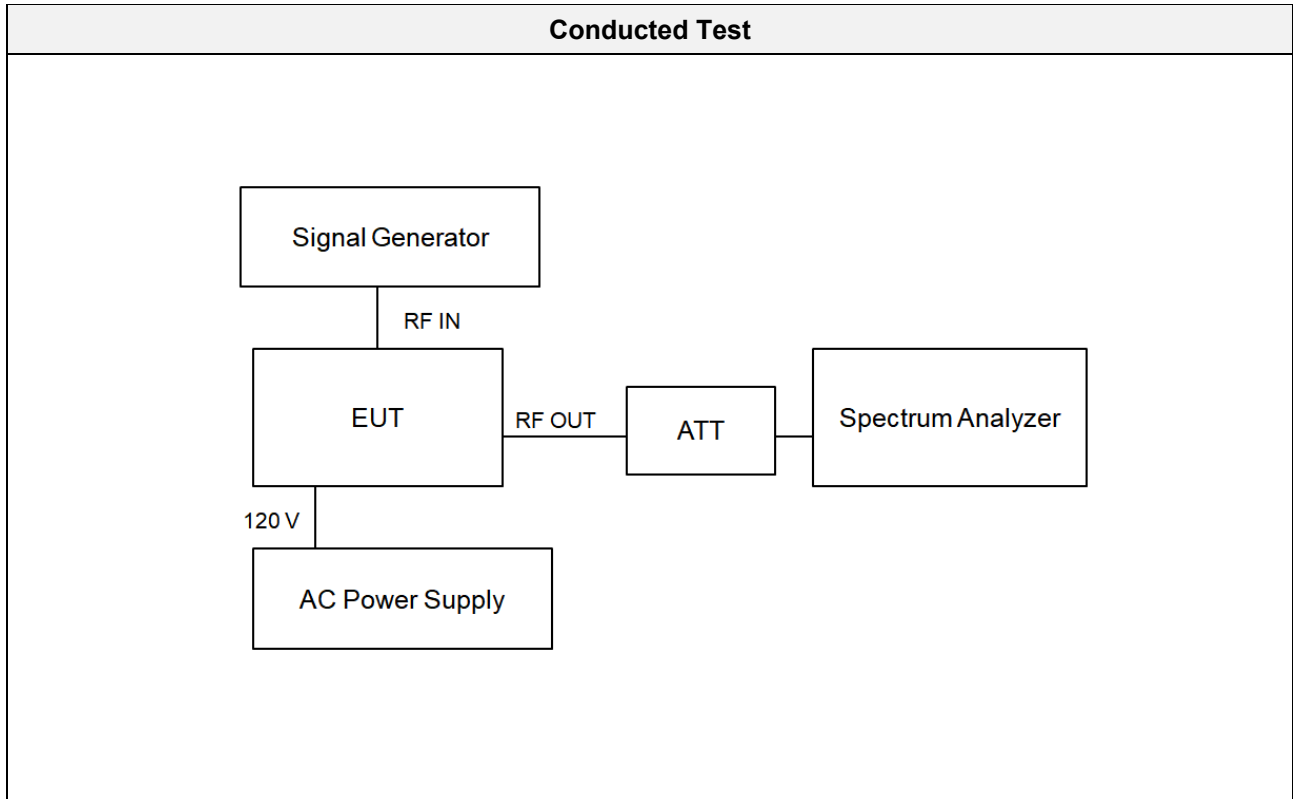

## 4. TEST EQUIPMENTS

Manufacturer	Model / Equipment	Calibration Date	Calibration Interval	Serial No.
Agilent	N9020A / Spectrum Analyzer	08/29/2018	Annual	MY52440870
Agilent	E4438C /Signal Generator	12/22/2017	Annual	MY42082646
Agilent	N5182A / Signal Generator	08/09/2018	Annual	MY50140312
Weinschel	67-30-33 / Attenuator	02/08/2018	Annual	BU5347
Deayoung ENT	DFSS60 / AC Power Supply	04/05/2018	Annual	1003030-1
Innco system	CO3000 / Controller(Antenna mast)	N/A	N/A	CO3000-4p
Innco system	MA4640/800-XP-EP / Antenna Position Tower	N/A	N/A	N/A
Emco	2090 / Controller	N/A	N/A	060520
Ets	- / Turn Table	N/A	N/A	N/A
Rohde&Schwarz	- / Loop Antenna	04/19/2017	Biennial	1513-175
Schwarzbeck	VULB 9168 / Hybrid Antenna	04/06/2017	Biennial	760
Schwarzbeck	BBHA 9120D / Horn Antenna	06/30/2017	Biennial	9120D-1300
Schwarzbeck	BBHA9170 / Horn Antenna(15 GHz ~ 40 GHz)	04/25/2017	Biennial	BBHA9170124
Rohde&Schwarz	FSP / Spectrum Analyzer	09/21/2017	Annual	836650/016
Wainwright Instruments	WHKX10-900-1000-15000-40SS / High Pass Filter	07/20/2018	Annual	5
Wainwright Instruments	WHKX10-2700-3000-18000-40SS / High Pass Filter	07/20/2018	Annual	3
CERNEX	CBLU1183540 / Power Amplifier	01/03/2018	Annual	24613
CERNEX	CBL06185030 / Power Amplifier	01/03/2018	Annual	24615
CERNEX	CBL18265035 / Power Amplifier	01/10/2018	Annual	22966

## 5. AGC THRESHOLD

### FCC Rules

#### Test Requirement:

#### KDB 935210 D05 v01r02

Testing at and above the AGC threshold is required.

#### Test Procedures:

Measurements were in accordance with the test methods section 4.2 of KDB 935210 D05 v01r02.

*The AGC threshold shall be determined by applying section 3.2 of same KDB standard, but with the signal generator configured to produce a test signal defined in digitally modulated signal.*

- a) Connect a signal generator to the input of the EUT.
- b) Connect a spectrum analyzer or power meter to the output of the EUT using appropriate attenuation as necessary.
- c) The signal generator should initially be configured to produce either of the required test signals (i.e., broadband or narrowband).
- d) Set the signal generator frequency to the center frequency of the EUT operating band.
- e) While monitoring the output power of the EUT, measured using the methods of ANSI C63.26-2015 subclause 5.2.4.4.1, increase the input level until a 1 dB increase in the input signal power no longer causes a 1 dB increase in the output signal power.
- f) Record this level as the AGC threshold level.
- g) Repeat the procedure with the remaining test signal.

Output power measurement in subclause 5.2.4.4.1 of ANSI C63.26

- a) Set span to  $2 \times$  to  $3 \times$  the OBW.
- b) Set RBW = 1% to 5% of the OBW.
- c) Set VBW  $\geq 3 \times$  RBW.
- d) Set number of measurement points in sweep  $\geq 2 \times$  span / RBW.
- e) Sweep time: auto-couple
- f) Detector = power averaging (rms).
- g) If the EUT can be configured to transmit continuously, then set the trigger to free run.
- h) Omit
- i) Trace average at least 100 traces in power averaging (rms) mode if sweep is set to auto-couple. To accurately determine the average power over multiple symbols, it can be necessary to increase the number of traces to be averaged above 100 or, if using a manually configured sweep time, increase the

sweep time.

j) Compute the power by integrating the spectrum across the OBW of the signal using the instrument's band or channel power measurement function, with the band/channel limits set equal to the OBW band edges. If the instrument does not have a band or channel power function, then sum the spectrum levels (in linear power units) at intervals equal to the RBW extending across the entire OBW of the spectrum.

**Test Results:**

Test Band	Link	Tech	Frequency (MHz)	AGC Threshold Level (dBm)	Output Level (dBm)
PS Narrowband	Uplink	P25 Phase 1	802.000	-62	33.89
		P25 Phase 2	802.000	-62	33.81
	Downlink	P25 Phase 1	772.000	-62	36.42
		P25 Phase 2	772.000	-62	36.40
NPSPAC	Uplink	P25 Phase 1	807.500	-62	33.54
		P25 Phase 2	807.500	-62	33.44
	Downlink	P25 Phase 1	852.500	-62	36.66
		P25 Phase 2	852.500	-62	36.53
PS B/ILT SMR	Uplink	P25 Phase 1	812.500	-62	32.57
		P25 Phase 2	812.500	-62	32.98
	Downlink	P25 Phase 1	857.500	-62	36.75
		P25 Phase 2	857.500	-62	36.64

## 6. OUT-OF-BAND REJECTION

### FCC Rules

#### Test Requirement:

#### KDB 935210 D05 v01r02

Out-of-band rejection required.

### Test Procedures:

Measurements were in accordance with the test methods section 4.3 of KDB 935210 D05 v01r02.

*Adjust the internal gain control of the EUT to the maximum gain for which equipment certification is sought.*

- a) Connect a signal generator to the input of the EUT.
- b) Configure a swept CW signal with the following parameters:
  - 1) Frequency range =  $\pm 250$  % of the manufacturer's specified pass band.
  - 2) The CW amplitude shall be 3 dB below the AGC threshold and shall not activate the AGC threshold throughout the test.
  - 3) Dwell time = approximately 10 ms.
  - 4) Frequency step = 50 kHz.
- c) Connect a spectrum analyzer to the output of the EUT using appropriate attenuation.
- d) Set the RBW of the spectrum analyzer to between 1 % and 5 % of the manufacturer's pass band with the VBW set to  $3 \times$  RBW.
- e) Set the detector to Peak and the trace to Max-Hold.
- f) After the trace is completely filled place a marker at the peak amplitude which is designated as  $f_0$ , with two additional markers (use the marker delta method) at the 20 dB bandwidth (i.e., at the points where the level has fallen by 20 dB).
- g) Capture the frequency response plot for inclusion in the test report.

**Test Results:**

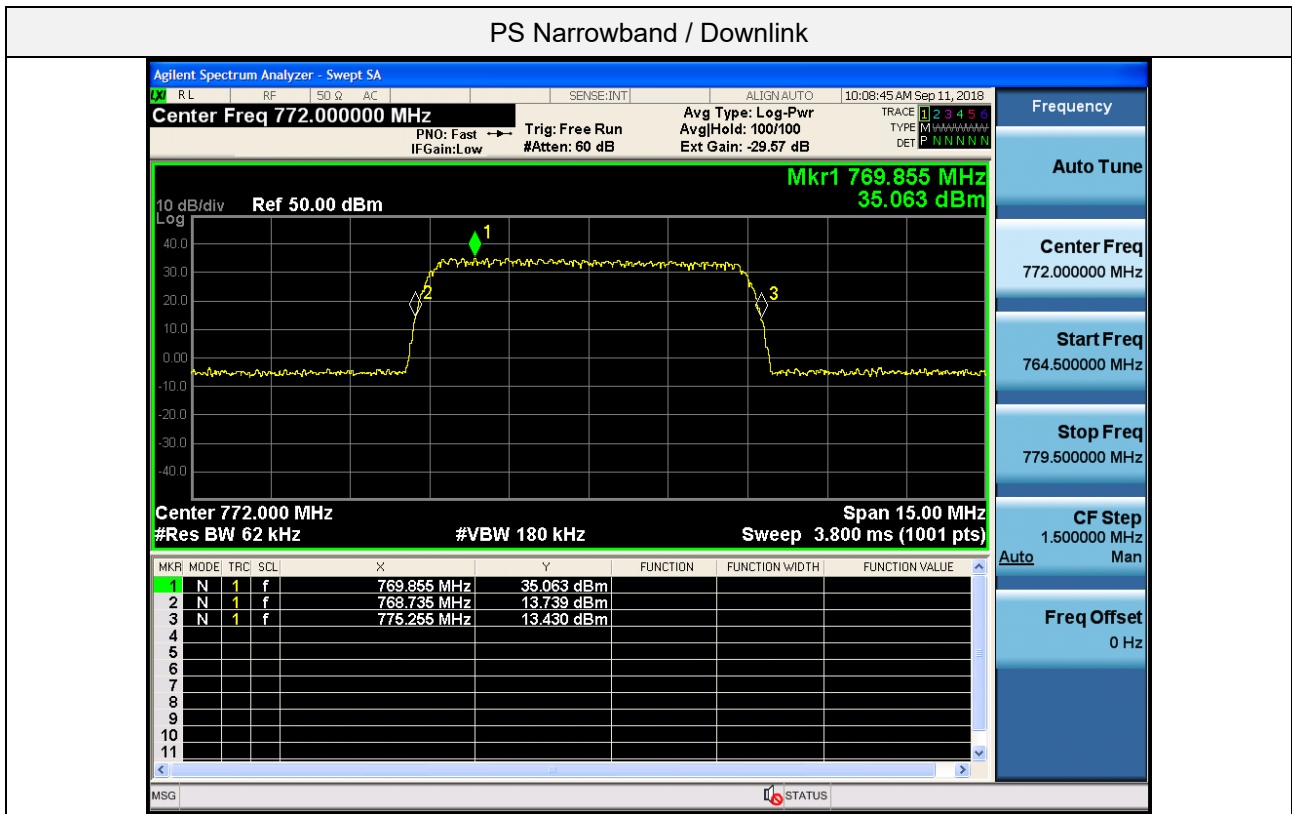
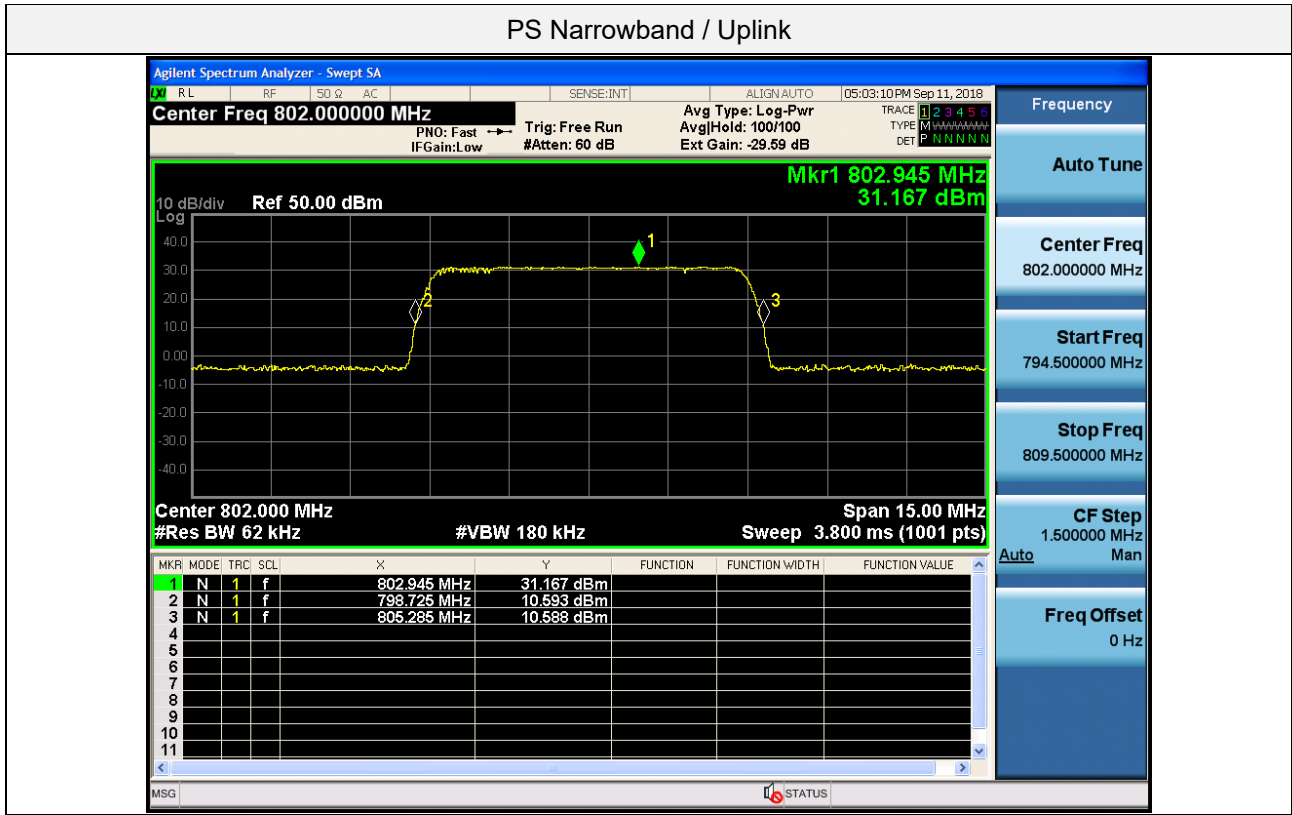

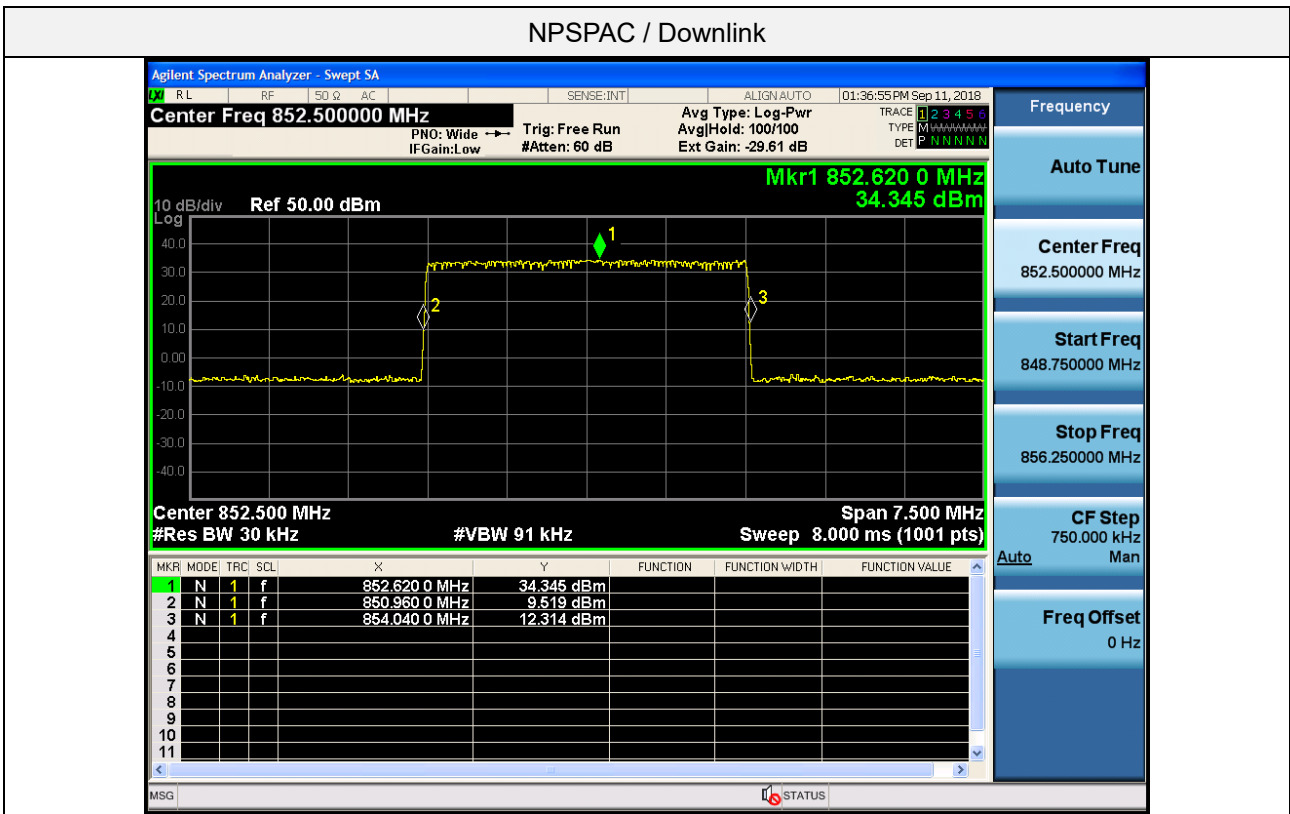
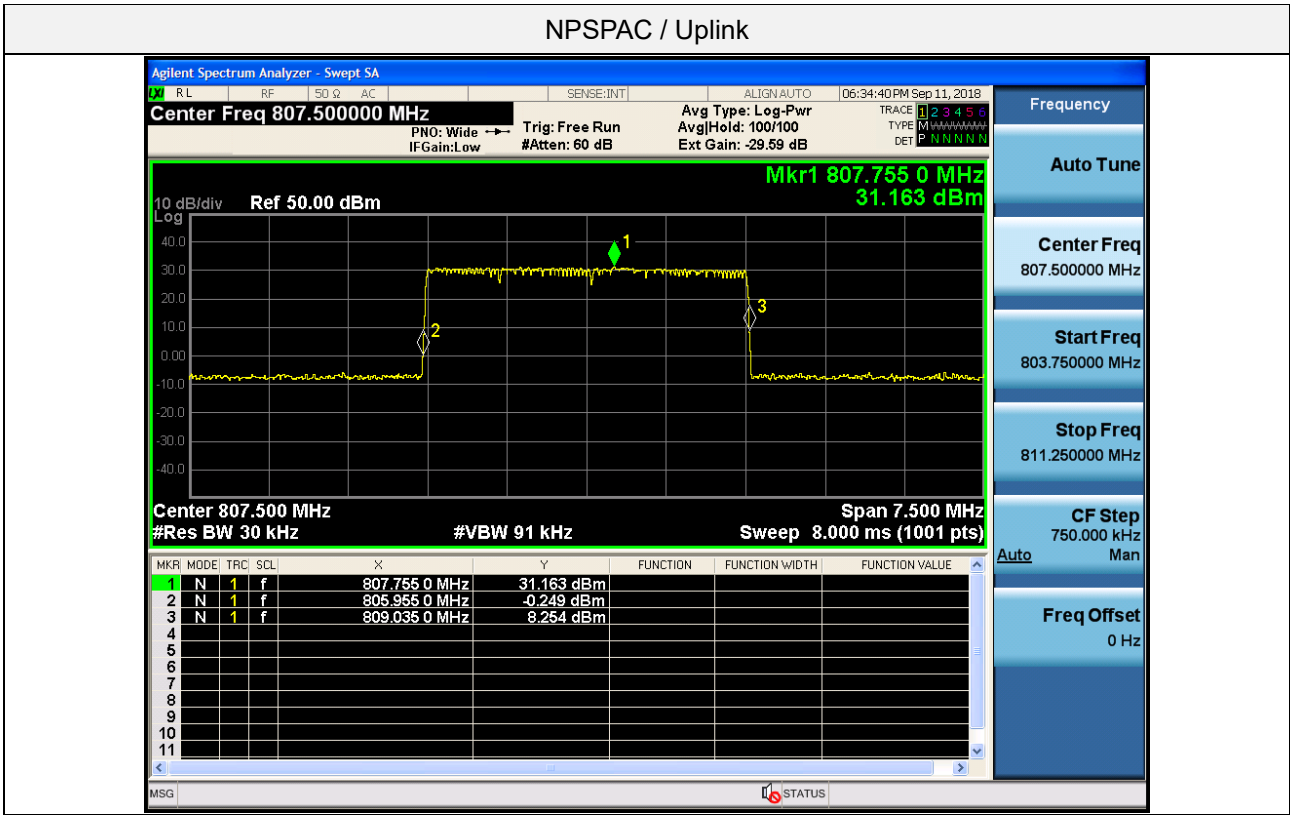



PS B/ILT SMR / Uplink

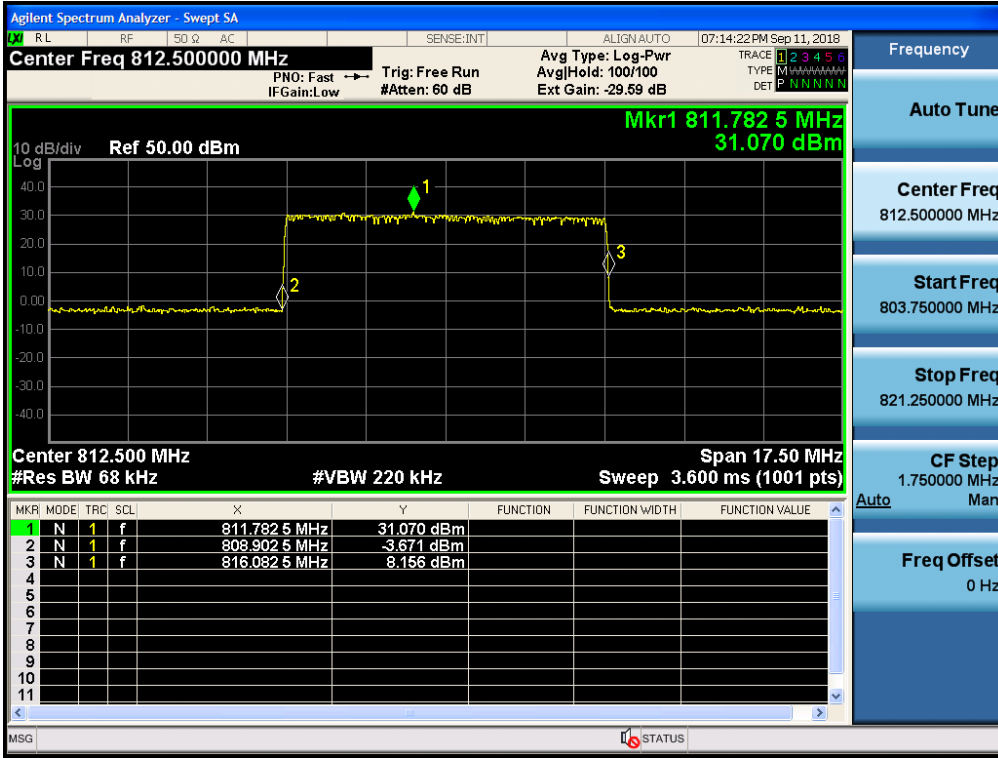

PS B/ILT SMR / Downlink

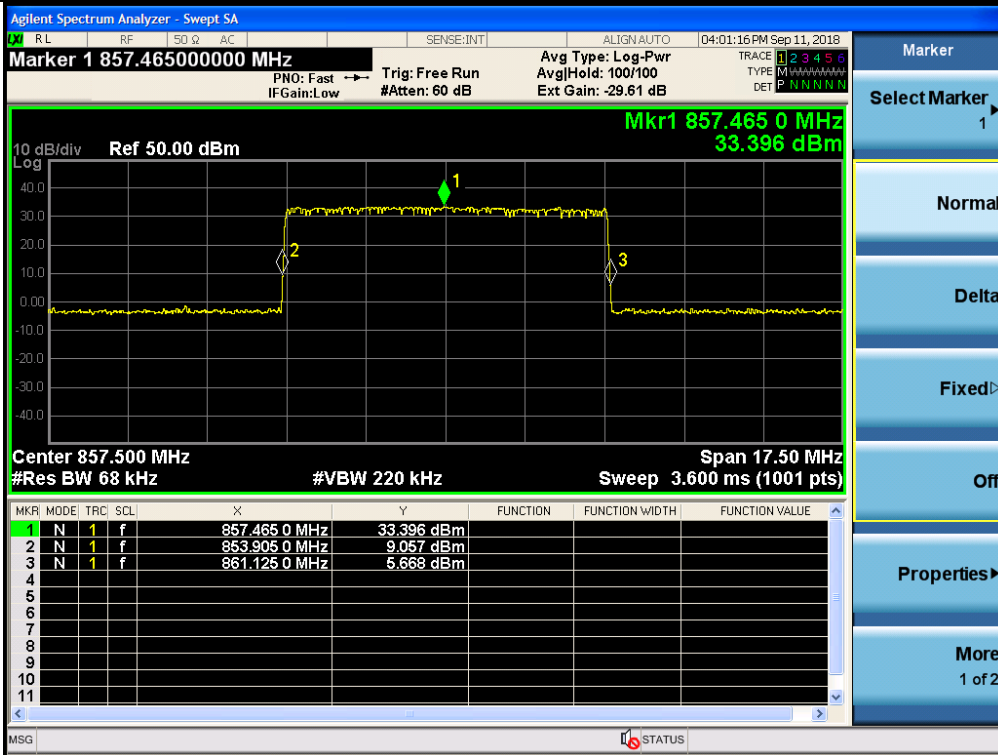

## 7. OCCUPIED BANDWIDTH

### FCC Rules

#### Test Requirement:

#### § 2.1049 Measurements required: Occupied bandwidth.

The occupied bandwidth, that is the frequency bandwidth such that, below its lower and above its upper frequency limits, the mean powers radiated are each equal to 0.5 percent of the total mean power radiated by a given emission shall be measured under the specified conditions of § 2.1049 (a) through (i) as applicable.

#### § 90.219 Use of signal boosters.

(e) Device Specifications. In addition to the general rules for equipment certification in §90.203(a)(2) and part 2, subpart J of this chapter, a signal booster must also meet the rules in this paragraph.

(4) A signal booster must be designed such that all signals that it retransmits meet the following requirements:

(ii) There is no change in the occupied bandwidth of the retransmitted signals.

#### Test Procedures:

Because KDB 935210 D05 procedure does not provide this requirement, measurements were in accordance with the test methods section 5.4.4 of ANSI C63.26-2015.

a) The spectrum analyzer center frequency is set to the nominal EUT channel center frequency. The frequency span for the spectrum analyzer shall be set wide enough to capture all modulation products including the emission skirts (typically a span of  $1.5 \times \text{OBW}$  is sufficient).

b) The nominal IF filter 3 dB bandwidth (RBW) shall be in the range of 1% to 5% of the anticipated OBW, and the VBW shall be set  $\geq 3 \times \text{RBW}$ .

c) Set the reference level of the instrument as required to prevent the signal amplitude from exceeding the maximum spectrum analyzer input mixer level for linear operation. See guidance provided in 4.2.3.

*NOTE—Step a), step b), and step c) may require iteration to adjust within the specified tolerances.*

d) Set the detection mode to peak, and the trace mode to max-hold.

e) Omit

f) The OBW shall be reported and plot(s) of the measuring instrument display shall be provided with the test report. The frequency and amplitude axis and scale shall be clearly labeled. Tabular data can be reported in addition to the plot(s).

**Test Results:**

**Tabular data of Input Occupied Bandwidth**

Test Band	Link	Tech	Frequency (MHz)	Measured bandwidth (kHz)
PS Narrowband	Uplink	P25 Phase 1	802.000	8.260
		P25 Phase 2	802.000	4.825
	Downlink	P25 Phase 1	772.000	8.287
		P25 Phase 2	772.000	4.778
NPSPAC	Uplink	P25 Phase 1	807.500	8.260
		P25 Phase 2	807.500	4.844
	Downlink	P25 Phase 1	852.500	8.341
		P25 Phase 2	852.500	4.845
PS B/ILT SMR	Uplink	P25 Phase 1	812.500	8.286
		P25 Phase 2	812.500	4.849
	Downlink	P25 Phase 1	857.500	8.424
		P25 Phase 2	857.500	4.836

**Tabular data of Output Occupied Bandwidth**

Test Band	Link	Tech	Frequency (MHz)	Measured bandwidth (kHz)
PS Narrowband	Uplink	P25 Phase 1	802.000	8.324
		P25 Phase 2	802.000	4.829
	Downlink	P25 Phase 1	772.000	8.167
		P25 Phase 2	772.000	4.827
NPSPAC	Uplink	P25 Phase 1	807.500	8.269
		P25 Phase 2	807.500	4.819
	Downlink	P25 Phase 1	852.500	8.403
		P25 Phase 2	852.500	4.795
PS B/ILT SMR	Uplink	P25 Phase 1	812.500	8.296
		P25 Phase 2	812.500	4.818
	Downlink	P25 Phase 1	857.500	8.463
		P25 Phase 2	857.500	4.790

**Tabular data of 3 dB above the AGC threshold Output Occupied Bandwidth**

Test Band	Link	Tech	Frequency (MHz)	Measured bandwidth (kHz)
PS Narrowband	Uplink	P25 Phase 1	802.000	8.407
		P25 Phase 2	802.000	4.822
	Downlink	P25 Phase 1	772.000	8.264
		P25 Phase 2	772.000	4.832
NPSPAC	Uplink	P25 Phase 1	807.500	8.446
		P25 Phase 2	807.500	4.819
	Downlink	P25 Phase 1	852.500	8.192
		P25 Phase 2	852.500	4.836
PS B/ILT SMR	Uplink	P25 Phase 1	812.500	8.455
		P25 Phase 2	812.500	4.788
	Downlink	P25 Phase 1	857.500	8.391
		P25 Phase 2	857.500	4.797

**Measured Occupied Bandwidth Comparison**

Test Band	Link	Tech	Variant of Input and output Occupied Bandwidth (%)	Variant of Input and 3 dB above the AGC threshold output Occupied Bandwidth (%)
PS Narrowband	Uplink	P25 Phase 1	1.08	2.17
		P25 Phase 2	0.06	-0.59
	Downlink	P25 Phase 1	4.41	-2.08
		P25 Phase 2	0.04	-0.17
NPSPAC	Uplink	P25 Phase 1	-0.18	1.33
		P25 Phase 2	-0.62	-0.59
	Downlink	P25 Phase 1	0.29	1.54
		P25 Phase 2	-0.55	-1.06
PS B/ILT SMR	Uplink	P25 Phase 1	4.52	2.71
		P25 Phase 2	-0.11	-1.01
	Downlink	P25 Phase 1	3.58	-4.39
		P25 Phase 2	-0.75	-0.29

\* Change in input-output OBW is less than  $\pm 5\%$ .

**Plot data of Occupied Bandwidth**

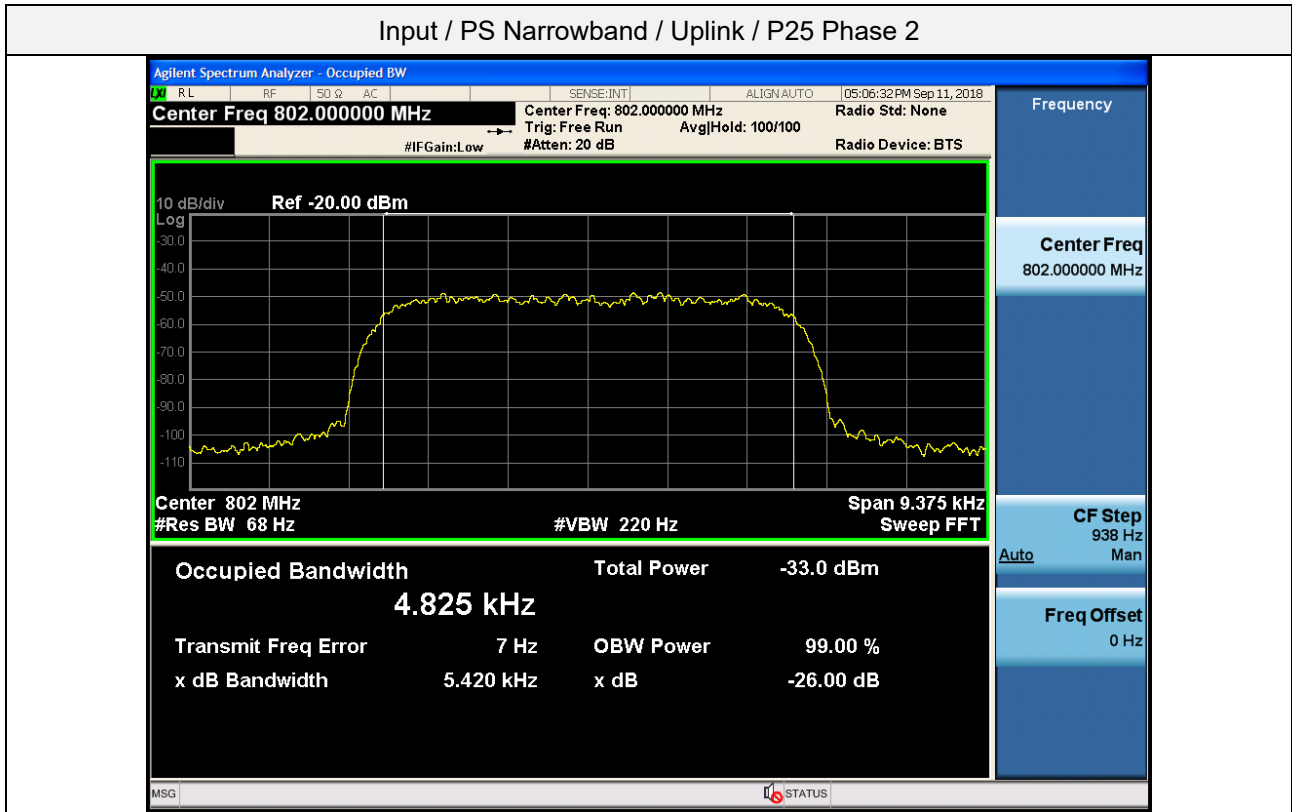
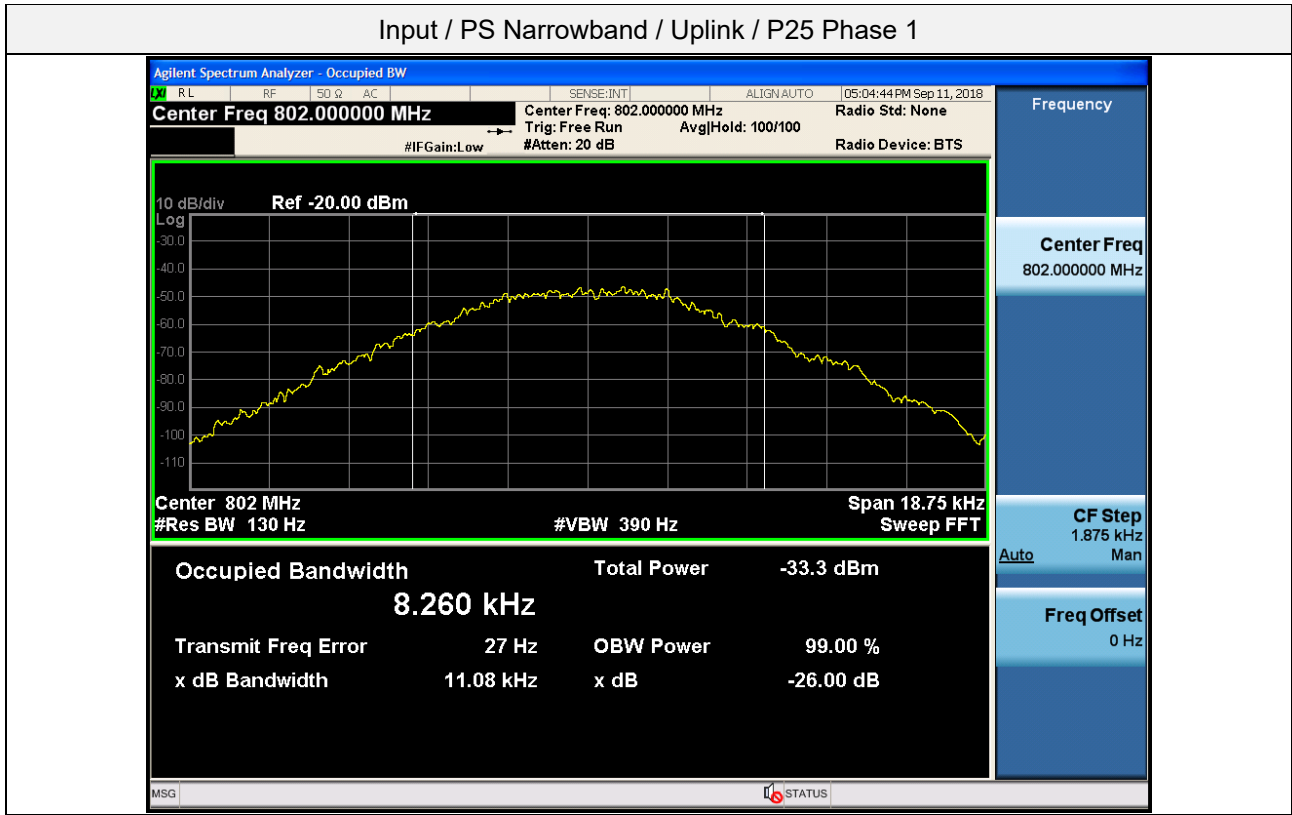

Input / PS Narrowband / Downlink / P25 Phase 1

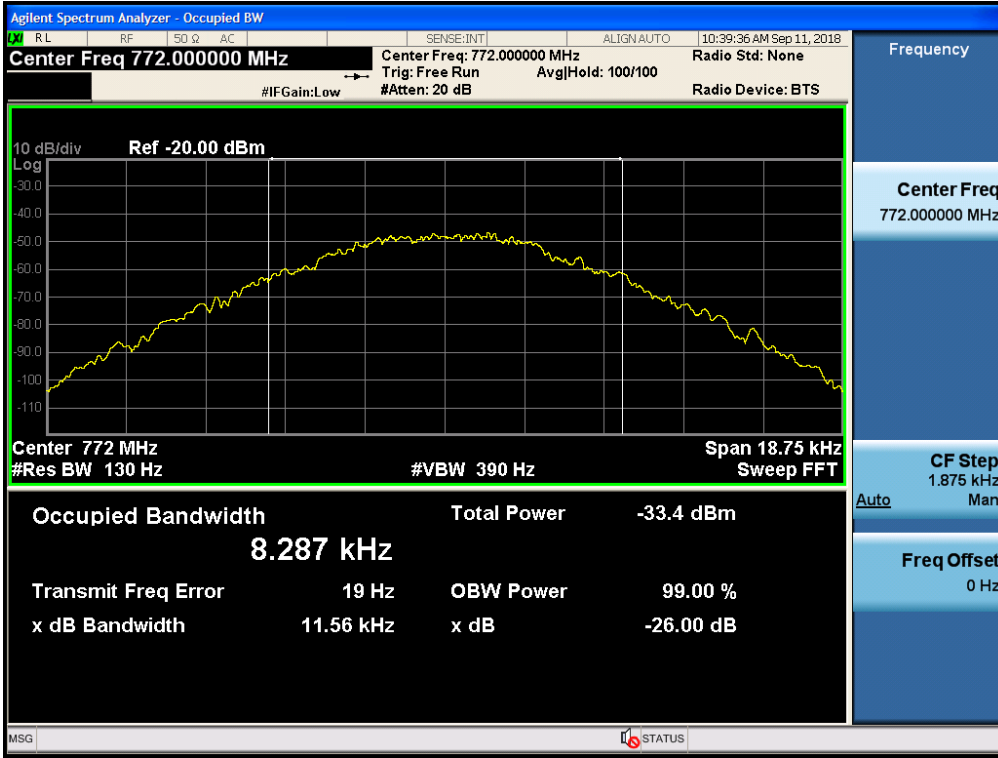

Input / PS Narrowband / Downlink / P25 Phase 2

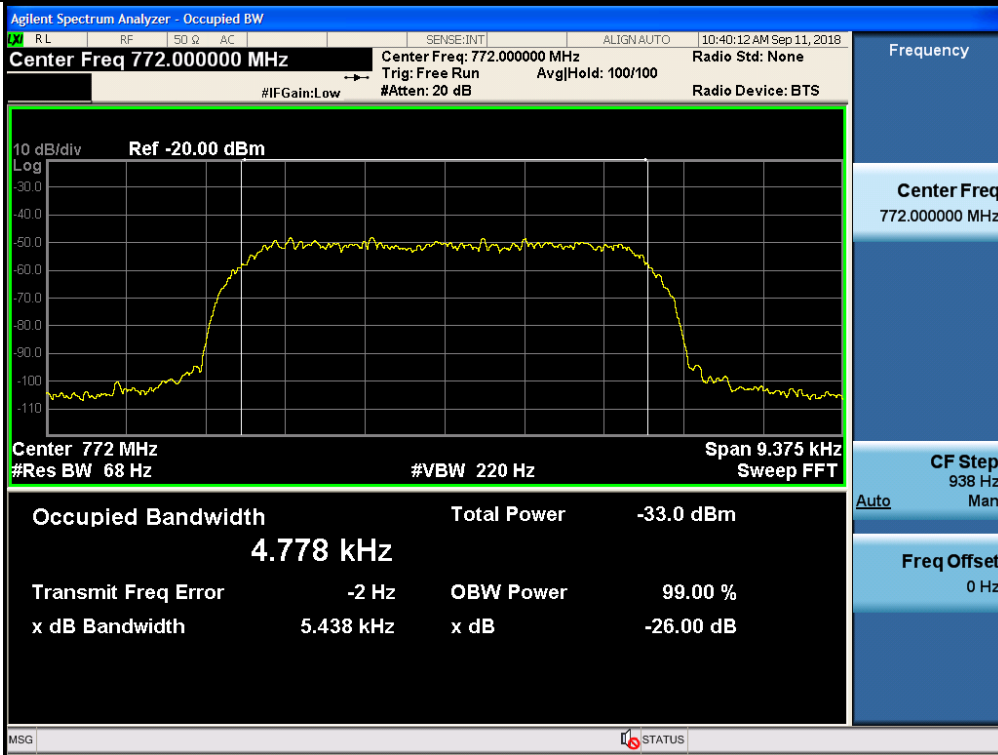



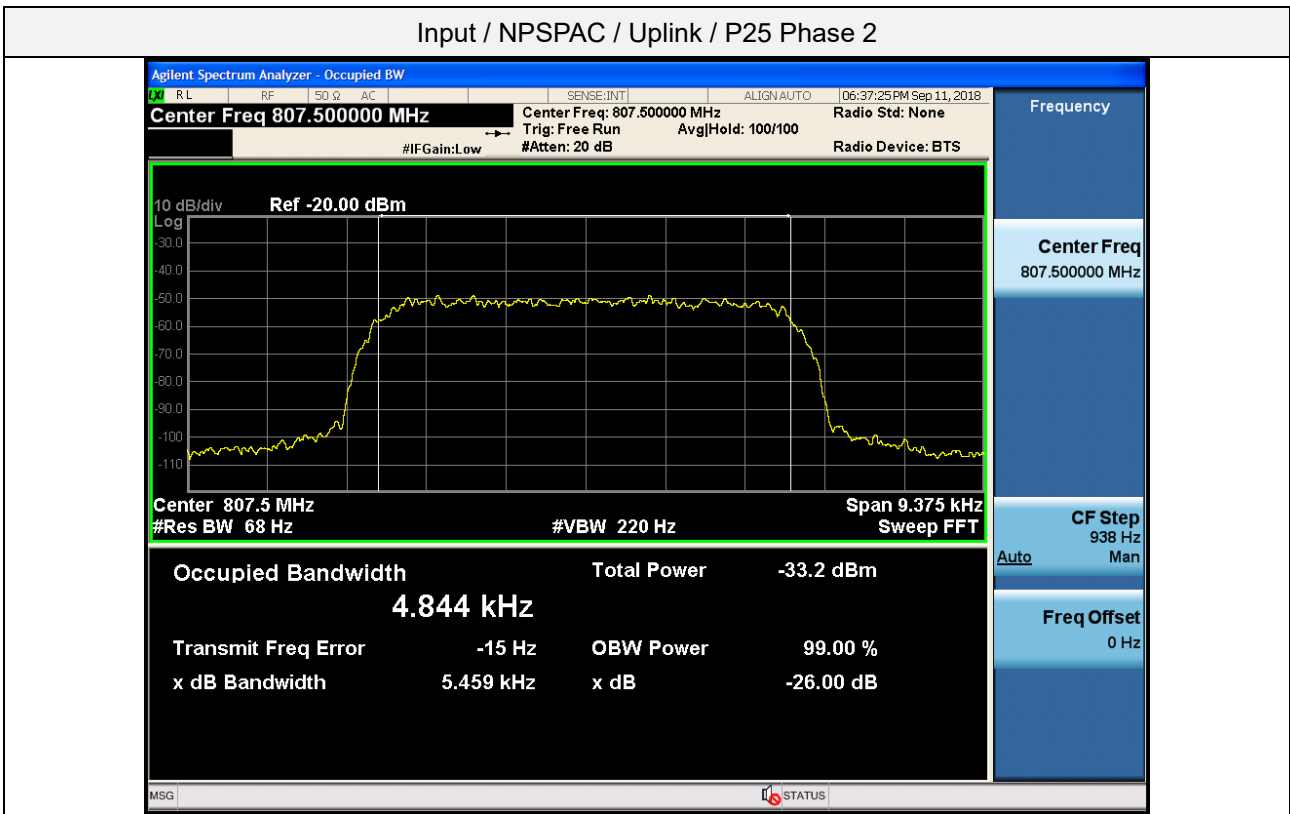
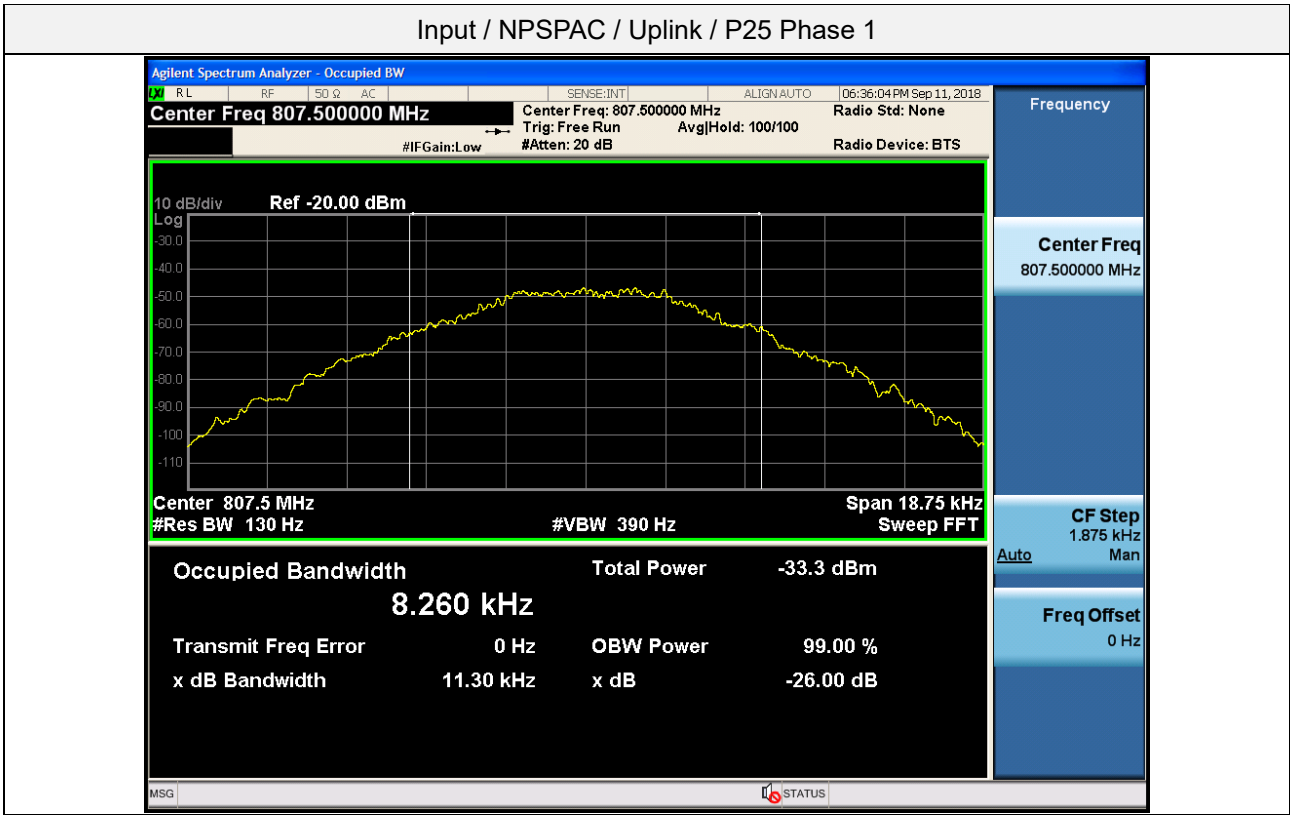

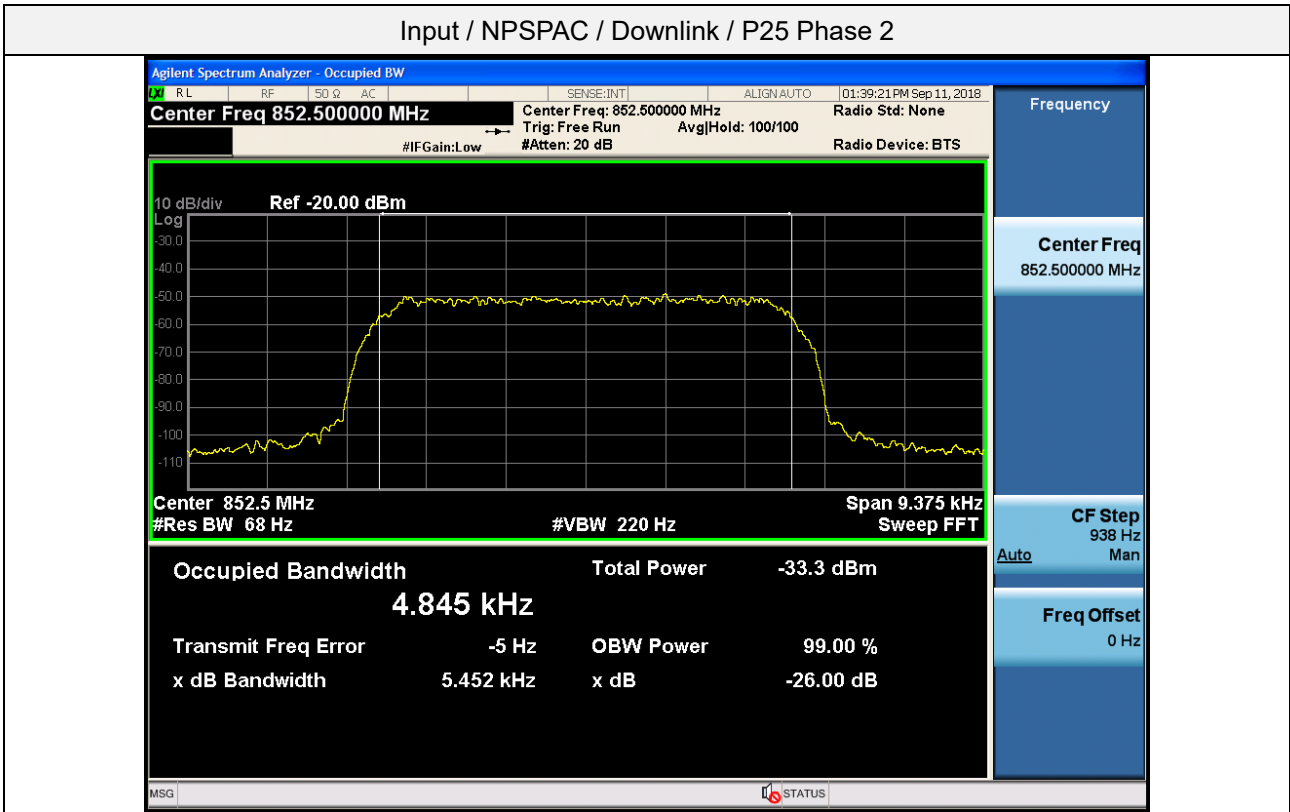
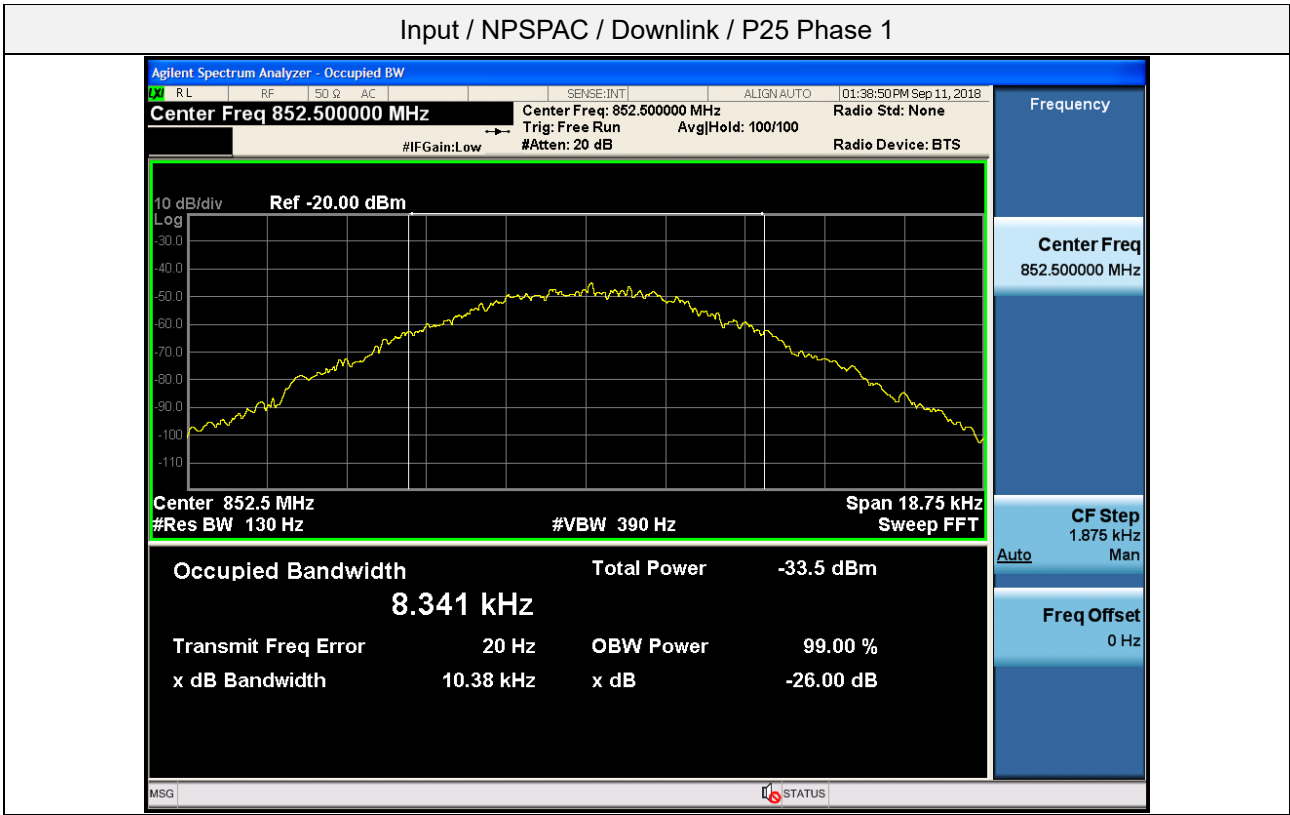

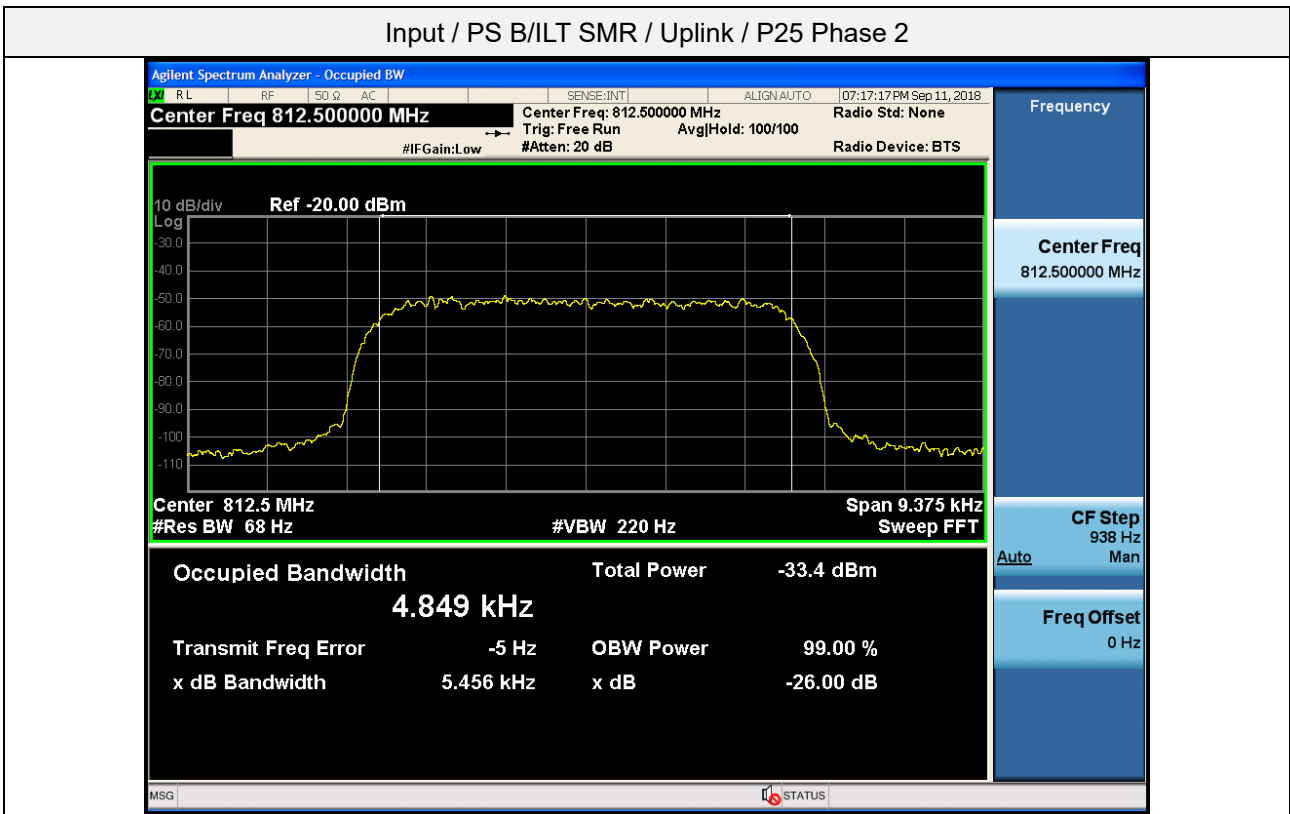
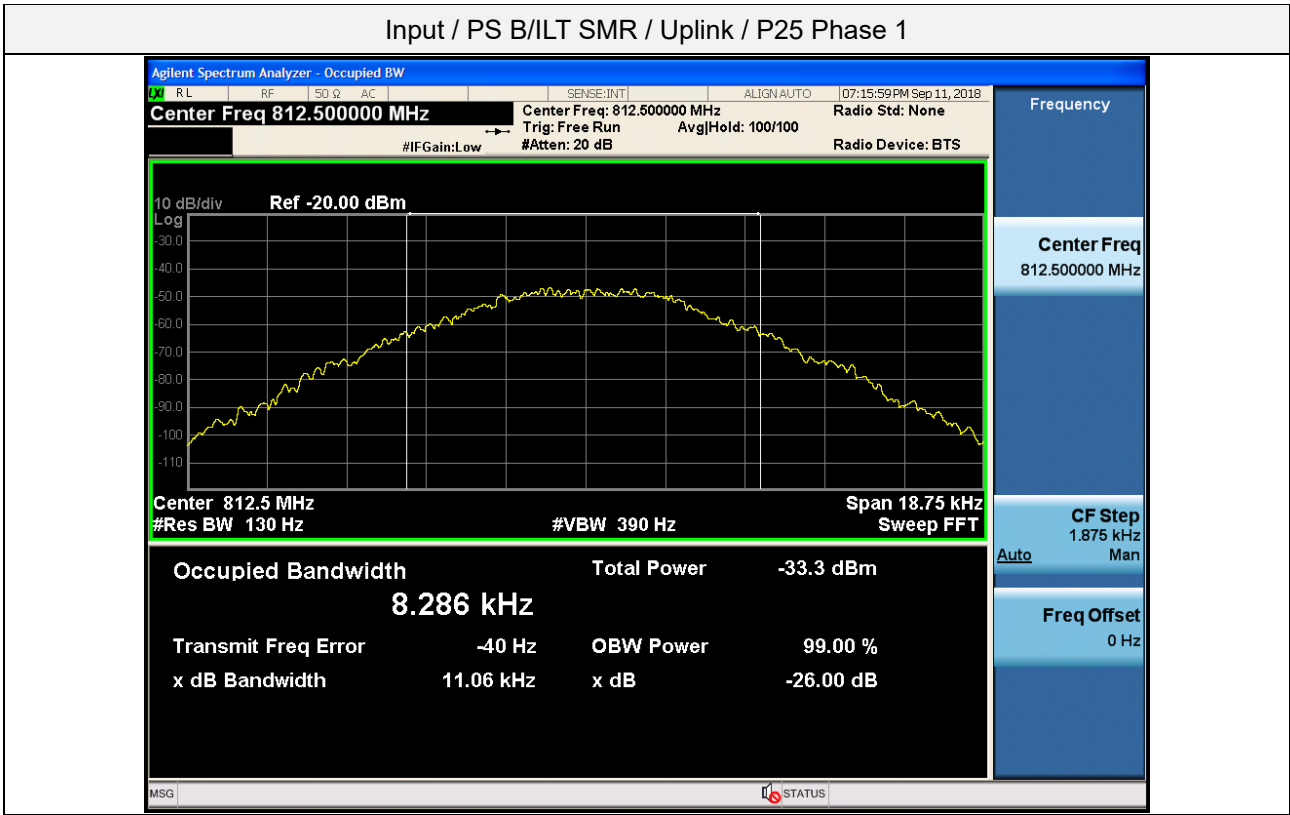

Input / PS B/ILT SMR / Downlink / P25 Phase 1

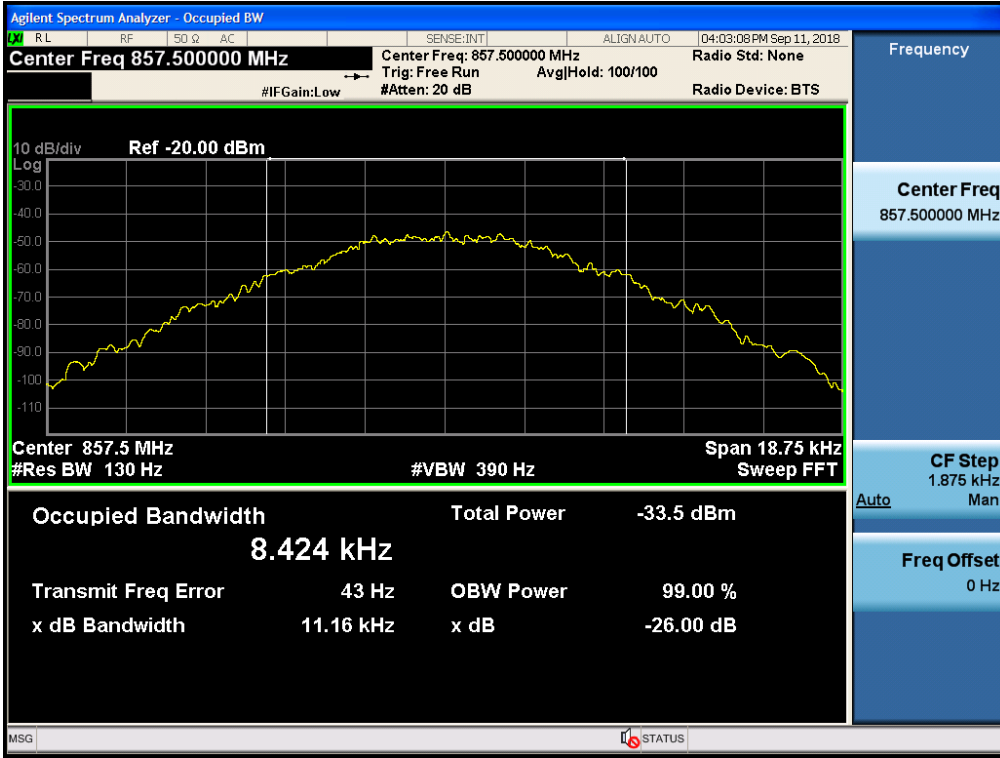

Input / PS B/ILT SMR / Downlink / P25 Phase 2

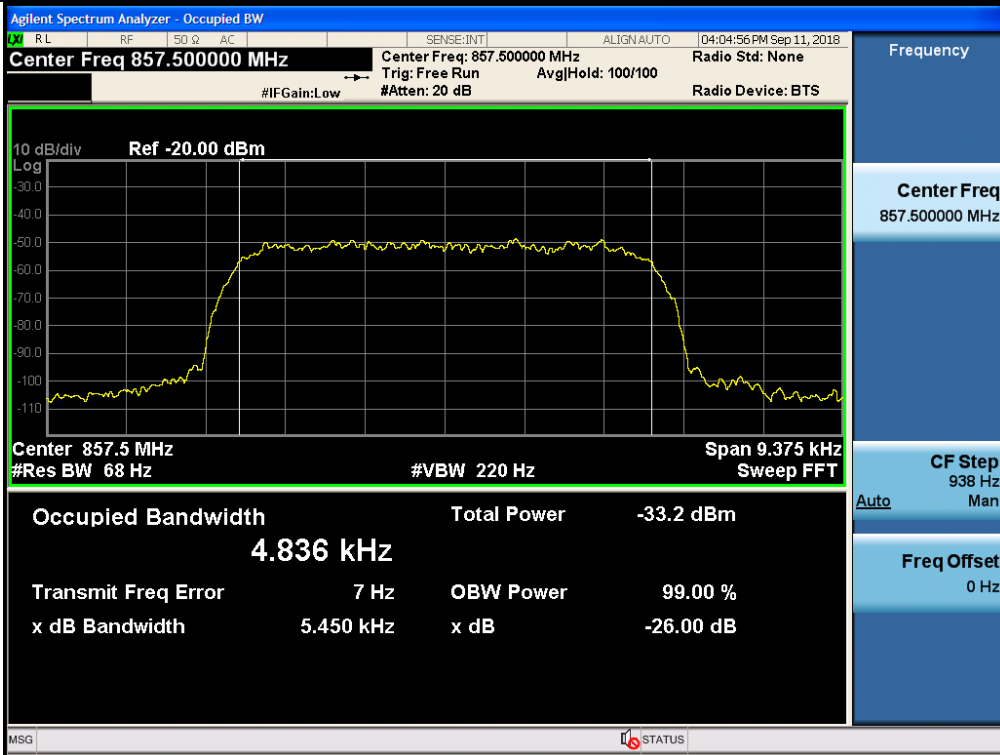

Output / PS Narrowband / Uplink / P25 Phase 1

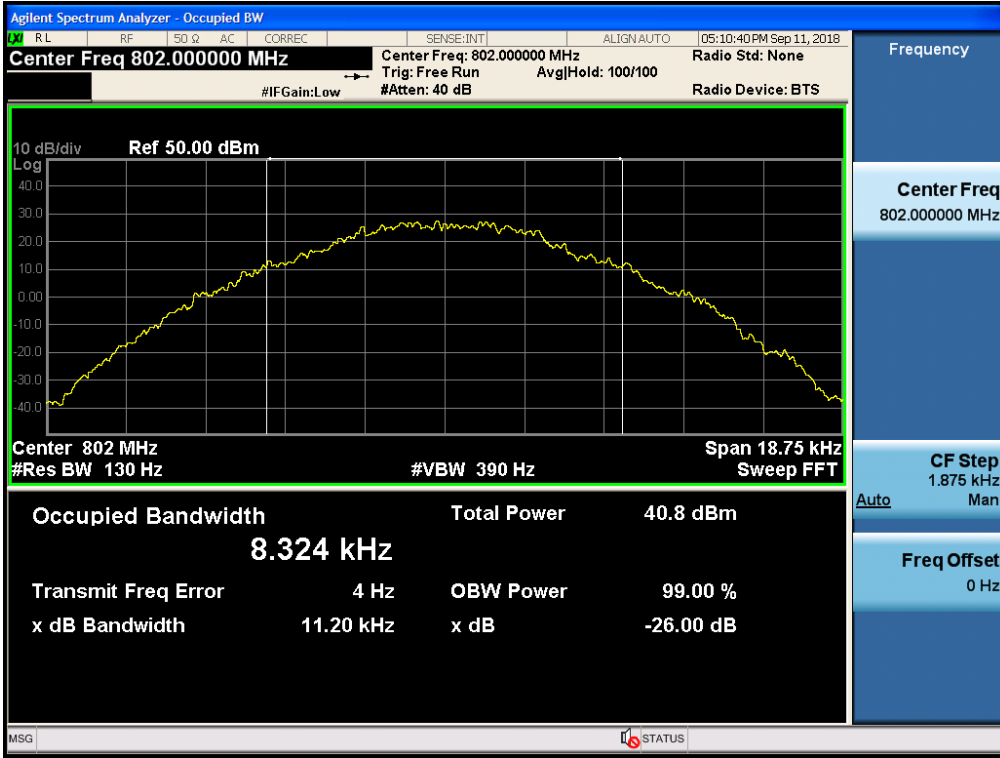

Output / PS Narrowband / Uplink / P25 Phase 2

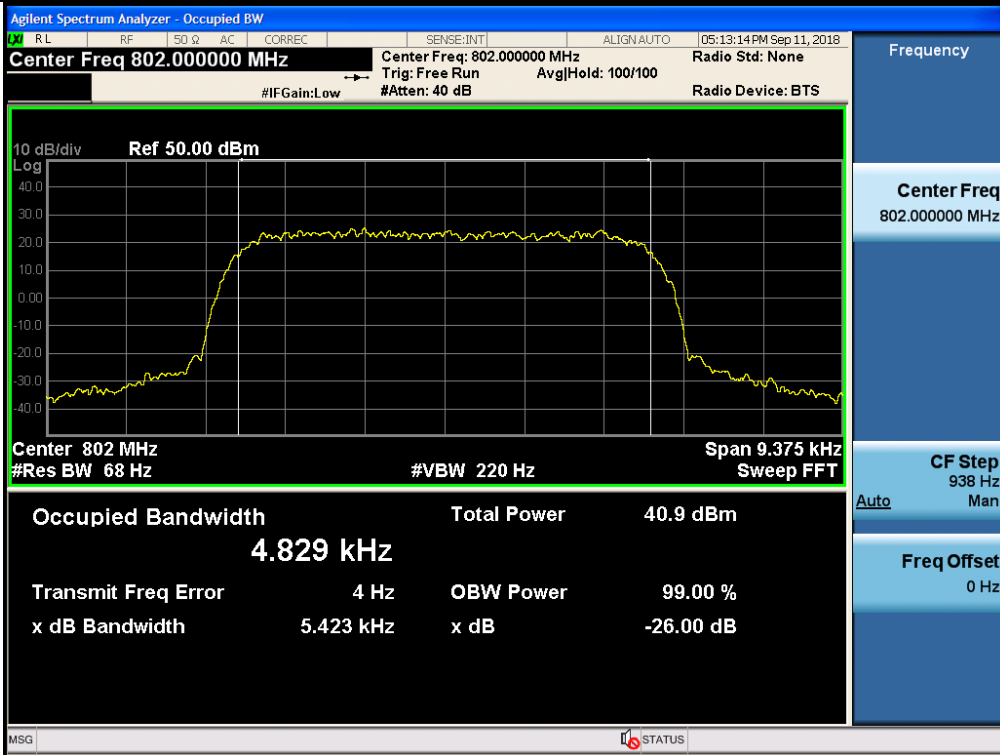

Output / PS Narrowband / Downlink / P25 Phase 1

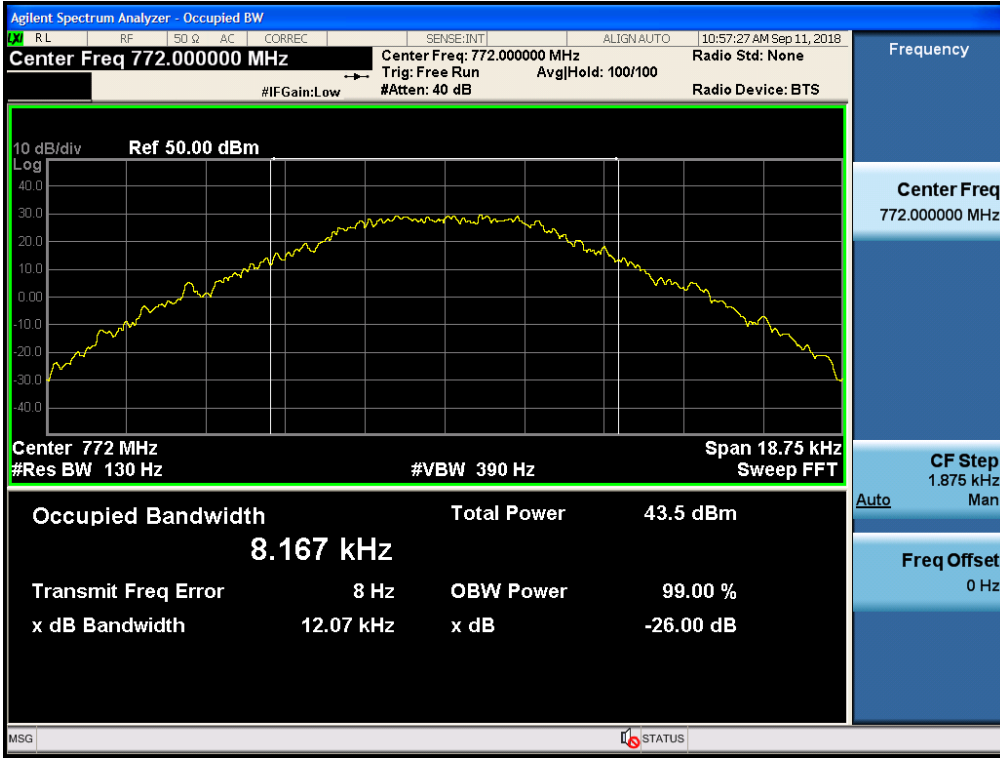

Output / PS Narrowband / Downlink / P25 Phase 2

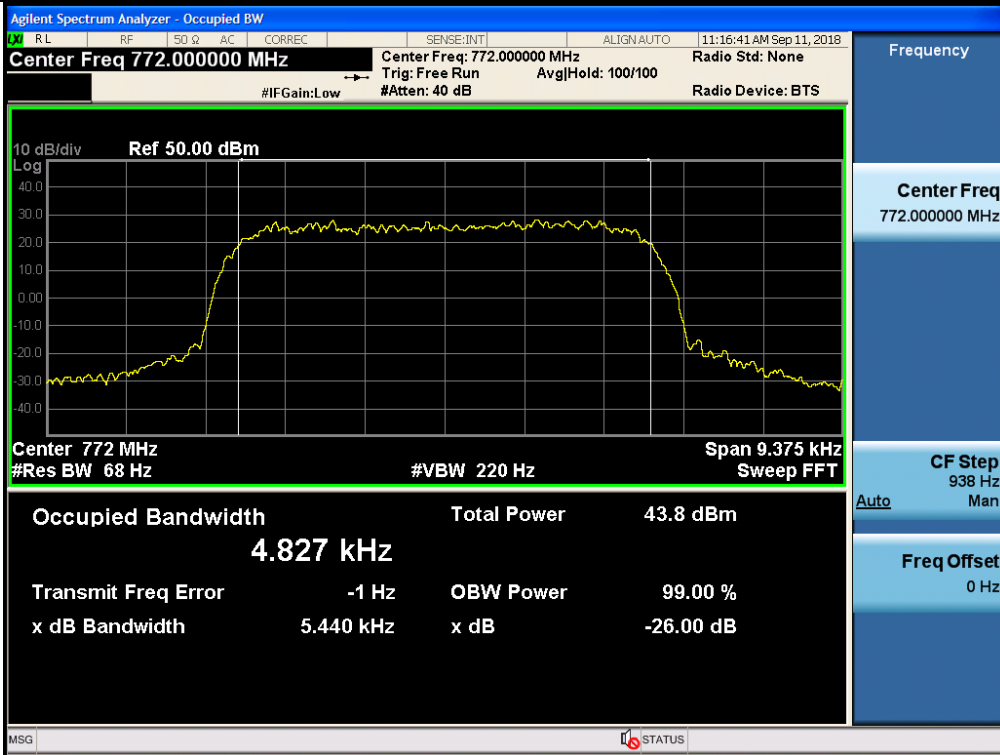

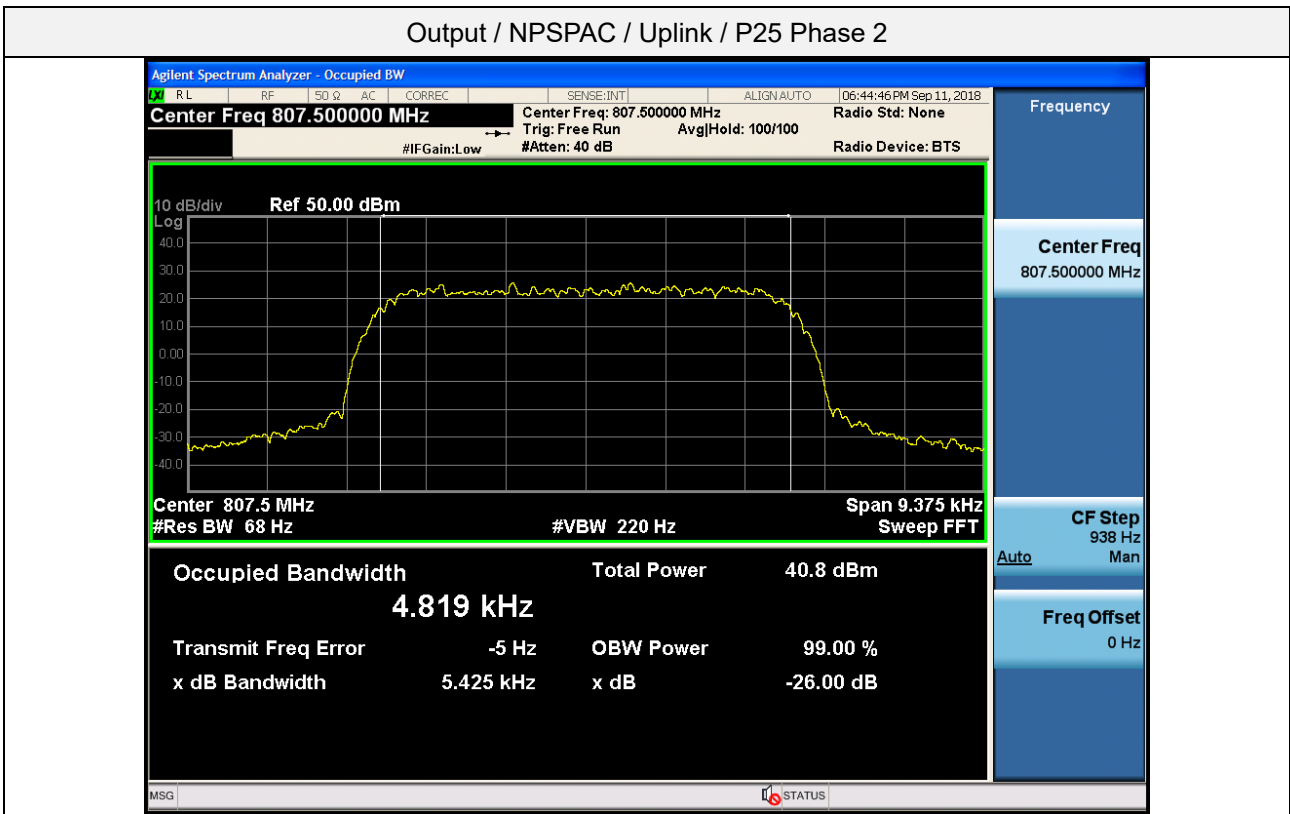
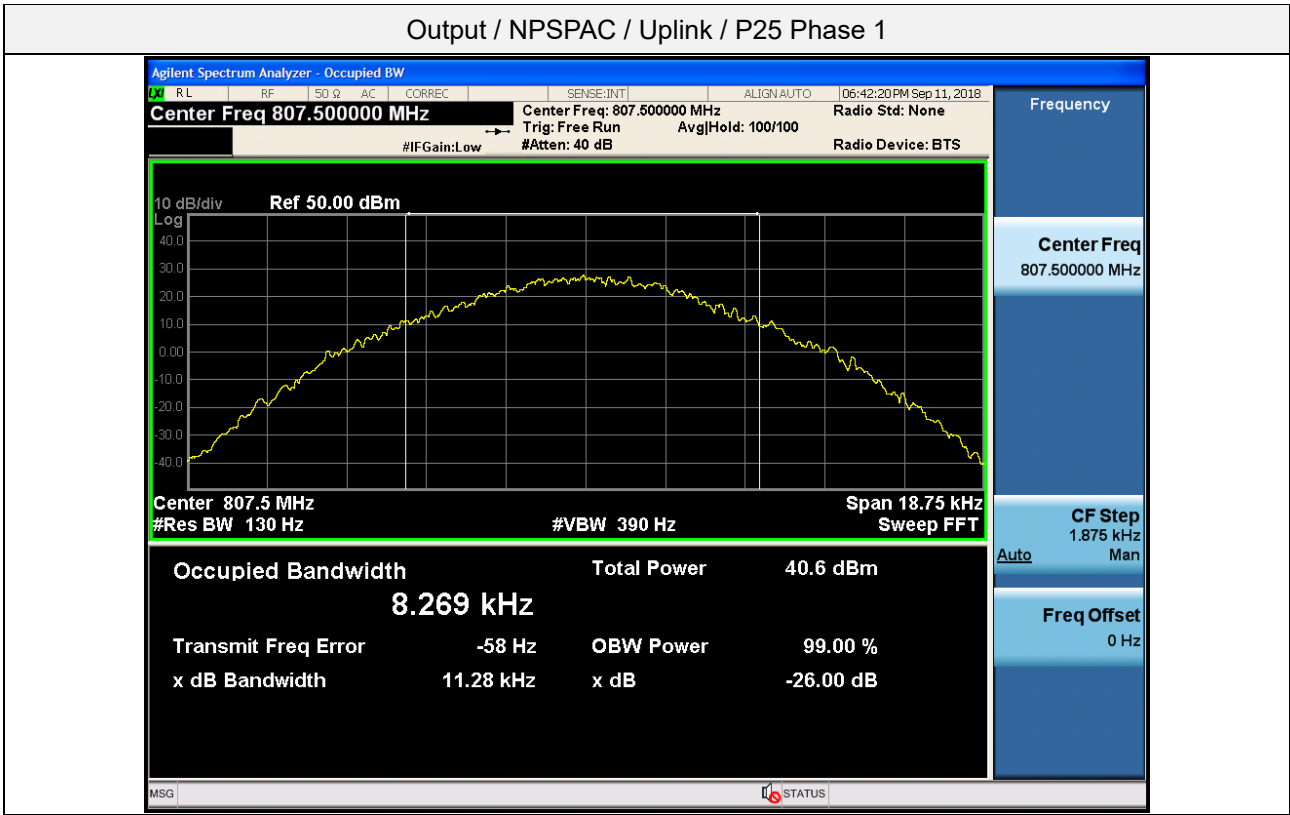

Output / NPSPAC / Downlink / P25 Phase 1

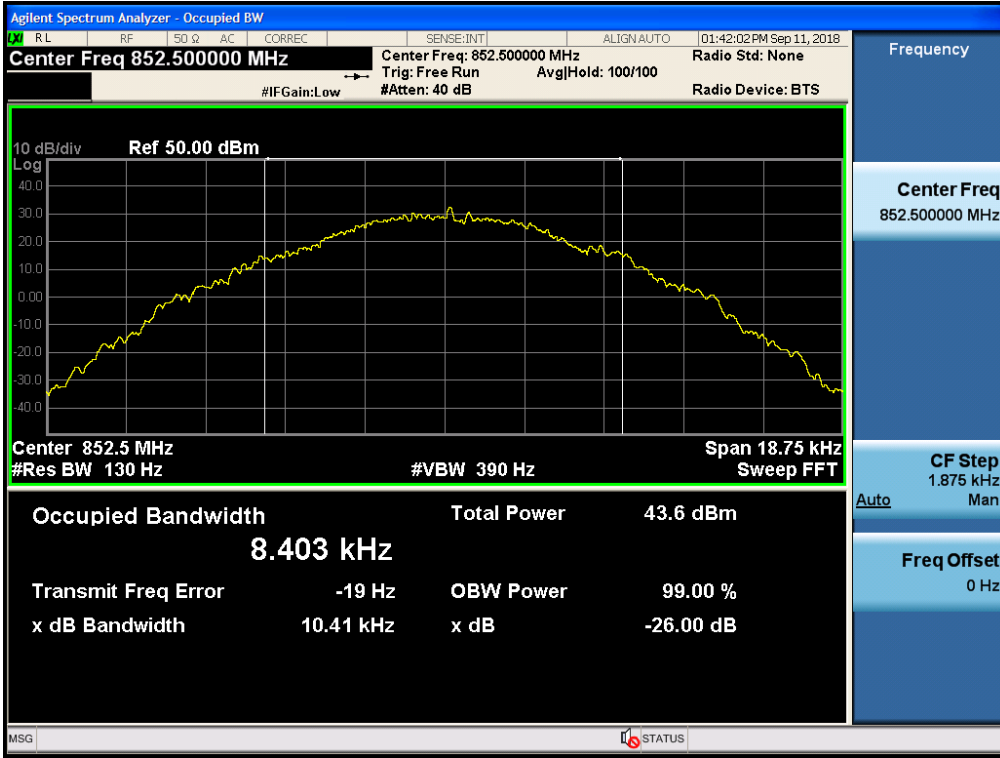

Output / NPSPAC / Downlink / P25 Phase 2

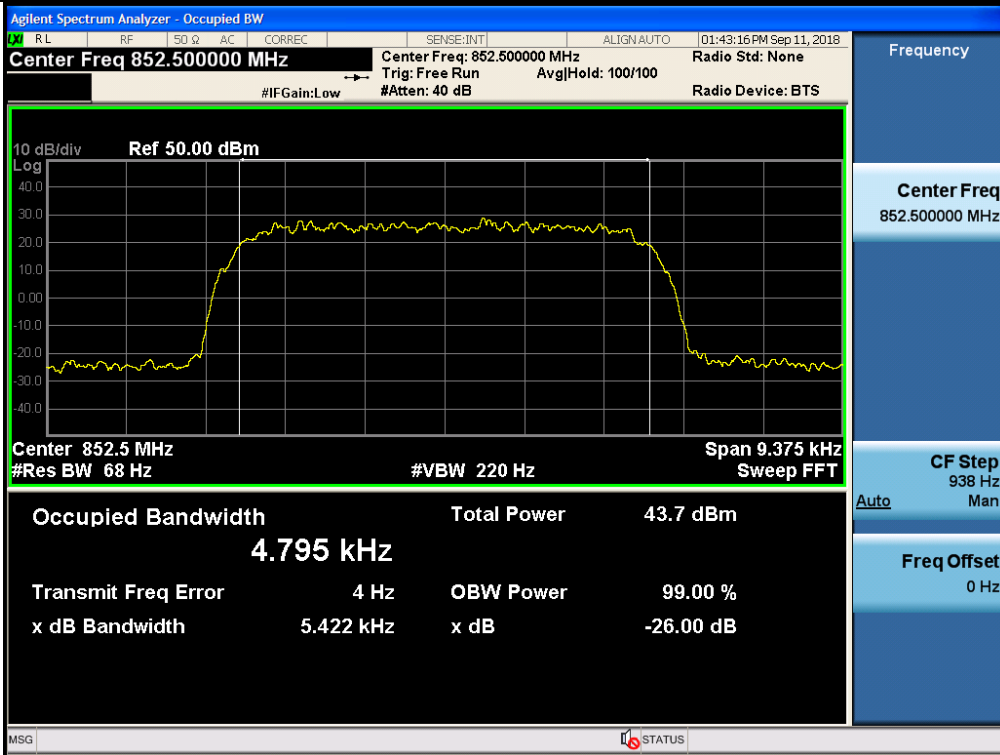



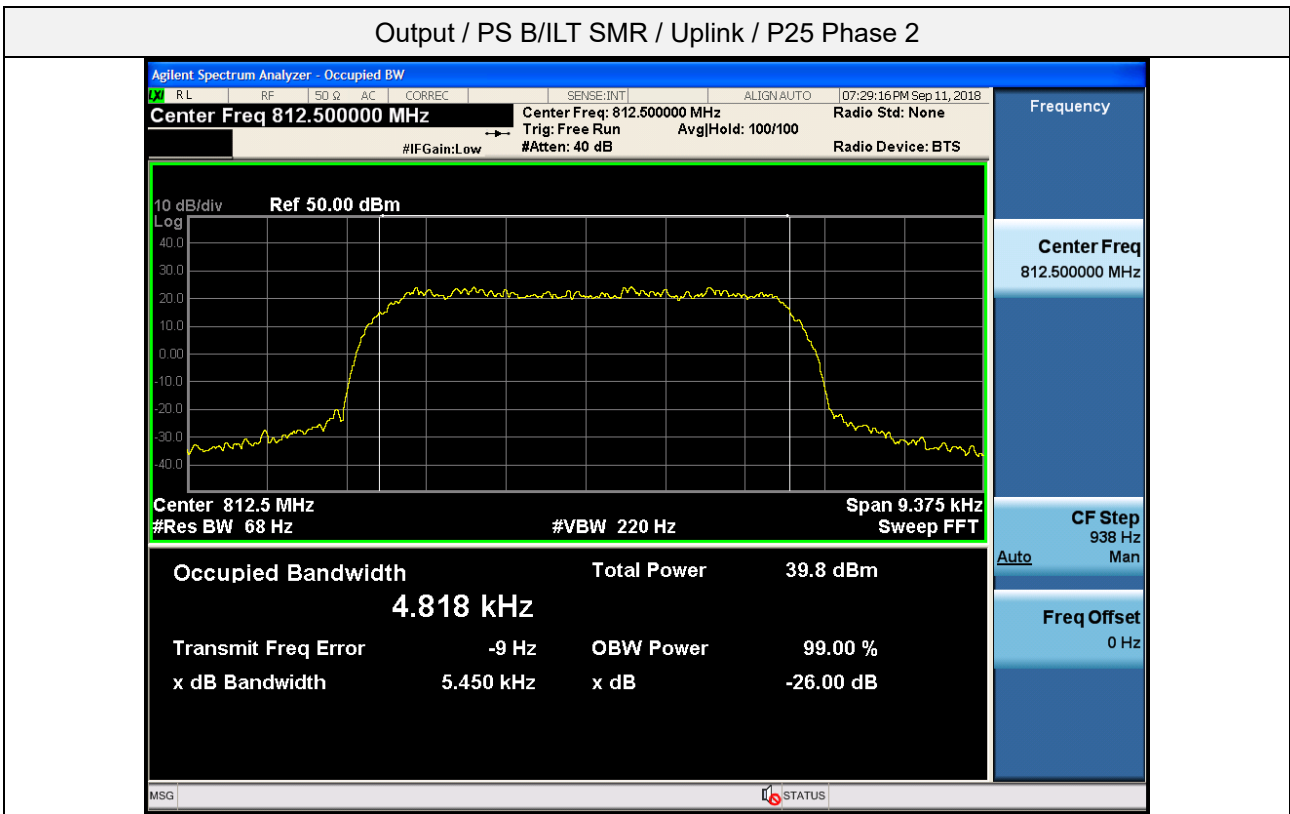
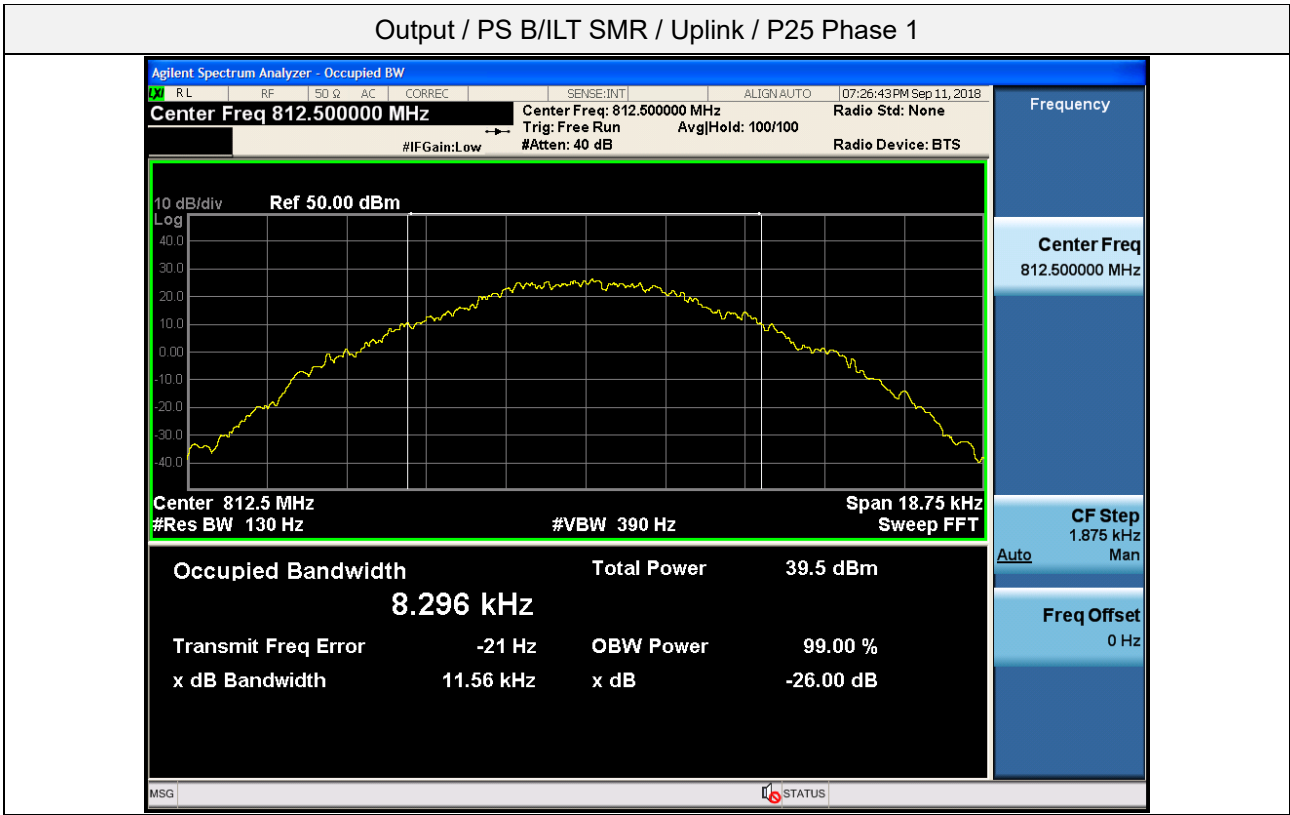

Output / PS B/ILT SMR / Downlink / P25 Phase 1

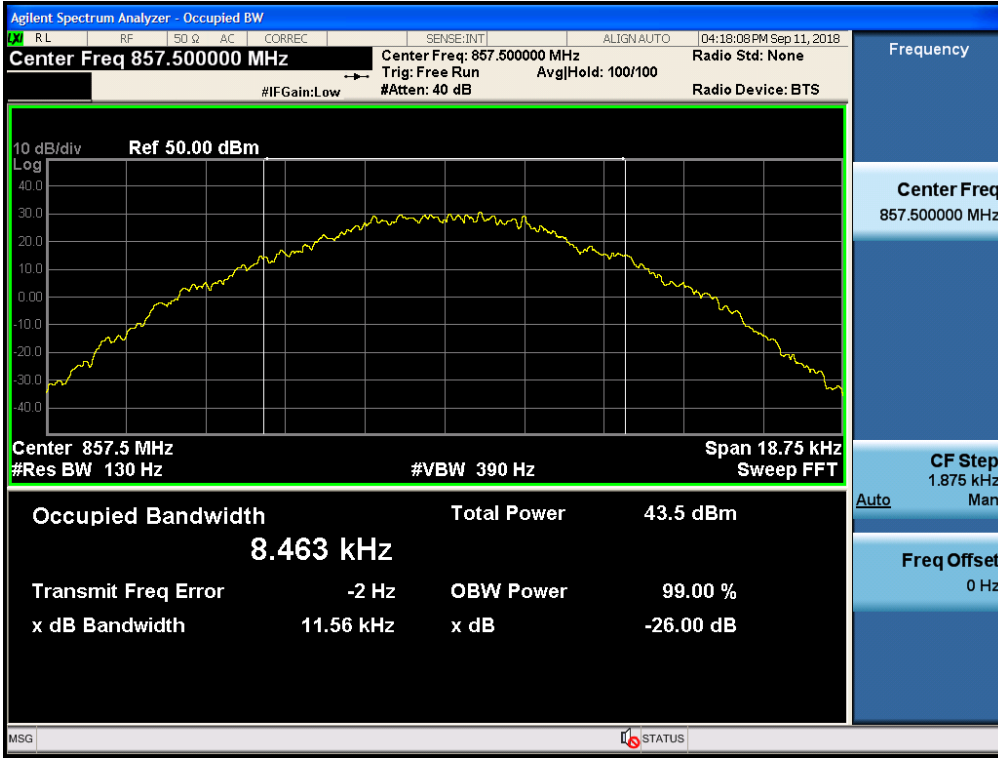

Output / PS B/ILT SMR / Downlink / P25 Phase 2

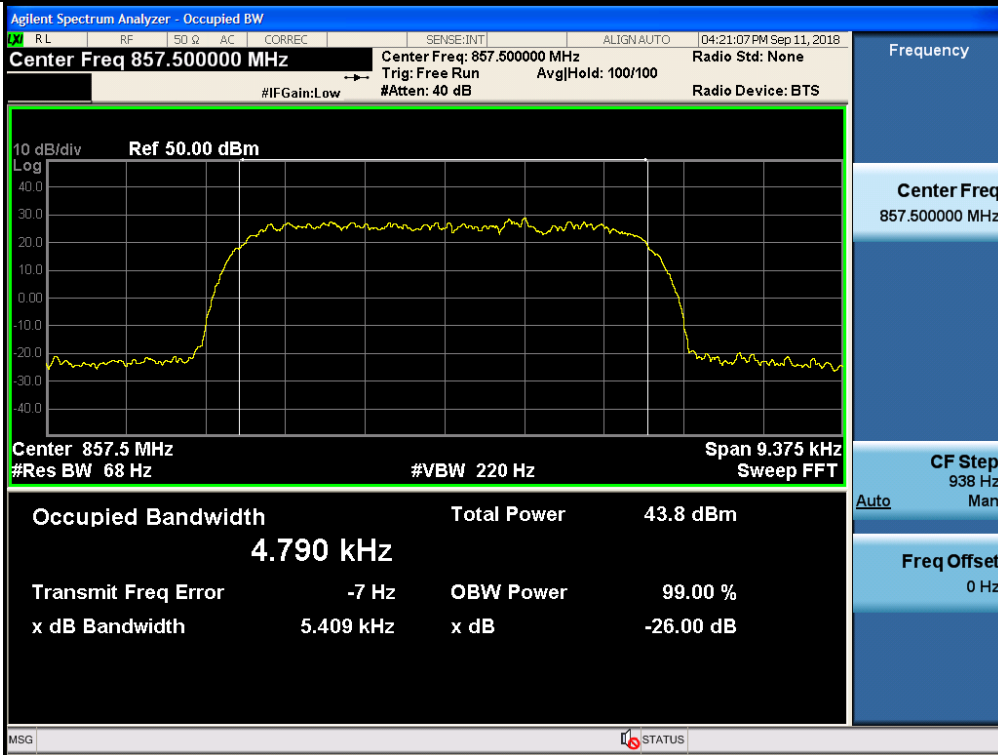

3 dB above the AGC threshold Output / PS Narrowband / Uplink / P25 Phase 1

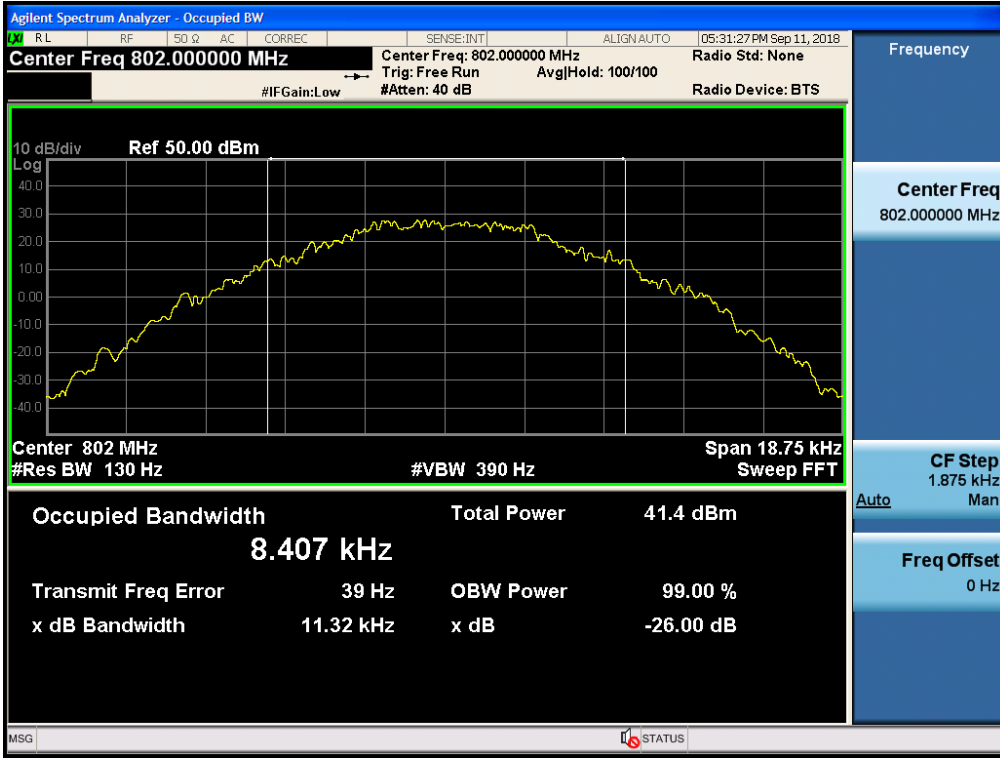

3 dB above the AGC threshold Output / PS Narrowband / Uplink / P25 Phase 2

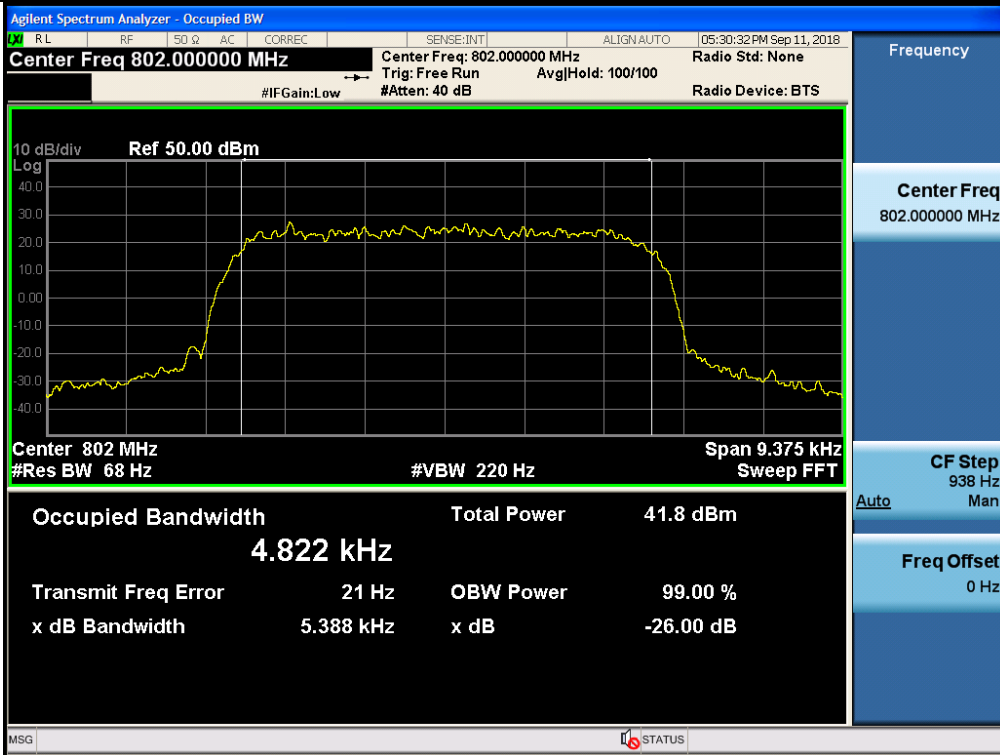

3 dB above the AGC threshold Output / PS Narrowband / Downlink / P25 Phase 1

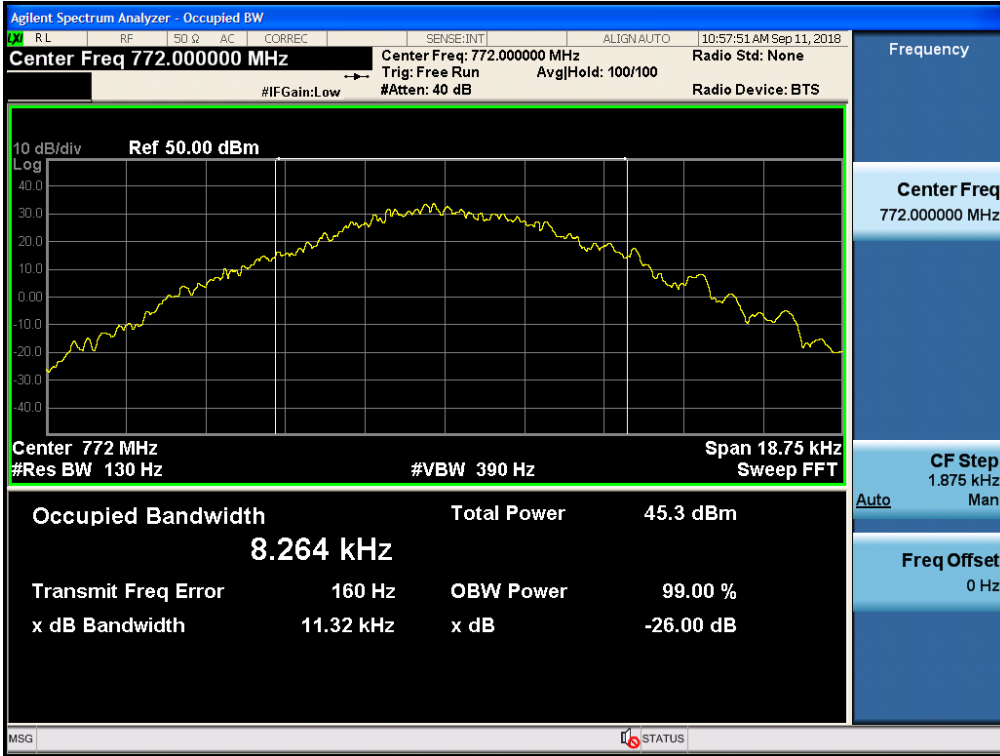

3 dB above the AGC threshold Output / PS Narrowband / Downlink / P25 Phase 2

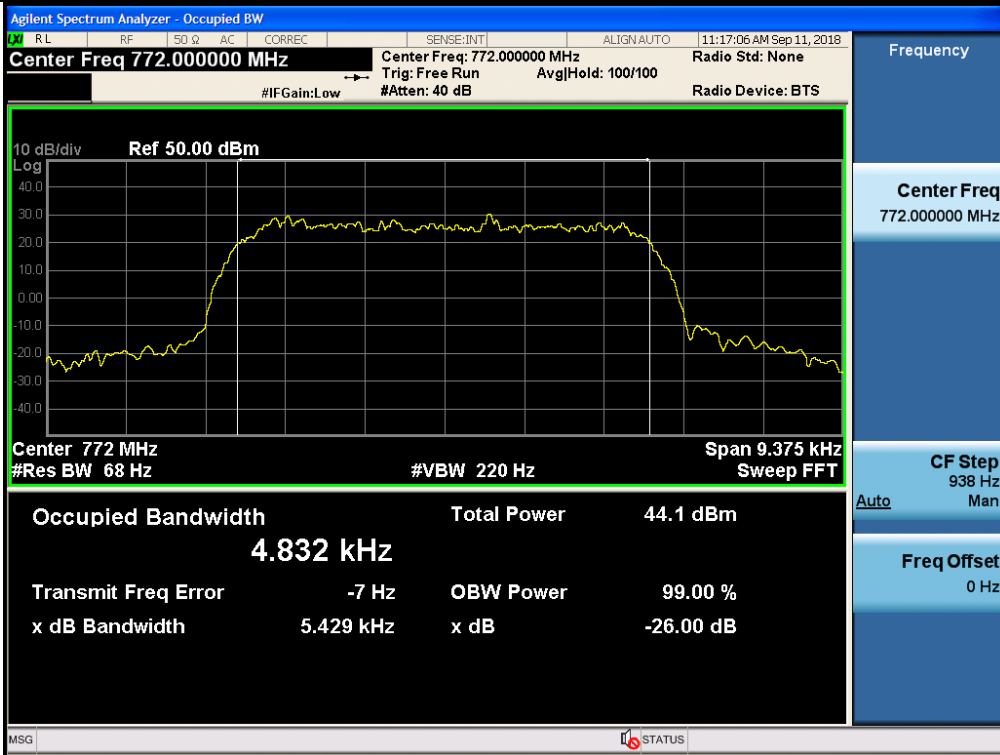

3 dB above the AGC threshold Output / NPSPAC / Uplink / P25 Phase 1

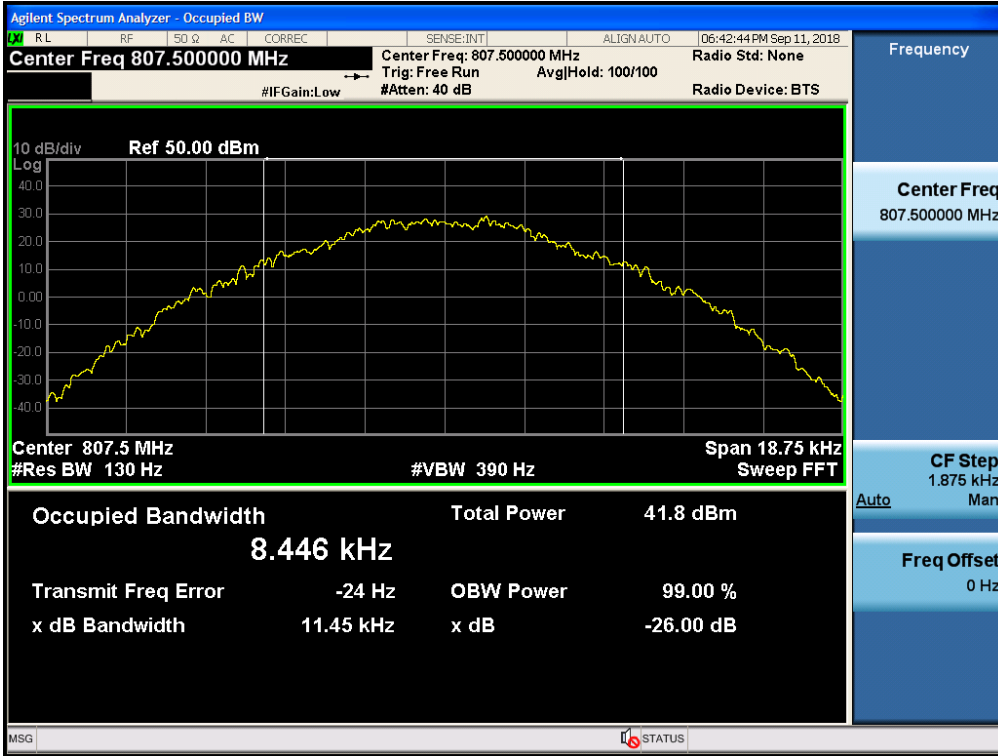

3 dB above the AGC threshold Output / NPSPAC / Uplink / P25 Phase 2

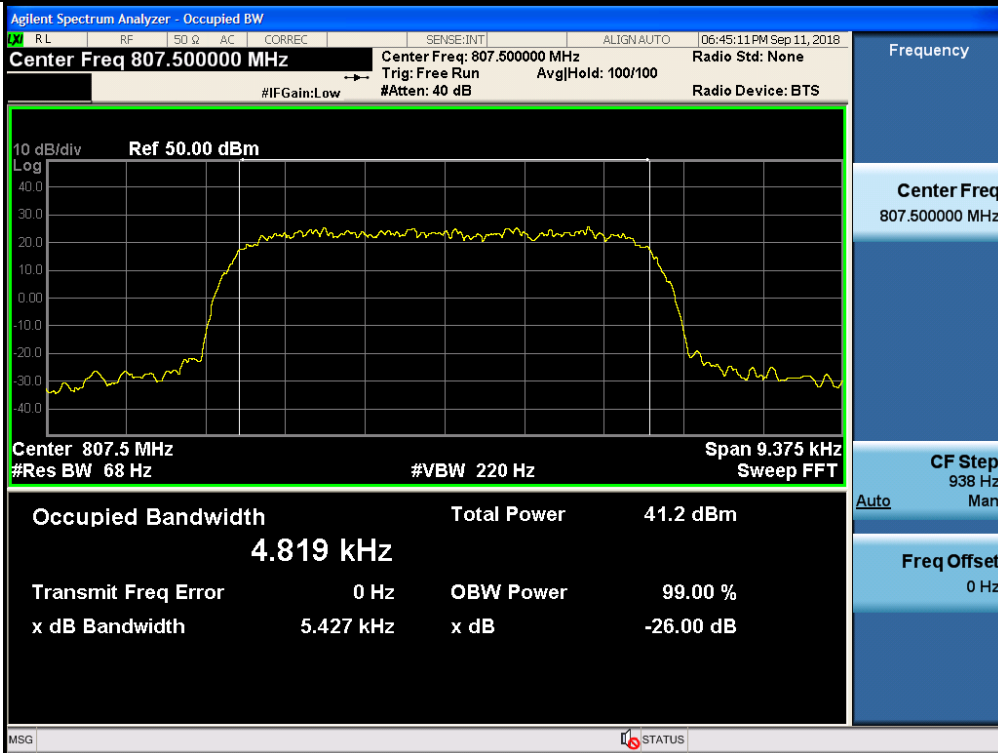

3 dB above the AGC threshold Output / NPSPAC / Downlink / P25 Phase 1

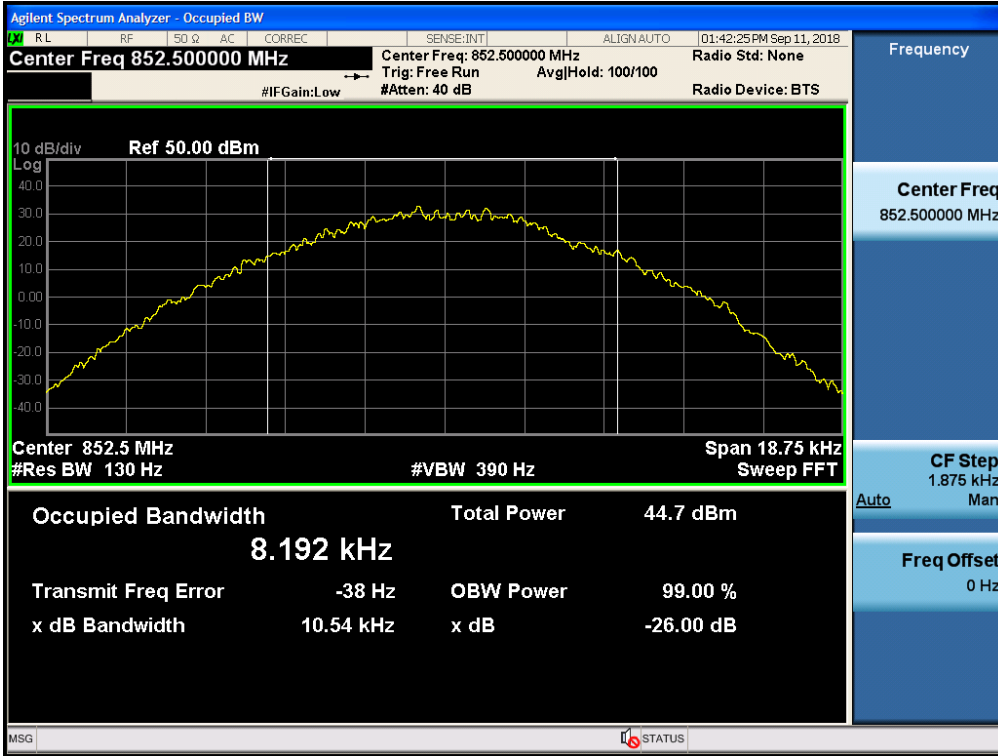

3 dB above the AGC threshold Output / NPSPAC / Downlink / P25 Phase 2

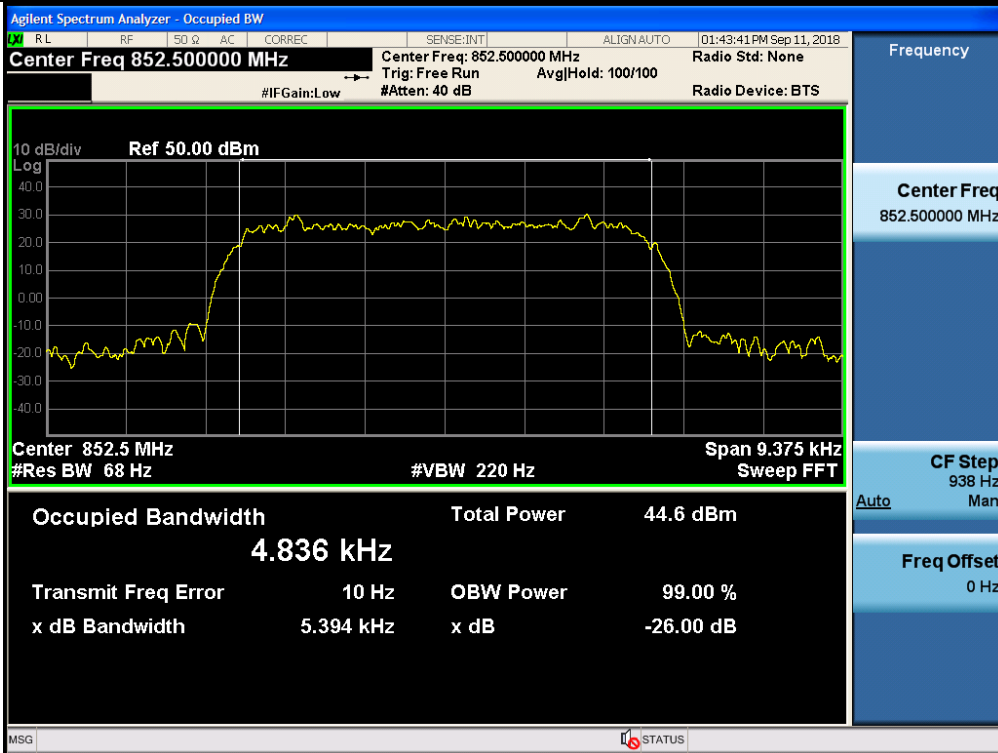

3 dB above the AGC threshold Output / PS B/ILT SMR / Uplink / P25 Phase 1

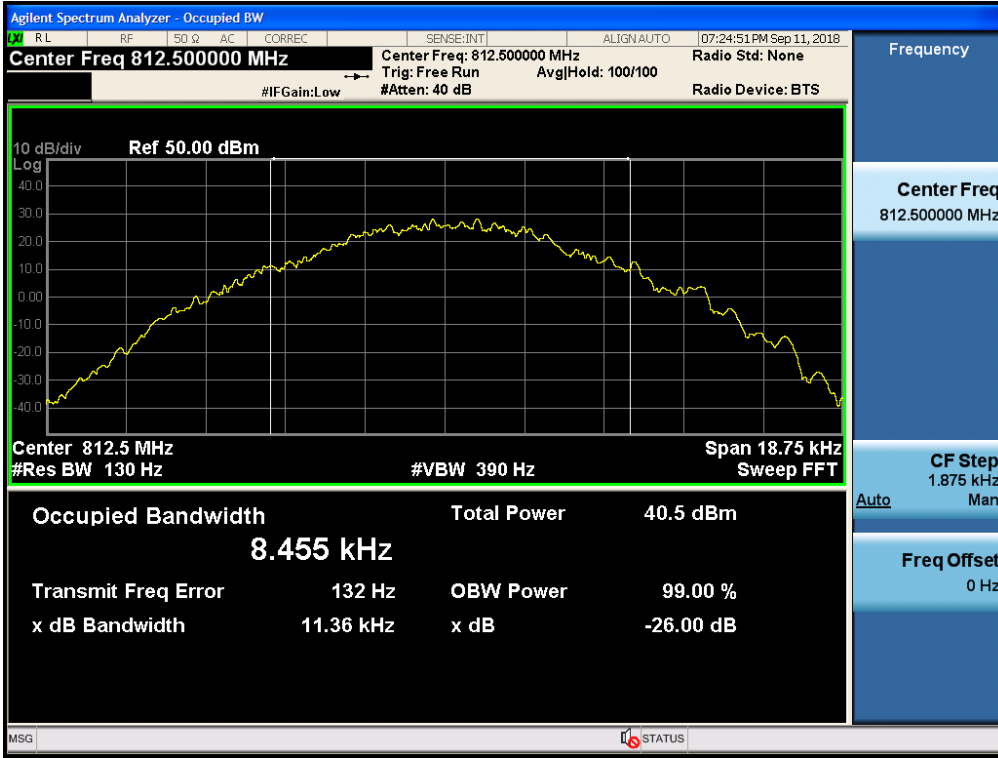

3 dB above the AGC threshold Output / PS B/ILT SMR / Uplink / P25 Phase 2

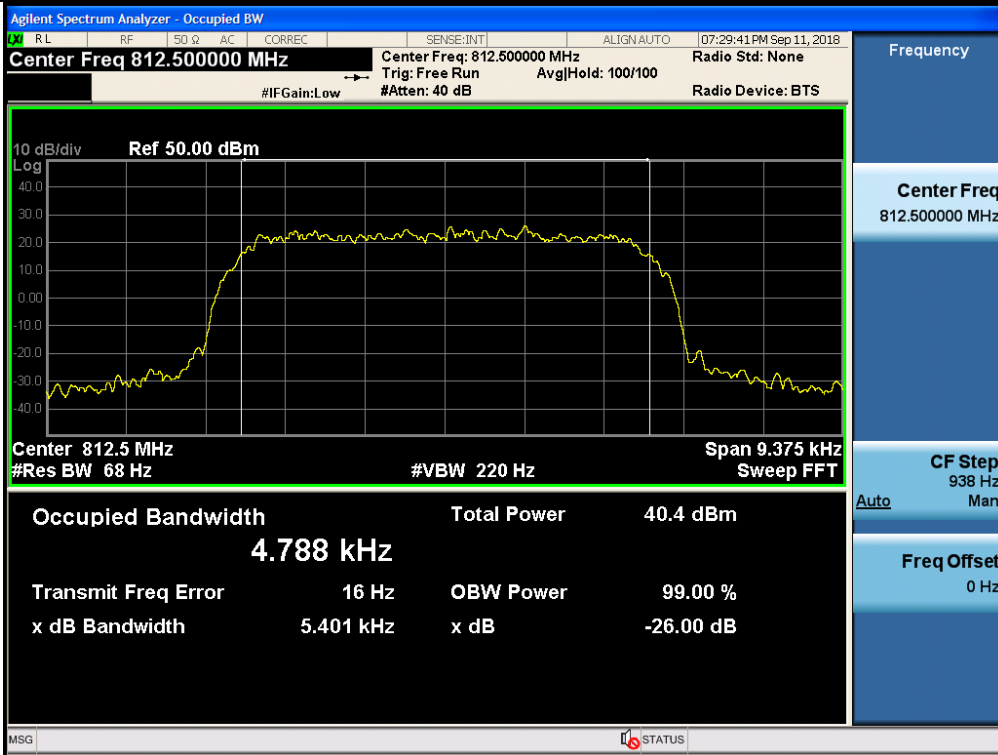

3 dB above the AGC threshold Output / PS B/ILT SMR / Downlink / P25 Phase 1

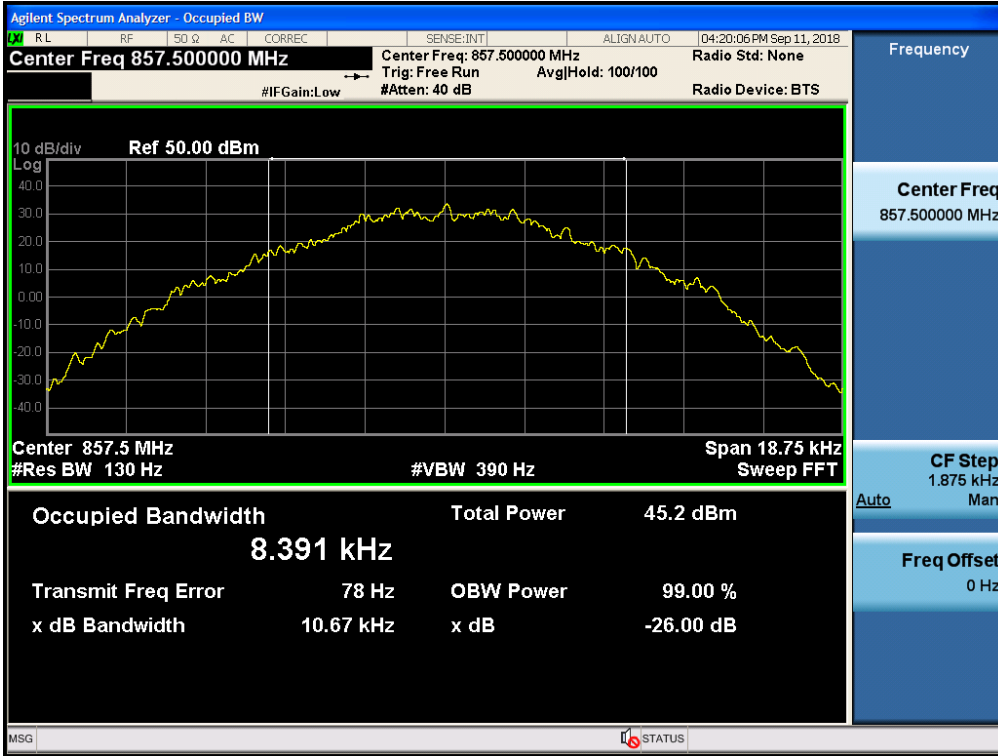

3 dB above the AGC threshold Output / PS B/ILT SMR / Downlink / P25 Phase 2

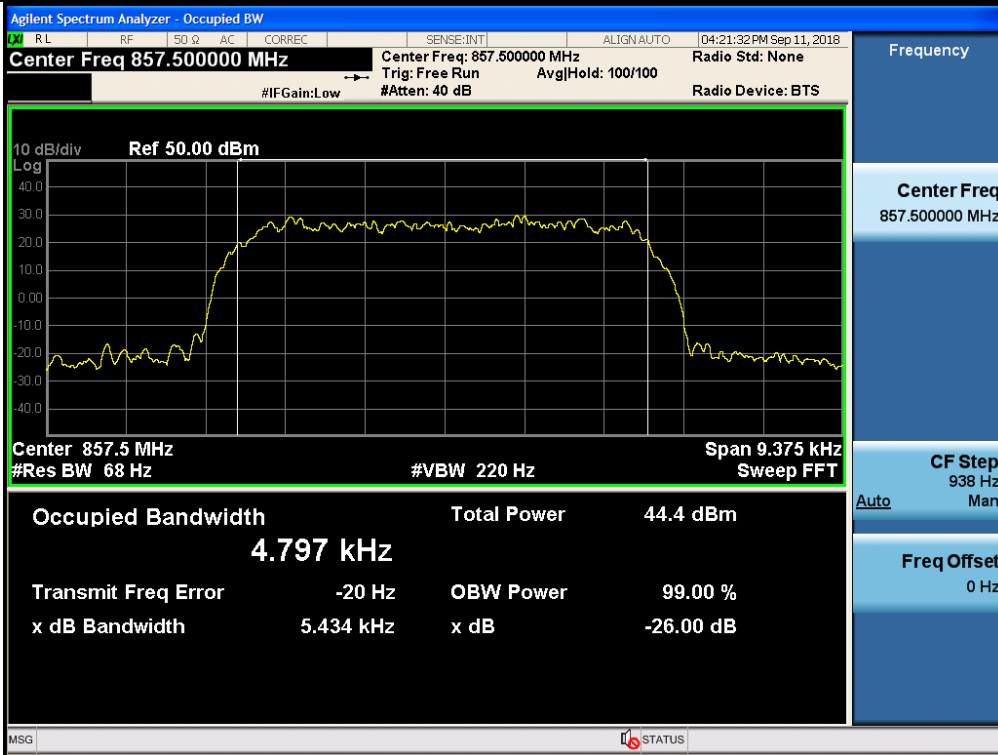



## 8. INPUT-VERSUS-OUTPUT SIGNAL COMPARISON

### FCC Rules

#### Test Requirement:

#### § 90.210 Emission masks.

Except as indicated elsewhere in this part, transmitters used in the radio services governed by this part must comply with the emission masks outlined in this section. Unless otherwise stated, per paragraphs (d)(4), (e)(4), and (o) of this section, measurements of emission power can be expressed in either peak or average values provided that emission powers are expressed with the same parameters used to specify the unmodulated transmitter carrier power. For transmitters that do not produce a full power unmodulated carrier, reference to the unmodulated transmitter carrier power refers to the total power contained in the channel bandwidth. Unless indicated elsewhere in this part, the table in this section specifies the emission masks for equipment operating under this part.

**APPLICABLE EMISSION MASKS**

Frequency band (MHz)	Mask for equipment with audio Low pass filter	Mask for equipment without audio low pass filter
Below 25	A or B	A or C
25-50	B	C
72-76	B	C
150-174	B, D, or E	C, D or E
150 paging only	B	C
220-222	F	F
421-512	B, D, or E	C, D, or E
450 paging only	B	G
806-809/851-854	B	H
809-824/854-869	B	G
896-901/935-940	I	J
902-928	K	K
929-930	B	G
4940-4990	L or M	L or M
5850-5925		
All other bands	B	C

(c) Emission Mask C. For transmitters that are not equipped with an audio low-pass filter, the power of any emission must be attenuated below the unmodulated carrier output power (P) as follows:

- (1) On any frequency removed from the center of the authorized bandwidth by a displacement frequency ( $f_d$  in kHz) of more than 5 kHz, but not more than 10 kHz: At least  $83 \log (f_d/5)$  dB;
- (2) On any frequency removed from the center of the authorized bandwidth by a displacement frequency ( $f_d$  in kHz) of more than 10 kHz, but not more than 250 percent of the authorized bandwidth: At least  $29 \log (f_d^2/11)$  dB or 50 dB, whichever is the lesser attenuation;
- (3) On any frequency removed from the center of the authorized bandwidth by more than 250 percent of the authorized bandwidth: At least  $43 + 10 \log (P)$  dB.

(g) Emission Mask G. For transmitters that are not equipped with an audio low-pass filter, the power of any emission must be attenuated below the unmodulated carrier power (P) as follows:

- (1) On any frequency removed from the center of the authorized bandwidth by a displacement frequency ( $f_d$  in kHz) of more than 10 kHz, but no more than 250 percent of the authorized bandwidth: At least  $116 \log(f_d/6.1)$  dB, or  $50 + 10 \log(P)$  dB, or 70 dB, whichever is the lesser attenuation;
- (2) On any frequency removed from the center of the authorized bandwidth by more than 250 percent of the authorized bandwidth: At least  $43 + 10 \log(P)$  dB.

(h) Emission Mask H. For transmitters that are not equipped with an audio low-pass filter, the power of any emission must be attenuated below the unmodulated carrier power (P) as follows:

- (1) On any frequency removed from the center of the authorized bandwidth by a displacement frequency ( $f_d$  in kHz) of 4 kHz or less: Zero dB.
- (2) On any frequency removed from the center of the authorized bandwidth by a displacement frequency ( $f_d$  in kHz) of more than 4 kHz, but no more than 8.5 kHz: At least  $107 \log(f_d/4)$  dB;
- (3) On any frequency removed from the center of the authorized bandwidth by a displacement frequency ( $f_d$  in kHz) of more than 8.5 kHz, but no more than 15 kHz: At least  $40.5 \log(f_d/1.16)$  dB;
- (4) On any frequency removed from the center of the authorized bandwidth by a displacement frequency ( $f_d$  in kHz) of more than 15 kHz, but no more than 25 kHz: At least  $116 \log(f_d/6.1)$  dB;
- (5) On any frequency removed from the center of the authorized bandwidth by more than 25 kHz: At least  $43 + 10 \log(P)$  dB.

#### **§ 90.219 Use of signal boosters.**

(e) Device Specifications. In addition to the general rules for equipment certification in §90.203(a)(2) and part 2, subpart J of this chapter, a signal booster must also meet the rules in this paragraph.

- (4) A signal booster must be designed such that all signals that it retransmits meet the following requirements:

- (iii) The retransmitted signals continue to meet the unwanted emissions limits of §90.210 applicable to the corresponding received signals (assuming that these received signals meet the applicable unwanted emissions limits by a reasonable margin).

#### **Test Procedures:**

Measurements were in accordance with the test methods section 4.4 of KDB 935210 D05 v01r02.

- a) Connect a signal generator to the input of the EUT.
- b) Configure the signal generator to transmit the appropriate test signal associated with the public safety emission designation.
- c) Configure the signal level to be just below the AGC threshold (see results from 5).
- d) Connect a spectrum analyzer to the output of the EUT using appropriate attenuation as necessary.

- e) Set the spectrum analyzer center frequency to the nominal EUT channel center frequency. The span range for the spectrum analyzer shall be between 2 times to 5 times the EBW (or OBW).
- f) The nominal RBW shall be 300 Hz for 16K0F3E, and 100 Hz for all other emissions types.
- g) Set the reference level of the spectrum analyzer to accommodate the maximum input amplitude level, i.e., the level at  $f_0$  and  $f_1$  per Out-of-band rejection test.
- h) Set spectrum analyzer detection mode to peak, and trace mode to max hold.
- i) Allow the trace to fully stabilize.
- j) Confirm that the signal is contained within the appropriate emissions mask.
- k) Use the marker function to determine the maximum emission level and record the associated frequency as  $f_0$ .
- l) Capture the emissions mask plot for inclusion in the test report (output signal spectra).
- m) Measure the EUT input signal power (signal generator output signal) directly from the signal generator using power measurement guidance provided in KDB Publication 971168 [R8] (input signal spectra).
- n) Compare the spectral plot of the output signal (determined in step k), to the input signal (determined in step l) to affirm they are similar (in passband and rolloff characteristic features and relative spectral locations).
- o) Repeat steps d) to n) with the input signal amplitude set 3 dB above the AGC threshold.
- p) Repeat steps b) to o) for all authorized operational bands and emissions types (see applicable regulatory specifications, e.g., Section 90.210).
- q) Include all accumulated spectral plots depicting EUT input signal and EUT output signal in the test report, and note any observed dissimilarities.

*Note. Mask C cannot cover broadband signals like LTE, so test did not be performed in PS broadband and it will be replaced Occupied Bandwidth test data.*

**Test Results:**

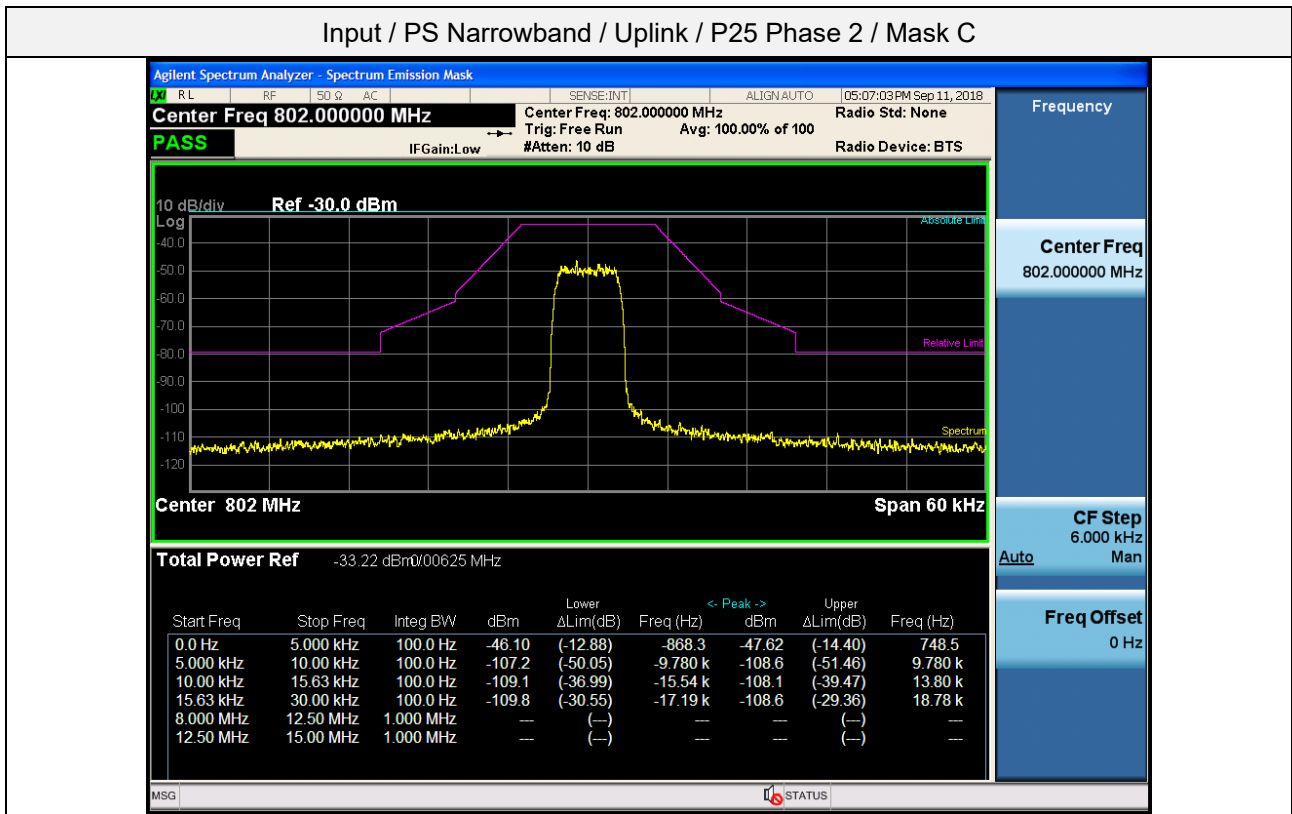
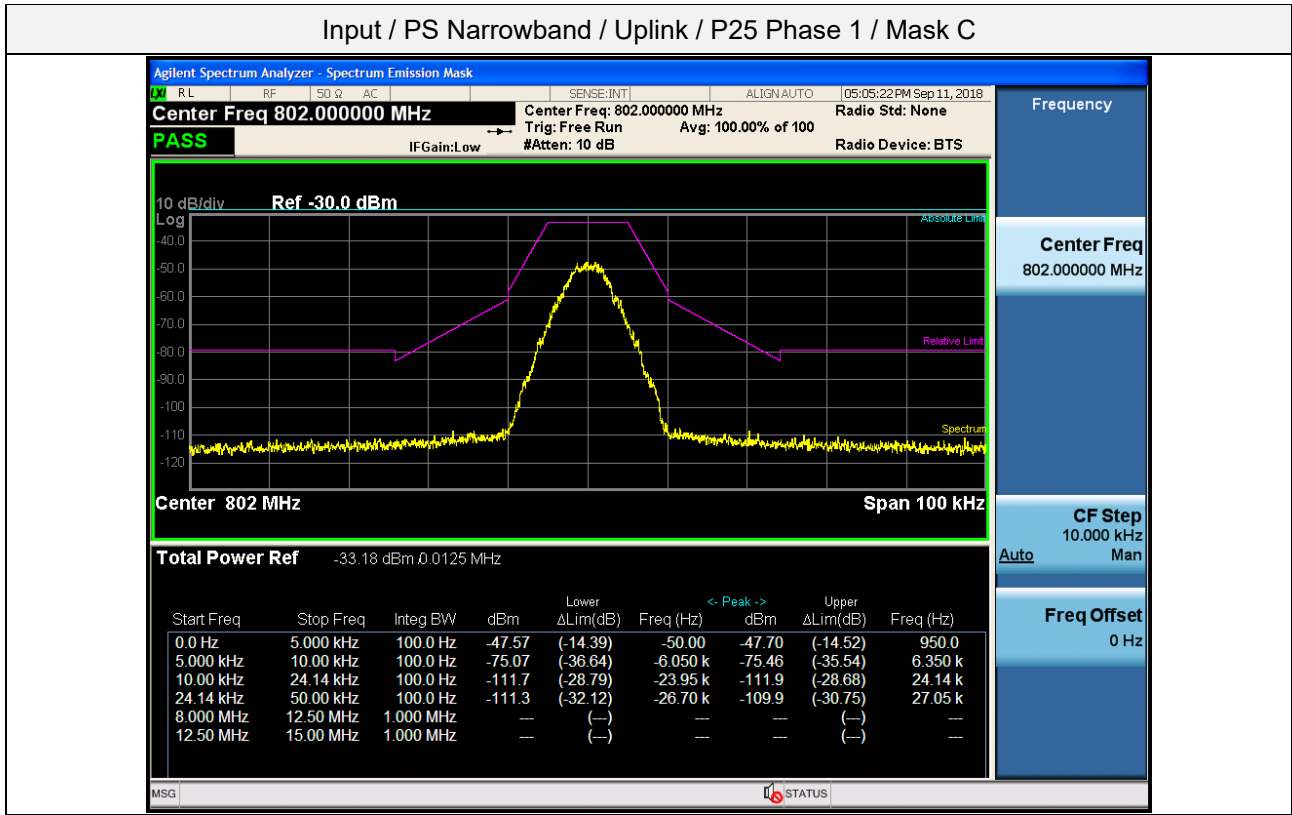

Input / PS Narrowband / Downlink / P25 Phase 1 / Mask C

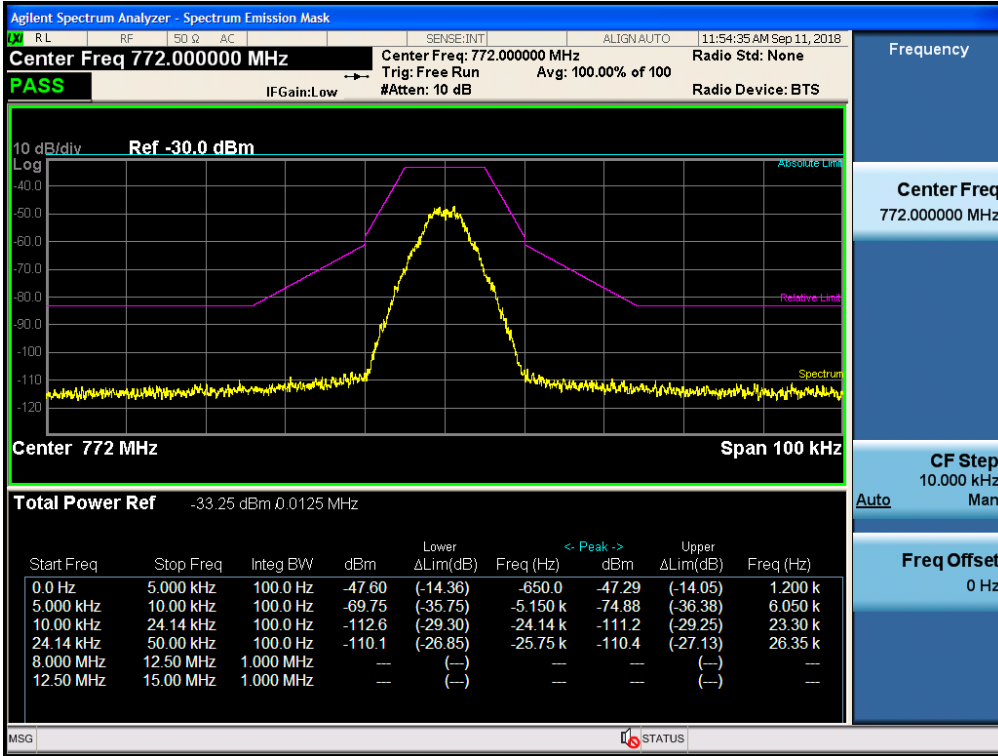

Input / PS Narrowband / Downlink / P25 Phase 2 / Mask C

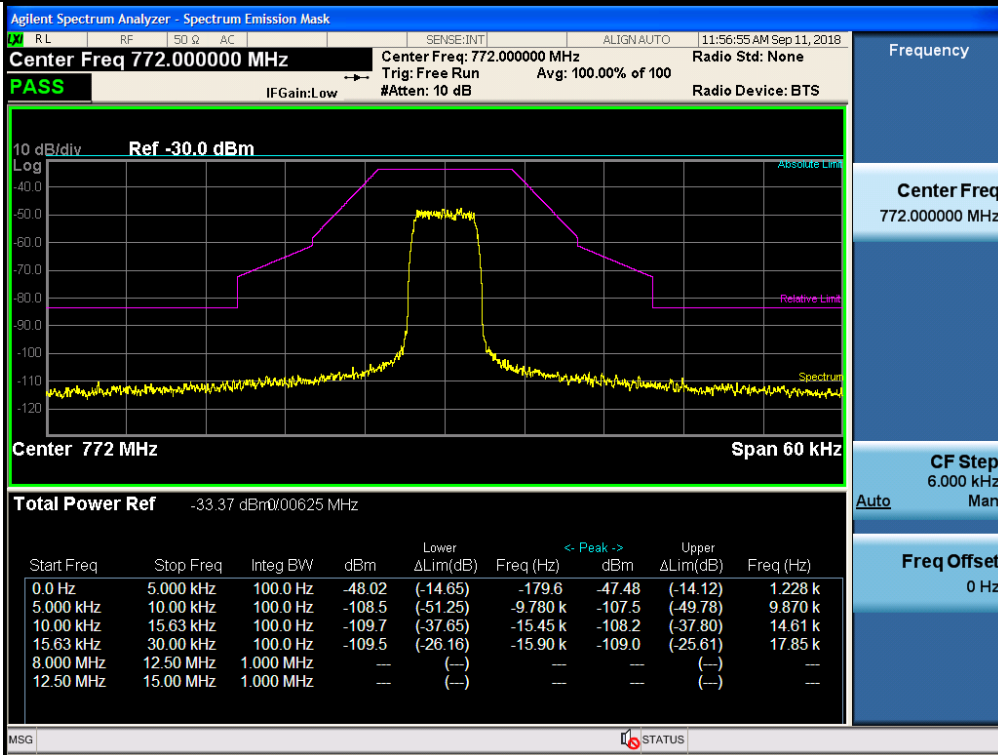

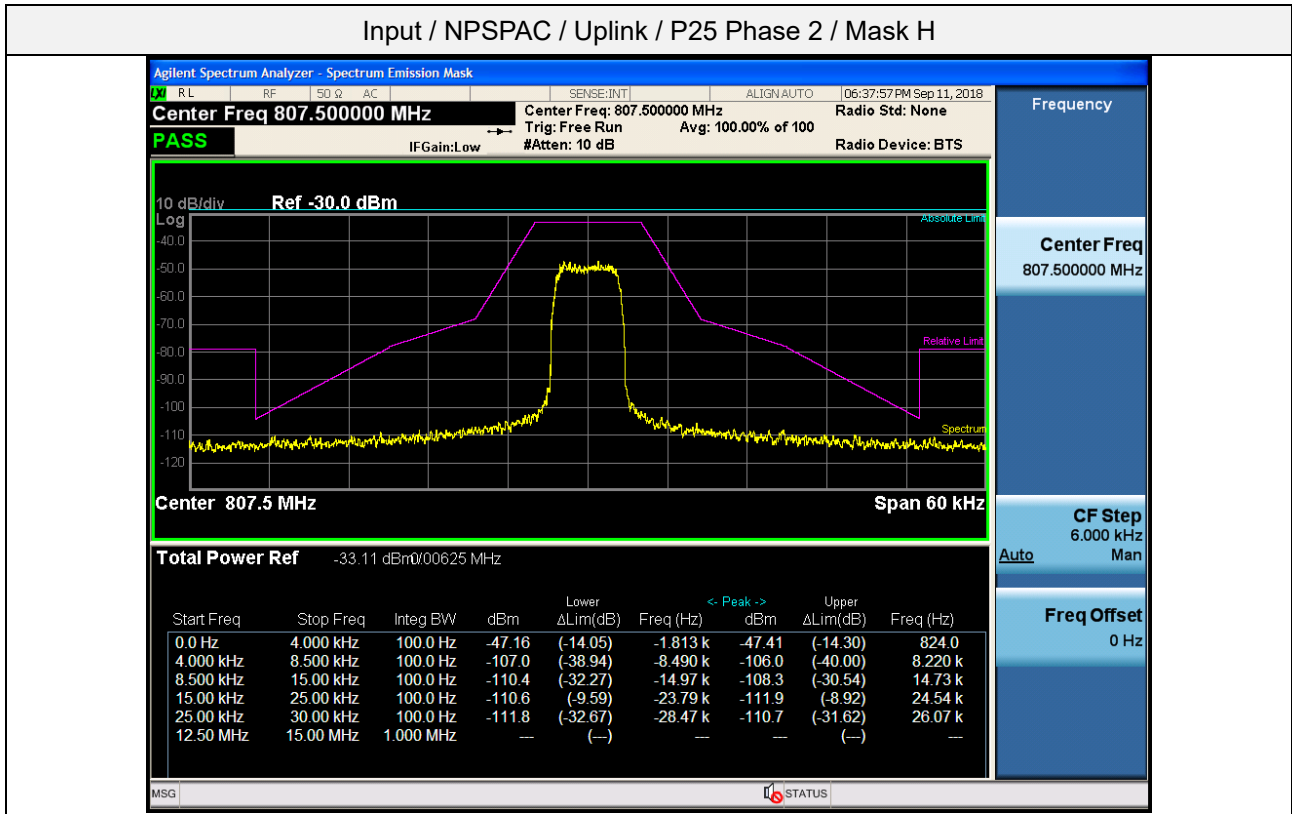
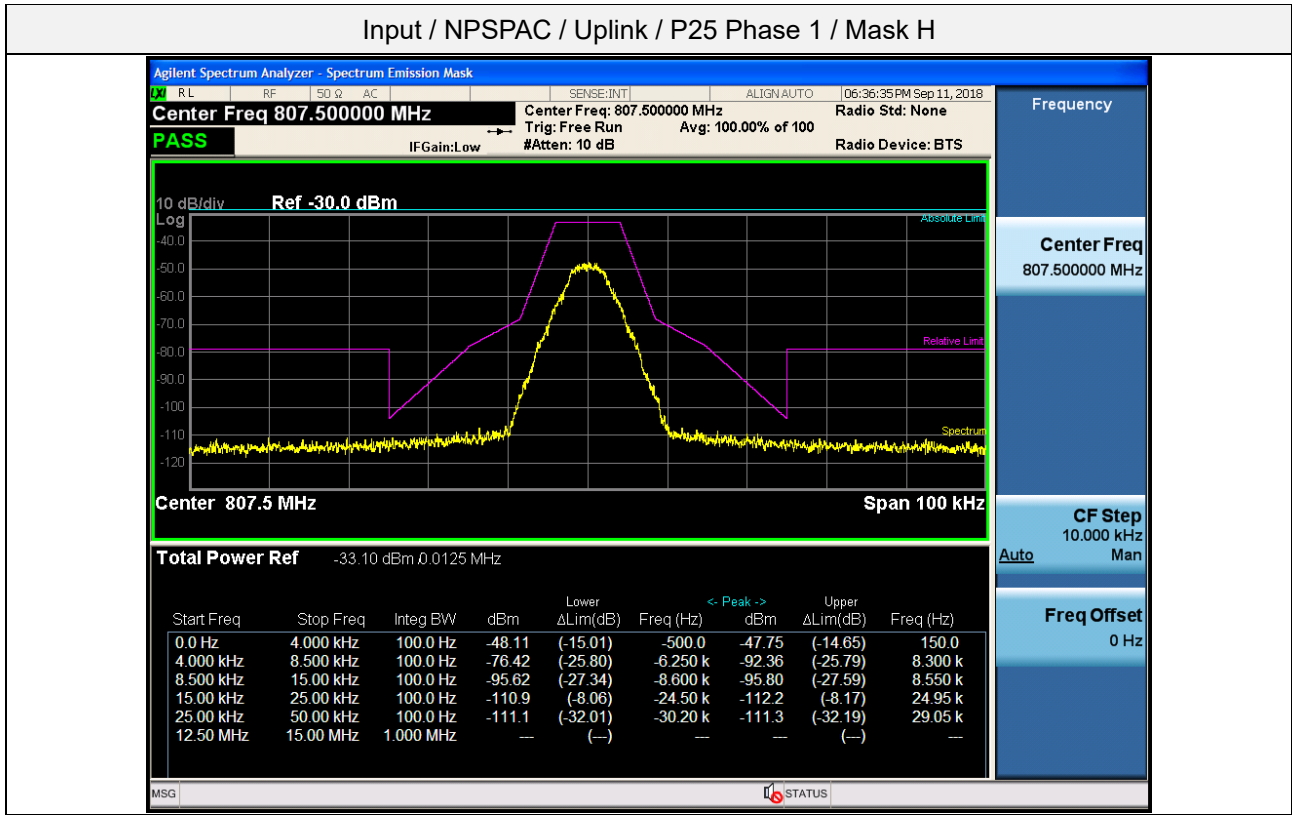

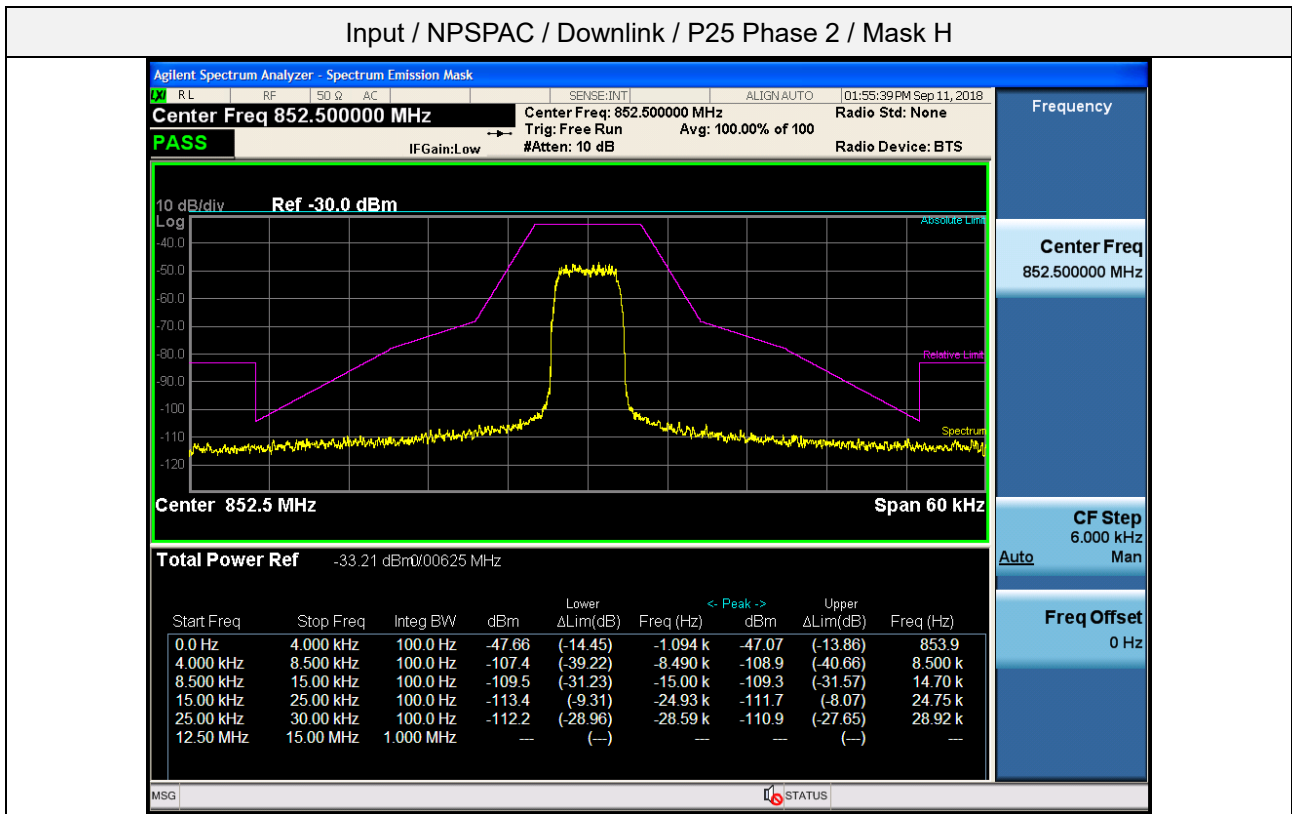
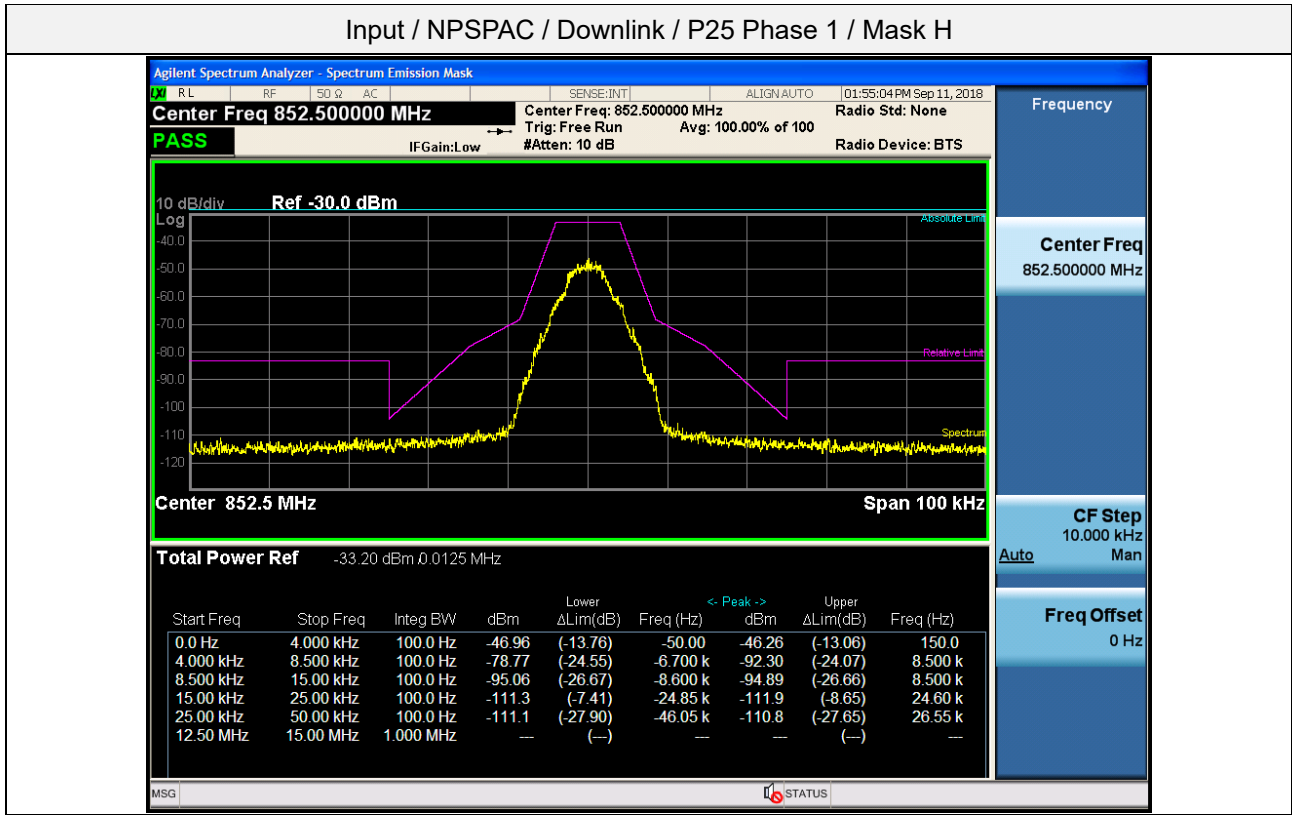

Input / PS B/ILT SMR / Uplink / P25 Phase 1 / Mask G

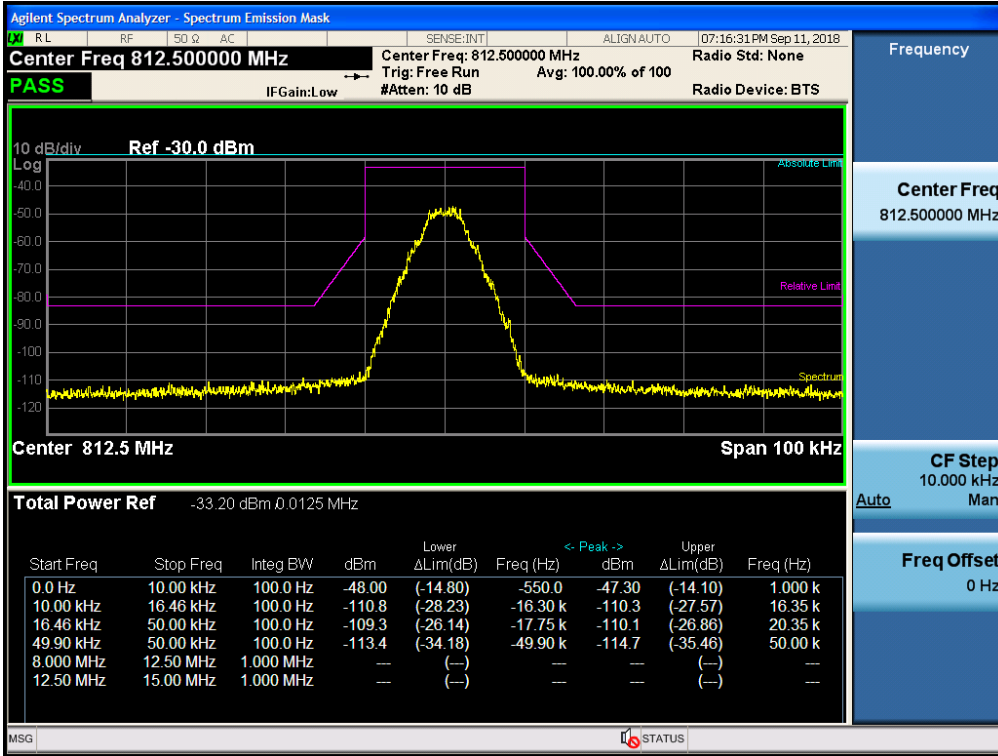

Input / PS B/ILT SMR / Uplink / P25 Phase 2 / Mask G

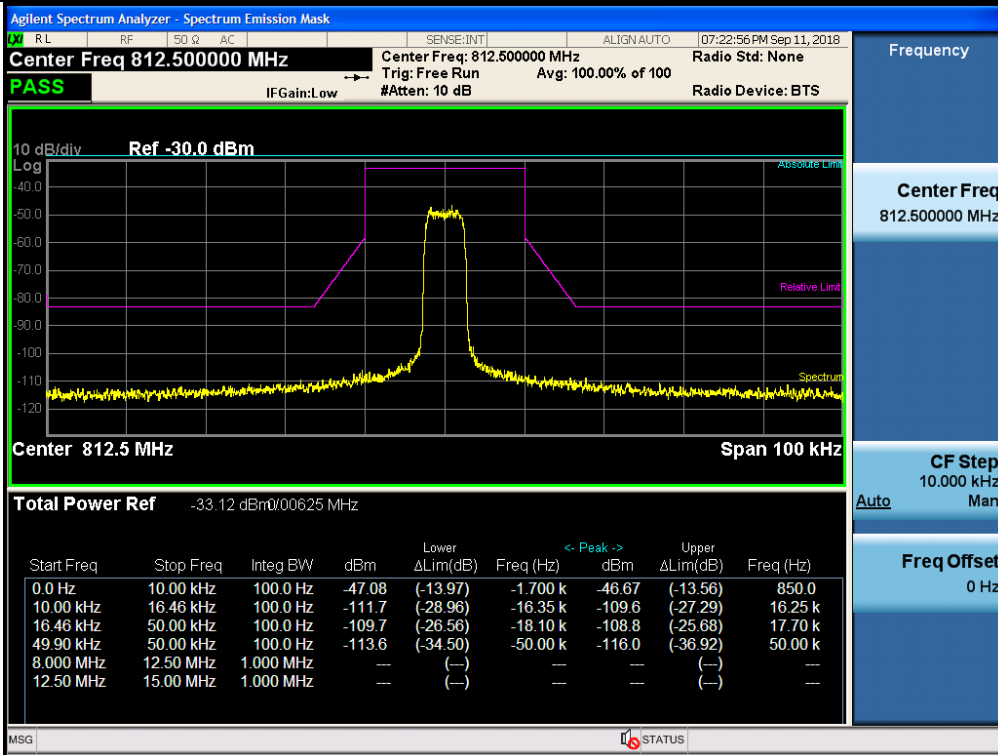



Input / PS B/ILT SMR / Downlink / P25 Phase 1 / Mask G

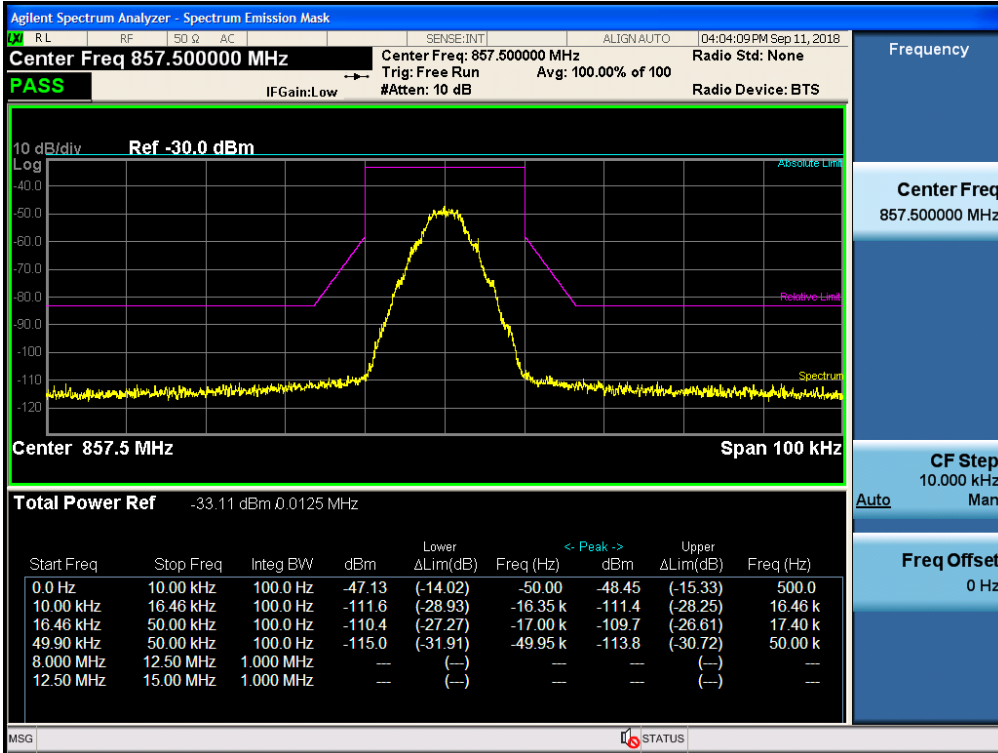

Input / PS B/ILT SMR / Downlink / P25 Phase 2 / Mask G

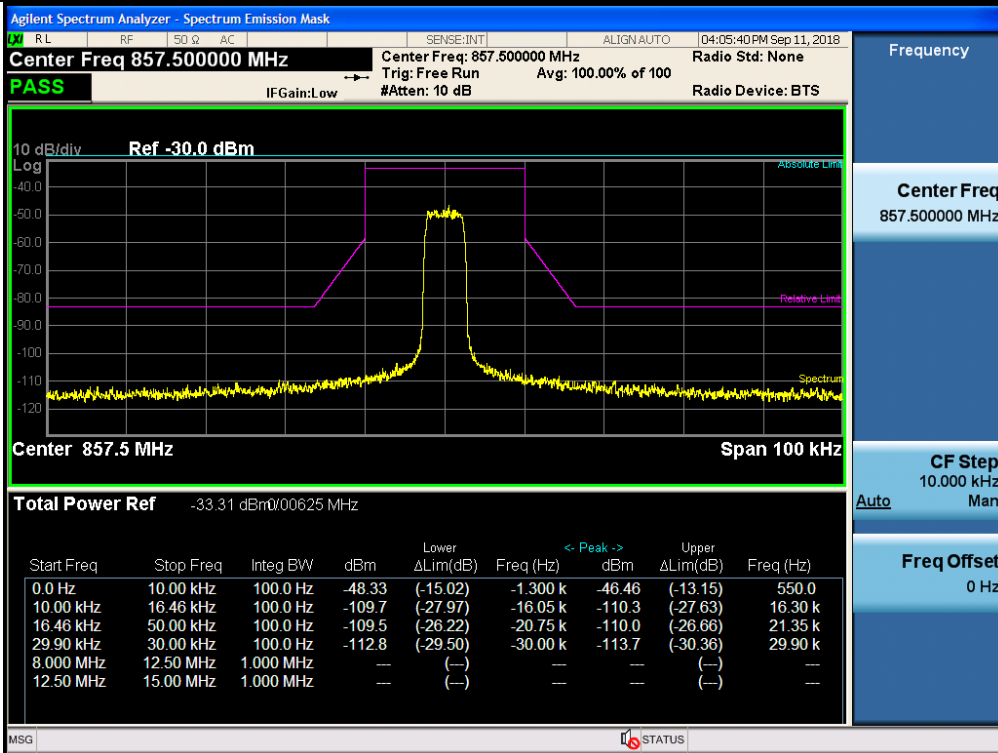

Output / PS Narrowband / Uplink / P25 Phase 1 / Mask C

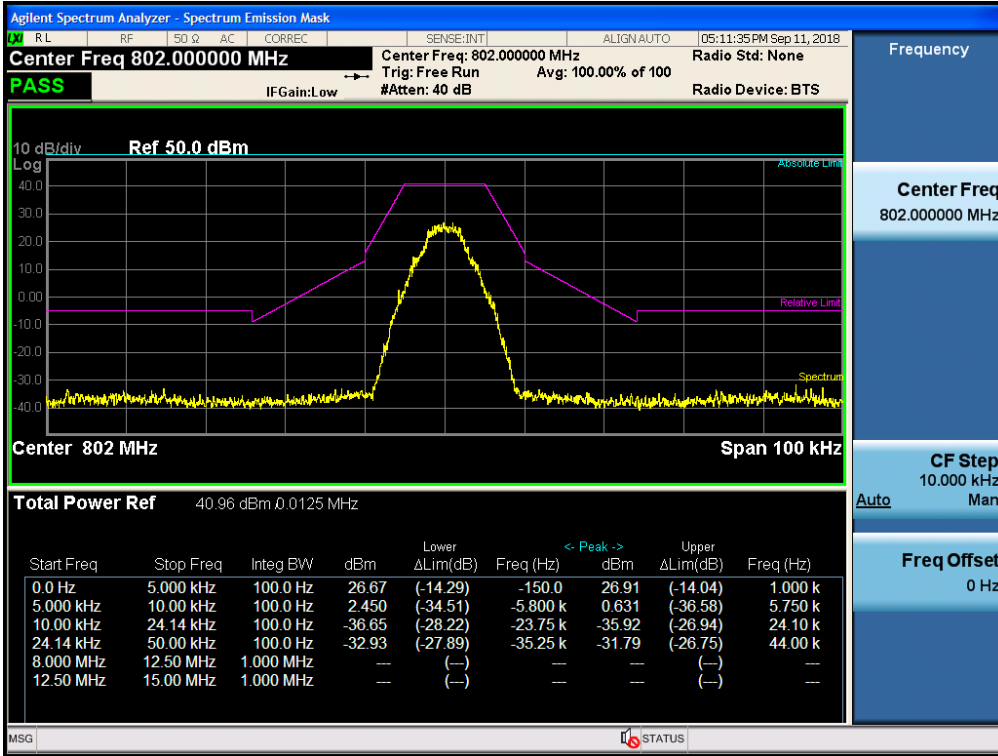

Output / PS Narrowband / Uplink / P25 Phase 2 / Mask C

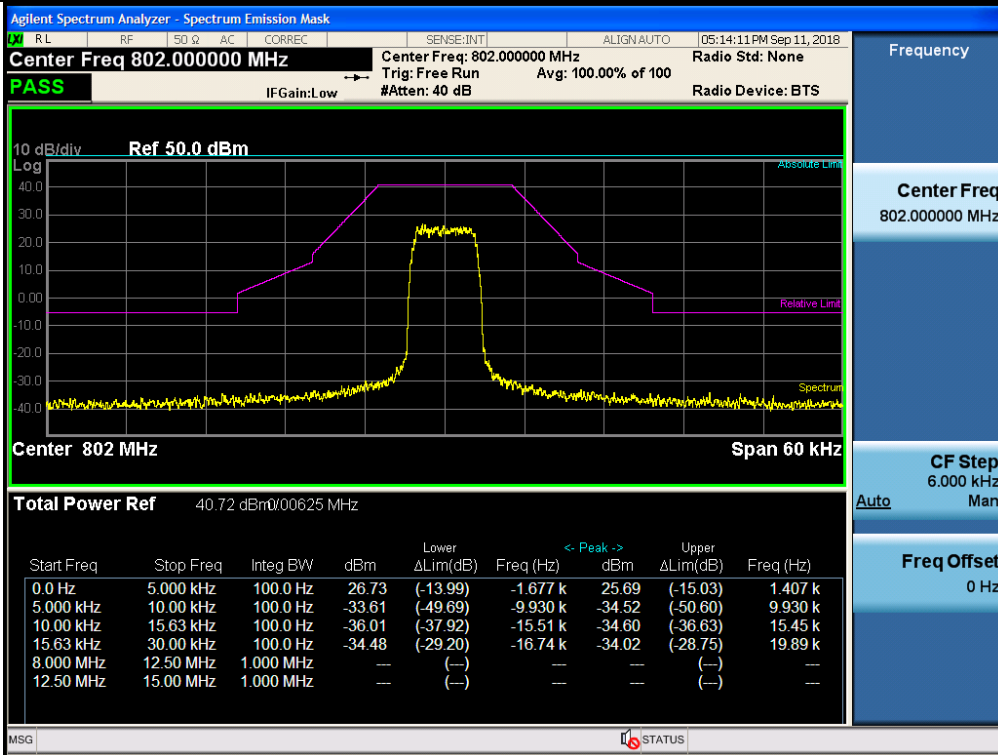

Output / PS Narrowband / Downlink / P25 Phase 1 / Mask C

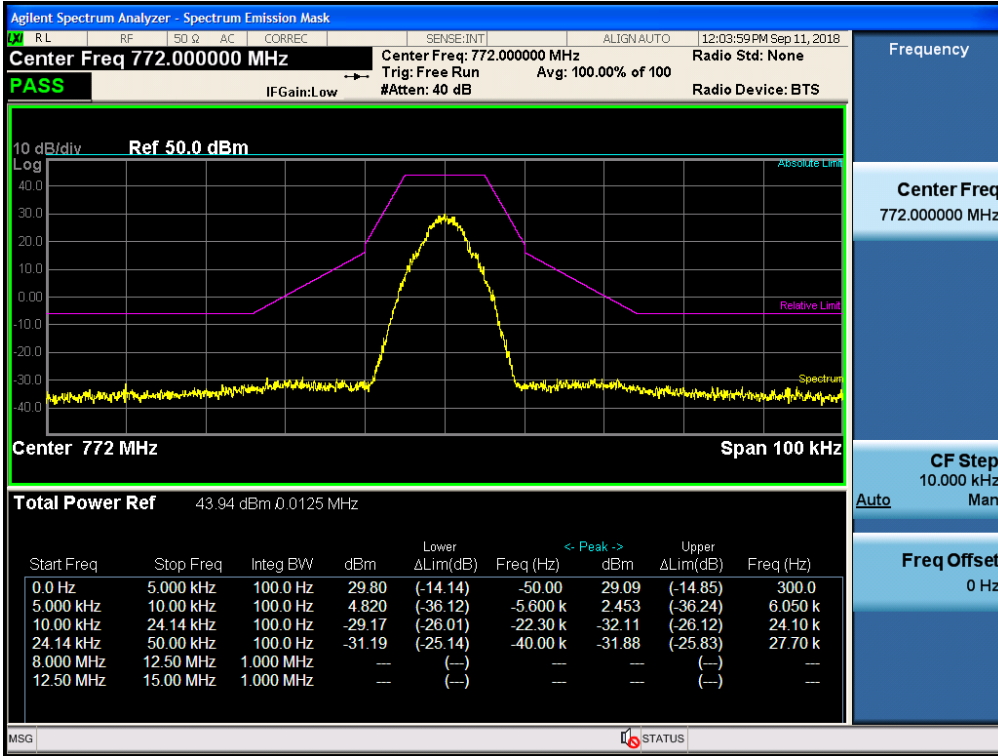

Output / PS Narrowband / Downlink / P25 Phase 2 / Mask C

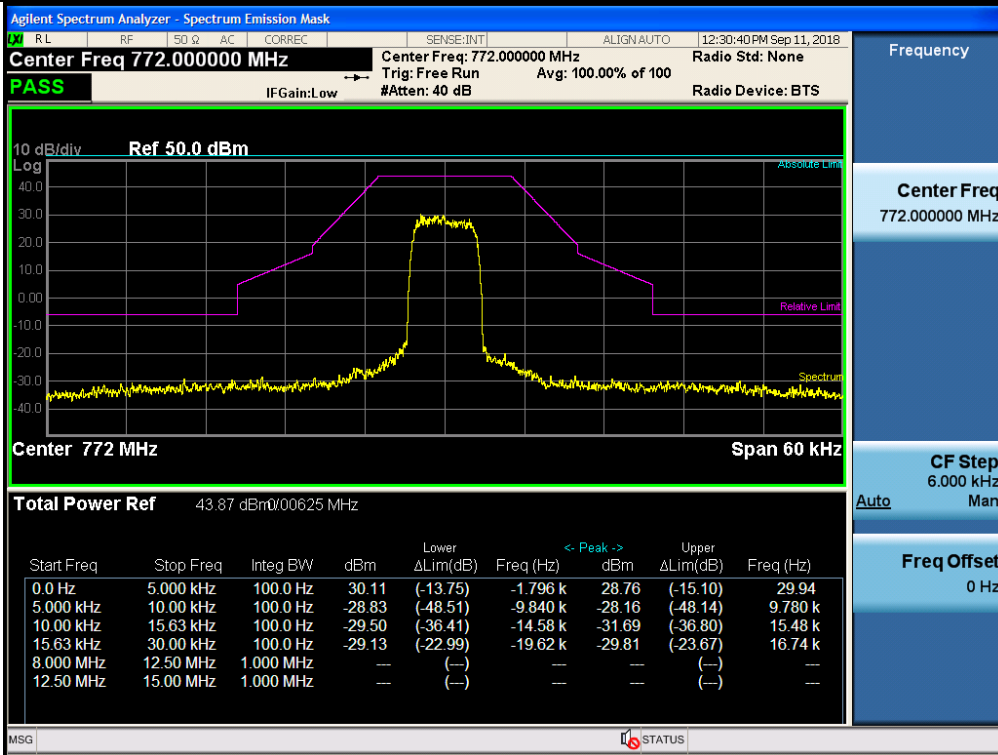

Output / NPSPAC / Uplink / P25 Phase 1 / Mask H

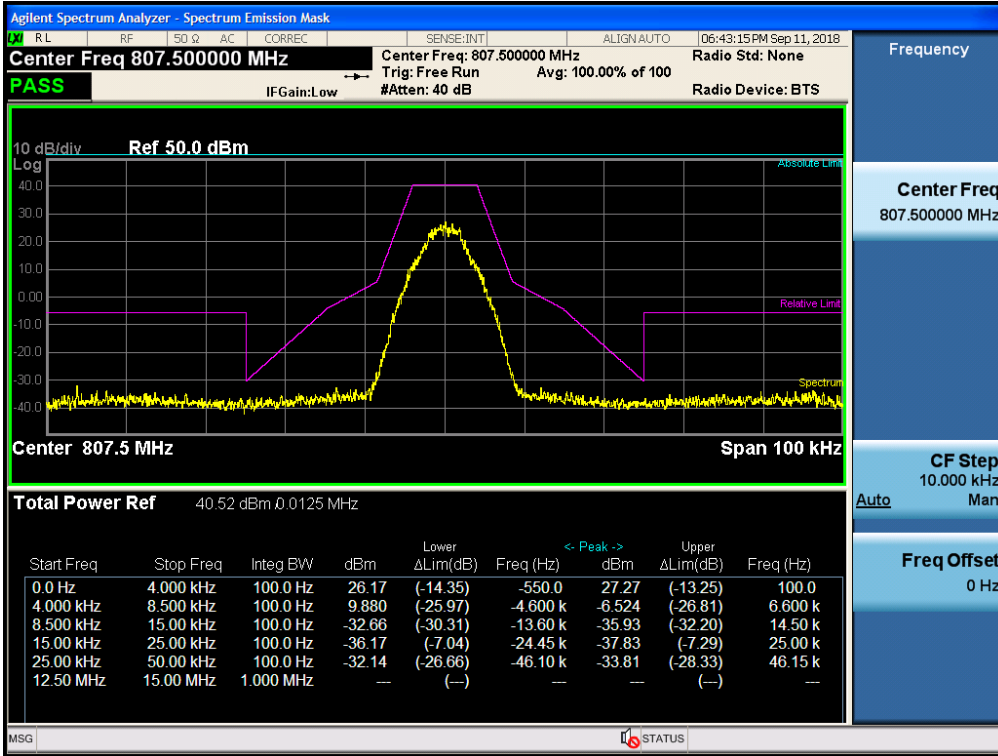

Output / NPSPAC / Uplink / P25 Phase 2 / Mask H

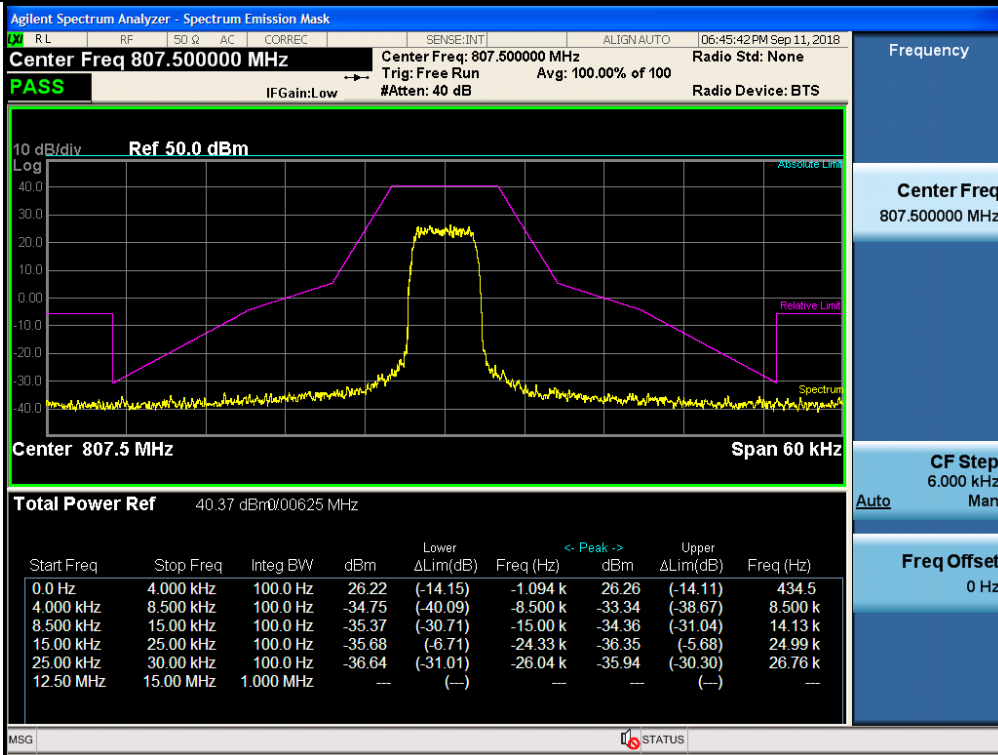

Output / NPSPAC / Downlink / P25 Phase 1 / Mask H

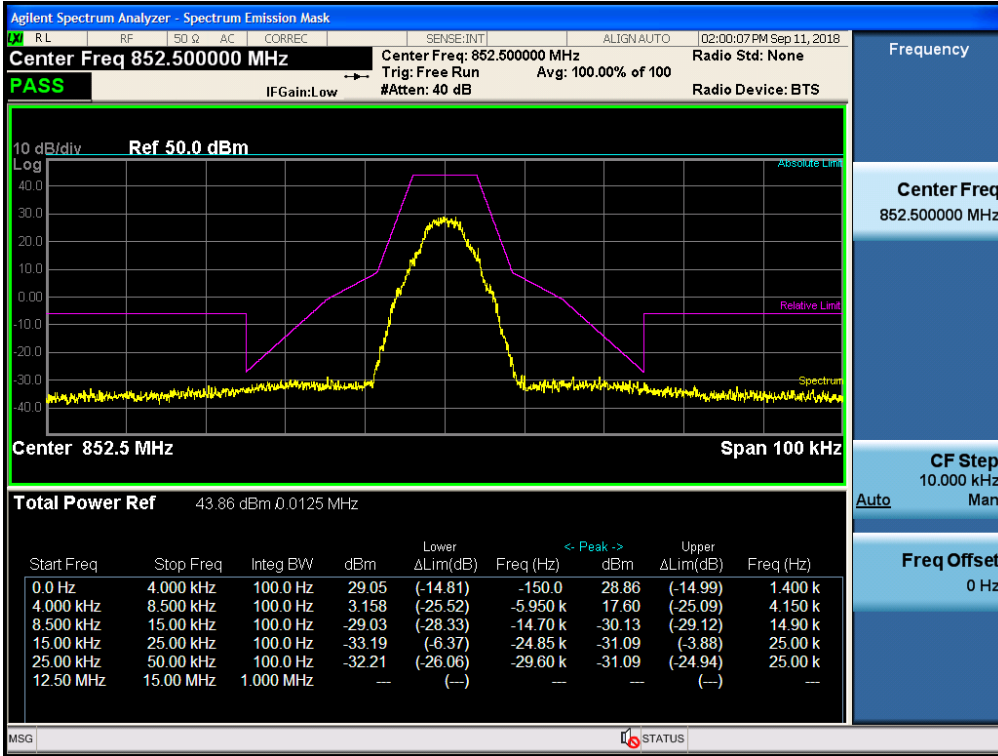

Output / NPSPAC / Downlink / P25 Phase 2 / Mask H

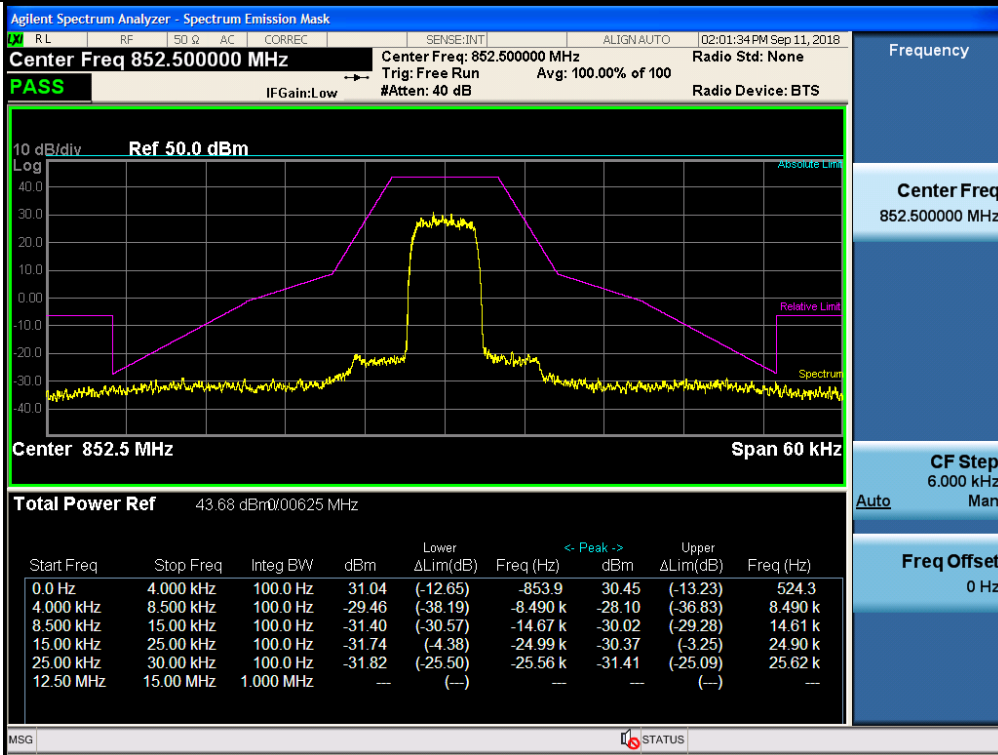

Output / PS B/ILT SMR / Uplink / P25 Phase 1 / Mask G

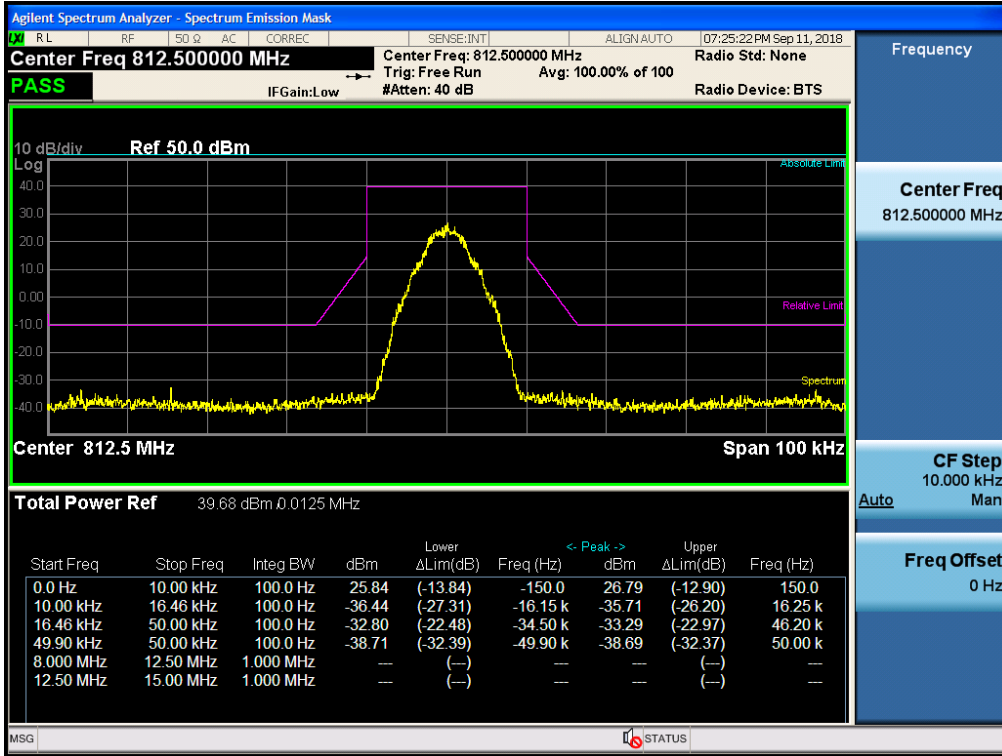

Output / PS B/ILT SMR / Uplink / P25 Phase 2 / Mask G

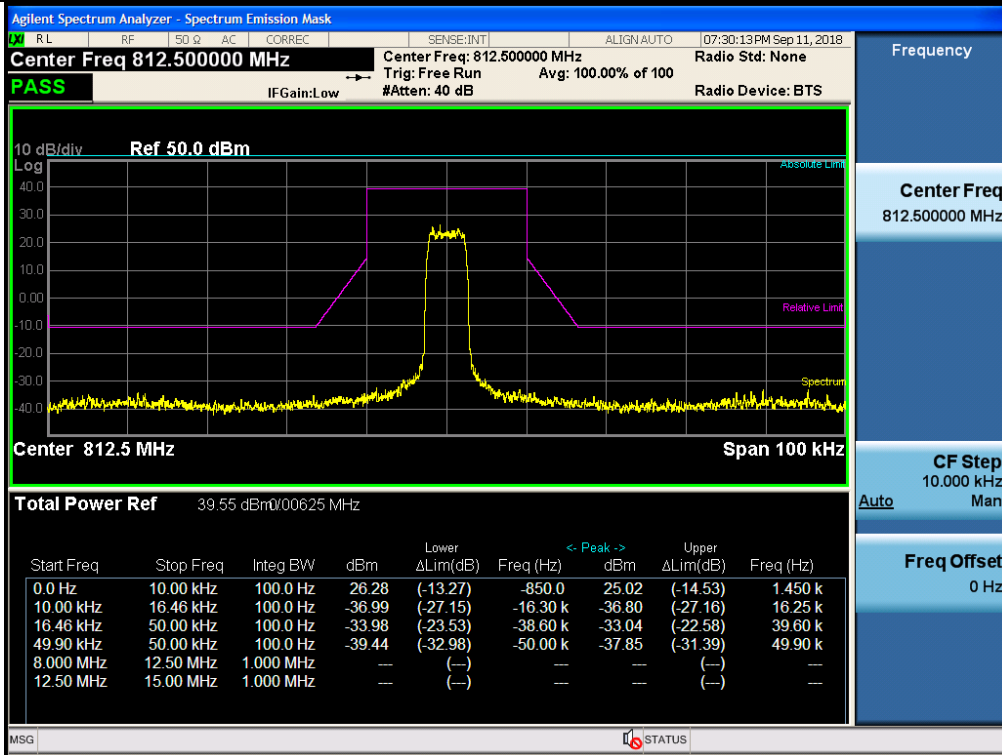

Output / PS B/ILT SMR / Downlink / P25 Phase 1 / Mask G

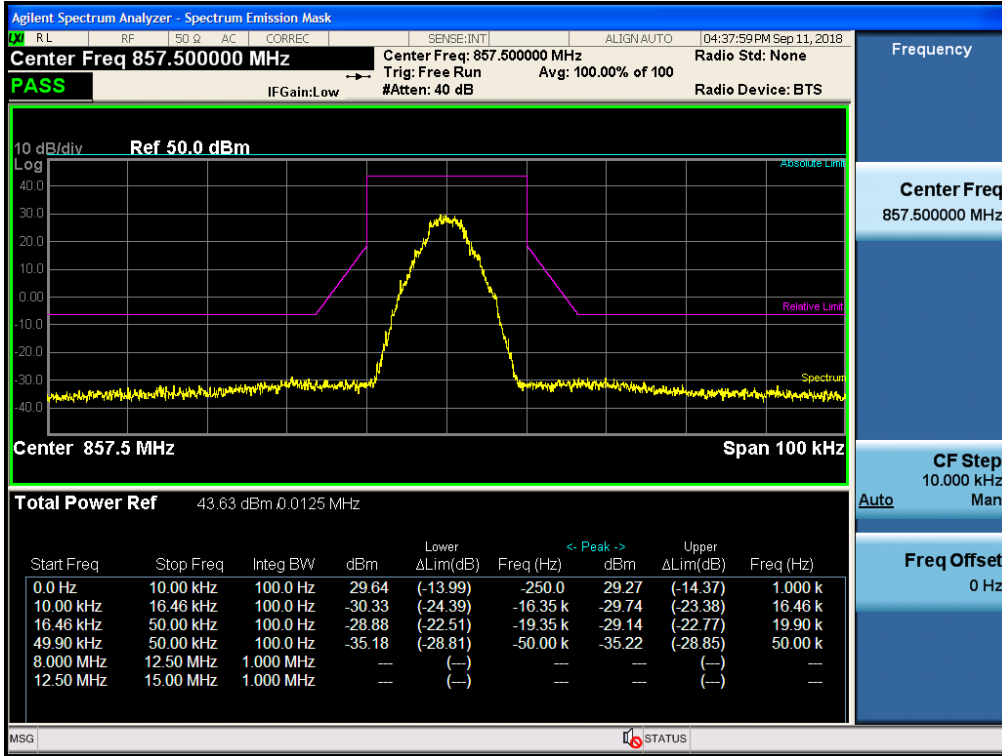

Output / PS B/ILT SMR / Downlink / P25 Phase 2 / Mask G

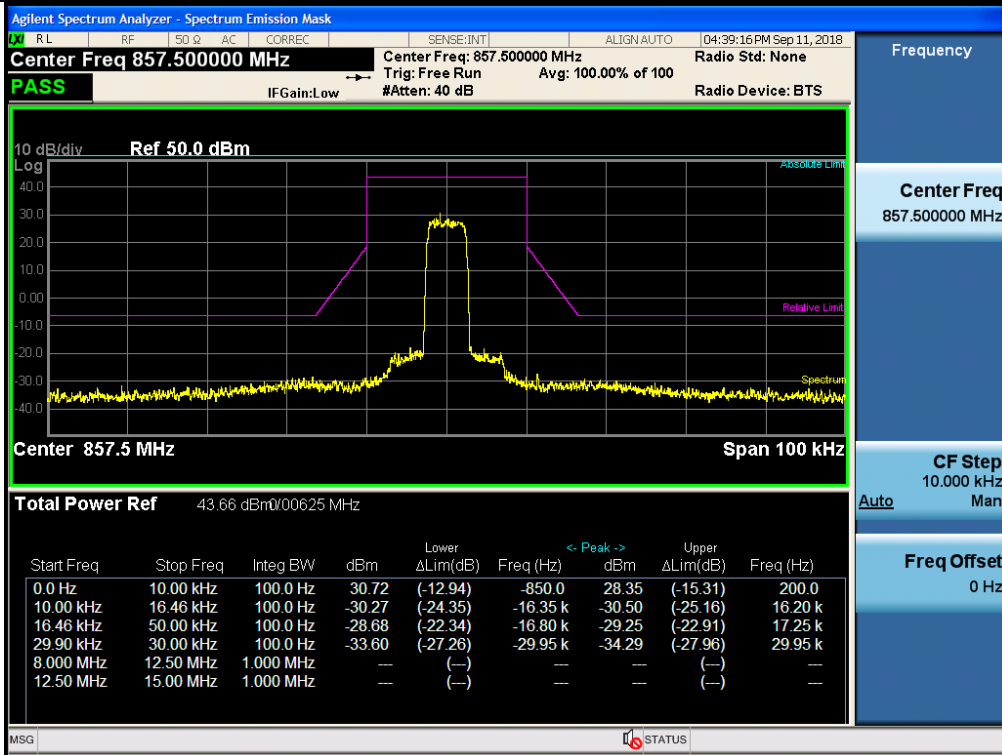

3 dB above the AGC threshold Output / PS Narrowband / Uplink / P25 Phase 1 / Mask C

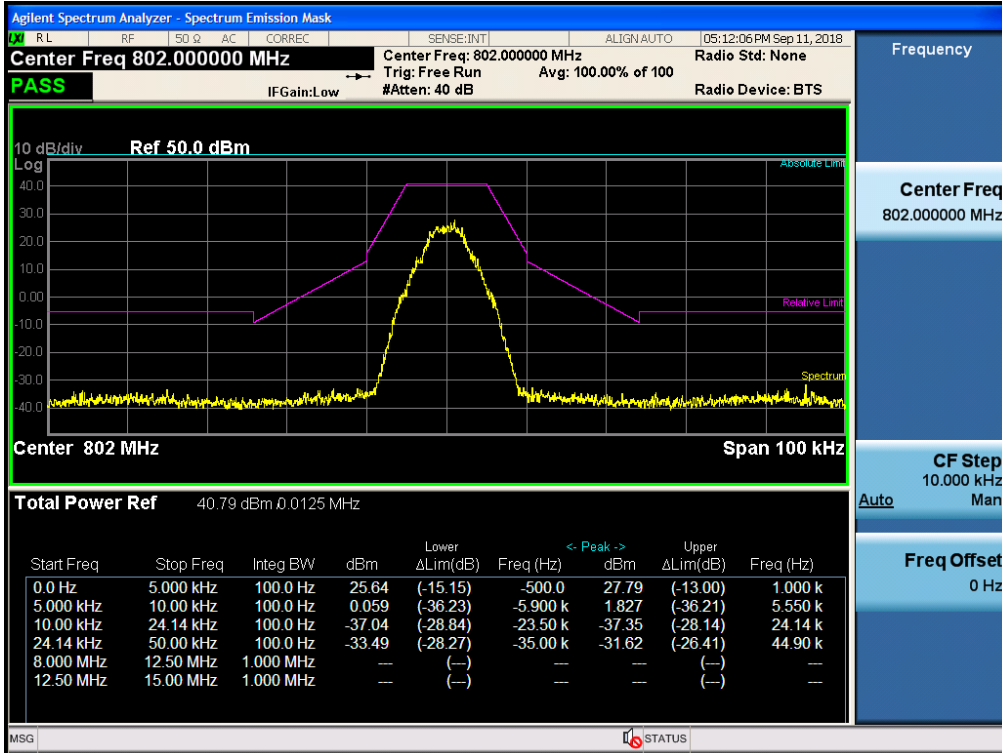

3 dB above the AGC threshold Output / PS Narrowband / Uplink / P25 Phase 2 / Mask C

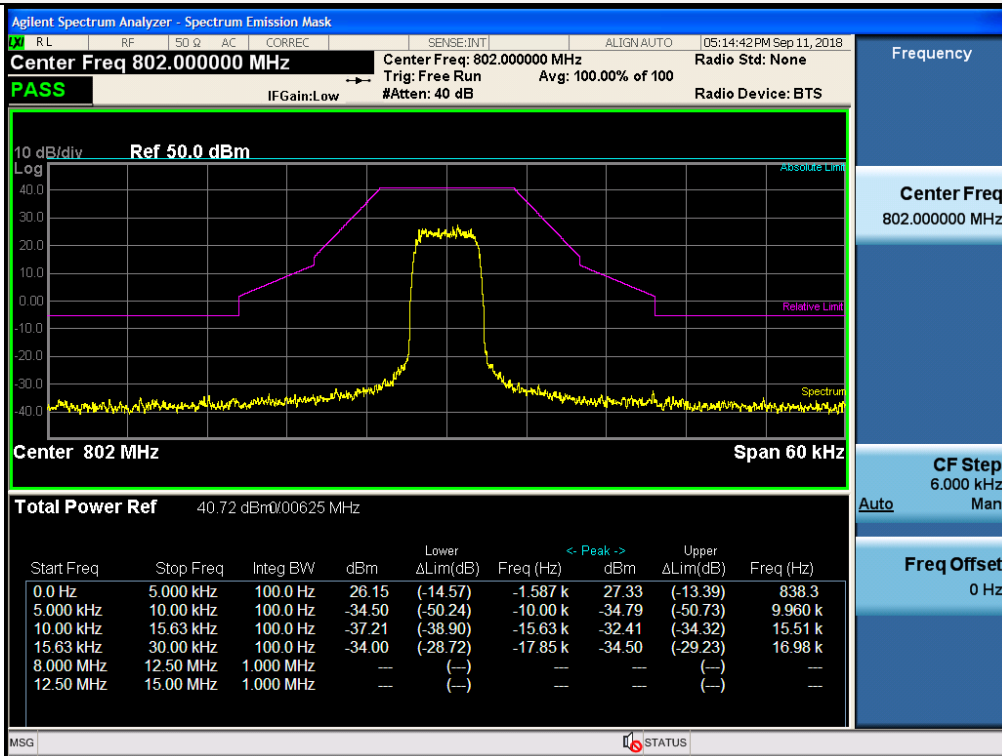



3 dB above the AGC threshold Output / PS Narrowband / Downlink / P25 Phase 1 / Mask C

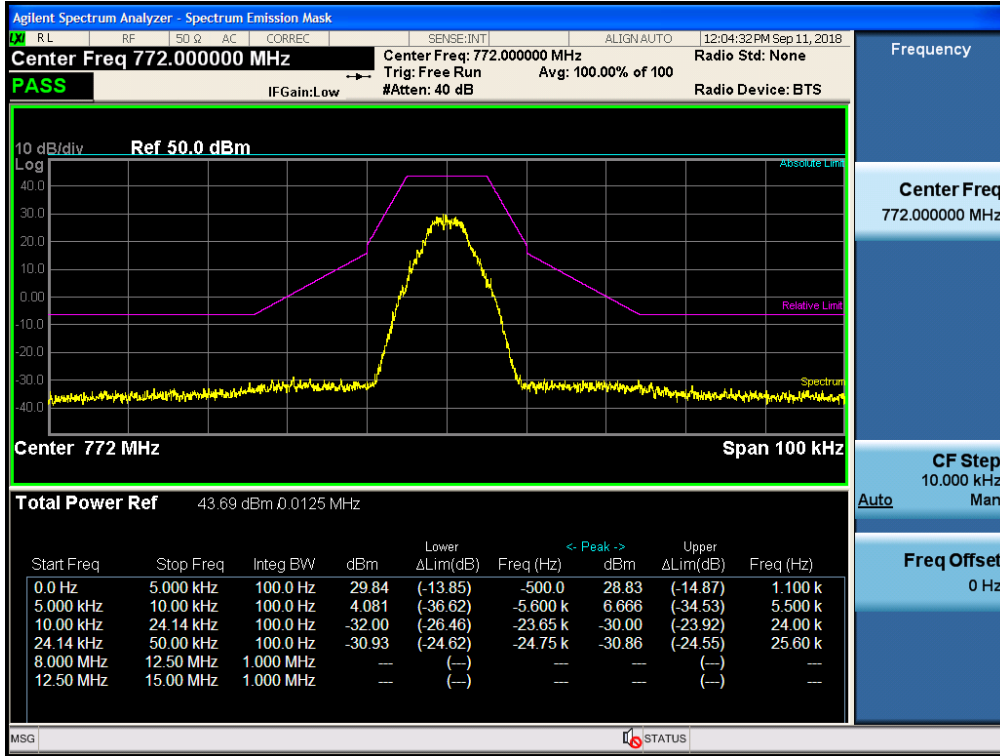

3 dB above the AGC threshold Output / PS Narrowband / Downlink / P25 Phase 2 / Mask C

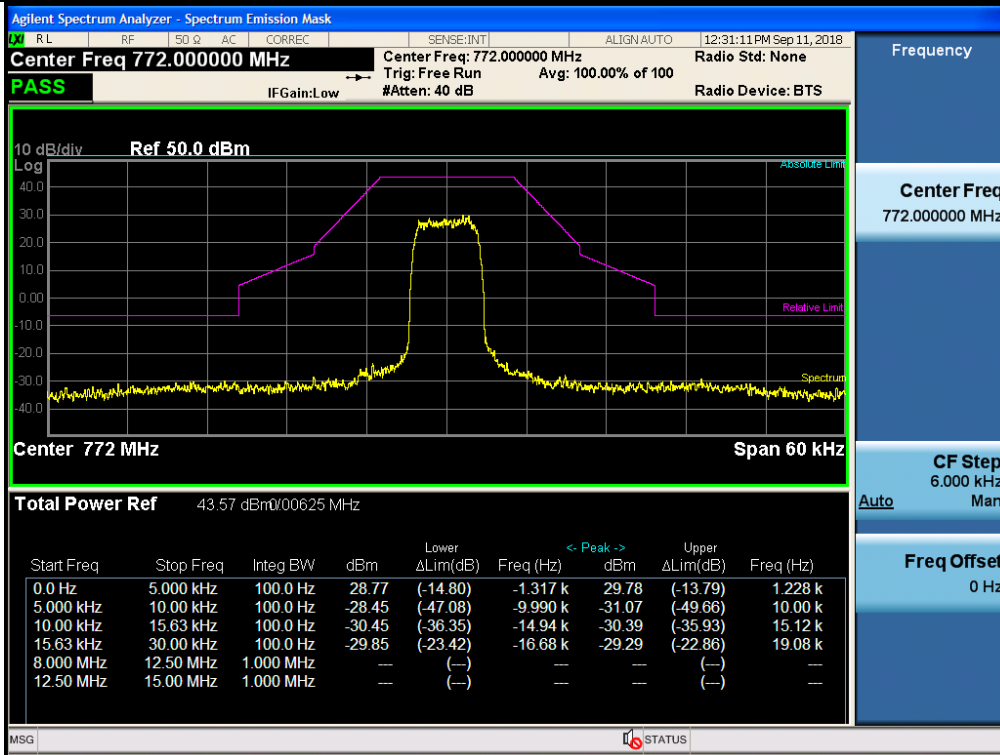

3 dB above the AGC threshold Output / NPSPAC / Uplink / P25 Phase 1 / Mask H

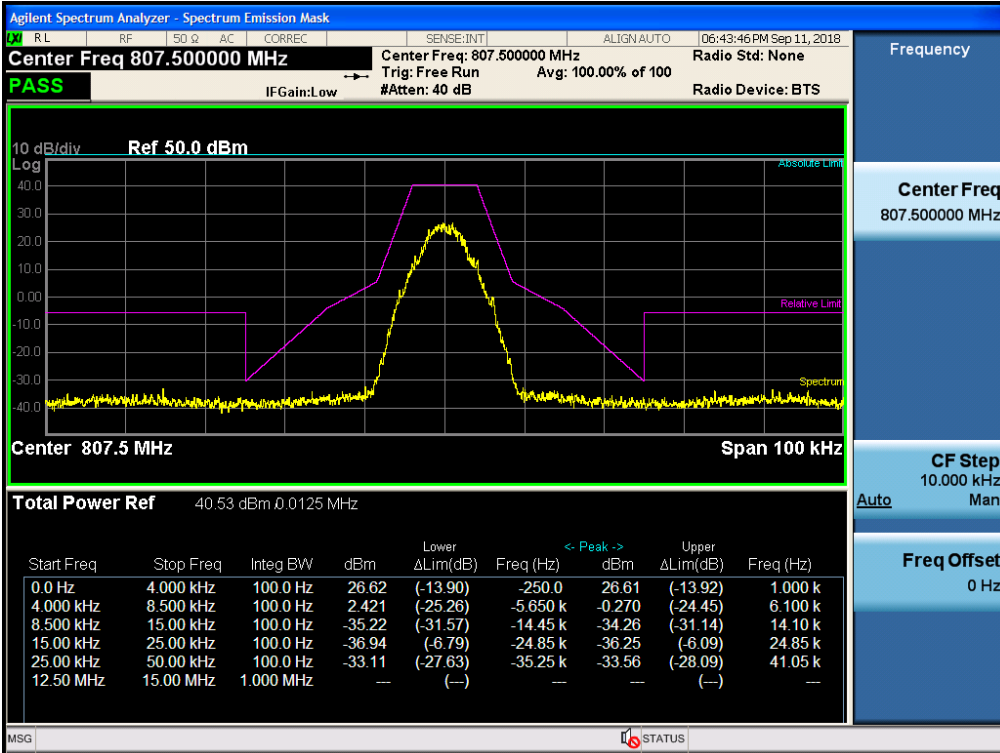

3 dB above the AGC threshold Output / NPSPAC / Uplink / P25 Phase 2 / Mask H

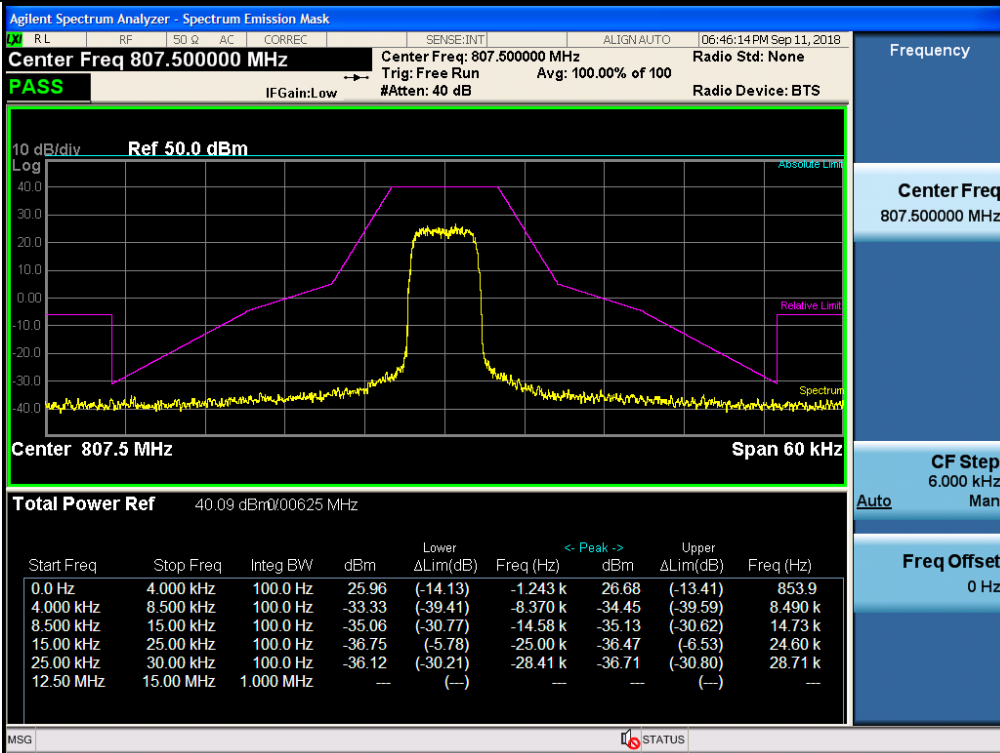

3 dB above the AGC threshold Output / NPSPAC / Downlink / P25 Phase 1 / Mask H

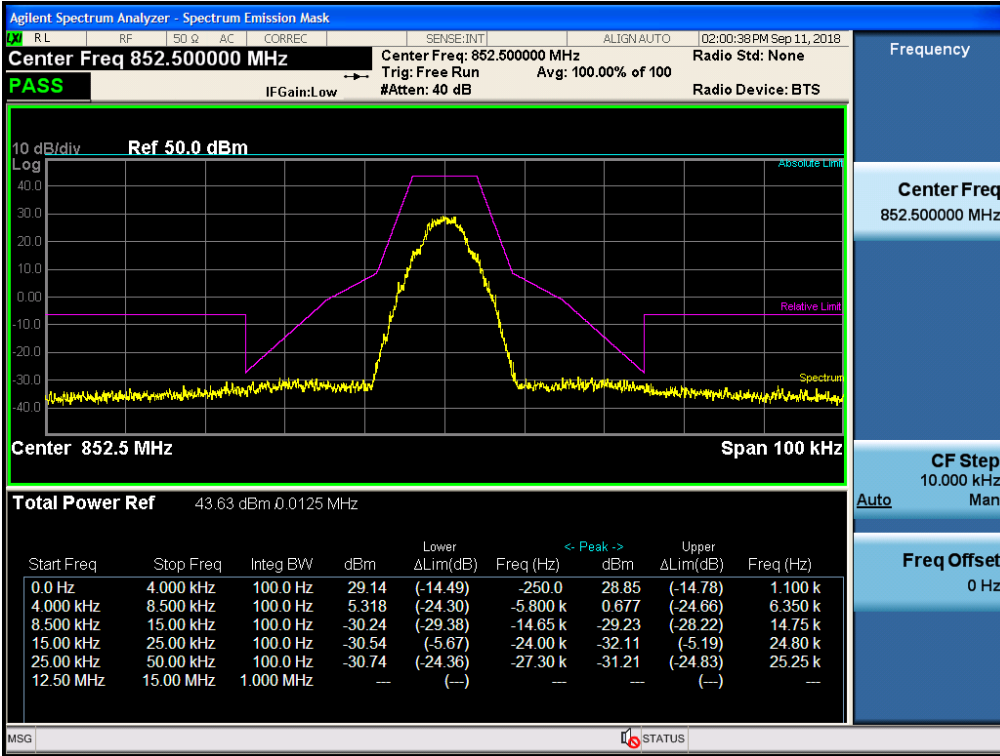

3 dB above the AGC threshold Output / NPSPAC / Downlink / P25 Phase 2 / Mask H

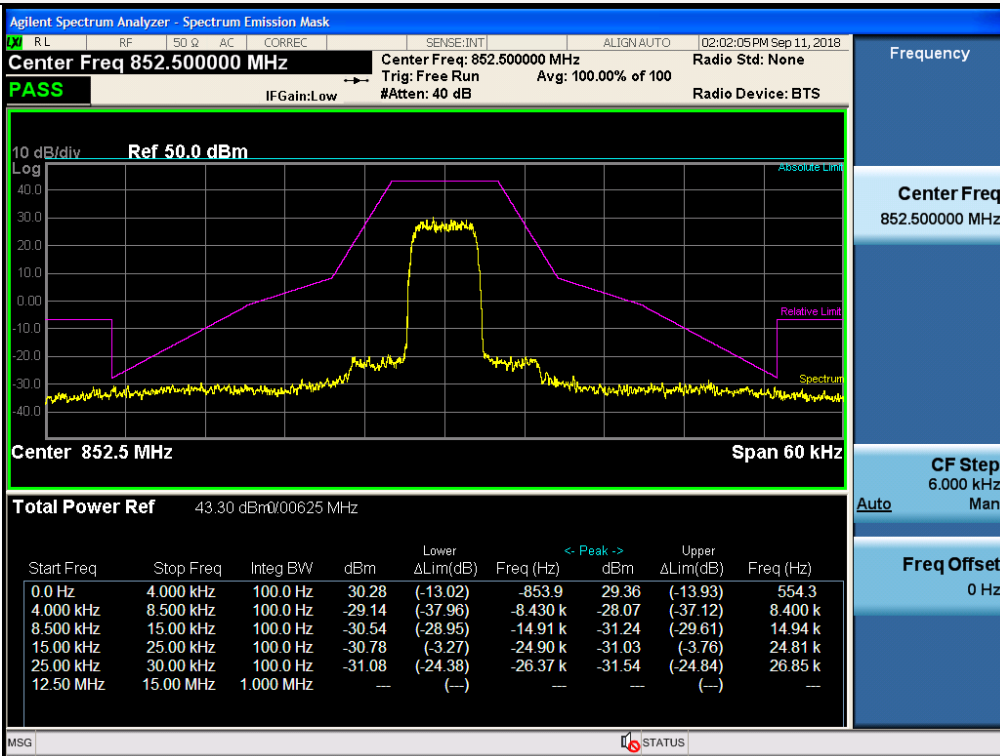

3 dB above the AGC threshold Output / PS B/ILT SMR / Uplink / P25 Phase 1 / Mask G

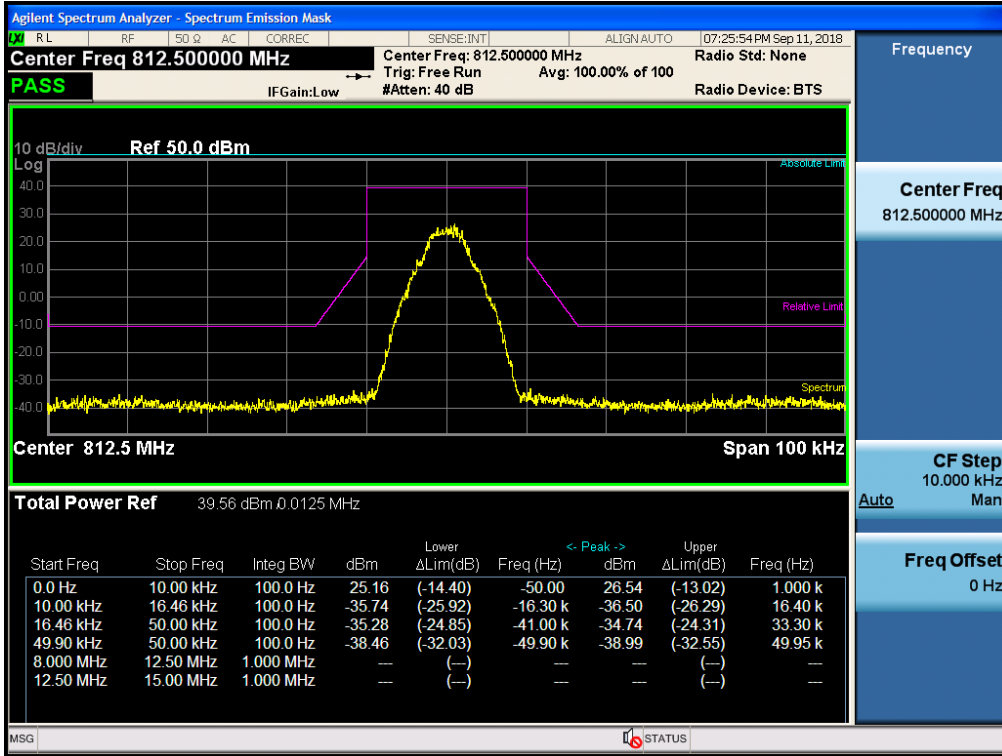

3 dB above the AGC threshold Output / PS B/ILT SMR / Uplink / P25 Phase 2 / Mask G

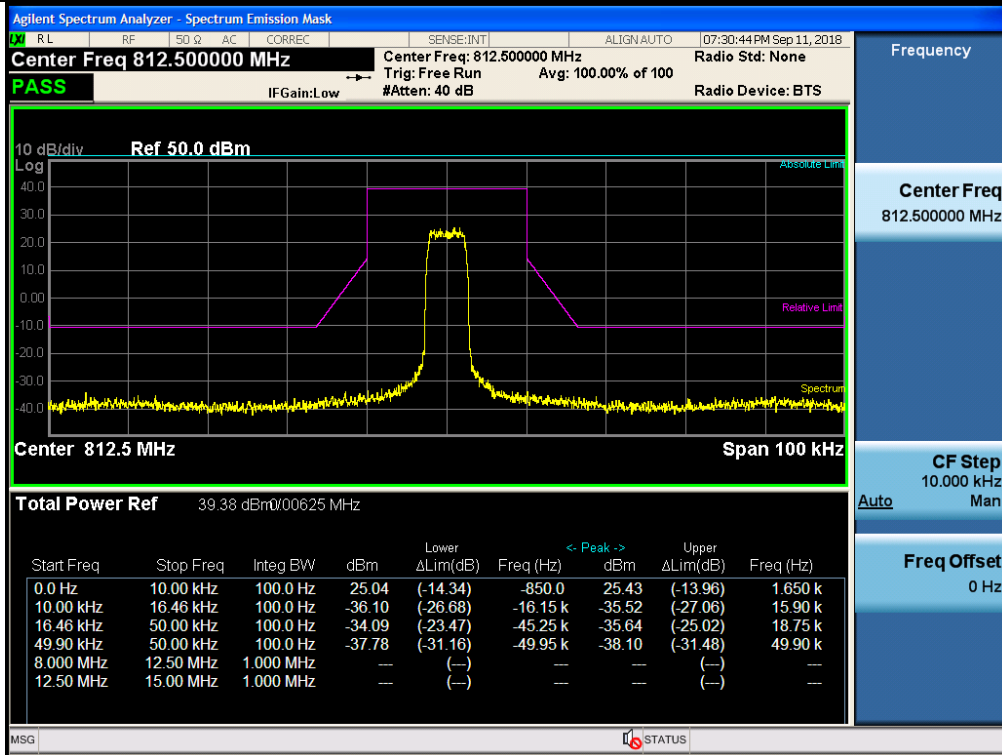

3 dB above the AGC threshold Output / PS B/ILT SMR / Downlink / P25 Phase 1 / Mask G

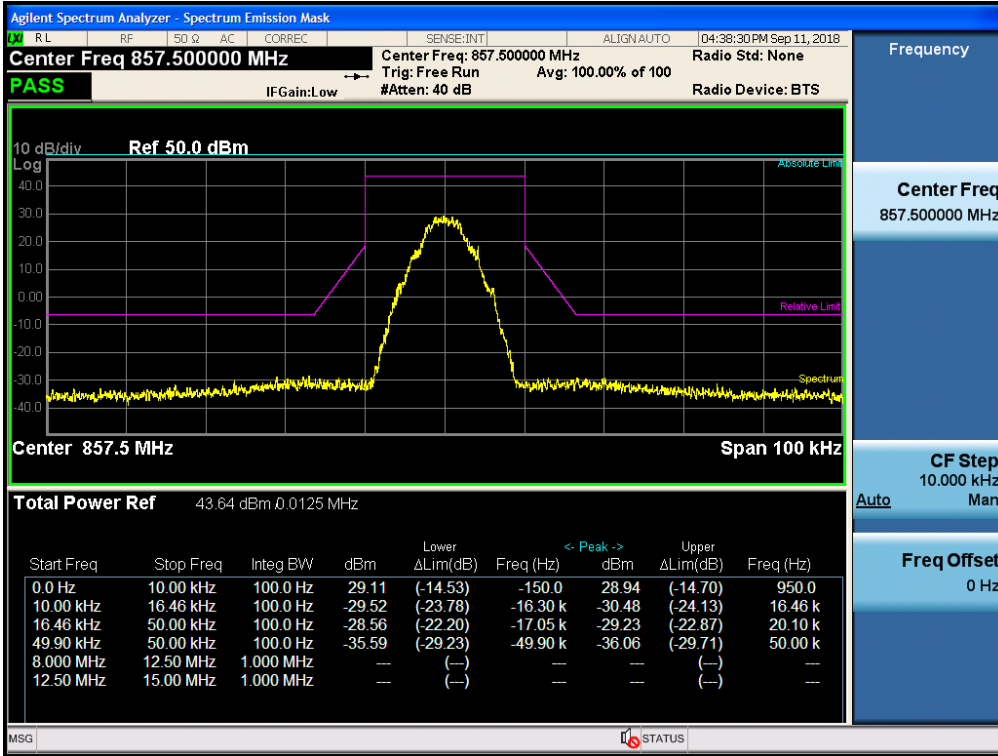

3 dB above the AGC threshold Output / PS B/ILT SMR / Downlink / P25 Phase 2 / Mask G

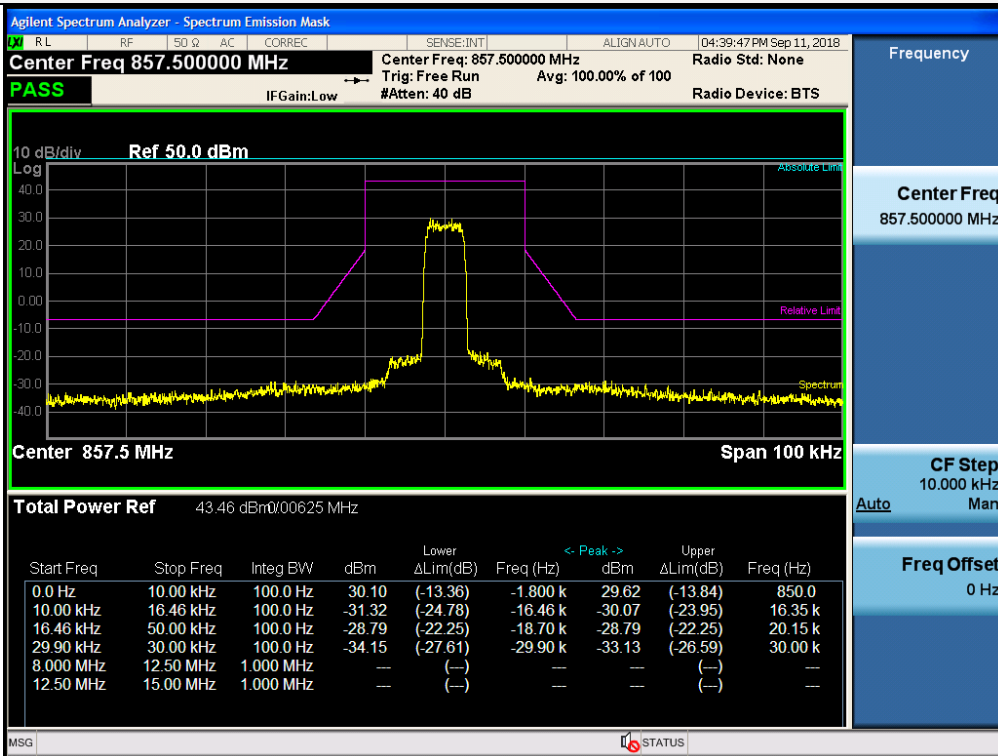

## 9. INPUT/OUTPUT POWER AND AMPLIFIER/BOOSTER GAIN

### FCC Rules

#### Test Requirement:

#### § 2.1046 Measurements required: RF power output.

(a) For transmitters other than single sideband, independent sideband and controlled carrier radiotelephone, power output shall be measured at the RF output terminals when the transmitter is adjusted in accordance with the tune-up procedure to give the values of current and voltage on the circuit elements specified in §2.1033(c)(8). The electrical characteristics of the radio frequency load attached to the output terminals when this test is made shall be stated.

(b) For single sideband, independent sideband, and single channel, controlled carrier radiotelephone transmitters the procedure specified in paragraph (a) of this section shall be employed and, in addition, the transmitter shall be modulated during the test as specified and applicable in § 2.1046 (b) (1-5). In all tests, the input level of the modulating signal shall be such as to develop rated peak envelope power or carrier power, as appropriate, for the transmitter.

(c) For measurements conducted pursuant to paragraphs (a) and (b) of this section, all calculations and methods used by the applicant for determining carrier power or peak envelope power, as appropriate, on the basis of measured power in the radio frequency load attached to the transmitter output terminals shall be shown. Under the test conditions specified, no components of the emission spectrum shall exceed the limits specified in the applicable rule parts as necessary for meeting occupied bandwidth or emission limitations.

#### § 90.219 Use of signal boosters.

(e) Device Specifications. In addition to the general rules for equipment certification in §90.203(a)(2) and part 2, subpart J of this chapter, a signal booster must also meet the rules in this paragraph.

(1) The output power capability of a signal booster must be designed for deployments providing a radiated power not exceeding 5 Watts ERP for each retransmitted channel.

#### §90.541 Transmitting power and antenna height limits.

The transmitting power and antenna height of base, mobile, portable and control stations operating in the 769-775 MHz and 799-805 MHz frequency bands must not exceed the maximum limits in this section. Power limits are listed in effective radiated power (ERP).

(a) The transmitting power and antenna height of base stations must not exceed the limits given in paragraph (a) of §90.635.

#### §90.542 Broadband transmitting power limits.

(a) The following power limits apply to the 758-768/788-798 MHz band:

(2) Fixed and base stations located in a county with population density of 100 or fewer persons per square mile, based upon the most recently available population statistics from the Bureau of the Census, and transmitting a signal in the 758-768 MHz band with an emission bandwidth of 1 MHz or less must not exceed an ERP of 2000 watts and an antenna height of 305 m HAAT, except that antenna heights greater than 305 m HAAT are permitted if power levels are reduced below 2000 watts ERP in accordance with Table 2 of this section.

(3) Fixed and base stations transmitting a signal in the 758-768 MHz band with an emission bandwidth greater than 1 MHz must not exceed an ERP of 1000 watts/MHz and an antenna height of 305 m HAAT, except that antenna heights greater than 305 m HAAT are permitted if power levels are reduced below 1000 watts/MHz ERP accordance with Table 3 of this section.

(4) Fixed and base stations located in a county with population density of 100 or fewer persons per square mile, based upon the most recently available population statistics from the Bureau of the Census, and transmitting a signal in the 758-768 MHz band with an emission bandwidth greater than 1 MHz must not exceed an ERP of 2000 watts/MHz and an antenna height of 305 m HAAT, except that antenna heights greater than 305 m HAAT are permitted if power levels are reduced below 2000 watts/MHz ERP in accordance with Table 4 of this section.

(5) Licensees of fixed or base stations transmitting a signal in the 758-768 MHz band at an ERP greater than 1000 watts must comply with the provisions set forth in paragraph (b) of this section.

(8) For transmissions in the 758-768 MHz and 788-798 MHz bands, licensees may employ equipment operating in compliance with either of the following measurement techniques:

- (i) The maximum composite transmit power shall be measured over any interval of continuous transmission using instrumentation calibrated in terms of RMS-equivalent voltage. The measurement results shall be properly adjusted for any instrument limitations, such as detector response times, limited resolution bandwidth capability when compared to the emission bandwidth, etc., so as to obtain a true maximum composite measurement for the emission in question over the full bandwidth of the channel.
- (ii) A Commission-approved average power technique.

**Table 3 to §90.542(a)—Permissible Power and Antenna Heights for Base and Fixed Stations in the 758-768 MHz Band Transmitting a Signal With an Emission Bandwidth Greater Than 1 MHz**

Antenna height (AAT) in meters (feet)	Effective radiated power (ERP) per MHz (watts/MHz)
Above 1372 (4500)	65
Above 1220 (4000) To 1372 (4500)	70
Above 1067 (3500) To 1220 (4000)	75
Above 915 (3000) To 1067 (3500)	100
Above 763 (2500) To 915 (3000)	140
Above 610 (2000) To 763 (2500)	200
Above 458 (1500) To 610 (2000)	350
Above 305 (1000) To 458 (1500)	600
Up to 305 (1000)	1000

**Table 4 to §90.542(a)—Permissible Power and Antenna Heights for Base and Fixed Stations in the 758-768 MHz Band Transmitting a Signal With an Emission Bandwidth Greater Than 1 MHz**

Antenna height (AAT) in meters (feet)	Effective radiated power (ERP) per MHz (watts/MHz)
Above 1372 (4500)	130
Above 1220 (4000) To 1372 (4500)	140
Above 1067 (3500) To 1220 (4000)	150
Above 915 (3000) To 1067 (3500)	200
Above 763 (2500) To 915 (3000)	280
Above 610 (2000) To 763 (2500)	400
Above 458 (1500) To 610 (2000)	700
Above 305 (1000) To 458 (1500)	1200
Up to 305 (1000)	2000

(b) For base and fixed stations operating in the 758-768 MHz band in accordance with the provisions of paragraph (a)(5) of this section, the power flux density that would be produced by such stations through a combination of antenna height and vertical gain pattern must not exceed 3000 microwatts per square meter on the ground over the area extending to 1 km from the base of the antenna mounting structure.

**§90.635 Limitations on power and antenna height.**

(a) The effective radiated power and antenna height for base stations may not exceed 1 kilowatt (30 dBw) and 304 m. (1,000 ft.) above average terrain (AAT), respectively, or the equivalent thereof as determined from the Table. These are maximum values, and applicants will be required to justify power levels and antenna heights requested.

**Table—Equivalent Power and Antenna Heights for Base Stations in the 851-869 MHz and 935-940 MHz Bands Which Have a Requirement for a 32 km (20 mi) Service Area Radius**

Antenna height (ATT) meters (feet)	Effective radiated power (watts)
Above 1,372 (4,500)	65
Above 1,220 (4,000) to 1,372 (4,500)	70
Above 1,067 (3,500) to 1,220 (4,000)	75
Above 915 (3,000) to 1,067 (3,500)	100
Above 763 (2,500) to 915 (3,000)	140
Above 610 (2,000) to 763 (2,500)	200
Above 458 (1,500) to 610 (2,000)	350
Above 305 (1,000) to 458 (1,500)	600
Up to 305 (1,000)	1,000

**Test Procedures:**

Measurements were in accordance with the test methods section 4.5 of KDB 935210 D05 v01r02.

4.5.2 Measuring input and output power levels for determining amplifier/booster gain

- a) Connect a signal generator to the input of the EUT.
- b) Configure to generate the CW test signal.
- c) The frequency of the signal generator shall be set to the frequency  $f_0$  as determined from Out-of-band rejection test.
- d) Connect a spectrum analyzer or power meter to the output of the EUT using appropriate attenuation



as necessary.

- e) Set the signal generator output power to a level that produces a EUT output level that is just below the AGC threshold, but not more than 0.5 dB below.
- f) Measure and record the output power of the EUT; use 4.5.3 for power measurement.
- g) Remove the EUT from the measurement setup. Using the same signal generator settings, repeat the power measurement at the signal generator port, which was used as the input signal to the EUT, and record as the input power. EUT gain may be calculated as described in 3.5.5.
- h) Repeat steps f) and g) with input signal amplitude set to 3 dB above the AGC threshold level.
- i) Omit
- j) Repeat steps e) to i) for all frequency bands authorized for use by the EUT.

#### 4.5.3 Power measurement Method 1: using a spectrum or signal analyzer

- a) Set the span to at least 1 MHz.
- b) Set the RBW 100 kHz.
- c) Set the VBW to  $\geq 3 \times$  RBW.
- d) Set the detector to PEAK with the trace to MAX HOLD.
- e) Place a marker on the peak of the signal a record the value.
- f) Repeat without EUT in place.
- g) Calculate gain with the following formula: Gain (dB) = output (dBm) – input (dBm).

#### 4.5.5 Calculating amplifier, repeater, or industrial booster gain

After the input and output power levels have been measured as described in the preceding subclauses, the gain of the EUT can be determined from:

$$\text{Gain (dB)} = \text{output power (dBm)} - \text{input power (dBm)}.$$

Report the gain for each authorized operating frequency band, and each test signal stimulus.

**Test Results:****Tabular data of Input / Output Power and Gain**

Test Band	Link	Frequency (MHz)	Input Power (dBm)	Output Power (dBm)	Gain (dB)
PS Narrowband	Uplink	802.945	-62.236	33.618	95.85
	Downlink	769.855	-62.099	36.648	98.75
NPSPAC	Uplink	807.755	-62.334	33.855	96.19
	Downlink	852.620	-62.137	36.845	98.98
PS B/ILT SMR	Uplink	811.783	-62.370	33.384	95.75
	Downlink	857.465	-62.142	36.764	98.91

## 10. NOISE FIGURE

### FCC Rules

#### Test Requirements:

##### § 90.219 Use of signal boosters.

(e) Device Specifications. In addition to the general rules for equipment certification in §90.203(a)(2) and part 2, subpart J of this chapter, a signal booster must also meet the rules in this paragraph.

(2) The noise figure of a signal booster must not exceed 9 dB in either direction.

### Test Procedures:

Measurements were in accordance with Agilent Application Note 57-1, 'The Direct Noise Measurement Method'.

The output power of the device is measured with an input termination at a temperature of approximately 290K. If the gain of the device and noise bandwidth of the measurement system is known, the noise factor can be determined.

$$F_{\text{sys}} = \frac{N_o}{kT_oBG}$$

$F_{\text{sys}}$  = System Noise Factor

$N_o$  = Output Noise Power

$k$  = Boltzmann's Constant

$T_o$  = Standard Noise Temperature (290K)

$B$  = Noise Bandwidth

$G$  = Gain

' $kT_oB$ ' calculation result for 1 MHz noise bandwidth is -114 dBm/MHz.

'Gain' value can be obtained from the test performed previously.

For measure the 'output noise power', perform the following procedure.

- a) Remove a signal generator from the input port of EUT then terminate it.
- b) Turn off the AGC function in EUT.
- c) Connect a spectrum analyzer to output port of EUT.
- e) Set the RBW 1 MHz. and set the VBW to  $\geq 3 \times$  RBW.
- f) Measure the maximum output noise power for EUT pass band.

After the measurement, calculate the noise figure according to the following formular.

$$\text{Noise Figure} = \text{Noise Output Power} - kT_oB - \text{Gain}$$

**Test Results:**

Test Band	Link	Measured Value (dBm)	Calculated Factor (kT0B-Gain, dB)	Noise Figure (dB)
PS Narrowband	Uplink	-14.818	18.15	3.33
	Downlink	-11.198	15.25	4.06
NPSPAC	Uplink	-14.417	17.81	3.39
	Downlink	-13.060	15.02	1.96
PS B/ILT SMR	Uplink	-15.400	18.25	2.85
	Downlink	-13.080	15.09	2.01

## 11. OUT-OF-BAND/OUT-OF-BLOCK EMISSIONS AND SPURIOUS EMISSIONS

### FCC Rules

#### Test Requirements:

##### § 2.1051 Measurements required: Spurious emissions at antenna terminals.

The radio frequency voltage or powers generated within the equipment and appearing on a spurious frequency shall be checked at the equipment output terminals when properly loaded with a suitable artificial antenna. Curves or equivalent data shall show the magnitude of each harmonic and other spurious emission that can be detected when the equipment is operated under the conditions specified in §2.1049 as appropriate. The magnitude of spurious emissions which are attenuated more than 20 dB below the permissible value need not be specified.

##### § 90.219 Use of signal boosters.

(e) *Device Specifications.* In addition to the general rules for equipment certification in §90.203(a)(2) and part 2, subpart J of this chapter, a signal booster must also meet the rules in this paragraph.

(3) Spurious emissions from a signal booster must not exceed -13 dBm within any 100 kHz measurement bandwidth.

##### §90.543 Emission limitations.

Transmitters designed to operate in 769-775 MHz and 799-805 MHz frequency bands must meet the emission limitations in paragraphs (a) through (d) of this section. Class A and Class B signal boosters retransmitting signals in the 769-775 MHz and 799-805 MHz frequency bands are exempt from the limits listed in paragraph (a) of this section when simultaneously retransmitting multiple signals and instead shall be subject to the limit listed in paragraph (c) of this section when operating in this manner. Transmitters operating in 758-768 MHz and 788-798 MHz bands must meet the emission limitations in (e) of this section.

(c) Out-of-band emission limit. On any frequency outside of the frequency ranges covered by the ACP tables in this section, the power of any emission must be reduced below the mean output power (P) by at least  $43 + 10\log(P)$  dB measured in a 100 kHz bandwidth for frequencies less than 1 GHz, and in a 1 MHz bandwidth for frequencies greater than 1 GHz.

(e) For operations in the 758-768 MHz and the 788-798 MHz bands, the power of any emission outside the licensee's frequency band(s) of operation shall be attenuated below the transmitter power (P) within the licensed band(s) of operation, measured in watts, in accordance with the following:

(1) On all frequencies between 769-775 MHz and 799-805 MHz, by a factor not less than  $76 + 10\log(P)$  dB in a 6.25 kHz band segment, for base and fixed stations.

(3) On any frequency between 775-788 MHz, above 805 MHz, and below 758 MHz, by at least  $43 + 10\log(P)$  dB.

(4) Compliance with the provisions of paragraphs (e)(1) and (2) of this section is based on the use of measurement instrumentation such that the reading taken with any resolution bandwidth setting should

be adjusted to indicate spectral energy in a 6.25 kHz segment.

(5) Compliance with the provisions of paragraph (e)(3) of this section is based on the use of measurement instrumentation employing a resolution bandwidth of 100 kHz or greater. However, in the 100 kHz bands immediately outside and adjacent to the frequency block, a resolution bandwidth of 30 kHz may be employed.

#### **Test Procedures:**

Measurements were in accordance with the test methods section 4.7 of KDB 935210 D05 v01r02.

*Spurious emissions shall be measured using a single test signal sequentially tuned to frequencies within each authorized frequency band of operation.*

*Intermodulation products shall be measured using two CW signals with all available channel spacing with the center between these channels being equal to the center frequency  $f_0$  as determined from Out-of-band rejection test.*

#### 4.7.2 Out-of-band/out-of-block emissions conducted measurements

a) Connect a signal generator to the input of the EUT.

*If the signal generator is not capable of producing two independent modulated carriers simultaneously, then two discrete signal generators can be connected, with an appropriate combining network to support the two-signal test.*

b) Configure the two signal generators to produce CW on frequencies spaced consistent with  $f_0$ , with amplitude levels set to just below the AGC threshold.

c) Connect a spectrum analyzer to the EUT output.

d) Set the span to 100 kHz.

e) Set RBW = 300 Hz with VBW  $\geq 3 \times$  RBW.

f) Set the detector to power averaging (rms).

g) Place a marker on highest intermodulation product amplitude.

h) Capture the plot for inclusion in the test report.

i) Repeat steps c) to h) with the composite input power level set to 3 dB above the AGC threshold.

j) Repeat steps b) to i) for all operational bands.

#### 4.7.3 EUT spurious emissions conducted measurements

a) Connect a signal generator to the input of the EUT.

b) Configure the signal generator to produce a CW signal.

c) Set the frequency of the CW signal to the center channel of the EUT passband.

d) Set the output power level so that the resultant signal is just below the AGC threshold.

e) Connect a spectrum analyzer to the output of the EUT, using appropriate attenuation as necessary.

- f) Set the RBW = 100 kHz. (i.e., for 30 MHz to 1 GHz PLMRS and/or PSRS booster devices)
- g) Set the VBW = 3 × RBW.
- h) Set the Sweep time = auto-couple.
- i) Set the detector to PEAK.
- j) Set the spectrum analyzer start frequency to 30 MHz (or the lowest radio frequency signal generated in the EUT, without going below 9 kHz if the EUT has additional internal clock frequencies), and the stop frequency to 10 times the highest allowable frequency of the EUT passband.
- k) Select MAX HOLD, and use the marker peak function to find the highest emission(s) outside the passband. (This could be either at a frequency lesser or greater than the passband frequencies.)
- l) Capture a plot for inclusion in the test report.
- m) Repeat steps c) to l) for each authorized frequency band/block of operation.

*Note1. According to §90.209, 12.5 kHz channel spacing is used in NPSPAC band and 25 kHz channel spacing used in PS B/ILT SMR band.*

*Note2. In PS narrowband, test performed using 6.25 kHz and 12.5 kHz spacing of P25 test signal because there is no channel spacing limit at §90.209.*

*Note3. Channel bandwidth is greater than span of test method in KDB 935210 D05 4.2.2, so we didn't performed test on PS Broadband.*

*Note4. Because of special emission level is not detected in input and output comparison test, inter-modulation test is performed at center frequency.*

*Note5. 769 ~ 775 MHz / 799 ~ 805 MHz test processor referred to CMRS booster test.*

**Test Results:**

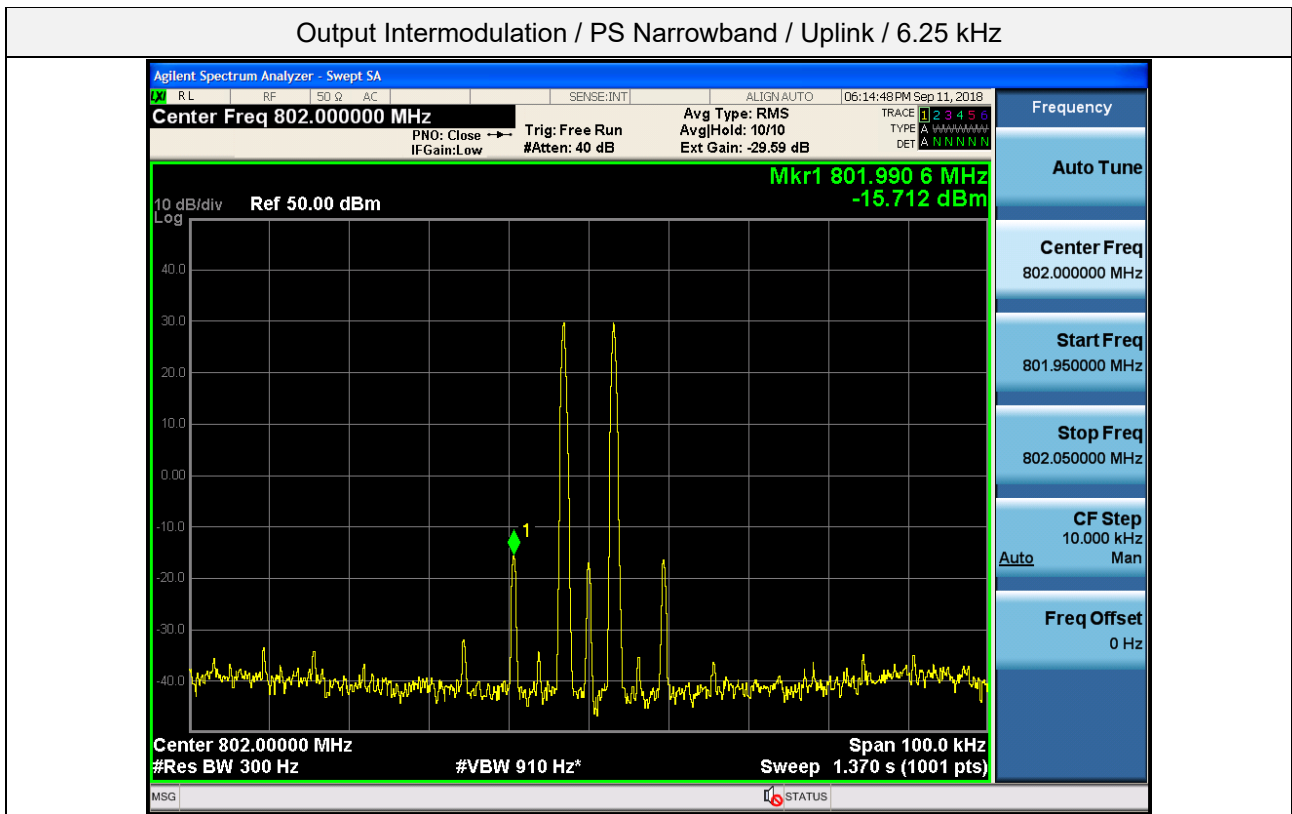
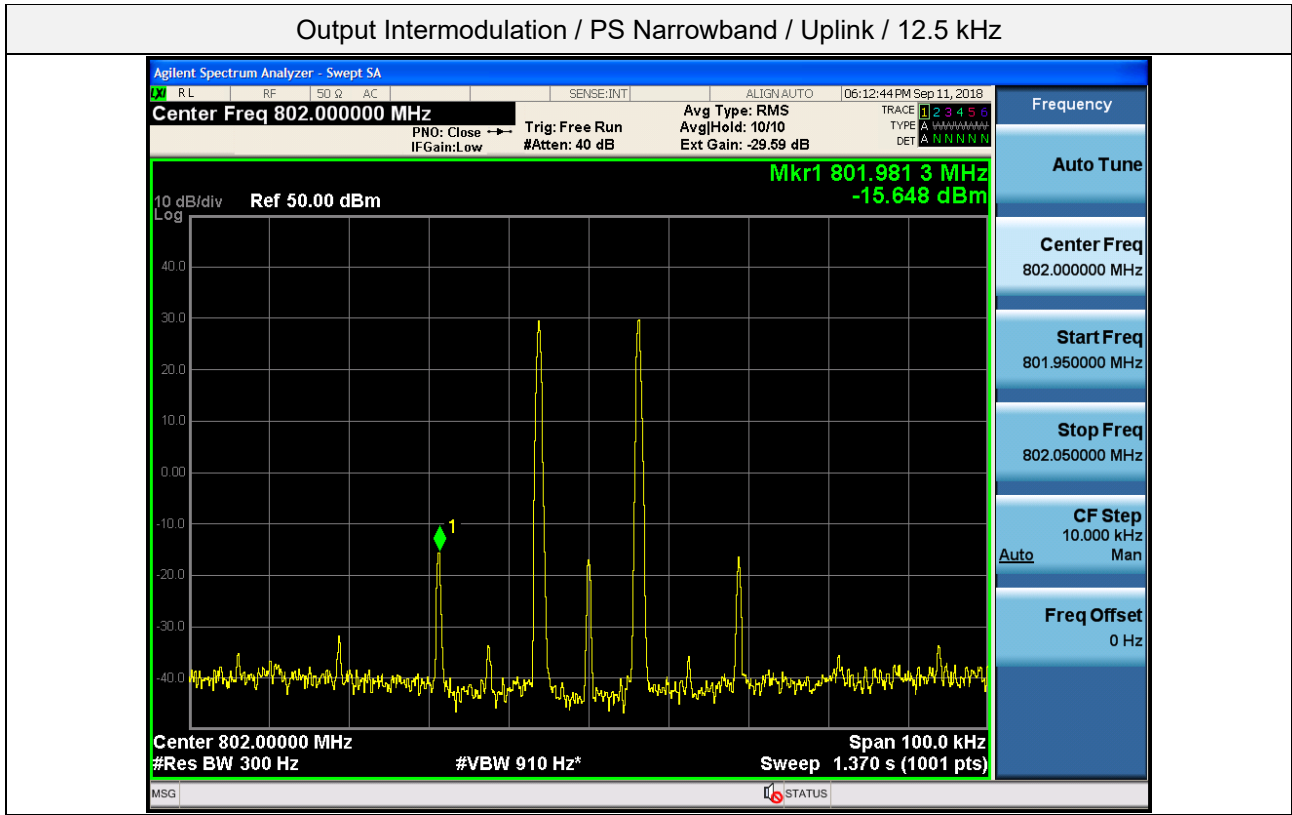



Output Intermodulation / PS Narrowband / Downlink / 12.5 kHz

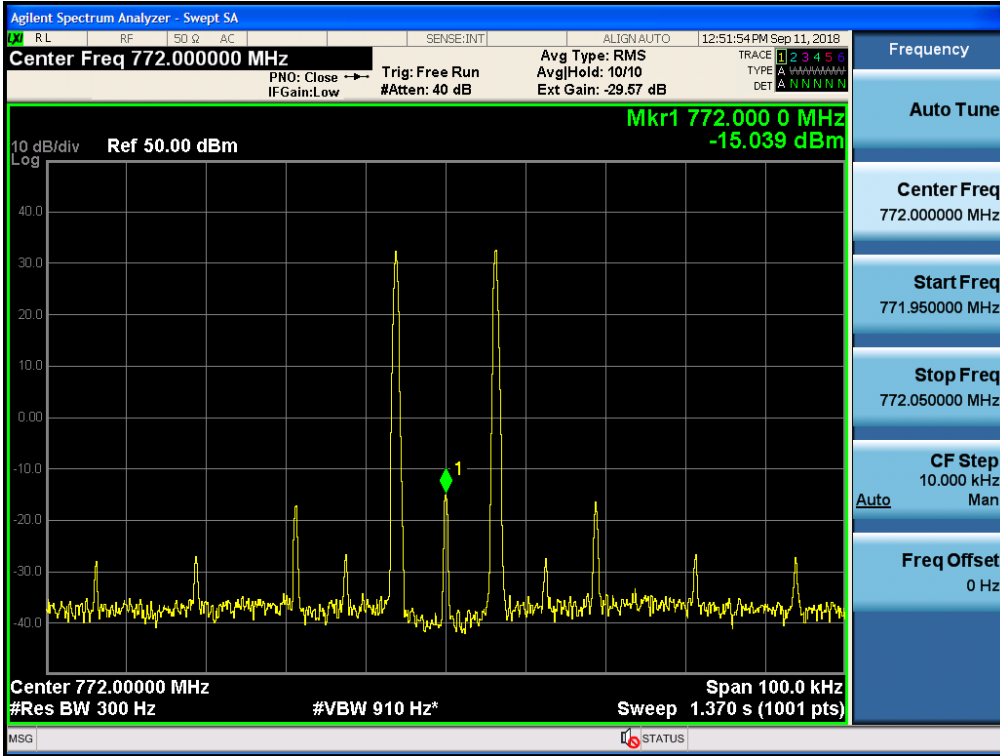

Output Intermodulation / PS Narrowband / Downlink / 6.25 kHz

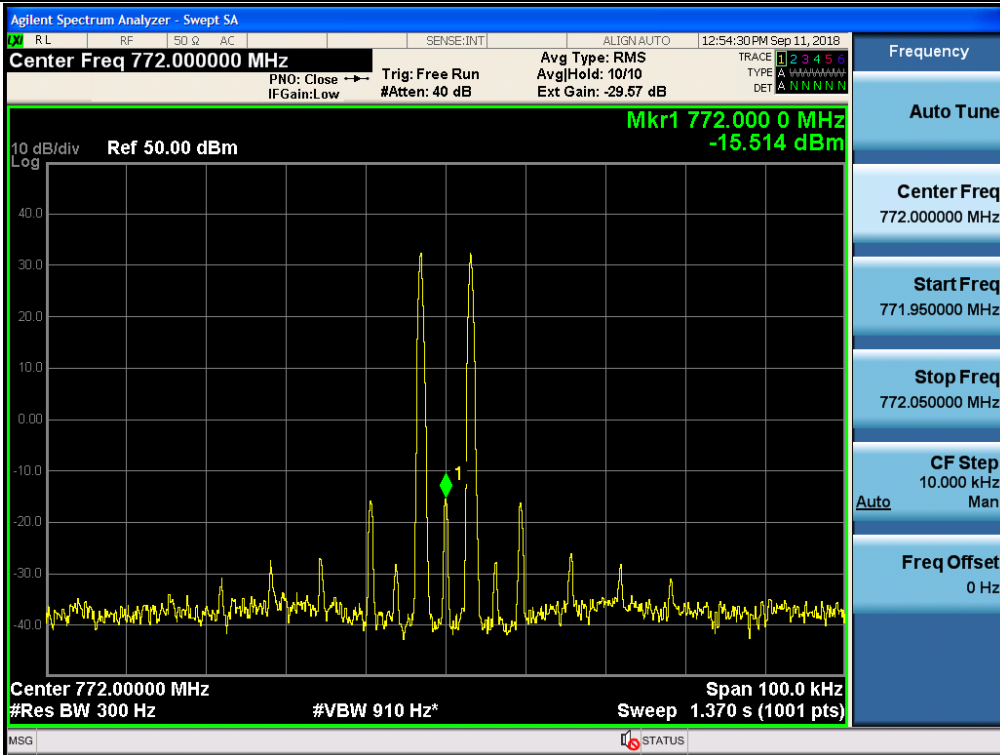

Output Intermodulation / NPSPAC / Uplink / 12.5 kHz

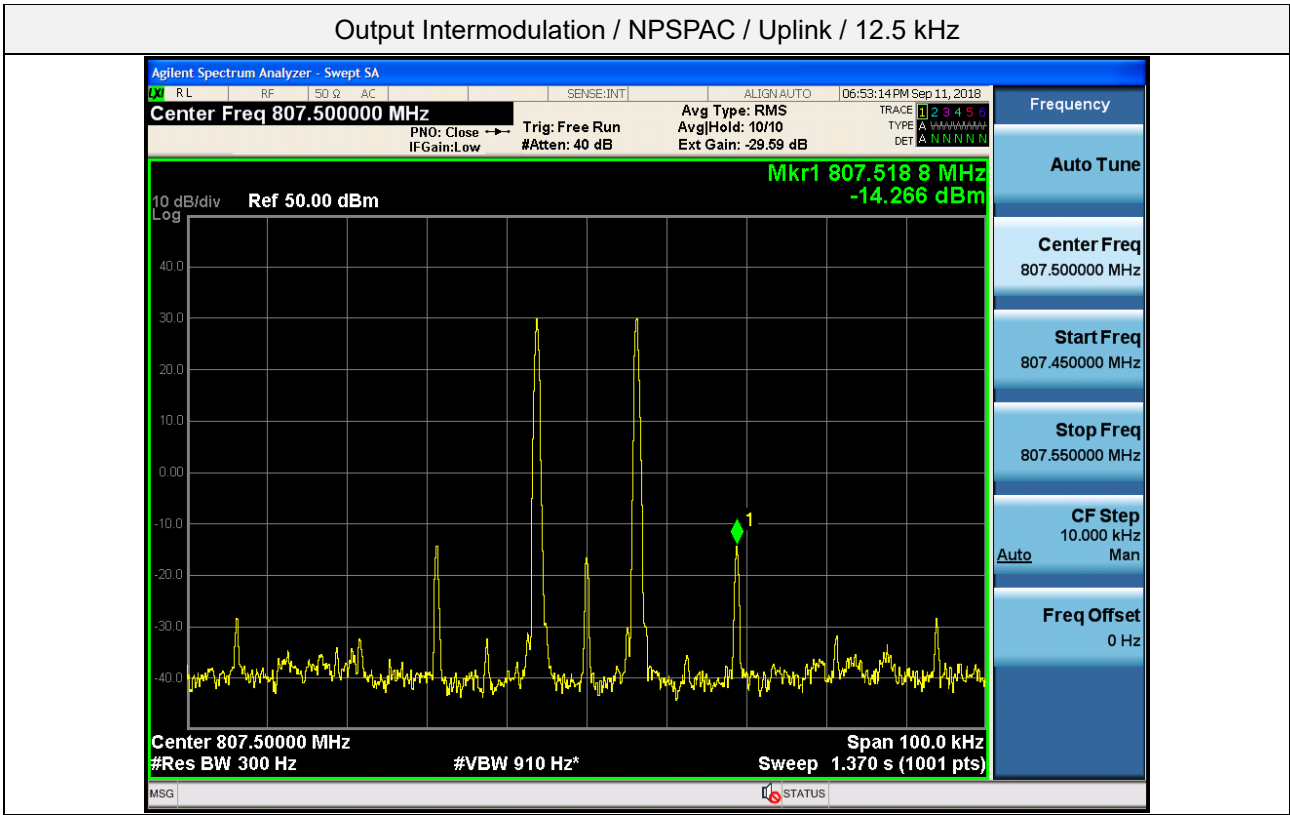

Output Intermodulation / NPSPAC / Downlink / 12.5 kHz

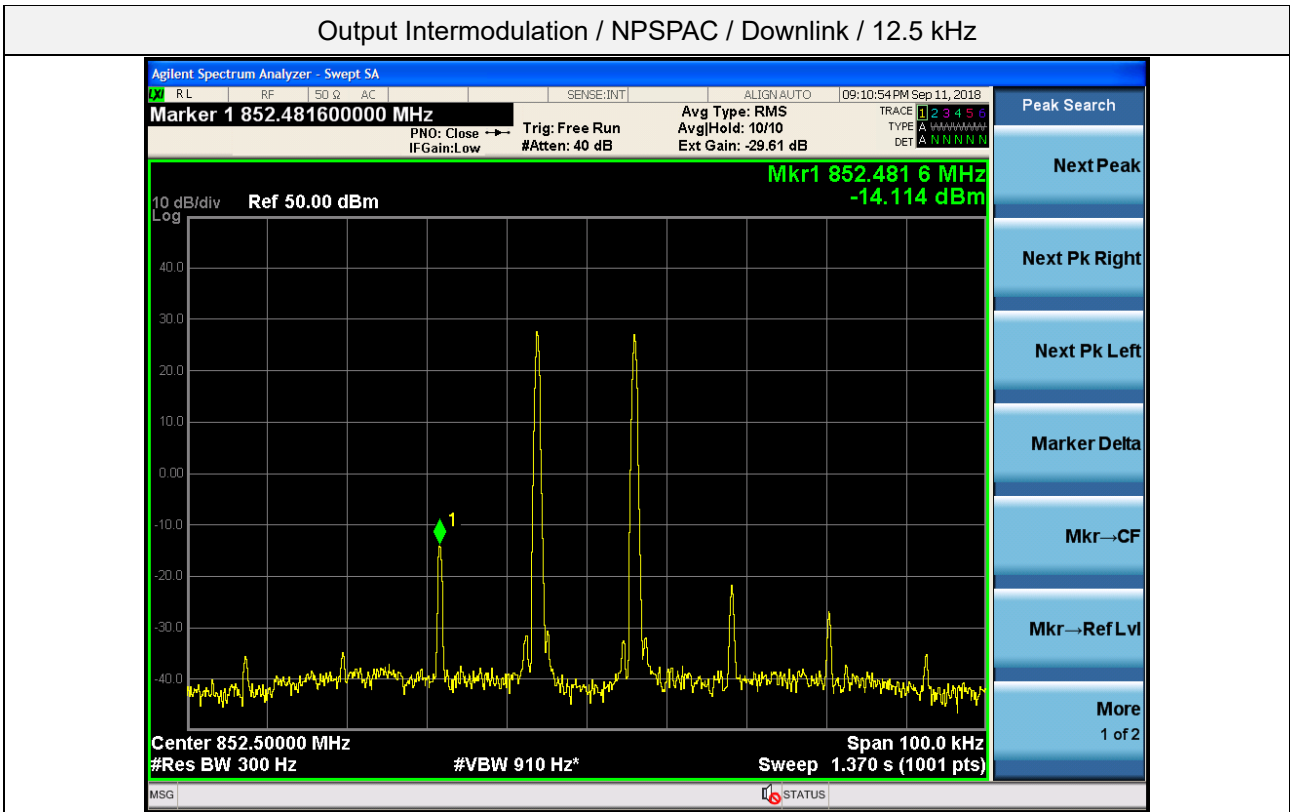

Output Intermodulation / PS B/ILT SMR / Uplink / 25 kHz

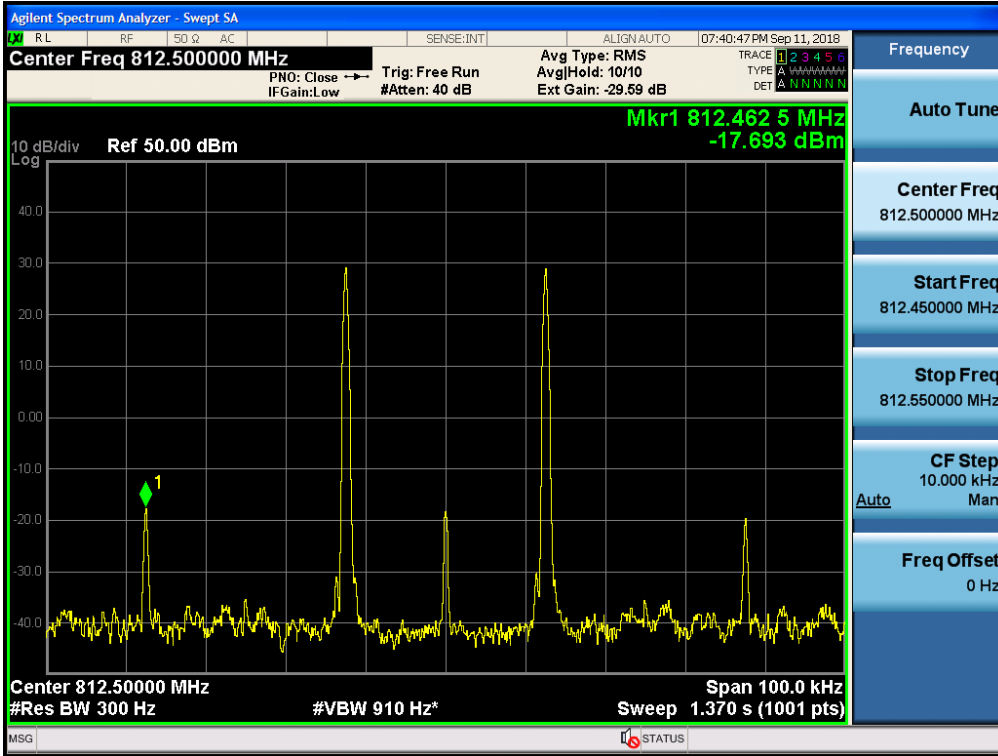

Output Intermodulation / PS B/ILT SMR / Downlink / 25 kHz

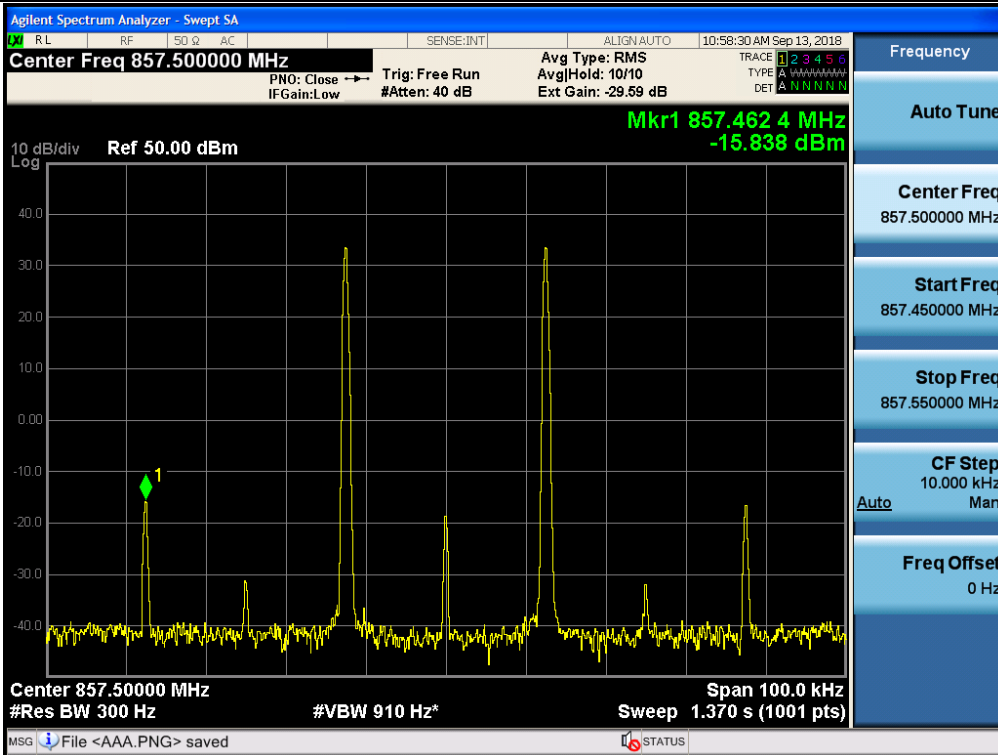

3 dB above the AGC threshold Output Intermodulation / PS Narrowband / Uplink / 12.5 kHz

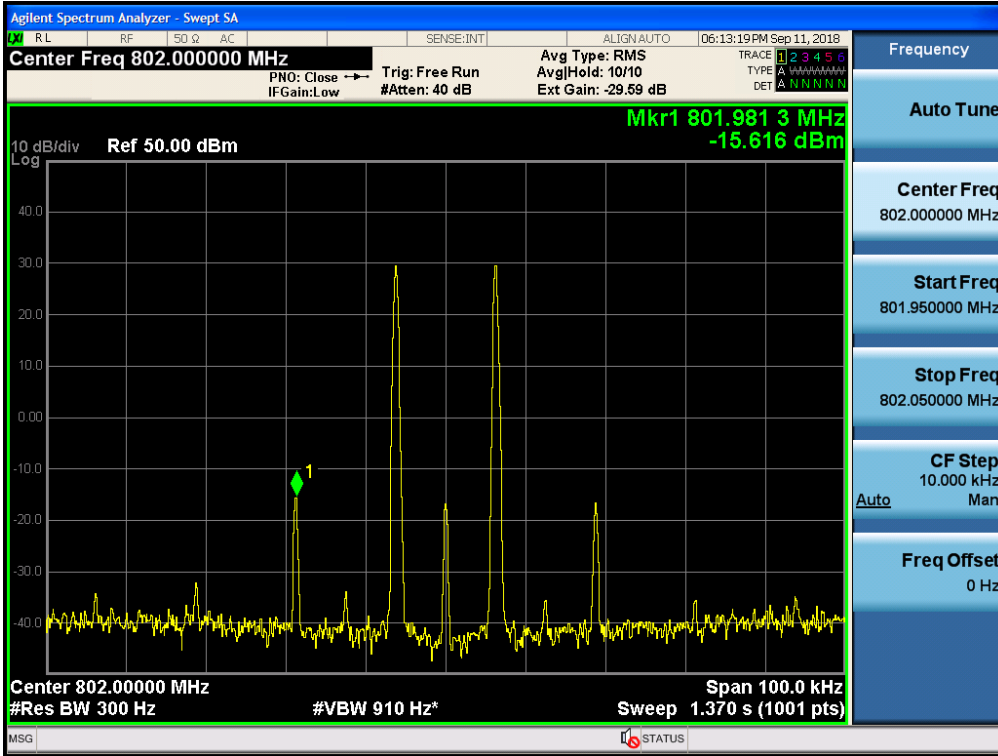

3 dB above the AGC threshold Output Intermodulation / PS Narrowband / Uplink / 6.25 kHz

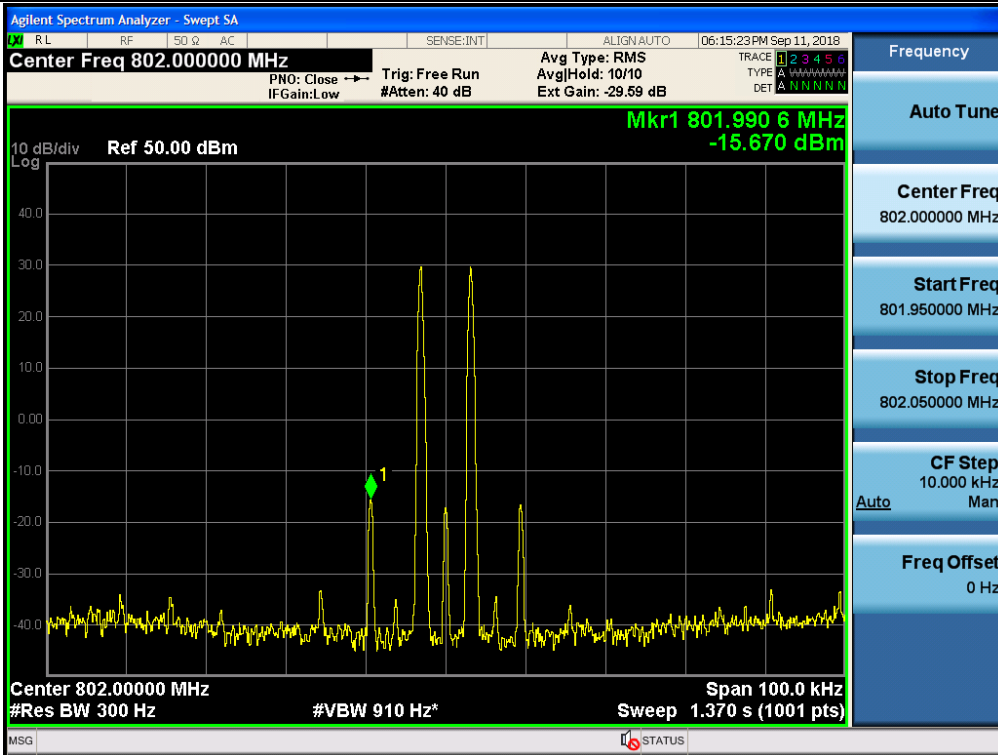

3 dB above the AGC threshold Output Intermodulation / PS Narrowband / Downlink / 12.5 kHz

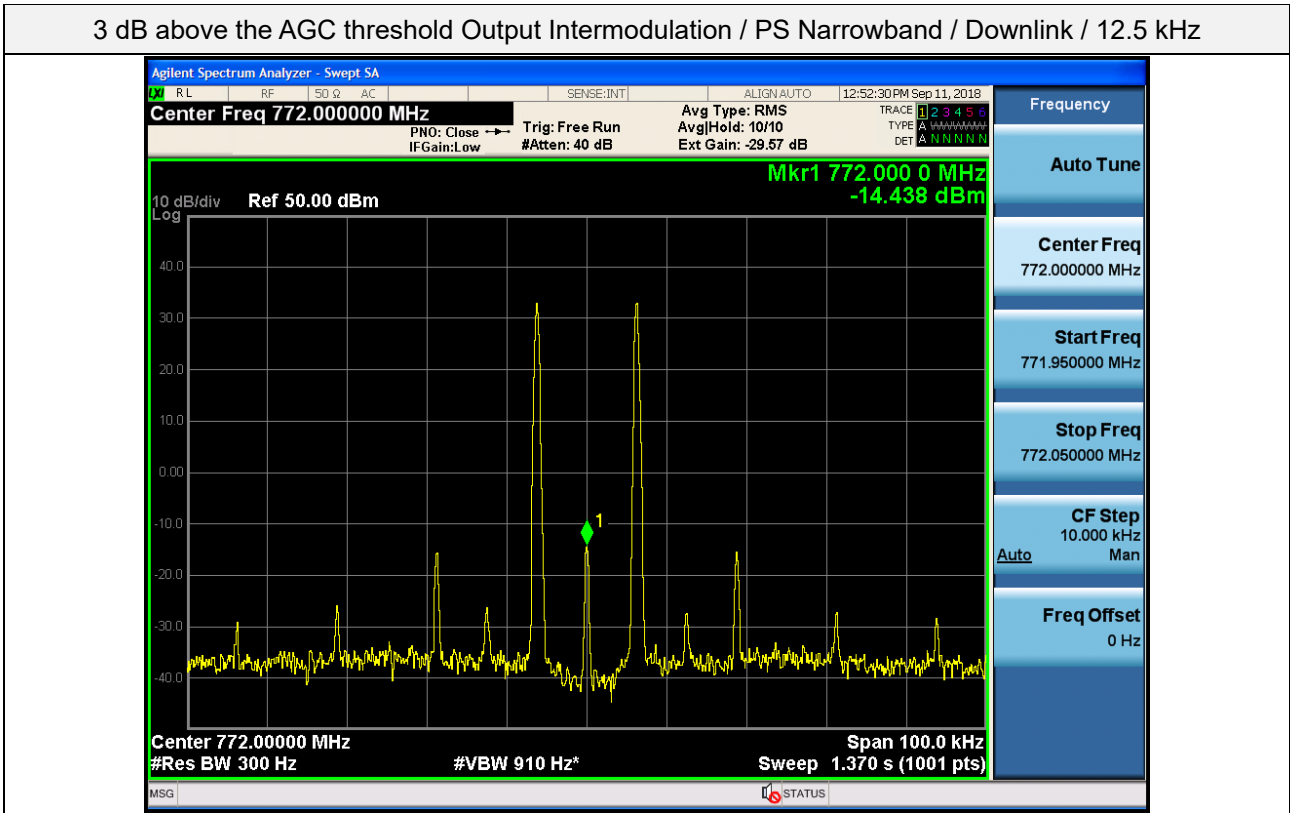

3 dB above the AGC threshold Output Intermodulation / PS Narrowband / Downlink / 6.25 kHz

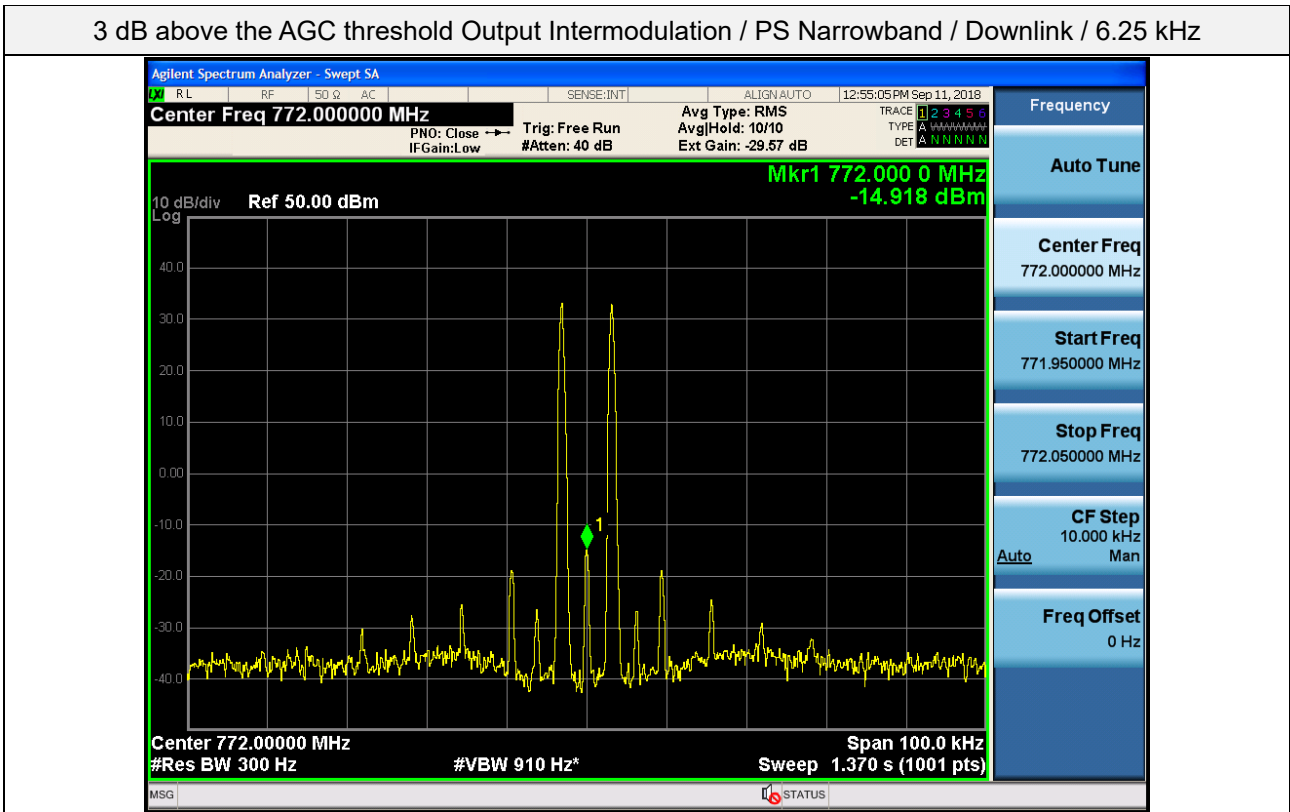

3 dB above the AGC threshold Output Intermodulation / NPSPAC / Uplink / 12.5 kHz

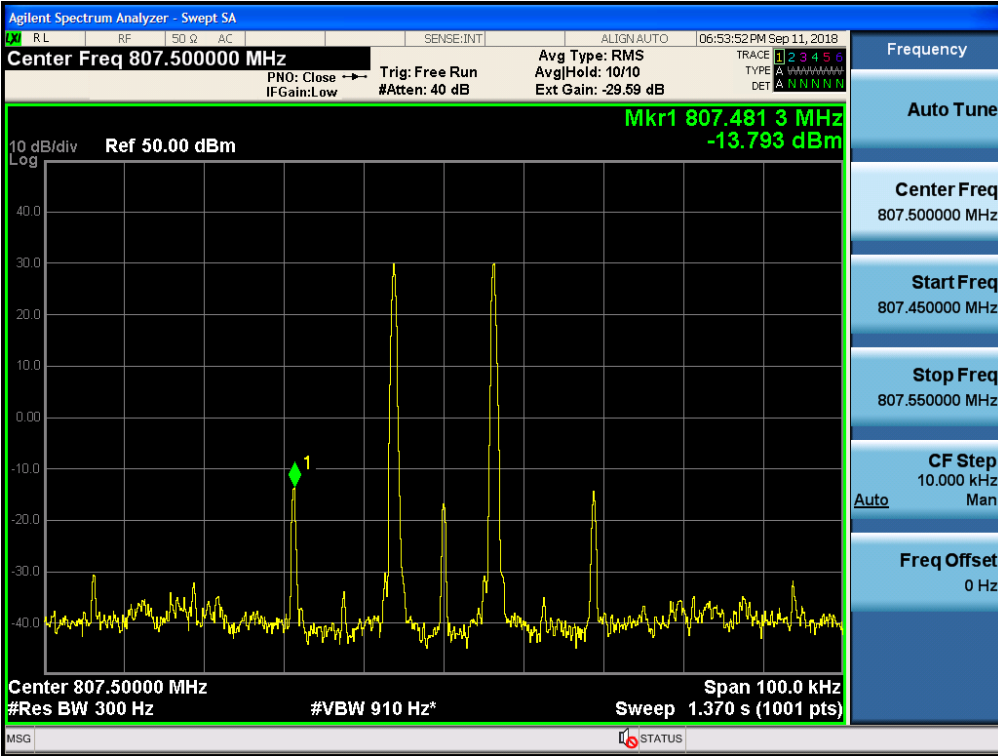

3 dB above the AGC threshold Output Intermodulation / NPSPAC / Downlink / 12.5 kHz

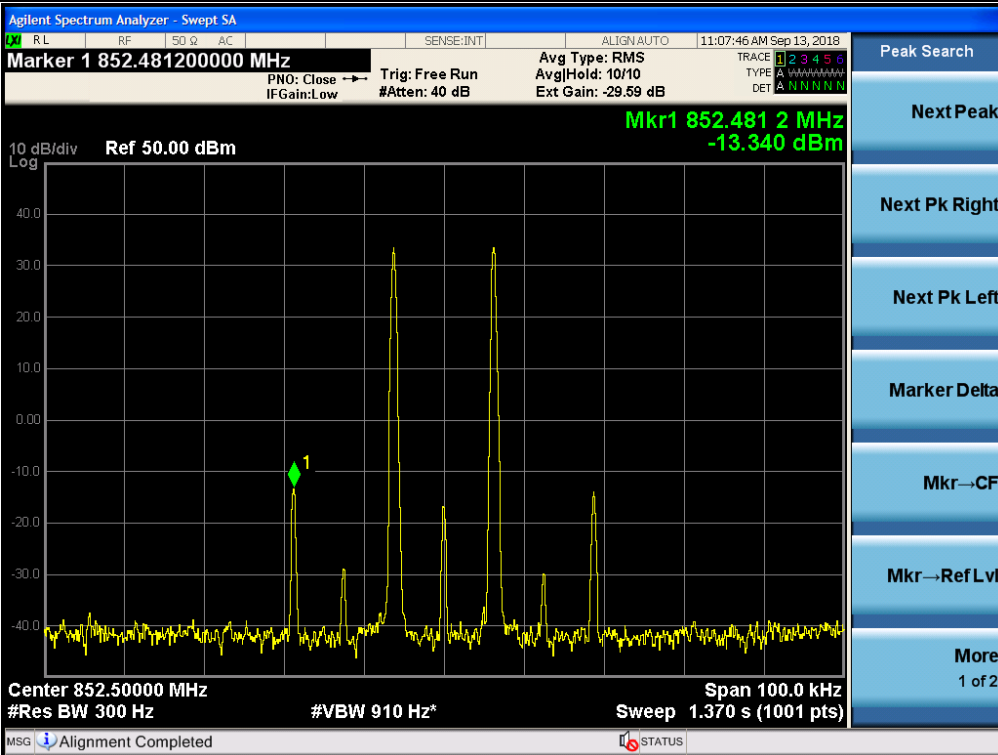

3 dB above the AGC threshold Output Intermodulation / PS B/ILT SMR / Uplink / 25 kHz

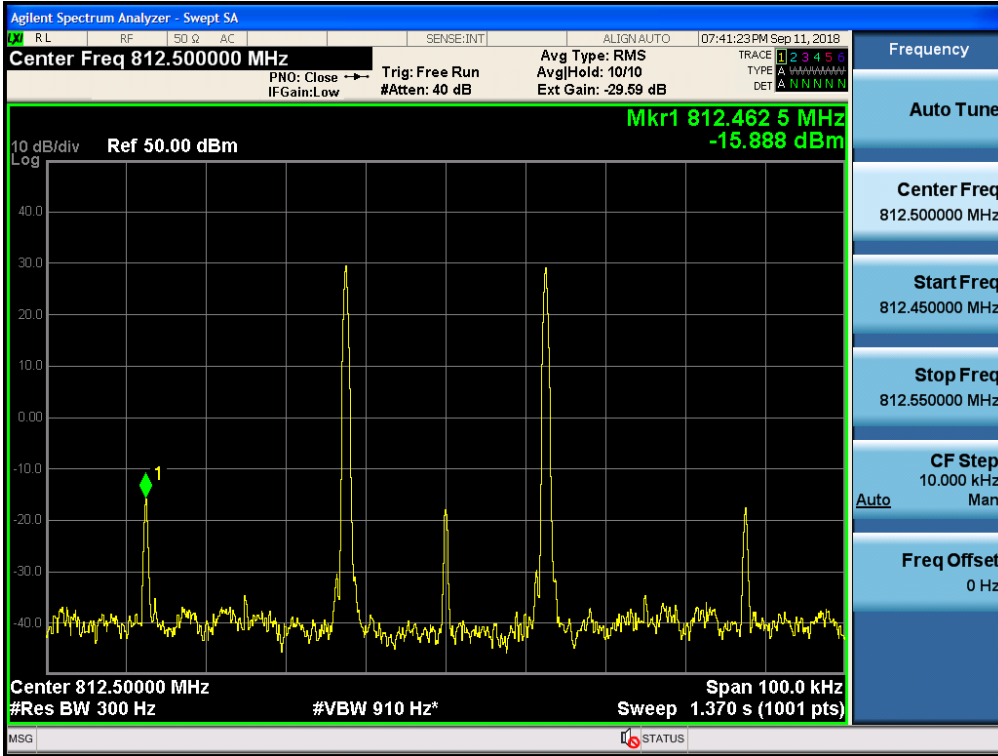

3 dB above the AGC threshold Output Intermodulation / PS B/ILT SMR / Downlink / 25 kHz

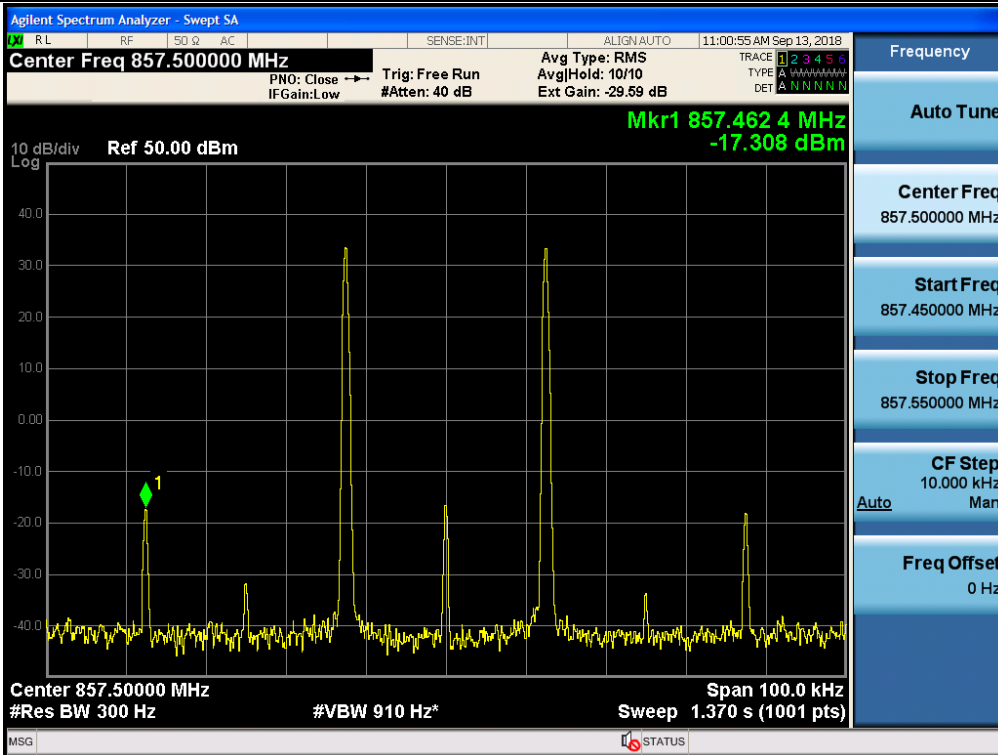

Spurious Emissions / PS Narrowband / Uplink

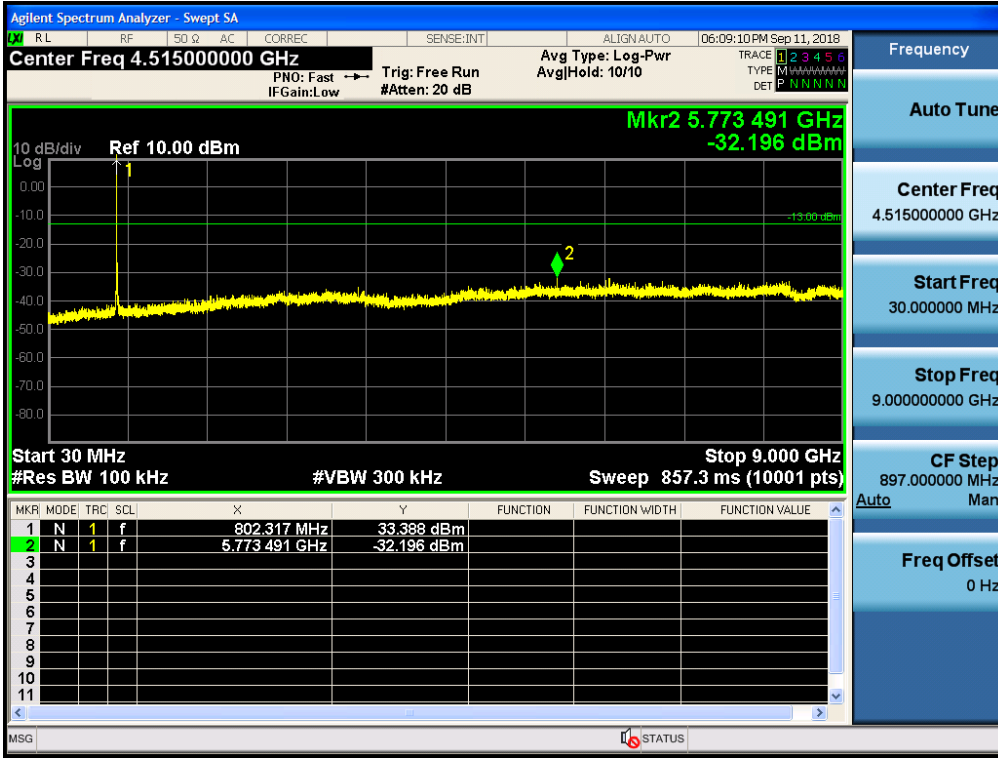

Spurious Emissions / PS Narrowband / Downlink

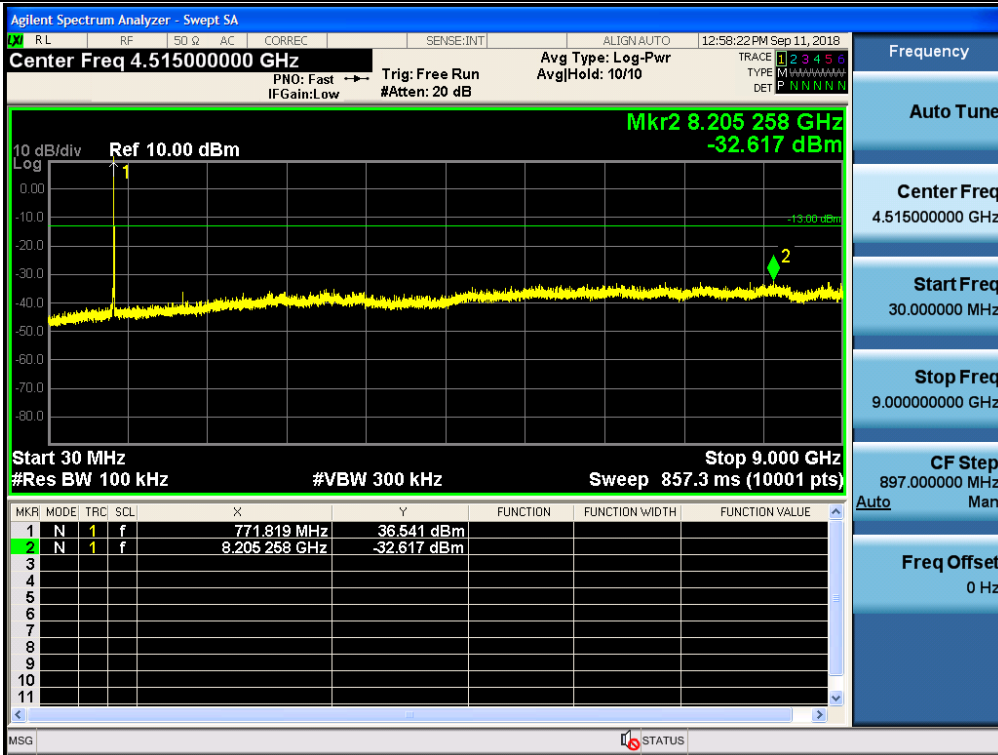



Spurious Emissions / NPSPAC / Uplink

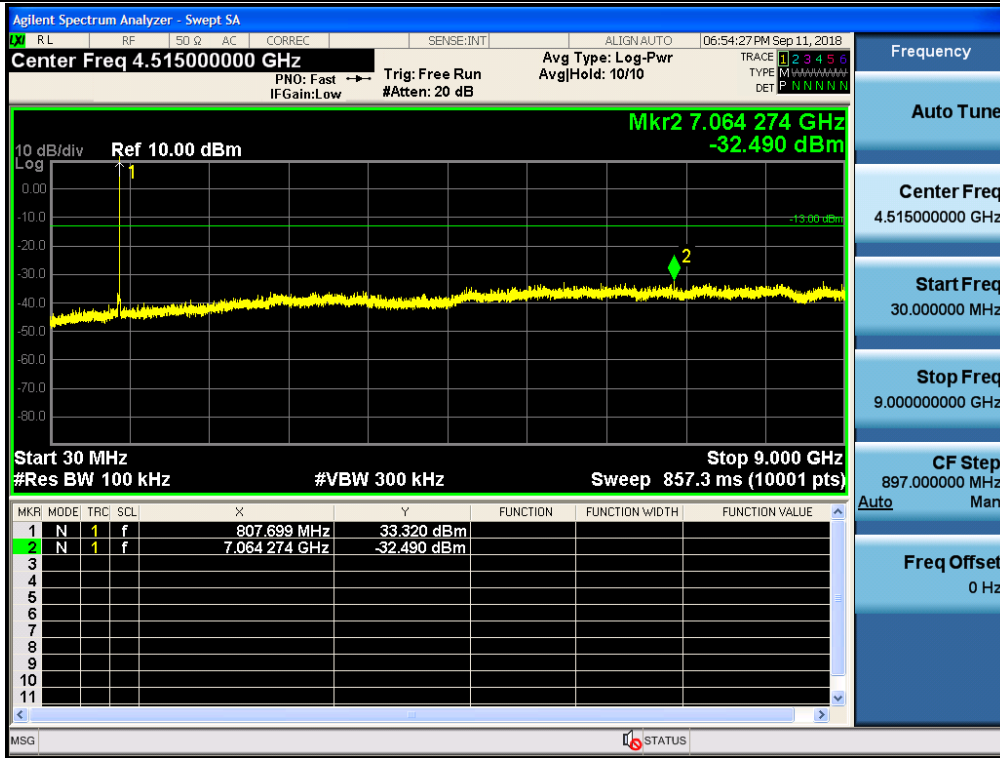

Spurious Emissions / NPSPAC / Downlink



Spurious Emissions / PS B/ILT SMR / Uplink

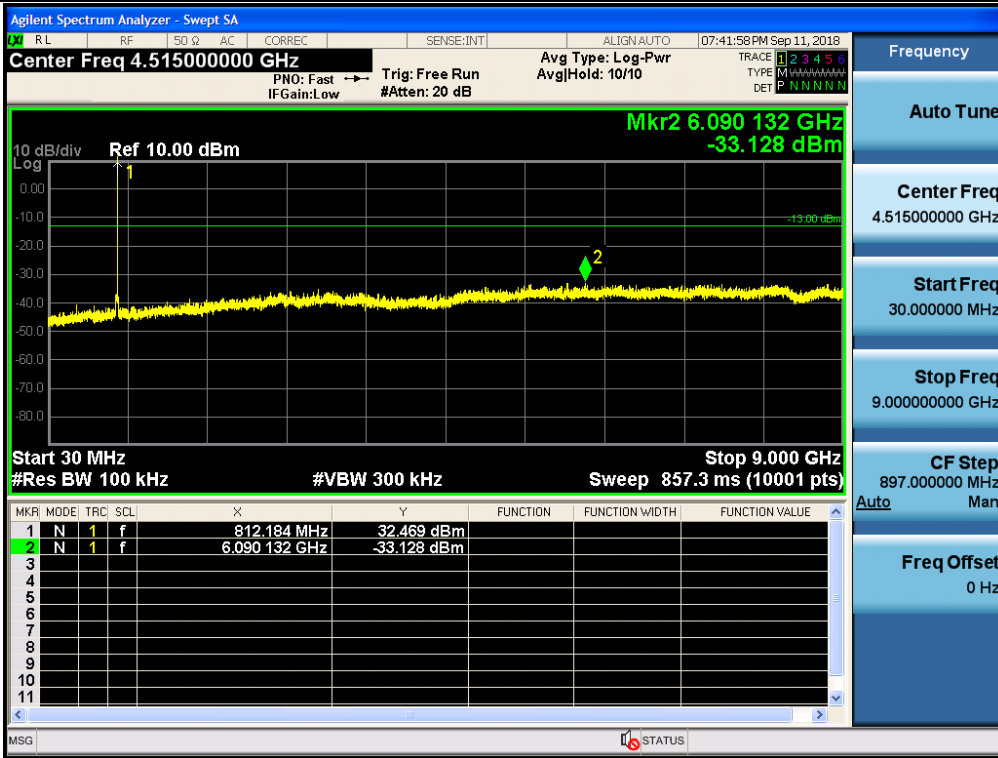

Spurious Emissions // PS B/ILT SMR / Downlink

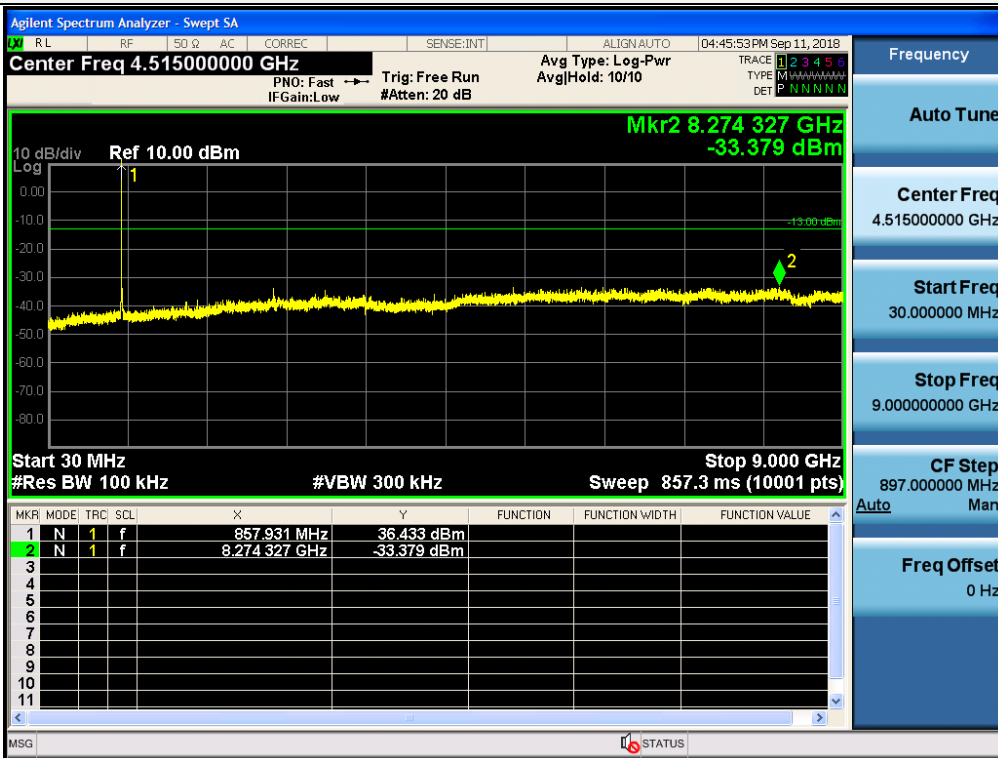

Spurious Emissions (769 ~ 775 MHz) / PS Broadband / Uplink

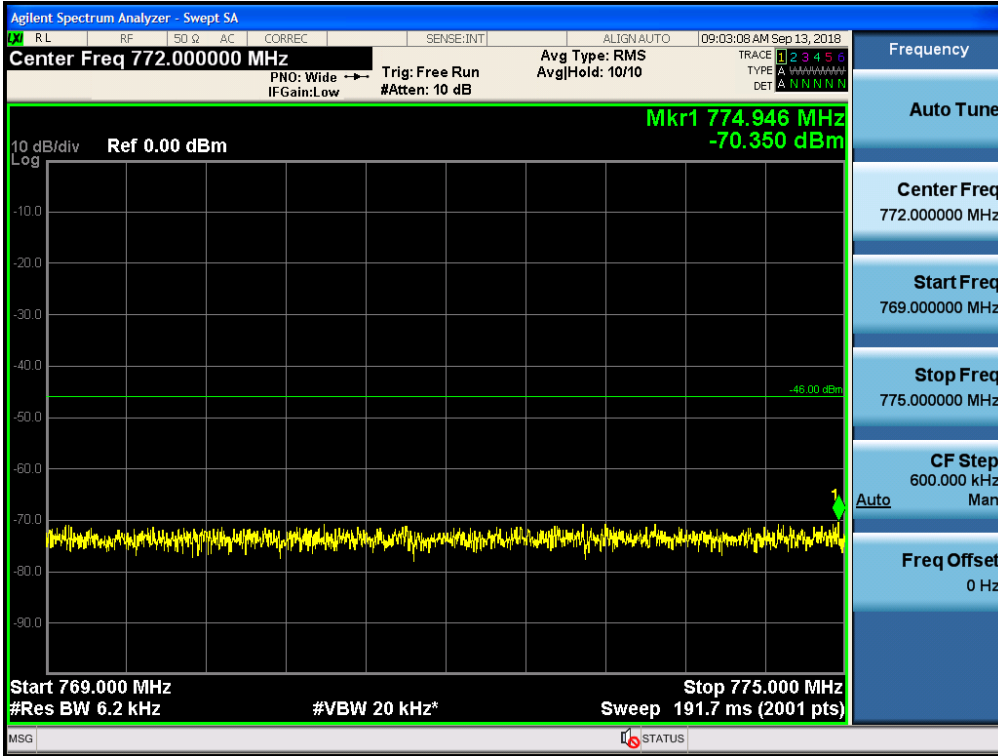

Spurious Emissions (769 ~ 775 MHz) / PS Broadband / Downlink

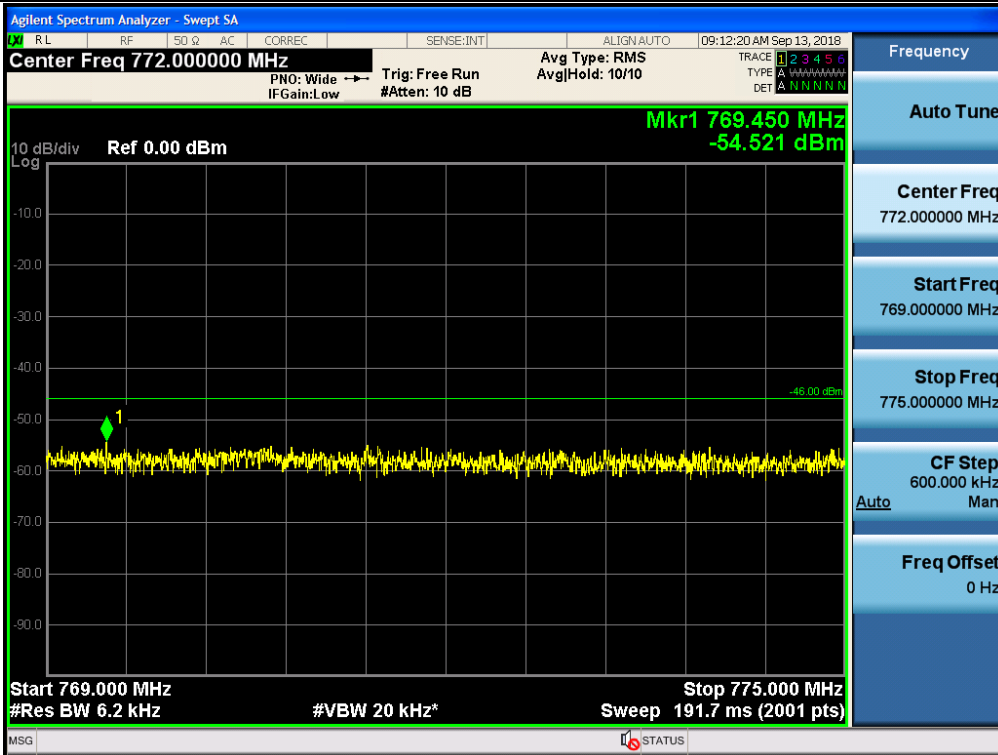

Spurious Emissions (799 ~ 805 MHz) / PS Broadband / Uplink

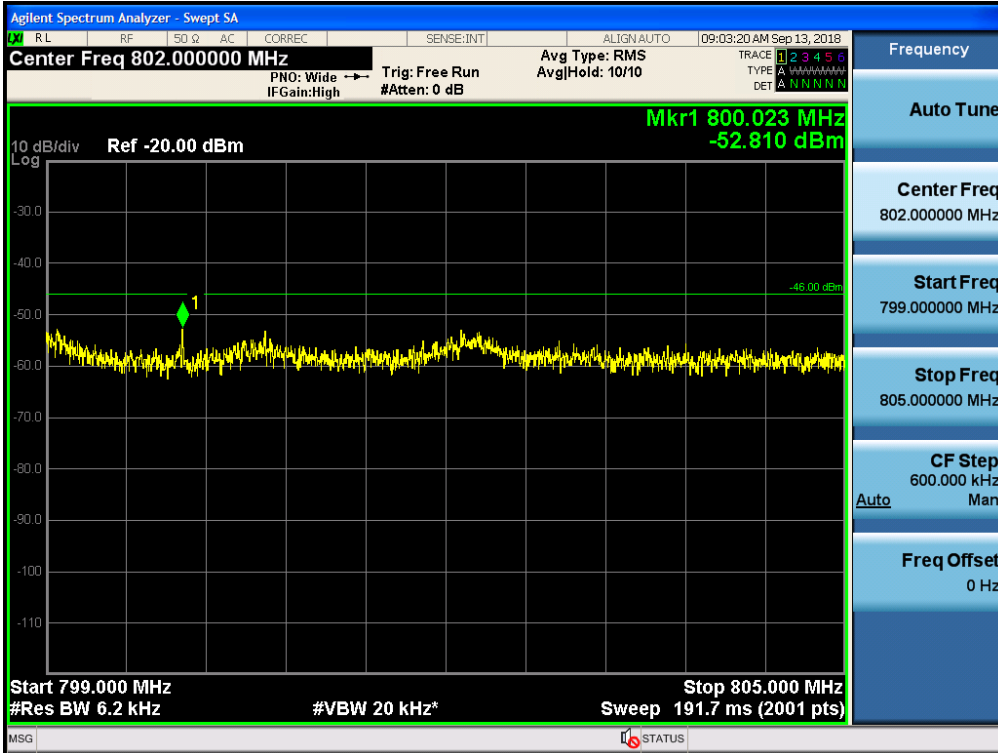

Spurious Emissions (799 ~ 805 MHz) / PS Broadband / Downlink

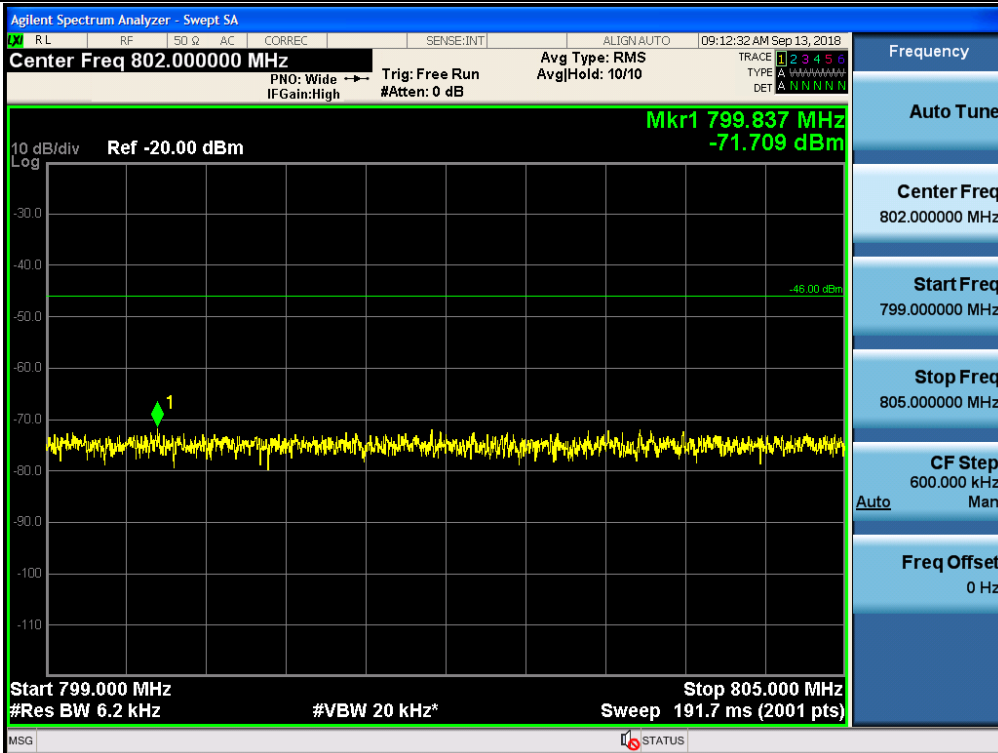

## 12. RADIATED SPURIOUS EMISSIONS

### FCC Rules

#### Test Requirements:

#### § 2.1053 Measurements required: Field strength of spurious radiation.

(a) Measurements shall be made to detect spurious emissions that may be radiated directly from the cabinet, control circuits, power leads, or intermediate circuit elements under normal conditions of installation and operation. Curves or equivalent data shall be supplied showing the magnitude of each harmonic and other spurious emission. For this test, single sideband, independent sideband, and controlled carrier transmitters shall be modulated under the conditions specified in paragraph (c) of §2.1049, as appropriate. For equipment operating on frequencies below 890 MHz, an open field test is normally required, with the measuring instrument antenna located in the far-field at all test frequencies. In the event it is either impractical or impossible to make open field measurements (e.g. a broadcast transmitter installed in a building) measurements will be accepted of the equipment as installed. Such measurements must be accompanied by a description of the site where the measurements were made showing the location of any possible source of reflections which might distort the field strength measurements. Information submitted shall include the relative radiated power of each spurious emission with reference to the rated power output of the transmitter, assuming all emissions are radiated from halfwave dipole antennas.

(b) The measurements specified in paragraph (a) of this section shall be made for the following equipment:

- (1) Those in which the spurious emissions are required to be 60 dB or more below the mean power of the transmitter.
- (2) All equipment operating on frequencies higher than 25 MHz.
- (3) All equipment where the antenna is an integral part of, and attached directly to the transmitter.
- (4) Other types of equipment as required, when deemed necessary by the Commission.

**Test Procedures:**

Because KDB 935210 D05 procedure does not provide this requirement, measurements were in accordance with the test methods section 5.5 of ANSI C63.26-2015

- a) Place the EUT in the center of the turntable. The EUT shall be configured to transmit into the standard non-radiating load (for measuring radiated spurious emissions), connected with cables of minimal length unless specified otherwise. If the EUT uses an adjustable antenna, the antenna shall be positioned to the length that produces the worst case emission at the fundamental operating frequency.
- b) Each emission under consideration shall be evaluated:
  - 1) Raise and lower the measurement antenna in accordance 5.5.2, as necessary to enable detection of the maximum emission amplitude relative to measurement antenna height.
  - 2) Rotate the EUT through 360° to determine the maximum emission level relative to the axial position.
  - 3) Return the turntable to the azimuth where the highest emission amplitude level was observed.
  - 4) Vary the measurement antenna height again through 1 m to 4 m again to find the height associated with the maximum emission amplitude.
  - 5) Record the measured emission amplitude level and frequency using the appropriate RBW.
- c) Repeat step b) for each emission frequency with the measurement antenna oriented in both the horizontal and vertical polarizations to determine the orientation that gives the maximum emissions amplitude.

**Test Result:**

Ch.	Frequency (MHz)	Measured Level (dBuV/m)	Measured Power (dBm)	Ant. Factor (dB/m)	C.L (dB)	A.G. (dB)	D.F. (dB)	Pol.	Result (dBm)
No Critical Peaks Found									

\* C.L.: Cable Loss / A.G.: Ant. Gain / D.F.: Distance Factor (3.75 m)

### 13. Annex A\_EUT AND TEST SETUP PHOTO

Please refer to test setup photo file no. as follows;

No.	Description
1	HCT-RF-1809-FC080-P