

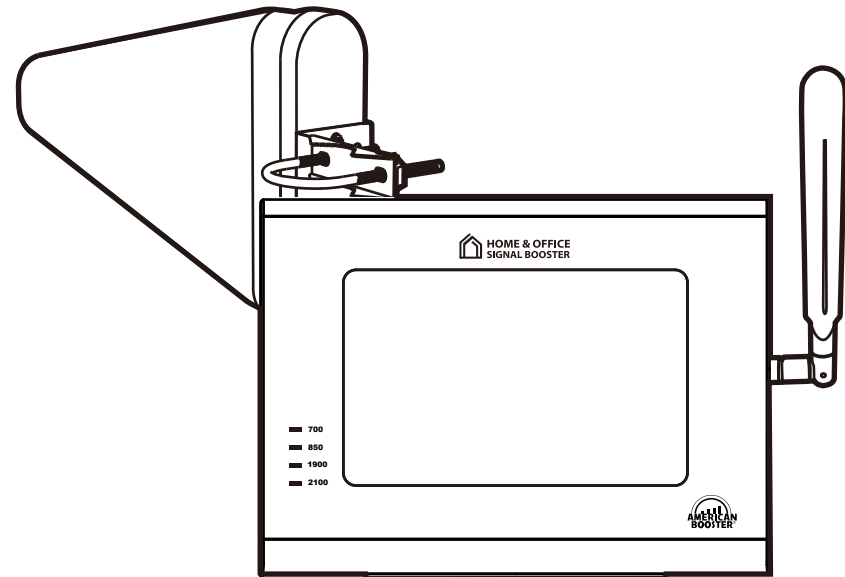

HOME 3000 User Guide

www.americanbst.com
Technical Support : 913 469 6699



HOME Cellular Signal Booster

This publication provides instructions for installing **Cellular Signal Booster Home 3000**.

Copyright© 2019, American Booster Inc.
All Rights Reserved.

Revision History

Date	Version	Changes
2019, January	Version 1.0	Original

.....

.....

.....

.....

.....

.....

.....

.....

.....

.....

.....

.....

.....

.....

.....

.....

.....

.....

.....

.....

.....

.....

.....

Certification
This equipment complies with the FCC / IC directives.

.....

.....

.....

.....

.....

.....

.....

.....

.....

.....

.....

.....

.....

.....

.....

.....

.....

.....

.....

.....

.....

.....

.....

INDEX

Product Introduction	4
Package Contents	5
Application Example	6
Installation Guide	7
STEP 1. Find the Strongest Signal	8
STEP 2. Install the Outside Antenna	8
STEP 3. Run the Antenna Cable	10
STEP 4. Run the Cable to the Booster	12
STEP 5. Install the Signal Booster	13
LED Indicators	15
Troubleshooting	16
Specifications	17
Safety Guidelines	18
FCC Warning Statements	19
IC Warning Statements	20
Warranty	21
Memo	22

HOME 3000

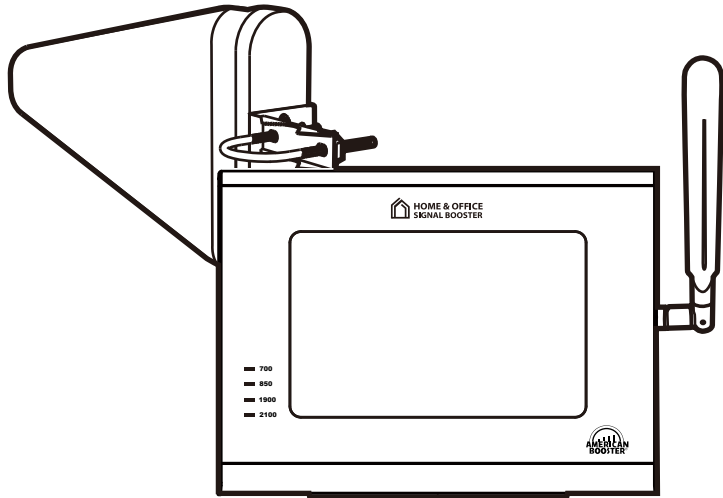

American Booster® Home 3000 has been designed to provide an advanced solution for boosting your signal and increasing the cellular data speeds in your house or office.

WARRANTY

Opening or tampering with the Signal Booster will void all warranties.

American Booster provides a 2-year warranty with all of its equipment.

Every product of American Booster is guaranteed to be free of material defects or component malfunctions.

This warranty does not cover any Signal Boosters that have been exposed to any misuse, abuse, physical damage or inadequate maintenance.

Products returned by customers must be in their original, unmodified condition, shipped in the original packaging with proof of purchase documentation enclosed, and a Return Merchandise Authorization (RMA) number printed on the outside of the shipping box.

To repair or replace damaged Signal Boosters we may include refurbished American Booster's products.

How it works

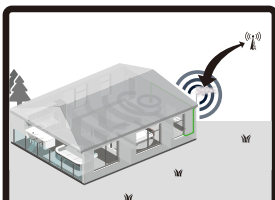

Receives Signal

The signal booster's outside antenna receives voice and data signals from a nearby cell tower.

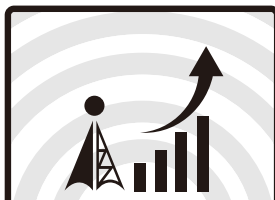

Boosts Signal

The signal booster receives the signal from the outside antenna and amplifies the voice and data signals.

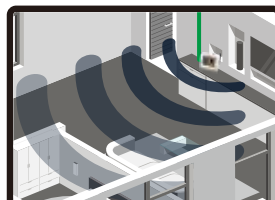

Distributes Signal

The boosted signals are distributed inside your house/office.



130 E Covey Run, Union, WA 98592

Technical Support : 913 469 6699

www.americanbst.com

⚠ IC Warning Statements

RSS-GEN, Sec. 7.1.2 – (transmitters)

Under Industry Canada regulations, this radio transmitter may only operate using an antenna of a type and maximum (or lesser) gain approved for the transmitter by Industry Canada. To reduce potential radio interference to other users, the antenna type and its gain should be so chosen that the equivalent isotropically radiated power (e.i.r.p.) is not more than that necessary for successful communication.

Conformément à la réglementation d'Industrie Canada, le présent émetteur radio peut fonctionner avec une antenne d'un type et d'un gain maximal (ou inférieur) approuvé pour l'émetteur par Industrie Canada.

Dans le but de réduire les risques de brouillage radioélectrique à l'intention des autres utilisateurs, il faut choisir le type d'antenne et son gain de sorte que la puissance isotrope rayonnée équivalente (p.i.r.e.) ne dépasse pas l'intensité nécessaire à l'établissement d'une communication satisfaisante.

RSS-GEN, Sec. 7.1.2 – (detachable antennas)

This radio transmitter (identify the device by certification number, or model number if Category II) has been approved by Industry Canada to operate with the antenna types listed below with the maximum permissible gain and required antenna impedance for each antenna type indicated. Antenna types not included in this list, having a gain greater than the maximum gain indicated for that type, are strictly prohibited for use with this device.

Le présent émetteur radio (identifier le dispositif par son numéro de certification ou son numéro de modèle s'il fait partie du matériel de catégorie I) a été approuvé par Industrie Canada pour fonctionner avec les types d'antenne énumérés ci-dessous et ayant un gain admissible maximal et l'impédance requise pour chaque type d'antenne. Les types d'antenne non inclus dans cette liste, ou dont le gain est supérieur au gain maximal indiqué, sont strictement interdits pour l'exploitation de l'émetteur.

RF Radiation Exposure

This equipment complies with RF radiation exposure limits set forth for an uncontrolled environment. This equipment should be installed and operated with a minimum distance of UL : 40cm, DL : 20cm between the radiator and your body. This transmitter must not be co-located or operating in conjunction with any other antenna or transmitter. RF exposure will be addressed at time of installation and the use of higher gain antennas require larger separation distances.

RSS-102 RF Exposure

L'antenne (ou les antennes) doit être installée de façon à maintenir à tout instant une distance minimum de au moins UL : 40cm, DL : 20cm entre la source de radiation (l'antenne) et toute personne physique. Cet appareil ne doit pas être installé ou utilisé en conjonction avec une autre antenne ou émetteur.

📦 Package Contents

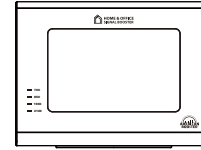

Signal Booster
Code No. : 0182

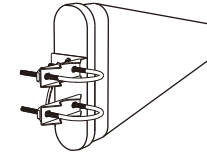

Outside Antenna Kit
Code No. : 83615



Bar Antenna
Code No. : 837K3

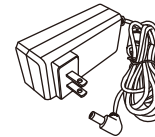

AC/DC Adaptor
Code No. : 835U3

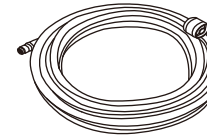

5D-FB Cable, 40 ft.
(N-SMA)
Outside Coaxial Cable
Code No. : 8384S

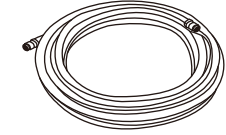

5D-FB Cable, 20 ft.
(SMA-SMA)
Outside Coaxial Cable
Code No. : 837K2

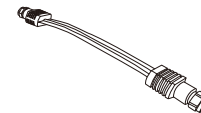

Window Flat Cable, 1ft.
(SMA-SMA)
Code No. : 837K1

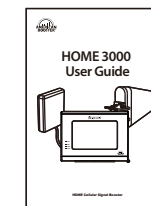

User Guide

Application Example

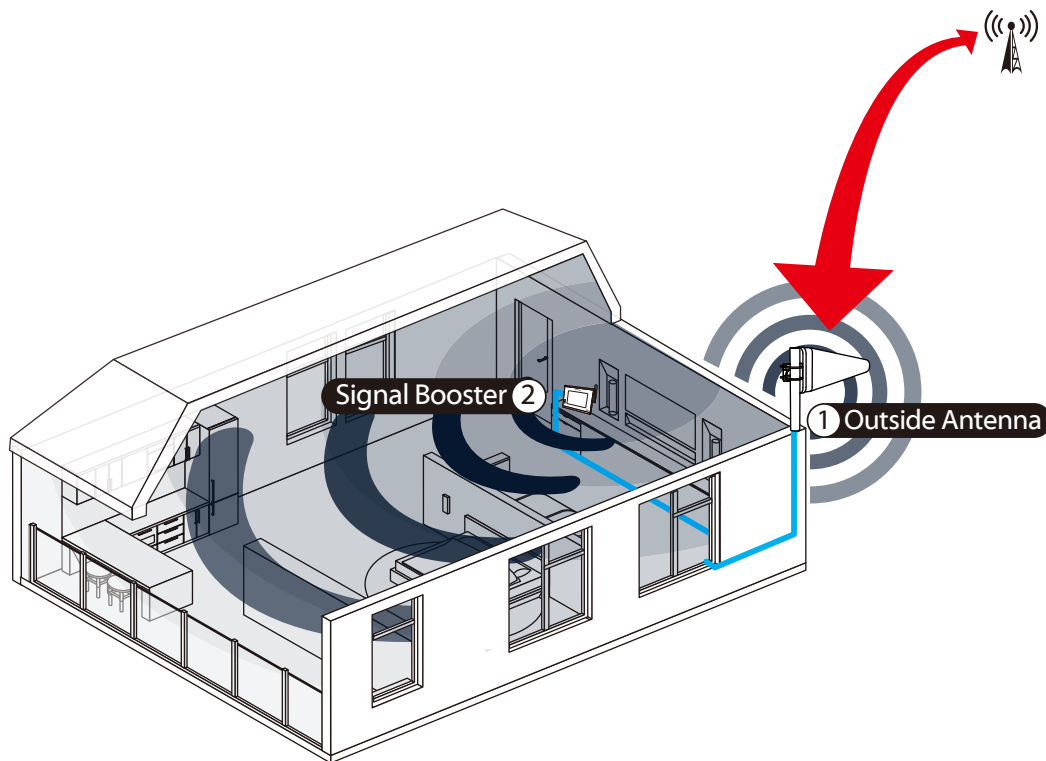

⚠ FCC Warning Statements

FCC Part 15.105 statement Class B

This equipment has been tested and found to comply with the limits for a Class B digital device, pursuant to part 15 of the FCC Rules. These limits are designed to provide reasonable protection against harmful interference in a residential installation. This equipment generates, uses and can radiate radio frequency energy and, if not installed and used in accordance with the instructions, may cause harmful interference to radio communications. However, there is no guarantee that interference will not occur in a particular installation. If this equipment does cause harmful interference to radio or television reception, which can be determined by turning the equipment off and on, the user is encouraged to try to correct the interference by one or more of the following measures:

- Reorient or relocate the receiving antenna.
- Increase the separation between the equipment and receiver.
- Connect the equipment into an outlet on a circuit different from that to which the receiver is connected.
- Consult the dealer or an experienced radio/TV technician for help.

FCC Part 15.21 statement

Any changes or modifications not expressly approved by the party responsible for compliance could void the user's authority to operate this equipment.

RF Exposure Statement

The antenna(s) must be installed such that a minimum separation distance of at least UL : 40cm, DL : 20cm is maintained between the radiator (antenna) and all persons at all times. This device must not be co-located or operating in conjunction with any other antenna or transmitter.

Use of unauthorized antennas, cables, and/or coupling devices not conforming with ERP/EIRP and/or indoor-only restrictions is prohibited.

⚠ Safety Guidelines

WARNING

ELECTRIC SHOCK

Opening the Signal Booster could result in electric shock and may cause severe injury.

DAMAGE TO EQUIPMENT

Use only the power supply provided in this package.

Operating the Signal Booster with antennas in very close proximity facing each other could lead to a severe damage to the Signal Booster.

The installation height of the antenna for AWS band (1700/2100 MHz) operations is limited to 10 meters above ground for compliance with Section 27.50

CAUTION

**THE SIGNAL BOOSTER SHOULD BE INSTALLED AS CLOSE AS POSSIBLE TO THE POWER SOURCE.
THIS REPEATER IS FOR INDOOR USE ONLY AND SHOULD BE INSTALLED INSIDE OF THE HOUSE.**

FCC ID : U88-HOME3000 IC : 8137A-HOME3000 MODEL : HOME 3000

This is a CONSUMER device

This device complies with Part 15 of the FCC Rules. Operation is subject to the following two conditions: (1) this device may not cause harmful interference, and (2) this device must accept any interference received, including interference that may cause undesired operation.

BEFORE USE, you **MUST REGISTER THIS DEVICE** with your wireless provider and have your provider's consent. Most wireless providers consent to the use of signal boosters. Some providers may not consent to the use of this device on their network. If you are unsure, contact your provider. In Canada, **BEFORE USE** you must meet all requirements set out in ISED CPC-2-1-05. You **MUST** operate this device with approved antennas and cables as specified by the manufacturer. Antennas **MUST** be installed at least UL : 40cm, DL : 20cm from (i.e. **MUST NOT** be installed within UL : 40cm, DL : 20cm of) any person. You **MUST** cease operating this device immediately if requested by the FCC (or ISED in Canada) or a licensed wireless service provider.

WARNING. E911 location information may not be provided or may be inaccurate for calls served by using this device. This device may be operated **ONLY** in a fixed location (i.e. may operate in a fixed location only) for in-building use.

For more information on registering your signal booster with your wireless provider, please see below

<https://www.sprint.com/en/legal/signal-boosters.html?id16=signal%20booster>

<https://support.t-mobile.com/docs/DOC-9827>

<https://www.verizonwireless.com/solutions-and-services/accessories/register-signal-booster/>

<https://securec45.securewebsession.com/attsignalbooster.com/>

<https://www.uscellular.com/uscellular/support/fcc-booster-registration.jsp>

👉 Installation Guide

STEP 1. Find the Strongest Signal

1-1. Using an iPhone®

Dial *3001#12345#*, then press Call.

1-2. Using an Android™

Download the 'Network Signal info' from the Google Play store.

After installing, you will be able to view your dB strength.

1-3. Using a Meter

If you have a meter that detects and displays the current signal levels, you can use it.

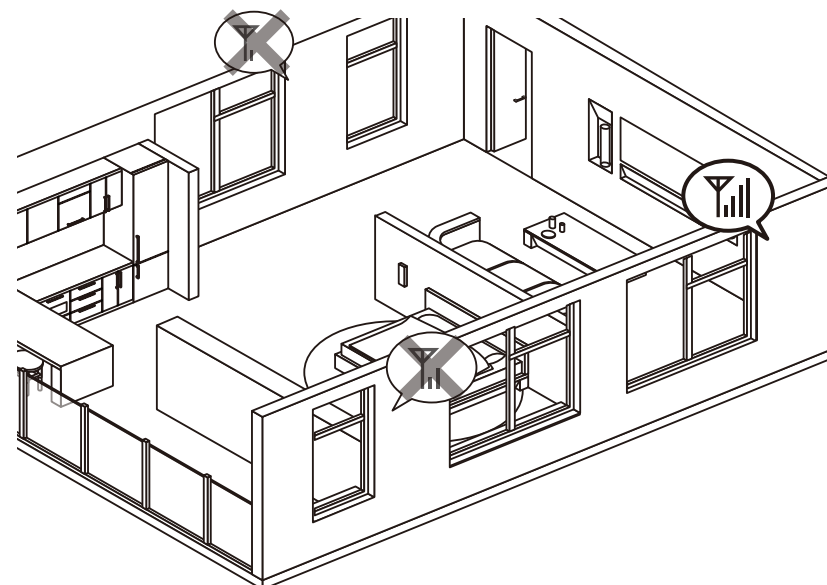
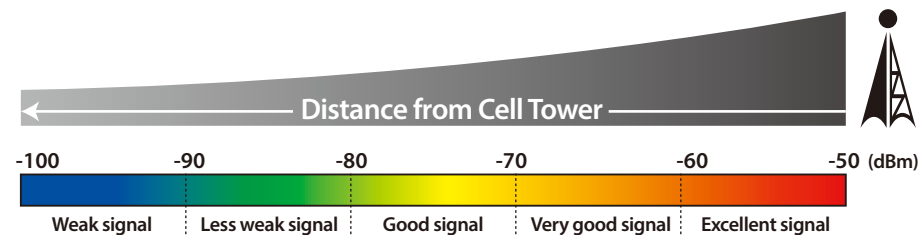

Specifications

STEP 1. Find the Strongest Signal

Note The stronger signal you receive from the base station, the better coverage you will have inside your house/office.

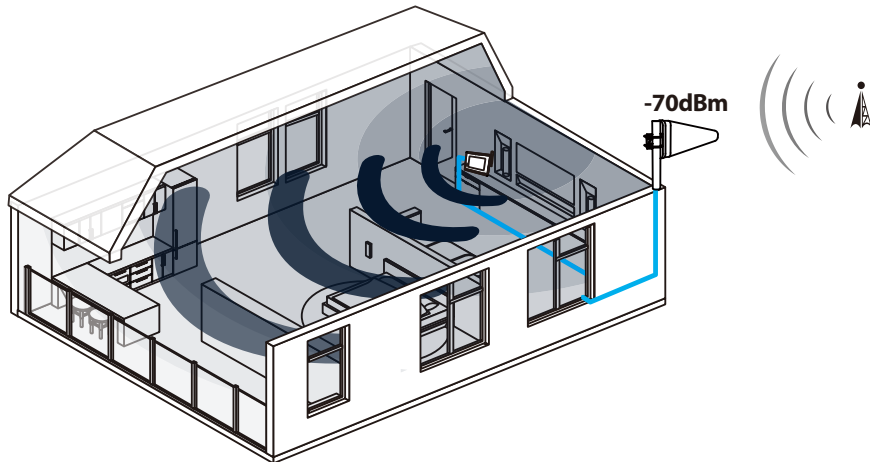

If you have -70dBm outside signal, then you will have an excellent signal inside your house or office.

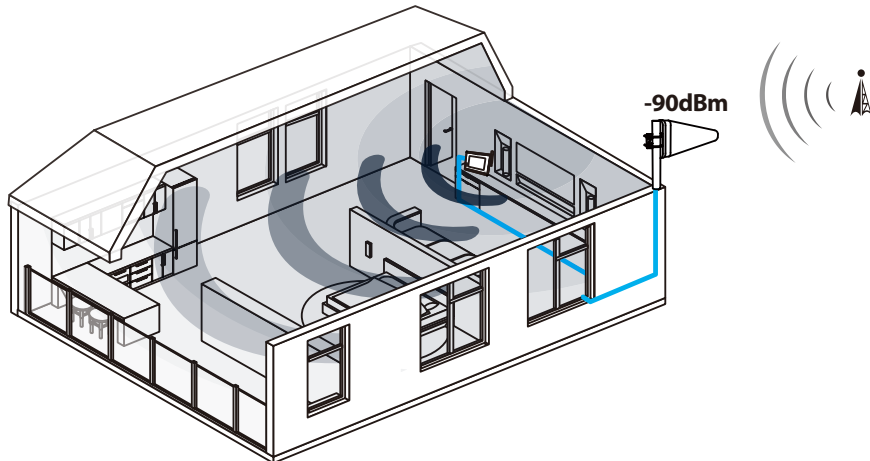

If you have -90dBm outside signal, then you will have a good signal inside your house & office.

Parameter	Downlink	Uplink	Remark
700MHz LTE	734~757MHz	704~716MHz	Band 17 & 13
		776~787MHz	Band 17
850MHz Cellular	869~894MHz	824~849MHz	Band 5
1900MHz PCS	1930~1990MHz	1850~1910MHz	Band 25
2100MHz AWS	2110~2155MHz	1700~1755MHz	Band 4
Output Power	5dBm	23dBm	Per Band
Maximum Gain	60dB		
Noise Figure	5dB nominal		
Impedance	50 Ohm		
RF Connector	SMA Female		
Power Connector	DC Jack(DC-045B)		
Power	DC 12V/3A Adaptor		
Size, inch	7.68" x 5.71" x 1.83"		W x H x D
Weight, lbs	< 1.98		
Operation Temperature	23 ~ 122°F (-5°C ~ +50°C)		
Humidity	0 ~ 80%		

For a detected oscillation, the device output will turn off within 300 ms for the Uplink and 1 second for the Downlink and remained off for 1 minute. And, the device will have a maximum of 5 attempts at restart from oscillation before permanently shutting off. Noise power, gain, and linearity are maintained by the device's microprocessor.

Instructions to fix flashing or solid red.

If you have a good voice signal and fast data speeds even though one or two of LEDs are solid red, you may continue to use the Signal Booster as it is. However, if one of the LED's has flashing or solid red, your voice signal is weak and data speeds are low. Then follow the troubleshooting steps below.

1. Unplug the Signal Booster's power adapter.
2. Check if the outside antenna and Home 3000 signal booster are located a minimum distance of 20 feet from each other.
3. Plug the Signal Booster into a power source.
4. Check the LED on the Signal Booster. If one or two of the LEDs are still flashing or solid red, then try moving the signal booster further away from the outside antenna and repeat steps 1 through 3 to see if the additional distance resolves the problem.
5. If you have any difficulties with installation or troubleshooting the Signal Booster, please contact our technical support team for assistance (Tel : 913-469-6699).

LED's Off

1. If none of the LEDs on the Home 3000 Signal booster are lit, verify that the signal booster is connected properly to the AC/DC power adapter cord and then verify that the power adapter is plugged into a live AC outlet in the house.
2. Check if there is any damage in the power cable.
3. Check if there is any damage in the Signal Booster's connector.

STEP 2. Install the Outside Antenna

The outside antenna is shaped like a triangle. This antenna must be mounted as high as possible on the exterior of the house or office, but never higher than 10m above the ground. Mount the outside antenna on the side of the house where you detected the strongest cell phone signal. The point of the antenna triangle should be pointed towards the location of the strongest cell phone signal (which should also be the direction of the closest cell tower) and away from the expected placement of the signal booster.

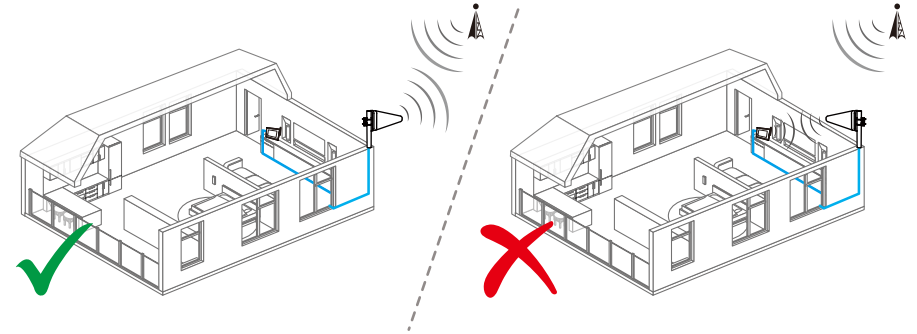

Separation Between Outside Antenna and Signal Booster

For the best performance, the outside antenna and the signal booster should be a minimum distance of 20 ft. apart from each other. A bigger separation between outside antenna and signal booster will provide a stronger signal and better coverage.

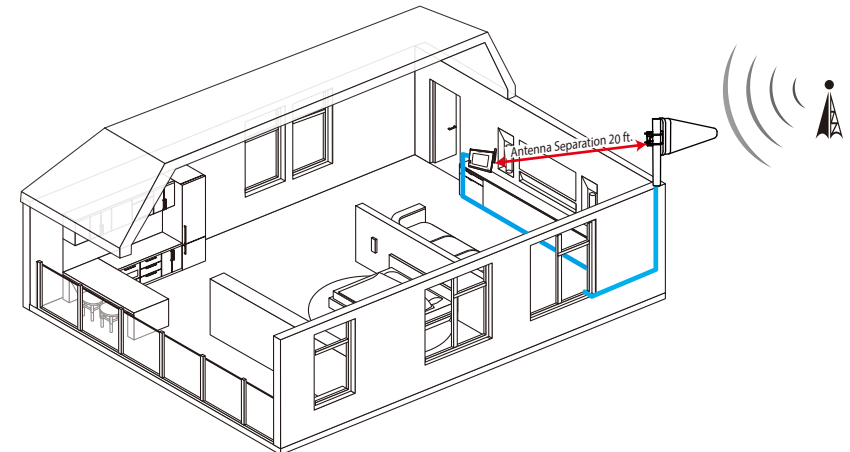



LED Indicators

STEP 2. Install the Outside Antenna

Install the outside antenna in a location where you can receive the strongest signal according to the instructions described in STEP 1. Make sure outside antenna is installed with the point of the triangle facing toward the cell tower.

1

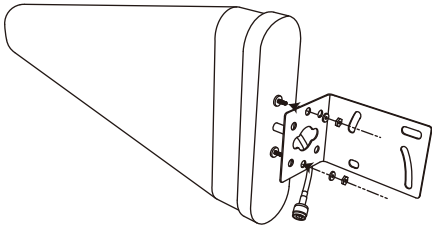

2

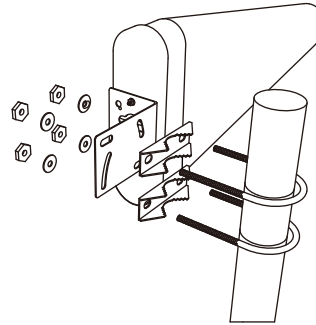

3

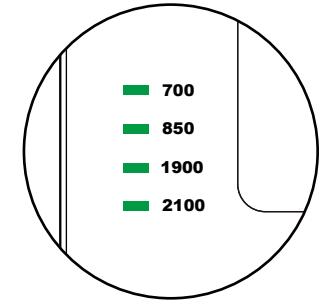
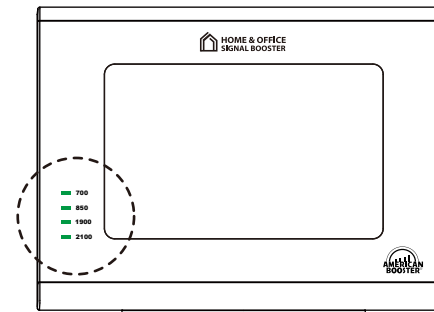
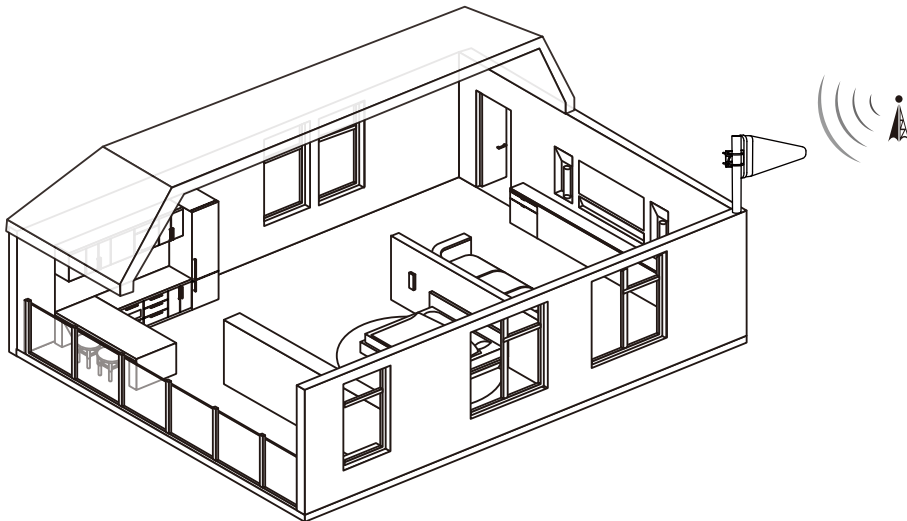

Flashing Green

After the Signal Booster is powered on, flashing green will last for 20 seconds.

It means that the Signal Booster is being set up for optimal performance.

The Signal Booster will need a few minutes to adapt to the network environment and start boosting the signal at the highest power.

The Signal Booster provides a real-time self-diagnosis, so in case of flashing or solid red, refer to the Troubleshooting instructions on the next page.

Solid Green

This indicates that the Signal Booster has been installed and works properly.

Solid Orange

If one or more LEDs are solid orange, it means that the input signal from the nearby cell tower is between -25dBm and -30dBm (very strong). In this event, we recommend that you reposition the outside antenna to point in a different direction to weaken the signal. If the rest of the LEDs are green and you have a strong signal and fast data speeds on your cell phone, then troubleshooting is not needed.

Flashing & Solid Red

If one or more of the LEDs is flashing or solid red, this indicates that the input signal from the nearby cell tower is too strong.

After flashing red for 10 seconds the solid red will appear.

Signal Booster will stop amplifying signals of the frequency with a solid red indicator automatically to prevent the Booster from any damage.

If the rest of LEDs are green and you have a strong signal and fast data speeds on your cell phone or tablet, then troubleshooting is not needed.

STEP 5. Install the Signal Booster

Home 3000 has a 360° directional bar antenna. It means you can put the booster on the table or floor or any other place you would like to. Home 3000 can also be attached to the wall, using provided wall-mount brackets.

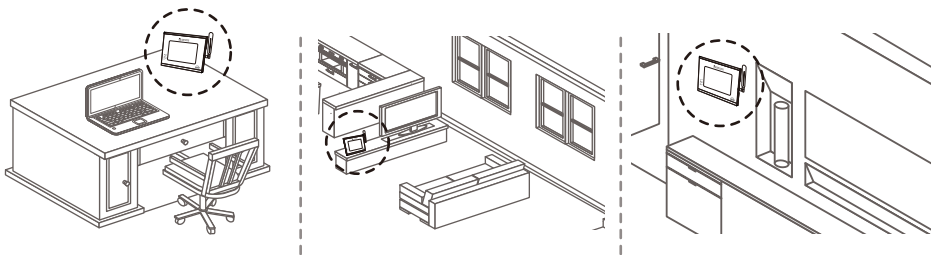
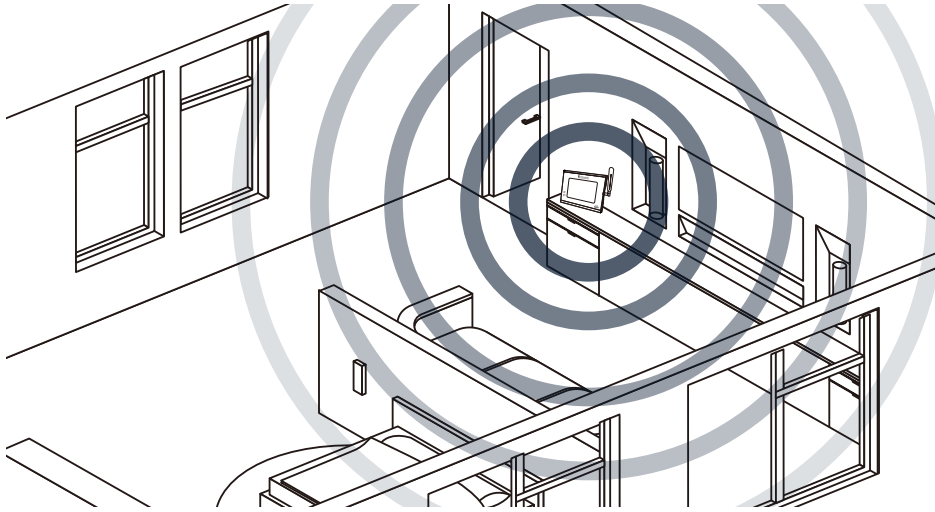

STEP 3. Run the Outside Antenna Cable

Connect the outside N-SMA cable with the yagi antenna. Then, connect the window flat cable with the outside cable.

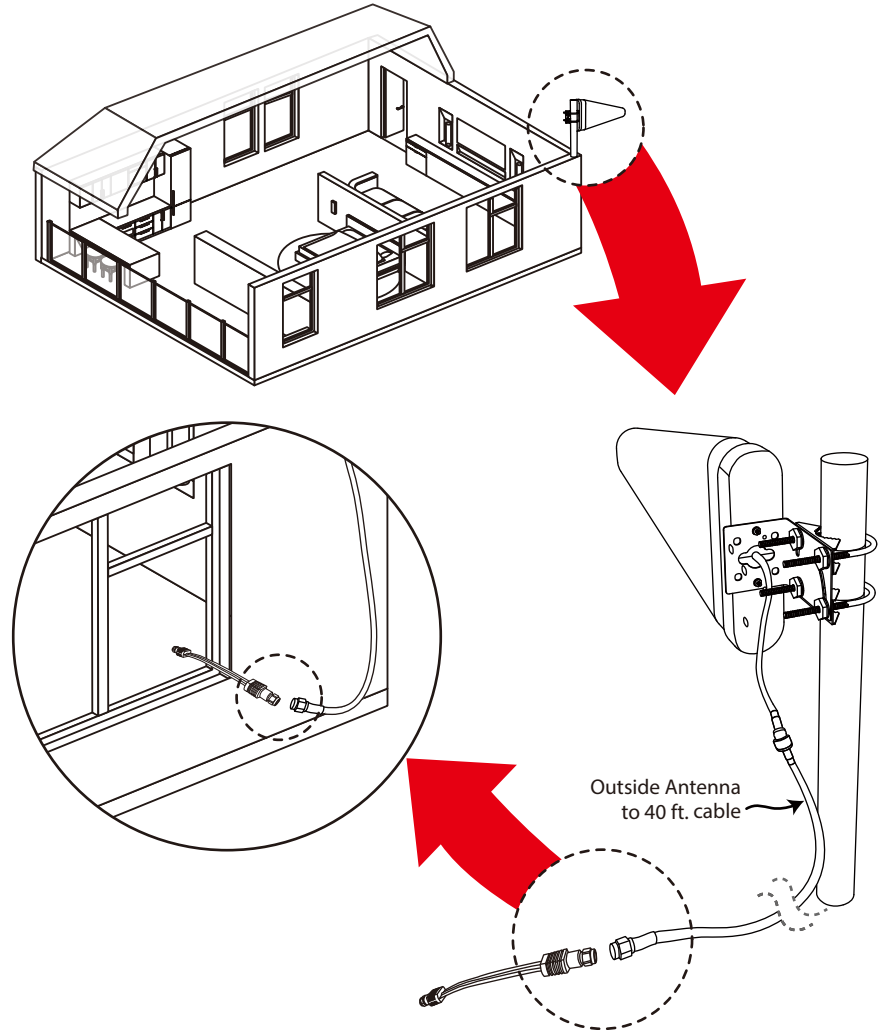

STEP 4. Run the Cable to the Booster

Connect the cable from the booster to the window flat cable.

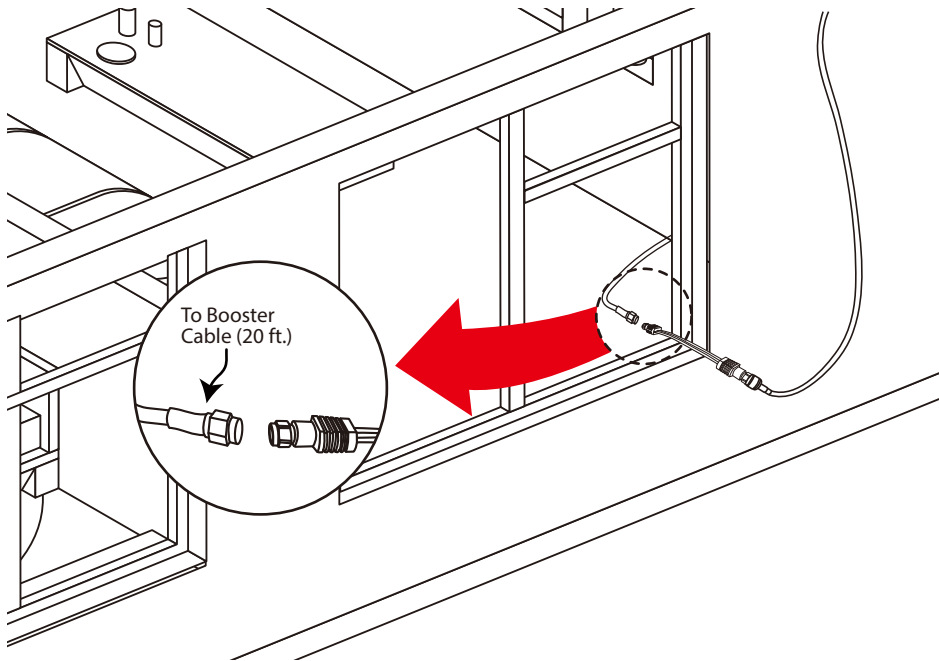

HOME 3000 Cable Line

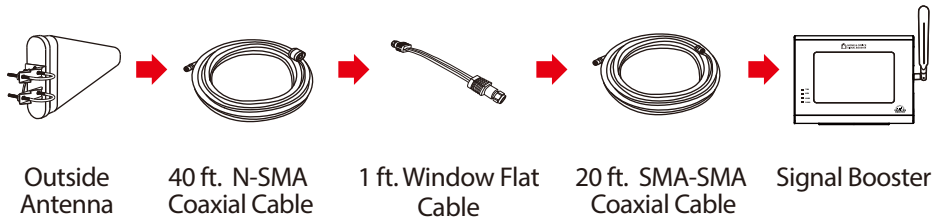

STEP 5. Install the Signal Booster

Choose a location for the signal booster, preferably away from excessive heat, direct sunlight, moisture and free from high temperatures. Do not place the signal booster in an air-tight enclosure. Attic installations may expose the booster to high heat.



Note The Booster should be installed a minimum distance of 20 ft. from the outside antenna.

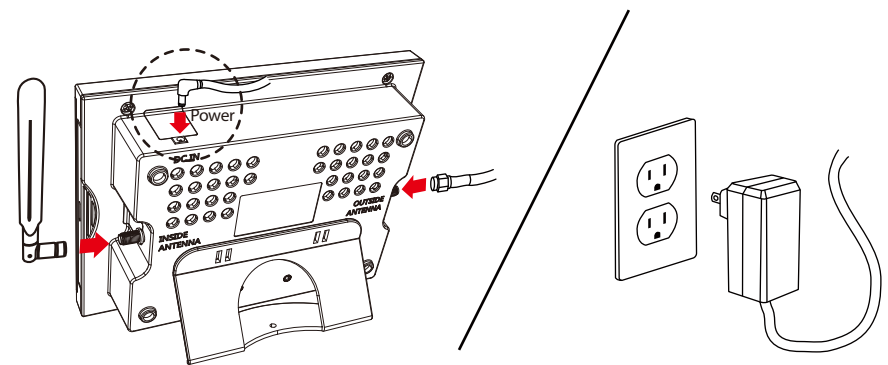

▲ Signal Booster's Back View

Connect the Bar antenna to the 'Inside Antenna' port. Connect the AC/DC power adaptor to the booster and plug into a power source. The power LED will light, indicating that the signal booster is ready for use.