

# FCC Test Report

**FCC ID** : U72OLYM  
**Equipment** : Olympus WiFi Module  
**Model No.** : OLYM  
**Brand Name** : Carestream  
**Applicant** : Carestream Health, Inc.  
**Address** : 150 Verona Street, Rochester, New York  
United States 14608  
**Standard** : 47 CFR FCC Part 15.247  
**Received Date** : Nov. 12, 2018  
**Tested Date** : Nov. 22 ~ Dec. 11, 2018

We, International Certification Corp., would like to declare that the tested sample has been evaluated and in compliance with the requirement of the above standards. The test results contained in this report refer exclusively to the product. It may be duplicated completely for legal use with the approval of the applicant. It shall not be reproduced except in full without the written approval of our laboratory.

Reviewed by:



Along Chen / Assistant Manager

Approved by:



Gary Chang / Manager



---

## Table of Contents

|          |   |           |
|----------|---|-----------|
| <b>1</b> | <b>GENERAL DESCRIPTION .....</b>                            | <b>5</b>  |
| 1.1      | Information.....  | 5         |
| 1.2      | Local Support Equipment List .....                          | 8         |
| 1.3      | Test Setup Chart .....                                      | 8         |
| 1.4      | The Equipment List .....                                    | 9         |
| 1.5      | Test Standards .....  | 10        |
| 1.6      | Deviation from Test Standard and Measurement Procedure..... | 10        |
| 1.7      | Measurement Uncertainty .....                               | 10        |
| <b>2</b> | <b>TEST CONFIGURATION .....</b>                             | <b>11</b> |
| 2.1      | Testing Condition .....                                     | 11        |
| 2.2      | The Worst Test Modes and Channel Details .....              | 11        |
| <b>3</b> | <b>TRANSMITTER TEST RESULTS.....</b>                        | <b>12</b> |
| 3.1      | Conducted Emissions.....                                    | 12        |
| 3.2      | 6dB and Occupied Bandwidth .....                            | 15        |
| 3.3      | RF Output Power.....  | 21        |
| 3.4      | Power Spectral Density .....                                | 24        |
| 3.5      | Unwanted Emissions into Restricted Frequency Bands .....    | 30        |
| 3.6      | Emissions in Non-Restricted Frequency Bands.....            | 58        |
| <b>4</b> | <b>TEST LABORATORY INFORMATION .....</b>                    | <b>63</b> |

---

## Release Record

| Report No. | Version | Description   | Issued Date   |
|------------|---------|---------------|---------------|
| FR8N1203AC | Rev. 01 | Initial issue | Feb. 20, 2019 |

## Summary of Test Results

| FCC Rules           | Test Items             | Measured  | Result |
|---------------------|------------------------|---|--------|
| 15.207              | Conducted Emissions    | [dBuV]: 0.360MHz<br>36.70 (Margin -12.04dB) - AV          | Pass   |
| 15.247(d)<br>15.209 | Radiated Emissions     | [dBuV/m at 3m]: 2483.50MHz<br>73.00 (Margin -1.00dB) - PK | Pass   |
| 15.247(b)(3)        | Maximum Output Power   | Max Power [dBm]: 25.54                                    | Pass   |
| 15.247(a)(2)        | 6dB Bandwidth          | Meet the requirement of limit                             | Pass   |
| 15.247(e)           | Power Spectral Density | Meet the requirement of limit                             | Pass   |
| 15.203              | Antenna Requirement    | Meet the requirement of limit                             | Pass   |

### Declaration of Conformity:

The test results with all measurement uncertainty excluded are presented in accordance with the regulation limits or requirements declared by manufacturers.

### Comments and Explanations:

The declared values of gain for EUT presented in the report are provided by the manufacturer, and the manufacturer takes all the responsibilities for the accuracy of the gain.

# 1 General Description

## 1.1 Information

### 1.1.1 Specification of the Equipment under Test (EUT)

| RF General Information |                  |                 |                |                                    |                 |
|------------------------|------------------|-----------------|----------------|------------------------------------|-----------------|
| Frequency Range (MHz)  | IEEE Std. 802.11 | Ch. Freq. (MHz) | Channel Number | Transmit Chains (N <sub>TX</sub> ) | Data Rate / MCS |
| 2400-2483.5            | b                | 2412-2462       | 1-11 [11]      | 2                                  | 1-11 Mbps       |
| 2400-2483.5            | g                | 2412-2462       | 1-11 [11]      | 2                                  | 6-54 Mbps       |
| 2400-2483.5            | n (HT20)         | 2412-2462       | 1-11 [11]      | 2                                  | MCS 0-15        |
| 2400-2483.5            | n (HT40)         | 2422-2452       | 3-9 [7]        | 2                                  | MCS 0-15        |

Note 1: RF output power specifies that Maximum Peak Conducted Output Power.  
 Note 2: 802.11b uses a combination of DSSS-DBPSK, DQPSK, CCK modulation.  
 Note 3: 802.11g/n uses a combination of OFDM-BPSK, QPSK, 16QAM, 64QAM modulation.

### 1.1.2 Antenna Details

| Ant. No. | Model                 | Type | Connector | Operating Frequencies (MHz) / Antenna Gain (dBi) |           |           |
|----------|-----------------------|------|-----------|--|-----------|-----------|
|          |                       |      |           | 2400~2483.5                                      | 5150~5250 | 5725~5850 |
| 1        | ANTX600P00<br>1B24553 | PCB  | ipex      | 4.6  | 4.9       | 5.1       |
| 2        | ANTX350P00<br>1B24553 | PCB  | ipex      | 4.6  | 4.9       | 5.1       |

### 1.1.3 Power Supply Type of Equipment under Test (EUT)

|                   |        |
|-------------------|--------|
| Power Supply Type | 3.3Vdc |
|-------------------|--------|

### 1.1.4 Accessories

N/A

### 1.1.5 Channel List

| Frequency band (MHz)  |                | 2400~2483.5  |                |
|-----------------------|----------------|--------------|----------------|
| 802.11 b / g / n HT20 |                | 802.11n HT40 |                |
| Channel               | Frequency(MHz) | Channel      | Frequency(MHz) |
| 1                     | 2412           | 3            | 2422           |
| 2                     | 2417           | 4            | 2427           |
| 3                     | 2422           | 5            | 2432           |
| 4                     | 2427           | 6            | 2437           |
| 5                     | 2432           | 7            | 2442           |
| 6                     | 2437           | 8            | 2447           |
| 7                     | 2442           | 9            | 2452           |
| 8                     | 2447           | ---          | ---            |
| 9                     | 2452           | ---          | ---            |
| 10                    | 2457           | ---          | ---            |
| 11                    | 2462           | ---          | ---            |

### 1.1.6 Test Tool and Duty Cycle

| Test Tool                  | MP_Kit_RTL11ac_8822BU_USB, v0.54 |                |                  |
|----------------------------|----------------------------------|----------------|------------------|
| Duty Cycle and Duty Factor | Mode                             | Duty Cycle (%) | Duty Factor (dB) |
|                            | 11b                              | 100.00%        | 0.00             |
|                            | 11g                              | 97.54%         | 0.11             |
|                            | HT20                             | 96.94%         | 0.13             |
|                            | HT40                             | 93.25%         | 0.30             |

### 1.1.7 Power Index of Test Tool

| Modulation Mode | Test Frequency (MHz) | Power Index |
|-----------------|----------------------|-------------|
| 11b             | 2412                 | 62/60       |
| 11b             | 2437                 | 62/61       |
| 11b             | 2462                 | 62/62       |
| 11g             | 2412                 | 55/54       |
| 11g             | 2437                 | 63/62       |
| 11g             | 2462                 | 58/58       |
| HT20            | 2412                 | 53/52       |
| HT20            | 2437                 | 63/63       |
| HT20            | 2462                 | 57/57       |
| HT40            | 2422                 | 47/46       |
| HT40            | 2437                 | 55/55       |
| HT40            | 2452                 | 50/50       |

## 1.2 Local Support Equipment List

| Support Equipment List |           |       |                |        |         |
|------------------------|-----------|-------|----------------|--------|---------|
| No.                    | Equipment | Brand | Model          | FCC ID | Remarks |
| 1                      | Notebook  | DELL  | Latitude E5470 | DoC    | ---     |

## 1.3 Test Setup Chart

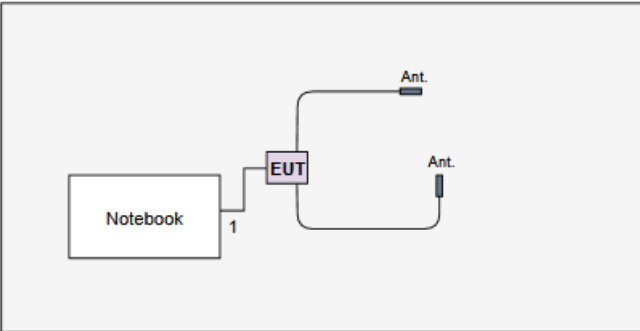
| Test Setup Diagram  |                           |
|---|---------------------------|
|  |                           |
| No.   | Signal cable / Length (m) |
| 1   | USB, 0.36m non-shielded.  |



## 1.4 The Equipment List

| Test Item            | Conducted Emission            |                      |            |                  |                   |
|----------------------|-------------------------------|----------------------|------------|------------------|-------------------|
| Test Site            | Conduction room 1 / (CO01-WS) |                      |            |                  |                   |
| Instrument           | Manufacturer                  | Model No.            | Serial No. | Calibration Date | Calibration Until |
| Receiver             | R&S                           | ESR3                 | 101657     | Jan. 05, 2018    | Jan. 04, 2019     |
| LISN                 | SCHWARZBECK                   | Schwarzbeck 8127     | 8127-667   | Nov. 05, 2018    | Nov. 04, 2019     |
| RF Cable-CON         | EMC                           | EMCCFD300-BM-BM-6000 | 50821      | Dec. 18, 2017    | Dec. 17, 2018     |
| Measurement Software | AUDIX                         | e3                   | 6.120210k  | NA               | NA                |

Note: Calibration Interval of instruments listed above is one year.

| Test Item            | Radiated Emission           |                   |                     |                  |                   |
|----------------------|-----------------------------|-------------------|---------------------|------------------|-------------------|
| Test Site            | 966 chamber 3 / (03CH03-WS) |                   |                     |                  |                   |
| Instrument           | Manufacturer                | Model No.         | Serial No.          | Calibration Date | Calibration Until |
| Spectrum Analyzer    | R&S                         | FSV40             | 101499              | Jan. 03, 2018    | Jan. 02, 2019     |
| Receiver             | R&S                         | ESR3              | 101657              | Jan. 05, 2018    | Jan. 04, 2019     |
| Bilog Antenna        | SCHWARZBECK                 | VULB9168          | VULB9168-685        | Apr. 19, 2018    | Apr. 18, 2019     |
| Horn Antenna 1G-18G  | SCHWARZBECK                 | BBHA 9120 D       | BBHA 9120 D 1206    | Jan. 18, 2018    | Jan. 17, 2019     |
| Horn Antenna 18G-40G | SCHWARZBECK                 | BBHA 9170         | BBHA 9170517        | Nov. 15, 2018    | Nov. 14, 2019     |
| Loop Antenna         | R&S                         | HFH2-Z2           | 100330              | Nov. 09, 2018    | Nov. 08, 2019     |
| Loop Antenna Cable   | KOAX KABEL                  | 101354-BW         | 101354-BW           | Oct. 08, 2018    | Oct. 07, 2019     |
| Preamplifier         | EMC                         | EMC02325          | 980187              | Aug. 24, 2018    | Aug. 23, 2019     |
| Preamplifier         | Agilent                     | 83017A            | MY53270014          | Aug. 09, 2018    | Aug. 08, 2019     |
| Preamplifier         | EMC                         | EMC184045B        | 980192              | Aug. 09, 2018    | Aug. 08, 2019     |
| RF cable-3M          | EMC                         | EMC104-SM-SM-8000 | 181107              | Oct. 30, 2018    | Oct. 29, 2019     |
| RF cable-8M          | HUBER+SUHNER                | SUCOFLEX104       | MY32487/4           | Oct. 30, 2018    | Oct. 29, 2019     |
| RF cable-1M          | HUBER+SUHNER                | SUCOFLEX104       | MY22624/4           | Oct. 30, 2018    | Oct. 29, 2019     |
| LF cable-0.8M        | EMC                         | EMC8D-NM-NM-800   | EMC8D-NM-NM-800-001 | Oct. 30, 2018    | Oct. 29, 2019     |
| LF cable-3M          | EMC                         | EMC8D-NM-NM-3000  | 131103              | Oct. 30, 2018    | Oct. 29, 2019     |
| LF cable-13M         | EMC                         | EMC8D-NM-NM-13000 | 131104              | Oct. 30, 2018    | Oct. 29, 2019     |
| Measurement Software | AUDIX                       | e3                | 6.120210g           | NA               | NA                |

Note: Calibration Interval of instruments listed above is one year.

|   |                     |                  |                   |                         |                          |
|---|---------------------|------------------|-------------------|-------------------------|--------------------------|
| <b>Test Item</b>  | RF Conducted        |                  |                   |                         |                          |
| <b>Test Site</b>  | (TH01-WS)           |                  |                   |                         |                          |
| <b>Instrument</b>   | <b>Manufacturer</b> | <b>Model No.</b> | <b>Serial No.</b> | <b>Calibration Date</b> | <b>Calibration Until</b> |
| Spectrum Analyzer   | R&S                 | FSV40            | 101063            | Apr. 16, 2018           | Apr. 15, 2019            |
| Power Meter   | Anritsu             | ML2495A          | 1241002           | Oct. 09, 2018           | Oct. 08, 2019            |
| Power Sensor  | Anritsu             | MA2411B          | 1207366           | Oct. 09, 2018           | Oct. 08, 2019            |
| DC POWER SOURCE   | GW INSTEK           | GPC-6030D        | EM892433          | Oct. 25, 2018           | Oct. 24, 2019            |
| Measurement Software  | Sporton             | Sporton_1        | 1.3.30            | NA                      | NA                       |
| Note: Calibration Interval of instruments listed above is one year. |                     |                  |                   |                         |                          |

## 1.5 Test Standards

According to the specification of EUT, the EUT must comply with following standards and KDB documents.

47 CFR FCC Part 15.247

ANSI C63.10-2013

FCC KDB 558074 D01 15.247 Meas Guidance v05

FCC KDB 662911 D01 Multiple Transmitter Output v02r01

## 1.6 Deviation from Test Standard and Measurement Procedure

None

## 1.7 Measurement Uncertainty

ISO/IEC 17025 requires that an estimate of the measurement uncertainties associated with the emissions test results be included in the report. The measurement uncertainties given below are based on a 95% confidence level (based on a coverage factor ( $k=2$ ))

| Measurement Uncertainty        |                 |
|--------------------------------|-----------------|
| Parameters                     | Uncertainty     |
| Bandwidth                      | $\pm 34.134$ Hz |
| Conducted power                | $\pm 0.808$ dB  |
| Power density                  | $\pm 0.463$ dB  |
| Conducted emission             | $\pm 2.670$ dB  |
| AC conducted emission          | $\pm 2.90$ dB   |
| Radiated emission $\leq 1$ GHz | $\pm 3.66$ dB   |
| Radiated emission $> 1$ GHz    | $\pm 5.37$ dB   |

## 2 Test Configuration

### 2.1 Testing Condition

| Test Item          | Test Site | Ambient Condition | Tested By                |
|--------------------|-----------|-------------------|--------------------------|
| AC Conduction      | CO01-WS   | 24°C / 59%        | Steve Chin               |
| Radiated Emissions | 03CH03-WS | 22-25°C / 62-66%  | Akun Chung<br>Aska Huang |
| RF Conducted       | TH01-WS   | 19°C / 66%        | Aska Huang               |

- FCC Designation No.: TW0009
- FCC site registration No.: 207696
- IC site registration No.: 10807C-1

### 2.2 The Worst Test Modes and Channel Details

| Test item                | Modulation Mode | Test Frequency (MHz) | Data Rate | Test Configuration |
|--------------------------|-----------------|----------------------|-----------|--------------------|
| Conducted Emissions      | HT20            | 2437                 | MCS 0     | ---                |
| Radiated Emissions ≤1GHz | HT20            | 2437                 | MCS 0     | ---                |
| Radiated Emissions >1GHz | 11b             | 2412 / 2437 / 2462   | 1 Mbps    | ---                |
| Maximum Output Power     | 11g             | 2412 / 2437 / 2462   | 6 Mbps    |                    |
| 6dB bandwidth            | HT20            | 2412 / 2437 / 2462   | MCS 0     |                    |
| Power spectral density   | HT40            | 2422 / 2437 / 2452   | MCS 0     |                    |

**NOTE:**

The EUT was pretested with 3 orientations placed on the table for the radiated emission measurement – X, Y, and Z-plane. The **Y-plane** results were found as the worst case and were shown in this report.

## 3 Transmitter Test Results

### 3.1 Conducted Emissions

#### 3.1.1 Limit of Conducted Emissions

| Conducted Emissions Limit |            |           |
|---------------------------|------------|-----------|
| Frequency Emission (MHz)  | Quasi-Peak | Average   |
| 0.15-0.5                  | 66 - 56 *  | 56 - 46 * |
| 0.5-5                     | 56         | 46        |
| 5-30                      | 60         | 50        |

Note 1: \* Decreases with the logarithm of the frequency.

#### 3.1.2 Test Procedures

1. The device is placed on a test table, raised 80 cm above the reference ground plane. The vertical conducting plane is located 40 cm to the rear of the device.
2. The device is connected to line impedance stabilization network (LISN) and other accessories are connected to other LISN. Measured levels of AC power line conducted emission are across the 50  $\Omega$  LISN port.
3. AC conducted emission measurements is made over frequency range from 150 kHz to 30 MHz.
4. This measurement was performed with AC 120V / 60Hz.

#### 3.1.3 Test Setup



Note: 1. Support units were connected to second LISN.

2. Both of LISNs (AMN) are 80 cm from EUT and at least 80 cm from other units and other metal planes

### 3.1.4 Test Result of Conducted Emissions

|                    |      |                         |      |
|--------------------|------|-------------------------|------|
| <b>Modulation</b>  | HT20 | <b>Test Freq. (MHz)</b> | 2437 |
| <b>Power Phase</b> | Line |                         |      |

  

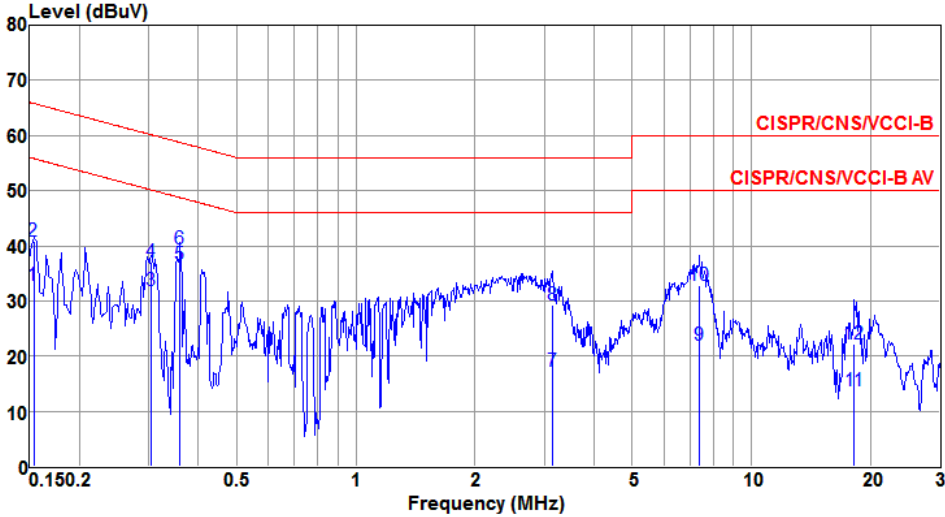

|    | Freq<br>MHz | Level<br>dBuV | Limit<br>Line<br>dBuV | Over<br>Limit<br>dB | Read<br>Level<br>dBuV | LISN<br>factor<br>dB | cable<br>loss<br>dB | Remark  |
|----|-------------|---------------|-----------------------|---------------------|-----------------------|----------------------|---------------------|---------|
| 1  | 0.153       | 32.74         | 55.82                 | -23.08              | 32.66                 | 0.07                 | 0.01                | Average |
| 2  | 0.153       | 40.92         | 65.82                 | -24.90              | 40.84                 | 0.07                 | 0.01                | QP      |
| 3  | 0.303       | 31.86         | 50.15                 | -18.29              | 31.78                 | 0.06                 | 0.02                | Average |
| 4  | 0.303       | 36.97         | 60.15                 | -23.18              | 36.89                 | 0.06                 | 0.02                | QP      |
| 5* | 0.360       | 36.70         | 48.74                 | -12.04              | 36.62                 | 0.06                 | 0.02                | Average |
| 6  | 0.360       | 39.48         | 58.74                 | -19.26              | 39.40                 | 0.06                 | 0.02                | QP      |
| 7  | 3.140       | 17.17         | 46.00                 | -28.83              | 16.89                 | 0.10                 | 0.18                | Average |
| 8  | 3.140       | 29.34         | 56.00                 | -26.66              | 29.06                 | 0.10                 | 0.18                | QP      |
| 9  | 7.407       | 21.98         | 50.00                 | -28.02              | 21.53                 | 0.16                 | 0.29                | Average |
| 10 | 7.407       | 32.71         | 60.00                 | -27.29              | 32.26                 | 0.16                 | 0.29                | QP      |
| 11 | 18.232      | 13.61         | 50.00                 | -36.39              | 13.05                 | 0.23                 | 0.33                | Average |
| 12 | 18.232      | 22.26         | 60.00                 | -37.74              | 21.70                 | 0.23                 | 0.33                | QP      |

Note 1: Level (dBuV) = Read Level (dBuV) + LISN Factor (dB) + Cable Loss (dB).  
 Note 2: Over Limit (dB) = Level (dBuV) – Limit Line (dBuV).

|                    |         |                         |      |
|--------------------|---------|-------------------------|------|
| <b>Modulation</b>  | HT20    | <b>Test Freq. (MHz)</b> | 2437 |
| <b>Power Phase</b> | Neutral |                         |      |

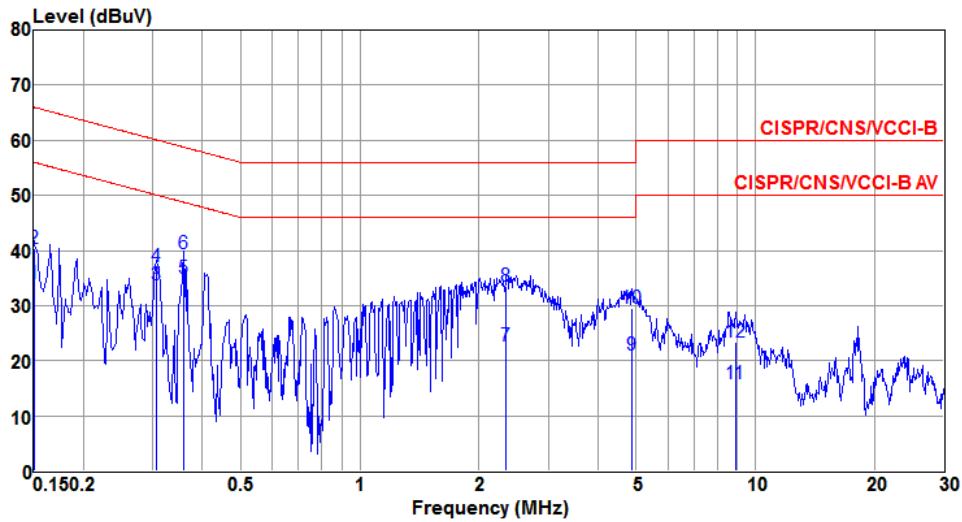

|    | Freq<br>MHz | Level<br>dBuV | Limit<br>Line<br>dBuV | Over<br>Limit<br>dB | Read<br>Level<br>dBuV | LISN<br>factor<br>dB | cable<br>loss<br>dB | Remark  |
|----|-------------|---------------|-----------------------|---------------------|-----------------------|----------------------|---------------------|---------|
| 1  | 0.150       | 33.88         | 56.00                 | -22.12              | 33.82                 | 0.05                 | 0.01                | Average |
| 2  | 0.150       | 40.36         | 66.00                 | -25.64              | 40.30                 | 0.05                 | 0.01                | QP      |
| 3  | 0.307       | 33.86         | 50.06                 | -16.20              | 33.79                 | 0.05                 | 0.02                | Average |
| 4  | 0.307       | 37.06         | 60.06                 | -23.00              | 36.99                 | 0.05                 | 0.02                | QP      |
| 5* | 0.358       | 34.99         | 48.78                 | -13.79              | 34.92                 | 0.05                 | 0.02                | Average |
| 6  | 0.358       | 39.46         | 58.78                 | -19.32              | 39.39                 | 0.05                 | 0.02                | QP      |
| 7  | 2.346       | 22.66         | 46.00                 | -23.34              | 22.46                 | 0.07                 | 0.13                | Average |
| 8  | 2.346       | 33.56         | 56.00                 | -22.44              | 33.36                 | 0.07                 | 0.13                | QP      |
| 9  | 4.874       | 21.10         | 46.00                 | -24.90              | 20.75                 | 0.11                 | 0.24                | Average |
| 10 | 4.874       | 29.40         | 56.00                 | -26.60              | 29.05                 | 0.11                 | 0.24                | QP      |
| 11 | 8.916       | 15.75         | 50.00                 | -34.25              | 15.27                 | 0.17                 | 0.31                | Average |
| 12 | 8.916       | 23.30         | 60.00                 | -36.70              | 22.82                 | 0.17                 | 0.31                | QP      |

Note 1: Level (dBuV) = Read Level (dBuV) + LISN Factor (dB) + Cable Loss (dB).  
 2: Over Limit (dB) = Level (dBuV) – Limit Line (dBuV).

## 3.2 6dB and Occupied Bandwidth

### 3.2.1 Limit of 6dB Bandwidth

The minimum 6dB bandwidth shall be at least 500 kHz.

### 3.2.2 Test Procedures

#### 6dB Bandwidth

1. Set resolution bandwidth (RBW) = 100 kHz, Video bandwidth = 300 kHz.
2. Detector = Peak, Trace mode = max hold.
3. Sweep = auto couple, Allow the trace to stabilize.
4. Measure the maximum width of the emission that is constrained by the frequencies associated with the two outermost amplitude points (upper and lower) that are attenuated by 6dB relative to the maximum level measured in the fundamental emission.

#### Occupied Bandwidth

1. Set resolution bandwidth (RBW) = 1% ~ 5 % of OBW, Video bandwidth = 3 x RBW
2. Detector = Sample, Trace mode = max hold.
3. Sweep = auto couple, Allow the trace to stabilize.
4. Use the OBW measurement function of spectrum analyzer to measure the occupied bandwidth.

### 3.2.3 Test Setup



### 3.2.4 Test Result of 6dB and Occupied Bandwidth

#### Summary

| Mode                         | Max-N dB<br>(Hz) | Max-OBW<br>(Hz) | ITU-Code | Min-N dB<br>(Hz) | Min-OBW<br>(Hz) |
|------------------------------|------------------|-----------------|----------|------------------|-----------------|
| 2.4-2.4835GHz                | -                | -               | -        | -                | -               |
| 802.11b_Nss1,(1Mbps)_2TX     | 10.072M          | 13.748M         | 13M7G1D  | 8.551M           | 13.459M         |
| 802.11g_Nss1,(6Mbps)_2TX     | 16.377M          | 16.57M          | 16M6D1D  | 16.087M          | 16.498M         |
| 802.11n HT20_Nss1,(MCS0)_2TX | 16.957M          | 17.656M         | 17M7D1D  | 16.594M          | 17.511M         |
| 802.11n HT40_Nss1,(MCS0)_2TX | 35.507M          | 36.469M         | 36M5D1D  | 35.217M          | 36.324M         |

**Max-N dB** = Maximum 6dB down bandwidth; **Max-OBW** = Maximum 99% occupied bandwidth;  
**Min-N dB** = Minimum 6dB down bandwidth; **Min-OBW** = Minimum 99% occupied bandwidth;

#### Result

| Mode                         | Result | Limit<br>(Hz) | Port 1-N dB<br>(Hz) | Port 1-OBW<br>(Hz) | Port 2-N dB<br>(Hz) | Port 2-OBW<br>(Hz) |
|------------------------------|--------|---------------|---------------------|--------------------|---------------------|--------------------|
| 802.11b_Nss1,(1Mbps)_2TX     | -      | -             | -                   | -                  | -                   | -                  |
| 2412MHz                      | Pass   | 500k          | 9.058M              | 13.676M            | 9.058M              | 13.459M            |
| 2437MHz                      | Pass   | 500k          | 9.058M              | 13.676M            | 9.565M              | 13.459M            |
| 2462MHz                      | Pass   | 500k          | 8.551M              | 13.748M            | 10.072M             | 13.531M            |
| 802.11g_Nss1,(6Mbps)_2TX     | -      | -             | -                   | -                  | -                   | -                  |
| 2412MHz                      | Pass   | 500k          | 16.304M             | 16.498M            | 16.377M             | 16.498M            |
| 2437MHz                      | Pass   | 500k          | 16.304M             | 16.57M             | 16.087M             | 16.57M             |
| 2462MHz                      | Pass   | 500k          | 16.377M             | 16.498M            | 16.377M             | 16.498M            |
| 802.11n HT20_Nss1,(MCS0)_2TX | -      | -             | -                   | -                  | -                   | -                  |
| 2412MHz                      | Pass   | 500k          | 16.957M             | 17.511M            | 16.957M             | 17.583M            |
| 2437MHz                      | Pass   | 500k          | 16.957M             | 17.656M            | 16.739M             | 17.656M            |
| 2462MHz                      | Pass   | 500k          | 16.594M             | 17.656M            | 16.957M             | 17.583M            |
| 802.11n HT40_Nss1,(MCS0)_2TX | -      | -             | -                   | -                  | -                   | -                  |
| 2422MHz                      | Pass   | 500k          | 35.217M             | 36.324M            | 35.362M             | 36.324M            |
| 2437MHz                      | Pass   | 500k          | 35.507M             | 36.469M            | 35.217M             | 36.324M            |
| 2452MHz                      | Pass   | 500k          | 35.362M             | 36.324M            | 35.362M             | 36.324M            |

**Port X-N dB** = Port X 6dB down bandwidth; **Port X-OBW** = Port X 99% occupied bandwidth;



### 802.11b\_Nss1,(1Mbps)\_2TX

EBW

2412MHz

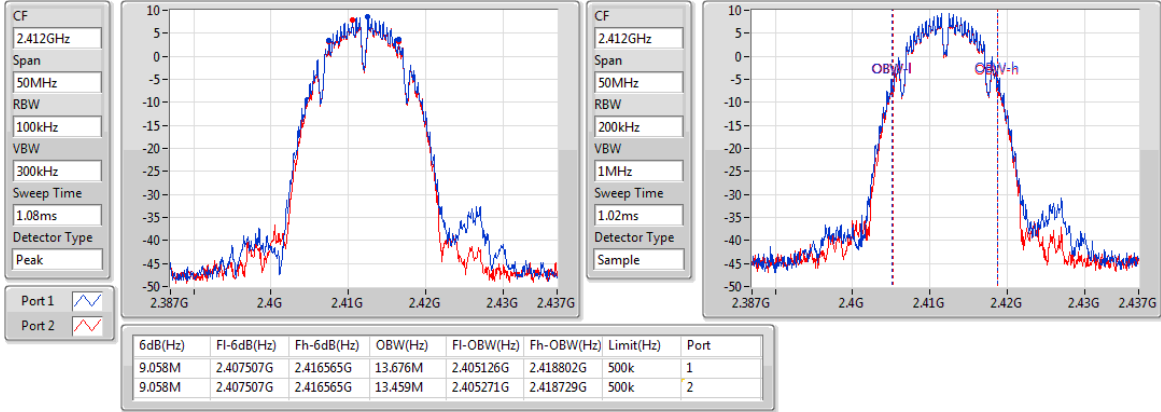

### 802.11b\_Nss1,(1Mbps)\_2TX

EBW

2437MHz

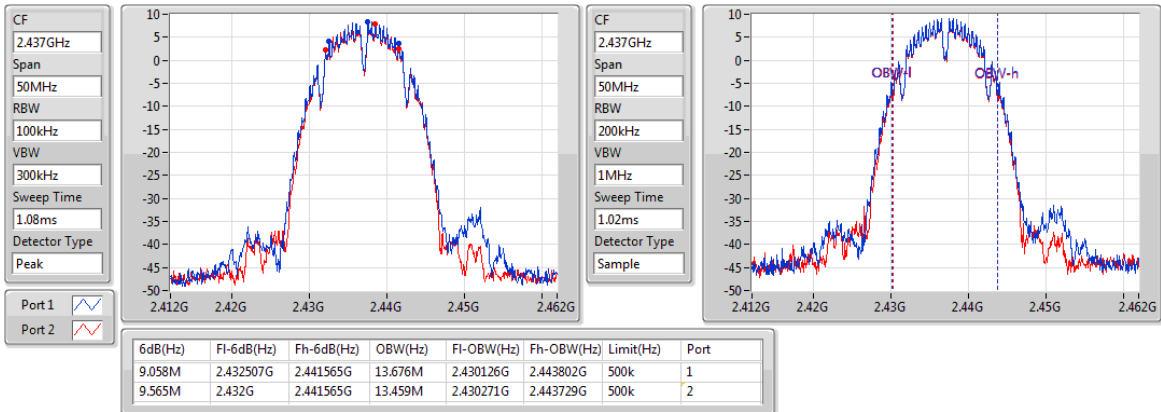

### 802.11b\_Nss1,(1Mbps)\_2TX

EBW

2462MHz

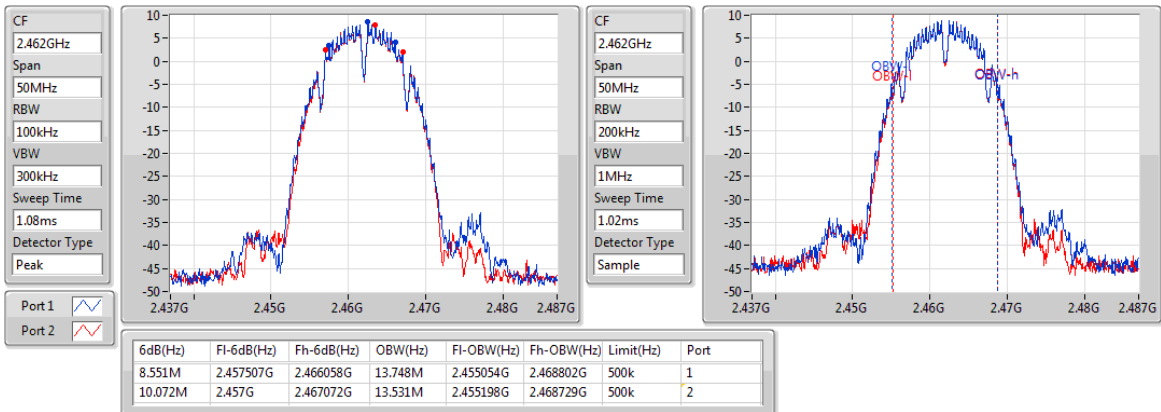

### 802.11g\_Nss1,(6Mbps)\_2TX

EBW

#### 2412MHz

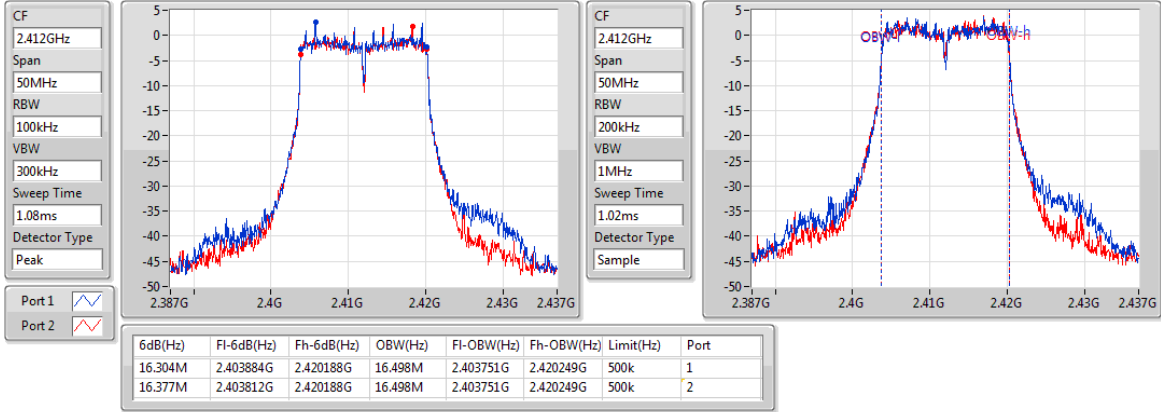

### 802.11g\_Nss1,(6Mbps)\_2TX

EBW

#### 2437MHz

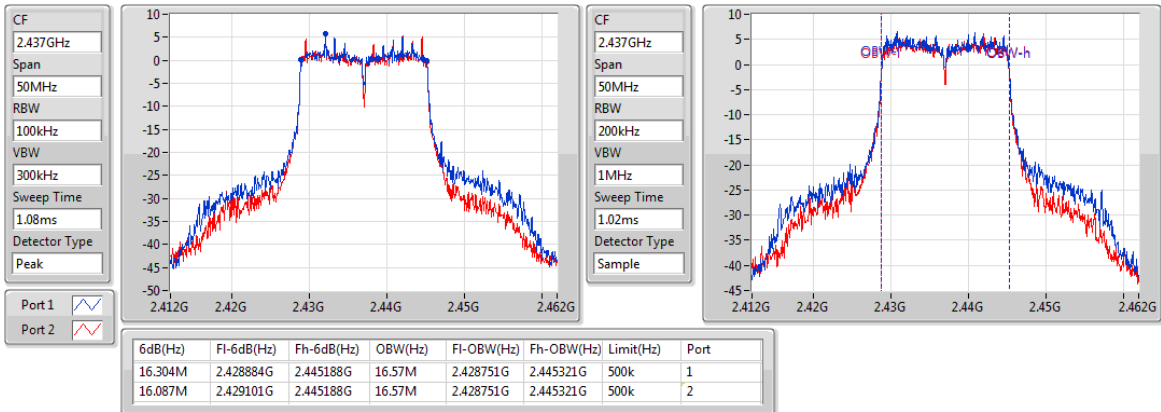

### 802.11g\_Nss1,(6Mbps)\_2TX

EBW

#### 2462MHz

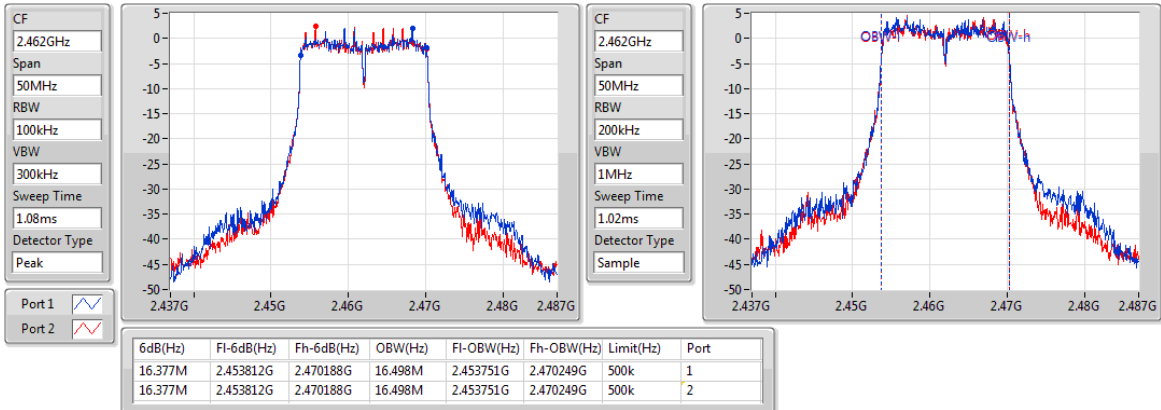

### 802.11n HT20\_Nss1,(MCS0)\_2TX

EBW

2412MHz

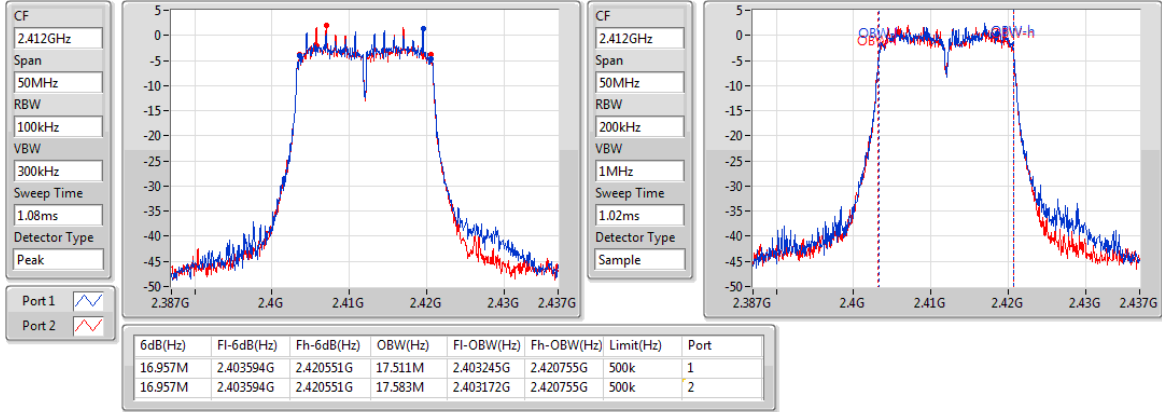

### 802.11n HT20\_Nss1,(MCS0)\_2TX

EBW

2437MHz

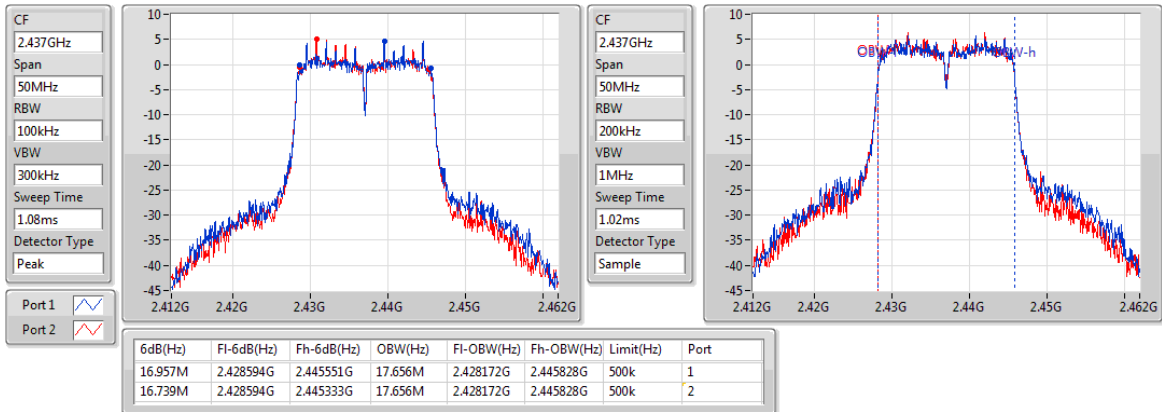

### 802.11n HT20\_Nss1,(MCS0)\_2TX

EBW

2462MHz

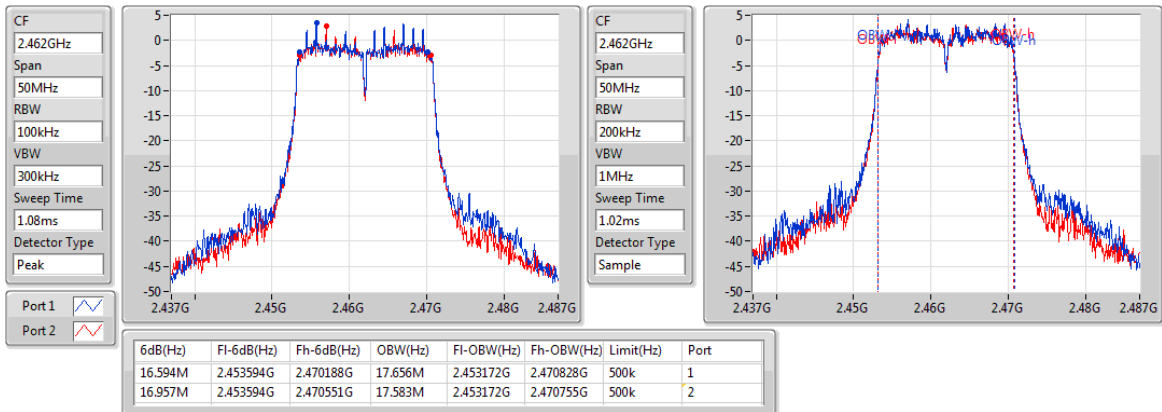

### 802.11n HT40\_Nss1,(MCS0)\_2TX

EBW

2422MHz

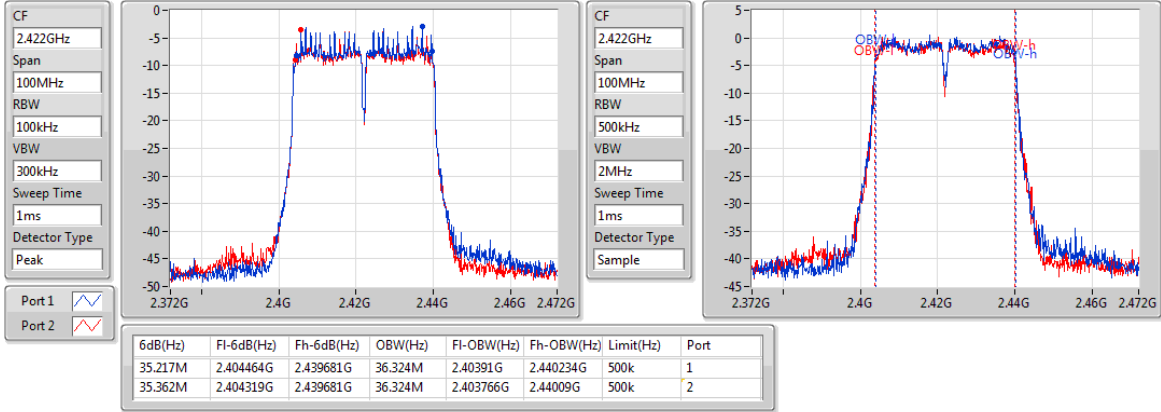

### 802.11n HT40\_Nss1,(MCS0)\_2TX

EBW

2437MHz

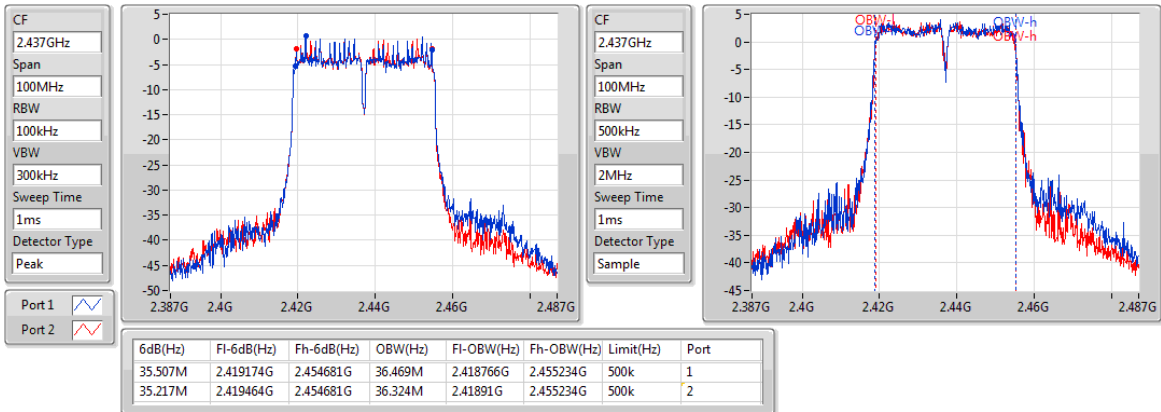

### 802.11n HT40\_Nss1,(MCS0)\_2TX

EBW

2452MHz

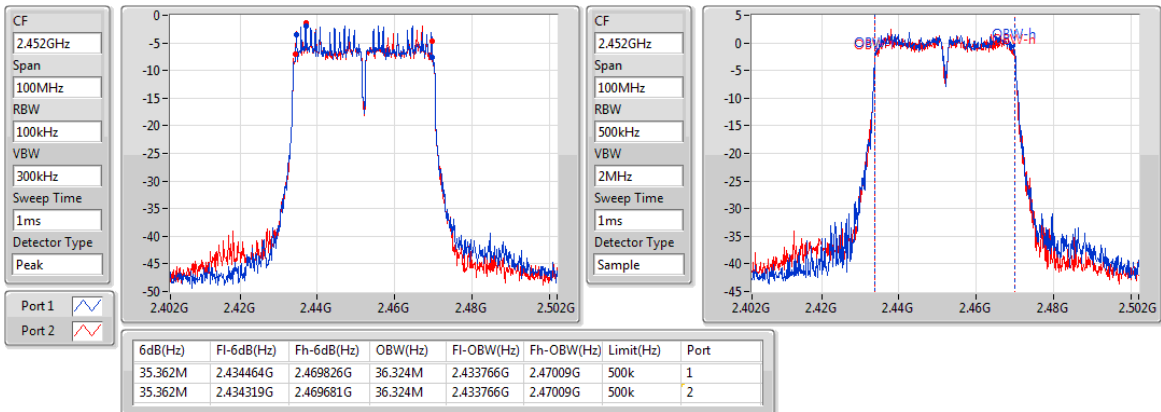

### 3.3 RF Output Power

#### 3.3.1 Limit of RF Output Power

Conducted power shall not exceed 1Watt.

Antenna gain  $\leq 6\text{dBi}$ , no any corresponding reduction is in output power limit.

#### 3.3.2 Test Procedures

A broadband RF power meter is used for output power measurement. The video bandwidth of power meter is greater than DTS bandwidth of EUT. If duty cycle of test signal is not 100 %, trigger and gating function of power meter will be enabled to capture transmission burst for measuring output power.

#### 3.3.3 Test Setup

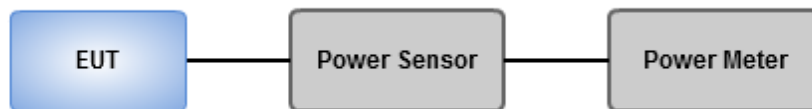

### 3.3.4 Test Result of Maximum Output Power

#### Summary of Peak Conducted Output Power

| Mode                         | Total Power (dBm) | Total Power (W) |
|------------------------------|-------------------|-----------------|
| 2.4-2.4835GHz                | -                 | -               |
| 802.11b_Nss1,(1Mbps)_2TX     | 23.19             | 0.20845         |
| 802.11g_Nss1,(6Mbps)_2TX     | 25.38             | 0.34514         |
| 802.11n HT20_Nss1,(MCS0)_2TX | 25.54             | 0.35810         |
| 802.11n HT40_Nss1,(MCS0)_2TX | 25.31             | 0.33963         |

#### Result

| Mode                         | Result | DG (dBi) | Port 1 (dBm) | Port 2 (dBm) | Total Power (dBm) | Power Limit (dBm) | EIRP (dBm) | EIRP Limit (dBm) |
|------------------------------|--------|----------|--------------|--------------|-------------------|-------------------|------------|------------------|
| 802.11b_Nss1,(1Mbps)_2TX     | -      | -        | -            | -            | -                 | -                 | -          | -                |
| 2412MHz                      | Pass   | 4.60     | 20.11        | 20.01        | 23.07             | 30.00             | 27.67      | 36.00            |
| 2437MHz                      | Pass   | 4.60     | 20.20        | 20.15        | 23.19             | 30.00             | 27.79      | 36.00            |
| 2462MHz                      | Pass   | 4.60     | 20.18        | 20.11        | 23.16             | 30.00             | 27.76      | 36.00            |
| 802.11g_Nss1,(6Mbps)_2TX     | -      | -        | -            | -            | -                 | -                 | -          | -                |
| 2412MHz                      | Pass   | 4.60     | 21.25        | 21.64        | 24.46             | 30.00             | 29.06      | 36.00            |
| 2437MHz                      | Pass   | 4.60     | 22.45        | 22.29        | 25.38             | 30.00             | 29.98      | 36.00            |
| 2462MHz                      | Pass   | 4.60     | 21.65        | 22.16        | 24.92             | 30.00             | 29.52      | 36.00            |
| 802.11n HT20_Nss1,(MCS0)_2TX | -      | -        | -            | -            | -                 | -                 | -          | -                |
| 2412MHz                      | Pass   | 4.60     | 21.39        | 20.85        | 24.14             | 30.00             | 28.74      | 36.00            |
| 2437MHz                      | Pass   | 4.60     | 22.55        | 22.50        | 25.54             | 30.00             | 30.14      | 36.00            |
| 2462MHz                      | Pass   | 4.60     | 21.59        | 21.32        | 24.47             | 30.00             | 29.07      | 36.00            |
| 802.11n HT40_Nss1,(MCS0)_2TX | -      | -        | -            | -            | -                 | -                 | -          | -                |
| 2422MHz                      | Pass   | 4.60     | 18.22        | 19.02        | 21.65             | 30.00             | 26.25      | 36.00            |
| 2437MHz                      | Pass   | 4.60     | 22.35        | 22.24        | 25.31             | 30.00             | 29.91      | 36.00            |
| 2452MHz                      | Pass   | 4.60     | 21.15        | 21.15        | 24.16             | 30.00             | 28.76      | 36.00            |

DG = Directional Gain; Port X = Port X output power

### Summary of Conducted (Average) Output Power

| Mode                         | Total Power (dBm) | Total Power (W) |
|------------------------------|-------------------|-----------------|
| 2.4-2.4835GHz                | -                 | -               |
| 802.11b_Nss1,(1Mbps)_2TX     | 20.64             | 0.11588         |
| 802.11g_Nss1,(6Mbps)_2TX     | 19.07             | 0.08072         |
| 802.11n HT20_Nss1,(MCS0)_2TX | 19.03             | 0.07998         |
| 802.11n HT40_Nss1,(MCS0)_2TX | 16.90             | 0.04898         |

### Result

| Mode                         | Result | DG (dBi) | Port 1 (dBm) | Port 2 (dBm) | Total Power (dBm) | Power Limit (dBm) | EIRP (dBm) | EIRP Limit (dBm) |
|------------------------------|--------|----------|--------------|--------------|-------------------|-------------------|------------|------------------|
| 802.11b_Nss1,(1Mbps)_2TX     | -      | -        | -            | -            | -                 | -                 | -          | -                |
| 2412MHz                      | Pass   | 4.60     | 17.67        | 17.41        | 20.55             | -                 | 25.15      | -                |
| 2437MHz                      | Pass   | 4.60     | 17.63        | 17.58        | 20.62             | -                 | 25.22      | -                |
| 2462MHz                      | Pass   | 4.60     | 17.65        | 17.60        | 20.64             | -                 | 25.24      | -                |
| 802.11g_Nss1,(6Mbps)_2TX     | -      | -        | -            | -            | -                 | -                 | -          | -                |
| 2412MHz                      | Pass   | 4.60     | 13.55        | 13.40        | 16.49             | -                 | 21.09      | -                |
| 2437MHz                      | Pass   | 4.60     | 16.11        | 16.01        | 19.07             | -                 | 23.67      | -                |
| 2462MHz                      | Pass   | 4.60     | 14.62        | 14.59        | 17.62             | -                 | 22.22      | -                |
| 802.11n HT20_Nss1,(MCS0)_2TX | -      | -        | -            | -            | -                 | -                 | -          | -                |
| 2412MHz                      | Pass   | 4.60     | 12.44        | 12.55        | 15.51             | -                 | 20.11      | -                |
| 2437MHz                      | Pass   | 4.60     | 16.03        | 16.01        | 19.03             | -                 | 23.63      | -                |
| 2462MHz                      | Pass   | 4.60     | 14.06        | 13.89        | 16.99             | -                 | 21.59      | -                |
| 802.11n HT40_Nss1,(MCS0)_2TX | -      | -        | -            | -            | -                 | -                 | -          | -                |
| 2422MHz                      | Pass   | 4.60     | 10.29        | 10.11        | 13.21             | -                 | 17.81      | -                |
| 2437MHz                      | Pass   | 4.60     | 14.02        | 13.76        | 16.90             | -                 | 21.50      | -                |
| 2452MHz                      | Pass   | 4.60     | 11.80        | 11.65        | 14.74             | -                 | 19.34      | -                |

DG = Directional Gain; Port X = Port X output power

Note : Conducted average output power is for reference only

## 3.4 Power Spectral Density

### 3.4.1 Limit of Power Spectral Density

Power spectral density shall not be greater than 8 dBm in any 3 kHz band.

### 3.4.2 Test Procedures

#### Peak PSD

1. Set the RBW = 3 kHz, VBW = 10 kHz.
2. Detector = Peak, Sweep time = auto couple.
3. Trace mode = max hold, allow trace to fully stabilize.
4. Use the peak marker function to determine the maximum amplitude level.

#### Average PSD, duty cycle $\geq$ 98%

1. Set the RBW = 30 kHz, VBW = 100 kHz.
2. Detector = RMS, Sweep time = auto couple.
3. Sweep time = auto couple.
4. Employ trace averaging (RMS) mode over a minimum of 100 traces.
5. Use the peak marker function to determine the maximum amplitude level.

#### Average PSD, duty cycle $<$ 98%

1. Set the RBW = 30 kHz, VBW = 100 kHz. Detector = RMS.
2. Set the sweep time to:  $\geq 10$  (number of measurement points in sweep) x (total on/off period of the transmitted signal).
3. Perform the measurement over a single sweep.
4. Use the peak marker function to determine the maximum amplitude level.
5. Add  $10 \log (1/x)$ , where x is the duty cycle.

### 3.4.3 Test Setup

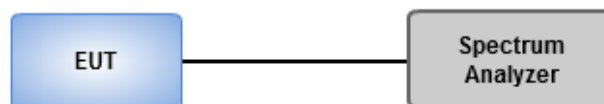



### 3.4.4 Test Result of Power Spectral Density

#### Summary

| Mode                         | PD<br>(dBm/RBW) |
|------------------------------|-----------------|
| 2.4-2.4835GHz                | -               |
| 802.11b_Nss1,(1Mbps)_2TX     | -3.42           |
| 802.11g_Nss1,(6Mbps)_2TX     | -6.22           |
| 802.11n HT20_Nss1,(MCS0)_2TX | -6.12           |
| 802.11n HT40_Nss1,(MCS0)_2TX | -11.74          |

#### Result

| Mode                         | Result | DG<br>(dBi) | Port 1<br>(dBm/RBW) | Port 2<br>(dBm/RBW) | PD<br>(dBm/RBW) | PD Limit<br>(dBm/RBW) |
|------------------------------|--------|-------------|---------------------|---------------------|-----------------|-----------------------|
| 802.11b_Nss1,(1Mbps)_2TX     | -      | -           | -                   | -                   | -               | -                     |
| 2412MHz                      | Pass   | 7.61        | -5.98               | -6.55               | -3.60           | 6.39                  |
| 2437MHz                      | Pass   | 7.61        | -5.85               | -6.29               | -3.69           | 6.39                  |
| 2462MHz                      | Pass   | 7.61        | -6.80               | -5.91               | -3.42           | 6.39                  |
| 802.11g_Nss1,(6Mbps)_2TX     | -      | -           | -                   | -                   | -               | -                     |
| 2412MHz                      | Pass   | 7.61        | -11.53              | -12.04              | -8.77           | 6.39                  |
| 2437MHz                      | Pass   | 7.61        | -8.63               | -9.43               | -6.22           | 6.39                  |
| 2462MHz                      | Pass   | 7.61        | -11.36              | -11.59              | -8.56           | 6.39                  |
| 802.11n HT20_Nss1,(MCS0)_2TX | -      | -           | -                   | -                   | -               | -                     |
| 2412MHz                      | Pass   | 7.61        | -12.03              | -12.14              | -9.07           | 6.39                  |
| 2437MHz                      | Pass   | 7.61        | -8.89               | -9.39               | -6.12           | 6.39                  |
| 2462MHz                      | Pass   | 7.61        | -10.62              | -10.93              | -7.76           | 6.39                  |
| 802.11n HT40_Nss1,(MCS0)_2TX | -      | -           | -                   | -                   | -               | -                     |
| 2422MHz                      | Pass   | 7.61        | -18.22              | -17.96              | -15.08          | 6.39                  |
| 2437MHz                      | Pass   | 7.61        | -14.68              | -14.47              | -11.74          | 6.39                  |
| 2452MHz                      | Pass   | 7.61        | -16.69              | -16.83              | -13.84          | 6.39                  |

**DG** = Directional Gain;

**PD** = trace bin-by-bin of each transmits port summing can be performed maximum power density;

**Port X** = Port X power density;

Directional gain =  $4.6 + 10 \cdot \log(2/1) = 7.61 \text{ dBi} > 6 \text{ dBi}$ , Limit shall be reduced to  $8 \text{ dBm} - (7.61 \text{ dBi} - 6 \text{ dBi}) = 6.39 \text{ dBm}$

### 802.11b\_Nss1,(1Mbps)\_2TX

PSD

2412MHz

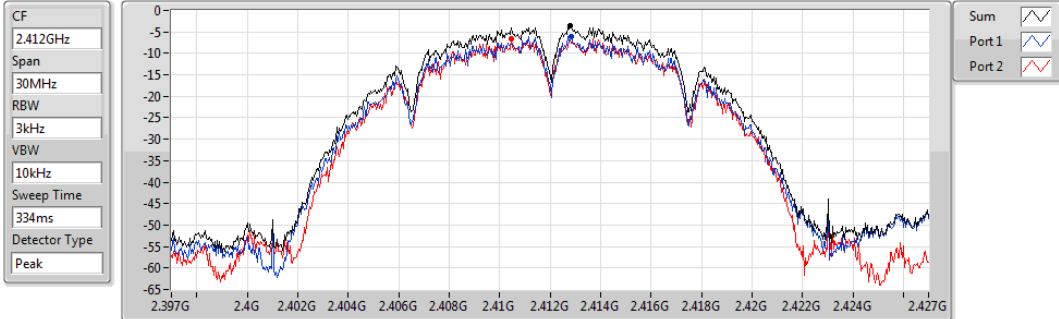

| Sum          | PD           | Port 1       | Port 2       |
|--------------|--------------|--------------|--------------|
| (dBm/100kHz) | (dBm/100kHz) | (dBm/100kHz) | (dBm/100kHz) |
| -3.60        | -3.60        | -5.98        | -6.55        |

### 802.11b\_Nss1,(1Mbps)\_2TX

PSD

2437MHz

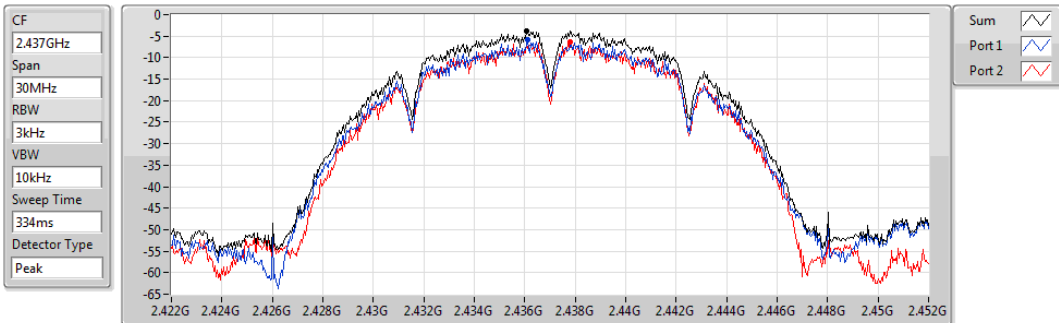

| Sum          | PD           | Port 1       | Port 2       |
|--------------|--------------|--------------|--------------|
| (dBm/100kHz) | (dBm/100kHz) | (dBm/100kHz) | (dBm/100kHz) |
| -3.69        | -3.69        | -5.85        | -6.29        |

### 802.11b\_Nss1,(1Mbps)\_2TX

PSD

2462MHz

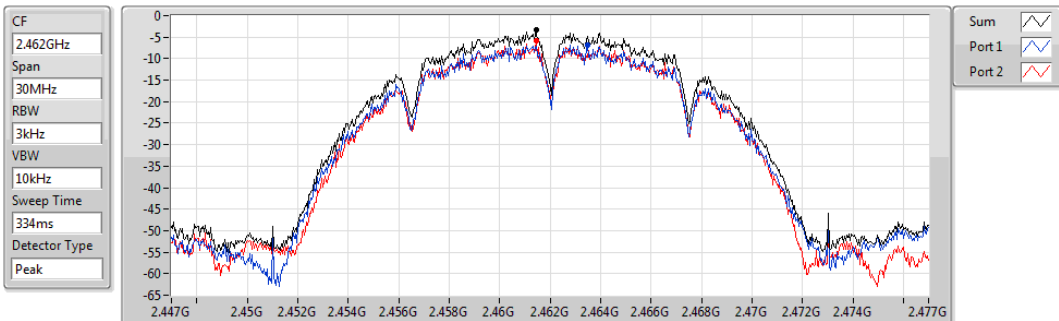

| Sum          | PD           | Port 1       | Port 2       |
|--------------|--------------|--------------|--------------|
| (dBm/100kHz) | (dBm/100kHz) | (dBm/100kHz) | (dBm/100kHz) |
| -3.42        | -3.42        | -6.80        | -5.91        |

### 802.11g\_Nss1,(6Mbps)\_2TX

PSD

2412MHz

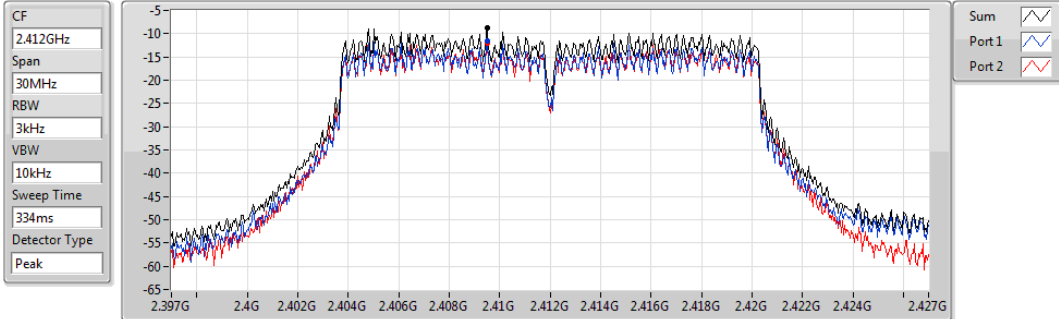

| Sum       | PD        | Port 1    | Port 2    |
|-----------|-----------|-----------|-----------|
| (dBm/RBW) | (dBm/RBW) | (dBm/RBW) | (dBm/RBW) |
| -8.77     | -8.77     | -11.53    | -12.04    |

### 802.11g\_Nss1,(6Mbps)\_2TX

PSD

2437MHz

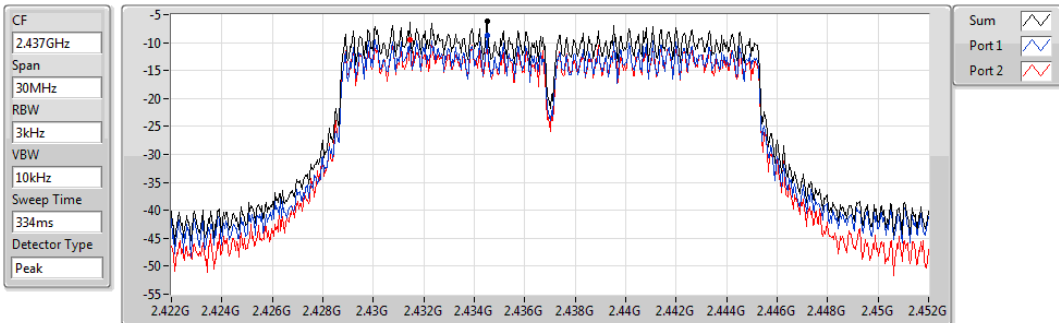

| Sum       | PD        | Port 1    | Port 2    |
|-----------|-----------|-----------|-----------|
| (dBm/RBW) | (dBm/RBW) | (dBm/RBW) | (dBm/RBW) |
| -6.22     | -6.22     | -8.63     | -9.43     |

### 802.11g\_Nss1,(6Mbps)\_2TX

PSD

2462MHz

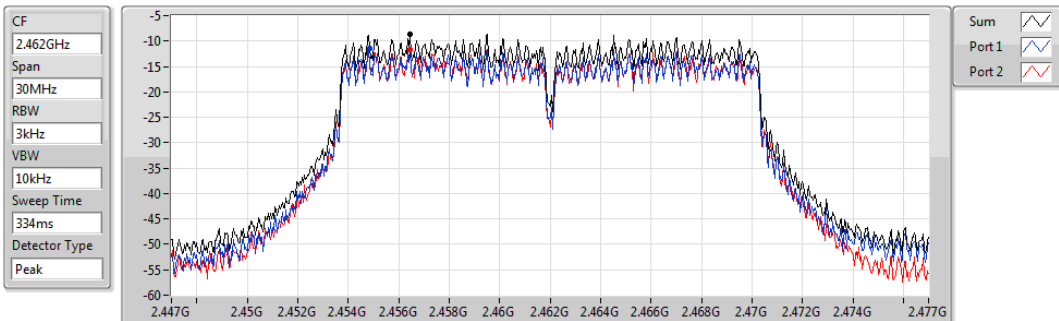

| Sum       | PD        | Port 1    | Port 2    |
|-----------|-----------|-----------|-----------|
| (dBm/RBW) | (dBm/RBW) | (dBm/RBW) | (dBm/RBW) |
| -8.56     | -8.56     | -11.36    | -11.59    |

### 802.11n HT20\_Nss1,(MCS0)\_2TX

PSD

2412MHz

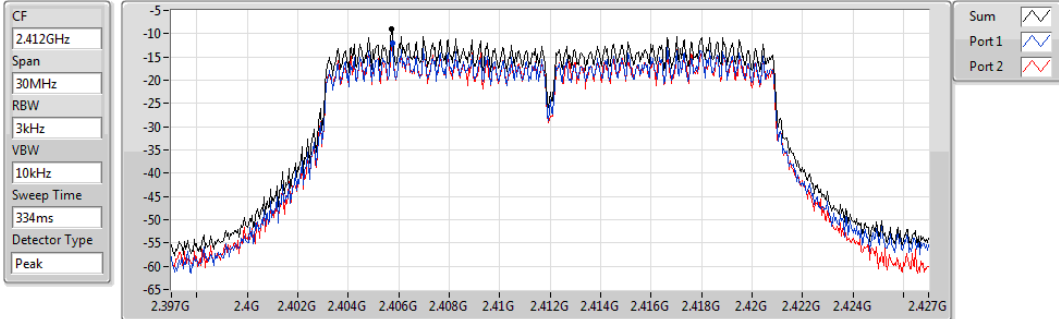

| Sum          | PD           | Port 1       | Port 2       |
|--------------|--------------|--------------|--------------|
| (dBm/100kHz) | (dBm/100kHz) | (dBm/100kHz) | (dBm/100kHz) |
| -9.07        | -9.07        | -12.03       | -12.14       |

### 802.11n HT20\_Nss1,(MCS0)\_2TX

PSD

2437MHz

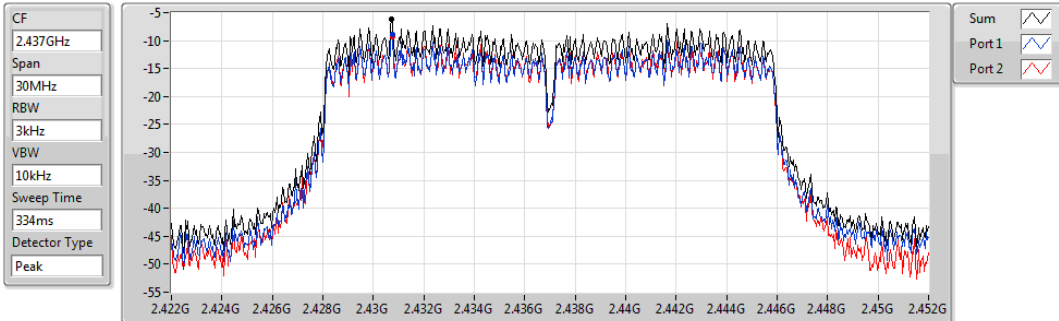

| Sum          | PD           | Port 1       | Port 2       |
|--------------|--------------|--------------|--------------|
| (dBm/100kHz) | (dBm/100kHz) | (dBm/100kHz) | (dBm/100kHz) |
| -6.12        | -6.12        | -8.89        | -9.39        |

### 802.11n HT20\_Nss1,(MCS0)\_2TX

PSD

2462MHz

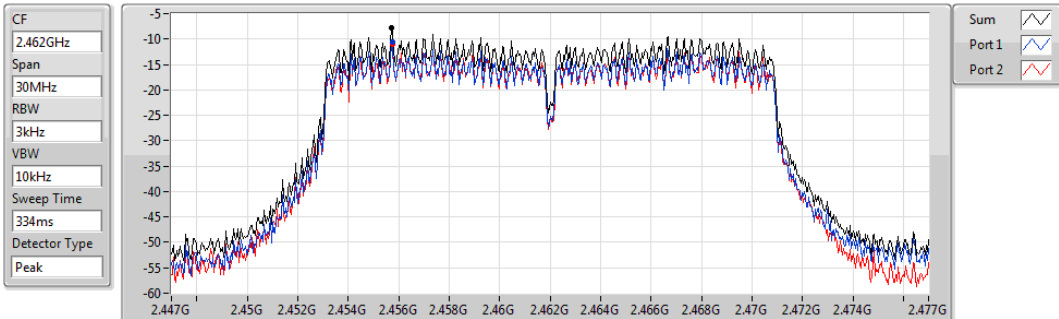

| Sum          | PD           | Port 1       | Port 2       |
|--------------|--------------|--------------|--------------|
| (dBm/100kHz) | (dBm/100kHz) | (dBm/100kHz) | (dBm/100kHz) |
| -7.76        | -7.76        | -10.62       | -10.93       |

### 802.11n HT40\_Nss1,(MCS0)\_2TX

PSD

2422MHz

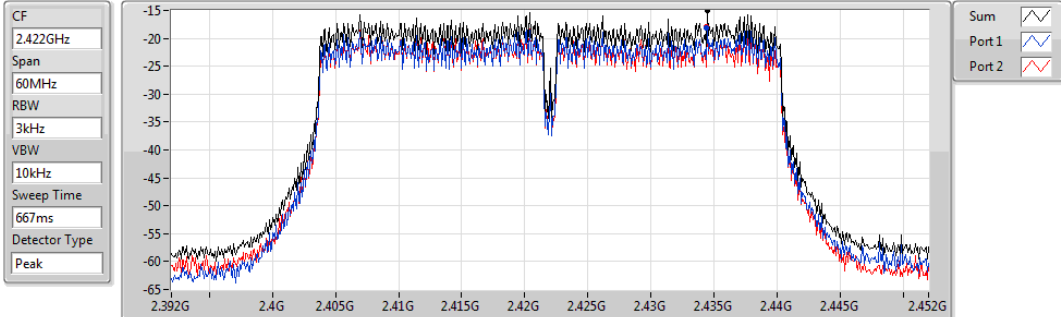

| Sum       | PD        | Port 1    | Port 2    |
|-----------|-----------|-----------|-----------|
| (dBm/RBW) | (dBm/RBW) | (dBm/RBW) | (dBm/RBW) |
| -15.08    | -15.08    | -18.22    | -17.96    |

### 802.11n HT40\_Nss1,(MCS0)\_2TX

PSD

2437MHz

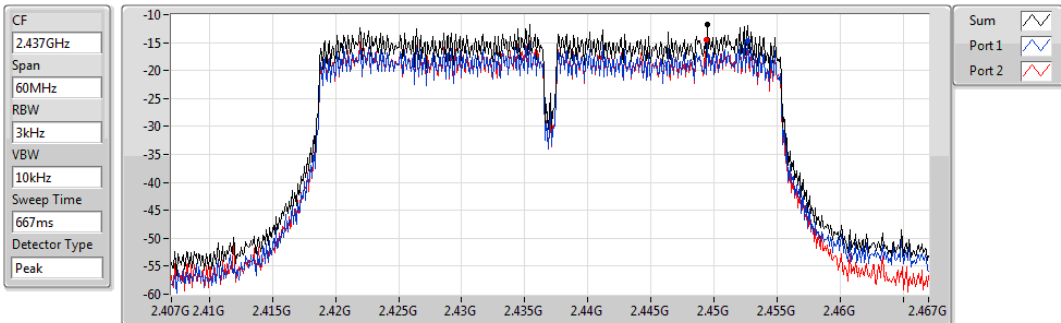

| Sum       | PD        | Port 1    | Port 2    |
|-----------|-----------|-----------|-----------|
| (dBm/RBW) | (dBm/RBW) | (dBm/RBW) | (dBm/RBW) |
| -11.74    | -11.74    | -14.68    | -14.47    |

### 802.11n HT40\_Nss1,(MCS0)\_2TX

PSD

2452MHz

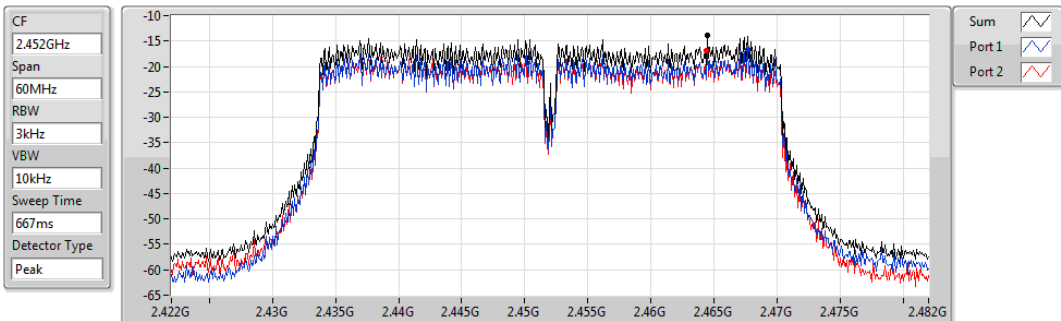

| Sum       | PD        | Port 1    | Port 2    |
|-----------|-----------|-----------|-----------|
| (dBm/RBW) | (dBm/RBW) | (dBm/RBW) | (dBm/RBW) |
| -13.84    | -13.84    | -16.69    | -16.83    |

## 3.5 Unwanted Emissions into Restricted Frequency Bands

### 3.5.1 Limit of Unwanted Emissions into Restricted Frequency Bands

| Restricted Band Emissions Limit |                       |                         |                      |
|---------------------------------|-----------------------|-------------------------|----------------------|
| Frequency Range (MHz)           | Field Strength (uV/m) | Field Strength (dBuV/m) | Measure Distance (m) |
| 0.009~0.490                     | 2400/F(kHz)           | 48.5 - 13.8             | 300                  |
| 0.490~1.705                     | 24000/F(kHz)          | 33.8 - 23               | 30                   |
| 1.705~30.0                      | 30                    | 29                      | 30                   |
| 30~88                           | 100                   | 40                      | 3                    |
| 88~216                          | 150                   | 43.5                    | 3                    |
| 216~960                         | 200                   | 46                      | 3                    |
| Above 960                       | 500                   | 54                      | 3                    |

**Note 1:**  
Quasi-Peak value is measured for frequency below 1GHz except for 9–90 kHz, 110–490 kHz frequency band. Peak and average value are measured for frequency above 1GHz. The limit on average radio frequency emission is as above table. The limit on peak radio frequency emissions is 20 dB above the maximum permitted average emission limit

**Note 2:**  
Measurements may be performed at a distance other than what is specified provided. When performing measurements at a distance other than that specified, the results shall be extrapolated to the specified distance using an extrapolation factor as below, Frequency at or above 30 MHz: 20 dB/decade Frequency below 30 MHz: 40 dB/decade.

### 3.5.2 Test Procedures

1. Measurement is made at a semi-anechoic chamber that incorporates a turntable allowing a EUT rotation of 360°. A continuously-rotating, remotely-controlled turntable is installed at the test site to support the EUT and facilitate determination of the direction of maximum radiation for each EUT emission frequency. The EUT is placed at test table. For emissions testing at or below 1 GHz, the table height is 80 cm above the reference ground plane. For emission measurements above 1 GHz, the table height is 1.5 m
2. Measurement is made with the antenna positioned in both the horizontal and vertical planes of polarization. The measurement antenna is varied in height (1m ~ 4m) above the reference ground plane to obtain the maximum signal strength. Distance between EUT and antenna is 3 m.
3. This investigation is performed with the EUT rotated 360°, the antenna height scanned between 1 m and 4 m, and the antenna rotated to repeat the measurements for both the horizontal and vertical antenna polarizations.

Note:

1. 120kHz measurement bandwidth of test receiver and Quasi-peak detector is for radiated emission below 1GHz.
2. RBW=1MHz, VBW=3MHz and Peak detector is for peak measured value of radiated emission above 1GHz.
3. RBW=1MHz, VBW=1/T and Peak detector is for average measured value of radiated emission above 1GHz.

### 3.5.3 Test Setup

#### Radiated Emissions below 1 GHz



#### Radiated Emissions above 1 GHz

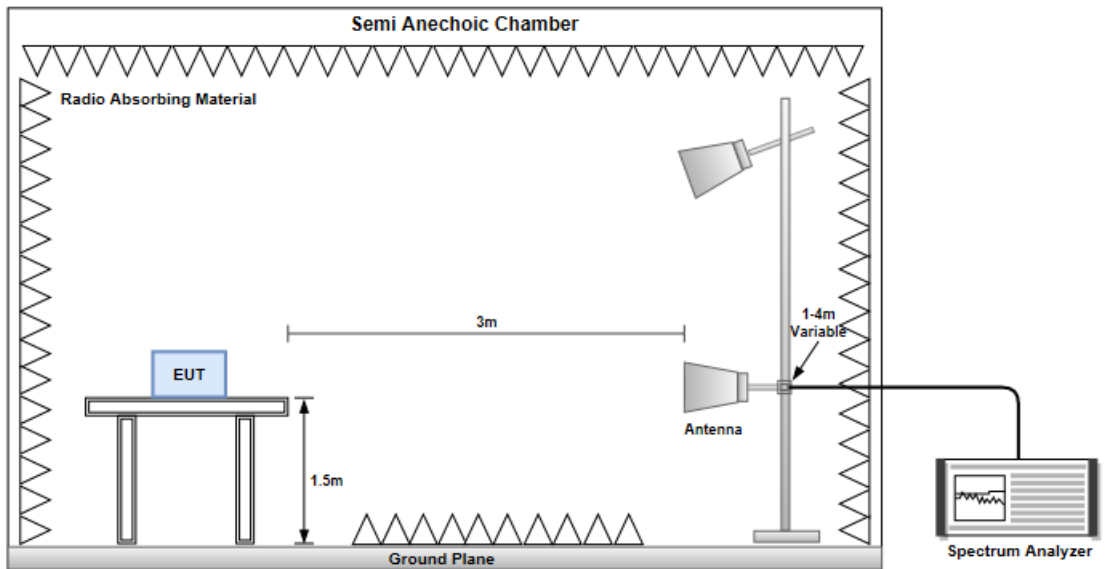

### 3.5.4 Transmitter Radiated Unwanted Emissions (Below 1GHz)

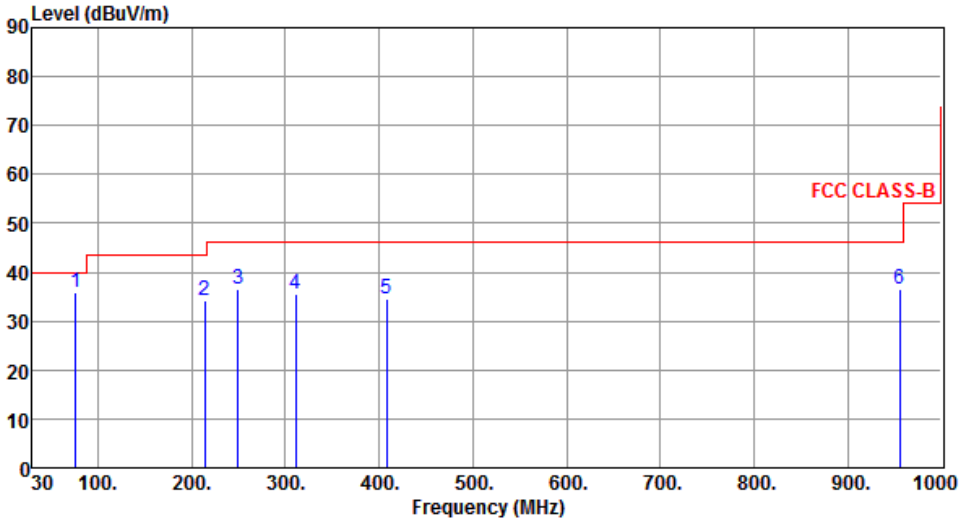
| Modulation   | 11g        | Test Freq. (MHz) | 2437   |        |            |        |        |          |            |
|--|------------|------------------|--------|--------|------------|--------|--------|----------|------------|
| Polarization   | Horizontal |                  |        |        |            |        |        |          |            |
|   |            |                  |        |        |            |        |        |          |            |
|  | Freq.      | Emission level   | Limit  | Margin | SA reading | Factor | Remark | ANT High | Turn Table |
|  | MHz        | dBuV/m           | dBuV/m | dB     | dBuV       | dB     |        | cm       | deg        |
| 1  | 76.56      | 35.83            | 40.00  | -4.17  | 47.93      | -12.10 | Peak   | ---      | ---        |
| 2  | 214.30     | 34.19            | 43.50  | -9.31  | 45.16      | -10.97 | Peak   | ---      | ---        |
| 3  | 249.22     | 36.53            | 46.00  | -9.47  | 45.82      | -9.29  | Peak   | ---      | ---        |
| 4  | 311.30     | 35.39            | 46.00  | -10.61 | 42.78      | -7.39  | Peak   | ---      | ---        |
| 5  | 408.30     | 34.46            | 46.00  | -11.54 | 39.23      | -4.77  | Peak   | ---      | ---        |
| 6  | 955.38     | 36.65            | 46.00  | -9.35  | 30.89      | 5.76   | Peak   | ---      | ---        |
| <p>Note 1: Emission Level (dBuV/m) = SA Reading (dBuV/m) + Factor* (dB)<br/>           *Factor includes antenna factor , cable loss and amplifier gain<br/>           Note 2: Margin (dB) = Emission level (dBuV/m) – Limit (dBuV/m).<br/>           Note 3: All spurious emissions below 30MHz are more than 20 dB below the limit.</p> |            |                  |        |        |            |        |        |          |            |



|                     |          |                         |      |
|---------------------|----------|-------------------------|------|
| <b>Modulation</b>   | 11g      | <b>Test Freq. (MHz)</b> | 2437 |
| <b>Polarization</b> | Vertical |                         |      |

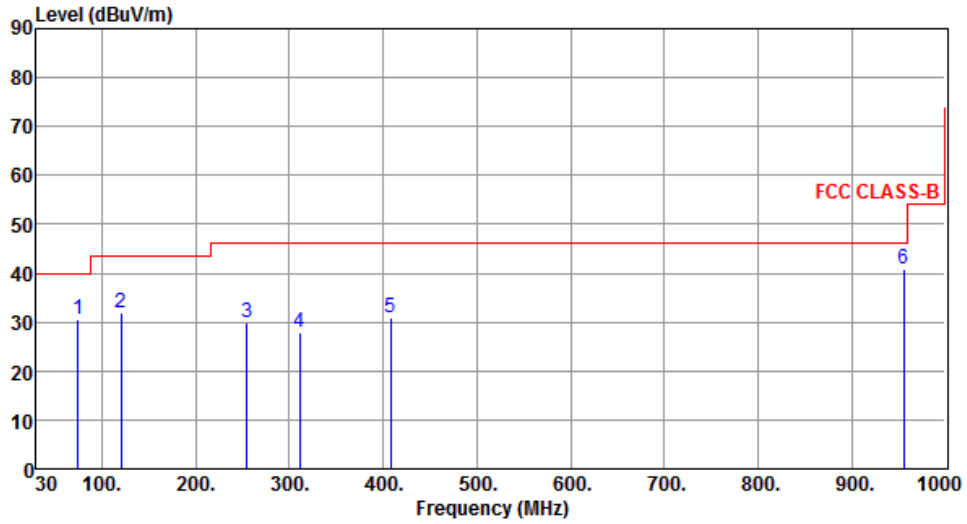

|   | Freq.<br>MHz | Emission<br>level<br>dBuV/m | Limit<br>dBuV/m | Margin<br>dB | SA<br>reading<br>dBuV | Factor<br>dB | Remark | ANT<br>High<br>cm | Turn<br>Table<br>deg |
|---|--------------|-----------------------------|-----------------|--------------|-----------------------|--------------|--------|-------------------|----------------------|
| 1 | 74.62        | 30.50                       | 40.00           | -9.50        | 42.13                 | -11.63       | Peak   | ---               | ---                  |
| 2 | 120.21       | 31.90                       | 43.50           | -11.60       | 42.72                 | -10.82       | Peak   | ---               | ---                  |
| 3 | 255.04       | 29.99                       | 46.00           | -16.01       | 39.14                 | -9.15        | Peak   | ---               | ---                  |
| 4 | 311.30       | 27.77                       | 46.00           | -18.23       | 35.16                 | -7.39        | Peak   | ---               | ---                  |
| 5 | 408.30       | 31.03                       | 46.00           | -14.97       | 35.80                 | -4.77        | Peak   | ---               | ---                  |
| 6 | 955.38       | 40.69                       | 46.00           | -5.31        | 34.93                 | 5.76         | Peak   | ---               | ---                  |

Note 1: Emission Level (dBuV/m) = SA Reading (dBuV/m) + Factor\* (dB)

\*Factor includes antenna factor , cable loss and amplifier gain

Note 2: Margin (dB) = Emission level (dBuV/m) – Limit (dBuV/m).

Note 3: All spurious emissions below 30MHz are more than 20 dB below the limit.

### 3.5.5 Transmitter Radiated Unwanted Emissions (Above 1GHz) for 11b

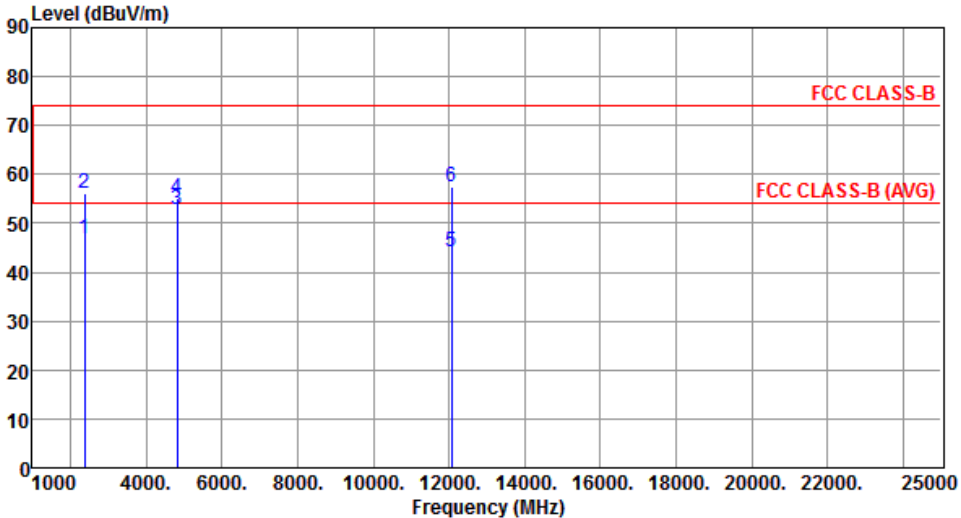
| Modulation  | 11b          | Test Freq. (MHz)            | 2412            |              |                       |              |         |                   |                      |
|---|--------------|-----------------------------|-----------------|--------------|-----------------------|--------------|---------|-------------------|----------------------|
| Polarization  | Horizontal   |                             |                 |              |                       |              |         |                   |                      |
|  |              |                             |                 |              |                       |              |         |                   |                      |
|   | Freq.<br>MHz | Emission<br>level<br>dBuV/m | Limit<br>dBuV/m | Margin<br>dB | SA<br>reading<br>dBuV | Factor<br>dB | Remark  | ANT<br>High<br>cm | Turn<br>Table<br>deg |
| 1   | 2390.00      | 46.95                       | 54.00           | -7.05        | 48.54                 | -1.59        | Average | 212               | 294                  |
| 2   | 2390.00      | 56.10                       | 74.00           | -17.90       | 57.69                 | -1.59        | Peak    | 212               | 294                  |
| 3   | 4824.00      | 52.81                       | 54.00           | -1.19        | 47.81                 | 5.00         | Average | 100               | 343                  |
| 4   | 4824.00      | 55.25                       | 74.00           | -18.75       | 50.25                 | 5.00         | Peak    | 100               | 343                  |
| 5   | 12060.00     | 44.14                       | 54.00           | -9.86        | 29.61                 | 14.53        | Average | 100               | 25                   |
| 6   | 12060.00     | 57.42                       | 74.00           | -16.58       | 42.89                 | 14.53        | Peak    | 100               | 25                   |

Note 1: Emission Level (dBuV/m) = SA Reading (dBuV/m) + Factor\* (dB)  
\*Factor includes antenna factor , cable loss and amplifier gain  
Note 2: Margin (dB) = Emission level (dBuV/m) – Limit (dBuV/m).

|                     |          |                         |      |
|---------------------|----------|-------------------------|------|
| <b>Modulation</b>   | 11b      | <b>Test Freq. (MHz)</b> | 2412 |
| <b>Polarization</b> | Vertical |                         |      |

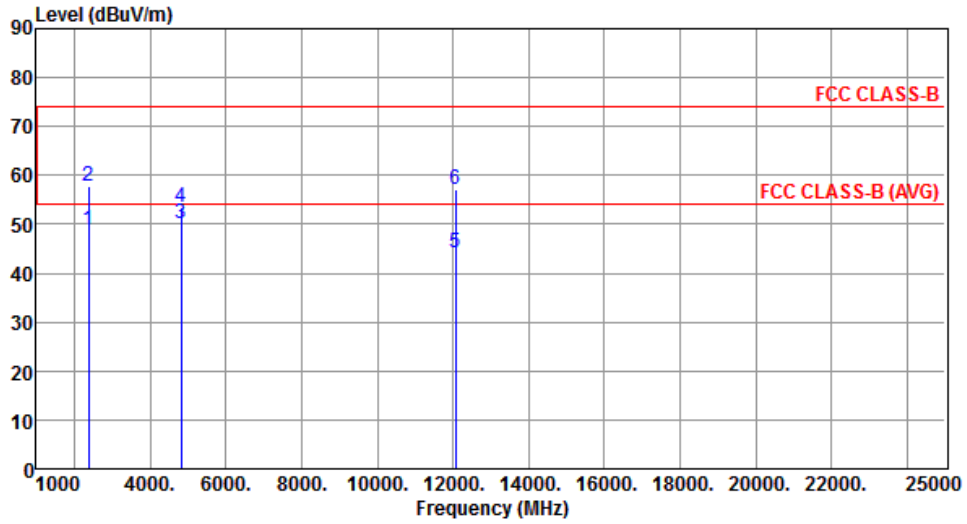

|   | Freq.<br>MHz | Emission<br>level<br>dBuV/m | Limit<br>dBuV/m | Margin<br>dB | SA<br>reading<br>dBuV | Factor<br>dB | Remark  | ANT<br>High<br>cm | Turn<br>Table<br>deg |
|---|--------------|-----------------------------|-----------------|--------------|-----------------------|--------------|---------|-------------------|----------------------|
| 1 | 2390.00      | 48.68                       | 54.00           | -5.32        | 50.27                 | -1.59        | Average | 265               | 260                  |
| 2 | 2390.00      | 57.86                       | 74.00           | -16.14       | 59.45                 | -1.59        | Peak    | 265               | 260                  |
| 3 | 4824.00      | 50.04                       | 54.00           | -3.96        | 45.04                 | 5.00         | Average | 350               | 240                  |
| 4 | 4824.00      | 53.35                       | 74.00           | -20.65       | 48.35                 | 5.00         | Peak    | 350               | 240                  |
| 5 | 12060.00     | 44.19                       | 54.00           | -9.81        | 29.66                 | 14.53        | Average | 100               | 58                   |
| 6 | 12060.00     | 57.10                       | 74.00           | -16.90       | 42.57                 | 14.53        | Peak    | 100               | 58                   |

Note 1: Emission Level (dBuV/m) = SA Reading (dBuV/m) + Factor\* (dB)

\*Factor includes antenna factor , cable loss and amplifier gain

Note 2: Margin (dB) = Emission level (dBuV/m) – Limit (dBuV/m).

|                     |            |                         |      |
|---------------------|------------|-------------------------|------|
| <b>Modulation</b>   | 11b        | <b>Test Freq. (MHz)</b> | 2437 |
| <b>Polarization</b> | Horizontal |                         |      |

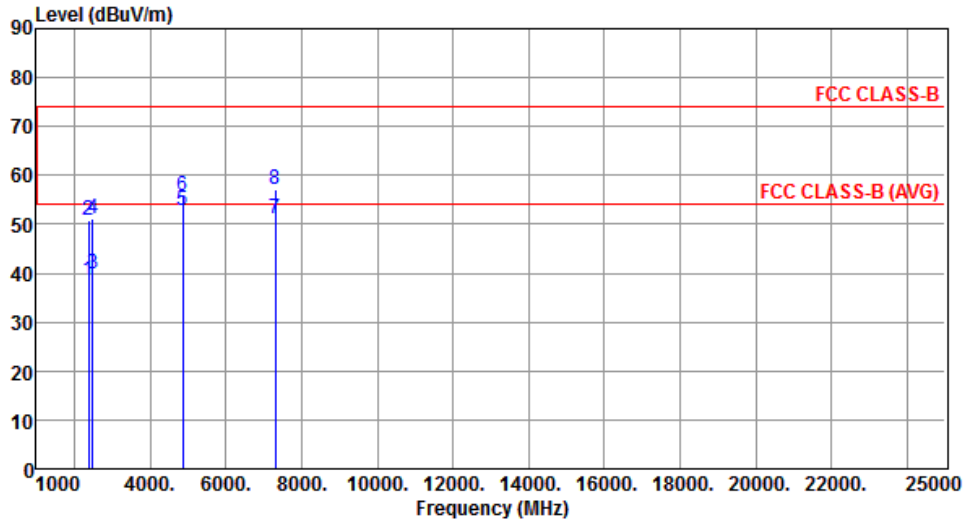

|   | Freq.<br>MHz | Emission<br>level<br>dBuV/m | Limit<br>dBuV/m | Margin<br>dB | SA<br>reading<br>dBuV | Factor<br>dB | Remark  | ANT<br>High<br>cm | Turn<br>Table<br>deg |
|---|--------------|-----------------------------|-----------------|--------------|-----------------------|--------------|---------|-------------------|----------------------|
| 1 | 2390.00      | 38.58                       | 54.00           | -15.42       | 40.17                 | -1.59        | Average | 206               | 299                  |
| 2 | 2390.00      | 50.77                       | 74.00           | -23.23       | 52.36                 | -1.59        | Peak    | 206               | 299                  |
| 3 | 2483.50      | 39.97                       | 54.00           | -14.03       | 41.20                 | -1.23        | Average | 206               | 299                  |
| 4 | 2483.50      | 51.22                       | 74.00           | -22.78       | 52.45                 | -1.23        | Peak    | 206               | 299                  |
| 5 | 4874.00      | 52.82                       | 54.00           | -1.18        | 47.69                 | 5.13         | Average | 100               | 344                  |
| 6 | 4874.00      | 55.64                       | 74.00           | -18.36       | 50.51                 | 5.13         | Peak    | 100               | 344                  |
| 7 | 7311.00      | 51.10                       | 54.00           | -2.90        | 41.18                 | 9.92         | Average | 128               | 356                  |
| 8 | 7311.00      | 57.22                       | 74.00           | -16.78       | 47.30                 | 9.92         | Peak    | 128               | 356                  |

Note 1: Emission Level (dBuV/m) = SA Reading (dBuV/m) + Factor\* (dB)

\*Factor includes antenna factor , cable loss and amplifier gain

Note 2: Margin (dB) = Emission level (dBuV/m) – Limit (dBuV/m).

|                     |          |                         |      |
|---------------------|----------|-------------------------|------|
| <b>Modulation</b>   | 11b      | <b>Test Freq. (MHz)</b> | 2437 |
| <b>Polarization</b> | Vertical |                         |      |

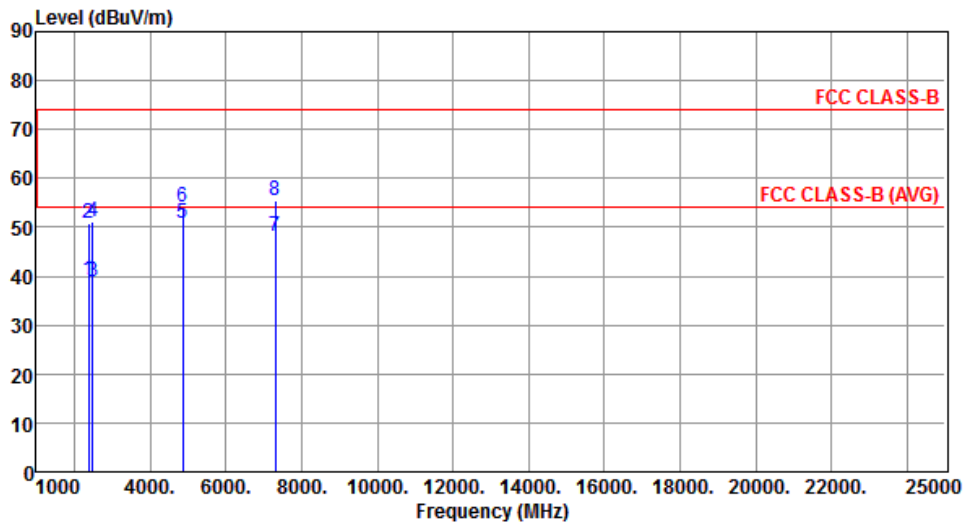

|   | Freq.<br>MHz | Emission<br>level<br>dBuV/m | Limit<br>dBuV/m | Margin<br>dB | SA<br>reading<br>dBuV | Factor<br>dB | Remark  | ANT<br>High<br>cm | Turn<br>Table<br>deg |
|---|--------------|-----------------------------|-----------------|--------------|-----------------------|--------------|---------|-------------------|----------------------|
| 1 | 2390.00      | 39.27                       | 54.00           | -14.73       | 40.86                 | -1.59        | Average | 262               | 271                  |
| 2 | 2390.00      | 50.77                       | 74.00           | -23.23       | 52.36                 | -1.59        | Peak    | 262               | 271                  |
| 3 | 2483.50      | 38.98                       | 54.00           | -15.02       | 40.21                 | -1.23        | Average | 262               | 271                  |
| 4 | 2483.50      | 51.14                       | 74.00           | -22.86       | 52.37                 | -1.23        | Peak    | 262               | 271                  |
| 5 | 4874.00      | 50.76                       | 54.00           | -3.24        | 45.63                 | 5.13         | Average | 350               | 236                  |
| 6 | 4874.00      | 54.17                       | 74.00           | -19.83       | 49.04                 | 5.13         | Peak    | 350               | 236                  |
| 7 | 7311.00      | 48.26                       | 54.00           | -5.74        | 38.34                 | 9.92         | Average | 100               | 94                   |
| 8 | 7311.00      | 55.58                       | 74.00           | -18.42       | 45.66                 | 9.92         | Peak    | 100               | 94                   |

Note 1: Emission Level (dBuV/m) = SA Reading (dBuV/m) + Factor\* (dB)

\*Factor includes antenna factor , cable loss and amplifier gain

Note 2: Margin (dB) = Emission level (dBuV/m) – Limit (dBuV/m).

|                     |            |                         |      |
|---------------------|------------|-------------------------|------|
| <b>Modulation</b>   | 11b        | <b>Test Freq. (MHz)</b> | 2462 |
| <b>Polarization</b> | Horizontal |                         |      |

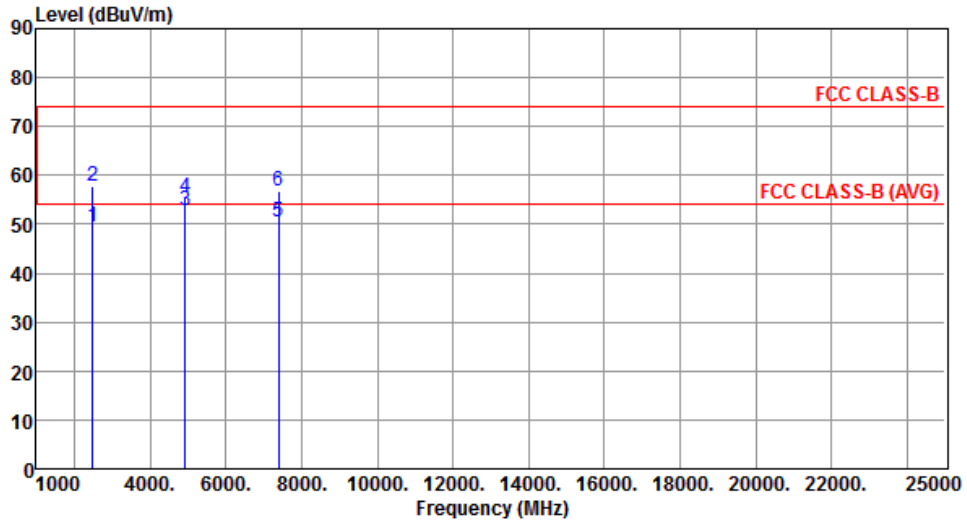

|   | Freq.<br>MHz | Emission<br>level<br>dBuV/m | Limit<br>dBuV/m | Margin<br>dB | SA<br>reading<br>dBuV | Factor<br>dB | Remark  | ANT<br>High<br>cm | Turn<br>Table<br>deg |
|---|--------------|-----------------------------|-----------------|--------------|-----------------------|--------------|---------|-------------------|----------------------|
| 1 | 2483.50      | 49.34                       | 54.00           | -4.66        | 50.57                 | -1.23        | Average | 216               | 296                  |
| 2 | 2483.50      | 57.89                       | 74.00           | -16.11       | 59.12                 | -1.23        | Peak    | 216               | 296                  |
| 3 | 4924.00      | 52.73                       | 54.00           | -1.27        | 47.46                 | 5.27         | Average | 100               | 345                  |
| 4 | 4924.00      | 55.30                       | 74.00           | -18.70       | 50.03                 | 5.27         | Peak    | 100               | 345                  |
| 5 | 7386.00      | 50.62                       | 54.00           | -3.38        | 40.57                 | 10.05        | Average | 130               | 355                  |
| 6 | 7386.00      | 56.63                       | 74.00           | -17.37       | 46.58                 | 10.05        | Peak    | 130               | 355                  |

Note 1: Emission Level (dBuV/m) = SA Reading (dBuV/m) + Factor\* (dB)

\*Factor includes antenna factor , cable loss and amplifier gain

Note 2: Margin (dB) = Emission level (dBuV/m) – Limit (dBuV/m).

|                     |          |                         |      |
|---------------------|----------|-------------------------|------|
| <b>Modulation</b>   | 11b      | <b>Test Freq. (MHz)</b> | 2462 |
| <b>Polarization</b> | Vertical |                         |      |

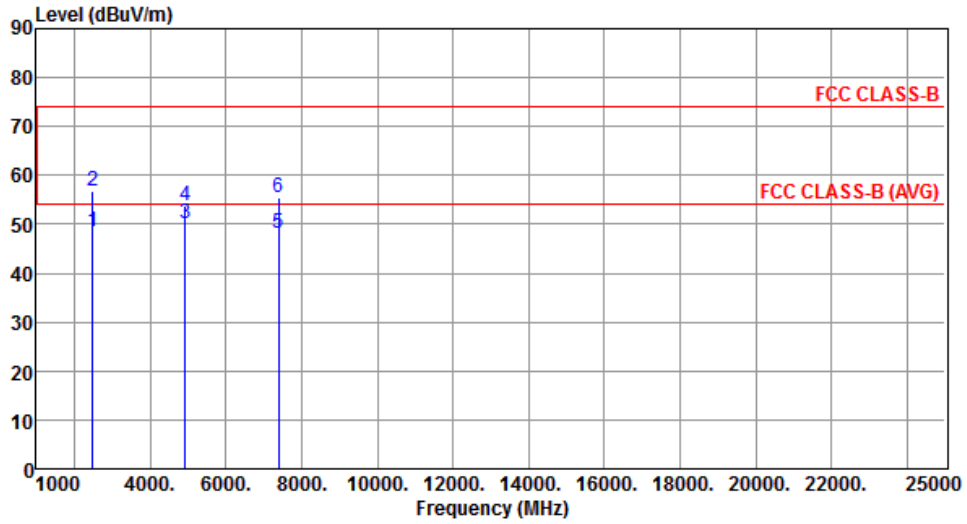

|   | Freq.<br>MHz | Emission<br>level<br>dBuV/m | Limit<br>dBuV/m | Margin<br>dB | SA<br>reading<br>dBuV | Factor<br>dB | Remark  | ANT<br>High<br>cm | Turn<br>Table<br>deg |
|---|--------------|-----------------------------|-----------------|--------------|-----------------------|--------------|---------|-------------------|----------------------|
| 1 | 2483.50      | 48.35                       | 54.00           | -5.65        | 49.58                 | -1.23        | Average | 260               | 266                  |
| 2 | 2483.50      | 56.79                       | 74.00           | -17.21       | 58.02                 | -1.23        | Peak    | 260               | 266                  |
| 3 | 4924.00      | 50.23                       | 54.00           | -3.77        | 44.96                 | 5.27         | Average | 350               | 269                  |
| 4 | 4924.00      | 53.68                       | 74.00           | -20.32       | 48.41                 | 5.27         | Peak    | 350               | 269                  |
| 5 | 7386.00      | 48.15                       | 54.00           | -5.85        | 38.10                 | 10.05        | Average | 100               | 99                   |
| 6 | 7386.00      | 55.46                       | 74.00           | -18.54       | 45.41                 | 10.05        | Peak    | 100               | 99                   |

Note 1: Emission Level (dBuV/m) = SA Reading (dBuV/m) + Factor\* (dB)

\*Factor includes antenna factor , cable loss and amplifier gain

Note 2: Margin (dB) = Emission level (dBuV/m) – Limit (dBuV/m).

### 3.5.6 Transmitter Radiated Unwanted Emissions (Above 1GHz) for 11g

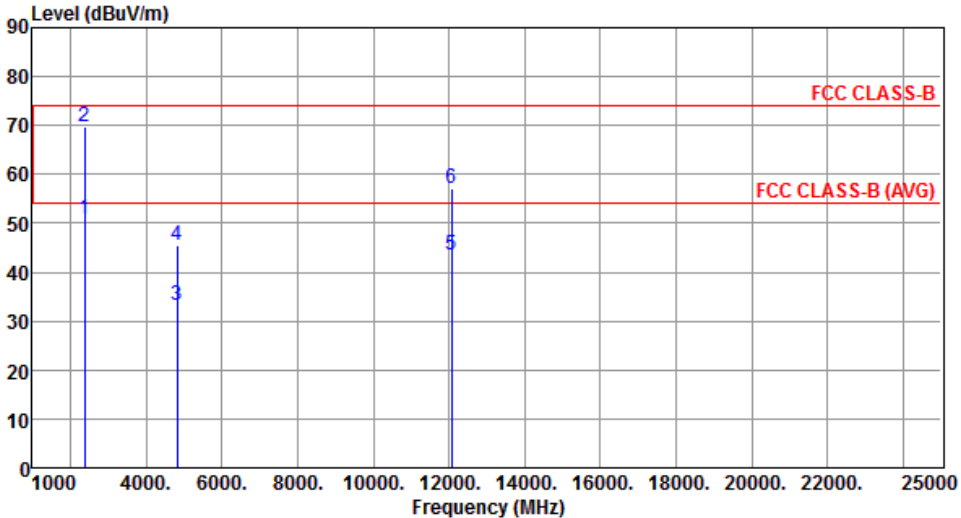
| Modulation  | 11g          | Test Freq. (MHz)            | 2412            |              |                       |              |         |                   |                      |
|---|--------------|-----------------------------|-----------------|--------------|-----------------------|--------------|---------|-------------------|----------------------|
| Polarization  | Horizontal   |                             |                 |              |                       |              |         |                   |                      |
|    |              |                             |                 |              |                       |              |         |                   |                      |
|   | Freq.<br>MHz | Emission<br>level<br>dBUV/m | Limit<br>dBUV/m | Margin<br>dB | SA<br>reading<br>dBUV | Factor<br>dB | Remark  | ANT<br>High<br>cm | Turn<br>Table<br>deg |
| 1   | 2390.00      | 50.95                       | 54.00           | -3.05        | 52.54                 | -1.59        | Average | 205               | 298                  |
| 2   | 2390.00      | 69.64                       | 74.00           | -4.36        | 71.23                 | -1.59        | Peak    | 205               | 298                  |
| 3   | 4824.00      | 33.05                       | 54.00           | -20.95       | 28.05                 | 5.00         | Average | 100               | 60                   |
| 4   | 4824.00      | 45.57                       | 74.00           | -28.43       | 40.57                 | 5.00         | Peak    | 100               | 60                   |
| 5   | 12060.00     | 43.64                       | 54.00           | -10.36       | 29.11                 | 14.53        | Average | 100               | 70                   |
| 6   | 12060.00     | 57.03                       | 74.00           | -16.97       | 42.50                 | 14.53        | Peak    | 100               | 70                   |
| <p>Note 1: Emission Level (dBUV/m) = SA Reading (dBUV/m) + Factor* (dB)<br/> *Factor includes antenna factor , cable loss and amplifier gain<br/> Note 2: Margin (dB) = Emission level (dBUV/m) – Limit (dBUV/m).</p> |              |                             |                 |              |                       |              |         |                   |                      |



|                     |          |                         |      |
|---------------------|----------|-------------------------|------|
| <b>Modulation</b>   | 11g      | <b>Test Freq. (MHz)</b> | 2412 |
| <b>Polarization</b> | Vertical |                         |      |

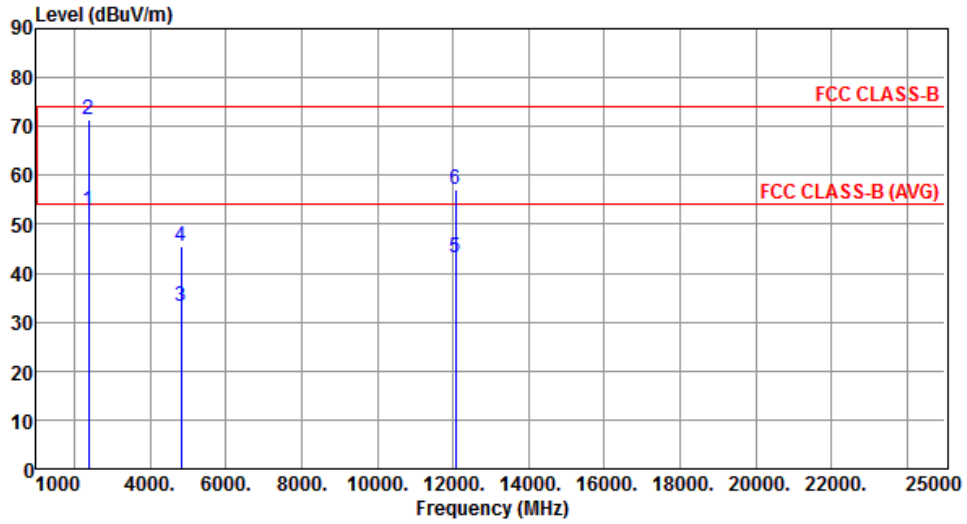

|   | Freq.<br>MHz | Emission<br>level<br>dBuV/m | Limit<br>dBuV/m | Margin<br>dB | SA<br>reading<br>dBuV | Factor<br>dB | Remark  | ANT<br>High<br>cm | Turn<br>Table<br>deg |
|---|--------------|-----------------------------|-----------------|--------------|-----------------------|--------------|---------|-------------------|----------------------|
| 1 | 2390.00      | 52.84                       | 54.00           | -1.16        | 54.43                 | -1.59        | Average | 273               | 267                  |
| 2 | 2390.00      | 71.27                       | 74.00           | -2.73        | 72.86                 | -1.59        | Peak    | 273               | 267                  |
| 3 | 4824.00      | 33.12                       | 54.00           | -20.88       | 28.12                 | 5.00         | Average | 100               | 20                   |
| 4 | 4824.00      | 45.57                       | 74.00           | -28.43       | 40.57                 | 5.00         | Peak    | 100               | 20                   |
| 5 | 12060.00     | 43.09                       | 54.00           | -10.91       | 28.56                 | 14.53        | Average | 100               | 60                   |
| 6 | 12060.00     | 57.09                       | 74.00           | -16.91       | 42.56                 | 14.53        | Peak    | 100               | 60                   |

Note 1: Emission Level (dBuV/m) = SA Reading (dBuV/m) + Factor\* (dB)

\*Factor includes antenna factor , cable loss and amplifier gain

Note 2: Margin (dB) = Emission level (dBuV/m) – Limit (dBuV/m).

|                     |            |                         |      |
|---------------------|------------|-------------------------|------|
| <b>Modulation</b>   | 11g        | <b>Test Freq. (MHz)</b> | 2437 |
| <b>Polarization</b> | Horizontal |                         |      |

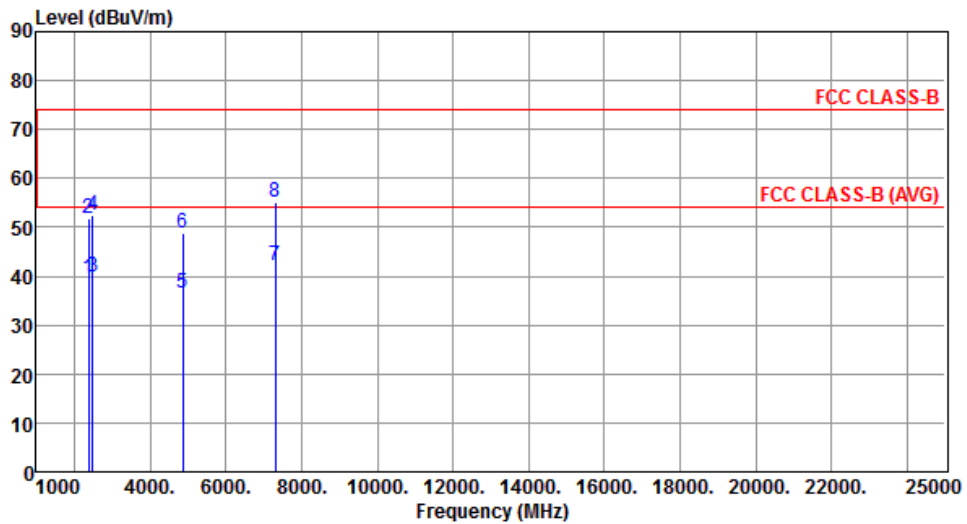

|   | Freq.<br>MHz | Emission<br>level<br>dBuV/m | Limit<br>dBuV/m | Margin<br>dB | SA<br>reading<br>dBuV | Factor<br>dB | Remark  | ANT<br>High<br>cm | Turn<br>Table<br>deg |
|---|--------------|-----------------------------|-----------------|--------------|-----------------------|--------------|---------|-------------------|----------------------|
| 1 | 2390.00      | 39.66                       | 54.00           | -14.34       | 41.25                 | -1.59        | Average | 198               | 297                  |
| 2 | 2390.00      | 51.91                       | 74.00           | -22.09       | 53.50                 | -1.59        | Peak    | 198               | 297                  |
| 3 | 2483.50      | 39.80                       | 54.00           | -14.20       | 41.03                 | -1.23        | Average | 198               | 297                  |
| 4 | 2483.50      | 52.42                       | 74.00           | -21.58       | 53.65                 | -1.23        | Peak    | 198               | 297                  |
| 5 | 4874.00      | 36.39                       | 54.00           | -17.61       | 31.26                 | 5.13         | Average | 100               | 315                  |
| 6 | 4874.00      | 48.70                       | 74.00           | -25.30       | 43.57                 | 5.13         | Peak    | 100               | 315                  |
| 7 | 7311.00      | 42.18                       | 54.00           | -11.82       | 32.26                 | 9.92         | Average | 100               | 10                   |
| 8 | 7311.00      | 55.12                       | 74.00           | -18.88       | 45.20                 | 9.92         | Peak    | 100               | 10                   |

Note 1: Emission Level (dBuV/m) = SA Reading (dBuV/m) + Factor\* (dB)

\*Factor includes antenna factor , cable loss and amplifier gain

Note 2: Margin (dB) = Emission level (dBuV/m) – Limit (dBuV/m).

|                     |          |                         |      |
|---------------------|----------|-------------------------|------|
| <b>Modulation</b>   | 11g      | <b>Test Freq. (MHz)</b> | 2437 |
| <b>Polarization</b> | Vertical |                         |      |

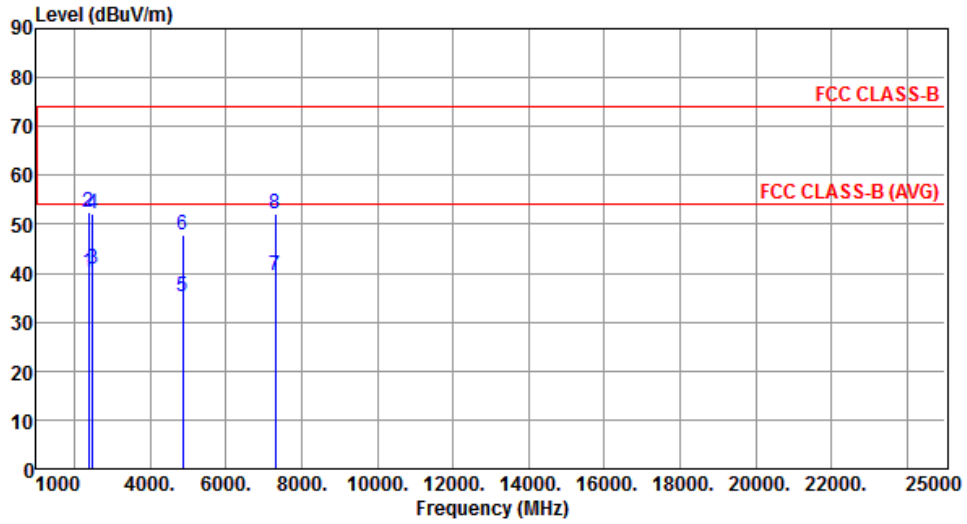

|   | Freq.<br>MHz | Emission<br>level<br>dBuV/m | Limit<br>dBuV/m | Margin<br>dB | SA<br>reading<br>dBuV | Factor<br>dB | Remark  | ANT<br>High<br>cm | Turn<br>Table<br>deg |
|---|--------------|-----------------------------|-----------------|--------------|-----------------------|--------------|---------|-------------------|----------------------|
| 1 | 2390.00      | 40.10                       | 54.00           | -13.90       | 41.69                 | -1.59        | Average | 263               | 270                  |
| 2 | 2390.00      | 52.36                       | 74.00           | -21.64       | 53.95                 | -1.59        | Peak    | 263               | 270                  |
| 3 | 2483.50      | 40.72                       | 54.00           | -13.28       | 41.95                 | -1.23        | Average | 263               | 270                  |
| 4 | 2483.50      | 52.12                       | 74.00           | -21.88       | 53.35                 | -1.23        | Peak    | 263               | 270                  |
| 5 | 4874.00      | 35.16                       | 54.00           | -18.84       | 30.03                 | 5.13         | Average | 100               | 194                  |
| 6 | 4874.00      | 47.70                       | 74.00           | -26.30       | 42.57                 | 5.13         | Peak    | 100               | 194                  |
| 7 | 7311.00      | 39.45                       | 54.00           | -14.55       | 29.53                 | 9.92         | Average | 100               | 30                   |
| 8 | 7311.00      | 52.05                       | 74.00           | -21.95       | 42.13                 | 9.92         | Peak    | 100               | 30                   |

Note 1: Emission Level (dBuV/m) = SA Reading (dBuV/m) + Factor\* (dB)

\*Factor includes antenna factor , cable loss and amplifier gain

Note 2: Margin (dB) = Emission level (dBuV/m) – Limit (dBuV/m).

|                     |            |                         |      |
|---------------------|------------|-------------------------|------|
| <b>Modulation</b>   | 11g        | <b>Test Freq. (MHz)</b> | 2462 |
| <b>Polarization</b> | Horizontal |                         |      |

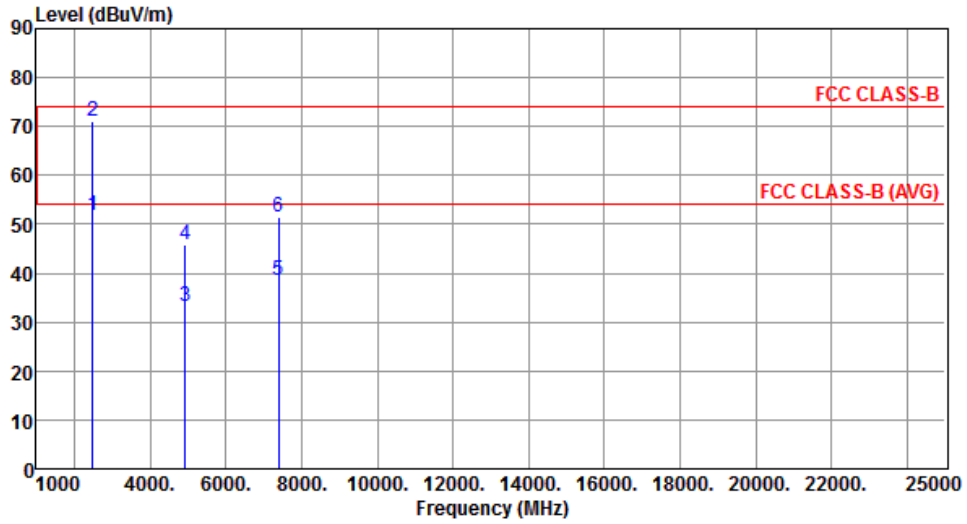

|   | Freq.<br>MHz | Emission<br>level<br>dBuV/m | Limit<br>dBuV/m | Margin<br>dB | SA<br>reading<br>dBuV | Factor<br>dB | Remark  | ANT<br>High<br>cm | Turn<br>Table<br>deg |
|---|--------------|-----------------------------|-----------------|--------------|-----------------------|--------------|---------|-------------------|----------------------|
| 1 | 2483.50      | 51.72                       | 54.00           | -2.28        | 52.95                 | -1.23        | Average | 191               | 295                  |
| 2 | 2483.50      | 71.14                       | 74.00           | -2.86        | 72.37                 | -1.23        | Peak    | 191               | 295                  |
| 3 | 4924.00      | 33.28                       | 54.00           | -20.72       | 28.01                 | 5.27         | Average | 100               | 20                   |
| 4 | 4924.00      | 45.83                       | 74.00           | -28.17       | 40.56                 | 5.27         | Peak    | 100               | 20                   |
| 5 | 7386.00      | 38.52                       | 54.00           | -15.48       | 28.47                 | 10.05        | Average | 100               | 50                   |
| 6 | 7386.00      | 51.47                       | 74.00           | -22.53       | 41.42                 | 10.05        | Peak    | 100               | 50                   |

Note 1: Emission Level (dBuV/m) = SA Reading (dBuV/m) + Factor\* (dB)

\*Factor includes antenna factor , cable loss and amplifier gain

Note 2: Margin (dB) = Emission level (dBuV/m) – Limit (dBuV/m).

|                     |          |                         |      |
|---------------------|----------|-------------------------|------|
| <b>Modulation</b>   | 11g      | <b>Test Freq. (MHz)</b> | 2462 |
| <b>Polarization</b> | Vertical |                         |      |

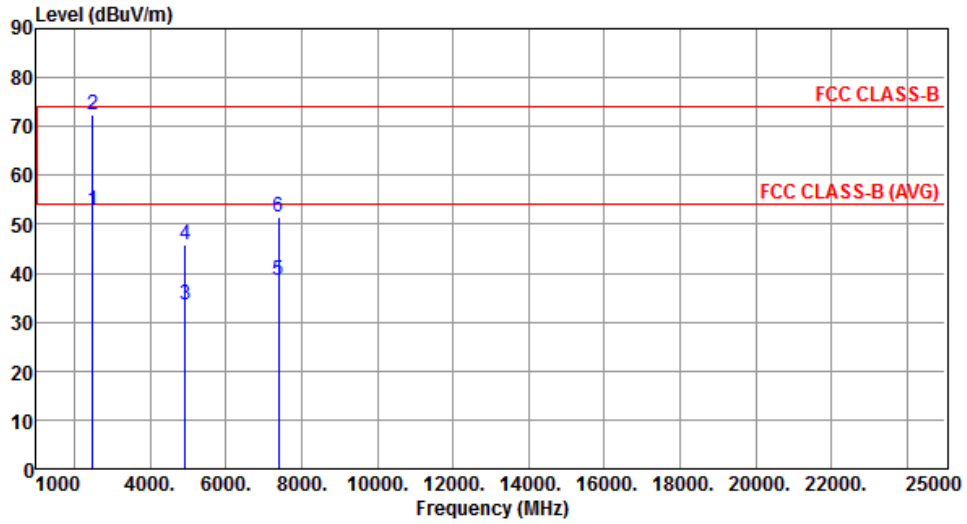

|   | Freq.<br>MHz | Emission<br>level<br>dBuV/m | Limit<br>dBuV/m | Margin<br>dB | SA<br>reading<br>dBuV | Factor<br>dB | Remark  | ANT<br>High<br>cm | Turn<br>Table<br>deg |
|---|--------------|-----------------------------|-----------------|--------------|-----------------------|--------------|---------|-------------------|----------------------|
| 1 | 2483.50      | 52.72                       | 54.00           | -1.28        | 53.95                 | -1.23        | Average | 257               | 270                  |
| 2 | 2483.50      | 72.31                       | 74.00           | -1.69        | 73.54                 | -1.23        | Peak    | 257               | 270                  |
| 3 | 4924.00      | 33.39                       | 54.00           | -20.61       | 28.12                 | 5.27         | Average | 100               | 30                   |
| 4 | 4924.00      | 45.84                       | 74.00           | -28.16       | 40.57                 | 5.27         | Peak    | 100               | 30                   |
| 5 | 7386.00      | 38.64                       | 54.00           | -15.36       | 28.59                 | 10.05        | Average | 100               | 50                   |
| 6 | 7386.00      | 51.32                       | 74.00           | -22.68       | 41.27                 | 10.05        | Peak    | 100               | 50                   |

Note 1: Emission Level (dBuV/m) = SA Reading (dBuV/m) + Factor\* (dB)

\*Factor includes antenna factor , cable loss and amplifier gain

Note 2: Margin (dB) = Emission level (dBuV/m) – Limit (dBuV/m).

### 3.5.7 Transmitter Radiated Unwanted Emissions (Above 1GHz) for HT20

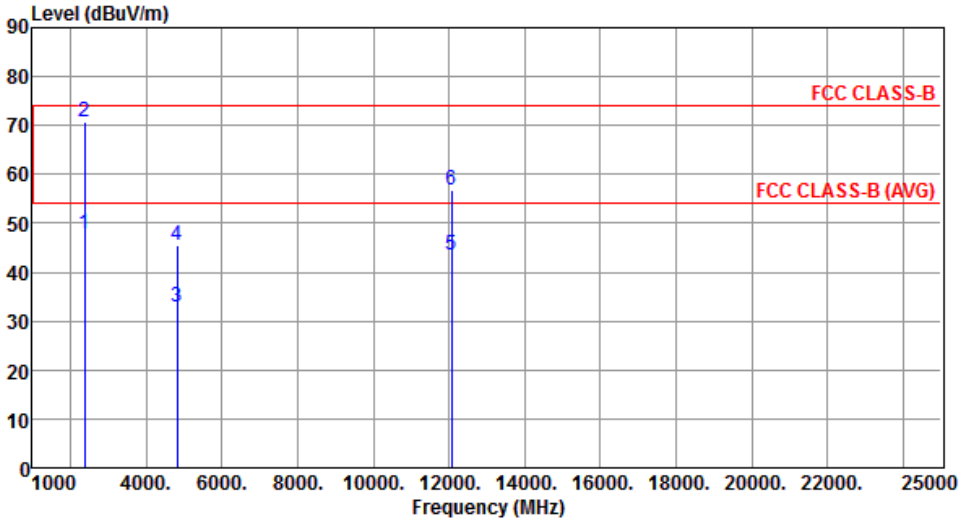
| Modulation  | HT20                  | Test Freq. (MHz) | 2412      |                 |           |        |             |                |     |
|---|-----------------------|------------------|-----------|-----------------|-----------|--------|-------------|----------------|-----|
| Polarization  | Horizontal            |                  |           |                 |           |        |             |                |     |
|  <p>The graph plots Level (dBuV/m) on the y-axis (0 to 90) against Frequency (MHz) on the x-axis (1000 to 25000). Two horizontal red lines represent FCC CLASS-B (at ~74 dBuV/m) and FCC CLASS-B (AVG) (at ~54 dBuV/m). Six vertical blue lines represent measured emission levels at various frequencies, labeled 1 through 6. The data points are summarized in the table below.</p> |                       |                  |           |                 |           |        |             |                |     |
| Freq. MHz   | Emission level dBuV/m | Limit dBuV/m     | Margin dB | SA reading dBuV | Factor dB | Remark | ANT High cm | Turn Table deg |     |
| 1   | 2390.00               | 47.95            | 54.00     | -6.05           | 49.54     | -1.59  | Average     | 208            | 298 |
| 2   | 2390.00               | 70.64            | 74.00     | -3.36           | 72.23     | -1.59  | Peak        | 208            | 298 |
| 3   | 4824.00               | 32.95            | 54.00     | -21.05          | 27.95     | 5.00   | Average     | 100            | 60  |
| 4   | 4824.00               | 45.57            | 74.00     | -28.43          | 40.57     | 5.00   | Peak        | 100            | 60  |
| 5   | 12060.00              | 43.37            | 54.00     | -10.63          | 28.84     | 14.53  | Average     | 100            | 70  |
| 6   | 12060.00              | 56.64            | 74.00     | -17.36          | 42.11     | 14.53  | Peak        | 100            | 70  |

Note 1: Emission Level (dBuV/m) = SA Reading (dBuV/m) + Factor\* (dB)  
\*Factor includes antenna factor , cable loss and amplifier gain  
Note 2: Margin (dB) = Emission level (dBuV/m) – Limit (dBuV/m).

|                     |          |                         |      |
|---------------------|----------|-------------------------|------|
| <b>Modulation</b>   | HT20     | <b>Test Freq. (MHz)</b> | 2412 |
| <b>Polarization</b> | Vertical |                         |      |

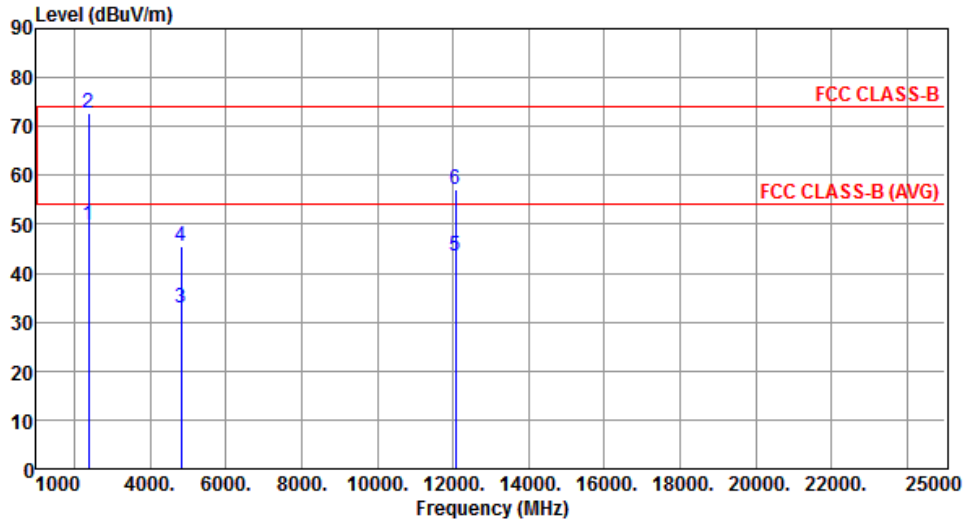

|   | Freq.<br>MHz | Emission<br>level<br>dBuV/m | Limit<br>dBuV/m | Margin<br>dB | SA<br>reading<br>dBuV | Factor<br>dB | Remark  | ANT<br>High<br>cm | Turn<br>Table<br>deg |
|---|--------------|-----------------------------|-----------------|--------------|-----------------------|--------------|---------|-------------------|----------------------|
| 1 | 2390.00      | 49.84                       | 54.00           | -4.16        | 51.43                 | -1.59        | Average | 274               | 266                  |
| 2 | 2390.00      | 72.86                       | 74.00           | -1.14        | 74.45                 | -1.59        | Peak    | 274               | 266                  |
| 3 | 4824.00      | 33.04                       | 54.00           | -20.96       | 28.04                 | 5.00         | Average | 100               | 100                  |
| 4 | 4824.00      | 45.54                       | 74.00           | -28.46       | 40.54                 | 5.00         | Peak    | 100               | 100                  |
| 5 | 12060.00     | 43.39                       | 54.00           | -10.61       | 28.86                 | 14.53        | Average | 100               | 90                   |
| 6 | 12060.00     | 57.08                       | 74.00           | -16.92       | 42.55                 | 14.53        | Peak    | 100               | 90                   |

Note 1: Emission Level (dBuV/m) = SA Reading (dBuV/m) + Factor\* (dB)

\*Factor includes antenna factor , cable loss and amplifier gain

Note 2: Margin (dB) = Emission level (dBuV/m) – Limit (dBuV/m).

|                     |            |                         |      |
|---------------------|------------|-------------------------|------|
| <b>Modulation</b>   | HT20       | <b>Test Freq. (MHz)</b> | 2437 |
| <b>Polarization</b> | Horizontal |                         |      |

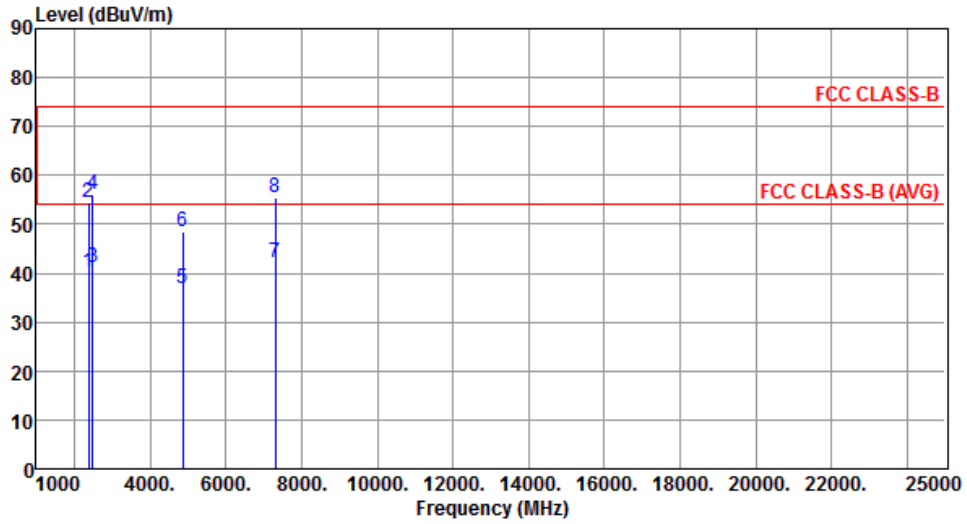

|   | Freq.<br>MHz | Emission<br>level<br>dBuV/m | Limit<br>dBuV/m | Margin<br>dB | SA<br>reading<br>dBuV | Factor<br>dB | Remark  | ANT<br>High<br>cm | Turn<br>Table<br>deg |
|---|--------------|-----------------------------|-----------------|--------------|-----------------------|--------------|---------|-------------------|----------------------|
| 1 | 2390.00      | 40.22                       | 54.00           | -13.78       | 41.81                 | -1.59        | Average | 204               | 296                  |
| 2 | 2390.00      | 54.57                       | 74.00           | -19.43       | 56.16                 | -1.59        | Peak    | 204               | 296                  |
| 3 | 2483.50      | 41.07                       | 54.00           | -12.93       | 42.30                 | -1.23        | Average | 204               | 296                  |
| 4 | 2483.50      | 56.01                       | 74.00           | -17.99       | 57.24                 | -1.23        | Peak    | 204               | 296                  |
| 5 | 4874.00      | 36.86                       | 54.00           | -17.14       | 31.73                 | 5.13         | Average | 100               | 310                  |
| 6 | 4874.00      | 48.64                       | 74.00           | -25.36       | 43.51                 | 5.13         | Peak    | 100               | 310                  |
| 7 | 7311.00      | 42.04                       | 54.00           | -11.96       | 32.12                 | 9.92         | Average | 100               | 6                    |
| 8 | 7311.00      | 55.48                       | 74.00           | -18.52       | 45.56                 | 9.92         | Peak    | 100               | 6                    |

Note 1: Emission Level (dBuV/m) = SA Reading (dBuV/m) + Factor\* (dB)

\*Factor includes antenna factor , cable loss and amplifier gain

Note 2: Margin (dB) = Emission level (dBuV/m) – Limit (dBuV/m).



|                     |          |                         |      |
|---------------------|----------|-------------------------|------|
| <b>Modulation</b>   | HT20     | <b>Test Freq. (MHz)</b> | 2437 |
| <b>Polarization</b> | Vertical |                         |      |

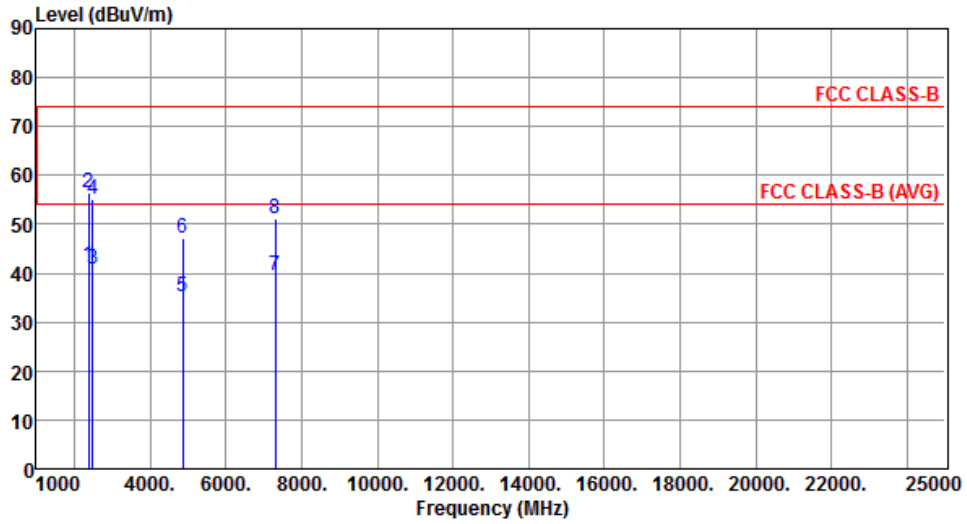

|   | Freq.<br>MHz | Emission<br>level<br>dBuV/m | Limit<br>dBuV/m | Margin<br>dB | SA<br>reading<br>dBuV | Factor<br>dB | Remark  | ANT<br>High<br>cm | Turn<br>Table<br>deg |
|---|--------------|-----------------------------|-----------------|--------------|-----------------------|--------------|---------|-------------------|----------------------|
| 1 | 2390.00      | 41.50                       | 54.00           | -12.50       | 43.09                 | -1.59        | Average | 268               | 267                  |
| 2 | 2390.00      | 56.53                       | 74.00           | -17.47       | 58.12                 | -1.59        | Peak    | 268               | 267                  |
| 3 | 2483.50      | 40.89                       | 54.00           | -13.11       | 42.12                 | -1.23        | Average | 268               | 267                  |
| 4 | 2483.50      | 54.98                       | 74.00           | -19.02       | 56.21                 | -1.23        | Peak    | 268               | 267                  |
| 5 | 4874.00      | 35.13                       | 54.00           | -18.87       | 30.00                 | 5.13         | Average | 100               | 195                  |
| 6 | 4874.00      | 47.14                       | 74.00           | -26.86       | 42.01                 | 5.13         | Peak    | 100               | 195                  |
| 7 | 7311.00      | 39.42                       | 54.00           | -14.58       | 29.50                 | 9.92         | Average | 100               | 20                   |
| 8 | 7311.00      | 51.25                       | 74.00           | -22.75       | 41.33                 | 9.92         | Peak    | 100               | 20                   |

Note 1: Emission Level (dBuV/m) = SA Reading (dBuV/m) + Factor\* (dB)

\*Factor includes antenna factor , cable loss and amplifier gain

Note 2: Margin (dB) = Emission level (dBuV/m) – Limit (dBuV/m).

|                     |            |                         |      |
|---------------------|------------|-------------------------|------|
| <b>Modulation</b>   | HT20       | <b>Test Freq. (MHz)</b> | 2462 |
| <b>Polarization</b> | Horizontal |                         |      |

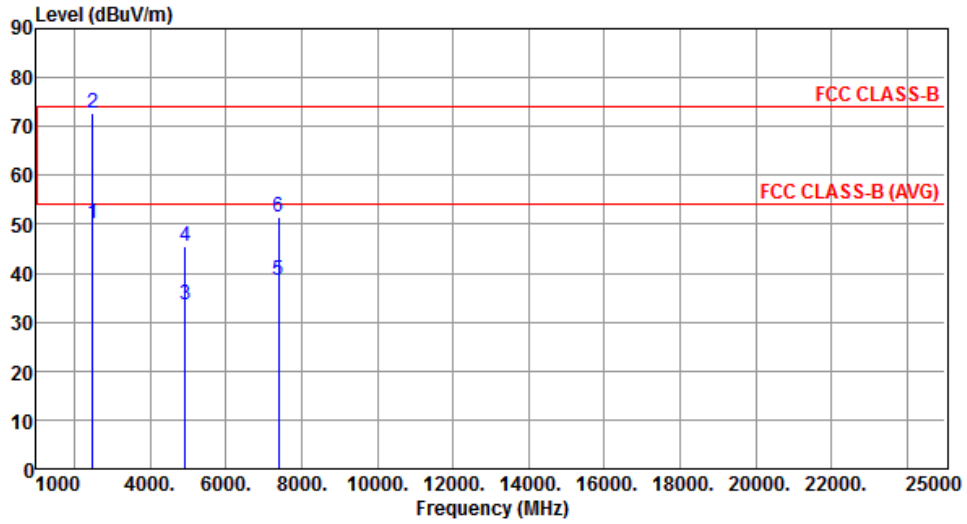

|   | Freq.<br>MHz | Emission<br>level<br>dBUV/m | Limit<br>dBUV/m | Margin<br>dB | SA<br>reading<br>dBUV | Factor<br>dB | Remark  | ANT<br>High<br>cm | Turn<br>Table<br>deg |
|---|--------------|-----------------------------|-----------------|--------------|-----------------------|--------------|---------|-------------------|----------------------|
| 1 | 2483.50      | 50.03                       | 54.00           | -3.97        | 51.26                 | -1.23        | Average | 191               | 297                  |
| 2 | 2483.50      | 72.84                       | 74.00           | -1.16        | 74.07                 | -1.23        | Peak    | 191               | 297                  |
| 3 | 4924.00      | 33.39                       | 54.00           | -20.61       | 28.12                 | 5.27         | Average | 100               | 20                   |
| 4 | 4924.00      | 45.62                       | 74.00           | -28.38       | 40.35                 | 5.27         | Peak    | 100               | 20                   |
| 5 | 7386.00      | 38.60                       | 54.00           | -15.40       | 28.55                 | 10.05        | Average | 100               | 50                   |
| 6 | 7386.00      | 51.38                       | 74.00           | -22.62       | 41.33                 | 10.05        | Peak    | 100               | 50                   |

Note 1: Emission Level (dBUV/m) = SA Reading (dBUV/m) + Factor\* (dB)

\*Factor includes antenna factor , cable loss and amplifier gain

Note 2: Margin (dB) = Emission level (dBUV/m) – Limit (dBUV/m).

|                     |          |                         |      |
|---------------------|----------|-------------------------|------|
| <b>Modulation</b>   | HT20     | <b>Test Freq. (MHz)</b> | 2462 |
| <b>Polarization</b> | Vertical |                         |      |

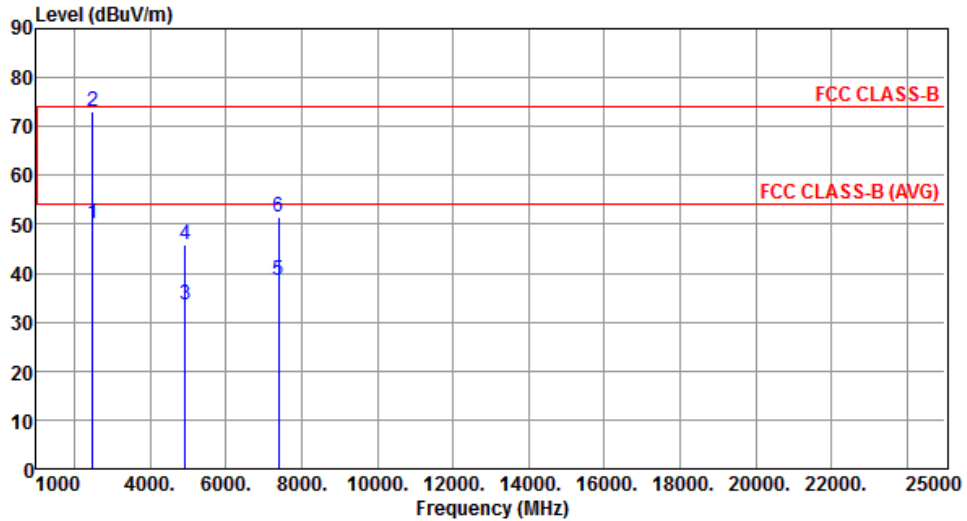

|   | Freq.<br>MHz | Emission<br>level<br>dBuV/m | Limit<br>dBuV/m | Margin<br>dB | SA<br>reading<br>dBuV | Factor<br>dB | Remark  | ANT<br>High<br>cm | Turn<br>Table<br>deg |
|---|--------------|-----------------------------|-----------------|--------------|-----------------------|--------------|---------|-------------------|----------------------|
| 1 | 2483.50      | 50.23                       | 54.00           | -3.77        | 51.46                 | -1.23        | Average | 255               | 269                  |
| 2 | 2483.50      | 73.00                       | 74.00           | -1.00        | 74.23                 | -1.23        | Peak    | 255               | 269                  |
| 3 | 4924.00      | 33.44                       | 54.00           | -20.56       | 28.17                 | 5.27         | Average | 100               | 80                   |
| 4 | 4924.00      | 45.83                       | 74.00           | -28.17       | 40.56                 | 5.27         | Peak    | 100               | 80                   |
| 5 | 7386.00      | 38.52                       | 54.00           | -15.48       | 28.47                 | 10.05        | Average | 100               | 90                   |
| 6 | 7386.00      | 51.57                       | 74.00           | -22.43       | 41.52                 | 10.05        | Peak    | 100               | 90                   |

Note 1: Emission Level (dBuV/m) = SA Reading (dBuV/m) + Factor\* (dB)

\*Factor includes antenna factor , cable loss and amplifier gain

Note 2: Margin (dB) = Emission level (dBuV/m) – Limit (dBuV/m).

### 3.5.8 Transmitter Radiated Unwanted Emissions (Above 1GHz) for HT40

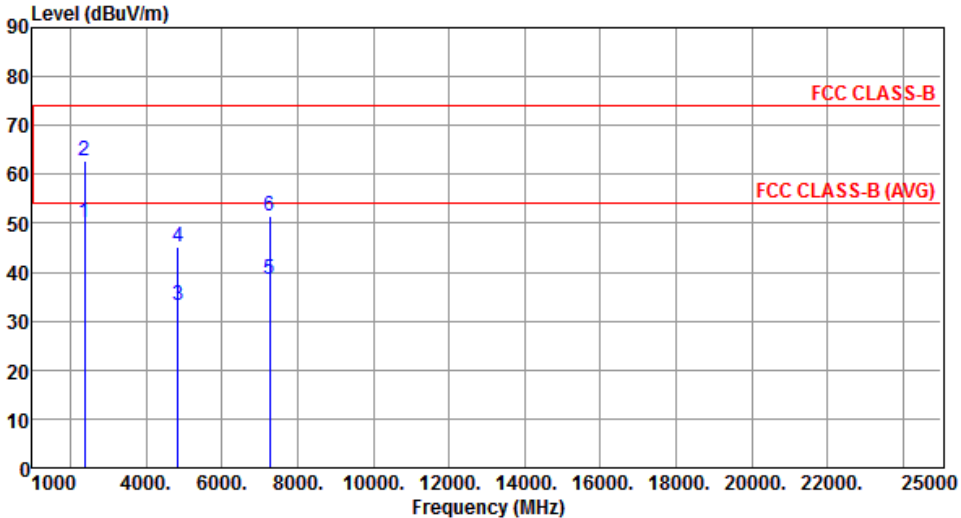
| Modulation  | HT40       | Test Freq. (MHz) | 2422   |        |            |        |         |          |            |
|---|------------|------------------|--------|--------|------------|--------|---------|----------|------------|
| Polarization  | Horizontal |                  |        |        |            |        |         |          |            |
|    |            |                  |        |        |            |        |         |          |            |
|   | Freq.      | Emission level   | Limit  | Margin | SA reading | Factor | Remark  | ANT High | Turn Table |
|   | MHz        | dBuV/m           | dBuV/m | dB     | dBuV       | dB     |         | cm       | deg        |
| 1   | 2390.00    | 50.11            | 54.00  | -3.89  | 51.70      | -1.59  | Average | 213      | 293        |
| 2   | 2390.00    | 62.69            | 74.00  | -11.31 | 64.28      | -1.59  | Peak    | 213      | 293        |
| 3   | 4844.00    | 33.11            | 54.00  | -20.89 | 28.05      | 5.06   | Average | 100      | 50         |
| 4   | 4844.00    | 45.32            | 74.00  | -28.68 | 40.26      | 5.06   | Peak    | 100      | 50         |
| 5   | 7266.00    | 38.38            | 54.00  | -15.62 | 28.54      | 9.84   | Average | 100      | 60         |
| 6   | 7266.00    | 51.42            | 74.00  | -22.58 | 41.58      | 9.84   | Peak    | 100      | 60         |
| <p>Note 1: Emission Level (dBuV/m) = SA Reading (dBuV/m) + Factor* (dB)<br/> *Factor includes antenna factor , cable loss and amplifier gain<br/> Note 2: Margin (dB) = Emission level (dBuV/m) – Limit (dBuV/m).</p> |            |                  |        |        |            |        |         |          |            |

|                     |          |                         |      |
|---------------------|----------|-------------------------|------|
| <b>Modulation</b>   | HT40     | <b>Test Freq. (MHz)</b> | 2422 |
| <b>Polarization</b> | Vertical |                         |      |

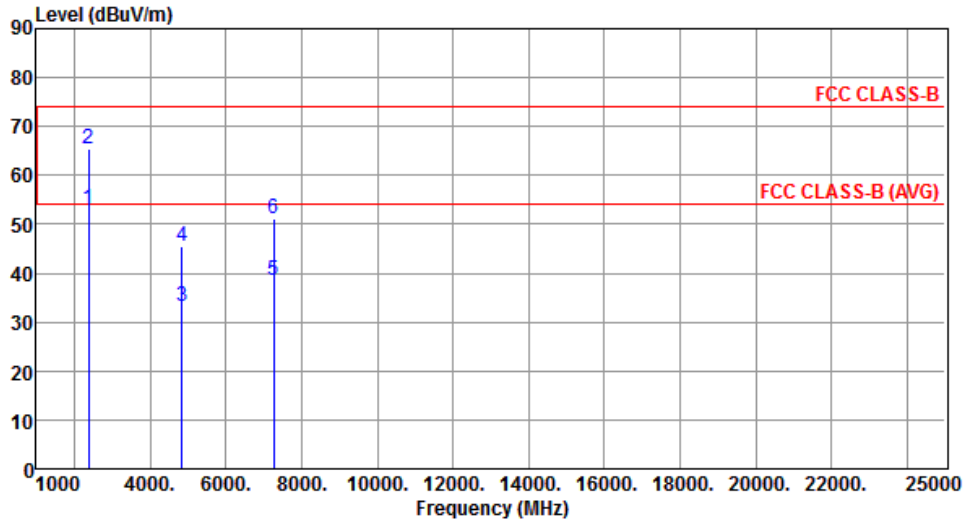

|   | Freq.<br>MHz | Emission<br>level<br>dBuV/m | Limit<br>dBuV/m | Margin<br>dB | SA<br>reading<br>dBuV | Factor<br>dB | Remark  | ANT<br>High<br>cm | Turn<br>Table<br>deg |
|---|--------------|-----------------------------|-----------------|--------------|-----------------------|--------------|---------|-------------------|----------------------|
| 1 | 2390.00      | 52.97                       | 54.00           | -1.03        | 54.56                 | -1.59        | Average | 275               | 268                  |
| 2 | 2390.00      | 65.53                       | 74.00           | -8.47        | 67.12                 | -1.59        | Peak    | 275               | 268                  |
| 3 | 4844.00      | 33.07                       | 54.00           | -20.93       | 28.01                 | 5.06         | Average | 100               | 20                   |
| 4 | 4844.00      | 45.41                       | 74.00           | -28.59       | 40.35                 | 5.06         | Peak    | 100               | 20                   |
| 5 | 7266.00      | 38.49                       | 54.00           | -15.51       | 28.65                 | 9.84         | Average | 100               | 20                   |
| 6 | 7266.00      | 51.10                       | 74.00           | -22.90       | 41.26                 | 9.84         | Peak    | 100               | 20                   |

Note 1: Emission Level (dBuV/m) = SA Reading (dBuV/m) + Factor\* (dB)

\*Factor includes antenna factor , cable loss and amplifier gain

Note 2: Margin (dB) = Emission level (dBuV/m) – Limit (dBuV/m).

|                     |            |                         |      |
|---------------------|------------|-------------------------|------|
| <b>Modulation</b>   | HT40       | <b>Test Freq. (MHz)</b> | 2437 |
| <b>Polarization</b> | Horizontal |                         |      |

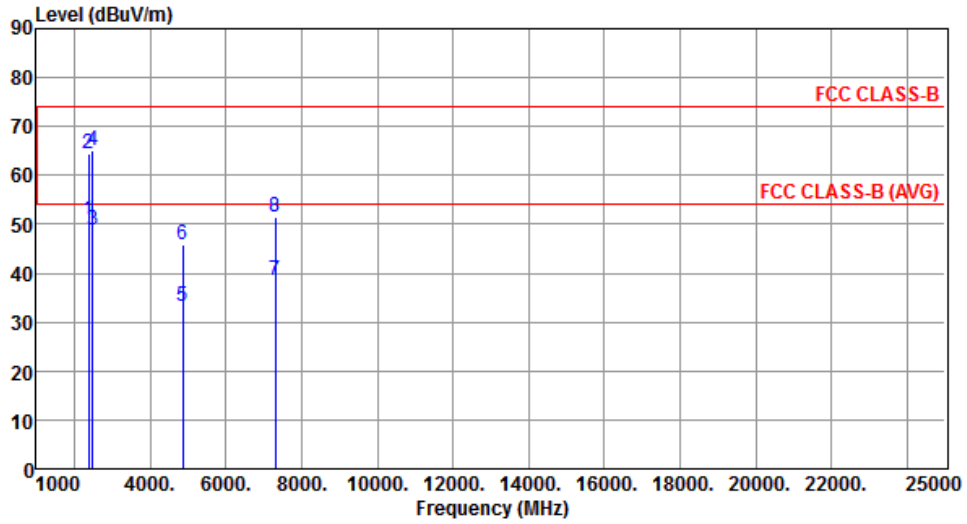

|   | Freq.<br>MHz | Emission<br>level<br>dBuV/m | Limit<br>dBuV/m | Margin<br>dB | SA<br>reading<br>dBuV | Factor<br>dB | Remark  | ANT<br>High<br>cm | Turn<br>Table<br>deg |
|---|--------------|-----------------------------|-----------------|--------------|-----------------------|--------------|---------|-------------------|----------------------|
| 1 | 2390.00      | 50.96                       | 54.00           | -3.04        | 52.55                 | -1.59        | Average | 202               | 295                  |
| 2 | 2390.00      | 64.37                       | 74.00           | -9.63        | 65.96                 | -1.59        | Peak    | 202               | 295                  |
| 3 | 2483.50      | 48.82                       | 54.00           | -5.18        | 50.05                 | -1.23        | Average | 202               | 295                  |
| 4 | 2483.50      | 65.04                       | 74.00           | -8.96        | 66.27                 | -1.23        | Peak    | 202               | 295                  |
| 5 | 4874.00      | 33.18                       | 54.00           | -20.82       | 28.05                 | 5.13         | Average | 100               | 30                   |
| 6 | 4874.00      | 45.70                       | 74.00           | -28.30       | 40.57                 | 5.13         | Peak    | 100               | 30                   |
| 7 | 7311.00      | 38.60                       | 54.00           | -15.40       | 28.68                 | 9.92         | Average | 100               | 90                   |
| 8 | 7311.00      | 51.43                       | 74.00           | -22.57       | 41.51                 | 9.92         | Peak    | 100               | 90                   |

Note 1: Emission Level (dBuV/m) = SA Reading (dBuV/m) + Factor\* (dB)

\*Factor includes antenna factor , cable loss and amplifier gain

Note 2: Margin (dB) = Emission level (dBuV/m) – Limit (dBuV/m).

|                     |          |                         |      |
|---------------------|----------|-------------------------|------|
| <b>Modulation</b>   | HT40     | <b>Test Freq. (MHz)</b> | 2437 |
| <b>Polarization</b> | Vertical |                         |      |

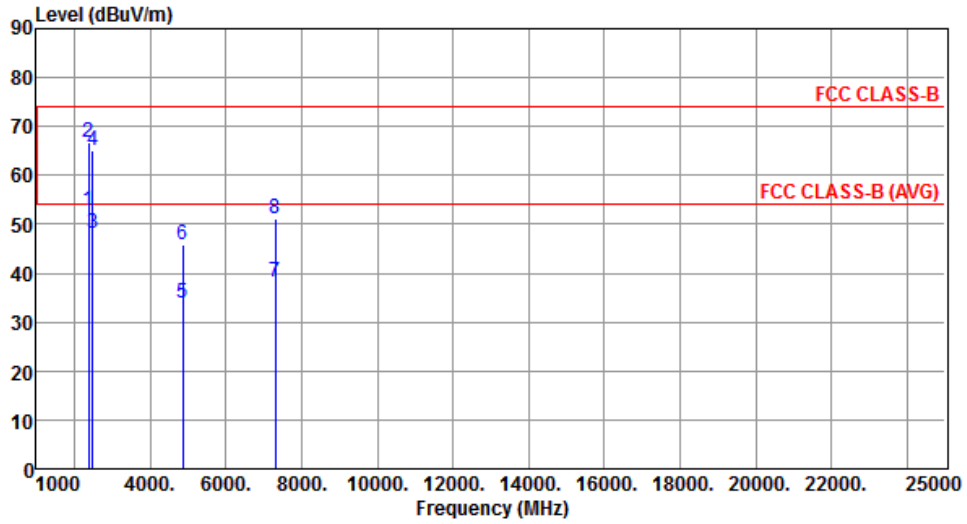

|   | Freq.<br>MHz | Emission<br>level<br>dBuV/m | Limit<br>dBuV/m | Margin<br>dB | SA<br>reading<br>dBuV | Factor<br>dB | Remark  | ANT<br>High<br>cm | Turn<br>Table<br>deg |
|---|--------------|-----------------------------|-----------------|--------------|-----------------------|--------------|---------|-------------------|----------------------|
| 1 | 2390.00      | 52.72                       | 54.00           | -1.28        | 54.31                 | -1.59        | Average | 265               | 270                  |
| 2 | 2390.00      | 66.81                       | 74.00           | -7.19        | 68.40                 | -1.59        | Peak    | 265               | 270                  |
| 3 | 2483.50      | 48.13                       | 54.00           | -5.87        | 49.36                 | -1.23        | Average | 265               | 270                  |
| 4 | 2483.50      | 64.98                       | 74.00           | -9.02        | 66.21                 | -1.23        | Peak    | 265               | 270                  |
| 5 | 4874.00      | 33.79                       | 54.00           | -20.21       | 28.66                 | 5.13         | Average | 100               | 50                   |
| 6 | 4874.00      | 45.82                       | 74.00           | -28.18       | 40.69                 | 5.13         | Peak    | 100               | 50                   |
| 7 | 7311.00      | 38.33                       | 54.00           | -15.67       | 28.41                 | 9.92         | Average | 100               | 90                   |
| 8 | 7311.00      | 51.26                       | 74.00           | -22.74       | 41.34                 | 9.92         | Peak    | 100               | 90                   |

Note 1: Emission Level (dBuV/m) = SA Reading (dBuV/m) + Factor\* (dB)

\*Factor includes antenna factor , cable loss and amplifier gain

Note 2: Margin (dB) = Emission level (dBuV/m) – Limit (dBuV/m).

|                     |            |                         |      |
|---------------------|------------|-------------------------|------|
| <b>Modulation</b>   | HT40       | <b>Test Freq. (MHz)</b> | 2452 |
| <b>Polarization</b> | Horizontal |                         |      |

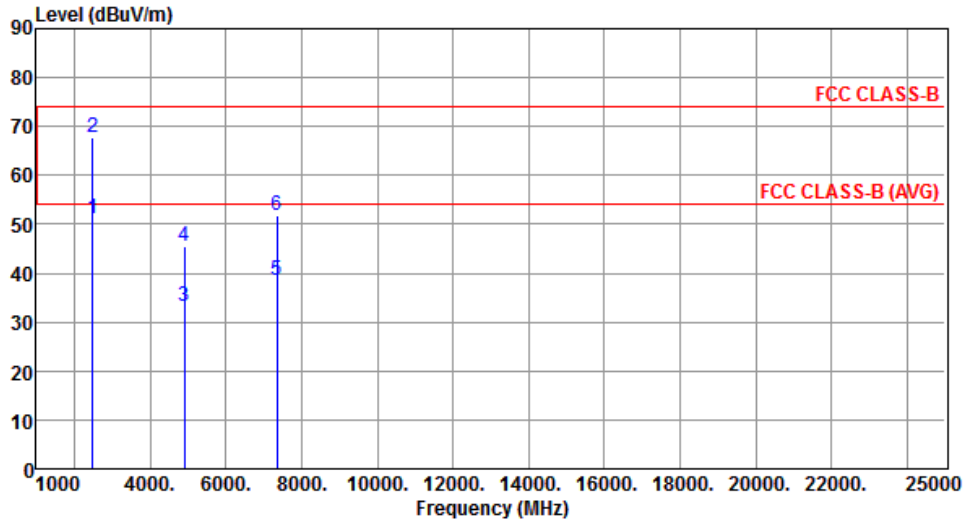

|   | Freq.<br>MHz | Emission<br>level<br>dBuV/m | Limit<br>dBuV/m | Margin<br>dB | SA<br>reading<br>dBuV | Factor<br>dB | Remark  | ANT<br>High<br>cm | Turn<br>Table<br>deg |
|---|--------------|-----------------------------|-----------------|--------------|-----------------------|--------------|---------|-------------------|----------------------|
| 1 | 2483.50      | 51.18                       | 54.00           | -2.82        | 52.41                 | -1.23        | Average | 204               | 294                  |
| 2 | 2483.50      | 67.70                       | 74.00           | -6.30        | 68.93                 | -1.23        | Peak    | 204               | 294                  |
| 3 | 4904.00      | 33.20                       | 54.00           | -20.80       | 27.98                 | 5.22         | Average | 100               | 50                   |
| 4 | 4904.00      | 45.43                       | 74.00           | -28.57       | 40.21                 | 5.22         | Peak    | 100               | 50                   |
| 5 | 7356.00      | 38.64                       | 54.00           | -15.36       | 28.65                 | 9.99         | Average | 100               | 60                   |
| 6 | 7356.00      | 51.68                       | 74.00           | -22.32       | 41.69                 | 9.99         | Peak    | 100               | 60                   |

Note 1: Emission Level (dBuV/m) = SA Reading (dBuV/m) + Factor\* (dB)

\*Factor includes antenna factor , cable loss and amplifier gain

Note 2: Margin (dB) = Emission level (dBuV/m) – Limit (dBuV/m).



|                     |          |                         |      |
|---------------------|----------|-------------------------|------|
| <b>Modulation</b>   | HT40     | <b>Test Freq. (MHz)</b> | 2452 |
| <b>Polarization</b> | Vertical |                         |      |

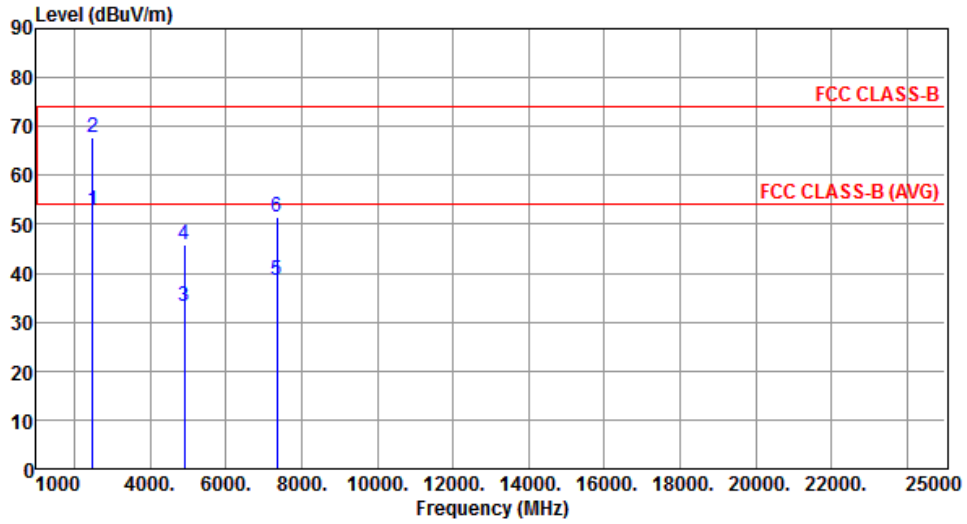

|   | Freq.<br>MHz | Emission<br>level<br>dBuV/m | Limit<br>dBuV/m | Margin<br>dB | SA<br>reading<br>dBuV | Factor<br>dB | Remark  | ANT<br>High<br>cm | Turn<br>Table<br>deg |
|---|--------------|-----------------------------|-----------------|--------------|-----------------------|--------------|---------|-------------------|----------------------|
| 1 | 2483.50      | 52.86                       | 54.00           | -1.14        | 54.09                 | -1.23        | Average | 266               | 259                  |
| 2 | 2483.50      | 67.82                       | 74.00           | -6.18        | 69.05                 | -1.23        | Peak    | 266               | 259                  |
| 3 | 4904.00      | 33.24                       | 54.00           | -20.76       | 28.02                 | 5.22         | Average | 100               | 30                   |
| 4 | 4904.00      | 45.80                       | 74.00           | -28.20       | 40.58                 | 5.22         | Peak    | 100               | 30                   |
| 5 | 7356.00      | 38.44                       | 54.00           | -15.56       | 28.45                 | 9.99         | Average | 100               | 60                   |
| 6 | 7356.00      | 51.55                       | 74.00           | -22.45       | 41.56                 | 9.99         | Peak    | 100               | 60                   |

Note 1: Emission Level (dBuV/m) = SA Reading (dBuV/m) + Factor\* (dB)

\*Factor includes antenna factor , cable loss and amplifier gain

Note 2: Margin (dB) = Emission level (dBuV/m) – Limit (dBuV/m).

## 3.6 Emissions in Non-Restricted Frequency Bands

### 3.6.1 Emissions in Non-Restricted Frequency Bands Limit

Peak power in any 100 kHz bandwidth outside of the authorized frequency band shall be attenuated by at least 20 dB relative to the maximum in-band peak PSD level in 100 kHz.

### 3.6.2 Test Procedures

#### Reference level measurement

1. Set RBW=100kHz, VBW = 300kHz , Detector = Peak, Sweep time = Auto
2. Trace = max hold , Allow Trace to fully stabilize
3. Use the peak marker function to determine the maximum PSD level

#### Emission level measurement

1. Set RBW=100kHz, VBW = 300kHz , Detector = Peak, Sweep time = Auto
2. Trace = max hold , Allow Trace to fully stabilize
3. Scan Frequency range is up to 25GHz
4. Use the peak marker function to determine the maximum amplitude level

### 3.6.3 Test Setup

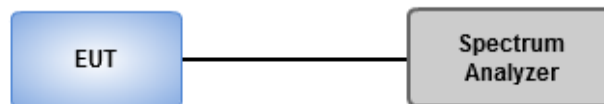

### 3.6.4 Unwanted Emissions into Non-Restricted Frequency Bands

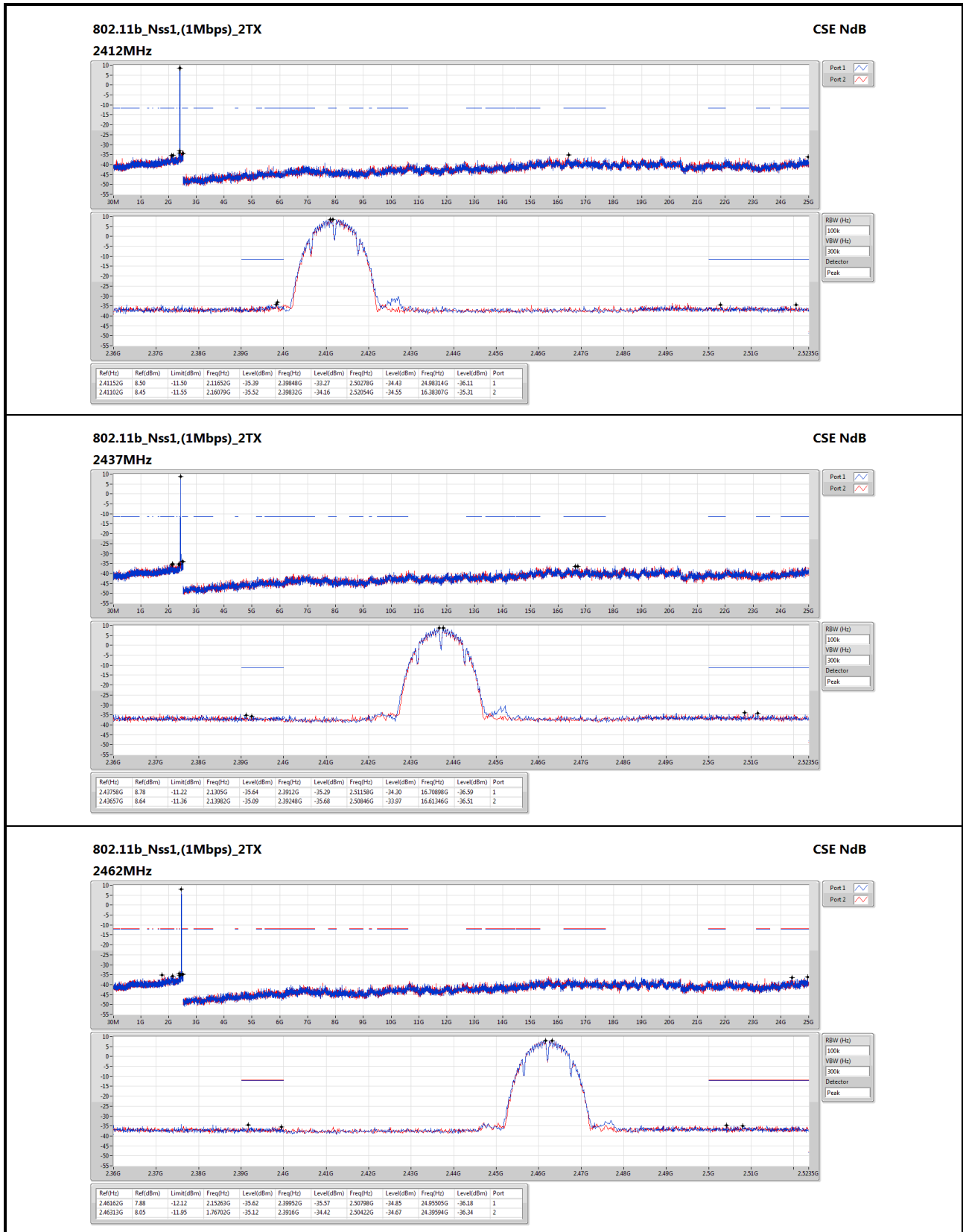
**802.11b\_Nss1,(1Mbps)\_2TX**
**CSE NdB**

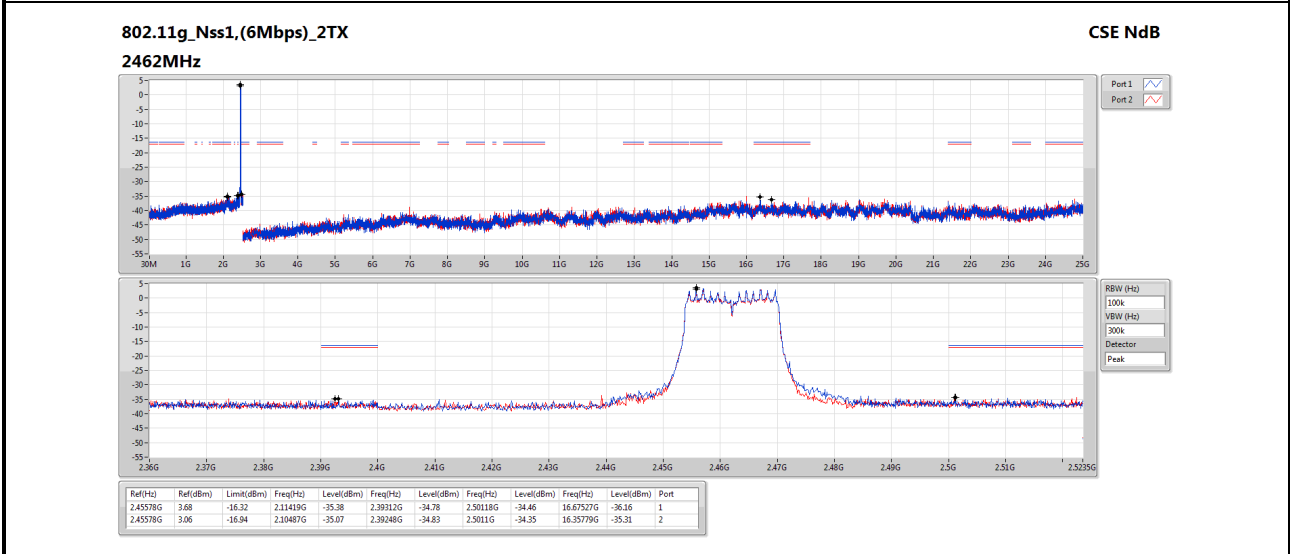
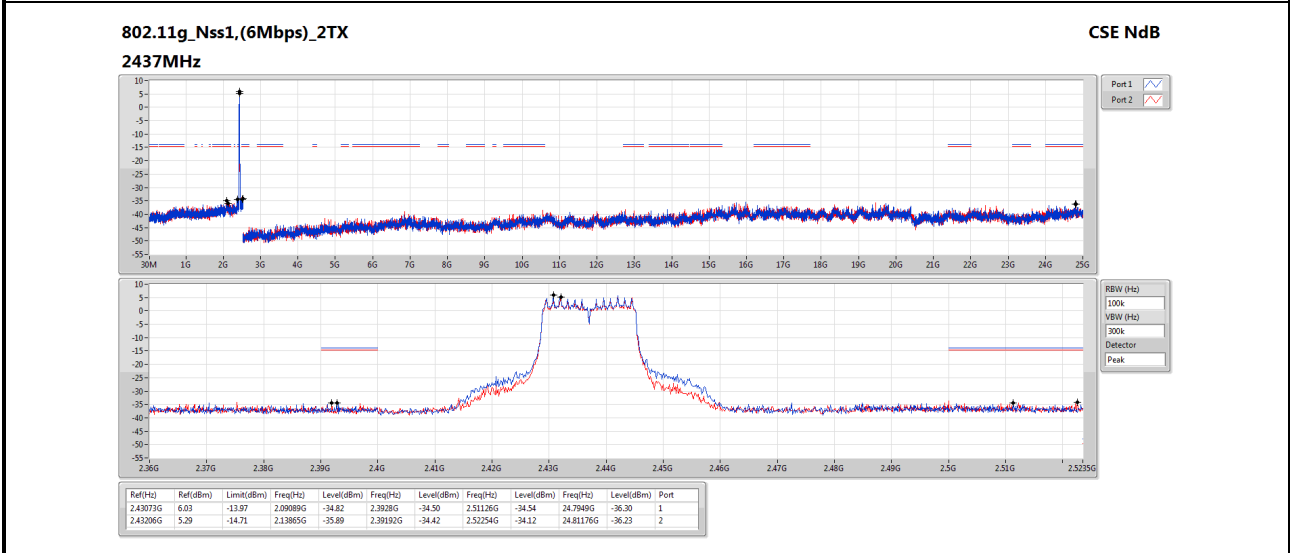
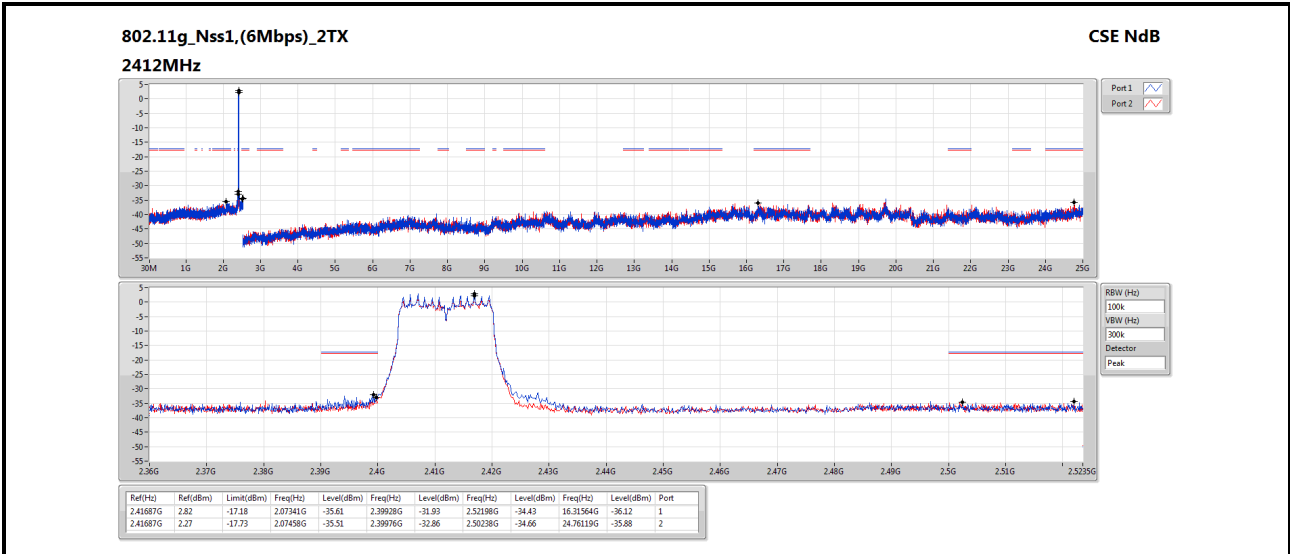

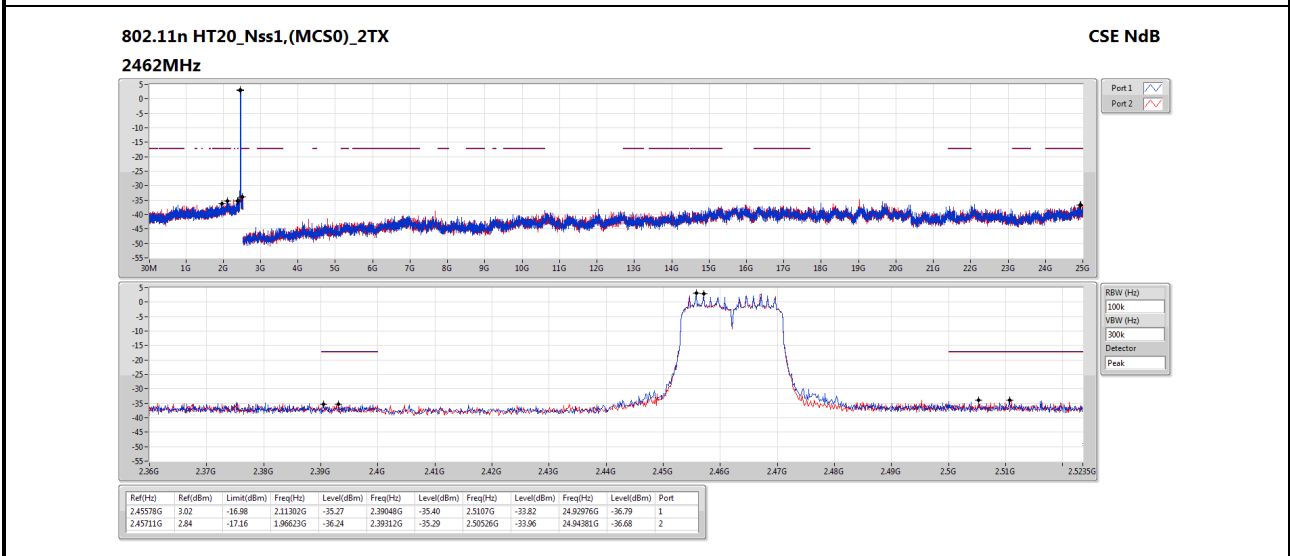
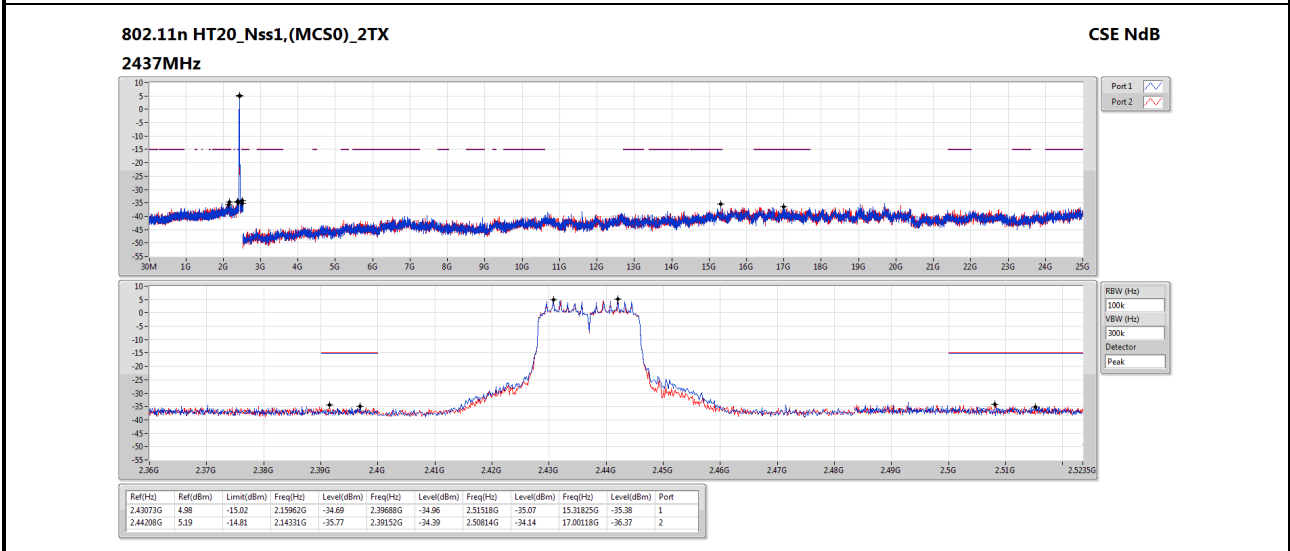
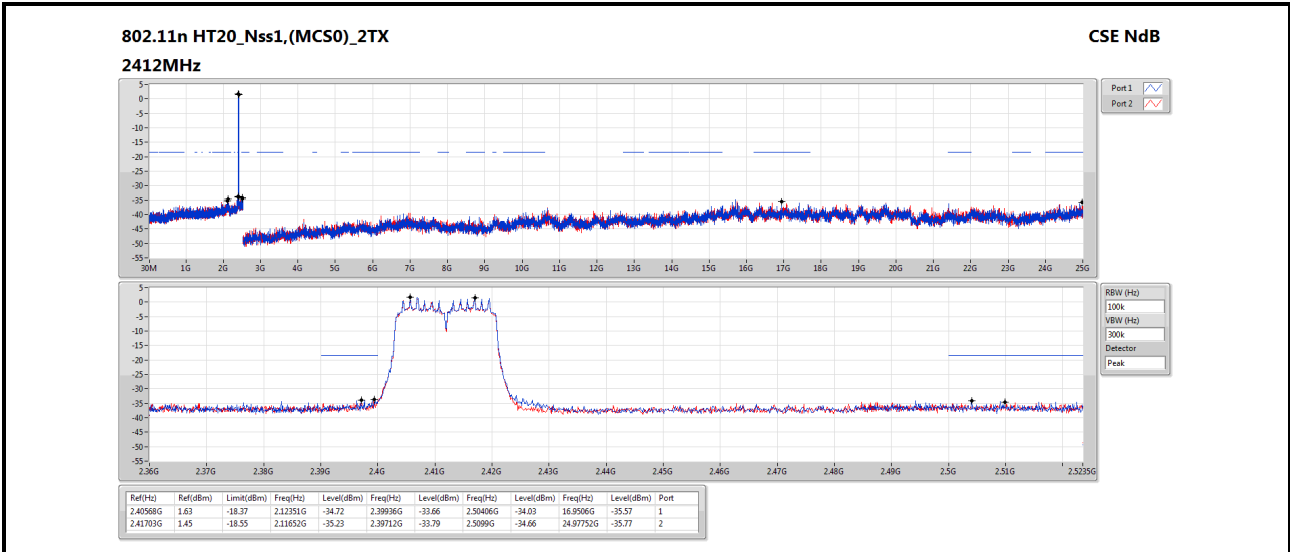

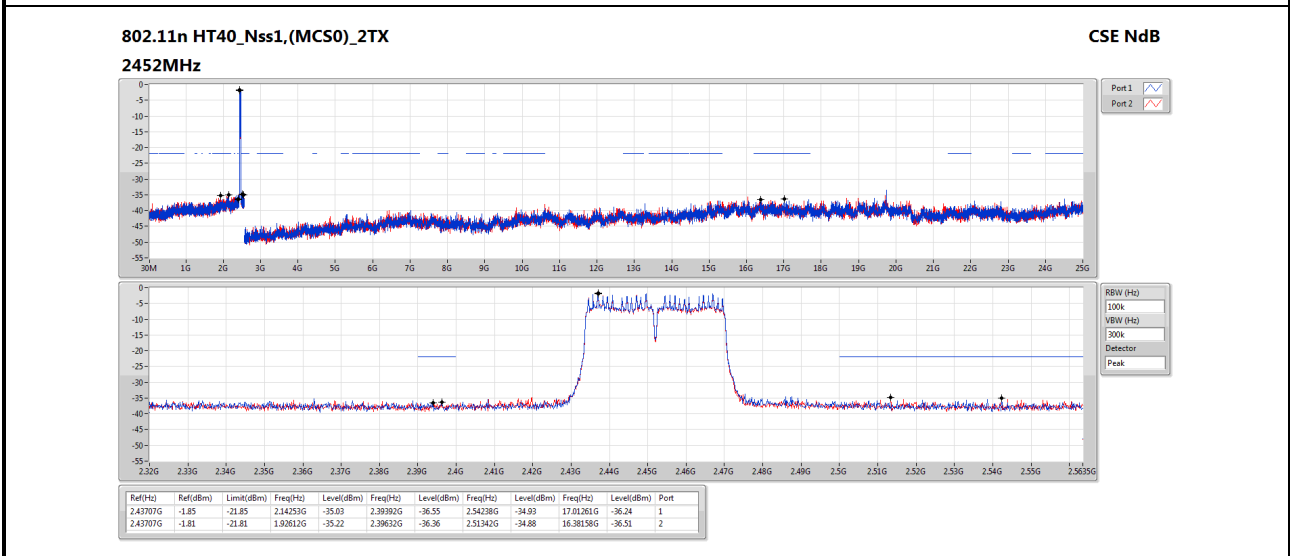
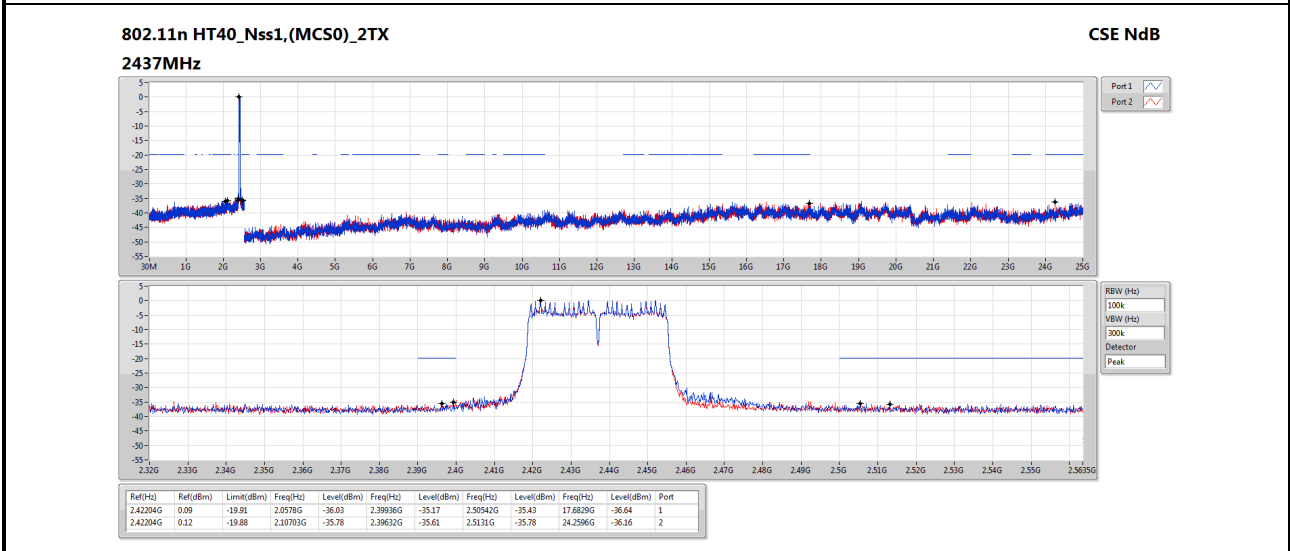
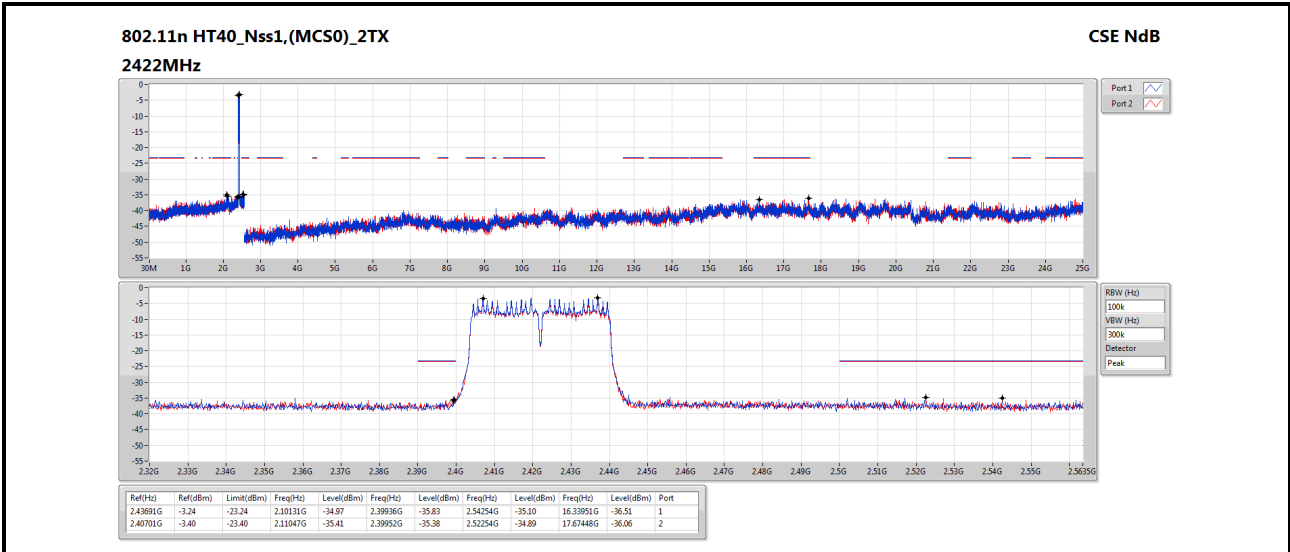

## 4 Test laboratory information

Established in 2012, ICC provides foremost EMC & RF Testing and advisory consultation services by our skilled engineers and technicians. Our services employ a wide variety of advanced edge test equipment and one of the widest certification extents in the business.

International Certification Corp (EMC and Wireless Communication Laboratory), it is our definitive objective is to institute long term, trust-based associations with our clients. The expectation we set up with our clients is based on outstanding service, practical expertise and devotion to a certified value structure. Our passion is to grant our clients with best EMC / RF services by oriented knowledgeable and accommodating staff.

Our Test sites are located at Linkou District and Kwei Shan District. Location map can be found on our website <http://www.icertifi.com.tw>.

### **Linkou**

Tel: 886-2-2601-1640

No. 30-2, Ding Fwu Tsuen, Lin  
Kou District, New Taipei City,  
Taiwan, R.O.C.

### **Kwei Shan**

Tel: 886-3-271-8666

No. 3-1, Lane 6, Wen San 3rd St.,  
Kwei Shan District, Tao Yuan City  
333, Taiwan, R.O.C.

### **Kwei Shan Site II**

Tel: 886-3-271-8640

No. 14-1, Lane 19, Wen San 3rd  
St., Kwei Shan District, Tao Yuan  
City 333, Taiwan, R.O.C.

If you have any suggestion, please feel free to contact us as below information.

Tel: 886-3-271-8666

Fax: 886-3-318-0155

Email: ICC\_Service@icertifi.com.tw

==END==