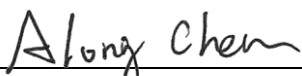

# FCC Test Report

**FCC ID** : U6Y-M120000015  
**Equipment** : IEEE 802.11A/B/G/N/AC DUAL 3T3R WIFI PCIE  
**Model No.** : M120000015  
**Brand Name** : Panasonic  
**Applicant** : Panasonic Avionics Corporation  
**Address** : 26200 ENTERPRISE WAY, LAKE FOREST, CA  
92630-8400 USA  
**Standard** : 47 CFR FCC Part 15.407  
**Received Date** : Nov. 28, 2016  
**Tested Date** : Dec. 02, 2016 ~ Feb. 03, 2017

We, International Certification Corp., would like to declare that the tested sample has been evaluated and in compliance with the requirement of the above standards. The test results contained in this report refer exclusively to the product. It may be duplicated completely for legal use with the approval of the applicant. It shall not be reproduced except in full without the written approval of our laboratory.

Reviewed by:

  
\_\_\_\_\_  
Along Chen / Assistant Manager

Approved by:

  
\_\_\_\_\_  
Gary Chang / Manager



---

## Table of Contents

<b>1</b>	<b>GENERAL DESCRIPTION .....</b>	<b>5</b>
1.1	Information.....	5
1.2	Local Support Equipment List .....	10
1.3	Test Setup Chart .....	10
1.4	The Equipment List .....	11
1.5	Testing Applied Standards .....	12
1.6	Measurement Uncertainty .....	12
<b>2</b>	<b>TEST CONFIGURATION .....</b>	<b>13</b>
2.1	Testing Condition .....	13
2.2	The Worst Test Modes and Channel Details .....	13
<b>3</b>	<b>TRANSMITTER TEST RESULTS.....</b>	<b>15</b>
3.1	Conducted Emissions.....	15
3.2	Emission Bandwidth .....	20
3.3	RF Output Power .....	25
3.4	Peak Power Spectral Density .....	31
3.5	Transmitter Radiated and Band Edge Emissions .....	36
3.6	Frequency Stability.....	125
<b>4</b>	<b>TEST LABORATORY INFORMATION .....</b>	<b>127</b>

---

## Release Record

Report No.	Version	Description	Issued Date
FR6N2801AN	Rev. 01	Initial issue	Apr. 06, 2017

## Summary of Test Results

FCC Rules	Test Items	Measured	Result
15.207	Conducted Emissions	[dBuV]: 0.484MHz 30.59 (Margin -15.68dB) - AV	Pass
15.407(b) 15.209	Radiated Emissions	[dBuV/m at 3m]: 5350.000MHz 53.00 (Margin -1.00dB) - AV	Pass
15.407(a)	Emission Bandwidth	Meet the requirement of limit	Pass
15.407(e)	6dB bandwidth	Meet the requirement of limit	Pass
15.407(a)	RF Output Power	Max Power [dBm]: 5150~5250MHz: 23.32 5250~5350MHz: 23.16 5470~5725MHz: 23.39 5725~5850MHz: 24.70	Pass
15.407(a)	Peak Power Spectral Density	Meet the requirement of limit	Pass
15.407(g)	Frequency Stability	Meet the requirement of limit	Pass
15.203	Antenna Requirement	Meet the requirement of limit	Pass

# 1 General Description

## 1.1 Information

### 1.1.1 Specification of the Equipment under Test (EUT)

RF General Information					
Frequency Range (MHz)	IEEE Std. 802.11	Ch. Freq. (MHz)	Channel Number	Transmit Chains (N <sub>TX</sub> )	Data Rate / MCS
5150-5250 5250-5350 5470-5725 5725-5850	a	5180-5240 5260-5320 5500-5720 5745-5825	36-48 [4] 52-64 [4] 100-144 [9] 149-165 [5]	3	6-54 Mbps
5150-5250 5250-5350 5470-5725 5725-5850	n (HT20)	5180-5240 5260-5320 5500-5720 5745-5825	36-48 [4] 52-64 [4] 100-144 [9] 149-165 [5]	3	MCS 0-23
5150-5250 5250-5350 5470-5725 5725-5850	n (HT40)	5190-5230 5270-5310 5510-5710 5755-5795	38-46 [2] 54-62 [2] 102-142 [4] 151-159 [2]	3	MCS 0-23
5150-5250 5250-5350 5470-5725 5725-5850	ac (VHT20)	5180-5240 5260-5320 5500-5720 5745-5825	36-48 [4] 52-64 [4] 100-144 [9] 149-165 [5]	3	MCS 0-9
5150-5250 5250-5350 5470-5725 5725-5850	ac (VHT40)	5190-5230 5270-5310 5510-5710 5755-5795	38-46 [2] 54-62 [2] 102-142 [4] 151-159 [2]	3	MCS 0-9
5150-5250 5250-5350 5470-5725 5725-5850	ac (VHT80)	5210 5290 5530~5690 5775	42 [1] 58 [1] 106-138 [2] 155 [1]	3	MCS 0-9

Note 1: RF output power specifies that Maximum Conducted Output Power.  
 Note 2: 802.11a/n/ac uses a combination of OFDM-BPSK, QPSK, 16QAM, 64QAM, 256QAM modulation.  
 Note 3: The device has disabled the 5600-5650MHz band by S/W setting.

### 1.1.2 Antenna Details

Ant. No.	Model	Type	Connector	Operating Frequencies (GHz) / Antenna Gain (dBi)					
				2.4~2.4835	5.15~5.25	5.25~5.35	5.47~5.725	5.725~5.85	
1	RD-NB2573-PULSE SN11	Dipole	R-SMA	3	5				
2	RD-NB2573-PULSE SN02	Dipole	R-SMA	3	5				
3	RD-NB2573-PULSE SN03	Dipole	R-SMA	3	5				

### 1.1.3 Power Supply Type of Equipment under Test (EUT)

<b>Power Supply Type</b>	3.3Vdc from host
--------------------------	------------------

### 1.1.4 Accessories

N/A

### 1.1.5 Channel List

802.11 a / HT20 / VHT20		HT40 / VHT40	
Channel	Frequency(MHz)	Channel	Frequency(MHz)
36	5180	38	5190
40	5200	46	5230
44	5220	54	5270
48	5240	62	5310
52	5260	102	5510
56	5280	110	5550
60	5300	134	5670
64	5320	142	5710
100	5500	151	5755
104	5520	159	5795
108	5540	<b>VHT80</b>	
112	5560	42	5210
116	5580	58	5290
132	5660	106	5530
136	5680	138	5690
140	5700	155	5775
144	5720	---	---
149	5745	---	---
153	5765	---	---
157	5785	---	---
161	5805	---	---
165	5825	---	---

### 1.1.6 Test Tool and Duty Cycle

<b>Test Tool</b>	ART2, Version: 4.9.802.1		
<b>Duty Cycle and Duty Factor</b>	<b>Mode</b>	<b>Duty cycle (%)</b>	<b>Duty factor (dB)</b>
	11a	98.34%	0.07
	VHT20	98.15%	0.08
	VHT40	94.78%	0.23
	VHT80	90.37%	0.44

### 1.1.7 Power Setting

For Frequency band 5150-5250 MHz		
Modulation Mode	Test Frequency (MHz)	Power Set
11a	5180	14
11a	5200	14
11a	5240	14
HT20	5180	14
HT20	5200	14
HT20	5240	14.5
HT40	5190	11.5
HT40	5230	18.5
VHT20	5180	14
VHT20	5200	14
VHT20	5240	14.5
VHT40	5190	11.5
VHT40	5230	18.5
VHT80	5210	9

For Frequency band 5250~5350 MHz		
Modulation Mode	Test Frequency (MHz)	Power Set
11a	5260	14.5
11a	5300	15
11a	5320	15
HT20	5260	14.5
HT20	5300	15
HT20	5320	15
HT40	5270	19
HT40	5310	13
VHT20	5260	14.5
VHT20	5300	15
VHT20	5320	15
VHT40	5270	19
VHT40	5310	13
VHT80	5290	10.5

For Frequency band 5470~5725 MHz		
Modulation Mode	Test Frequency (MHz)	Power Set
11a	5500	14.5
11a	5580	14.5
11a	5700	14.5
HT20	5500	14
HT20	5580	14.5
HT20	5700	14.5
HT40	5510	12
HT40	5550	19
HT40	5670	19
VHT20	5500	14
VHT20	5580	14.5
VHT20	5700	14.5
VHT40	5510	12
VHT40	5550	19
VHT40	5670	19
VHT80	5530	9



**Channel that extends across the 5.725 GHz boundary**

For Frequency band 5470~5725 MHz		
Modulation Mode	Test Frequency (MHz)	Power Set
11a	5720	15.5
HT20	5720	16
HT40	5710	20
VHT20	5720	16
VHT40	5710	20
VHT80	5690	20

For Frequency band 5725~5850 MHz		
Modulation Mode	Test Frequency (MHz)	Power Set
11a	5745	21
11a	5785	21
11a	5825	21
HT20	5745	21
HT20	5785	21
HT20	5825	21
HT40	5755	21
HT40	5795	21
VHT20	5745	21
VHT20	5785	21
VHT20	5825	21
VHT40	5755	21
VHT40	5795	21
VHT80	5775	19.5

## 1.2 Local Support Equipment List

Support Equipment List					
No.	Equipment	Brand	Model	FCC ID	Signal cable / Length (m)
1	Notebook	Latitude E6430	9ZFB4X1	DoC	---
2	DC Power Supply	GWINSTEK	GPC-3060D	---	---
3	Extension Card	---	---	---	---

## 1.3 Test Setup Chart

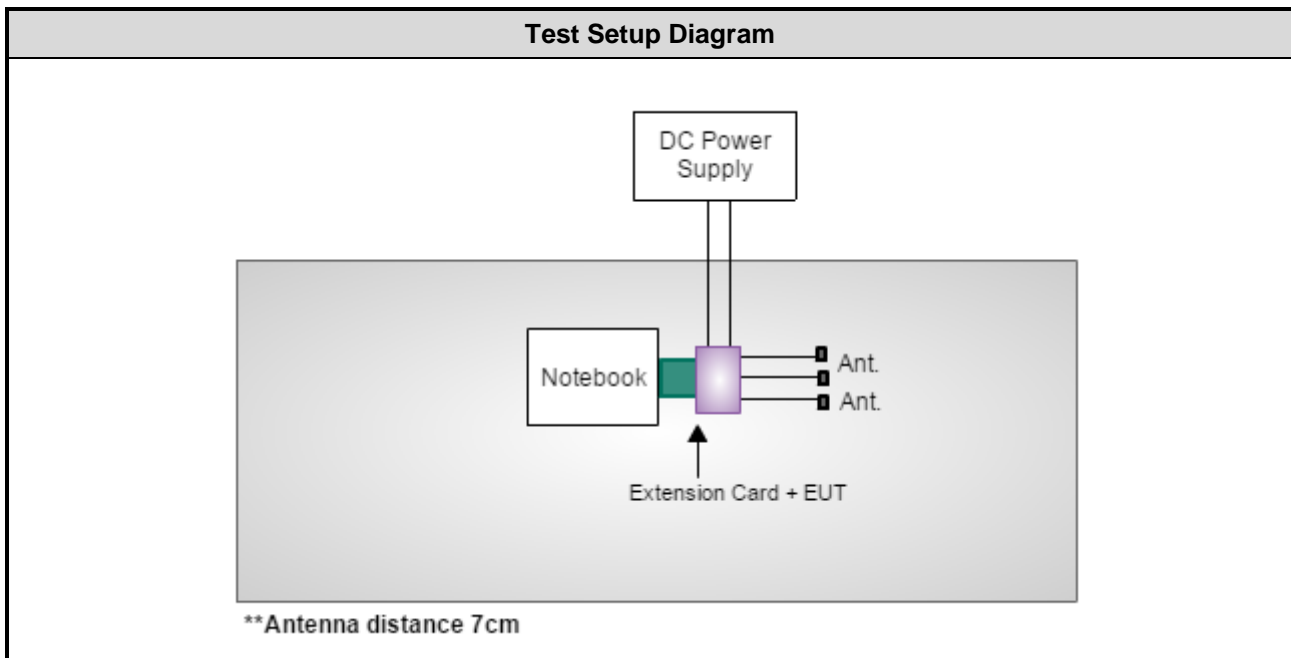

## 1.4 The Equipment List

Test Item	Conducted Emission				
Test Site	Conduction room 1 / (CO01-WS)				
Tested date	Dec. 23, 2016				
Instrument	Manufacturer	Model No.	Serial No.	Calibration Date	Calibration Until
Receiver	R&S	ESR3	101657	Jan. 12, 2016	Jan. 11, 2017
Receiver	R&S	ESR3	101657	Dec. 21, 2016	Dec. 20, 2017
LISN	SCHWARZBECK	Schwarzbeck 8127	8127-667	Nov. 08, 2016	Nov. 07, 2017
RF Cable-CON	EMC	EMCCFD300-BM-BM-6000	50821	Dec. 20, 2016	Dec. 19, 2017
Measurement Software	AUDIX	e3	6.120210k	NA	NA

Note: Calibration Interval of instruments listed above is one year.

Test Item	Radiated Emission				
Test Site	966 chamber3 / (03CH03-WS)				
Tested date	Dec. 06, 2016 ~ Feb. 03, 2017				
Instrument	Manufacturer	Model No.	Serial No.	Calibration Date	Calibration Until
Spectrum Analyzer	Agilent	N9010A	MY53400091	Sep. 09, 2016	Sep. 08, 2017
Receiver	Agilent	N9038A	MY53290044	Oct. 06, 2016	Oct. 05, 2017
Bilog Antenna	SCHWARZBECK	VULB9168	VULB9168-685	Apr. 26, 2016	Apr. 25, 2017
Horn Antenna 1G-18G	SCHWARZBECK	BBHA 9120 D	BBHA 9120 D 1206	Feb. 24, 2016	Feb. 23, 2017
Horn Antenna 18G-40G	SCHWARZBECK	BBHA 9170	BBHA 9170517	Oct. 25, 2016	Oct. 24, 2017
Loop Antenna	R&S	HFH2-Z2	100330	Nov. 10, 2016	Nov. 09, 2017
Preamplifier	EMC	EMC02325	980187	Sep. 08, 2016	Sep. 07, 2017
Preamplifier	Agilent	83017A	MY53270014	Aug. 22, 2016	Aug. 21, 2017
Preamplifier	EMC	EMC184045B	980192	Aug. 24, 2016	Aug. 23, 2017
RF cable-3M	HUBER+SUHNER	SUCOFLEX104	MY22620/4	Feb. 05, 2016	Feb. 04, 2017
RF cable-8M	HUBER+SUHNER	SUCOFLEX104	MY22600/4	Feb. 05, 2016	Feb. 04, 2017
RF cable-1M	HUBER+SUHNER	SUCOFLEX104	MY22624/4	Feb. 05, 2016	Feb. 04, 2017
LF cable-0.8M	EMC	EMC8D-NM-NM-800	EMC8D-NM-NM-800-001	Feb. 05, 2016	Feb. 04, 2017
LF cable-3M	EMC	EMC8D-NM-NM-3000	131103	Feb. 05, 2016	Feb. 04, 2017
LF cable-13M	EMC	EMC8D-NM-NM-13000	131104	Feb. 05, 2016	Feb. 04, 2017
Measurement Software	AUDIX	e3	6.120210g	NA	NA

Note: Calibration Interval of instruments listed above is one year.

<b>Test Item</b>	RF Conducted				
<b>Test Site</b>	(TH01-WS)				
<b>Tested date</b>	Dec. 02, 2016 ~ Feb. 03, 2017				
<b>Instrument</b>	<b>Manufacturer</b>	<b>Model No.</b>	<b>Serial No.</b>	<b>Calibration Date</b>	<b>Calibration Until</b>
Spectrum Analyzer	R&S	FSV40	101063	Feb. 17, 2016	Feb. 16, 2017
TEMP&HUMIDITY CHAMBER	GIANT FORCE	GCT-225-40-SP-SD	MAF1212-002	Nov. 21, 2016	Nov. 20, 2017
Power Meter	Anritsu	ML2495A	1241002	Oct. 06, 2016	Oct. 05, 2017
Power Sensor	Anritsu	MA2411B	1207366	Oct. 06, 2016	Oct. 05, 2017
DC POWER SOURCE	GW INSTRON	GPC-6030D	EM892433	Oct. 20, 2016	Oct. 19, 2017
Measurement Software	Sporton	Sporton_1	1.3.30	NA	NA
Note: Calibration Interval of instruments listed above is one year.					

## 1.5 Testing Applied Standards

According to the specification of EUT, the EUT must comply with following standards and KDB documents.

47 CFR FCC Part 15.407

ANSI C63.10-2013

FCC KDB 789033 D02 General UNII Test Procedures New Rules v01r03

FCC KDB 644545 D03 Guidance for IEEE 802.11ac New Rules v01

FCC KDB 662911 D01 Multiple Transmitter Output v02r01

FCC KDB 412172 D01 Determining ERP and EIRP v01r01

## 1.6 Measurement Uncertainty

ISO/IEC 17025 requires that an estimate of the measurement uncertainties associated with the emissions test results be included in the report. The measurement uncertainties given below are based on a 95% confidence level (based on a coverage factor (k=2))

Measurement Uncertainty	
Parameters	Uncertainty
Bandwidth	±34.134 Hz
Conducted power	±0.808 dB
Frequency error	±34.134 Hz
Power density	±0.463 dB
Conducted emission	±2.670 dB
AC conducted emission	±2.90 dB
Radiated emission ≤ 1GHz	±3.72 dB
Radiated emission > 1GHz	±5.65 dB
Time	±0.1%
Temperature	±0.6 °C

## 2 Test Configuration

### 2.1 Testing Condition

Test Item	Test Site	Ambient Condition	Tested By
AC Conduction	CO01-WS	17°C / 61%	Howard Huang
Radiated Emissions	03CH03-WS	22°C / 65%	Brad Wu Kevin Lee Vincent Yeh
RF Conducted	TH01-WS	21°C / 64%	Alex Huang

- FCC Designation No.: TW0009
- FCC site registration No.: 207696
- IC site registration No.: 10807C-1

### 2.2 The Worst Test Modes and Channel Details

Frequency band 5150~5250 MHz / 5250~5350 MHz / 5470~5725 MHz				
Test item	Modulation Mode	Test Frequency (MHz)	Data Rate (Mbps) / MCS	Test Configuration
Conducted Emissions	VHT40	5670	MCS 0	---
Radiated Emissions ≤1GHz	VHT40	5670	MCS 0	---
RF Output Power	11a	5180 / 5200 / 5240 / 5260 / 5300 5320 / 5500 / 5580 / 5700 / 5720	6 Mbps	---
	HT20	5180 / 5200 / 5240 / 5260 / 5300 5320 / 5500 / 5580 / 5700 / 5720	MCS 0	
	HT40	5190 / 5230/ 5270 / 5310 / 5510 5550 / 5670 / 5710	MCS 0	
	VHT20	5180 / 5200 / 5240 / 5260 / 5300 5320 / 5500 / 5580 / 5700 / 5720	MCS 0	
	VHT40	5190 / 5230/ 5270 / 5310 / 5510 5550 / 5670 / 5710	MCS 0	
	VHT80	5210 / 5290 / 5530 / 5690	MCS 0	
Radiated Emissions >1GHz Emission Bandwidth Peak Power Spectral Density	11a	5180 / 5200 / 5240 / 5260 / 5300 5320 / 5500 / 5580 / 5700 / 5720	6 Mbps	---
	VHT20	5180 / 5200 / 5240 / 5260 / 5300 5320 / 5500 / 5580 / 5700 / 5720	MCS 0	
	VHT40	5190 / 5230/ 5270 / 5310 / 5510 5550 / 5670 / 5710	MCS 0	
	VHT80	5210 / 5290 / 5530 / 5690	MCS 0	
Frequency Stability	Un-modulation	5320	---	---

Frequency band 5725-5850 MHz				
Test item	Modulation Mode	Test Frequency (MHz)	Data Rate (Mbps) / MCS	Test Configuration
Conducted Emissions	VHT20	5745	MCS 0	---
Radiated Emissions $\leq$ 1GHz	VHT20	5745	MCS 0	---
RF Output Power	11a	5745 / 5785 / 5825	6 Mbps	---
	HT20	5745 / 5785 / 5825	MCS 0	
	HT40	5755 / 5795	MCS 0	
	VHT20	5745 / 5785 / 5825	MCS 0	
	VHT40	5755 / 5795	MCS 0	
	VHT80	5775	MCS 0	
Radiated Emissions >1GHz Emission Bandwidth 6dB bandwidth Peak Power Spectral Density	11a	5745 / 5785 / 5825	6 Mbps	---
	VHT20	5745 / 5785 / 5825	MCS 0	
	VHT40	5755 / 5795	MCS 0	
	VHT80	5775	MCS 0	
Frequency Stability	Un-modulation	5785	---	---

### 3 Transmitter Test Results

#### 3.1 Conducted Emissions

##### 3.1.1 Limit of Conducted Emissions

Conducted Emissions Limit		
Frequency Emission (MHz)	Quasi-Peak	Average
0.15-0.5	66 - 56 *	56 - 46 *
0.5-5	56	46
5-30	60	50

Note 1: \* Decreases with the logarithm of the frequency.

##### 3.1.2 Test Procedures

1. The device is placed on a test table, raised 80 cm above the reference ground plane. The vertical conducting plane is located 40 cm to the rear of the device.
2. The device is connected to line impedance stabilization network (LISN) and other accessories are connected to other LISN. Measured levels of AC power line conducted emission are across the 50 Ω LISN port.
3. AC conducted emission measurements is made over frequency range from 150 kHz to 30 MHz.
4. This measurement was performed with AC 120V/60Hz

##### 3.1.3 Test Setup

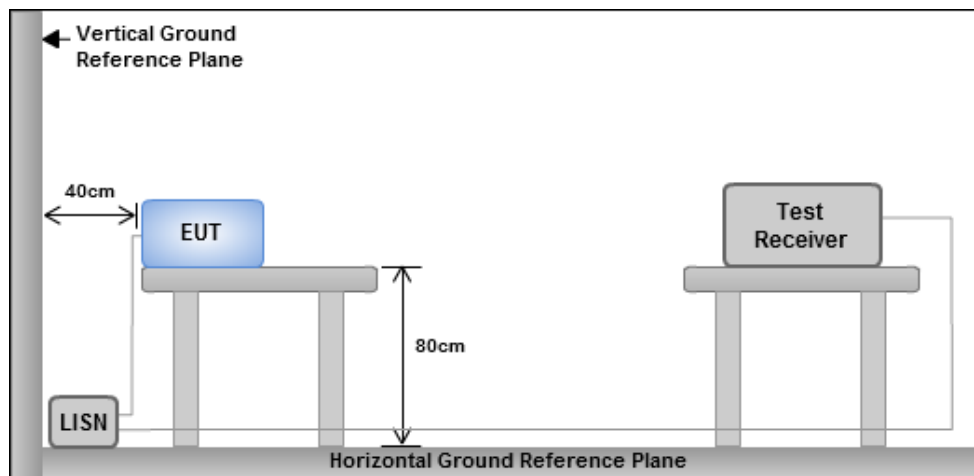

- Note: 1. Support units were connected to second LISN.  
 2. Both of LISNs (AMN) are 80 cm from EUT and at least 80 cm from other units and other metal planes

### 3.1.4 Test Result of Conducted Emissions

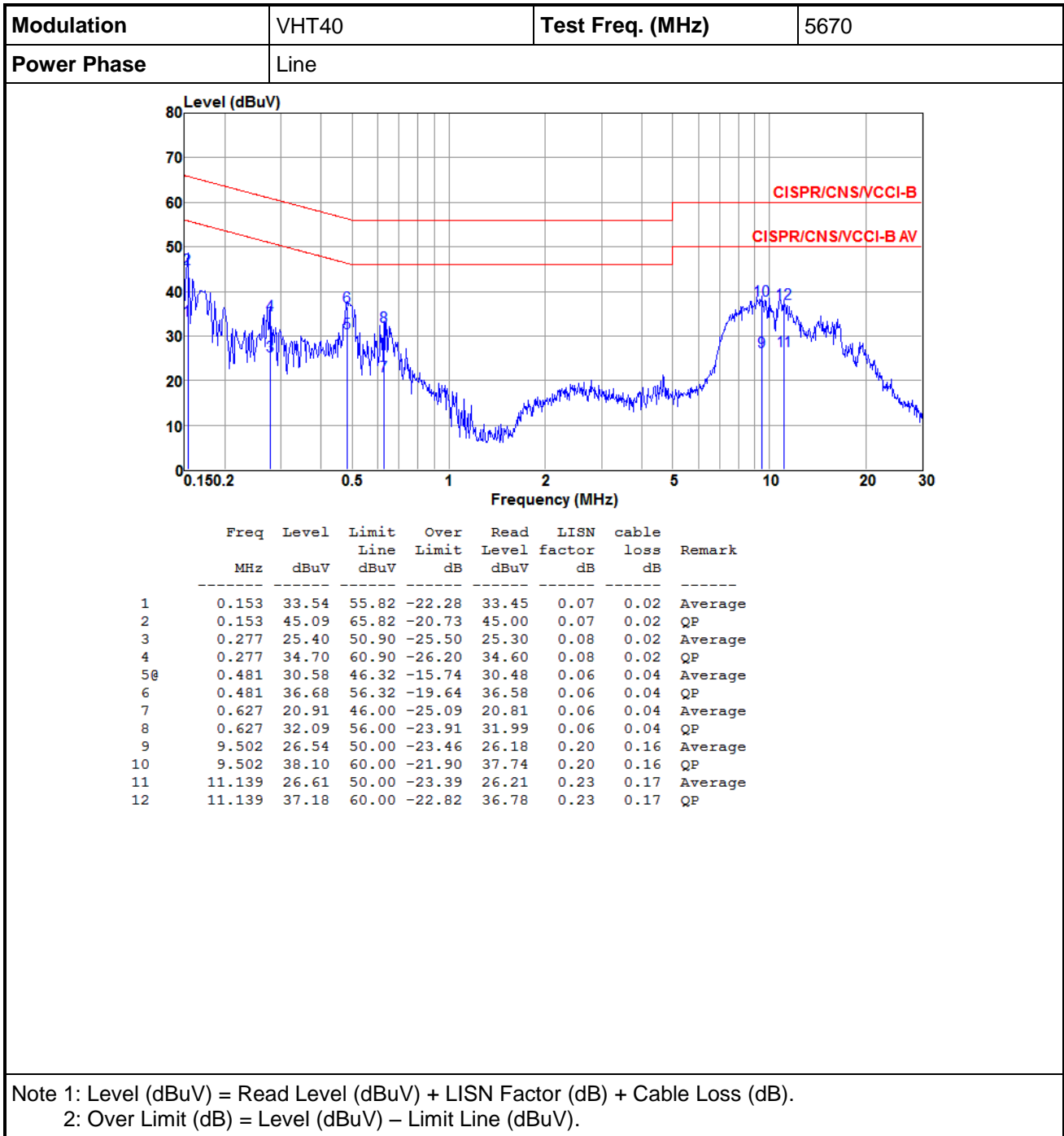



<b>Modulation</b>	VHT40	<b>Test Freq. (MHz)</b>	5670
<b>Power Phase</b>	Neutral		

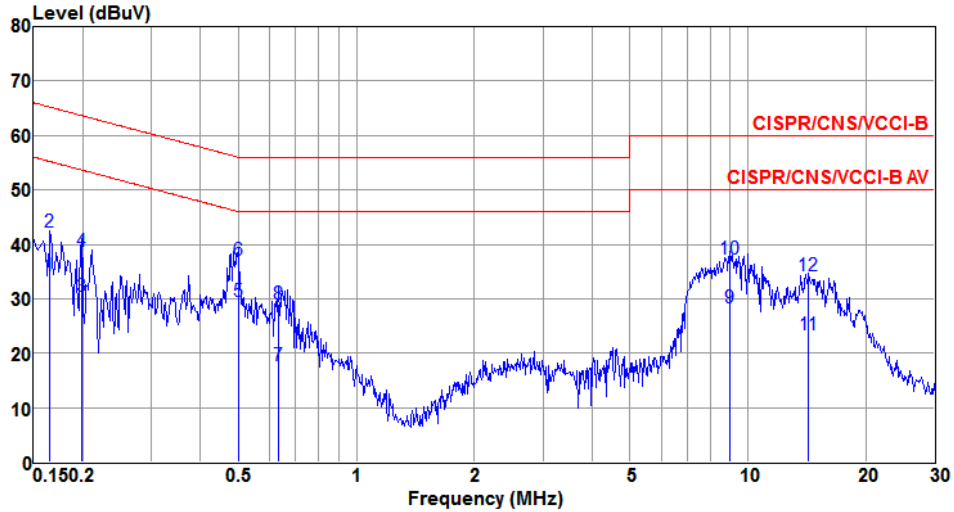

	Freq MHz	Level dBuV	Limit Line dBuV	Over Limit dB	Read Level dBuV	LISN factor dB	cable loss dB	Remark
1	0.165	34.31	55.21	-20.90	34.19	0.10	0.02	Average
2	0.165	42.20	65.21	-23.01	42.08	0.10	0.02	QP
3	0.199	30.38	53.67	-23.29	30.27	0.09	0.02	Average
4	0.199	38.66	63.67	-25.01	38.55	0.09	0.02	QP
5	0.499	29.54	46.01	-16.47	29.38	0.12	0.04	Average
6	0.499	36.97	56.01	-19.04	36.81	0.12	0.04	QP
7	0.630	17.83	46.00	-28.17	17.68	0.11	0.04	Average
8	0.630	29.14	56.00	-26.86	28.99	0.11	0.04	QP
9	9.011	28.23	50.00	-21.77	27.78	0.29	0.16	Average
10	9.011	37.33	60.00	-22.67	36.88	0.29	0.16	QP
11	14.288	23.45	50.00	-26.55	22.89	0.36	0.20	Average
12	14.288	34.26	60.00	-25.74	33.70	0.36	0.20	QP

Note 1: Level (dBuV) = Read Level (dBuV) + LISN Factor (dB) + Cable Loss (dB).  
 Note 2: Over Limit (dB) = Level (dBuV) – Limit Line (dBuV).

<b>Modulation</b>	VHT20	<b>Test Freq. (MHz)</b>	5745
-------------------	-------	-------------------------	------

<b>Power Phase</b>	Line
--------------------	------

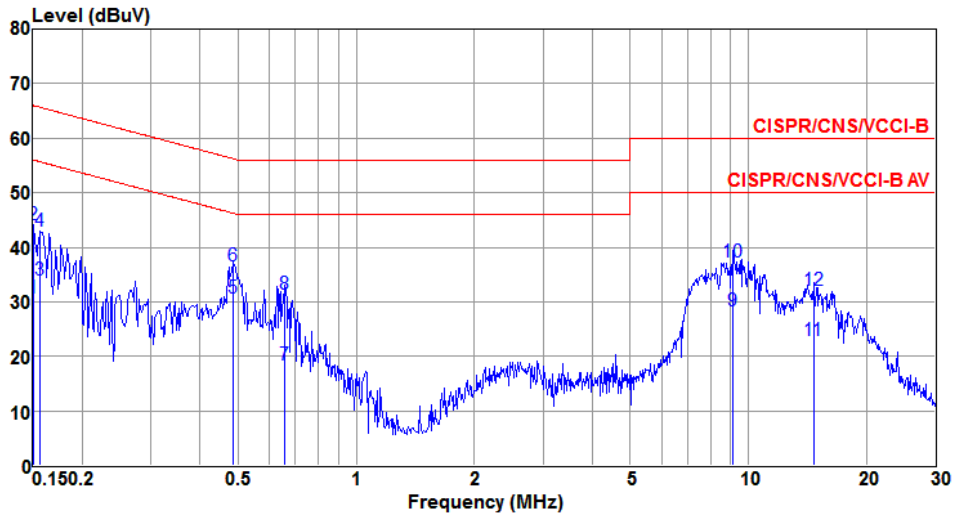

	Freq MHz	Level dBUV	Limit Line dBUV	Over Limit dB	Read Level dBUV	LISN factor dB	cable loss dB	Remark
1	0.150	30.78	56.00	-25.22	30.69	0.07	0.02	Average
2	0.150	44.14	66.00	-21.86	44.05	0.07	0.02	QP
3	0.156	33.93	55.65	-21.72	33.84	0.07	0.02	Average
4	0.156	43.03	65.65	-22.62	42.94	0.07	0.02	QP
5@	0.484	30.59	46.27	-15.68	30.49	0.06	0.04	Average
6	0.484	36.56	56.27	-19.71	36.46	0.06	0.04	QP
7	0.658	18.52	46.00	-27.48	18.40	0.07	0.05	Average
8	0.658	31.49	56.00	-24.51	31.37	0.07	0.05	QP
9	9.156	28.35	50.00	-21.65	27.99	0.20	0.16	Average
10	9.156	37.37	60.00	-22.63	37.01	0.20	0.16	QP
11	14.672	22.86	50.00	-27.14	22.34	0.31	0.21	Average
12	14.672	32.17	60.00	-27.83	31.65	0.31	0.21	QP

Note 1: Level (dBUV) = Read Level (dBUV) + LISN Factor (dB) + Cable Loss (dB).  
 Note 2: Over Limit (dB) = Level (dBUV) – Limit Line (dBUV).

<b>Modulation</b>	VHT20	<b>Test Freq. (MHz)</b>	5745
-------------------	-------	-------------------------	------

<b>Power Phase</b>	Neutral
--------------------	---------

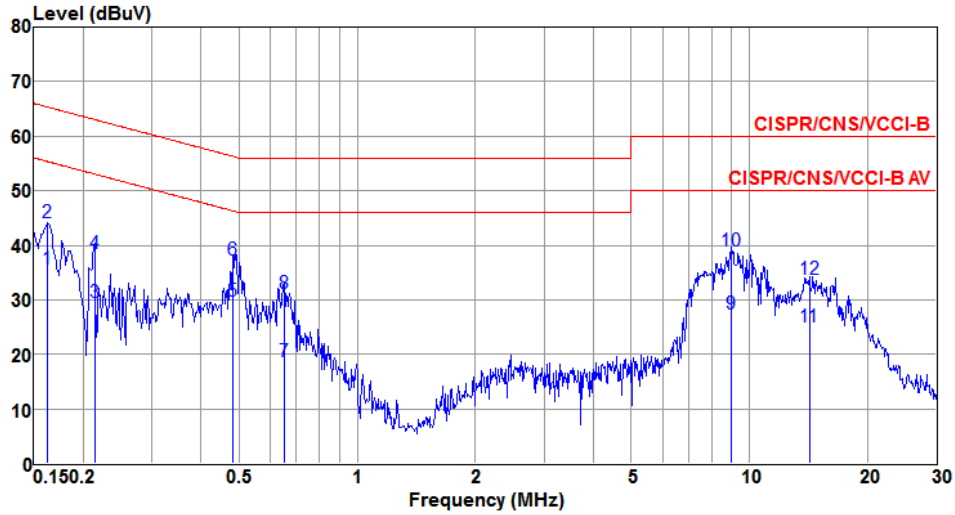

	Freq MHz	Level dBUV	Limit Line dBUV	Over Limit dB	Read Level dBUV	LISN factor dB	cable loss dB	Remark
1	0.162	35.64	55.34	-19.70	35.52	0.10	0.02	Average
2	0.162	44.19	65.34	-21.15	44.07	0.10	0.02	QP
3	0.214	29.61	53.05	-23.44	29.50	0.09	0.02	Average
4	0.214	38.52	63.05	-24.53	38.41	0.09	0.02	QP
5	0.481	29.77	46.32	-16.55	29.61	0.12	0.04	Average
6	0.481	37.24	56.32	-19.08	37.08	0.12	0.04	QP
7	0.651	18.72	46.00	-27.28	18.56	0.11	0.05	Average
8	0.651	31.19	56.00	-24.81	31.03	0.11	0.05	QP
9	8.964	27.39	50.00	-22.61	26.94	0.29	0.16	Average
10	8.964	38.83	60.00	-21.17	38.38	0.29	0.16	QP
11	14.213	25.07	50.00	-24.93	24.51	0.36	0.20	Average
12	14.213	33.69	60.00	-26.31	33.13	0.36	0.20	QP

Note 1: Level (dBUV) = Read Level (dBUV) + LISN Factor (dB) + Cable Loss (dB).  
 2: Over Limit (dB) = Level (dBUV) – Limit Line (dBUV).

## 3.2 Emission Bandwidth

### 3.2.1 Limit of Emission Bandwidth

Within the 5.725-5.85 GHz band, the minimum 6 dB bandwidth of U-NII devices shall be at least 500 kHz.

### 3.2.2 Test Procedures

#### 26dB Bandwidth

1. Set RBW = approximately 1% of the emission bandwidth.
2. Set the VBW > RBW, Detector = Peak.
3. Trace mode = max hold.
4. Measure the maximum width of the emission that is 26 dB down from the peak of the emission.

#### Occupied Bandwidth

1. Set RBW = 1 % to 5 % of the OBW
2. Set VBW  $\geq$  3 RBW
3. Sample detection and single sweep mode shall be used
4. Use the 99 % power bandwidth function of the instrument

#### 6dB Bandwidth

1. Set RBW = 100kHz, VBW = 300kHz
2. Detector = Peak, Trace mode = max hold.
3. Allow the trace to stabilize.
4. Measure the maximum width of the emission that is constrained by the frequencies associated with the two outermost amplitude points (upper and lower frequencies) that are attenuated by 6 dB relative to the maximum level measured in the fundamental emission

### 3.2.3 Test Setup

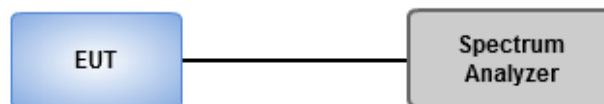

### 3.2.4 Test Result of Emission Bandwidth

For Frequency band 5150~5250 MHz										
Emission Bandwidth										
Mode	N <sub>TX</sub>	Freq. (MHz)	26dB Bandwidth (MHz)				99% Bandwidth (MHz)			
			Chain 0	Chain 1	Chain 2	Chain 3	Chain 0	Chain 1	Chain 2	Chain 3
11a	3	5180	24.00	23.83	24.29	---	16.87	16.86	16.78	---
11a	3	5200	24.46	23.94	24.64	---	16.89	16.78	16.70	---
11a	3	5240	23.83	23.94	23.59	---	16.77	16.74	16.67	---
VHT20	3	5180	25.57	25.16	24.64	---	17.93	17.89	17.86	---
VHT20	3	5200	25.04	24.64	25.45	---	17.94	17.92	17.92	---
VHT20	3	5240	24.87	24.75	23.48	---	17.89	17.91	17.99	---
VHT40	3	5190	45.91	45.33	45.91	---	36.80	36.82	36.76	---
VHT40	3	5230	86.23	85.36	81.01	---	37.86	37.78	37.66	---
VHT80	3	5210	87.42	87.65	88.58	---	76.84	76.84	77.20	---

For Frequency band 5250~5350 MHz											
Mode	N <sub>TX</sub>	Freq. (MHz)	26dB Bandwidth (MHz)				99% Bandwidth (MHz)				Power Limit (dBm)
			Chain 0	Chain 1	Chain 2	Chain 3	Chain 0	Chain 1	Chain 2	Chain 3	
11a	3	5260	23.71	23.25	24.06	---	16.90	16.82	16.71	---	24.00
11a	3	5300	24.06	22.26	23.48	---	16.88	16.81	16.69	---	24.00
11a	3	5320	23.48	23.19	22.72	---	16.81	16.83	16.71	---	24.00
VHT20	3	5260	24.41	24.46	23.25	---	17.95	17.92	17.71	---	24.00
VHT20	3	5300	24.70	24.52	24.46	---	17.96	17.95	17.71	---	24.00
VHT20	3	5320	23.94	24.70	24.29	---	17.96	17.98	17.71	---	24.00
VHT40	3	5270	72.35	59.01	54.61	---	37.04	36.96	36.76	---	24.00
VHT40	3	5310	46.73	44.87	45.33	---	36.90	37.00	36.90	---	24.00
VHT80	3	5290	89.97	86.03	86.49	---	76.48	76.56	76.12	---	24.00

For Frequency band 5470~5725 MHz

Mode	N <sub>TX</sub>	Freq. (MHz)	26dB Bandwidth (MHz)				99% Bandwidth (MHz)				Power Limit (dBm)
			Chain 0	Chain 1	Chain 2	Chain 3	Chain 0	Chain 1	Chain 2	Chain 3	
11a	3	5500	23.65	23.01	22.90	---	16.79	16.70	16.69	---	24.00
11a	3	5580	23.71	23.01	22.20	---	16.77	16.79	16.63	---	24.00
11a	3	5700	22.96	23.42	22.55	---	16.78	16.82	16.72	---	24.00
VHT20	3	5500	23.65	24.35	23.42	---	17.89	17.74	17.72	---	24.00
VHT20	3	5580	24.00	24.35	23.88	---	17.85	17.71	17.77	---	24.00
VHT20	3	5700	23.94	24.64	23.94	---	17.94	18.01	17.90	---	24.00
VHT40	3	5510	47.07	46.03	46.03	---	36.84	36.84	36.58	---	24.00
VHT40	3	5550	69.80	60.41	51.36	---	37.04	37.18	36.96	---	24.00
VHT40	3	5670	61.80	60.52	50.55	---	37.02	37.16	36.84	---	24.00
VHT80	3	5530	87.65	86.73	86.26	---	76.52	76.64	76.56	---	24.00

Worst Plot of 26dB Bandwidth

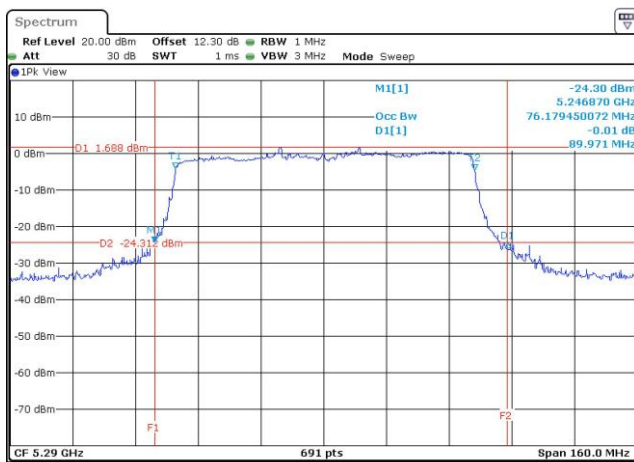

Worst Plot of 99% Bandwidth

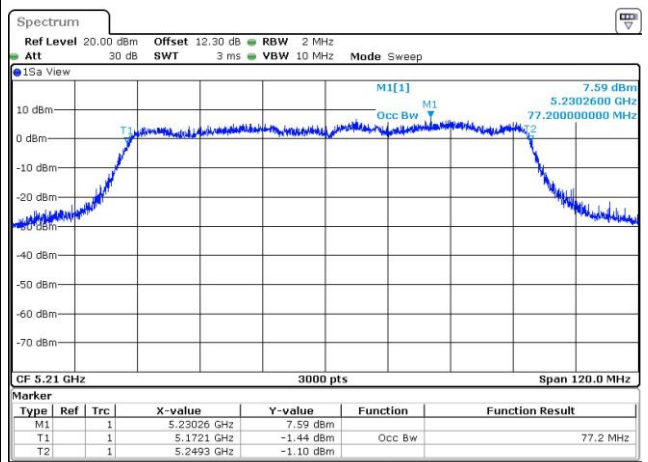

**Channel that extends across the 5.725 GHz boundary**

Frequency band			UNII Emission Bandwidth Result ( Within 5470-5725MHz band )								
Mode	N <sub>TX</sub>	Freq. (MHz)	26dB Bandwidth (MHz)				99% Bandwidth (MHz)				Power Limit (dBm)
			Chain 0	Chain 1	Chain 2	Chain 3	Chain 0	Chain 1	Chain 2	Chain 3	
11a	3	5720	16.88	18.05	16.51	---	13.40	13.38	13.37	---	23.18
VHT20	3	5720	16.45	17.55	17.68	---	13.99	13.99	13.94	---	23.16
VHT40	3	5710	51.74	55.39	48.29	---	33.65	33.73	33.51	---	24.00
VHT80	3	5690	125.87	126.52	91.96	---	73.62	73.82	73.46	---	24.00

Frequency band			UNII Emission Bandwidth Result (Extends across 5725MHz band )								
Mode	N <sub>TX</sub>	Freq. (MHz)	26dB Bandwidth (MHz)				99% Bandwidth (MHz)				Power Limit (dBm)
			Chain 0	Chain 1	Chain 2	Chain 3	Chain 0	Chain 1	Chain 2	Chain 3	
11a	3	5720	7.61	8.91	7.24	---	3.40	3.41	3.35	---	30.00
VHT20	3	5720	27.83	30.09	22.67	---	3.98	4.00	3.92	---	30.00
VHT40	3	5710	53.04	59.30	40.61	---	3.59	3.65	3.49	---	30.00
VHT80	3	5690	7.61	8.91	7.24	---	3.34	3.54	3.22	---	30.00

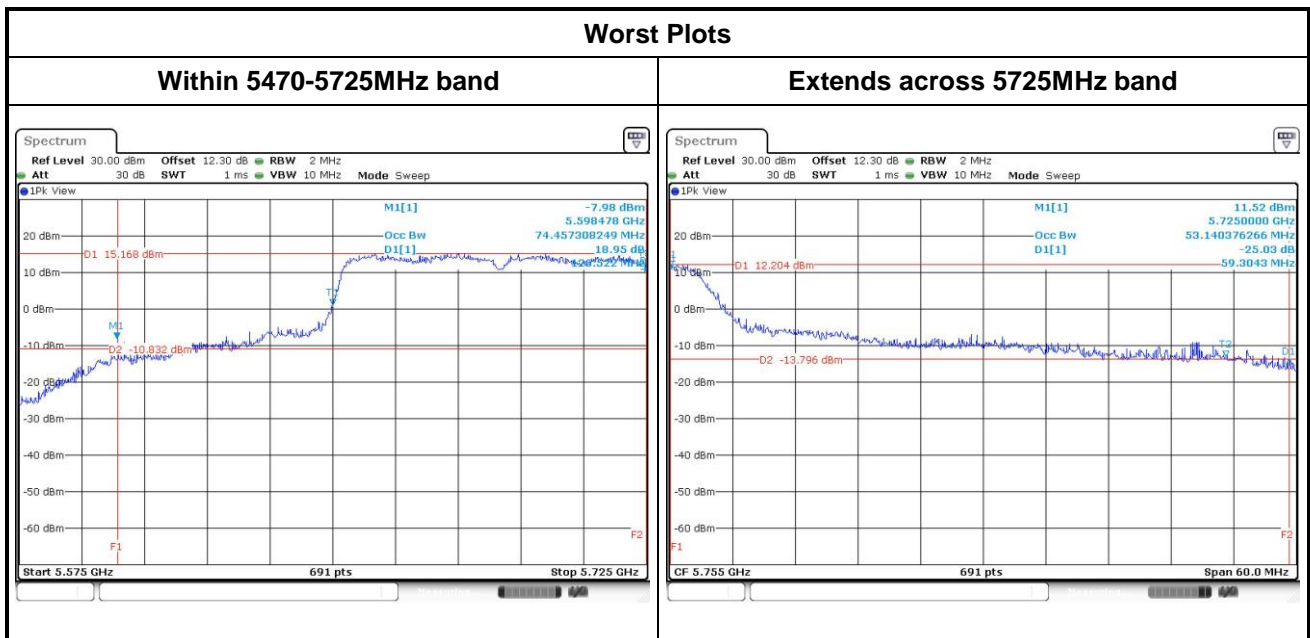

For Frequency band 5725-5850 MHz											
Emission Bandwidth											
Mode	N <sub>TX</sub>	Freq. (MHz)	OBW Bandwidth (MHz)				6dB Bandwidth (MHz)				6dB BW Limit (MHz)
			Chain 0	Chain 1	Chain 2	Chain 3	Chain 0	Chain 1	Chain 2	Chain 3	
11a	3	5745	20.49	21.84	21.97	---	16.29	15.94	16.35	---	0.5
11a	3	5785	21.77	21.31	22.09	---	15.71	16.06	16.35	---	0.5
11a	3	5825	20.33	22.60	20.64	---	16.35	16.35	15.71	---	0.5
VHT20	3	5745	20.08	21.47	18.48	---	17.16	17.57	17.57	---	0.5
VHT20	3	5785	19.85	22.05	21.39	---	17.57	16.06	17.57	---	0.5
VHT20	3	5825	21.36	22.48	20.92	---	17.57	17.57	17.57	---	0.5
VHT40	3	5755	38.35	39.25	40.35	---	35.36	35.94	36.29	---	0.5
VHT40	3	5795	38.45	40.03	39.49	---	36.29	35.13	35.13	---	0.5
VHT80	3	5775	77.65	77.44	77.55	---	71.42	73.04	66.78	---	0.5

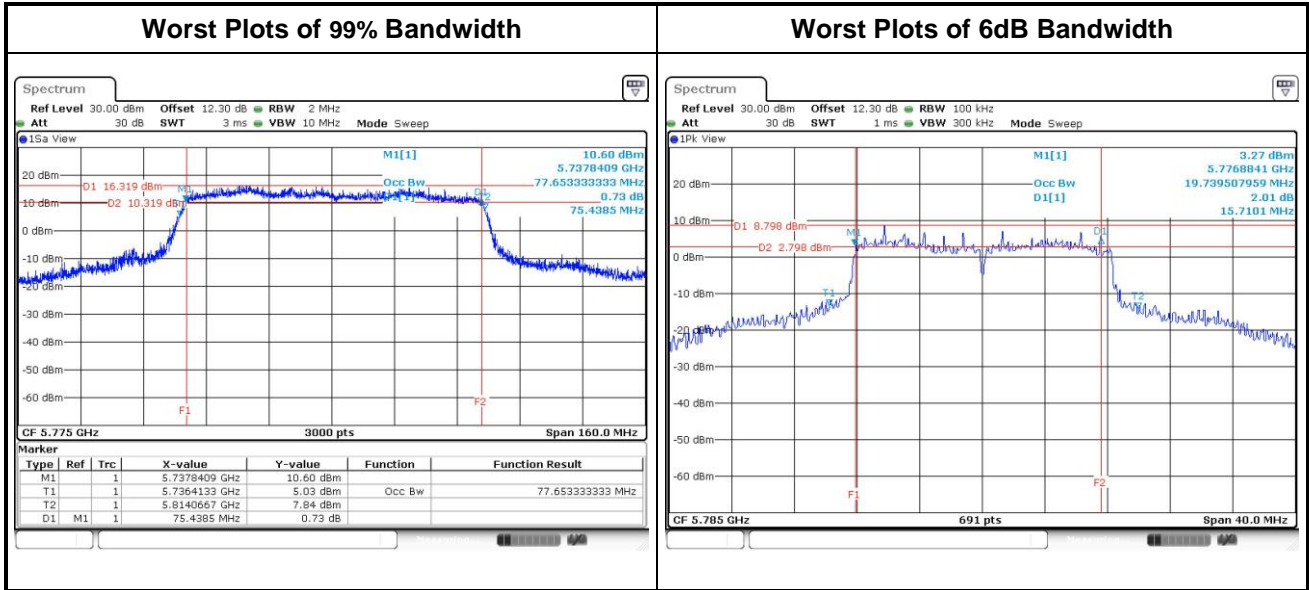



### 3.3 RF Output Power

#### 3.3.1 Limit of RF Output Power

Frequency band 5150-5250 MHz	
Operating Mode	Limit
<input type="checkbox"/> Outdoor access point	Conducted Power: 1 W The maximum e.i.r.p. at any elevation angle above 30 degrees as measured from the horizon must not exceed 125 mW (21 dBm)
<input type="checkbox"/> Indoor access point	Conducted Power: 1 W
<input type="checkbox"/> Fixed point-to-point access points	Conducted Power: 1 W
<input checked="" type="checkbox"/> Client devices	Conducted Power: 250 mW

Frequency Band (MHz)	Limit
<input checked="" type="checkbox"/> 5250 ~ 5350	250mW or 11dBm+10 log B
<input checked="" type="checkbox"/> 5470 ~ 5725	250mW or 11dBm+10 log B
<input checked="" type="checkbox"/> 5725 ~ 5850	1 W

Note: "B" is the 26dB emission bandwidth in MHz.

#### 3.3.2 Test Procedures

- Power meter ( For channel that does not extends across the 5.725 GHz boundary )
  - Measurements is performed using a wideband gated RF power meter provided that the gate parameters are adjusted such that the power is measured only when the EUT is transmitting at its maximum power control level. Since the measurement is made only during the ON time of the transmitter, no duty cycle correction factor is required
- Spectrum analyzer ( For channel that extends across the 5.725 GHz boundary )
  1. Set RBW=1MHz, VBW=3MHz , Sweep time= Auto, Detector = RMS
  2. Trace average at least 100 traces in power averaging mode
  3. Compute power by integrating the spectrum across the 26 dB EBW

### 3.3.3 Test Setup

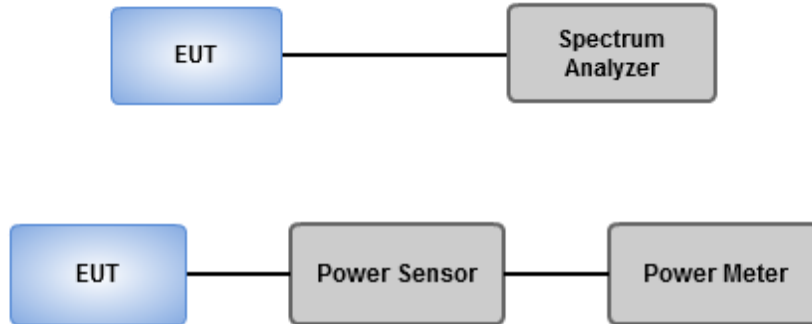

### 3.3.4 Test Result of Maximum Conducted Output Power

For Frequency band 5150~5250 MHz									
Mode	N <sub>TX</sub>	Freq. (MHz)	Conducted Power (dBm)				Total Power (mW)	Total Power (dBm)	Limit (dBm)
			Chain 0	Chain 1	Chain 2	Chain 3			
11a	3	5180	15.81	15.02	13.85	---	94.141	19.74	24.00
11a	3	5200	15.57	14.83	14.39	---	93.946	19.73	24.00
11a	3	5240	15.12	14.26	13.56	---	81.876	19.13	24.00
HT20	3	5180	16.05	15.09	14.15	---	98.558	19.94	24.00
HT20	3	5200	16.21	15.26	14.30	---	102.272	20.10	24.00
HT20	3	5240	16.08	14.91	13.59	---	94.381	19.75	24.00
HT40	3	5190	12.99	12.05	11.80	---	51.075	17.08	24.00
HT40	3	5230	18.86	18.41	18.15	---	211.569	23.25	24.00
VHT20	3	5180	16.09	15.15	14.21	---	99.742	19.99	24.00
VHT20	3	5200	16.26	15.32	14.38	---	103.723	20.16	24.00
VHT20	3	5240	16.11	14.97	13.66	---	95.464	19.80	24.00
VHT40	3	5190	13.06	12.14	11.86	---	51.945	17.16	24.00
VHT40	3	5230	18.93	18.46	18.22	---	214.683	<b>23.32</b>	24.00
VHT80	3	5210	10.25	9.22	8.86	---	26.640	14.26	24.00

For Frequency band 5250~5350 MHz									
Mode	N <sub>TX</sub>	Freq. (MHz)	Conducted Power (dBm)				Total Power (mW)	Total Power (dBm)	Limit (dBm)
			Chain 0	Chain 1	Chain 2	Chain 3			
11a	3	5260	14.64	14.73	13.49	---	81.160	19.09	24.00
11a	3	5300	14.46	14.4	13.75	---	79.181	18.99	24.00
11a	3	5320	14.66	14.78	13.61	---	82.264	19.15	24.00
HT20	3	5260	14.63	14.69	13.47	---	80.718	19.07	24.00
HT20	3	5300	14.39	14.30	13.64	---	77.515	18.89	24.00
HT20	3	5320	14.61	14.59	13.71	---	81.177	19.09	24.00
HT40	3	5270	18.47	18.61	17.79	---	203.035	23.08	24.00
HT40	3	5310	11.59	11.25	11.02	---	40.404	16.06	24.00
VHT20	3	5260	14.67	14.76	13.53	---	81.774	19.13	24.00
VHT20	3	5300	14.45	14.36	13.69	---	78.539	18.95	24.00
VHT20	3	5320	14.68	14.65	13.75	---	82.265	19.15	24.00
VHT40	3	5270	18.55	18.68	17.88	---	206.781	<b>23.16</b>	24.00
VHT40	3	5310	11.68	11.29	11.09	---	41.035	16.13	24.00
VHT80	3	5290	9.95	9.86	9.52	---	28.522	14.55	24.00

For Frequency band 5470~5725 MHz									
Mode	N <sub>TX</sub>	Freq. (MHz)	Conducted Power (dBm)				Total Power (mW)	Total Power (dBm)	Limit (dBm)
			Chain 0	Chain 1	Chain 2	Chain 3			
11a	3	5500	14.67	15.02	13.38	---	82.855	19.18	24.00
11a	3	5580	14.61	15.04	13.46	---	83.004	19.19	24.00
11a	3	5700	14	15.01	14.42	---	84.484	19.27	24.00
HT20	3	5500	14.58	14.81	13.29	---	80.307	19.05	24.00
HT20	3	5580	14.79	14.69	13.58	---	82.378	19.16	24.00
HT20	3	5700	13.97	15.01	13.81	---	80.685	19.07	24.00
HT40	3	5510	12.29	11.72	11.42	---	45.670	16.60	24.00
HT40	3	5550	18.70	18.97	17.88	---	214.393	23.31	24.00
HT40	3	5670	18.29	19.12	18.21	---	215.333	23.33	24.00
VHT20	3	5500	14.62	14.85	13.35	---	81.150	19.09	24.00
VHT20	3	5580	14.86	14.75	13.66	---	83.701	19.23	24.00
VHT20	3	5700	14.02	15.03	13.85	---	81.343	19.10	24.00
VHT40	3	5510	12.31	11.76	11.48	---	46.079	16.64	24.00
VHT40	3	5550	18.75	19.01	17.93	---	216.692	23.36	24.00
VHT40	3	5670	18.37	19.16	18.23	---	217.648	23.38	24.00
VHT80	3	5530	9.86	9.72	8.86	---	26.750	14.27	24.00

**Channel that extends across the 5.725 GHz boundary**

Maximum Conducted Output Power (Within 5470-5725MHz band)											
Mode	N <sub>TX</sub>	Freq. (MHz)	Conducted Power without duty factor					Duty factor (dB)	Total Power (mW)	Total Power (dBm)	Limit (dBm)
			Chain 0	Chain 1	Chain 2	Chain 3	Total Power (dBm)				
11a	3	5720	13.77	14.56	13.68	---	18.79	0.00	75.734	18.79	23.18
HT20	3	5720	13.68	14.92	13.77	---	18.93	0.00	78.203	18.93	23.16
HT40	3	5710	18.11	18.73	17.44	---	22.90	0.23	205.417	23.13	24.00
VHT20	3	5720	13.76	14.99	13.89	---	19.02	0.00	79.809	19.02	23.16
VHT40	3	5710	18.23	18.82	17.41	---	22.96	0.23	208.575	23.19	24.00
VHT80	3	5690	18.20	18.59	17.71	---	22.95	0.44	218.410	23.39	24.00

Maximum Conducted Output Power (Extends across 5725MHz band)											
Mode	N <sub>TX</sub>	Freq. (MHz)	Conducted Power without duty factor					Duty factor (dB)	Total Power (mW)	Total Power (dBm)	Limit (dBm)
			Chain 0	Chain 1	Chain 2	Chain 3	Total Power (dBm)				
11a	3	5720	7.50	8.42	7.56	---	12.62	0.00	18.275	12.62	30.00
HT20	3	5720	8.69	10.09	7.96	---	13.78	0.00	23.857	13.78	30.00
HT40	3	5710	7.00	7.31	7.04	---	11.89	0.23	16.293	12.12	30.00
VHT20	3	5720	8.71	10.09	8.08	---	13.81	0.00	24.066	13.81	30.00
VHT40	3	5710	7.09	7.34	7.12	---	11.96	0.23	16.542	12.19	30.00
VHT80	3	5690	3.26	4.34	2.92	---	8.32	0.44	7.518	8.76	30.00

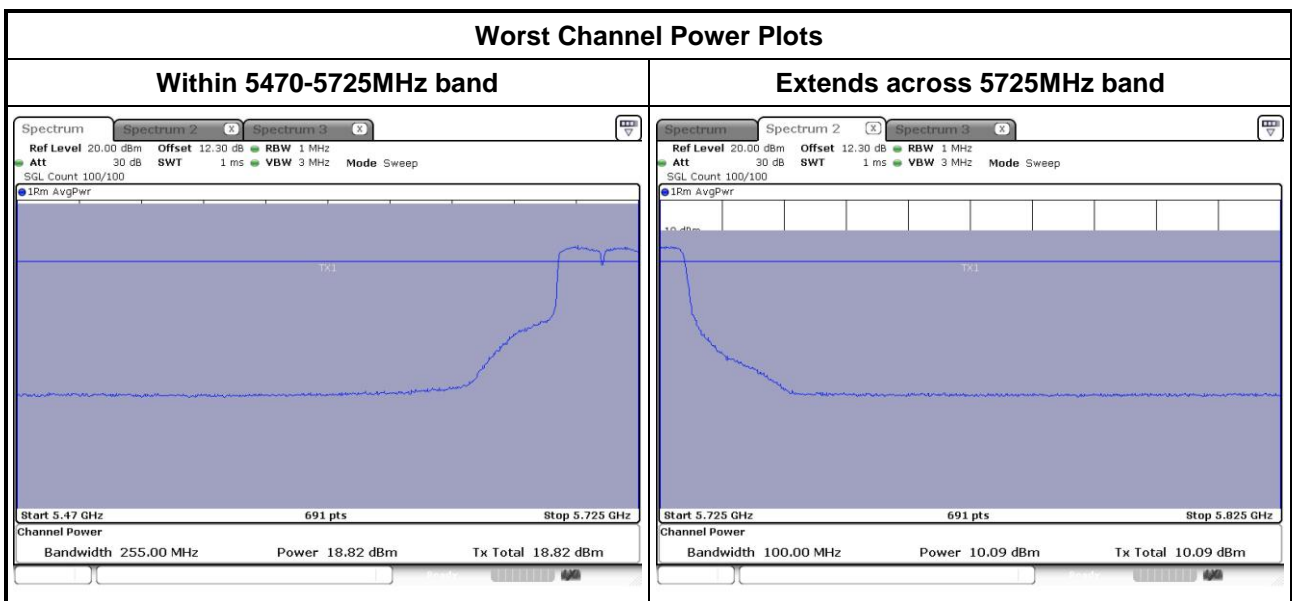

Note: Above plots are without duty factor.

For Frequency band 5725-5850 MHz									
Mode	N <sub>TX</sub>	Freq. (MHz)	Conducted Power (dBm)				Total Power (mW)	Total Power (dBm)	Limit (dBm)
			Chain 0	Chain 1	Chain 2	Chain 3			
11a	3	5745	19.56	19.51	19.65	---	271.953	24.34	30.00
11a	3	5785	19.53	19.54	20.32	---	287.339	24.58	30.00
11a	3	5825	19.53	19.56	19.71	---	273.648	24.37	30.00
HT20	3	5745	19.59	19.81	20.25	---	292.636	24.66	30.00
HT20	3	5785	19.47	19.71	19.47	---	270.564	24.32	30.00
HT20	3	5825	19.48	19.71	19.80	---	277.755	24.44	30.00
HT40	3	5755	19.46	19.48	19.54	---	266.973	24.26	30.00
HT40	3	5795	19.49	19.47	19.98	---	276.972	24.42	30.00
VHT20	3	5745	19.62	19.84	20.31	---	295.404	<b>24.70</b>	30.00
VHT20	3	5785	19.54	19.76	19.53	---	274.316	24.38	30.00
VHT20	3	5825	19.52	19.75	19.84	---	280.325	24.48	30.00
VHT40	3	5755	19.52	19.52	19.57	---	269.646	24.31	30.00
VHT40	3	5795	19.53	19.52	20.02	---	279.741	24.47	30.00
VHT80	3	5775	18.11	17.67	18.04	---	186.873	22.72	30.00

### 3.4 Peak Power Spectral Density

#### 3.4.1 Limit of Peak Power Spectral Density

Frequency band 5150-5250 MHz		
Operating Mode		Limit
<input type="checkbox"/>	Outdoor access point	17 dBm / MHz
<input type="checkbox"/>	Indoor access point	17 dBm / MHz
<input type="checkbox"/>	Fixed point-to-point access points	17 dBm / MHz
<input checked="" type="checkbox"/>	Client devices	11 dBm / MHz

Frequency Band (MHz)		Limit
<input checked="" type="checkbox"/>	5250 ~ 5350	11 dBm / MHz
<input checked="" type="checkbox"/>	5470 ~ 5725	11 dBm / MHz
<input checked="" type="checkbox"/>	5725 ~ 5850	30 dBm /500 kHz

### 3.4.2 Test Procedures

#### For 5150~5250 MHz, 5250~5350 MHz, 5470~5725 MHz

- Method SA-1 (For 11a / 11ac VHT20)
  1. Set RBW = 1 MHz, VBW = 3 MHz, Sweep time = auto, Detector = RMS.
  2. Trace average 100 traces.
  3. Use the peak marker function to determine the maximum amplitude level.
- Method SA-2 Alternative (For 11ac VHT40 / VHT80)
  1. Set RBW = 1 MHz, VBW = 3 MHz, Detector = RMS.
  2. Set sweep time  $\geq 10 * (\text{number of points in sweep}) * (\text{total on/off period of the transmitted signal})$ .
  3. Perform a single sweep.
  4. Use the peak marker function to determine the maximum amplitude level.
  5. Add  $10 \log(1/x)$ , where x is the duty cycle.

#### For 5725~5850 MHz

- Method SA-1 (For 11a / 11ac VHT20)
  1. Set RBW = 500 kHz, VBW = 2 MHz, Sweep time = auto, Detector = RMS.
  2. Trace average 100 traces.
  3. Use the peak marker function to determine the maximum amplitude level.
- Method SA-2 Alternative(For 11ac VHT40 / VHT80)
  1. Set RBW = 500 kHz, VBW = 2 MHz, Detector = RMS.
  2. Set sweep time  $\geq 10 * (\text{number of points in sweep}) * (\text{total on/off period of the transmitted signal})$ .
  3. Perform a single sweep.
  4. Use the peak marker function to determine the maximum amplitude level.
  5. Add  $10 \log(1/x)$ , where x is the duty cycle.

### 3.4.3 Test Setup

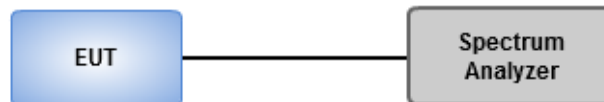



### 3.4.4 Test Result of Peak Power Spectral Density

Frequency band			5150~5250 MHz / 5250~5350 MHz			
Condition			Peak Power Spectral Density (dBm/MHz)			
Mode	N <sub>TX</sub>	Freq. (MHz)	PPSD w/o D.F (dBm/MHz)	Duty Factor (dB)	PPSD with D.F (dBm/MHz)	PPSD Limit (dBm/MHz)
11a	3	5180	7.02	0.00	7.02	7.23
11a	3	5200	7.11	0.00	7.11	7.23
11a	3	5240	6.45	0.00	6.45	7.23
VHT20	3	5180	6.84	0.00	6.84	7.23
VHT20	3	5200	6.95	0.00	6.95	7.23
VHT20	3	5240	6.82	0.00	6.82	7.23
VHT40	3	5190	-2.58	0.23	-2.35	7.23
VHT40	3	5230	6.93	0.23	7.16	7.23
VHT80	3	5210	-8.68	0.44	-8.24	7.23
11a	3	5260	6.77	0.00	6.77	7.23
11a	3	5300	6.67	0.00	6.67	7.23
11a	3	5320	6.77	0.00	6.77	7.23
VHT20	3	5260	6.67	0.00	6.67	7.23
VHT20	3	5300	6.78	0.00	6.78	7.23
VHT20	3	5320	6.91	0.00	6.91	7.23
VHT40	3	5270	6.46	0.23	6.69	7.23
VHT40	3	5310	0.07	0.23	0.30	7.23
VHT80	3	5290	-4.82	0.44	-4.38	7.23

**Note:**

1. D.F is duty factor.
2. Test results are bin-by-bin summing measured value of each TX port.
3. Directional gain =  $5 + 10 * \log(3/1) = 9.77 \text{ dBi} > 6 \text{ dBi}$   
Limit shall be reduced to  $11 \text{ dBm} - (9.77 \text{ dBi} - 6 \text{ dBi}) = 7.23 \text{ dBm}$

Frequency band			5470~5725 MHz			
Condition			Peak Power Spectral Density (dBm/MHz)			
Mode	N <sub>TX</sub>	Freq. (MHz)	PPSD w/o D.F (dBm/MHz)	Duty Factor (dB)	PPSD with D.F (dBm/MHz)	PPSD Limit (dBm/MHz)
11a	3	5500	7.07	0.00	7.07	7.23
11a	3	5580	6.96	0.00	6.96	7.23
11a	3	5700	6.85	0.00	6.85	7.23
11a	3	5720	6.93	0.00	6.93	7.23
VHT20	3	5500	6.59	0.00	6.59	7.23
VHT20	3	5580	7.02	0.00	7.02	7.23
VHT20	3	5700	6.65	0.00	6.65	7.23
VHT20	3	5720	7.13	0.00	7.13	7.23
VHT40	3	5510	0.42	0.23	0.65	7.23
VHT40	3	5550	6.82	0.23	7.05	7.23
VHT40	3	5670	6.59	0.23	6.82	7.23
VHT40	3	5710	6.86	0.23	7.09	7.23
VHT80	3	5530	-6.09	0.44	-5.65	7.23
VHT80	3	5690	3.91	0.44	4.35	7.23

**Note:**

1. D.F is duty factor.
2. Test results are bin-by-bin summing measured value of each TX port.
3. Directional gain =  $5 + 10 \cdot \log(3/1) = 9.77 \text{ dBi} > 6 \text{ dBi}$   
Limit shall be reduced to  $11 \text{ dBm} - (9.77 \text{ dBi} - 6 \text{ dBi}) = 7.23 \text{ dBm}$

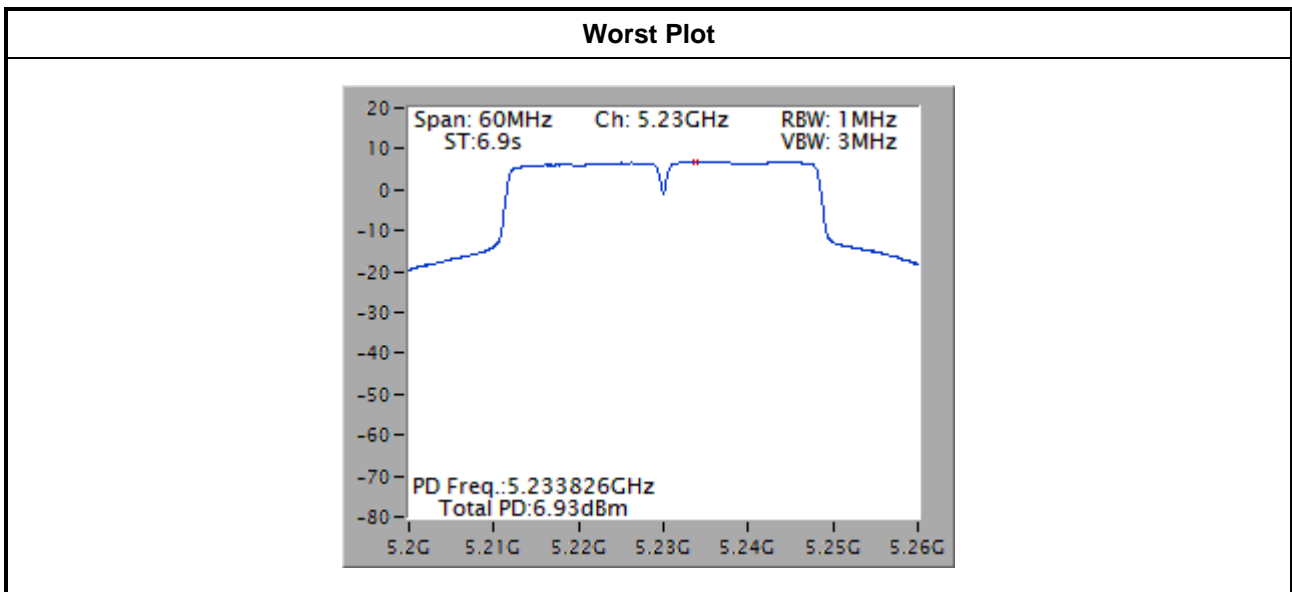

Note: Power density plot without duty factor.

Frequency band			5725-5850 MHz			
Condition			Peak Power Spectral Density (dBm/500kHz)			
Mode	N <sub>TX</sub>	Freq. (MHz)	PPSD w/o D.F (dBm/500kHz)	Duty Factor (dB)	PPSD with D.F (dBm/500kHz)	PPSD Limit (dBm/500kHz)
11a	3	5745	9.77	0.00	9.77	26.23
11a	3	5785	9.58	0.00	9.58	26.23
11a	3	5825	9.29	0.00	9.29	26.23
VHT20	3	5745	9.33	0.00	9.33	26.23
VHT20	3	5785	9.30	0.00	9.30	26.23
VHT20	3	5825	9.05	0.00	9.05	26.23
VHT40	3	5755	5.57	0.23	5.80	26.23
VHT40	3	5795	5.63	0.23	5.86	26.23
VHT80	3	5775	0.81	0.44	1.25	26.23

**Note:**

1. D.F is duty factor.
2. Test results are bin-by-bin summing measured value of each TX port.
3. Directional gain =  $5 + 10 * \log(3/1) = 9.77 \text{ dBi} > 6 \text{ dBi}$   
Limit shall be reduced to  $30 \text{ dBm} - (9.77 \text{ dBi} - 6 \text{ dBi}) = 26.23 \text{ dBm}$

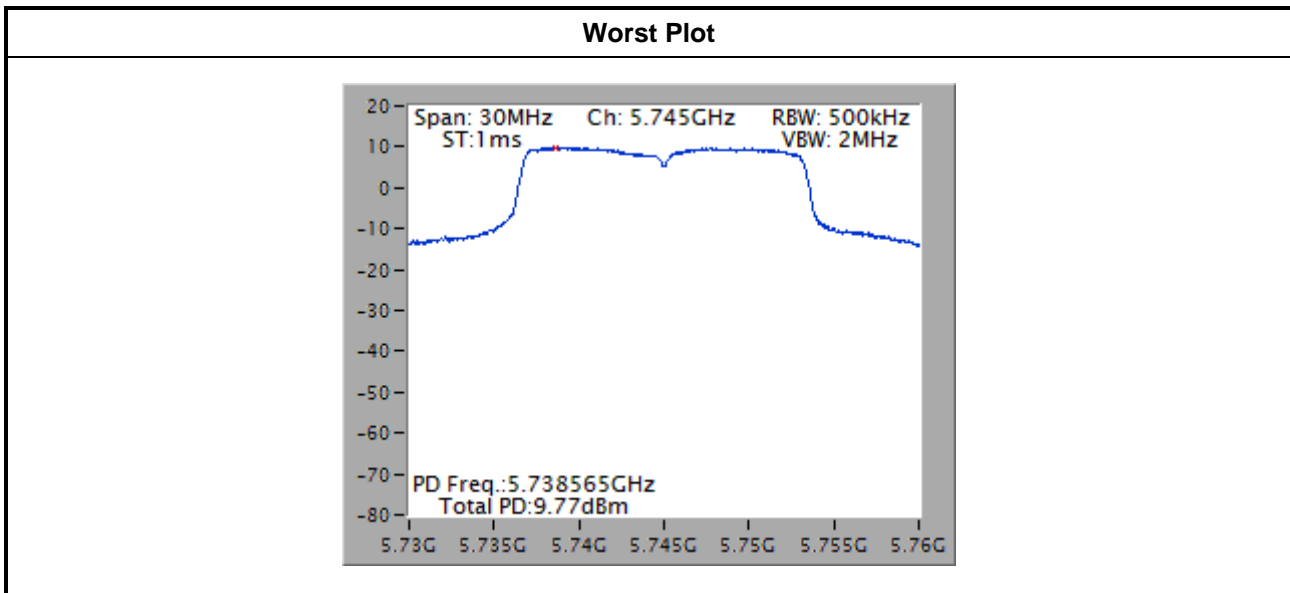

### 3.5 Transmitter Radiated and Band Edge Emissions

#### 3.5.1 Limit of Transmitter Radiated and Band Edge Emissions

Restricted Band Emissions Limit			
Frequency Range (MHz)	Field Strength (uV/m)	Field Strength (dBuV/m)	Measure Distance (m)
0.009~0.490	2400/F(kHz)	48.5 - 13.8	300
0.490~1.705	24000/F(kHz)	33.8 - 23	30
1.705~30.0	30	29	30
30~88	100	40	3
88~216	150	43.5	3
216~960	200	46	3
Above 960	500	54	3

**Note 1:**  
Qusai-Peak value is measured for frequency below 1GHz except for 9–90 kHz, 110–490 kHz frequency band. Peak and average value are measured for frequency above 1GHz. The limit on average radio frequency emission is as above table. The limit on peak radio frequency emissions is 20 dB above the maximum permitted average emission limit

**Note 2:**  
Measurements may be performed at a distance other than what is specified provided. When performing measurements at a distance other than that specified, the results shall be extrapolated to the specified distance using an extrapolation factor as below, Frequency at or above 30 MHz: 20 dB/decade Frequency below 30 MHz: 40 dB/decade.

Un-restricted band emissions above 1GHz Limit	
Operating Band	Limit
5.15 - 5.25 GHz	e.i.r.p. -27 dBm [68.2 dBuV/m@3m]
5.25 - 5.35 GHz	e.i.r.p. -27 dBm [68.2 dBuV/m@3m]
5.47 - 5.725 GHz	e.i.r.p. -27 dBm [68.2 dBuV/m@3m]
5.725 - 5.850 GHz	<input checked="" type="checkbox"/> 15.407(b)(4)(i) All emissions shall be limited to a level of -27 dBm/MHz at 75 MHz or more above or below the band edge increasing linearly to 10 dBm/MHz at 25 MHz above or below the band edge, and from 25 MHz above or below the band edge increasing linearly to a level of 15.6 dBm/MHz at 5 MHz above or below the band edge, and from 5 MHz above or below the band edge increasing linearly to a level of 27 dBm/MHz at the band edge.
	<input type="checkbox"/> 15.407(b)(4)(ii) ,compliance with the emission limits in § 15.247(d) Shall be at least 30dB below that in the 100 kHz bandwidth within the band that contains the highest level of the desired power,. Attenuation below the general limits specified in §15.209(a) is not required. In addition,radiated emissions which fall in the restricted bands, as defined in §15.205(a), must also comply with the radiated emission limits specified in §15.209(a) (see § 15.205(c))

**Note 1:** Measurements may be performed at a distance other than the limit distance provided they are not performed in the near field and the emissions to be measured can be detected by the measurement equipment. When performing measurements at a distance other than that specified, the results shall be extrapolated to the specified distance using an extrapolation factor of 20 dB/decade (inverse of linear distance for field-strength measurements, inverse of linear distance-squared for power-density measurements).

### 3.5.2 Test Procedures

1. Measurement is made at a semi-anechoic chamber that incorporates a turntable allowing a EUT rotation of 360°. A continuously-rotating, remotely-controlled turntable is installed at the test site to support the EUT and facilitate determination of the direction of maximum radiation for each EUT emission frequency. The EUT is placed at test table. For emissions testing at or below 1 GHz, the table height is 80 cm above the reference ground plane. For emission measurements above 1 GHz, the table height is 1.5 m
2. Measurement is made with the antenna positioned in both the horizontal and vertical planes of polarization. The measurement antenna is varied in height (1m ~ 4m) above the reference ground plane to obtain the maximum signal strength. Distance between EUT and antenna is 3 m.
3. This investigation is performed with the EUT rotated 360°, the antenna height scanned between 1 m and 4 m, and the antenna rotated to repeat the measurements for both the horizontal and vertical antenna polarizations.

Note:

1. 120kHz measurement bandwidth of test receiver and Quasi-peak detector is for radiated emission below 1GHz.
2. RBW=1MHz, VBW=3MHz and Peak detector is for peak measured value of radiated emission above 1GHz.
3. RBW=1MHz, VBW=1/T and Peak detector is for average measured value of radiated emission above 1GHz.

### 3.5.3 Test Setup

#### Radiated Emissions below 1 GHz

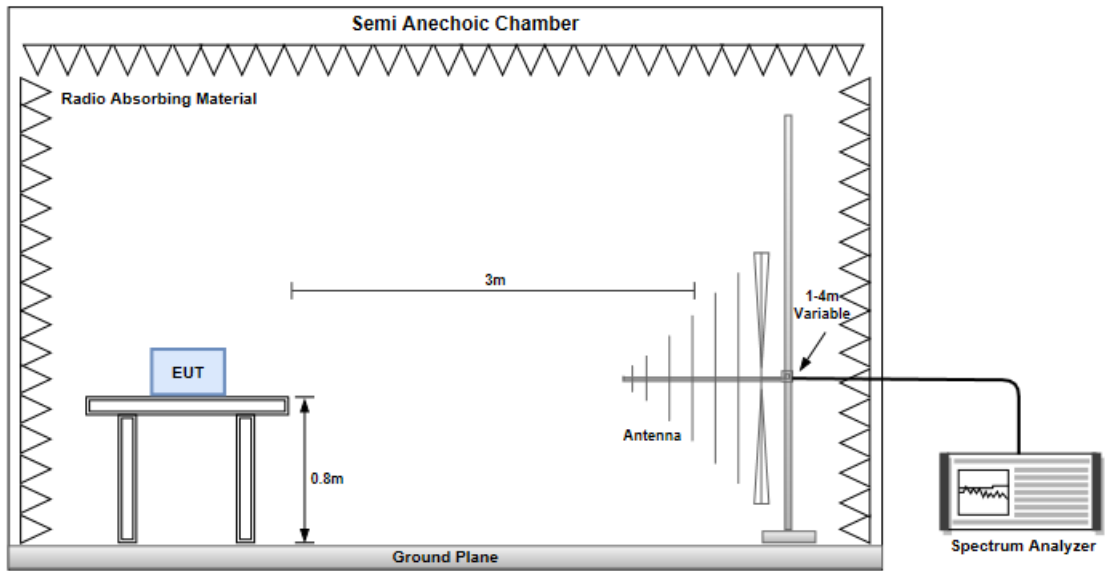

#### Radiated Emissions above 1 GHz

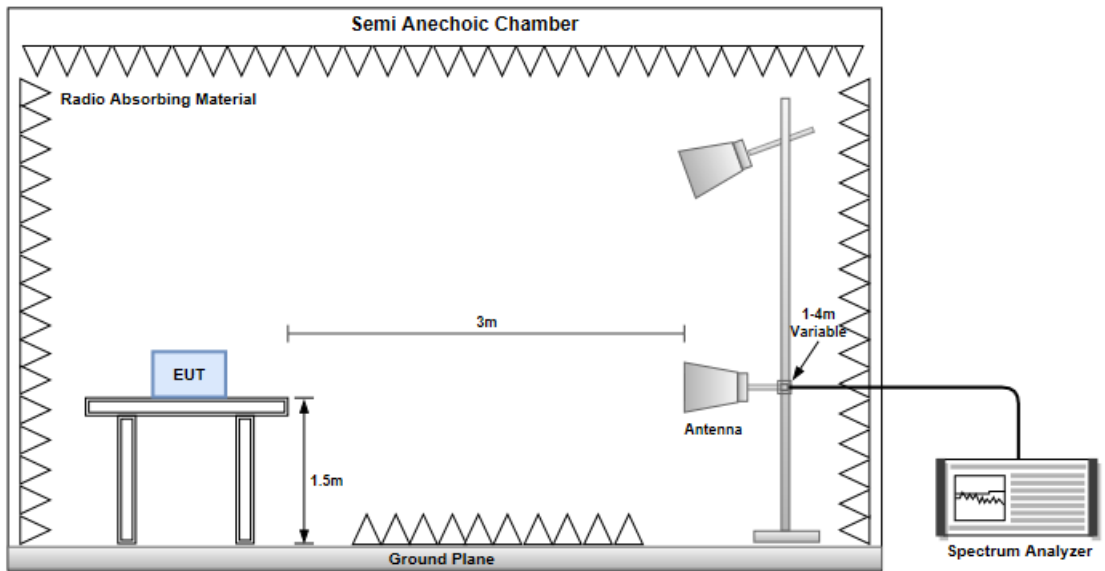

### 3.5.4 Transmitter Radiated Unwanted Emissions (Below 1GHz)

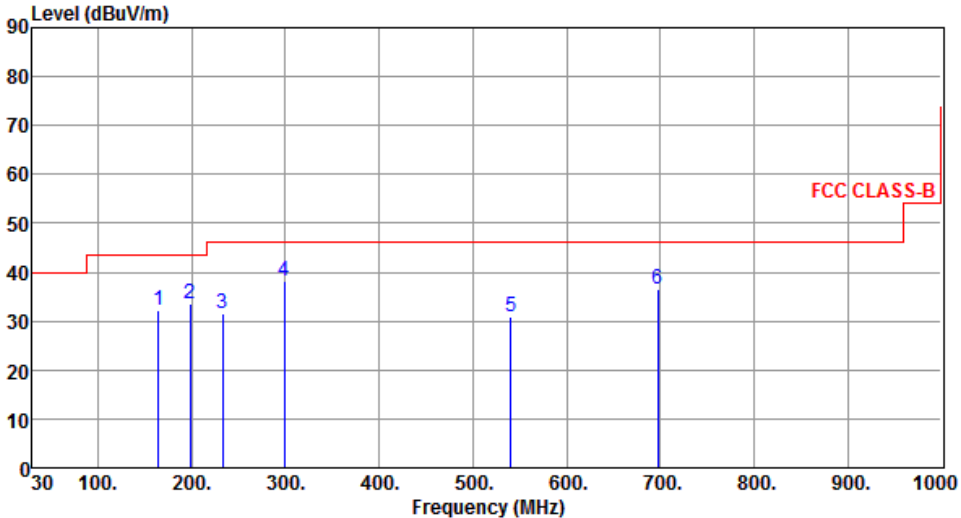
<b>Modulation</b>	VHT40	<b>Test Freq. (MHz)</b>	5670						
<b>Polarization</b>	Horizontal								
									
	Freq.	Emission level	Limit	Margin	SA reading	Factor	Remark	ANT High	Turn Table
	MHz	dBuV/m	dBuV/m	dB	dBuV	dB		cm	deg
1	164.83	32.31	43.50	-11.19	40.55	-8.24	Peak	---	---
2	198.78	33.52	43.50	-9.98	44.48	-10.96	Peak	---	---
3	232.73	31.43	46.00	-14.57	41.53	-10.10	Peak	---	---
4	298.69	38.25	46.00	-7.75	45.98	-7.73	Peak	---	---
5	540.22	30.79	46.00	-15.21	32.97	-2.18	Peak	---	---
6	697.36	36.52	46.00	-9.48	35.86	0.66	Peak	---	---
<p>Note 1: Emission Level (dBuV/m) = SA Reading (dBuV/m) + Factor* (dB)            *Factor includes antenna factor , cable loss and amplifier gain            Note 2: Margin (dB) = Emission level (dBuV/m) – Limit (dBuV/m).            Note 3: All spurious emissions below 30MHz are more than 20 dB below the limit.</p>									

<b>Modulation</b>	VHT40	<b>Test Freq. (MHz)</b>	5670
<b>Polarization</b>	Vertical		

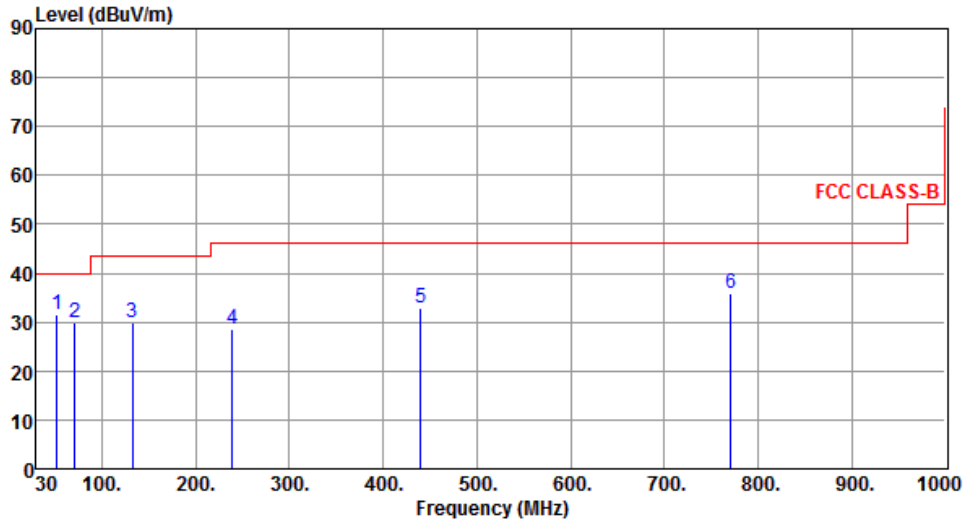

	Freq. MHz	Emission level dBuV/m	Limit dBuV/m	Margin dB	SA reading dBuV	Factor dB	Remark	ANT High cm	Turn Table deg
1	52.31	31.43	40.00	-8.57	39.42	-7.99	Peak	---	---
2	70.74	29.87	40.00	-10.13	40.58	-10.71	Peak	---	---
3	132.82	29.90	43.50	-13.60	39.31	-9.41	Peak	---	---
4	239.52	28.41	46.00	-17.59	38.01	-9.60	Peak	---	---
5	440.31	32.84	46.00	-13.16	36.72	-3.88	Peak	---	---
6	771.08	35.71	46.00	-10.29	33.51	2.20	Peak	---	---

Note 1: Emission Level (dBuV/m) = SA Reading (dBuV/m) + Factor\* (dB)

\*Factor includes antenna factor , cable loss and amplifier gain

Note 2: Margin (dB) = Emission level (dBuV/m) – Limit (dBuV/m).

Note 3: All spurious emissions below 30MHz are more than 20 dB below the limit.



<b>Modulation</b>	VHT20	<b>Test Freq. (MHz)</b>	5745
<b>Polarization</b>	Horizontal		

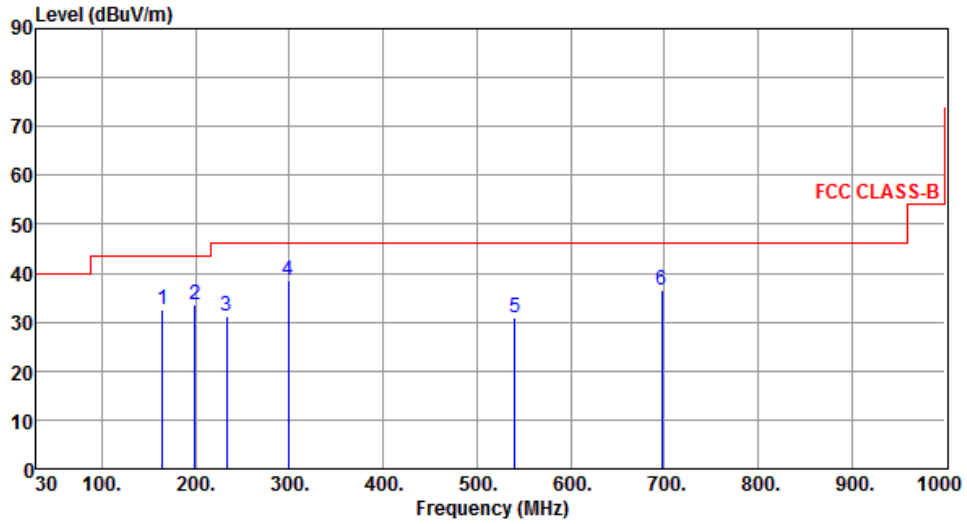

	Freq. MHz	Emission level dBuV/m	Limit dBuV/m	Margin dB	SA reading dBuV	Factor dB	Remark	ANT High cm	Turn Table deg
1	164.65	32.46	43.50	-11.04	40.70	-8.24	Peak	---	---
2	198.82	33.38	43.50	-10.12	44.34	-10.96	Peak	---	---
3	232.64	31.29	46.00	-14.71	41.40	-10.11	Peak	---	---
4	298.45	38.46	46.00	-7.54	46.19	-7.73	Peak	---	---
5	540.55	30.86	46.00	-15.14	33.03	-2.17	Peak	---	---
6	697.65	36.68	46.00	-9.32	36.02	0.66	Peak	---	---

Note 1: Emission Level (dBuV/m) = SA Reading (dBuV/m) + Factor\* (dB)

\*Factor includes antenna factor , cable loss and amplifier gain

Note 2: Margin (dB) = Emission level (dBuV/m) – Limit (dBuV/m).

Note 3: All spurious emissions below 30MHz are more than 20 dB below the limit.

<b>Modulation</b>	VHT20	<b>Test Freq. (MHz)</b>	5745
<b>Polarization</b>	Vertical		

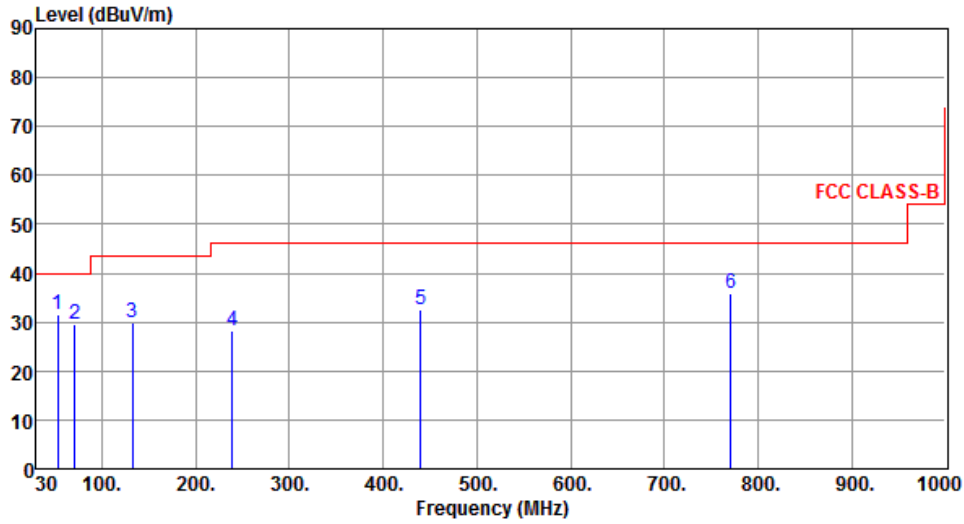

	Freq. MHz	Emission level dBuV/m	Limit dBuV/m	Margin dB	SA reading dBuV	Factor dB	Remark	ANT High cm	Turn Table deg
1	52.45	31.58	40.00	-8.42	39.59	-8.01	Peak	---	---
2	70.85	29.64	40.00	-10.36	40.37	-10.73	Peak	---	---
3	132.58	29.84	43.50	-13.66	39.29	-9.45	Peak	---	---
4	239.34	28.32	46.00	-17.68	37.94	-9.62	Peak	---	---
5	440.44	32.66	46.00	-13.34	36.54	-3.88	Peak	---	---
6	771.25	35.81	46.00	-10.19	33.61	2.20	Peak	---	---

Note 1: Emission Level (dBuV/m) = SA Reading (dBuV/m) + Factor\* (dB)

\*Factor includes antenna factor , cable loss and amplifier gain

Note 2: Margin (dB) = Emission level (dBuV/m) – Limit (dBuV/m).

Note 3: All spurious emissions below 30MHz are more than 20 dB below the limit.

### 3.5.5 Transmitter Radiated Unwanted Emissions (Above 1GHz) for 11a

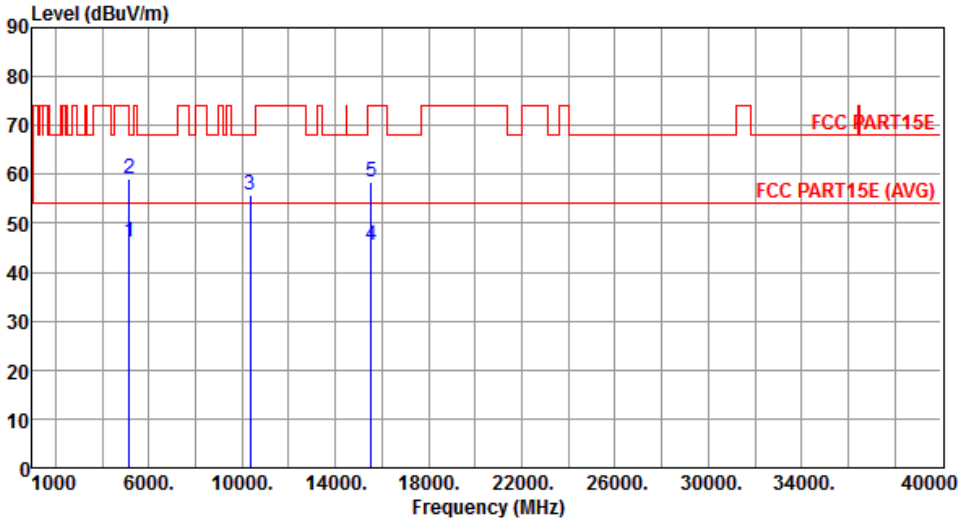
Modulation	11a	Test Freq. (MHz)	5180																																																																					
Polarization	Horizontal																																																																							
																																																																								
	<table border="1"> <thead> <tr> <th>Freq.</th> <th>Emission level</th> <th>Limit</th> <th>Margin</th> <th>SA reading</th> <th>Factor</th> <th>Remark</th> <th>ANT High</th> <th>Turn Table</th> </tr> <tr> <th>MHz</th> <th>dBuV/m</th> <th>dBuV/m</th> <th>dB</th> <th>dBuV</th> <th>dB</th> <th></th> <th>cm</th> <th>deg</th> </tr> </thead> <tbody> <tr> <td>1</td> <td>5150.00</td> <td>46.31</td> <td>54.00</td> <td>-7.69</td> <td>40.44</td> <td>5.87</td> <td>Average</td> <td>295</td> <td>279</td> </tr> <tr> <td>2</td> <td>5150.00</td> <td>59.15</td> <td>74.00</td> <td>-14.85</td> <td>53.28</td> <td>5.87</td> <td>Peak</td> <td>295</td> <td>279</td> </tr> <tr> <td>3</td> <td>10360.00</td> <td>55.83</td> <td>68.20</td> <td>-12.37</td> <td>40.61</td> <td>15.22</td> <td>Peak</td> <td>162</td> <td>163</td> </tr> <tr> <td>4</td> <td>15540.00</td> <td>45.42</td> <td>54.00</td> <td>-8.58</td> <td>29.35</td> <td>16.07</td> <td>Average</td> <td>152</td> <td>202</td> </tr> <tr> <td>5</td> <td>15540.00</td> <td>58.38</td> <td>74.00</td> <td>-15.62</td> <td>42.31</td> <td>16.07</td> <td>Peak</td> <td>152</td> <td>202</td> </tr> </tbody> </table>	Freq.	Emission level	Limit	Margin	SA reading	Factor	Remark	ANT High	Turn Table	MHz	dBuV/m	dBuV/m	dB	dBuV	dB		cm	deg	1	5150.00	46.31	54.00	-7.69	40.44	5.87	Average	295	279	2	5150.00	59.15	74.00	-14.85	53.28	5.87	Peak	295	279	3	10360.00	55.83	68.20	-12.37	40.61	15.22	Peak	162	163	4	15540.00	45.42	54.00	-8.58	29.35	16.07	Average	152	202	5	15540.00	58.38	74.00	-15.62	42.31	16.07	Peak	152	202			
Freq.	Emission level	Limit	Margin	SA reading	Factor	Remark	ANT High	Turn Table																																																																
MHz	dBuV/m	dBuV/m	dB	dBuV	dB		cm	deg																																																																
1	5150.00	46.31	54.00	-7.69	40.44	5.87	Average	295	279																																																															
2	5150.00	59.15	74.00	-14.85	53.28	5.87	Peak	295	279																																																															
3	10360.00	55.83	68.20	-12.37	40.61	15.22	Peak	162	163																																																															
4	15540.00	45.42	54.00	-8.58	29.35	16.07	Average	152	202																																																															
5	15540.00	58.38	74.00	-15.62	42.31	16.07	Peak	152	202																																																															
<p>Note 1: Emission Level (dBuV/m) = SA Reading (dBuV/m) + Factor* (dB)            *Factor includes antenna factor , cable loss and amplifier gain            Note 2: Margin (dB) = Emission level (dBuV/m) – Limit (dBuV/m).</p>																																																																								

<b>Modulation</b>	11a	<b>Test Freq. (MHz)</b>	5180
<b>Polarization</b>	Vertical		

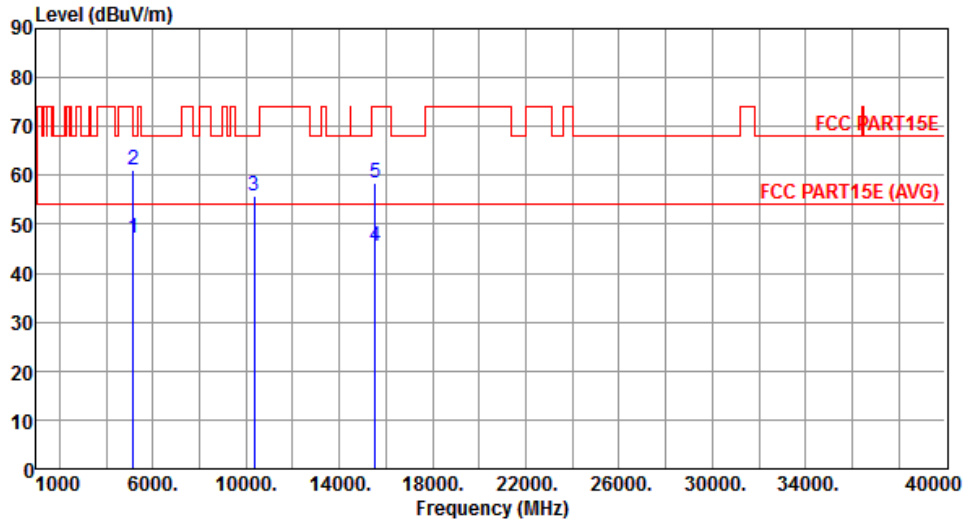

	Freq. MHz	Emission level dBuV/m	Limit dBuV/m	Margin dB	SA reading dBuV	Factor dB	Remark	ANT High cm	Turn Table deg
1	5150.00	47.20	54.00	-6.80	41.33	5.87	Average	254	232
2	5150.00	61.08	74.00	-12.92	55.21	5.87	Peak	254	232
3	10360.00	55.76	68.20	-12.44	40.54	15.22	Peak	155	143
4	15540.00	45.57	54.00	-8.43	29.50	16.07	Average	100	162
5	15540.00	58.32	74.00	-15.68	42.25	16.07	Peak	100	162

Note 1: Emission Level (dBuV/m) = SA Reading (dBuV/m) + Factor\* (dB)

\*Factor includes antenna factor , cable loss and amplifier gain

Note 2: Margin (dB) = Emission level (dBuV/m) – Limit (dBuV/m).

<b>Modulation</b>	11a	<b>Test Freq. (MHz)</b>	5200
<b>Polarization</b>	Horizontal		

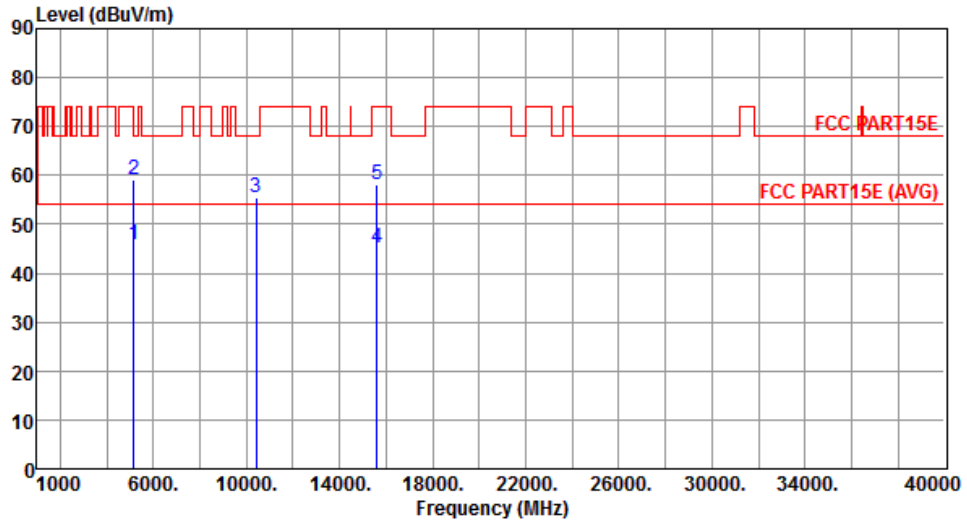

	Freq. MHz	Emission level dBuV/m	Limit dBuV/m	Margin dB	SA reading dBuV	Factor dB	Remark	ANT High cm	Turn Table deg
1	5150.00	45.99	54.00	-8.01	40.12	5.87	Average	292	280
2	5150.00	58.98	74.00	-15.02	53.11	5.87	Peak	292	280
3	10400.00	55.58	68.20	-12.62	40.31	15.27	Peak	161	162
4	15600.00	45.21	54.00	-8.79	29.21	16.00	Average	150	201
5	15600.00	58.16	74.00	-15.84	42.16	16.00	Peak	150	201

Note 1: Emission Level (dBuV/m) = SA Reading (dBuV/m) + Factor\* (dB)

\*Factor includes antenna factor , cable loss and amplifier gain

Note 2: Margin (dB) = Emission level (dBuV/m) – Limit (dBuV/m).

<b>Modulation</b>	11a	<b>Test Freq. (MHz)</b>	5200
<b>Polarization</b>	Vertical		

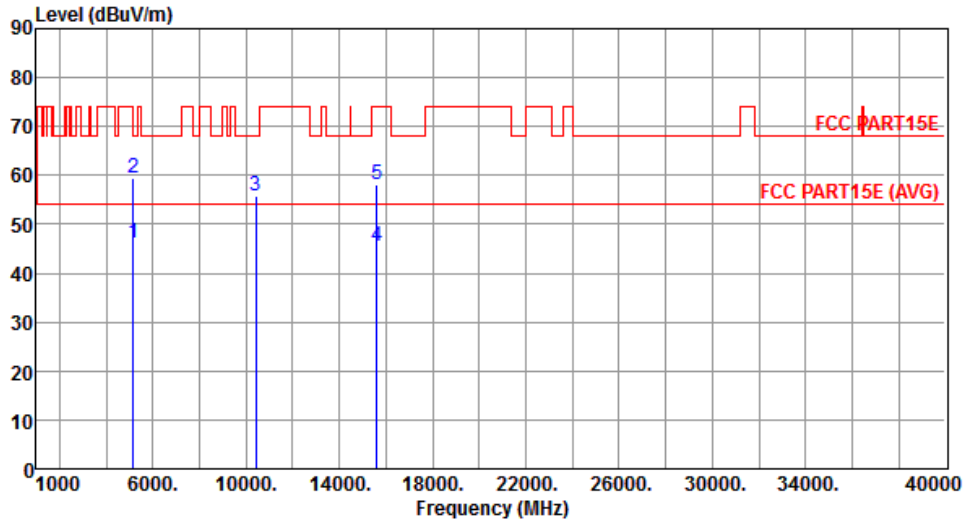

	Freq. MHz	Emission level dBuV/m	Limit dBuV/m	Margin dB	SA reading dBuV	Factor dB	Remark	ANT High cm	Turn Table deg
1	5150.00	46.05	54.00	-7.95	40.18	5.87	Average	252	231
2	5150.00	59.29	74.00	-14.71	53.42	5.87	Peak	252	231
3	10400.00	55.71	68.20	-12.49	40.44	15.27	Peak	153	146
4	15600.00	45.44	54.00	-8.56	29.44	16.00	Average	100	158
5	15600.00	58.16	74.00	-15.84	42.16	16.00	Peak	100	158

Note 1: Emission Level (dBuV/m) = SA Reading (dBuV/m) + Factor\* (dB)

\*Factor includes antenna factor , cable loss and amplifier gain

Note 2: Margin (dB) = Emission level (dBuV/m) – Limit (dBuV/m).

<b>Modulation</b>	11a	<b>Test Freq. (MHz)</b>	5240
<b>Polarization</b>	Horizontal		

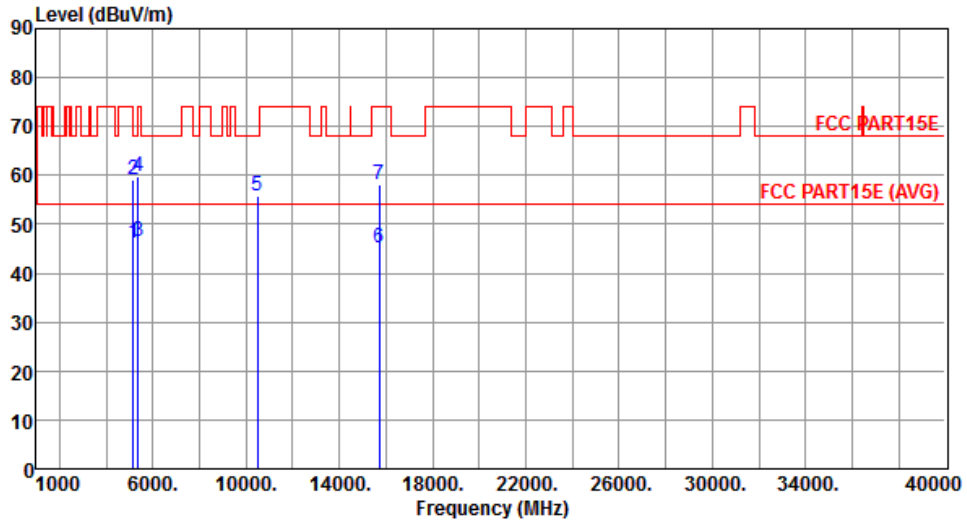

	Freq. MHz	Emission level dBuV/m	Limit dBuV/m	Margin dB	SA reading dBuV	Factor dB	Remark	ANT High cm	Turn Table deg
1	5150.00	46.03	54.00	-7.97	40.16	5.87	Average	292	281
2	5150.00	59.18	74.00	-14.82	53.31	5.87	Peak	292	281
3	5350.00	46.47	54.00	-7.53	40.26	6.21	Average	292	281
4	5350.00	59.70	74.00	-14.30	53.49	6.21	Peak	292	281
5	10480.00	55.69	68.20	-12.51	40.33	15.36	Peak	160	161
6	15720.00	45.10	54.00	-8.90	29.24	15.86	Average	150	201
7	15720.00	58.17	74.00	-15.83	42.31	15.86	Peak	150	201

Note 1: Emission Level (dBuV/m) = SA Reading (dBuV/m) + Factor\* (dB)

\*Factor includes antenna factor , cable loss and amplifier gain

Note 2: Margin (dB) = Emission level (dBuV/m) – Limit (dBuV/m).

<b>Modulation</b>	11a	<b>Test Freq. (MHz)</b>	5240
<b>Polarization</b>	Vertical		

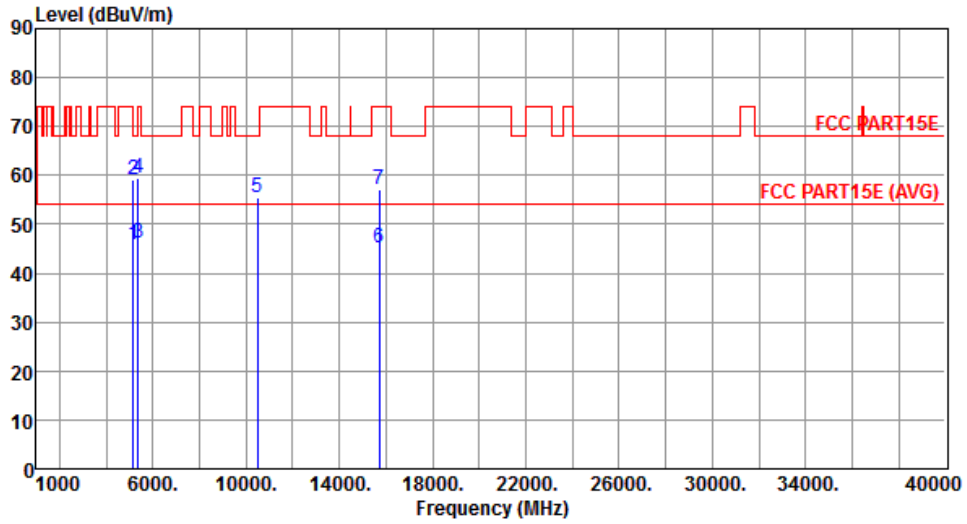

	Freq. MHz	Emission level dBuV/m	Limit dBuV/m	Margin dB	SA reading dBuV	Factor dB	Remark	ANT High cm	Turn Table deg
1	5150.00	45.92	54.00	-8.08	40.05	5.87	Average	251	235
2	5150.00	59.22	74.00	-14.78	53.35	5.87	Peak	251	235
3	5350.00	46.32	54.00	-7.68	40.11	6.21	Average	251	235
4	5350.00	59.44	74.00	-14.56	53.23	6.21	Peak	251	235
5	10480.00	55.62	68.20	-12.58	40.26	15.36	Peak	152	142
6	15720.00	45.21	54.00	-8.79	29.35	15.86	Average	100	160
7	15720.00	57.24	74.00	-16.76	41.38	15.86	Peak	100	160

Note 1: Emission Level (dBuV/m) = SA Reading (dBuV/m) + Factor\* (dB)

\*Factor includes antenna factor , cable loss and amplifier gain

Note 2: Margin (dB) = Emission level (dBuV/m) – Limit (dBuV/m).



<b>Modulation</b>	11a	<b>Test Freq. (MHz)</b>	5260
<b>Polarization</b>	Horizontal		

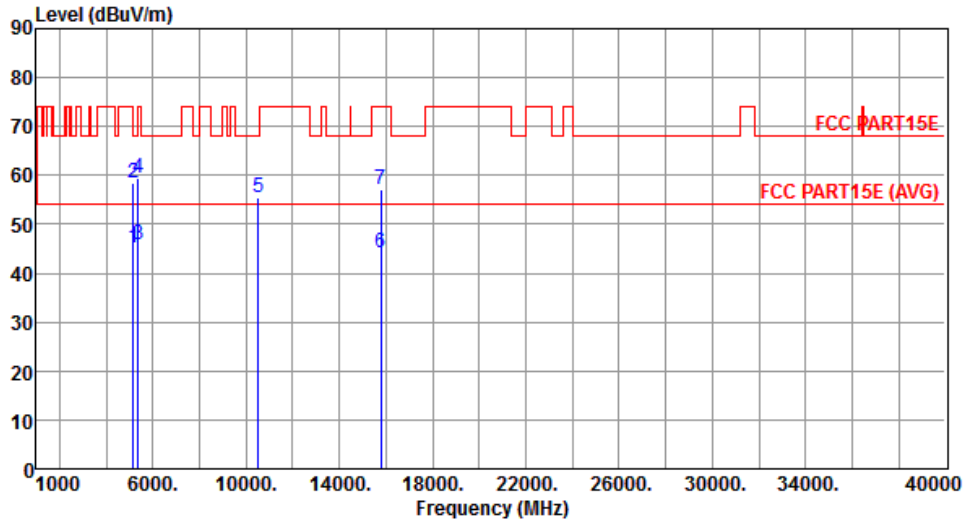

	Freq. MHz	Emission level dBuV/m	Limit dBuV/m	Margin dB	SA reading dBuV	Factor dB	Remark	ANT High cm	Turn Table deg
1	5150.00	45.01	54.00	-8.99	39.14	5.87	Average	100	216
2	5150.00	58.34	74.00	-15.66	52.47	5.87	Peak	100	216
3	5350.00	45.80	54.00	-8.20	39.59	6.21	Average	100	216
4	5350.00	59.46	74.00	-14.54	53.25	6.21	Peak	100	216
5	10520.00	55.50	68.20	-12.70	40.09	15.41	Peak	135	118
6	15780.00	44.06	54.00	-9.94	28.28	15.78	Average	174	219
7	15780.00	57.09	74.00	-16.91	41.31	15.78	Peak	174	219

Note 1: Emission Level (dBuV/m) = SA Reading (dBuV/m) + Factor\* (dB)

\*Factor includes antenna factor , cable loss and amplifier gain

Note 2: Margin (dB) = Emission level (dBuV/m) – Limit (dBuV/m).

<b>Modulation</b>	11a	<b>Test Freq. (MHz)</b>	5260
<b>Polarization</b>	Vertical		

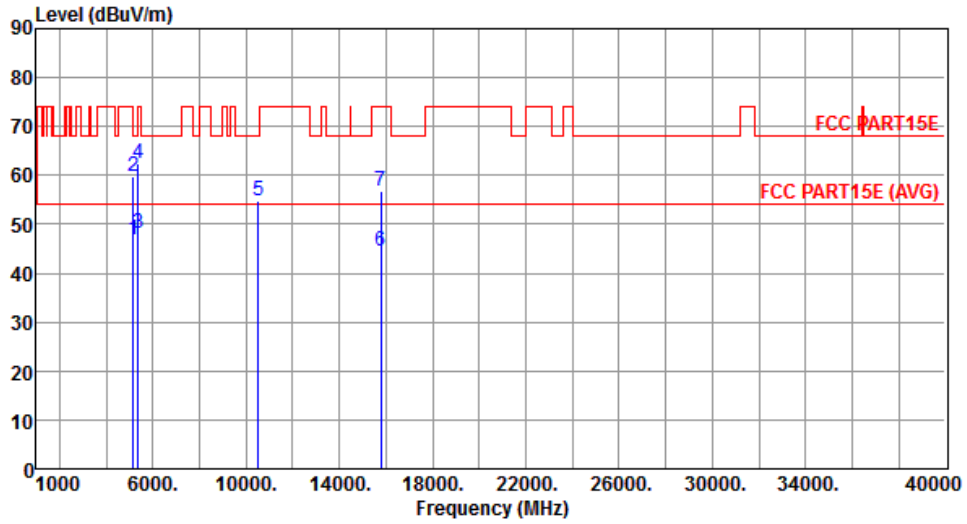

	Freq. MHz	Emission level dBuV/m	Limit dBuV/m	Margin dB	SA reading dBuV	Factor dB	Remark	ANT High cm	Turn Table deg
1	5150.00	46.92	54.00	-7.08	41.05	5.87	Average	100	130
2	5150.00	59.63	74.00	-14.37	53.76	5.87	Peak	100	130
3	5350.00	48.31	54.00	-5.69	42.10	6.21	Average	100	130
4	5350.00	62.32	74.00	-11.68	56.11	6.21	Peak	100	130
5	10520.00	54.93	68.20	-13.27	39.52	15.41	Peak	271	182
6	15780.00	44.38	54.00	-9.62	28.60	15.78	Average	143	86
7	15780.00	56.76	74.00	-17.24	40.98	15.78	Peak	143	86

Note 1: Emission Level (dBuV/m) = SA Reading (dBuV/m) + Factor\* (dB)

\*Factor includes antenna factor , cable loss and amplifier gain

Note 2: Margin (dB) = Emission level (dBuV/m) – Limit (dBuV/m).

<b>Modulation</b>	11a	<b>Test Freq. (MHz)</b>	5300
<b>Polarization</b>	Horizontal		

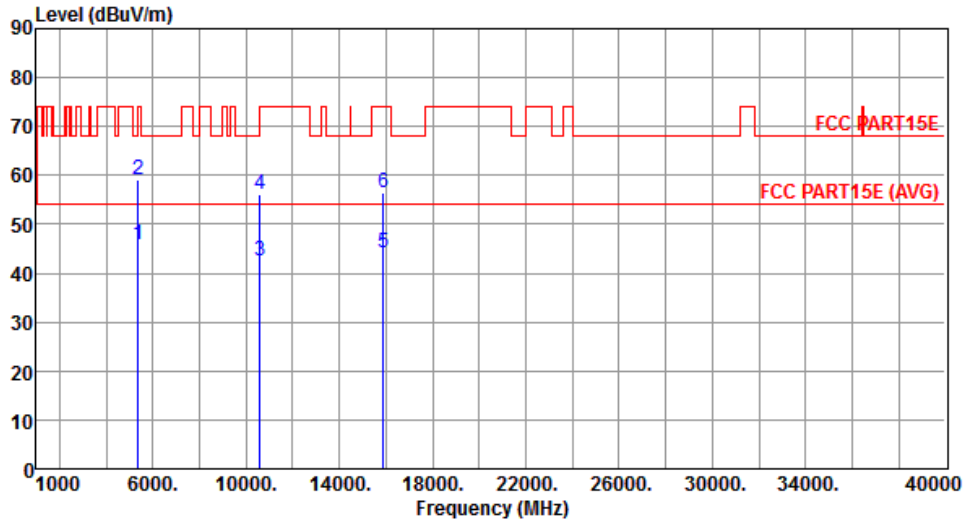

	Freq. MHz	Emission level dBuV/m	Limit dBuV/m	Margin dB	SA reading dBuV	Factor dB	Remark	ANT High cm	Turn Table deg
1	5350.00	45.80	54.00	-8.20	39.59	6.21	Average	100	169
2	5350.00	59.07	74.00	-14.93	52.86	6.21	Peak	100	169
3	10600.00	42.56	54.00	-11.44	27.10	15.46	Average	260	147
4	10600.00	56.05	74.00	-17.95	40.59	15.46	Peak	260	147
5	15900.00	44.11	54.00	-9.89	28.47	15.64	Average	161	105
6	15900.00	56.48	74.00	-17.52	40.84	15.64	Peak	161	105

Note 1: Emission Level (dBuV/m) = SA Reading (dBuV/m) + Factor\* (dB)

\*Factor includes antenna factor , cable loss and amplifier gain

Note 2: Margin (dB) = Emission level (dBuV/m) – Limit (dBuV/m).

<b>Modulation</b>	11a	<b>Test Freq. (MHz)</b>	5300
<b>Polarization</b>	Vertical		

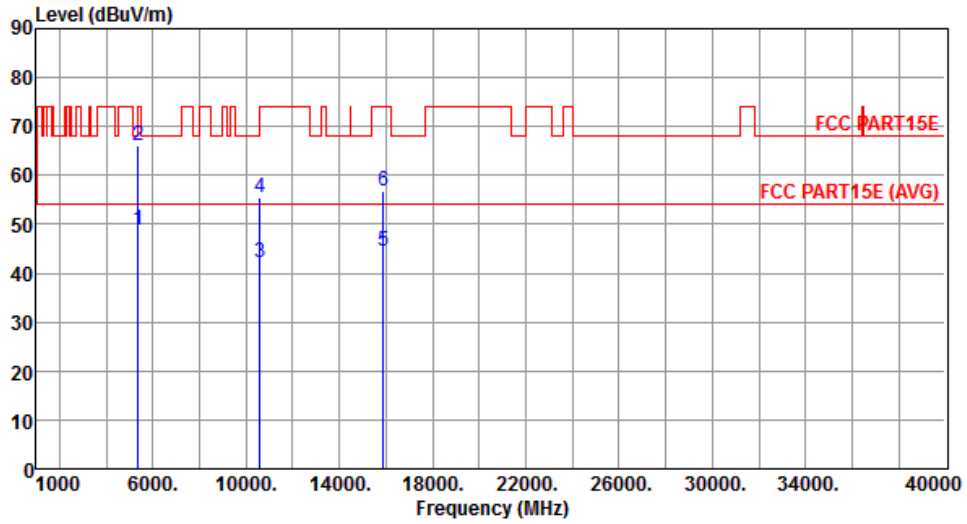

	Freq. MHz	Emission level dBuV/m	Limit dBuV/m	Margin dB	SA reading dBuV	Factor dB	Remark	ANT High cm	Turn Table deg
1	5350.00	48.71	54.00	-5.29	42.50	6.21	Average	100	131
2	5350.00	66.06	74.00	-7.94	59.85	6.21	Peak	100	131
3	10600.00	42.02	54.00	-11.98	26.56	15.46	Average	281	195
4	10600.00	55.49	74.00	-18.51	40.03	15.46	Peak	281	195
5	15900.00	44.51	54.00	-9.49	28.87	15.64	Average	130	155
6	15900.00	56.72	74.00	-17.28	41.08	15.64	Peak	130	155

Note 1: Emission Level (dBuV/m) = SA Reading (dBuV/m) + Factor\* (dB)

\*Factor includes antenna factor , cable loss and amplifier gain

Note 2: Margin (dB) = Emission level (dBuV/m) – Limit (dBuV/m).

<b>Modulation</b>	11a	<b>Test Freq. (MHz)</b>	5320
<b>Polarization</b>	Horizontal		

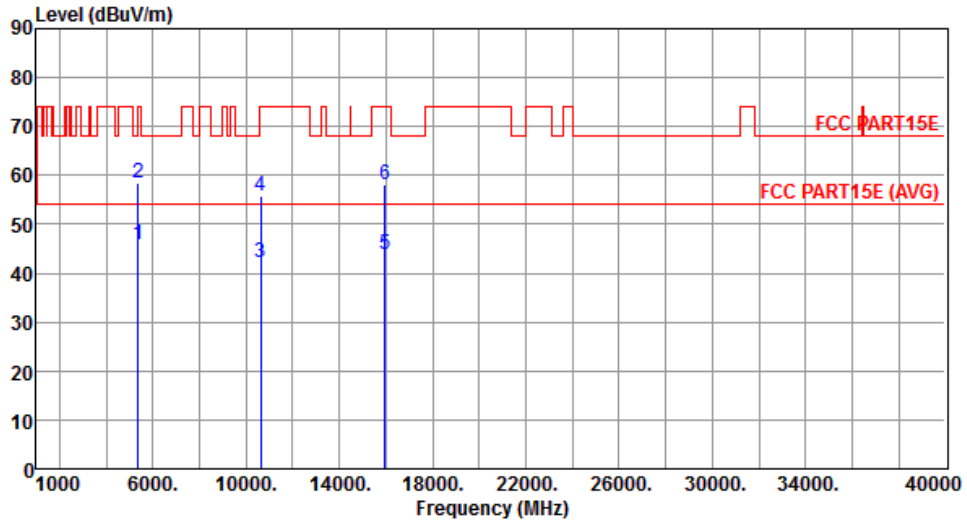

	Freq. MHz	Emission level dBuV/m	Limit dBuV/m	Margin dB	SA reading dBuV	Factor dB	Remark	ANT High cm	Turn Table deg
1	5350.00	45.92	54.00	-8.08	39.71	6.21	Average	100	287
2	5350.00	58.59	74.00	-15.41	52.38	6.21	Peak	100	287
3	10640.00	42.24	54.00	-11.76	26.68	15.56	Average	163	45
4	10640.00	55.93	74.00	-18.07	40.44	15.49	Peak	163	45
5	15960.00	43.82	54.00	-10.18	28.25	15.57	Average	203	175
6	15960.00	58.01	74.00	-15.99	42.44	15.57	Peak	203	175

Note 1: Emission Level (dBuV/m) = SA Reading (dBuV/m) + Factor\* (dB)

\*Factor includes antenna factor , cable loss and amplifier gain

Note 2: Margin (dB) = Emission level (dBuV/m) – Limit (dBuV/m).

<b>Modulation</b>	11a	<b>Test Freq. (MHz)</b>	5320
<b>Polarization</b>	Vertical		

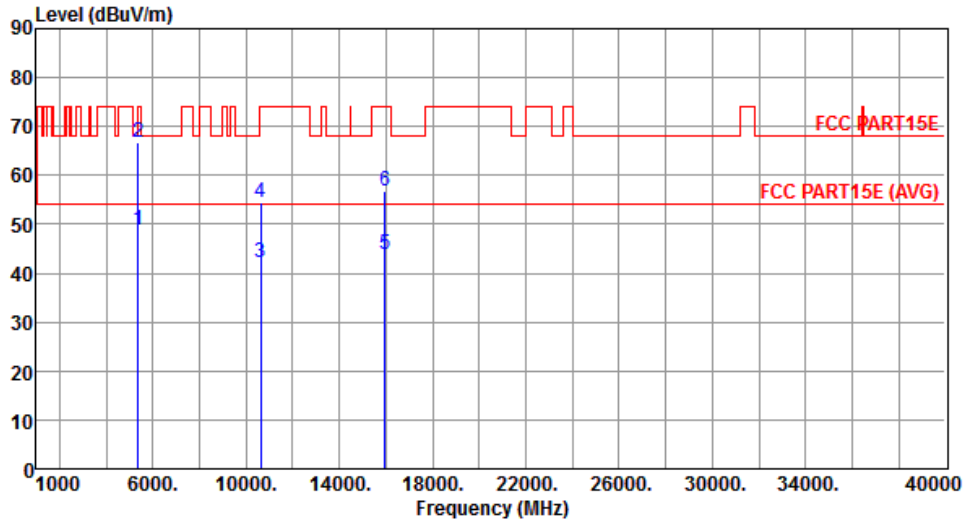

	Freq. MHz	Emission level dBuV/m	Limit dBuV/m	Margin dB	SA reading dBuV	Factor dB	Remark	ANT High cm	Turn Table deg
1	5350.00	48.74	54.00	-5.26	42.53	6.21	Average	100	133
2	5350.00	66.88	74.00	-7.12	60.67	6.21	Peak	100	133
3	10640.00	42.06	54.00	-11.94	26.57	15.49	Average	193	342
4	10640.00	54.45	74.00	-19.55	38.96	15.49	Peak	193	342
5	15960.00	43.87	54.00	-10.13	28.30	15.57	Average	251	148
6	15960.00	56.63	74.00	-17.37	41.06	15.57	Peak	251	148

Note 1: Emission Level (dBuV/m) = SA Reading (dBuV/m) + Factor\* (dB)

\*Factor includes antenna factor , cable loss and amplifier gain

Note 2: Margin (dB) = Emission level (dBuV/m) – Limit (dBuV/m).

<b>Modulation</b>	11a	<b>Test Freq. (MHz)</b>	5500
<b>Polarization</b>	Horizontal		

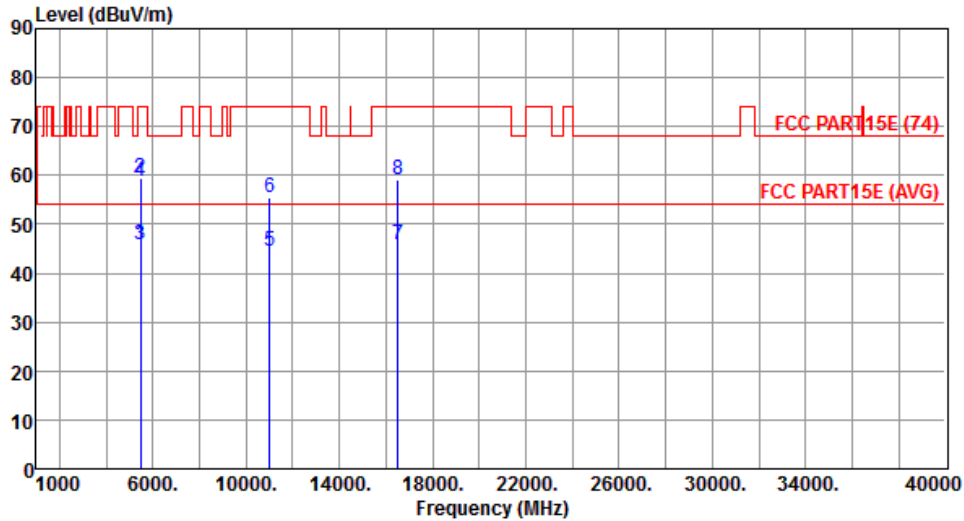

	Freq. MHz	Emission level dBuV/m	Limit dBuV/m	Margin dB	SA reading dBuV	Factor dB	Remark	ANT High cm	Turn Table deg
1	5460.00	45.72	54.00	-8.28	39.36	6.36	Average	152	287
2	5460.00	59.45	74.00	-14.55	53.09	6.36	Peak	152	287
3	5470.00	45.88	54.00	-8.12	39.51	6.37	Average	152	287
4	5470.00	58.84	74.00	-15.16	52.47	6.37	Peak	152	287
5	11000.00	44.54	54.00	-9.46	28.80	15.74	Average	241	183
6	11000.00	55.57	74.00	-18.43	39.83	15.74	Peak	241	183
7	16500.00	45.90	54.00	-8.10	29.87	16.03	Average	170	335
8	16500.00	59.18	74.00	-14.82	43.15	16.03	Peak	170	335

Note 1: Emission Level (dBuV/m) = SA Reading (dBuV/m) + Factor\* (dB)

\*Factor includes antenna factor , cable loss and amplifier gain

Note 2: Margin (dB) = Emission level (dBuV/m) – Limit (dBuV/m).

<b>Modulation</b>	11a	<b>Test Freq. (MHz)</b>	5500
<b>Polarization</b>	Vertical		

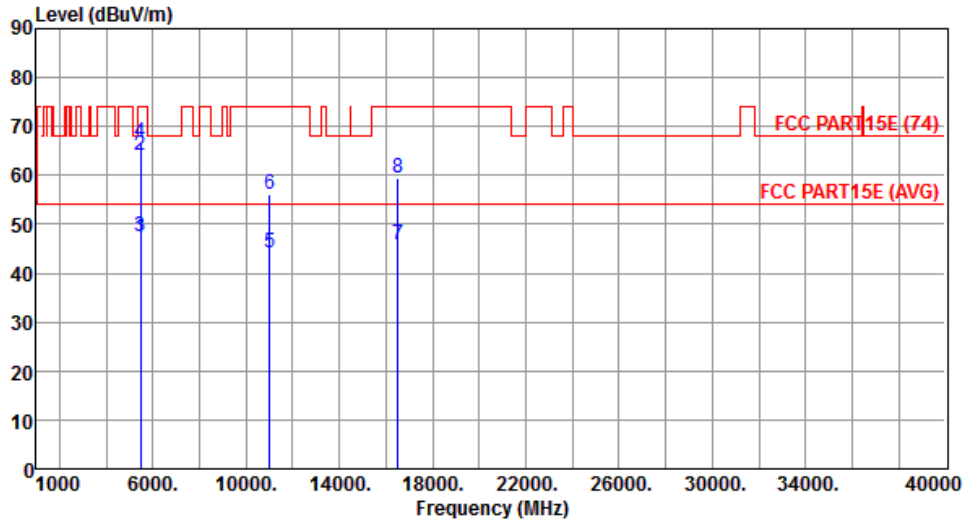

	Freq. MHz	Emission level dBuV/m	Limit dBuV/m	Margin dB	SA reading dBuV	Factor dB	Remark	ANT High cm	Turn Table deg
1	5460.00	47.16	54.00	-6.84	40.80	6.36	Average	100	41
2	5460.00	63.94	74.00	-10.06	57.58	6.36	Peak	100	41
3	5470.00	47.44	54.00	-6.56	41.07	6.37	Average	100	41
4	5470.00	66.69	74.00	-7.31	60.32	6.37	Peak	100	41
5	11000.00	44.11	54.00	-9.89	28.37	15.74	Average	209	264
6	11000.00	56.14	74.00	-17.86	40.40	15.74	Peak	209	264
7	16500.00	45.89	54.00	-8.11	29.86	16.03	Average	135	94
8	16500.00	59.42	74.00	-14.58	43.39	16.03	Peak	135	94

Note 1: Emission Level (dBuV/m) = SA Reading (dBuV/m) + Factor\* (dB)

\*Factor includes antenna factor , cable loss and amplifier gain

Note 2: Margin (dB) = Emission level (dBuV/m) – Limit (dBuV/m).



<b>Modulation</b>	11a	<b>Test Freq. (MHz)</b>	5580
<b>Polarization</b>	Horizontal		

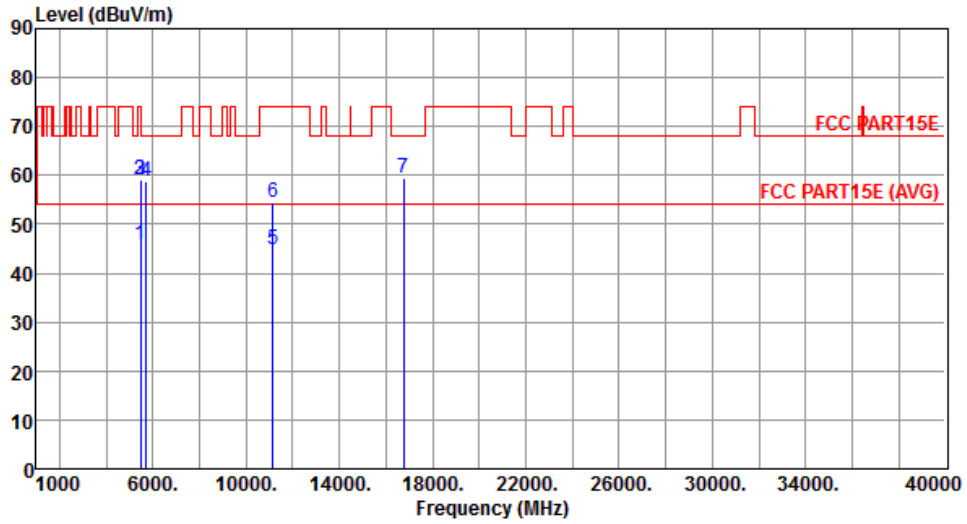

	Freq. MHz	Emission level dBuV/m	Limit dBuV/m	Margin dB	SA reading dBuV	Factor dB	Remark	ANT High cm	Turn Table deg
1	5460.00	45.68	54.00	-8.32	39.32	6.36	Average	100	292
2	5460.00	59.17	74.00	-14.83	52.81	6.36	Peak	100	292
3	5470.00	59.27	68.20	-8.93	52.90	6.37	Peak	100	292
4	5725.00	58.83	68.20	-9.37	52.00	6.83	Peak	100	292
5	11160.00	44.68	54.00	-9.32	28.85	15.83	Average	147	53
6	11160.00	54.33	74.00	-19.67	38.50	15.83	Peak	147	53
7	16740.00	59.54	68.20	-8.66	42.74	16.80	Peak	263	158

Note 1: Emission Level (dBuV/m) = SA Reading (dBuV/m) + Factor\* (dB)

\*Factor includes antenna factor , cable loss and amplifier gain

Note 2: Margin (dB) = Emission level (dBuV/m) – Limit (dBuV/m).

<b>Modulation</b>	11a	<b>Test Freq. (MHz)</b>	5580
<b>Polarization</b>	Vertical		

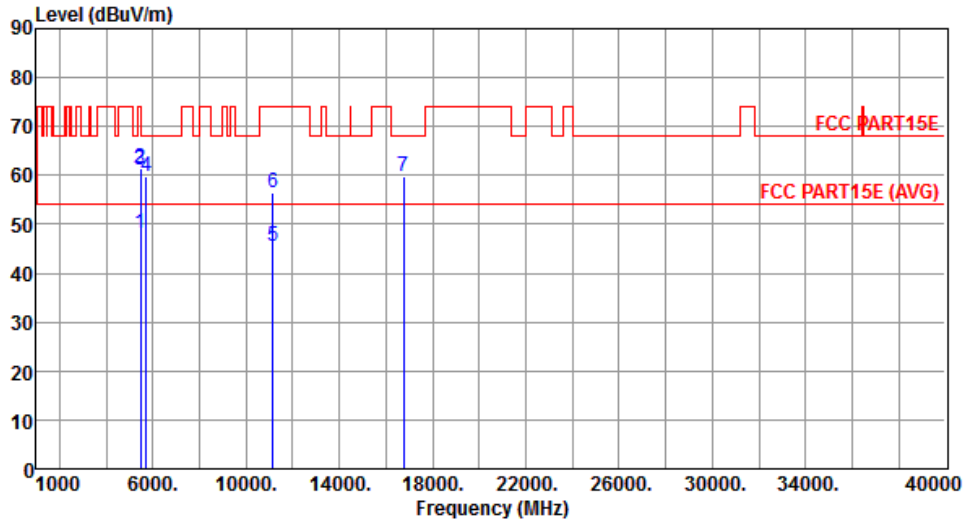

	Freq. MHz	Emission level dBuV/m	Limit dBuV/m	Margin dB	SA reading dBuV	Factor dB	Remark	ANT High cm	Turn Table deg
1	5460.00	48.25	54.00	-5.75	41.89	6.36	Average	100	80
2	5460.00	61.37	74.00	-12.63	55.01	6.36	Peak	100	80
3	5470.00	61.15	68.20	-7.05	54.78	6.37	Peak	100	80
4	5725.00	59.80	68.20	-8.40	52.97	6.83	Peak	100	80
5	11160.00	45.58	54.00	-8.42	29.75	15.83	Average	163	187
6	11160.00	56.51	74.00	-17.49	40.68	15.83	Peak	163	187
7	16740.00	59.70	68.20	-8.50	42.90	16.80	Peak	315	162

Note 1: Emission Level (dBuV/m) = SA Reading (dBuV/m) + Factor\* (dB)

\*Factor includes antenna factor , cable loss and amplifier gain

Note 2: Margin (dB) = Emission level (dBuV/m) – Limit (dBuV/m).

<b>Modulation</b>	11a	<b>Test Freq. (MHz)</b>	5700
<b>Polarization</b>	Horizontal		

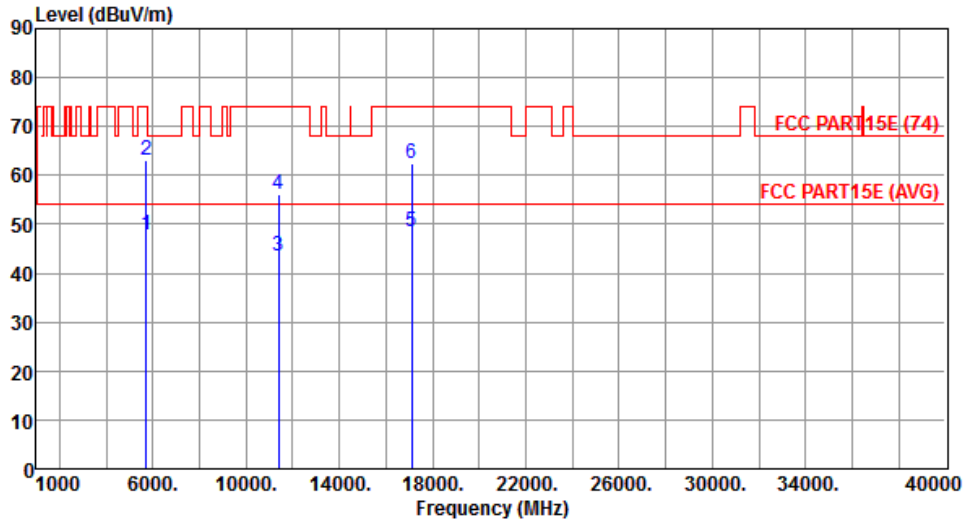

	Freq. MHz	Emission level dBuV/m	Limit dBuV/m	Margin dB	SA reading dBuV	Factor dB	Remark	ANT High cm	Turn Table deg
1	5725.00	47.86	54.00	-6.14	41.03	6.83	Average	129	288
2	5725.00	63.19	74.00	-10.81	56.36	6.83	Peak	129	288
3	11400.00	43.51	54.00	-10.49	27.55	15.96	Average	163	185
4	11400.00	56.24	74.00	-17.76	40.28	15.96	Peak	163	185
5	17100.00	48.50	54.00	-5.50	30.54	17.96	Average	340	196
6	17100.00	62.33	74.00	-11.67	44.37	17.96	Peak	340	196

Note 1: Emission Level (dBuV/m) = SA Reading (dBuV/m) + Factor\* (dB)

\*Factor includes antenna factor , cable loss and amplifier gain

Note 2: Margin (dB) = Emission level (dBuV/m) – Limit (dBuV/m).

<b>Modulation</b>	11a	<b>Test Freq. (MHz)</b>	5700
<b>Polarization</b>	Vertical		

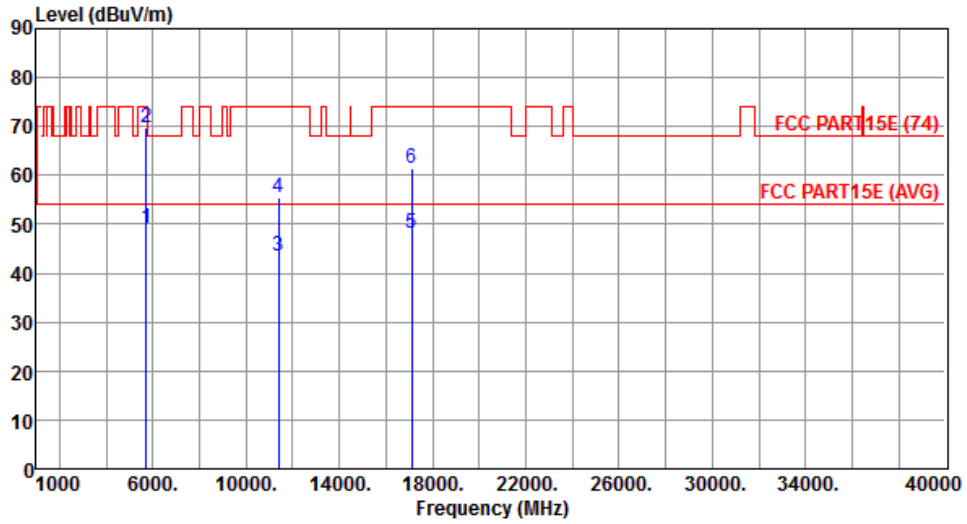

	Freq. MHz	Emission level dBuV/m	Limit dBuV/m	Margin dB	SA reading dBuV	Factor dB	Remark	ANT High cm	Turn Table deg
1	5725.00	49.09	54.00	-4.91	42.26	6.83	Average	100	136
2	5725.00	69.70	74.00	-4.30	62.87	6.83	Peak	100	136
3	11400.00	43.59	54.00	-10.41	27.63	15.96	Average	183	295
4	11400.00	55.54	74.00	-18.46	39.58	15.96	Peak	183	295
5	17100.00	48.01	54.00	-5.99	30.05	17.96	Average	206	287
6	17100.00	61.38	74.00	-12.62	43.42	17.96	Peak	206	287

Note 1: Emission Level (dBuV/m) = SA Reading (dBuV/m) + Factor\* (dB)

\*Factor includes antenna factor , cable loss and amplifier gain

Note 2: Margin (dB) = Emission level (dBuV/m) – Limit (dBuV/m).

<b>Modulation</b>	11a	<b>Test Freq. (MHz)</b>	5720
<b>Polarization</b>	Horizontal		

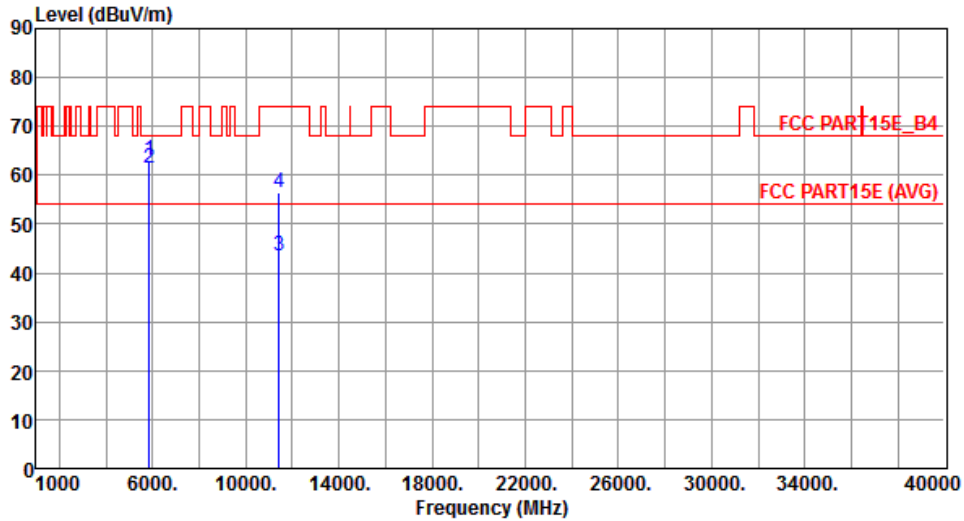

	Freq. MHz	Emission level dBuV/m	Limit dBuV/m	Margin dB	SA reading dBuV	Factor dB	Remark	ANT High cm	Turn Table deg
1	5850.00	63.01	78.20	-15.19	55.85	7.16	Peak	128	285
2	5860.00	61.60	68.20	-6.60	54.42	7.18	Peak	128	285
3	11440.00	43.67	54.00	-10.33	27.68	15.99	Average	162	175
4	11440.00	56.34	74.00	-17.66	40.35	15.99	Peak	162	175

Note 1: Emission Level (dBuV/m) = SA Reading (dBuV/m) + Factor\* (dB)

\*Factor includes antenna factor , cable loss and amplifier gain

Note 2: Margin (dB) = Emission level (dBuV/m) – Limit (dBuV/m).

<b>Modulation</b>	11a	<b>Test Freq. (MHz)</b>	5720
<b>Polarization</b>	Vertical		

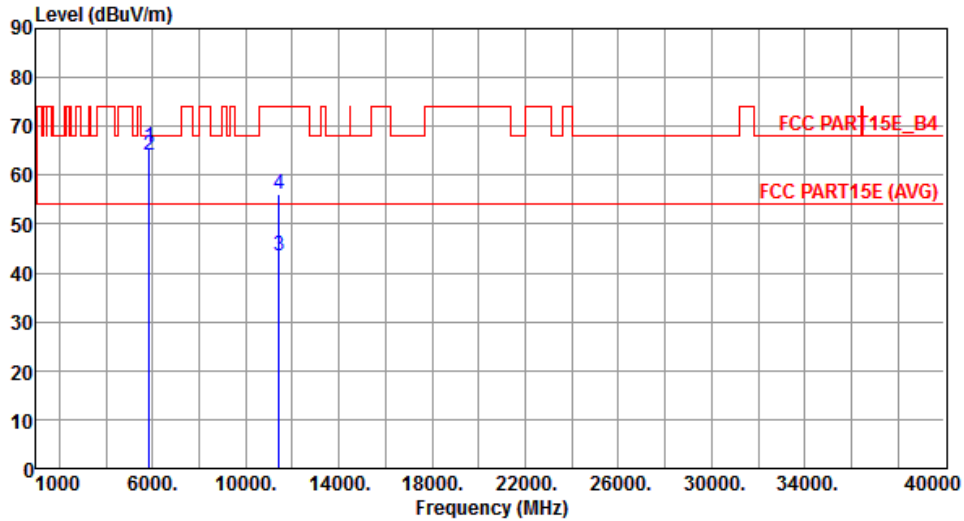

	Freq. MHz	Emission level dBuV/m	Limit dBuV/m	Margin dB	SA reading dBuV	Factor dB	Remark	ANT High cm	Turn Table deg
1	5850.00	65.81	78.20	-12.39	58.65	7.16	Peak	100	132
2	5860.00	63.94	68.20	-4.26	56.76	7.18	Peak	100	132
3	11440.00	43.52	54.00	-10.48	27.53	15.99	Average	182	292
4	11440.00	56.23	74.00	-17.77	40.24	15.99	Peak	182	292

Note 1: Emission Level (dBuV/m) = SA Reading (dBuV/m) + Factor\* (dB)

\*Factor includes antenna factor , cable loss and amplifier gain

Note 2: Margin (dB) = Emission level (dBuV/m) – Limit (dBuV/m).

<b>Modulation</b>	11a	<b>Test Freq. (MHz)</b>	5745
<b>Polarization</b>	Horizontal		

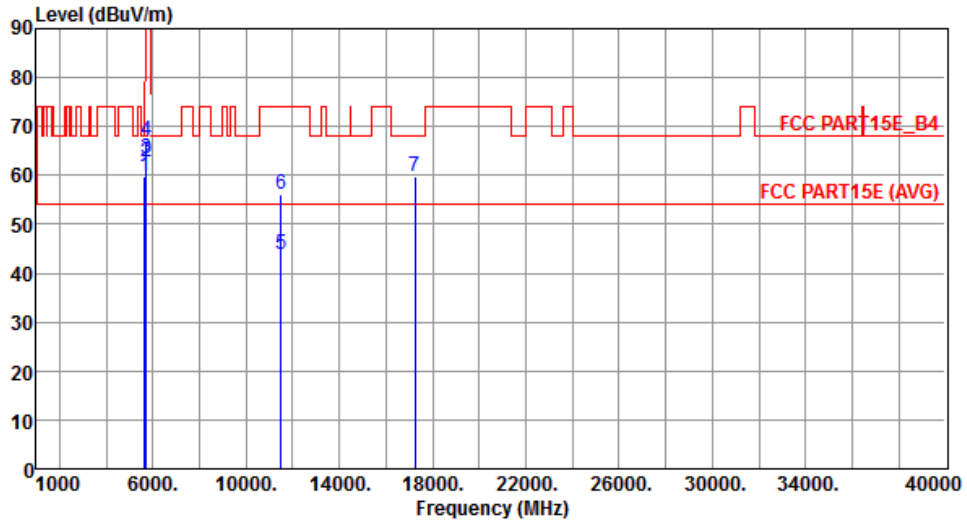

	Freq. MHz	Emission level dBuV/m	Limit dBuV/m	Margin dB	SA reading dBuV	Factor dB	Remark	ANT High cm	Turn Table deg
1	5650.00	59.79	68.20	-8.41	53.16	6.63	Peak	109	289
2	5700.00	62.73	105.20	-42.47	55.96	6.77	Peak	109	289
3	5720.00	63.30	110.80	-47.50	56.48	6.82	Peak	109	289
4	5725.00	67.25	122.20	-54.95	60.42	6.83	Peak	109	289
5	11490.00	43.77	54.00	-10.23	27.76	16.01	Average	189	30
6	11490.00	56.07	74.00	-17.93	40.06	16.01	Peak	189	30
7	17235.00	59.66	68.20	-8.54	41.23	18.43	Peak	185	36

Note 1: Emission Level (dBuV/m) = SA Reading (dBuV/m) + Factor\* (dB)

\*Factor includes antenna factor , cable loss and amplifier gain

Note 2: Margin (dB) = Emission level (dBuV/m) – Limit (dBuV/m).

<b>Modulation</b>	11a	<b>Test Freq. (MHz)</b>	5745
<b>Polarization</b>	Vertical		

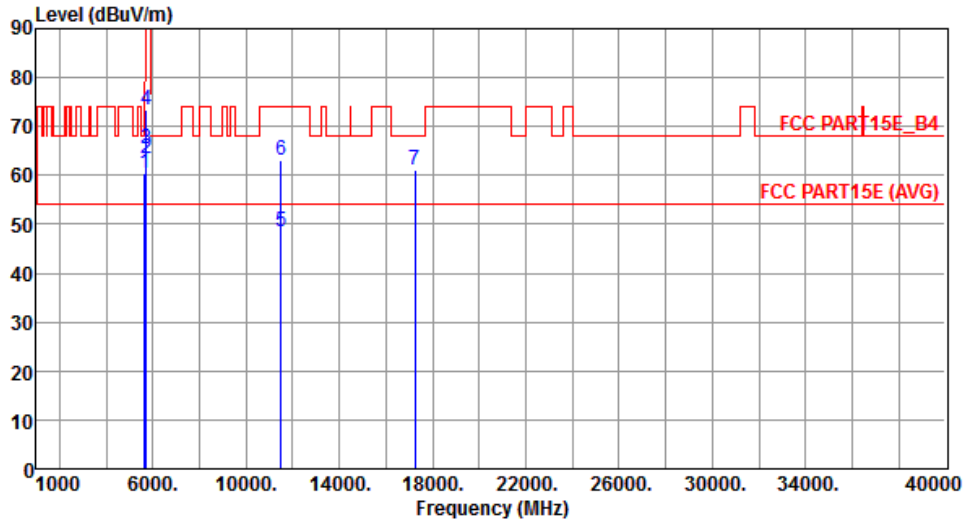

	Freq. MHz	Emission level dBuV/m	Limit dBuV/m	Margin dB	SA reading dBuV	Factor dB	Remark	ANT High cm	Turn Table deg
1	5650.00	60.56	68.20	-7.64	53.93	6.63	Peak	138	41
2	5700.00	63.39	105.20	-41.81	56.62	6.77	Peak	138	41
3	5720.00	65.45	110.80	-45.35	58.63	6.82	Peak	138	41
4	5725.00	73.56	122.20	-48.64	66.73	6.83	Peak	138	41
5	11490.00	48.44	54.00	-5.56	32.43	16.01	Average	128	94
6	11490.00	63.05	74.00	-10.95	47.04	16.01	Peak	128	94
7	17235.00	61.08	68.20	-7.12	42.65	18.43	Peak	129	98

Note 1: Emission Level (dBuV/m) = SA Reading (dBuV/m) + Factor\* (dB)

\*Factor includes antenna factor , cable loss and amplifier gain

Note 2: Margin (dB) = Emission level (dBuV/m) – Limit (dBuV/m).



<b>Modulation</b>	11a	<b>Test Freq. (MHz)</b>	5785
<b>Polarization</b>	Horizontal		

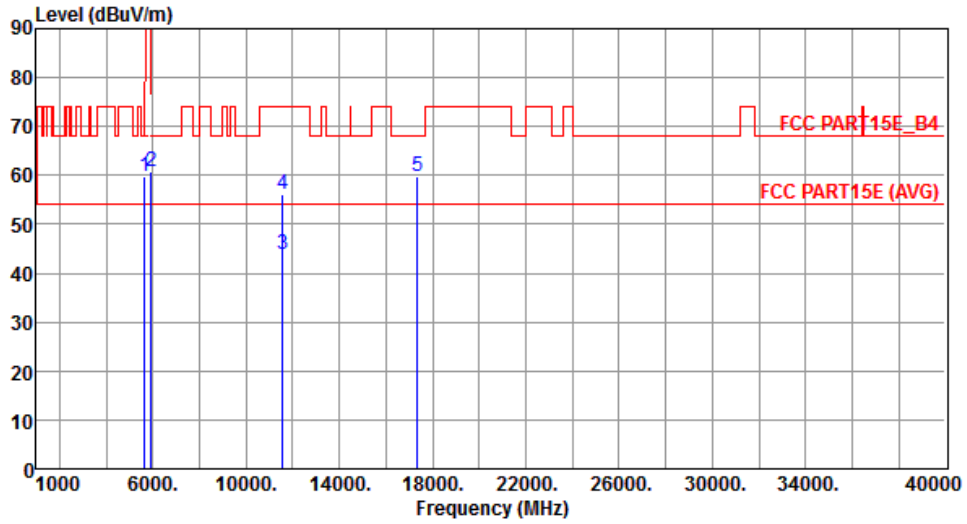

	Freq. MHz	Emission level dBuV/m	Limit dBuV/m	Margin dB	SA reading dBuV	Factor dB	Remark	ANT High cm	Turn Table deg
1	5650.00	59.62	68.20	-8.58	52.99	6.63	Peak	110	288
2	5925.00	60.78	68.20	-7.42	53.44	7.34	Peak	110	288
3	11570.00	43.86	54.00	-10.14	27.97	15.89	Average	191	35
4	11570.00	56.15	74.00	-17.85	40.26	15.89	Peak	191	35
5	17355.00	59.84	68.20	-8.36	41.02	18.82	Peak	192	36

Note 1: Emission Level (dBuV/m) = SA Reading (dBuV/m) + Factor\* (dB)

\*Factor includes antenna factor , cable loss and amplifier gain

Note 2: Margin (dB) = Emission level (dBuV/m) – Limit (dBuV/m).

<b>Modulation</b>	11a	<b>Test Freq. (MHz)</b>	5785
<b>Polarization</b>	Vertical		

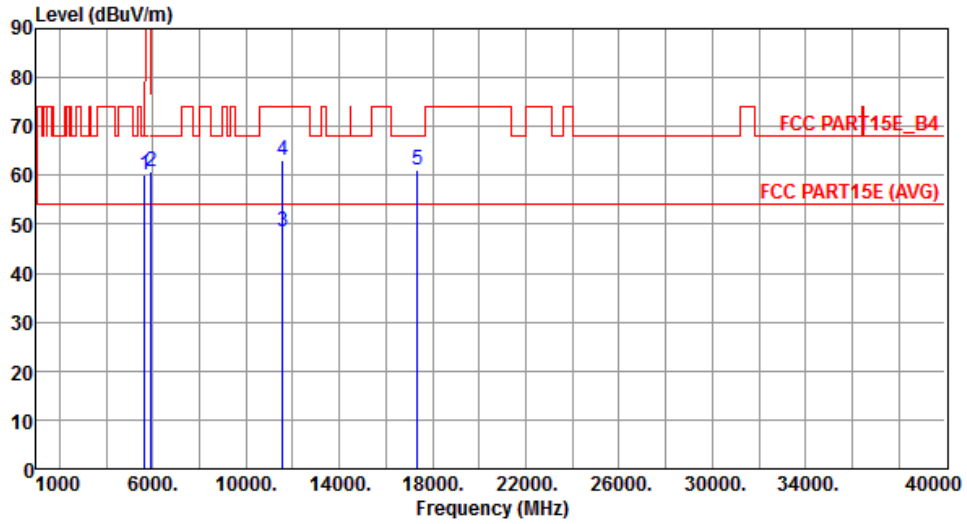

	Freq. MHz	Emission level dBuV/m	Limit dBuV/m	Margin dB	SA reading dBuV	Factor dB	Remark	ANT High cm	Turn Table deg
1	5650.00	60.24	68.20	-7.96	53.61	6.63	Peak	158	34
2	5925.00	60.82	68.20	-7.38	53.48	7.34	Peak	158	34
3	11570.00	48.52	54.00	-5.48	32.63	15.89	Average	129	96
4	11570.00	63.14	74.00	-10.86	47.25	15.89	Peak	129	96
5	17355.00	61.18	68.20	-7.02	42.36	18.82	Peak	131	96

Note 1: Emission Level (dBuV/m) = SA Reading (dBuV/m) + Factor\* (dB)

\*Factor includes antenna factor , cable loss and amplifier gain

Note 2: Margin (dB) = Emission level (dBuV/m) – Limit (dBuV/m).

<b>Modulation</b>	11a	<b>Test Freq. (MHz)</b>	5825
<b>Polarization</b>	Horizontal		

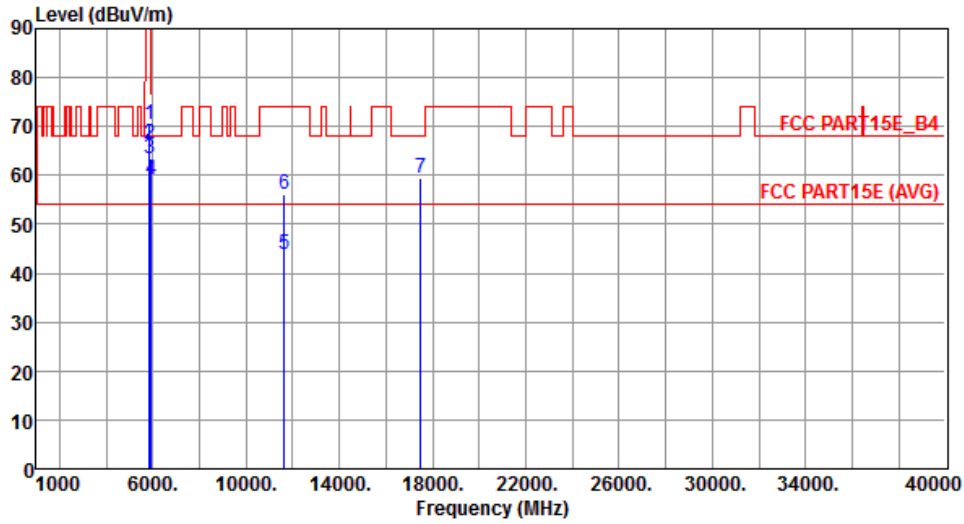

	Freq. MHz	Emission level dBuV/m	Limit dBuV/m	Margin dB	SA reading dBuV	Factor dB	Remark	ANT High cm	Turn Table deg
1	5850.00	70.44	122.20	-51.76	63.28	7.16	Peak	109	288
2	5855.00	66.33	110.80	-44.47	59.15	7.18	Peak	109	288
3	5875.00	63.53	105.20	-41.67	56.30	7.23	Peak	109	288
4	5925.00	58.98	68.20	-9.22	51.64	7.34	Peak	109	288
5	11650.00	43.92	54.00	-10.08	28.18	15.74	Average	185	42
6	11650.00	56.28	74.00	-17.72	40.54	15.74	Peak	185	42
7	17475.00	59.56	68.20	-8.64	40.33	19.23	Peak	182	31

Note 1: Emission Level (dBuV/m) = SA Reading (dBuV/m) + Factor\* (dB)

\*Factor includes antenna factor , cable loss and amplifier gain

Note 2: Margin (dB) = Emission level (dBuV/m) – Limit (dBuV/m).

<b>Modulation</b>	11a	<b>Test Freq. (MHz)</b>	5825
<b>Polarization</b>	Vertical		

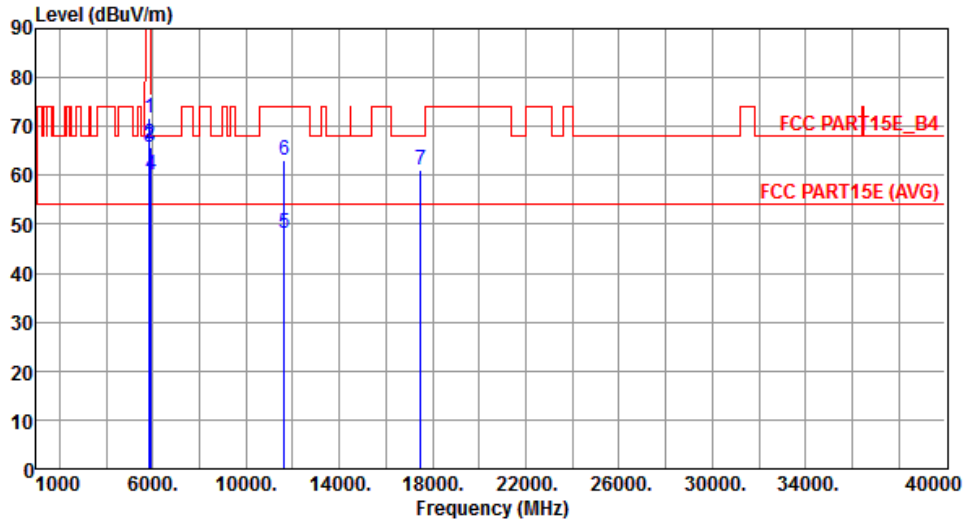

	Freq. MHz	Emission level dBuV/m	Limit dBuV/m	Margin dB	SA reading dBuV	Factor dB	Remark	ANT High cm	Turn Table deg
1	5850.00	71.69	122.20	-50.51	64.53	7.16	Peak	147	71
2	5855.00	66.33	110.80	-44.47	59.15	7.18	Peak	147	71
3	5875.00	65.66	105.20	-39.54	58.43	7.23	Peak	147	71
4	5925.00	59.97	68.20	-8.23	52.63	7.34	Peak	147	71
5	11650.00	48.26	54.00	-5.74	32.52	15.74	Average	131	102
6	11650.00	63.01	74.00	-10.99	47.27	15.74	Peak	131	102
7	17475.00	61.25	68.20	-6.95	42.02	19.23	Peak	132	95

Note 1: Emission Level (dBuV/m) = SA Reading (dBuV/m) + Factor\* (dB)

\*Factor includes antenna factor , cable loss and amplifier gain

Note 2: Margin (dB) = Emission level (dBuV/m) – Limit (dBuV/m).

### 3.5.6 Transmitter Radiated Unwanted Emissions (Above 1GHz) for VHT20

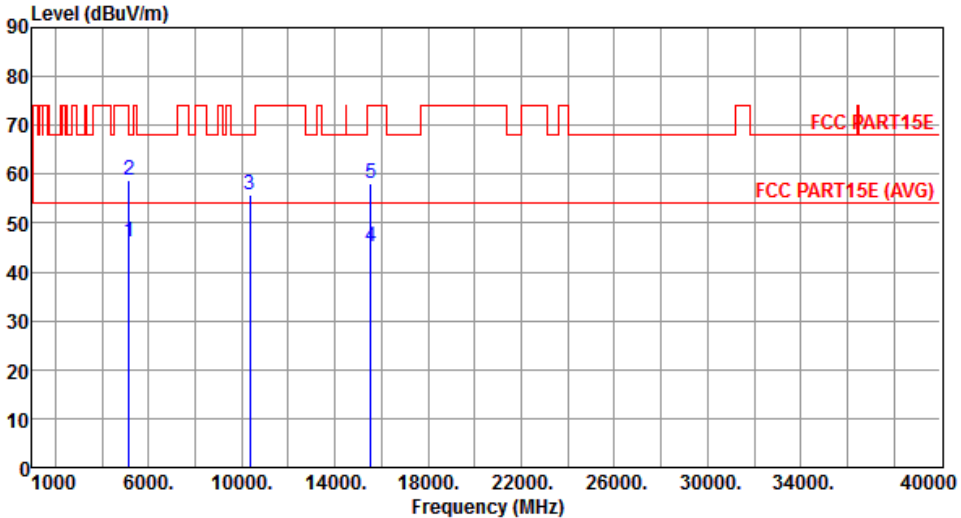
Modulation	VHT20	Test Freq. (MHz)	5180																																																																		
Polarization	Horizontal																																																																				
																																																																					
	<table border="1"> <thead> <tr> <th>Freq.</th> <th>Emission level</th> <th>Limit</th> <th>Margin</th> <th>SA reading</th> <th>Factor</th> <th>Remark</th> <th>ANT High</th> <th>Turn Table</th> </tr> <tr> <th>MHz</th> <th>dBuV/m</th> <th>dBuV/m</th> <th>dB</th> <th>dBuV</th> <th>dB</th> <th></th> <th>cm</th> <th>deg</th> </tr> </thead> <tbody> <tr> <td>1</td> <td>5150.00</td> <td>46.08</td> <td>54.00</td> <td>-7.92</td> <td>40.21</td> <td>5.87</td> <td>Average</td> <td>292</td> <td>280</td> </tr> <tr> <td>2</td> <td>5150.00</td> <td>58.87</td> <td>74.00</td> <td>-15.13</td> <td>53.00</td> <td>5.87</td> <td>Peak</td> <td>292</td> <td>280</td> </tr> <tr> <td>3</td> <td>10360.00</td> <td>55.78</td> <td>68.20</td> <td>-12.42</td> <td>40.56</td> <td>15.22</td> <td>Peak</td> <td>161</td> <td>164</td> </tr> <tr> <td>4</td> <td>15540.00</td> <td>45.30</td> <td>54.00</td> <td>-8.70</td> <td>29.23</td> <td>16.07</td> <td>Average</td> <td>151</td> <td>201</td> </tr> <tr> <td>5</td> <td>15540.00</td> <td>58.23</td> <td>74.00</td> <td>-15.77</td> <td>42.16</td> <td>16.07</td> <td>Peak</td> <td>151</td> <td>201</td> </tr> </tbody> </table>	Freq.	Emission level	Limit	Margin	SA reading	Factor	Remark	ANT High	Turn Table	MHz	dBuV/m	dBuV/m	dB	dBuV	dB		cm	deg	1	5150.00	46.08	54.00	-7.92	40.21	5.87	Average	292	280	2	5150.00	58.87	74.00	-15.13	53.00	5.87	Peak	292	280	3	10360.00	55.78	68.20	-12.42	40.56	15.22	Peak	161	164	4	15540.00	45.30	54.00	-8.70	29.23	16.07	Average	151	201	5	15540.00	58.23	74.00	-15.77	42.16	16.07	Peak	151	201
Freq.	Emission level	Limit	Margin	SA reading	Factor	Remark	ANT High	Turn Table																																																													
MHz	dBuV/m	dBuV/m	dB	dBuV	dB		cm	deg																																																													
1	5150.00	46.08	54.00	-7.92	40.21	5.87	Average	292	280																																																												
2	5150.00	58.87	74.00	-15.13	53.00	5.87	Peak	292	280																																																												
3	10360.00	55.78	68.20	-12.42	40.56	15.22	Peak	161	164																																																												
4	15540.00	45.30	54.00	-8.70	29.23	16.07	Average	151	201																																																												
5	15540.00	58.23	74.00	-15.77	42.16	16.07	Peak	151	201																																																												
<p>Note 1: Emission Level (dBuV/m) = SA Reading (dBuV/m) + Factor* (dB)            *Factor includes antenna factor , cable loss and amplifier gain            Note 2: Margin (dB) = Emission level (dBuV/m) – Limit (dBuV/m).</p>																																																																					

<b>Modulation</b>	VHT20	<b>Test Freq. (MHz)</b>	5180
<b>Polarization</b>	Vertical		

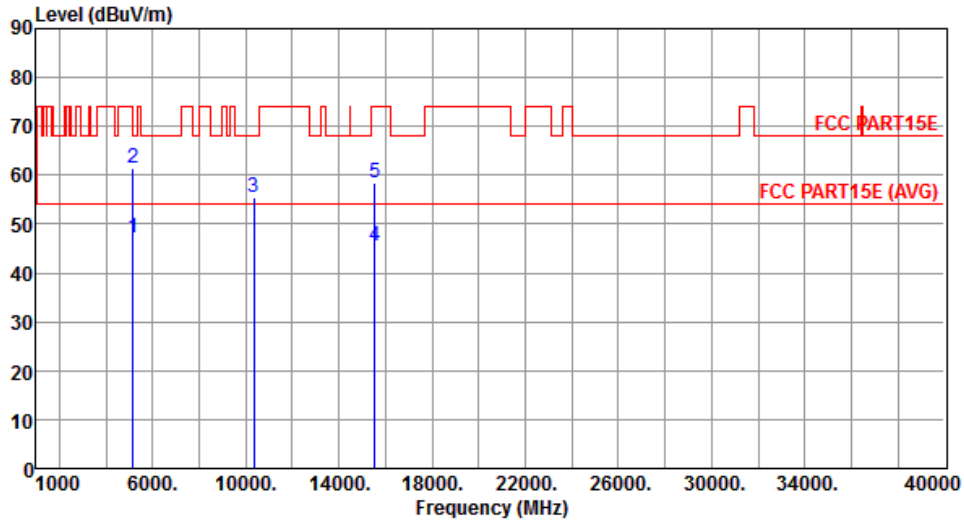

	Freq. MHz	Emission level dBuV/m	Limit dBuV/m	Margin dB	SA reading dBuV	Factor dB	Remark	ANT High cm	Turn Table deg
1	5150.00	47.25	54.00	-6.75	41.38	5.87	Average	251	240
2	5150.00	61.49	74.00	-12.51	55.62	5.87	Peak	251	240
3	10360.00	55.61	68.20	-12.59	40.39	15.22	Peak	152	145
4	15540.00	45.40	54.00	-8.60	29.33	16.07	Average	100	160
5	15540.00	58.40	74.00	-15.60	42.33	16.07	Peak	100	160

Note 1: Emission Level (dBuV/m) = SA Reading (dBuV/m) + Factor\* (dB)

\*Factor includes antenna factor , cable loss and amplifier gain

Note 2: Margin (dB) = Emission level (dBuV/m) – Limit (dBuV/m).

<b>Modulation</b>	VHT20	<b>Test Freq. (MHz)</b>	5200
<b>Polarization</b>	Horizontal		

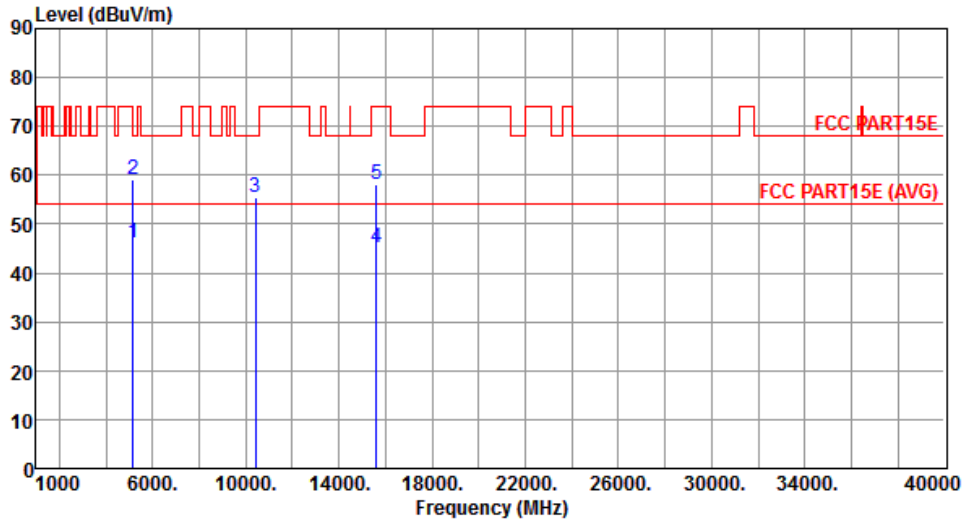

	Freq. MHz	Emission level dBuV/m	Limit dBuV/m	Margin dB	SA reading dBuV	Factor dB	Remark	ANT High cm	Turn Table deg
1	5150.00	46.09	54.00	-7.91	40.22	5.87	Average	291	279
2	5150.00	59.18	74.00	-14.82	53.31	5.87	Peak	291	279
3	10400.00	55.49	68.20	-12.71	40.22	15.27	Peak	160	161
4	15600.00	45.31	54.00	-8.69	29.31	16.00	Average	148	200
5	15600.00	58.28	74.00	-15.72	42.28	16.00	Peak	148	200

Note 1: Emission Level (dBuV/m) = SA Reading (dBuV/m) + Factor\* (dB)

\*Factor includes antenna factor , cable loss and amplifier gain

Note 2: Margin (dB) = Emission level (dBuV/m) – Limit (dBuV/m).

<b>Modulation</b>	VHT20	<b>Test Freq. (MHz)</b>	5200
<b>Polarization</b>	Vertical		

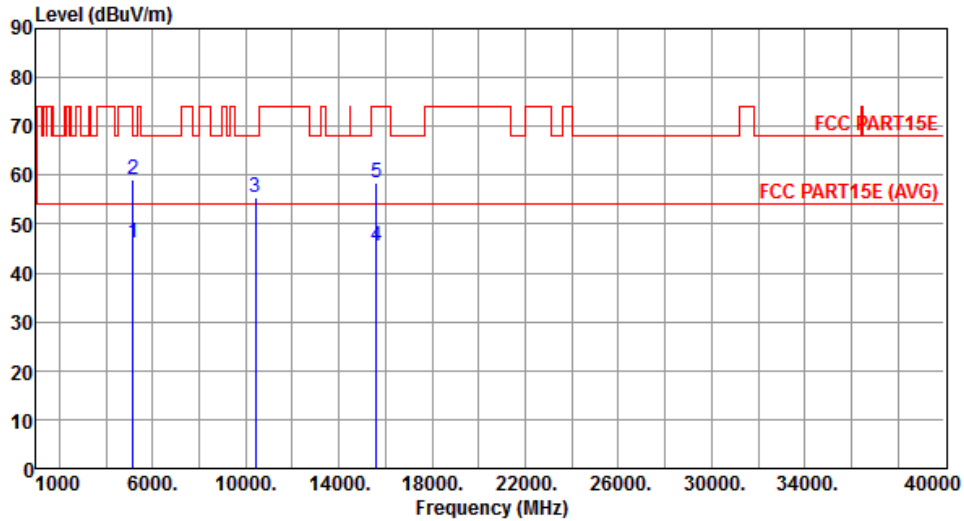

	Freq. MHz	Emission level dBuV/m	Limit dBuV/m	Margin dB	SA reading dBuV	Factor dB	Remark	ANT High cm	Turn Table deg
1	5150.00	46.18	54.00	-7.82	40.31	5.87	Average	250	230
2	5150.00	59.14	74.00	-14.86	53.27	5.87	Peak	250	230
3	10400.00	55.59	68.20	-12.61	40.32	15.27	Peak	152	145
4	15600.00	45.53	54.00	-8.47	29.53	16.00	Average	100	162
5	15600.00	58.31	74.00	-15.69	42.31	16.00	Peak	100	162

Note 1: Emission Level (dBuV/m) = SA Reading (dBuV/m) + Factor\* (dB)

\*Factor includes antenna factor , cable loss and amplifier gain

Note 2: Margin (dB) = Emission level (dBuV/m) – Limit (dBuV/m).



<b>Modulation</b>	VHT20	<b>Test Freq. (MHz)</b>	5240
<b>Polarization</b>	Horizontal		

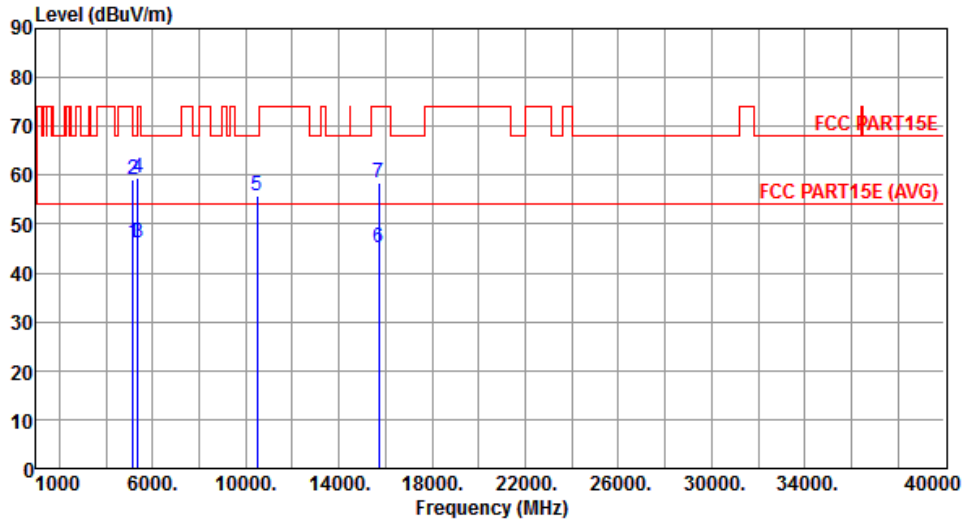

	Freq. MHz	Emission level dBuV/m	Limit dBuV/m	Margin dB	SA reading dBuV	Factor dB	Remark	ANT High cm	Turn Table deg
1	5150.00	46.15	54.00	-7.85	40.28	5.87	Average	293	282
2	5150.00	59.14	74.00	-14.86	53.27	5.87	Peak	293	282
3	5350.00	46.27	54.00	-7.73	40.06	6.21	Average	293	282
4	5350.00	59.33	74.00	-14.67	53.12	6.21	Peak	293	282
5	10480.00	55.80	68.20	-12.40	40.44	15.36	Peak	160	160
6	15720.00	45.02	54.00	-8.98	29.16	15.86	Average	148	200
7	15720.00	58.30	74.00	-15.70	42.44	15.86	Peak	148	200

Note 1: Emission Level (dBuV/m) = SA Reading (dBuV/m) + Factor\* (dB)

\*Factor includes antenna factor , cable loss and amplifier gain

Note 2: Margin (dB) = Emission level (dBuV/m) – Limit (dBuV/m).

<b>Modulation</b>	VHT20	<b>Test Freq. (MHz)</b>	5240
<b>Polarization</b>	Vertical		

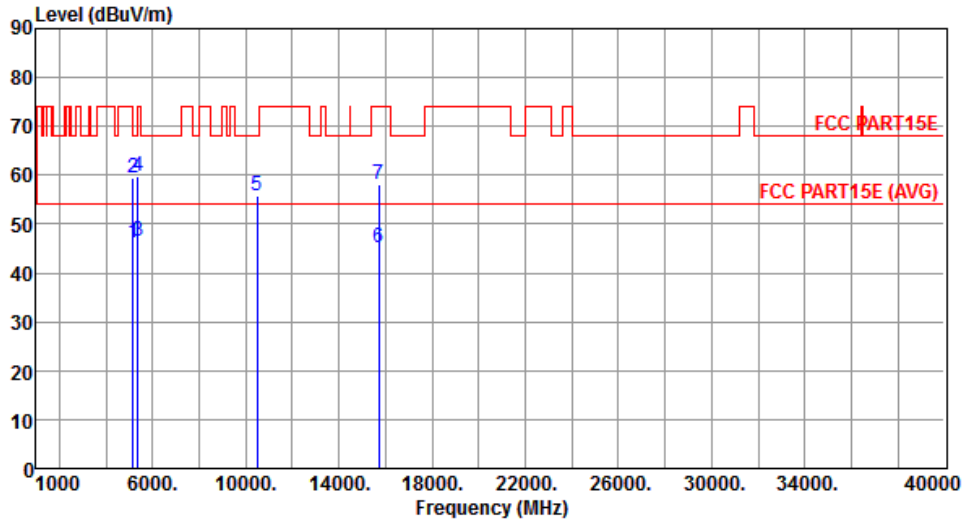

	Freq. MHz	Emission level dBuV/m	Limit dBuV/m	Margin dB	SA reading dBuV	Factor dB	Remark	ANT High cm	Turn Table deg
1	5150.00	46.09	54.00	-7.91	40.22	5.87	Average	250	236
2	5150.00	59.29	74.00	-14.71	53.42	5.87	Peak	250	236
3	5350.00	46.66	54.00	-7.34	40.45	6.21	Average	250	236
4	5350.00	59.73	74.00	-14.27	53.52	6.21	Peak	250	236
5	10480.00	55.80	68.20	-12.40	40.44	15.36	Peak	153	141
6	15720.00	45.30	54.00	-8.70	29.44	15.86	Average	100	161
7	15720.00	58.10	74.00	-15.90	42.24	15.86	Peak	100	161

Note 1: Emission Level (dBuV/m) = SA Reading (dBuV/m) + Factor\* (dB)

\*Factor includes antenna factor , cable loss and amplifier gain

Note 2: Margin (dB) = Emission level (dBuV/m) – Limit (dBuV/m).

<b>Modulation</b>	VHT20	<b>Test Freq. (MHz)</b>	5260
<b>Polarization</b>	Horizontal		

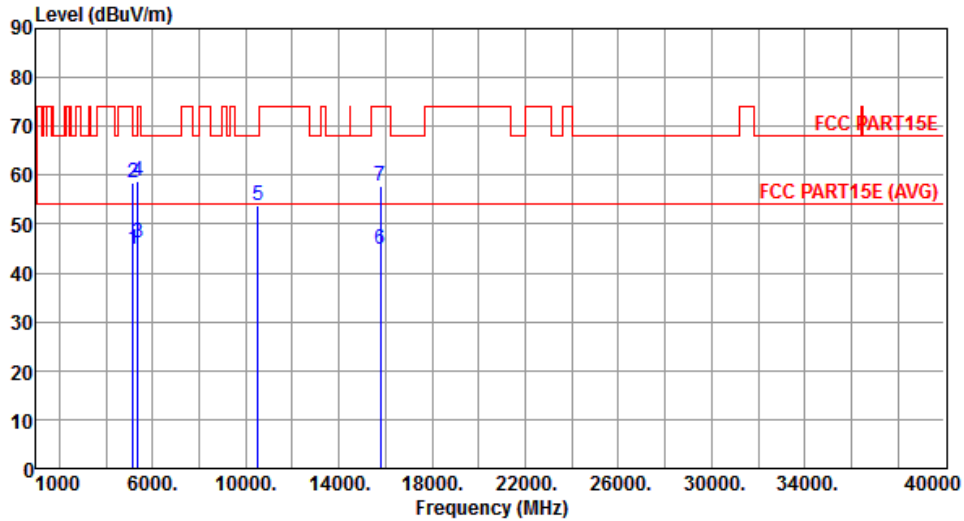

	Freq. MHz	Emission level dBuV/m	Limit dBuV/m	Margin dB	SA reading dBuV	Factor dB	Remark	ANT High cm	Turn Table deg
1	5150.00	44.98	54.00	-9.02	39.11	5.87	Average	100	224
2	5150.00	58.41	74.00	-15.59	52.54	5.87	Peak	100	224
3	5350.00	46.08	54.00	-7.92	39.87	6.21	Average	100	224
4	5350.00	58.85	74.00	-15.15	52.64	6.21	Peak	100	224
5	10520.00	53.95	68.20	-14.25	38.54	15.41	Peak	131	185
6	15780.00	44.81	54.00	-9.19	29.03	15.78	Average	185	68
7	15780.00	57.77	74.00	-16.23	41.99	15.78	Peak	185	68

Note 1: Emission Level (dBuV/m) = SA Reading (dBuV/m) + Factor\* (dB)

\*Factor includes antenna factor , cable loss and amplifier gain

Note 2: Margin (dB) = Emission level (dBuV/m) – Limit (dBuV/m).

<b>Modulation</b>	VHT20	<b>Test Freq. (MHz)</b>	5260
<b>Polarization</b>	Vertical		

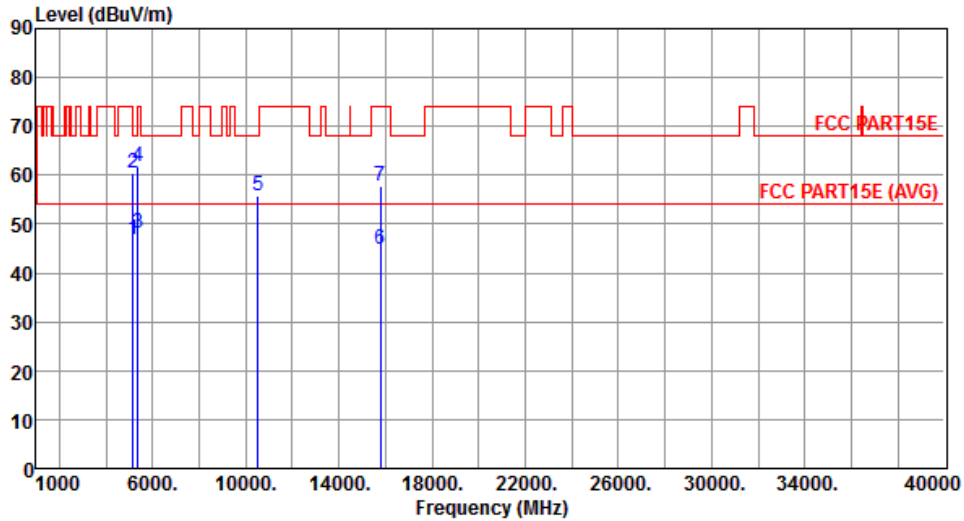

	Freq. MHz	Emission level dBuV/m	Limit dBuV/m	Margin dB	SA reading dBuV	Factor dB	Remark	ANT High cm	Turn Table deg
1	5150.00	46.66	54.00	-7.34	40.79	5.87	Average	146	52
2	5150.00	60.30	74.00	-13.70	54.43	5.87	Peak	146	52
3	5350.00	47.99	54.00	-6.01	41.78	6.21	Average	146	52
4	5350.00	61.92	74.00	-12.08	55.71	6.21	Peak	146	52
5	10520.00	55.88	68.20	-12.32	40.47	15.41	Peak	193	348
6	15780.00	44.97	54.00	-9.03	29.19	15.78	Average	205	261
7	15780.00	57.90	74.00	-16.10	42.12	15.78	Peak	205	261

Note 1: Emission Level (dBuV/m) = SA Reading (dBuV/m) + Factor\* (dB)

\*Factor includes antenna factor , cable loss and amplifier gain

Note 2: Margin (dB) = Emission level (dBuV/m) – Limit (dBuV/m).

<b>Modulation</b>	VHT20	<b>Test Freq. (MHz)</b>	5300
<b>Polarization</b>	Horizontal		

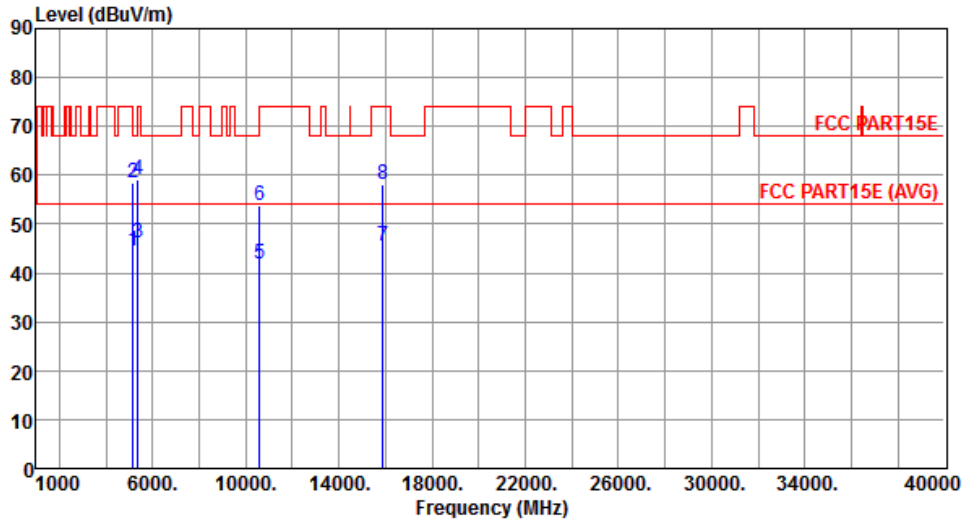

	Freq. MHz	Emission level dBuV/m	Limit dBuV/m	Margin dB	SA reading dBuV	Factor dB	Remark	ANT High cm	Turn Table deg
1	5150.00	44.60	54.00	-9.40	38.73	5.87	Average	100	230
2	5150.00	58.32	74.00	-15.68	52.45	5.87	Peak	100	230
3	5350.00	46.30	54.00	-7.70	40.09	6.21	Average	100	230
4	5350.00	59.06	74.00	-14.94	52.85	6.21	Peak	100	230
5	10600.00	41.91	54.00	-12.09	26.45	15.46	Average	214	92
6	10600.00	53.69	74.00	-20.31	38.23	15.46	Peak	214	92
7	15900.00	45.34	54.00	-8.66	29.70	15.64	Average	174	105
8	15900.00	58.02	74.00	-15.98	42.38	15.64	Peak	174	105

Note 1: Emission Level (dBuV/m) = SA Reading (dBuV/m) + Factor\* (dB)

\*Factor includes antenna factor , cable loss and amplifier gain

Note 2: Margin (dB) = Emission level (dBuV/m) – Limit (dBuV/m).

<b>Modulation</b>	VHT20	<b>Test Freq. (MHz)</b>	5300
<b>Polarization</b>	Vertical		

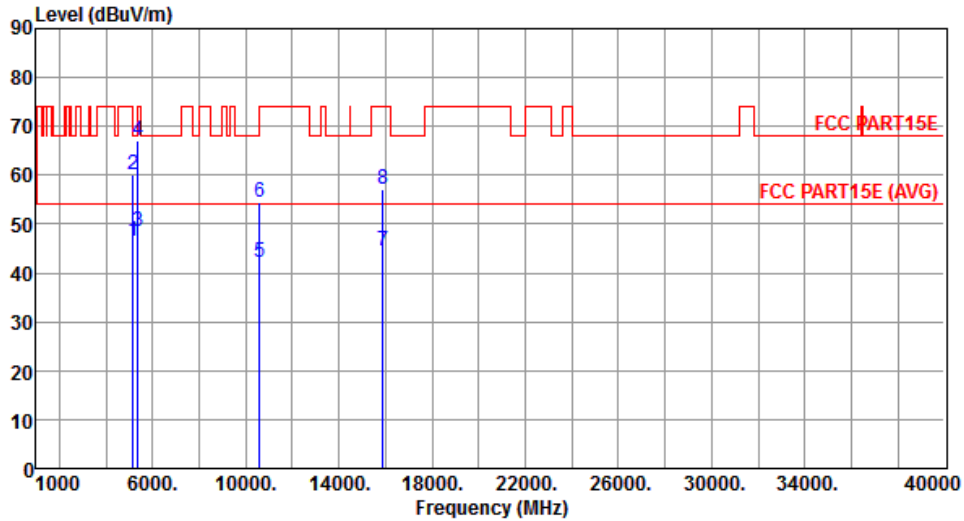

	Freq. MHz	Emission level dBuV/m	Limit dBuV/m	Margin dB	SA reading dBuV	Factor dB	Remark	ANT High cm	Turn Table deg
1	5150.00	46.52	54.00	-7.48	40.65	5.87	Average	154	56
2	5150.00	60.18	74.00	-13.82	54.31	5.87	Peak	154	56
3	5350.00	48.54	54.00	-5.46	42.33	6.21	Average	154	56
4	5350.00	67.15	74.00	-6.85	60.94	6.21	Peak	154	56
5	10600.00	42.19	54.00	-11.81	26.73	15.46	Average	131	96
6	10600.00	54.30	74.00	-19.70	38.84	15.46	Peak	131	96
7	15900.00	44.49	54.00	-9.51	28.85	15.64	Average	125	67
8	15900.00	57.26	74.00	-16.74	41.62	15.64	Peak	125	67

Note 1: Emission Level (dBuV/m) = SA Reading (dBuV/m) + Factor\* (dB)

\*Factor includes antenna factor , cable loss and amplifier gain

Note 2: Margin (dB) = Emission level (dBuV/m) – Limit (dBuV/m).

<b>Modulation</b>	VHT20	<b>Test Freq. (MHz)</b>	5320
<b>Polarization</b>	Horizontal		

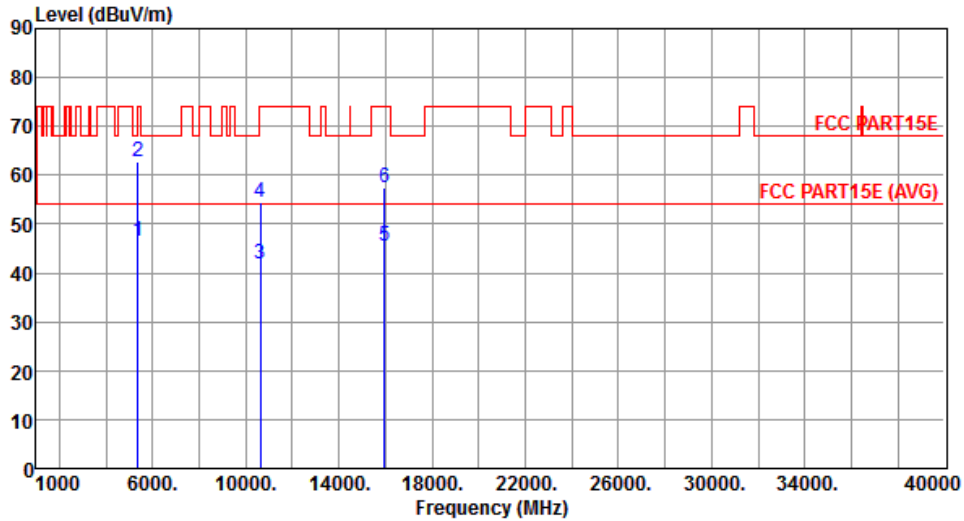

	Freq. MHz	Emission level dBuV/m	Limit dBuV/m	Margin dB	SA reading dBuV	Factor dB	Remark	ANT High cm	Turn Table deg
1	5350.00	46.58	54.00	-7.42	40.37	6.21	Average	125	228
2	5350.00	62.68	74.00	-11.32	56.47	6.21	Peak	125	228
3	10640.00	41.92	54.00	-12.08	26.43	15.49	Average	169	205
4	10640.00	54.31	74.00	-19.69	38.82	15.49	Peak	169	205
5	15960.00	45.37	54.00	-8.63	29.80	15.57	Average	158	260
6	15960.00	57.50	74.00	-16.50	41.93	15.57	Peak	158	260

Note 1: Emission Level (dBuV/m) = SA Reading (dBuV/m) + Factor\* (dB)

\*Factor includes antenna factor , cable loss and amplifier gain

Note 2: Margin (dB) = Emission level (dBuV/m) – Limit (dBuV/m).

<b>Modulation</b>	VHT20	<b>Test Freq. (MHz)</b>	5320
<b>Polarization</b>	Vertical		

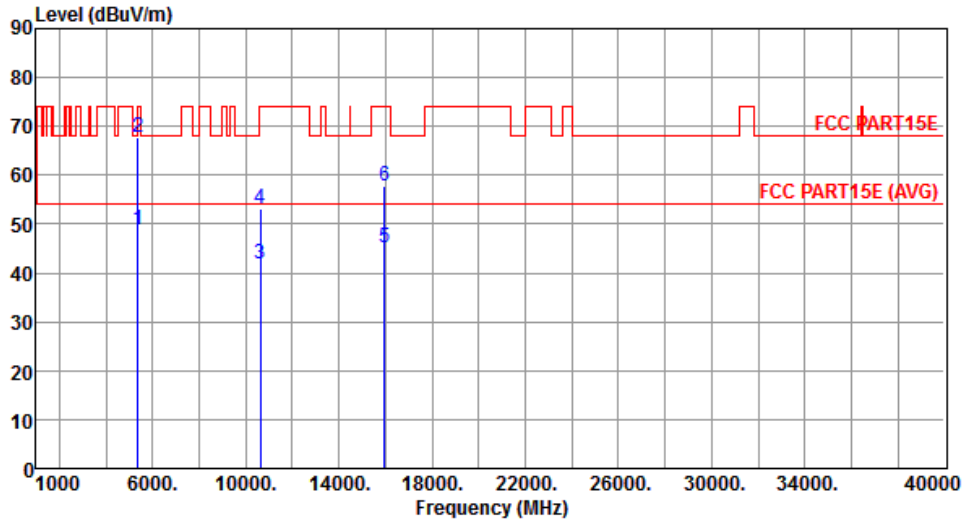

	Freq. MHz	Emission level dBuV/m	Limit dBuV/m	Margin dB	SA reading dBuV	Factor dB	Remark	ANT High cm	Turn Table deg
1	5350.00	48.79	54.00	-5.21	42.58	6.21	Average	100	133
2	5350.00	67.83	74.00	-6.17	61.62	6.21	Peak	100	133
3	10640.00	41.98	54.00	-12.02	26.49	15.49	Average	129	76
4	10640.00	53.24	74.00	-20.76	37.75	15.49	Peak	129	76
5	15960.00	45.06	54.00	-8.94	29.49	15.57	Average	148	109
6	15960.00	57.80	74.00	-16.20	42.23	15.57	Peak	148	109

Note 1: Emission Level (dBuV/m) = SA Reading (dBuV/m) + Factor\* (dB)

\*Factor includes antenna factor , cable loss and amplifier gain

Note 2: Margin (dB) = Emission level (dBuV/m) – Limit (dBuV/m).



<b>Modulation</b>	VHT20	<b>Test Freq. (MHz)</b>	5500
<b>Polarization</b>	Horizontal		

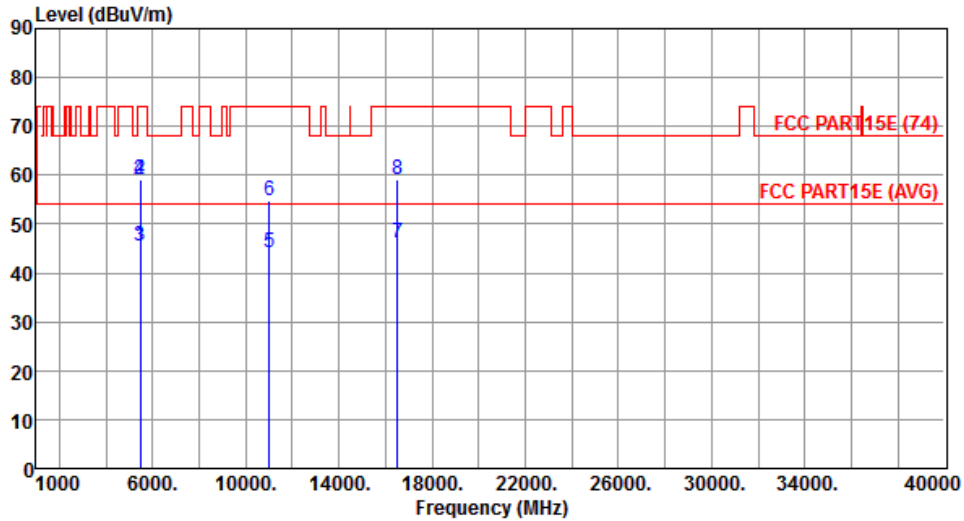

	Freq. MHz	Emission level dBuV/m	Limit dBuV/m	Margin dB	SA reading dBuV	Factor dB	Remark	ANT High cm	Turn Table deg
1	5460.00	45.42	54.00	-8.58	39.06	6.36	Average	150	285
2	5460.00	59.10	74.00	-14.90	52.74	6.36	Peak	150	285
3	5470.00	45.63	54.00	-8.37	39.26	6.37	Average	150	285
4	5470.00	59.02	74.00	-14.98	52.65	6.37	Peak	150	285
5	11000.00	44.24	54.00	-9.76	28.50	15.74	Average	240	182
6	11000.00	54.91	74.00	-19.09	39.17	15.74	Peak	240	182
7	16500.00	46.13	54.00	-7.87	30.10	16.03	Average	165	332
8	16500.00	59.13	74.00	-14.87	43.10	16.03	Peak	165	332

Note 1: Emission Level (dBuV/m) = SA Reading (dBuV/m) + Factor\* (dB)

\*Factor includes antenna factor , cable loss and amplifier gain

Note 2: Margin (dB) = Emission level (dBuV/m) – Limit (dBuV/m).

<b>Modulation</b>	VHT20	<b>Test Freq. (MHz)</b>	5500
<b>Polarization</b>	Vertical		

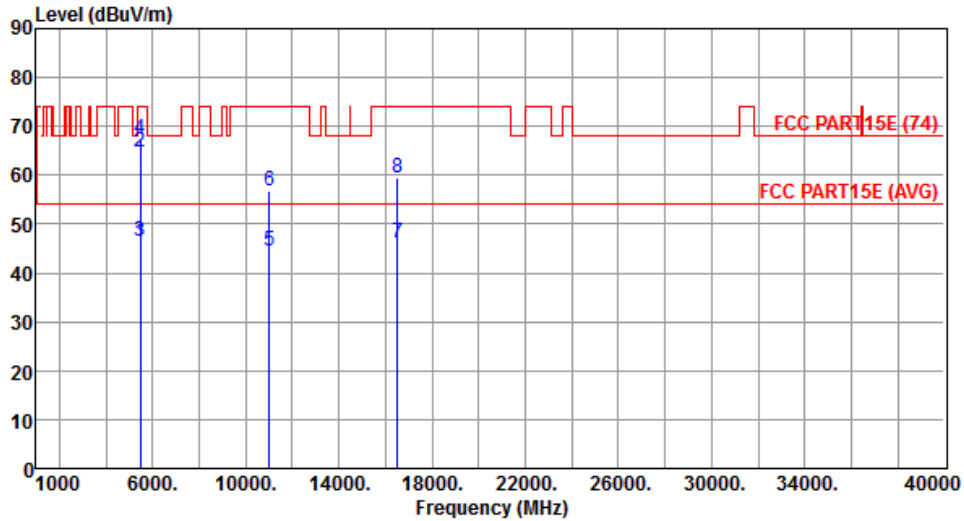

	Freq. MHz	Emission level dBuV/m	Limit dBuV/m	Margin dB	SA reading dBuV	Factor dB	Remark	ANT High cm	Turn Table deg
1	5460.00	46.08	54.00	-7.92	39.72	6.36	Average	100	81
2	5460.00	64.89	74.00	-9.11	58.53	6.36	Peak	100	81
3	5470.00	46.34	54.00	-7.66	39.97	6.37	Average	100	81
4	5470.00	67.26	74.00	-6.74	60.89	6.37	Peak	100	81
5	11000.00	44.60	54.00	-9.40	28.86	15.74	Average	100	165
6	11000.00	56.69	74.00	-17.31	40.95	15.74	Peak	100	165
7	16500.00	46.08	54.00	-7.92	30.05	16.03	Average	100	212
8	16500.00	59.29	74.00	-14.71	43.26	16.03	Peak	100	212

Note 1: Emission Level (dBuV/m) = SA Reading (dBuV/m) + Factor\* (dB)

\*Factor includes antenna factor , cable loss and amplifier gain

Note 2: Margin (dB) = Emission level (dBuV/m) – Limit (dBuV/m).

<b>Modulation</b>	VHT20	<b>Test Freq. (MHz)</b>	5580
<b>Polarization</b>	Horizontal		

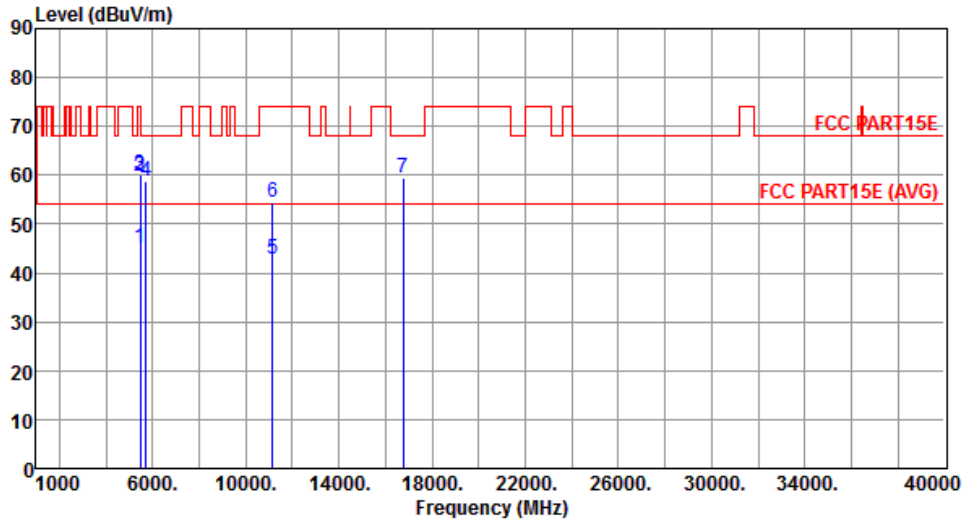

	Freq. MHz	Emission level dBuV/m	Limit dBuV/m	Margin dB	SA reading dBuV	Factor dB	Remark	ANT High cm	Turn Table deg
1	5460.00	45.30	54.00	-8.70	38.94	6.36	Average	100	295
2	5460.00	59.77	74.00	-14.23	53.41	6.36	Peak	100	295
3	5470.00	60.05	68.20	-8.15	53.68	6.37	Peak	100	295
4	5725.00	58.83	68.20	-9.37	52.00	6.83	Peak	100	295
5	11160.00	42.87	54.00	-11.13	27.04	15.83	Average	151	49
6	11160.00	54.40	74.00	-19.60	38.57	15.83	Peak	151	49
7	16740.00	59.60	68.20	-8.60	42.80	16.80	Peak	275	143

Note 1: Emission Level (dBuV/m) = SA Reading (dBuV/m) + Factor\* (dB)

\*Factor includes antenna factor , cable loss and amplifier gain

Note 2: Margin (dB) = Emission level (dBuV/m) – Limit (dBuV/m).

<b>Modulation</b>	VHT20	<b>Test Freq. (MHz)</b>	5580
<b>Polarization</b>	Vertical		

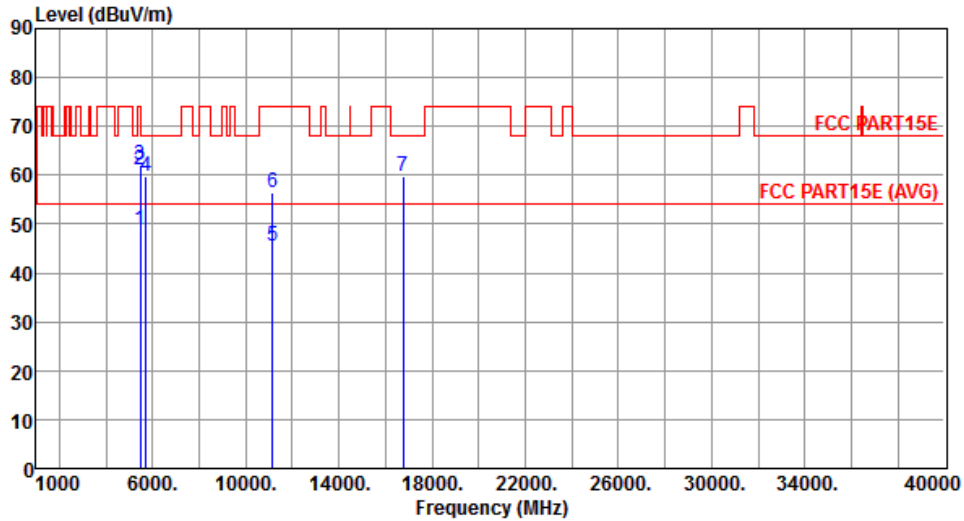

	Freq. MHz	Emission level dBuV/m	Limit dBuV/m	Margin dB	SA reading dBuV	Factor dB	Remark	ANT High cm	Turn Table deg
1	5460.00	48.93	54.00	-5.07	42.57	6.36	Average	100	83
2	5460.00	60.98	74.00	-13.02	54.62	6.36	Peak	100	83
3	5470.00	62.27	68.20	-5.93	55.90	6.37	Peak	100	83
4	5725.00	59.67	68.20	-8.53	52.84	6.83	Peak	100	83
5	11160.00	45.66	54.00	-8.34	29.83	15.83	Average	159	184
6	11160.00	56.57	74.00	-17.43	40.74	15.83	Peak	159	184
7	16740.00	59.93	68.20	-8.27	43.13	16.80	Peak	308	149

Note 1: Emission Level (dBuV/m) = SA Reading (dBuV/m) + Factor\* (dB)

\*Factor includes antenna factor , cable loss and amplifier gain

Note 2: Margin (dB) = Emission level (dBuV/m) – Limit (dBuV/m).

<b>Modulation</b>	VHT20	<b>Test Freq. (MHz)</b>	5700
<b>Polarization</b>	Horizontal		

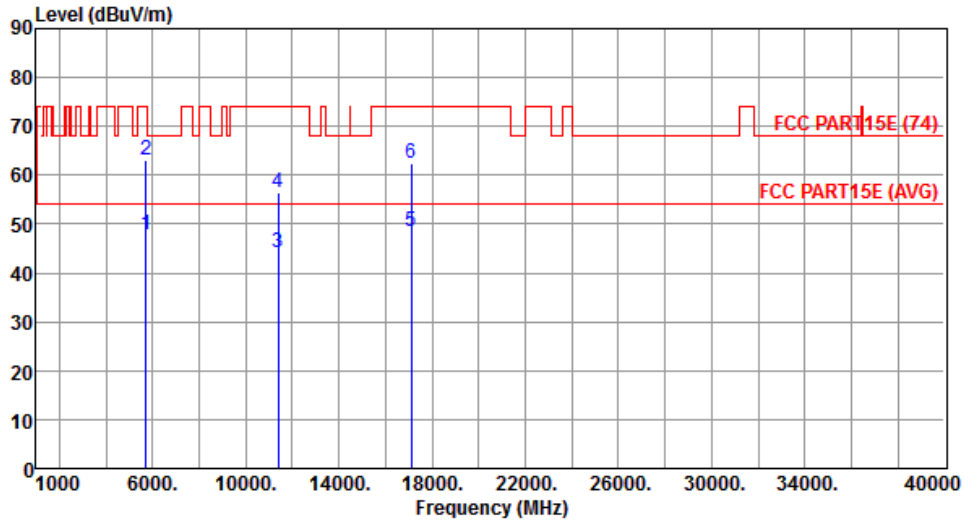

	Freq. MHz	Emission level dBuV/m	Limit dBuV/m	Margin dB	SA reading dBuV	Factor dB	Remark	ANT High cm	Turn Table deg
1	5725.00	47.91	54.00	-6.09	41.08	6.83	Average	131	285
2	5725.00	63.07	74.00	-10.93	56.24	6.83	Peak	131	285
3	11400.00	44.03	54.00	-9.97	28.07	15.96	Average	169	82
4	11400.00	56.31	74.00	-17.69	40.35	15.96	Peak	169	82
5	17100.00	48.61	54.00	-5.39	30.65	17.96	Average	336	193
6	17100.00	62.37	74.00	-11.63	44.41	17.96	Peak	336	193

Note 1: Emission Level (dBuV/m) = SA Reading (dBuV/m) + Factor\* (dB)

\*Factor includes antenna factor , cable loss and amplifier gain

Note 2: Margin (dB) = Emission level (dBuV/m) – Limit (dBuV/m).

<b>Modulation</b>	VHT20	<b>Test Freq. (MHz)</b>	5700
<b>Polarization</b>	Vertical		

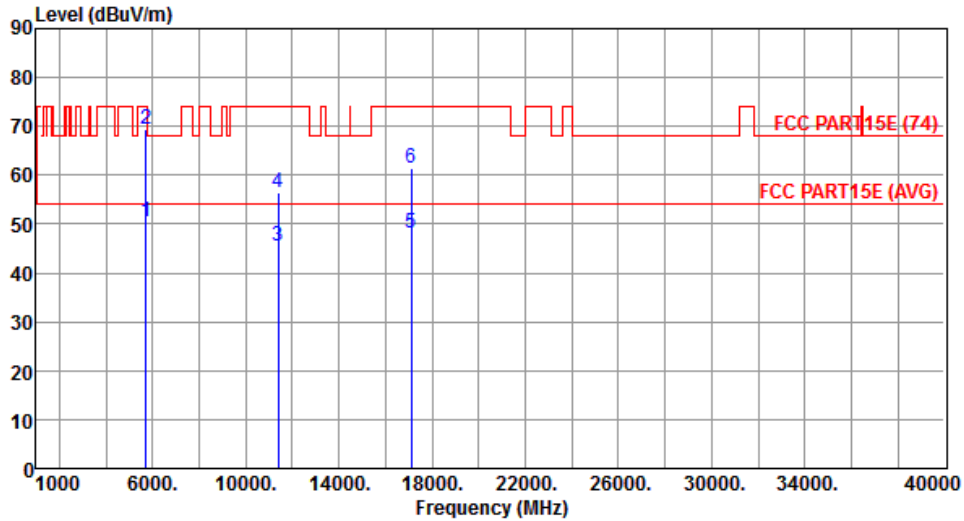

	Freq. MHz	Emission level dBuV/m	Limit dBuV/m	Margin dB	SA reading dBuV	Factor dB	Remark	ANT High cm	Turn Table deg
1	5725.00	50.48	54.00	-3.52	43.65	6.83	Average	152	79
2	5725.00	69.26	74.00	-4.74	62.43	6.83	Peak	152	79
3	11400.00	45.56	54.00	-8.44	29.60	15.96	Average	121	180
4	11400.00	56.51	74.00	-17.49	40.55	15.96	Peak	121	180
5	17100.00	48.24	54.00	-5.76	30.28	17.96	Average	161	105
6	17100.00	61.28	74.00	-12.72	43.32	17.96	Peak	161	105

Note 1: Emission Level (dBuV/m) = SA Reading (dBuV/m) + Factor\* (dB)

\*Factor includes antenna factor , cable loss and amplifier gain

Note 2: Margin (dB) = Emission level (dBuV/m) – Limit (dBuV/m).

<b>Modulation</b>	VHT20	<b>Test Freq. (MHz)</b>	5720
<b>Polarization</b>	Horizontal		

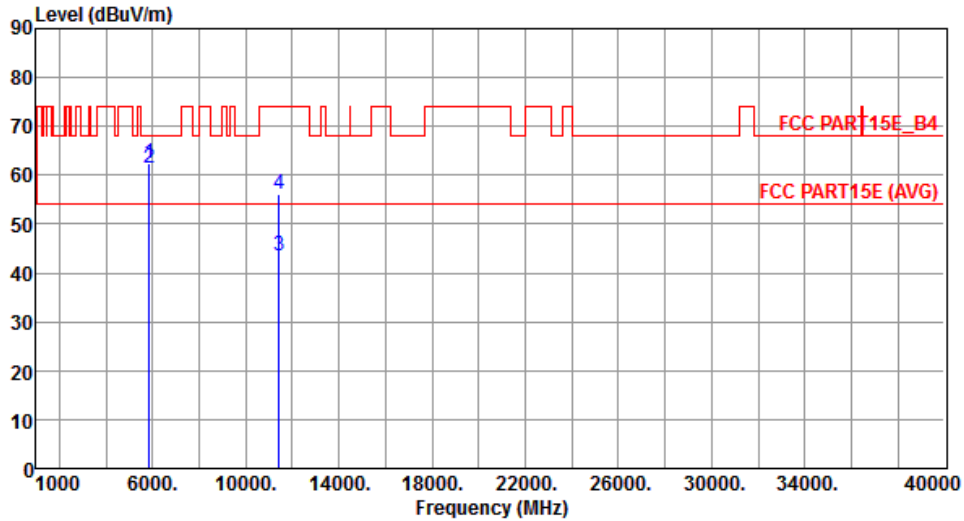

	Freq. MHz	Emission level dBuV/m	Limit dBuV/m	Margin dB	SA reading dBuV	Factor dB	Remark	ANT High cm	Turn Table deg
1	5850.00	62.57	78.20	-15.63	55.41	7.16	Peak	125	281
2	5860.00	61.57	68.20	-6.63	54.39	7.18	Peak	125	281
3	11440.00	43.47	54.00	-10.53	27.48	15.99	Average	160	172
4	11440.00	56.23	74.00	-17.77	40.24	15.99	Peak	160	172

Note 1: Emission Level (dBuV/m) = SA Reading (dBuV/m) + Factor\* (dB)

\*Factor includes antenna factor , cable loss and amplifier gain

Note 2: Margin (dB) = Emission level (dBuV/m) – Limit (dBuV/m).

<b>Modulation</b>	VHT20	<b>Test Freq. (MHz)</b>	5720
<b>Polarization</b>	Vertical		

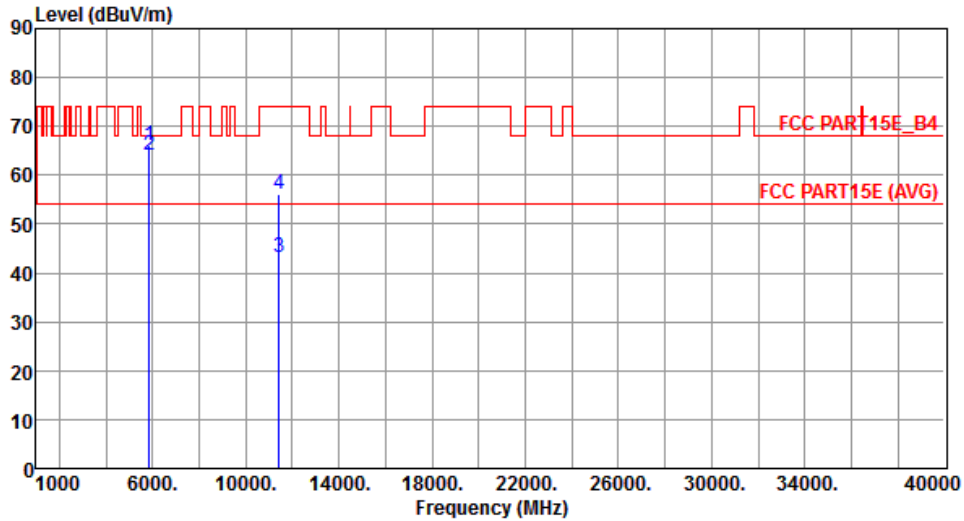

	Freq. MHz	Emission level dBuV/m	Limit dBuV/m	Margin dB	SA reading dBuV	Factor dB	Remark	ANT High cm	Turn Table deg
1	5850.00	66.05	78.20	-12.15	58.89	7.16	Peak	100	130
2	5860.00	63.96	68.20	-4.24	56.78	7.18	Peak	100	130
3	11440.00	43.23	54.00	-10.77	27.24	15.99	Average	180	288
4	11440.00	56.14	74.00	-17.86	40.15	15.99	Peak	180	288

Note 1: Emission Level (dBuV/m) = SA Reading (dBuV/m) + Factor\* (dB)

\*Factor includes antenna factor , cable loss and amplifier gain

Note 2: Margin (dB) = Emission level (dBuV/m) – Limit (dBuV/m).



<b>Modulation</b>	VHT20	<b>Test Freq. (MHz)</b>	5745
<b>Polarization</b>	Horizontal		

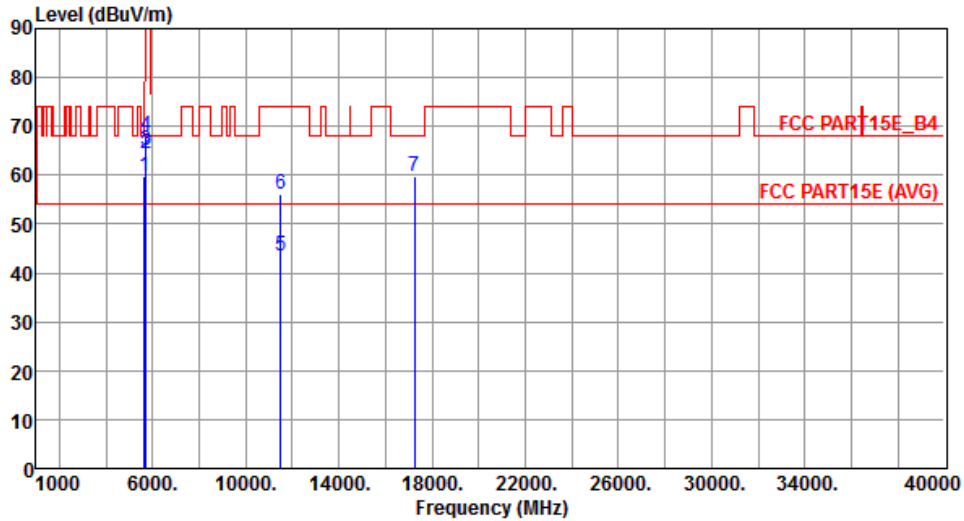

	Freq. MHz	Emission level dBuV/m	Limit dBuV/m	Margin dB	SA reading dBuV	Factor dB	Remark	ANT High cm	Turn Table deg
1	5650.00	59.65	68.20	-8.55	53.02	6.63	Peak	110	289
2	5700.00	64.30	105.20	-40.90	57.53	6.77	Peak	110	289
3	5720.00	64.98	110.80	-45.82	58.16	6.82	Peak	110	289
4	5725.00	68.17	122.20	-54.03	61.34	6.83	Peak	110	289
5	11490.00	43.65	54.00	-10.35	27.64	16.01	Average	191	36
6	11490.00	55.98	74.00	-18.02	39.97	16.01	Peak	191	36
7	17235.00	59.82	68.20	-8.38	41.39	18.43	Peak	186	39

Note 1: Emission Level (dBuV/m) = SA Reading (dBuV/m) + Factor\* (dB)

\*Factor includes antenna factor , cable loss and amplifier gain

Note 2: Margin (dB) = Emission level (dBuV/m) – Limit (dBuV/m).

<b>Modulation</b>	VHT20	<b>Test Freq. (MHz)</b>	5745
<b>Polarization</b>	Vertical		

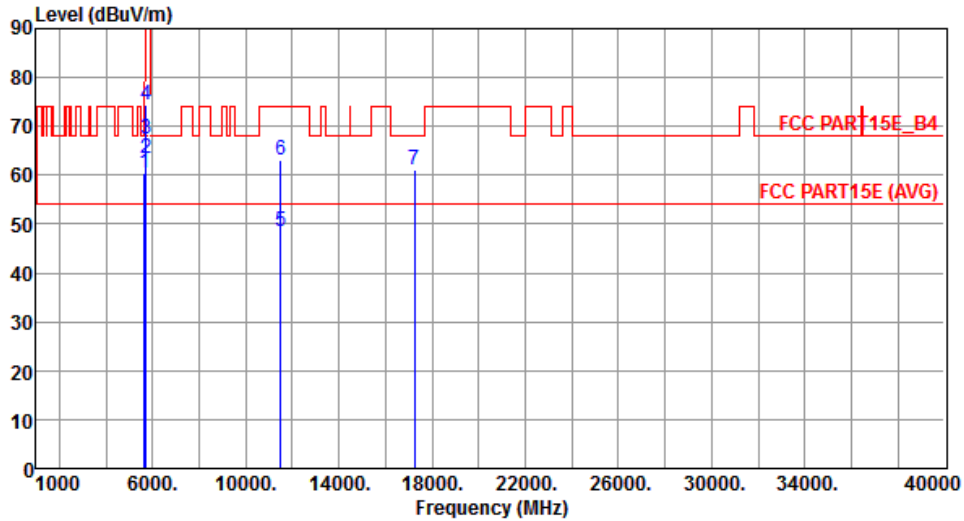

	Freq. MHz	Emission level dBuV/m	Limit dBuV/m	Margin dB	SA reading dBuV	Factor dB	Remark	ANT High cm	Turn Table deg
1	5650.00	60.53	68.20	-7.67	53.90	6.63	Peak	138	40
2	5700.00	63.40	105.20	-41.80	56.63	6.77	Peak	138	40
3	5720.00	67.26	110.80	-43.54	60.44	6.82	Peak	138	40
4	5725.00	74.32	122.20	-47.88	67.49	6.83	Peak	138	40
5	11490.00	48.36	54.00	-5.64	32.35	16.01	Average	129	94
6	11490.00	63.12	74.00	-10.88	47.11	16.01	Peak	129	94
7	17235.00	61.24	68.20	-6.96	42.81	18.43	Peak	135	91

Note 1: Emission Level (dBuV/m) = SA Reading (dBuV/m) + Factor\* (dB)

\*Factor includes antenna factor , cable loss and amplifier gain

Note 2: Margin (dB) = Emission level (dBuV/m) – Limit (dBuV/m).

<b>Modulation</b>	VHT20	<b>Test Freq. (MHz)</b>	5785
<b>Polarization</b>	Horizontal		

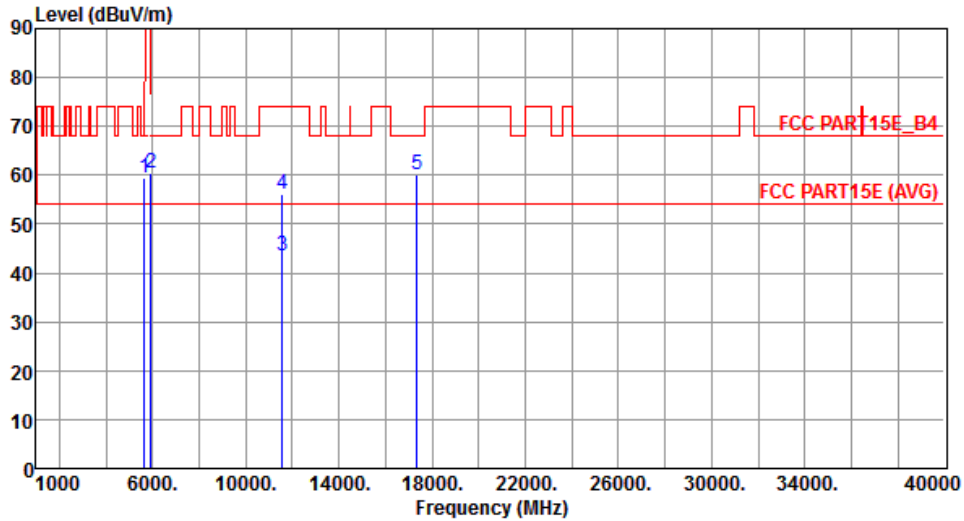

	Freq. MHz	Emission level dBuV/m	Limit dBuV/m	Margin dB	SA reading dBuV	Factor dB	Remark	ANT High cm	Turn Table deg
1	5650.00	59.53	68.20	-8.67	52.90	6.63	Peak	111	288
2	5925.00	60.50	68.20	-7.70	53.16	7.34	Peak	111	288
3	11570.00	43.65	54.00	-10.35	27.76	15.89	Average	193	35
4	11570.00	56.04	74.00	-17.96	40.15	15.89	Peak	193	35
5	17355.00	59.96	68.20	-8.24	41.14	18.82	Peak	195	44

Note 1: Emission Level (dBuV/m) = SA Reading (dBuV/m) + Factor\* (dB)

\*Factor includes antenna factor , cable loss and amplifier gain

Note 2: Margin (dB) = Emission level (dBuV/m) – Limit (dBuV/m).

<b>Modulation</b>	VHT20	<b>Test Freq. (MHz)</b>	5785
<b>Polarization</b>	Vertical		

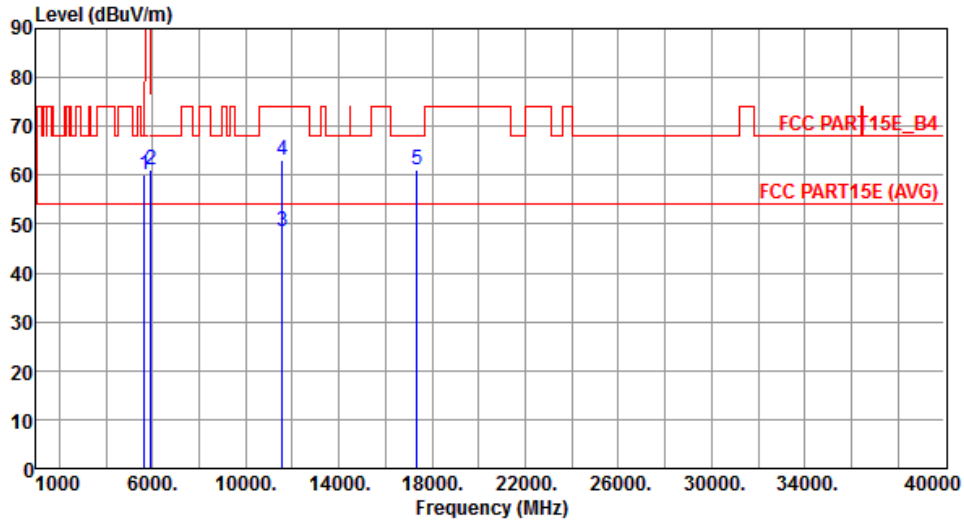

	Freq. MHz	Emission level dBuV/m	Limit dBuV/m	Margin dB	SA reading dBuV	Factor dB	Remark	ANT High cm	Turn Table deg
1	5650.00	60.19	68.20	-8.01	53.56	6.63	Peak	155	36
2	5925.00	61.27	68.20	-6.93	53.93	7.34	Peak	155	36
3	11570.00	48.39	54.00	-5.61	32.50	15.89	Average	131	96
4	11570.00	63.05	74.00	-10.95	47.16	15.89	Peak	131	96
5	17355.00	61.25	68.20	-6.95	42.43	18.82	Peak	129	88

Note 1: Emission Level (dBuV/m) = SA Reading (dBuV/m) + Factor\* (dB)

\*Factor includes antenna factor , cable loss and amplifier gain

Note 2: Margin (dB) = Emission level (dBuV/m) – Limit (dBuV/m).

<b>Modulation</b>	VHT20	<b>Test Freq. (MHz)</b>	5825
<b>Polarization</b>	Horizontal		

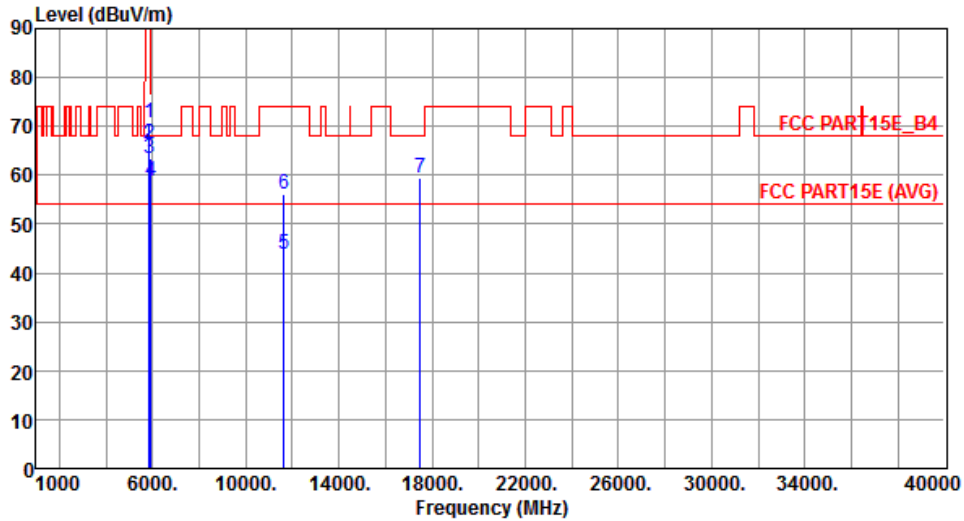

	Freq. MHz	Emission level dBuV/m	Limit dBuV/m	Margin dB	SA reading dBuV	Factor dB	Remark	ANT High cm	Turn Table deg
1	5850.00	70.82	122.20	-51.38	63.66	7.16	Peak	110	286
2	5855.00	66.57	110.80	-44.23	59.39	7.18	Peak	110	286
3	5875.00	63.34	105.20	-41.86	56.11	7.23	Peak	110	286
4	5925.00	58.89	68.20	-9.31	51.55	7.34	Peak	110	286
5	11650.00	43.86	54.00	-10.14	28.12	15.74	Average	187	45
6	11650.00	56.15	74.00	-17.85	40.41	15.74	Peak	187	45
7	17475.00	59.43	68.20	-8.77	40.20	19.23	Peak	193	52

Note 1: Emission Level (dBuV/m) = SA Reading (dBuV/m) + Factor\* (dB)

\*Factor includes antenna factor , cable loss and amplifier gain

Note 2: Margin (dB) = Emission level (dBuV/m) – Limit (dBuV/m).

<b>Modulation</b>	VHT20	<b>Test Freq. (MHz)</b>	5825
<b>Polarization</b>	Vertical		

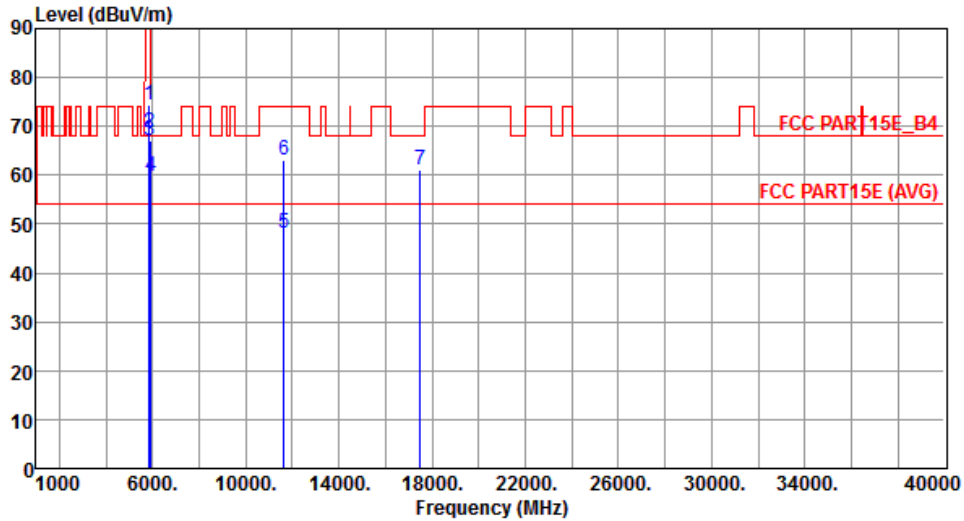

	Freq. MHz	Emission level dBuV/m	Limit dBuV/m	Margin dB	SA reading dBuV	Factor dB	Remark	ANT High cm	Turn Table deg
1	5850.00	74.54	122.20	-47.66	67.38	7.16	Peak	149	82
2	5855.00	68.79	110.80	-42.01	61.61	7.18	Peak	149	82
3	5875.00	67.15	105.20	-38.05	59.92	7.23	Peak	149	82
4	5925.00	59.88	68.20	-8.32	52.54	7.34	Peak	149	82
5	11650.00	48.14	54.00	-5.86	32.40	15.74	Average	133	106
6	11650.00	62.95	74.00	-11.05	47.21	15.74	Peak	133	106
7	17475.00	61.23	68.20	-6.97	42.00	19.23	Peak	135	106

Note 1: Emission Level (dBuV/m) = SA Reading (dBuV/m) + Factor\* (dB)

\*Factor includes antenna factor , cable loss and amplifier gain

Note 2: Margin (dB) = Emission level (dBuV/m) – Limit (dBuV/m).

### 3.5.7 Transmitter Radiated Unwanted Emissions (Above 1GHz) for VHT40

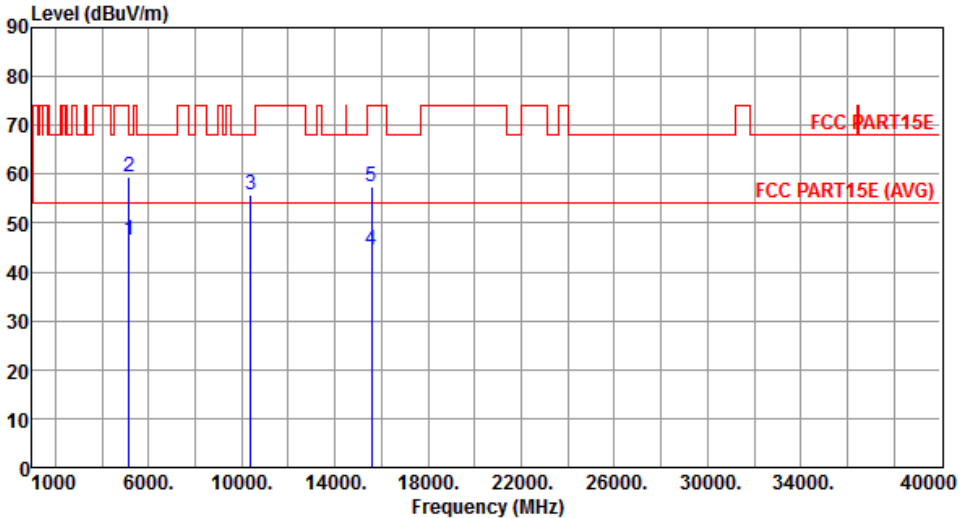
Modulation	VHT40	Test Freq. (MHz)	5190						
Polarization	Horizontal								
									
	Freq.	Emission level	Limit	Margin	SA reading	Factor	Remark	ANT High	Turn Table
	MHz	dBuV/m	dBuV/m	dB	dBuV	dB		cm	deg
1	5150.00	46.62	54.00	-7.38	40.75	5.87	Average	305	279
2	5150.00	59.31	74.00	-14.69	53.44	5.87	Peak	305	279
3	10380.00	55.86	68.20	-12.34	40.61	15.25	Peak	162	147
4	15570.00	44.58	54.00	-9.42	28.54	16.04	Average	142	163
5	15570.00	57.42	74.00	-16.58	41.38	16.04	Peak	142	163
<p>Note 1: Emission Level (dBuV/m) = SA Reading (dBuV/m) + Factor* (dB)            *Factor includes antenna factor , cable loss and amplifier gain            Note 2: Margin (dB) = Emission level (dBuV/m) – Limit (dBuV/m).</p>									

<b>Modulation</b>	VHT40	<b>Test Freq. (MHz)</b>	5190
<b>Polarization</b>	Vertical		

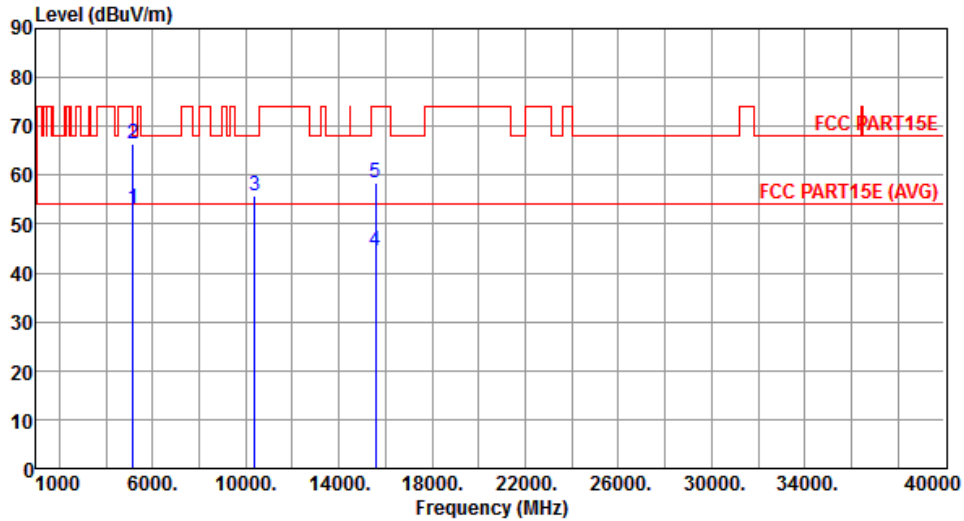

	Freq. MHz	Emission level dBuV/m	Limit dBuV/m	Margin dB	SA reading dBuV	Factor dB	Remark	ANT High cm	Turn Table deg
1	5150.00	52.98	54.00	-1.02	47.11	5.87	Average	254	239
2	5150.00	66.32	74.00	-7.68	60.45	5.87	Peak	254	239
3	10380.00	55.78	68.20	-12.42	40.53	15.25	Peak	155	163
4	15570.00	44.59	54.00	-9.41	28.55	16.04	Average	162	147
5	15570.00	58.35	74.00	-15.65	42.31	16.04	Peak	162	147

Note 1: Emission Level (dBuV/m) = SA Reading (dBuV/m) + Factor\* (dB)

\*Factor includes antenna factor , cable loss and amplifier gain

Note 2: Margin (dB) = Emission level (dBuV/m) – Limit (dBuV/m).



<b>Modulation</b>	VHT40	<b>Test Freq. (MHz)</b>	5230
<b>Polarization</b>	Horizontal		

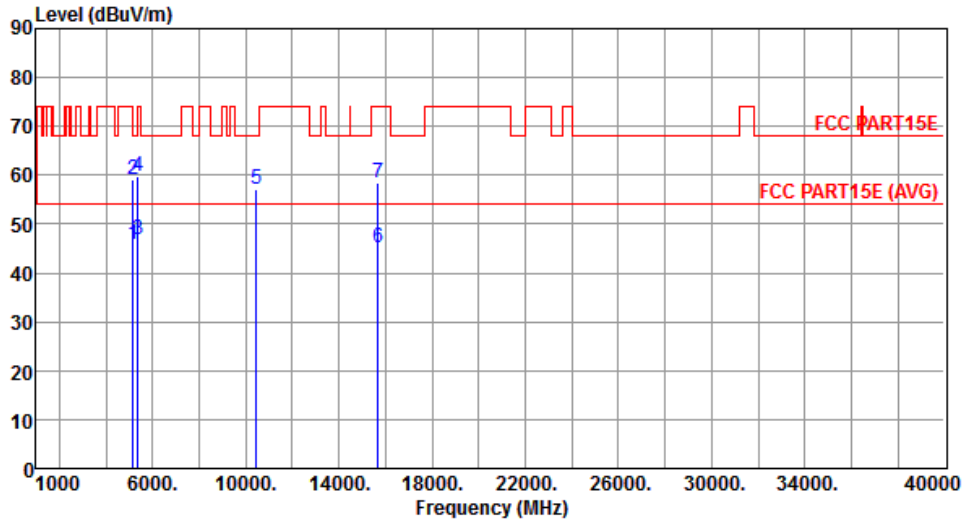

	Freq. MHz	Emission level dBuV/m	Limit dBuV/m	Margin dB	SA reading dBuV	Factor dB	Remark	ANT High cm	Turn Table deg
1	5150.00	45.99	54.00	-8.01	40.12	5.87	Average	256	263
2	5150.00	59.18	74.00	-14.82	53.31	5.87	Peak	256	263
3	5350.00	46.75	54.00	-7.25	40.54	6.21	Average	256	263
4	5350.00	59.70	74.00	-14.30	53.49	6.21	Peak	256	263
5	10460.00	57.02	68.20	-11.18	41.68	15.34	Peak	153	162
6	15690.00	45.27	54.00	-8.73	29.38	15.89	Average	148	216
7	15690.00	58.44	74.00	-15.56	42.55	15.89	Peak	148	216

Note 1: Emission Level (dBuV/m) = SA Reading (dBuV/m) + Factor\* (dB)

\*Factor includes antenna factor , cable loss and amplifier gain

Note 2: Margin (dB) = Emission level (dBuV/m) – Limit (dBuV/m).

<b>Modulation</b>	VHT40	<b>Test Freq. (MHz)</b>	5230
<b>Polarization</b>	Vertical		

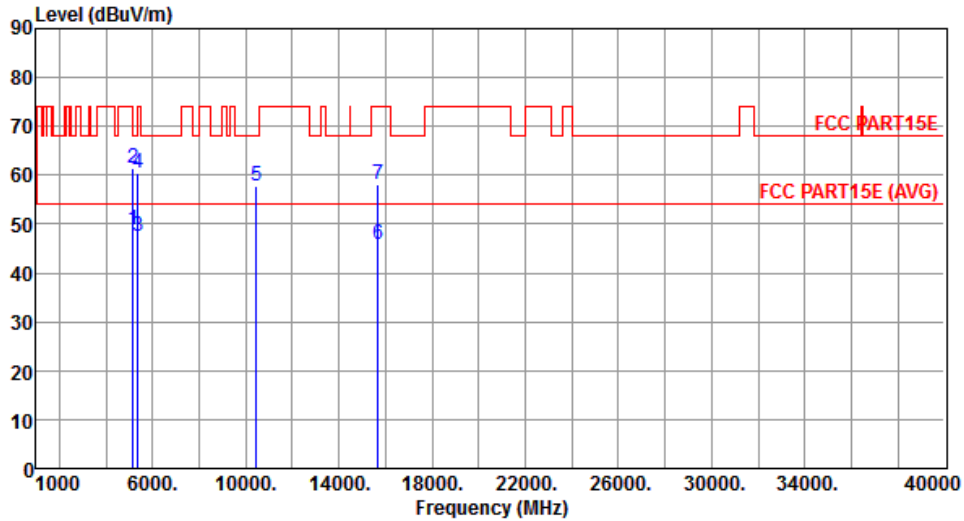

	Freq. MHz	Emission level dBuV/m	Limit dBuV/m	Margin dB	SA reading dBuV	Factor dB	Remark	ANT High cm	Turn Table deg
1	5150.00	48.96	54.00	-5.04	43.09	5.87	Average	250	256
2	5150.00	61.55	74.00	-12.45	55.68	5.87	Peak	250	256
3	5350.00	47.63	54.00	-6.37	41.42	6.21	Average	250	256
4	5350.00	60.29	74.00	-13.71	54.08	6.21	Peak	250	256
5	10460.00	57.65	68.20	-10.55	42.31	15.34	Peak	155	136
6	15690.00	45.79	54.00	-8.21	29.90	15.89	Average	288	49
7	15690.00	58.02	74.00	-15.98	42.13	15.89	Peak	288	49

Note 1: Emission Level (dBuV/m) = SA Reading (dBuV/m) + Factor\* (dB)

\*Factor includes antenna factor , cable loss and amplifier gain

Note 2: Margin (dB) = Emission level (dBuV/m) – Limit (dBuV/m).

<b>Modulation</b>	VHT40	<b>Test Freq. (MHz)</b>	5270
<b>Polarization</b>	Horizontal		

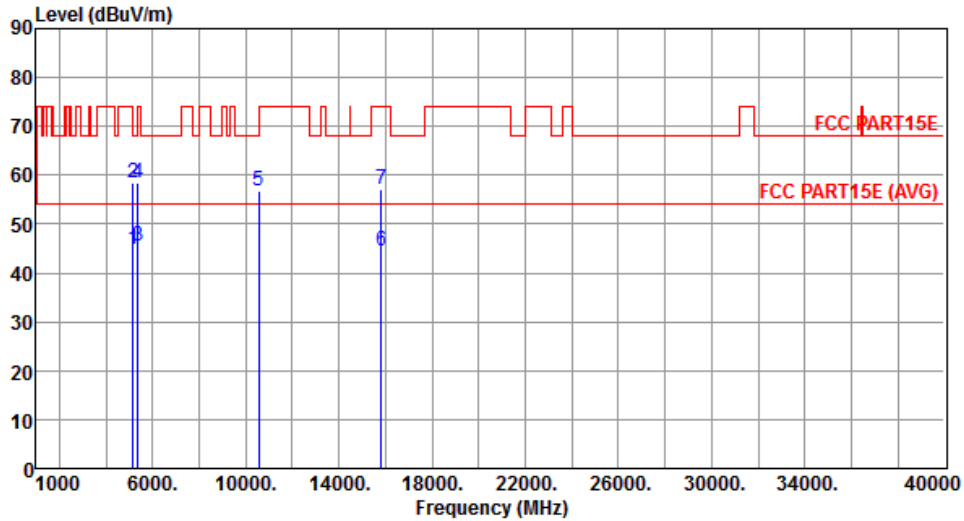

	Freq. MHz	Emission level dBuV/m	Limit dBuV/m	Margin dB	SA reading dBuV	Factor dB	Remark	ANT High cm	Turn Table deg
1	5150.00	44.70	54.00	-9.30	38.83	5.87	Average	100	276
2	5150.00	58.33	74.00	-15.67	52.46	5.87	Peak	100	276
3	5350.00	45.40	54.00	-8.60	39.19	6.21	Average	100	276
4	5350.00	58.40	74.00	-15.60	52.19	6.21	Peak	100	276
5	10540.00	56.80	68.20	-11.40	41.38	15.42	Peak	100	156
6	15810.00	44.43	54.00	-9.57	28.68	15.75	Average	100	212
7	15810.00	57.12	74.00	-16.88	41.37	15.75	Peak	100	212

Note 1: Emission Level (dBuV/m) = SA Reading (dBuV/m) + Factor\* (dB)

\*Factor includes antenna factor , cable loss and amplifier gain

Note 2: Margin (dB) = Emission level (dBuV/m) – Limit (dBuV/m).

<b>Modulation</b>	VHT40	<b>Test Freq. (MHz)</b>	5270
<b>Polarization</b>	Vertical		

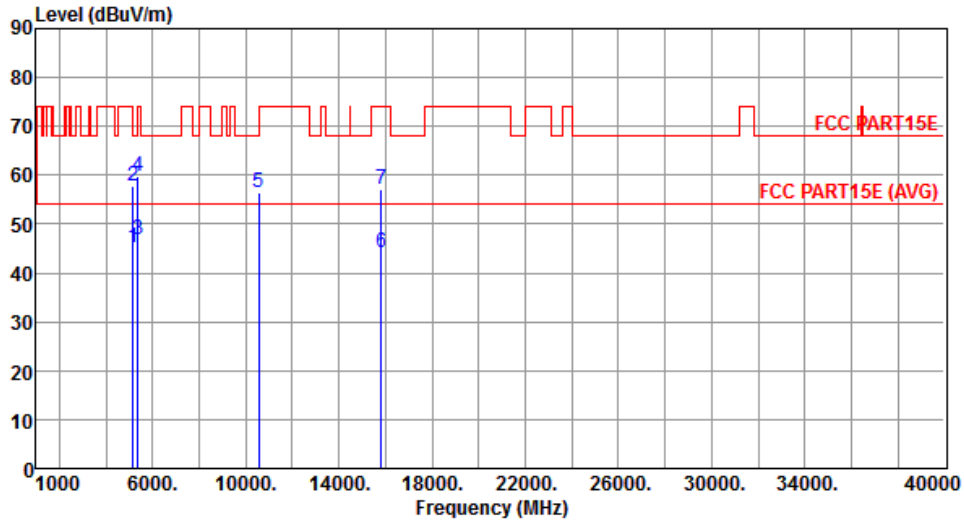

	Freq. MHz	Emission level dBuV/m	Limit dBuV/m	Margin dB	SA reading dBuV	Factor dB	Remark	ANT High cm	Turn Table deg
1	5150.00	45.21	54.00	-8.79	39.34	5.87	Average	100	128
2	5150.00	57.83	74.00	-16.17	51.96	5.87	Peak	100	128
3	5350.00	46.90	54.00	-7.10	40.69	6.21	Average	100	128
4	5350.00	59.94	74.00	-14.06	53.73	6.21	Peak	100	128
5	10540.00	56.38	68.20	-11.82	40.96	15.42	Peak	100	168
6	15810.00	44.31	54.00	-9.69	28.56	15.75	Average	100	185
7	15810.00	57.13	74.00	-16.87	41.38	15.75	Peak	100	185

Note 1: Emission Level (dBuV/m) = SA Reading (dBuV/m) + Factor\* (dB)

\*Factor includes antenna factor , cable loss and amplifier gain

Note 2: Margin (dB) = Emission level (dBuV/m) – Limit (dBuV/m).

<b>Modulation</b>	VHT40	<b>Test Freq. (MHz)</b>	5310
<b>Polarization</b>	Horizontal		

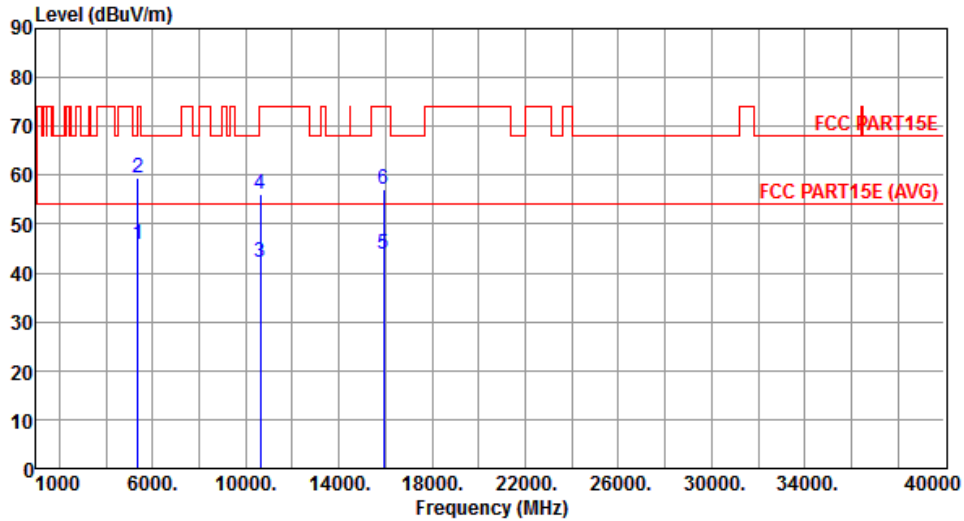

	Freq. MHz	Emission level dBuV/m	Limit dBuV/m	Margin dB	SA reading dBuV	Factor dB	Remark	ANT High cm	Turn Table deg
1	5350.00	45.87	54.00	-8.13	39.66	6.21	Average	100	312
2	5350.00	59.53	74.00	-14.47	53.32	6.21	Peak	100	312
3	10620.00	42.24	54.00	-11.76	26.76	15.48	Average	100	168
4	10620.00	55.97	74.00	-18.03	40.49	15.48	Peak	100	168
5	15930.00	43.81	54.00	-10.19	28.21	15.60	Average	100	144
6	15930.00	57.27	74.00	-16.73	41.67	15.60	Peak	100	144

Note 1: Emission Level (dBuV/m) = SA Reading (dBuV/m) + Factor\* (dB)

\*Factor includes antenna factor , cable loss and amplifier gain

Note 2: Margin (dB) = Emission level (dBuV/m) – Limit (dBuV/m).

<b>Modulation</b>	VHT40	<b>Test Freq. (MHz)</b>	5310
<b>Polarization</b>	Vertical		

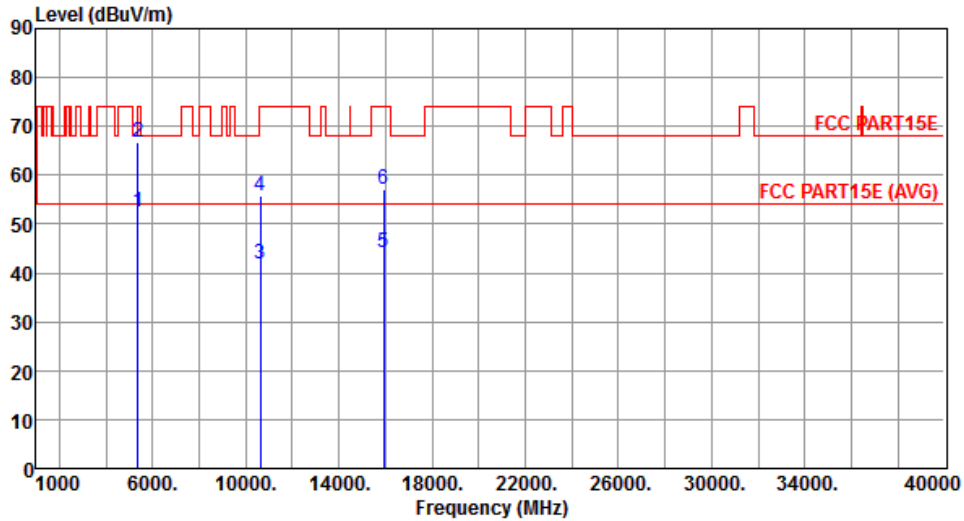

	Freq. MHz	Emission level dBuV/m	Limit dBuV/m	Margin dB	SA reading dBuV	Factor dB	Remark	ANT High cm	Turn Table deg
1	5350.00	52.59	54.00	-1.41	46.38	6.21	Average	162	311
2	5350.00	66.76	74.00	-7.24	60.55	6.21	Peak	162	311
3	10620.00	41.85	54.00	-12.15	26.37	15.48	Average	100	146
4	10620.00	55.85	74.00	-18.15	40.37	15.48	Peak	100	146
5	15930.00	44.27	54.00	-9.73	28.67	15.60	Average	100	152
6	15930.00	57.01	74.00	-16.99	41.41	15.60	Peak	100	152

Note 1: Emission Level (dBuV/m) = SA Reading (dBuV/m) + Factor\* (dB)

\*Factor includes antenna factor , cable loss and amplifier gain

Note 2: Margin (dB) = Emission level (dBuV/m) – Limit (dBuV/m).

<b>Modulation</b>	VHT40	<b>Test Freq. (MHz)</b>	5510
<b>Polarization</b>	Horizontal		

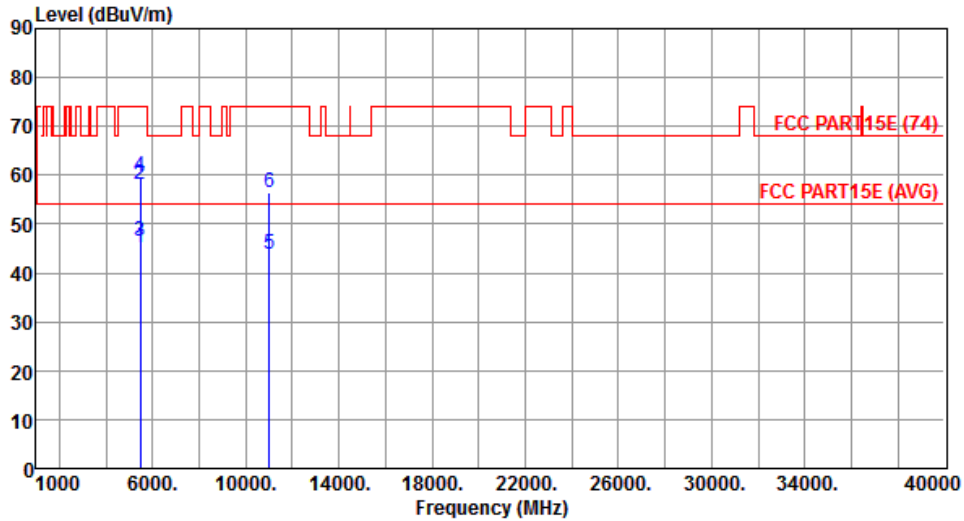

	Freq. MHz	Emission level dBuV/m	Limit dBuV/m	Margin dB	SA reading dBuV	Factor dB	Remark	ANT High cm	Turn Table deg
1	5460.00	45.04	54.00	-8.96	38.68	6.36	Average	147	287
2	5460.00	58.03	74.00	-15.97	51.67	6.36	Peak	147	287
3	5470.00	46.58	54.00	-7.42	40.21	6.37	Average	147	287
4	5470.00	59.92	74.00	-14.08	53.55	6.37	Peak	147	287
5	11020.00	43.97	54.00	-10.03	28.22	15.75	Average	100	165
6	11020.00	56.32	74.00	-17.68	40.57	15.75	Peak	100	165

Note 1: Emission Level (dBuV/m) = SA Reading (dBuV/m) + Factor\* (dB)

\*Factor includes antenna factor , cable loss and amplifier gain

Note 2: Margin (dB) = Emission level (dBuV/m) – Limit (dBuV/m).

<b>Modulation</b>	VHT40	<b>Test Freq. (MHz)</b>	5510
<b>Polarization</b>	Vertical		

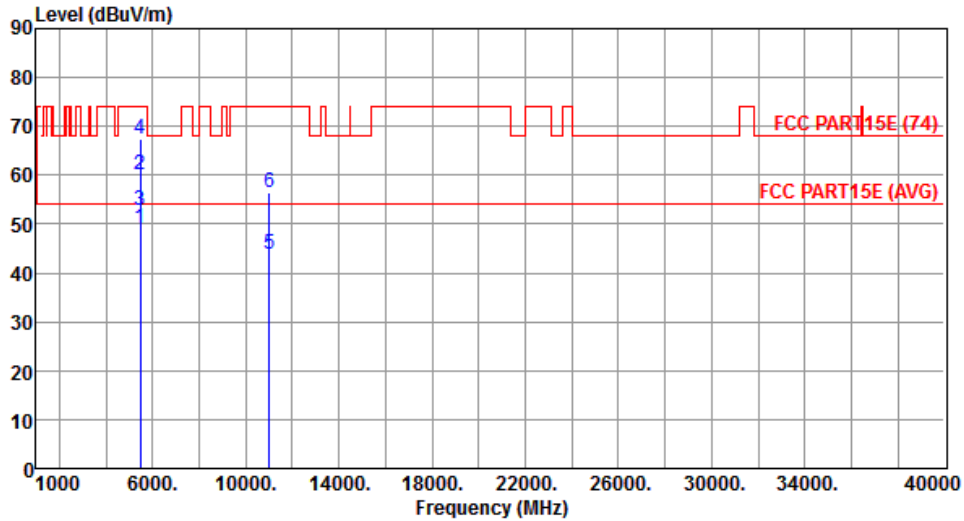

	Freq. MHz	Emission level dBuV/m	Limit dBuV/m	Margin dB	SA reading dBuV	Factor dB	Remark	ANT High cm	Turn Table deg
1	5460.00	49.00	54.00	-5.00	42.64	6.36	Average	100	222
2	5460.00	60.01	74.00	-13.99	53.65	6.36	Peak	100	222
3	5470.00	52.88	54.00	-1.12	46.51	6.37	Average	100	222
4	5470.00	67.58	74.00	-6.42	61.21	6.37	Peak	100	222
5	11020.00	43.87	54.00	-10.13	28.12	15.75	Average	100	172
6	11020.00	56.43	74.00	-17.57	40.68	15.75	Peak	100	172

Note 1: Emission Level (dBuV/m) = SA Reading (dBuV/m) + Factor\* (dB)

\*Factor includes antenna factor , cable loss and amplifier gain

Note 2: Margin (dB) = Emission level (dBuV/m) – Limit (dBuV/m).



<b>Modulation</b>	VHT40	<b>Test Freq. (MHz)</b>	5550
<b>Polarization</b>	Horizontal		

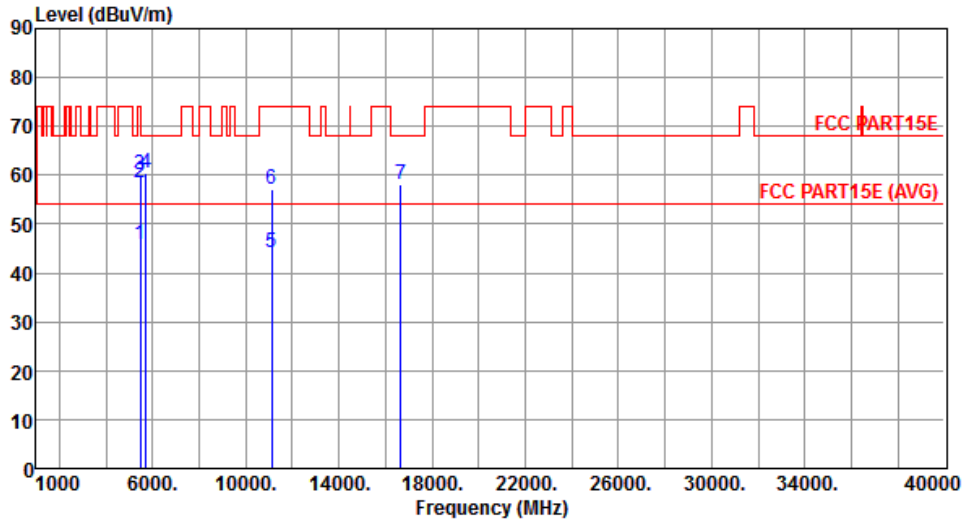

	Freq. MHz	Emission level dBuV/m	Limit dBuV/m	Margin dB	SA reading dBuV	Factor dB	Remark	ANT High cm	Turn Table deg
1	5460.00	45.89	54.00	-8.11	39.53	6.36	Average	100	286
2	5460.00	58.60	74.00	-15.40	52.24	6.36	Peak	100	286
3	5470.00	60.05	68.20	-8.15	53.68	6.37	Peak	100	286
4	5725.00	60.28	68.20	-7.92	53.45	6.83	Peak	100	286
5	11100.00	44.04	54.00	-9.96	28.24	15.80	Average	100	175
6	11100.00	57.18	74.00	-16.82	41.38	15.80	Peak	100	175
7	16650.00	58.05	68.20	-10.15	41.55	16.50	Peak	100	172

Note 1: Emission Level (dBuV/m) = SA Reading (dBuV/m) + Factor\* (dB)

\*Factor includes antenna factor , cable loss and amplifier gain

Note 2: Margin (dB) = Emission level (dBuV/m) – Limit (dBuV/m).

<b>Modulation</b>	VHT40	<b>Test Freq. (MHz)</b>	5550
<b>Polarization</b>	Vertical		

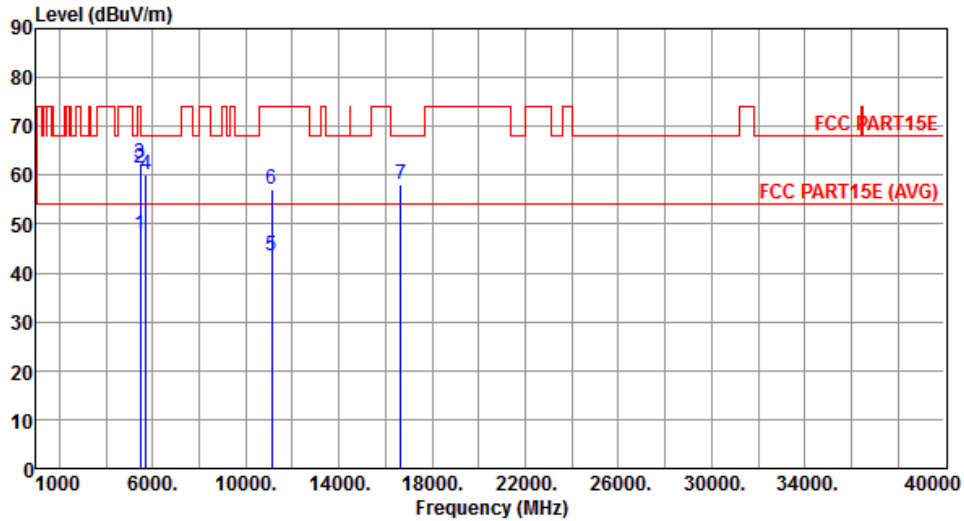

	Freq. MHz	Emission level dBUV/m	Limit dBUV/m	Margin dB	SA reading dBUV	Factor dB	Remark	ANT High cm	Turn Table deg
1	5460.00	47.81	54.00	-6.19	41.45	6.36	Average	153	320
2	5460.00	61.57	74.00	-12.43	55.21	6.36	Peak	153	320
3	5470.00	62.47	68.20	-5.73	56.10	6.37	Peak	153	320
4	5725.00	60.05	68.20	-8.15	53.22	6.83	Peak	153	320
5	11100.00	43.48	54.00	-10.52	27.68	15.80	Average	100	164
6	11100.00	57.18	74.00	-16.82	41.38	15.80	Peak	100	164
7	16650.00	58.19	68.20	-10.01	41.69	16.50	Peak	100	196

Note 1: Emission Level (dBUV/m) = SA Reading (dBUV/m) + Factor\* (dB)

\*Factor includes antenna factor , cable loss and amplifier gain

Note 2: Margin (dB) = Emission level (dBUV/m) – Limit (dBUV/m).

<b>Modulation</b>	VHT40	<b>Test Freq. (MHz)</b>	5670
<b>Polarization</b>	Horizontal		

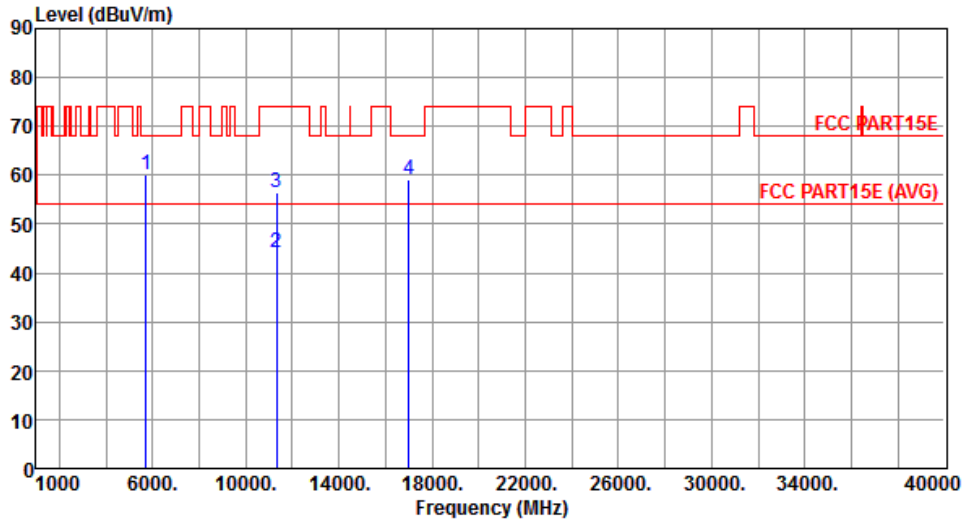

	Freq. MHz	Emission level dBuV/m	Limit dBuV/m	Margin dB	SA reading dBuV	Factor dB	Remark	ANT High cm	Turn Table deg
1	5725.00	60.05	68.20	-8.15	53.22	6.83	Peak	174	288
2	11340.00	44.17	54.00	-9.83	28.24	15.93	Average	100	156
3	11340.00	56.31	74.00	-17.69	40.38	15.93	Peak	100	156
4	17010.00	59.07	68.20	-9.13	41.42	17.65	Peak	100	141

Note 1: Emission Level (dBuV/m) = SA Reading (dBuV/m) + Factor\* (dB)

\*Factor includes antenna factor , cable loss and amplifier gain

Note 2: Margin (dB) = Emission level (dBuV/m) – Limit (dBuV/m).

<b>Modulation</b>	VHT40	<b>Test Freq. (MHz)</b>	5670
<b>Polarization</b>	Vertical		

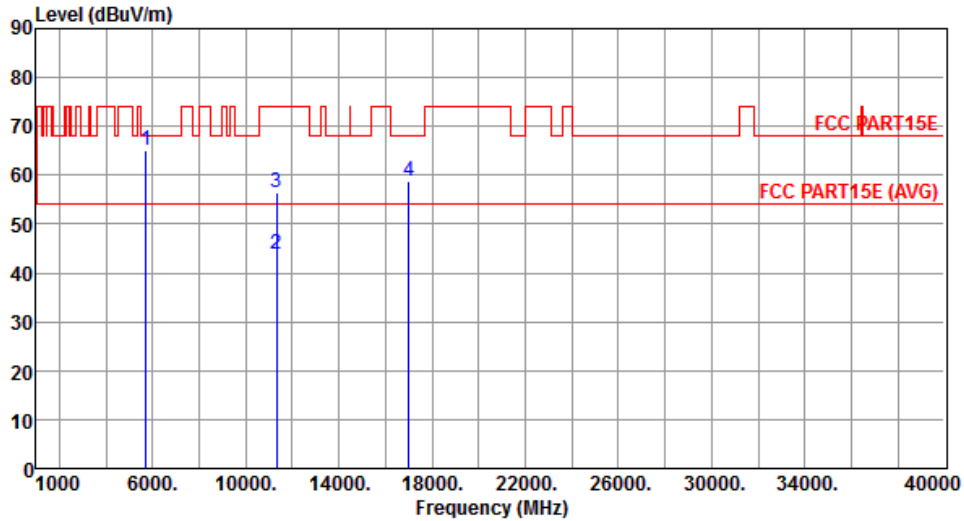

	Freq. MHz	Emission level dBuV/m	Limit dBuV/m	Margin dB	SA reading dBuV	Factor dB	Remark	ANT High cm	Turn Table deg
1	5725.00	65.15	68.20	-3.05	58.32	6.83	Peak	123	320
2	11340.00	43.74	54.00	-10.26	27.81	15.93	Average	100	153
3	11340.00	56.31	74.00	-17.69	40.38	15.93	Peak	100	153
4	17010.00	58.92	68.20	-9.28	41.27	17.65	Peak	100	168

Note 1: Emission Level (dBuV/m) = SA Reading (dBuV/m) + Factor\* (dB)

\*Factor includes antenna factor , cable loss and amplifier gain

Note 2: Margin (dB) = Emission level (dBuV/m) – Limit (dBuV/m).

<b>Modulation</b>	VHT40	<b>Test Freq. (MHz)</b>	5710
<b>Polarization</b>	Horizontal		

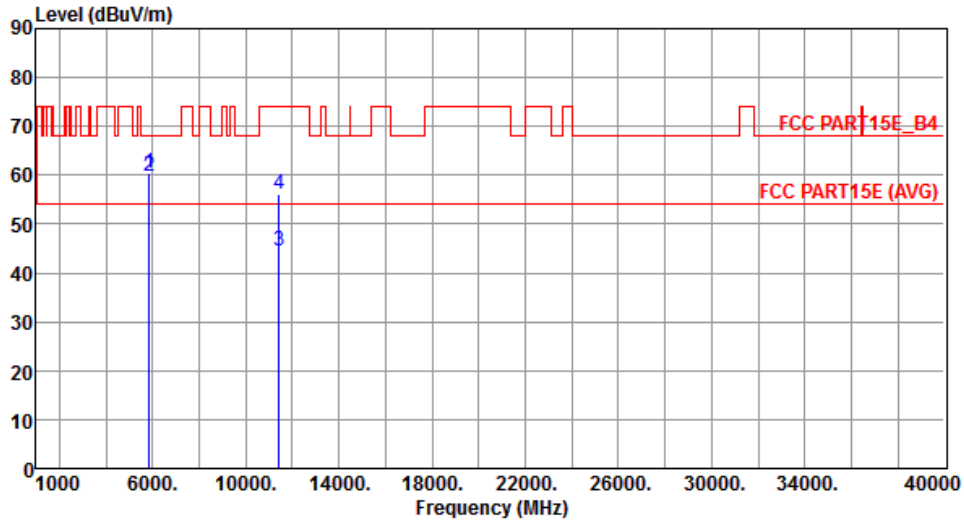

	Freq. MHz	Emission level dBuV/m	Limit dBuV/m	Margin dB	SA reading dBuV	Factor dB	Remark	ANT High cm	Turn Table deg
1	5850.00	60.31	78.20	-17.89	53.15	7.16	Peak	172	286
2	5860.00	59.87	68.20	-8.33	52.69	7.18	Peak	172	286
3	11420.00	44.52	54.00	-9.48	28.54	15.98	Average	100	152
4	11420.00	56.22	74.00	-17.78	40.24	15.98	Peak	100	152

Note 1: Emission Level (dBuV/m) = SA Reading (dBuV/m) + Factor\* (dB)

\*Factor includes antenna factor , cable loss and amplifier gain

Note 2: Margin (dB) = Emission level (dBuV/m) – Limit (dBuV/m).

<b>Modulation</b>	VHT40	<b>Test Freq. (MHz)</b>	5710
<b>Polarization</b>	Vertical		

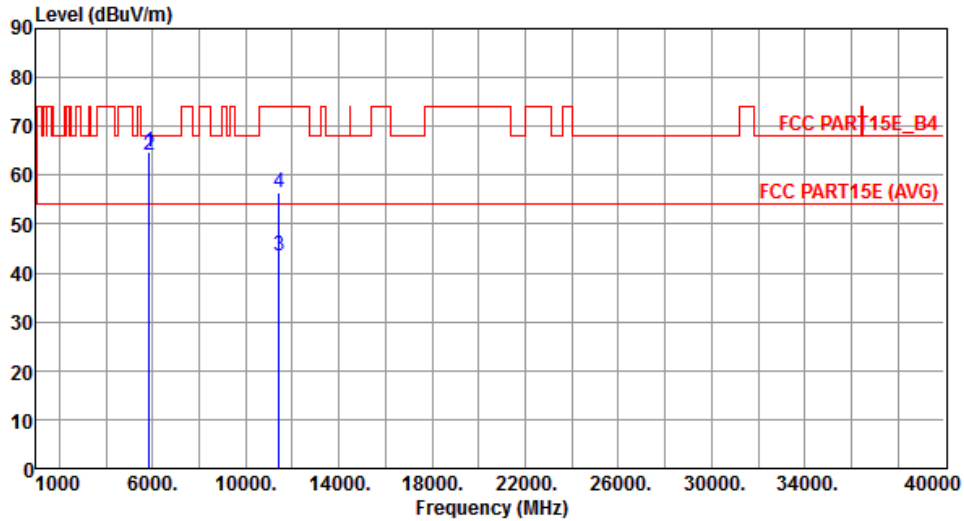

	Freq. MHz	Emission level dBuV/m	Limit dBuV/m	Margin dB	SA reading dBuV	Factor dB	Remark	ANT High cm	Turn Table deg
1	5850.00	64.72	78.20	-13.48	57.56	7.16	Peak	122	319
2	5860.00	64.01	68.20	-4.19	56.83	7.18	Peak	122	319
3	11420.00	43.66	54.00	-10.34	27.68	15.98	Average	100	151
4	11420.00	56.45	74.00	-17.55	40.47	15.98	Peak	100	151

Note 1: Emission Level (dBuV/m) = SA Reading (dBuV/m) + Factor\* (dB)

\*Factor includes antenna factor , cable loss and amplifier gain

Note 2: Margin (dB) = Emission level (dBuV/m) – Limit (dBuV/m).

<b>Modulation</b>	VHT40	<b>Test Freq. (MHz)</b>	5755
<b>Polarization</b>	Horizontal		

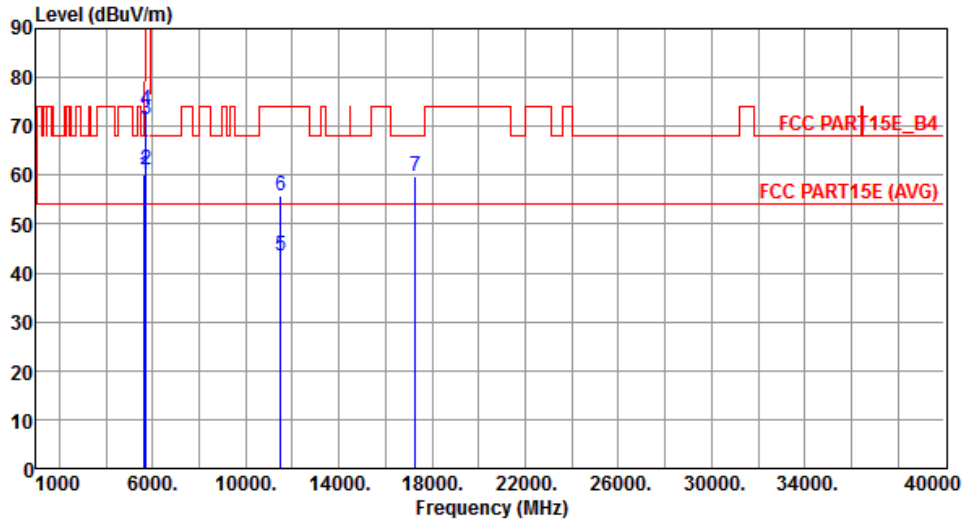

	Freq. MHz	Emission level dBuV/m	Limit dBuV/m	Margin dB	SA reading dBuV	Factor dB	Remark	ANT High cm	Turn Table deg
1	5650.00	59.96	68.20	-8.24	53.33	6.63	Peak	114	292
2	5700.00	61.15	105.20	-44.05	54.38	6.77	Peak	114	292
3	5720.00	71.35	110.80	-39.45	64.53	6.82	Peak	114	292
4	5725.00	73.56	122.20	-48.64	66.73	6.83	Peak	114	292
5	11510.00	43.52	54.00	-10.48	27.52	16.00	Average	193	42
6	11510.00	55.81	74.00	-18.19	39.81	16.00	Peak	193	42
7	17265.00	59.74	68.20	-8.46	41.23	18.51	Peak	196	53

Note 1: Emission Level (dBuV/m) = SA Reading (dBuV/m) + Factor\* (dB)

\*Factor includes antenna factor , cable loss and amplifier gain

Note 2: Margin (dB) = Emission level (dBuV/m) – Limit (dBuV/m).

<b>Modulation</b>	VHT40	<b>Test Freq. (MHz)</b>	5755
<b>Polarization</b>	Vertical		

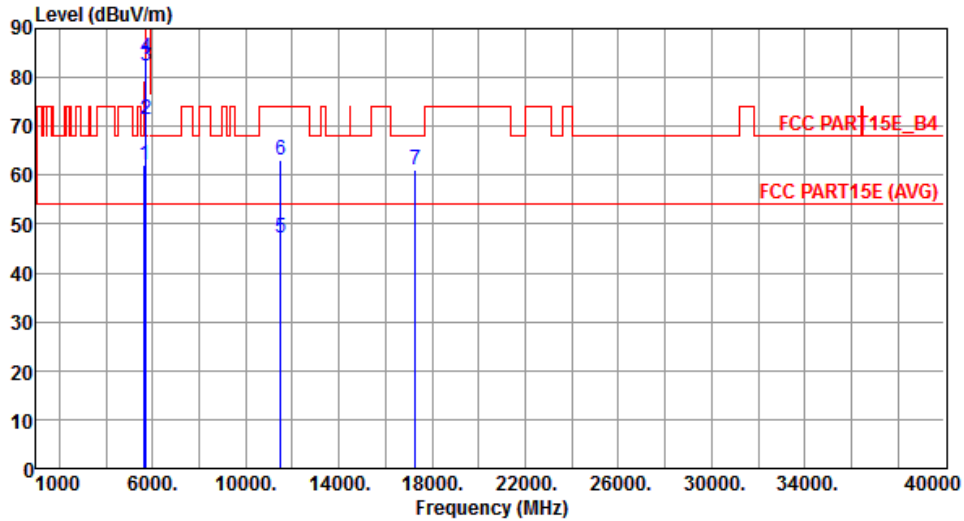

	Freq. MHz	Emission level dBuV/m	Limit dBuV/m	Margin dB	SA reading dBuV	Factor dB	Remark	ANT High cm	Turn Table deg
1	5650.00	62.12	68.20	-6.08	55.49	6.63	Peak	148	100
2	5700.00	71.34	105.20	-33.86	64.57	6.77	Peak	148	100
3	5720.00	82.26	110.80	-28.54	75.44	6.82	Peak	148	100
4	5725.00	84.15	122.20	-38.05	77.32	6.83	Peak	148	100
5	11510.00	47.21	54.00	-6.79	31.21	16.00	Average	131	98
6	11510.00	63.05	74.00	-10.95	47.05	16.00	Peak	131	98
7	17265.00	61.08	68.20	-7.12	42.57	18.51	Peak	135	102

Note 1: Emission Level (dBuV/m) = SA Reading (dBuV/m) + Factor\* (dB)

\*Factor includes antenna factor , cable loss and amplifier gain

Note 2: Margin (dB) = Emission level (dBuV/m) – Limit (dBuV/m).



<b>Modulation</b>	VHT40	<b>Test Freq. (MHz)</b>	5795
<b>Polarization</b>	Horizontal		

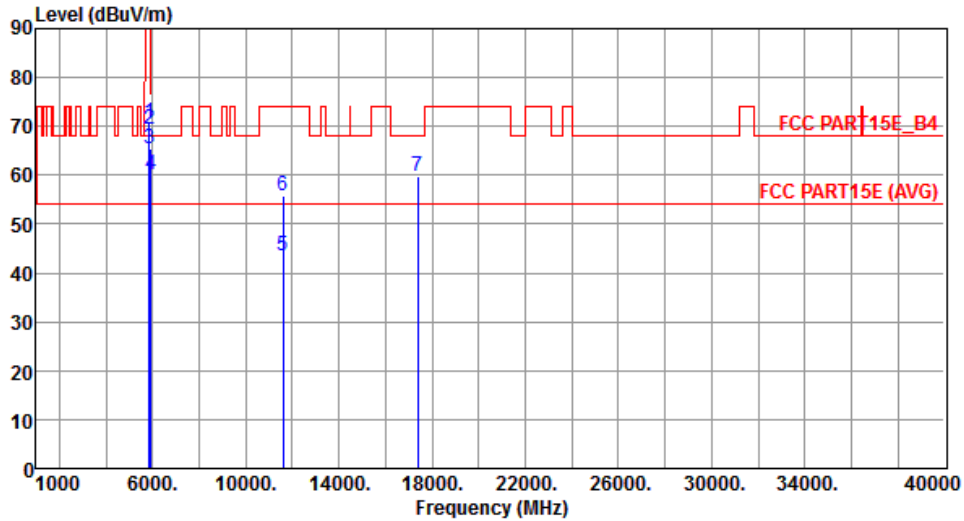

	Freq. MHz	Emission level dBuV/m	Limit dBuV/m	Margin dB	SA reading dBuV	Factor dB	Remark	ANT High cm	Turn Table deg
1	5850.00	70.69	122.20	-51.51	63.53	7.16	Peak	115	294
2	5855.00	69.41	110.80	-41.39	62.23	7.18	Peak	115	294
3	5875.00	65.38	105.20	-39.82	58.15	7.23	Peak	115	294
4	5925.00	60.18	68.20	-8.02	52.84	7.34	Peak	115	294
5	11590.00	43.42	54.00	-10.58	27.57	15.85	Average	198	56
6	11590.00	55.65	74.00	-18.35	39.80	15.85	Peak	198	56
7	17385.00	59.62	68.20	-8.58	40.69	18.93	Peak	205	56

Note 1: Emission Level (dBuV/m) = SA Reading (dBuV/m) + Factor\* (dB)

\*Factor includes antenna factor , cable loss and amplifier gain

Note 2: Margin (dB) = Emission level (dBuV/m) – Limit (dBuV/m).

<b>Modulation</b>	VHT40	<b>Test Freq. (MHz)</b>	5795
<b>Polarization</b>	Vertical		

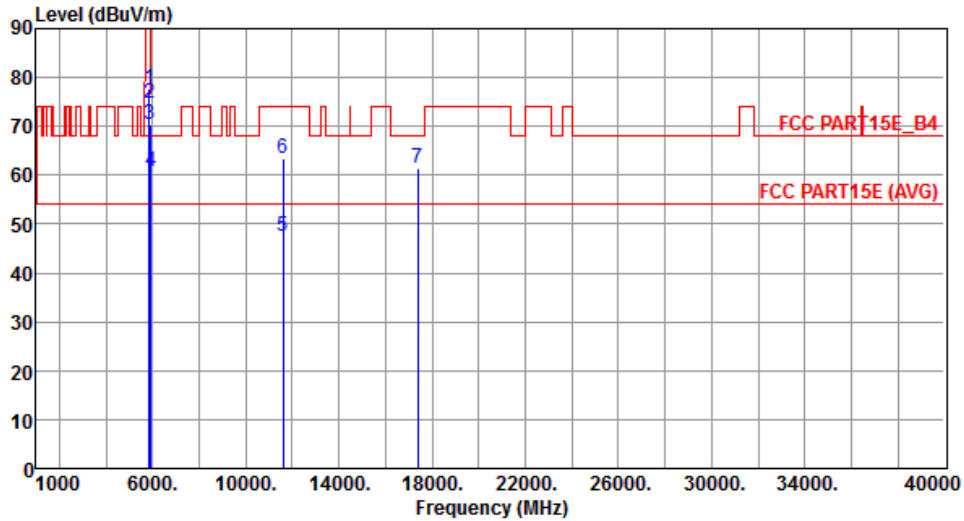

	Freq. MHz	Emission level dBuV/m	Limit dBuV/m	Margin dB	SA reading dBuV	Factor dB	Remark	ANT High cm	Turn Table deg
1	5850.00	77.64	122.20	-44.56	70.48	7.16	Peak	148	101
2	5855.00	74.80	110.80	-36.00	67.62	7.18	Peak	148	101
3	5875.00	70.53	105.20	-34.67	63.30	7.23	Peak	148	101
4	5925.00	60.64	68.20	-7.56	53.30	7.34	Peak	148	101
5	11590.00	47.56	54.00	-6.44	31.71	15.85	Average	135	110
6	11590.00	63.29	74.00	-10.71	47.44	15.85	Peak	135	110
7	17385.00	61.45	68.20	-6.75	42.52	18.93	Peak	129	103

Note 1: Emission Level (dBuV/m) = SA Reading (dBuV/m) + Factor\* (dB)

\*Factor includes antenna factor , cable loss and amplifier gain

Note 2: Margin (dB) = Emission level (dBuV/m) – Limit (dBuV/m).

### 3.5.8 Transmitter Radiated Unwanted Emissions (Above 1GHz) for VHT80

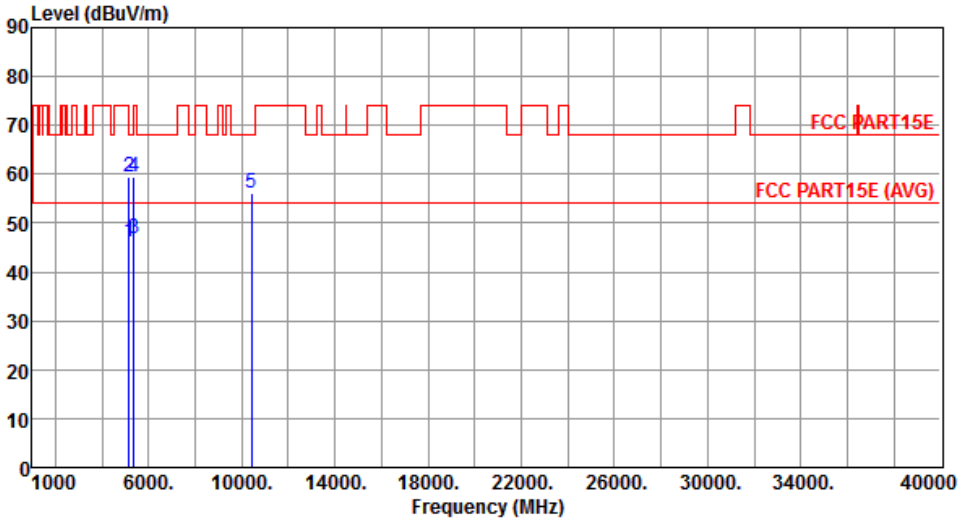
Modulation	VHT80	Test Freq. (MHz)	5210																																																																		
Polarization	Horizontal																																																																				
																																																																					
	<table border="1"> <thead> <tr> <th>Freq.</th> <th>Emission level</th> <th>Limit</th> <th>Margin</th> <th>SA reading</th> <th>Factor</th> <th>Remark</th> <th>ANT High</th> <th>Turn Table</th> </tr> <tr> <th>MHz</th> <th>dBuV/m</th> <th>dBuV/m</th> <th>dB</th> <th>dBuV</th> <th>dB</th> <th></th> <th>cm</th> <th>deg</th> </tr> </thead> <tbody> <tr> <td>1</td> <td>5150.00</td> <td>46.18</td> <td>54.00</td> <td>-7.82</td> <td>40.31</td> <td>5.87</td> <td>Average</td> <td>263</td> <td>279</td> </tr> <tr> <td>2</td> <td>5150.00</td> <td>59.31</td> <td>74.00</td> <td>-14.69</td> <td>53.44</td> <td>5.87</td> <td>Peak</td> <td>263</td> <td>279</td> </tr> <tr> <td>3</td> <td>5350.00</td> <td>46.78</td> <td>54.00</td> <td>-7.22</td> <td>40.57</td> <td>6.21</td> <td>Average</td> <td>263</td> <td>279</td> </tr> <tr> <td>4</td> <td>5350.00</td> <td>59.50</td> <td>74.00</td> <td>-14.50</td> <td>53.29</td> <td>6.21</td> <td>Peak</td> <td>263</td> <td>279</td> </tr> <tr> <td>5</td> <td>10420.00</td> <td>56.02</td> <td>68.20</td> <td>-12.18</td> <td>40.72</td> <td>15.30</td> <td>Peak</td> <td>166</td> <td>214</td> </tr> </tbody> </table>	Freq.	Emission level	Limit	Margin	SA reading	Factor	Remark	ANT High	Turn Table	MHz	dBuV/m	dBuV/m	dB	dBuV	dB		cm	deg	1	5150.00	46.18	54.00	-7.82	40.31	5.87	Average	263	279	2	5150.00	59.31	74.00	-14.69	53.44	5.87	Peak	263	279	3	5350.00	46.78	54.00	-7.22	40.57	6.21	Average	263	279	4	5350.00	59.50	74.00	-14.50	53.29	6.21	Peak	263	279	5	10420.00	56.02	68.20	-12.18	40.72	15.30	Peak	166	214
Freq.	Emission level	Limit	Margin	SA reading	Factor	Remark	ANT High	Turn Table																																																													
MHz	dBuV/m	dBuV/m	dB	dBuV	dB		cm	deg																																																													
1	5150.00	46.18	54.00	-7.82	40.31	5.87	Average	263	279																																																												
2	5150.00	59.31	74.00	-14.69	53.44	5.87	Peak	263	279																																																												
3	5350.00	46.78	54.00	-7.22	40.57	6.21	Average	263	279																																																												
4	5350.00	59.50	74.00	-14.50	53.29	6.21	Peak	263	279																																																												
5	10420.00	56.02	68.20	-12.18	40.72	15.30	Peak	166	214																																																												
<p>Note 1: Emission Level (dBuV/m) = SA Reading (dBuV/m) + Factor* (dB)            *Factor includes antenna factor , cable loss and amplifier gain            Note 2: Margin (dB) = Emission level (dBuV/m) – Limit (dBuV/m).</p>																																																																					

<b>Modulation</b>	VHT80	<b>Test Freq. (MHz)</b>	5210
<b>Polarization</b>	Vertical		

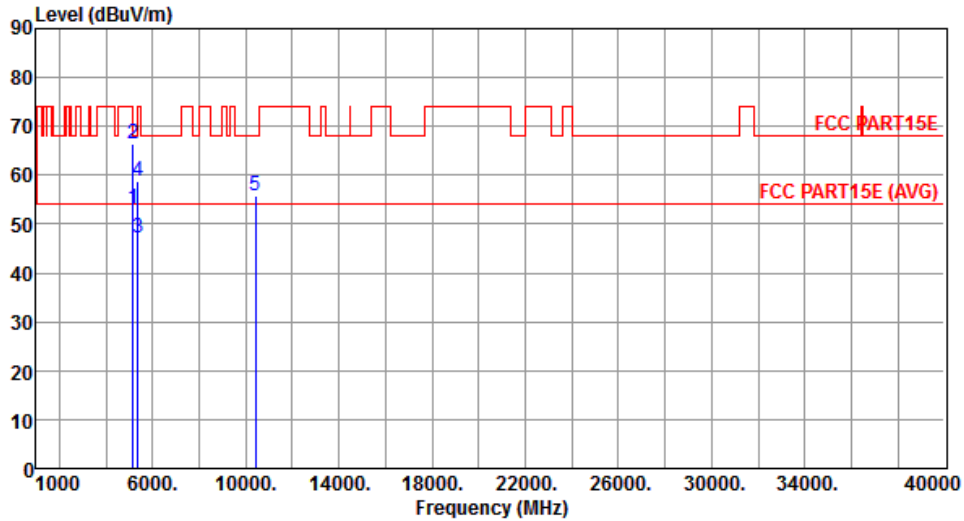

	Freq. MHz	Emission level dBuV/m	Limit dBuV/m	Margin dB	SA reading dBuV	Factor dB	Remark	ANT High cm	Turn Table deg
1	5150.00	52.99	54.00	-1.01	47.12	5.87	Average	251	253
2	5150.00	66.53	74.00	-7.47	60.66	5.87	Peak	251	253
3	5350.00	47.06	54.00	-6.94	40.85	6.21	Average	251	253
4	5350.00	58.91	74.00	-15.09	52.70	6.21	Peak	251	253
5	10420.00	55.83	68.20	-12.37	40.53	15.30	Peak	166	172

Note 1: Emission Level (dBuV/m) = SA Reading (dBuV/m) + Factor\* (dB)

\*Factor includes antenna factor , cable loss and amplifier gain

Note 2: Margin (dB) = Emission level (dBuV/m) – Limit (dBuV/m).

<b>Modulation</b>	VHT80	<b>Test Freq. (MHz)</b>	5290
<b>Polarization</b>	Horizontal		

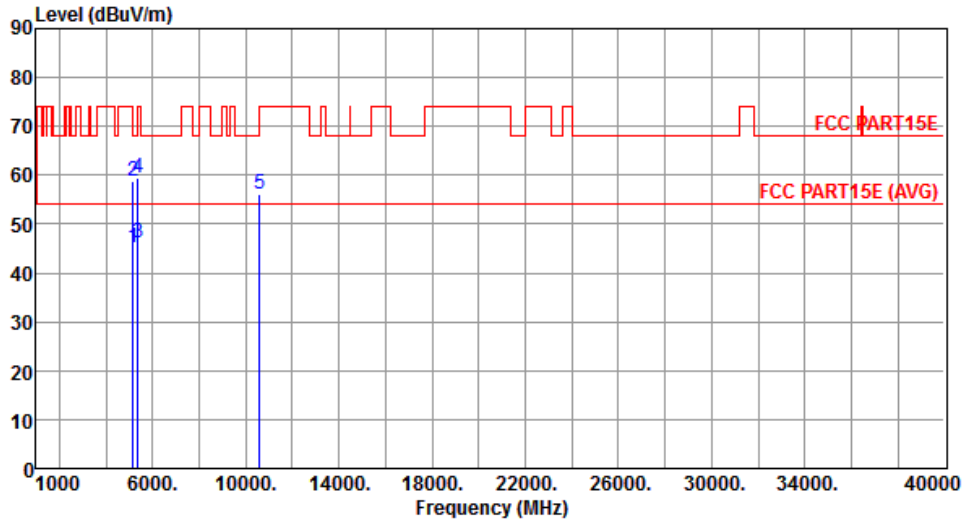

	Freq. MHz	Emission level dBuV/m	Limit dBuV/m	Margin dB	SA reading dBuV	Factor dB	Remark	ANT High cm	Turn Table deg
1	5150.00	45.02	54.00	-8.98	39.15	5.87	Average	100	313
2	5150.00	58.64	74.00	-15.36	52.77	5.87	Peak	100	313
3	5350.00	46.24	54.00	-7.76	40.03	6.21	Average	100	313
4	5350.00	59.43	74.00	-14.57	53.22	6.21	Peak	100	313
5	10580.00	56.00	68.20	-12.20	40.56	15.44	Peak	100	149

Note 1: Emission Level (dBuV/m) = SA Reading (dBuV/m) + Factor\* (dB)

\*Factor includes antenna factor , cable loss and amplifier gain

Note 2: Margin (dB) = Emission level (dBuV/m) – Limit (dBuV/m).

<b>Modulation</b>	VHT80	<b>Test Freq. (MHz)</b>	5290
<b>Polarization</b>	Vertical		

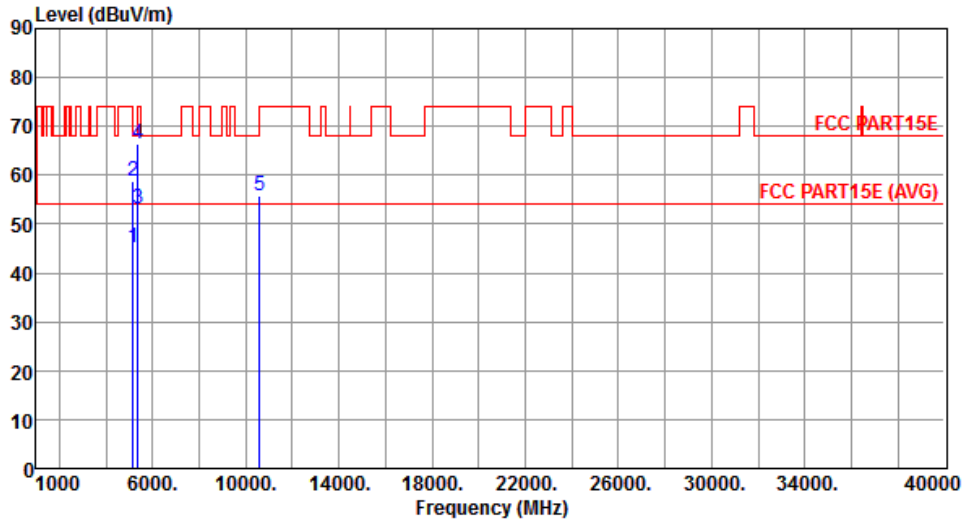

	Freq. MHz	Emission level dBuV/m	Limit dBuV/m	Margin dB	SA reading dBuV	Factor dB	Remark	ANT High cm	Turn Table deg
1	5150.00	45.08	54.00	-8.92	39.21	5.87	Average	152	306
2	5150.00	58.62	74.00	-15.38	52.75	5.87	Peak	152	306
3	5350.00	53.00	54.00	-1.00	46.79	6.21	Average	152	306
4	5350.00	66.46	74.00	-7.54	60.25	6.21	Peak	152	306
5	10580.00	55.92	68.20	-12.28	40.48	15.44	Peak	100	163

Note 1: Emission Level (dBuV/m) = SA Reading (dBuV/m) + Factor\* (dB)

\*Factor includes antenna factor , cable loss and amplifier gain

Note 2: Margin (dB) = Emission level (dBuV/m) – Limit (dBuV/m).

<b>Modulation</b>	VHT80	<b>Test Freq. (MHz)</b>	5530
<b>Polarization</b>	Horizontal		

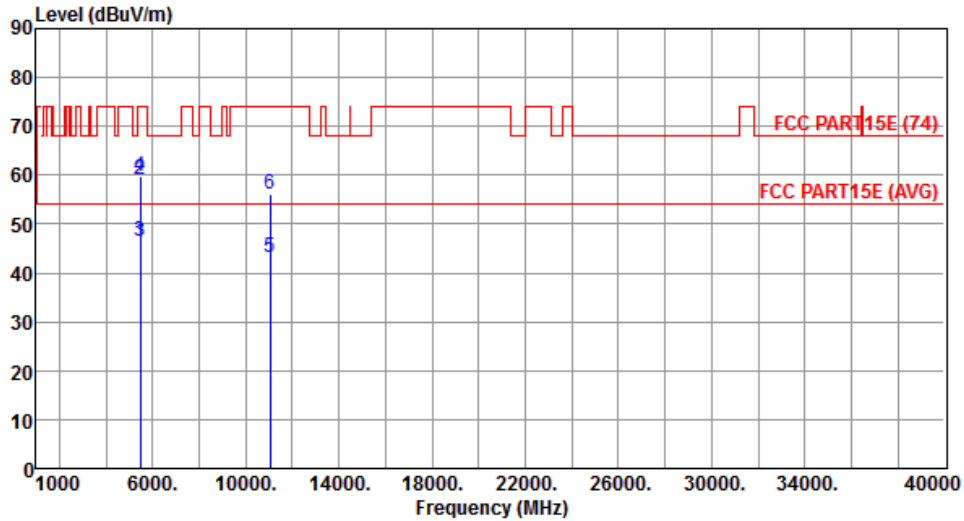

	Freq. MHz	Emission level dBuV/m	Limit dBuV/m	Margin dB	SA reading dBuV	Factor dB	Remark	ANT High cm	Turn Table deg
1	5460.00	46.19	54.00	-7.81	39.83	6.36	Average	121	287
2	5460.00	59.11	74.00	-14.89	52.75	6.36	Peak	121	287
3	5470.00	46.42	54.00	-7.58	40.05	6.37	Average	121	287
4	5470.00	59.72	74.00	-14.28	53.35	6.37	Peak	121	287
5	11060.00	43.31	54.00	-10.69	27.54	15.77	Average	100	152
6	11060.00	56.07	74.00	-17.93	40.30	15.77	Peak	100	152

Note 1: Emission Level (dBuV/m) = SA Reading (dBuV/m) + Factor\* (dB)

\*Factor includes antenna factor , cable loss and amplifier gain

Note 2: Margin (dB) = Emission level (dBuV/m) – Limit (dBuV/m).

<b>Modulation</b>	VHT80	<b>Test Freq. (MHz)</b>	5530
<b>Polarization</b>	Vertical		

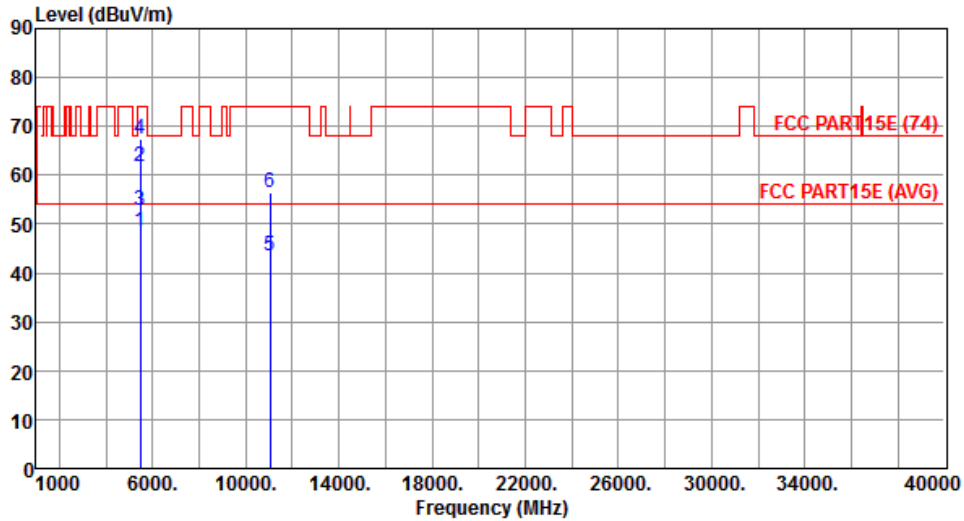

	Freq. MHz	Emission level dBuV/m	Limit dBuV/m	Margin dB	SA reading dBuV	Factor dB	Remark	ANT High cm	Turn Table deg
1	5460.00	48.63	54.00	-5.37	42.27	6.36	Average	141	321
2	5460.00	61.90	74.00	-12.10	55.54	6.36	Peak	141	321
3	5470.00	52.92	54.00	-1.08	46.55	6.37	Average	141	321
4	5470.00	67.39	74.00	-6.61	61.02	6.37	Peak	141	321
5	11060.00	43.45	54.00	-10.55	27.68	15.77	Average	100	185
6	11060.00	56.52	74.00	-17.48	40.75	15.77	Peak	100	185

Note 1: Emission Level (dBuV/m) = SA Reading (dBuV/m) + Factor\* (dB)

\*Factor includes antenna factor , cable loss and amplifier gain

Note 2: Margin (dB) = Emission level (dBuV/m) – Limit (dBuV/m).



<b>Modulation</b>	VHT80	<b>Test Freq. (MHz)</b>	5690
<b>Polarization</b>	Horizontal		

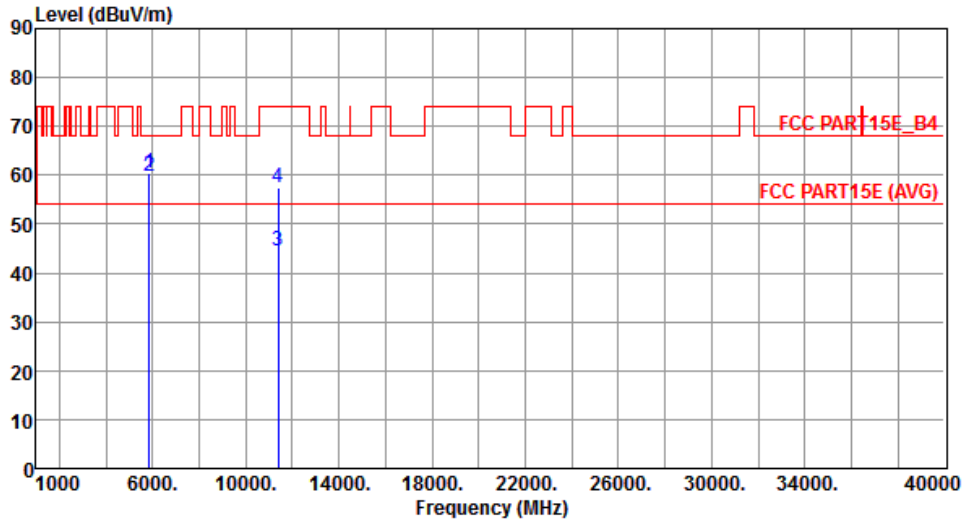

	Freq. MHz	Emission level dBuV/m	Limit dBuV/m	Margin dB	SA reading dBuV	Factor dB	Remark	ANT High cm	Turn Table deg
1	5850.00	60.51	78.20	-17.69	53.35	7.16	Peak	120	286
2	5860.00	59.87	68.20	-8.33	52.69	7.18	Peak	120	286
3	11380.00	44.39	54.00	-9.61	28.44	15.95	Average	100	150
4	11380.00	57.33	74.00	-16.67	41.38	15.95	Peak	100	150

Note 1: Emission Level (dBuV/m) = SA Reading (dBuV/m) + Factor\* (dB)

\*Factor includes antenna factor , cable loss and amplifier gain

Note 2: Margin (dB) = Emission level (dBuV/m) – Limit (dBuV/m).

<b>Modulation</b>	VHT80	<b>Test Freq. (MHz)</b>	5690
<b>Polarization</b>	Vertical		

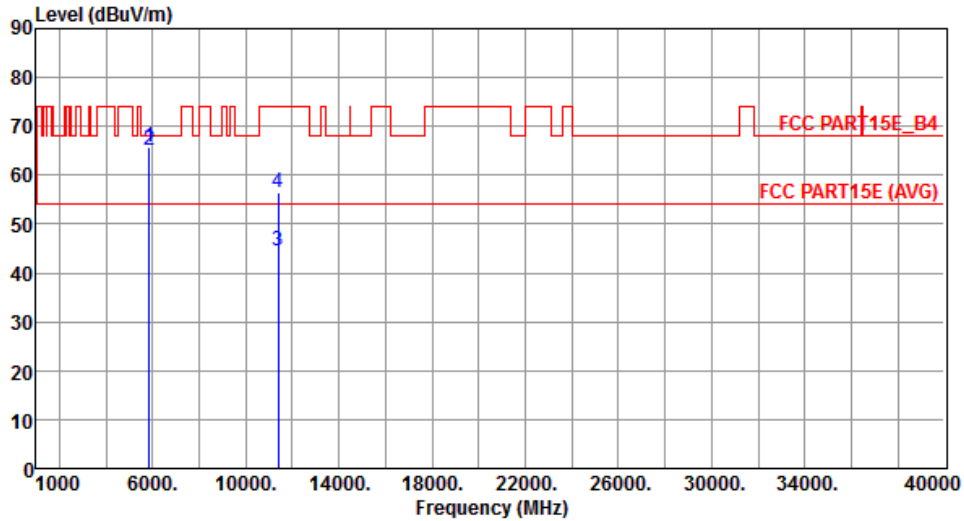

	Freq. MHz	Emission level dBuV/m	Limit dBuV/m	Margin dB	SA reading dBuV	Factor dB	Remark	ANT High cm	Turn Table deg
1	5850.00	65.78	78.20	-12.42	58.62	7.16	Peak	140	320
2	5860.00	65.15	68.20	-3.05	57.97	7.18	Peak	140	320
3	11380.00	44.39	54.00	-9.61	28.44	15.95	Average	100	183
4	11380.00	56.29	74.00	-17.71	40.34	15.95	Peak	100	183

Note 1: Emission Level (dBuV/m) = SA Reading (dBuV/m) + Factor\* (dB)

\*Factor includes antenna factor , cable loss and amplifier gain

Note 2: Margin (dB) = Emission level (dBuV/m) – Limit (dBuV/m).

<b>Modulation</b>	VHT80	<b>Test Freq. (MHz)</b>	5775
<b>Polarization</b>	Horizontal		

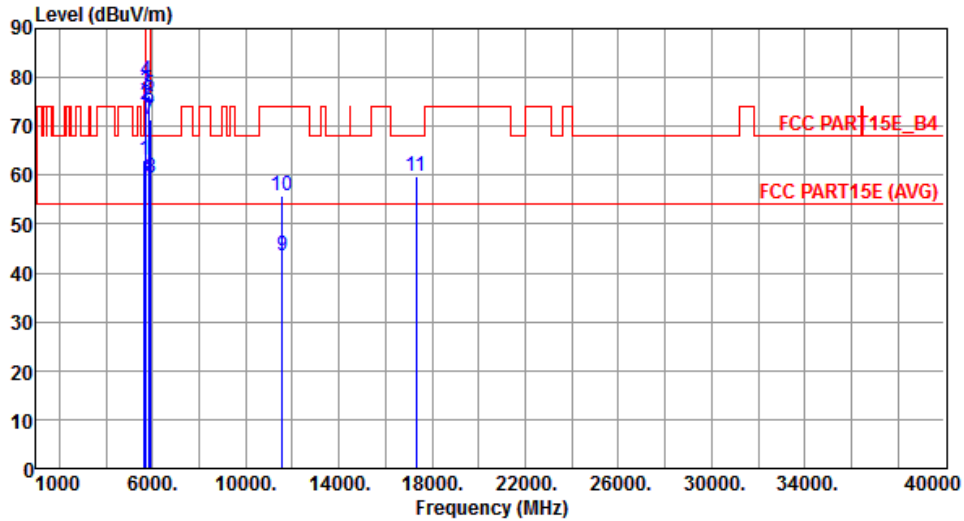

	Freq. MHz	Emission level dBuV/m	Limit dBuV/m	Margin dB	SA reading dBuV	Factor dB	Remark	ANT High cm	Turn Table deg
1	5650.00	63.25	68.20	-4.95	56.62	6.63	Peak	111	294
2	5700.00	74.33	105.20	-30.87	67.56	6.77	Peak	111	294
3	5720.00	77.13	110.80	-33.67	70.31	6.82	Peak	111	294
4	5725.00	79.48	122.20	-42.72	72.65	6.83	Peak	111	294
5	5850.00	76.51	122.20	-45.69	69.35	7.16	Peak	111	294
6	5855.00	73.78	110.80	-37.02	66.60	7.18	Peak	111	294
7	5875.00	71.43	105.20	-33.77	64.20	7.23	Peak	111	294
8	5925.00	59.41	68.20	-8.79	52.07	7.34	Peak	111	294
9	11550.00	43.39	54.00	-10.61	27.46	15.93	Average	196	42
10	11550.00	55.68	74.00	-18.32	39.75	15.93	Peak	196	42
11	17325.00	59.62	68.20	-8.58	40.90	18.72	Peak	204	51

Note 1: Emission Level (dBuV/m) = SA Reading (dBuV/m) + Factor\* (dB)

\*Factor includes antenna factor , cable loss and amplifier gain

Note 2: Margin (dB) = Emission level (dBuV/m) – Limit (dBuV/m).

<b>Modulation</b>	VHT80	<b>Test Freq. (MHz)</b>	5775
<b>Polarization</b>	Vertical		

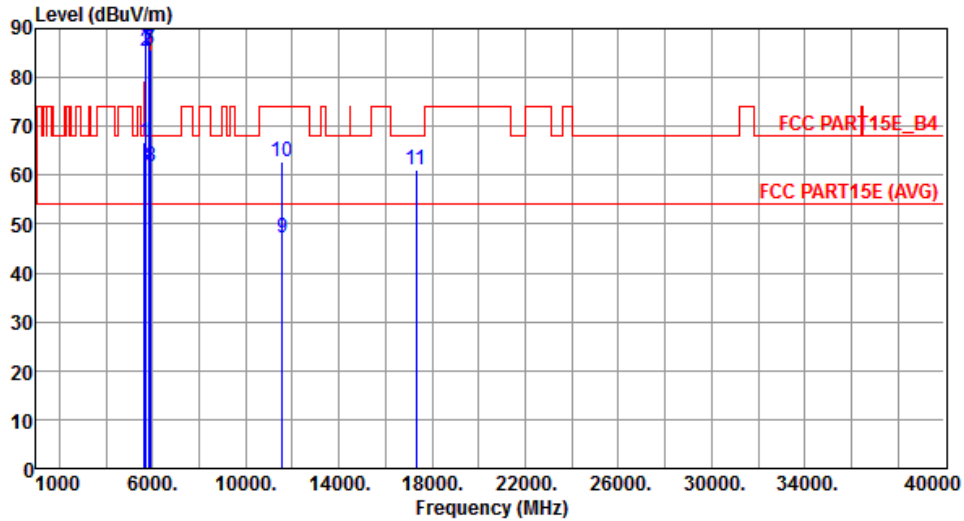

	Freq. MHz	Emission level dBuV/m	Limit dBuV/m	Margin dB	SA reading dBuV	Factor dB	Remark	ANT High cm	Turn Table deg
1	5650.00	66.82	68.20	-1.38	60.19	6.63	Peak	150	102
2	5700.00	85.30	105.20	-19.90	78.53	6.77	Peak	150	102
3	5720.00	88.26	110.80	-22.54	81.44	6.82	Peak	150	102
4	5725.00	90.50	122.20	-31.70	83.67	6.83	Peak	150	102
5	5850.00	87.75	122.20	-34.45	80.59	7.16	Peak	150	102
6	5855.00	85.68	110.80	-25.12	78.50	7.18	Peak	150	102
7	5875.00	85.63	105.20	-19.57	78.40	7.23	Peak	150	102
8	5925.00	61.72	68.20	-6.48	54.38	7.34	Peak	150	102
9	11550.00	47.15	54.00	-6.85	31.22	15.93	Average	135	106
10	11550.00	62.86	74.00	-11.14	46.93	15.93	Peak	135	106
11	17325.00	61.27	68.20	-6.93	42.55	18.72	Peak	131	95

Note 1: Emission Level (dBuV/m) = SA Reading (dBuV/m) + Factor\* (dB)

\*Factor includes antenna factor , cable loss and amplifier gain

Note 2: Margin (dB) = Emission level (dBuV/m) – Limit (dBuV/m).

## 3.6 Frequency Stability

### 3.6.1 Limit of Frequency Stability

Manufacturers of U-NII devices are responsible for ensuring frequency stability such that an emission is maintained within the band of operation under all conditions of normal operation as specified in the user's manual.

### 3.6.2 Test Procedures

1. The EUT is installed in an environment test chamber with external power source.
2. Set the chamber to operate at 55 centigrade and external power source to output at nominal voltage of EUT.
3. A sufficient stabilization period at each temperature is used prior to each frequency measurement.
4. When temperature is stabled, measure the frequency stability.
5. The test shall be performed under -30 to 55 centigrade and 85 to 115 percent of the nominal voltage. Change setting of chamber and external power source to complete all conditions.

### 3.6.3 Test Setup

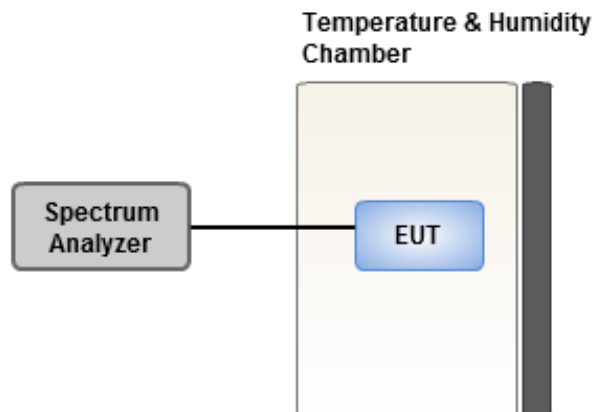

### 3.6.4 Test Result of Frequency Stability

Frequency: 5320 MHz	Frequency Drift (ppm)			
Temperature (°C)	0 minute	2 minutes	5 minutes	10 minutes
T20°C Vmax	0.05	-0.39	0.40	0.02
T20°C Vmin	0.19	0.57	0.91	0.47
T55°C Vnom	1.38	1.21	1.63	1.27
T50°C Vnom	0.56	1.20	0.51	0.61
T40°C Vnom	0.46	0.34	0.45	0.48
T30°C Vnom	0.33	0.77	0.31	0.30
T20°C Vnom	0.42	0.49	0.59	0.89
T10°C Vnom	-0.17	0.05	0.10	0.27
T0°C Vnom	0.30	0.34	0.13	0.57
T-10°C Vnom	0.77	1.44	0.34	1.21
T-20°C Vnom	-0.20	0.56	0.32	0.12
T-30°C Vnom	0.12	0.39	-0.14	-0.08
Vnom [Vac]: 120	Vmax [Vac]: 138		Vmin [Vac]: 102	
Tnom [°C]: 20	Tmax [°C]: 55		Tmin [°C]: -30	

Frequency: 5785 MHz	Frequency Drift (ppm)			
Temperature (°C)	0 minute	2 minutes	5 minutes	10 minutes
T20°C Vmax	-0.11	-0.22	0.22	0.16
T20°C Vmin	0.43	0.71	0.79	0.36
T55°C Vnom	0.08	0.15	0.36	-0.25
T50°C Vnom	0.31	0.58	0.39	0.39
T40°C Vnom	0.44	0.00	0.02	0.39
T30°C Vnom	0.85	1.02	1.13	0.87
T20°C Vnom	0.10	0.27	0.42	-0.06
T10°C Vnom	0.03	0.75	0.63	0.51
T0°C Vnom	0.29	0.26	0.15	0.68
T-10°C Vnom	0.27	0.67	0.87	0.04
T-20°C Vnom	-0.20	0.14	-0.14	-0.01
T-30°C Vnom	0.23	0.46	0.63	0.66
Vnom [Vac]: 120	Vmax [Vac]: 138		Vmin [Vac]: 102	
Tnom [°C]: 20	Tmax [°C]: 55		Tmin [°C]: -30	

## 4 Test laboratory information

Established in 2012, ICC provides foremost EMC & RF Testing and advisory consultation services by our skilled engineers and technicians. Our services employ a wide variety of advanced edge test equipment and one of the widest certification extents in the business.

International Certification Corp (EMC and Wireless Communication Laboratory), it is our definitive objective is to institute long term, trust-based associations with our clients. The expectation we set up with our clients is based on outstanding service, practical expertise and devotion to a certified value structure. Our passion is to grant our clients with best EMC / RF services by oriented knowledgeable and accommodating staff.

Our Test sites are located at Linkou District and Kwei Shan District. Location map can be found on our website <http://www.icertifi.com.tw>.

### **Linkou**

Tel: 886-2-2601-1640

No. 30-2, Ding Fwu Tsuen, Lin  
Kou District, New Taipei City,  
Taiwan, R.O.C.

### **Kwei Shan**

Tel: 886-3-271-8666

No. 3-1, Lane 6, Wen San 3rd St.,  
Kwei Shan District, Tao Yuan City  
333, Taiwan, R.O.C.

### **Kwei Shan Site II**

Tel: 886-3-271-8640

No. 14-1, Lane 19, Wen San 3rd  
St., Kwei Shan District, Tao Yuan  
City 333, Taiwan, R.O.C.

If you have any suggestion, please feel free to contact us as below information.

Tel: 886-3-271-8666

Fax: 886-3-318-0155

Email: ICC\_Service@icertifi.com.tw

==END==