

FCC Test Report

FCC ID : U6Y-M120000015
Equipment : IEEE 802.11A/B/G/N/AC DUAL 3T3R WIFI PCIE
Model No. : M120000015
Brand Name : Panasonic
Applicant : Panasonic Avionics Corporation
Address : 26200 ENTERPRISE WAY, LAKE FOREST, CA
92630-8400 USA
Standard : 47 CFR FCC Part 15.247
Received Date : Nov. 28, 2016
Tested Date : Dec. 02 ~ Dec. 15, 2016

We, International Certification Corp., would like to declare that the tested sample has been evaluated and in compliance with the requirement of the above standards. The test results contained in this report refer exclusively to the product. It may be duplicated completely for legal use with the approval of the applicant. It shall not be reproduced except in full without the written approval of our laboratory.

Reviewed by:

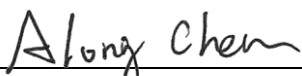

Along Chen / Assistant Manager

Approved by:



Gary Chang / Manager



Table of Contents

1	GENERAL DESCRIPTION	5
1.1	Information.....	5
1.2	Local Support Equipment List	8
1.3	Test Setup Chart	8
1.4	The Equipment List	9
1.5	Test Standards	10
1.6	Measurement Uncertainty	10
2	TEST CONFIGURATION	11
2.1	Testing Condition	11
2.2	The Worst Test Modes and Channel Details	11
3	TRANSMITTER TEST RESULTS.....	12
3.1	Conducted Emissions.....	12
3.2	6dB and Occupied Bandwidth	15
3.3	RF Output Power	18
3.4	Power Spectral Density	20
3.5	Unwanted Emissions into Restricted Frequency Bands	22
3.6	Emissions in Non-Restricted Frequency Bands	50
4	TEST LABORATORY INFORMATION	63

Release Record

Report No.	Version	Description	Issued Date
FR6N2801AC	Rev. 01	Initial issue	Apr. 06, 2017

Summary of Test Results

FCC Rules	Test Items	Measured	Result
15.207	Conducted Emissions	[dBuV]: 0.481MHz 30.86 (Margin -15.46dB) - AV	Pass
15.247(d) 15.209	Radiated Emissions	[dBuV/m at 3m]: 4874.00MHz 52.99 (Margin -1.01dB) - AV	Pass
15.247(b)(3)	Maximum Output Power	Max Power [dBm]: 29.01	Pass
15.247(a)(2)	6dB Bandwidth	Meet the requirement of limit	Pass
15.247(e)	Power Spectral Density	Meet the requirement of limit	Pass
15.203	Antenna Requirement	Meet the requirement of limit	Pass

1 General Description

1.1 Information

1.1.1 Specification of the Equipment under Test (EUT)

RF General Information					
Frequency Range (MHz)	IEEE Std. 802.11	Ch. Freq. (MHz)	Channel Number	Transmit Chains (N _{TX})	Data Rate / MCS
2400-2483.5	b	2412-2462	1-11 [11]	3	1-11 Mbps
2400-2483.5	g	2412-2462	1-11 [11]	3	6-54 Mbps
2400-2483.5	n (HT20)	2412-2462	1-11 [11]	3	MCS 0-15
2400-2483.5	n (HT40)	2422-2452	3-9 [7]	3	MCS 0-15

Note 1: RF output power specifies that Maximum Peak Conducted Output Power.
 Note 2: 802.11b uses a combination of DSSS-DBPSK, DQPSK, CCK modulation.
 Note 3: 802.11g/n uses a combination of OFDM-BPSK, QPSK, 16QAM, 64QAM modulation.

1.1.2 Antenna Details

Ant. No.	Model	Type	Connector	Operating Frequencies (MHz) / Antenna Gain (dBi)		
				2400~2483.5	5150~5250	5725~5850
1	RD-NB2573-PULSE SN11	Dipole	R-SMA	3	5	5
2	RD-NB2573-PULSE SN02	Dipole	R-SMA	3	5	5
3	RD-NB2573-PULSE SN03	Dipole	R-SMA	3	5	5

1.1.3 Power Supply Type of Equipment under Test (EUT)

Power Supply Type	3.3Vdc from host
--------------------------	------------------

1.1.4 Accessories

N/A

1.1.5 Channel List

Frequency band (MHz)		2400~2483.5	
802.11 b / g / n HT20		802.11n HT40	
Channel	Frequency(MHz)	Channel	Frequency(MHz)
1	2412	3	2422
2	2417	4	2427
3	2422	5	2432
4	2427	6	2437
5	2432	7	2442
6	2437	8	2447
7	2442	9	2452
8	2447	---	---
9	2452	---	---
10	2457	---	---
11	2462	---	---

1.1.6 Test Tool and Duty Cycle

Test Tool	ART2, Version: 4.9.802.1		
Duty Cycle and Duty Factor	Mode	Duty cycle (%)	Duty factor (dB)
	11b	100.00%	0.00
	11g	98.62%	0.06
	HT20	98.52%	0.06
	HT40	95.66%	0.19

1.1.7 Power Setting

Modulation Mode	Test Frequency (MHz)	Power Set
11b	2412	16
11b	2437	14
11b	2462	13
11g	2412	15.5
11g	2437	19.5
11g	2462	16
HT20	2412	15.5
HT20	2437	20
HT20	2462	15.5
HT40	2422	9
HT40	2437	16
HT40	2452	9.5

1.2 Local Support Equipment List

Support Equipment List					
No.	Equipment	Brand	Model	FCC ID	Signal cable / Length (m)
1	Notebook	Latitude E6430	9ZFB4X1	DoC	---
2	DC Power Supply	GWINSTEK	GPC-3060D	---	---
3	Extension Card	---	---	---	---

1.3 Test Setup Chart

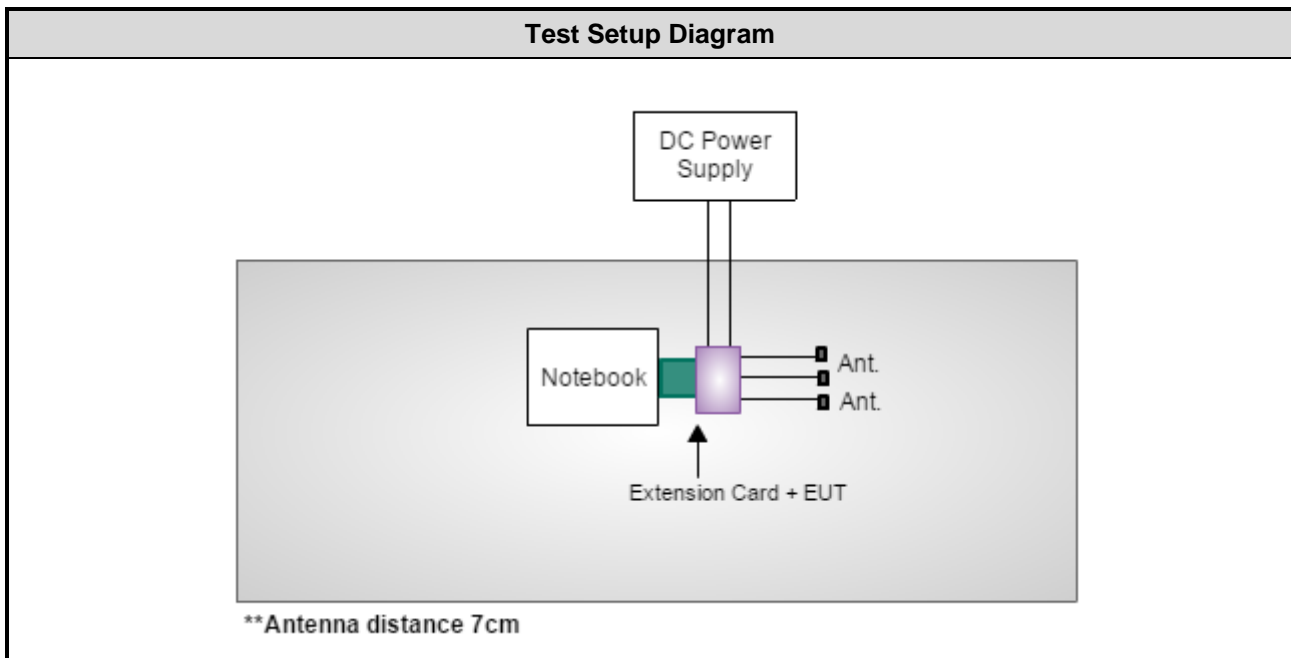

1.4 The Equipment List

Test Item	Conducted Emission				
Test Site	Conduction room 1 / (CO01-WS)				
Instrument	Manufacturer	Model No.	Serial No.	Calibration Date	Calibration Until
Receiver	R&S	ESR3	101657	Jan. 12, 2016	Jan. 11, 2017
LISN	SCHWARZBECK	Schwarzbeck 8127	8127-667	Nov. 08, 2016	Nov. 07, 2017
RF Cable-CON	EMC	EMCCFD300-BM-BM-6000	50821	Dec. 21, 2015	Dec. 20, 2016
Measurement Software	AUDIX	e3	6.120210k	NA	NA

Note: Calibration Interval of instruments listed above is one year.

Test Item	Radiated Emission				
Test Site	966 chamber3 / (03CH03-WS)				
Instrument	Manufacturer	Model No.	Serial No.	Calibration Date	Calibration Until
Spectrum Analyzer	Agilent	N9010A	MY53400091	Sep. 09, 2016	Sep. 08, 2017
Receiver	Agilent	N9038A	MY53290044	Oct. 06, 2016	Oct. 05, 2017
Bilog Antenna	SCHWARZBECK	VULB9168	VULB9168-685	Apr. 26, 2016	Apr. 25, 2017
Horn Antenna 1G-18G	SCHWARZBECK	BBHA 9120 D	BBHA 9120 D 1206	Feb. 24, 2016	Feb. 23, 2017
Horn Antenna 18G-40G	SCHWARZBECK	BBHA 9170	BBHA 9170517	Oct. 25, 2016	Oct. 24, 2017
Loop Antenna	R&S	HFH2-Z2	100330	Nov. 10, 2016	Nov. 09, 2017
Preamplifier	EMC	EMC02325	980187	Sep. 08, 2016	Sep. 07, 2017
Preamplifier	Agilent	83017A	MY53270014	Aug. 22, 2016	Aug. 21, 2017
Preamplifier	EMC	EMC184045B	980192	Aug. 24, 2016	Aug. 23, 2017
RF cable-3M	HUBER+SUHNER	SUCOFLEX104	MY22620/4	Feb. 05, 2016	Feb. 04, 2017
RF cable-8M	HUBER+SUHNER	SUCOFLEX104	MY22600/4	Feb. 05, 2016	Feb. 04, 2017
RF cable-1M	HUBER+SUHNER	SUCOFLEX104	MY22624/4	Feb. 05, 2016	Feb. 04, 2017
LF cable-0.8M	EMC	EMC8D-NM-NM-800	EMC8D-NM-NM-800-001	Feb. 05, 2016	Feb. 04, 2017
LF cable-3M	EMC	EMC8D-NM-NM-3000	131103	Feb. 05, 2016	Feb. 04, 2017
LF cable-13M	EMC	EMC8D-NM-NM-13000	131104	Feb. 05, 2016	Feb. 04, 2017
Measurement Software	AUDIX	e3	6.120210g	NA	NA

Note: Calibration Interval of instruments listed above is one year.

Test Item	RF Conducted				
Test Site	(TH01-WS)				
Instrument	Manufacturer	Model No.	Serial No.	Calibration Date	Calibration Until
Spectrum Analyzer	R&S	FSV40	101063	Feb. 17, 2016	Feb. 16, 2017
Power Meter	Anritsu	ML2495A	1241002	Oct. 06, 2016	Oct. 05, 2017
Power Sensor	Anritsu	MA2411B	1207366	Oct. 06, 2016	Oct. 05, 2017
DC POWER SOURCE	GW INSTRON	GPC-6030D	EM892433	Oct. 20, 2016	Oct. 19, 2017
Measurement Software	Sporton	Sporton_1	1.3.30	NA	NA

Note: Calibration Interval of instruments listed above is one year.

1.5 Test Standards

According to the specification of EUT, the EUT must comply with following standards and KDB documents.

47 CFR FCC Part 15.247

ANSI C63.10-2013

FCC KDB 558074 D01 DTS Meas Guidance v03r05

FCC KDB 662911 D01 Multiple Transmitter Output v02r01

1.6 Measurement Uncertainty

ISO/IEC 17025 requires that an estimate of the measurement uncertainties associated with the emissions test results be included in the report. The measurement uncertainties given below are based on a 95% confidence level (based on a coverage factor (k=2))

Measurement Uncertainty	
Parameters	Uncertainty
Bandwidth	±34.134 Hz
Conducted power	±0.808 dB
Power density	±0.463 dB
Conducted emission	±2.670 dB
AC conducted emission	±2.90 dB
Radiated emission ≤ 1GHz	±3.66 dB
Radiated emission > 1GHz	±5.37 dB

2 Test Configuration

2.1 Testing Condition

Test Item	Test Site	Ambient Condition	Tested By
AC Conduction	CO01-WS	17°C / 61%	Howard Huang
Radiated Emissions	03CH03-WS	22°C / 65%	Brad Wu Kevin Lee Vincent Yeh
RF Conducted	TH01-WS	21°C / 64%	Alex Huang

- FCC Designation No.: TW0009
- FCC site registration No.: 207696
- IC site registration No.: 10807C-1

2.2 The Worst Test Modes and Channel Details

Test item	Modulation Mode	Test Frequency (MHz)	Data Rate	Test Configuration
Conducted Emissions	HT20	2437	MCS 0	---
Radiated Emissions ≤1GHz	HT20	2437	MCS 0	---
Radiated Emissions >1GHz	11b	2412 / 2437 / 2462	1 Mbps	---
Maximum Output Power	11g	2412 / 2437 / 2462	6 Mbps	
6dB bandwidth	HT20	2412 / 2437 / 2462	MCS 0	
Power spectral density	HT40	2422 / 2437 / 2452	MCS 0	

3 Transmitter Test Results

3.1 Conducted Emissions

3.1.1 Limit of Conducted Emissions

Conducted Emissions Limit		
Frequency Emission (MHz)	Quasi-Peak	Average
0.15-0.5	66 - 56 *	56 - 46 *
0.5-5	56	46
5-30	60	50

Note 1: * Decreases with the logarithm of the frequency.

3.1.2 Test Procedures

1. The device is placed on a test table, raised 80 cm above the reference ground plane. The vertical conducting plane is located 40 cm to the rear of the device.
2. The device is connected to line impedance stabilization network (LISN) and other accessories are connected to other LISN. Measured levels of AC power line conducted emission are across the 50 Ω LISN port.
3. AC conducted emission measurements is made over frequency range from 150 kHz to 30 MHz.
4. This measurement was performed with AC 120V / 60Hz.

3.1.3 Test Setup



- Note: 1. Support units were connected to second LISN.
2. Both of LISNs (AMN) are 80 cm from EUT and at least 80 cm from other units and other metal planes

3.1.4 Test Result of Conducted Emissions

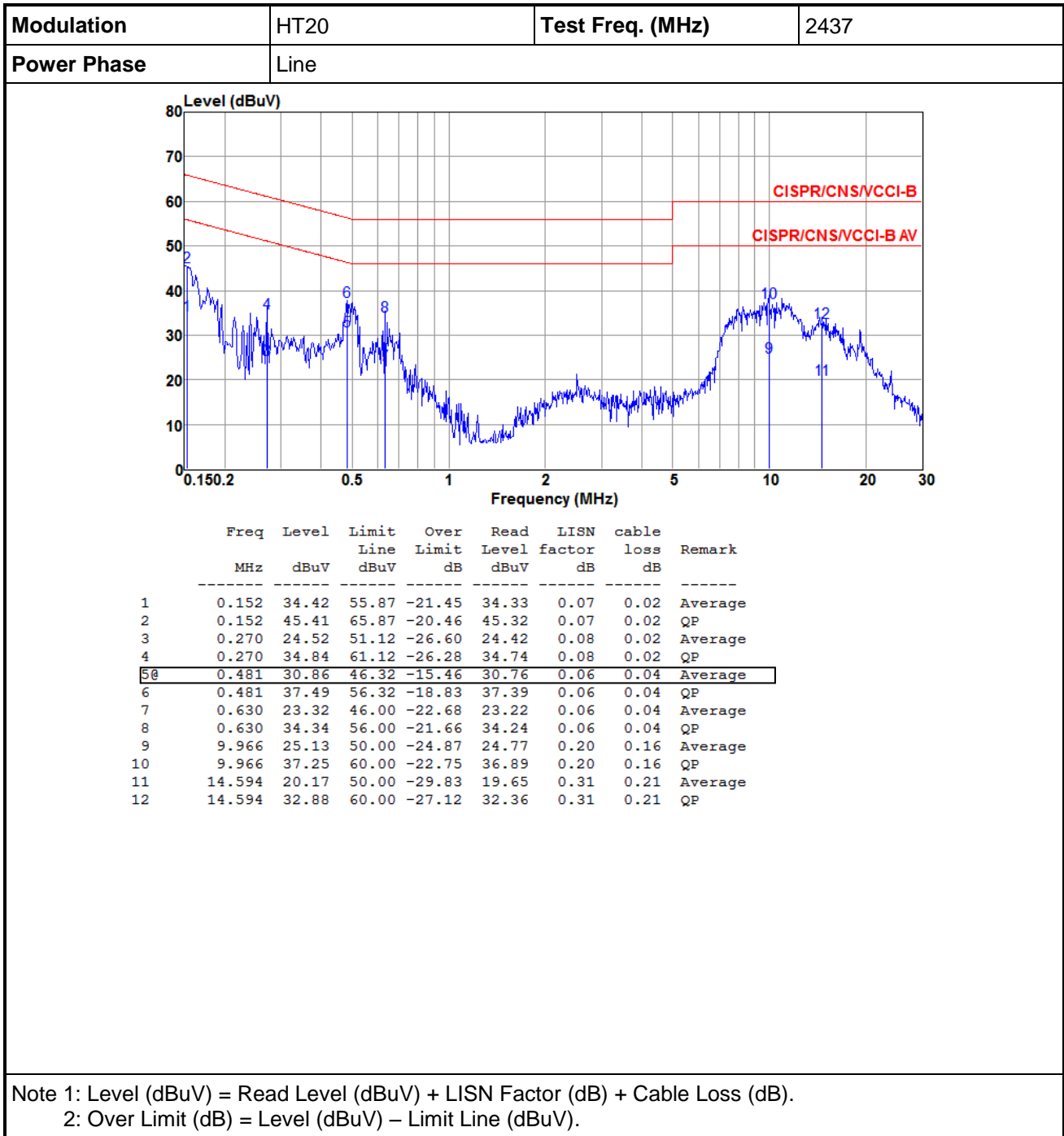

Modulation	HT20	Test Freq. (MHz)	2437
-------------------	------	-------------------------	------

Power Phase	Neutral
--------------------	---------

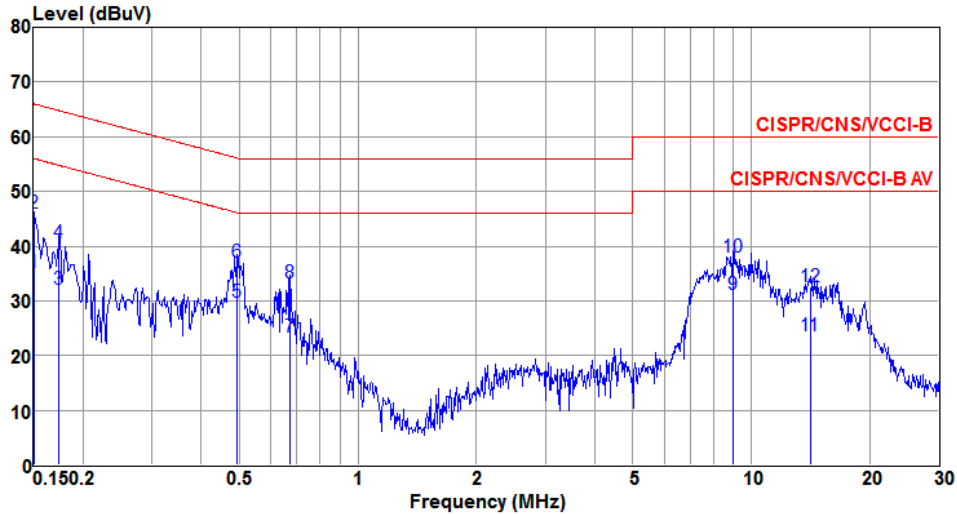

	Freq MHz	Level dBuV	Limit Line dBuV	Over Limit dB	Read Level dBuV	LISN factor dB	cable loss dB	Remark
1	0.150	35.14	56.00	-20.86	35.02	0.10	0.02	Average
2	0.150	45.93	66.00	-20.07	45.81	0.10	0.02	QP
3	0.174	32.00	54.77	-22.77	31.89	0.09	0.02	Average
4	0.174	40.65	64.77	-24.12	40.54	0.09	0.02	QP
5@	0.494	29.69	46.10	-16.41	29.53	0.12	0.04	Average
6	0.494	37.09	56.10	-19.01	36.93	0.12	0.04	QP
7	0.672	23.40	46.00	-22.60	23.24	0.11	0.05	Average
8	0.672	33.38	56.00	-22.62	33.22	0.11	0.05	QP
9	8.964	31.14	50.00	-18.86	30.69	0.29	0.16	Average
10	8.964	38.05	60.00	-21.95	37.60	0.29	0.16	QP
11	14.138	23.64	50.00	-26.36	23.08	0.36	0.20	Average
12	14.138	32.49	60.00	-27.51	31.93	0.36	0.20	QP

Note 1: Level (dBuV) = Read Level (dBuV) + LISN Factor (dB) + Cable Loss (dB).
 2: Over Limit (dB) = Level (dBuV) – Limit Line (dBuV).

3.2 6dB and Occupied Bandwidth

3.2.1 Limit of 6dB Bandwidth

The minimum 6dB bandwidth shall be at least 500 kHz.

3.2.2 Test Procedures

6dB Bandwidth

1. Set resolution bandwidth (RBW) = 100 kHz, Video bandwidth = 300 kHz.
2. Detector = Peak, Trace mode = max hold.
3. Sweep = auto couple, Allow the trace to stabilize.
4. Measure the maximum width of the emission that is constrained by the frequencies associated with the two outermost amplitude points (upper and lower) that are attenuated by 6dB relative to the maximum level measured in the fundamental emission.

Occupied Bandwidth

1. Set resolution bandwidth (RBW) = 1 MHz, Video bandwidth = 3 MHz.
2. Detector = Sample, Trace mode = max hold.
3. Sweep = auto couple, Allow the trace to stabilize.
4. Use the OBW measurement function of spectrum analyzer to measure the occupied bandwidth.

3.2.3 Test Setup



3.2.4 Test Result of 6dB and Occupied Bandwidth

Modulation Mode	N _{TX}	Freq. (MHz)	6dB Bandwidth (MHz)				Limit (kHz)
			Chain 0	Chain 1	Chain 2	Chain 3	
11b	3	2412	7.07	6.55	7.07	---	500
11b	3	2437	7.07	7.07	7.07	---	500
11b	3	2462	6.55	7.07	7.07	---	500
11g	3	2412	16.35	16.35	16.35	---	500
11g	3	2437	16.35	16.35	16.35	---	500
11g	3	2462	16.35	16.35	16.35	---	500
HT20	3	2412	17.04	17.62	17.62	---	500
HT20	3	2437	17.51	17.28	17.51	---	500
HT20	3	2462	17.28	17.22	17.51	---	500
HT40	3	2422	35.94	35.48	35.94	---	500
HT40	3	2437	36.06	36.06	35.13	---	500
HT40	3	2452	36.29	36.48	35.48	---	500

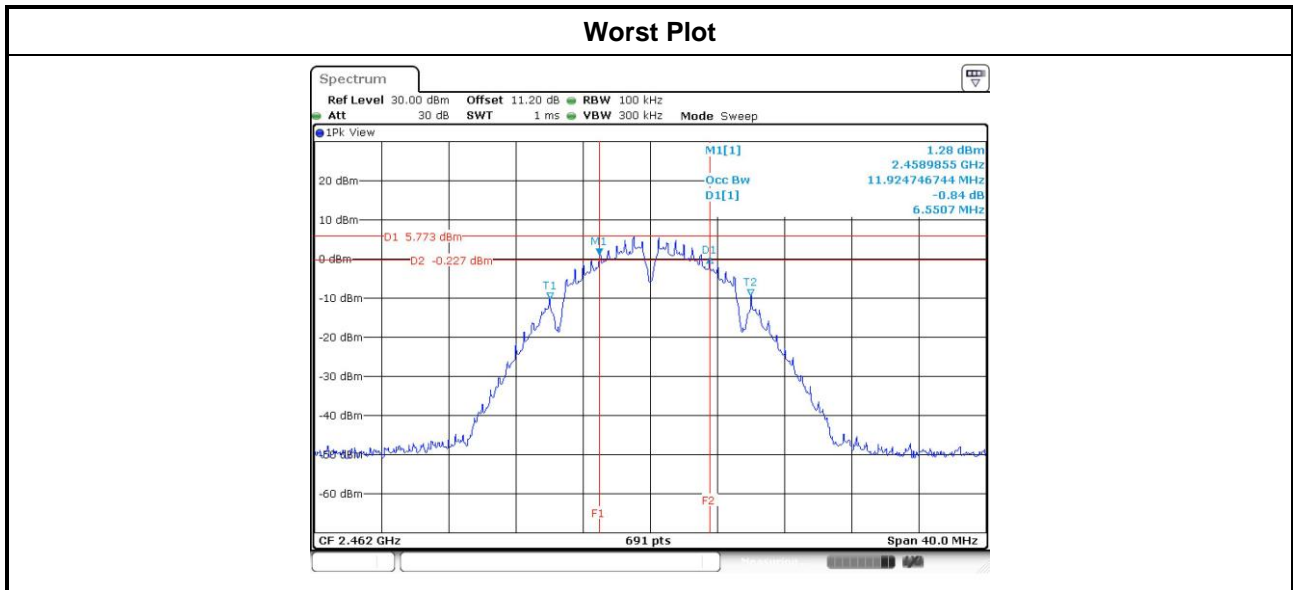

Modulation Mode	N _{TX}	Freq. (MHz)	99% Occupied Bandwidth (MHz)			
			Chain 0	Chain 1	Chain 2	Chain 3
11b	3	2412	11.97	11.88	11.96	---
11b	3	2437	11.93	12.00	11.96	---
11b	3	2462	11.93	12.00	12.00	---
11g	3	2412	16.73	16.69	16.64	---
11g	3	2437	16.93	16.85	16.76	---
11g	3	2462	16.72	16.64	16.61	---
HT20	3	2412	17.88	17.84	17.79	---
HT20	3	2437	18.13	18.00	18.31	---
HT20	3	2462	17.83	17.75	17.79	---
HT40	3	2422	36.72	36.91	36.77	---
HT40	3	2437	36.75	36.67	36.59	---
HT40	3	2452	36.72	36.85	36.77	---

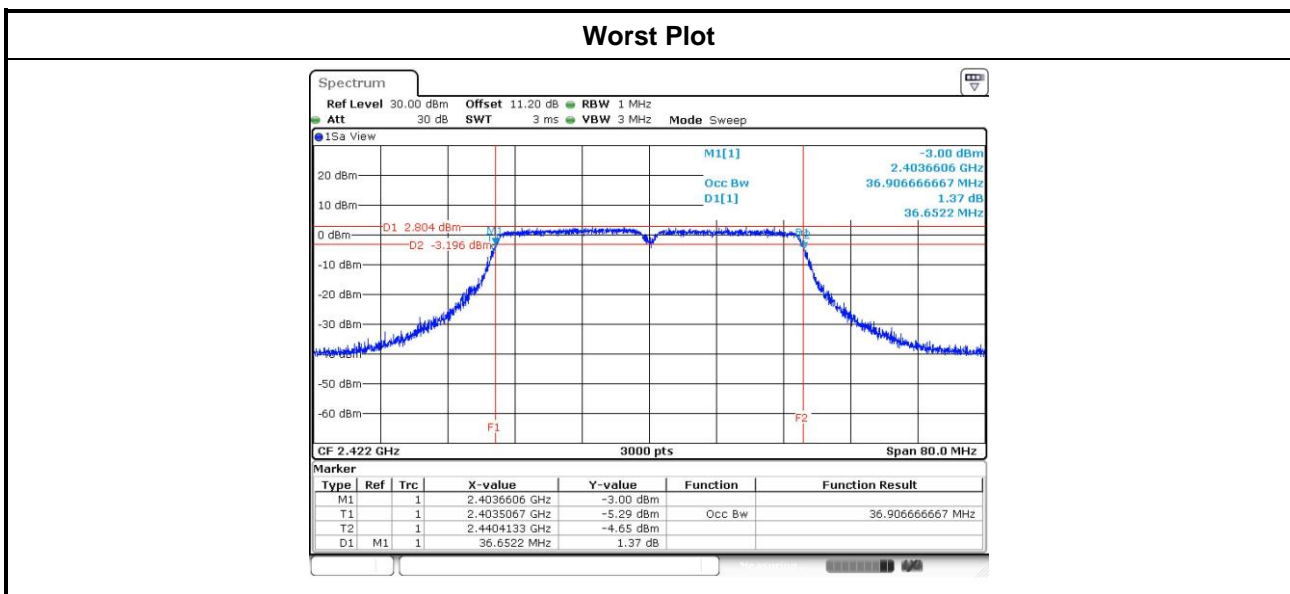

3.3 RF Output Power

3.3.1 Limit of RF Output Power

Conducted power shall not exceed 1Watt.

- Antenna gain \leq 6dBi, no any corresponding reduction is in output power limit.
- Antenna gain $>$ 6dBi
 - Non Fixed, point to point operations.
The conducted output power from the intentional radiator shall be reduced by the amount in dB that the directional gain of the antenna exceeds 6 dB
 - Fixed, point to point operations
Systems operating in the 2400–2483.5 MHz band that are used exclusively for fixed, point-to-point Operations, maximum peak output power of the intentional radiator is reduced by 1 dB for every 3 dB that the directional gain of the antenna exceeds 6 dBi.

Systems operating in the 5725–5850 MHz band that are used exclusively for fixed, point-to-point operations ,no any corresponding reduction is in transmitter peak output power

3.3.2 Test Procedures

- Maximum Peak Conducted Output Power
 - Spectrum analyzer**
 1. Set RBW = 1MHz, VBW = 3MHz, Detector = Peak.
 2. Sweep time = auto, Trace mode = max hold, Allow trace to fully stabilize.
 3. Use the spectrum analyzer channel power measurement function with the band limits set equal to the DTS bandwidth edges.
 - Power meter**
 1. A broadband Peak RF power meter is used for output power measurement. The video bandwidth of power meter is greater than DTS bandwidth of EUT. If duty cycle of test signal is not 100 %, trigger and gating function of power meter will be enabled to capture transmission burst for measuring output power.
- Maximum Conducted Output Power (For reference only)
 - Power meter**
 1. A broadband Average RF power meter is used for output power measurement. The video bandwidth of power meter is greater than DTS bandwidth of EUT. If duty cycle of test signal is not 100 %, trigger and gating function of power meter will be enabled to capture transmission burst for measuring output power.

3.3.3 Test Setup

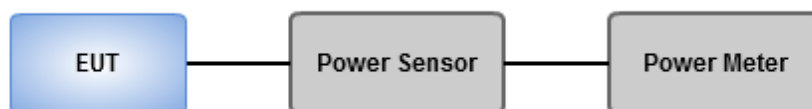

3.3.4 Test Result of Maximum Output Power

Modulation Mode	N _{TX}	Freq. (MHz)	Peak conducted Output Power (dBm)							Ant. Gain (dBi)	EIRP (dBm)	EIRP Limit (dBm)
			Chain 0	Chain 1	Chain 2	Chain 3	Total Power (mW)	Total Power (dBm)	Limit (dBm)			
11b	3	2412	19.79	19.53	19.42	---	272.521	24.35	30.00	3.00	27.35	36.00
11b	3	2437	18.14	17.45	17.61	---	178.430	22.51	30.00	3.00	25.51	36.00
11b	3	2462	16.78	16.65	16.69	---	140.547	21.48	30.00	3.00	24.48	36.00
11g	3	2412	21.87	21.57	21.54	---	439.925	26.43	30.00	3.00	29.43	36.00
11g	3	2437	24.01	24.05	23.61	---	735.480	28.67	30.00	3.00	31.67	36.00
11g	3	2462	22.34	22.15	21.9	---	490.336	26.90	30.00	3.00	29.90	36.00
HT20	3	2412	22.04	21.59	21.34	---	440.312	26.44	30.00	3.00	29.44	36.00
HT20	3	2437	24.56	24.34	23.77	---	795.635	29.01	30.00	3.00	32.01	36.00
HT20	3	2462	21.85	21.78	21.6	---	448.313	26.52	30.00	3.00	29.52	36.00
HT40	3	2422	15.36	14.96	15.42	---	100.522	20.02	30.00	3.00	23.02	36.00
HT40	3	2437	21.62	21.74	21.61	---	439.368	26.43	30.00	3.00	29.43	36.00
HT40	3	2452	16.19	15.91	15.81	---	118.692	20.74	30.00	3.00	23.74	36.00

Modulation Mode	N _{TX}	Freq. (MHz)	Conducted (Average) Output Power (dBm)				Total Power (mW)	Total Power (dBm)	Limit (dBm)
			Chain 0	Chain 1	Chain 2	Chain 3			
11b	3	2412	16.83	16.27	16.35	---	133.711	21.26	---
11b	3	2437	14.99	14.52	14.59	---	88.638	19.48	---
11b	3	2462	13.54	13.7	13.67	---	69.318	18.41	---
11g	3	2412	16.32	15.77	15.88	---	119.338	20.77	---
11g	3	2437	19.24	19.26	19.06	---	248.817	23.96	---
11g	3	2462	16.71	16.47	16.45	---	135.399	21.32	---
HT20	3	2412	16.31	15.76	15.74	---	117.924	20.72	---
HT20	3	2437	19.95	19.52	19.44	---	276.294	24.41	---
HT20	3	2462	16.17	15.92	15.88	---	119.210	20.76	---
HT40	3	2422	9.24	8.86	9.14	---	24.289	13.85	---
HT40	3	2437	15.91	15.76	15.77	---	114.422	20.59	---
HT40	3	2452	10.05	9.69	9.67	---	28.695	14.58	---

Note: Conducted average output power is for reference only.

3.4 Power Spectral Density

3.4.1 Limit of Power Spectral Density

Power spectral density shall not be greater than 8 dBm in any 3 kHz band.

3.4.2 Test Procedures

- Maximum peak conducted output power was used to demonstrate compliance to the fundamental output power limit.
 1. Set the RBW = 3kHz, VBW = 10kHz.
 2. Detector = Peak, Sweep time = auto couple.
 3. Trace mode = max hold, allow trace to fully stabilize.
 4. Use the peak marker function to determine the maximum amplitude level.
- Maximum (average) conducted output power was used to demonstrate compliance to the fundamental output power limit.
 1. Set the RBW = 100kHz, VBW = 300 kHz.
 2. Detector = RMS, Sweep time = auto couple.
 3. Set the sweep time to: $\geq 10 \times$ (number of measurement points in sweep) \times (maximum data rate per stream).
 4. Perform the measurement over a single sweep.
 5. Use the peak marker function to determine the maximum amplitude level.

3.4.3 Test Setup

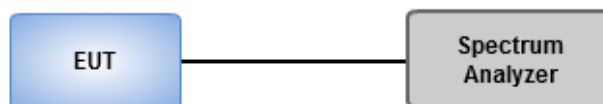

3.4.4 Test Result of Power Spectral Density

Modulation Mode	N _{TX}	Freq. (MHz)	Total Power Spectral Density (dBm/3kHz)	Limit (dBm/3kHz)
11b	3	2412	-0.87	6.23
11b	3	2437	-2.57	6.23
11b	3	2462	-3.51	6.23
11g	3	2412	-5.18	6.23
11g	3	2437	-1.10	6.23
11g	3	2462	-4.92	6.23
HT20	3	2412	-5.83	6.23
HT20	3	2437	-2.21	6.23
HT20	3	2462	-5.66	6.23
HT40	3	2422	-15.03	6.23
HT40	3	2437	-7.81	6.23
HT40	3	2452	-14.06	6.23

Note: Test result is bin-by-bin summing measured value of each TX port.

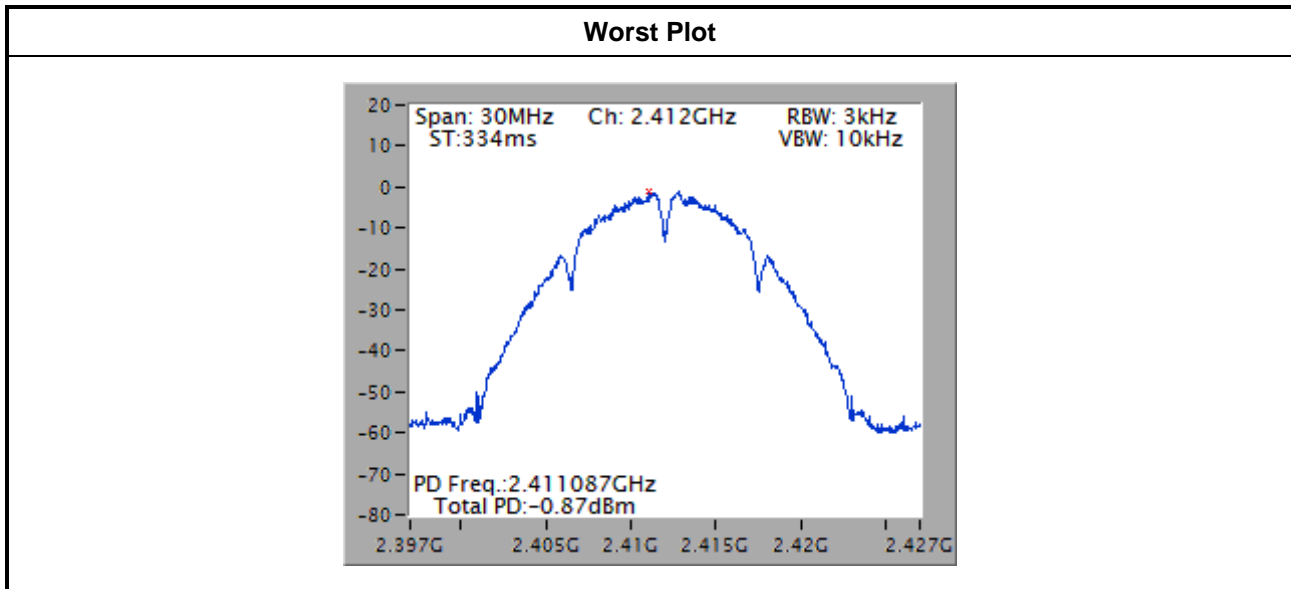

3.5 Unwanted Emissions into Restricted Frequency Bands

3.5.1 Limit of Unwanted Emissions into Restricted Frequency Bands

Restricted Band Emissions Limit			
Frequency Range (MHz)	Field Strength (uV/m)	Field Strength (dBuV/m)	Measure Distance (m)
0.009~0.490	2400/F(kHz)	48.5 - 13.8	300
0.490~1.705	24000/F(kHz)	33.8 - 23	30
1.705~30.0	30	29	30
30~88	100	40	3
88~216	150	43.5	3
216~960	200	46	3
Above 960	500	54	3

Note 1:
Quasi-Peak value is measured for frequency below 1GHz except for 9–90 kHz, 110–490 kHz frequency band. Peak and average value are measured for frequency above 1GHz. The limit on average radio frequency emission is as above table. The limit on peak radio frequency emissions is 20 dB above the maximum permitted average emission limit

Note 2:
Measurements may be performed at a distance other than what is specified provided. When performing measurements at a distance other than that specified, the results shall be extrapolated to the specified distance using an extrapolation factor as below, Frequency at or above 30 MHz: 20 dB/decade Frequency below 30 MHz: 40 dB/decade.

3.5.2 Test Procedures

1. Measurement is made at a semi-anechoic chamber that incorporates a turntable allowing a EUT rotation of 360°. A continuously-rotating, remotely-controlled turntable is installed at the test site to support the EUT and facilitate determination of the direction of maximum radiation for each EUT emission frequency. The EUT is placed at test table. For emissions testing at or below 1 GHz, the table height is 80 cm above the reference ground plane. For emission measurements above 1 GHz, the table height is 1.5 m
2. Measurement is made with the antenna positioned in both the horizontal and vertical planes of polarization. The measurement antenna is varied in height (1m ~ 4m) above the reference ground plane to obtain the maximum signal strength. Distance between EUT and antenna is 3 m.
3. This investigation is performed with the EUT rotated 360°, the antenna height scanned between 1 m and 4 m, and the antenna rotated to repeat the measurements for both the horizontal and vertical antenna polarizations.

Note:

1. 120kHz measurement bandwidth of test receiver and Quasi-peak detector is for radiated emission below 1GHz.
2. RBW=1MHz, VBW=3MHz and Peak detector is for peak measured value of radiated emission above 1GHz.
3. RBW=1MHz, VBW=1/T and Peak detector is for average measured value of radiated emission above 1GHz.

3.5.3 Test Setup

Radiated Emissions below 1 GHz

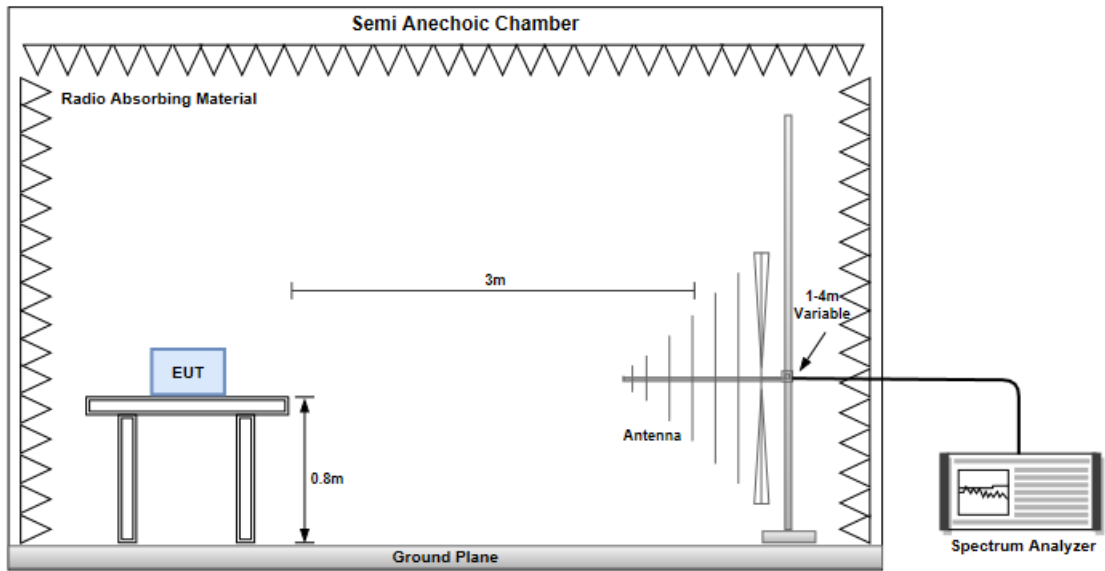

Radiated Emissions above 1 GHz

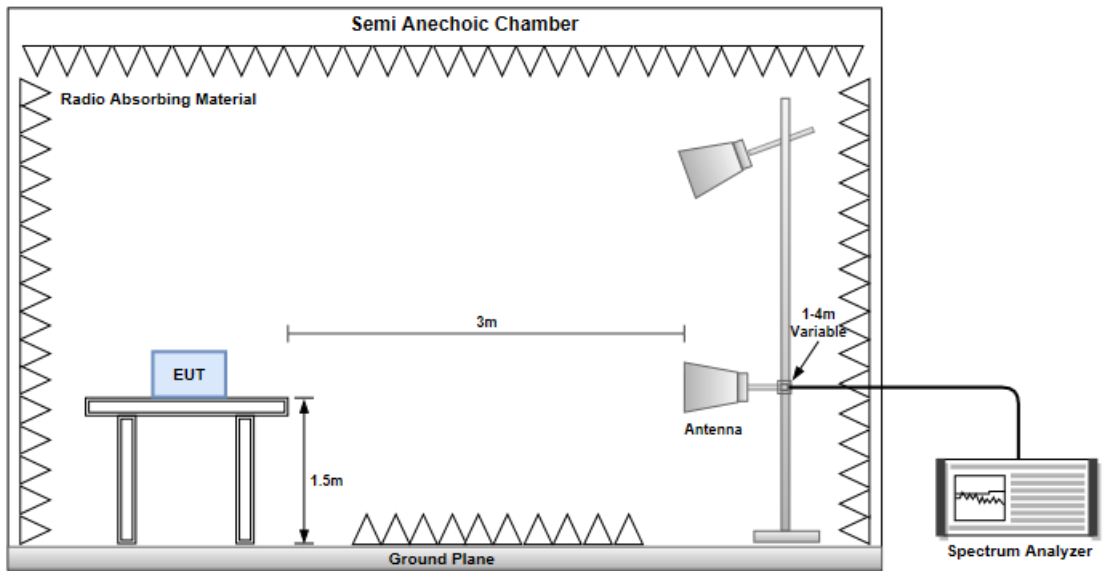

3.5.4 Transmitter Radiated Unwanted Emissions (Below 1GHz)

Modulation	HT20	Test Freq. (MHz)	2437
Polarization	Horizontal		

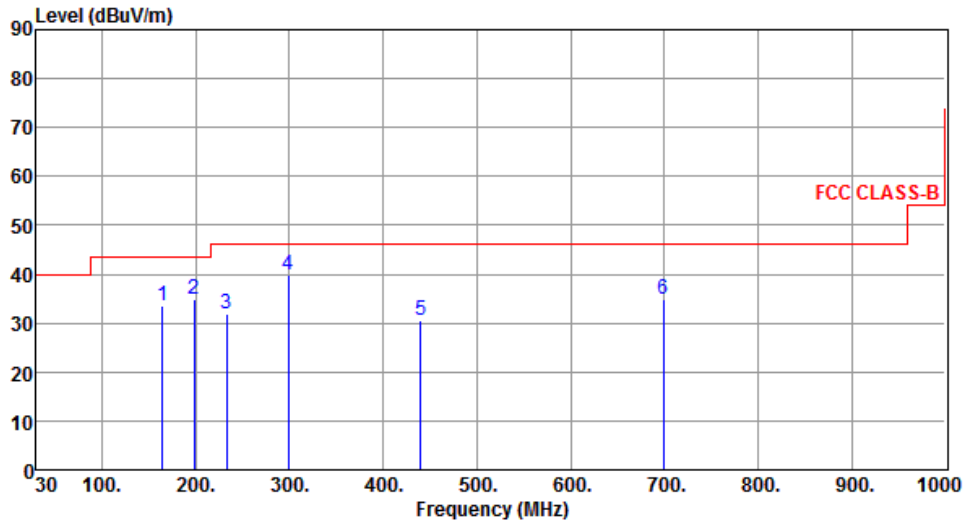

	Freq. MHz	Emission level dBuV/m	Limit dBuV/m	Margin dB	SA reading dBuV	Factor dB	Remark	ANT High cm	Turn Table deg
1	164.83	33.43	43.50	-10.07	41.67	-8.24	Peak	---	---
2	198.78	34.71	43.50	-8.79	45.67	-10.96	Peak	---	---
3	232.73	31.94	46.00	-14.06	42.04	-10.10	Peak	---	---
4	298.69	39.83	46.00	-6.17	47.56	-7.73	Peak	---	---
5	440.31	30.66	46.00	-15.34	34.54	-3.88	Peak	---	---
6	699.30	34.99	46.00	-11.01	34.30	0.69	Peak	---	---

Note 1: Emission Level (dBuV/m) = SA Reading (dBuV/m) + Factor* (dB)

*Factor includes antenna factor , cable loss and amplifier gain

Note 2: Margin (dB) = Emission level (dBuV/m) – Limit (dBuV/m).

Note 3: All spurious emissions below 30MHz are more than 20 dB below the limit.

Modulation	HT20	Test Freq. (MHz)	2437
Polarization	Vertical		

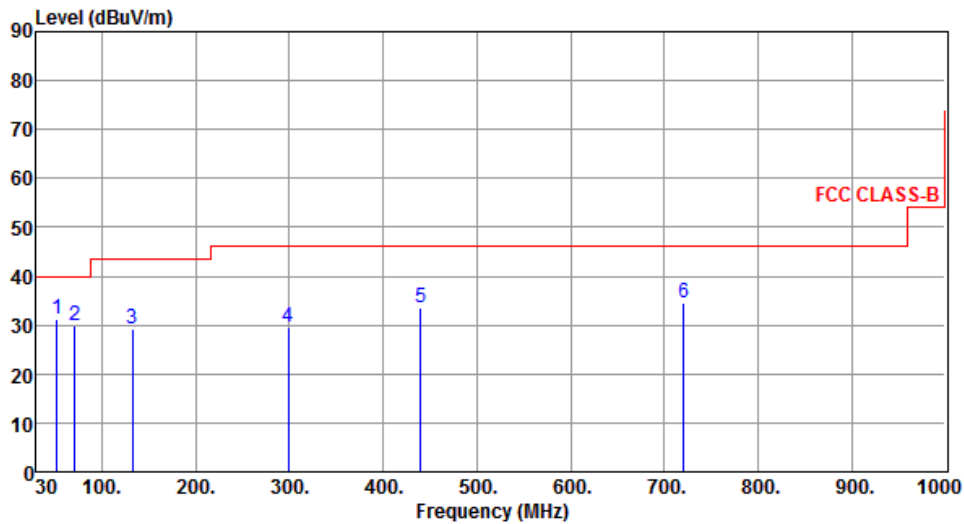

	Freq. MHz	Emission level dBuV/m	Limit dBuV/m	Margin dB	SA reading dBuV	Factor dB	Remark	ANT High cm	Turn Table deg
1	52.31	31.34	40.00	-8.66	39.33	-7.99	Peak	---	---
2	70.74	29.98	40.00	-10.02	40.69	-10.71	Peak	---	---
3	132.82	29.34	43.50	-14.16	38.75	-9.41	Peak	---	---
4	298.69	29.43	46.00	-16.57	37.16	-7.73	Peak	---	---
5	440.31	33.68	46.00	-12.32	37.56	-3.88	Peak	---	---
6	720.64	34.62	46.00	-11.38	33.42	1.20	Peak	---	---

Note 1: Emission Level (dBuV/m) = SA Reading (dBuV/m) + Factor* (dB)

*Factor includes antenna factor , cable loss and amplifier gain

Note 2: Margin (dB) = Emission level (dBuV/m) – Limit (dBuV/m).

Note 3: All spurious emissions below 30MHz are more than 20 dB below the limit.

3.5.5 Transmitter Radiated Unwanted Emissions (Above 1GHz) for 11b

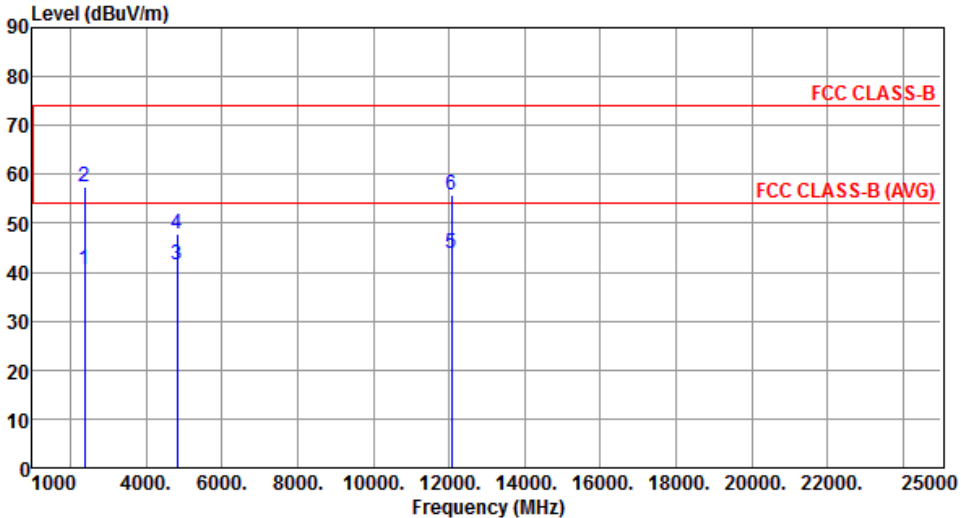
Modulation	11b	Test Freq. (MHz)	2412						
Polarization	Horizontal								
									
	Freq. MHz	Emission level dBuV/m	Limit dBuV/m	Margin dB	SA reading dBuV	Factor dB	Remark	ANT High cm	Turn Table deg
1	2390.00	40.49	54.00	-13.51	41.60	-1.11	Average	219	287
2	2390.00	57.37	74.00	-16.63	58.48	-1.11	Peak	219	287
3	4824.00	41.54	54.00	-12.46	36.23	5.31	Average	152	298
4	4824.00	47.77	74.00	-26.23	42.46	5.31	Peak	152	298
5	12060.00	43.77	54.00	-10.23	28.74	15.03	Average	115	142
6	12060.00	55.95	74.00	-18.05	40.92	15.03	Peak	115	142

Note 1: Emission Level (dBuV/m) = SA Reading (dBuV/m) + Factor* (dB)
*Factor includes antenna factor , cable loss and amplifier gain
Note 2: Margin (dB) = Emission level (dBuV/m) – Limit (dBuV/m).

Modulation	11b	Test Freq. (MHz)	2412
Polarization	Vertical		

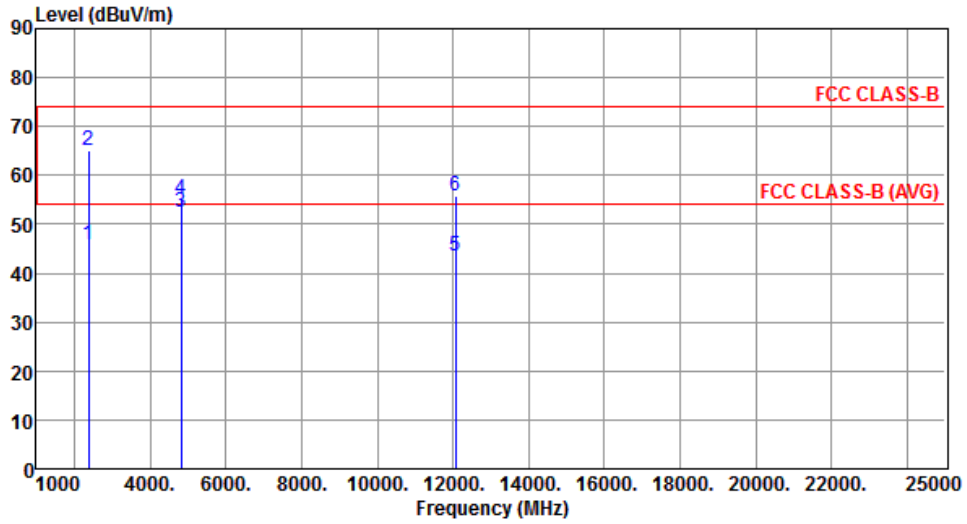

	Freq. MHz	Emission level dBuV/m	Limit dBuV/m	Margin dB	SA reading dBuV	Factor dB	Remark	ANT High cm	Turn Table deg
1	2390.00	45.95	54.00	-8.05	47.06	-1.11	Average	306	94
2	2390.00	65.07	74.00	-8.93	66.18	-1.11	Peak	306	94
3	4824.00	52.59	54.00	-1.41	47.28	5.31	Average	173	268
4	4824.00	55.02	74.00	-18.98	49.71	5.31	Peak	173	268
5	12060.00	43.63	54.00	-10.37	28.60	15.03	Average	193	108
6	12060.00	55.72	74.00	-18.28	40.69	15.03	Peak	193	108

Note 1: Emission Level (dBuV/m) = SA Reading (dBuV/m) + Factor* (dB)

*Factor includes antenna factor , cable loss and amplifier gain

Note 2: Margin (dB) = Emission level (dBuV/m) – Limit (dBuV/m).

Modulation	11b	Test Freq. (MHz)	2437
Polarization	Horizontal		

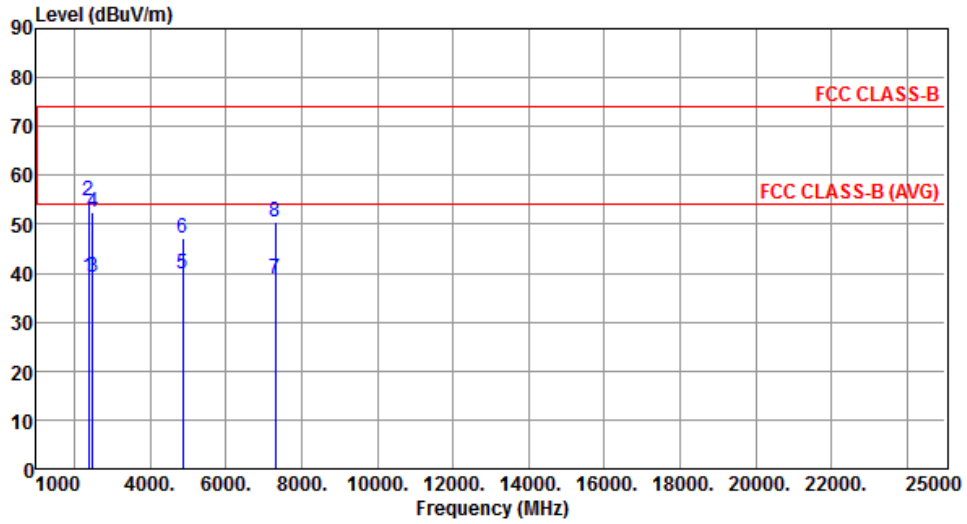

	Freq. MHz	Emission level dBuV/m	Limit dBuV/m	Margin dB	SA reading dBuV	Factor dB	Remark	ANT High cm	Turn Table deg
1	2390.00	39.31	54.00	-14.69	40.42	-1.11	Average	215	288
2	2390.00	54.69	74.00	-19.31	55.80	-1.11	Peak	215	288
3	2483.50	39.26	54.00	-14.74	39.88	-0.62	Average	215	288
4	2483.50	52.49	74.00	-21.51	53.11	-0.62	Peak	215	288
5	4874.00	39.84	54.00	-14.16	34.41	5.43	Average	100	108
6	4874.00	47.29	74.00	-26.71	41.86	5.43	Peak	100	108
7	7311.00	38.92	54.00	-15.08	28.66	10.26	Average	173	308
8	7311.00	50.32	74.00	-23.68	40.06	10.26	Peak	173	308

Note 1: Emission Level (dBuV/m) = SA Reading (dBuV/m) + Factor* (dB)

*Factor includes antenna factor , cable loss and amplifier gain

Note 2: Margin (dB) = Emission level (dBuV/m) – Limit (dBuV/m).

Modulation	11b	Test Freq. (MHz)	2437
Polarization	Vertical		

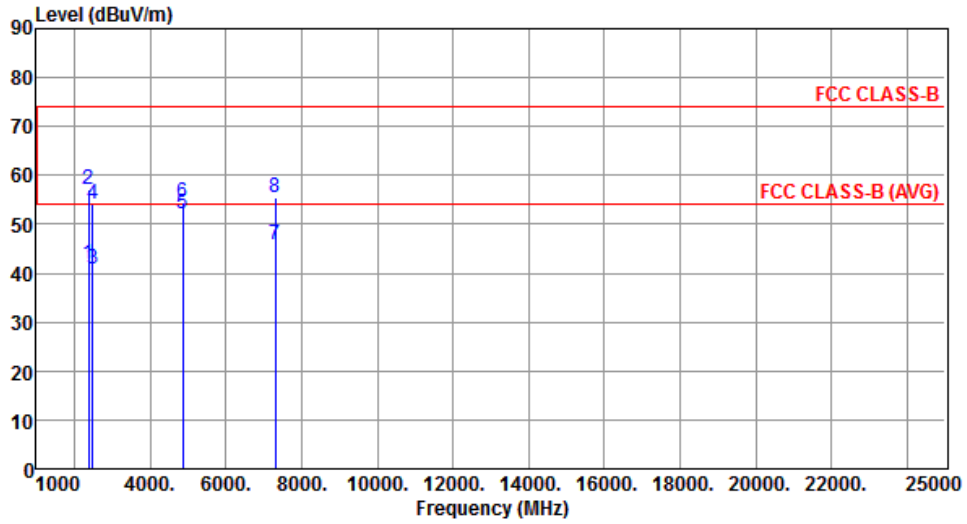

	Freq. MHz	Emission level dBuV/m	Limit dBuV/m	Margin dB	SA reading dBuV	Factor dB	Remark	ANT High cm	Turn Table deg
1	2390.00	41.98	54.00	-12.02	43.09	-1.11	Average	204	92
2	2390.00	57.23	74.00	-16.77	58.34	-1.11	Peak	204	92
3	2483.50	40.73	54.00	-13.27	41.35	-0.62	Average	204	92
4	2483.50	54.19	74.00	-19.81	54.81	-0.62	Peak	204	92
5	4874.00	52.02	54.00	-1.98	46.59	5.43	Average	100	59
6	4874.00	54.37	74.00	-19.63	48.94	5.43	Peak	100	59
7	7311.00	45.74	54.00	-8.26	35.48	10.26	Average	306	335
8	7311.00	55.51	74.00	-18.49	45.25	10.26	Peak	306	335

Note 1: Emission Level (dBuV/m) = SA Reading (dBuV/m) + Factor* (dB)

*Factor includes antenna factor , cable loss and amplifier gain

Note 2: Margin (dB) = Emission level (dBuV/m) – Limit (dBuV/m).

Modulation	11b	Test Freq. (MHz)	2462
Polarization	Horizontal		

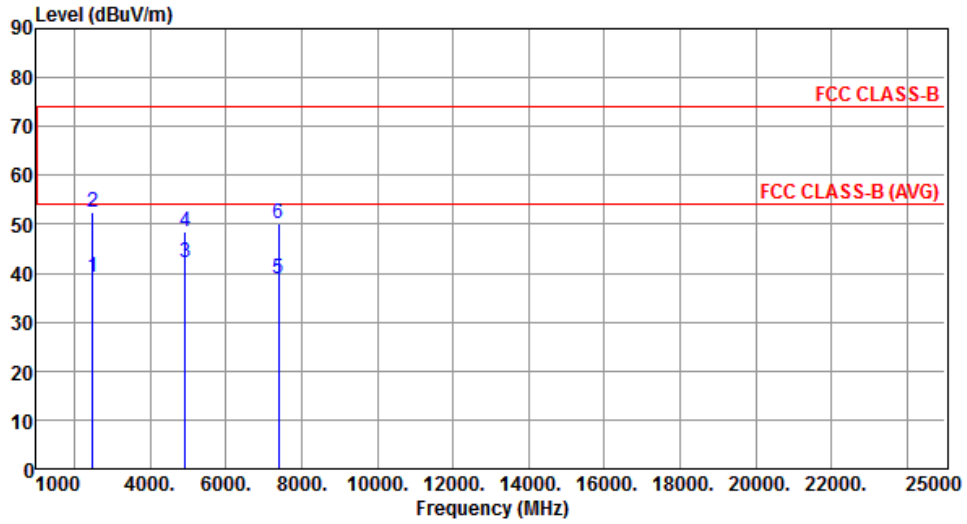

	Freq. MHz	Emission level dBuV/m	Limit dBuV/m	Margin dB	SA reading dBuV	Factor dB	Remark	ANT High cm	Turn Table deg
1	2483.50	39.24	54.00	-14.76	39.86	-0.62	Average	148	302
2	2483.50	52.42	74.00	-21.58	53.04	-0.62	Peak	148	302
3	4924.00	42.07	54.00	-11.93	36.52	5.55	Average	100	108
4	4924.00	48.44	74.00	-25.56	42.89	5.55	Peak	100	108
5	7386.00	38.75	54.00	-15.25	28.36	10.39	Average	130	246
6	7386.00	50.22	74.00	-23.78	39.83	10.39	Peak	130	246

Note 1: Emission Level (dBuV/m) = SA Reading (dBuV/m) + Factor* (dB)

*Factor includes antenna factor , cable loss and amplifier gain

Note 2: Margin (dB) = Emission level (dBuV/m) – Limit (dBuV/m).

Modulation	11b	Test Freq. (MHz)	2462
Polarization	Vertical		

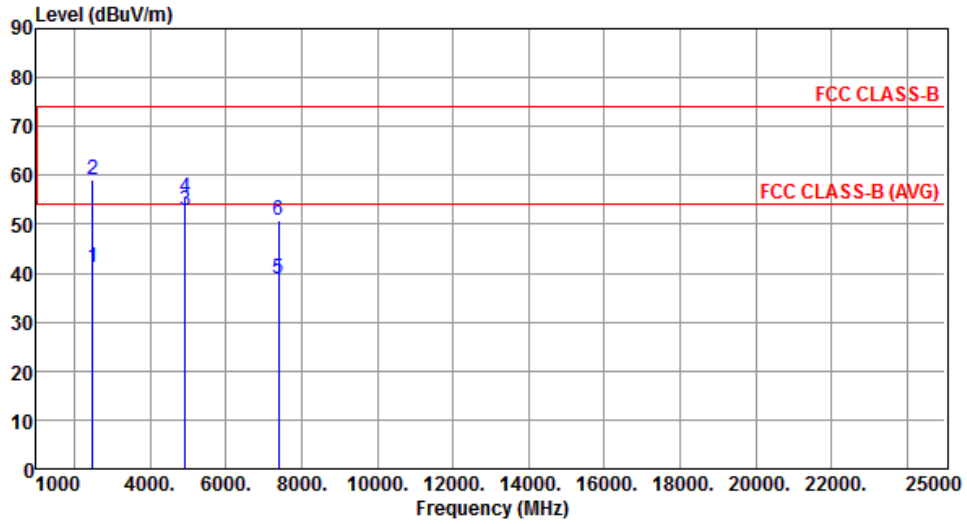

	Freq. MHz	Emission level dBuV/m	Limit dBuV/m	Margin dB	SA reading dBuV	Factor dB	Remark	ANT High cm	Turn Table deg
1	2483.50	41.34	54.00	-12.66	41.96	-0.62	Average	252	113
2	2483.50	59.15	74.00	-14.85	59.77	-0.62	Peak	252	113
3	4924.00	52.78	54.00	-1.22	47.23	5.55	Average	100	58
4	4924.00	55.32	74.00	-18.68	49.77	5.55	Peak	100	58
5	7386.00	38.90	54.00	-15.10	28.51	10.39	Average	276	258
6	7386.00	50.74	74.00	-23.26	40.35	10.39	Peak	276	258

Note 1: Emission Level (dBuV/m) = SA Reading (dBuV/m) + Factor* (dB)

*Factor includes antenna factor , cable loss and amplifier gain

Note 2: Margin (dB) = Emission level (dBuV/m) – Limit (dBuV/m).

3.5.6 Transmitter Radiated Unwanted Emissions (Above 1GHz) for 11g

Modulation	11g	Test Freq. (MHz)	2412
Polarization	Horizontal		

	Freq. MHz	Emission level dBuV/m	Limit dBuV/m	Margin dB	SA reading dBuV	Factor dB	Remark	ANT High cm	Turn Table deg
1	2390.00	45.58	54.00	-8.42	46.69	-1.11	Average	220	285
2	2390.00	64.33	74.00	-9.67	65.44	-1.11	Peak	220	285
3	4824.00	34.66	54.00	-19.34	29.35	5.31	Average	175	143
4	4824.00	46.08	74.00	-27.92	40.77	5.31	Peak	175	143
5	12060.00	44.47	54.00	-9.53	29.44	15.03	Average	193	117
6	12060.00	55.79	74.00	-18.21	40.76	15.03	Peak	193	117

Note 1: Emission Level (dBuV/m) = SA Reading (dBuV/m) + Factor* (dB)
*Factor includes antenna factor , cable loss and amplifier gain
Note 2: Margin (dB) = Emission level (dBuV/m) – Limit (dBuV/m).

Modulation	11g	Test Freq. (MHz)	2412
Polarization	Vertical		

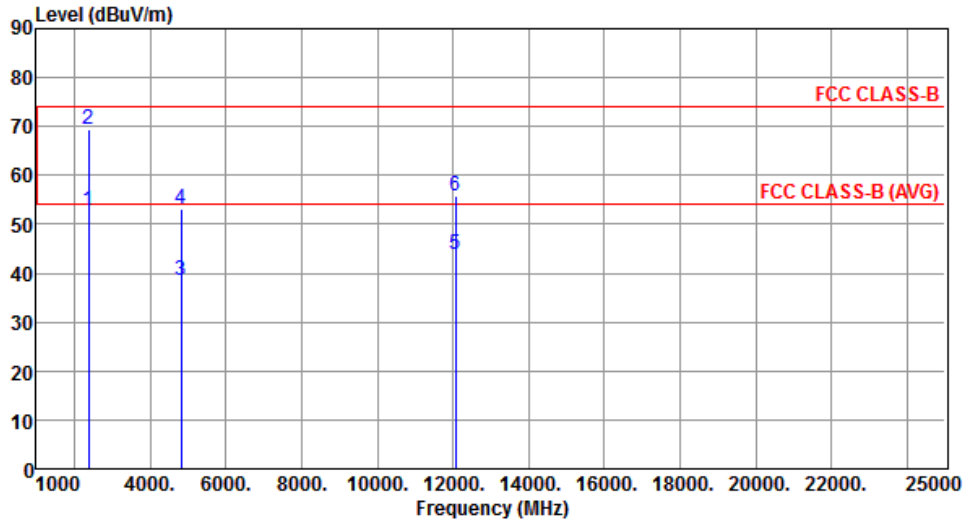

	Freq. MHz	Emission level dBuV/m	Limit dBuV/m	Margin dB	SA reading dBuV	Factor dB	Remark	ANT High cm	Turn Table deg
1	2390.00	52.78	54.00	-1.22	53.89	-1.11	Average	120	73
2	2390.00	69.29	74.00	-4.71	70.40	-1.11	Peak	120	73
3	4824.00	38.42	54.00	-15.58	33.11	5.31	Average	100	64
4	4824.00	53.15	74.00	-20.85	47.84	5.31	Peak	100	64
5	12060.00	43.70	54.00	-10.30	28.67	15.03	Average	189	264
6	12060.00	55.93	74.00	-18.07	40.90	15.03	Peak	189	264

Note 1: Emission Level (dBuV/m) = SA Reading (dBuV/m) + Factor* (dB)

*Factor includes antenna factor , cable loss and amplifier gain

Note 2: Margin (dB) = Emission level (dBuV/m) – Limit (dBuV/m).

Modulation	11g	Test Freq. (MHz)	2437
Polarization	Horizontal		

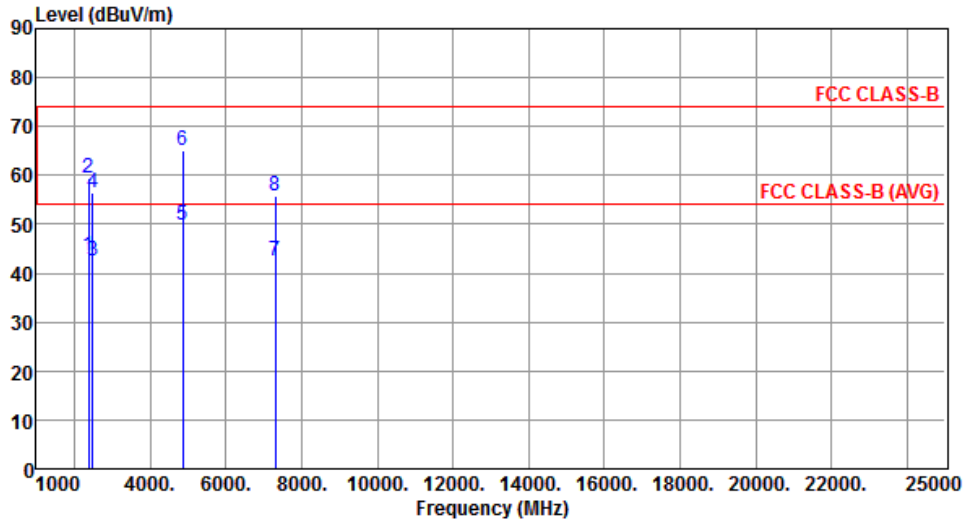

	Freq. MHz	Emission level dBuV/m	Limit dBuV/m	Margin dB	SA reading dBuV	Factor dB	Remark	ANT High cm	Turn Table deg
1	2390.00	43.53	54.00	-10.47	44.64	-1.11	Average	219	288
2	2390.00	59.29	74.00	-14.71	60.40	-1.11	Peak	219	288
3	2483.50	42.46	54.00	-11.54	43.08	-0.62	Average	219	288
4	2483.50	56.32	74.00	-17.68	56.94	-0.62	Peak	219	288
5	4874.00	49.68	54.00	-4.32	44.25	5.43	Average	274	166
6	4874.00	65.12	74.00	-8.88	59.69	5.43	Peak	274	166
7	7311.00	42.66	54.00	-11.34	32.40	10.26	Average	100	48
8	7311.00	55.78	74.00	-18.22	45.52	10.26	Peak	100	48

Note 1: Emission Level (dBuV/m) = SA Reading (dBuV/m) + Factor* (dB)

*Factor includes antenna factor , cable loss and amplifier gain

Note 2: Margin (dB) = Emission level (dBuV/m) – Limit (dBuV/m).

Modulation	11g	Test Freq. (MHz)	2437
Polarization	Vertical		

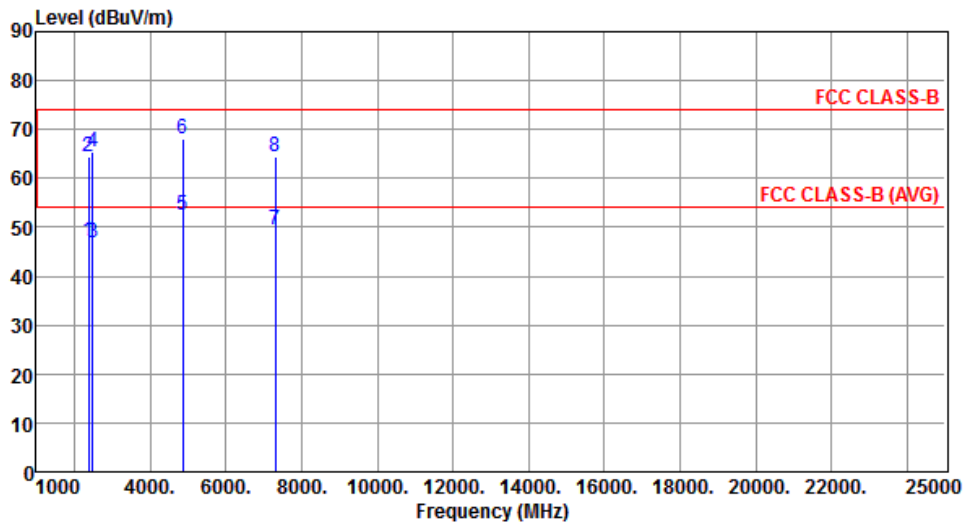

	Freq. MHz	Emission level dBuV/m	Limit dBuV/m	Margin dB	SA reading dBuV	Factor dB	Remark	ANT High cm	Turn Table deg
1	2390.00	47.23	54.00	-6.77	48.34	-1.11	Average	201	94
2	2390.00	64.48	74.00	-9.52	65.59	-1.11	Peak	201	94
3	2483.50	46.92	54.00	-7.08	47.54	-0.62	Average	201	94
4	2483.50	65.55	74.00	-8.45	66.17	-0.62	Peak	201	94
5	4874.00	52.54	54.00	-1.46	47.11	5.43	Average	100	63
6	4874.00	68.18	74.00	-5.82	62.75	5.43	Peak	100	63
7	7311.00	49.52	54.00	-4.48	39.26	10.26	Average	377	318
8	7311.00	64.53	74.00	-9.47	54.27	10.26	Peak	377	318

Note 1: Emission Level (dBuV/m) = SA Reading (dBuV/m) + Factor* (dB)

*Factor includes antenna factor , cable loss and amplifier gain

Note 2: Margin (dB) = Emission level (dBuV/m) – Limit (dBuV/m).

Modulation	11g	Test Freq. (MHz)	2462
Polarization	Horizontal		

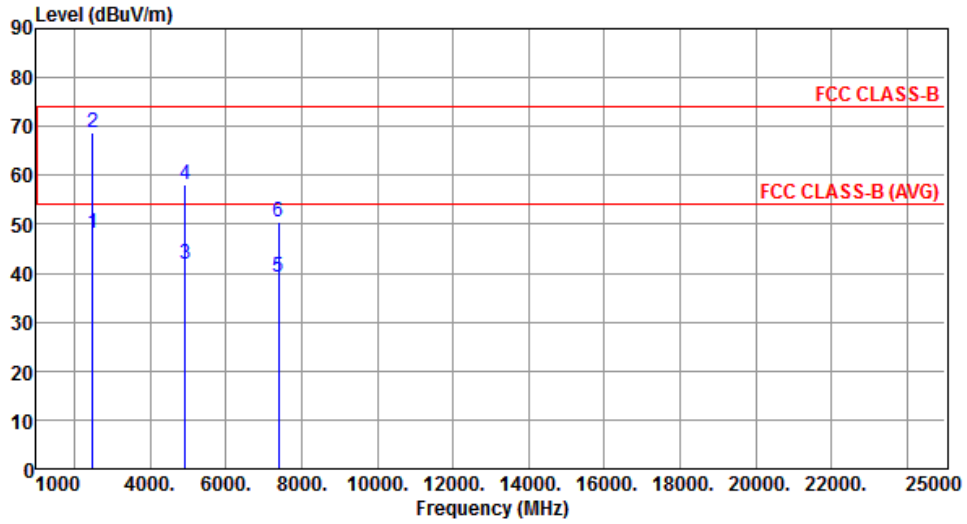

	Freq. MHz	Emission level dBuV/m	Limit dBuV/m	Margin dB	SA reading dBuV	Factor dB	Remark	ANT High cm	Turn Table deg
1	2483.50	48.22	54.00	-5.78	48.84	-0.62	Average	210	287
2	2483.50	68.67	74.00	-5.33	69.29	-0.62	Peak	210	287
3	4924.00	41.82	54.00	-12.18	36.27	5.55	Average	270	170
4	4924.00	58.02	74.00	-15.98	52.47	5.55	Peak	270	170
5	7386.00	39.26	54.00	-14.74	28.87	10.39	Average	193	308
6	7386.00	50.41	74.00	-23.59	40.02	10.39	Peak	193	308

Note 1: Emission Level (dBuV/m) = SA Reading (dBuV/m) + Factor* (dB)

*Factor includes antenna factor , cable loss and amplifier gain

Note 2: Margin (dB) = Emission level (dBuV/m) – Limit (dBuV/m).

Modulation	11g	Test Freq. (MHz)	2462
Polarization	Vertical		

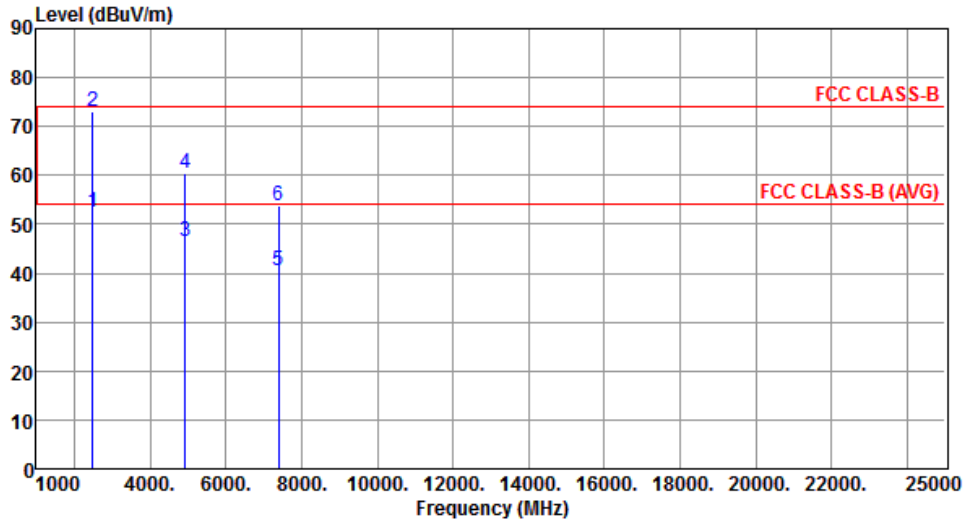

	Freq. MHz	Emission level dBuV/m	Limit dBuV/m	Margin dB	SA reading dBuV	Factor dB	Remark	ANT High cm	Turn Table deg
1	2483.50	52.49	54.00	-1.51	53.11	-0.62	Average	100	195
2	2483.50	72.98	74.00	-1.02	73.60	-0.62	Peak	100	195
3	4924.00	46.64	54.00	-7.36	41.09	5.55	Average	100	7
4	4924.00	60.59	74.00	-13.41	55.04	5.55	Peak	100	7
5	7386.00	40.57	54.00	-13.43	30.18	10.39	Average	100	337
6	7386.00	53.84	74.00	-20.16	43.45	10.39	Peak	100	337

Note 1: Emission Level (dBuV/m) = SA Reading (dBuV/m) + Factor* (dB)

*Factor includes antenna factor , cable loss and amplifier gain

Note 2: Margin (dB) = Emission level (dBuV/m) – Limit (dBuV/m).

3.5.7 Transmitter Radiated Unwanted Emissions (Above 1GHz) for HT20

Modulation	HT20	Test Freq. (MHz)	2412						
Polarization	Horizontal								
	Freq.	Emission level	Limit	Margin	SA reading	Factor	Remark	ANT High	Turn Table
	MHz	dBuV/m	dBuV/m	dB	dBuV	dB		cm	deg
1	2390.00	47.58	54.00	-6.42	48.69	-1.11	Average	220	284
2	2390.00	61.84	74.00	-12.16	62.95	-1.11	Peak	220	284
3	4824.00	34.20	54.00	-19.80	28.89	5.31	Average	181	150
4	4824.00	45.84	74.00	-28.16	40.53	5.31	Peak	181	150
5	12060.00	43.93	54.00	-10.07	28.90	15.03	Average	196	105
6	12060.00	55.72	74.00	-18.28	40.69	15.03	Peak	196	105
<p>Note 1: Emission Level (dBuV/m) = SA Reading (dBuV/m) + Factor* (dB) *Factor includes antenna factor , cable loss and amplifier gain Note 2: Margin (dB) = Emission level (dBuV/m) – Limit (dBuV/m).</p>									

Modulation	HT20	Test Freq. (MHz)	2412
Polarization	Vertical		

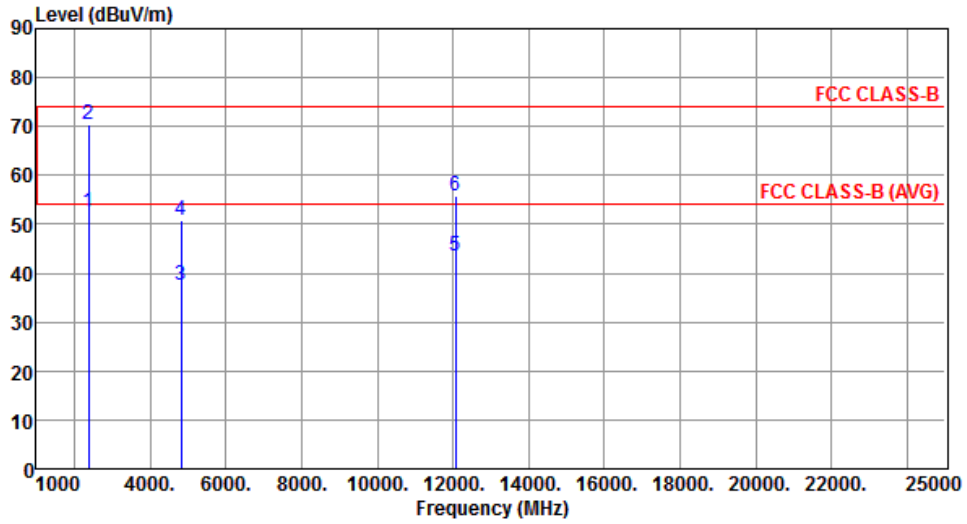

	Freq. MHz	Emission level dBuV/m	Limit dBuV/m	Margin dB	SA reading dBuV	Factor dB	Remark	ANT High cm	Turn Table deg
1	2390.00	52.58	54.00	-1.42	53.69	-1.11	Average	118	28
2	2390.00	70.32	74.00	-3.68	71.43	-1.11	Peak	118	28
3	4824.00	37.44	54.00	-16.56	32.13	5.31	Average	100	62
4	4824.00	50.72	74.00	-23.28	45.41	5.31	Peak	100	62
5	12060.00	43.57	54.00	-10.43	28.54	15.03	Average	193	258
6	12060.00	55.85	74.00	-18.15	40.82	15.03	Peak	193	258

Note 1: Emission Level (dBuV/m) = SA Reading (dBuV/m) + Factor* (dB)

*Factor includes antenna factor , cable loss and amplifier gain

Note 2: Margin (dB) = Emission level (dBuV/m) – Limit (dBuV/m).

Modulation	HT20	Test Freq. (MHz)	2437
Polarization	Horizontal		

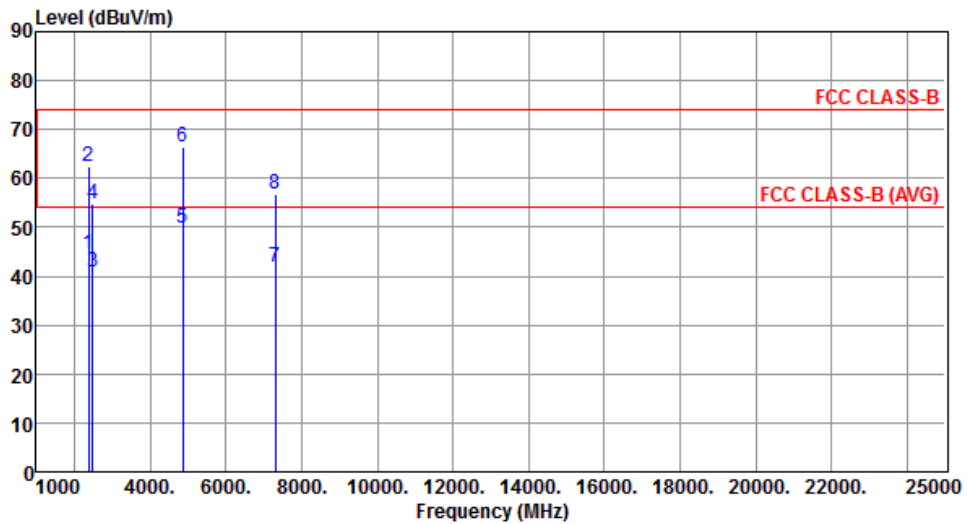

	Freq. MHz	Emission level dBuV/m	Limit dBuV/m	Margin dB	SA reading dBuV	Factor dB	Remark	ANT High cm	Turn Table deg
1	2390.00	44.39	54.00	-9.61	45.50	-1.11	Average	215	281
2	2390.00	62.40	74.00	-11.60	63.51	-1.11	Peak	215	281
3	2483.50	40.76	54.00	-13.24	41.38	-0.62	Average	215	281
4	2483.50	54.76	74.00	-19.24	55.38	-0.62	Peak	215	281
5	4874.00	49.92	54.00	-4.08	44.49	5.43	Average	274	166
6	4874.00	66.37	74.00	-7.63	60.94	5.43	Peak	274	166
7	7311.00	41.87	54.00	-12.13	31.61	10.26	Average	100	47
8	7311.00	56.79	74.00	-17.21	46.53	10.26	Peak	100	47

Note 1: Emission Level (dBuV/m) = SA Reading (dBuV/m) + Factor* (dB)

*Factor includes antenna factor , cable loss and amplifier gain

Note 2: Margin (dB) = Emission level (dBuV/m) – Limit (dBuV/m).

Modulation	HT20	Test Freq. (MHz)	2437
Polarization	Vertical		

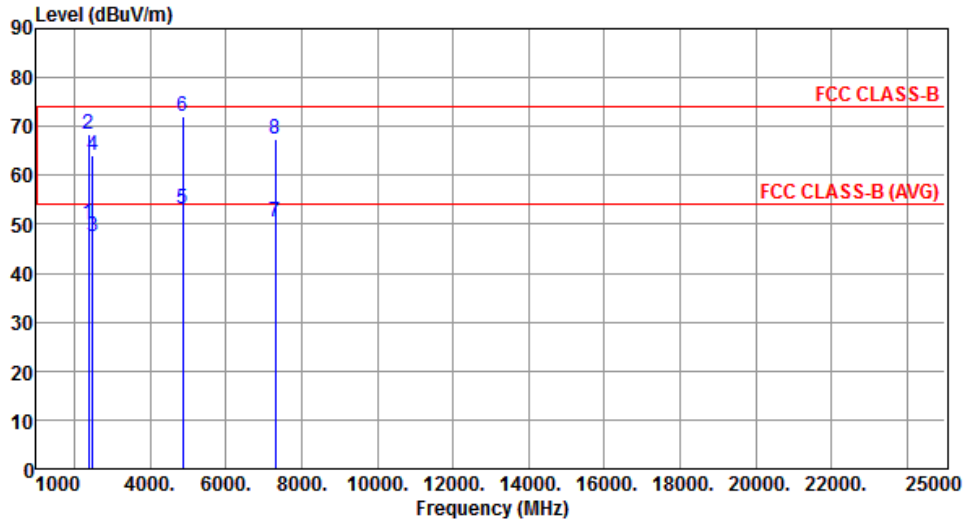

	Freq. MHz	Emission level dBuV/m	Limit dBuV/m	Margin dB	SA reading dBuV	Factor dB	Remark	ANT High cm	Turn Table deg
1	2390.00	50.17	54.00	-3.83	51.28	-1.11	Average	205	97
2	2390.00	68.58	74.00	-5.42	69.69	-1.11	Peak	205	97
3	2483.50	47.63	54.00	-6.37	48.25	-0.62	Average	205	97
4	2483.50	64.08	74.00	-9.92	64.70	-0.62	Peak	205	97
5	4874.00	52.99	54.00	-1.01	47.56	5.43	Average	100	63
6	4874.00	71.93	74.00	-2.07	66.50	5.43	Peak	100	63
7	7311.00	50.58	54.00	-3.42	40.32	10.26	Average	377	317
8	7311.00	67.54	74.00	-6.46	57.28	10.26	Peak	377	317

Note 1: Emission Level (dBuV/m) = SA Reading (dBuV/m) + Factor* (dB)

*Factor includes antenna factor , cable loss and amplifier gain

Note 2: Margin (dB) = Emission level (dBuV/m) – Limit (dBuV/m).

Modulation	HT20	Test Freq. (MHz)	2462
Polarization	Horizontal		

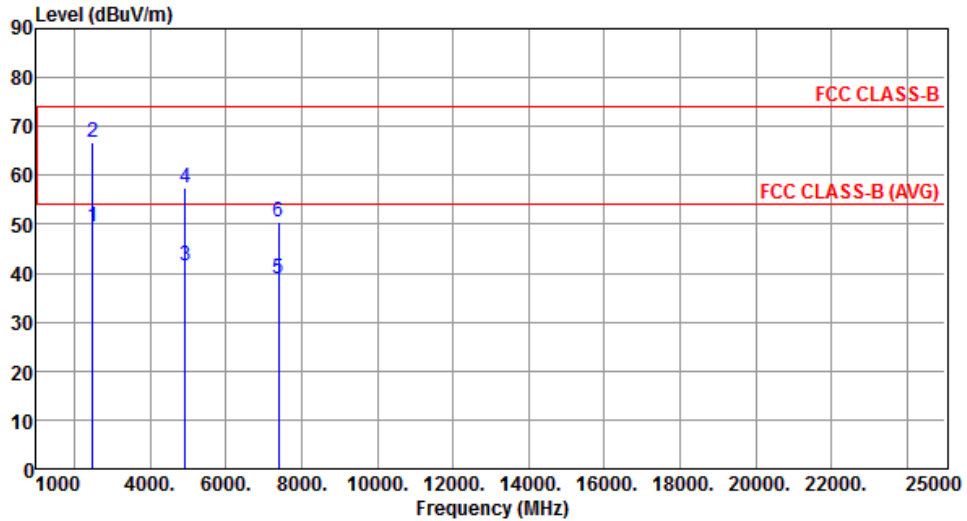

	Freq. MHz	Emission level dBuV/m	Limit dBuV/m	Margin dB	SA reading dBuV	Factor dB	Remark	ANT High cm	Turn Table deg
1	2483.50	49.35	54.00	-4.65	49.97	-0.62	Average	210	279
2	2483.50	66.67	74.00	-7.33	67.29	-0.62	Peak	210	279
3	4924.00	41.64	54.00	-12.36	36.09	5.55	Average	271	183
4	4924.00	57.30	74.00	-16.70	51.75	5.55	Peak	271	183
5	7386.00	38.87	54.00	-15.13	28.48	10.39	Average	189	314
6	7386.00	50.56	74.00	-23.44	40.17	10.39	Peak	189	314

Note 1: Emission Level (dBuV/m) = SA Reading (dBuV/m) + Factor* (dB)

*Factor includes antenna factor , cable loss and amplifier gain

Note 2: Margin (dB) = Emission level (dBuV/m) – Limit (dBuV/m).

Modulation	HT20	Test Freq. (MHz)	2462
Polarization	Vertical		

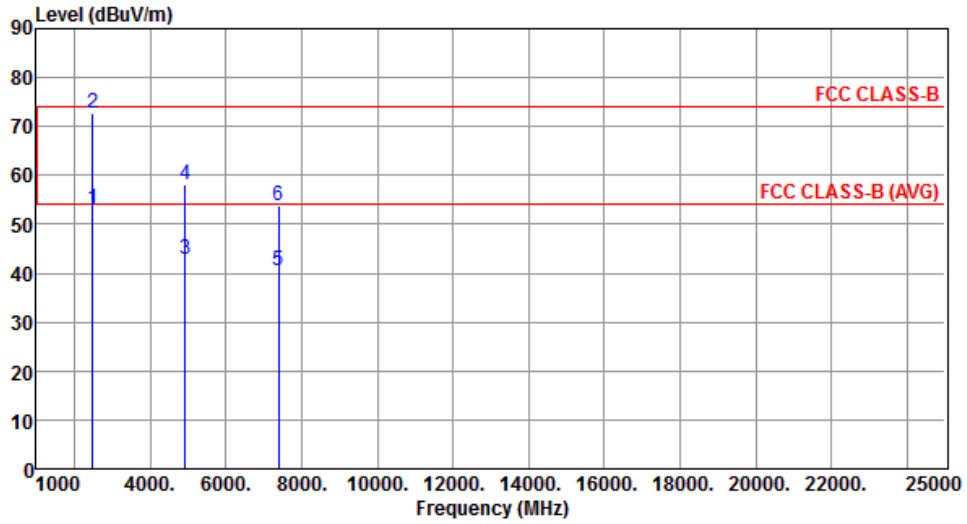

	Freq. MHz	Emission level dBuV/m	Limit dBuV/m	Margin dB	SA reading dBuV	Factor dB	Remark	ANT High cm	Turn Table deg
1	2483.50	52.97	54.00	-1.03	53.59	-0.62	Average	145	234
2	2483.50	72.65	74.00	-1.35	73.27	-0.62	Peak	145	234
3	4924.00	42.97	54.00	-11.03	37.42	5.55	Average	100	8
4	4924.00	58.14	74.00	-15.86	52.59	5.55	Peak	100	8
5	7386.00	40.42	54.00	-13.58	30.03	10.39	Average	100	339
6	7386.00	53.76	74.00	-20.24	43.37	10.39	Peak	100	339

Note 1: Emission Level (dBuV/m) = SA Reading (dBuV/m) + Factor* (dB)

*Factor includes antenna factor , cable loss and amplifier gain

Note 2: Margin (dB) = Emission level (dBuV/m) – Limit (dBuV/m).

3.5.8 Transmitter Radiated Unwanted Emissions (Above 1GHz) for HT40

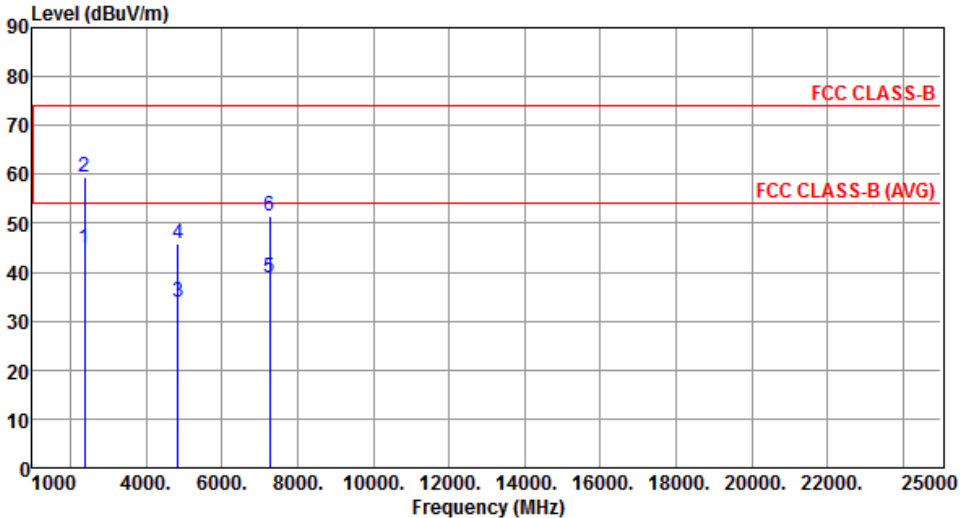
Modulation	HT40	Test Freq. (MHz)	2422						
Polarization	Horizontal								
									
	Freq.	Emission level	Limit	Margin	SA reading	Factor	Remark	ANT High	Turn Table
	MHz	dBUV/m	dBUV/m	dB	dBUV	dB		cm	deg
1	2390.00	44.86	54.00	-9.14	45.97	-1.11	Average	219	286
2	2390.00	59.50	74.00	-14.50	60.61	-1.11	Peak	219	286
3	4844.00	34.03	54.00	-19.97	28.67	5.36	Average	130	348
4	4844.00	45.67	74.00	-28.33	40.31	5.36	Peak	130	348
5	7266.00	38.74	54.00	-15.26	28.56	10.18	Average	262	196
6	7266.00	51.47	74.00	-22.53	41.29	10.18	Peak	262	196
<p>Note 1: Emission Level (dBUV/m) = SA Reading (dBUV/m) + Factor* (dB) *Factor includes antenna factor , cable loss and amplifier gain Note 2: Margin (dB) = Emission level (dBUV/m) – Limit (dBUV/m).</p>									

Modulation	HT40	Test Freq. (MHz)	2422
Polarization	Vertical		

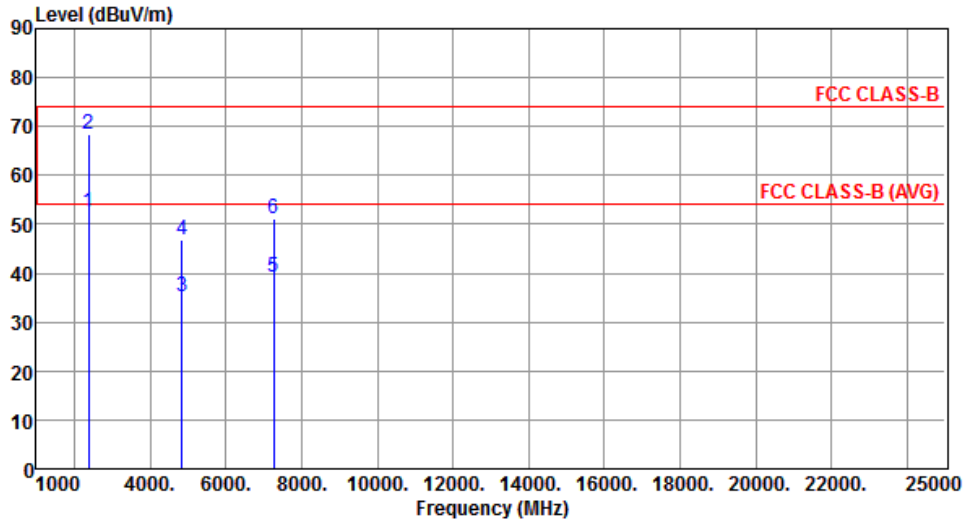

	Freq. MHz	Emission level dBuV/m	Limit dBuV/m	Margin dB	SA reading dBuV	Factor dB	Remark	ANT High cm	Turn Table deg
1	2390.00	52.64	54.00	-1.36	53.75	-1.11	Average	250	95
2	2390.00	68.42	74.00	-5.58	69.53	-1.11	Peak	250	95
3	4844.00	35.30	54.00	-18.70	29.94	5.36	Average	130	141
4	4844.00	46.94	74.00	-27.06	41.58	5.36	Peak	130	141
5	7266.00	39.04	54.00	-14.96	28.86	10.18	Average	161	215
6	7266.00	51.20	74.00	-22.80	41.02	10.18	Peak	161	215

Note 1: Emission Level (dBuV/m) = SA Reading (dBuV/m) + Factor* (dB)

*Factor includes antenna factor , cable loss and amplifier gain

Note 2: Margin (dB) = Emission level (dBuV/m) – Limit (dBuV/m).

Modulation	HT40	Test Freq. (MHz)	2437
Polarization	Horizontal		

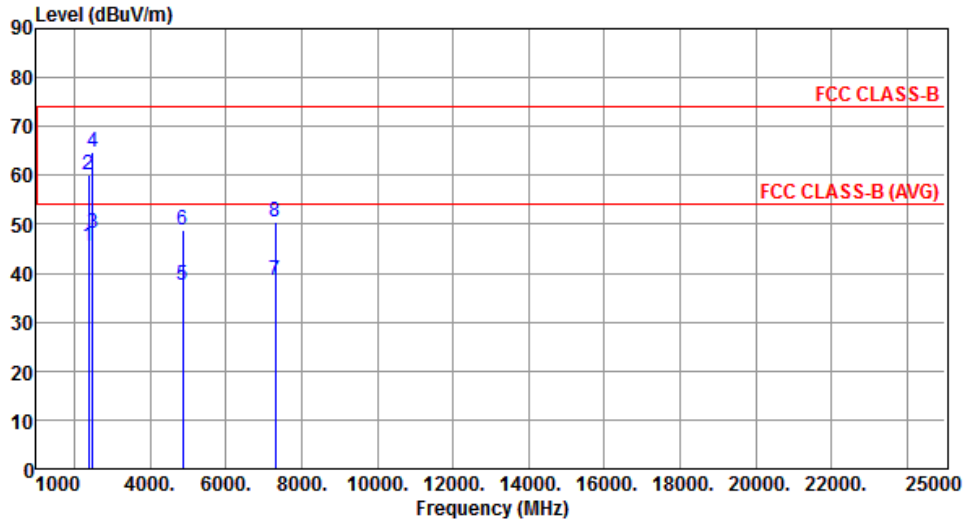

	Freq. MHz	Emission level dBuV/m	Limit dBuV/m	Margin dB	SA reading dBuV	Factor dB	Remark	ANT High cm	Turn Table deg
1	2390.00	45.52	54.00	-8.48	46.63	-1.11	Average	219	285
2	2390.00	60.16	74.00	-13.84	61.27	-1.11	Peak	219	285
3	2483.50	47.99	54.00	-6.01	48.61	-0.62	Average	219	285
4	2483.50	64.68	74.00	-9.32	65.30	-0.62	Peak	219	285
5	4874.00	37.36	54.00	-16.64	31.93	5.43	Average	140	76
6	4874.00	48.90	74.00	-25.10	43.47	5.43	Peak	140	76
7	7311.00	38.57	54.00	-15.43	28.31	10.26	Average	284	301
8	7311.00	50.61	74.00	-23.39	40.35	10.26	Peak	284	301

Note 1: Emission Level (dBuV/m) = SA Reading (dBuV/m) + Factor* (dB)

*Factor includes antenna factor , cable loss and amplifier gain

Note 2: Margin (dB) = Emission level (dBuV/m) – Limit (dBuV/m).

Modulation	HT40	Test Freq. (MHz)	2437
Polarization	Vertical		

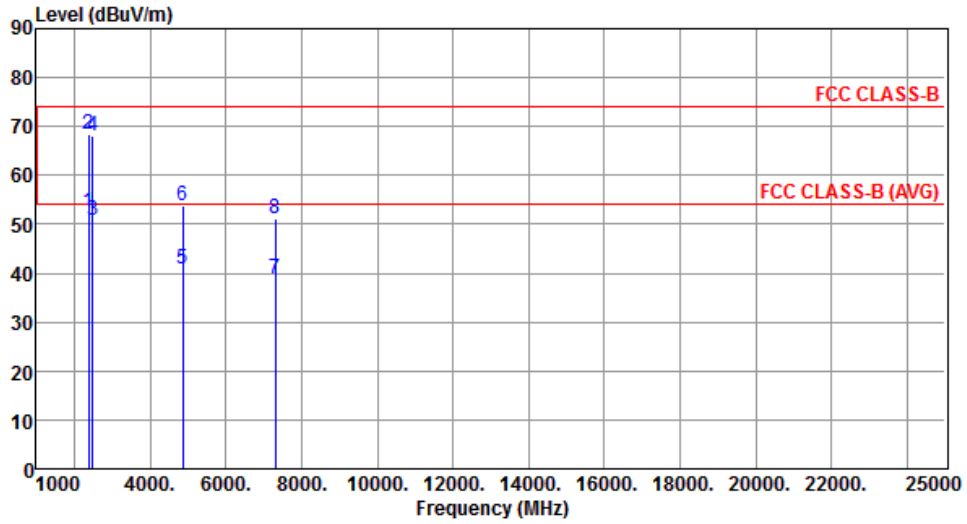

	Freq. MHz	Emission level dBuV/m	Limit dBuV/m	Margin dB	SA reading dBuV	Factor dB	Remark	ANT High cm	Turn Table deg
1	2390.00	52.51	54.00	-1.49	53.62	-1.11	Average	147	20
2	2390.00	68.27	74.00	-5.73	69.38	-1.11	Peak	147	20
3	2483.50	50.83	54.00	-3.17	51.45	-0.62	Average	245	97
4	2483.50	68.13	74.00	-5.87	68.75	-0.62	Peak	245	97
5	4874.00	40.93	54.00	-13.07	35.50	5.43	Average	120	7
6	4874.00	53.80	74.00	-20.20	48.37	5.43	Peak	120	7
7	7311.00	38.84	54.00	-15.16	28.58	10.26	Average	131	96
8	7311.00	51.00	74.00	-23.00	40.74	10.26	Peak	131	96

Note 1: Emission Level (dBuV/m) = SA Reading (dBuV/m) + Factor* (dB)

*Factor includes antenna factor , cable loss and amplifier gain

Note 2: Margin (dB) = Emission level (dBuV/m) – Limit (dBuV/m).

Modulation	HT40	Test Freq. (MHz)	2452
Polarization	Horizontal		

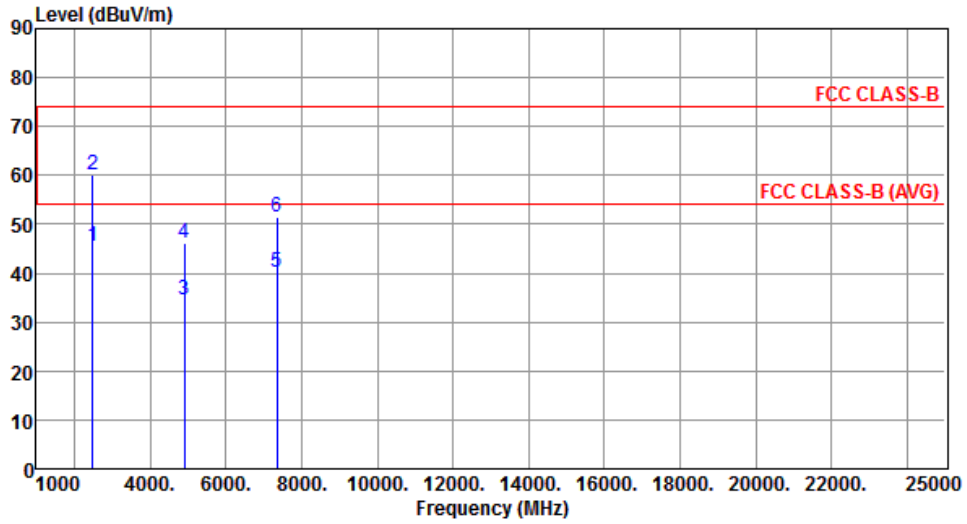

	Freq. MHz	Emission level dBuV/m	Limit dBuV/m	Margin dB	SA reading dBuV	Factor dB	Remark	ANT High cm	Turn Table deg
1	2483.50	45.38	54.00	-8.62	46.00	-0.62	Average	215	285
2	2483.50	60.20	74.00	-13.80	60.82	-0.62	Peak	215	285
3	4904.00	34.56	54.00	-19.44	29.05	5.51	Average	311	143
4	4904.00	46.19	74.00	-27.81	40.68	5.51	Peak	311	143
5	7356.00	40.18	54.00	-13.82	29.83	10.35	Average	130	72
6	7356.00	51.59	74.00	-22.41	41.24	10.35	Peak	130	72

Note 1: Emission Level (dBuV/m) = SA Reading (dBuV/m) + Factor* (dB)

*Factor includes antenna factor , cable loss and amplifier gain

Note 2: Margin (dB) = Emission level (dBuV/m) – Limit (dBuV/m).

Modulation	HT40	Test Freq. (MHz)	2452
Polarization	Vertical		

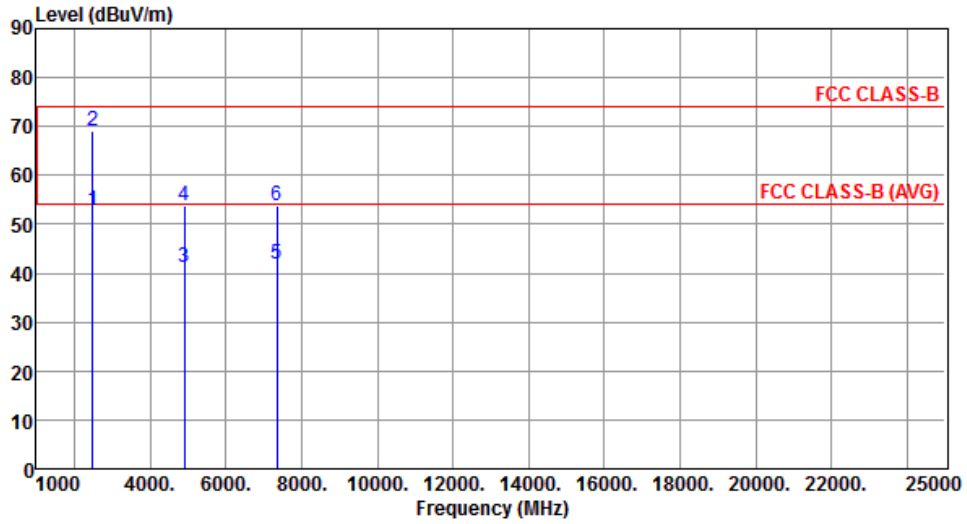

	Freq. MHz	Emission level dBuV/m	Limit dBuV/m	Margin dB	SA reading dBuV	Factor dB	Remark	ANT High cm	Turn Table deg
1	2483.50	52.96	54.00	-1.04	53.58	-0.62	Average	200	91
2	2483.50	69.16	74.00	-4.84	69.78	-0.62	Peak	200	91
3	4904.00	41.20	54.00	-12.80	35.69	5.51	Average	215	203
4	4904.00	53.87	74.00	-20.13	48.36	5.51	Peak	215	203
5	7356.00	41.87	54.00	-12.13	31.52	10.35	Average	191	125
6	7356.00	53.71	74.00	-20.29	43.36	10.35	Peak	191	125

Note 1: Emission Level (dBuV/m) = SA Reading (dBuV/m) + Factor* (dB)

*Factor includes antenna factor , cable loss and amplifier gain

Note 2: Margin (dB) = Emission level (dBuV/m) – Limit (dBuV/m).

3.6 Emissions in Non-Restricted Frequency Bands

3.6.1 Emissions in Non-Restricted Frequency Bands Limit

Peak power in any 100 kHz bandwidth outside of the authorized frequency band shall be attenuated by at least 20 dB relative to the maximum in-band peak PSD level in 100 kHz

3.6.2 Measuring Instruments

Refer a test equipment and calibration data table in this test report.

3.6.3 Test Procedures

Reference level measurement

1. Set RBW=100kHz, VBW = 300kHz , Detector = Peak, Sweep time = Auto
2. Trace = max hold , Allow Trace to fully stabilize
3. Use the peak marker function to determine the maximum PSD level

Emission level measurement

1. Set RBW=100kHz, VBW = 300kHz , Detector = Peak, Sweep time = Auto
2. Trace = max hold , Allow Trace to fully stabilize
3. Scan Frequency range is up to 25GHz
4. Use the peak marker function to determine the maximum amplitude level

3.6.4 Test Setup

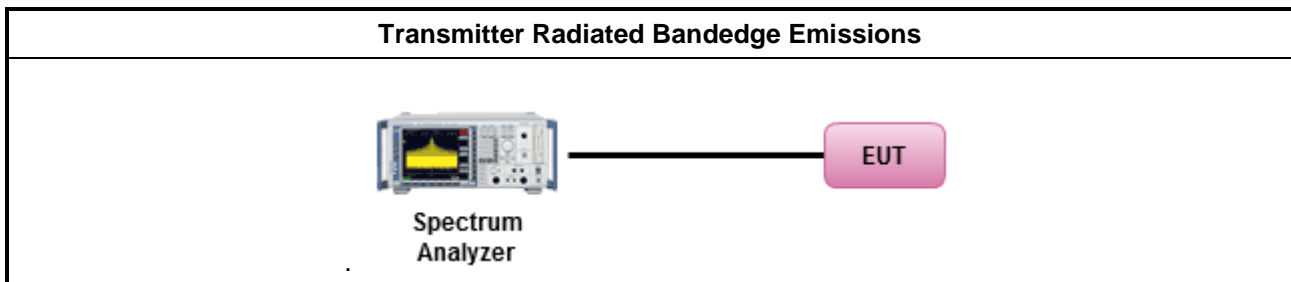

3.6.5 Test Result of Emissions in non-restricted frequency bands

This test item is performed on each TX output individually without summing or adding $10 \log(N_{ANT})$ since measurements are made relative to the in-band emissions on the individual outputs. Only worst test result of each operating mode is presented.

3.6.6 Unwanted Emissions into Non-Restricted Frequency Bands

802.11b

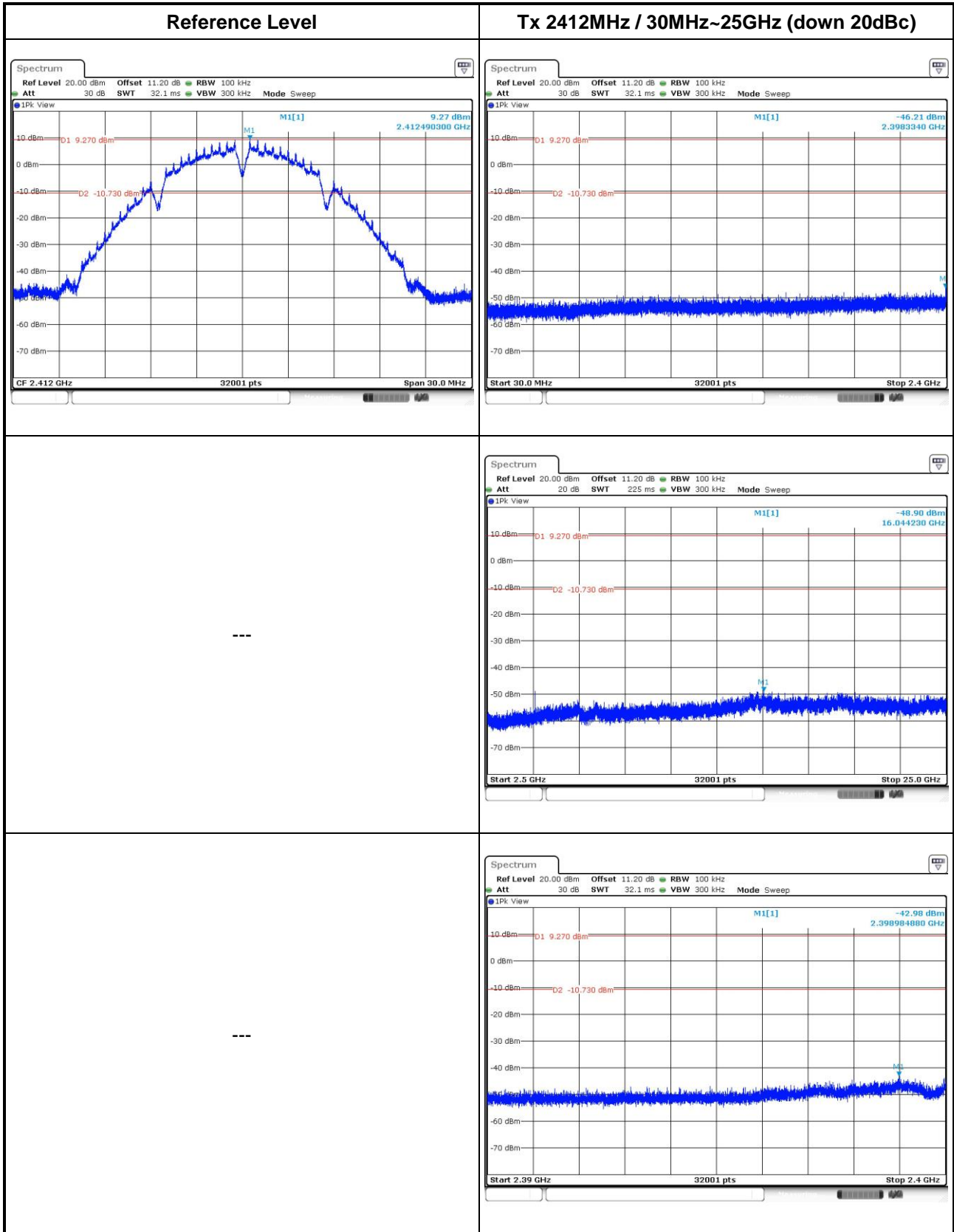

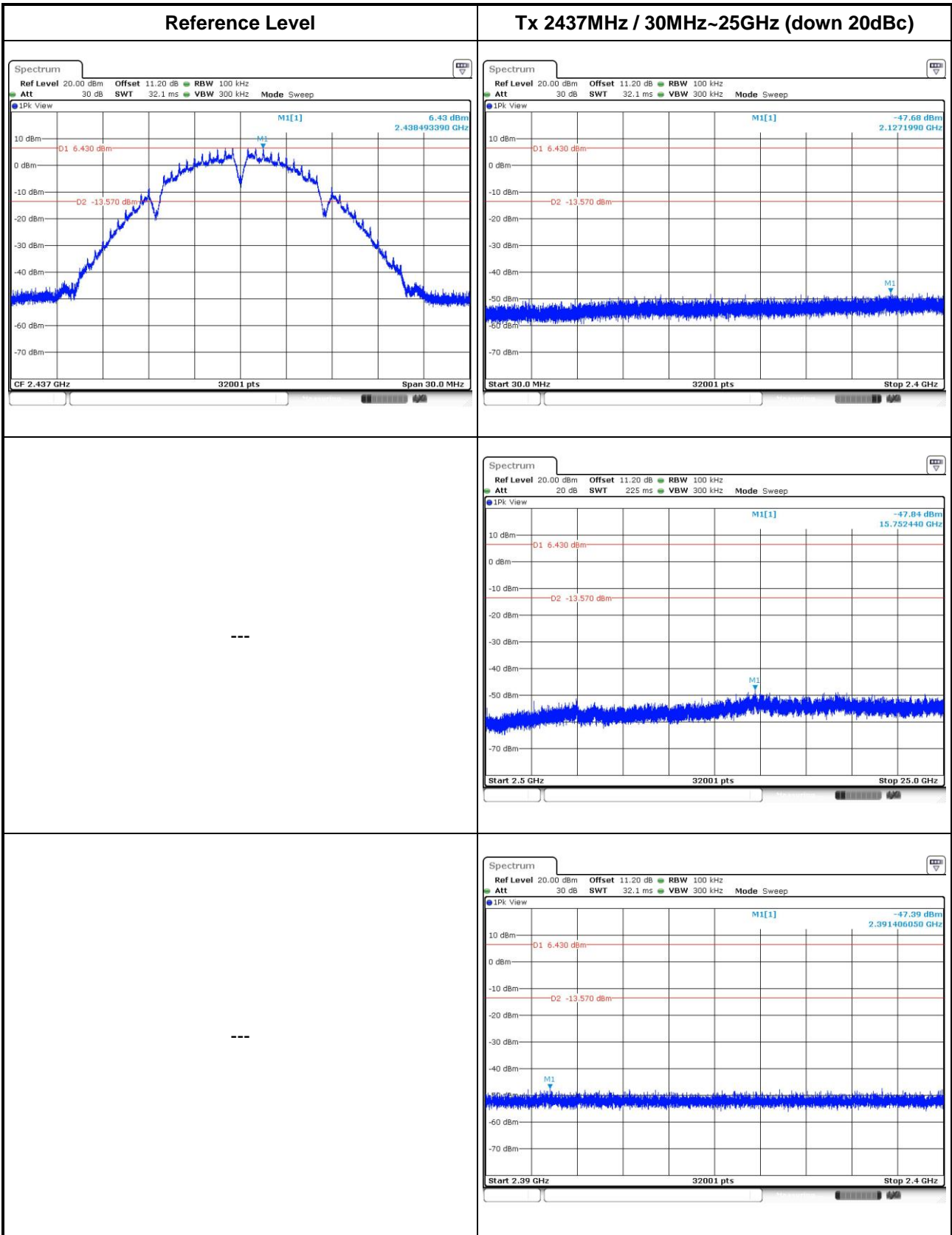

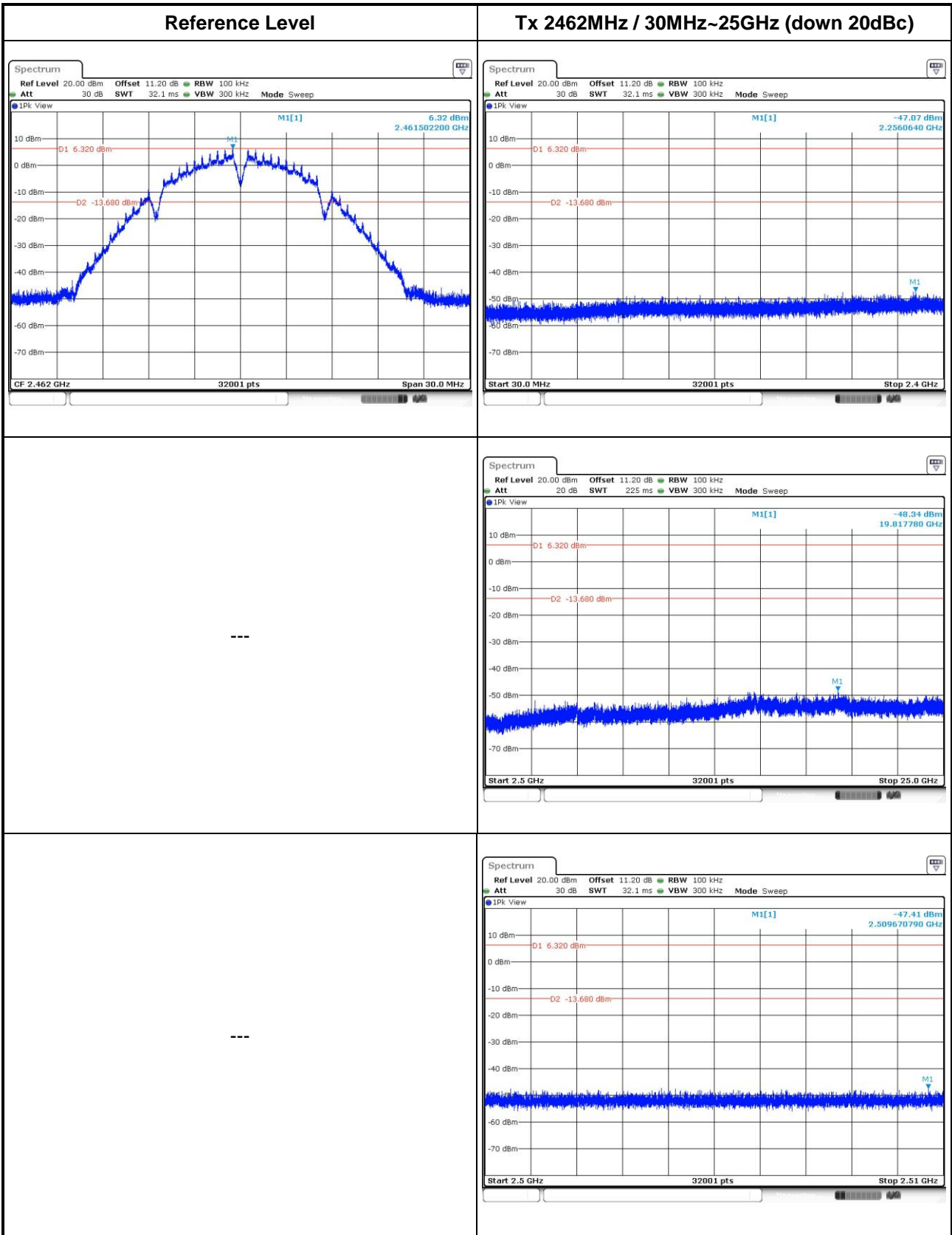

802.11g

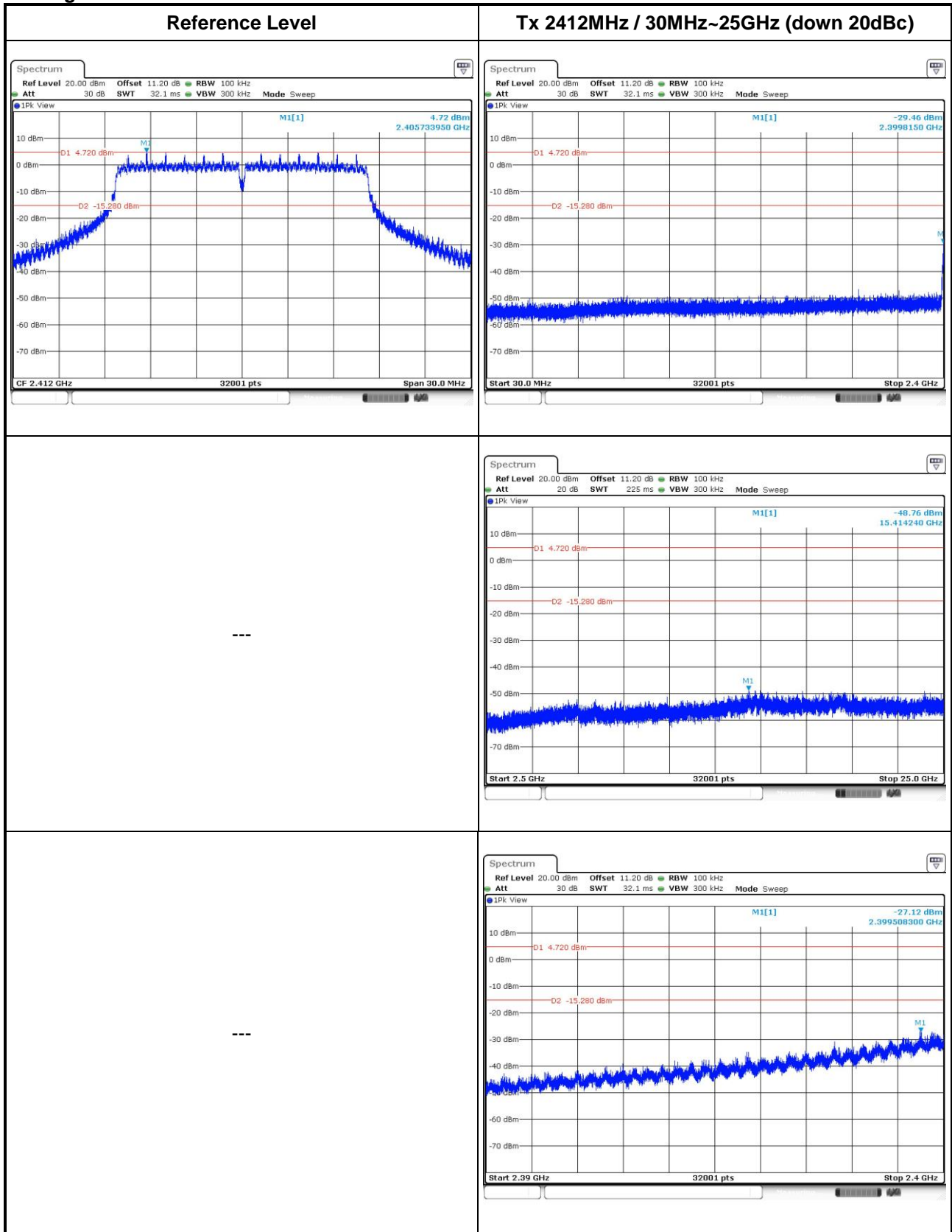

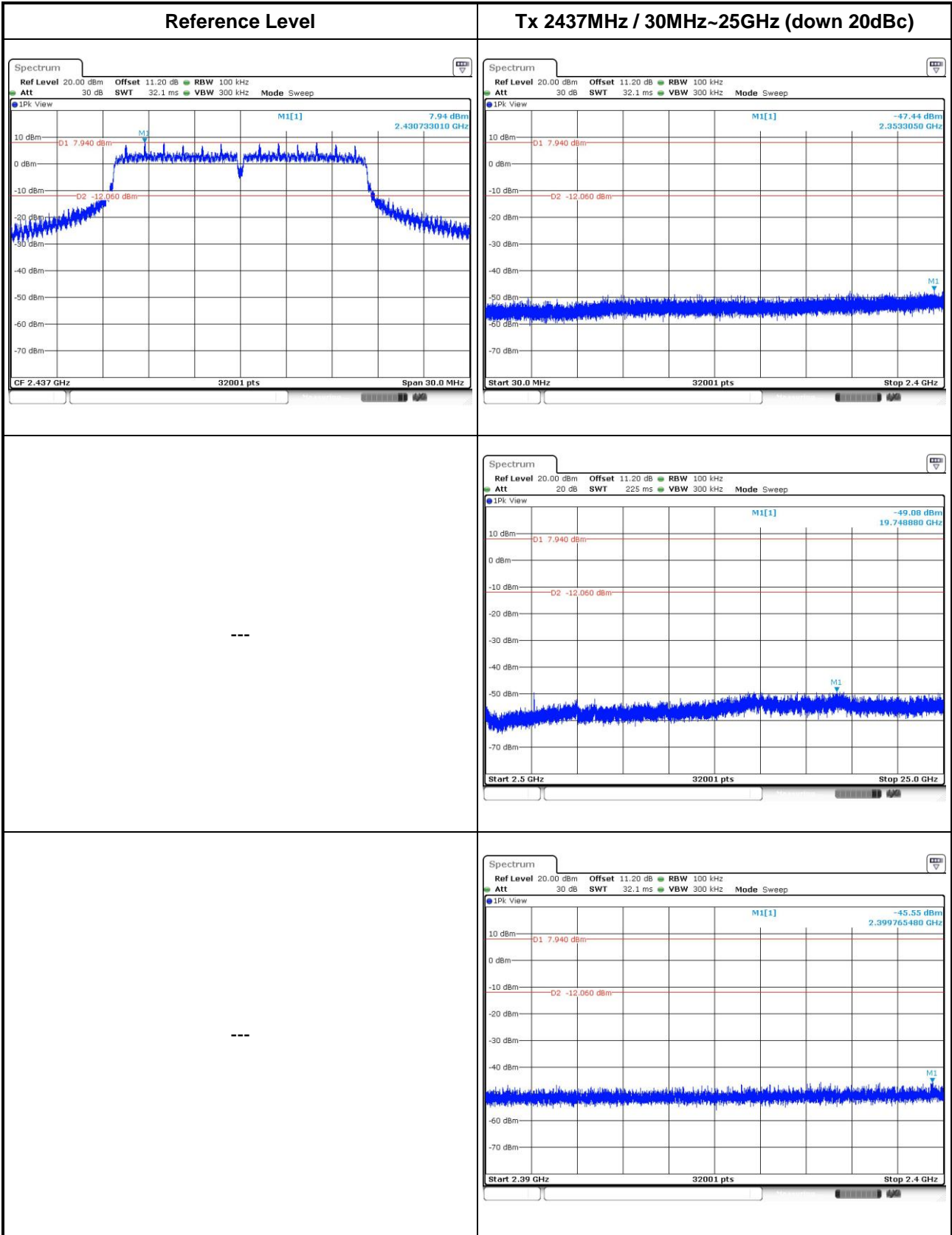

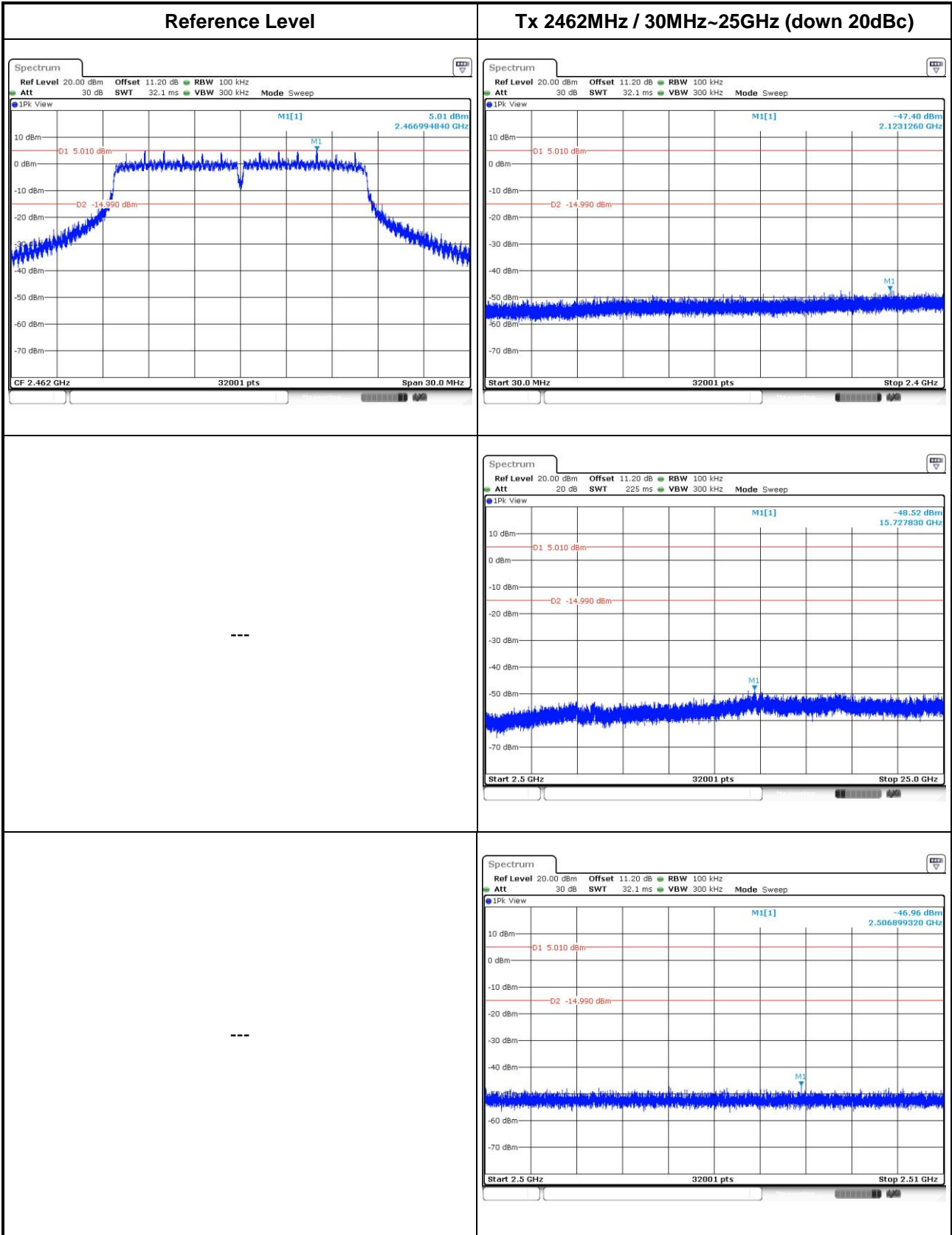

802.11n HT20

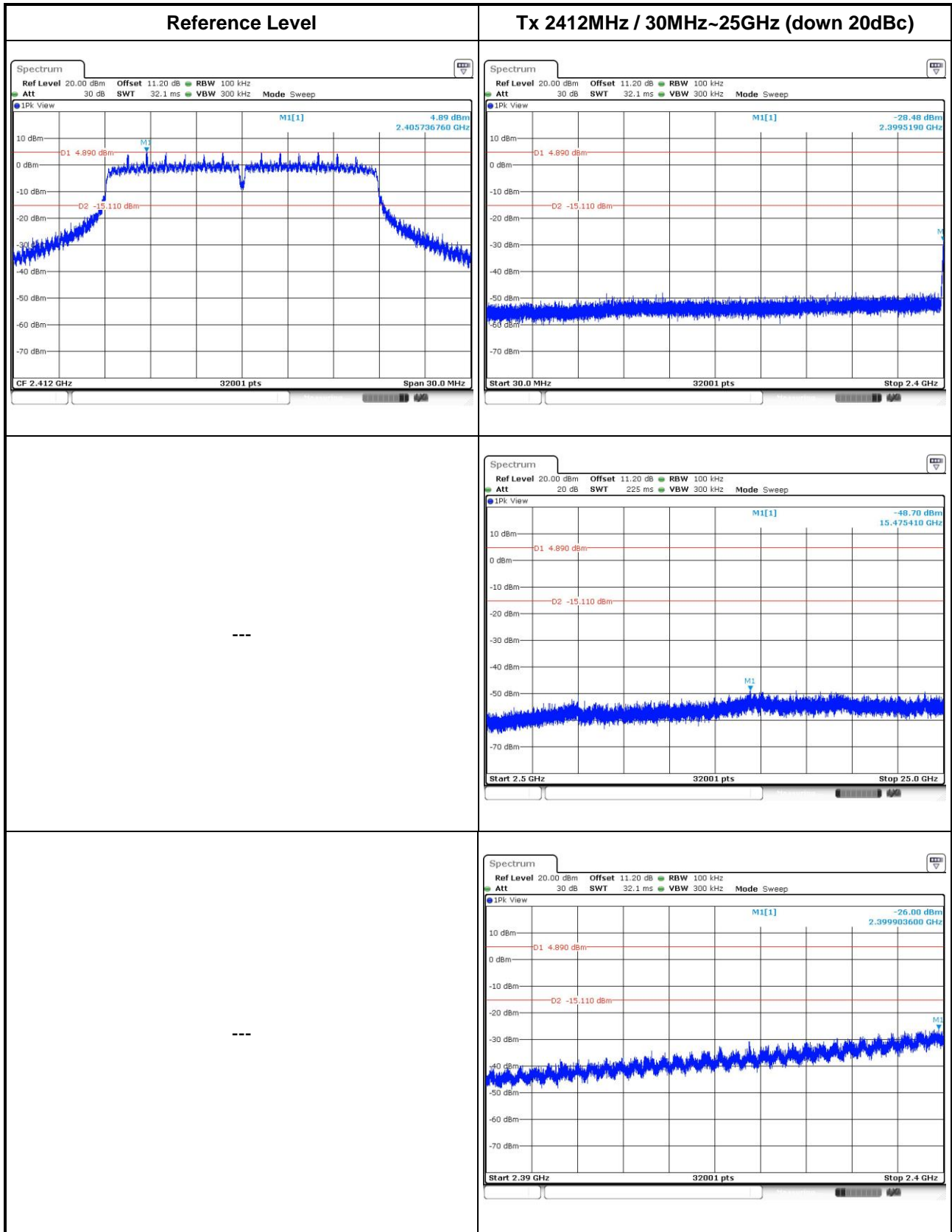

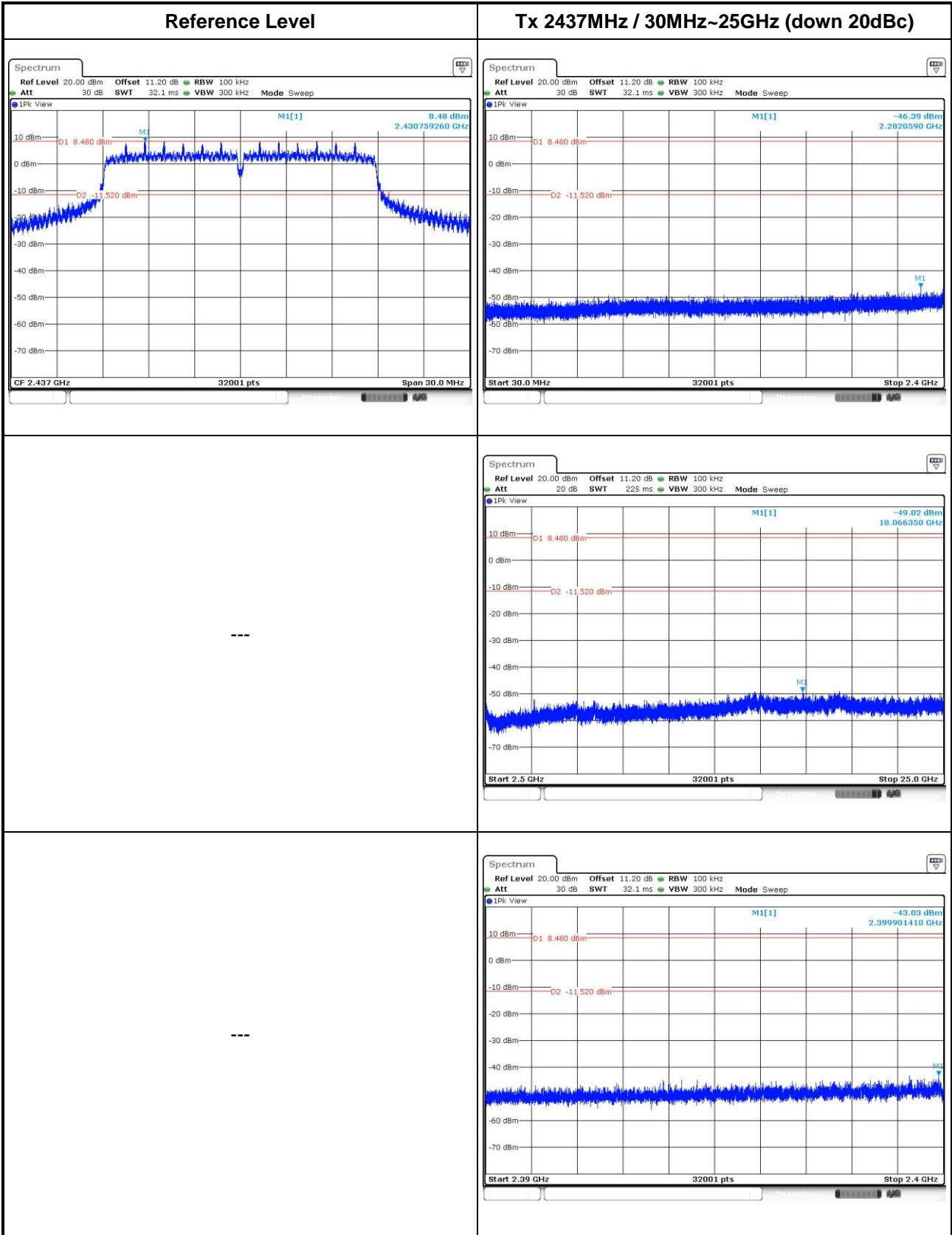

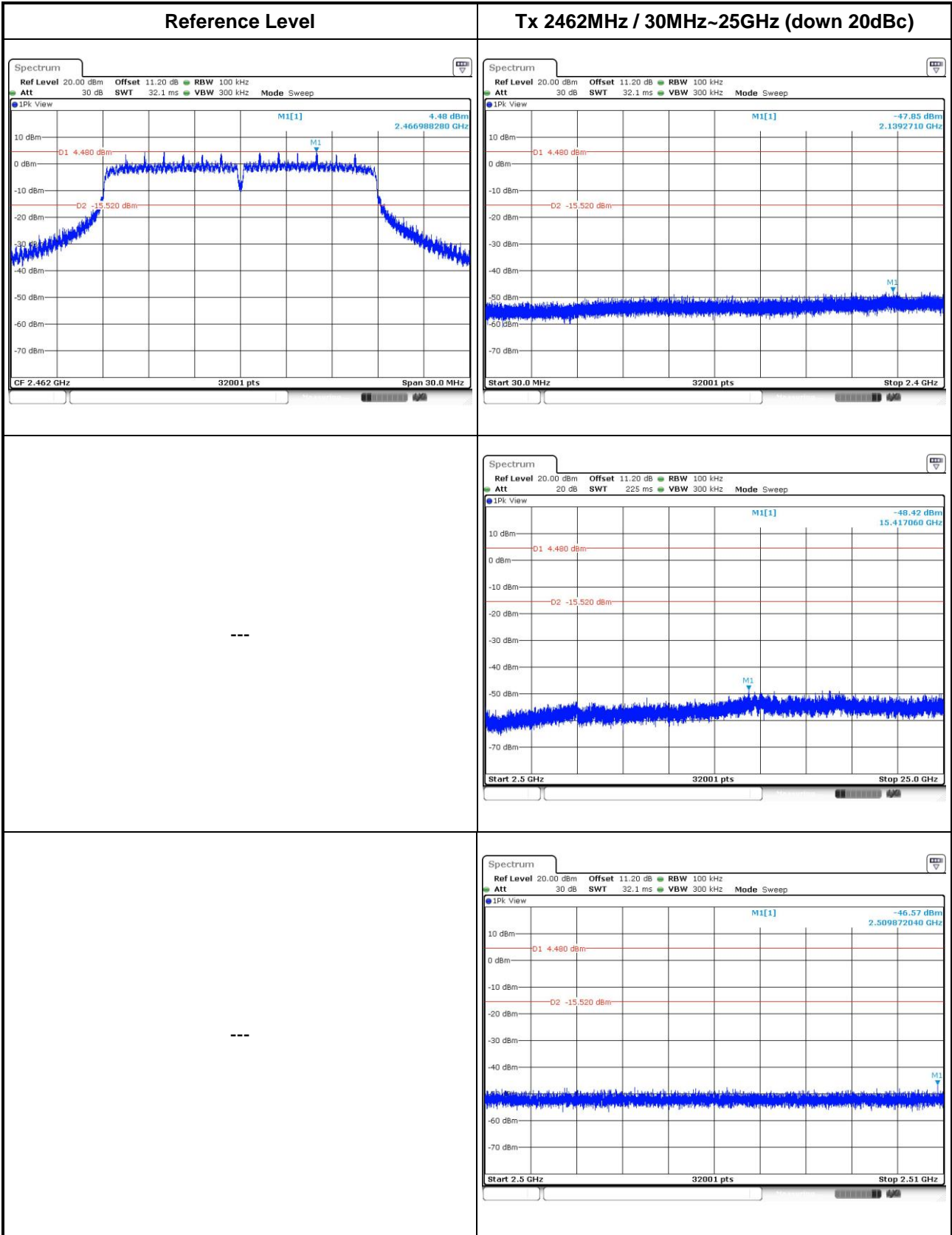

802.11n HT40

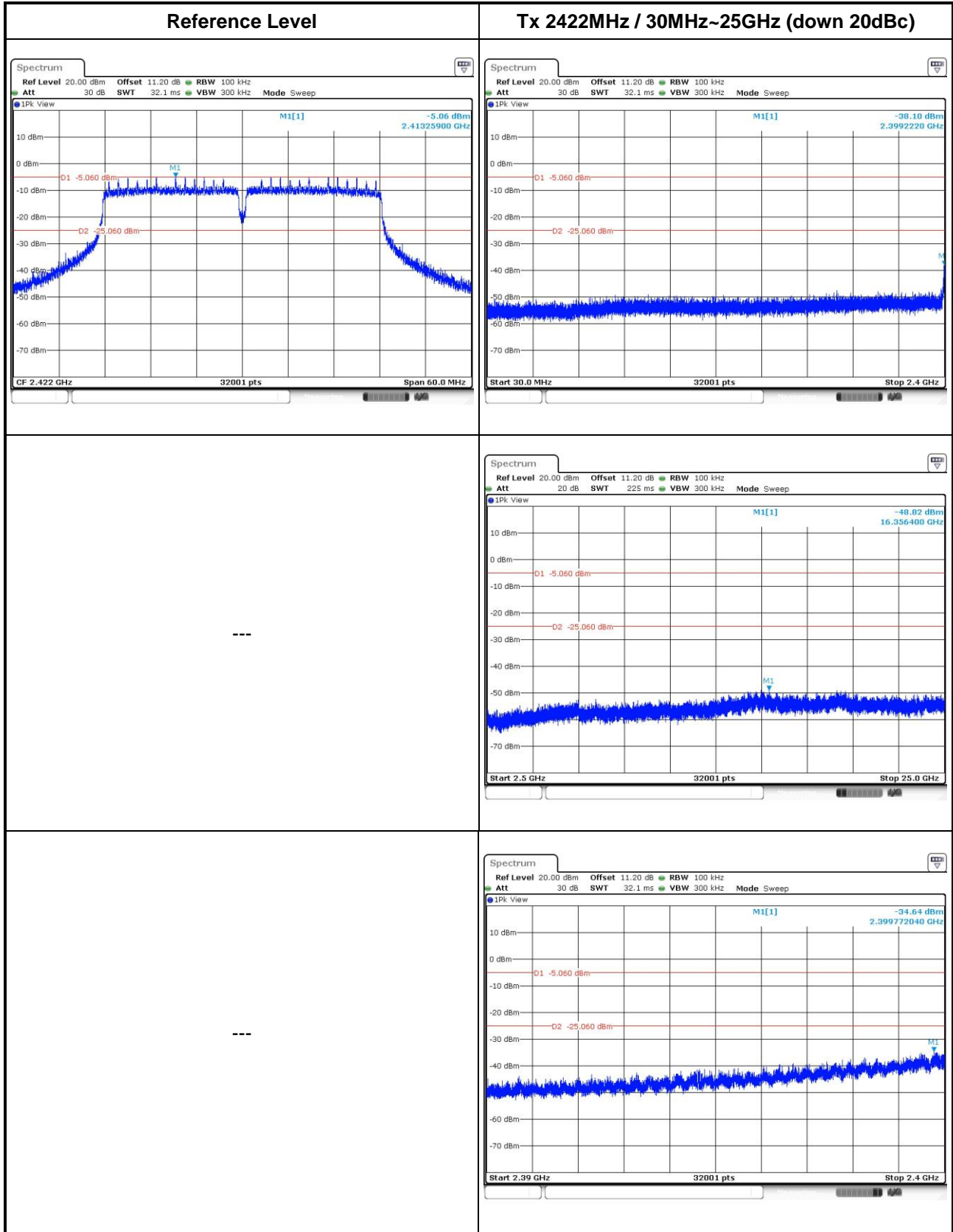

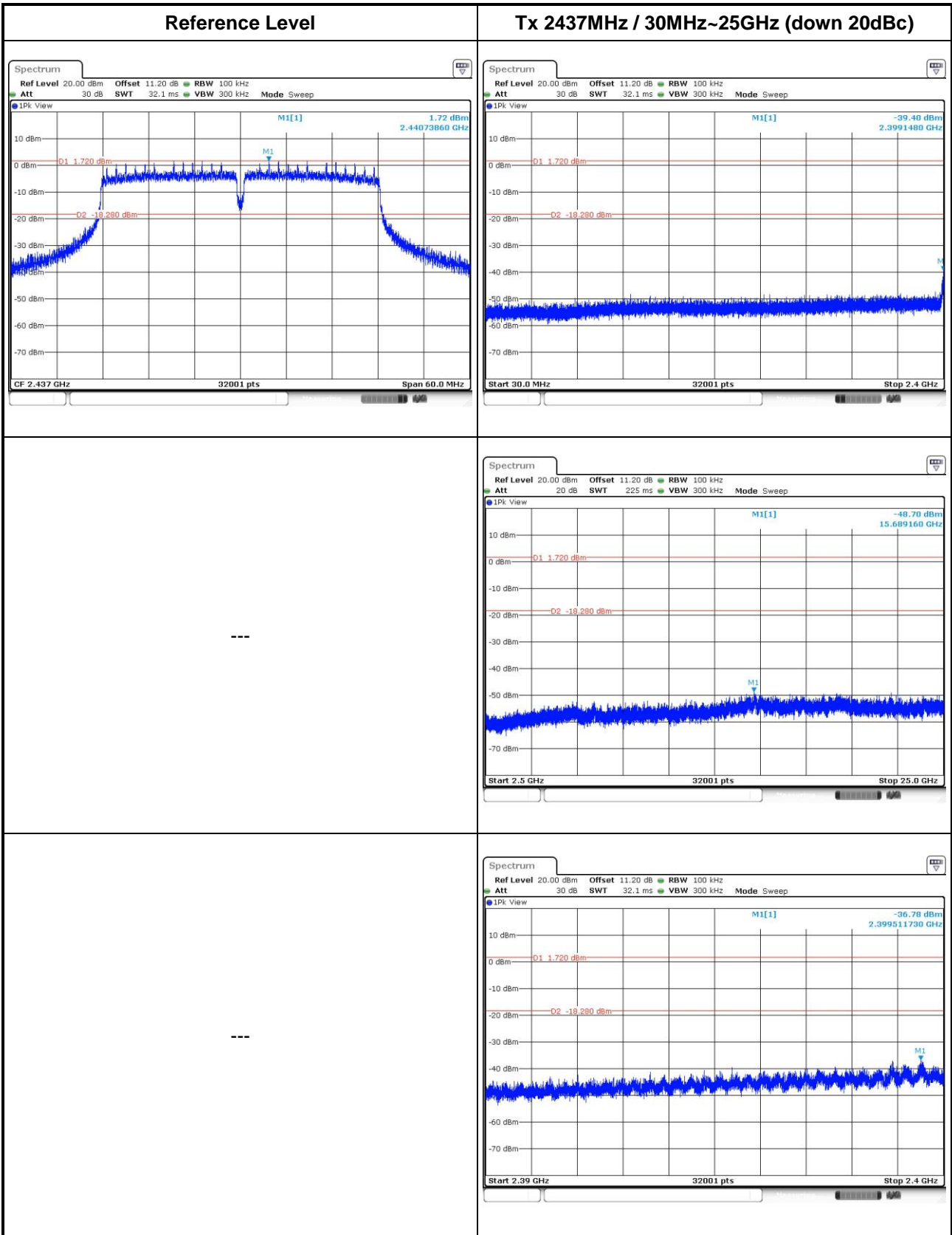

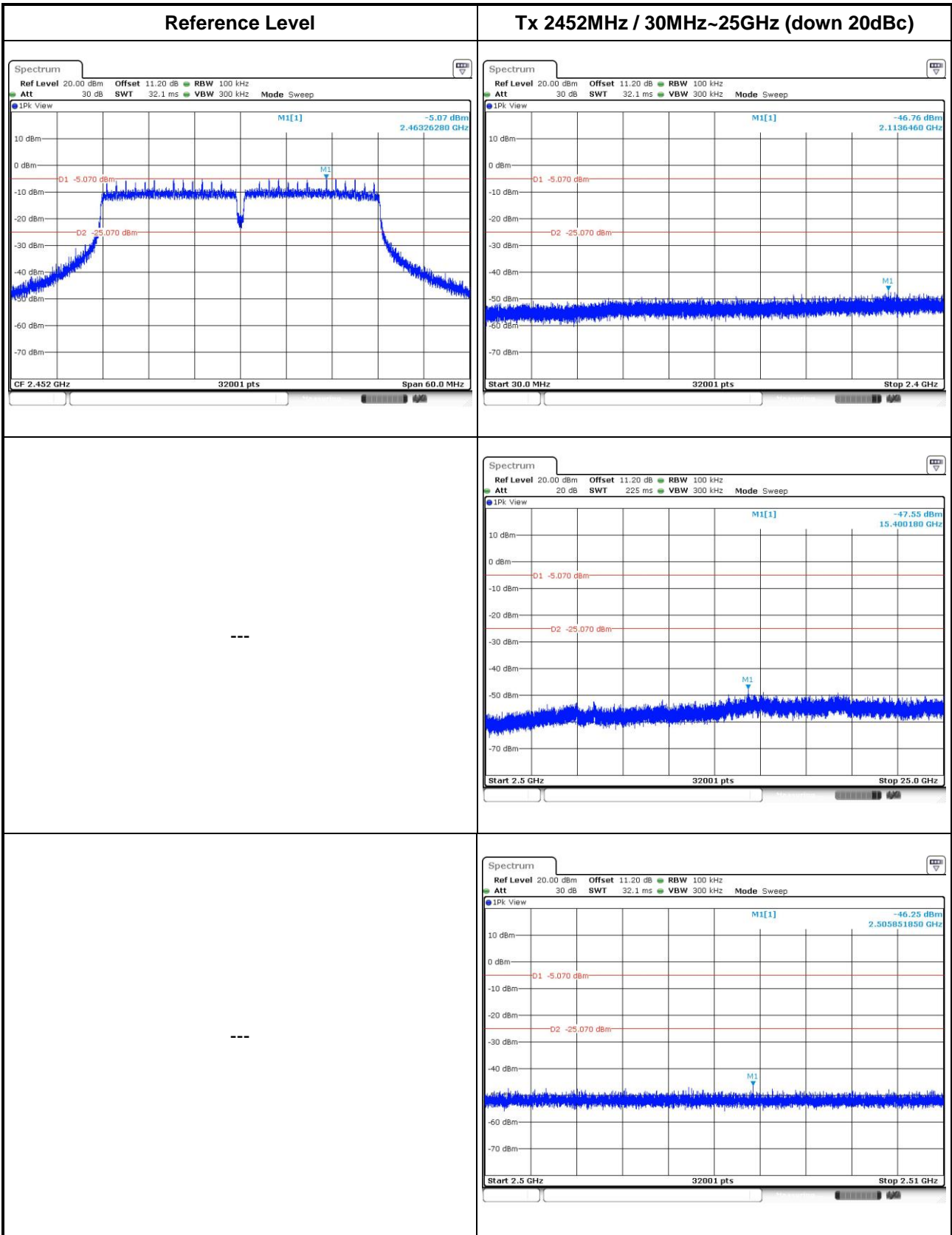

4 Test laboratory information

Established in 2012, ICC provides foremost EMC & RF Testing and advisory consultation services by our skilled engineers and technicians. Our services employ a wide variety of advanced edge test equipment and one of the widest certification extents in the business.

International Certification Corp (EMC and Wireless Communication Laboratory), it is our definitive objective is to institute long term, trust-based associations with our clients. The expectation we set up with our clients is based on outstanding service, practical expertise and devotion to a certified value structure. Our passion is to grant our clients with best EMC / RF services by oriented knowledgeable and accommodating staff.

Our Test sites are located at Linkou District and Kwei Shan District. Location map can be found on our website <http://www.icertifi.com.tw>.

Linkou

Tel: 886-2-2601-1640

No. 30-2, Ding Fwu Tsuen, Lin
Kou District, New Taipei City,
Taiwan, R.O.C.

Kwei Shan

Tel: 886-3-271-8666

No. 3-1, Lane 6, Wen San 3rd St.,
Kwei Shan District, Tao Yuan City
333, Taiwan, R.O.C.

Kwei Shan Site II

Tel: 886-3-271-8640

No. 14-1, Lane 19, Wen San 3rd
St., Kwei Shan District, Tao Yuan
City 333, Taiwan, R.O.C.

If you have any suggestion, please feel free to contact us as below information.

Tel: 886-3-271-8666

Fax: 886-3-318-0155

Email: ICC_Service@icertifi.com.tw

==END==