



RADIO TEST REPORT

Test Report No. : 13745639H-A-R1

Applicant : Panasonic Avionics Corporation
Type of EUT : Bluetooth v5 Dual-Mode USB Module
Model Number of EUT : R8U3FJ8326Z
FCC ID : U6YBT850
Test regulation : FCC Part 15 Subpart C: 2021
For Permissive Change
*Bluetooth Low Energy parts
Test Result : Complied (Refer to SECTION 3)
*Radiated Spurious Emission test only

1. This test report shall not be reproduced in full or partial, without the written approval of UL Japan, Inc.
2. The results in this report apply only to the sample tested.
3. This sample tested is in compliance with the limits of the above regulation.
4. The test results in this test report are traceable to the national or international standards.
5. This test report must not be used by the customer to claim product certification, approval, or endorsement by the A2LA accreditation body.
6. This test report covers Radio technical requirements.
It does not cover administrative issues such as Manual or non-Radio test related Requirements. (if applicable)
7. The all test items in this test report are conducted by UL Japan, Inc. Ise EMC Lab.
8. The opinions and the interpretations to the result of the description in this report are outside scopes where UL Japan, Inc. has been accredited.
9. The information provided from the customer for this report is identified in Section 1.
10. This report is a revised version of 13745639H-A. 13745639H-A is replaced with this report.

Date of test: August 29 and 30, 2021

Representative test engineer: 
Nachi Konegawa
Engineer

Approved by: 
Takumi Shimada
Engineer



CERTIFICATE 5107.02

- The testing in which "Non-accreditation" is displayed is outside the accreditation scopes in UL Japan, Inc.
 There is no testing item of "Non-accreditation".

UL Japan, Inc.

Ise EMC Lab.

4383-326 Asama-cho, Ise-shi, Mie-ken 516-0021 JAPAN

Telephone : +81 596 24 8999

Facsimile : +81 596 24 8124

REVISION HISTORY

Original Test Report No.: 13745639H-A

Revision	Test report No.	Date	Page revised	Contents
- (Original)	13745639H-A	September 27, 2021	-	-
1	13745639H-A-R1	October 20, 2021	P1, 5, 9	Corrected Model Number of EUT; R8U4FJ5164Z ↓ R8U3FJ8326Z

UL Japan, Inc.

Ise EMC Lab.

4383-326 Asama-cho, Ise-shi, Mie-ken 516-0021 JAPAN

Telephone : +81 596 24 8999

Facsimile : +81 596 24 8124

Reference: Abbreviations (Including words undescribed in this report)

A2LA	The American Association for Laboratory Accreditation	MCS	Modulation and Coding Scheme
AC	Alternating Current	MRA	Mutual Recognition Arrangement
AFH	Adaptive Frequency Hopping	N/A	Not Applicable
AM	Amplitude Modulation	NIST	National Institute of Standards and Technology
Amp, AMP	Amplifier	NS	No signal detect.
ANSI	American National Standards Institute	NSA	Normalized Site Attenuation
Ant, ANT	Antenna	NVLAP	National Voluntary Laboratory Accreditation Program
AP	Access Point	OBW	Occupied Band Width
ASK	Amplitude Shift Keying	OFDM	Orthogonal Frequency Division Multiplexing
Atten., ATT	Attenuator	P/M	Power meter
AV	Average	PCB	Printed Circuit Board
BPSK	Binary Phase-Shift Keying	PER	Packet Error Rate
BR	Bluetooth Basic Rate	PHY	Physical Layer
BT	Bluetooth	PK	Peak
BT LE	Bluetooth Low Energy	PN	Pseudo random Noise
BW	BandWidth	PRBS	Pseudo-Random Bit Sequence
Cal Int	Calibration Interval	PSD	Power Spectral Density
CCK	Complementary Code Keying	QAM	Quadrature Amplitude Modulation
Ch., CH	Channel	QP	Quasi-Peak
CISPR	Comite International Special des Perturbations Radioelectriques	QPSK	Quadri-Phase Shift Keying
CW	Continuous Wave	RBW	Resolution Band Width
DBPSK	Differential BPSK	RDS	Radio Data System
DC	Direct Current	RE	Radio Equipment
D-factor	Distance factor	RF	Radio Frequency
DFS	Dynamic Frequency Selection	RMS	Root Mean Square
DQPSK	Differential QPSK	RSS	Radio Standards Specifications
DSSS	Direct Sequence Spread Spectrum	Rx	Receiving
EDR	Enhanced Data Rate	SA, S/A	Spectrum Analyzer
EIRP, e.i.r.p.	Equivalent Isotropically Radiated Power	SG	Signal Generator
EMC	ElectroMagnetic Compatibility	SVSWR	Site-Voltage Standing Wave Ratio
EMI	ElectroMagnetic Interference	TR	Test Receiver
EN	European Norm	Tx	Transmitting
ERP, e.r.p.	Effective Radiated Power	VBW	Video BandWidth
EU	European Union	Vert.	Vertical
EUT	Equipment Under Test	WLAN	Wireless LAN
Fac.	Factor		
FCC	Federal Communications Commission		
FHSS	Frequency Hopping Spread Spectrum		
FM	Frequency Modulation		
Freq.	Frequency		
FSK	Frequency Shift Keying		
GFSK	Gaussian Frequency-Shift Keying		
GNSS	Global Navigation Satellite System		
GPS	Global Positioning System		
Hori.	Horizontal		
ICES	Interference-Causing Equipment Standard		
IEC	International Electrotechnical Commission		
IEEE	Institute of Electrical and Electronics Engineers		
IF	Intermediate Frequency		
ILAC	International Laboratory Accreditation Conference		
ISED	Innovation, Science and Economic Development Canada		
ISO	International Organization for Standardization		
JAB	Japan Accreditation Board		
LAN	Local Area Network		
LIMS	Laboratory Information Management System		

UL Japan, Inc.

Ise EMC Lab.

4383-326 Asama-cho, Ise-shi, Mie-ken 516-0021 JAPAN

Telephone : +81 596 24 8999

Facsimile : +81 596 24 8124

CONTENTS	PAGE
SECTION 1: Customer information.....	5
SECTION 2: Equipment under test (EUT).....	5
SECTION 3: Test specification, procedures & results.....	6
SECTION 4: Operation of EUT during testing.....	9
SECTION 5: Radiated Spurious Emission	10
APPENDIX 1: Test data	12
Radiated Spurious Emission	13
APPENDIX 2: Test instruments	19
APPENDIX 3: Photographs of test setup	20
Radiated Spurious Emission	20
Worst Case Position	21

SECTION 1: Customer information

Company Name : Panasonic Avionics Corporation
Address : 26200 Enterprise Way Lake Forest, CA 92630 USA
Telephone Number : +1-949-672-2000
Facsimile Number : +1-949-462-7100
Contact Person : Steve Dang

The information provided from the customer is as follows;

- Applicant, Type of EUT, Model Number of EUT, FCC ID on the cover and other relevant pages
- Operating/Test Mode(s) (Mode(s)) on all the relevant pages
- SECTION 1: Customer information
- SECTION 2: Equipment under test (EUT) other than the Receipt Date
- SECTION 4: Operation of EUT during testing

* The laboratory is exempted from liability of any test results affected from the above information in SECTION 2 and 4.

SECTION 2: Equipment under test (EUT)

2.1 Identification of EUT

Type : Bluetooth v5 Dual-Mode USB Module
Model Number : R8U3FJ8326Z
Serial Number : Refer to SECTION 4.2
Rating : DC 3.3 V
Receipt Date : August 23, 2021
Country of Mass-production : Japan
Condition : Engineering prototype
(Not for Sale: This sample is equivalent to mass-produced items.)
Modification : No Modification by the test lab.

2.2 Product Description

Model: R8U3FJ8326Z (referred to as the EUT in this report) is a Bluetooth v5 Dual-Mode USB Module.

Radio Specification

[Bluetooth (Classic Bluetooth and BLE)]

Radio Type : Transceiver
Frequency of Operation : 2402 MHz - 2480 MHz
Modulation : BT: FHSS (GFSK, $\pi/4$ DQPSK, 8DPSK)
LE: GFSK
Channel spacing : BT: 1 MHz
LE: 2 MHz
Antenna type : Microstrip Antenna
Antenna Gain : 2.7 dBi
Clock frequency (Maximum) : 40 MHz

* This test report applies to Bluetooth Low Energy function (2402 MHz to 2480 MHz) except for Bluetooth with EDR.

<Contents of the change from previous model>

Antenna gain was changed 1.5 dBi to 2.7 dBi.

UL Japan, Inc.

Ise EMC Lab.

4383-326 Asama-cho, Ise-shi, Mie-ken 516-0021 JAPAN

Telephone : +81 596 24 8999

Facsimile : +81 596 24 8124

SECTION 3: Test specification, procedures & results

3.1 Test Specification

Test Specification : FCC Part 15 Subpart C
FCC Part 15 final revised on May 3, 2021 and effective July 2, 2021

Title : FCC 47 CFR Part 15 Radio Frequency Device Subpart C Intentional Radiators
Section 15.207 Conducted limits
Section 15.247 Operation within the bands 902-928 MHz, 2400-2483.5 MHz,
and 5725-5850 MHz

3.2 Procedures and results

Item	Test Procedure	Specification	Worst margin	Results	Remarks
Spurious Emission Restricted Band Edges	FCC: KDB 558074 D01 15.247 Meas Guidance v05r02	FCC: Section15.247(d)	6.8 dB 84.0 MHz / 83.9 MHz, Vertical, QP / PK	Complied a)	Radiated (above 30 MHz) *1)
	ISED: RSS-Gen 6.13	ISED: RSS-247 5.5 RSS-Gen 8.9 RSS-Gen 8.10			

Note: UL Japan, Inc.'s EMI Work Procedures No. 13-EM-W0420 and 13-EM-W0422.

*1) Radiated test was selected over 30 MHz based on section 15.247(d) and KDB 558074 D01 15.247 Meas Guidance v05r02 8.5 and 8.6.

a) Refer to APPENDIX 1 (data of Radiated Spurious Emission)

Symbols:

Complied The data of this test item has enough margin, more than the measurement uncertainty.

Complied# The data of this test item meets the limits unless the measurement uncertainty is taken into consideration.

* In case any questions arise about test procedure, ANSI C63.10: 2013 is also referred.

FCC Part 15.31 (e)

This EUT provides stable voltage constantly to RF Module regardless of input voltage.
Therefore, this EUT complies with the requirement.

FCC Part 15.203/212 Antenna requirement

The antenna is not removable from the EUT.
Therefore, the equipment complies with the antenna requirement of Section 15.203.

3.3 Addition to standard

No addition, exclusion nor deviation has been made from the standard.

3.4 Uncertainty

There is no applicable rule of uncertainty in this applied standard. Therefore, the results are derived depending on whether or not laboratory uncertainty is applied.

The following uncertainties have been calculated to provide a confidence level of 95 % using a coverage factor $k=2$.

Ise EMC Lab.

Radiated emission

Measurement distance	Frequency range	Uncertainty (+/-)
3 m	9 kHz to 30 MHz	3.3 dB
10 m		3.2 dB
3 m	30 MHz to 200 MHz (Horizontal)	4.8 dB
	(Vertical)	5.0 dB
	200 MHz to 1000 MHz (Horizontal)	5.2 dB
	(Vertical)	6.3 dB
10 m	30 MHz to 200 MHz (Horizontal)	4.8 dB
	(Vertical)	4.8 dB
	200 MHz to 1000 MHz (Horizontal)	5.0 dB
	(Vertical)	5.0 dB
3 m	1 GHz to 6 GHz	4.9 dB
	6 GHz to 18 GHz	5.2 dB
1 m	10 GHz to 26.5 GHz	5.5 dB
	26.5 GHz to 40 GHz	5.5 dB
10 m	1 GHz to 18 GHz	5.2 dB

3.5 Test Location

UL Japan, Inc. Ise EMC Lab.

*A2LA Certificate Number: 5107.02 / FCC Test Firm Registration Number: 199967

ISED Lab Company Number: 2973C / CAB identifier: JP0002

4383-326 Asama-cho, Ise-shi, Mie-ken 516-0021 JAPAN

Telephone: +81 596 24 8999, Facsimile: +81 596 24 8124

Test site	Width x Depth x Height (m)	Size of reference ground plane (m) / horizontal conducting plane	Other rooms	Maximum measurement distance
No.1 semi-anechoic chamber	19.2 x 11.2 x 7.7	7.0 x 6.0	No.1 Power source room	10 m
No.2 semi-anechoic chamber	7.5 x 5.8 x 5.2	4.0 x 4.0	-	3 m
No.3 semi-anechoic chamber	12.0 x 8.5 x 5.9	6.8 x 5.75	No.3 Preparation room	3 m
No.3 shielded room	4.0 x 6.0 x 2.7	N/A	-	-
No.4 semi-anechoic chamber	12.0 x 8.5 x 5.9	6.8 x 5.75	No.4 Preparation room	3 m
No.4 shielded room	4.0 x 6.0 x 2.7	N/A	-	-
No.5 semi-anechoic chamber	6.0 x 6.0 x 3.9	6.0 x 6.0	-	-
No.5 measurement room	6.4 x 6.4 x 3.0	6.4 x 6.4	-	-
No.6 shielded room	4.0 x 4.5 x 2.7	4.0 x 4.5	-	-
No.6 measurement room	4.75 x 5.4 x 3.0	4.75 x 4.15	-	-
No.7 shielded room	4.7 x 7.5 x 2.7	4.7 x 7.5	-	-
No.8 measurement room	3.1 x 5.0 x 2.7	3.1 x 5.0	-	-
No.9 measurement room	8.8 x 4.6 x 2.8	2.4 x 2.4	-	-
No.10 shielded room	3.8 x 2.8 x 2.8	3.8 x 2.8	-	-
No.11 measurement room	4.0 x 3.4 x 2.5	N/A	-	-
No.12 measurement room	2.6 x 3.4 x 2.5	N/A	-	-

* Size of vertical conducting plane (for Conducted Emission test) : 2.0 x 2.0 m for No.1, No.2, No.3, and No.4 semi-anechoic chambers and No.3 and No.4 shielded rooms.

3.6 Test data, Test instruments, and Test set up

Refer to APPENDIX.

SECTION 4: Operation of EUT during testing

4.1 Operating Mode(s)

Mode	Remarks*
Bluetooth Low Energy (BT LE)	Maximum Packet Size, PRBS9
*As a result of preliminary check of Radiated Spurious Emission test, the formal test was performed with the worst condition.	
*Power of the EUT was set by the software as follows; - Power settings: 2 dBm - Software: cybluetool version 0.1.55. 1 (Date: 2020.05.07, Storage location: Driven by connected PC)*This setting of software is the worst case. Any conditions under the normal use do not exceed the condition of setting. In addition, end users cannot change the settings of the output power of the product.	

*The details of Operating mode(s)

Test Item	Operating Mode	Tested frequency
Radiated Spurious Emission	Tx BT LE	2402 MHz 2440 MHz 2480 MHz

4.2 Configuration and peripherals

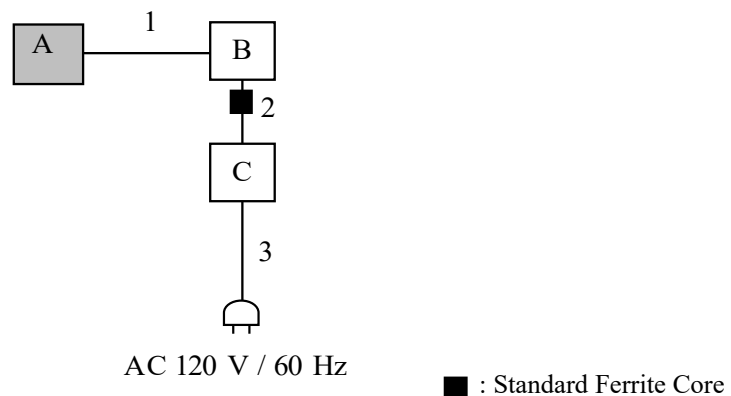

* Cabling and setup(s) were taken into consideration and test data was taken under worse case conditions.

Description of EUT and Support equipment

No.	Item	Model number	Serial number	Manufacturer	Remarks
A	Bluetooth v5 Dual-Mode USB Module	R8U3FJ8326Z	59C86D	Panasonic Corporation	EUT
B	Laptop PC	CF-SX2	4KKSA78923	Panasonic Corporation	-
C	AC adaptor	CF-AA6402A M1	6402AM111901030A	Panasonic Corporation	-

List of cables used

No.	Name	Length (m)	Shield		Remarks
			Cable	Connector	
1	USB Cable	0.9	Shielded	Shielded	-
2	DC Cable	1.0	Unshielded	Unshielded	-
3	AC Cable	1.8	Unshielded	Unshielded	-

UL Japan, Inc.

Ise EMC Lab.

4383-326 Asama-cho, Ise-shi, Mie-ken 516-0021 JAPAN

Telephone : +81 596 24 8999

Facsimile : +81 596 24 8124

SECTION 5: Radiated Spurious Emission

Test Procedure

It was measured based on "8.5 and 8.6 of KDB 558074 D01 15.247 Meas Guidance v05r02".

[For below 1 GHz]

EUT was placed on a urethane platform of nominal size, 1.0 m by 1.5 m, raised 0.8 m above the conducting ground plane. The Radiated Electric Field Strength has been measured in a Semi Anechoic Chamber with a ground plane.

[For above 1 GHz]

EUT was placed on a urethane platform of nominal size, 0.5 m by 0.5 m, raised 1.5 m above the conducting ground plane. The Radiated Electric Field Strength has been measured in a Semi Anechoic Chamber with absorbent materials lined on a ground plane.

The height of the measuring antenna varied between 1 m and 4 m and EUT was rotated a full revolution in order to obtain the maximum value of the electric field strength.

Test antenna was aimed at the EUT for receiving the maximum signal and always kept within the illumination area of the 3 dB beamwidth of the antenna.

The measurements were performed for both vertical and horizontal antenna polarization with the Test Receiver, or the Spectrum Analyzer.

The measurements were made with the following detector function of the test receiver and the Spectrum analyzer (in linear mode).

The test was made with the detector (RBW/VBW) in the following table.

When using Spectrum analyzer, the test was made with adjusting span to zero by using peak hold.

Test Antennas are used as below;

Frequency	30 MHz to 200 MHz	200 MHz to 1 GHz	Above 1 GHz
Antenna Type	Biconical	Logperiodic	Horn

In any 100 kHz bandwidth outside the restricted band in which the spread spectrum intentional radiator is operating, the radio frequency power that is produced by the intentional radiator confirmed 20 dB below that in the 100 kHz bandwidth within the band that contains the highest level of the desired power, based on a radiated measurement.

20 dBc was applied to the frequency over the limit of FCC 15.209 / Table 4 of RSS-Gen 8.9(ISED) and outside the restricted band of FCC15.205 / Table 6 of RSS-Gen 8.10 (ISED).

Frequency	Below 1 GHz	Above 1 GHz		20 dBc
Instrument used	Test Receiver	Spectrum Analyzer		Spectrum Analyzer
Detector	QP	PK	AV *1)	PK
IF Bandwidth	BW 120 kHz	RBW: 1 MHz VBW: 3 MHz	<u>11.12.2.5.1</u> RBW: 1 MHz VBW: 3 MHz Detector: Power Averaging (RMS) Trace: 100 traces <u>11.12.2.5.2</u> The duty cycle was less than 98% for detected noise, a duty factor was added to the 11.12.2.5.1 results.	RBW: 100 kHz VBW: 300 kHz

*1) Average Power Measurement was performed based on ANSI C63.10-2013.

UL Japan, Inc.

Ise EMC Lab.

4383-326 Asama-cho, Ise-shi, Mie-ken 516-0021 JAPAN

Telephone : +81 596 24 8999

Facsimile : +81 596 24 8124

Figure 1: Test Setup

Below 1 GHz

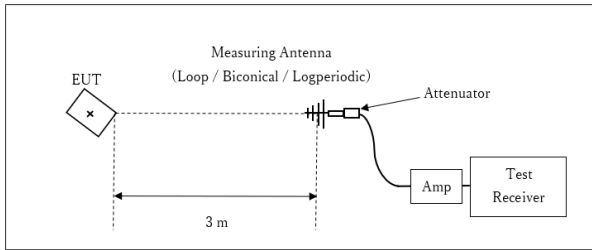

x : Center of turn table

Test Distance: 3 m

1 GHz - 10 GHz

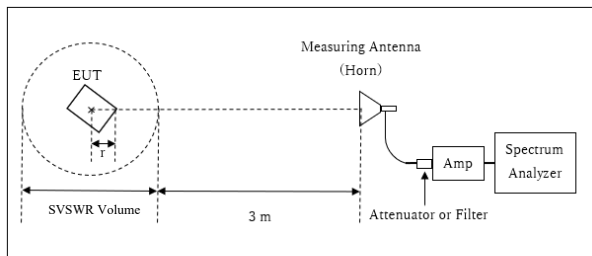

r : Radius of an outer periphery of EUT
x : Center of turn table

Distance Factor: $20 \times \log(3.7 \text{ m} / 3.0 \text{ m}) = 1.82 \text{ dB}$
 * Test Distance: $(3 + \text{SVSWR Volume} / 2) - r = 3.7 \text{ m}$

SVSWR Volume : 1.5 m
 (SVSWR Volume has been calibrated based on CISPR 16-1-4.)
 $r = 0.05 \text{ m}$

10 GHz - 26.5 GHz

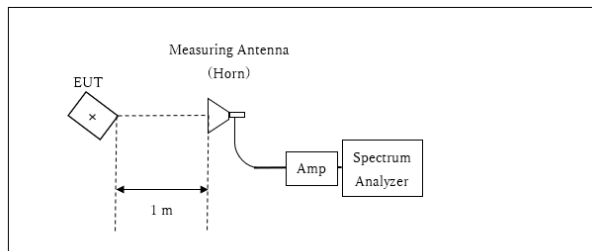

x : Center of turn table

Distance Factor: $20 \times \log(1.0 \text{ m} / 3.0 \text{ m}) = -9.5 \text{ dB}$
 *Test Distance: 1 m

- The carrier level and noise levels were confirmed at each position of X, Y and Z axes of EUT to see the position of maximum noise, and the test was made at the position that has the maximum noise.

The test results and limit are rounded off to one decimal place, so some differences might be observed.

Measurement range : 30 MHz - 26.5 GHz
Test data : APPENDIX
Test result : Pass

APPENDIX 1: Test data

Burst rate confirmation

Report No. 13745639H
 Test place Ise EMC Lab. No.2 Semi Anechoic Chamber
 Date August 30, 2021
 Temperature / Humidity 20 deg. C / 58 % RH
 Engineer Nachi Konegawa
 Mode Tx BT LE

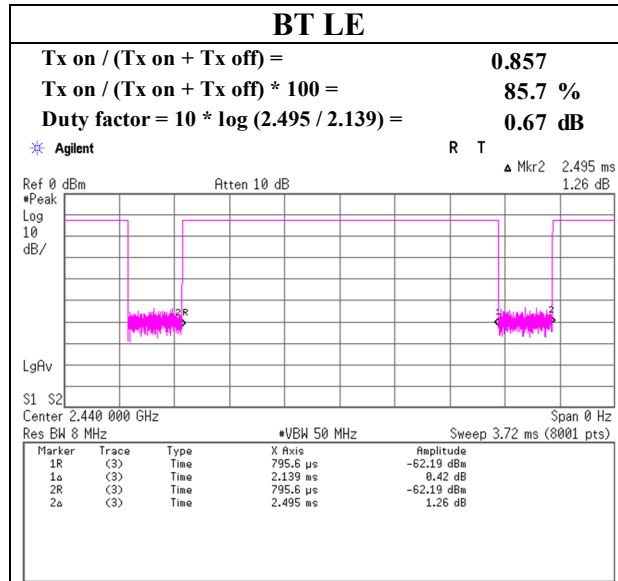

* Since the burst rate is not different between the channels, the data has been obtained on the representative channel.

Radiated Spurious Emission

Report No.	13745639H		
Test place	Ise EMC Lab.		
Semi Anechoic Chamber	No.2	No.2	No.2
Date	August 29, 2021	August 30, 2021	August 30, 2021
Temperature / Humidity	20 deg. C / 58 % RH	21 deg. C / 55 % RH	23 deg. C / 58 % RH
Engineer	Nachi Konegawa (1 GHz - 10 GHz)	Kiyoshiro Okazaki (10 GHz - 26.5 GHz)	Nachi Konegawa (Below 1 GHz)
Mode	Tx BT LE 2402 MHz		

Polarity	Frequency	Reading (QP / PK)	Reading (AV)	Ant. Factor	Loss	Gain	Duty Factor	Result (QP / PK)	Result (AV)	Limit (QP / PK)	Limit (AV)	Margin (QP / PK)	Margin (AV)	Remark
[Hori/Vert]	[MHz]	[dBuV]	[dBuV]	[dB/m]	[dB]	[dB]	[dB]	[dBuV/m]	[dBuV/m]	[dBuV/m]	[dBuV/m]	[dB]	[dB]	
Hori.	84.0	42.3	-	7.5	7.3	28.4	-	28.8	-	40.0	-	11.2	-	
Hori.	89.2	36.2	-	8.4	7.4	28.3	-	23.7	-	43.5	-	19.8	-	
Hori.	137.1	25.7	-	14.3	7.8	28.2	-	19.5	-	43.5	-	24.0	-	
Hori.	299.8	31.0	-	14.1	8.9	27.6	-	26.3	-	46.0	-	19.7	-	
Hori.	451.7	29.5	-	16.8	9.7	28.8	-	27.2	-	46.0	-	18.8	-	
Hori.	499.1	25.9	-	18.2	9.8	29.0	-	24.9	-	46.0	-	21.1	-	
Hori.	2361.9	45.8	38.2	27.7	4.9	34.6	0.7	43.8	36.9	73.9	53.9	30.1	17.0	
Hori.	2390.0	44.5	35.2	27.6	4.9	34.6	0.7	42.4	33.7	73.9	53.9	31.5	20.2	*1)
Hori.	4804.0	42.4	32.1	31.6	7.0	33.7	-	47.2	36.9	73.9	53.9	26.7	17.0	Floor noise
Hori.	7206.0	42.5	32.1	35.8	8.4	33.6	-	53.1	42.7	73.9	53.9	20.8	11.2	Floor noise
Hori.	9608.0	43.5	32.6	38.6	8.8	34.2	-	56.6	45.7	73.9	53.9	17.3	8.2	Floor noise
Vert.	84.0	46.7	-	7.5	7.3	28.4	-	33.2	-	40.0	-	6.8	-	
Vert.	88.8	40.7	-	8.4	7.4	28.3	-	28.1	-	43.5	-	15.4	-	
Vert.	136.8	34.1	-	14.3	7.8	28.2	-	27.9	-	43.5	-	15.6	-	
Vert.	449.8	32.2	-	16.8	9.6	28.8	-	29.8	-	46.0	-	16.2	-	
Vert.	516.9	27.8	-	17.9	9.9	29.1	-	26.5	-	46.0	-	19.5	-	
Vert.	601.0	29.8	-	19.5	10.2	29.3	-	30.2	-	46.0	-	15.8	-	
Vert.	2361.9	45.9	37.8	27.7	4.9	34.6	0.7	43.9	36.5	73.9	53.9	30.0	17.4	
Vert.	2390.0	44.7	35.8	27.6	4.9	34.6	0.7	42.6	34.4	73.9	53.9	31.3	19.5	*1)
Vert.	4804.0	42.3	32.0	31.6	7.0	33.7	-	47.1	36.9	73.9	53.9	26.8	17.0	Floor noise
Vert.	7206.0	42.3	32.0	35.8	8.4	33.6	-	52.9	42.6	73.9	53.9	21.0	11.3	Floor noise
Vert.	9608.0	43.3	32.5	38.6	8.8	34.2	-	56.5	45.7	73.9	53.9	17.4	8.2	Floor noise

Result (QP / PK) = Reading + Ant Factor + Loss (Cable+Attenuator+Filter+Distance factor(above 1 GHz)) - Gain(Amplifier)
Result (AV)= Reading + Ant Factor + Loss (Cable+Attenuator+Filter+Distance factor(above 1 GHz)) - Gain(Amplifier) + Duty factor
*Other frequency noises omitted in this report were not seen or had enough margin (more than 20 dB).
*QP detector was used up to 1GHz.
*1) Not Out of Band emission(Leakage Power)

20dBc Data Sheet

Polarity	Frequency	Reading (PK)	Ant Factor	Loss	Gain	Result	Limit	Margin	Remark
[Hori/Vert]	[MHz]	[dBuV]	[dB/m]	[dB]	[dB]	[dBuV/m]	[dBuV/m]	[dB]	
Hori.	2402.0	99.9	27.5	4.9	34.6	97.7	-	-	Carrier
Hori.	2400.0	43.0	27.6	4.9	34.6	40.8	77.7	36.9	
Vert.	2402.0	101.3	27.5	4.9	34.6	99.1	-	-	Carrier
Vert.	2400.0	44.2	27.6	4.9	34.6	42.0	79.1	37.1	

Result = Reading + Ant Factor + Loss (Cable+Attenuator+Filter+Distance factor(above 1 GHz)) - Gain(Amplifier)
Distance factor: 1 GHz - 10 GHz 20log(3.7 m / 3.0 m) = 1.83 dB
10 GHz - 26.5 GHz 20log(1.0 m / 3.0 m) = -9.5 dB

UL Japan, Inc.

Ise EMC Lab.

4383-326 Asama-cho, Ise-shi, Mie-ken 516-0021 JAPAN

Telephone : +81 596 24 8999

Facsimile : +81 596 24 8124

Radiated Spurious Emission (Reference Plot for band-edge)

Report No.	13745639H
Test place	Ise EMC Lab.
Semi Anechoic Chamber	No.2
Date	August 30, 2021
Temperature / Humidity	20 deg. C / 58 % RH
Engineer	Nachi Konegawa (1 GHz - 10 GHz)
Mode	Tx BT LE 2402 MHz

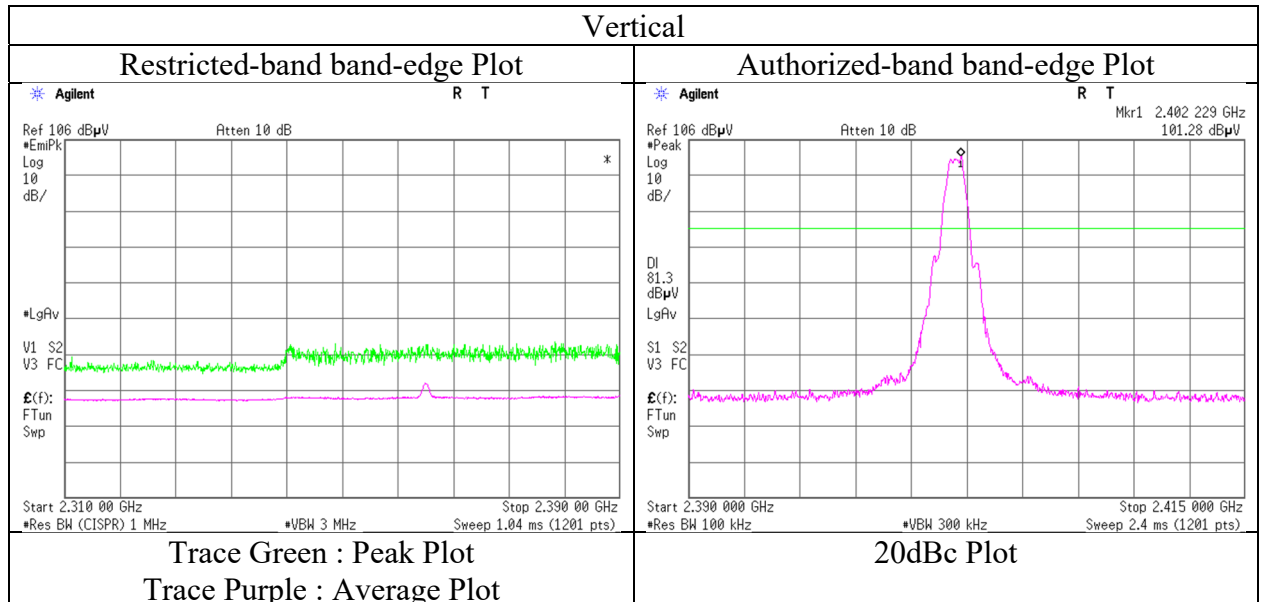
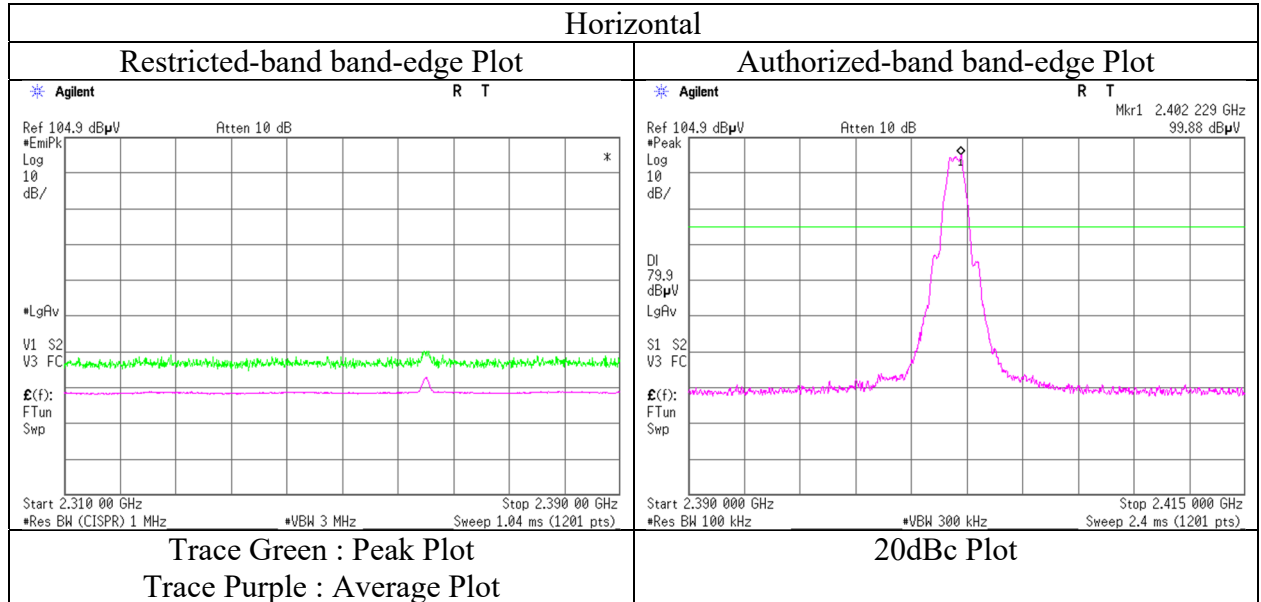

* The measurement was conducted for a sufficiently long enough time to detect any possible spurious emissions. Final result of restricted band edge was shown in tabular data.

UL Japan, Inc.

Ise EMC Lab.

4383-326 Asama-cho, Ise-shi, Mie-ken 516-0021 JAPAN

Telephone : +81 596 24 8999

Facsimile : +81 596 24 8124

Radiated Spurious Emission

Report No.	13745639H		
Test place	Ise EMC Lab.		
Semi Anechoic Chamber	No.2	No.2	No.2
Date	August 30, 2021	August 30, 2021	August 30, 2021
Temperature / Humidity	20 deg. C / 58 % RH	21 deg. C / 55 % RH	23 deg. C / 58 % RH
Engineer	Nachi Konegawa (1 GHz - 10 GHz)	Kiyoshiro Okazaki (10 GHz - 26.5 GHz)	Nachi Konegawa (Below 1 GHz)
Mode	Tx BT LE 2440 MHz		

Polarity [Hori/Vert]	Frequency [MHz]	Reading (QP / PK) [dBuV]	Reading (AV) [dBuV]	Ant. Factor [dB/m]	Loss [dB]	Gain [dB]	Duty Factor [dB]	Result (QP / PK) [dBuV/m]	Result (AV) [dBuV/m]	Limit (QP / PK) [dBuV/m]	Limit (AV) [dBuV/m]	Margin (QP / PK) [dB]	Margin (AV) [dB]	Remark
Hori.	84.0	42.4	-	7.5	7.3	28.4	-	28.9	-	40.0	-	11.1	-	
Hori.	89.5	36.3	-	8.5	7.4	28.3	-	23.8	-	43.5	-	19.7	-	
Hori.	136.9	25.5	-	14.3	7.8	28.2	-	19.3	-	43.5	-	24.2	-	
Hori.	299.8	31.1	-	14.1	8.9	27.6	-	26.4	-	46.0	-	19.6	-	
Hori.	451.0	29.4	-	16.8	9.6	28.8	-	27.1	-	46.0	-	18.9	-	
Hori.	499.0	26.0	-	18.2	9.8	29.0	-	25.0	-	46.0	-	21.0	-	
Hori.	4880.0	41.6	34.1	31.6	6.3	33.8	-	45.7	38.1	73.9	53.9	28.2	15.8	Floor noise
Hori.	7320.0	42.5	33.9	36.2	7.5	33.6	-	52.5	43.9	73.9	53.9	21.4	10.0	Floor noise
Hori.	9760.0	42.5	34.2	38.8	8.3	34.2	-	55.4	47.1	73.9	53.9	18.5	6.8	Floor noise
Vert.	84.0	46.6	-	7.5	7.3	28.4	-	33.1	-	40.0	-	6.9	-	
Vert.	88.8	40.8	-	8.4	7.4	28.3	-	28.2	-	43.5	-	15.3	-	
Vert.	136.9	34.3	-	14.3	7.8	28.2	-	28.1	-	43.5	-	15.4	-	
Vert.	449.8	32.3	-	16.8	9.6	28.8	-	29.9	-	46.0	-	16.1	-	
Vert.	516.9	27.5	-	17.9	9.9	29.1	-	26.2	-	46.0	-	19.8	-	
Vert.	601.1	29.9	-	19.5	10.2	29.3	-	30.3	-	46.0	-	15.7	-	
Vert.	4880.0	41.2	34.1	31.6	7.0	33.8	-	46.0	38.9	73.9	53.9	27.9	15.0	Floor noise
Vert.	7320.0	42.4	34.0	36.2	8.3	33.6	-	53.3	44.9	73.9	53.9	20.6	9.0	Floor noise
Vert.	9760.0	42.8	34.2	38.8	8.8	34.2	-	56.3	47.6	73.9	53.9	17.7	6.3	Floor noise

Result = Reading + Ant Factor + Loss (Cable+Attenuator+Filter+Distance factor(above 1 GHz)) - Gain(Amplifier)

*Other frequency noises omitted in this report were not seen or had enough margin (more than 20 dB).

*QP detector was used up to 1GHz.

Radiated Spurious Emission

Report No.	13745639H		
Test place	Ise EMC Lab.		
Semi Anechoic Chamber	No.2	No.2	No.2
Date	August 30, 2021	August 30, 2021	August 30, 2021
Temperature / Humidity	20 deg. C / 58 % RH	21 deg. C / 55 % RH	23 deg. C / 58 % RH
Engineer	Nachi Konegawa	Kiyoshiro Okazaki	Nachi Konegawa
	(1 GHz - 10 GHz)	(10 GHz - 26.5 GHz)	(Below 1 GHz)
Mode	Tx BT LE 2480 MHz		

Polarity [Hori/Vert]	Frequency [MHz]	Reading (QP / PK) [dBuV]	Reading (AV) [dBuV]	Ant. Factor [dB/m]	Loss [dB]	Gain [dB]	Duty Factor [dB]	Result (QP / PK) [dBuV/m]	Result (AV) [dBuV/m]	Limit (QP / PK) [dBuV/m]	Limit (AV) [dBuV/m]	Margin (QP / PK) [dB]	Margin (AV) [dB]	Remark
Hori.	83.8	42.2	-	7.5	7.3	28.4	-	28.6	-	40.0	-	11.4	-	
Hori.	89.2	36.0	-	8.4	7.4	28.3	-	23.5	-	43.5	-	20.0	-	
Hori.	136.5	25.6	-	14.3	7.8	28.2	-	19.4	-	43.5	-	24.1	-	
Hori.	299.9	30.9	-	14.1	8.9	27.6	-	26.2	-	46.0	-	19.8	-	
Hori.	451.7	29.5	-	16.8	9.7	28.8	-	27.2	-	46.0	-	18.8	-	
Hori.	499.1	26.0	-	18.2	9.8	29.0	-	25.0	-	46.0	-	21.0	-	
Hori.	2483.5	47.6	37.9	27.4	5.0	34.6	0.7	45.4	36.4	73.9	53.9	28.5	17.5	*1)
Hori.	4960.0	42.4	33.8	31.6	7.0	33.8	-	47.2	38.6	73.9	53.9	26.7	15.4	Floor noise
Hori.	7440.0	42.6	33.7	36.0	8.3	33.7	-	53.3	44.4	73.9	53.9	20.6	9.5	Floor noise
Hori.	9920.0	43.3	34.1	38.9	8.9	34.3	-	56.8	47.7	73.9	53.9	17.1	6.2	Floor noise
Vert.	83.9	46.8	-	7.5	7.3	28.4	-	33.2	-	40.0	-	6.8	-	
Vert.	89.7	40.5	-	8.5	7.4	28.3	-	28.1	-	43.5	-	15.5	-	
Vert.	136.4	34.1	-	14.3	7.8	28.2	-	27.9	-	43.5	-	15.6	-	
Vert.	449.9	32.0	-	16.8	9.6	28.8	-	29.6	-	46.0	-	16.4	-	
Vert.	517.0	27.6	-	17.9	9.9	29.1	-	26.3	-	46.0	-	19.7	-	
Vert.	601.0	30.0	-	19.5	10.2	29.3	-	30.4	-	46.0	-	15.6	-	
Vert.	2483.5	47.4	37.9	27.4	5.0	34.6	0.7	45.2	36.3	73.9	53.9	28.7	17.6	*1)
Vert.	4960.0	42.1	33.8	31.6	7.0	33.8	-	46.8	38.5	73.9	53.9	27.1	15.4	Floor noise
Vert.	7440.0	42.7	33.6	36.0	8.3	33.7	-	53.4	44.3	73.9	53.9	20.5	9.6	Floor noise
Vert.	9920.0	43.2	34.2	38.9	8.9	34.3	-	56.7	47.8	73.9	53.9	17.2	6.1	Floor noise

Result (QP / PK) = Reading + Ant Factor + Loss (Cable+Attenuator+Filter+Distance factor(above 1 GHz)) - Gain(Amplifier)

Result (AV) = Reading + Ant Factor + Loss (Cable+Attenuator+Filter+Distance factor(above 1 GHz)) - Gain(Amplifier) + Duty factor

*Other frequency noises omitted in this report were not seen or had enough margin (more than 20 dB).

*QP detector was used up to 1GHz.

*1) Not Out of Band emission(Leakage Power)

Radiated Spurious Emission
(Reference Plot for band-edge)

Report No. 13745639H
Test place Ise EMC Lab.
Semi Anechoic Chamber No.2
Date August 30, 2021
Temperature / Humidity 20 deg. C / 58 % RH
Engineer Nachi Konegawa
(1 GHz - 10 GHz)
Mode Tx BT LE 2480 MHz

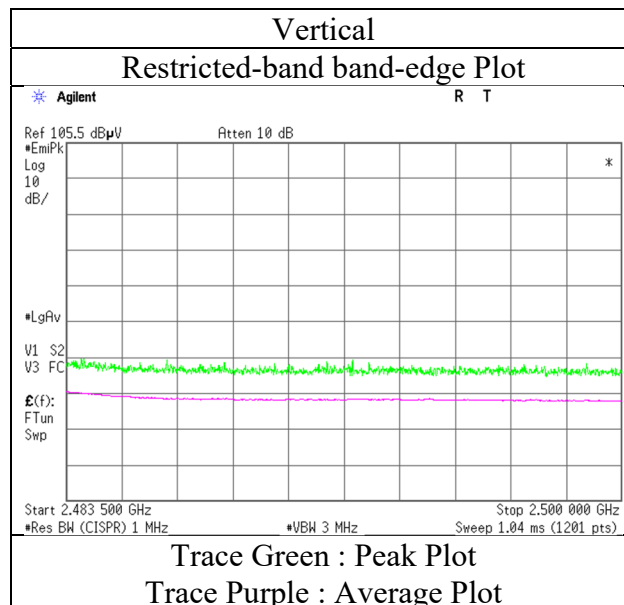
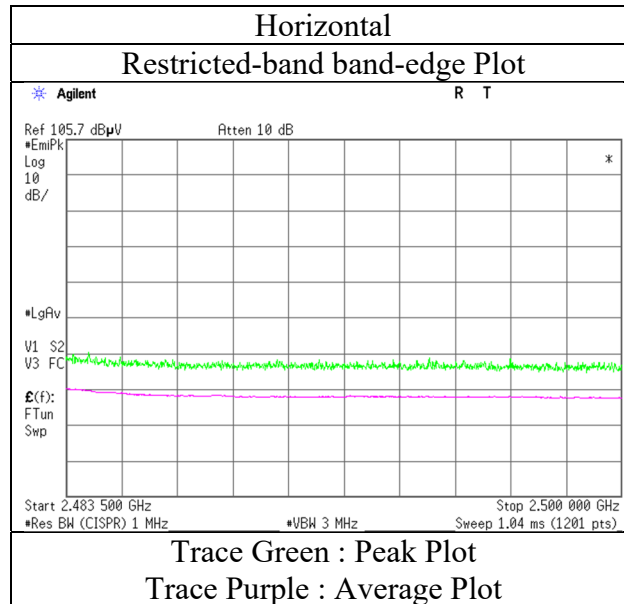

* The measurement was conducted for a sufficiently long enough time to detect any possible spurious emissions. Final result of restricted band edge was shown in tabular data.

Radiated Spurious Emission
(Plot data, Worst case)

Report No.	13745639H		
Test place	Ise EMC Lab.		
Semi Anechoic Chamber	No.2	No.2	No.2
Date	August 30, 2021	August 30, 2021	August 30, 2021
Temperature / Humidity	20 deg. C / 58 % RH	21 deg. C / 55 % RH	23 deg. C / 58 % RH
Engineer	Nachi Konegawa (1 GHz - 10 GHz)	Kiyoshiro Okazaki (10 GHz - 26.5 GHz)	Nachi Konegawa (Below 1 GHz)
Mode	Tx BT LE 2440 MHz		

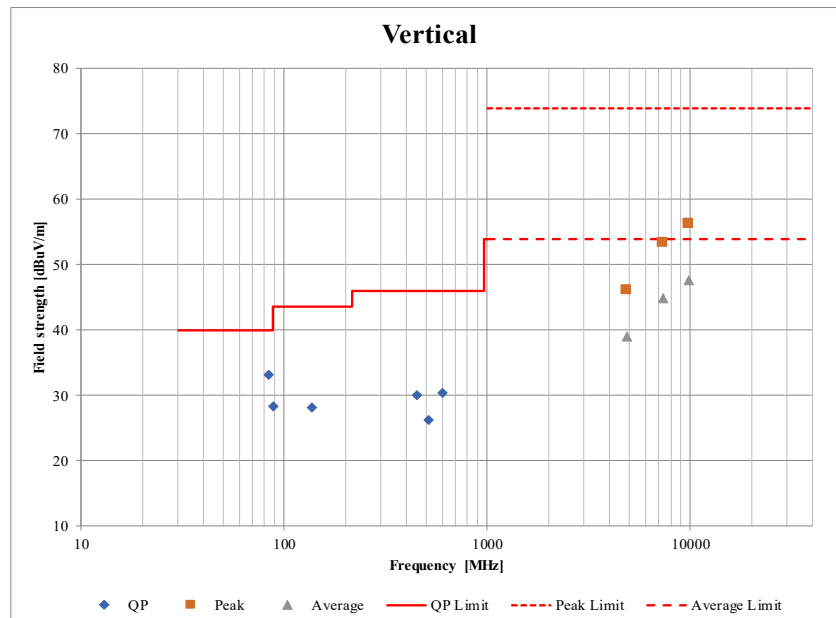
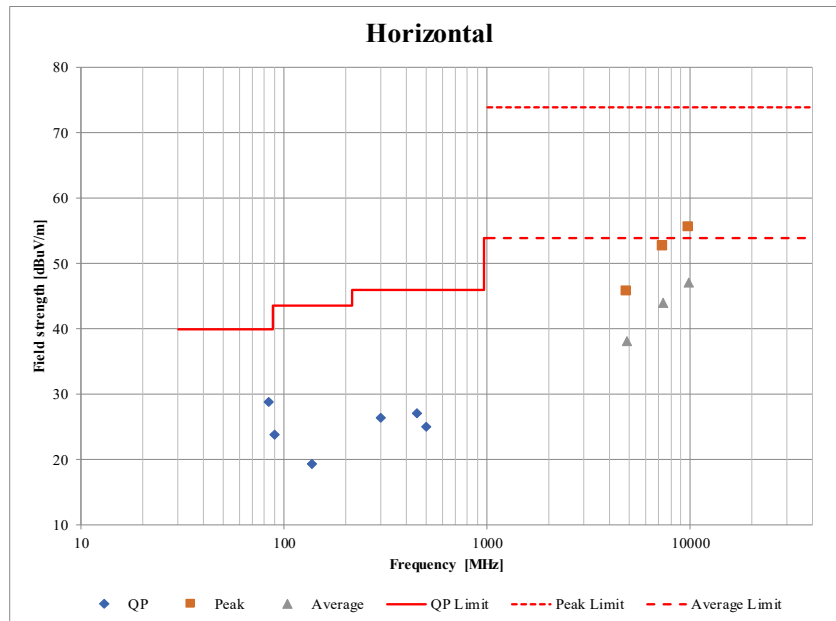

*These plots data contains sufficient number to show the trend of characteristic features for EUT.

UL Japan, Inc.

Ise EMC Lab.

4383-326 Asama-cho, Ise-shi, Mie-ken 516-0021 JAPAN

Telephone : +81 596 24 8999

Facsimile : +81 596 24 8124

APPENDIX 2: Test instruments

Test equipment

Test Item	Local ID	LIMS ID	Description	Manufacturer	Model	Serial	Last Calibration Date	Cal Int
RE	MAEC-02	142004	AC2_Semi Anechoic Chamber(NSA)	TDK	Semi Anechoic Chamber 3m	DA-06902	05/26/2020	24
RE	MOS-41	192300	Thermo-Hygrometer	CUSTOM. Inc	CTH-201	0013	12/06/2020	12
RE	MMM-01	141542	Digital Tester	Fluke Corporation	FLUKE 26-3	78030611	08/10/2021	12
RE	MJM-27	142228	Measure	KOMELON	KMC-36	-	-	-
RE	COTS-MEMI-02	178648	EMI measurement program	TSJ (Techno Science Japan)	TEPTO-DV	-	-	-
RE	MAEC-02-SVSWR	142006	AC2_Semi Anechoic Chamber(SVSWR)	TDK	Semi Anechoic Chamber 3m	DA-06902	04/09/2021	24
RE	MHA-06	141512	Horn Antenna 1-18GHz	Schwarzbeck Mess-Elektronik OHG	BBHA9120D	254	09/14/2020	12
RE	MCC-218	141394	Microwave Cable	Junkosha	MWX221	1607S141(1 m) / 1608S264(5 m)	09/23/2020	12
RE	MPA-10	141579	Pre Amplifier	Keysight Technologies Inc	8449B	3008A02142	02/18/2021	12
RE	MHF-25	141232	High Pass Filter 3.5-18.0GHz	UL Japan	HPF SELECTOR	001	09/23/2020	12
RE	MSA-15	141902	Spectrum Analyzer	Keysight Technologies Inc	E4440A	MY46187105	10/15/2020	12
RE	MHA-04	141505	Horn Antenna 26.5-40GHz	EMCO	3160-10	1140	08/03/2020	12
RE	MAT-07	141203	Attenuator(6dB)	Weinschel Corp	2	BK7970	11/13/2020	12
RE	MBA-08	141427	Biconical Antenna	Schwarzbeck Mess-Elektronik OHG	VHA9103B+BBA9106	08031	07/10/2021	12
RE	MCC-12	141317	Coaxial Cable	UL Japan Inc.	-	-	09/25/2020	12
RE	MLA-21	141265	Logperiodic Antenna(200-1000MHz)	Schwarzbeck Mess-Elektronik OHG	VUSLP9111B	9111B-190	07/10/2021	12
RE	MPA-24	141594	Pre Amplifier	Keysight Technologies Inc	8447D	2944A10150	02/18/2021	12
RE	MTR-03	141942	Test Receiver	Rohde & Schwarz	ESCI	100300	08/05/2021	12

*Hyphens for Last Calibration Date and Cal Int (month) are instruments that Calibration is not required (e.g. software), or instruments checked in advance before use.

The expiration date of the calibration is the end of the expired month.

As for some calibrations performed after the tested dates, those test equipment have been controlled by means of an unbroken chains of calibrations.

All equipment is calibrated with valid calibrations. Each measurement data is traceable to the national or international standards.

Test item: RE: Radiated Emission test

UL Japan, Inc.

Ise EMC Lab.

4383-326 Asama-cho, Ise-shi, Mie-ken 516-0021 JAPAN

Telephone : +81 596 24 8999

Facsimile : +81 596 24 8124

APPENDIX 3: Photographs of test setup

Radiated Spurious Emission

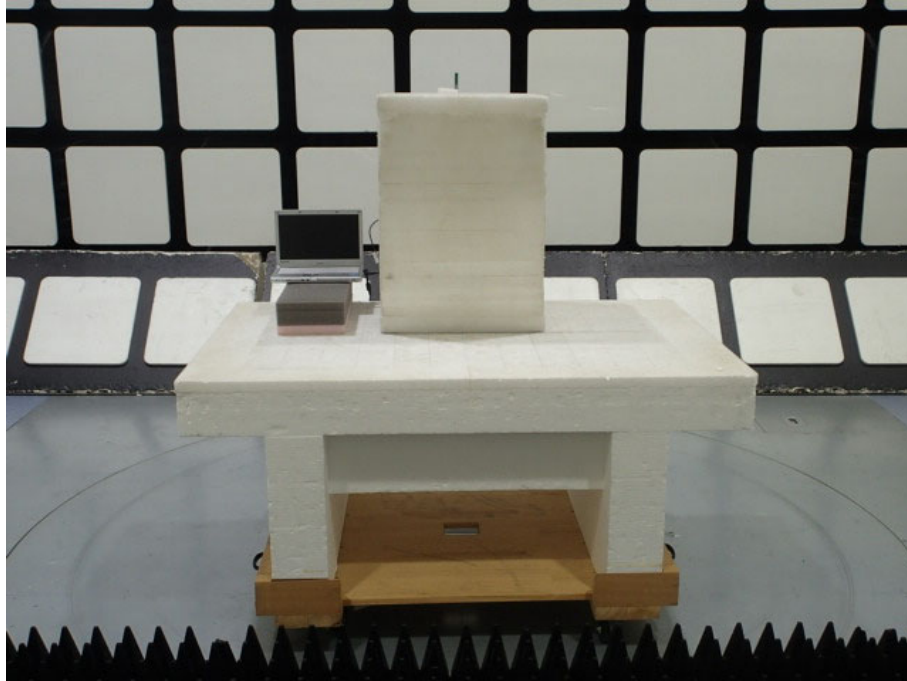

Photo 1

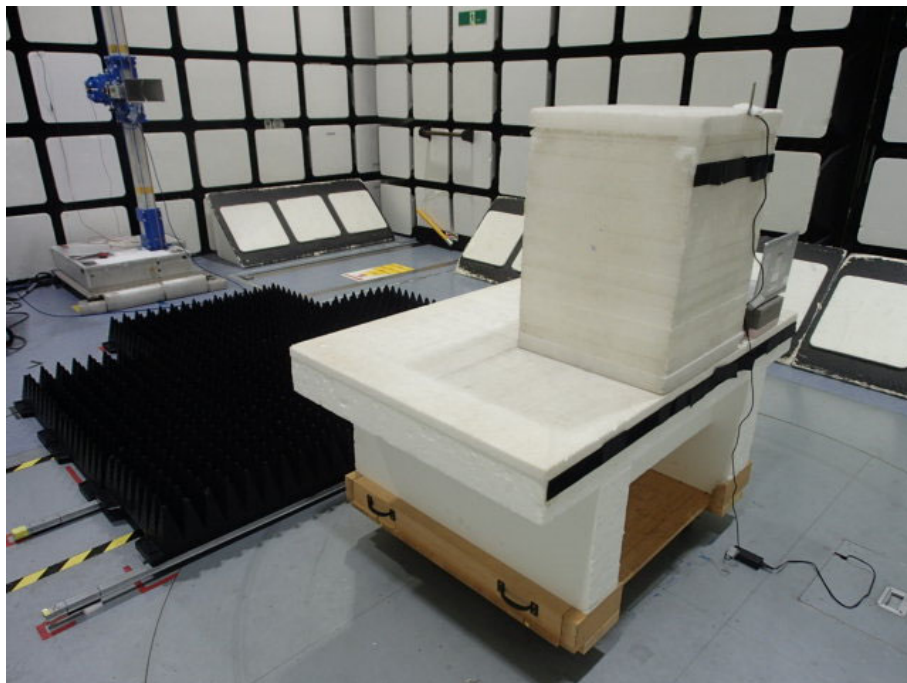

Photo 2

UL Japan, Inc.

Ise EMC Lab.

4383-326 Asama-cho, Ise-shi, Mie-ken 516-0021 JAPAN

Telephone : +81 596 24 8999

Facsimile : +81 596 24 8124

Worst Case Position

Below 1 GHz (Horizontal: X-axis/ Vertical: X-axis)
Above 1 GHz (Horizontal: X-axis/ Vertical: Z-axis)

X-axis



Y-axis

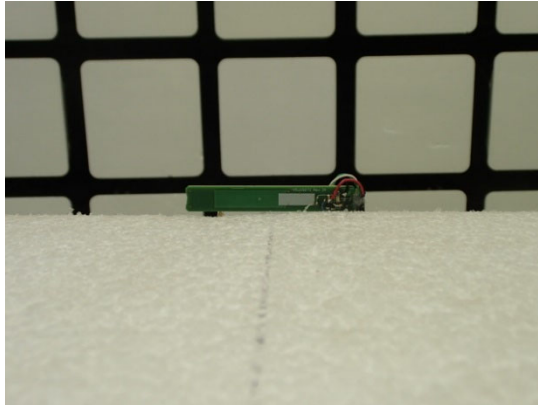

Z-axis

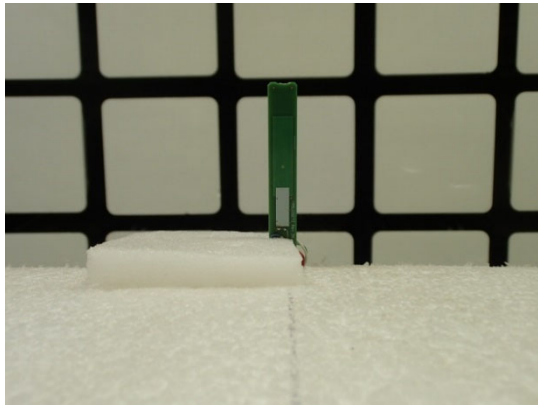

End of Report