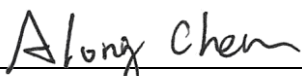

FCC Test Report

FCC ID : U6Y-M120000016
Equipment : 802.11b/g/n 4x4 WiFi module
Model No. : M120000016
Brand Name : Panasonic
Applicant : Panasonic Avionics Corporation
Address : 26200 ENTERPRISE WAY, LAKE FOREST, CA
92630-8400 USA
Standard : 47 CFR FCC Part 15.247
Received Date : Nov. 24, 2016
Tested Date : Nov. 28, 2016 ~ Mar. 14, 2017

We, International Certification Corp., would like to declare that the tested sample has been evaluated and in compliance with the requirement of the above standards. The test results contained in this report refer exclusively to the product. It may be duplicated completely for legal use with the approval of the applicant. It shall not be reproduced except in full without the written approval of our laboratory.

Reviewed by:

Along Chen / Assistant Manager

Approved by:

Gary Chang / Manager



Table of Contents

1	GENERAL DESCRIPTION	5
1.1	Information.....	5
1.2	Local Support Equipment List	8
1.3	Test Setup Chart	8
1.4	The Equipment List	10
1.5	Test Standards	13
1.6	Measurement Uncertainty	13
2	TEST CONFIGURATION	14
2.1	Testing Condition	14
2.2	The Worst Test Modes and Channel Details	14
3	TRANSMITTER TEST RESULTS.....	15
3.1	Conducted Emissions.....	15
3.2	6dB and Occupied Bandwidth	22
3.3	RF Output Power	27
3.4	Power Spectral Density	29
3.5	Unwanted Emissions into Restricted Frequency Bands	32
3.6	Emissions in Non-Restricted Frequency Bands	74
4	TEST LABORATORY INFORMATION	93

Release Record

Report No.	Version	Description	Issued Date
FR6N2401	Rev. 01	Initial issue	Mar. 29, 2017

Summary of Test Results

FCC Rules	Test Items	Measured	Result
15.207	Conducted Emissions	[dBuV]: 0.178MHz 56.04 (Margin -8.55dB) - QP	Pass
15.247(d) 15.209	Radiated Emissions	[dBuV/m at 3m]: 2483.50MHz 52.98 (Margin -1.02dB) – AV [dBuV/m at 3m]: 2390.000MHz 52.98 (Margin -1.02dB) - AV	Pass
15.247(b)(3)	Maximum Output Power	Max Power [dBm]: <i>Non-beamforming mode</i> 26.54 <i>Beamforming mode</i> 25.27	Pass
15.247(a)(2)	6dB Bandwidth	Meet the requirement of limit	Pass
15.247(e)	Power Spectral Density	Meet the requirement of limit	Pass
15.203	Antenna Requirement	Meet the requirement of limit	Pass

1 General Description

1.1 Information

1.1.1 Specification of the Equipment under Test (EUT)

RF General Information					
Frequency Range (MHz)	IEEE Std. 802.11	Ch. Freq. (MHz)	Channel Number	Transmit Chains (N _{TX})	Data Rate / MCS
2400-2483.5	b	2412-2462	1-11 [11]	4	1-11 Mbps
2400-2483.5	g	2412-2462	1-11 [11]	4	6-54 Mbps
2400-2483.5	n (HT20)	2412-2462	1-11 [11]	4	MCS 0-31
2400-2483.5	n (HT40)	2422-2452	3-9 [7]	4	MCS 0-31

Note 1: RF output power specifies that Maximum Conducted (Average) Output Power.
 Note 2: 802.11b uses a combination of DSSS-DBPSK, DQPSK, CCK modulation.
 Note 3: 802.11g/n uses a combination of OFDM-BPSK, QPSK, 16QAM, 64QAM modulation.
 Note 4: 802.11n supports beamforming function.

1.1.2 Antenna Details

Ant. No.	Type	Gain (dBi)	Connector	Remark
1	PIFA	4.2	MMCX	---
2	PIFA	4.2	MMCX	---
3	PIFA	4.3	MMCX	---
4	PIFA	4.2	MMCX	---

1.1.3 Power Supply Type of Equipment under Test (EUT)

Power Supply Type	3.3Vdc from host
-------------------	------------------

1.1.4 Accessories

N/A

1.1.5 Channel List

Frequency band (MHz)		2400~2483.5	
802.11 b / g / n HT20		802.11n HT40	
Channel	Frequency(MHz)	Channel	Frequency(MHz)
1	2412	3	2422
2	2417	4	2427
3	2422	5	2432
4	2427	6	2437
5	2432	7	2442
6	2437	8	2447
7	2442	9	2452
8	2447	---	---
9	2452	---	---
10	2457	---	---
11	2462	---	---

1.1.6 Test Tool and Duty Cycle

Test Tool	Non-beamforming: QCART, Version: 3.0.138.0 Beamforming: QCART, Version: 3.0.138.0				
Duty Cycle and Duty Factor	Mode	Non-beamforming		Beamforming	
		Duty cycle (%)	Duty factor (dB)	Duty cycle (%)	Duty factor (dB)
	11b	99.54%	0.02	---	---
	11g	98.10%	0.08	---	---
	HT20	99.63%	0.02	95.57%	0.20
HT40	98.38%	0.07	95.26%	0.21	

1.1.7 Power Setting

Modulation Mode	Test Frequency (MHz)	Power Set	
		Non-beamforming	Beamforming
11b	2412	19.5	---
11b	2437	19.5	---
11b	2462	18	---
11g	2412	16.5	---
11g	2437	21.5	---
11g	2462	16	---
HT20	2412	16.5	22
HT20	2437	21.5	26
HT20	2462	16	21
HT40	2422	13	18
HT40	2437	15.5	21
HT40	2452	14.5	19

1.2 Local Support Equipment List

Non-beamforming mode

Support Equipment List					
No.	Equipment	Brand	Model	FCC ID	Signal cable / Length (m)
1	Notebook	DELL	Latitude E6440	DoC	---
2	DC Power Supply	GWINSTEK	GPC-3060D	---	---
3	Extension Card	---	----	---	----

Beamforming mode

Support Equipment List					
No.	Equipment	Brand	Model	FCC ID	Signal cable / Length (m)
1	Notebook	DELL	Latitude E6440	DoC	---
2	DC Power Supply	GWINSTEK	GPC-3060D	---	---
3	Extension Card	---	----	---	----
4	System	Panasonic	CWAP	---	----
5	AP	NETGEAR	R7800	---	----

Note: No.4 & No. 5 were supplied by applicant

1.3 Test Setup Chart

Non-beamforming mode

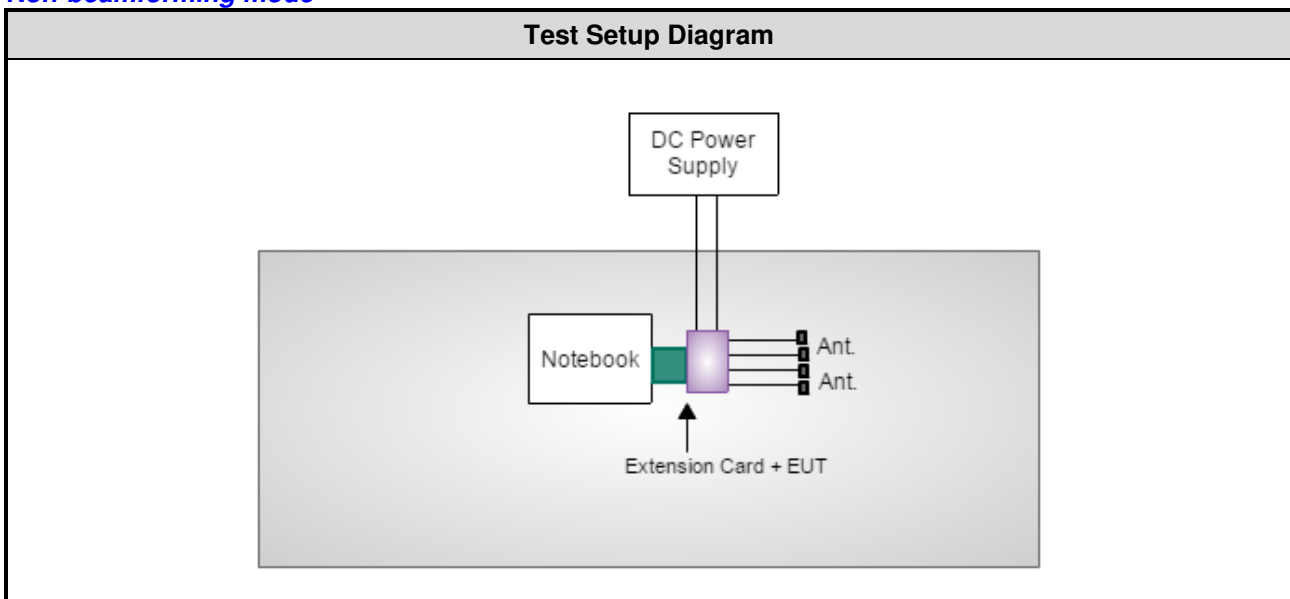

Beamforming mode

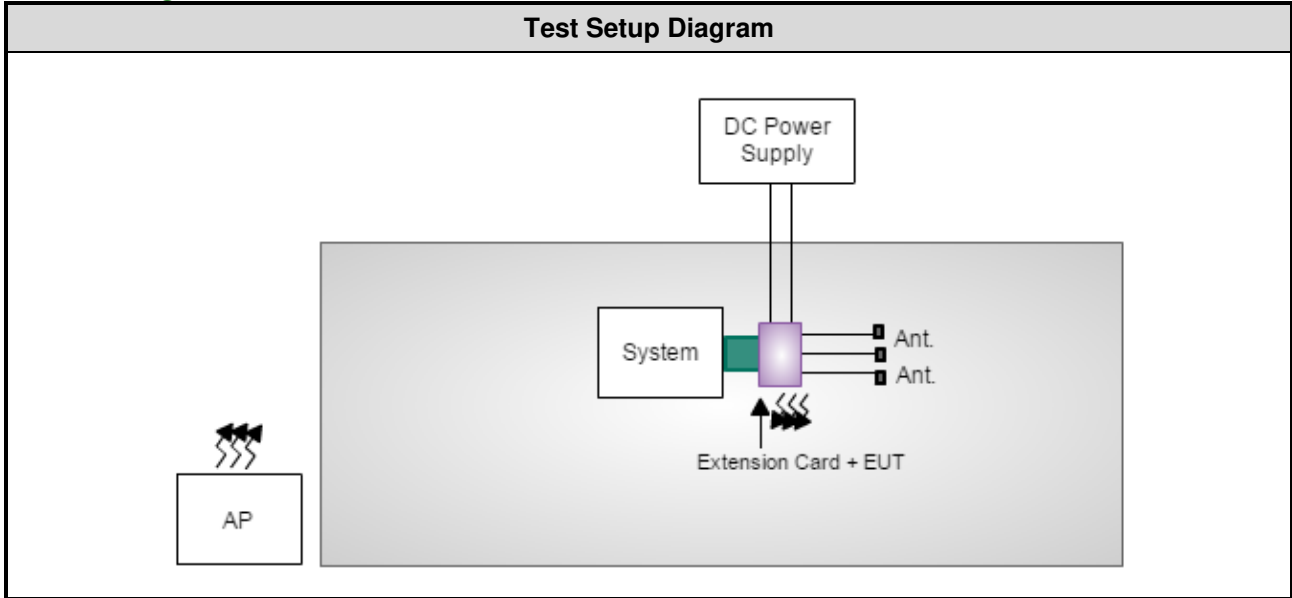

1.4 The Equipment List

For Non-beamforming mode

Test Item	Conducted Emission				
Test Site	Conduction room 1 / (CO01-WS)				
Tested Date	Dec. 19, 2016				
Instrument	Manufacturer	Model No.	Serial No.	Calibration Date	Calibration Until
Receiver	R&S	ESR3	101657	Jan. 12, 2016	Jan. 11, 2017
LISN	SCHWARZBECK	Schwarzbeck 8127	8127-667	Nov. 08, 2016	Nov. 07, 2017
RF Cable-CON	EMC	EMCCFD300-BM-BM-6000	50821	Dec. 21, 2015	Dec. 20, 2016
Measurement Software	AUDIX	e3	6.120210k	NA	NA
Note: Calibration Interval of instruments listed above is one year.					

Test Item	Radiated Emission				
Test Site	966 chamber3 / (03CH03-WS)				
Tested Date	Nov. 28 ~ Dec. 16, 2016				
Instrument	Manufacturer	Model No.	Serial No.	Calibration Date	Calibration Until
Spectrum Analyzer	Agilent	N9010A	MY53400091	Sep. 09, 2016	Sep. 08, 2017
Receiver	Agilent	N9038A	MY53290044	Oct. 06, 2016	Oct. 05, 2017
Bilog Antenna	SCHWARZBECK	VULB9168	VULB9168-685	Apr. 26, 2016	Apr. 25, 2017
Horn Antenna 1G-18G	SCHWARZBECK	BBHA 9120 D	BBHA 9120 D 1206	Feb. 24, 2016	Feb. 23, 2017
Horn Antenna 18G-40G	SCHWARZBECK	BBHA 9170	BBHA 9170517	Oct. 25, 2016	Oct. 24, 2017
Loop Antenna	R&S	HFH2-Z2	100330	Nov. 10, 2016	Nov. 09, 2017
Preamplifier	EMC	EMC02325	980187	Sep. 08, 2016	Sep. 07, 2017
Preamplifier	Agilent	83017A	MY53270014	Aug. 22, 2016	Aug. 21, 2017
Preamplifier	EMC	EMC184045B	980192	Aug. 24, 2016	Aug. 23, 2017
RF cable-3M	HUBER+SUHNER	SUCOFLEX104	MY22620/4	Feb. 05, 2016	Feb. 04, 2017
RF cable-8M	HUBER+SUHNER	SUCOFLEX104	MY22600/4	Feb. 05, 2016	Feb. 04, 2017
RF cable-1M	HUBER+SUHNER	SUCOFLEX104	MY22624/4	Feb. 05, 2016	Feb. 04, 2017
LF cable-0.8M	EMC	EMC8D-NM-NM-800	EMC8D-NM-NM-800-001	Feb. 05, 2016	Feb. 04, 2017
LF cable-3M	EMC	EMC8D-NM-NM-3000	131103	Feb. 05, 2016	Feb. 04, 2017
LF cable-13M	EMC	EMC8D-NM-NM-13000	131104	Feb. 05, 2016	Feb. 04, 2017
Measurement Software	AUDIX	e3	6.120210g	NA	NA
Note: Calibration Interval of instruments listed above is one year.					

Test Item	RF Conducted				
Test Site	(TH01-WS)				
Tested Date	Dec. 15, 2016				
Instrument	Manufacturer	Model No.	Serial No.	Calibration Date	Calibration Until
Spectrum Analyzer	R&S	FSV40	101063	Feb. 17, 2016	Feb. 16, 2017
Power Meter	Anritsu	ML2495A	1241002	Oct. 06, 2016	Oct. 05, 2017
Power Sensor	Anritsu	MA2411B	1207366	Oct. 06, 2016	Oct. 05, 2017
DC POWER SOURCE	GW INSTRON	GPC-6030D	EM892433	Oct. 20, 2016	Oct. 19, 2017
Measurement Software	Sporton	Sporton_1	1.3.30	NA	NA
Note: Calibration Interval of instruments listed above is one year.					

Beamforming mode

Test Item	Conducted Emission				
Test Site	Conduction room 1 / (CO01-WS)				
Tested Date	Mar. 14, 2017				
Instrument	Manufacturer	Model No.	Serial No.	Calibration Date	Calibration Until
Receiver	R&S	ESR3	101657	Dec. 21, 2016	Dec. 20, 2017
LISN	SCHWARZBECK	Schwarzbeck 8127	8127-667	Nov. 08, 2016	Nov. 07, 2017
RF Cable-CON	EMC	EMCCFD300-BM-BM-6000	50821	Dec. 20, 2016	Dec. 19, 2017
Measurement Software	AUDIX	e3	6.120210k	NA	NA
ESH3-Z6 V-Network	R&S	ESH3-Z6	100951	Feb. 17, 2017	Feb. 16, 2018
ESH3-Z6 V-Network	R&S	ESH3-Z6	100920	Nov. 25, 2016	Nov. 24, 2017
Note: Calibration Interval of instruments listed above is one year.					

Test Item	Radiated Emission				
Test Site	966 chamber3 / (03CH03-WS)				
Tested Date	Feb. 20 ~ Feb. 22, 2017				
Instrument	Manufacturer	Model No.	Serial No.	Calibration Date	Calibration Until
Spectrum Analyzer	Agilent	N9010A	MY53400091	Sep. 09, 2016	Sep. 08, 2017
Receiver	Agilent	N9038A	MY53290044	Oct. 06, 2016	Oct. 05, 2017
Bilog Antenna	SCHWARZBECK	VULB9168	VULB9168-685	Apr. 26, 2016	Apr. 25, 2017
Horn Antenna 1G-18G	SCHWARZBECK	BBHA 9120 D	BBHA 9120 D 1206	Feb. 09, 2017	Feb. 08, 2018
Horn Antenna 18G-40G	SCHWARZBECK	BBHA 9170	BBHA 9170517	Oct. 25, 2016	Oct. 24, 2017
Loop Antenna	R&S	HFH2-Z2	100330	Nov. 10, 2016	Nov. 09, 2017
Loop Antenna Cable	KOAX KABEL	101354-BW	101354-BW	Dec. 09, 2016	Dec. 08, 2017
Preamplifier	EMC	EMC02325	980187	Sep. 08, 2016	Sep. 07, 2017
Preamplifier	Agilent	83017A	MY53270014	Aug. 22, 2016	Aug. 21, 2017
Preamplifier	EMC	EMC184045B	980192	Aug. 24, 2016	Aug. 23, 2017
RF cable-3M	HUBER+SUHNER	SUCOFLEX104	MY22620/4	Feb. 04, 2017	Feb. 03, 2018
RF cable-8M	HUBER+SUHNER	SUCOFLEX104	MY22600/4	Feb. 04, 2017	Feb. 03, 2018
RF cable-1M	HUBER+SUHNER	SUCOFLEX104	MY22624/4	Feb. 04, 2017	Feb. 03, 2018
LF cable-0.8M	EMC	EMC8D-NM-NM-800	EMC8D-NM-NM-800-001	Feb. 04, 2017	Feb. 03, 2018
LF cable-3M	EMC	EMC8D-NM-NM-3000	131103	Feb. 04, 2017	Feb. 03, 2018
LF cable-13M	EMC	EMC8D-NM-NM-13000	131104	Feb. 04, 2017	Feb. 03, 2018
Measurement Software	AUDIX	e3	6.120210g	NA	NA
Note: Calibration Interval of instruments listed above is one year.					

Test Item	RF Conducted				
Test Site	(TH01-WS)				
Tested Date	Dec. 15, 2016				
Instrument	Manufacturer	Model No.	Serial No.	Calibration Date	Calibration Until
Spectrum Analyzer	R&S	FSV40	101063	Feb. 17, 2016	Feb. 16, 2017
Power Meter	Anritsu	ML2495A	1241002	Oct. 06, 2016	Oct. 05, 2017
Power Sensor	Anritsu	MA2411B	1207366	Oct. 06, 2016	Oct. 05, 2017
DC POWER SOURCE	GW INSTRON	GPC-6030D	EM892433	Oct. 20, 2016	Oct. 19, 2017
Measurement Software	Sporton	Sporton_1	1.3.30	NA	NA
Note: Calibration Interval of instruments listed above is one year.					

1.5 Test Standards

According to the specification of EUT, the EUT must comply with following standards and KDB documents.

47 CFR FCC Part 15.247

ANSI C63.10-2013

FCC KDB 558074 D01 DTS Meas Guidance v03r05

FCC KDB 662911 D01 Multiple Transmitter Output v02r01

1.6 Measurement Uncertainty

ISO/IEC 17025 requires that an estimate of the measurement uncertainties associated with the emissions test results be included in the report. The measurement uncertainties given below are based on a 95% confidence level (based on a coverage factor (k=2))

Measurement Uncertainty	
Parameters	Uncertainty
Bandwidth	± 34.134 Hz
Conducted power	± 0.808 dB
Power density	± 0.463 dB
Conducted emission	± 2.670 dB
AC conducted emission	± 2.90 dB
Radiated emission ≤ 1 GHz	± 3.66 dB
Radiated emission > 1 GHz	± 5.37 dB

2 Test Configuration

2.1 Testing Condition

Test Item	Test Site	Ambient Condition	Tested By
AC Conduction	CO01-WS	19°C / 61%	Howard Huang
Radiated Emissions	03CH03-WS	21-24°C / 62-67%	Vincent Yeh Aska Huang
RF Conducted	TH01-WS	21°C / 64%	Alex Huang

- FCC Designation.: TW0009
- FCC site registration No.: 207696
- IC site registration No.: 10807C-1

2.2 The Worst Test Modes and Channel Details

Non-beamforming mode

Test item	Modulation Mode	Test Frequency (MHz)	Data Rate	Test Configuration
Conducted Emissions	11g	2437	6 Mbps	---
Radiated Emissions ≤1GHz	11g	2437	6 Mbps	---
Radiated Emissions >1GHz	11b	2412 / 2437 / 2462	1 Mbps	---
Maximum Output Power	11g	2412 / 2437 / 2462	6 Mbps	
6dB bandwidth	HT20	2412 / 2437 / 2462	MCS 0	
Power spectral density	HT40	2422 / 2437 / 2452	MCS 0	
NOTE:				
The EUT was pretested with 3 orientations placed on the table for the radiated emission measurement – X, Y, and Z-plane. The X-plane results were found as the worst case and were shown in this report.				

Beamforming mode

Test item	Modulation Mode	Test Frequency (MHz)	Data Rate	Test Configuration
Conducted Emissions	HT20	2437	MCS 0	Note 2
Radiated Emissions ≤1GHz	HT20	2437	MCS 0	Note 2
Radiated Emissions >1GHz	HT20	2412 / 2437 / 2462	MCS 0	Note 2
Maximum Output Power	HT40	2422 / 2437 / 2452	MCS 0	
6dB bandwidth			MCS 0	
Power spectral density				
NOTE:				
1. The EUT was pretested with 3 orientations placed on the table for the radiated emission measurement – X, Y, and Z-plane. The X-plane results were found as the worst case and were shown in this report.				
2. Beamforming mode is powered by Power supply + System thus conducted emission is tested for each source, other test items are tested under Power supply + System.				

3 Transmitter Test Results

3.1 Conducted Emissions

3.1.1 Limit of Conducted Emissions

Conducted Emissions Limit		
Frequency Emission (MHz)	Quasi-Peak	Average
0.15-0.5	66 - 56 *	56 - 46 *
0.5-5	56	46
5-30	60	50

Note 1: * Decreases with the logarithm of the frequency.

3.1.2 Test Procedures

1. The device is placed on a test table, raised 80 cm above the reference ground plane. The vertical conducting plane is located 40 cm to the rear of the device.
2. The device is connected to line impedance stabilization network (LISN) and other accessories are connected to other LISN. Measured levels of AC power line conducted emission are across the 50 Ω LISN port.
3. AC conducted emission measurements is made over frequency range from 150 kHz to 30 MHz.
4. This measurement was performed with AC 120V / 60Hz.

3.1.3 Test Setup

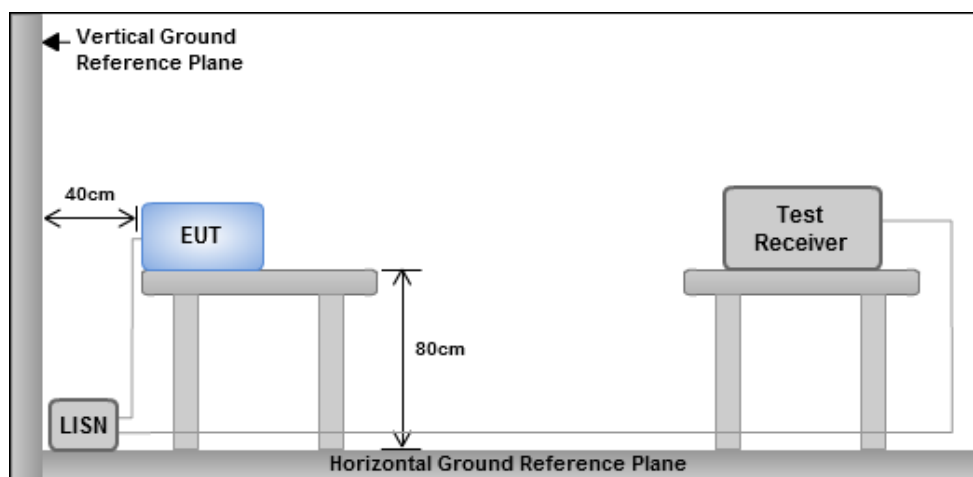

- Note: 1. Support units were connected to second LISN.
 2. Both of LISNs (AMN) are 80 cm from EUT and at least 80 cm from other units and other metal planes

3.1.4 Test Result of Conducted Emissions

Non-beamforming mode

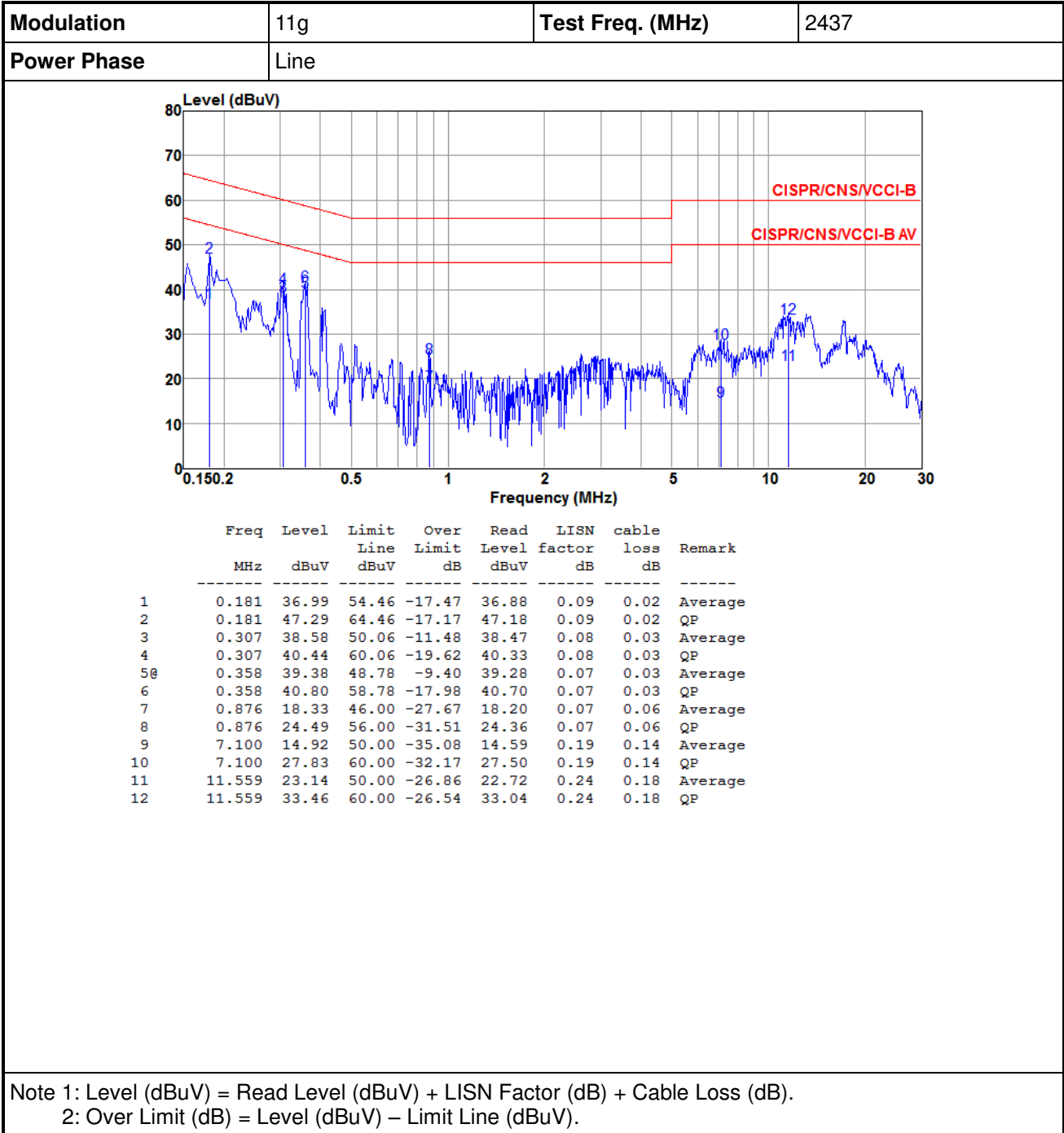

Modulation	11g	Test Freq. (MHz)	2437
-------------------	-----	-------------------------	------

Power Phase	Neutral
--------------------	---------

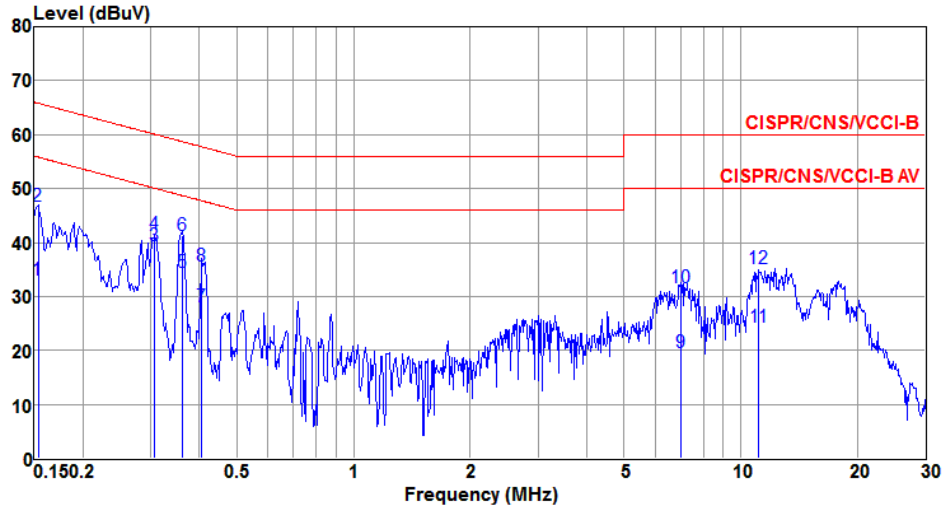

	Freq MHz	Level dBuV	Limit Line dBuV	Over Limit dB	Read Level dBuV	LISN factor dB	cable loss dB	Remark
1	0.153	33.03	55.82	-22.79	32.91	0.10	0.02	Average
2	0.153	46.62	65.82	-19.20	46.50	0.10	0.02	QP
3e	0.307	39.47	50.06	-10.59	39.33	0.11	0.03	Average
4	0.307	41.50	60.06	-18.56	41.36	0.11	0.03	QP
5	0.361	34.37	48.69	-14.32	34.22	0.12	0.03	Average
6	0.361	41.42	58.69	-17.27	41.27	0.12	0.03	QP
7	0.406	28.09	47.73	-19.64	27.93	0.13	0.03	Average
8	0.406	35.63	57.73	-22.10	35.47	0.13	0.03	QP
9	6.988	19.52	50.00	-30.48	19.14	0.24	0.14	Average
10	6.988	31.54	60.00	-28.46	31.16	0.24	0.14	QP
11	11.139	24.35	50.00	-25.65	23.85	0.33	0.17	Average
12	11.139	35.09	60.00	-24.91	34.59	0.33	0.17	QP

Note 1: Level (dBuV) = Read Level (dBuV) + LISN Factor (dB) + Cable Loss (dB).
 2: Over Limit (dB) = Level (dBuV) – Limit Line (dBuV).

Beamforming mode for power supply

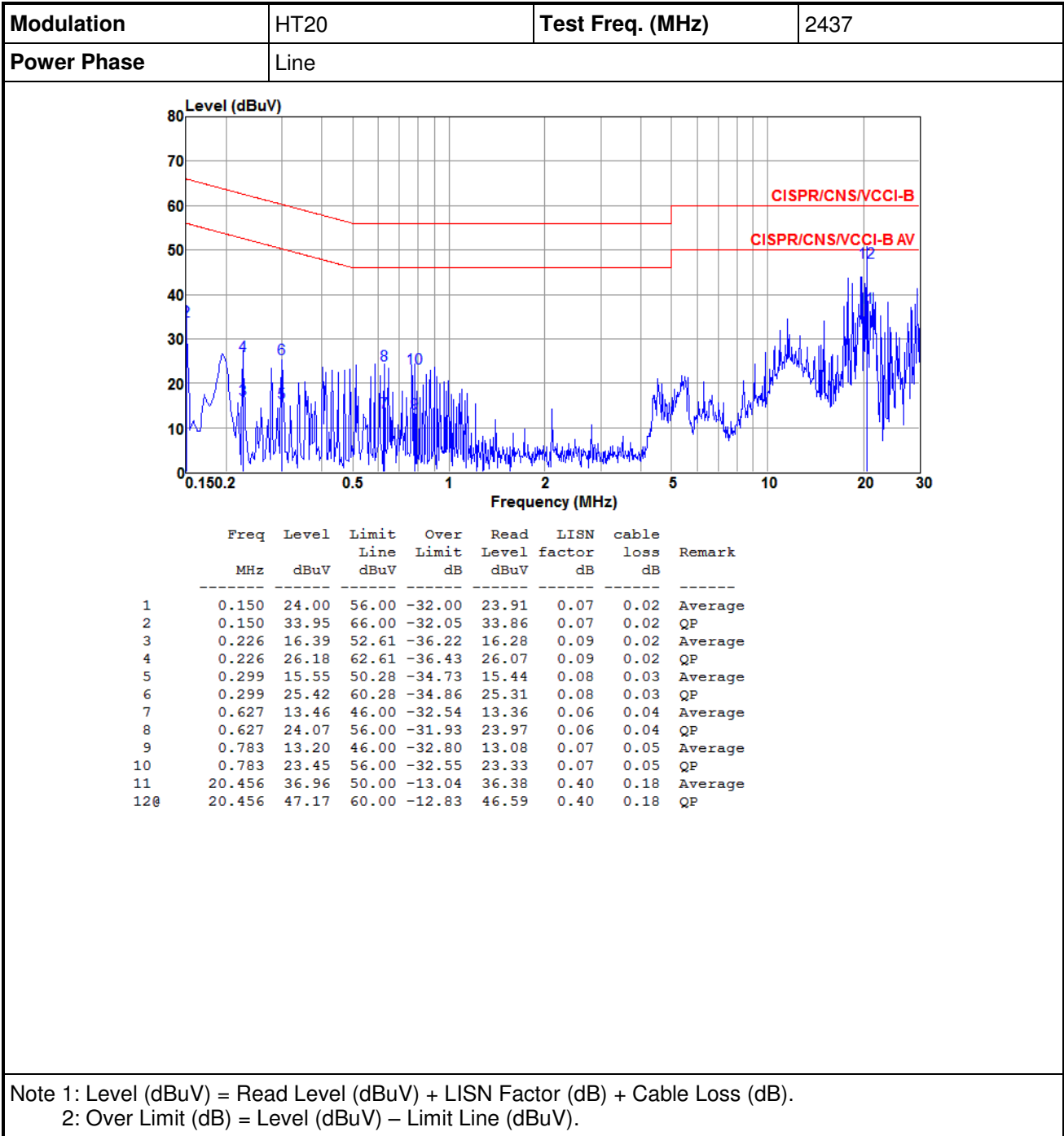

Modulation	HT20	Test Freq. (MHz)	2437
Power Phase	Neutral		

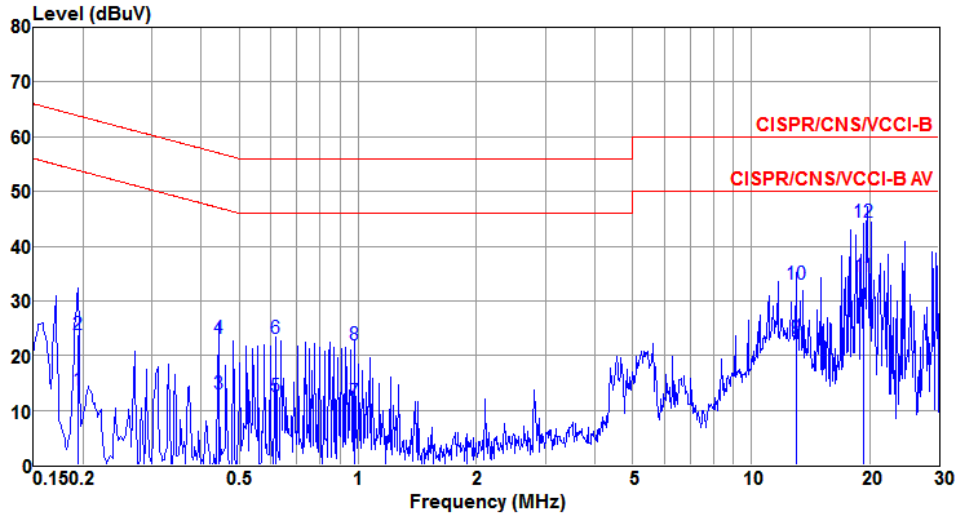

	Freq MHz	Level dBuV	Limit Line dBuV	Over Limit dB	Read Level dBuV	LISN factor dB	cable loss dB	Remark
1	0.194	13.62	53.84	-40.22	13.51	0.09	0.02	Average
2	0.194	23.87	63.84	-39.97	23.76	0.09	0.02	QP
3	0.442	12.88	47.02	-34.14	12.72	0.13	0.03	Average
4	0.442	23.12	57.02	-33.90	22.96	0.13	0.03	QP
5	0.617	12.61	46.00	-33.39	12.46	0.11	0.04	Average
6	0.617	23.10	56.00	-32.90	22.95	0.11	0.04	QP
7	0.979	11.51	46.00	-34.49	11.36	0.09	0.06	Average
8	0.979	22.07	56.00	-33.93	21.92	0.09	0.06	QP
9	12.988	23.21	50.00	-26.79	22.67	0.35	0.19	Average
10	12.988	33.11	60.00	-26.89	32.57	0.35	0.19	QP
11	19.357	34.42	50.00	-15.58	33.84	0.41	0.17	Average
12	19.357	44.36	60.00	-15.64	43.78	0.41	0.17	QP

Note 1: Level (dBuV) = Read Level (dBuV) + LISN Factor (dB) + Cable Loss (dB).
 2: Over Limit (dB) = Level (dBuV) – Limit Line (dBuV).

Beamforming mode for system

Modulation	HT20	Test Freq. (MHz)	2437
Power Phase	Line		

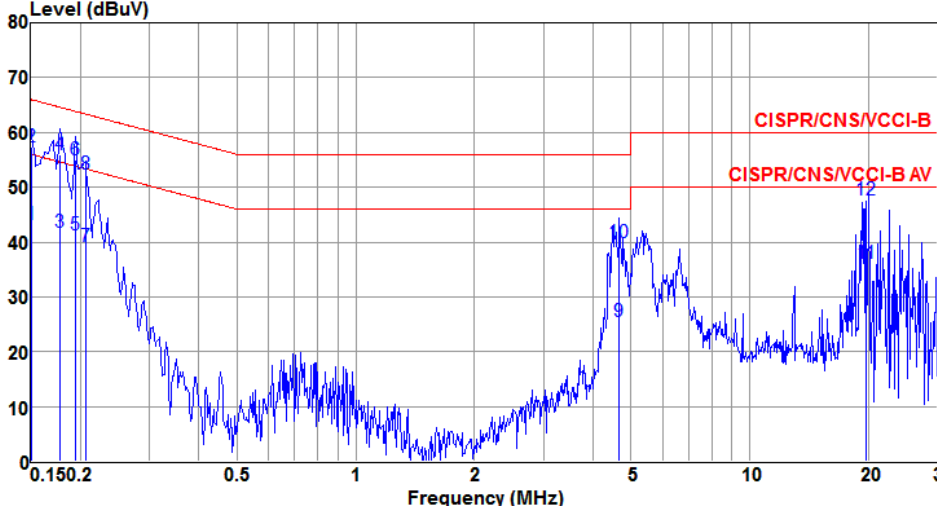

The plot shows a blue signal line with several peaks. Two red limit lines are shown: 'CISPR/CNS/VCCI-B' at approximately 60 dBuV and 'CISPR/CNS/VCCI-B AV' at approximately 50 dBuV. The x-axis is logarithmic from 0.1502 to 30 MHz. The y-axis is linear from 0 to 80 dBuV.

	Freq MHz	Level dBuV	Limit Line dBuV	Over Limit dB	Read Level dBuV	LISN factor dB	cable loss dB	Remark
1	0.150	43.25	56.00	-12.75	42.92	0.31	0.02	Average
2	0.150	57.37	66.00	-8.63	57.04	0.31	0.02	QP
3	0.178	41.68	54.59	-12.91	41.40	0.26	0.02	Average
4	0.178	56.04	64.59	-8.55	55.76	0.26	0.02	QP
5	0.194	41.31	53.84	-12.53	41.06	0.23	0.02	Average
6	0.194	54.92	63.84	-8.92	54.67	0.23	0.02	QP
7	0.206	39.21	53.36	-14.15	38.97	0.22	0.02	Average
8	0.206	52.41	63.36	-10.95	52.17	0.22	0.02	QP
9	4.672	25.46	46.00	-20.54	25.17	0.16	0.13	Average
10	4.672	39.89	56.00	-16.11	39.60	0.16	0.13	QP
11	19.785	36.22	50.00	-13.78	35.78	0.27	0.17	Average
12	19.785	47.64	60.00	-12.36	47.20	0.27	0.17	QP

Note 1: Level (dBuV) = Read Level (dBuV) + LISN Factor (dB) + Cable Loss (dB).
 Note 2: Over Limit (dB) = Level (dBuV) – Limit Line (dBuV).

Modulation	HT20	Test Freq. (MHz)	2437
-------------------	------	-------------------------	------

Power Phase	Neutral
--------------------	---------

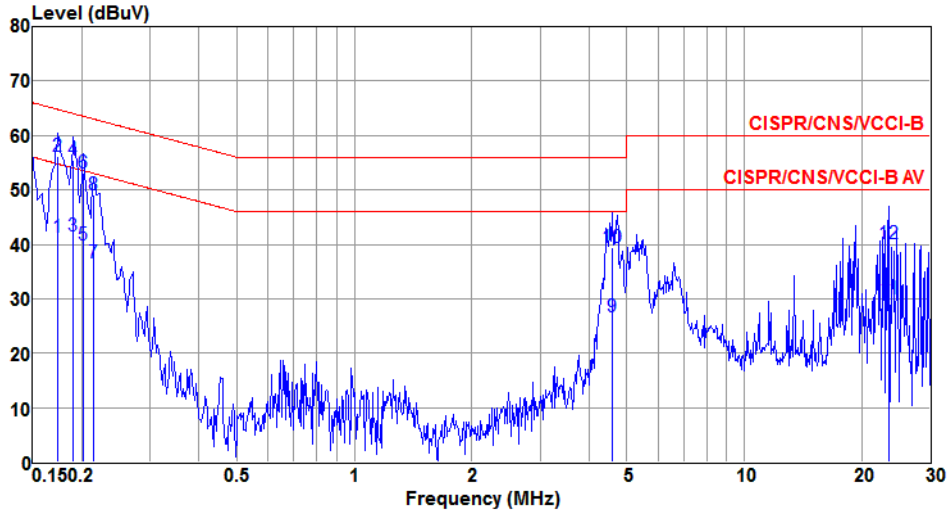

	Freq MHz	Level dBuV	Limit Line dBuV	Over Limit dB	Read Level dBuV	LISN factor dB	cable loss dB	Remark
1	0.174	41.41	54.77	-13.36	41.09	0.30	0.02	Average
2	0.174	56.07	64.77	-8.70	55.75	0.30	0.02	QP
3	0.190	41.60	54.02	-12.42	41.31	0.27	0.02	Average
4e	0.190	55.43	64.02	-8.59	55.14	0.27	0.02	QP
5	0.202	39.95	53.54	-13.59	39.68	0.25	0.02	Average
6	0.202	53.15	63.54	-10.39	52.88	0.25	0.02	QP
7	0.214	36.56	53.05	-16.49	36.30	0.24	0.02	Average
8	0.214	49.18	63.05	-13.87	48.92	0.24	0.02	QP
9	4.574	26.59	46.00	-19.41	26.34	0.12	0.13	Average
10	4.574	39.45	56.00	-16.55	39.20	0.12	0.13	QP
11	23.511	30.00	50.00	-20.00	29.53	0.24	0.23	Average
12	23.511	40.06	60.00	-19.94	39.59	0.24	0.23	QP

Note 1: Level (dBuV) = Read Level (dBuV) + LISN Factor (dB) + Cable Loss (dB).
 2: Over Limit (dB) = Level (dBuV) – Limit Line (dBuV).

3.2 6dB and Occupied Bandwidth

3.2.1 Limit of 6dB Bandwidth

The minimum 6dB bandwidth shall be at least 500 kHz.

3.2.2 Test Procedures

6dB Bandwidth

1. Set resolution bandwidth (RBW) = 100 kHz, Video bandwidth = 300 kHz.
2. Detector = Peak, Trace mode = max hold.
3. Sweep = auto couple, Allow the trace to stabilize.
4. Measure the maximum width of the emission that is constrained by the frequencies associated with the two outermost amplitude points (upper and lower) that are attenuated by 6dB relative to the maximum level measured in the fundamental emission.

Occupied Bandwidth

1. Set resolution bandwidth (RBW) = 1 MHz, Video bandwidth = 3 MHz.
2. Detector = Sample, Trace mode = max hold.
3. Sweep = auto couple, Allow the trace to stabilize.
4. Use the OBW measurement function of spectrum analyzer to measure the occupied bandwidth.

3.2.3 Test Setup

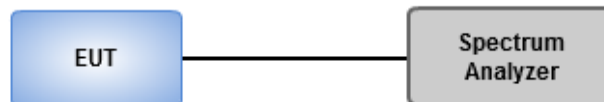

3.2.4 Test Result of 6dB and Occupied Bandwidth

Non-beamforming mode

Modulation Mode	N _{TX}	Freq. (MHz)	6dB Bandwidth (MHz)				Limit (kHz)
			Chain 0	Chain 1	Chain 2	Chain 3	
11b	4	2412	8.06	7.59	7.07	8.06	500
11b	4	2437	8.12	8.12	8.12	8.12	500
11b	4	2462	8.06	8.12	7.13	8.12	500
11g	4	2412	16.06	16.35	13.91	16.06	500
11g	4	2437	15.30	15.94	15.13	15.30	500
11g	4	2462	16.35	14.78	13.86	15.54	500
HT20	4	2412	16.99	17.62	14.43	16.29	500
HT20	4	2437	15.94	15.07	15.01	15.71	500
HT20	4	2462	16.58	15.71	15.07	16.29	500
HT40	4	2422	35.01	32.58	35.01	35.01	500
HT40	4	2437	35.36	35.25	35.25	35.13	500
HT40	4	2452	35.13	33.97	35.01	35.13	500

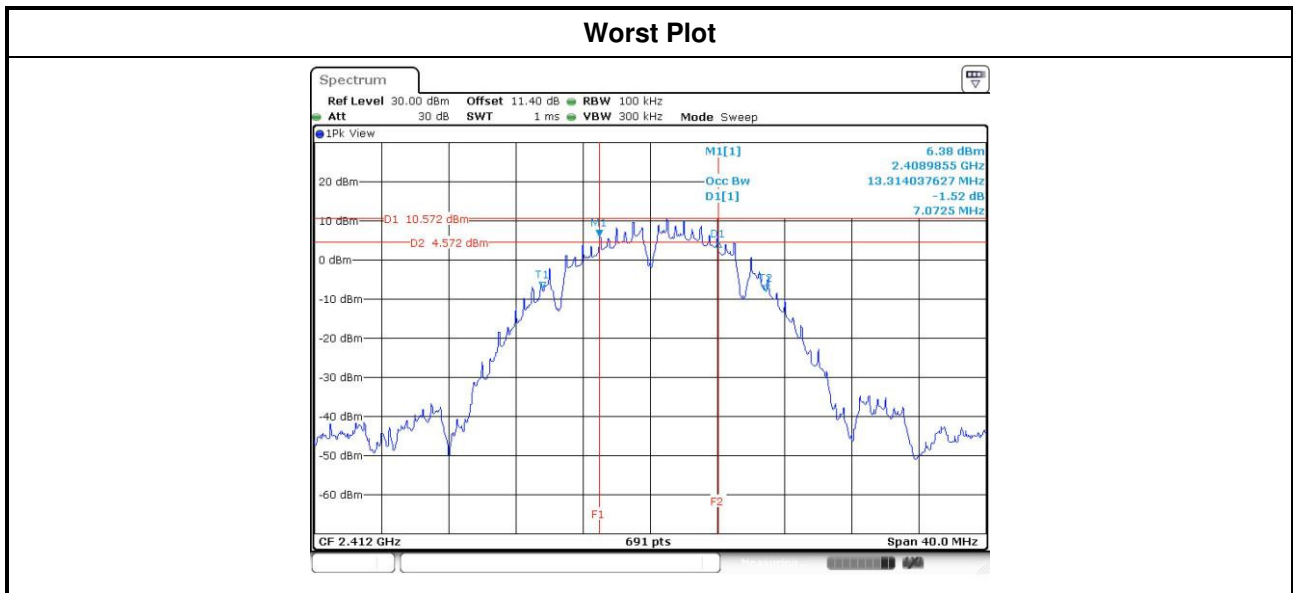

Modulation Mode	N _{TX}	Freq. (MHz)	99% Occupied Bandwidth (MHz)			
			Chain 0	Chain 1	Chain 2	Chain 3
11b	4	2412	13.31	13.09	13.39	13.31
11b	4	2437	13.57	13.56	13.89	13.61
11b	4	2462	13.00	13.31	12.95	13.04
11g	4	2412	16.44	16.40	16.41	16.39
11g	4	2437	22.67	24.99	26.19	25.05
11g	4	2462	16.45	16.51	16.39	16.40
HT20	4	2412	17.57	17.53	17.59	17.56
HT20	4	2437	19.85	23.65	23.57	22.47
HT20	4	2462	17.59	17.64	17.55	17.57
HT40	4	2422	35.95	35.95	35.84	35.97
HT40	4	2437	36.16	36.27	36.11	36.19
HT40	4	2452	36.11	36.00	36.19	36.03

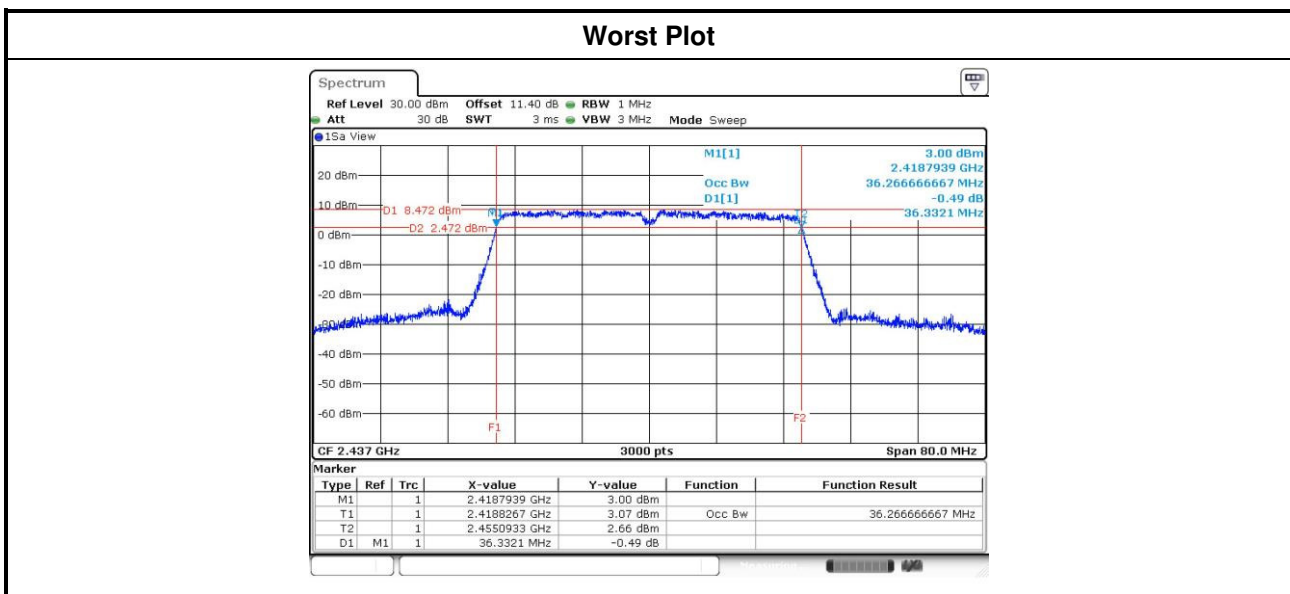

Beamforming mode

Modulation Mode	N _{TX}	Freq. (MHz)	6dB Bandwidth (MHz)				Limit (kHz)
			Chain 0	Chain 1	Chain 2	Chain 3	
HT20	4	2412	16.29	15.07	15.71	16.41	500
HT20	4	2437	16.35	17.16	16.17	17.62	500
HT20	4	2462	16.87	15.83	15.65	16.29	500
HT40	4	2422	27.59	27.48	28.87	30.03	500
HT40	4	2437	31.30	32.58	32.58	31.30	500
HT40	4	2452	30.15	30.15	31.42	30.15	500

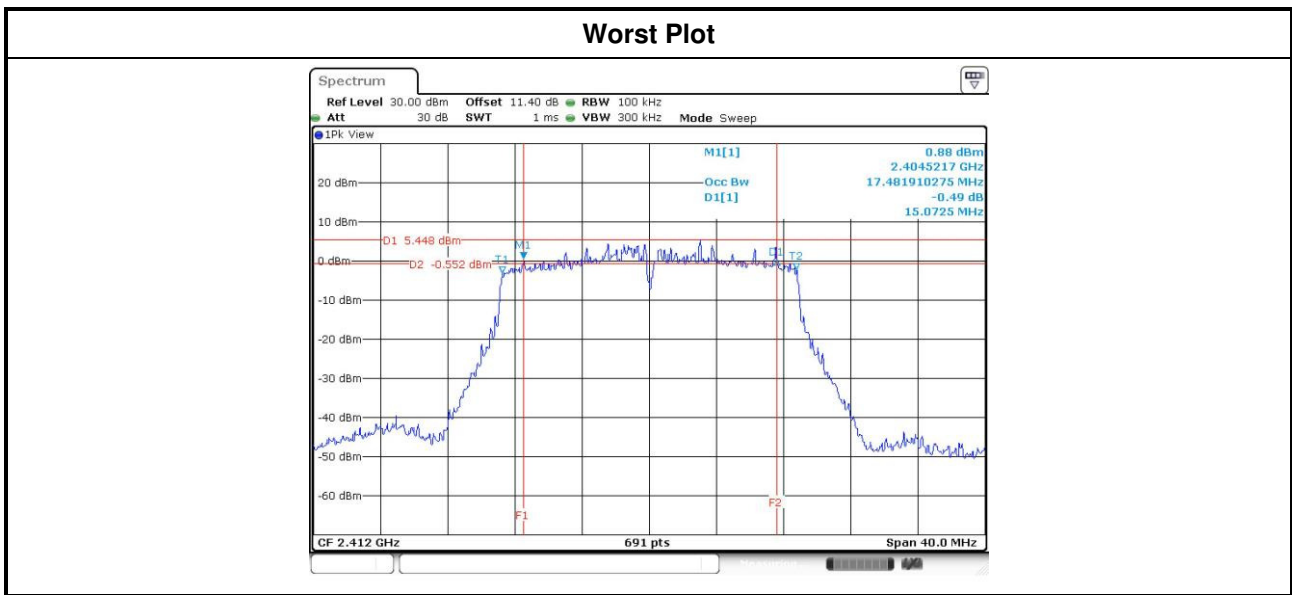

Modulation Mode	N _{TX}	Freq. (MHz)	99% Occupied Bandwidth (MHz)			
			Chain 0	Chain 1	Chain 2	Chain 3
HT20	4	2412	17.55	17.60	17.60	17.55
HT20	4	2437	21.99	18.69	21.51	18.23
HT20	4	2462	17.61	17.59	17.61	17.56
HT40	4	2422	35.65	35.95	35.76	35.95
HT40	4	2437	36.21	36.16	36.08	36.13
HT40	4	2452	36.24	36.08	36.05	36.11

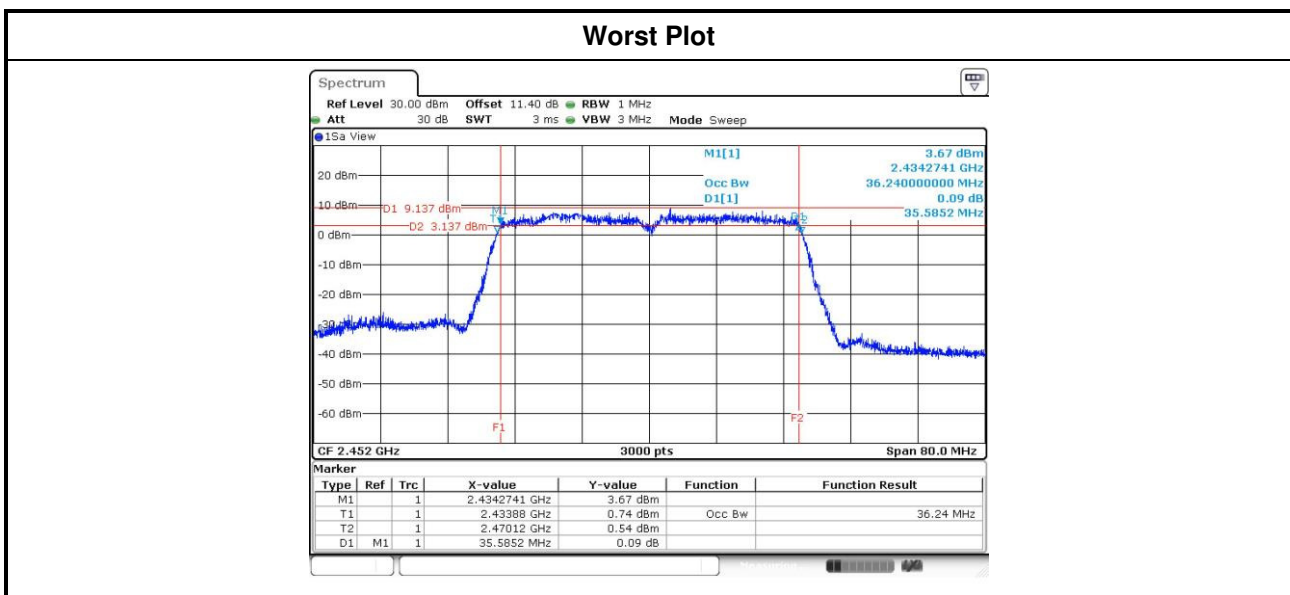

3.3 RF Output Power

3.3.1 Limit of RF Output Power

Conducted power shall not exceed 1Watt.

- Antenna gain \leq 6dBi, no any corresponding reduction is in output power limit.
- Antenna gain $>$ 6dBi
 - Non Fixed, point to point operations.
The conducted output power from the intentional radiator shall be reduced by the amount in dB that the directional gain of the antenna exceeds 6 dB
 - Fixed, point to point operations
Systems operating in the 2400–2483.5 MHz band that are used exclusively for fixed, point-to-point Operations, maximum peak output power of the intentional radiator is reduced by 1 dB for every 3 dB that the directional gain of the antenna exceeds 6 dBi.

Systems operating in the 5725–5850 MHz band that are used exclusively for fixed, point-to-point operations ,no any corresponding reduction is in transmitter peak output power

3.3.2 Test Procedures

- Maximum Peak Conducted Output Power
 - Spectrum analyzer**
 1. Set RBW = 1MHz, VBW = 3MHz, Detector = Peak.
 2. Sweep time = auto, Trace mode = max hold, Allow trace to fully stabilize.
 3. Use the spectrum analyzer channel power measurement function with the band limits set equal to the DTS bandwidth edges.
 - Power meter**
 1. A broadband Peak RF power meter is used for output power measurement. The video bandwidth of power meter is greater than DTS bandwidth of EUT. If duty cycle of test signal is not 100 %, trigger and gating function of power meter will be enabled to capture transmission burst for measuring output power.
- Maximum Conducted Output Power
 - Power meter**
 1. A broadband Average RF power meter is used for output power measurement. The video bandwidth of power meter is greater than DTS bandwidth of EUT. If duty cycle of test signal is not 100 %, trigger and gating function of power meter will be enabled to capture transmission burst for measuring output power.

3.3.3 Test Setup

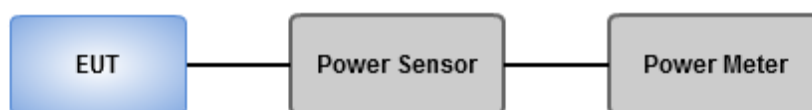

3.3.4 Test Result of Maximum Output Power

Non-beamforming mode

Modulation Mode	N _{TX}	Freq. (MHz)	Conducted (Average) Output Power (dBm)							Ant. Gain (dBi)	EIRP (dBm)	EIRP Limit (dBm)
			Chain 0	Chain 1	Chain 2	Chain 3	Total Power (mW)	Total Power (dBm)	Limit (dBm)			
11b	4	2412	19.75	19.53	19.56	19.67	367.197	25.65	30.00	4.30	29.95	36.00
11b	4	2437	19.22	19.33	19.6	19.46	348.773	25.43	30.00	4.30	29.73	36.00
11b	4	2462	18.53	18.54	18.85	18.67	293.092	24.67	30.00	4.30	28.97	36.00
11g	4	2412	15.66	15.47	15.45	15.63	143.685	21.57	30.00	4.30	25.87	36.00
11g	4	2437	20.43	20.41	20.53	20.72	451.320	26.54	30.00	4.30	30.84	36.00
11g	4	2462	15.77	15.48	15.76	15.73	148.157	21.71	30.00	4.30	26.01	36.00
HT20	4	2412	15.41	15.24	15.35	15.45	137.525	21.38	30.00	4.30	25.68	36.00
HT20	4	2437	20.25	20.31	20.46	20.69	441.717	26.45	30.00	4.30	30.75	36.00
HT20	4	2462	15.56	15.26	15.48	15.44	139.862	21.46	30.00	4.30	25.76	36.00
HT40	4	2422	12.92	12.71	12.81	12.94	77.030	18.87	30.00	4.30	23.17	36.00
HT40	4	2437	15.5	15.26	15.31	15.47	138.255	21.41	30.00	4.30	25.71	36.00
HT40	4	2452	14.87	14.55	14.65	14.83	118.784	20.75	30.00	4.30	25.05	36.00

Beamforming mode

Modulation Mode	N _{TX}	Freq. (MHz)	Conducted (Average) Output Power (dBm)							Ant. Gain (dBi)	EIRP (dBm)	EIRP Limit (dBm)
			Chain 0	Chain 1	Chain 2	Chain 3	Total Power (mW)	Total Power (dBm)	Limit (dBm)			
HT20	4	2412	15.03	14.75	15.14	15.2	127.468	21.05	25.75	10.25	31.30	36.00
HT20	4	2437	19.26	19.06	19.77	18.86	336.626	25.27	25.75	10.25	35.52	36.00
HT20	4	2462	14.64	14.58	14.91	14.52	117.103	20.69	25.75	10.25	30.94	36.00
HT40	4	2422	12.14	11.95	12.44	12.14	65.943	18.19	25.75	10.25	28.44	36.00
HT40	4	2437	15.19	14.98	15.55	15.17	133.292	21.25	25.75	10.25	31.50	36.00
HT40	4	2452	13.15	13.02	13.38	13.07	82.752	19.18	25.75	10.25	29.43	36.00

Note:

Directional gain = $10 * \log((10^{4.2/20} + 10^{4.2/20} + 10^{4.3/20} + 10^{4.2/20})^2 / 4) = 10.25 \text{ dBi} > 6 \text{ dBi}$
 Limit shall be reduced to $30 \text{ dBm} - (10.25 \text{ dBi} - 6 \text{ dBi}) = 25.75 \text{ dBm}$

3.4 Power Spectral Density

3.4.1 Limit of Power Spectral Density

Power spectral density shall not be greater than 8 dBm in any 3 kHz band.

3.4.2 Test Procedures

- Method AVGPS-1 (For non-Beamforming mode)
 1. Set the RBW = 30kHz, VBW = 100kHz.
 2. Detector = RMS, Sweep time = auto couple.
 3. Employ trace averaging (RMS) mode over a minimum of 100 traces.
 4. Use the peak marker function to determine the maximum amplitude level.
- Method AVGPS-2 Alternative(For Beamforming mode)
 1. Set the RBW = 30kHz, VBW = 100 kHz, Detector = RMS
 2. Manually set the sweep time to: $\geq 10 \times$ (number of measurement points in sweep) \times (total on/off period of the transmitted signal).
 3. Perform the measurement over a single sweep.
 4. Use the peak marker function to determine the maximum amplitude level.
 5. Add $10 \log(1/x)$, where x is the duty cycle

3.4.3 Test Setup

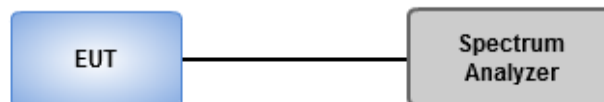

3.4.4 Test Result of Power Spectral Density

Non-beamforming mode

Modulation Mode	N _{TX}	Freq. (MHz)	PPSD w/o D.F (dBm/30kHz)	Duty Factor (dB)	PPSD with D.F (dBm/30kHz)	Limit (dBm/3kHz)
11b	4	2412	3.60	0.00	3.60	3.75
11b	4	2437	3.58	0.00	3.58	3.75
11b	4	2462	3.36	0.00	3.36	3.75
11g	4	2412	-2.86	0.00	-2.86	3.75
11g	4	2437	1.94	0.00	1.94	3.75
11g	4	2462	-2.11	0.00	-2.11	3.75
HT20	4	2412	-3.13	0.00	-3.13	3.75
HT20	4	2437	2.01	0.00	2.01	3.75
HT20	4	2462	-2.75	0.00	-2.75	3.75
HT40	4	2422	-8.22	0.00	-8.22	3.75
HT40	4	2437	-5.12	0.00	-5.12	3.75
HT40	4	2452	-6.71	0.00	-6.71	3.75

Note 1: Test result is bin-by-bin summing measured value of each TX port.

Note 2: D.F is duty factor

Note 3: Directional gain = $10 * \log((10^{4.2/20} + 10^{4.2/20} + 10^{4.3/20} + 10^{4.2/20})^2 / 4) = 10.25 \text{ dBi} > 6 \text{ dBi}$
Limit shall be reduced to $8 \text{ dBm} - (10.25 \text{ dBi} - 6 \text{ dBi}) = 3.75 \text{ dBm}$

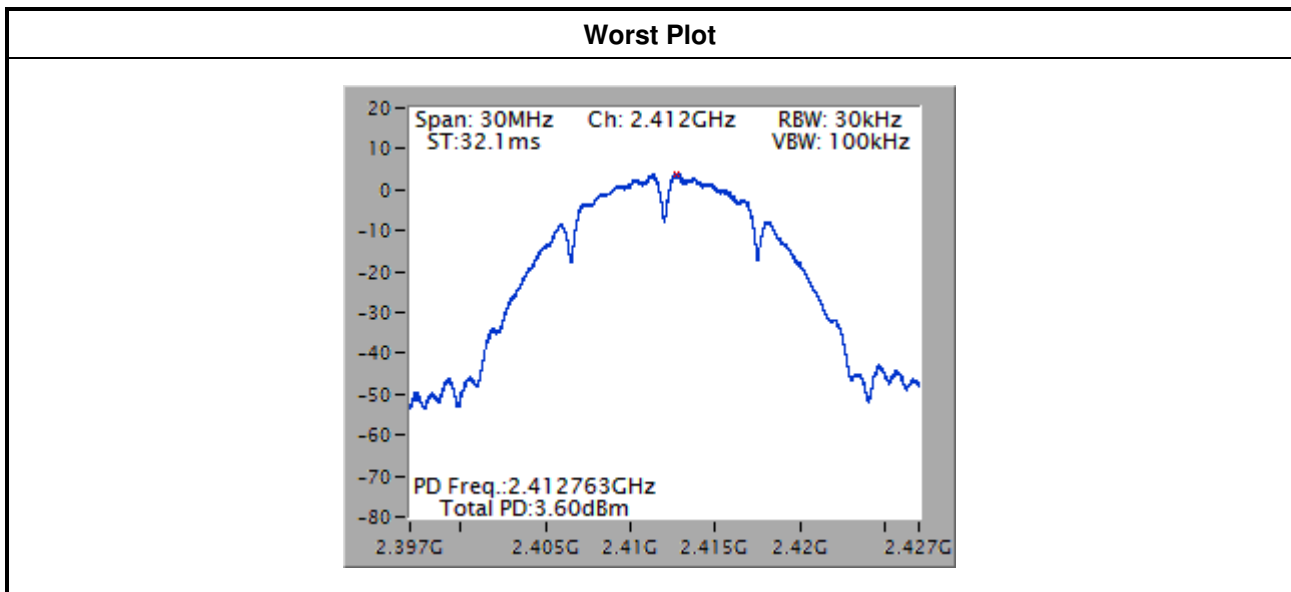

3.5 Unwanted Emissions into Restricted Frequency Bands

3.5.1 Limit of Unwanted Emissions into Restricted Frequency Bands

Restricted Band Emissions Limit			
Frequency Range (MHz)	Field Strength (uV/m)	Field Strength (dBuV/m)	Measure Distance (m)
0.009~0.490	2400/F(kHz)	48.5 - 13.8	300
0.490~1.705	24000/F(kHz)	33.8 - 23	30
1.705~30.0	30	29	30
30~88	100	40	3
88~216	150	43.5	3
216~960	200	46	3
Above 960	500	54	3

Note 1:
Qusai-Peak value is measured for frequency below 1GHz except for 9–90 kHz, 110–490 kHz frequency band. Peak and average value are measured for frequency above 1GHz. The limit on average radio frequency emission is as above table. The limit on peak radio frequency emissions is 20 dB above the maximum permitted average emission limit

Note 2:
Measurements may be performed at a distance other than what is specified provided. When performing measurements at a distance other than that specified, the results shall be extrapolated to the specified distance using an extrapolation factor as below, Frequency at or above 30 MHz: 20 dB/decade Frequency below 30 MHz: 40 dB/decade.

3.5.2 Test Procedures

1. Measurement is made at a semi-anechoic chamber that incorporates a turntable allowing a EUT rotation of 360°. A continuously-rotating, remotely-controlled turntable is installed at the test site to support the EUT and facilitate determination of the direction of maximum radiation for each EUT emission frequency. The EUT is placed at test table. For emissions testing at or below 1 GHz, the table height is 80 cm above the reference ground plane. For emission measurements above 1 GHz, the table height is 1.5 m
2. Measurement is made with the antenna positioned in both the horizontal and vertical planes of polarization. The measurement antenna is varied in height (1m ~ 4m) above the reference ground plane to obtain the maximum signal strength. Distance between EUT and antenna is 3 m.
3. This investigation is performed with the EUT rotated 360°, the antenna height scanned between 1 m and 4 m, and the antenna rotated to repeat the measurements for both the horizontal and vertical antenna polarizations.

Note:

1. 120kHz measurement bandwidth of test receiver and Quasi-peak detector is for radiated emission below 1GHz.
2. RBW=1MHz, VBW=3MHz and Peak detector is for peak measured value of radiated emission above 1GHz.
3. RBW=1MHz, VBW=1/T and Peak detector is for average measured value of radiated emission above 1GHz.

3.5.3 Test Setup

Radiated Emissions below 1 GHz

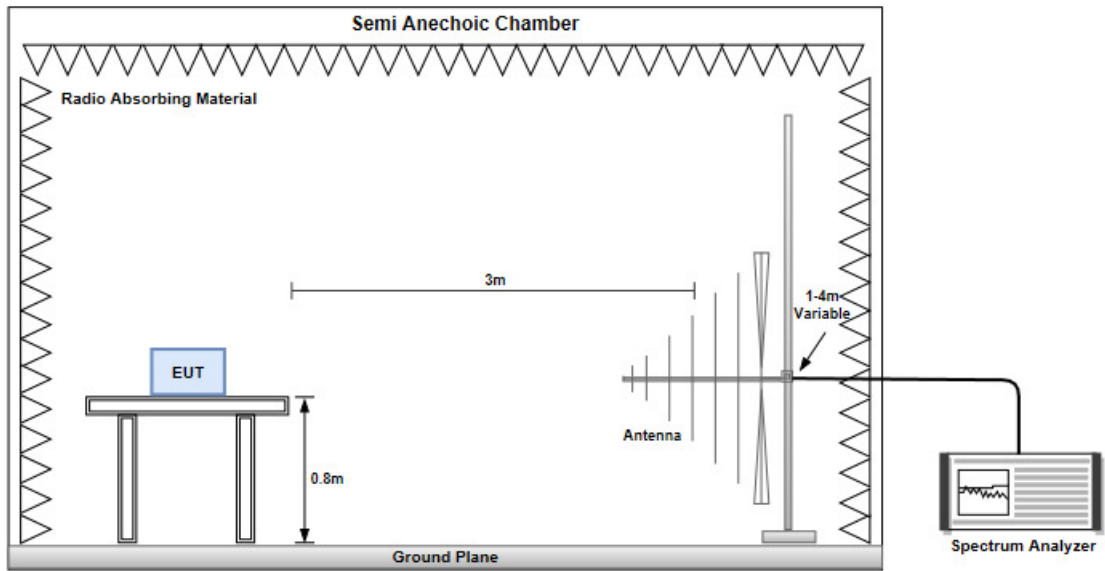

Radiated Emissions above 1 GHz

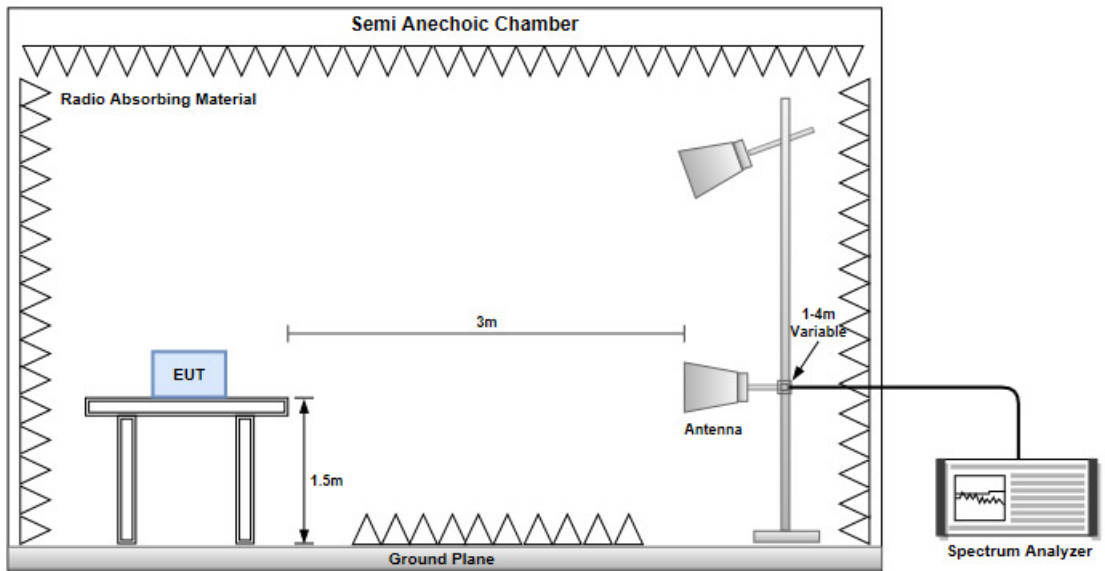

Non-beamforming mode

3.5.4 Transmitter Radiated Unwanted Emissions (Below 1GHz)

Modulation	11g	Test Freq. (MHz)	2437
Polarization	Horizontal		

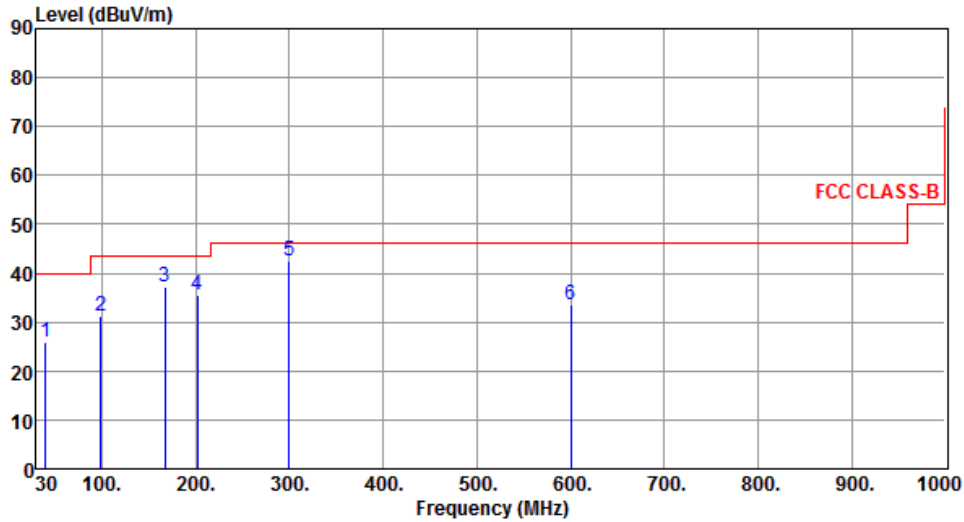

	Freq. MHz	Emission level dBuV/m	Limit dBuV/m	Margin dB	SA reading dBuV	Factor dB	Remark	ANT High cm	Turn Table deg
1	39.70	25.88	40.00	-14.12	34.21	-8.33	Peak	---	---
2	98.87	31.32	43.50	-12.18	44.68	-13.36	Peak	---	---
3	166.77	37.04	43.50	-6.46	45.37	-8.33	Peak	---	---
4	201.69	35.47	43.50	-8.03	46.46	-10.99	Peak	---	---
5	299.66	42.57	46.00	-3.43	50.28	-7.71	Peak	---	---
6	600.36	33.62	46.00	-12.38	34.27	-0.65	Peak	---	---

Note 1: Emission Level (dBuV/m) = SA Reading (dBuV/m) + Factor* (dB)

*Factor includes antenna factor , cable loss and amplifier gain

Note 2: Margin (dB) = Emission level (dBuV/m) – Limit (dBuV/m).

Note 3: All spurious emissions below 30MHz are more than 20 dB below the limit.

Modulation	11g	Test Freq. (MHz)	2437
Polarization	Vertical		

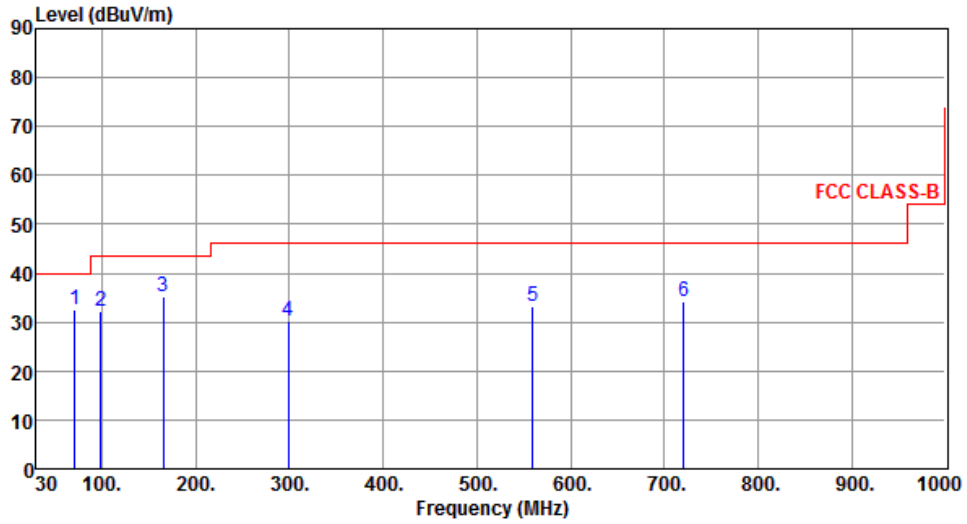

	Freq. MHz	Emission level dBuV/m	Limit dBuV/m	Margin dB	SA reading dBuV	Factor dB	Remark	ANT High cm	Turn Table deg
1	70.74	32.61	40.00	-7.39	43.32	-10.71	Peak	---	---
2	98.87	32.26	43.50	-11.24	45.62	-13.36	Peak	---	---
3	165.80	35.22	43.50	-8.28	43.50	-8.28	Peak	---	---
4	298.69	30.31	46.00	-15.69	38.04	-7.73	Peak	---	---
5	559.62	33.06	46.00	-12.94	34.79	-1.73	Peak	---	---
6	720.64	34.27	46.00	-11.73	33.07	1.20	Peak	---	---

Note 1: Emission Level (dBuV/m) = SA Reading (dBuV/m) + Factor* (dB)

*Factor includes antenna factor , cable loss and amplifier gain

Note 2: Margin (dB) = Emission level (dBuV/m) – Limit (dBuV/m).

Note 3: All spurious emissions below 30MHz are more than 20 dB below the limit.

3.5.5 Transmitter Radiated Unwanted Emissions (Above 1GHz) for 11b

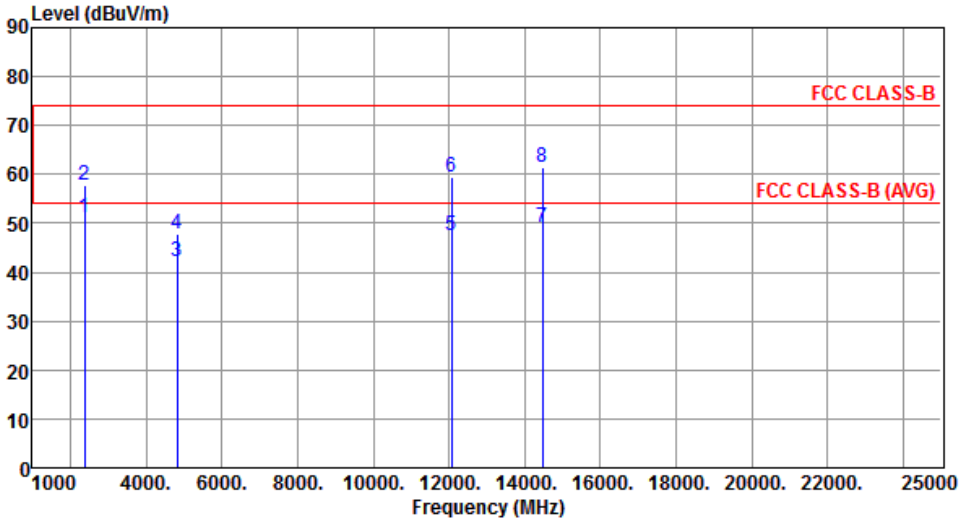
Modulation	11b	Test Freq. (MHz)	2412						
Polarization	Horizontal								
									
	Freq. MHz	Emission level dBuV/m	Limit dBuV/m	Margin dB	SA reading dBuV	Factor dB	Remark	ANT High cm	Turn Table deg
1	2390.00	51.03	54.00	-2.97	52.14	-1.11	Average	311	100
2	2390.00	57.72	74.00	-16.28	58.83	-1.11	Peak	311	100
3	4824.00	42.27	54.00	-11.73	36.96	5.31	Average	319	37
4	4824.00	47.86	74.00	-26.14	42.55	5.31	Peak	319	37
5	12060.00	47.37	54.00	-6.63	32.34	15.03	Average	222	252
6	12060.00	59.42	74.00	-14.58	44.39	15.03	Peak	222	252
7	14472.00	49.00	54.00	-5.00	30.53	18.47	Average	100	126
8	14472.00	61.32	74.00	-12.68	42.85	18.47	Peak	100	126

Note 1: Emission Level (dBuV/m) = SA Reading (dBuV/m) + Factor* (dB)
*Factor includes antenna factor , cable loss and amplifier gain
Note 2: Margin (dB) = Emission level (dBuV/m) – Limit (dBuV/m).

Modulation	11b	Test Freq. (MHz)	2412
Polarization	Vertical		

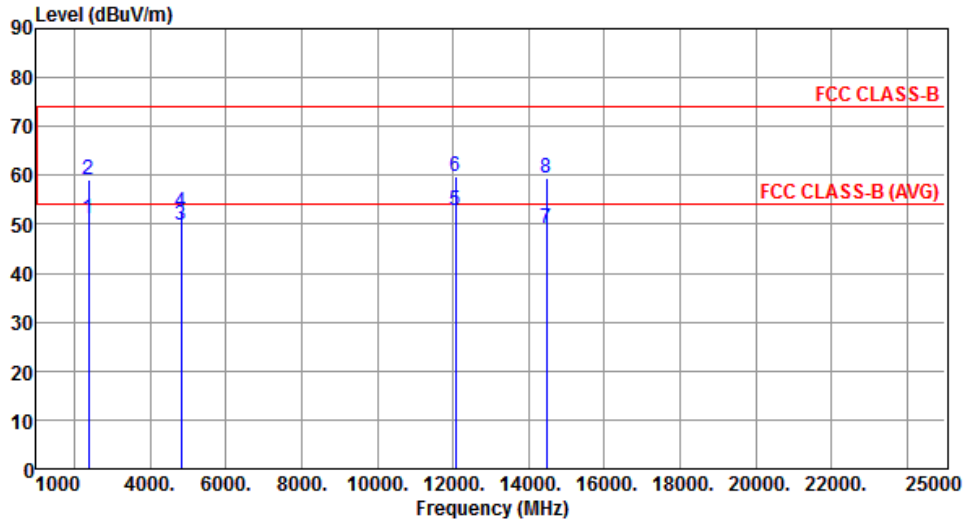

	Freq. MHz	Emission level dBuV/m	Limit dBuV/m	Margin dB	SA reading dBuV	Factor dB	Remark	ANT High cm	Turn Table deg
1	2390.00	51.26	54.00	-2.74	52.37	-1.11	Average	109	338
2	2390.00	59.04	74.00	-14.96	60.15	-1.11	Peak	109	338
3	4824.00	49.67	54.00	-4.33	44.36	5.31	Average	100	200
4	4824.00	52.50	74.00	-21.50	47.19	5.31	Peak	100	200
5	12060.00	52.82	54.00	-1.18	37.79	15.03	Average	100	107
6	12060.00	59.90	74.00	-14.10	44.87	15.03	Peak	100	107
7	14472.00	49.32	54.00	-4.68	30.85	18.47	Average	109	338
8	14472.00	59.33	74.00	-14.67	40.86	18.47	Peak	109	338

Note 1: Emission Level (dBuV/m) = SA Reading (dBuV/m) + Factor* (dB)

*Factor includes antenna factor , cable loss and amplifier gain

Note 2: Margin (dB) = Emission level (dBuV/m) – Limit (dBuV/m).

Modulation	11b	Test Freq. (MHz)	2437
Polarization	Horizontal		

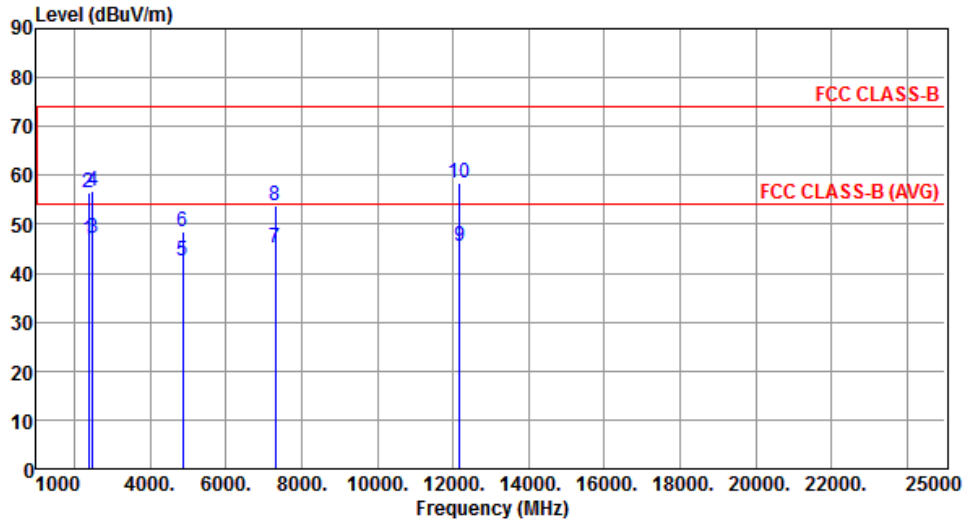

	Freq. MHz	Emission level dBuV/m	Limit dBuV/m	Margin dB	SA reading dBuV	Factor dB	Remark	ANT High cm	Turn Table deg
1	2390.00	46.75	54.00	-7.25	47.86	-1.11	Average	292	92
2	2390.00	56.48	74.00	-17.52	57.59	-1.11	Peak	292	92
3	2483.50	47.06	54.00	-6.94	47.68	-0.62	Average	292	92
4	2483.50	56.78	74.00	-17.22	57.40	-0.62	Peak	292	92
5	4874.00	42.39	54.00	-11.61	36.96	5.43	Average	274	82
6	4874.00	48.57	74.00	-25.43	43.14	5.43	Peak	274	82
7	7311.00	45.09	54.00	-8.91	34.83	10.26	Average	100	349
8	7311.00	53.91	74.00	-20.09	43.65	10.26	Peak	100	349
9	12185.00	45.58	54.00	-8.42	30.64	14.94	Average	100	117
10	12185.00	58.53	74.00	-15.47	43.59	14.94	Peak	100	117

Note 1: Emission Level (dBuV/m) = SA Reading (dBuV/m) + Factor* (dB)

*Factor includes antenna factor , cable loss and amplifier gain

Note 2: Margin (dB) = Emission level (dBuV/m) – Limit (dBuV/m).

Modulation	11b	Test Freq. (MHz)	2437
Polarization	Vertical		

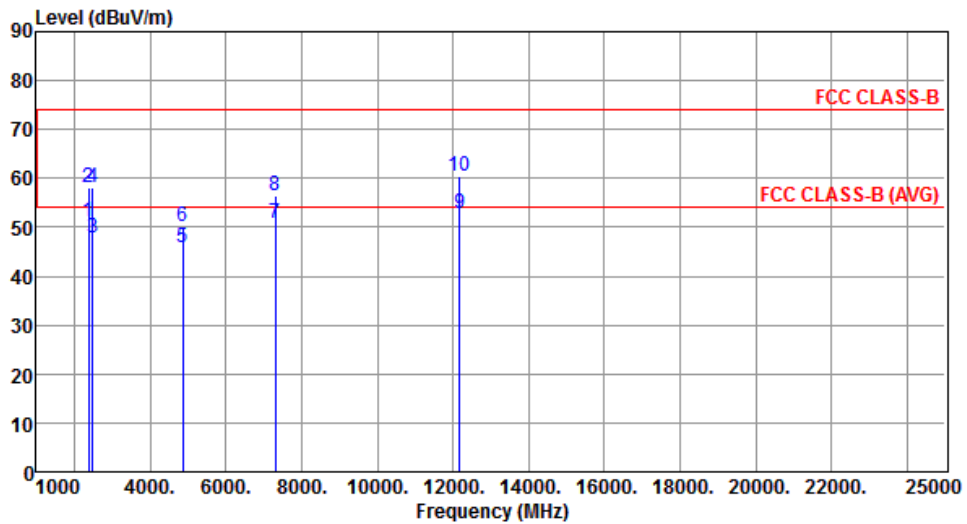

	Freq. MHz	Emission level dBuV/m	Limit dBuV/m	Margin dB	SA reading dBuV	Factor dB	Remark	ANT High cm	Turn Table deg
1	2390.00	51.16	54.00	-2.84	52.27	-1.11	Average	340	142
2	2390.00	58.01	74.00	-15.99	59.12	-1.11	Peak	340	142
3	2483.50	47.70	54.00	-6.30	48.32	-0.62	Average	340	142
4	2483.50	58.08	74.00	-15.92	58.70	-0.62	Peak	340	142
5	4874.00	45.88	54.00	-8.12	40.45	5.43	Average	259	190
6	4874.00	50.26	74.00	-23.74	44.83	5.43	Peak	259	190
7	7311.00	50.70	54.00	-3.30	40.44	10.26	Average	246	108
8	7311.00	56.51	74.00	-17.49	46.25	10.26	Peak	246	108
9	12185.00	52.97	54.00	-1.03	38.03	14.94	Average	102	320
10	12185.00	60.31	74.00	-13.69	45.37	14.94	Peak	102	320

Note 1: Emission Level (dBuV/m) = SA Reading (dBuV/m) + Factor* (dB)

*Factor includes antenna factor , cable loss and amplifier gain

Note 2: Margin (dB) = Emission level (dBuV/m) – Limit (dBuV/m).

Modulation	11b	Test Freq. (MHz)	2462
Polarization	Horizontal		

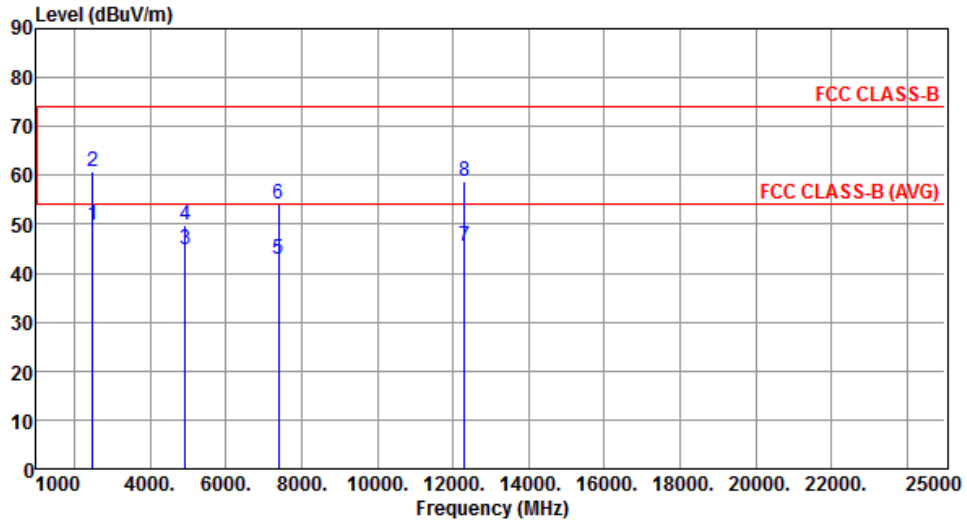

	Freq. MHz	Emission level dBuV/m	Limit dBuV/m	Margin dB	SA reading dBuV	Factor dB	Remark	ANT High cm	Turn Table deg
1	2483.50	49.74	54.00	-4.26	50.36	-0.62	Average	311	100
2	2483.50	60.63	74.00	-13.37	61.25	-0.62	Peak	311	100
3	4924.00	44.74	54.00	-9.26	39.19	5.55	Average	100	79
4	4924.00	49.68	74.00	-24.32	44.13	5.55	Peak	100	79
5	7386.00	42.77	54.00	-11.23	32.38	10.39	Average	100	324
6	7386.00	54.02	74.00	-19.98	43.63	10.39	Peak	100	324
7	12310.00	45.37	54.00	-8.63	30.51	14.86	Average	100	156
8	12310.00	58.66	74.00	-15.34	43.80	14.86	Peak	100	156

Note 1: Emission Level (dBuV/m) = SA Reading (dBuV/m) + Factor* (dB)

*Factor includes antenna factor , cable loss and amplifier gain

Note 2: Margin (dB) = Emission level (dBuV/m) – Limit (dBuV/m).

Modulation	11b	Test Freq. (MHz)	2462
Polarization	Vertical		

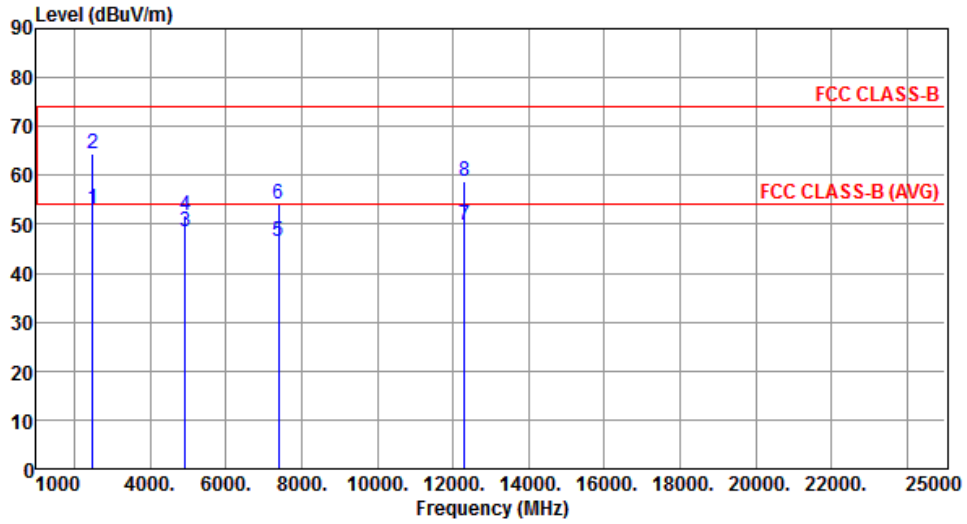

	Freq. MHz	Emission level dBuV/m	Limit dBuV/m	Margin dB	SA reading dBuV	Factor dB	Remark	ANT High cm	Turn Table deg
1	2483.50	52.98	54.00	-1.02	53.60	-0.62	Average	287	99
2	2483.50	64.32	74.00	-9.68	64.94	-0.62	Peak	287	99
3	4924.00	48.33	54.00	-5.67	42.78	5.55	Average	100	200
4	4924.00	51.72	74.00	-22.28	46.17	5.55	Peak	100	200
5	7386.00	46.45	54.00	-7.55	36.06	10.39	Average	100	171
6	7386.00	54.25	74.00	-19.75	43.86	10.39	Peak	100	171
7	12310.00	49.85	54.00	-4.15	34.99	14.86	Average	100	319
8	12310.00	58.81	74.00	-15.19	43.95	14.86	Peak	100	319

Note 1: Emission Level (dBuV/m) = SA Reading (dBuV/m) + Factor* (dB)

*Factor includes antenna factor , cable loss and amplifier gain

Note 2: Margin (dB) = Emission level (dBuV/m) – Limit (dBuV/m).

3.5.6 Transmitter Radiated Unwanted Emissions (Above 1GHz) for 11g

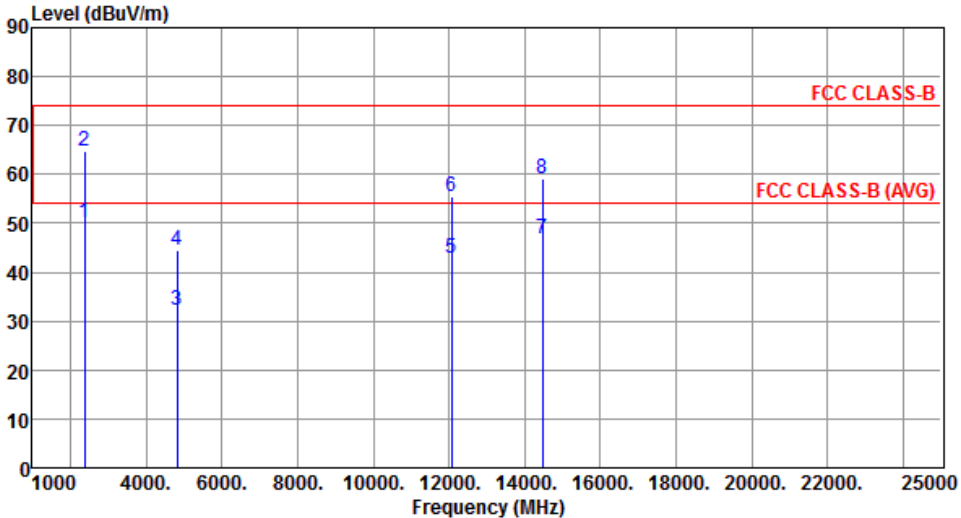
Modulation	11g	Test Freq. (MHz)	2412						
Polarization	Horizontal								
									
	Freq. MHz	Emission level dBuV/m	Limit dBuV/m	Margin dB	SA reading dBuV	Factor dB	Remark	ANT High cm	Turn Table deg
1	2390.00	50.01	54.00	-3.99	51.12	-1.11	Average	159	95
2	2390.00	64.67	74.00	-9.33	65.78	-1.11	Peak	159	95
3	4824.00	32.13	54.00	-21.87	26.82	5.31	Average	100	115
4	4824.00	44.50	74.00	-29.50	39.19	5.31	Peak	100	115
5	12060.00	42.72	54.00	-11.28	27.69	15.03	Average	100	284
6	12060.00	55.34	74.00	-18.66	40.31	15.03	Peak	100	284
7	14472.00	46.68	54.00	-7.32	28.21	18.47	Average	100	250
8	14472.00	59.06	74.00	-14.94	40.59	18.47	Peak	100	250

Note 1: Emission Level (dBuV/m) = SA Reading (dBuV/m) + Factor* (dB)
*Factor includes antenna factor , cable loss and amplifier gain
Note 2: Margin (dB) = Emission level (dBuV/m) – Limit (dBuV/m).

Modulation	11g	Test Freq. (MHz)	2412
Polarization	Vertical		

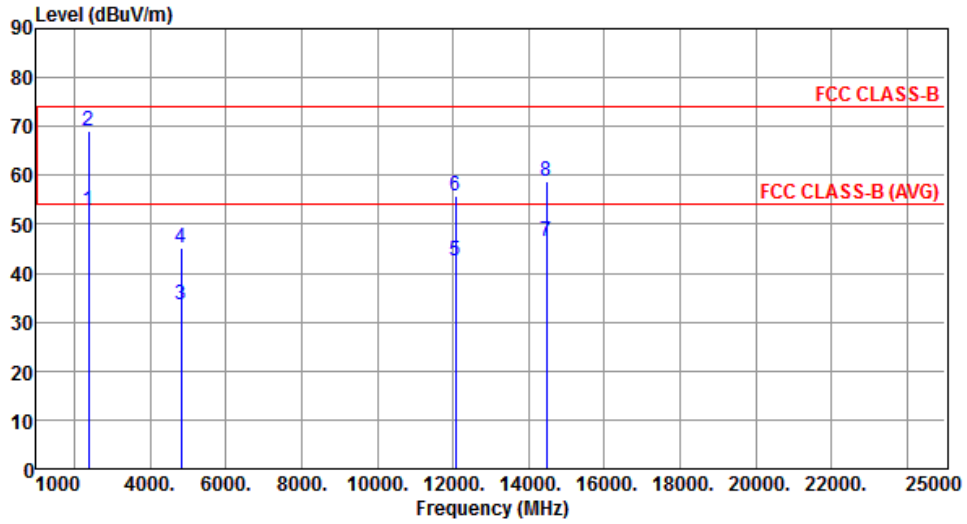

	Freq. MHz	Emission level dBuV/m	Limit dBuV/m	Margin dB	SA reading dBuV	Factor dB	Remark	ANT High cm	Turn Table deg
1	2390.00	52.92	54.00	-1.08	54.03	-1.11	Average	322	221
2	2390.00	69.14	74.00	-4.86	70.25	-1.11	Peak	322	221
3	4824.00	33.48	54.00	-20.52	28.17	5.31	Average	157	175
4	4824.00	45.19	74.00	-28.81	39.88	5.31	Peak	157	175
5	12060.00	42.47	54.00	-11.53	27.44	15.03	Average	100	227
6	12060.00	55.84	74.00	-18.16	40.81	15.03	Peak	100	227
7	14472.00	46.50	54.00	-7.50	28.03	18.47	Average	100	130
8	14472.00	58.75	74.00	-15.25	40.28	18.47	Peak	100	130

Note 1: Emission Level (dBuV/m) = SA Reading (dBuV/m) + Factor* (dB)

*Factor includes antenna factor , cable loss and amplifier gain

Note 2: Margin (dB) = Emission level (dBuV/m) – Limit (dBuV/m).

Modulation	11g	Test Freq. (MHz)	2437
Polarization	Horizontal		

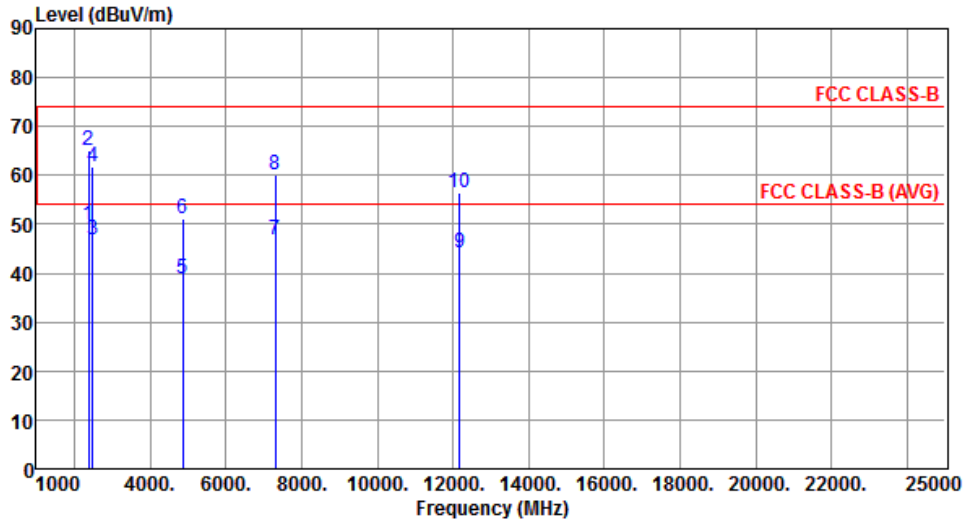

	Freq. MHz	Emission level dBuV/m	Limit dBuV/m	Margin dB	SA reading dBuV	Factor dB	Remark	ANT High cm	Turn Table deg
1	2390.00	49.68	54.00	-4.32	50.79	-1.11	Average	338	36
2	2390.00	65.26	74.00	-8.74	66.37	-1.11	Peak	338	36
3	2483.50	46.96	54.00	-7.04	47.58	-0.62	Average	338	74
4	2483.50	61.62	74.00	-12.38	62.24	-0.62	Peak	338	74
5	4874.00	38.94	54.00	-15.06	33.51	5.43	Average	356	306
6	4874.00	51.20	74.00	-22.80	45.77	5.43	Peak	356	306
7	7311.00	46.76	54.00	-7.24	36.50	10.26	Average	350	66
8	7311.00	60.03	74.00	-13.97	49.77	10.26	Peak	350	66
9	12185.00	44.25	54.00	-9.75	29.31	14.94	Average	386	18
10	12185.00	56.60	74.00	-17.40	41.66	14.94	Peak	386	18

Note 1: Emission Level (dBuV/m) = SA Reading (dBuV/m) + Factor* (dB)

*Factor includes antenna factor , cable loss and amplifier gain

Note 2: Margin (dB) = Emission level (dBuV/m) – Limit (dBuV/m).

Modulation	11g	Test Freq. (MHz)	2437
Polarization	Vertical		

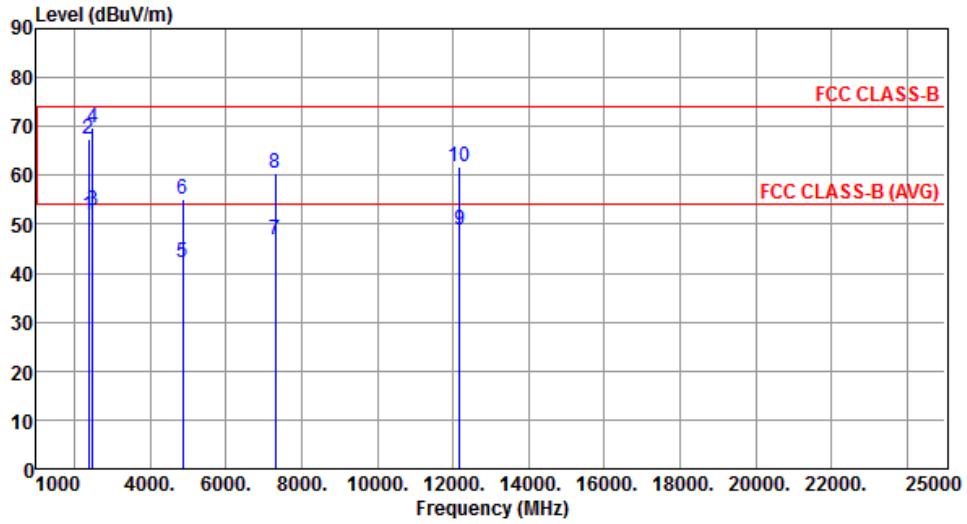

	Freq. MHz	Emission level dBuV/m	Limit dBuV/m	Margin dB	SA reading dBuV	Factor dB	Remark	ANT High cm	Turn Table deg
1	2390.00	51.95	54.00	-2.05	53.06	-1.11	Average	329	61
2	2390.00	67.36	74.00	-6.64	68.47	-1.11	Peak	329	61
3	2483.50	52.92	54.00	-1.08	53.54	-0.62	Average	329	145
4	2483.50	69.68	74.00	-4.32	70.30	-0.62	Peak	329	145
5	4874.00	42.23	54.00	-11.77	36.80	5.43	Average	372	198
6	4874.00	55.23	74.00	-18.77	49.80	5.43	Peak	372	198
7	7311.00	46.86	54.00	-7.14	36.60	10.26	Average	100	182
8	7311.00	60.30	74.00	-13.70	50.04	10.26	Peak	100	182
9	12185.00	48.78	54.00	-5.22	33.84	14.94	Average	100	329
10	12185.00	61.64	74.00	-12.36	46.70	14.94	Peak	100	321

Note 1: Emission Level (dBuV/m) = SA Reading (dBuV/m) + Factor* (dB)

*Factor includes antenna factor , cable loss and amplifier gain

Note 2: Margin (dB) = Emission level (dBuV/m) – Limit (dBuV/m).

Modulation	11g	Test Freq. (MHz)	2462
Polarization	Horizontal		

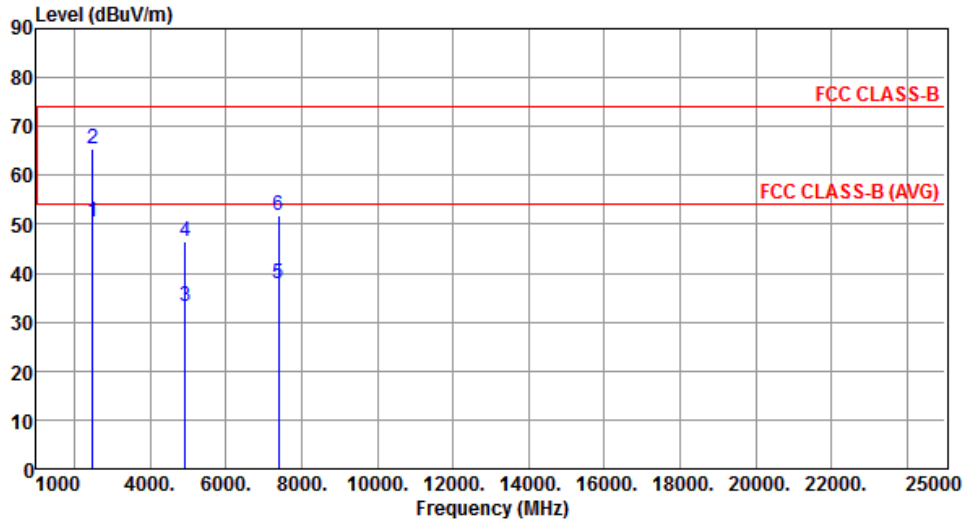

	Freq. MHz	Emission level dBuV/m	Limit dBuV/m	Margin dB	SA reading dBuV	Factor dB	Remark	ANT High cm	Turn Table deg
1	2483.50	50.50	54.00	-3.50	51.12	-0.62	Average	336	94
2	2483.50	65.47	74.00	-8.53	66.09	-0.62	Peak	336	94
3	4924.00	33.31	54.00	-20.69	27.76	5.55	Average	100	182
4	4924.00	46.57	74.00	-27.43	41.02	5.55	Peak	100	182
5	7386.00	37.83	54.00	-16.17	27.44	10.39	Average	100	196
6	7386.00	51.70	74.00	-22.30	41.31	10.39	Peak	100	196

Note 1: Emission Level (dBuV/m) = SA Reading (dBuV/m) + Factor* (dB)

*Factor includes antenna factor , cable loss and amplifier gain

Note 2: Margin (dB) = Emission level (dBuV/m) – Limit (dBuV/m).

Modulation	11g	Test Freq. (MHz)	2462
Polarization	Vertical		

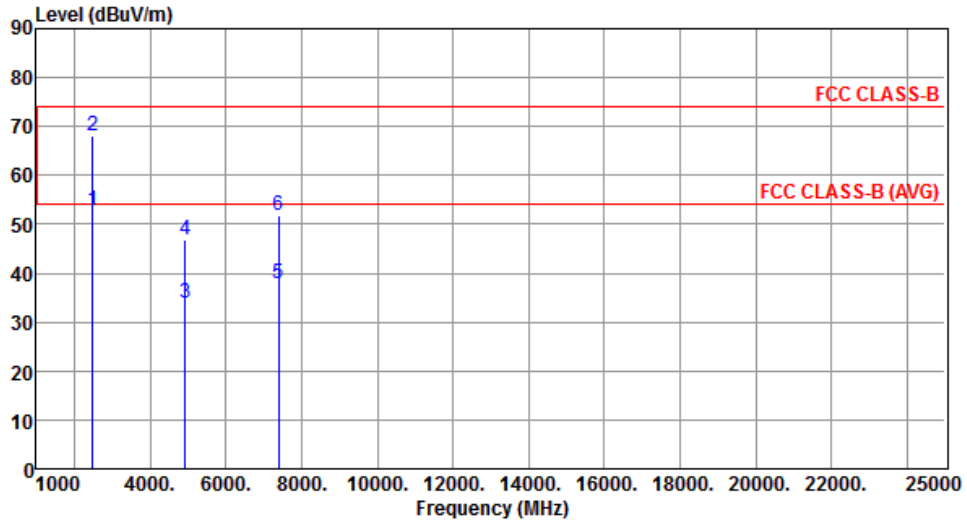

	Freq. MHz	Emission level dBuV/m	Limit dBuV/m	Margin dB	SA reading dBuV	Factor dB	Remark	ANT High cm	Turn Table deg
1	2483.50	52.96	54.00	-1.04	53.58	-0.62	Average	373	208
2	2483.50	68.08	74.00	-5.92	68.70	-0.62	Peak	373	208
3	4924.00	33.90	54.00	-20.10	28.35	5.55	Average	100	156
4	4924.00	46.86	74.00	-27.14	41.31	5.55	Peak	100	156
5	7386.00	37.80	54.00	-16.20	27.41	10.39	Average	100	196
6	7386.00	51.74	74.00	-22.26	41.35	10.39	Peak	100	196

Note 1: Emission Level (dBuV/m) = SA Reading (dBuV/m) + Factor* (dB)

*Factor includes antenna factor , cable loss and amplifier gain

Note 2: Margin (dB) = Emission level (dBuV/m) – Limit (dBuV/m).

3.5.7 Transmitter Radiated Unwanted Emissions (Above 1GHz) for HT20

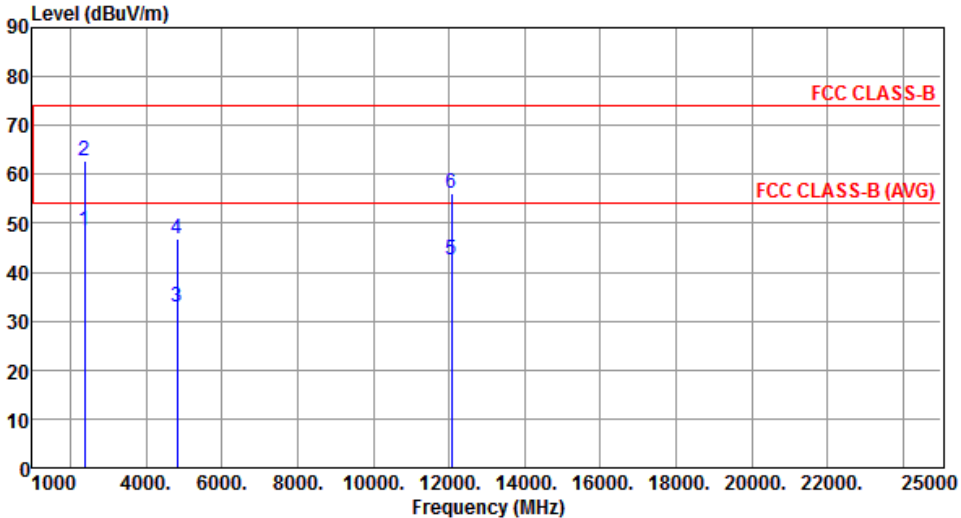
Modulation	HT20	Test Freq. (MHz)	2412						
Polarization	Horizontal								
									
	Freq. MHz	Emission level dBuV/m	Limit dBuV/m	Margin dB	SA reading dBuV	Factor dB	Remark	ANT High cm	Turn Table deg
1	2390.00	48.40	54.00	-5.60	49.51	-1.11	Average	325	91
2	2390.00	62.67	74.00	-11.33	63.78	-1.11	Peak	325	91
3	4824.00	32.95	54.00	-21.05	27.64	5.31	Average	100	122
4	4824.00	46.69	74.00	-27.31	41.38	5.31	Peak	100	122
5	12060.00	42.67	54.00	-11.33	27.64	15.03	Average	100	212
6	12060.00	56.07	74.00	-17.93	41.04	15.03	Peak	100	212

Note 1: Emission Level (dBuV/m) = SA Reading (dBuV/m) + Factor* (dB)
*Factor includes antenna factor , cable loss and amplifier gain
Note 2: Margin (dB) = Emission level (dBuV/m) – Limit (dBuV/m).

Modulation	HT20	Test Freq. (MHz)	2412
Polarization	Vertical		

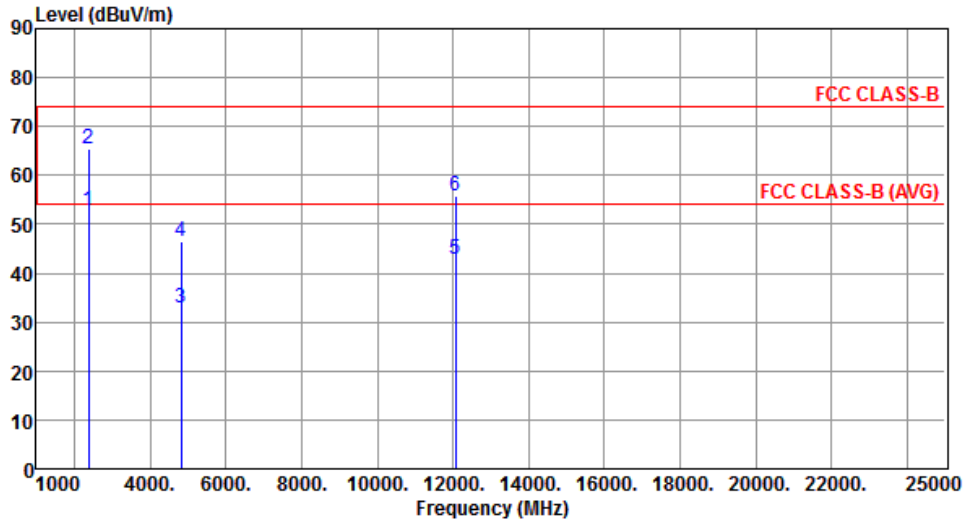

	Freq. MHz	Emission level dBuV/m	Limit dBuV/m	Margin dB	SA reading dBuV	Factor dB	Remark	ANT High cm	Turn Table deg
1	2390.00	52.83	54.00	-1.17	53.94	-1.11	Average	347	69
2	2390.00	65.39	74.00	-8.61	66.50	-1.11	Peak	347	69
3	4824.00	32.94	54.00	-21.06	27.63	5.31	Average	100	196
4	4824.00	46.56	74.00	-27.44	41.25	5.31	Peak	100	196
5	12060.00	42.81	54.00	-11.19	27.78	15.03	Average	100	152
6	12060.00	55.89	74.00	-18.11	40.86	15.03	Peak	100	152

Note 1: Emission Level (dBuV/m) = SA Reading (dBuV/m) + Factor* (dB)

*Factor includes antenna factor , cable loss and amplifier gain

Note 2: Margin (dB) = Emission level (dBuV/m) – Limit (dBuV/m).

Modulation	HT20	Test Freq. (MHz)	2437
Polarization	Horizontal		

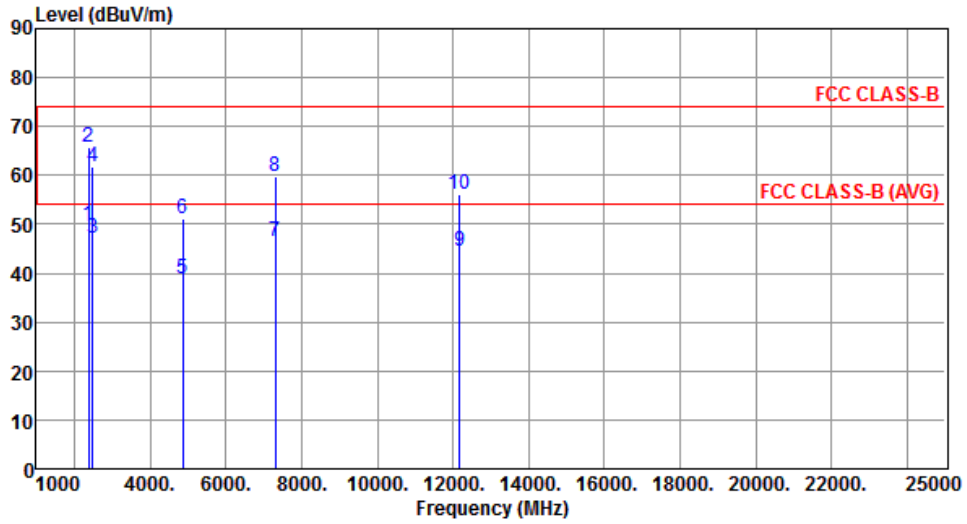

	Freq. MHz	Emission level dBuV/m	Limit dBuV/m	Margin dB	SA reading dBuV	Factor dB	Remark	ANT High cm	Turn Table deg
1	2390.00	49.86	54.00	-4.14	50.97	-1.11	Average	335	35
2	2390.00	65.62	74.00	-8.38	66.73	-1.11	Peak	335	35
3	2483.50	47.31	54.00	-6.69	47.93	-0.62	Average	335	35
4	2483.50	61.81	74.00	-12.19	62.43	-0.62	Peak	335	35
5	4874.00	38.70	54.00	-15.30	33.27	5.43	Average	322	302
6	4874.00	51.14	74.00	-22.86	45.71	5.43	Peak	322	302
7	7311.00	46.53	54.00	-7.47	36.27	10.26	Average	328	53
8	7311.00	59.70	74.00	-14.30	49.44	10.26	Peak	328	53
9	12185.00	44.39	54.00	-9.61	29.45	14.94	Average	385	20
10	12185.00	56.22	74.00	-17.78	41.28	14.94	Peak	385	20

Note 1: Emission Level (dBuV/m) = SA Reading (dBuV/m) + Factor* (dB)

*Factor includes antenna factor , cable loss and amplifier gain

Note 2: Margin (dB) = Emission level (dBuV/m) – Limit (dBuV/m).

Modulation	HT20	Test Freq. (MHz)	2437
Polarization	Vertical		

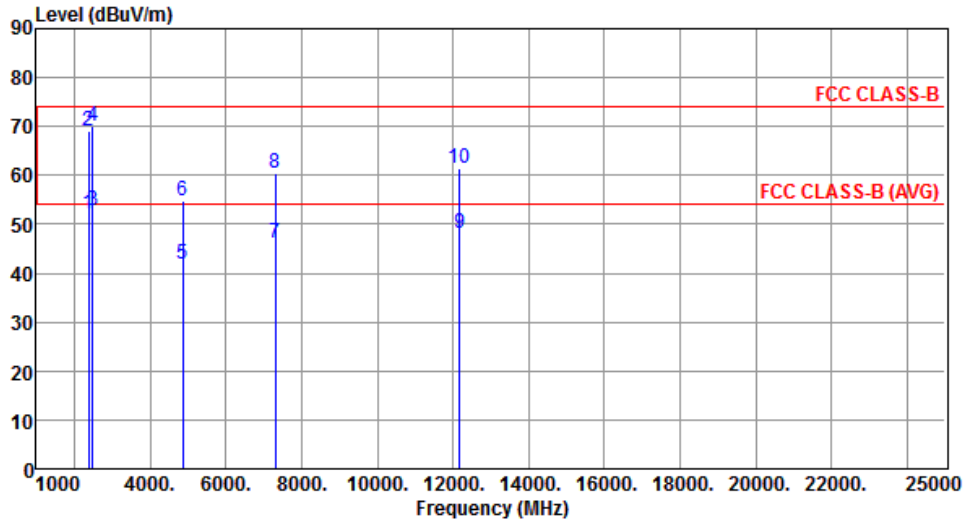

	Freq. MHz	Emission level dBuV/m	Limit dBuV/m	Margin dB	SA reading dBuV	Factor dB	Remark	ANT High cm	Turn Table deg
1	2390.00	52.01	54.00	-1.99	53.12	-1.11	Average	378	245
2	2390.00	68.92	74.00	-5.08	70.03	-1.11	Peak	378	245
3	2483.50	52.89	54.00	-1.11	53.51	-0.62	Average	378	245
4	2483.50	70.00	74.00	-4.00	70.62	-0.62	Peak	378	245
5	4874.00	41.76	54.00	-12.24	36.33	5.43	Average	378	199
6	4874.00	54.96	74.00	-19.04	49.53	5.43	Peak	378	199
7	7311.00	46.04	54.00	-7.96	35.78	10.26	Average	100	179
8	7311.00	60.47	74.00	-13.53	50.21	10.26	Peak	100	179
9	12185.00	48.16	54.00	-5.84	33.22	14.94	Average	100	156
10	12185.00	61.32	74.00	-12.68	46.38	14.94	Peak	100	156

Note 1: Emission Level (dBuV/m) = SA Reading (dBuV/m) + Factor* (dB)

*Factor includes antenna factor , cable loss and amplifier gain

Note 2: Margin (dB) = Emission level (dBuV/m) – Limit (dBuV/m).

Modulation	HT20	Test Freq. (MHz)	2462
Polarization	Horizontal		

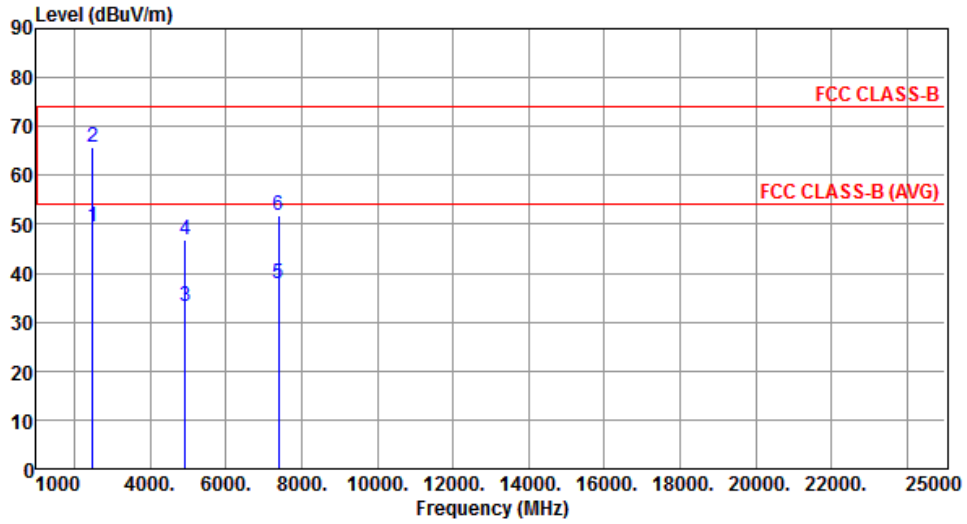

	Freq. MHz	Emission level dBuV/m	Limit dBuV/m	Margin dB	SA reading dBuV	Factor dB	Remark	ANT High cm	Turn Table deg
1	2483.50	49.53	54.00	-4.47	50.15	-0.62	Average	337	70
2	2483.50	65.62	74.00	-8.38	66.24	-0.62	Peak	337	70
3	4924.00	33.08	54.00	-20.92	27.53	5.55	Average	100	166
4	4924.00	46.89	74.00	-27.11	41.34	5.55	Peak	100	166
5	7386.00	37.95	54.00	-16.05	27.56	10.39	Average	100	193
6	7386.00	51.67	74.00	-22.33	41.28	10.39	Peak	100	193

Note 1: Emission Level (dBuV/m) = SA Reading (dBuV/m) + Factor* (dB)

*Factor includes antenna factor , cable loss and amplifier gain

Note 2: Margin (dB) = Emission level (dBuV/m) – Limit (dBuV/m).

Modulation	HT20	Test Freq. (MHz)	2462
Polarization	Vertical		

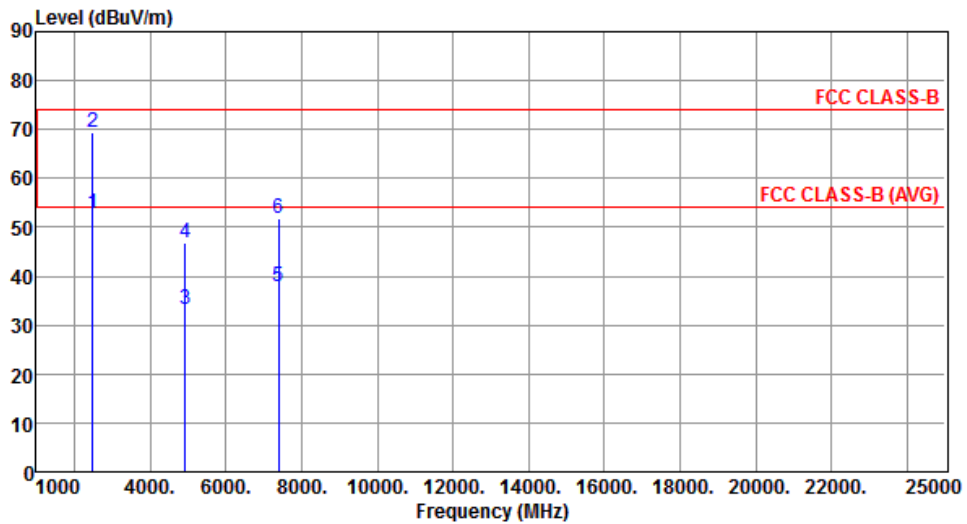

	Freq. MHz	Emission level dBuV/m	Limit dBuV/m	Margin dB	SA reading dBuV	Factor dB	Remark	ANT High cm	Turn Table deg
1	2483.50	52.87	54.00	-1.13	53.49	-0.62	Average	334	208
2	2483.50	69.51	74.00	-4.49	70.13	-0.62	Peak	334	208
3	4924.00	33.08	54.00	-20.92	27.53	5.55	Average	122	215
4	4924.00	46.77	74.00	-27.23	41.22	5.55	Peak	122	215
5	7386.00	38.00	54.00	-16.00	27.61	10.39	Average	100	123
6	7386.00	51.66	74.00	-22.34	41.27	10.39	Peak	100	123

Note 1: Emission Level (dBuV/m) = SA Reading (dBuV/m) + Factor* (dB)

*Factor includes antenna factor , cable loss and amplifier gain

Note 2: Margin (dB) = Emission level (dBuV/m) – Limit (dBuV/m).

3.5.8 Transmitter Radiated Unwanted Emissions (Above 1GHz) for HT40

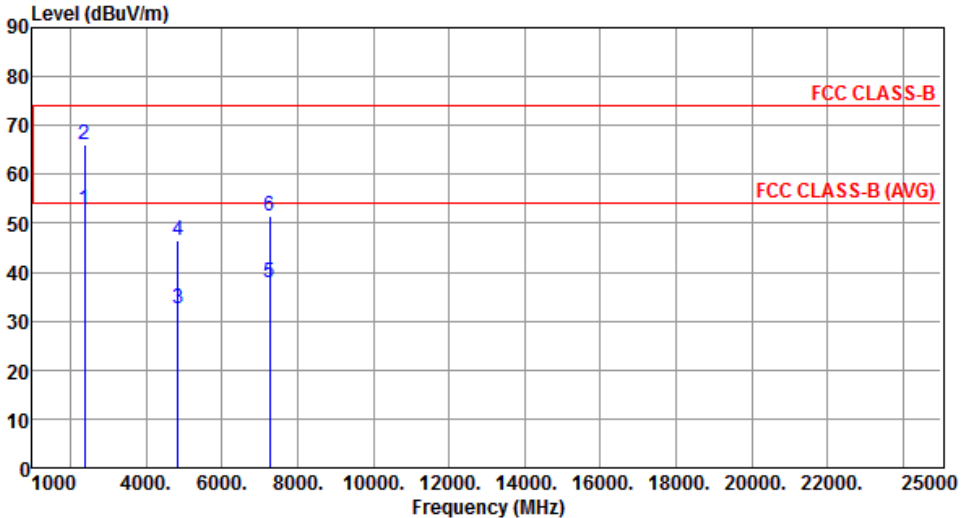
Modulation	HT40	Test Freq. (MHz)	2422						
Polarization	Horizontal								
									
	Freq.	Emission level	Limit	Margin	SA reading	Factor	Remark	ANT High	Turn Table
	MHz	dBuV/m	dBuV/m	dB	dBuV	dB		cm	deg
1	2390.00	52.95	54.00	-1.05	54.06	-1.11	Average	353	273
2	2390.00	66.10	74.00	-7.90	67.21	-1.11	Peak	353	273
3	4844.00	32.60	54.00	-21.40	27.24	5.36	Average	100	165
4	4844.00	46.38	74.00	-27.62	41.02	5.36	Peak	100	165
5	7266.00	37.81	54.00	-16.19	27.63	10.18	Average	100	182
6	7266.00	51.61	74.00	-22.39	41.43	10.18	Peak	100	182
<p>Note 1: Emission Level (dBuV/m) = SA Reading (dBuV/m) + Factor* (dB) *Factor includes antenna factor , cable loss and amplifier gain Note 2: Margin (dB) = Emission level (dBuV/m) – Limit (dBuV/m).</p>									

Modulation	HT40	Test Freq. (MHz)	2422
Polarization	Vertical		

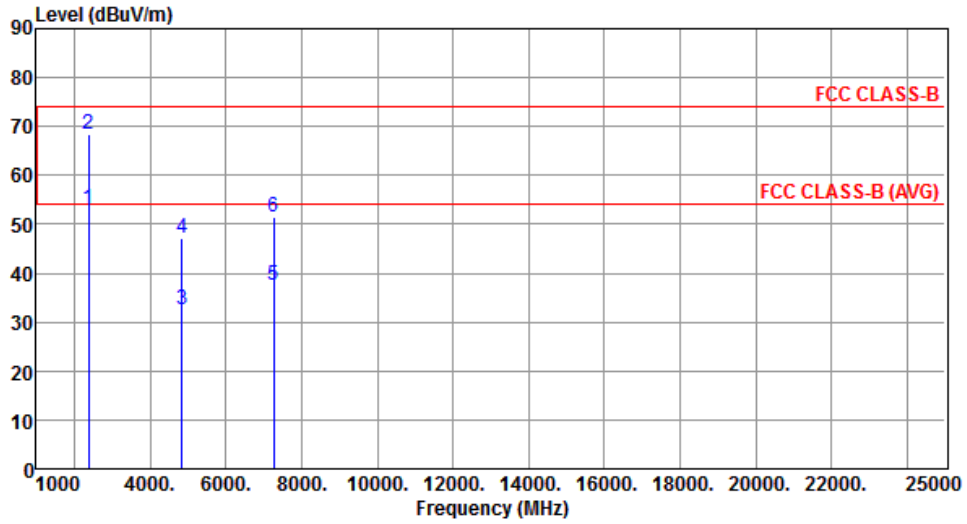

	Freq. MHz	Emission level dBuV/m	Limit dBuV/m	Margin dB	SA reading dBuV	Factor dB	Remark	ANT High cm	Turn Table deg
1	2390.00	52.98	54.00	-1.02	54.09	-1.11	Average	315	81
2	2390.00	68.44	74.00	-5.56	69.55	-1.11	Peak	315	81
3	4844.00	32.60	54.00	-21.40	27.24	5.36	Average	135	216
4	4844.00	47.07	74.00	-26.93	41.71	5.36	Peak	135	216
5	7266.00	37.53	54.00	-16.47	27.35	10.18	Average	100	138
6	7266.00	51.38	74.00	-22.62	41.20	10.18	Peak	100	138

Note 1: Emission Level (dBuV/m) = SA Reading (dBuV/m) + Factor* (dB)

*Factor includes antenna factor , cable loss and amplifier gain

Note 2: Margin (dB) = Emission level (dBuV/m) – Limit (dBuV/m).

Modulation	HT40	Test Freq. (MHz)	2437
Polarization	Horizontal		

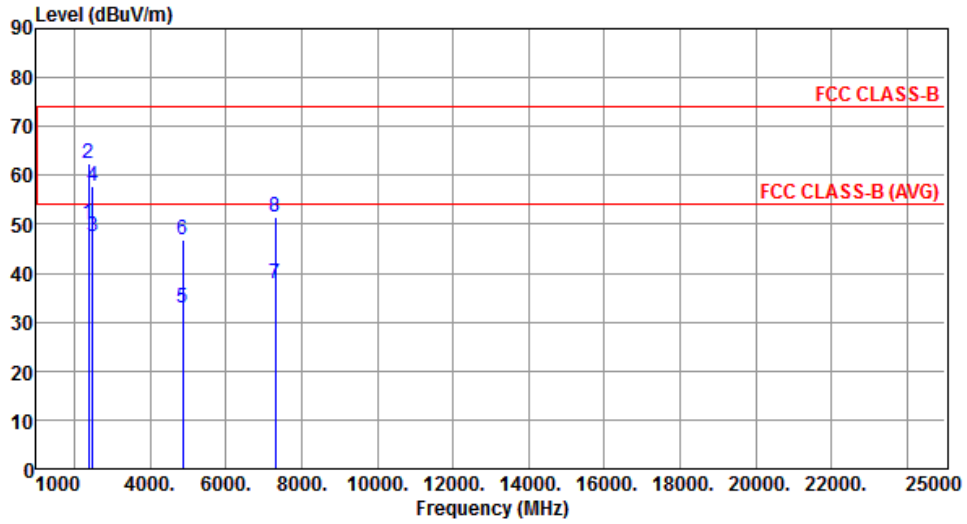

	Freq. MHz	Emission level dBuV/m	Limit dBuV/m	Margin dB	SA reading dBuV	Factor dB	Remark	ANT High cm	Turn Table deg
1	2390.00	50.03	54.00	-3.97	51.14	-1.11	Average	343	248
2	2390.00	62.56	74.00	-11.44	63.67	-1.11	Peak	343	248
3	2483.50	47.62	54.00	-6.38	48.24	-0.62	Average	343	248
4	2483.50	57.91	74.00	-16.09	58.53	-0.62	Peak	343	248
5	4874.00	32.85	54.00	-21.15	27.42	5.43	Average	122	147
6	4874.00	46.82	74.00	-27.18	41.39	5.43	Peak	122	147
7	7311.00	37.75	54.00	-16.25	27.49	10.26	Average	100	162
8	7311.00	51.54	74.00	-22.46	41.28	10.26	Peak	100	162

Note 1: Emission Level (dBuV/m) = SA Reading (dBuV/m) + Factor* (dB)

*Factor includes antenna factor , cable loss and amplifier gain

Note 2: Margin (dB) = Emission level (dBuV/m) – Limit (dBuV/m).

Modulation	HT40	Test Freq. (MHz)	2437
Polarization	Vertical		

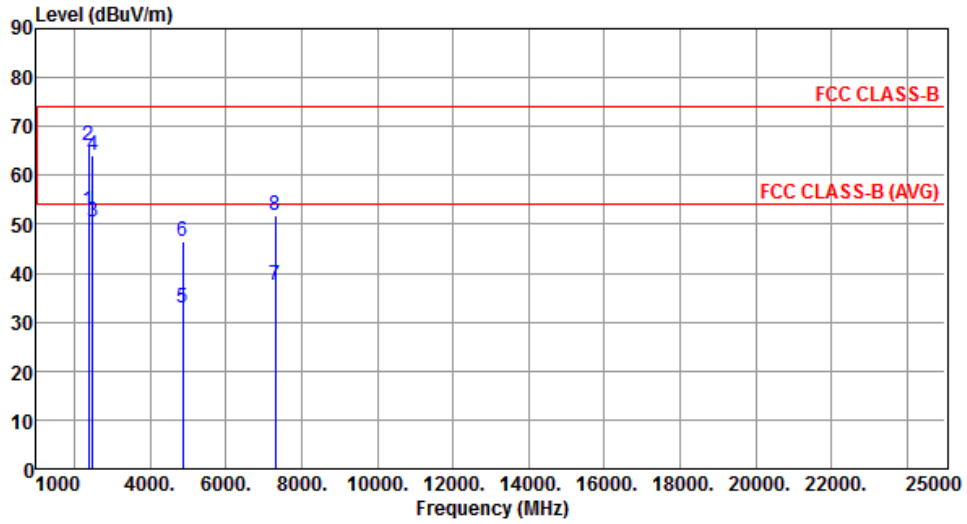

	Freq. MHz	Emission level dBuV/m	Limit dBuV/m	Margin dB	SA reading dBuV	Factor dB	Remark	ANT High cm	Turn Table deg
1	2390.00	52.73	54.00	-1.27	53.84	-1.11	Average	343	131
2	2390.00	66.06	74.00	-7.94	67.17	-1.11	Peak	343	131
3	2483.50	50.48	54.00	-3.52	51.10	-0.62	Average	343	131
4	2483.50	63.94	74.00	-10.06	64.56	-0.62	Peak	343	131
5	4874.00	32.96	54.00	-21.04	27.53	5.43	Average	100	152
6	4874.00	46.64	74.00	-27.36	41.21	5.43	Peak	100	152
7	7311.00	37.61	54.00	-16.39	27.35	10.26	Average	100	245
8	7311.00	51.68	74.00	-22.32	41.42	10.26	Peak	100	245

Note 1: Emission Level (dBuV/m) = SA Reading (dBuV/m) + Factor* (dB)

*Factor includes antenna factor , cable loss and amplifier gain

Note 2: Margin (dB) = Emission level (dBuV/m) – Limit (dBuV/m).

Modulation	HT40	Test Freq. (MHz)	2452
Polarization	Horizontal		

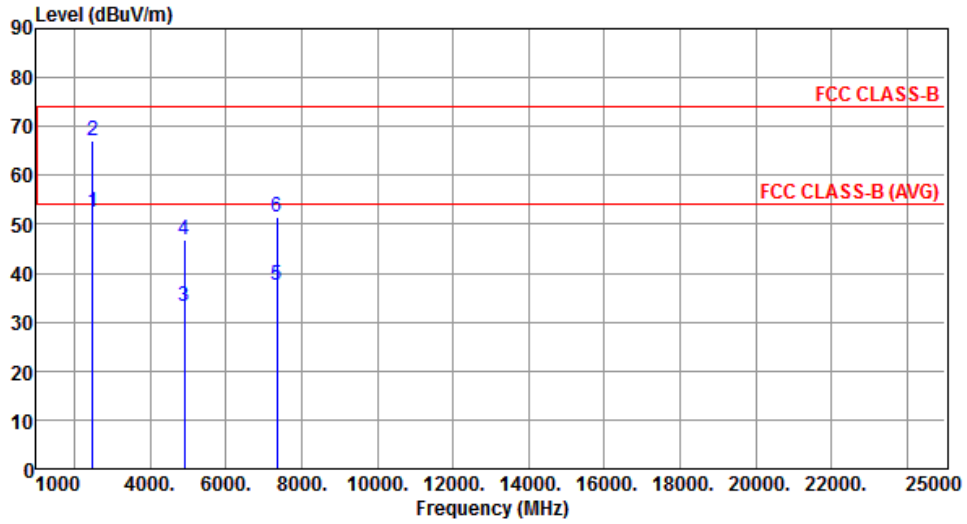

	Freq. MHz	Emission level dBuV/m	Limit dBuV/m	Margin dB	SA reading dBuV	Factor dB	Remark	ANT High cm	Turn Table deg
1	2483.50	52.60	54.00	-1.40	53.22	-0.62	Average	291	267
2	2483.50	67.13	74.00	-6.87	67.75	-0.62	Peak	291	267
3	4904.00	33.06	54.00	-20.94	27.55	5.51	Average	100	144
4	4904.00	46.78	74.00	-27.22	41.27	5.51	Peak	100	144
5	7356.00	37.69	54.00	-16.31	27.34	10.35	Average	100	222
6	7356.00	51.47	74.00	-22.53	41.12	10.35	Peak	100	222

Note 1: Emission Level (dBuV/m) = SA Reading (dBuV/m) + Factor* (dB)

*Factor includes antenna factor , cable loss and amplifier gain

Note 2: Margin (dB) = Emission level (dBuV/m) – Limit (dBuV/m).

Modulation	HT40	Test Freq. (MHz)	2452
Polarization	Vertical		

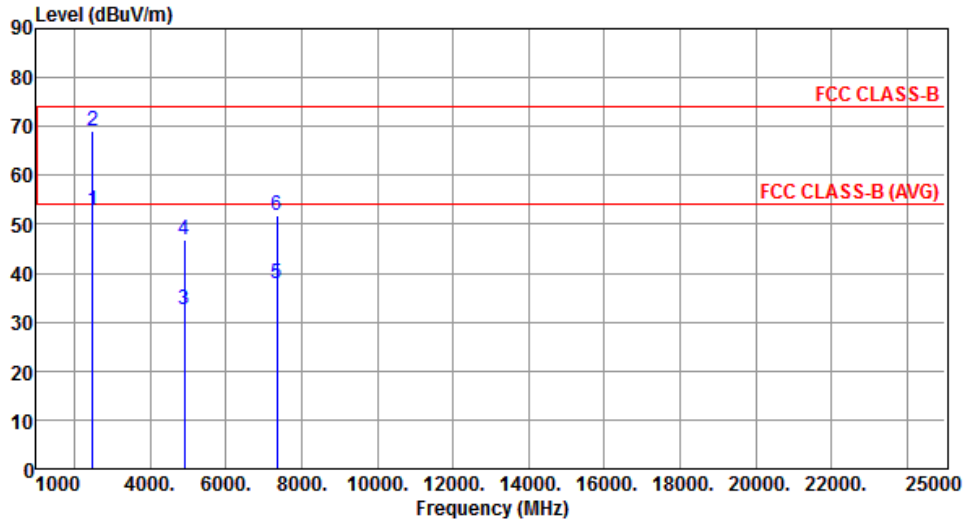

	Freq. MHz	Emission level dBuV/m	Limit dBuV/m	Margin dB	SA reading dBuV	Factor dB	Remark	ANT High cm	Turn Table deg
1	2483.50	52.69	54.00	-1.31	53.31	-0.62	Average	289	183
2	2483.50	68.92	74.00	-5.08	69.54	-0.62	Peak	289	183
3	4904.00	32.63	54.00	-21.37	27.12	5.51	Average	100	135
4	4904.00	46.79	74.00	-27.21	41.28	5.51	Peak	100	135
5	7356.00	37.78	54.00	-16.22	27.43	10.35	Average	100	127
6	7356.00	51.65	74.00	-22.35	41.30	10.35	Peak	100	127

Note 1: Emission Level (dBuV/m) = SA Reading (dBuV/m) + Factor* (dB)

*Factor includes antenna factor , cable loss and amplifier gain

Note 2: Margin (dB) = Emission level (dBuV/m) – Limit (dBuV/m).

Beamforming mode

3.5.9 Transmitter Radiated Unwanted Emissions (Below 1GHz)

Modulation	HT20	Test Freq. (MHz)	2437
Polarization	Horizontal		

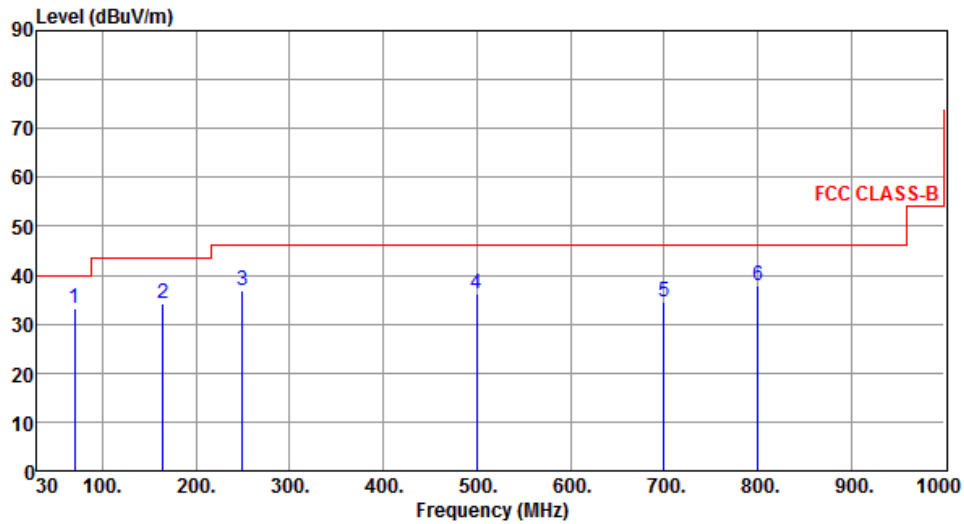

	Freq. MHz	Emission level dBUV/m	Limit dBUV/m	Margin dB	SA reading dBUV	Factor dB	Remark	ANT High cm	Turn Table deg
1	69.77	33.17	40.00	-6.83	44.01	-10.84	Peak	---	---
2	164.83	34.20	43.50	-9.30	42.76	-8.56	Peak	---	---
3	249.22	36.71	46.00	-9.29	46.34	-9.63	Peak	---	---
4	499.48	36.21	46.00	-9.79	39.36	-3.15	Peak	---	---
5	700.27	34.61	46.00	-11.39	34.05	0.56	Peak	---	---
6	800.18	37.88	46.00	-8.12	35.21	2.67	Peak	---	---

Note 1: Emission Level (dBUV/m) = SA Reading (dBUV/m) + Factor* (dB)

*Factor includes antenna factor, cable loss and amplifier gain

Note 2: Margin (dB) = Emission level (dBUV/m) – Limit (dBUV/m).

Note 3: All spurious emissions below 30MHz are more than 20 dB below the limit.

Modulation	HT20	Test Freq. (MHz)	2437
Polarization	Vertical		

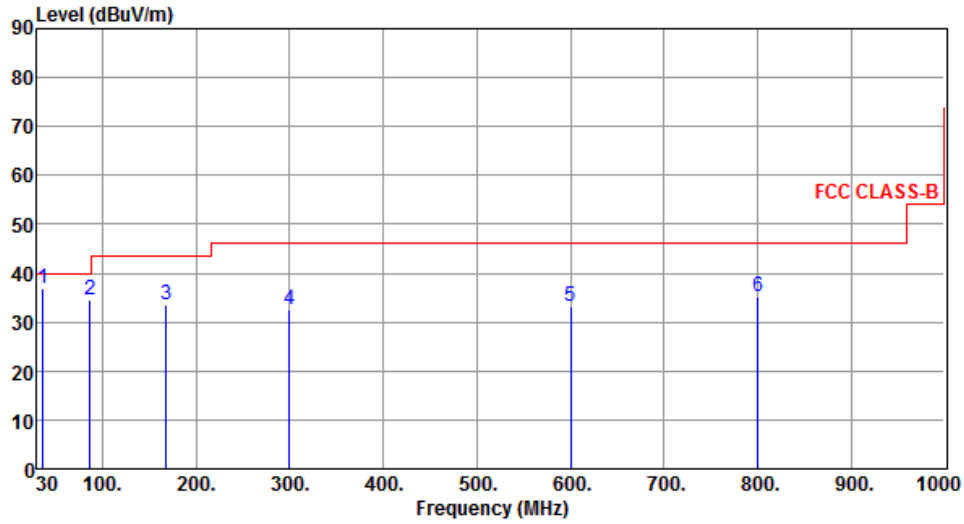

	Freq. MHz	Emission level dBuV/m	Limit dBuV/m	Margin dB	SA reading dBuV	Factor dB	Remark	ANT High cm	Turn Table deg
1	36.15	36.83	40.00	-3.17	45.96	-9.13	QP	100	50
2	86.41	34.39	40.00	-5.61	48.51	-14.12	QP	100	165
3	167.74	33.54	43.50	-9.96	42.22	-8.68	Peak	---	---
4	299.66	32.70	46.00	-13.30	40.65	-7.95	Peak	---	---
5	600.36	33.17	46.00	-12.83	33.99	-0.82	Peak	---	---
6	800.18	35.27	46.00	-10.73	32.60	2.67	Peak	---	---

Note 1: Emission Level (dBuV/m) = SA Reading (dBuV/m) + Factor* (dB)

*Factor includes antenna factor , cable loss and amplifier gain

Note 2: Margin (dB) = Emission level (dBuV/m) – Limit (dBuV/m).

Note 3: All spurious emissions below 30MHz are more than 20 dB below the limit.

3.5.10 Transmitter Radiated Unwanted Emissions (Above 1GHz) for HT20

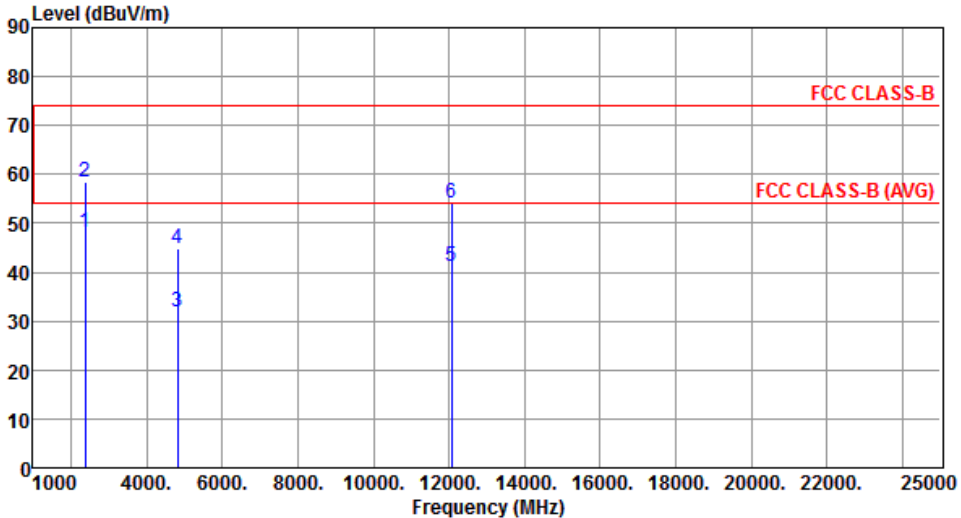
Modulation	HT20	Test Freq. (MHz)	2412						
Polarization	Horizontal								
									
	Freq.	Emission level	Limit	Margin	SA reading	Factor	Remark	ANT High	Turn Table
	MHz	dBuV/m	dBuV/m	dB	dBuV	dB		cm	deg
1	2390.00	48.20	54.00	-5.80	50.32	-2.12	Average	302	92
2	2390.00	58.45	74.00	-15.55	60.57	-2.12	Peak	302	92
3	4824.00	32.03	54.00	-21.97	27.55	4.48	Average	165	138
4	4824.00	44.93	74.00	-29.07	40.45	4.48	Peak	165	138
5	12060.00	41.09	54.00	-12.91	27.43	13.66	Average	145	144
6	12060.00	54.12	74.00	-19.88	40.46	13.66	Peak	145	144
<p>Note 1: Emission Level (dBuV/m) = SA Reading (dBuV/m) + Factor* (dB) *Factor includes antenna factor , cable loss and amplifier gain Note 2: Margin (dB) = Emission level (dBuV/m) – Limit (dBuV/m).</p>									

Modulation	HT20	Test Freq. (MHz)	2412
Polarization	Vertical		

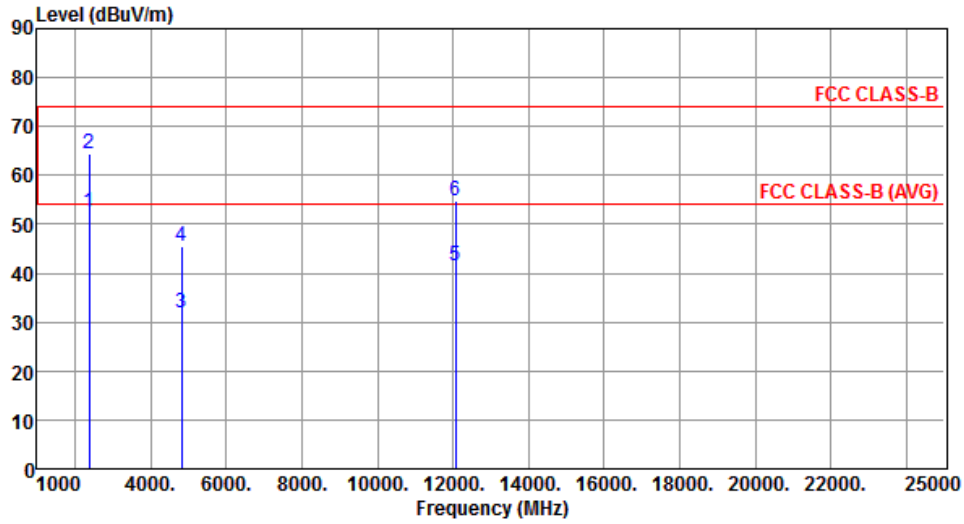

	Freq. MHz	Emission level dBuV/m	Limit dBuV/m	Margin dB	SA reading dBuV	Factor dB	Remark	ANT High cm	Turn Table deg
1	2390.00	52.54	54.00	-1.46	54.66	-2.12	Average	322	145
2	2390.00	64.42	74.00	-9.58	66.54	-2.12	Peak	322	145
3	4824.00	32.03	54.00	-21.97	27.55	4.48	Average	165	215
4	4824.00	45.44	74.00	-28.56	40.96	4.48	Peak	165	215
5	12060.00	41.44	54.00	-12.56	27.78	13.66	Average	138	156
6	12060.00	54.91	74.00	-19.09	41.25	13.66	Peak	138	156

Note 1: Emission Level (dBuV/m) = SA Reading (dBuV/m) + Factor* (dB)

*Factor includes antenna factor , cable loss and amplifier gain

Note 2: Margin (dB) = Emission level (dBuV/m) – Limit (dBuV/m).

Modulation	HT20	Test Freq. (MHz)	2437
Polarization	Horizontal		

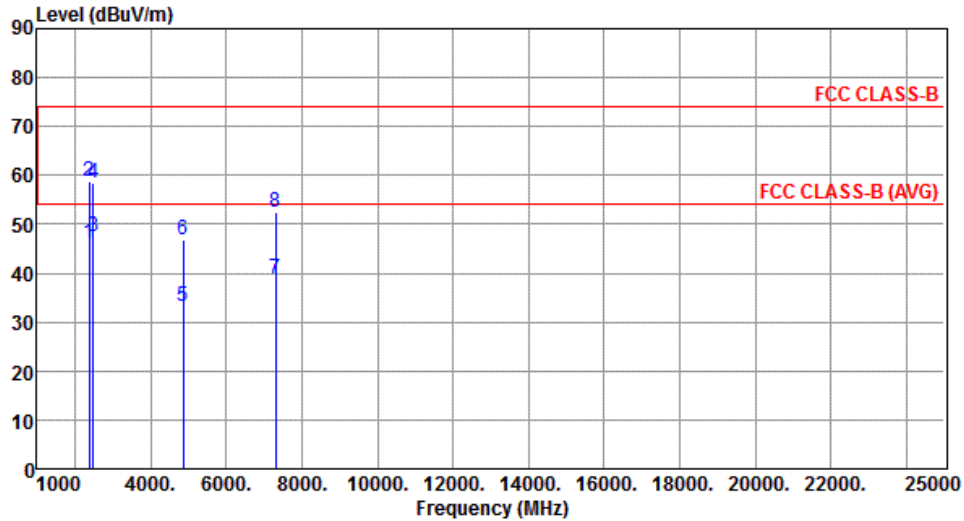

	Freq. MHz	Emission level dBuV/m	Limit dBuV/m	Margin dB	SA reading dBuV	Factor dB	Remark	ANT High cm	Turn Table deg
1	2390.00	46.32	54.00	-7.68	48.44	-2.12	Average	293	84
2	2390.00	58.85	74.00	-15.15	60.97	-2.12	Peak	293	84
3	2483.50	47.55	54.00	-6.45	49.32	-1.77	Average	293	84
4	2483.50	58.48	74.00	-15.52	60.25	-1.77	Peak	293	84
5	4874.00	33.11	54.00	-20.89	28.53	4.58	Average	168	142
6	4874.00	46.79	74.00	-27.21	42.21	4.58	Peak	168	142
7	7311.00	38.78	54.00	-15.22	29.65	9.13	Average	185	245
8	7311.00	52.51	74.00	-21.49	43.38	9.13	Peak	185	245

Note 1: Emission Level (dBuV/m) = SA Reading (dBuV/m) + Factor* (dB)

*Factor includes antenna factor , cable loss and amplifier gain

Note 2: Margin (dB) = Emission level (dBuV/m) – Limit (dBuV/m).

Modulation	HT20	Test Freq. (MHz)	2437
Polarization	Vertical		

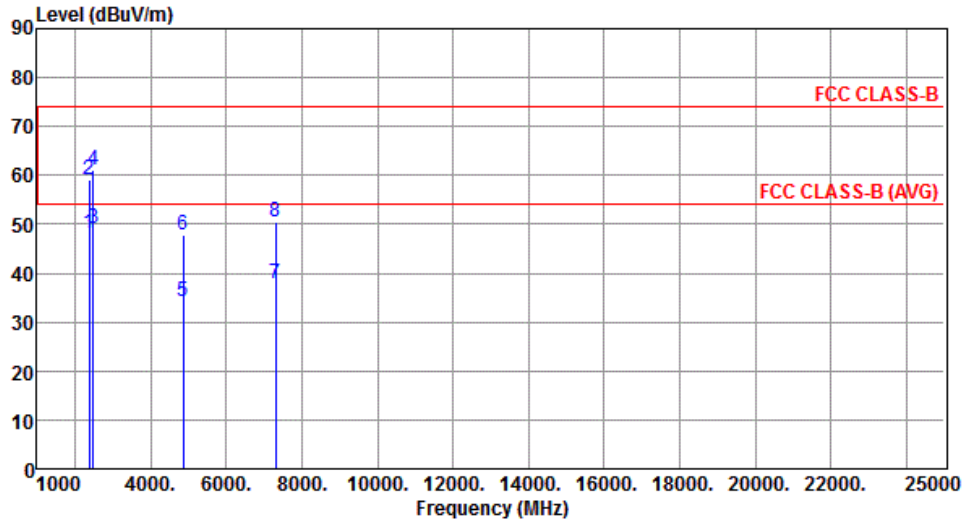

	Freq. MHz	Emission level dBuV/m	Limit dBuV/m	Margin dB	SA reading dBuV	Factor dB	Remark	ANT High cm	Turn Table deg
1	2390.00	48.06	54.00	-5.94	50.18	-2.12	Average	293	232
2	2390.00	59.01	74.00	-14.99	61.13	-2.12	Peak	293	232
3	2483.50	49.31	54.00	-4.69	51.08	-1.77	Average	293	232
4	2483.50	61.15	74.00	-12.85	62.92	-1.77	Peak	293	232
5	4874.00	34.11	54.00	-19.89	29.53	4.58	Average	255	243
6	4874.00	47.96	74.00	-26.04	43.38	4.58	Peak	255	243
7	7311.00	37.81	54.00	-16.19	28.68	9.13	Average	168	356
8	7311.00	50.44	74.00	-23.56	41.31	9.13	Peak	168	356

Note 1: Emission Level (dBuV/m) = SA Reading (dBuV/m) + Factor* (dB)

*Factor includes antenna factor , cable loss and amplifier gain

Note 2: Margin (dB) = Emission level (dBuV/m) – Limit (dBuV/m).

Modulation	HT20	Test Freq. (MHz)	2462
Polarization	Horizontal		

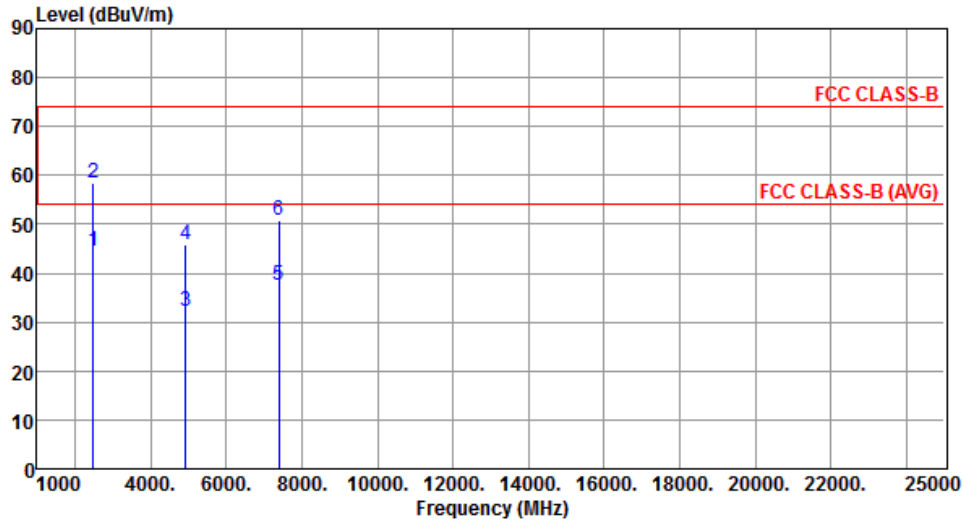

	Freq. MHz	Emission level dBuV/m	Limit dBuV/m	Margin dB	SA reading dBuV	Factor dB	Remark	ANT High cm	Turn Table deg
1	2483.50	44.64	54.00	-9.36	46.41	-1.77	Average	302	89
2	2483.50	58.54	74.00	-15.46	60.31	-1.77	Peak	302	89
3	4924.00	32.21	54.00	-21.79	27.54	4.67	Average	167	132
4	4924.00	45.88	74.00	-28.12	41.21	4.67	Peak	167	132
5	7386.00	37.64	54.00	-16.36	28.24	9.40	Average	165	182
6	7386.00	50.78	74.00	-23.22	41.38	9.40	Peak	165	182

Note 1: Emission Level (dBuV/m) = SA Reading (dBuV/m) + Factor* (dB)

*Factor includes antenna factor , cable loss and amplifier gain

Note 2: Margin (dB) = Emission level (dBuV/m) – Limit (dBuV/m).

Modulation	HT20	Test Freq. (MHz)	2462
Polarization	Vertical		

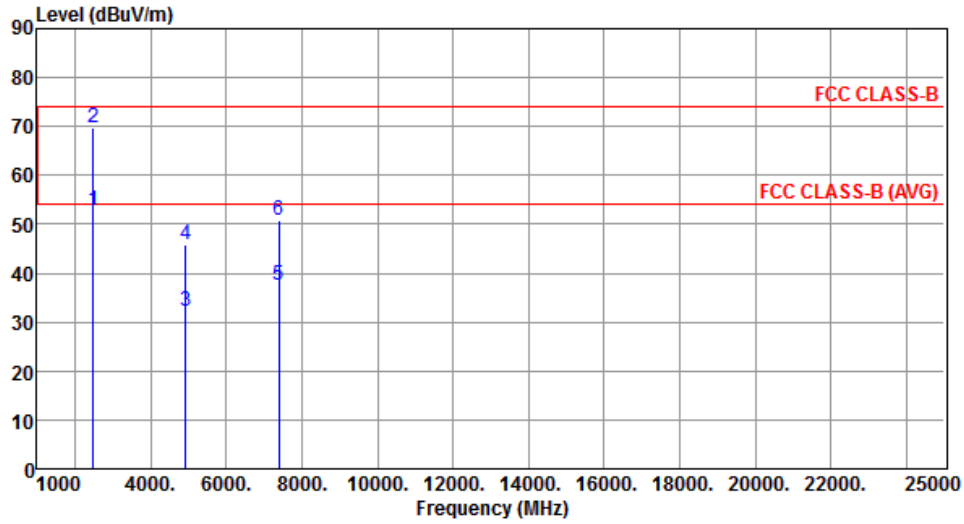

	Freq. MHz	Emission level dBuV/m	Limit dBuV/m	Margin dB	SA reading dBuV	Factor dB	Remark	ANT High cm	Turn Table deg
1	2483.50	52.96	54.00	-1.04	54.73	-1.77	Average	255	154
2	2483.50	69.61	74.00	-4.39	71.38	-1.77	Peak	255	154
3	4924.00	32.33	54.00	-21.67	27.66	4.67	Average	168	172
4	4924.00	45.82	74.00	-28.18	41.15	4.67	Peak	168	172
5	7386.00	37.61	54.00	-16.39	28.21	9.40	Average	162	182
6	7386.00	50.78	74.00	-23.22	41.38	9.40	Peak	162	182

Note 1: Emission Level (dBuV/m) = SA Reading (dBuV/m) + Factor* (dB)

*Factor includes antenna factor , cable loss and amplifier gain

Note 2: Margin (dB) = Emission level (dBuV/m) – Limit (dBuV/m).

3.5.11 Transmitter Radiated Unwanted Emissions (Above 1GHz) for HT40

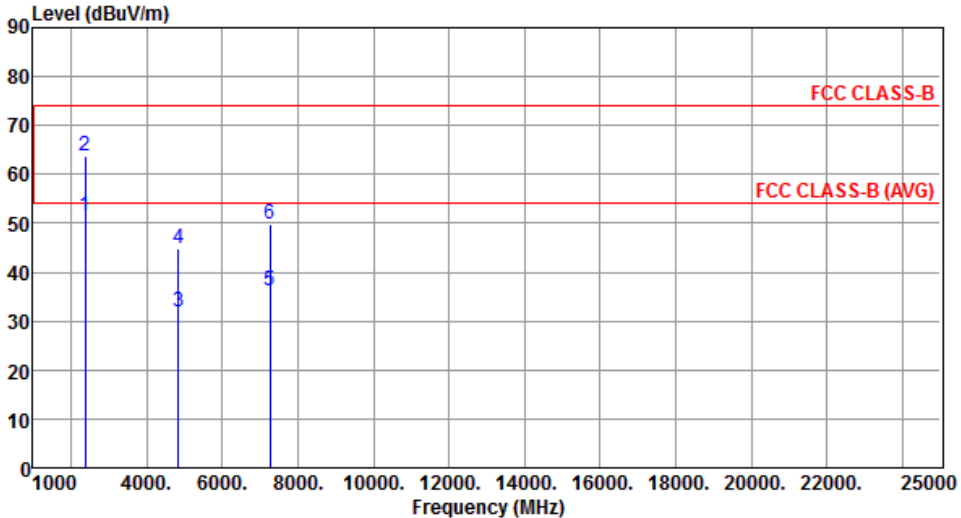
Modulation	HT40	Test Freq. (MHz)	2422						
Polarization	Horizontal								
									
	Freq.	Emission level	Limit	Margin	SA reading	Factor	Remark	ANT High	Turn Table
	MHz	dBuV/m	dBuV/m	dB	dBuV	dB		cm	deg
1	2390.00	51.43	54.00	-2.57	53.55	-2.12	Average	270	59
2	2390.00	63.75	74.00	-10.25	65.87	-2.12	Peak	270	59
3	4844.00	31.87	54.00	-22.13	27.36	4.51	Average	156	215
4	4844.00	44.76	74.00	-29.24	40.25	4.51	Peak	156	215
5	7266.00	36.21	54.00	-17.79	27.24	8.97	Average	138	163
6	7266.00	49.69	74.00	-24.31	40.72	8.97	Peak	138	163
<p>Note 1: Emission Level (dBuV/m) = SA Reading (dBuV/m) + Factor* (dB) *Factor includes antenna factor , cable loss and amplifier gain Note 2: Margin (dB) = Emission level (dBuV/m) – Limit (dBuV/m).</p>									

Modulation	HT40	Test Freq. (MHz)	2422
Polarization	Vertical		

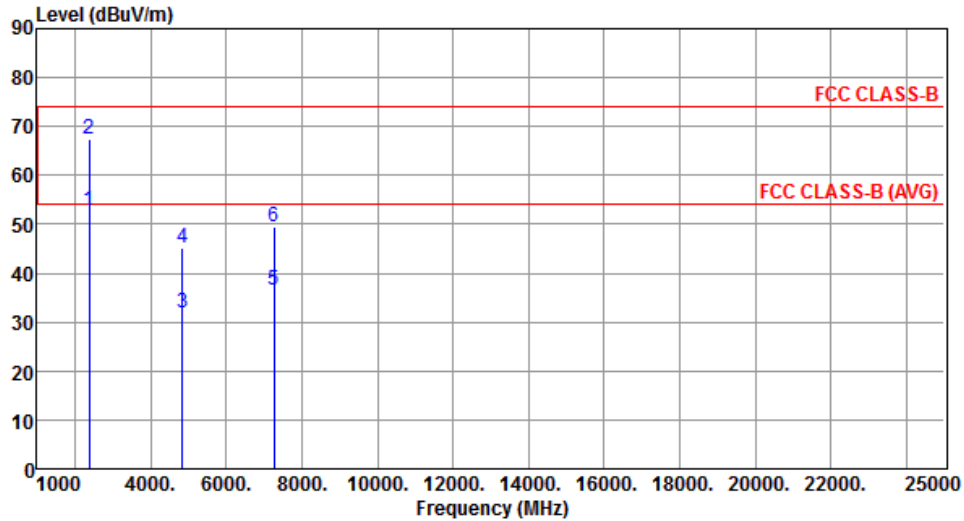

	Freq. MHz	Emission level dBuV/m	Limit dBuV/m	Margin dB	SA reading dBuV	Factor dB	Remark	ANT High cm	Turn Table deg
1	2390.00	52.94	54.00	-1.06	55.06	-2.12	Average	276	15
2	2390.00	67.54	74.00	-6.46	69.66	-2.12	Peak	276	15
3	4844.00	32.04	54.00	-21.96	27.53	4.51	Average	168	144
4	4844.00	45.25	74.00	-28.75	40.74	4.51	Peak	168	144
5	7266.00	36.59	54.00	-17.41	27.62	8.97	Average	142	168
6	7266.00	49.34	74.00	-24.66	40.37	8.97	Peak	142	168

Note 1: Emission Level (dBuV/m) = SA Reading (dBuV/m) + Factor* (dB)

*Factor includes antenna factor , cable loss and amplifier gain

Note 2: Margin (dB) = Emission level (dBuV/m) – Limit (dBuV/m).

Modulation	HT40	Test Freq. (MHz)	2437
Polarization	Horizontal		

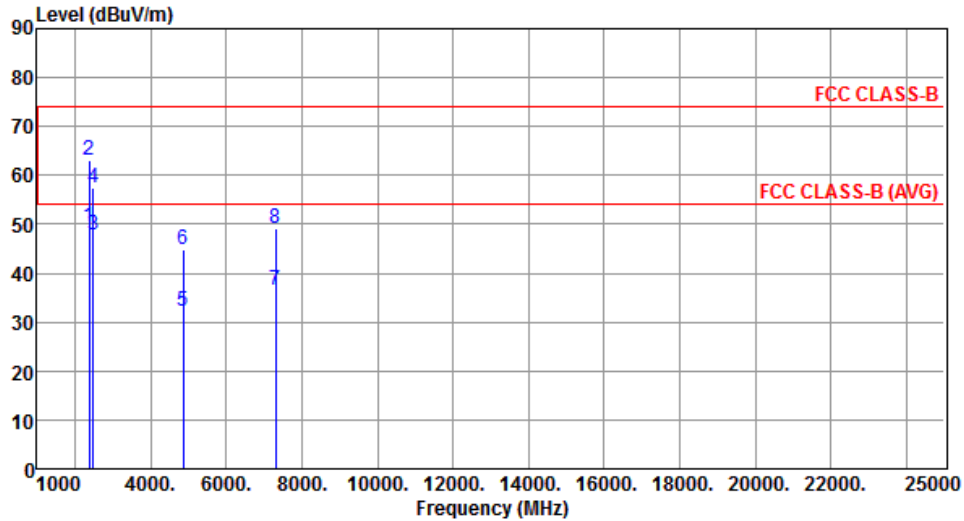

	Freq. MHz	Emission level dBuV/m	Limit dBuV/m	Margin dB	SA reading dBuV	Factor dB	Remark	ANT High cm	Turn Table deg
1	2390.00	49.42	54.00	-4.58	51.54	-2.12	Average	249	91
2	2390.00	63.10	74.00	-10.90	65.22	-2.12	Peak	249	91
3	2483.50	47.86	54.00	-6.14	49.63	-1.77	Average	249	91
4	2483.50	57.38	74.00	-16.62	59.15	-1.77	Peak	249	91
5	4874.00	32.13	54.00	-21.87	27.55	4.58	Average	145	216
6	4874.00	44.96	74.00	-29.04	40.38	4.58	Peak	145	216
7	7311.00	36.67	54.00	-17.33	27.54	9.13	Average	145	216
8	7311.00	49.29	74.00	-24.71	40.16	9.13	Peak	145	216

Note 1: Emission Level (dBuV/m) = SA Reading (dBuV/m) + Factor* (dB)

*Factor includes antenna factor , cable loss and amplifier gain

Note 2: Margin (dB) = Emission level (dBuV/m) – Limit (dBuV/m).

Modulation	HT40	Test Freq. (MHz)	2437
Polarization	Vertical		

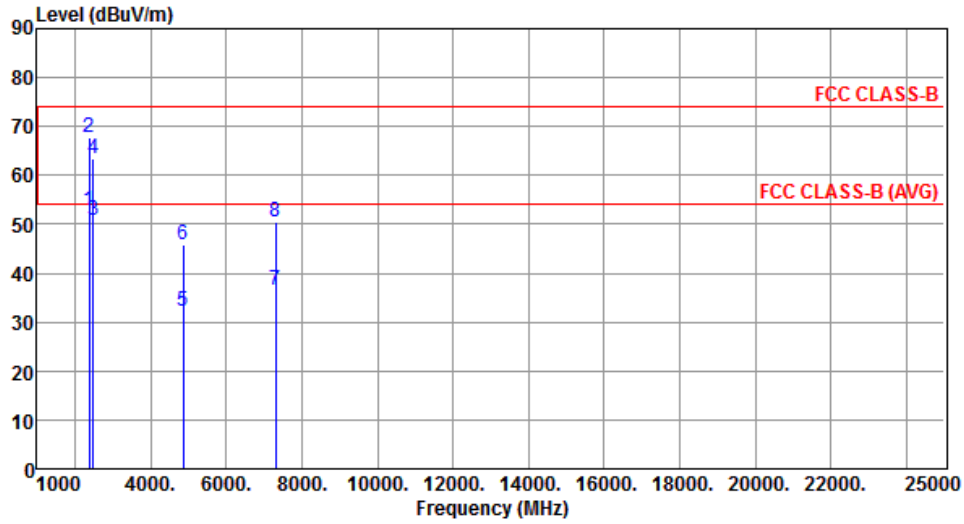

	Freq. MHz	Emission level dBuV/m	Limit dBuV/m	Margin dB	SA reading dBuV	Factor dB	Remark	ANT High cm	Turn Table deg
1	2390.00	52.89	54.00	-1.11	55.01	-2.12	Average	255	211
2	2390.00	67.63	74.00	-6.37	69.75	-2.12	Peak	255	211
3	2483.50	50.76	54.00	-3.24	52.53	-1.77	Average	255	211
4	2483.50	63.34	74.00	-10.66	65.11	-1.77	Peak	255	211
5	4874.00	32.12	54.00	-21.88	27.54	4.58	Average	165	138
6	4874.00	45.96	74.00	-28.04	41.38	4.58	Peak	165	138
7	7311.00	36.69	54.00	-17.31	27.56	9.13	Average	168	142
8	7311.00	50.38	74.00	-23.62	41.25	9.13	Peak	168	142

Note 1: Emission Level (dBuV/m) = SA Reading (dBuV/m) + Factor* (dB)

*Factor includes antenna factor , cable loss and amplifier gain

Note 2: Margin (dB) = Emission level (dBuV/m) – Limit (dBuV/m).

Modulation	HT40	Test Freq. (MHz)	2452
Polarization	Horizontal		

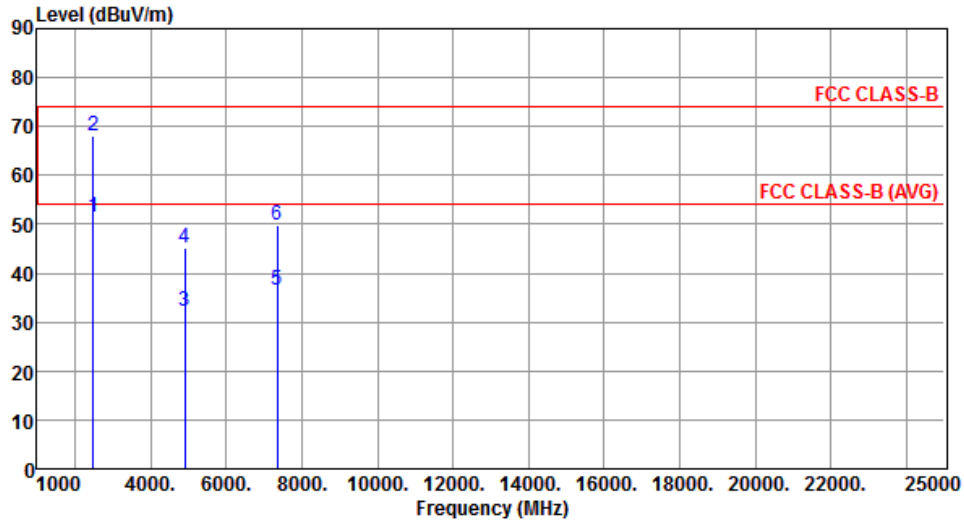

	Freq. MHz	Emission level dBuV/m	Limit dBuV/m	Margin dB	SA reading dBuV	Factor dB	Remark	ANT High cm	Turn Table deg
1	2483.50	51.48	54.00	-2.52	53.25	-1.77	Average	269	95
2	2483.50	67.94	74.00	-6.06	69.71	-1.77	Peak	269	95
3	4904.00	32.08	54.00	-21.92	27.45	4.63	Average	148	222
4	4904.00	45.11	74.00	-28.89	40.48	4.63	Peak	148	222
5	7356.00	36.53	54.00	-17.47	27.24	9.29	Average	163	210
6	7356.00	49.71	74.00	-24.29	40.42	9.29	Peak	163	210

Note 1: Emission Level (dBuV/m) = SA Reading (dBuV/m) + Factor* (dB)

*Factor includes antenna factor , cable loss and amplifier gain

Note 2: Margin (dB) = Emission level (dBuV/m) – Limit (dBuV/m).

Modulation	HT40	Test Freq. (MHz)	2452
Polarization	Vertical		

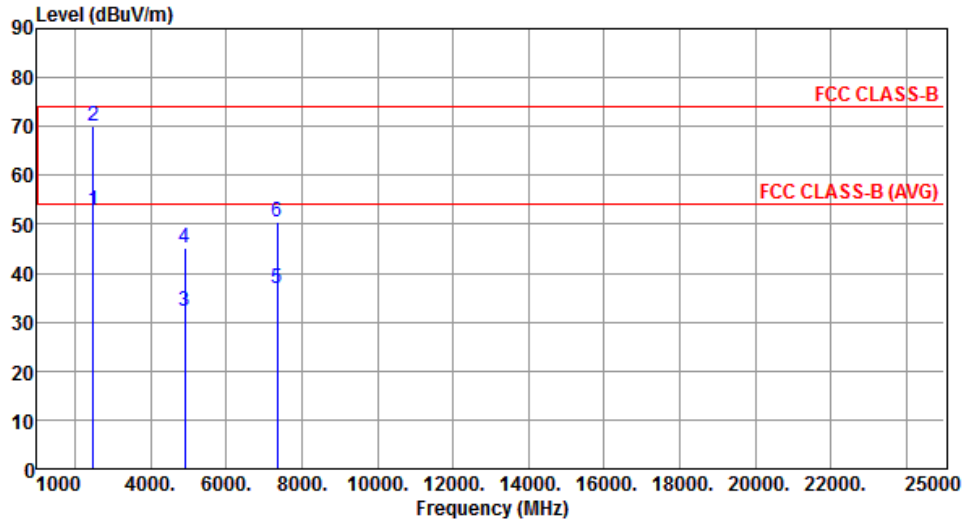

	Freq. MHz	Emission level dBuV/m	Limit dBuV/m	Margin dB	SA reading dBuV	Factor dB	Remark	ANT High cm	Turn Table deg
1	2483.50	52.95	54.00	-1.05	54.72	-1.77	Average	270	92
2	2483.50	70.04	74.00	-3.96	71.81	-1.77	Peak	270	92
3	4904.00	32.18	54.00	-21.82	27.55	4.63	Average	255	168
4	4904.00	45.01	74.00	-28.99	40.38	4.63	Peak	255	168
5	7356.00	36.74	54.00	-17.26	27.45	9.29	Average	175	321
6	7356.00	50.60	74.00	-23.40	41.31	9.29	Peak	175	321

Note 1: Emission Level (dBuV/m) = SA Reading (dBuV/m) + Factor* (dB)

*Factor includes antenna factor , cable loss and amplifier gain

Note 2: Margin (dB) = Emission level (dBuV/m) – Limit (dBuV/m).

3.6 Emissions in Non-Restricted Frequency Bands

3.6.1 Emissions in Non-Restricted Frequency Bands Limit

Peak power in any 100 kHz bandwidth outside of the authorized frequency band shall be attenuated by at least 30 dB relative to the maximum in-band peak PSD level in 100 kHz

3.6.2 Measuring Instruments

Refer a test equipment and calibration data table in this test report.

3.6.3 Test Procedures

Reference level measurement

1. Set RBW=100kHz, VBW = 300kHz , Detector = Peak, Sweep time = Auto
2. Trace = max hold , Allow Trace to fully stabilize
3. Use the peak marker function to determine the maximum PSD level

Emission level measurement

1. Set RBW=100kHz, VBW = 300kHz , Detector = Peak, Sweep time = Auto
2. Trace = max hold , Allow Trace to fully stabilize
3. Scan Frequency range is up to 25GHz
4. Use the peak marker function to determine the maximum amplitude level

3.6.4 Test Setup

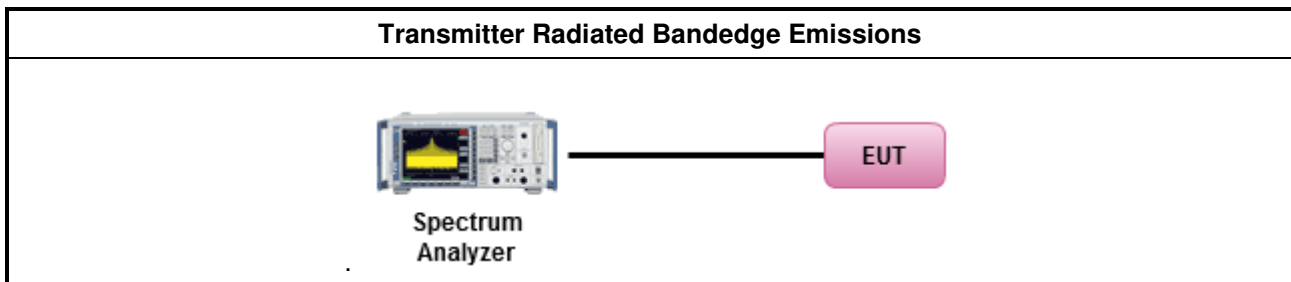

3.6.5 Test Result of Emissions in non-restricted frequency bands

This test item is performed on each TX output individually without summing or adding $10 \log(N_{ANT})$ since measurements are made relative to the in-band emissions on the individual outputs. Only worst test result of each operating mode is presented.

Non-beamforming mode

3.6.6 Unwanted Emissions into Non-Restricted Frequency Bands

802.11b

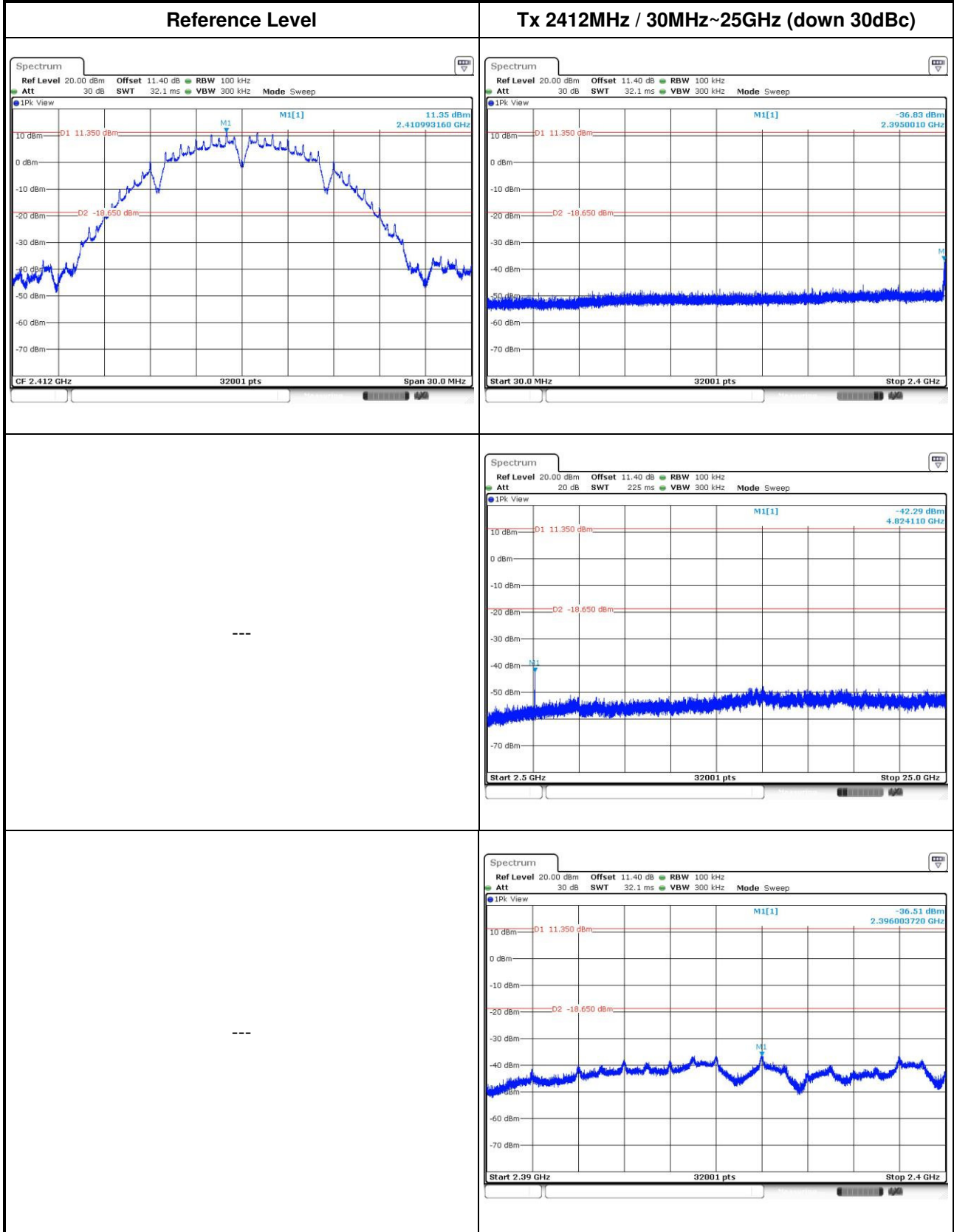

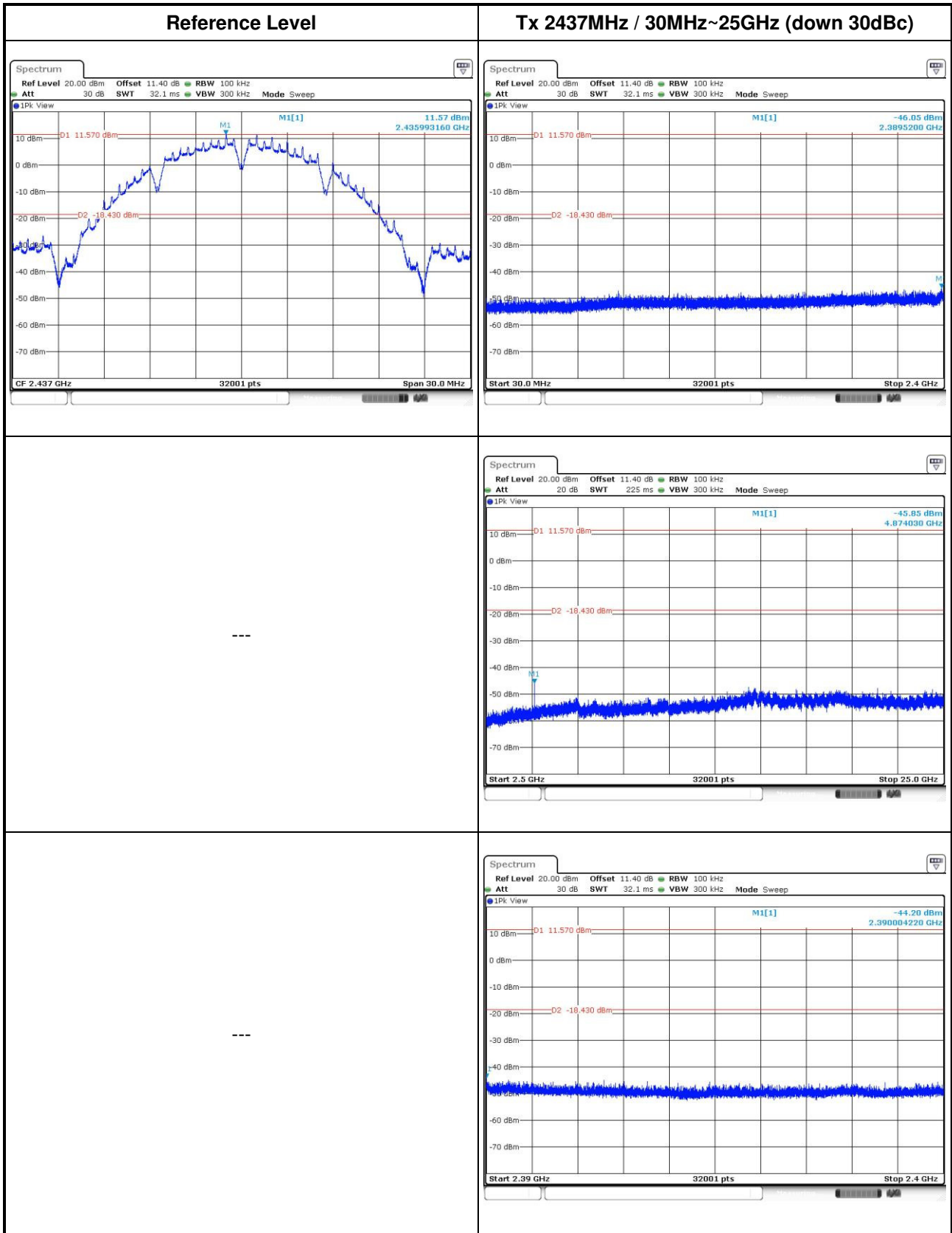

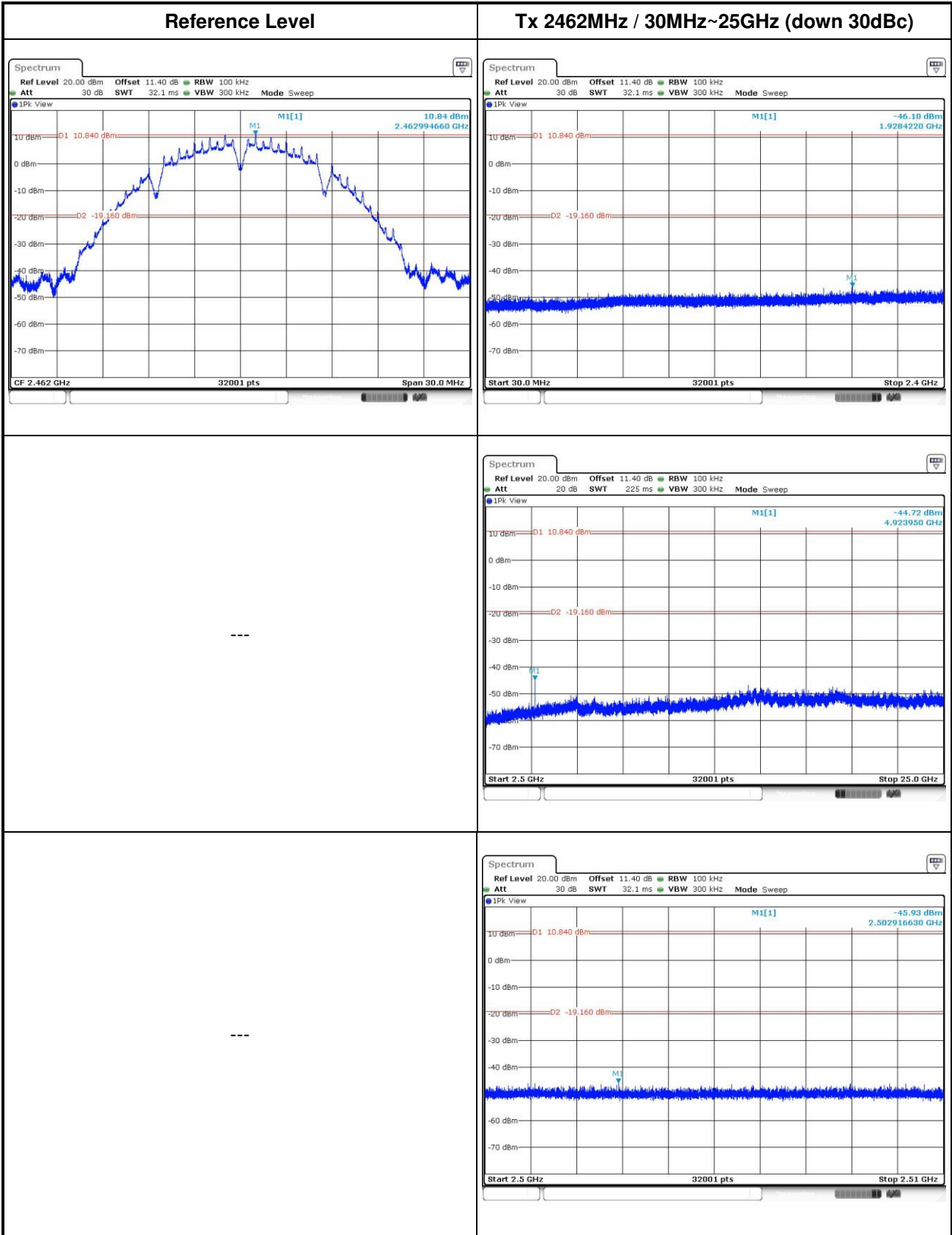

802.11g

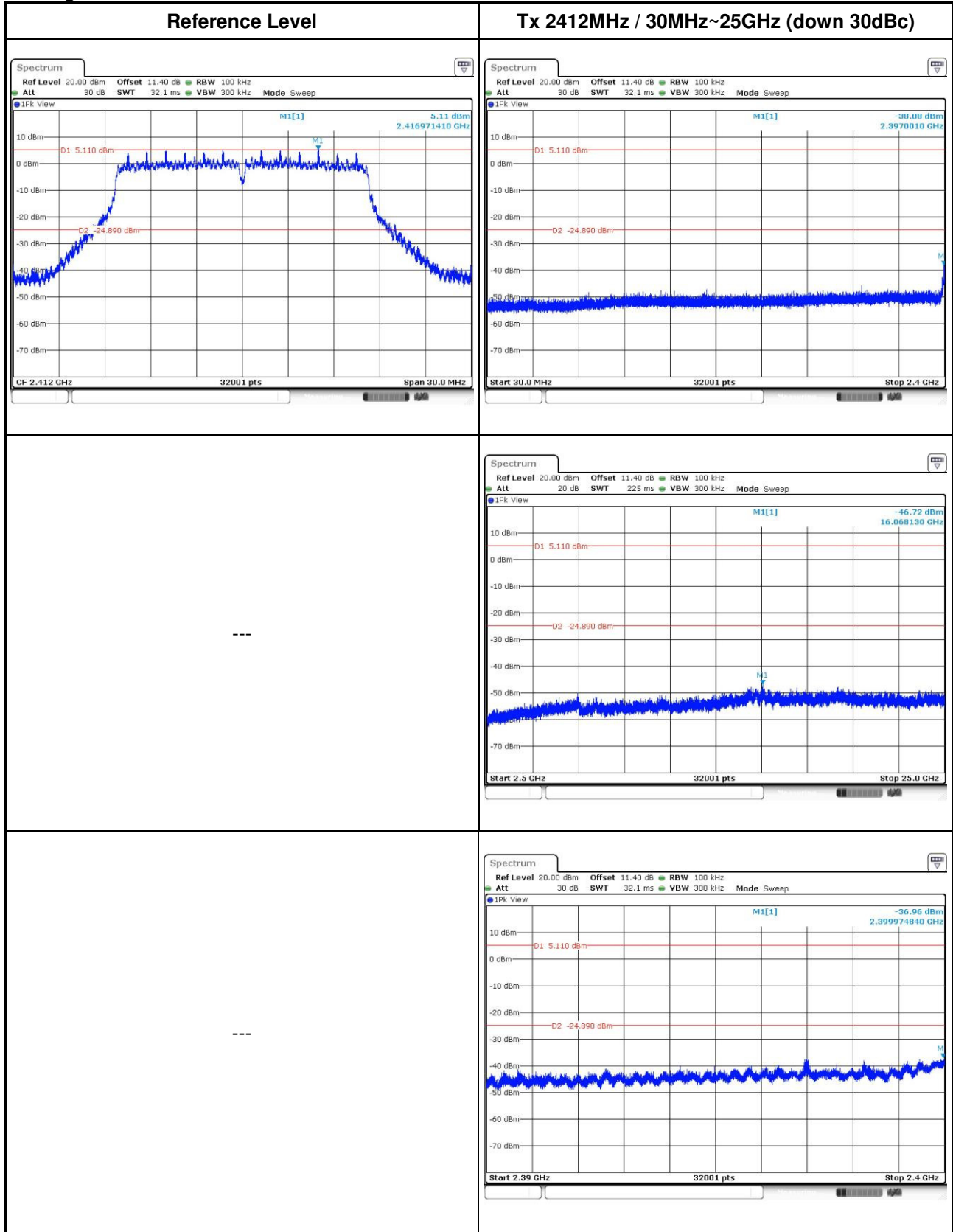

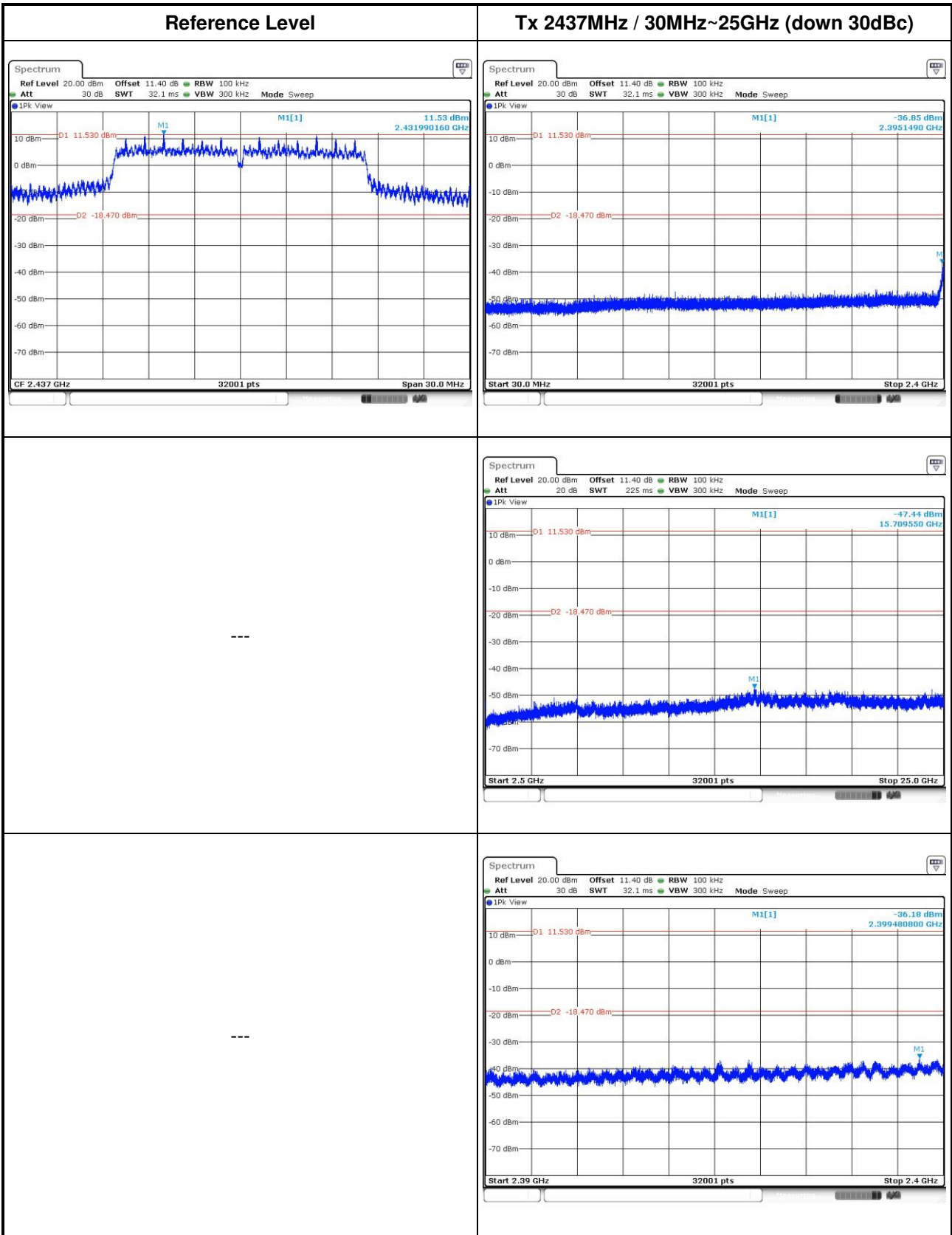

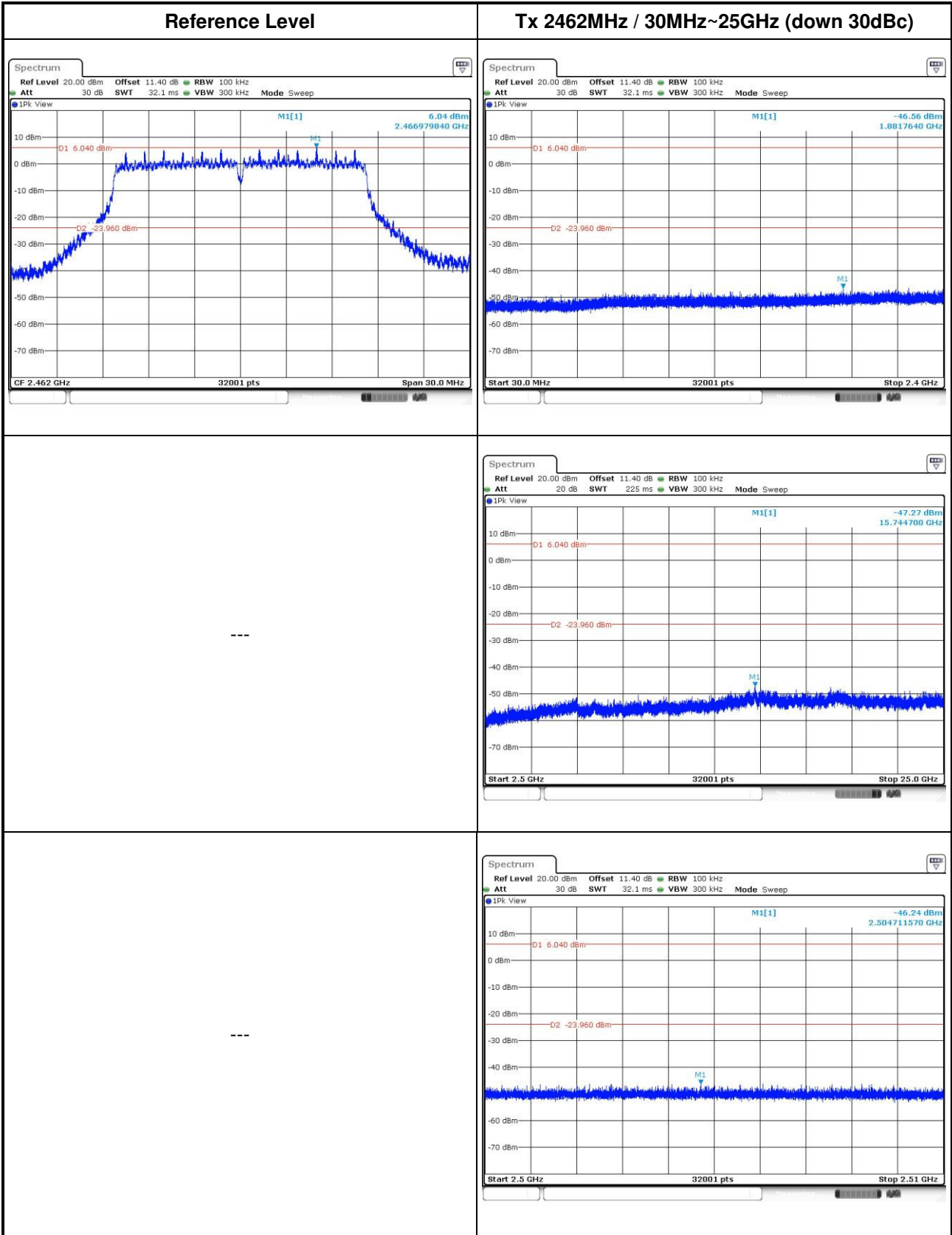

802.11n HT20

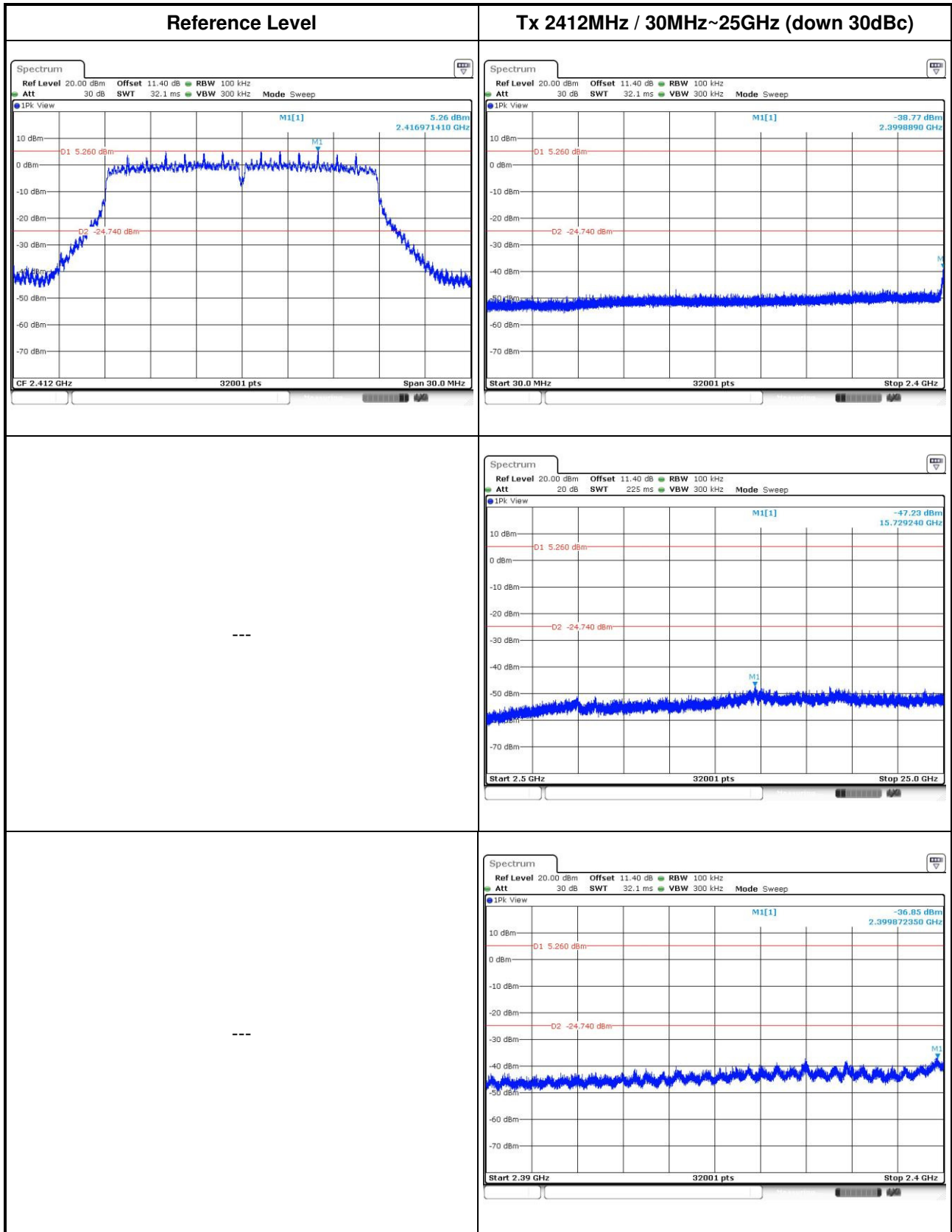

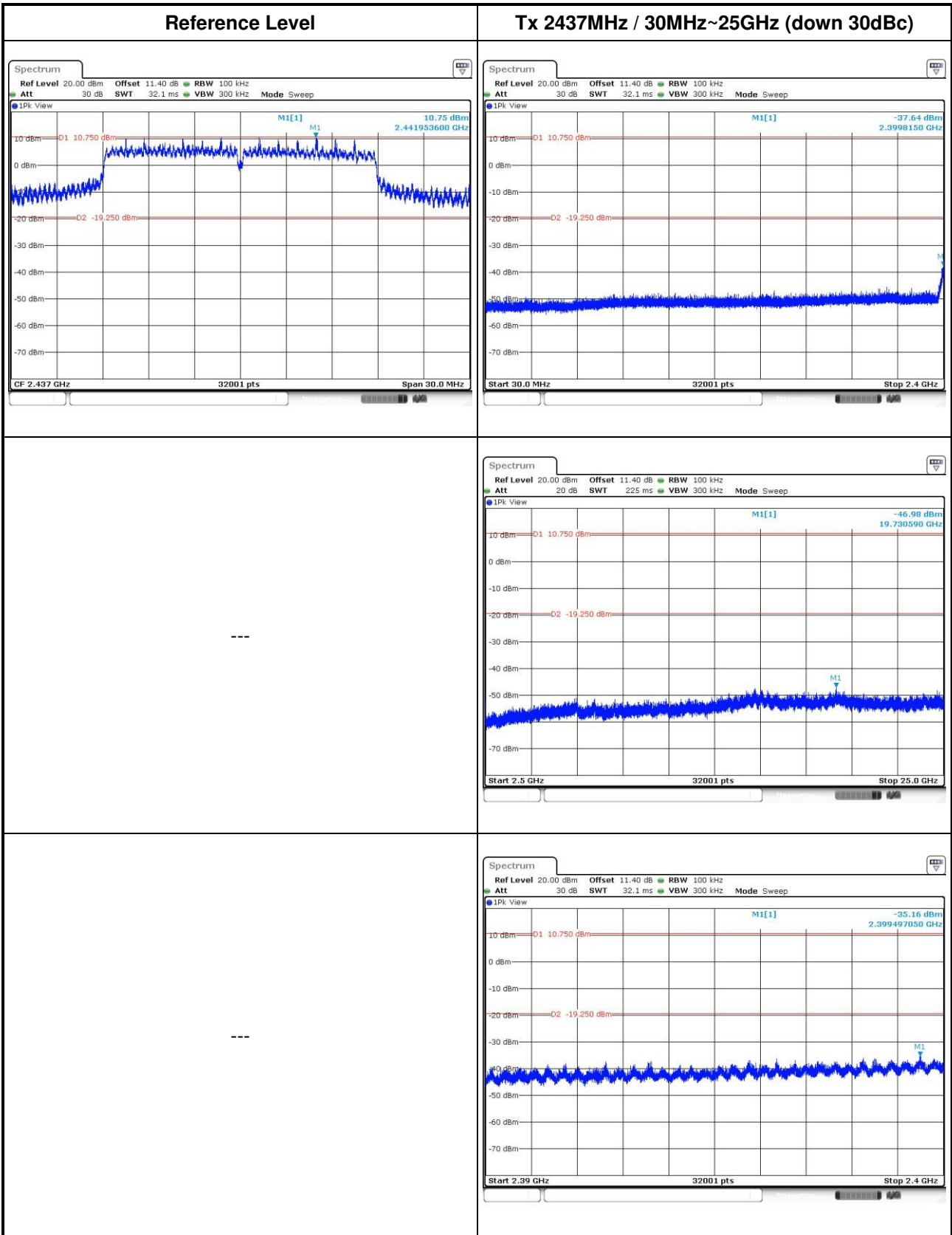

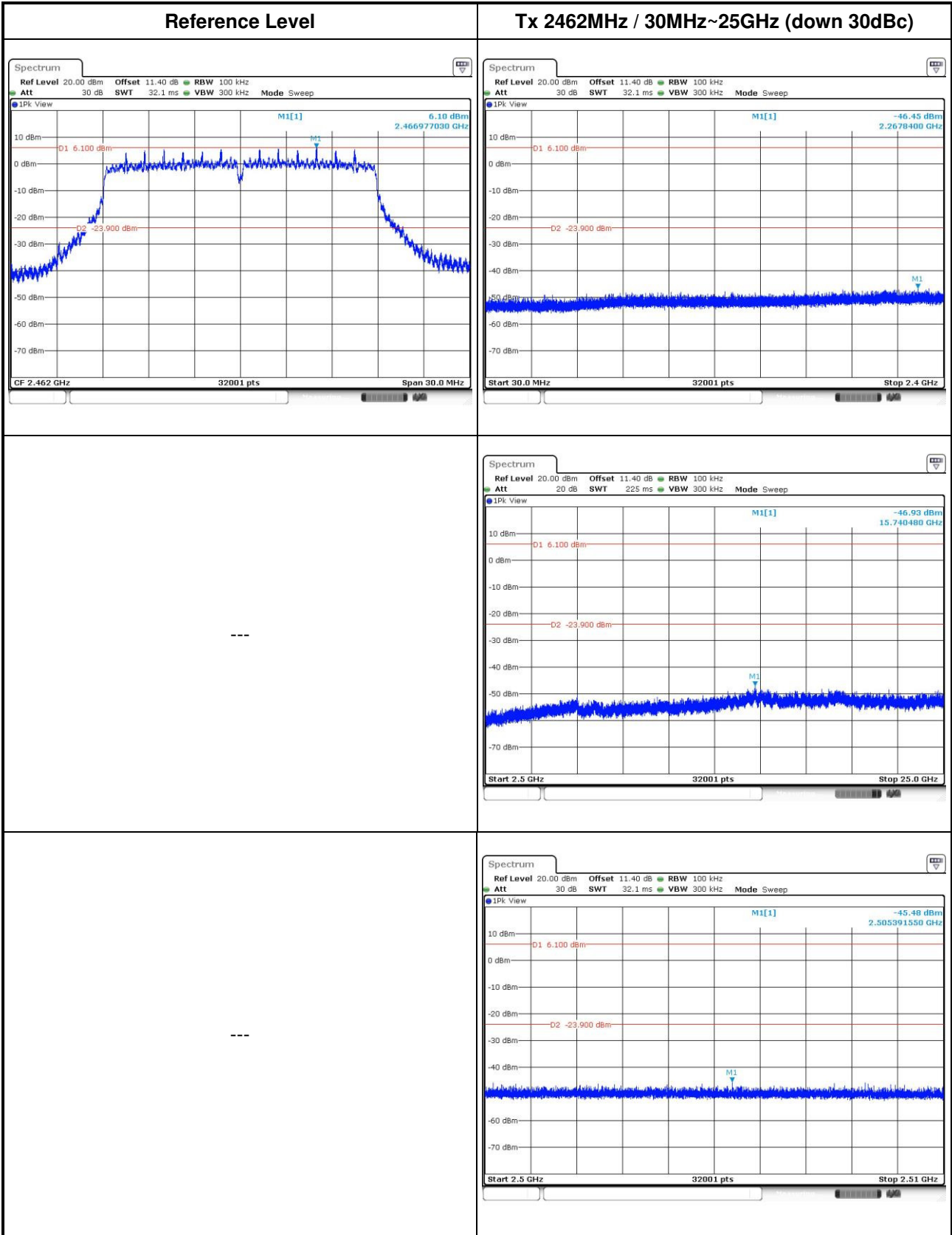

802.11n HT40

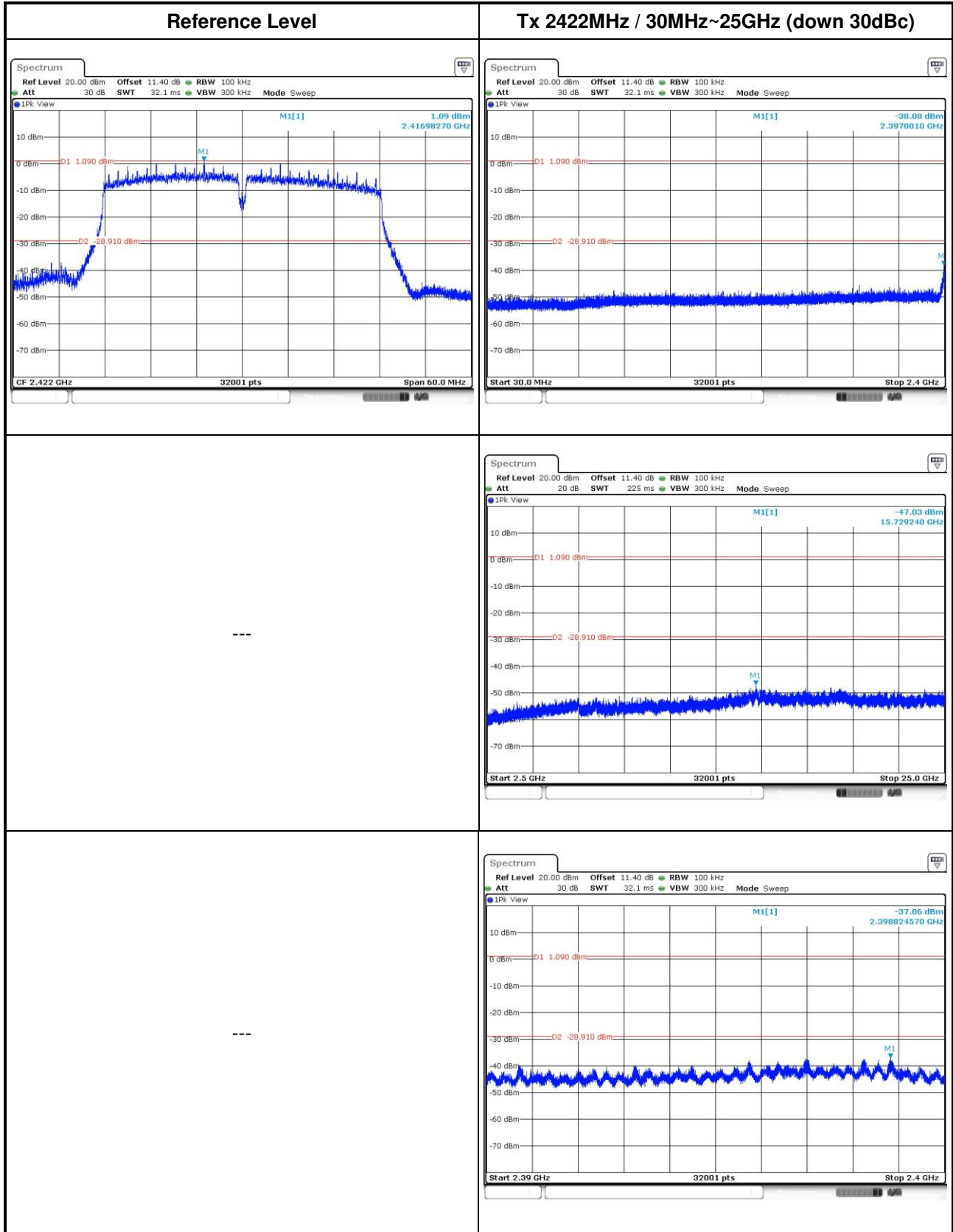

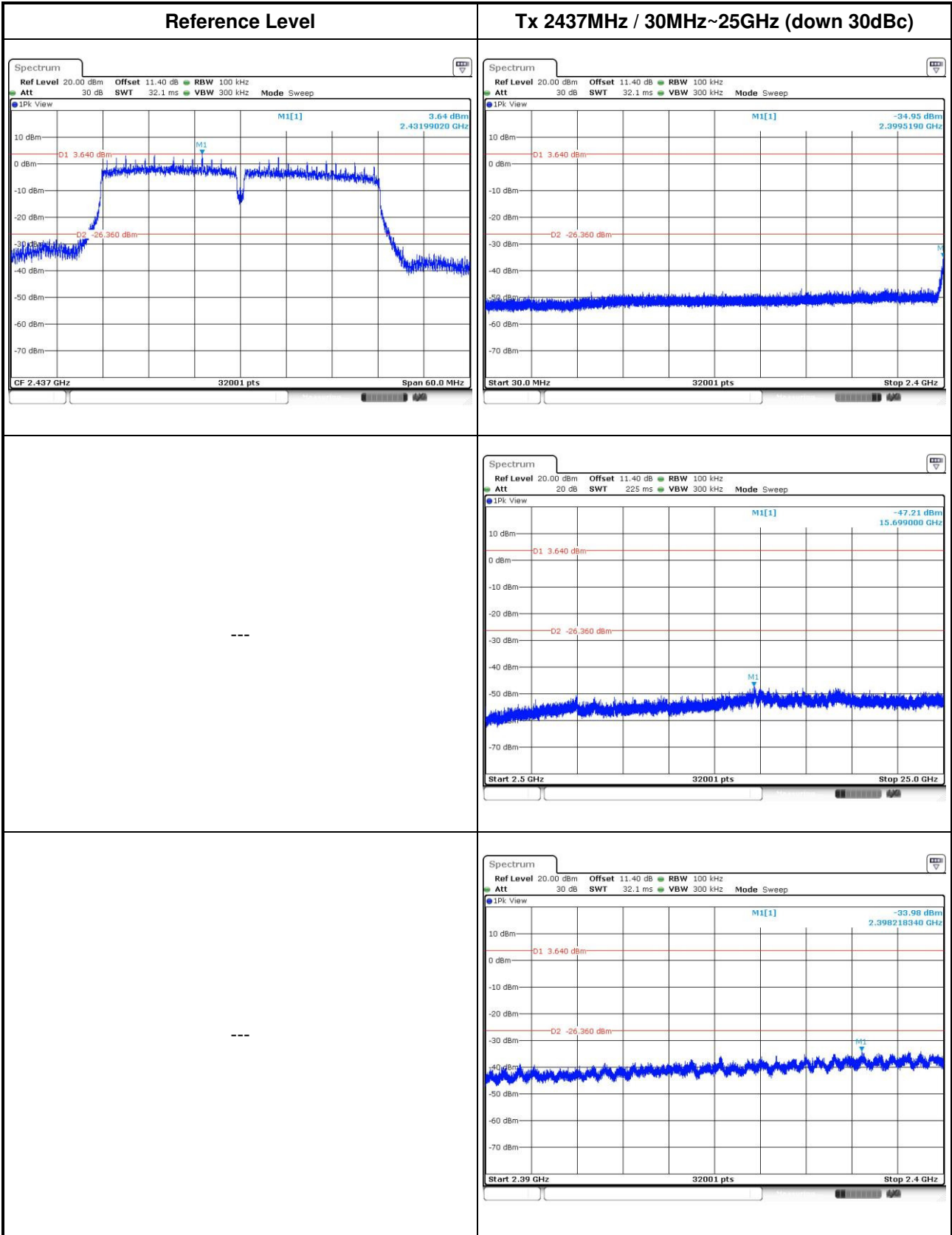

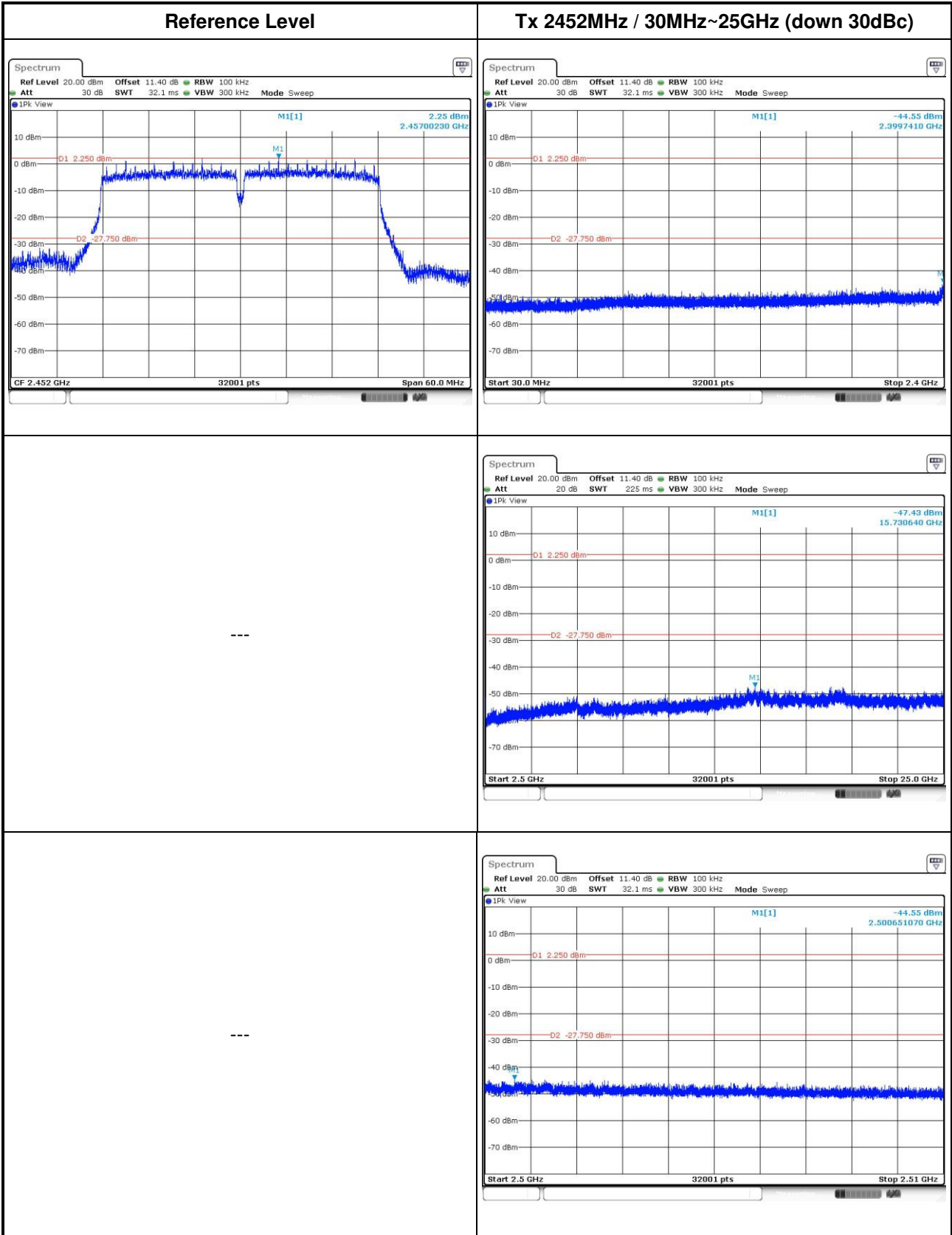

Beamforming mode

3.6.7 Unwanted Emissions into Non-Restricted Frequency Bands

802.11n HT20

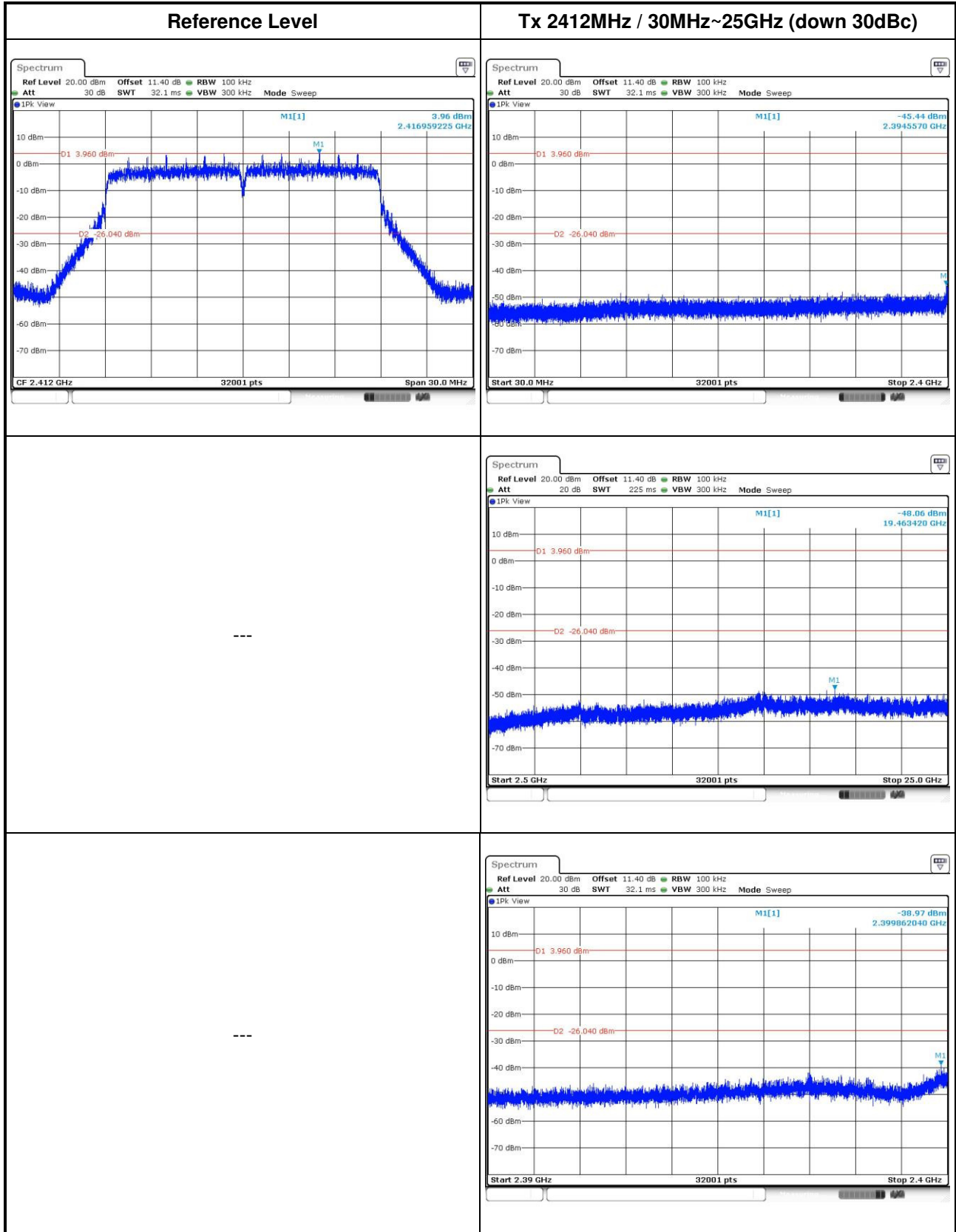

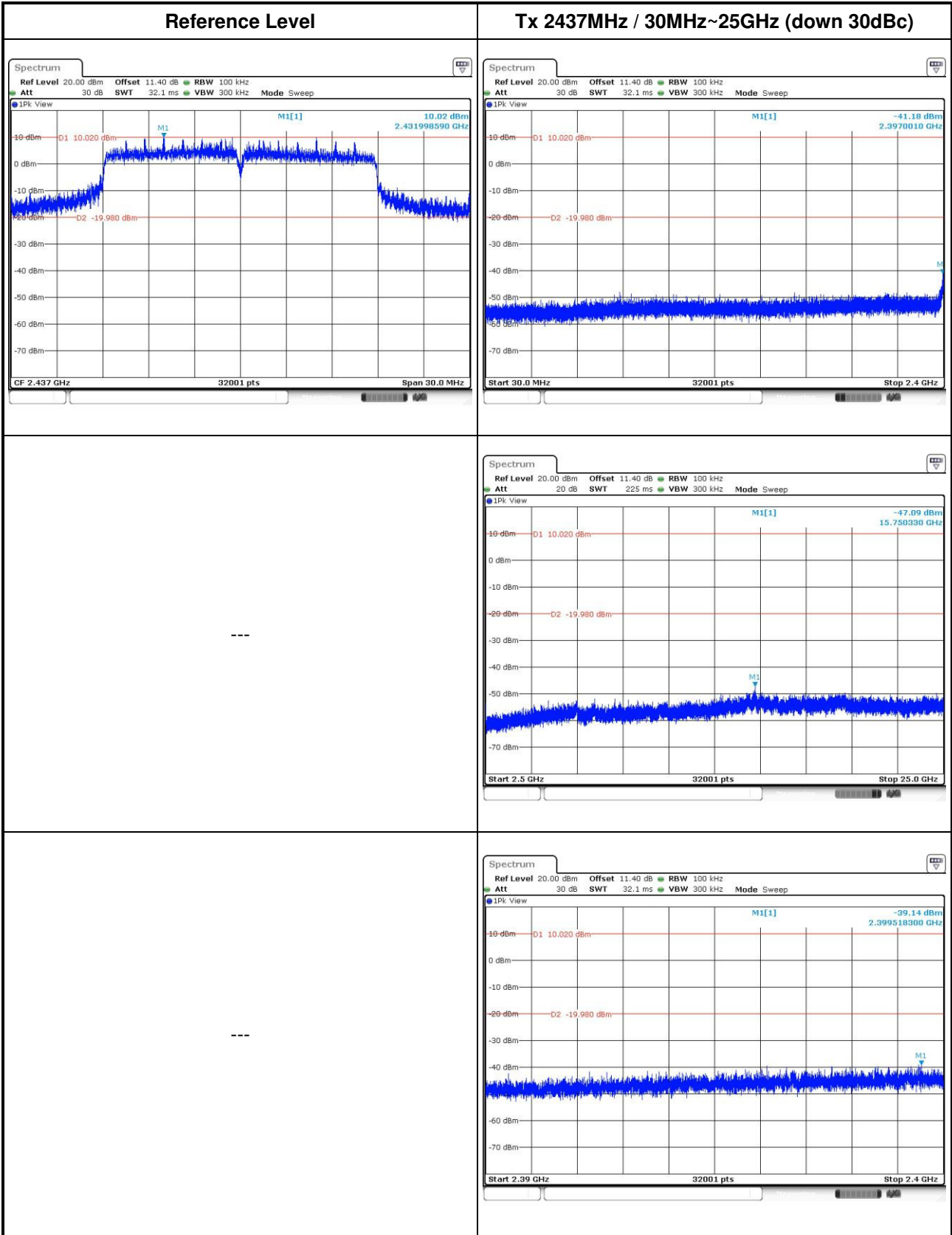

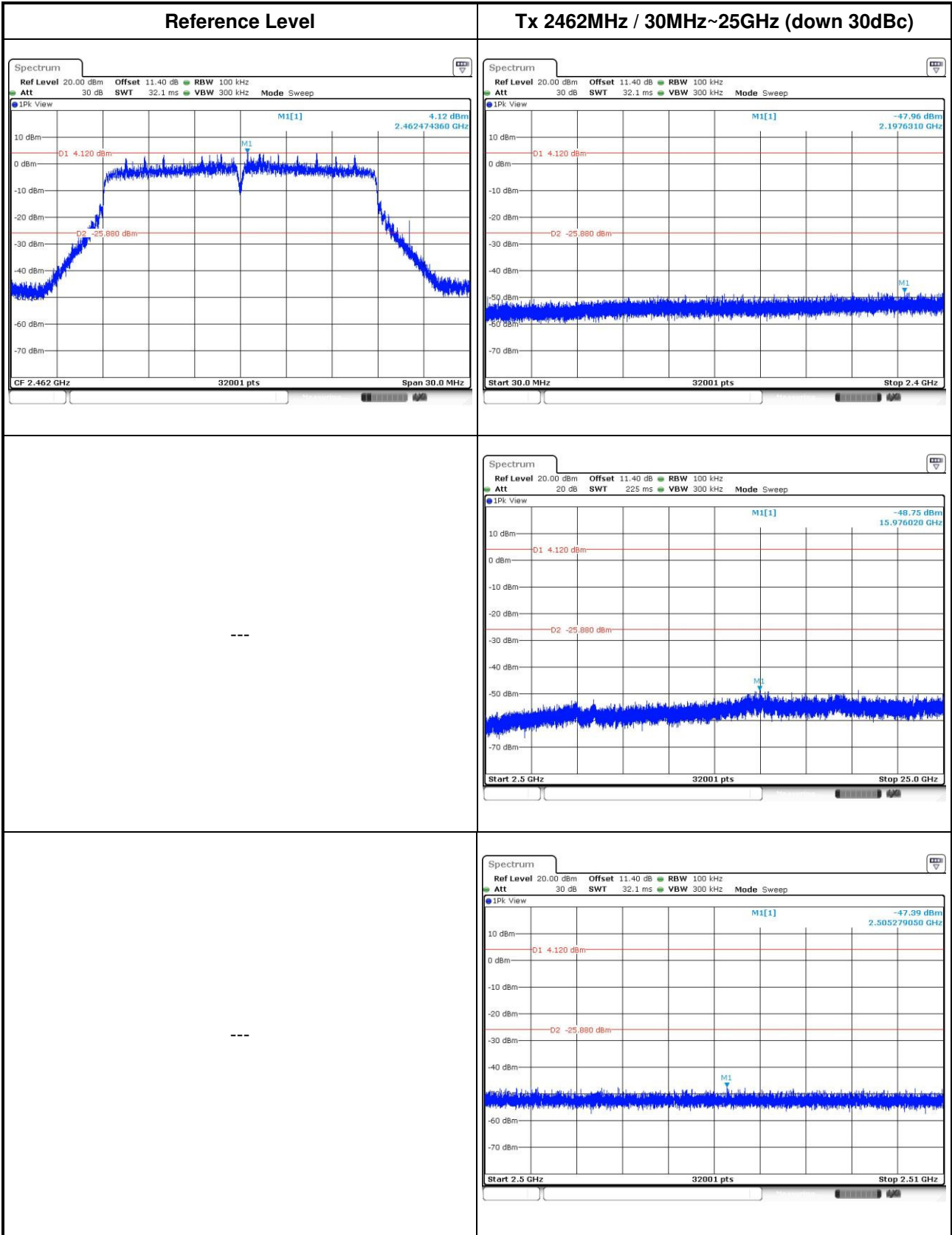

802.11n HT40

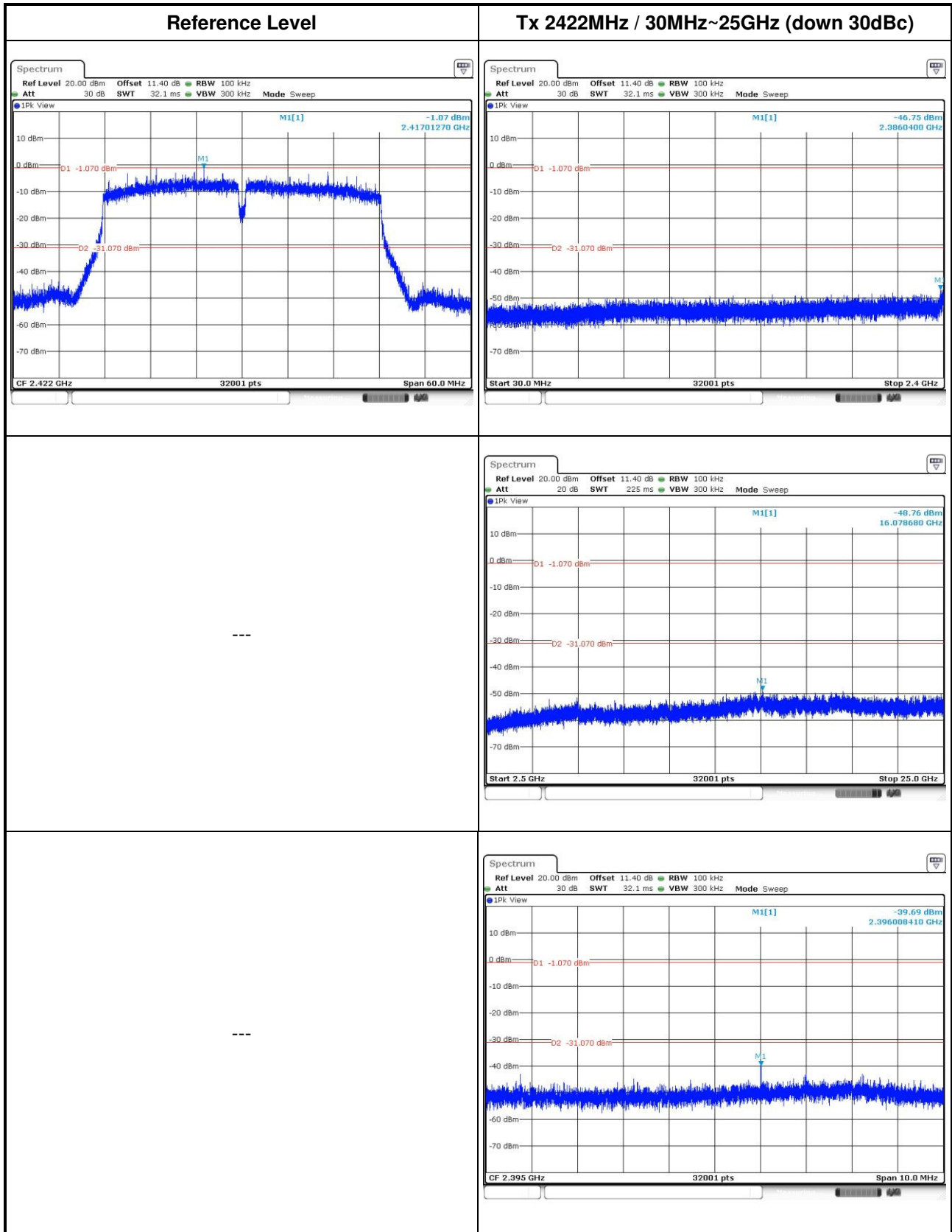

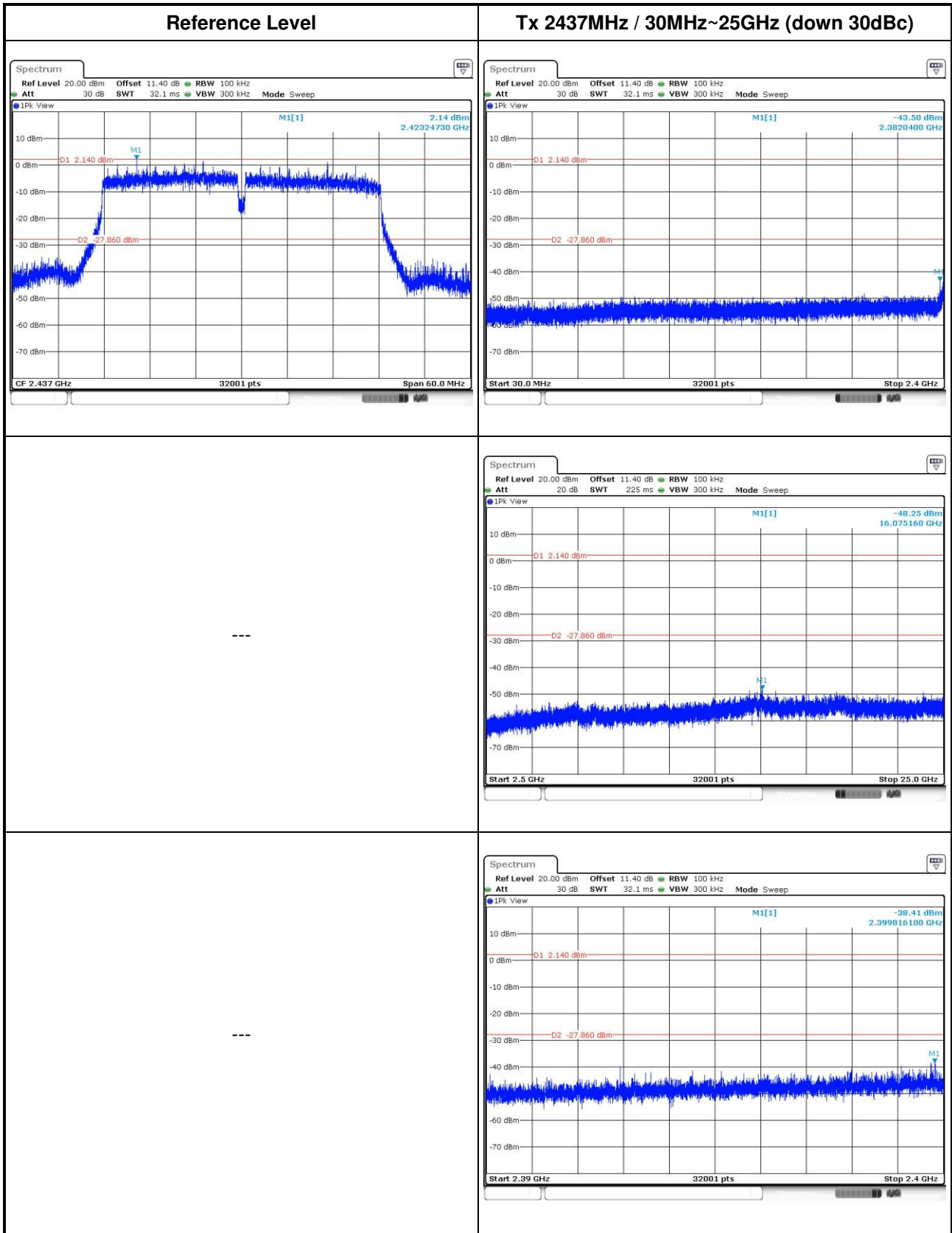

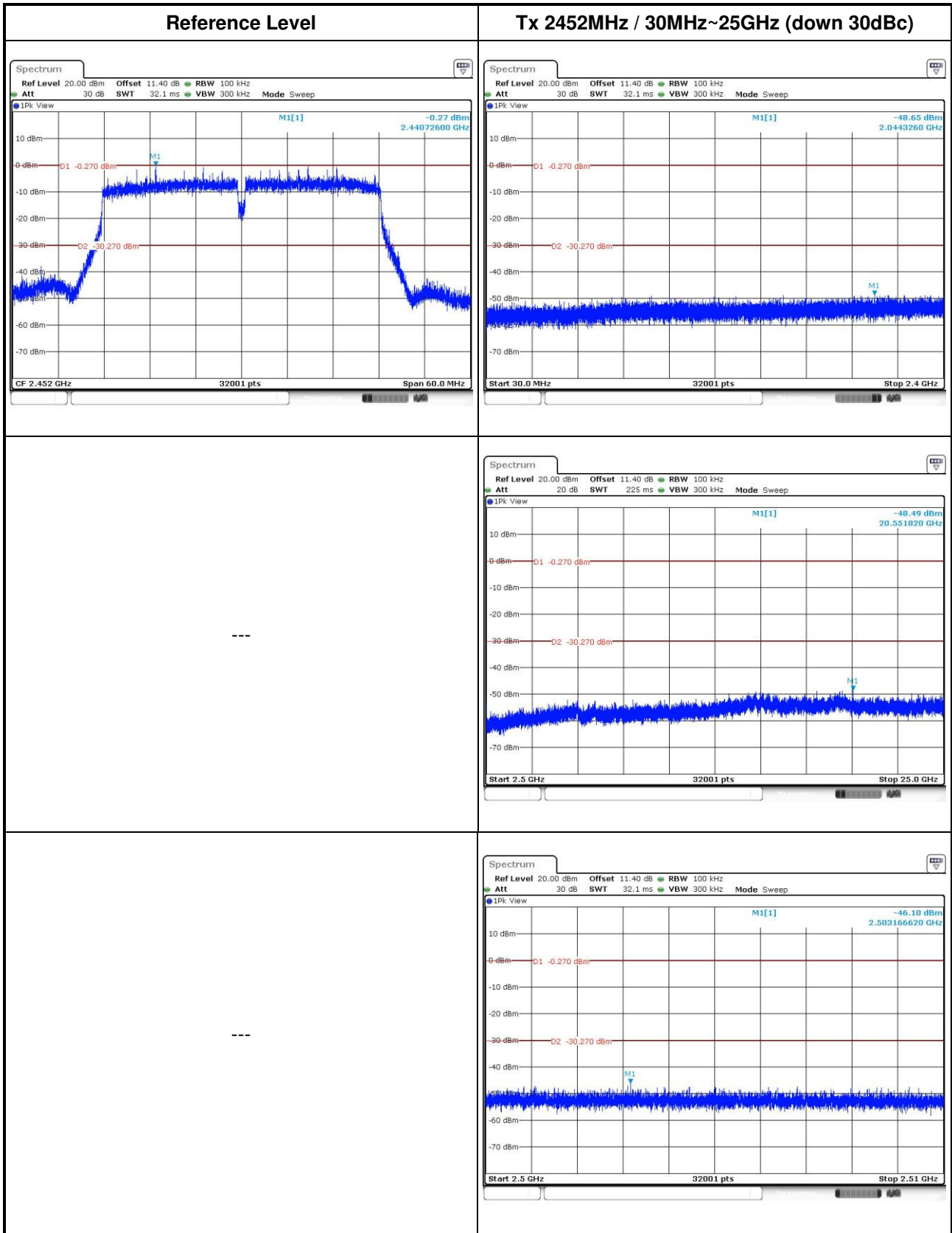

4 Test laboratory information

Established in 2012, ICC provides foremost EMC & RF Testing and advisory consultation services by our skilled engineers and technicians. Our services employ a wide variety of advanced edge test equipment and one of the widest certification extents in the business.

International Certification Corp (EMC and Wireless Communication Laboratory), it is our definitive objective is to institute long term, trust-based associations with our clients. The expectation we set up with our clients is based on outstanding service, practical expertise and devotion to a certified value structure. Our passion is to grant our clients with best EMC / RF services by oriented knowledgeable and accommodating staff.

Our Test sites are located at Linkou District and Kwei Shan District. Location map can be found on our website <http://www.icertifi.com.tw>.

Linkou

Tel: 886-2-2601-1640

No. 30-2, Ding Fwu Tsuen, Lin
Kou District, New Taipei City,
Taiwan, R.O.C.

Kwei Shan

Tel: 886-3-271-8666

No. 3-1, Lane 6, Wen San 3rd St.,
Kwei Shan District, Tao Yuan City
333, Taiwan, R.O.C.

Kwei Shan Site II

Tel: 886-3-271-8640

No. 14-1, Lane 19, Wen San 3rd
St., Kwei Shan District, Tao Yuan
City 333, Taiwan, R.O.C.

If you have any suggestion, please feel free to contact us as below information.

Tel: 886-3-271-8666

Fax: 886-3-318-0155

Email: ICC_Service@icertifi.com.tw

==END==