

TEST REPORT

Test report no.: 1-5178/12-01-05-C



Testing laboratory

CETECOM ICT Services GmbH
Untertuerkheimer Strasse 6 – 10
66117 Saarbruecken / Germany
Phone: + 49 681 5 98 - 0
Fax: + 49 681 5 98 - 9075
Internet: <http://www.cetecom.com>
e-mail: ict@cetecom.com

Accredited Testing Laboratory:

The testing laboratory (area of testing) is accredited according to DIN EN ISO/IEC 17025 (2005) by the Deutsche Akkreditierungsstelle GmbH (DAkkS). The accreditation is valid for the scope of testing procedures as stated in the accreditation certificate with the registration number: D-PL-12076-01-01
Area of Testing: Radio/Satellite Communications

Applicant

Bernafon AG
Morgenstraße 131
3018 Bern / SWITZERLAND
Phone: +41 31 9 98 15 15
Contact: Thomas Leuzinger
e-mail: tle@bernafon.ch
Phone: +41 31 998 16 92

Manufacturer

Bernafon AG
Morgenstraße 131
3018 Bern / SWITZERLAND

Test standard/s

47 CFR Part 15 Title 47 of the Code of Federal Regulations; Chapter I
Part 15 - Radio frequency devices
RSS - 210 Issue 8 Spectrum Management and Telecommunications - Radio Standards Specification
Low-power Licence-exempt Radiocommunication Devices (All Frequency Bands):
Category I Equipment

For further applied test standards please refer to section 3 of this test report.

Test Item

Kind of test item: Air Conduction Hearing Aid with Wireless Functionality
Model name: AR7 N, PC7 N, AR9 N, PC9 N
FCC ID: U6XF2BTE01
IC: 7031A-F2BTE01
Frequency: 3.84 MHz
Technology tested: Magnetic coupling
Antenna: Integrated coil antenna
Power Supply: 1.4 V DC by Zinc Air Cell (312)
Temperature Range: 0°C to +40 °C



This test report is electronically signed and valid without handwriting signature. For verification of the electronic signatures, the public keys can be requested at the testing laboratory.

Test report authorised:

[Signature box]

Stefan BöS
Senior Testing Manager

Test performed:

[Signature box]
p.o.

Andreas Luckenbill
Expert

1 Table of contents

1 Table of contents2

2 General information3

2.1 Notes and disclaimer3

2.2 Application details.....3

3 Test standard/s3

4 Test environment.....4

5 Test item.....4

6 Test laboratories sub-contracted4

7 Summary of measurement results5

8 RF measurements6

8.1 Description of test setup6

 8.1.1 Radiated measurements.....6

 8.1.2 Conducted measurements.....7

8.2 Additional comments7

8.3 RSP100 test report cover sheet / performance test data8

9 Measurement results.....9

9.1 Timing of the transmitter9

9.2 Bandwidth of the modulated carrier10

9.3 Field strength of the fundamental12

9.4 Field strength of the harmonics and spurious13

9.5 Receiver spurious emissions.....17

9.6 Conducted limits20

10 Test equipment and ancillaries used for tests.....21

11 Observations22

Annex A Photographs of the test setup23

Annex B External photographs of the EUT.....26

Annex C Internal photographs of the EUT30

Annex D Document history33

Annex E Further information.....33

Annex F Accreditation Certificate34

2 General information

2.1 Notes and disclaimer

The test results of this test report relate exclusively to the test item specified in this test report. CETECOM ICT Services GmbH does not assume responsibility for any conclusions and generalizations drawn from the test results with regard to other specimens or samples of the type of the equipment represented by the test item.

The test report may only be reproduced or published in full. Reproduction or publication of extracts from the report requires the prior written approval of CETECOM ICT Services GmbH.

The testing service provided by CETECOM ICT Services GmbH has been rendered under the current "General Terms and Conditions for CETECOM ICT Services GmbH".

CETECOM ICT Services GmbH will not be liable for any loss or damage resulting from false, inaccurate, inappropriate or incomplete product information provided by the customer.

Under no circumstances does the CETECOM ICT Services GmbH test report include any endorsement or warranty regarding the functionality, quality or performance of any other product or service provided.

Under no circumstances does the CETECOM ICT Services GmbH test report include or imply any product or service warranties from CETECOM ICT Services GmbH, including, without limitation, any implied warranties of merchantability, fitness for purpose, or non-infringement, all of which are expressly disclaimed by CETECOM ICT Services GmbH.

All rights and remedies regarding vendor's products and services for which CETECOM ICT Services GmbH has prepared this test report shall be provided by the party offering such products or services and not by CETECOM ICT Services GmbH.

In no case this test report can be considered as a Letter of Approval.

This test report is electronically signed and valid without handwritten signature. For verification of the electronic signatures, the public keys can be requested at the testing laboratory.

2.2 Application details

Date of receipt of order:	2012-09-14
Date of receipt of test item:	2012-09-17
Start of test:	2012-09-17
End of test:	2012-09-18
Person(s) present during the test:	-/-

3 Test standard/s

Test standard	Date	Test standard description
47 CFR Part 15	2010-10	Title 47 of the Code of Federal Regulations; Chapter I Part 15 - Radio frequency devices
RSS - 210 Issue 8	2010-12	Spectrum Management and Telecommunications - Radio Standards Specification Low-power Licence-exempt Radiocommunication Devices (All Frequency Bands): Category I Equipment

4 Test environment

Temperature:	T_{nom}	+22 °C during room temperature tests
	T_{max}	+40 °C during high temperature tests
	T_{min}	0 °C during low temperature tests
Relative humidity content:		52 %
Barometric pressure:		not relevant for this kind of testing
Power supply:	V_{nom}	1.4 V DC by Zinc Air Cell (312)
	V_{max}	1.5 V
	V_{min}	1.1 V

5 Test item

Kind of test item	:	Air Conduction Hearing Aid with Wireless Functionality
Type identification	:	AR7 N, PC7 N, AR9 N, PC9 N
S/N serial number	:	Rad. 2104 8298, 2104 8223, 2104 8241
HW hardware status	:	Accord 119441, PCB Rev. 0
SW software status	:	ALOHA22_1_1_SoC_Config_F
Frequency band [MHz]	:	3.84 MHz
Type of radio transmission	:	Single carrier
Use of frequency spectrum	:	
Type of modulation	:	A1D
Number of channels	:	1
Antenna	:	Integrated coil antenna
Power supply	:	1.4 V DC by Zinc Air Cell (312)
Temperature range	:	0°C to +40 °C

6 Test laboratories sub-contracted

None

7 Summary of measurement results

- No deviations from the technical specifications were ascertained**
- There were deviations from the technical specifications ascertained

TC Identifier	Description	Verdict	Date	Remark
RF-Testing	CFR Part 15 RSS 210, Issue 8	Passed	2012-12-20	-/-

Test Specification Clause	Test Case	Temperature Conditions	Power Source Voltages	Pass	Fail	NA	NP	Results
§ 15.35 (c) / RSS-GEN Issue 3 Section 4.5	Timing of the transmitter (Duty cycle correction factor)	Nominal	Nominal	<input type="checkbox"/>	<input type="checkbox"/>	<input type="checkbox"/>	<input type="checkbox"/>	Not rated!
§ 15.223 / RSS-210 Issue 8	Bandwidth of the modulated carrier	Nominal	Nominal	<input checked="" type="checkbox"/>	<input type="checkbox"/>	<input type="checkbox"/>	<input type="checkbox"/>	complies
§ 15.223 / RSS-210 Issue 8	Fieldstrength of fundamental	Nominal	Nominal	<input checked="" type="checkbox"/>	<input type="checkbox"/>	<input type="checkbox"/>	<input type="checkbox"/>	complies
§ 15.209 (a) / RSS-210 Issue 8	Fieldstrength of harmonics and spurious	Nominal	Nominal	<input checked="" type="checkbox"/>	<input type="checkbox"/>	<input type="checkbox"/>	<input type="checkbox"/>	complies
§ 15.109 / RSS-210 Issue 8	Receiver spurious emissions	Nominal	Nominal	<input checked="" type="checkbox"/>	<input type="checkbox"/>	<input type="checkbox"/>	<input type="checkbox"/>	complies
§ 15.107 / § 15.207	Conducted limits	Nominal	Nominal	<input type="checkbox"/>	<input type="checkbox"/>	<input checked="" type="checkbox"/>	<input type="checkbox"/>	-

Note: NA = Not Applicable; NP = Not Performed

8 RF measurements

8.1 Description of test setup

8.1.1 Radiated measurements

The radiated measurements are performed in vertical and horizontal plane in the frequency range from 9 kHz to 25 GHz in semi-anechoic chambers. The EUT is positioned on a non-conductive support with a height of 0.80 m above a conductive ground plane that covers the whole chamber. The receiving antennas are confirmed with specifications ANSI C63.2-1996 and ANSI C63.4-2009. These antennas can be moved over the height range between 1.0 m and 4.0 m in order to search for maximum field strength emitted from EUT. The measurement distances between EUT and receiving antennas are indicated in the test setups for the various frequency ranges. For each measurement, the EUT is rotated in all three axes until the maximum field strength is received. The wanted and unwanted emissions are received by spectrum analysers where the detector modes and resolution bandwidths over various frequency ranges are set according to requirement ANSI C63-4-2003. Antennas are confirmed with ANSI C63.2-1996 item 15.

Semi anechoic chamber

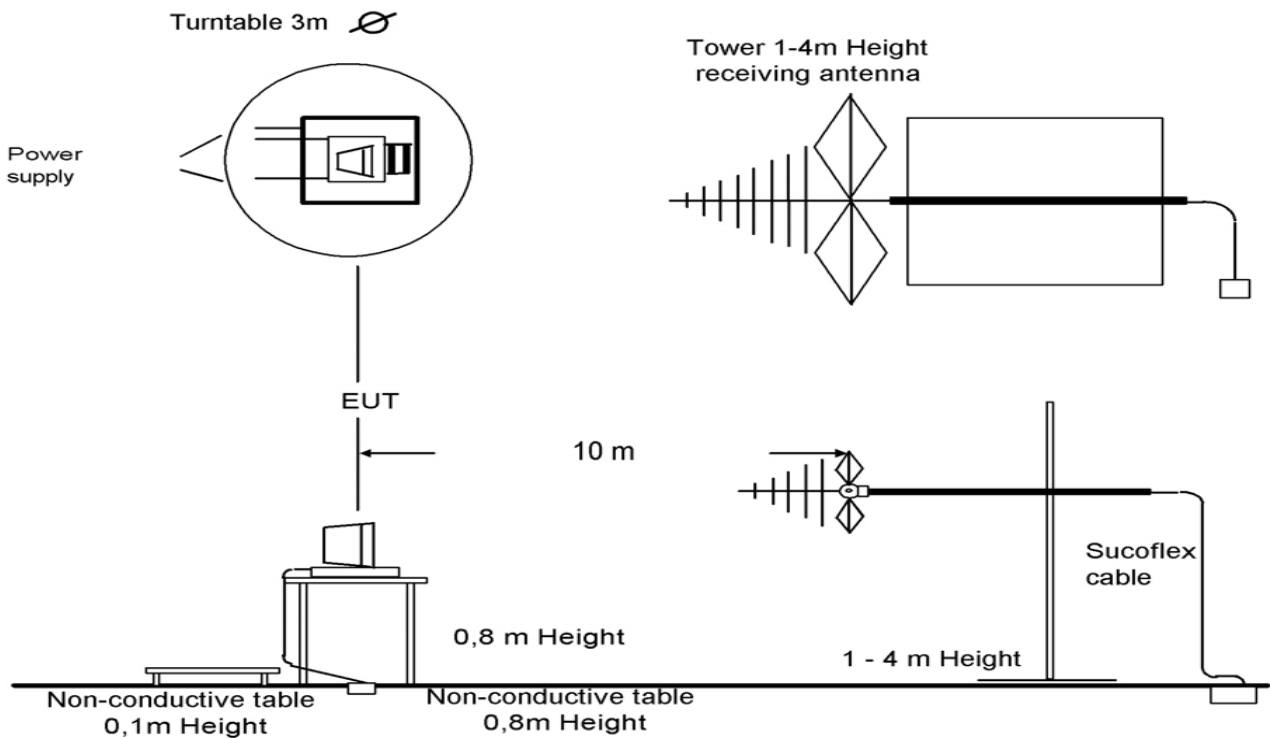

Picture 1: Diagram radiated measurements

9 kHz - 30 MHz:	active loop antenna
30 MHz – 1 GHz:	tri-log antenna
> 1 GHz:	horn antenna

The EUT is powered by an external power supply with nominal voltage. The signalling (if needed) is performed from outside the chamber with a signalling unit by air link using signalling antenna.

8.1.2 Conducted measurements

The EUT's RF signal is coupled out by the antenna connector which is supplied by the manufacturer. The signal is first 10dB attenuated before it is power divided (~6dB loss per branch). The measurement readings on the signalling unit/spectrum analyzer are corrected by the specific test set-up loss. The attenuator, power divider, and the spectrum analyzer are impedance matched on 50 Ohm.

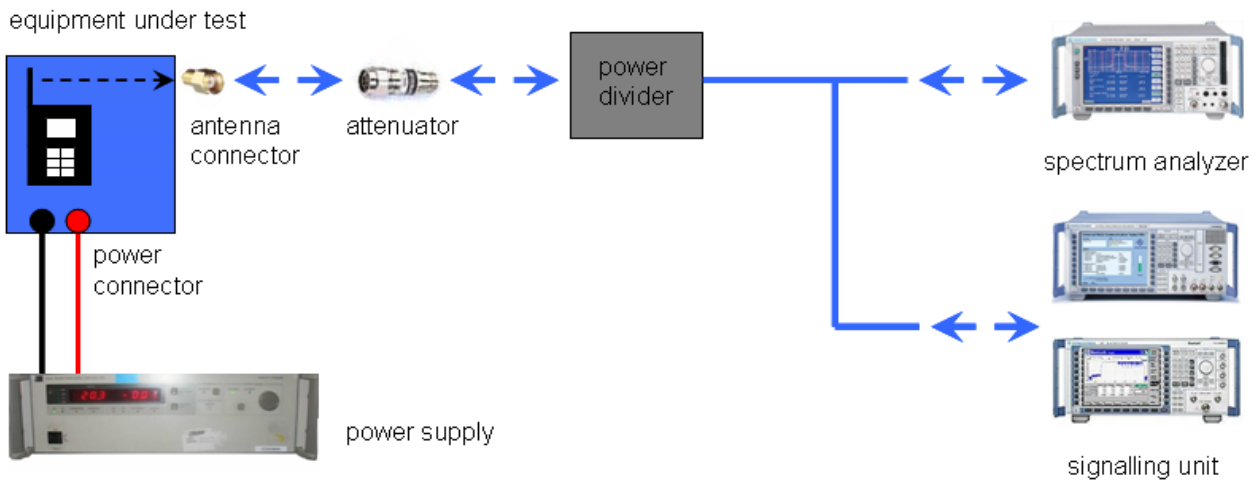

Picture 2: Diagram conducted measurements

8.2 Additional comments

Reference documents: None

Special test descriptions: We perform the radiated pre-scans in different spherical positions and consolidate the results in one result plot. The test procedure includes scans in the theta axes every 120° and in phi axes @ 0° and 90° for both polarizations vertical & horizontal or magnetic emissions.

Configuration descriptions: None

8.3 RSP100 test report cover sheet / performance test data

Test Report Number	:	1-5178/12-01-05-C
Equipment Model Number	:	AR7 N, PC7 N, AR9 N, PC9 N
Certification Number	:	7031A-F2BTE01
Manufacturer (complete Address)	:	Bernafon AG Morgenstraße 131 3018 Bern / SWITZERLAND
Tested to radio standards specification no.	:	RSS 210, Issue 8, Annex 2
Open Area Test Site IC No.	:	IC 3462C-1
Frequency Range or fixed frequency	:	3.84 MHz
Field Strength [dB μ V/m]	:	56 @ 1m
Occupied bandwidth (99%-BW) [kHz]	:	373.5 kHz
Type of modulation	:	A1D
Emission Designator (TRC-43)	:	374KA1D
Antenna Information	:	Integrated coil antenna
Transmitter Spurious (worst case) [dB μ V/m @ 10m]:		22.20 dB μ V/m @ 946.0 MHz

ATTESTATION:

DECLARATION OF COMPLIANCE:

I attest that the testing was performed or supervised by me; that the test measurements were made in accordance with the above-mentioned Industry Canada standard(s); and that the equipment identified in this application has been subjected to all the applicable test conditions specified in the Industry Canada standards and all of the requirements of the standard have been met.

Laboratory Manager:

2012-12-20

Andreas Luckenbill

Signature



9 Measurement results

9.1 Timing of the transmitter

Measurement:

Measurement parameter	
Detector:	Peak
Sweep time:	10 ms
Resolution bandwidth:	1 MHz
Video bandwidth:	3 MHz
Span:	Zero-Span
Sweep mode:	Single Sweep

Limits:

FCC	IC
Timing of the transmitter	
<p>(c) Unless otherwise specified, e.g. Section 15.255(b), when the radiated emission limits are expressed in terms of the average value of the emission, and pulsed operation is employed, the measurement field strength shall be determined by averaging over one complete pulse train, including blanking intervals, as long as the pulse train does not exceed 0.1 seconds. As an alternative (provided the transmitter operates for longer than 0.1 seconds) or in cases where the pulse train exceeds 0.1 seconds, the measured field strength shall be determined from the average absolute voltage during a 0.1 second interval during which the field strength is at its maximum value. The exact method of calculating the average field strength shall be submitted with any application for certification or shall be retained in the measurement data file for equipment subject to notification or verification.</p>	

Duty cycle of the sample with test mode: 40%

The device is sending for 2ms every 5ms.

Result: Passed

9.2 Bandwidth of the modulated carrier

Limits:

FCC	IC
Bandwidth of the modulated carrier	

Measured with the integrated OBW-function of the spectrum analyser Rohde & Schwarz ESPI (measurement criteria is the integrated power in %)

Result:

	Occupied Bandwidth (kHz)
6 dB (75%)	51 kHz
20 dB (99%)	373.5 kHz

Plots of the measurement

Plot 1: 6dB (75%) – bandwidth

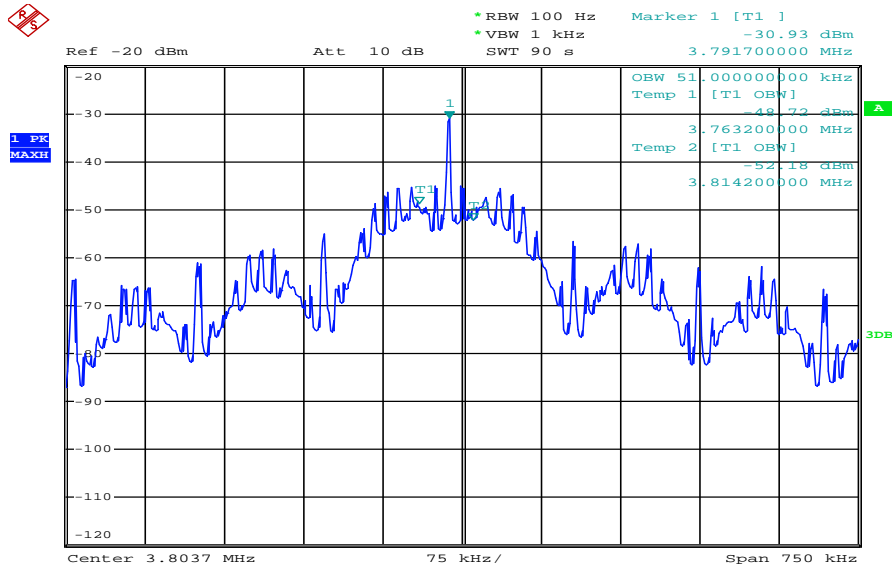

Date: 18.SEP.2012 15:08:43

Plot 2: 20dB (99%) - bandwidth

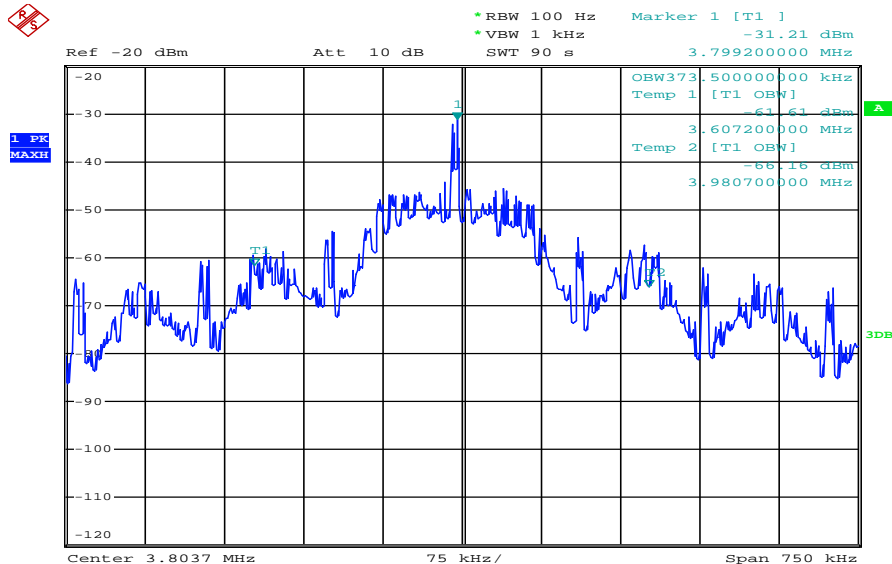

Date: 18.SEP.2012 15:03:43

9.3 Field strength of the fundamental

Measurement:

Measurement parameter	
Detector:	Quasi Peak (CISPR)
Resolution bandwidth:	10kHz
Trace-Mode:	Max Hold

Limits:

FCC		IC
Fundamental Frequency (MHz)	Field strength of Fundamental ($\mu\text{V/m}$)	Measurement distance (m)
1.705 – 10.0	[15] or [6dB-BW(kHz) / F(MHz)] Whichever is higher	30

Result:

TEST CONDITIONS		MAXIMUM POWER (dB $\mu\text{V/m}$)	
Frequency		3.8 MHz	3.8 MHz
Mode		at 1 m distance	at 30 m distance
T_{nom}	V_{nom}	56	-4
Measurement uncertainty		±3dB	

Recalculation to a measurement distance of 30m with a correction of 40 dB/decade.

Result: Passed

9.4 Field strength of the harmonics and spurious

Measurement:

Measurement parameter	
Detector:	Average / Quasi Peak
Sweep time:	Auto
Resolution bandwidth:	100 kHz / 1 MHz
Video bandwidth:	100 kHz / 1 MHz
Span:	Steps
Trace-Mode:	Max Hold

Limits:

FCC		IC	
Field strength of the harmonics and spurious.			
Frequency (MHz)	Field strength ($\mu\text{V}/\text{m}$)	Measurement distance (m)	
0.009 – 0.490	2400/F(kHz)	300	
0.490 – 1.705	24000/F(kHz)	30	
1.705 – 30	30 (29.5 dB $\mu\text{V}/\text{m}$)	30	
30 – 88	100 (40 dB $\mu\text{V}/\text{m}$)	3	
88 – 216	150 (43.5 dB $\mu\text{V}/\text{m}$)	3	
216 – 960	200 (46 dB $\mu\text{V}/\text{m}$)	3	

Result:

EMISSION LIMITATIONS				
f [MHz]	Detector	Limit max. allowed [dB $\mu\text{V}/\text{m}$]	Amplitude of emission [dB $\mu\text{V}/\text{m}$]	Results
No critical peaks detected!				

Result: Passed

Plots of the measurements

Plot 1: 9 kHz – 30 MHz

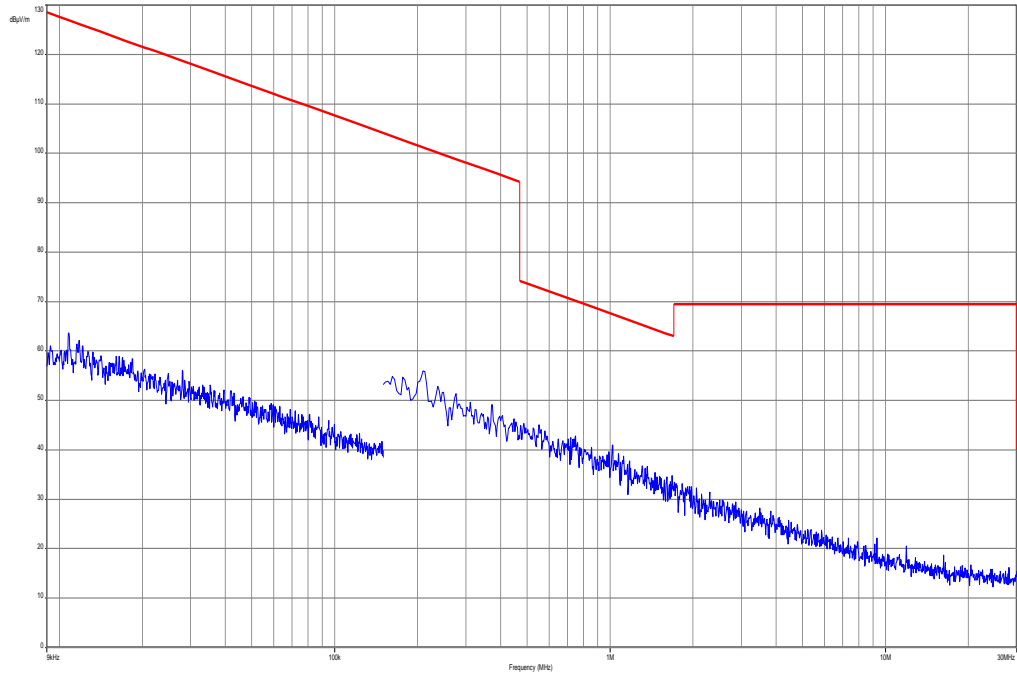

Plot 2: 30 MHz – 1000 MHz

Common Information

EUT: AR9 N
 Serial Number: 21048223
 Test Description: FCC part 15 B class B @ 10 m
 Operating Conditions: active
 Operator Name: Wolsdorfer
 Comment: bat powered

Scan Setup: STAN_Fin [EMI radiated]

Hardware Setup: Electric Field (NOS)
 Receiver: [ESCI 3]
 Level Unit: dBµV/m

Subrange	Step Size	Detectors	IF BW	Meas. Time	Preamp
30 MHz - 2 GHz	60 kHz	QPK	120 kHz	1 s	20 dB

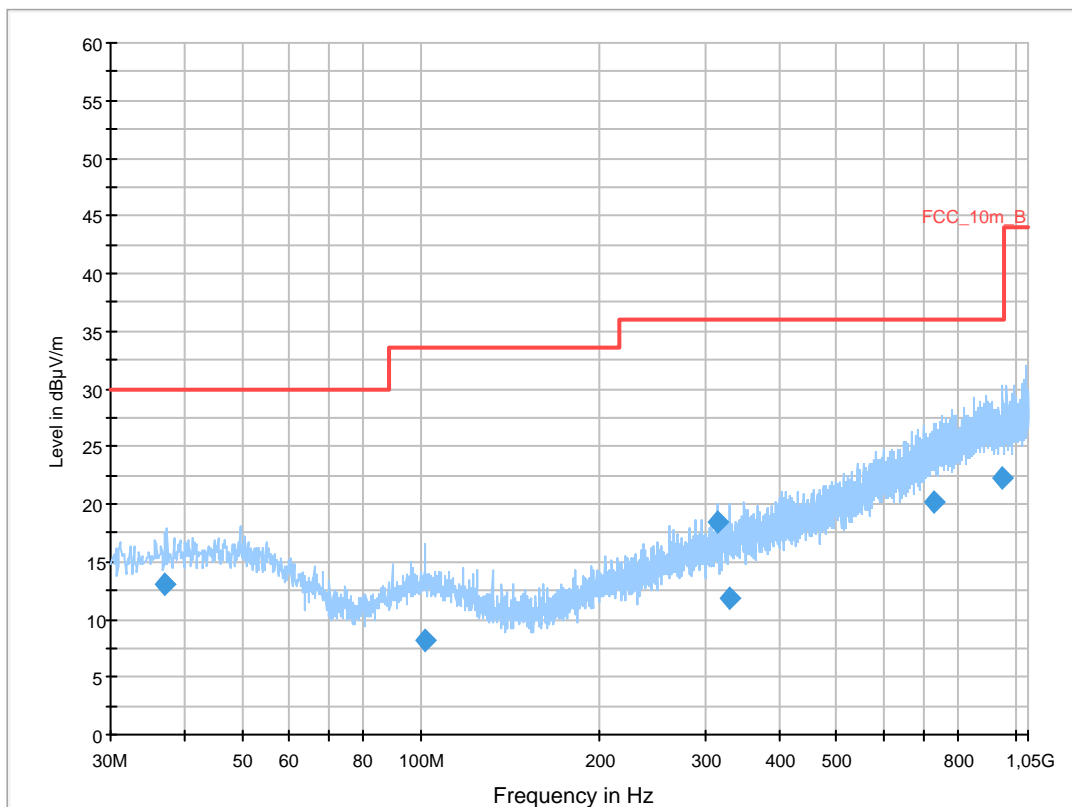

Final Result 1

Frequency (MHz)	QuasiPeak (dBµV/m)	Meas. Time (ms)	Bandwidth (kHz)	Height (cm)	Polarization	Azimuth (deg)	Corr. (dB)	Margin (dB)	Limit (dBµV/m)	Comment
36.996450	13.1	1000.0	120.000	152.0	V	190.0	13.2	16.9	30.0	
101.313150	8.2	1000.0	120.000	160.0	V	268.0	11.8	25.3	33.5	
315.017850	18.5	1000.0	120.000	98.0	V	175.0	15.0	17.5	36.0	
329.335500	11.8	1000.0	120.000	168.0	V	265.0	15.4	24.2	36.0	
727.586850	20.1	1000.0	120.000	168.0	H	-5.0	23.1	15.9	36.0	
945.965400	22.2	1000.0	120.000	168.0	V	0.0	25.3	13.8	36.0	

Hardware Setup: EMI radiated\Electric Field (NOS) - [EMI radiated]

Subrange 1

Frequency Range: 30 MHz - 2 GHz

Receiver: Receiver [ESCI 3]
@ GPIB0 (ADR 20), SN 100083/003, FW 4.42

Signal Path: without Notch
FW 1.0

Antenna: VULB 9163
SN 9163-295, FW ---
Correction Table (vertical): VULP6113
Correction Table (horizontal): VULP6113
Correction Table (vertical): Cable_EN_1GHz (1005)
Correction Table (horizontal): Cable_EN_1GHz (1005)

Antenna Tower: Tower [EMCO 2090 Antenna Tower]
@ GPIB0 (ADR 8), FW REV 3.12

Turntable: Turntable [EMCO Turntable]
@ GPIB0 (ADR 9), FW REV 3.12

EMC 32 Version 8.52

9.5 Receiver spurious emissions

Measurement:

Measurement parameter	
Detector:	Average / Quasi Peak
Sweep time:	Auto
Resolution bandwidth:	100 kHz / 1 MHz
Video bandwidth:	100 kHz / 1 MHz
Span:	Steps
Trace-Mode:	Max Hold

Limits:

FCC		IC
Field strength of the harmonics and spurious.		
Frequency (MHz)	Field strength ($\mu\text{V/m}$)	Measurement distance (m)
0.009 – 0.490	2400/F(kHz)	300
0.490 – 1.705	24000/F(kHz)	30
1.705 – 30	30 (29.5 dB $\mu\text{V/m}$)	30
30 – 88	100 (40 dB $\mu\text{V/m}$)	3
88 – 216	150 (43.5 dB $\mu\text{V/m}$)	3
216 – 960	200 (46 dB $\mu\text{V/m}$)	3

Result:

EMISSION LIMITATIONS				
f [MHz]	Detector	Limit max. allowed [dB $\mu\text{V/m}$]	Amplitude of emission [dB $\mu\text{V/m}$]	Results
No critical peaks detected!				

Result: Passed

Plots of the measurements

Plot 1: 9 kHz – 30 MHz

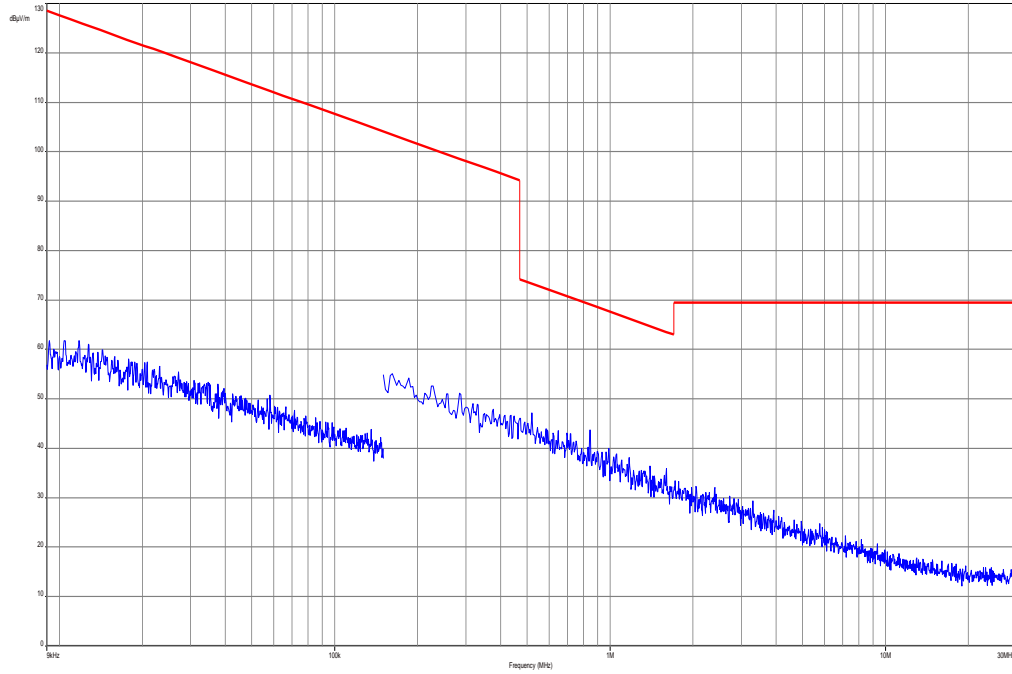

Plot 2: 30 MHz – 1000 MHz

Common Information

EUT: AR9 N
 Serial Number: 20615355
 Test Description: FCC part 15 B class B @ 10 m
 Operating Conditions: rx mode
 Operator Name: Wolsdorfer
 Comment: bat powered

Scan Setup: STAN_Fin [EMI radiated]

Hardware Setup: Electric Field (NOS)
 Receiver: [ESCI 3]
 Level Unit: dBµV/m

Subrange	Step Size	Detectors	IF BW	Meas. Time	Preamp
30 MHz - 2 GHz	60 kHz	QPK	120 kHz	1 s	20 dB

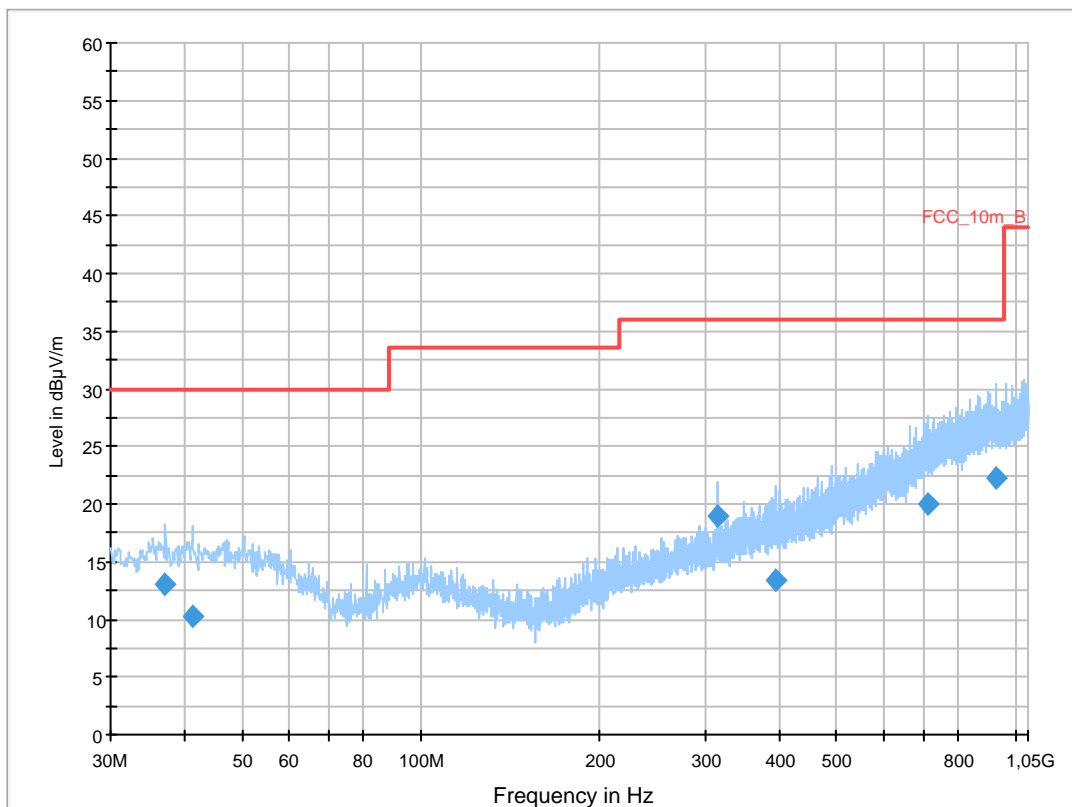

Final Result 1

Frequency (MHz)	QuasiPeak (dB μ V/m)	Meas. Time (ms)	Bandwidth (kHz)	Height (cm)	Polarization	Azimuth (deg)	Corr. (dB)	Margin (dB)	Limit (dB μ V/m)	Comment
37.061250	13.1	1000.0	120.000	170.0	V	190.0	13.2	16.9	30.0	
41.108700	10.2	1000.0	120.000	120.0	H	280.0	13.4	19.8	30.0	
314.999250	18.9	1000.0	120.000	119.0	V	260.0	15.0	17.1	36.0	
394.928700	13.3	1000.0	120.000	170.0	H	85.0	16.8	22.7	36.0	
711.724650	20.0	1000.0	120.000	132.0	V	100.0	22.8	16.0	36.0	
924.943350	22.3	1000.0	120.000	170.0	V	92.0	25.3	13.7	36.0	

Hardware Setup: EMI radiated\Electric Field (NOS) - [EMI radiated]

Subrange 1

Frequency Range: 30 MHz - 2 GHz

Receiver: Receiver [ESCI 3]
@ GPIB0 (ADR 20), SN 100083/003, FW 4.42

Signal Path: without Notch
FW 1.0

Antenna: VULB 9163
SN 9163-295, FW ---
Correction Table (vertical): VULP6113
Correction Table (horizontal): VULP6113
Correction Table (vertical): Cable_EN_1GHz (1005)
Correction Table (horizontal): Cable_EN_1GHz (1005)

Antenna Tower: Tower [EMCO 2090 Antenna Tower]
@ GPIB0 (ADR 8), FW REV 3.12

Turntable: Turntable [EMCO Turntable]
@ GPIB0 (ADR 9), FW REV 3.12

EMC 32 Version 8.52

9.6 Conducted limits

Not applicable

10 Test equipment and ancillaries used for tests

Typically, the calibrations of the test apparatus are commissioned to and performed by an accredited calibration laboratory. The calibration intervals are determined in accordance with the DIN EN ISO/IEC 17025. In addition to the external calibrations, the laboratory executes comparison measurements with other calibrated test systems or effective verifications. Weekly chamber inspections and range calibrations are performed. Where possible, rf-generating and signalling equipment as well as measuring receivers and analyzers are connected to an external high-precision 10 MHz reference (GPS-based or rubidium frequency standard).

In order to simplify the identification of the equipment used at some special tests, some items of test equipment and ancillaries can be provided with an identifier or number in the equipment list below (Labor/Item).

No.	Lab / Item	Equipment	Type	Manufact.	Serial No.	INV. No Cetecom	Kind of Calibration	Last Calibration	Next Calibration
1	n. a.	Test Receiver	ESH2	R&S	871921/095	300002505	Ve	12.01.2012	12.01.2014
2	n. a.	Loop Antenna 9 KHz - 30 MHz	HFH2-Z2	R&S	872096/61	300001824	vKI!	09.03.2012	09.03.2015
3	n. a.	EMI Test Receiver 9 kHz - 3 GHz incl. Preselector	ESPI3	R&S	101713	300004059	k	22.08.2012	22.08.2013
4	n. a.	DC Power Supply 0 – 32V	1108-32	Heiden	001802	300001383	Ve	23.06.2010	23.06.2013
5	n. a.	Temperature Test Chamber	VT 4002	Heraeus Voetsch	521/83761	300002326	Ve	20.09.2011	20.09.2013
6	n. a.	Double-Ridged Waveguide Horn Antenna 1-18.0GHz	3115	EMCO	8812-3088	300001032	vKI!	11.05.2011	11.05.2013
7	n. a.	Active Loop Antenna	6502	EMCO	2210	300001015	ne		
8	n. a.	Anechoic chamber	FAC 3/5m	MWB / TDK	87400/02	300000996	ev		
9	n. a.	Relais Matrix	3488A	HP Meßtechnik	2719A15013	300001156	ne		
10	n. a.	Three-Way Power Splitter, 50 Ohm	11850C	HP Meßtechnik		300000997	ne		
11	n. a.	Switch / Control Unit	3488A	HP	2605e08770	300001443	ne		
12	n. a.	Amplifier	js42-00502650-28-5a	Parzich GMBH	928979	300003143	ne		
13	n. a.	TRILOG Broadband Test-Antenna 30 MHz - 3 GHz	VULB9163	Schwarzbeck	371	300003854	vKI!	14.10.2011	14.10.2014
14	n. a.	MXE EMI Receiver 20 Hz bis 26,5 GHz	N9038A	Agilent Technologies	MY51210197	300004405	k	19.12.2011	19.12.2012
15	45	Switch-Unit	3488A	HP Meßtechnik	2719A14505	300000368	g		
16	50	DC power supply, 60Vdc, 50A, 1200 W	6032A	HP Meßtechnik	2920A04466	300000580	ne		
17	n. a.	software	SPS_PHE 1.4f	Spitzberger & Spieß	B5981; 5D1081; B5979	300000210	ne		
18	n. a.	EMI Test Receiver	ESCI 1166.5950.03	R&S	100083	300003312	k	04.01.2012	04.01.2013
19	n. a.	Analyzer-Reference-System (Harmonics and Flicker)	ARS 16/1	SPS	A3509 07/0 0205	300003314	k	14.07.2011	14.07.2013
20	n. a.	Amplifier	JS42-00502650-28-5A	MITEQ	1084532	300003379	ev		
21	n. a.	Antenna Tower	Model 2175	ETS-LINDGREN	64762	300003745	izw		
22	n. a.	Positioning Controller	Model 2090	ETS-LINDGREN	64672	300003746	izw		
23	n. a.	Turntable Interface-Box	Model 105637	ETS-LINDGREN	44583	300003747	izw		

24	n. a.	TRIOLOG Broadband Test-Antenna 30 MHz - 3 GHz	VULB9163	Schwarzbe ck	295	300003787	k	12.04.2012	12.04.2014
25	n. a.	Spectrum- Analyzer	FSU26	R&S	200809	300003874	k	06.01.2012	06.01.2014

Agenda: Kind of Calibration

k	calibration / calibrated	EK	limited calibration
ne	not required (k, ev, izw, zw not required)	zw	cyclical maintenance (external cyclical maintenance)
ev	periodic self verification	izw	internal cyclical maintenance
Ve	long-term stability recognized	g	blocked for accredited testing
vlk!	Attention: extended calibration interval	*	next calibration ordered / currently in progress
NK!	Attention: not calibrated		

11 Observations

No observations exceeding those reported with the single test cases have been made.

Annex A Photographs of the test setup

Photo documentation:

Photo 1:

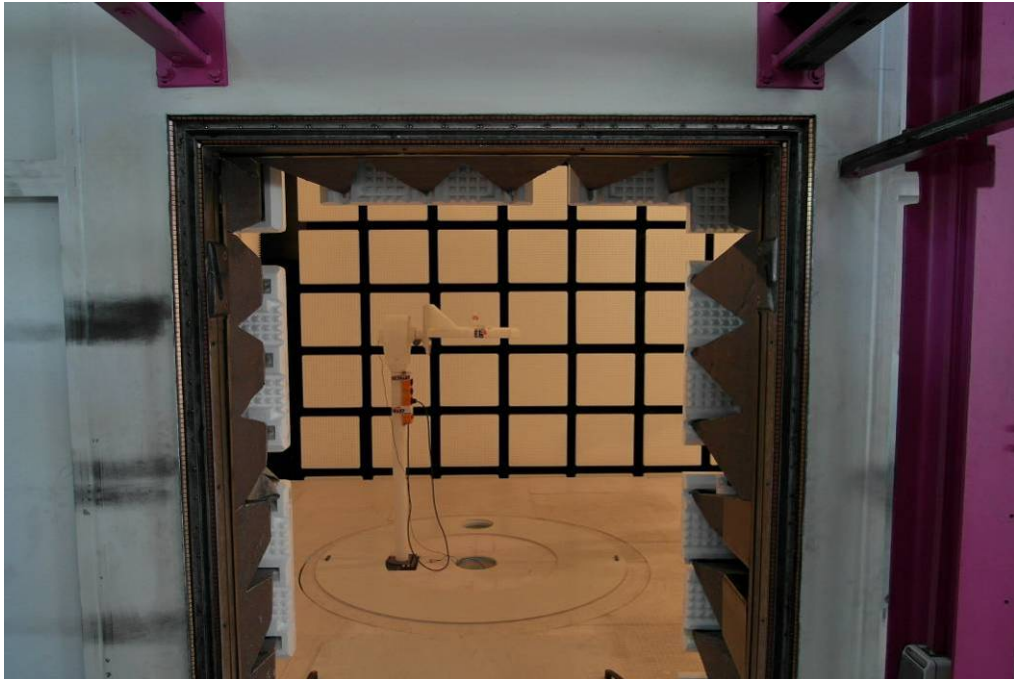

Photo 2:



Photo 3:

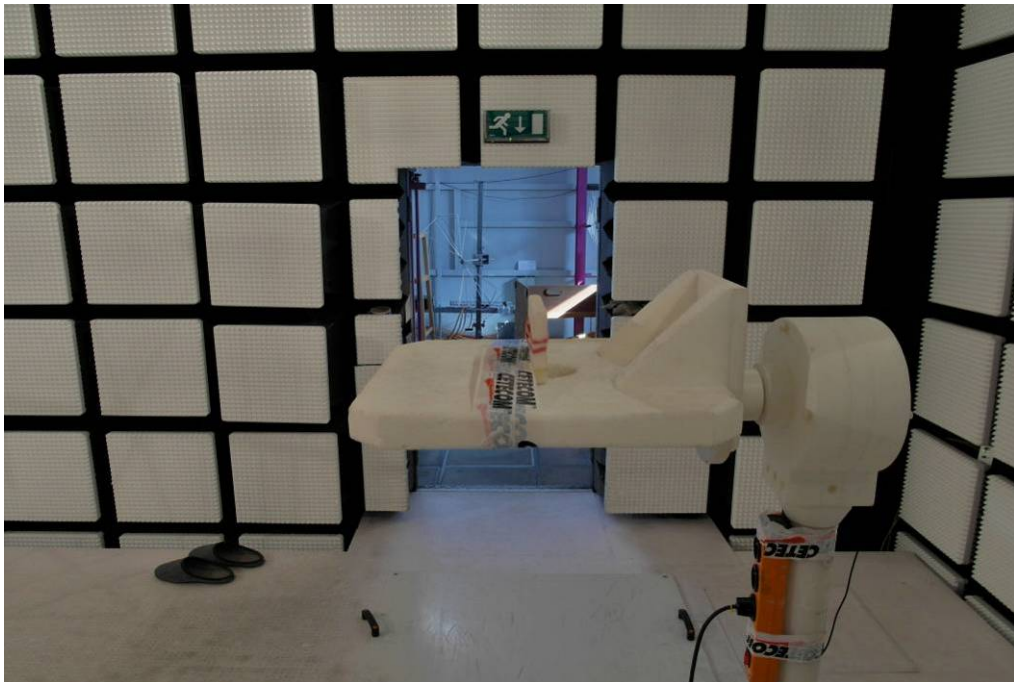

Photo 4:



Photo 5:



Photo 6:

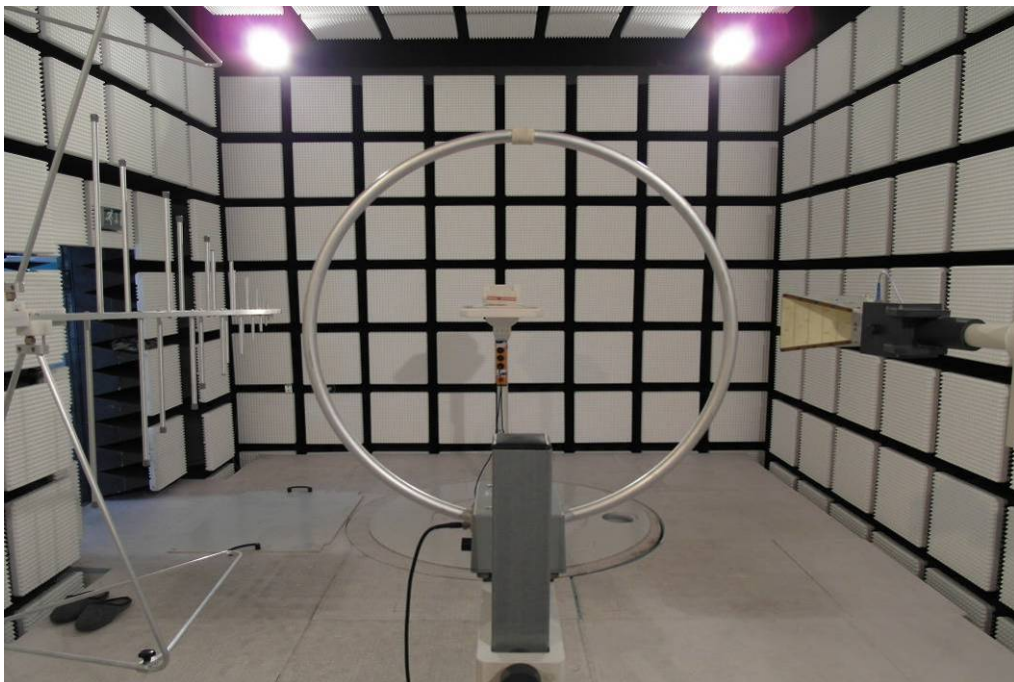

Annex B External photographs of the EUT

Photo documentation:

Photo 1:



Photo 2:



Photo 3:



Photo 4:



Photo 5:



Photo 6:



Photo 7:

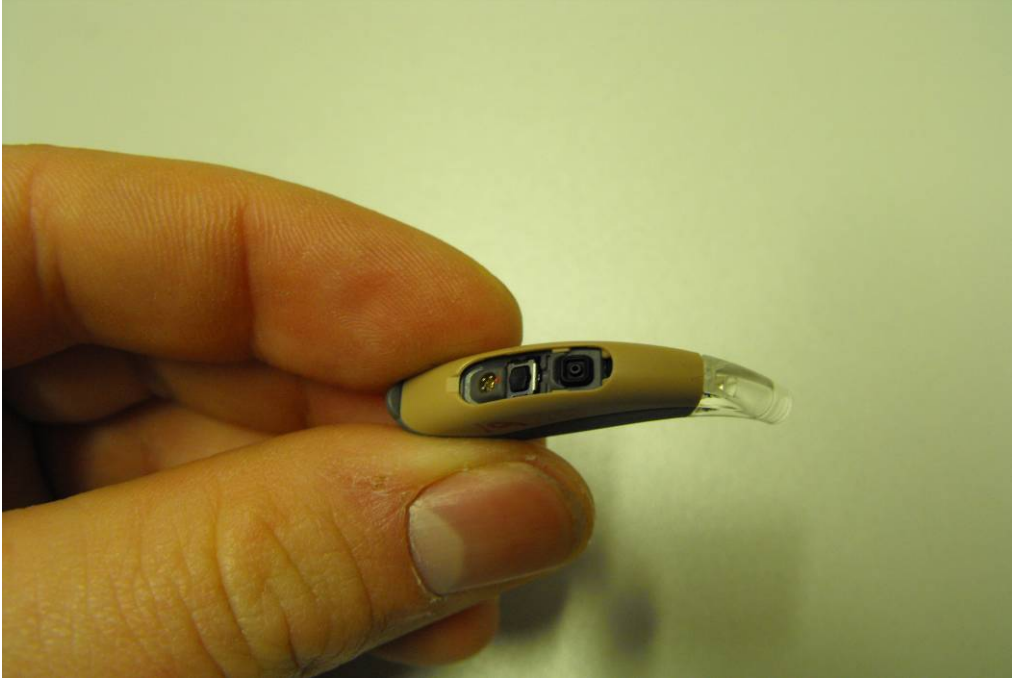
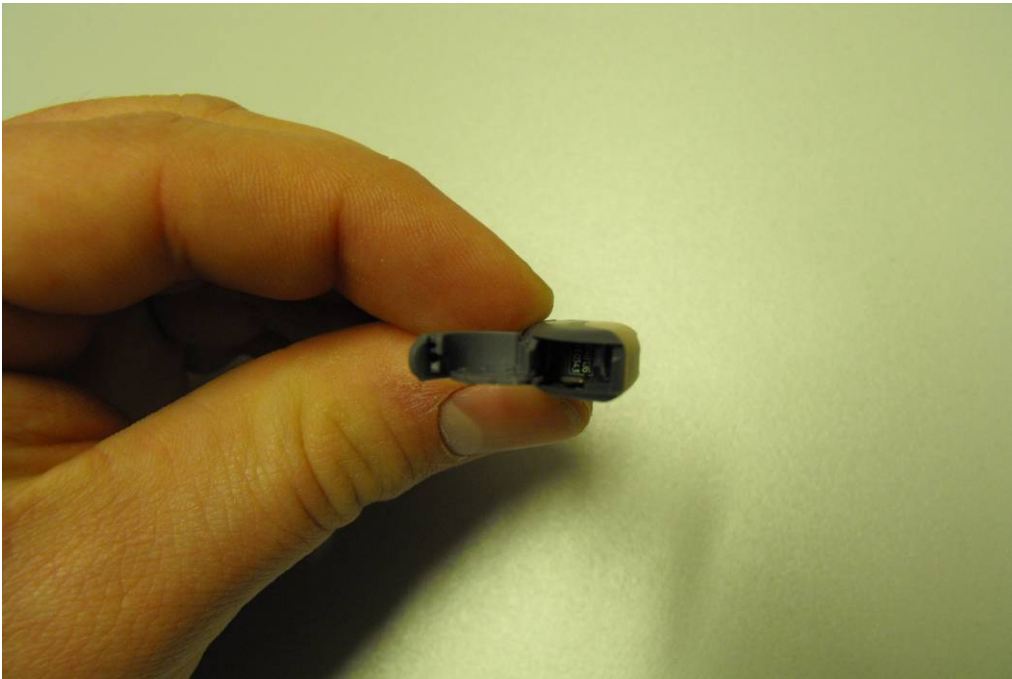

Photo 8:



Annex C Internal photographs of the EUT

Photo documentation:

Photo 1:



Photo 2:

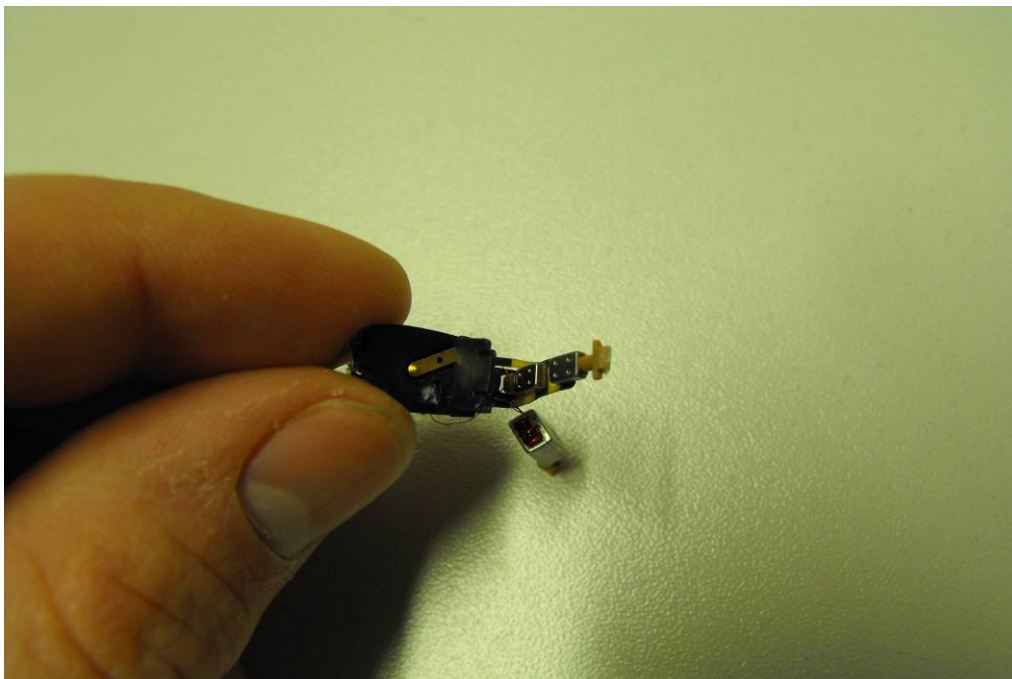

Photo 3:



Photo 4:

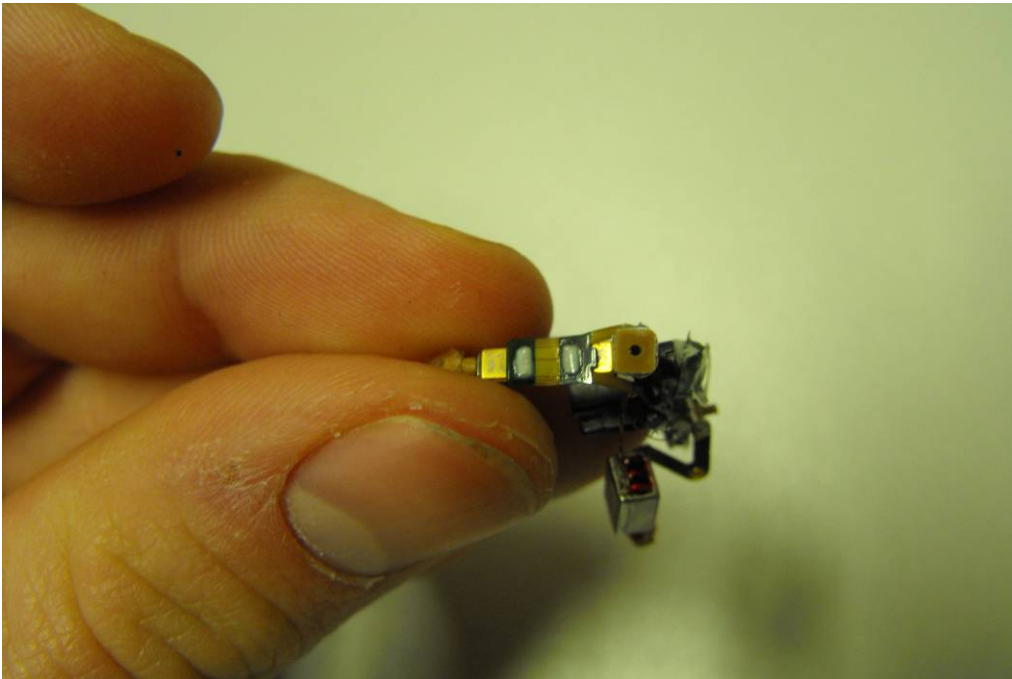
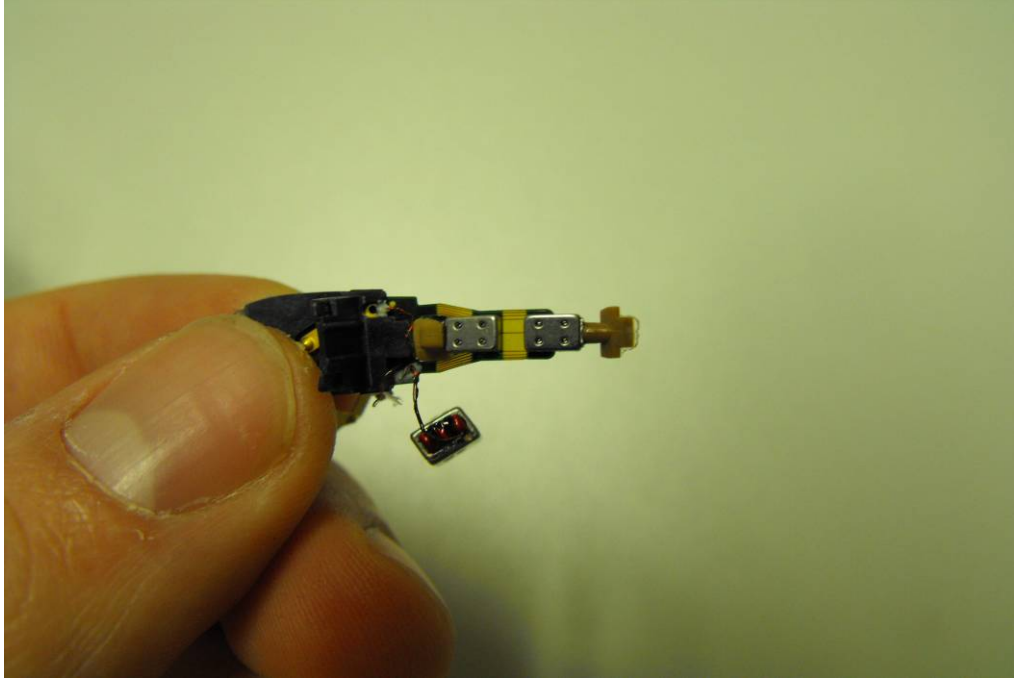

Photo 5:



Annex D Document history

Version	Applied changes	Date of release
1.0	Initial release	2012-09-24
-A	changed model name	2012-10-09
-B	changed model name, add internal & external photos	2012-12-14
-C	Correction of cover sheet	2012-12-19

Annex E Further information

Glossary

AVG	-	Average
DUT	-	Device under test
EMC	-	Electromagnetic Compatibility
EN	-	European Standard
EUT	-	Equipment under test
ETSI	-	European Telecommunications Standard Institute
FCC	-	Federal Communication Commission
FCC ID	-	Company Identifier at FCC
HW	-	Hardware
IC	-	Industry Canada
Inv. No.	-	Inventory number
N/A	-	Not applicable
PP	-	Positive peak
QP	-	Quasi peak
S/N	-	Serial number
SW	-	Software

Annex F Accreditation Certificate



Front side of certificate



Back side of certificate

Note:

The current certificate including annex is published on our website (see link below) or may be received from CETECOM ICT Services on request.

http://www.cetecom.com/fileadmin/de/CETECOM_D_Saarbruecken/accreditations_Jan_2010/DAKKS_Akkredi_Urk_EN17025-En_incl_Annex.pdf