

MEASUREMENT REPORT

(FCC : Part 15 Subpart C (15.247) / ANSI C63.4-2003)



Testing Laboratory
1288

Product.....: IEEE802.11g MIMO Mini PCI Adapter
Trade Name.....: E-TOP(The other see Appendix II)
Model No.....: WM101m (The other see Appendix II)
Applicant.....: E-Top Network Technology Inc.
Applicant Address.....: No.82, Gongye 2nd Rd., Tainan City
70955, Taiwan, R.O.C.

Report Number	MLT0702P15002-02
Applicant	E-Top Network Technology Inc.
Product	IEEE802.11g MIMO Mini PCI Adapter
Sample Received Date	2007/02/08

Report Prepared By	Jesse Tien
Signature	
Date Prepared	2007/02/09 ~ 2007/03/24

Report Authorized By	Roger Chen
Signature	
Date Authorized	2007/03/29

Test By

Max Light Technology Co., Ltd.
 Room 5, 8F, No.125, Section 3 Roosevelt Road,
 Taipei, Taiwan., R.O.C.
 Office : Tel: 886-2-2363-2447 Fax: 886-2-2363-2597
 Lab. : Tel: 886-2-2663-3486 Fax: 886-2-2663-3582

It may be duplicated completely for legal use with the allowance of the applicant.
 It shall not be reproduced except in full, without the written approval of our
 laboratory.

Table of Contents :

I. General	5.
II. Radiated Emissions Requirements	9.
III. Maximum Conducted Output Power Requirements	24.
IV. Minimum 6dB RF Bandwidth Requirements	29.
V. Maximum Power Density Requirements	34.
VI. Out of Band Conducted Emissions Requirements	37.
VII. Band Edges Requirements	55.
VIII. Antenna Requirements	58.
Appendix I (EUT Test Setup)	59.
Appendix II (Brand / Trade Name & Model No. Multiple Listee)	61

CERTIFICATION

We here by verify that :

The test data, data evaluation, test procedures and equipment configurations shown in this report were made in accordance with the procedures given in ANSI C63.4-2003. All test were conducted by

MLT(Max Light Technology Co.,Ltd) Room 5, 8F, No.125, Section 3 Roosevelt Road, Taipei, Taiwan, R.O.C Also, we attest to the accuracy of each.

We further submit that the energy emitted by the sample EUT tested as described in the report is in compliance with Class B radiated and conducted emission limit of FCC Rules Part 15 Subpart C (15.247).

Applicant Name	E-Top Network Technology Inc.
Applicant Address	No.82, Gongye 2nd Rd., Tainan City 70955, Taiwan, R.O.C.
Manufacturer Name	E-Top Network Technology Inc.
Manufacturer Address	No.82, Gongye 2nd Rd., Tainan City 70955, Taiwan, R.O.C.

Equipment	IEEE802.11g MIMO Mini PCI Adapter
Model No	WM101m (The other see Appendix II)
FCC ID	U6AWM101M

Report Prepared By	Jesse Tien
Signature	

Report Authorized By	Roger Chen
Signature	

I. GENERAL

1.1 Introduction

The following measurement report is submitted on behalf of E-Top Network Technology Inc. In support of a Class B Digital Device certification in accordance with Part2 Subpart J and Part 15 Subpart C of the Commission's and Regulations.

1.2 Customer Details

Applicant Name	E-Top Network Technology Inc.
Applicant Address	No.82, Gongye 2nd Rd., Tainan City 70955, Taiwan, R.O.C.
Manufacturer Name	E-Top Network Technology Inc.
Manufacturer Address	No.82, Gongye 2nd Rd., Tainan City 70955, Taiwan, R.O.C.

1.3 Technical data of EUT

Equipment	IEEE802.11g MIMO Mini PCI Adapter
Model No	WM101m (The other see Appendix II)
FCC ID	U6AWM101M
Power Type	Powered by PC(Desktop)
Type of Modulation	802.11b: CCK,DSSS 802.11g: OFDM
Type of Antenna	1/4λ Dipole Sleeve
Frequency of Channel	See Next page

During testing the EUT was operated at Tx or Rx mode for each emission measured. This was done in order to ensure that maximum emission levels were attained.

802.11b & 802.11g Frequency of Each Channel (Working Frequency)

Channel No.	Frequency (MHz)
01	2412
02	2417
03	2422
04	2427
05	2432
06	2437
07	2442
08	2447
09	2452
10	2457
11	2462

1.4 Summary Of Tests

47 CFR Part 15 Subpart C			
Reference	Test	Results	Note
15.107	AC Power Conducted Emission	PASS	
15.247(c)	Transmitter Radiated Emissions	PASS	
15.247(b)	Max. Output Power	PASS	
15.247(a)(2)	6dB RF Bandwidth	PASS	
15.247(d)	Max. Power Density	PASS	
15.247(c)	Out of Band Conducted Spurious Emission	PASS	
15.247(c)	Band Edge Measurement	PASS	
15.203	Antenna Requirement	PASS	

1.5 Description of Support Equipment

In order to construct the minimum system which required by the ANSI C63.4-2003, following equipments were used as the support units.

Component	Manufacturer	Model No.	Serial No.	FCC ID
Monitor	EIZO	FlexScan L375	20809091	FCC DOC
Computer	Dell	DMC	CD6Y91S	FCC DOC
Keyboard	Dell	SK8110	MY-05N456-38843-2CV-0642	FCC DOC
Mouse	Dell	SAW34	LZE24773928	DZL211029
Printer	PANASONIC	KX-P10801	70KAKE93933	FCC DOC
Modem	ASKEY	WS1414SV	V1414VQE	FCC DOC

1.6 Configuration of System Under Test

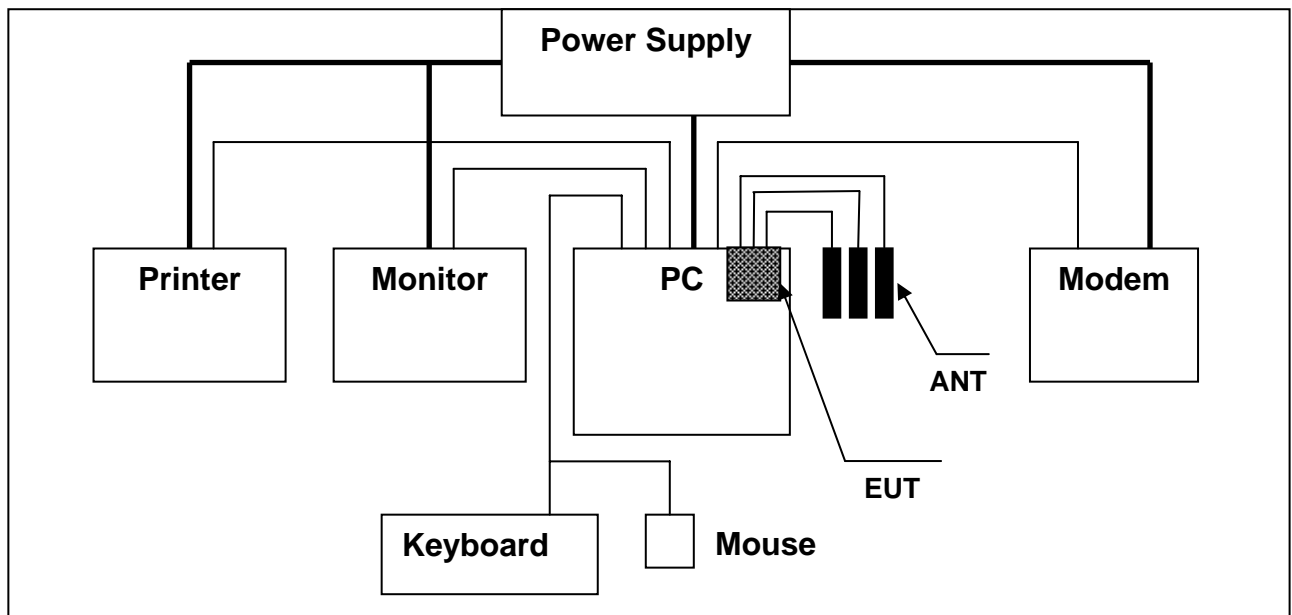

1.7 Test Procedure

All measurements contained in this report were performed according to the techniques described in Measurement procedure ANSI C63.4-2003 "Measurement of un-Intentional Radiators."

1.8 General Test Condition

The conditions under which the EUT operates were varied to determine their effect on the equipment's emission characteristics. The final configuration of the test system and the mode of operation used during these tests were chosen as that which produced the highest emission levels. However, only those conditions which the EUT was considered likely to encounter in normal use were investigated. The system's radiated and conducted emissions were investigated while the computer alternately transferred data to the EUT as well as to the monitor and printer. Using a test program which sent a continuous data and transferred data to and from the EUT was proven to worst case emissions. The system's physical layout and cabling was randomly arranged to ensure that maximum emission levels were attained.

II. Radiated Emissions Requirements

2.1 General Configuration:

Prior to open-field testing, the EUT was placed in a shielded enclosure and scanned at a close distance to determine its emission characteristics. The physical arrangement of the EUT was varied (within the scope of arrangements likely to be encountered in actual use) to determine the effect on the unit's emanations in amplitude, directivity, and frequency. The exact system configuration which produced the highest emissions was noted so it could be reproduced later during the open-field tests. This was done to ensure that the final measurements would demonstrate the worst-case interference potential of the EUT.

Final radiation measurements were made on a three-meter, open-field test site. The EUT system was placed on a nonconductive turntable which was 0.8 meters height, top surface 1.0 x 1.5 meter. During the test, EUT was set to transmit continuously & measurements spectrum range from 30 MHz to 26.5 GHz is investigated.

For measurements above 1 GHz the resolution bandwidth is set to 1 MHz, then the video bandwidth is set to 1 MHz for peak measurements and 10 Hz for average measurements.

A nonconductive material surrounded the EUT to supporting the EUT for standing on three orthogonal planes. At each condition, the EUT was rotated 360 degrees, and the antenna was raised and lowered from one to four meters to find the maximum emission levels. Measurements were taken using both horizontal and vertical antenna polarization.

For testing above 1GHz, the emission level of the EUT in peak mode was 20dB lower than average limit (that means the emission level in peak mode also complies with the limit in average mode), then testing will be stopped and peak values of EUT will be reported, otherwise, the emissions will be measured in average mode again and reported.

Appropriate preamplifiers were used for improving sensitivity and precautions were taken to avoid overloading or desensitizing the spectrum analyzer. No post – detector video filters were used in the test.

The spectrum analyzer's 6 dB bandwidth was set to 1 MHz, and the analyzer was operated in the peak detection mode, for frequencies both below and up 1 GHz. The average levels were obtained by subtracting the duty cycle correction factor from the peak readings.

The following procedures were used to convert the emission levels measured in decibels referenced to 1 microvolt (dBuV) into field intensity in microvolts per meter(uV/m). The actual field intensity in decibels referenced to 1 microvolt in to field intensity in microvolts per meter (dBuV/m).

The actual field intensity in referenced to 1 microvolt per meter (dBuV/m) is determined by algebraically adding the measured reading in dBuV, the antenna factor (dB), and cable loss (dB) and Subtracting the gain of preamplifier (dB) is auto calculate in spectrum analyzer.

$$\text{Amplitude (dBuV/m)} = \text{FI(dBuV)} + \text{AF(dBuV)} + \text{CL(dBuV)} - \text{Gain(dB)}$$

FI= Reading of the field intensity.

AF= Antenna factor.

CL= Cable loss.

P.S Amplitude is auto calculate in spectrum analyzer.

The FCC specified emission limits were calculated according the EUT operating frequency and by following linear interpolation equations:

(1) For fundamental frequency : Transmitter Output < +30dBm

(2) For spurious frequency : Spurious emission limits = fundamental emission limit /10

2.2 Test Equipment List:

Item	Mfr/Brand	Instruments	Serial No.	Model/Type No.	Calibrated Date	Next Cali. Date
1.	Agilent	Spectrum Analyzer	US39240419	E4407B	2007/02/01	2008/02/01
2.	HP	Pre Amplifier	3008A01463	8449B	2007/02/12	2008/02/12
3.	Agilent	Spectrum Analyzer	US44300422	E4446A	2006/04/19	2007/04/19
4.	SCHWARZBECK	Horn Antenna	181	BBHA 9170	2006/07/06	2007/07/06
5.	SCHWARZBECK	Horn Antenna	304	BBHA 9120 D	2006/07/06	2007/07/06

2.3 Test condition:

EUT tested in accordance with the specifications given by the manufacturer , and exercised in the most unfavorable manner.

2.4 Radiated Emissions Limits:

Frequency range (MHz)	Peak(dBuV/m)
30 to 88	40
88 to 216	43.5
216 to 960	46
Above 960	54

2.5 Measurement Data Of Radiated Emissions:

2.5.1 Open Field Radiated Emissions (Subpart C)

The highest peak values of radiated emissions from the EUT at various antenna heights, antenna polarization, EUT orientation , etc. are recorded on the following

Test Mode : 802.11b (CH01)

Radiated Emissions (HORIZONTAL)							
Frequency (MHz)	Amplitude (dBuV/m)	Ant. (m)	Table (Degree)	Duty (dB)	Limit (dBuV/m)	Margin (dB)	
1400.0	35.43	PK	1	240	0	74.00	-38.57
4819.5	41.89	AV	1	270	0	54.00	-12.11
6414.5	43.84	PK	1	210	0	74.00	-30.16

Notes : 1.Margin= Amplitude - Limits

2.Distance of Measurement : 3 Meter (1G-26.5GHz)

3.Height of table for EUT placed: 0.8 Meter.

4.ANT= Antenna height.

5.Duty= Duty cycle correction factor.

6.Amplitude= Reading Amplitude – Amplifier gain + Cable loss + Antenna factor
(Auto calculate in spectrum analyzer)

7.The other emission levels were very low against the limit.

2.5.2 Open Field Radiated Emissions (Subpart C)

The highest peak values of radiated emissions from the EUT at various antenna heights, antenna polarization, EUT orientation , etc. are recorded on the following

Test Mode : 802.11b (CH01)

Radiated Emissions (VERTICAL)							
Frequency (MHz)	Amplitude (dBuV/m)	Ant. (m)	Table (Degree)	Duty (dB)	Limit (dBuV/m)	Margin (dB)	
1065.0	41.39	PK	1	170	0	74.00	-32.61
3215.0	48.21	AV	1	210	0	54.00	-5.79
4819.5	49.66	AV	1	300	0	54.00	-4.34
6414.5	47.58	PK	1	200	0	74.00	-26.42

- Notes :**
- 1.Margin= Amplitude - Limits
 - 2.Distance of Measurement : 3 Meter (1G-26.5GHz)
 - 3.Height of table for EUT placed: 0.8 Meter.
 - 4.ANT= Antenna height.
 - 5.Duty= Duty cycle correction factor.
 - 6.Amplitude= Reading Amplitude – Amplifier gain + Cable loss + Antenna factor (Auto calculate in spectrum analyzer)
 - 7.The other emission levels were very low against the limit.

2.5.3 Open Field Radiated Emissions (Subpart C)

The highest peak values of radiated emissions from the EUT at various antenna heights, antenna polarization, EUT orientation , etc. are recorded on the following

Test Mode : 802.11b (CH06)

Radiated Emissions (HORIZONTAL)							
Frequency (MHz)	Amplitude (dBuV/m)		Ant. (m)	Table (Degree)	Duty (dB)	Limit (dBuV/m)	Margin (dB)
1450.0	35.48	PK	1	240	0	74.00	-38.52
1732.5	35.01	PK	1	110	0	74.00	-38.99
4877.5	52.42	PK	1	320	0	74.00	-21.58
6487.0	42.37	PK	1	260	0	74.00	-31.63

- Notes :**
- 1.Margin= Amplitude - Limits
 - 2.Distance of Measurement : 3 Meter (1G-26.5GHz)
 - 3.Height of table for EUT placed: 0.8 Meter.
 - 4.ANT= Antenna height.
 - 5.Duty= Duty cycle correction factor.
 - 6.Amplitude= Reading Amplitude – Amplifier gain + Cable loss + Antenna factor (Auto calculate in spectrum analyzer)
 - 7.The other emission levels were very low against the limit.

2.5.4 Open Field Radiated Emissions (Subpart C)

The highest peak values of radiated emissions from the EUT at various antenna heights, antenna polarization, EUT orientation , etc. are recorded on the following

Test Mode : 802.11b (CH06)

Radiated Emissions (VERTICAL)							
Frequency (MHz)	Amplitude (dBuV/m)	Ant. (m)	Table (Degree)	Duty (dB)	Limit (dBuV/m)	Margin (dB)	
1065.0	41.27	PK	1	250	0	74.00	-32.73
3250.0	53.18	PK	1	200	0	74.00	-20.82
4877.5	44.12	AV	1	310	0	54.00	-9.88
6487.0	45.50	PK	1	180	0	74.00	-28.50

- Notes :**
- 1.Margin= Amplitude - Limits
 - 2.Distance of Measurement : 3 Meter (1G-26.5GHz)
 - 3.Height of table for EUT placed: 0.8 Meter.
 - 4.ANT= Antenna height.
 - 5.Duty= Duty cycle correction factor.
 - 6.Amplitude= Reading Amplitude – Amplifier gain + Cable loss + Antenna factor (Auto calculate in spectrum analyzer)
 - 7.The other emission levels were very low against the limit.

2.5.5 Open Field Radiated Emissions (Subpart C)

The highest peak values of radiated emissions from the EUT at various antenna heights, antenna polarization, EUT orientation , etc. are recorded on the following

Test Mode : 802.11b (CH11)

Radiated Emissions (HORIZONTAL)							
Frequency (MHz)	Amplitude (dBuV/m)	Ant. (m)	Table (Degree)	Duty (dB)	Limit (dBuV/m)	Margin (dB)	
1445.0	35.56	PK	1	270	0	74.00	-38.44
2537.5	45.62	PK	1	180	0	74.00	-28.38
4921.0	48.26	PK	1	140	0	74.00	-25.74
6559.5	41.26	PK	1	200	0	74.00	-32.74

- Notes :**
- 1.Margin= Amplitude - Limits
 - 2.Distance of Measurement : 3 Meter (1G-26.5GHz)
 - 3.Height of table for EUT placed: 0.8 Meter.
 - 4.ANT= Antenna height.
 - 5.Duty= Duty cycle correction factor.
 - 6.Amplitude= Reading Amplitude – Amplifier gain + Cable loss + Antenna factor (Auto calculate in spectrum analyzer)
 - 7.The other emission levels were very low against the limit.

2.5.6 Open Field Radiated Emissions (Subpart C)

The highest peak values of radiated emissions from the EUT at various antenna heights, antenna polarization, EUT orientation , etc. are recorded on the following

Test Mode : 802.11b (CH11)

Radiated Emissions(VERTICAL)							
Frequency (MHz)	Amplitude (dBuV/m)	Ant. (m)	Table (Degree)	Duty (dB)	Limit (dBuV/m)	Margin (dB)	
1062.5	42.34	PK	1	240	0	74.00	-31.66
3282.5	51.22	PK	1	250	0	74.00	-22.78
4921.0	44.94	AV	1	340	0	54.00	-9.06
6559.5	44.52	PK	1	210	0	74.00	-29.48

- Notes :**
- 1.Margin= Amplitude - Limits
 - 2.Distance of Measurement : 3 Meter (1G-26.5GHz)
 - 3.Height of table for EUT placed: 0.8 Meter.
 - 4.ANT= Antenna height.
 - 5.Duty= Duty cycle correction factor.
 - 6.Amplitude= Reading Amplitude – Amplifier gain + Cable loss + Antenna factor (Auto calculate in spectrum analyzer)
 - 7.The other emission levels were very low against the limit.

2.5.7 Open Field Radiated Emissions (Subpart C)

The highest peak values of radiated emissions from the EUT at various antenna heights, antenna polarization, EUT orientation , etc. are recorded on the following

Test Mode : 802.11g (CH01)

Radiated Emissions(HORIZONTAL)							
Frequency (MHz)	Amplitude (dBuV/m)		Ant. (m)	Table (Degree)	Duty (dB)	Limit (dBuV/m)	Margin (dB)
1065.0	36.36	PK	1	350	0	74.00	-37.64
1750.0	36.23	PK	1	320	0	74.00	-37.77
4819.5	40.22	PK	1	90	0	74.00	-33.78
6414.5	43.79	PK	1	140	0	74.00	-30.21

- Notes :**
- 1.Margin= Amplitude - Limits
 - 2.Distance of Measurement : 3 Meter (1G-26.5GHz)
 - 3.Height of table for EUT placed: 0.8 Meter.
 - 4.ANT= Antenna height.
 - 5.Duty= Duty cycle correction factor.
 - 6.Amplitude= Reading Amplitude – Amplifier gain + Cable loss + Antenna factor (Auto calculate in spectrum analyzer)
 - 7.The other emission levels were very low against the limit.

2.5.8 Open Field Radiated Emissions (Subpart C)

The highest peak values of radiated emissions from the EUT at various antenna heights, antenna polarization, EUT orientation , etc. are recorded on the following

Test Mode : 802.11g (CH01)

Radiated Emissions(VERTICAL)							
Frequency (MHz)	Amplitude (dBuV/m)	Ant. (m)	Table (Degree)	Duty (dB)	Limit (dBuV/m)	Margin (dB)	
1062.5	45.83	PK	1	220	0	74.00	-28.17
3215.0	49.44	AV	1	240	0	54.00	-4.56
4819.5	47.11	PK	1	190	0	74.00	-26.89
6414.5	47.19	PK	1	350	0	74.00	-26.81

- Notes :**
- 1.Margin= Amplitude - Limits
 - 2.Distance of Measurement : 3 Meter (1G-26.5GHz)
 - 3.Height of table for EUT placed: 0.8 Meter.
 - 4.ANT= Antenna height.
 - 5.Duty= Duty cycle correction factor.
 - 6.Amplitude= Reading Amplitude – Amplifier gain + Cable loss + Antenna factor (Auto calculate in spectrum analyzer)
 - 7.The other emission levels were very low against the limit.

2.5.9 Open Field Radiated Emissions (Subpart C)

The highest peak values of radiated emissions from the EUT at various antenna heights, antenna polarization, EUT orientation , etc. are recorded on the following

Test Mode : 802.11g (CH06)

Radiated Emissions(HORIZONTAL)							
Frequency (MHz)	Amplitude (dBuV/m)	Ant. (m)	Table (Degree)	Duty (dB)	Limit (dBuV/m)	Margin (dB)	
1707.5	34.97	PK	1	200	0	74.00	-39.03
2512.5	43.65	PK	1	350	0	74.00	-30.35
4877.5	37.41	PK	1	270	0	74.00	-36.59
6487.0	41.99	PK	1	150	0	74.00	-32.01

- Notes :**
- 1.Margin= Amplitude - Limits
 - 2.Distance of Measurement : 3 Meter (1G-26.5GHz)
 - 3.Height of table for EUT placed: 0.8 Meter.
 - 4.ANT= Antenna height.
 - 5.Duty= Duty cycle correction factor.
 - 6.Amplitude= Reading Amplitude – Amplifier gain + Cable loss + Antenna factor (Auto calculate in spectrum analyzer)
 - 7.The other emission levels were very low against the limit.

2.5.10 Open Field Radiated Emissions (Subpart C)

The highest peak values of radiated emissions from the EUT at various antenna heights, antenna polarization, EUT orientation , etc. are recorded on the following

Test Mode : 802.11g (CH06)

Radiated Emissions (VERTICAL)							
Frequency (MHz)	Amplitude (dBuV/m)		Ant. (m)	Table (Degree)	Duty (dB)	Limit (dBuV/m)	Margin (dB)
1065.0	44.43	PK	1	180	0	74.00	-29.57
3250.0	52.33	PK	1	320	0	74.00	-21.67
4877.5	43.35	PK	1	250	0	74.00	-30.65
6487.0	45.59	PK	1	140	0	74.00	-28.41

- Notes :**
- 1.Margin= Amplitude - Limits
 - 2.Distance of Measurement : 3 Meter (1G-26.5GHz)
 - 3.Height of table for EUT placed: 0.8 Meter.
 - 4.ANT= Antenna height.
 - 5.Duty= Duty cycle correction factor.
 - 6.Amplitude= Reading Amplitude – Amplifier gain + Cable loss + Antenna factor (Auto calculate in spectrum analyzer)
 - 7.The other emission levels were very low against the limit.

2.5.11 Open Field Radiated Emissions (Subpart C)

The highest peak values of radiated emissions from the EUT at various antenna heights, antenna polarization, EUT orientation , etc. are recorded on the following

Test Mode : 802.11g (CH11)

Radiated Emissions(HORIZONTAL)							
Frequency (MHz)	Amplitude (dBuV/m)	Ant. (m)	Table (Degree)	Duty (dB)	Limit (dBuV/m)	Margin (dB)	
1677.5	35.26	PK	1	310	0	74.00	-38.74
2550.0	42.40	PK	1	80	0	74.00	-31.60
4921.0	37.21	PK	1	170	0	74.00	-36.79
6559.5	40.34	PK	1	190	0	74.00	-33.66

- Notes :**
- 1.Margin= Amplitude - Limits
 - 2.Distance of Measurement : 3 Meter (1G-26.5GHz)
 - 3.Height of table for EUT placed: 0.8 Meter.
 - 4.ANT= Antenna height.
 - 5.Duty= Duty cycle correction factor.
 - 6.Amplitude= Reading Amplitude – Amplifier gain + Cable loss + Antenna factor (Auto calculate in spectrum analyzer)
 - 7.The other emission levels were very low against the limit.

2.5.12 Open Field Radiated Emissions (Subpart C)

The highest peak values of radiated emissions from the EUT at various antenna heights, antenna polarization, EUT orientation , etc. are recorded on the following

Test Mode : 802.11g (CH11)

Radiated Emissions(VERTICAL)							
Frequency (MHz)	Amplitude (dBuV/m)	Ant. (m)	Table (Degree)	Duty (dB)	Limit (dBuV/m)	Margin (dB)	
1065.0	41.76	PK	1	320	0	74.00	-32.24
3282.5	51.02	PK	1	290	0	74.00	-22.98
4921.0	44.09	PK	1	70	0	74.00	-29.91
6559.5	43.19	PK	1	250	0	74.00	-30.81

- Notes :**
- 1.Margin= Amplitude - Limits
 - 2.Distance of Measurement : 3 Meter (1G-26.5GHz)
 - 3.Height of table for EUT placed: 0.8 Meter.
 - 4.ANT= Antenna height.
 - 5.Duty= Duty cycle correction factor.
 - 6.Amplitude= Reading Amplitude – Amplifier gain + Cable loss + Antenna factor (Auto calculate in spectrum analyzer)
 - 7.The other emission levels were very low against the limit.

III. Maximum Conducted Output Power Requirements

3.1 Test Condition & Setup :

The tests below are run with the EUT's transmitter set at high power in TDD mode. A RJ-45 port from a computer to the EUT is needed to force selection of output power level and channel number. While testing, EUT was set to transmit continuously. Remove the Subjective device's antenna and connect the RF output port to spectrum analyzer. The maximum peak output power shall not exceed 1 watt.

Use a direct connection between the antenna port of transmitter and the spectrum Analyzer, for prevent the spectrum analyzer input attenuation 40-50 dB. Set the RBW Bandwidth of the emission or use a channel power meter mode .

For antennas with gains of 6 dBi or less , maximum allowed transmitter output is 1 watt (+30 dBm). For antennas with gains greater than 6 dBi, transmitter output level must be decreased by an amount equal to $(GAIN - 6)/3$ dBm.

The antenna port of the EUT was connected to the input of a power meter. Power was read directly and cable loss correction was added to the reading to obtain power at the EUT antenna terminals.

3.2 Test Instruments Configuration:

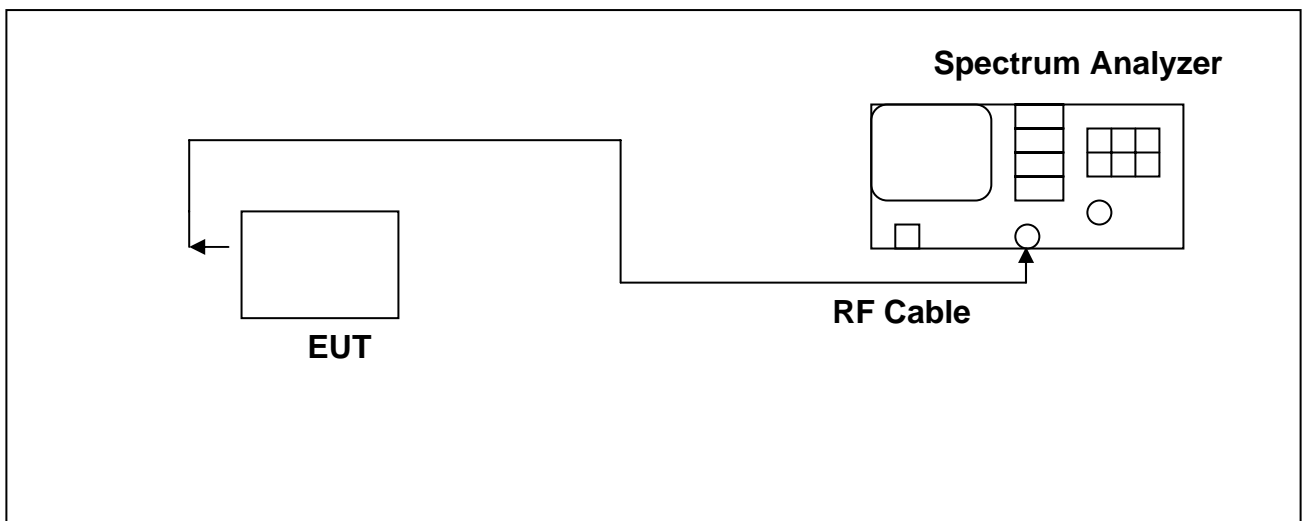

3.3 Test Equipment List:

Item	Mfr/Brand	Instruments	Serial No.	Model/Type No.	Calibrated Date	Next Cali. Date
1.	Agilent	Spectrum Analyzer	US39240419	E4407B	2007/02/01	2008/02/01

3.4 Test Result:

802.11b

Frequency (MHz)	Data Rate(Mbps)	Output(dBm)	Required Limit
2412	2	13.85	<30dBm
2437	11	13.70	<30dBm
2462	5.5	14.03	<30dBm

Note : 1.Test Graphs See next page.
2.Test result is the worst case of the different data rate.

802.11g

Frequency (MHz)	Data Rate(Mbps)	Output(dBm)	Required Limit
2412	54	9.43	<30dBm
2437	24	9.80	<30dBm
2462	6	10.22	<30dBm

Note : 1.Test Graphs See next page.
2.Test result is the worst case of the different data rate.

802.11b (2412MHz)

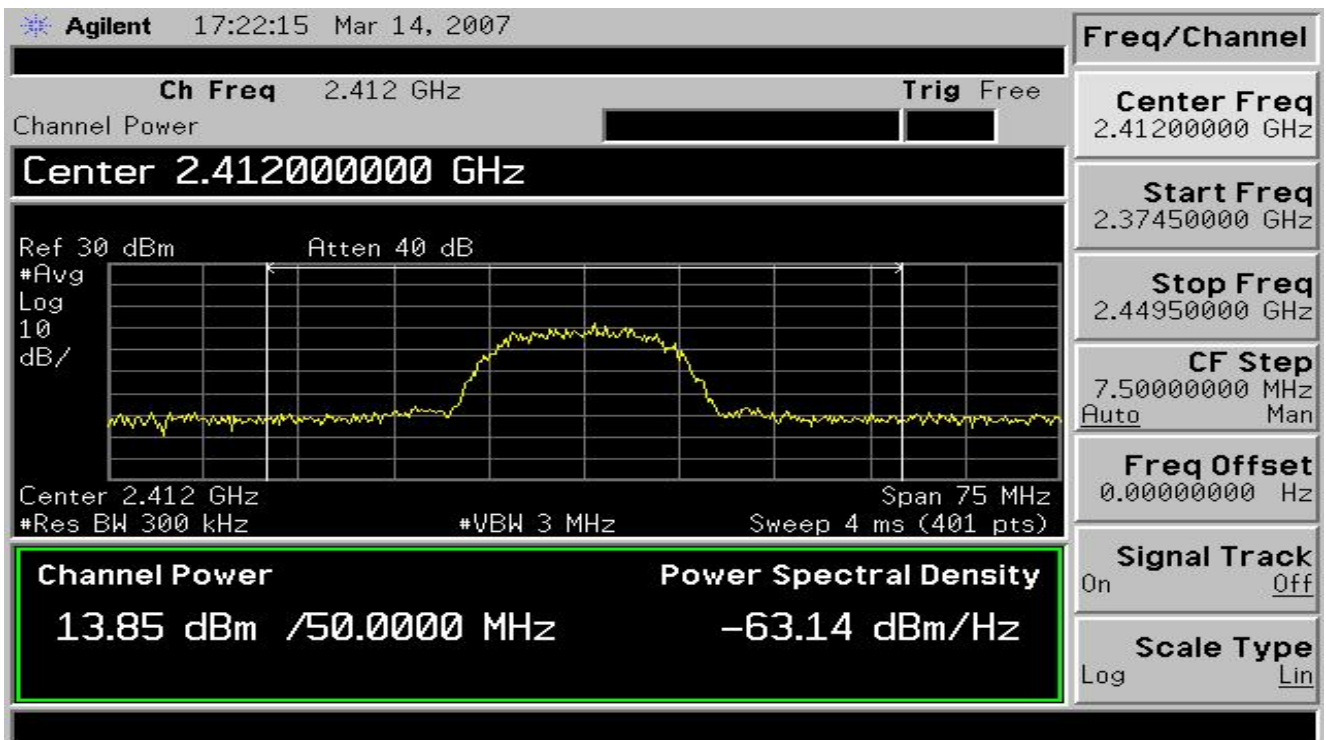

802.11b (2437MHz)

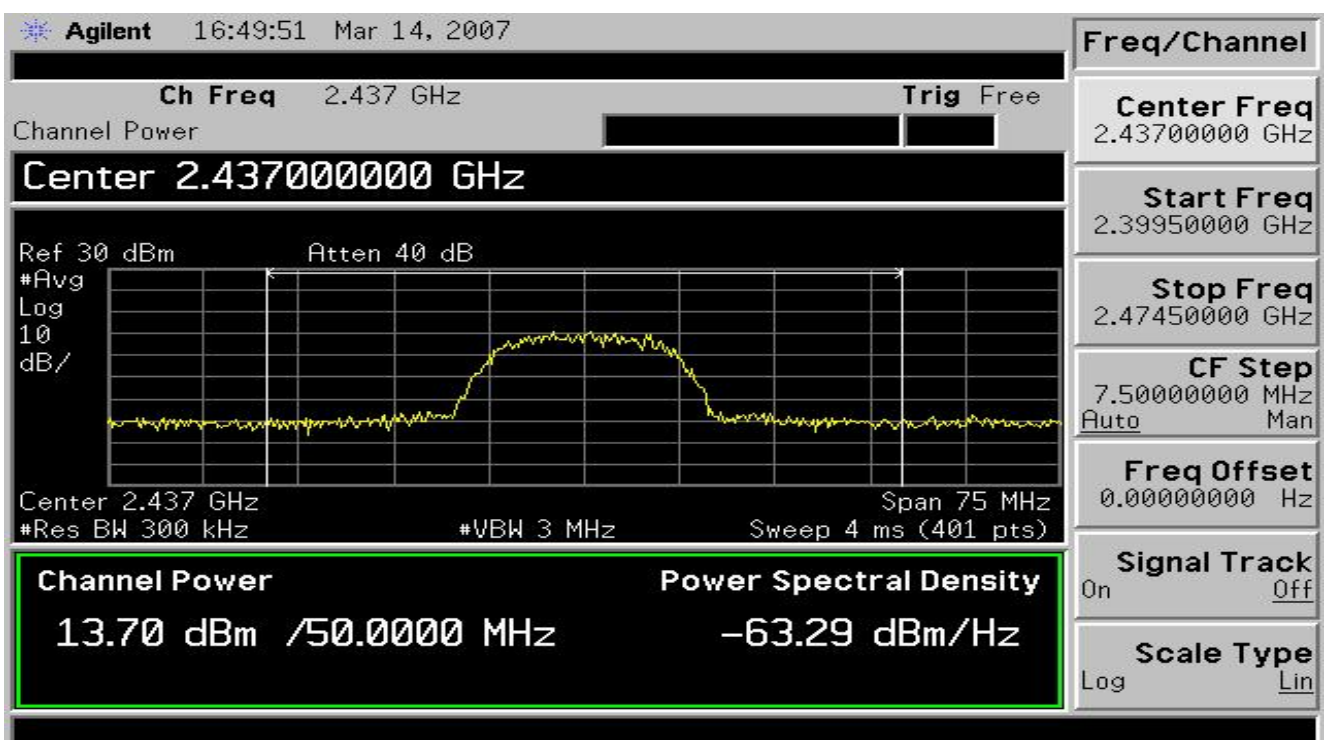

802.11b (2462MHz)

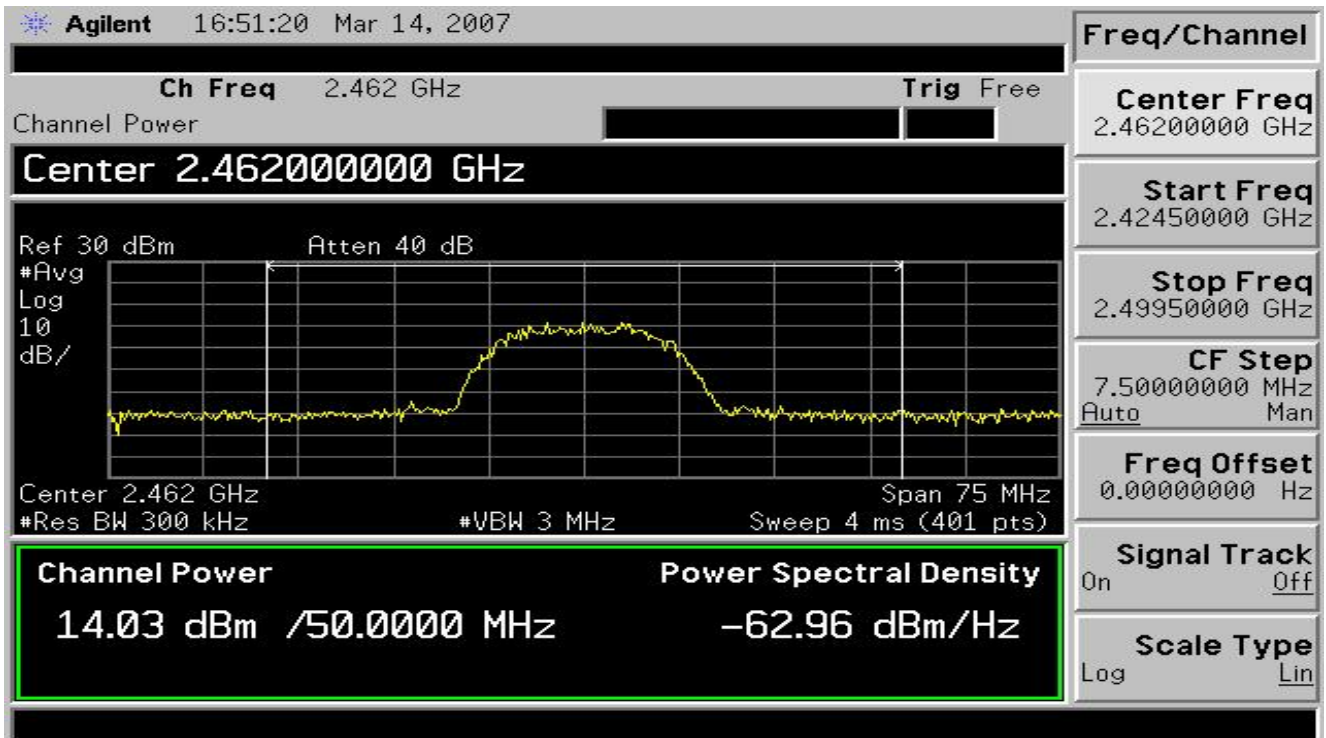

802.11g (2412MHz)

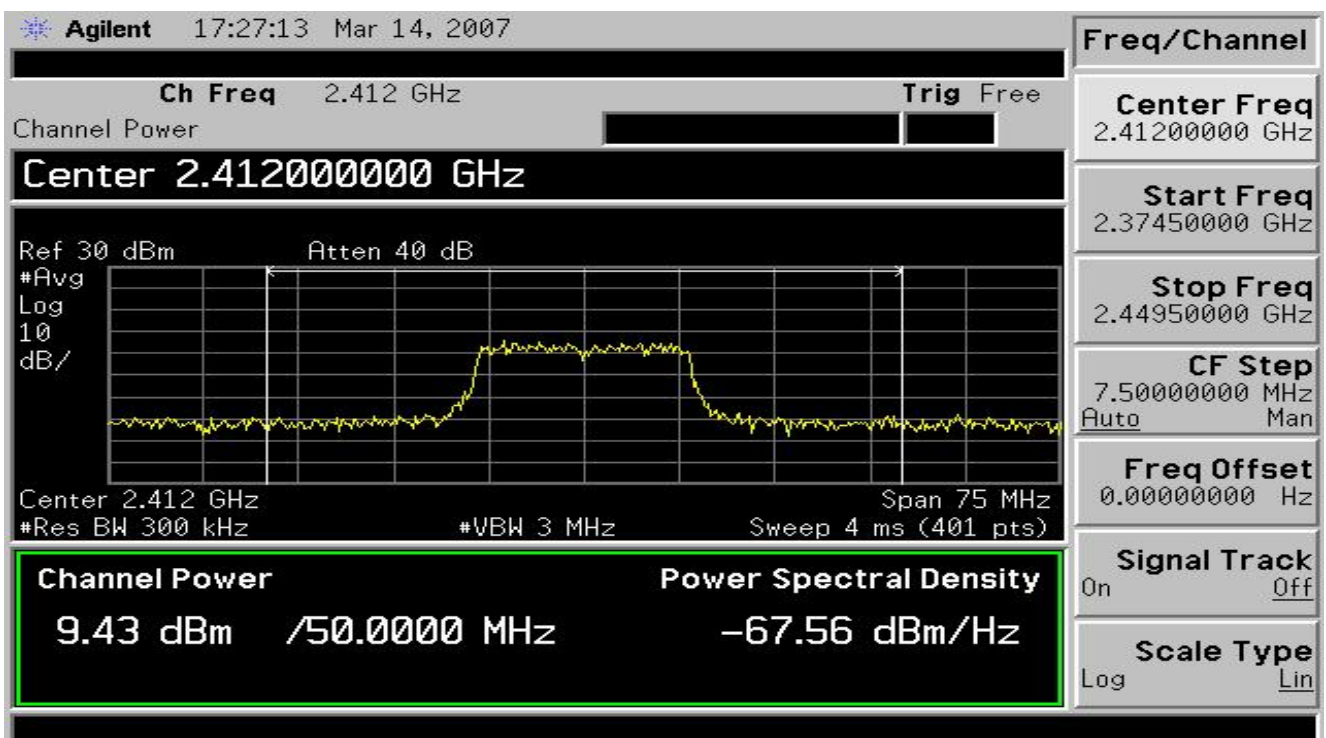

802.11g (2437MHz)

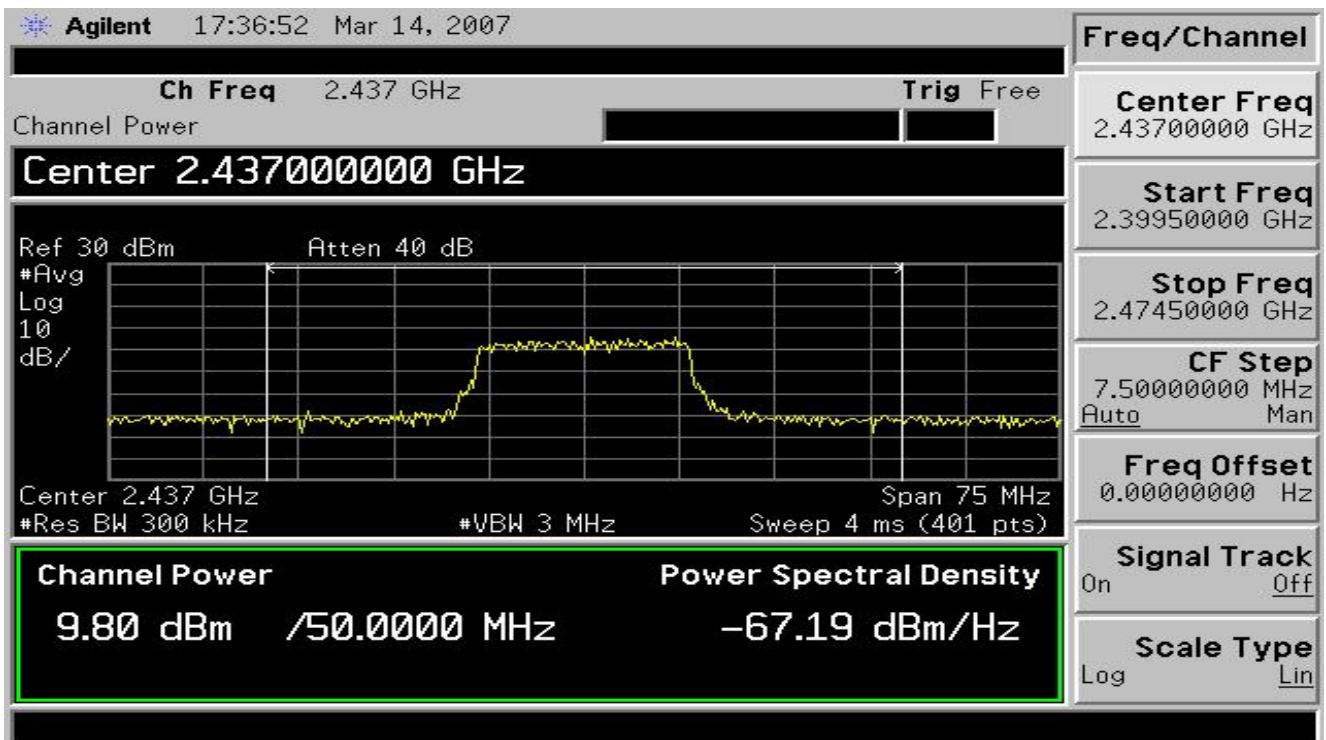

802.11g (2462MHz)

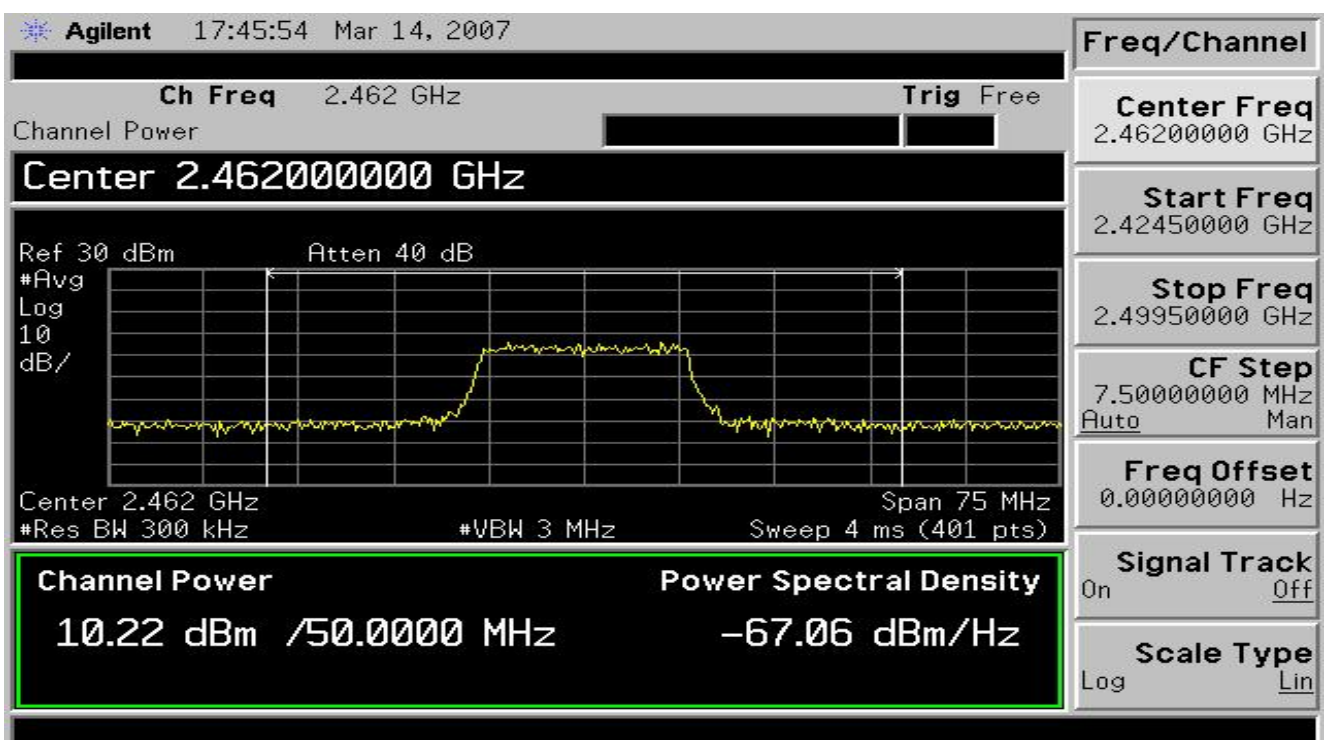

IV. Minimum 6dB RF Bandwidth Requirements

4.1 Test Condition & Setup :

The antenna port of the EUT was connected to the input of a spectrum analyzer. Analyzer RES BW was set to 100 kHz. For each RF output channel investigated, the spectrum analyzer center frequency was set to the channel carrier. A PEAK output reading was taken, a DISPLAY line was drawn 6 dB lower than PEAK level. The 6 dB bandwidth was determined from where the channel output spectrum intersected the display line. The test was performed at 3 channels (Channel 1, 6,11)

4.2 Test Instruments Configuration:

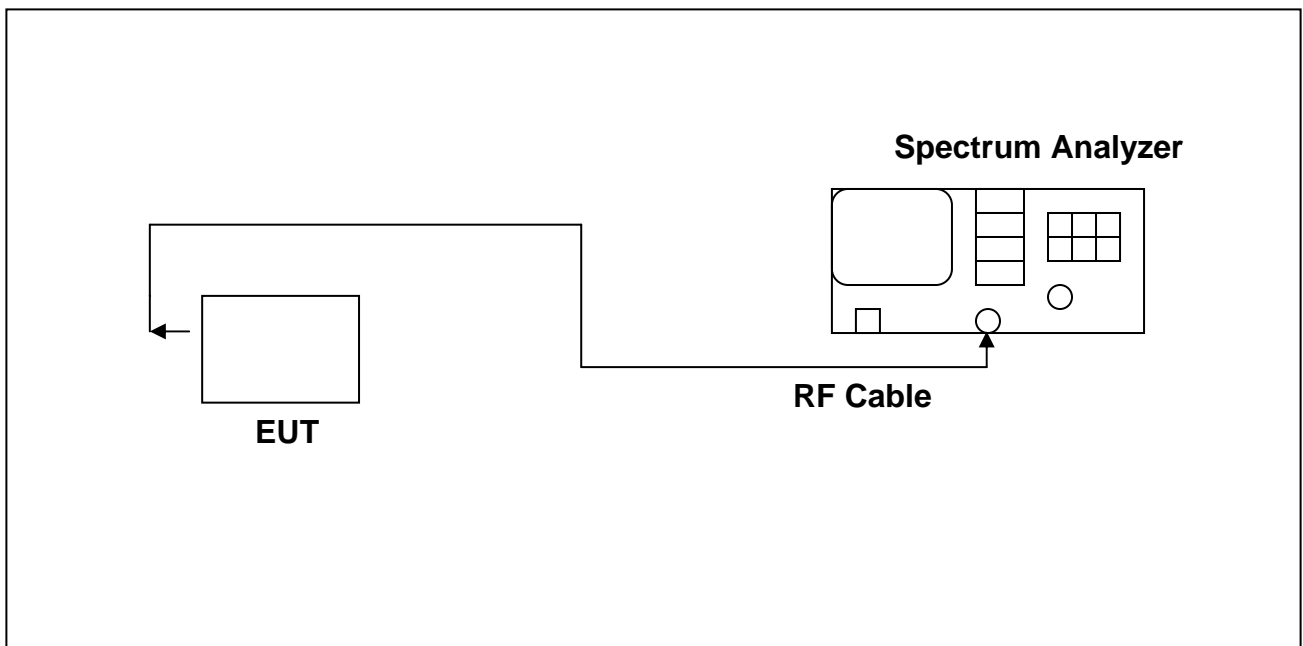

4.3 Test Equipment List:

Item	Mfr/Brand	Instruments	Serial No.	Model/Type No.	Calibrated Date	Next Cali. Date
1.	Agilent	Spectrum Analyzer	US39240419	E4407B	2007/02/01	2008/02/01

4.4 Test Result:

802.11b

Frequency (MHz)	Min. 6dB Bandwidth (MHz)	Required Limit
2412	11.87	>500KHz
2437	11.87	>500KHz
2462	11.87	>500KHz

Note : Test Graphs See next page.

802.11g

Frequency (MHz)	Min. 6dB Bandwidth (MHz)	Required Limit
2412	16.50	>500KHz
2437	16.50	>500KHz
2462	16.50	>500KHz

Note : Test Graphs See next page.

802.11b (2412MHz)

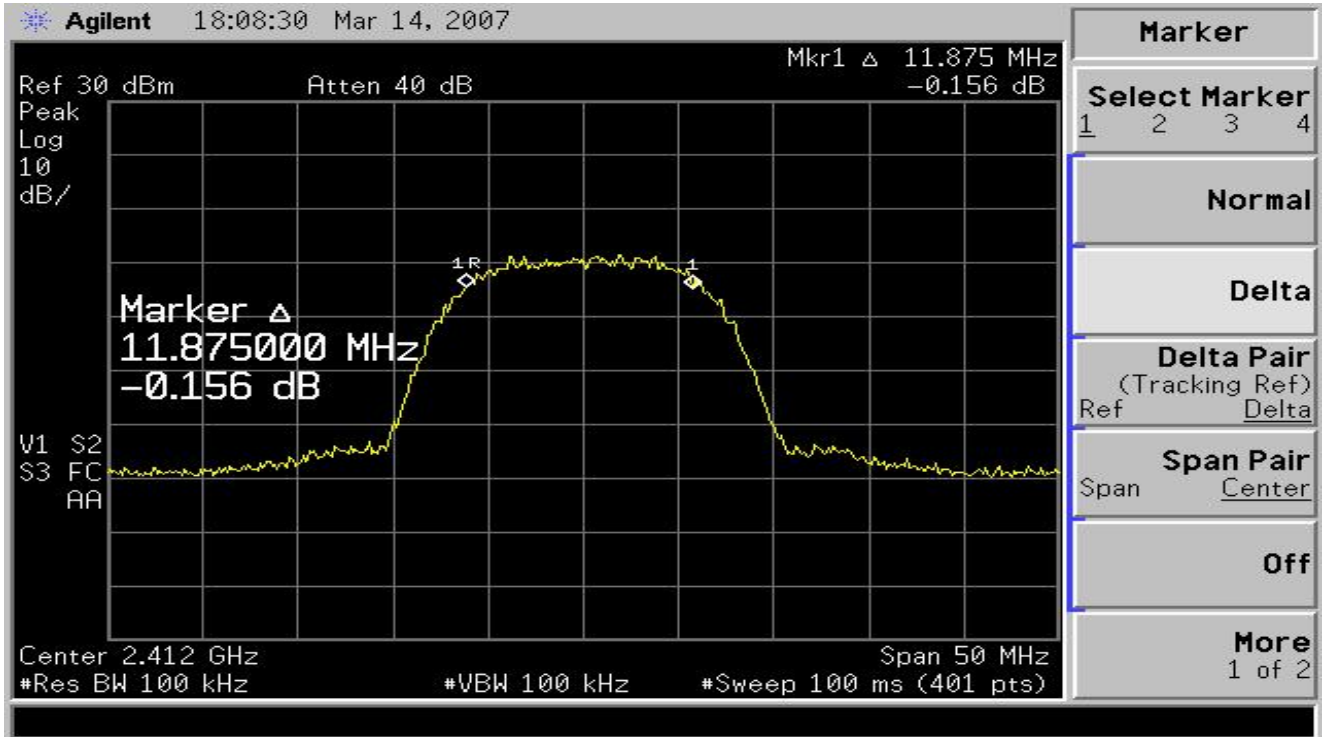

802.11b (2437MHz)

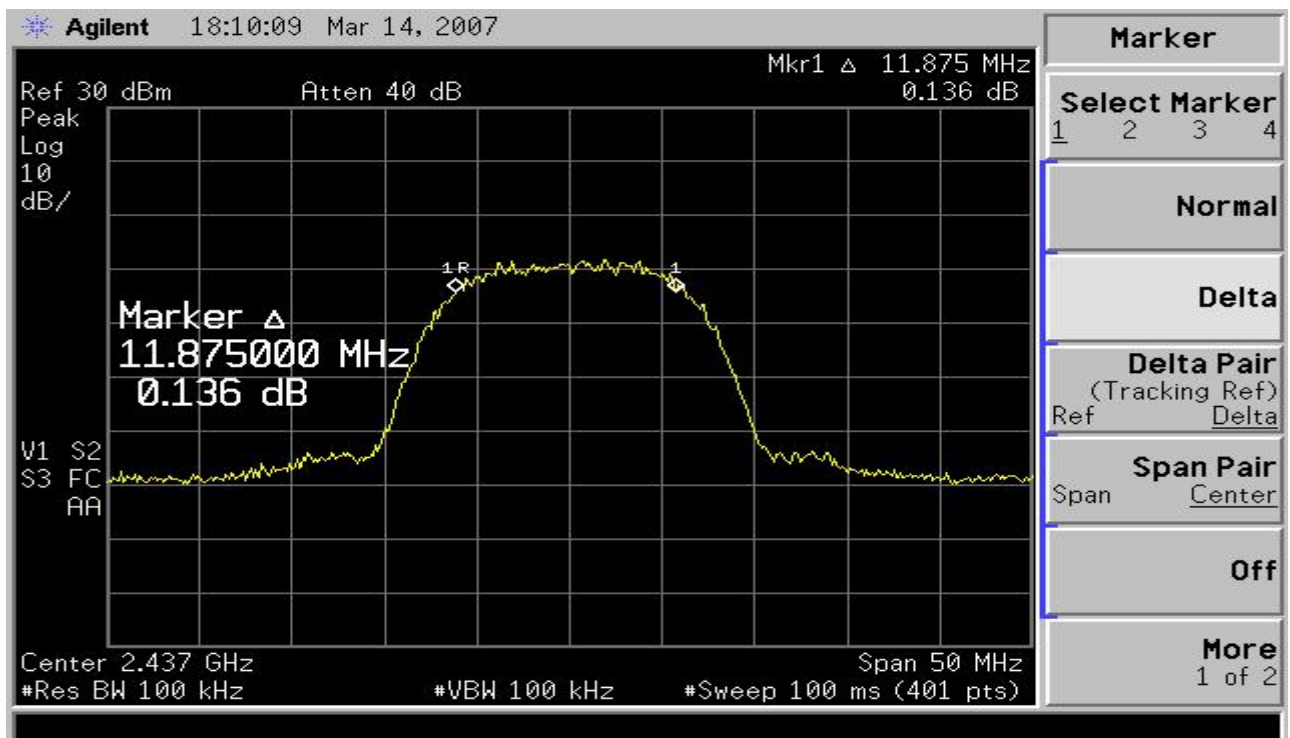

802.11b (2462MHz)

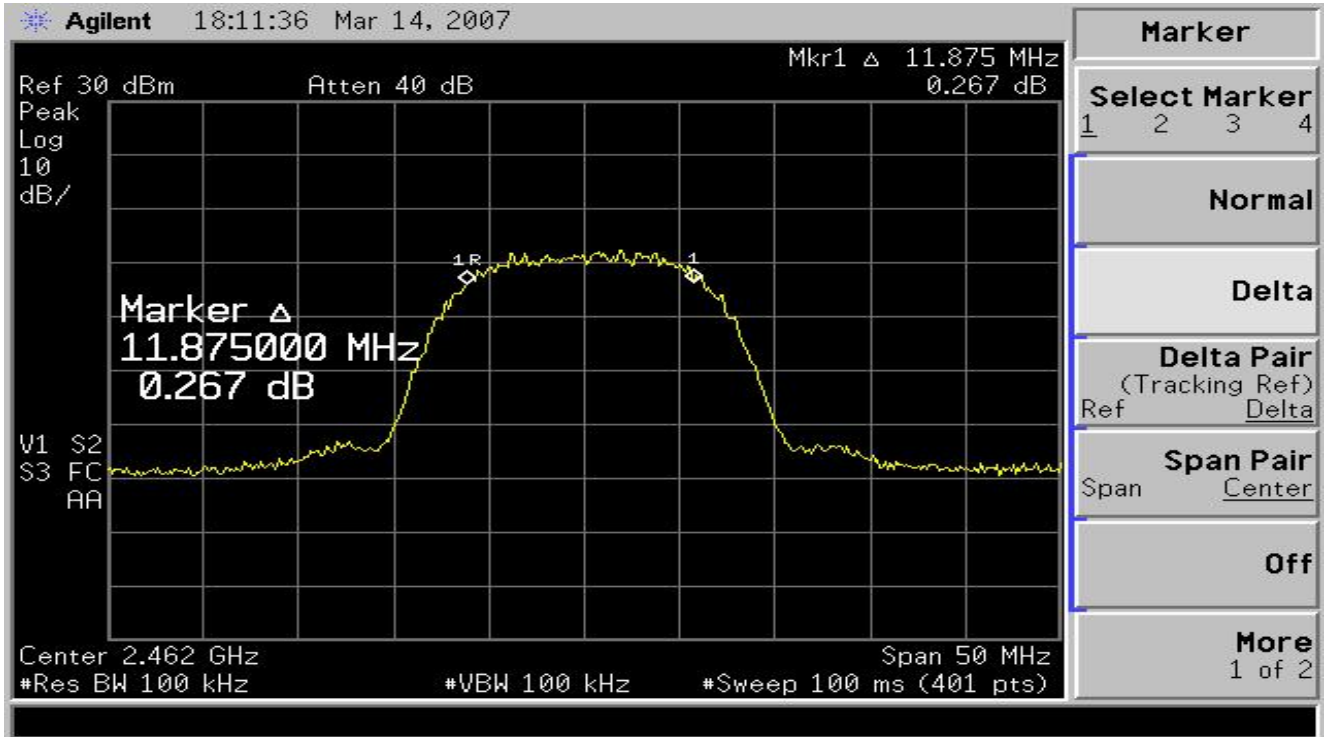

802.11g (2412MHz)

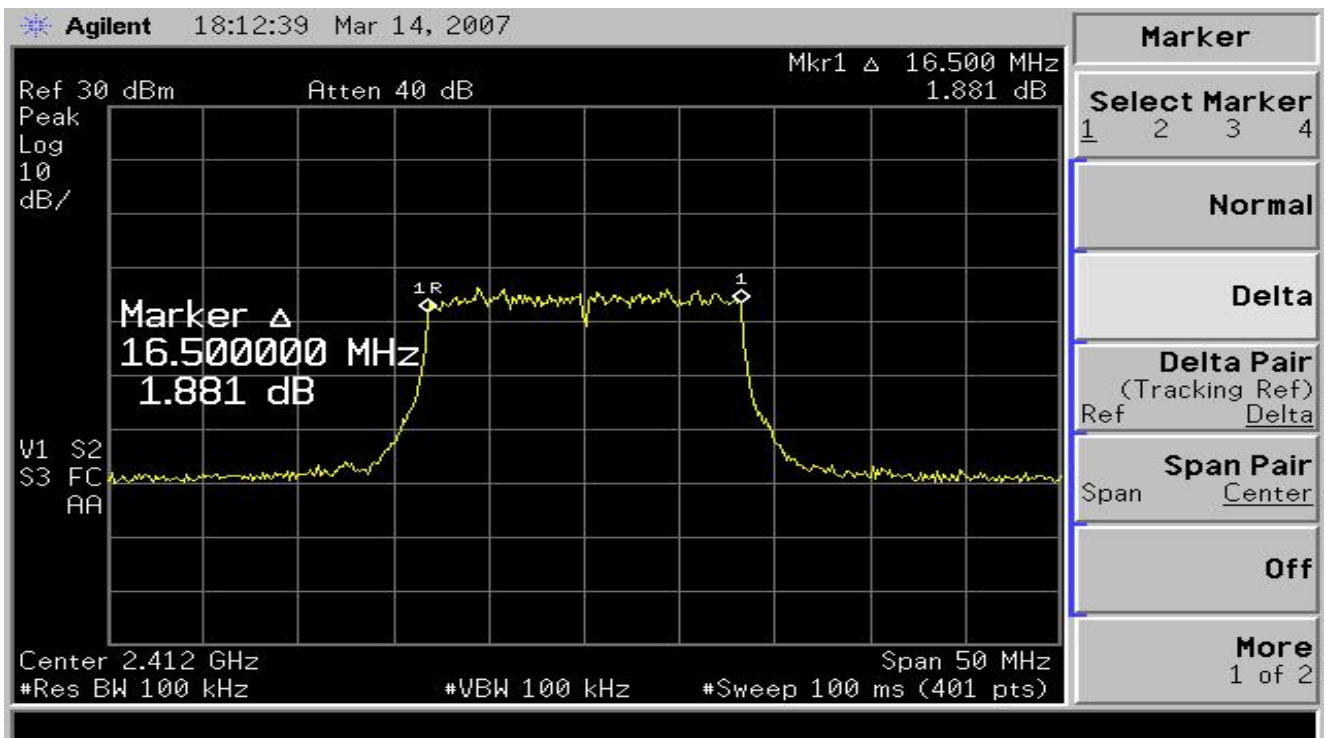

802.11g (2437MHz)

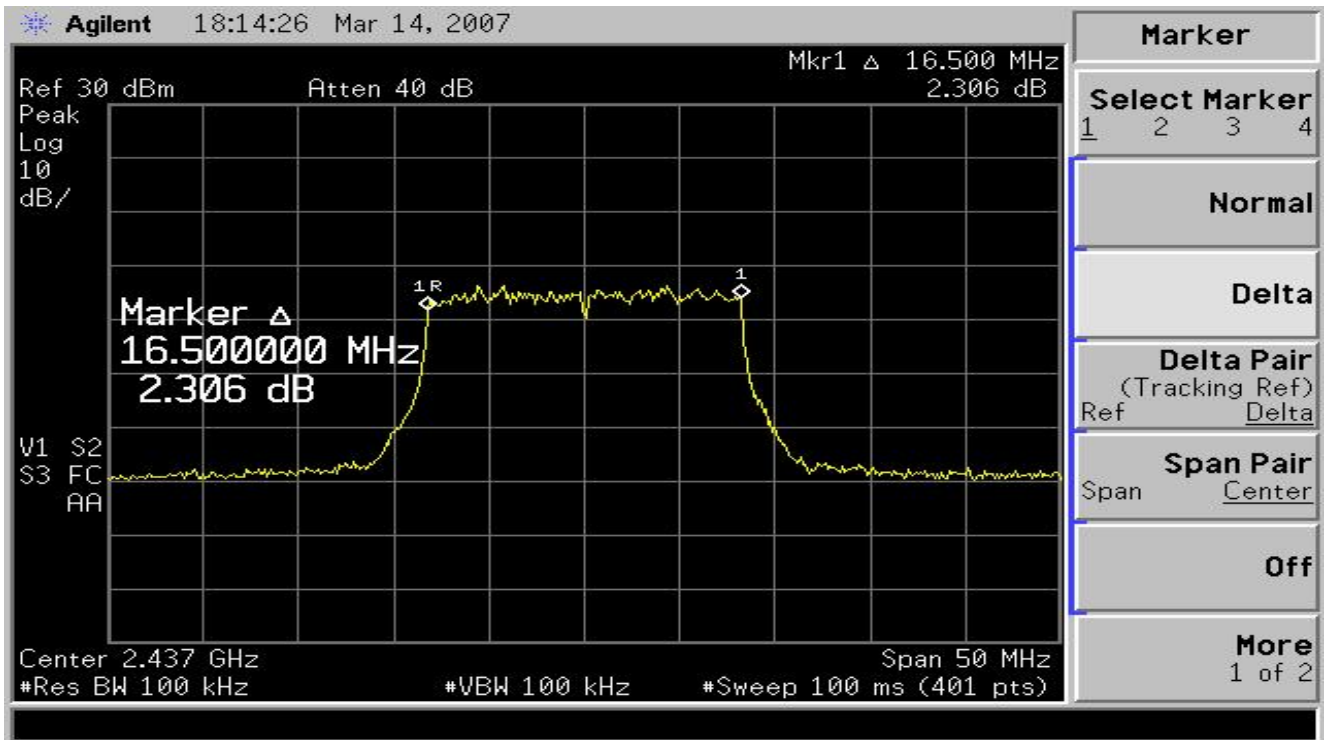

802.11g (2462MHz)

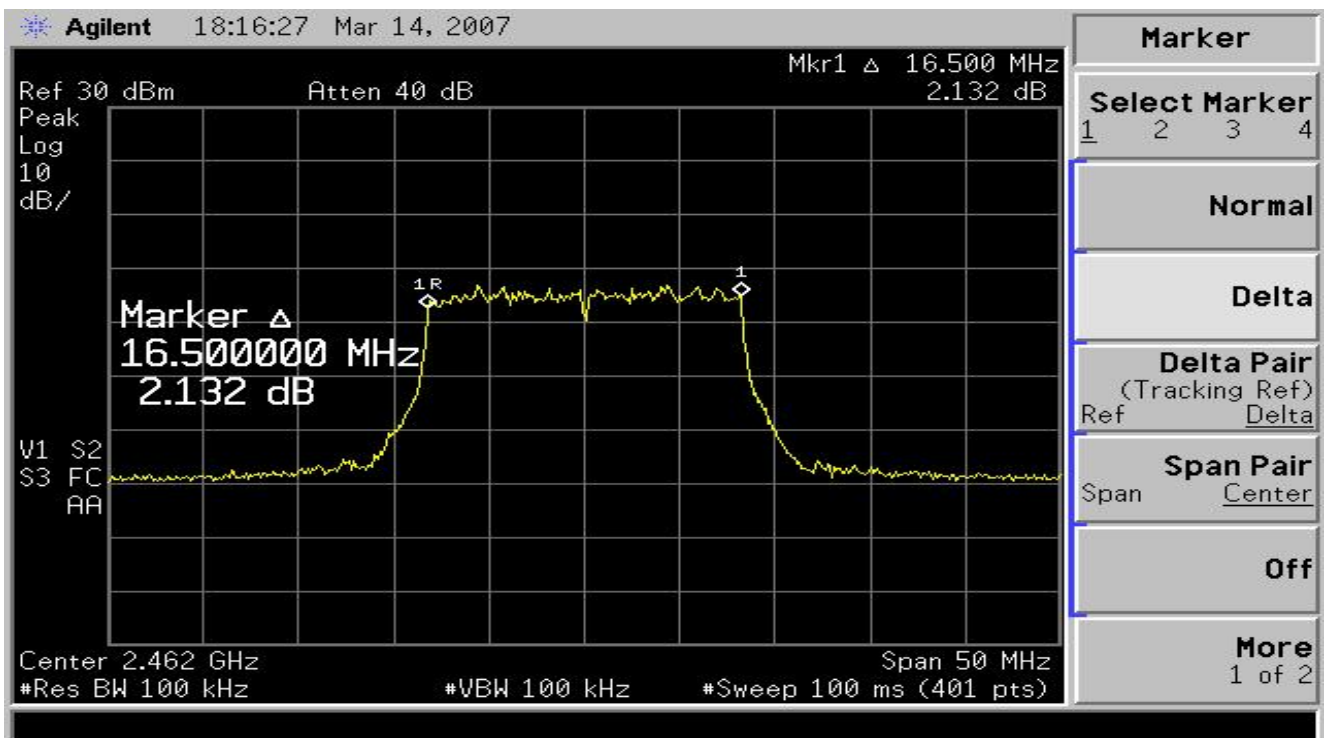

V. Maximum Power Density Requirements

5.1 Test Condition & Setup :

The spectrum analyzer RES BW was set to 3 kHz. The START and STOP frequencies were set to the band edges of the maximum output passband. If there is no clear maximum amplitude in any given portion of the band, it may be necessary to make measurements at a number of bands defined by several START and STOP frequency pairs. The specification calls for a 1 second interval at each 3 kHz bandwidth; total SWEEP TIME is calculated as follows:

$$\text{SWEEP TIME (SEC)} = (\text{Fstop, kHz} - \text{Fstart, kHz}) / 3 \text{ kHz}$$

Antenna output of the EUT was coupled directly to spectrum analyzer; if an external attenuator and/or cable was used, these losses are compensated for with the analyzer OFFSET function.

5.2 Test Instruments Configuration:

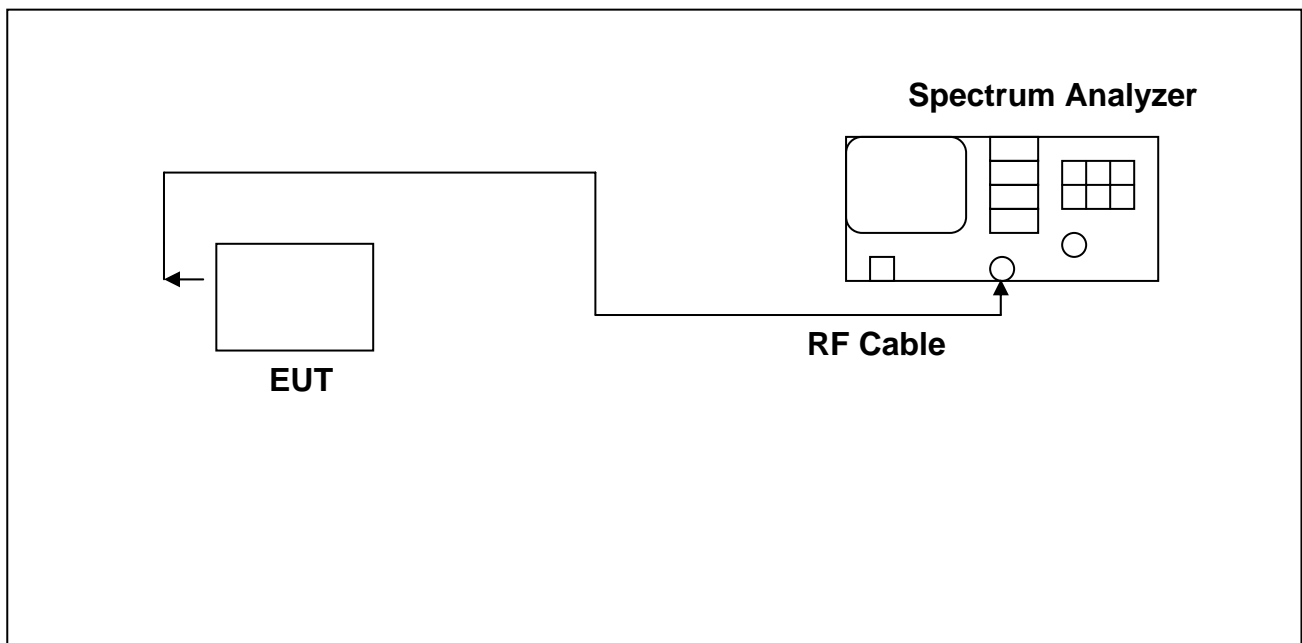

5.3 Test Equipment List:

Item	Mfr/Brand	Instruments	Serial No.	Model/Type No.	Calibrated Date	Next Cali. Date
1.	Agilent	Spectrum Analyzer	US39240419	E4407B	2007/02/01	2008/02/01

5.4 Test Result:

802.11b

Frequency (MHz)	Power Density (dBm)	Required Limit
2412	-12.74	<8dBm
2437	-11.74	<8dBm
2462	-11.32	<8dBm

Note : 1.Frequency Span= 1.5MHz
 2.Sweep Time =500secs
 3.Test Graphs See next page.

802.11g

Frequency (MHz)	Power Density (dBm)	Required Limit
2412	-15.93	<8dBm
2437	-15.68	<8dBm
2462	-15.15	<8dBm

Note : 1.Frequency Span= 1.5MHz
 2.Sweep Time =500secs
 3.Test Graphs See next page.

802.11b (2462MHz)

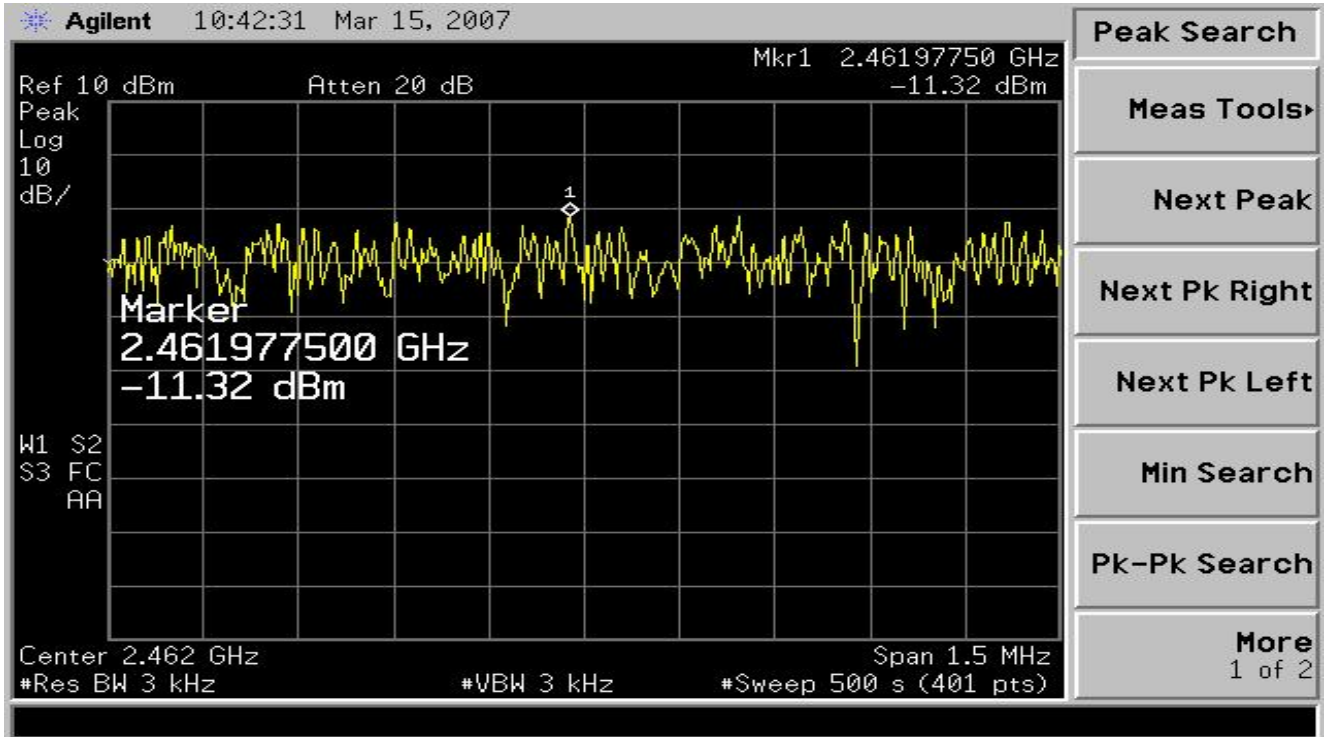

802.11g (2462MHz)

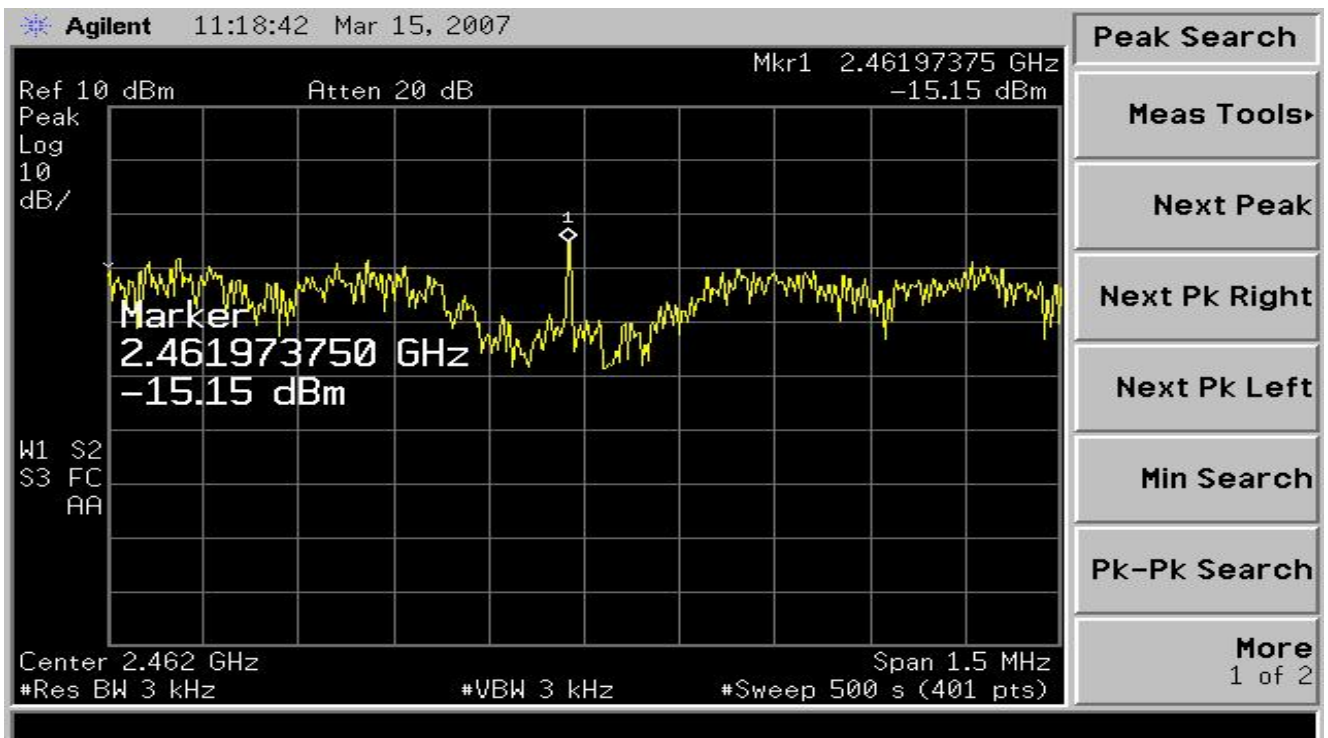

VI. Out of Band Conducted Emissions Requirements

6.1 Test Condition & Setup :

In any 100 kHz bandwidth outside the EUT pass band, the RF power produced by the modulation products of the spreading sequence, the information sequence, and the carrier frequency shall be at least 20 dB below that of the maximum in-band 100 kHz emission, antenna output of the EUT was coupled directly to spectrum analyzer; if an external attenuator and/or cable was used, these losses are compensated for with the analyzer OFFSET function.

All other types of emissions from the EUT shall meet the general limits for radiated frequencies outside the pass band. The test was performed at 3 channels (Channel 1, 6,11)

6.2 Test Instruments Configuration:

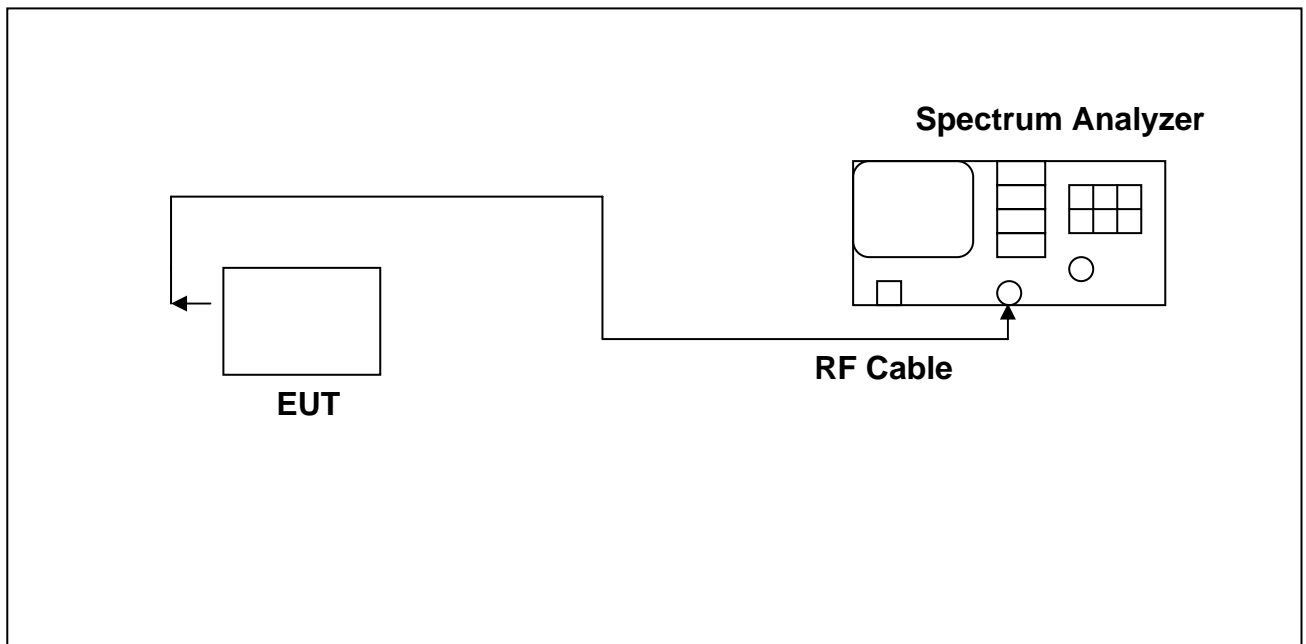

6.3 Test Equipment List:

Item	Mfr/Brand	Instruments	Serial No.	Model/Type No.	Calibrated Date	Next Cali. Date
1.	Agilent	Spectrum Analyzer	US39240419	E4407B	2007/02/01	2008/02/01



6.4 Test Result:

Refer to attached data sheets. Data shows out of band emissions are suppressed well below the -20 dBc minimum required by the Rules.

Note : Test Graphs See next page.

802.11b (CH01) (1 of 5)

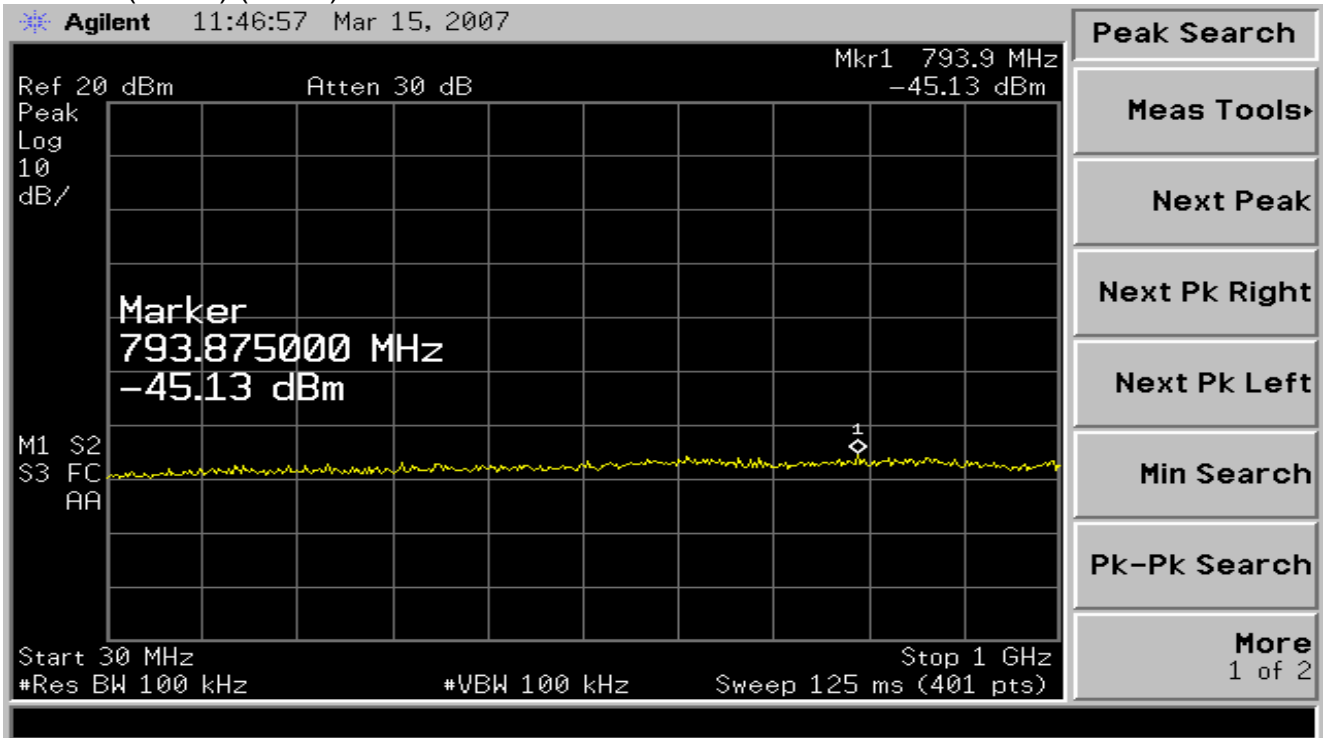

802.11b (CH01) (2 of 5)

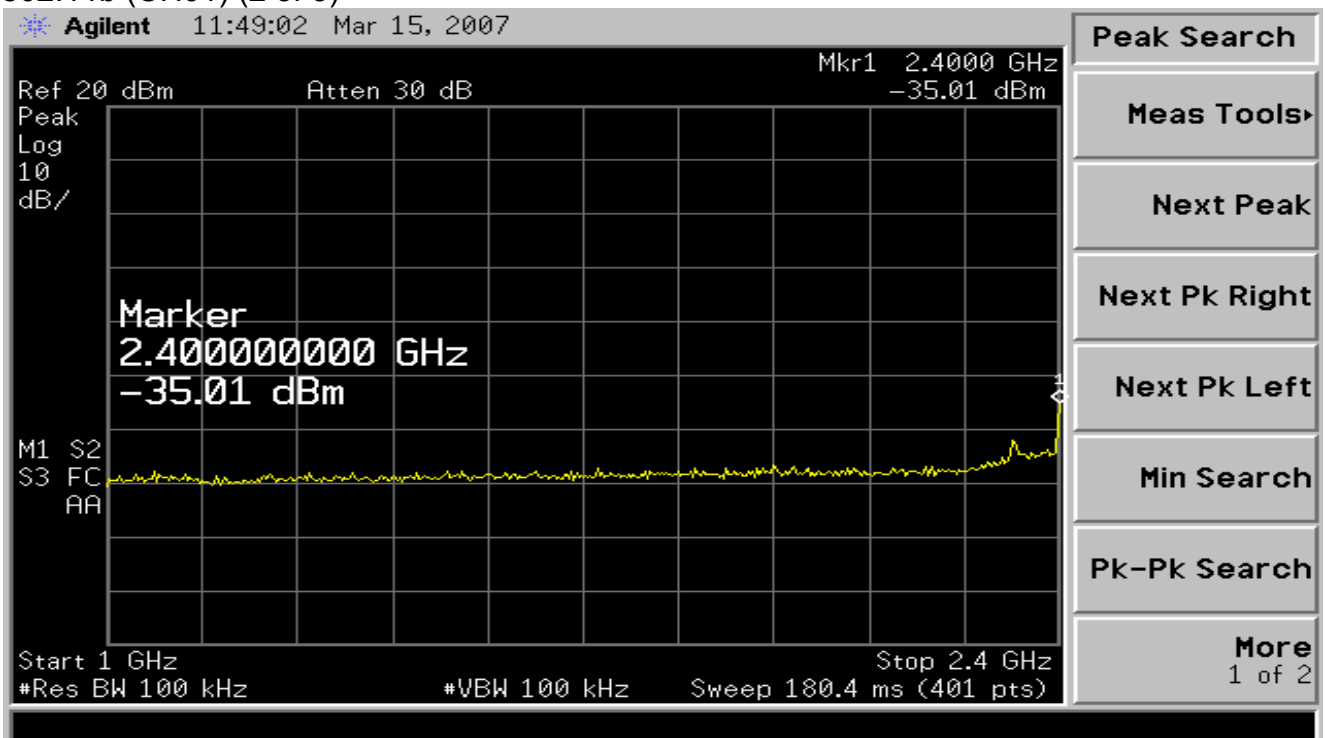

802.11b (CH01) (3 of 5)

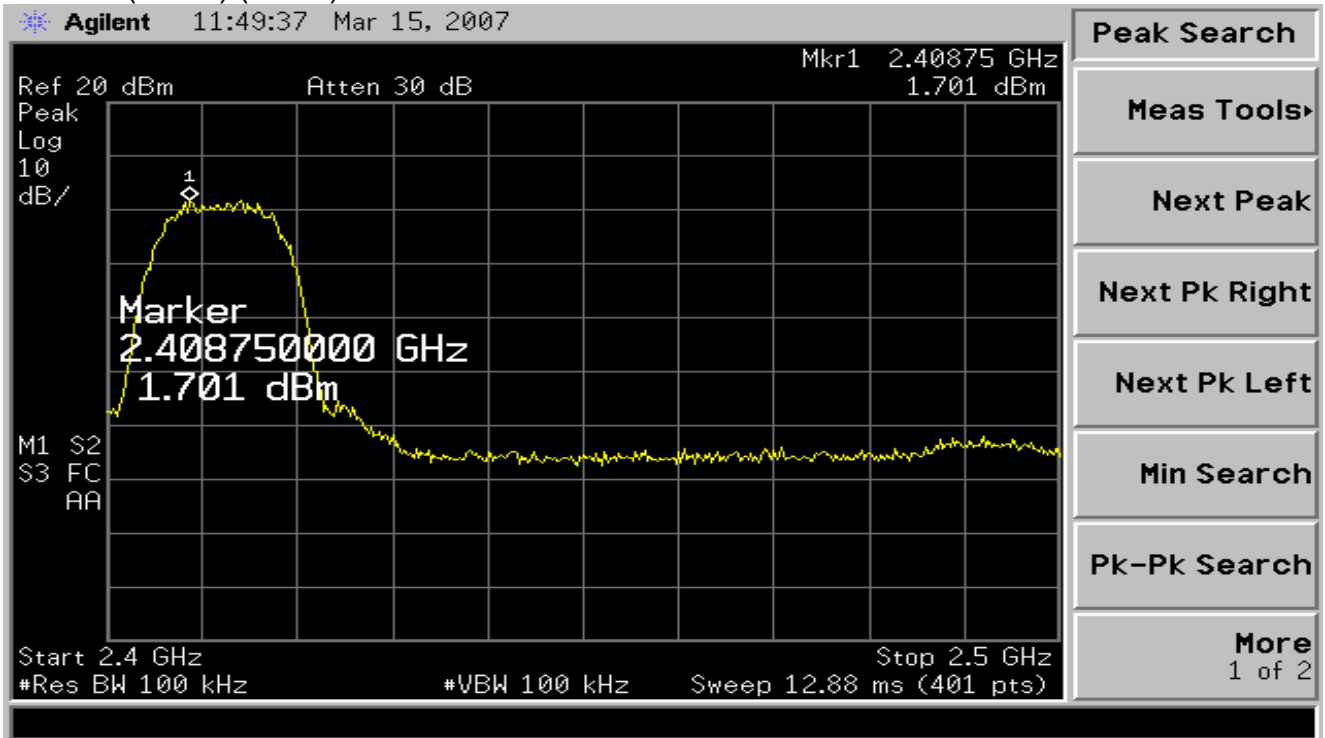

802.11b (CH01) (4 of 5)

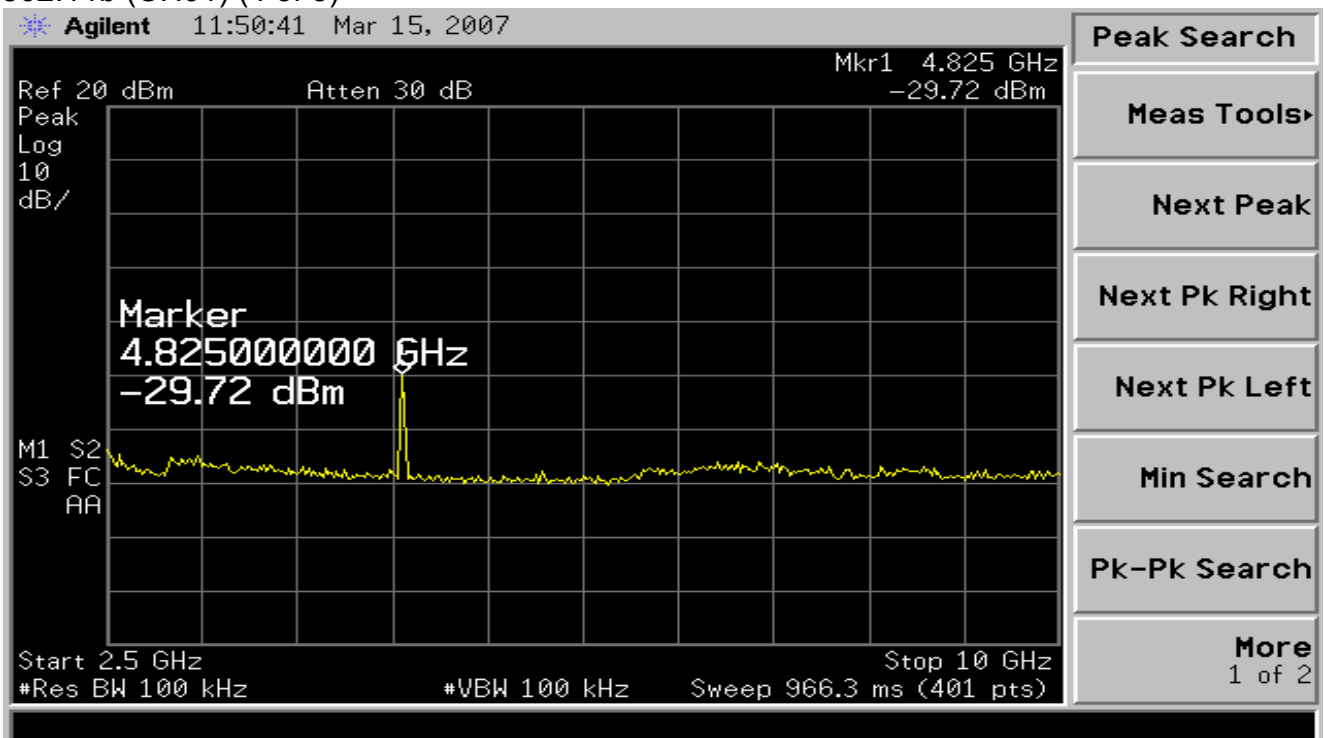

802.11b (CH01) (5 of 5)

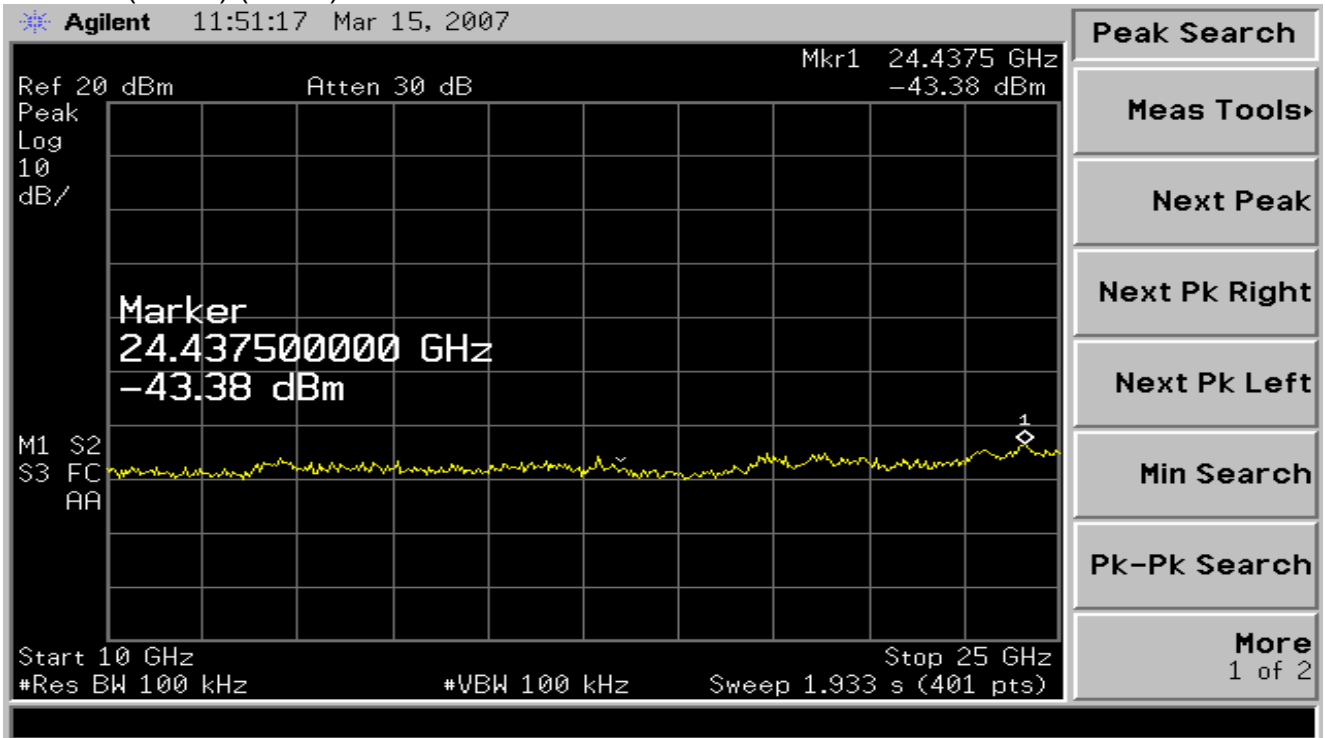

802.11b (CH06) (1 of 5)

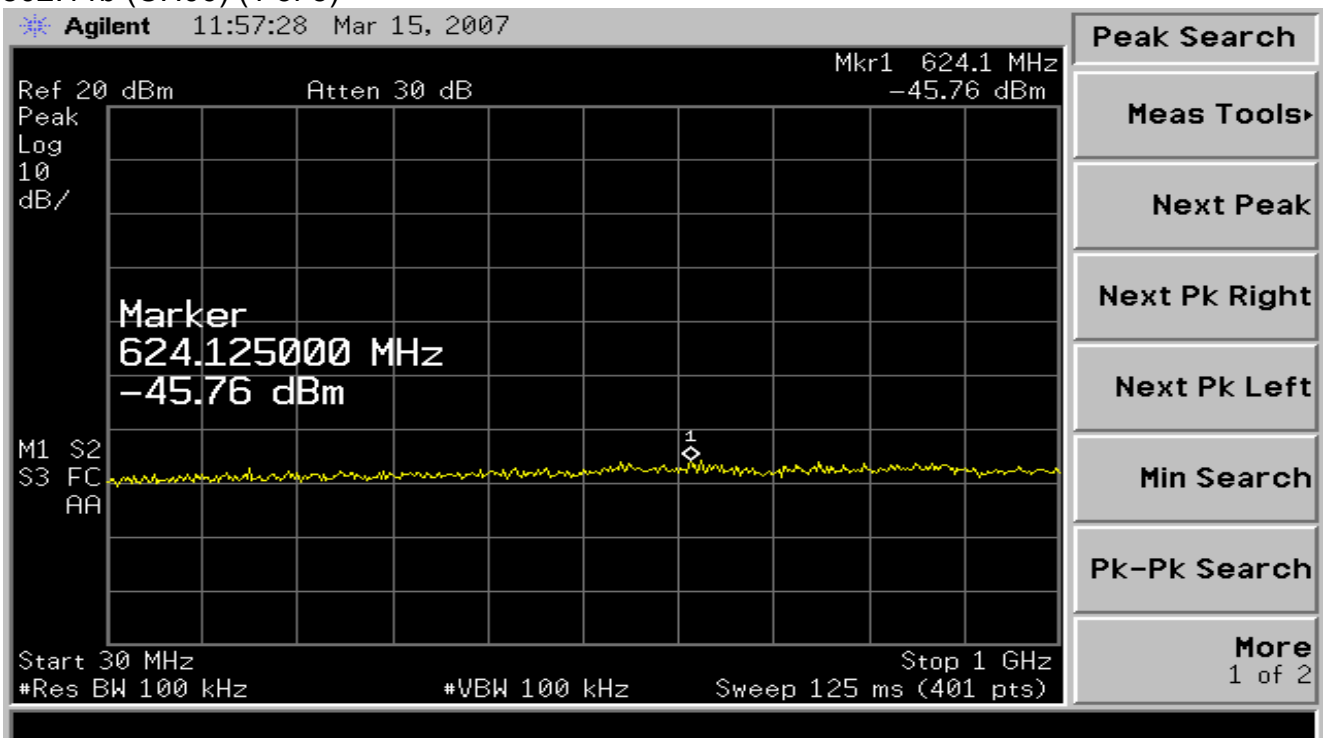

802.11b (CH06) (2 of 5)

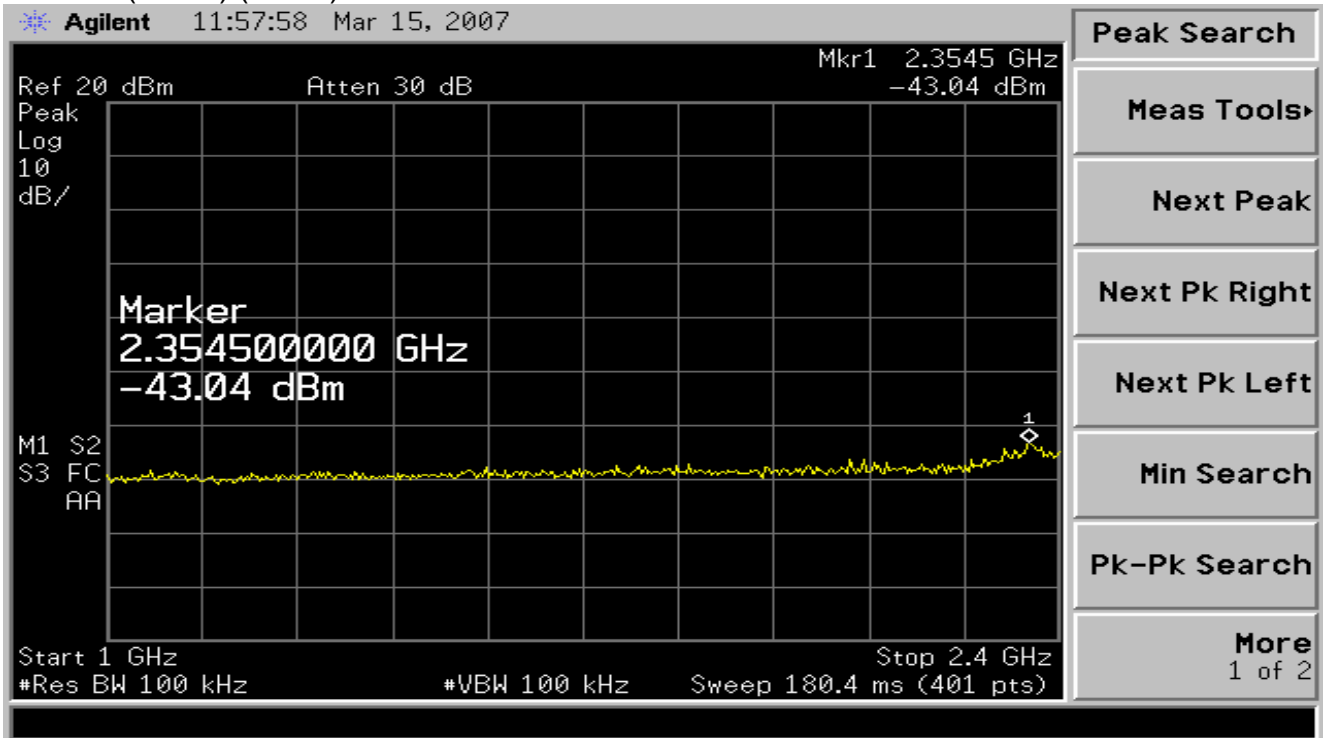

802.11b (CH06) (3 of 5)

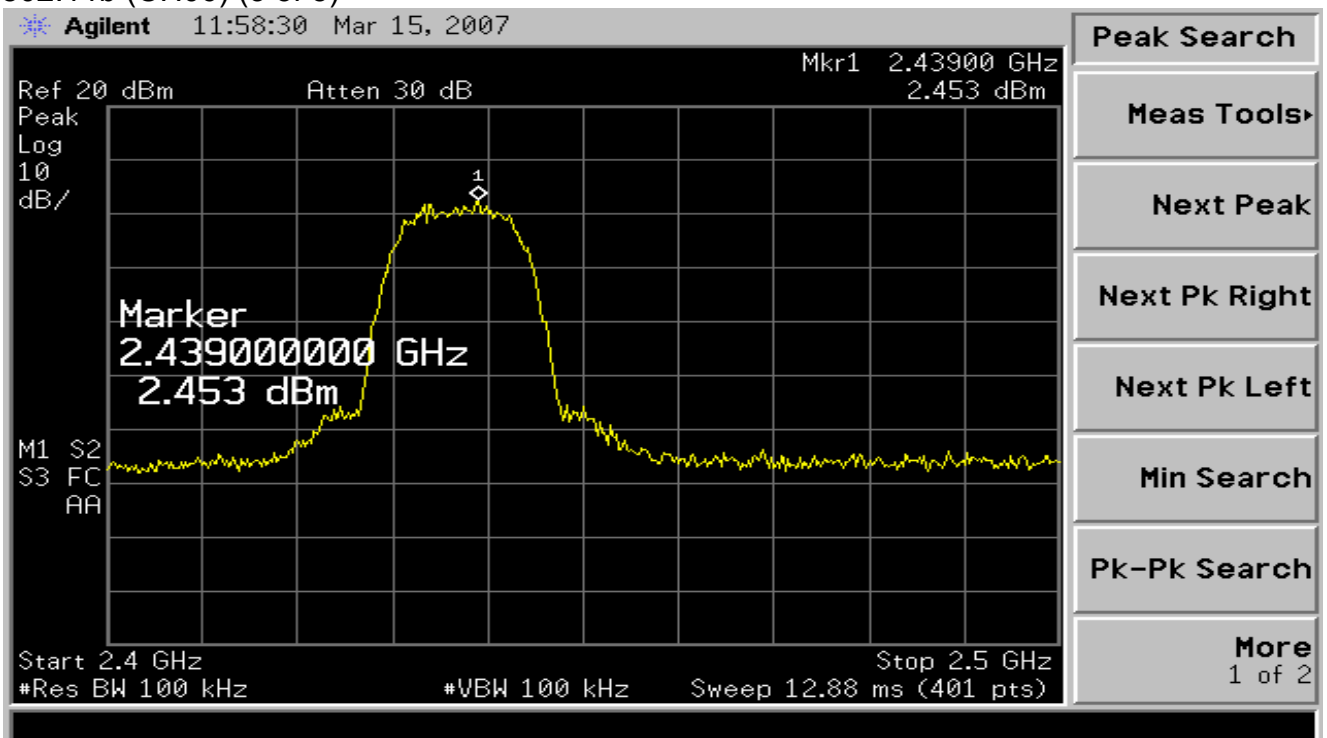

802.11b (CH06) (4 of 5)

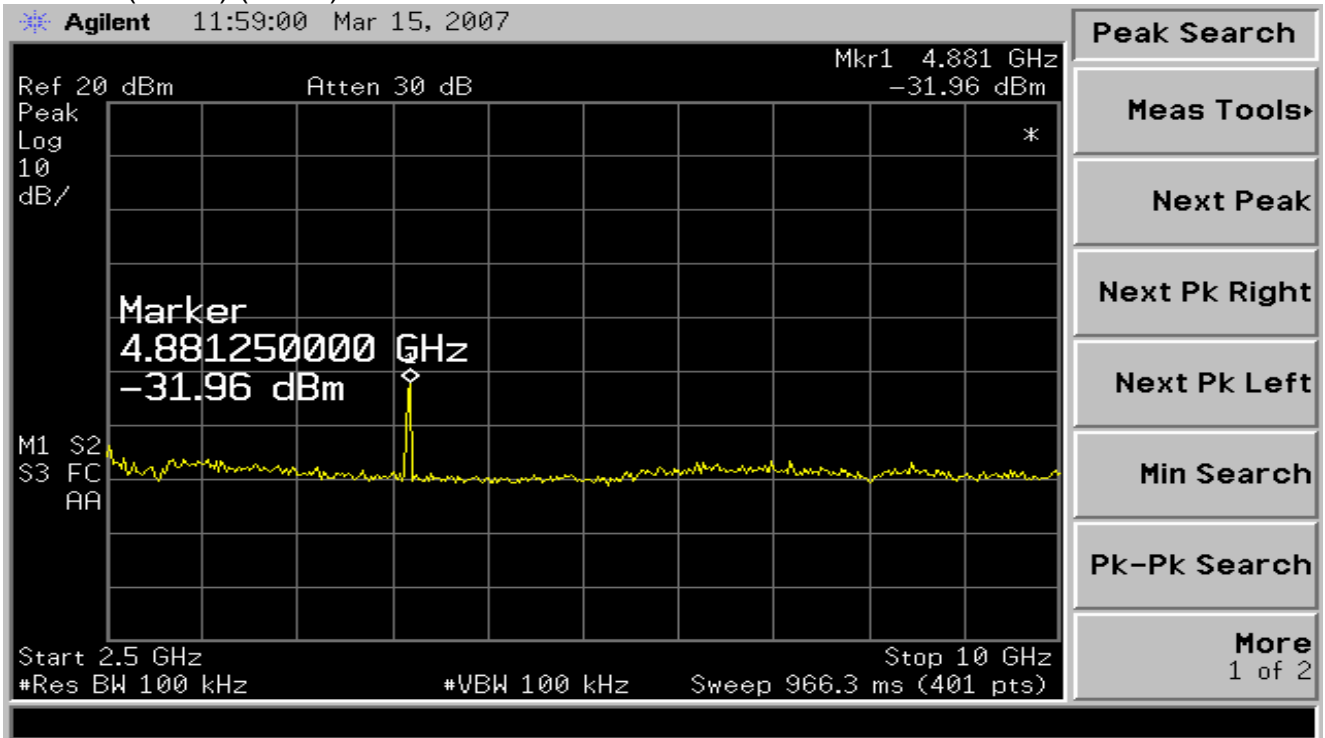

802.11b (CH06) (5 of 5)

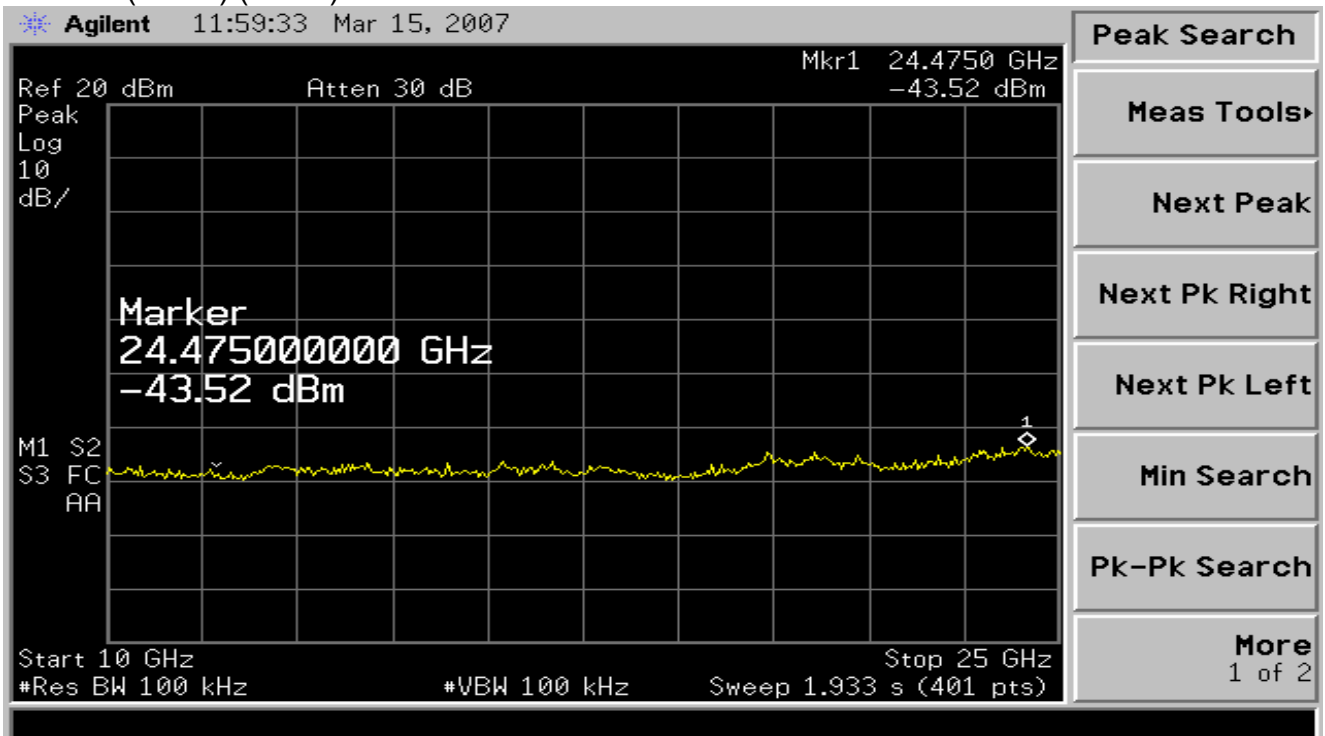

802.11b (CH11)(1 of 5)

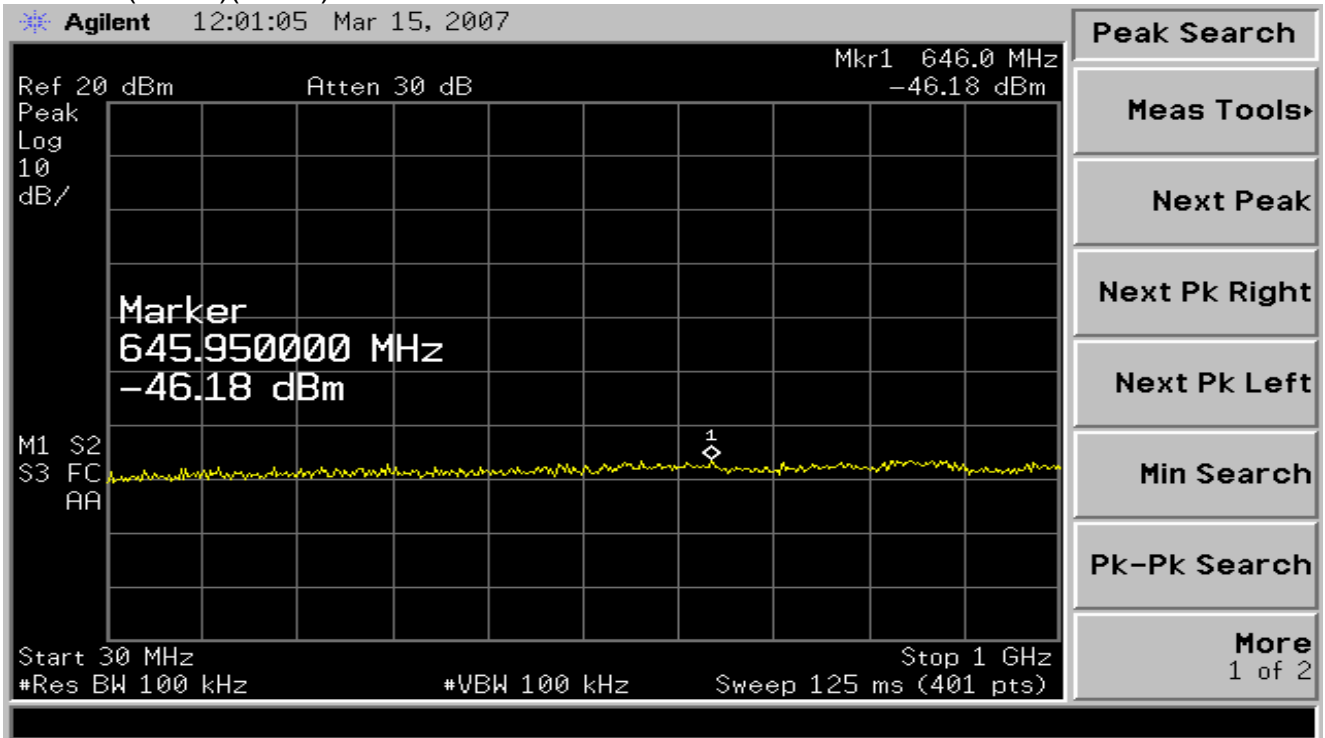

802.11b (CH11)(2 of 5)

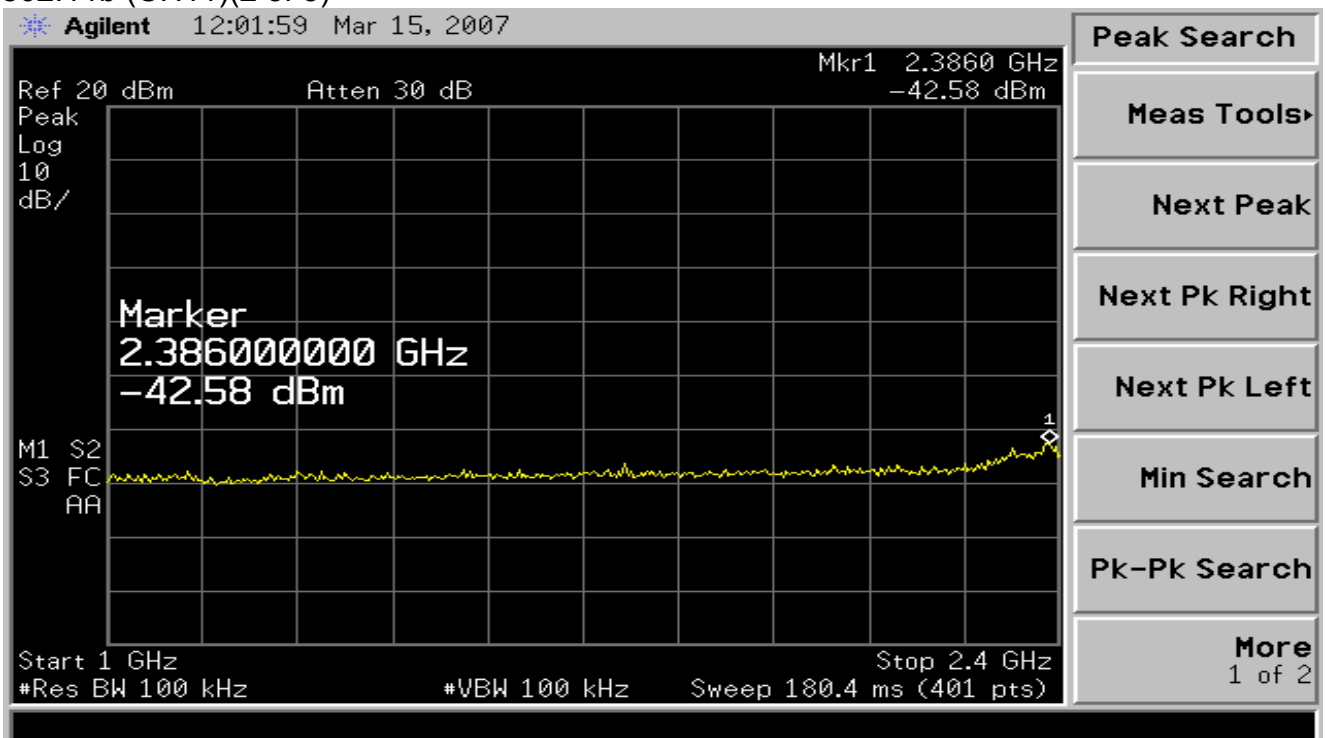

802.11b (CH11)(3 of 5)

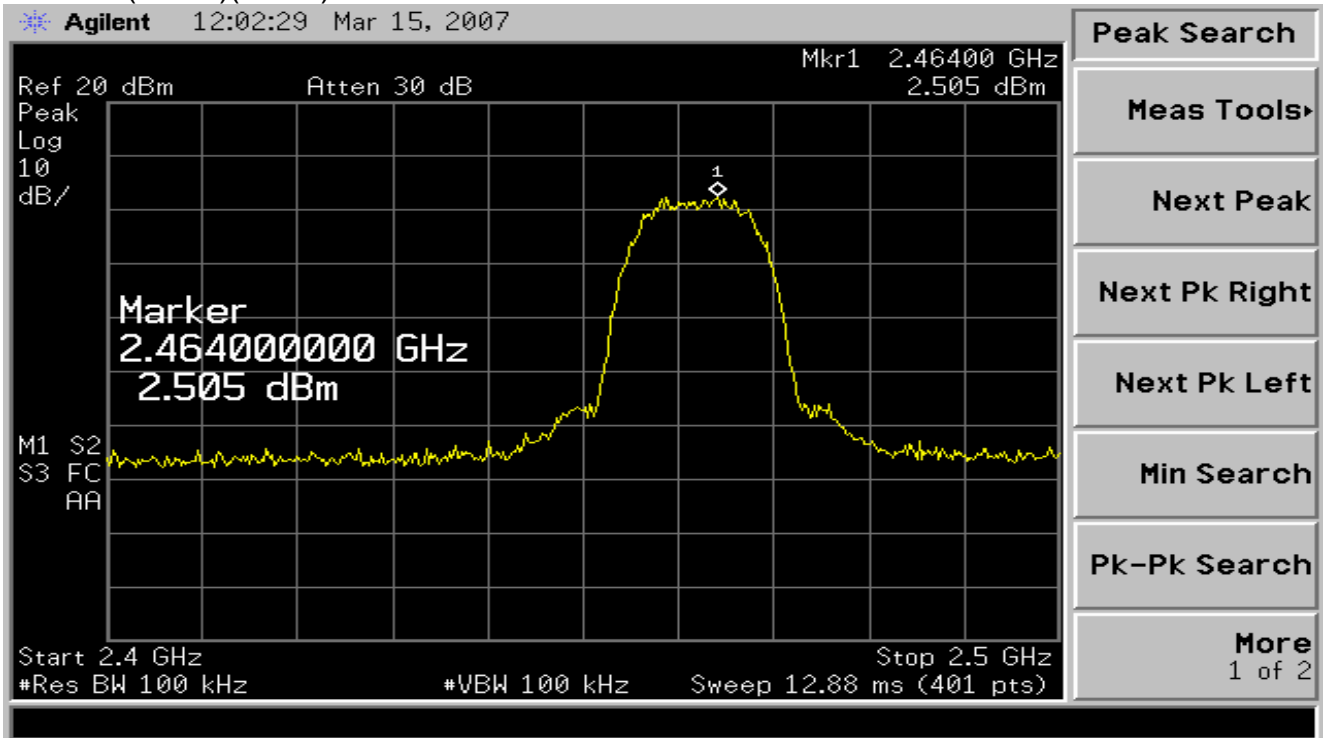

802.11b (CH11)(4 of 5)

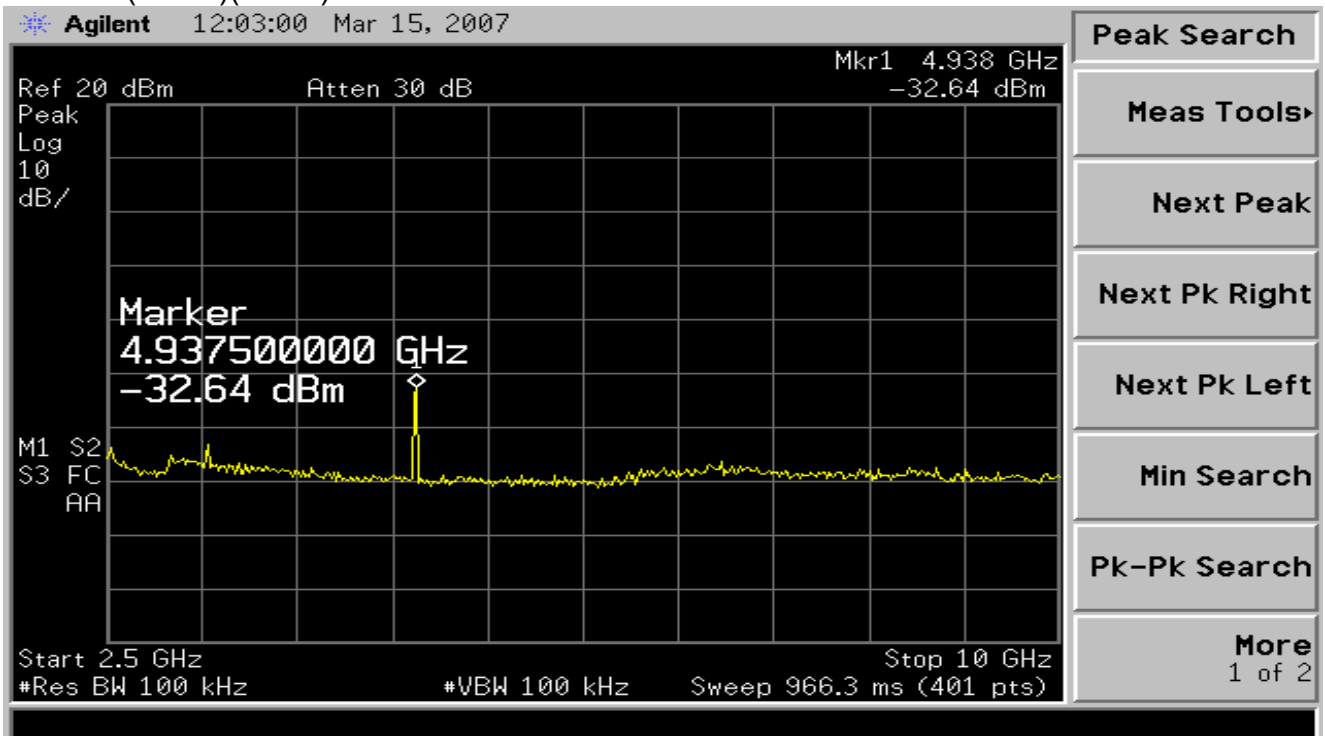

802.11b (CH11)(5 of 5)

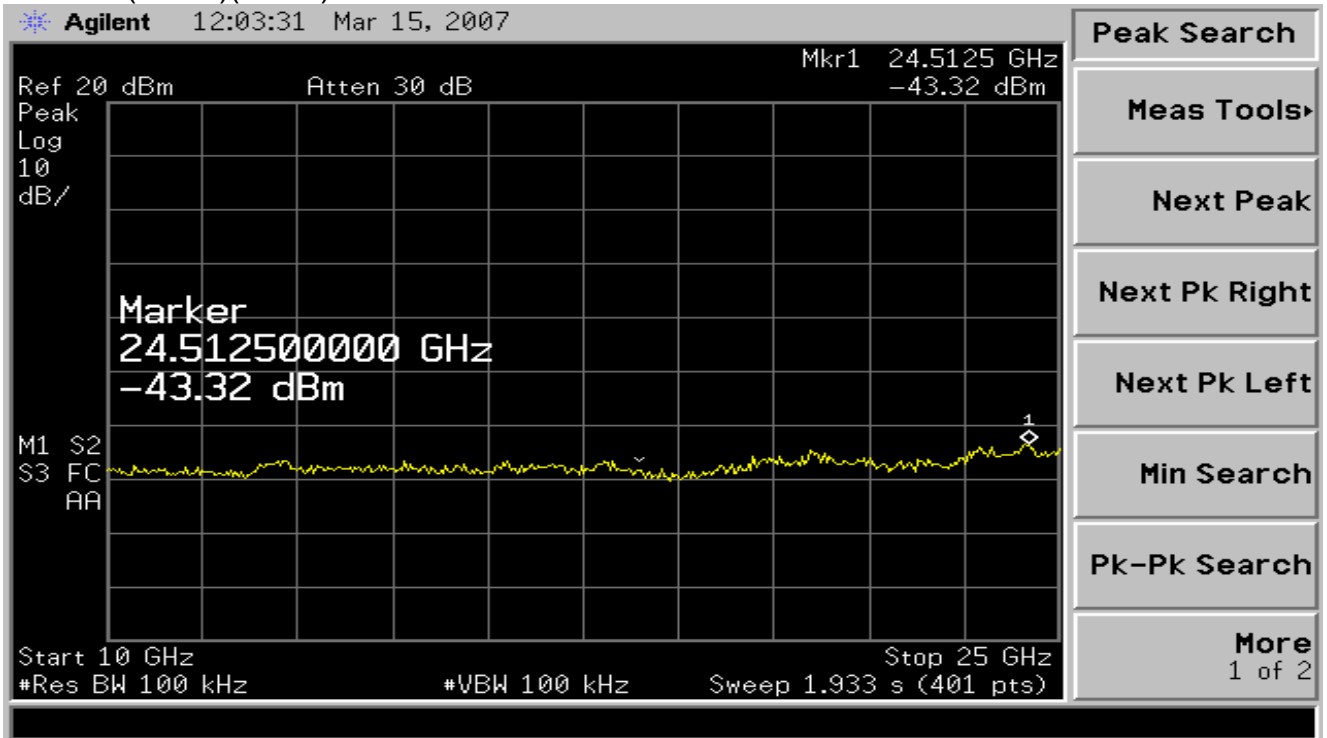

802.11g (CH01) (1 of 5)

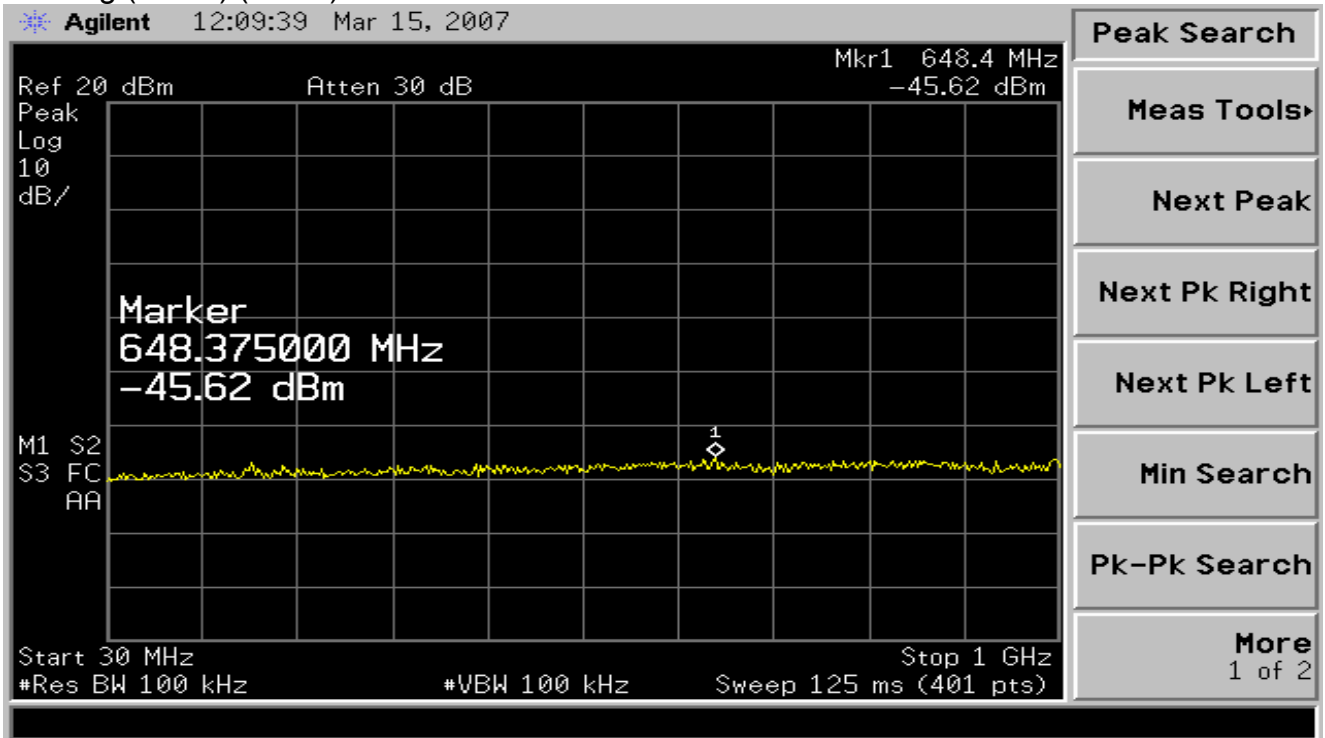

802.11g (CH01) (2 of 5)

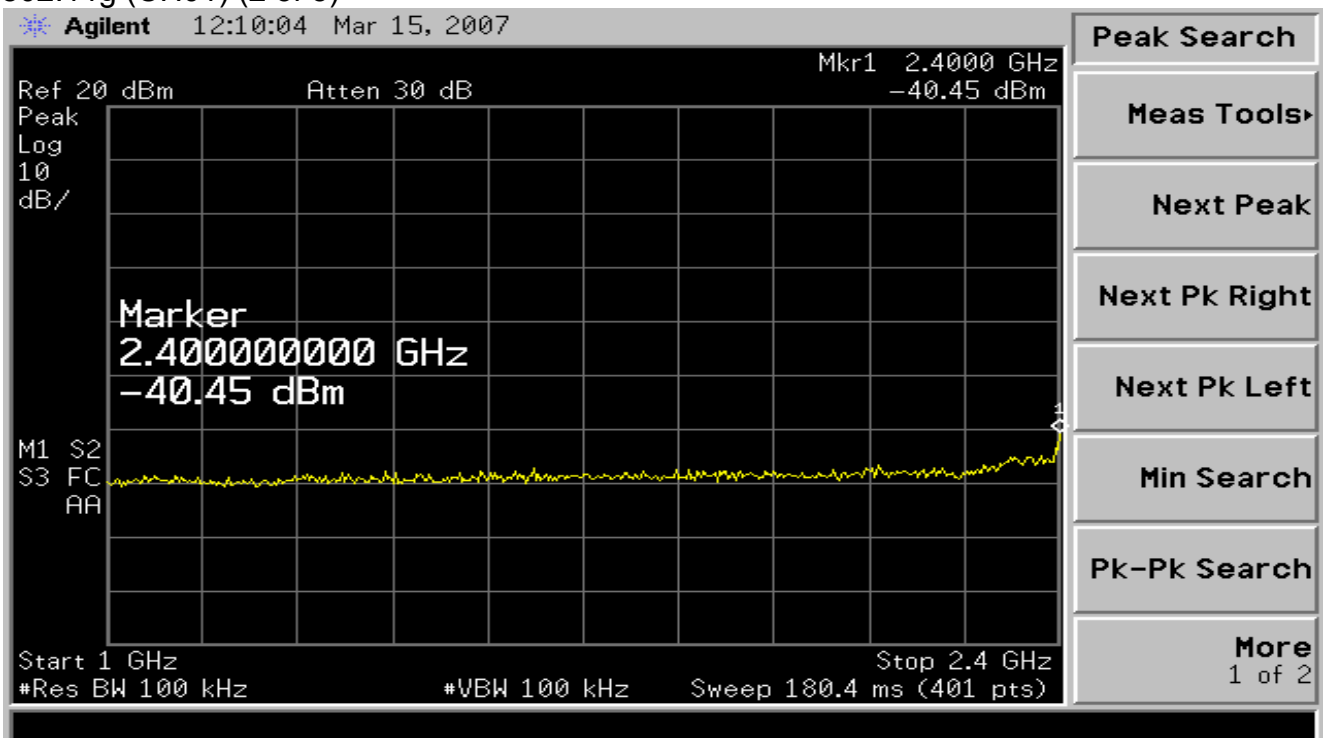

802.11g (CH01) (3 of 5)

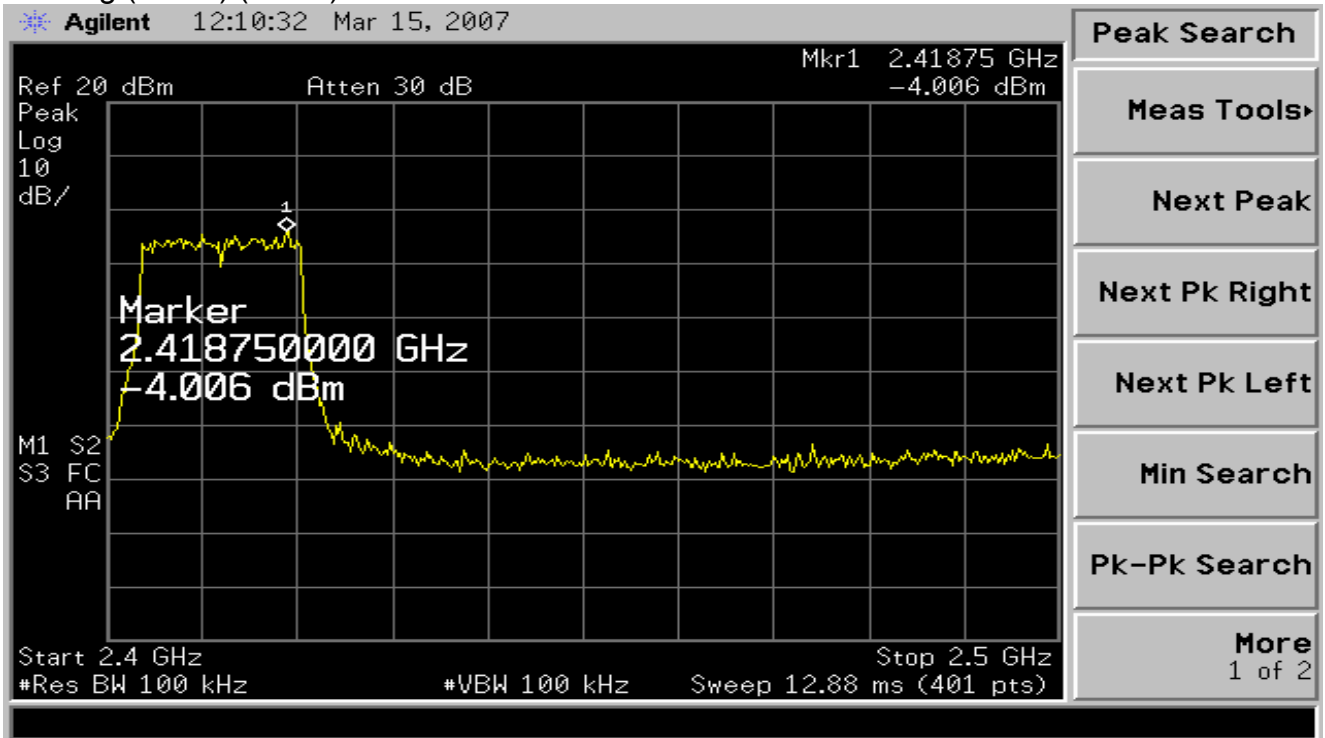

802.11g (CH01) (4 of 5)

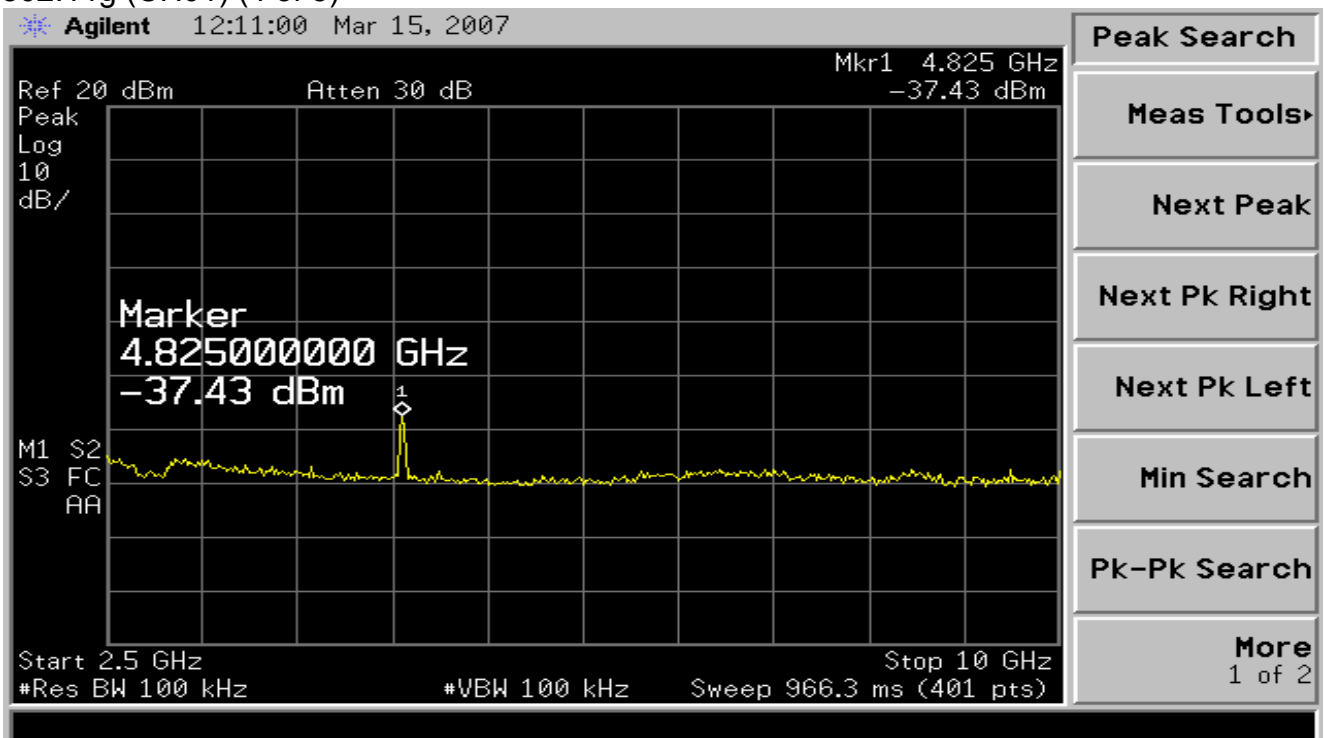

802.11g (CH01) (5 of 5)

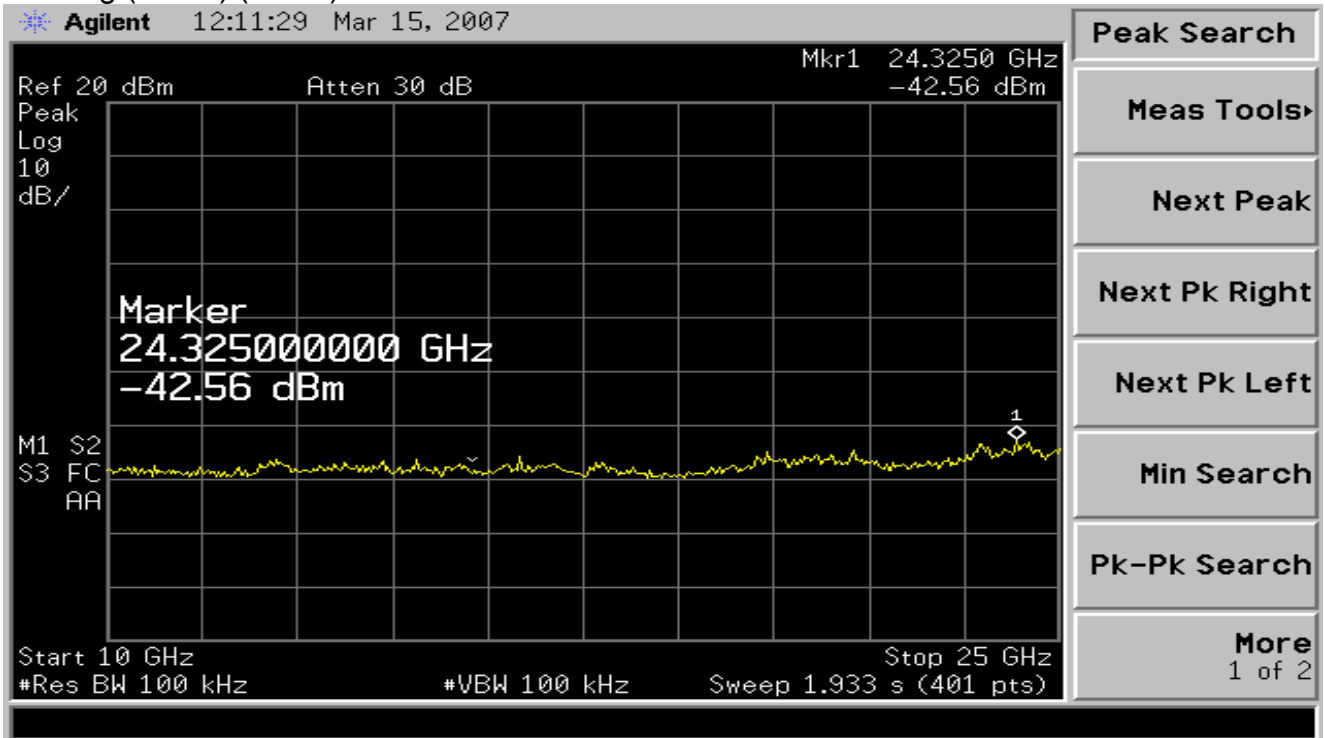

802.11g (CH06) (1 of 5)

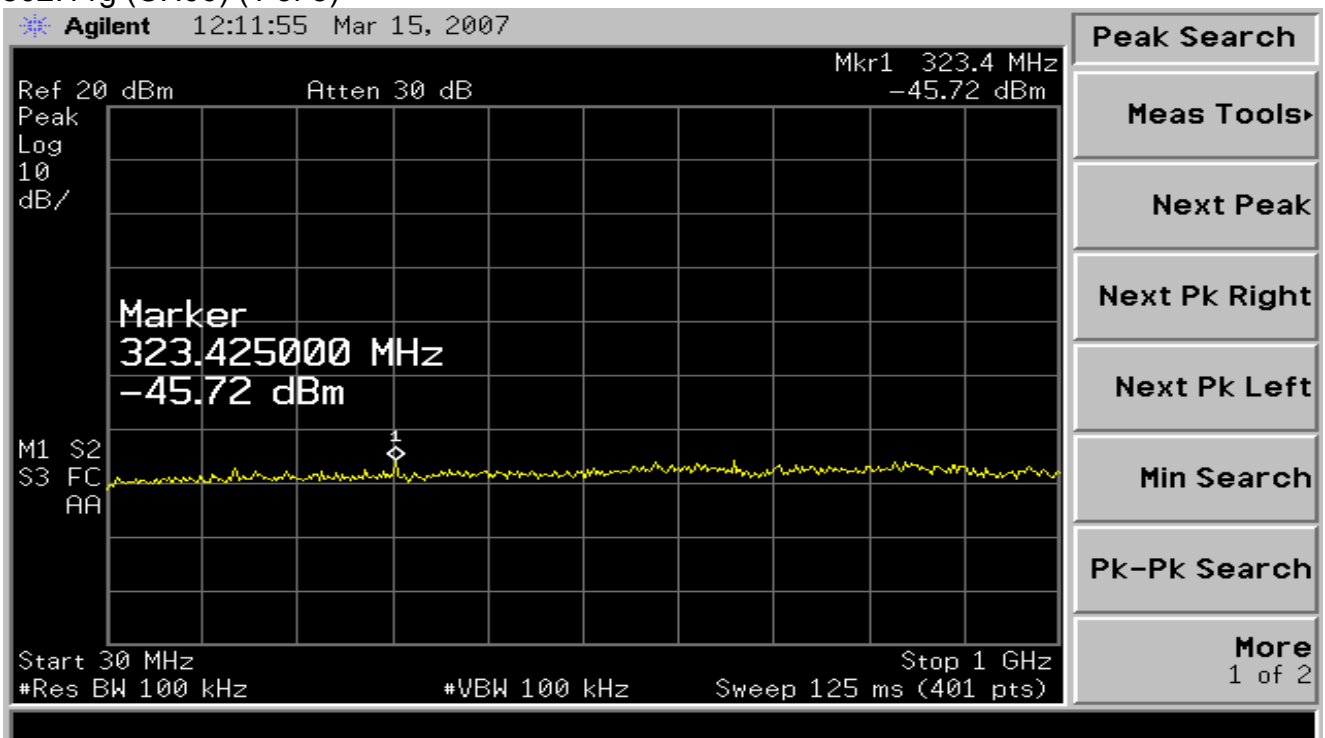

802.11g (CH06) (2 of 5)

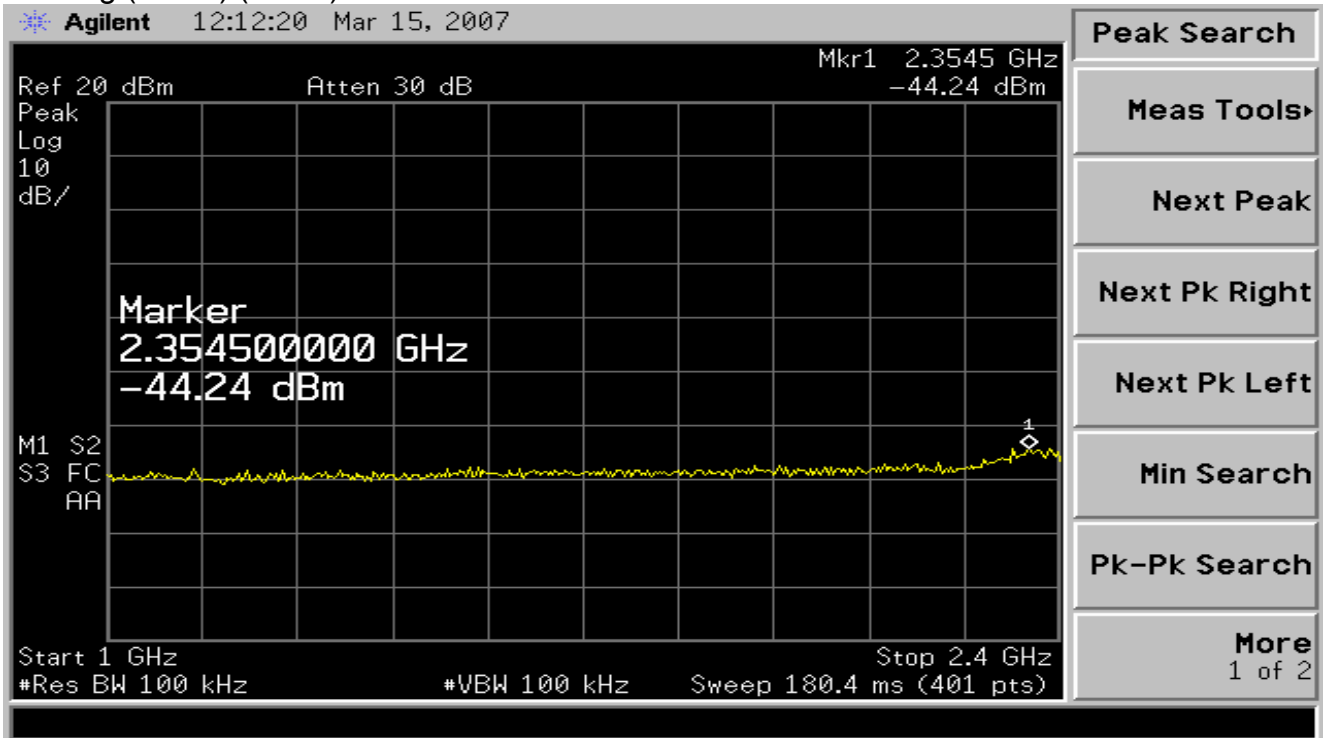

802.11g (CH06) (3 of 5)

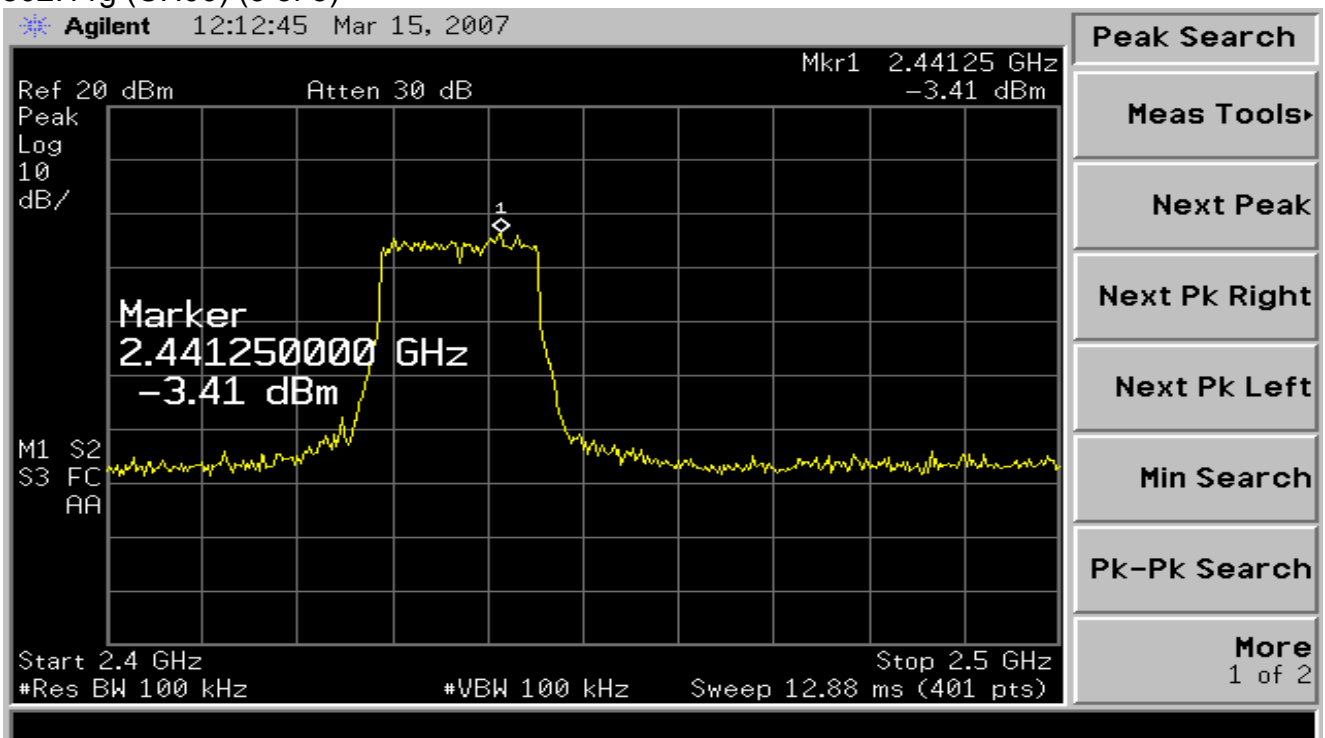

802.11g (CH06) (4 of 5)

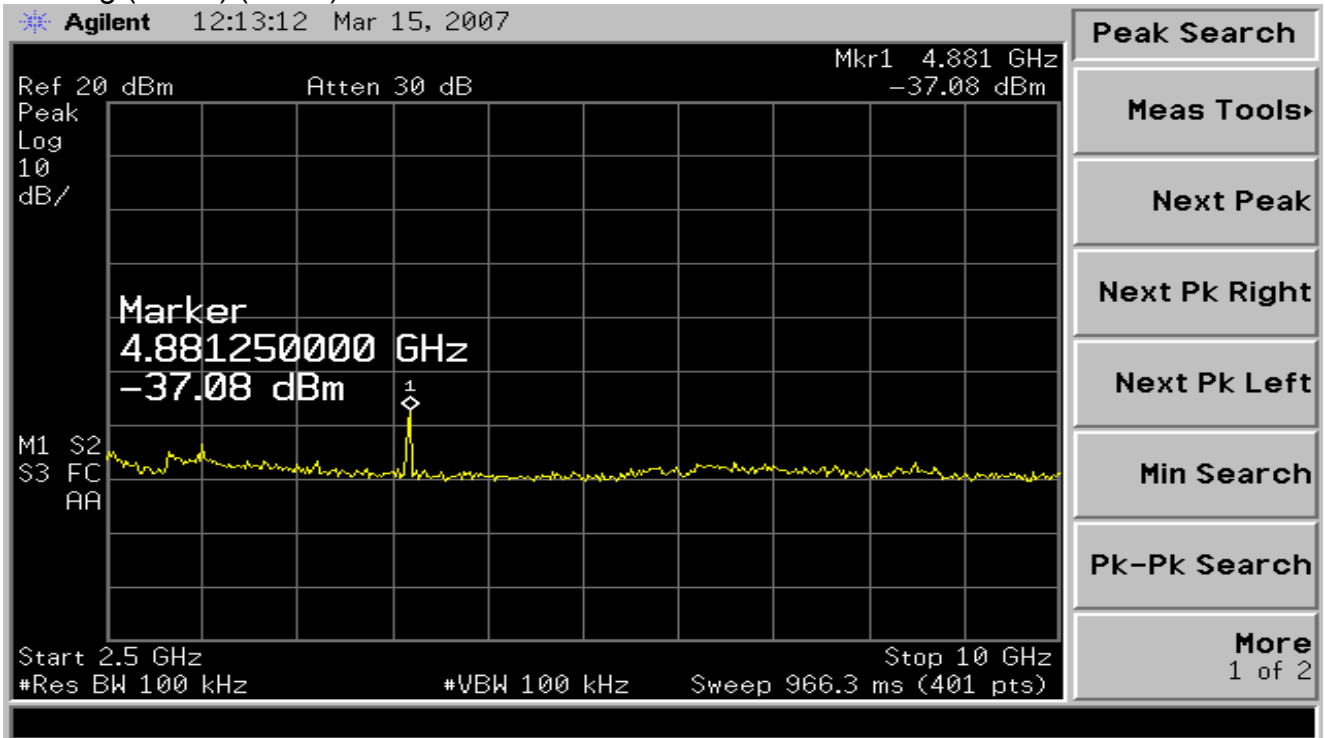

802.11g (CH06) (5 of 5)

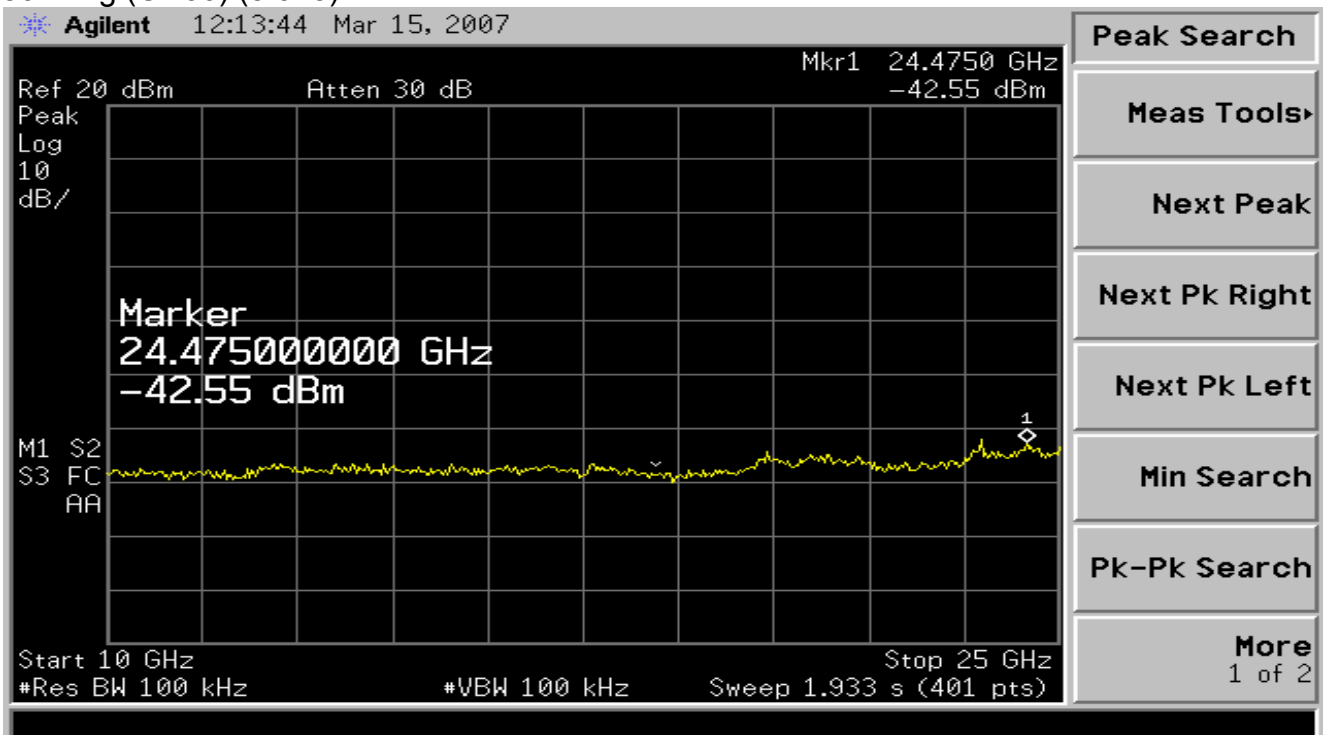

802.11g (CH11)(1 of 5)

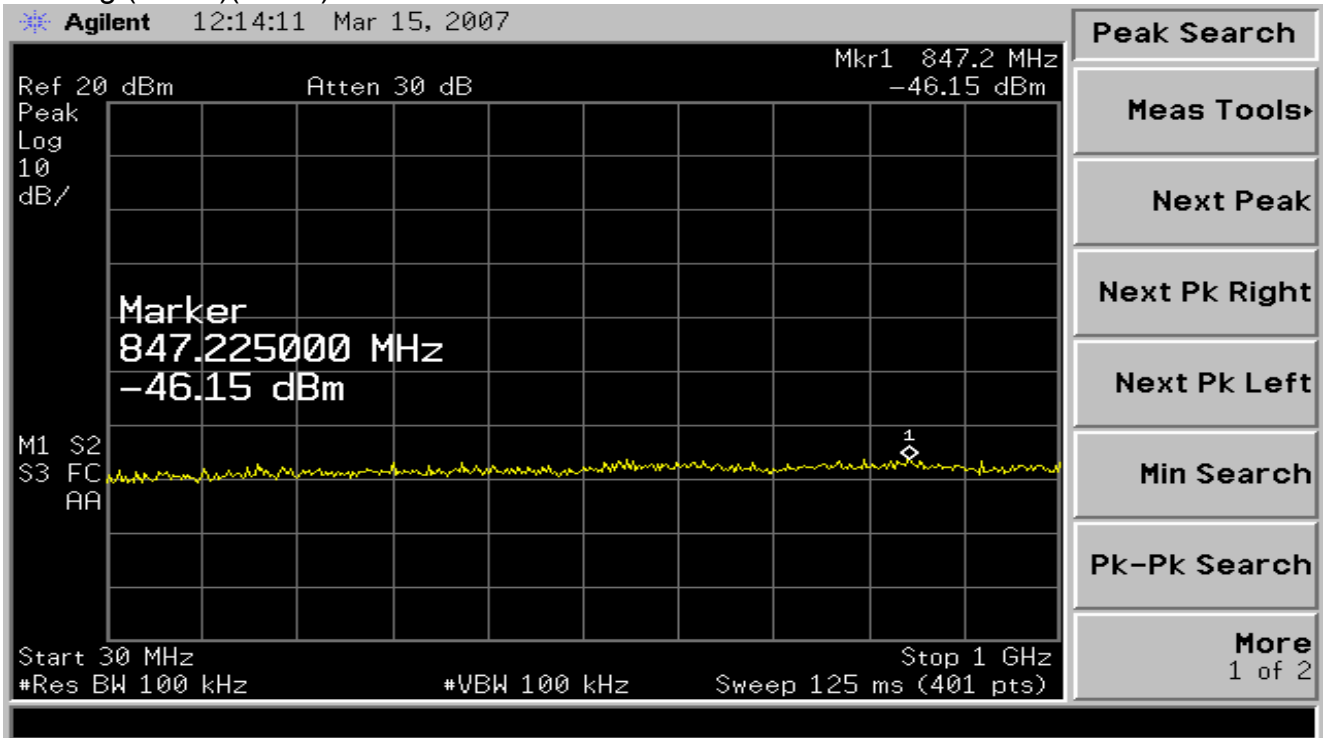

802.11g (CH11)(2 of 5)

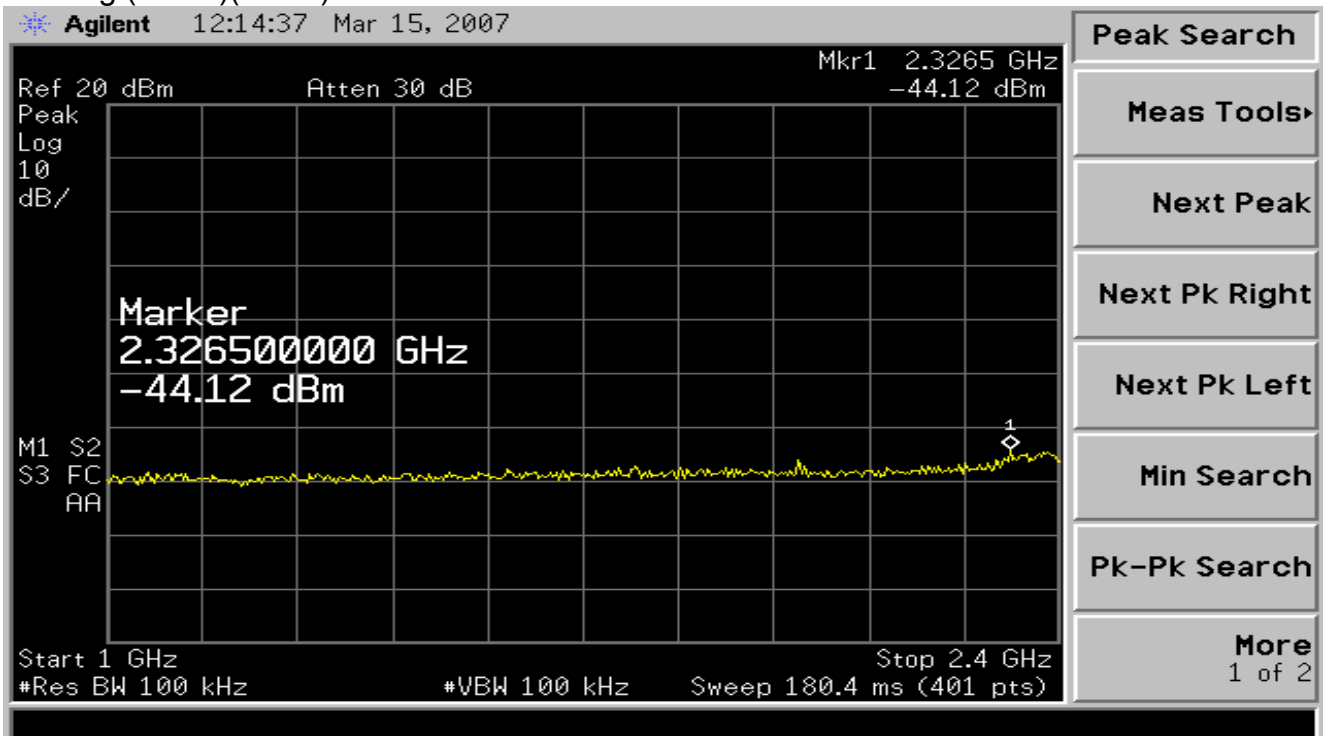

802.11g (CH11)(3 of 5)

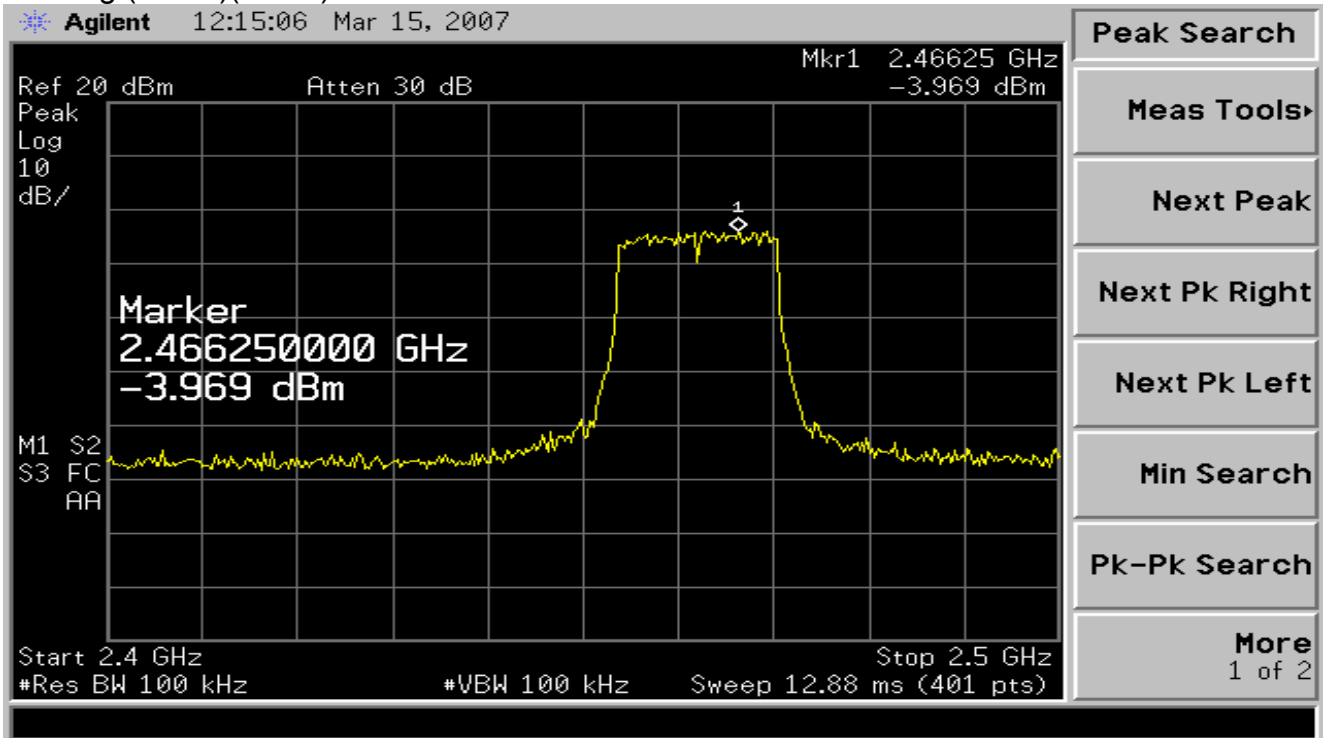

802.11g (CH11)(4 of 5)

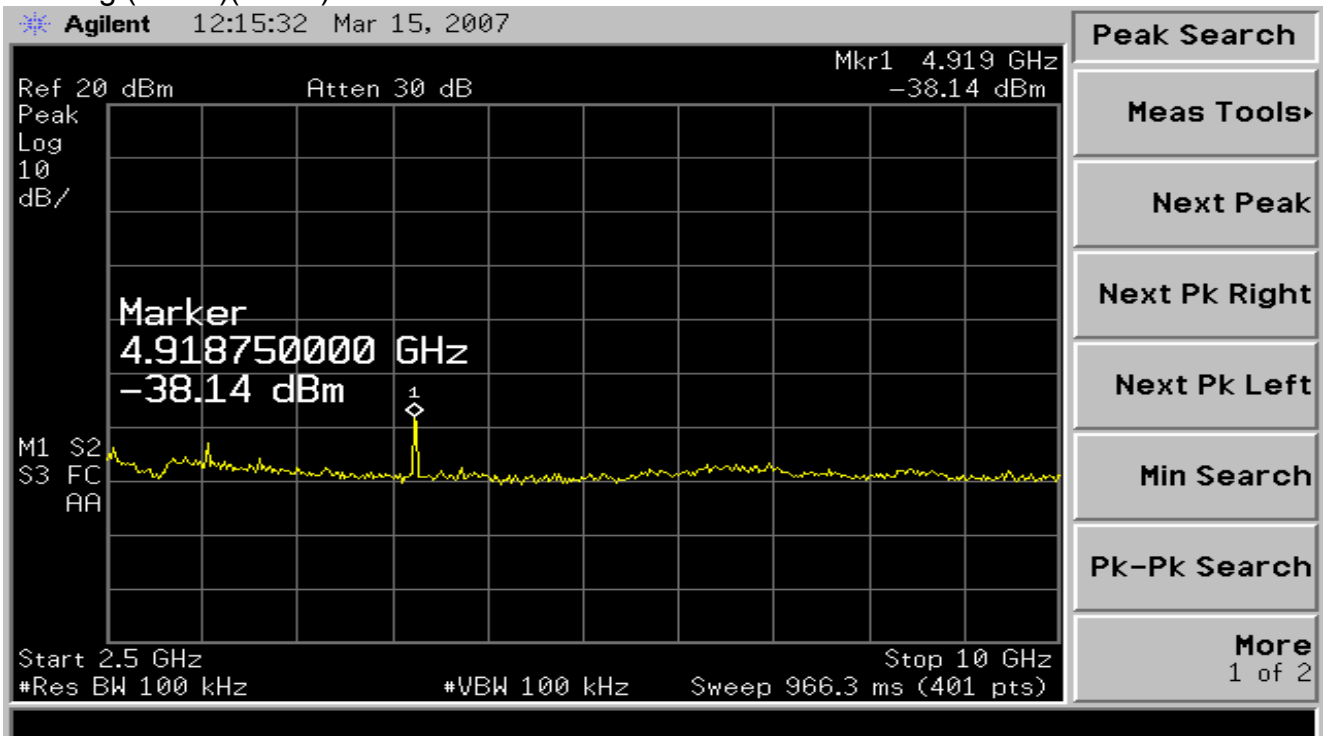

802.11g (CH11)(5 of 5)

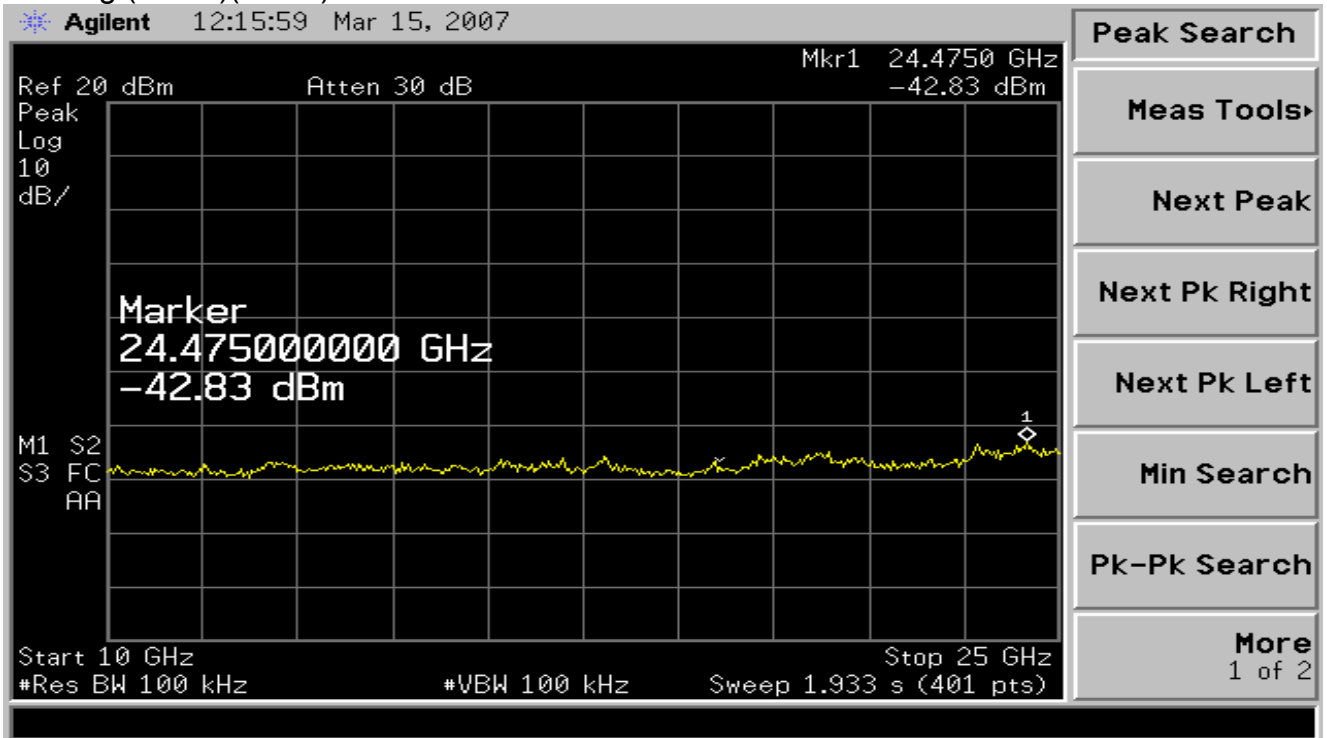

VII. Band Edges Requirements

7.1 Test Condition & Setup :

The emissions on the harmonics frequencies, the limits, and the margin of compliance are presented. These tests were made when the transmitter was in full radiated power. The additional test was performed to show compliance with the requirement at the band-edge frequency 2483.5 MHz and up to 2500 MHz and at 2390.0 MHz.

The transmitter was configured with the worst case antenna and setup to transmit at the highest channel. Then the field strength was measured at 2483.5 MHz.

The transmitter was then configured with the worst case antenna and setup to transmit at the lowest channel. Then the field strength was measured at 2390.0 MHz. These tests were performed at 4 different bit rates.

7.2 Test Instruments Configuration:

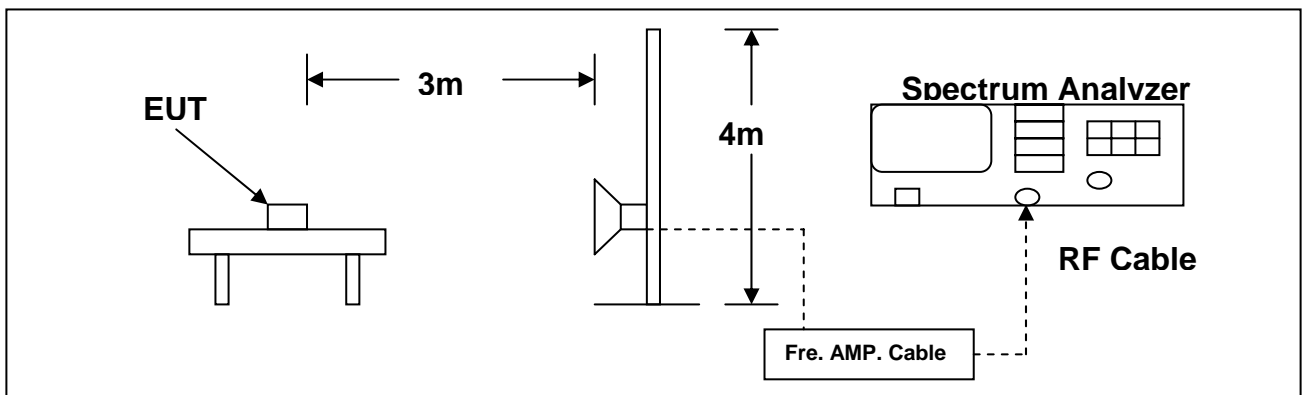

7.3 Test Equipment List:

Item	Mfr/Brand	Instruments	Serial No.	Model/Type No.	Calibrated Date	Next Cali. Date
1.	Agilent	Spectrum Analyzer	US39240419	E4407B	2007/02/01	2008/02/01
2.	HP	Pre Amplifier	3008A01463	8449B	2007/02/12	2008/02/12
3.	SCHWARZBECK	Horn Antenna	304	BBHA 9120 D	2006/07/06	2007/07/06

7.4 Test Result :

(802.11b)

Radiated Emissions (HORIZONTAL) CH01						
Frequency (MHz)	Amplitude (dBuV/m)	Ant. (m)	Table (Degree)	Duty (dB)	Limit (dBuV/m)	Margin (dB)
2387.04	52.05 (AV)	1	250	0	54.00	-1.95
Radiated Emissions (VERTICAL) CH01						
Frequency (MHz)	Amplitude (dBuV/m)	Ant. (m)	Table (Degree)	Duty (dB)	Limit (dBuV/m)	Margin (dB)
2386.64	46.42 (PK)	1	210	0	74.00	-27.58

Radiated Emissions (HORIZONTAL) CH11						
Frequency (MHz)	Amplitude (dBuV/m)	Ant. (m)	Table (Degree)	Duty (dB)	Limit (dBuV/m)	Margin (dB)
2487.25	47.50 (AV)	1	320	0	54.00	-6.50
Radiated Emissions (VERTICAL) CH11						
Frequency (MHz)	Amplitude (dBuV/m)	Ant. (m)	Table (Degree)	Duty (dB)	Limit (dBuV/m)	Margin (dB)
2487.05	44.16 (PK)	1	150	0	74.00	-29.84

Notes : 1.Margin= Amplitude - Limits

2.Height of table for EUT placed: 0.8 Meter.

3.ANT= Antenna height.

4.Duty= Duty cycle correction factor.

5. Amplitude= Reading Amplitude – Amplifier gain+ Cable loss+ Antenna factor
(Auto calculate in spectrum analyzer)

7.5 Test Result :

(802.11g)

Radiated Emissions (HORIZONTAL) CH01						
Frequency (MHz)	Amplitude (dBuV/m)	Ant. (m)	Table (Degree)	Duty (dB)	Limit (dBuV/m)	Margin (dB)
2389.99	49.97 (AV)	1	160	0	54.00	-4.03
Radiated Emissions (VERTICAL) CH01						
Frequency (MHz)	Amplitude (dBuV/m)	Ant. (m)	Table (Degree)	Duty (dB)	Limit (dBuV/m)	Margin (dB)
2389.99	45.23 (PK)	1	240	0	74.00	-28.77

Radiated Emissions (HORIZONTAL) CH11						
Frequency (MHz)	Amplitude (dBuV/m)	Ant. (m)	Table (Degree)	Duty (dB)	Limit (dBuV/m)	Margin (dB)
2483.65	48.89 (AV)	1	320	0	54.00	-5.11
Radiated Emissions (VERTICAL) CH11						
Frequency (MHz)	Amplitude (dBuV/m)	Ant. (m)	Table (Degree)	Duty (dB)	Limit (dBuV/m)	Margin (dB)
2483.75	48.76 (AV)	1	280	0	54.00	-5.24

Notes : 1.Margin= Amplitude - Limits

2.Height of table for EUT placed: 0.8 Meter.

3.ANT= Antenna height.

4.Duty= Duty cycle correction factor.

5. Amplitude= Reading Amplitude – Amplifier gain+ Cable loss+ Antenna factor
(Auto calculate in spectrum analyzer)

VIII. Antenna Requirements

8.1 Standard Applicable :

For intentional device, according to 15.203, an intentional radiator shall be designed to ensure that no antenna other than that furnished by the responsible party shall be used with the device.

And According to 15.247 (b), if transmitting antennas of directional gain greater than 6 dBi are used, the power shall be reduced by the amount in dB that the directional gain of the antenna exceeds 6dBi.

8.2 Antenna Construction

	Model No	ANT TYPE	GAIN	type of connector
1	WSS002	1/4 λ Dipole Sleeve	2.0 dBi	Reverse SMA

Appendix I- EUT Test SETUP

MEASUREMENT OF POWER LINE CONDUCTED RFI VOLTAGE

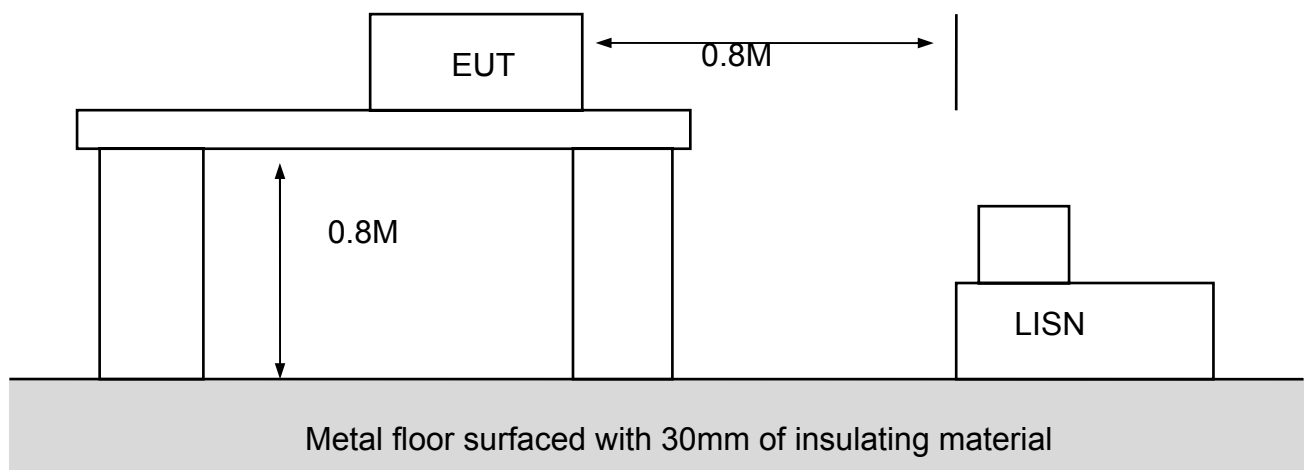

MEASUREMENT OF RADIATED EMISSION

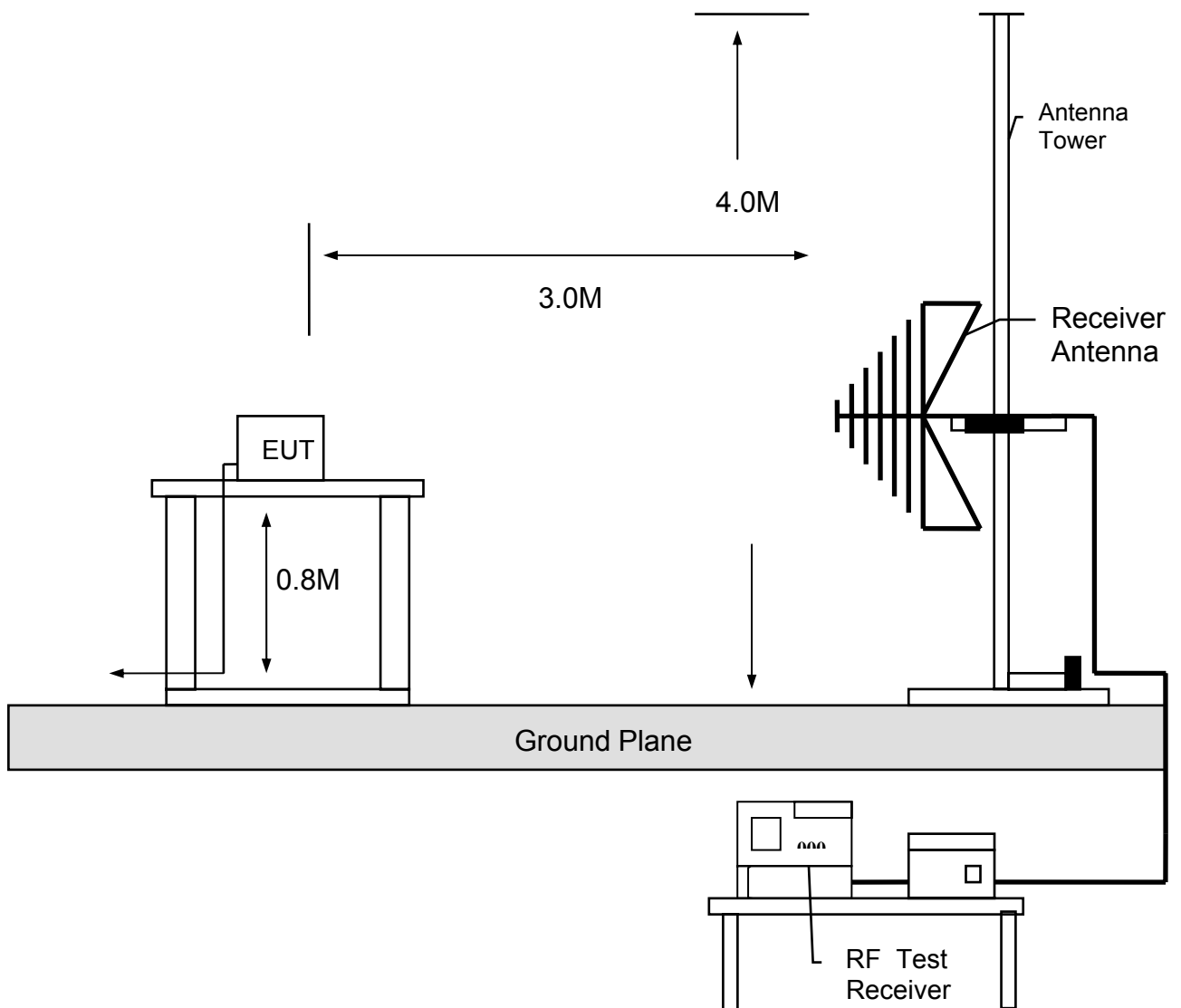

Appendix II - (Brand / Trade Name & Model No. Multiple Listee)

Model No.	Trade Name
Amigo E-TOP	AWI-922m WM101m