

Mini PCI I/F and Power

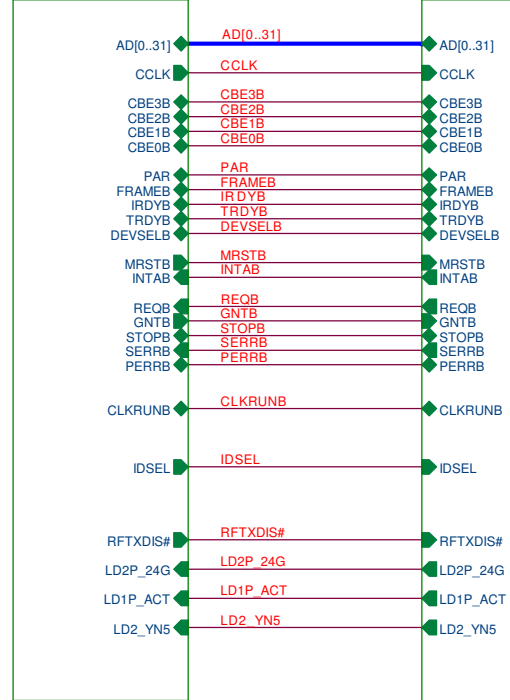

4-MINIPCI.SCH

MAC RT2661

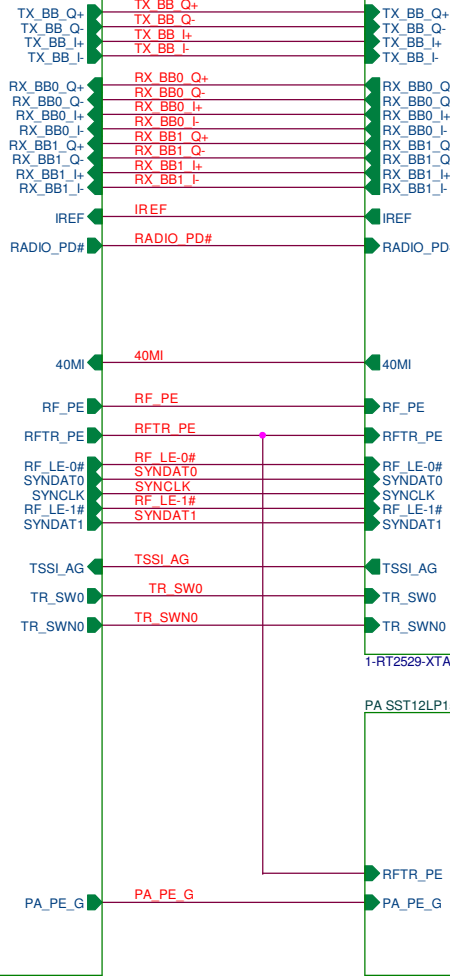

3-RT2661-MPCI

Transceiver RT2529

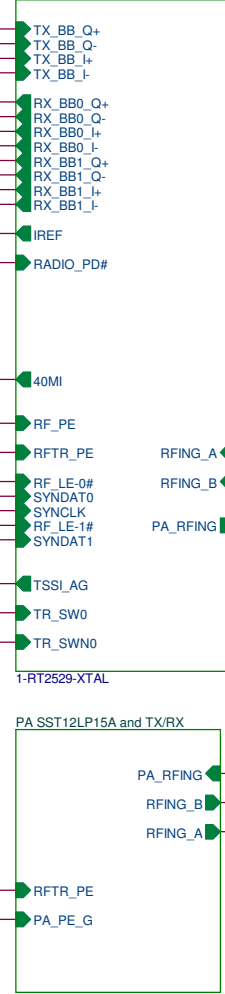

2-PA-SST12LP15A-LNA

E-TOP NETWORK TECHNOLOGY INC.

Title		
WM101m_V10_20070322		
Size	Document Number	Rev
B	MPCI-RT2600-V10ST-X-HP.SCH	1.0
Date:	Friday, March 23, 2007	Sheet 1 of 5

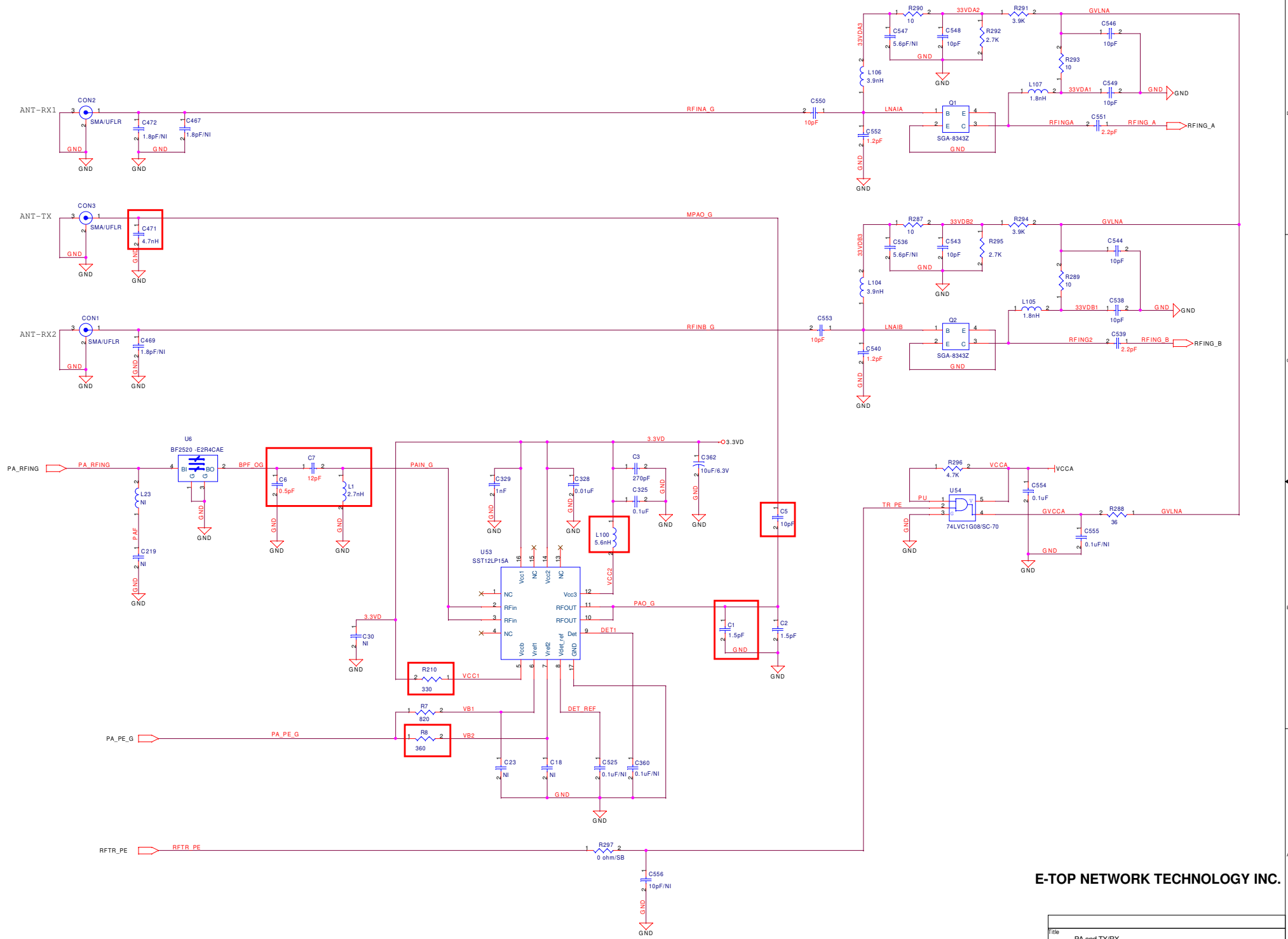

E-TOP NETWORK TECHNOLOGY INC.

Title		PA and TX/RX	
Size	Document Number	2-PA-SST12LP15A-LNA.SCH	
Date:	Friday, March 23, 2007	Sheet	3 of 5
Rev	1.0		

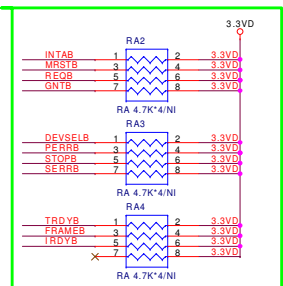

AD[0..31] AD[0..31]

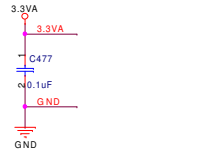
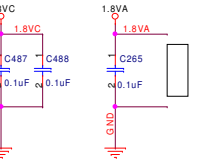
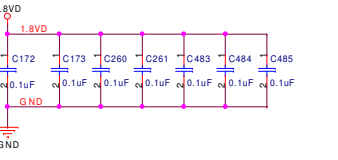
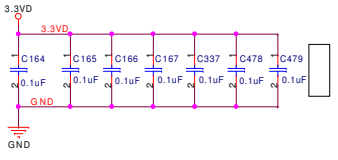
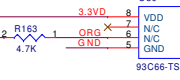
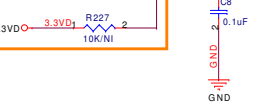
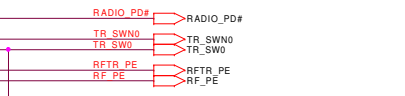
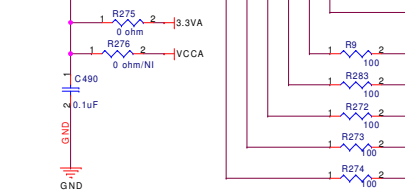
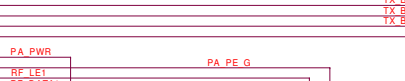
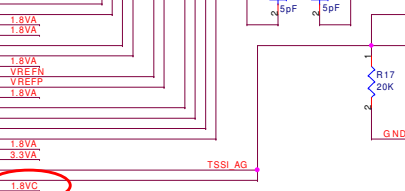
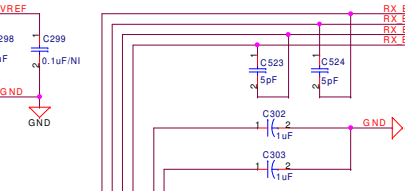
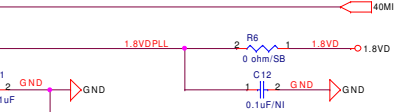
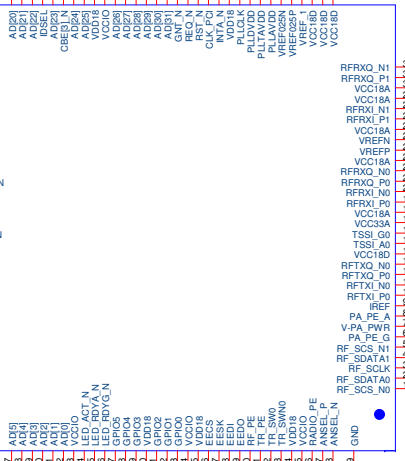
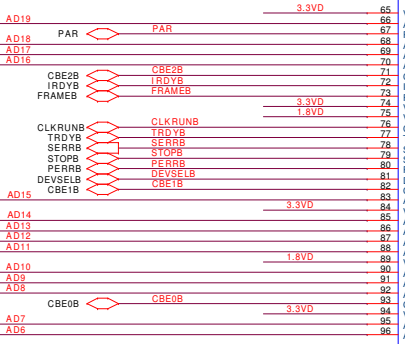

Mode	Install	Not Install
93C46	R206	R1
93C66	R1	R206

E-TOP NETWORK TECHNOLOGY INC.

Title: WLAN MAC+BBP - RT2661		
Size C	Document Number: 3-RT2661-MPCISCH	Rev 1.0
Date: Friday, March 23, 2007	Sheet 4 of 5	

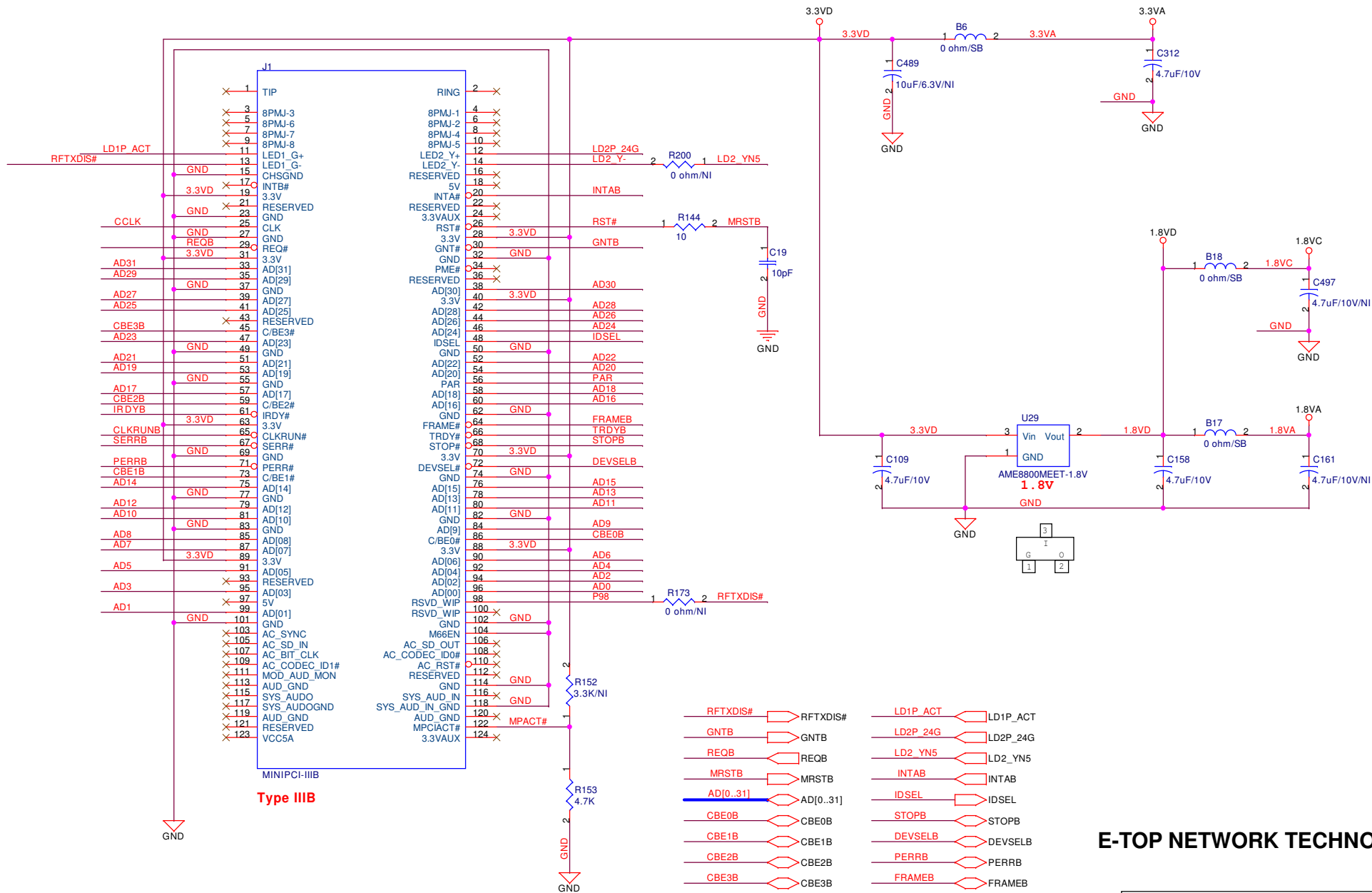

E-TOP NETWORK TECHNOLOGY INC.

Title		
Mini PCI Interface and Power		
Size	Document Number	Rev
B	4-MINIPCI.SCH	1.0
Date:	Friday, March 23, 2007	Sheet 5 of 5