

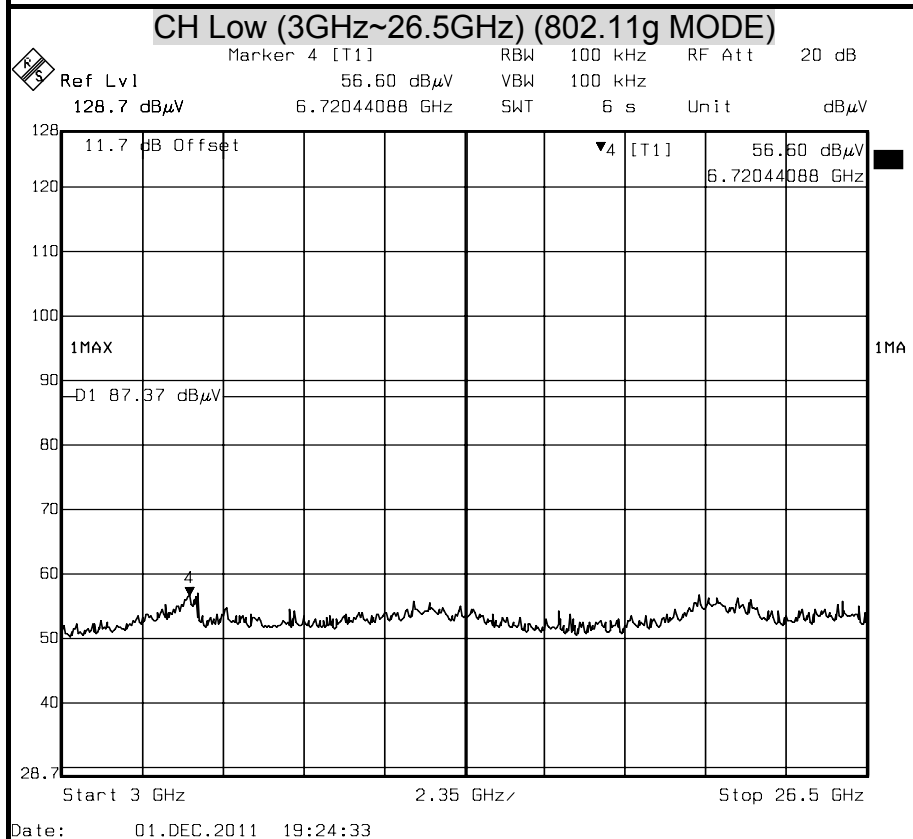

OUT-OF-BAND SPURIOUS EMISSIONS-CONDUCTED MEASUREMENT (802.11g MODE)

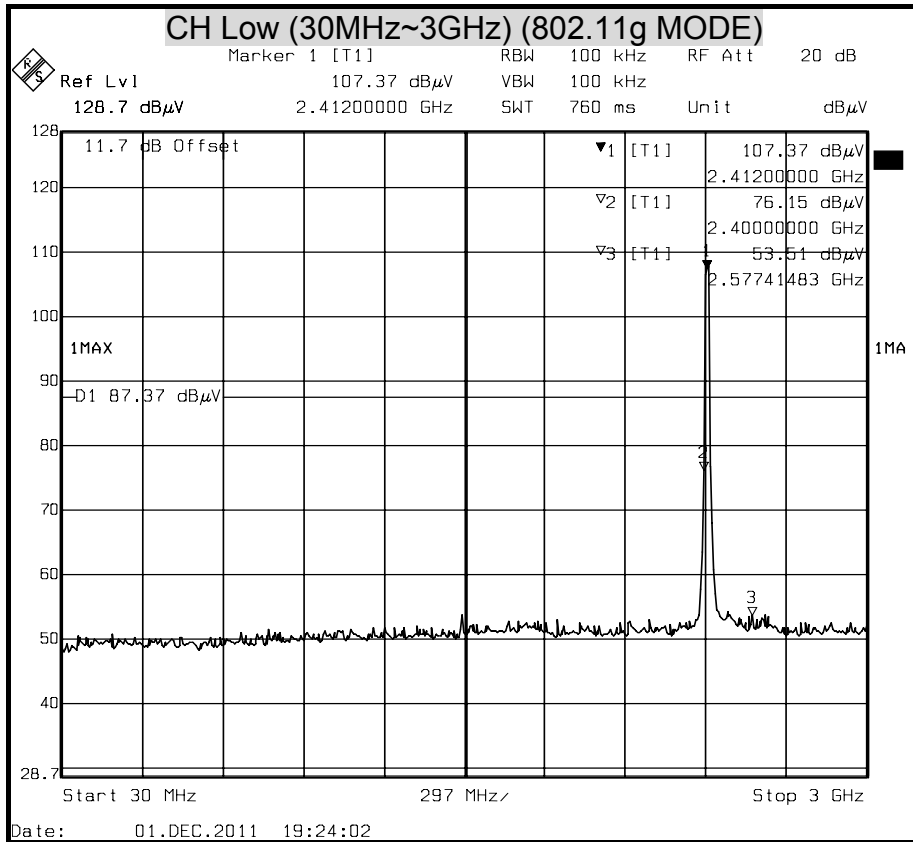

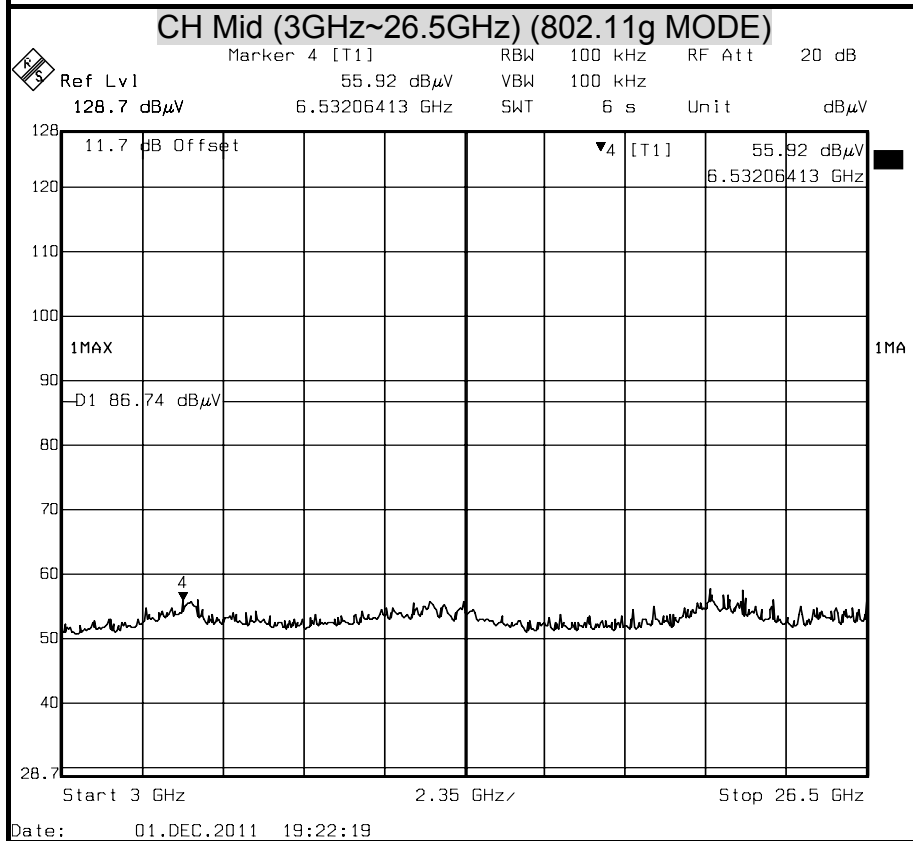

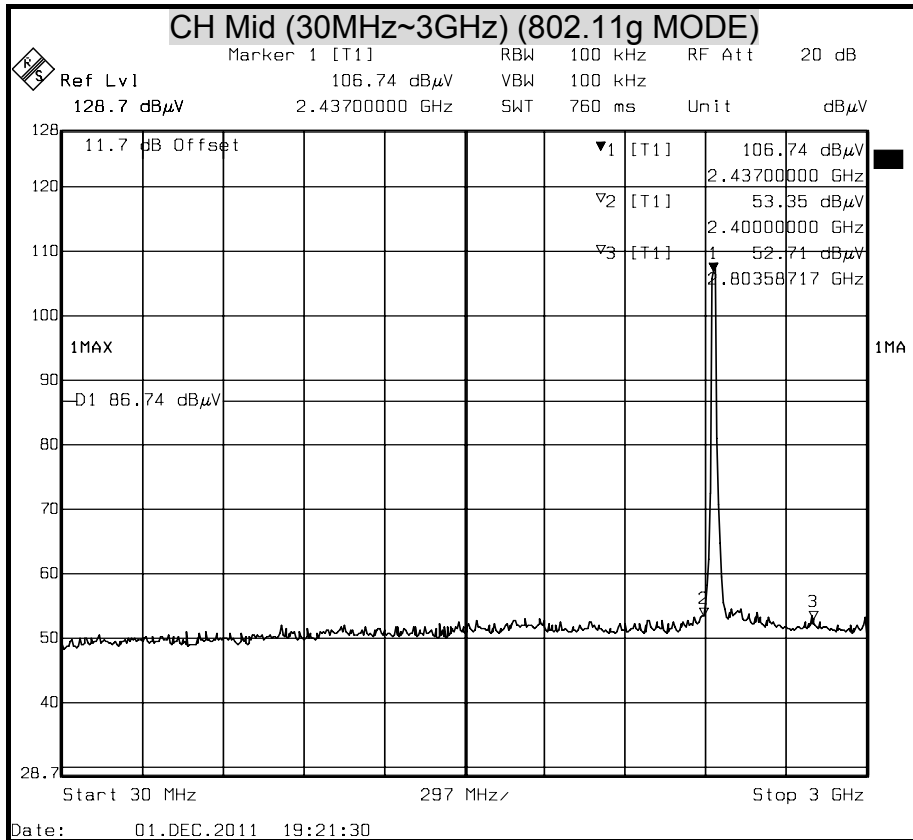
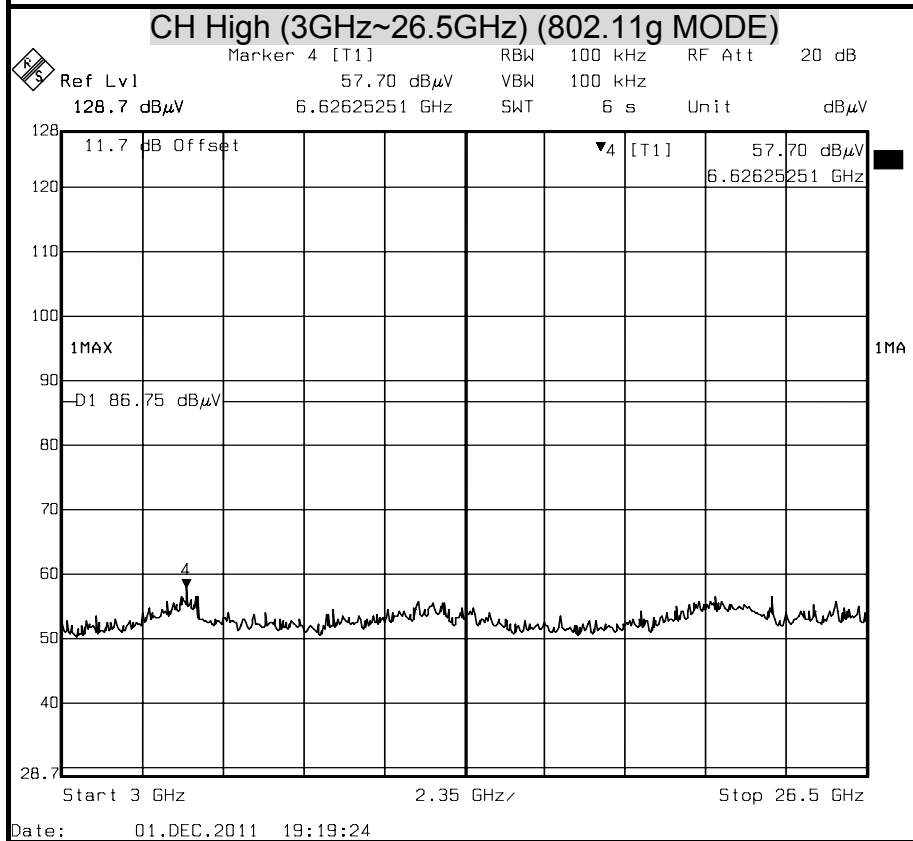
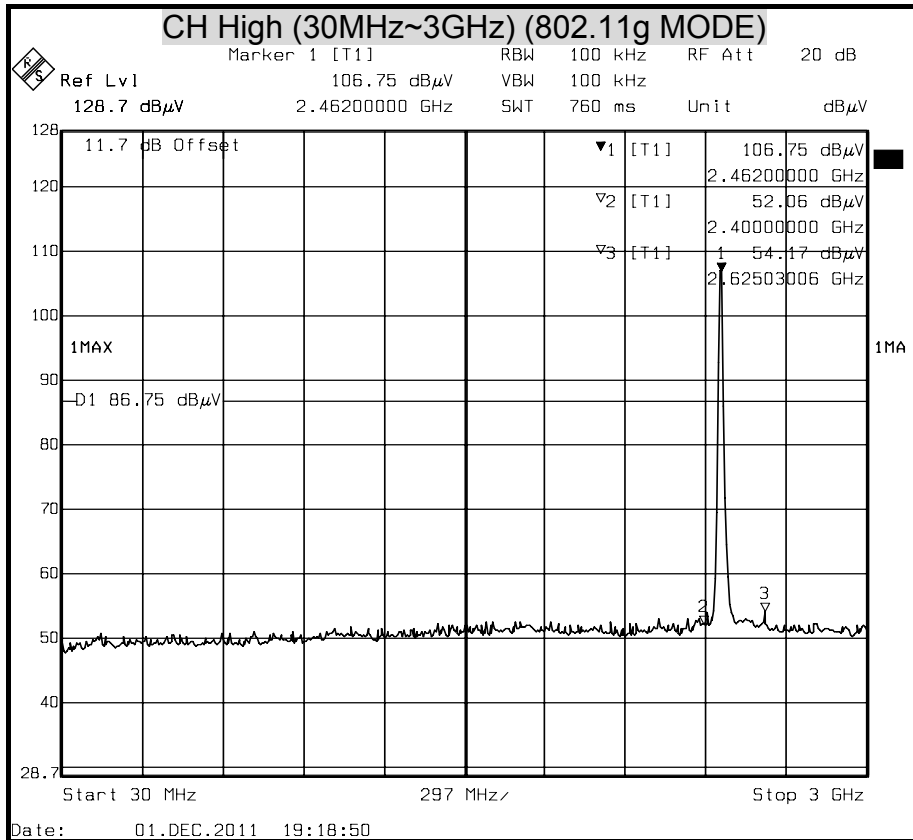



OUT-OF-BAND SPURIOUS EMISSIONS-CONDUCTED MEASUREMENT
(802.11n HT20 MODE)

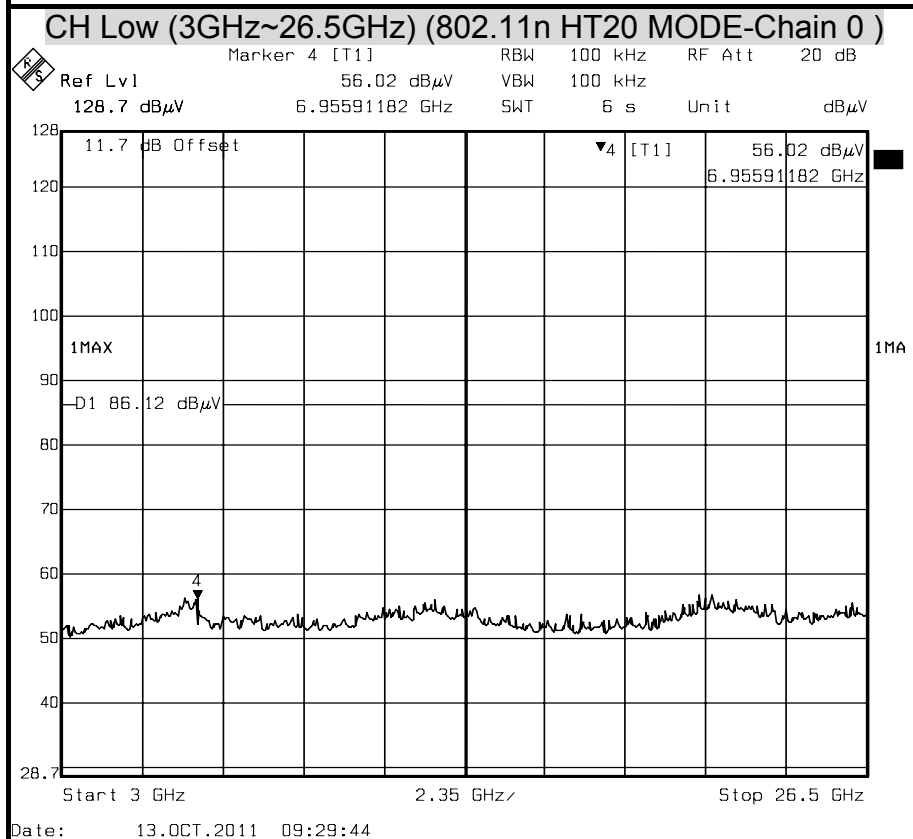
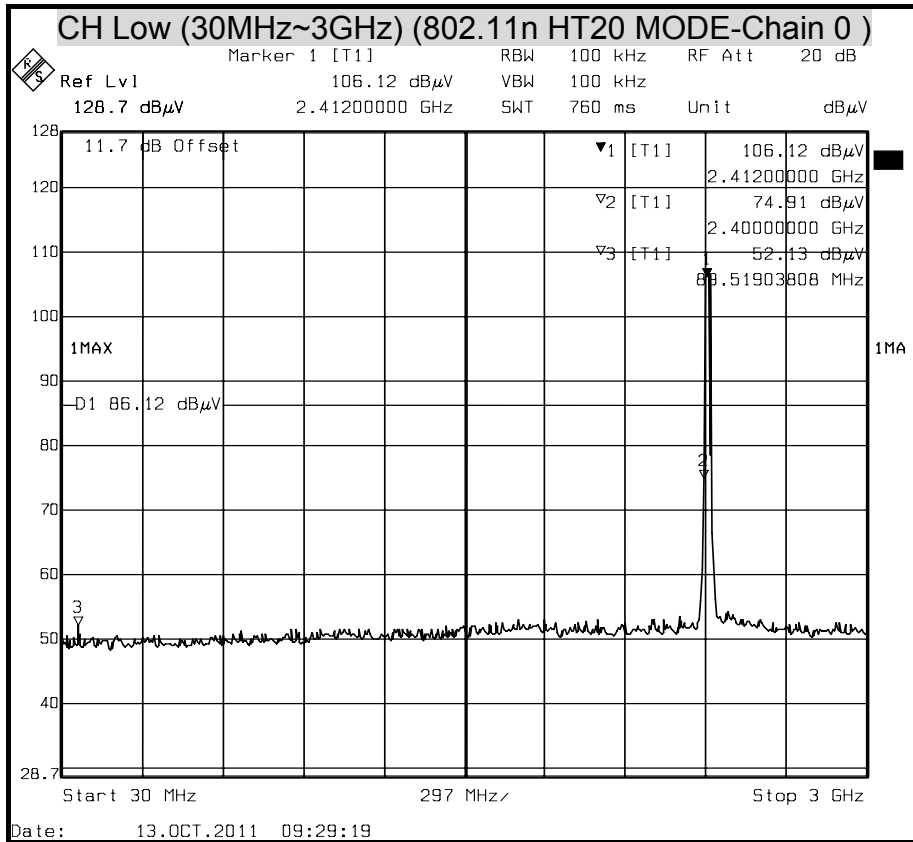

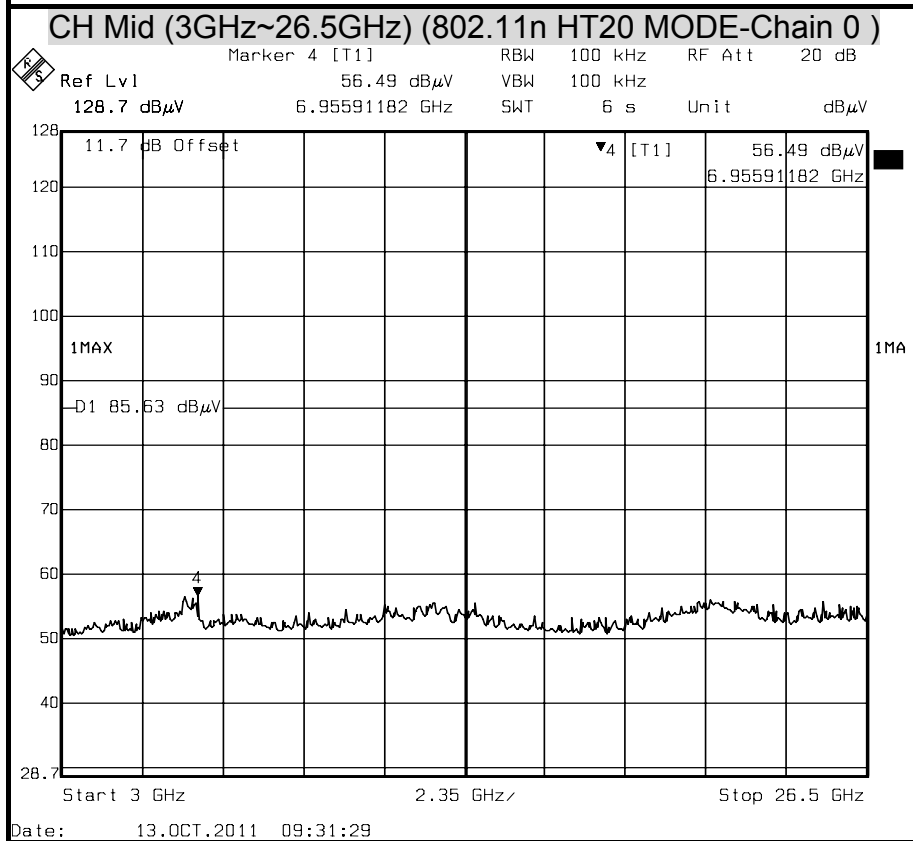
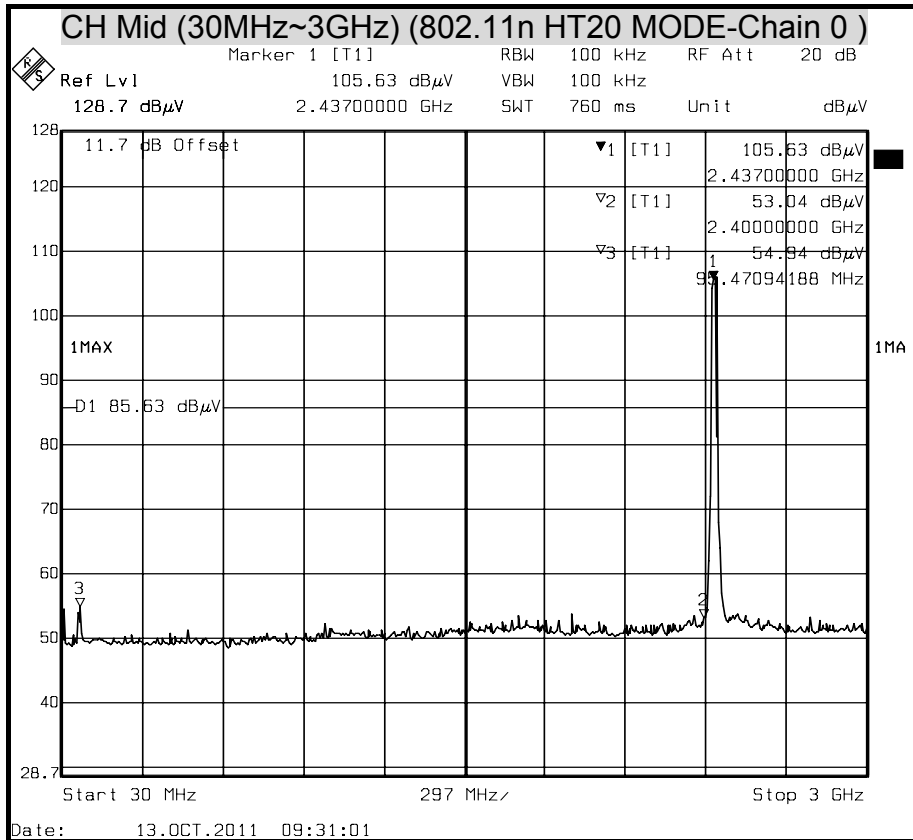

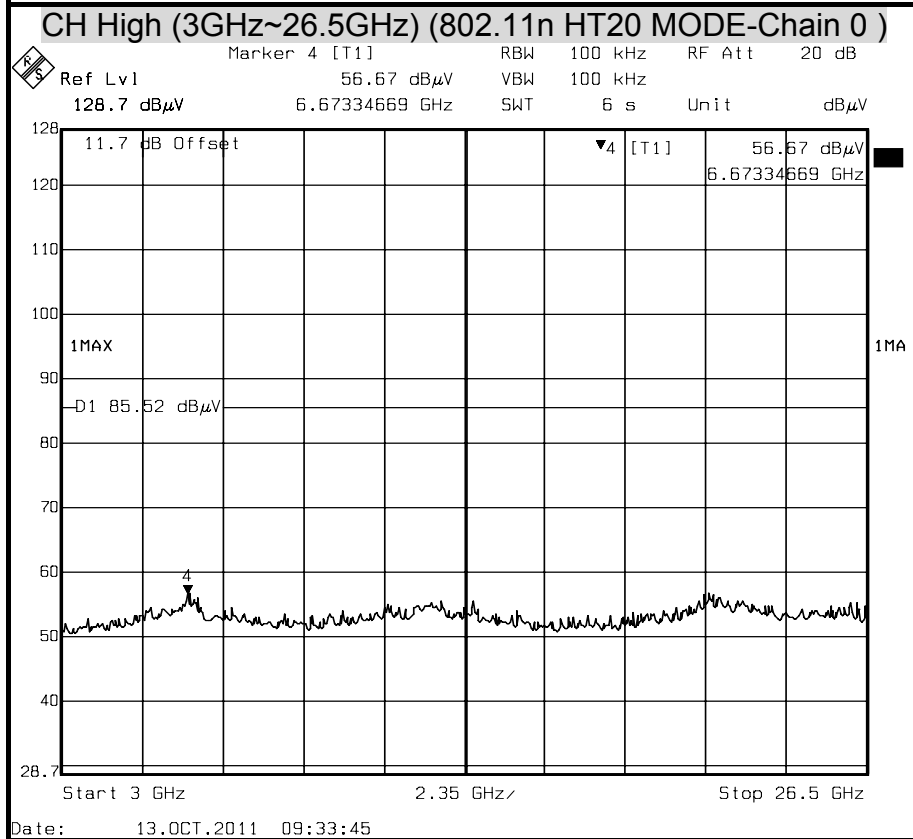
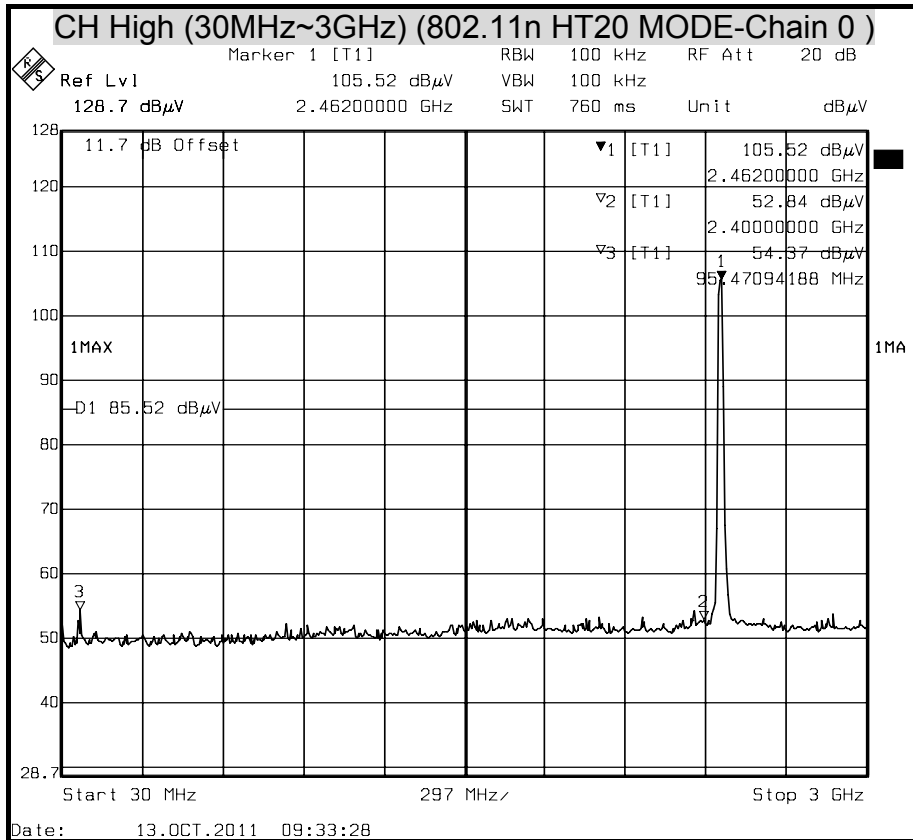



OUT-OF-BAND SPURIOUS EMISSIONS-CONDUCTED MEASUREMENT (802.11n HT20 MODE)

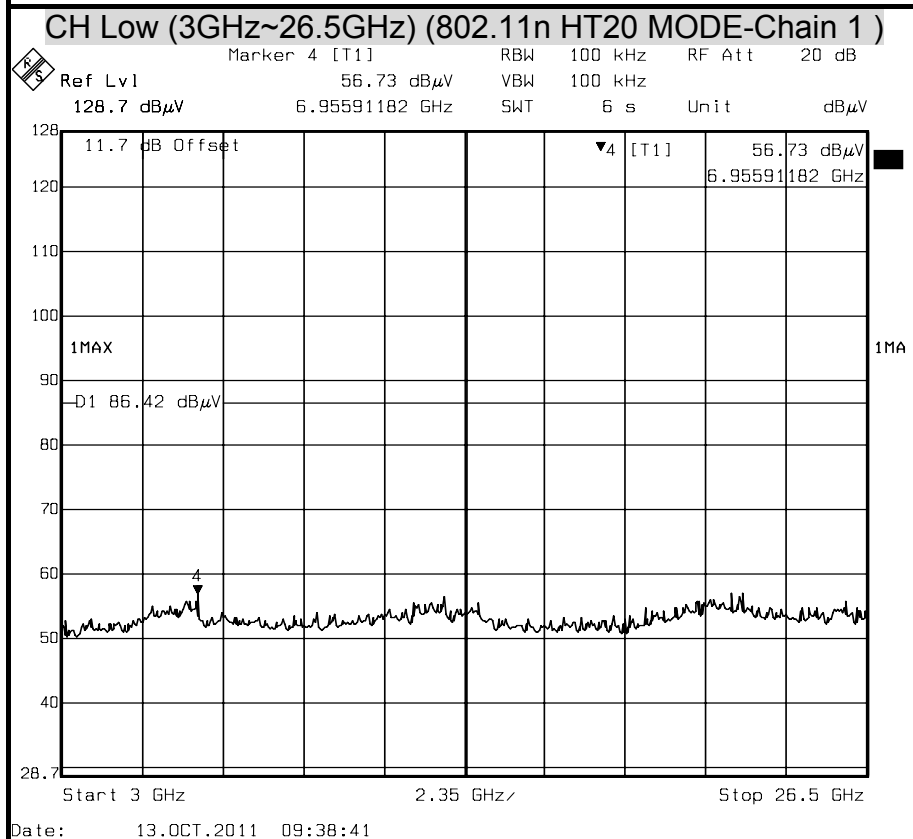
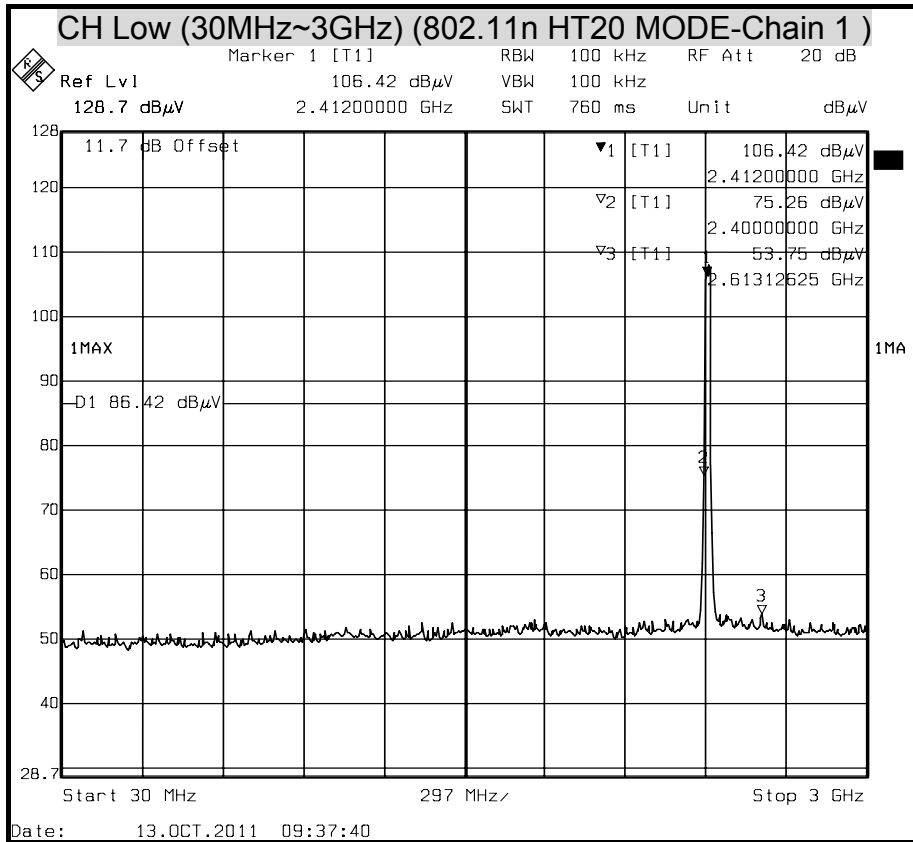

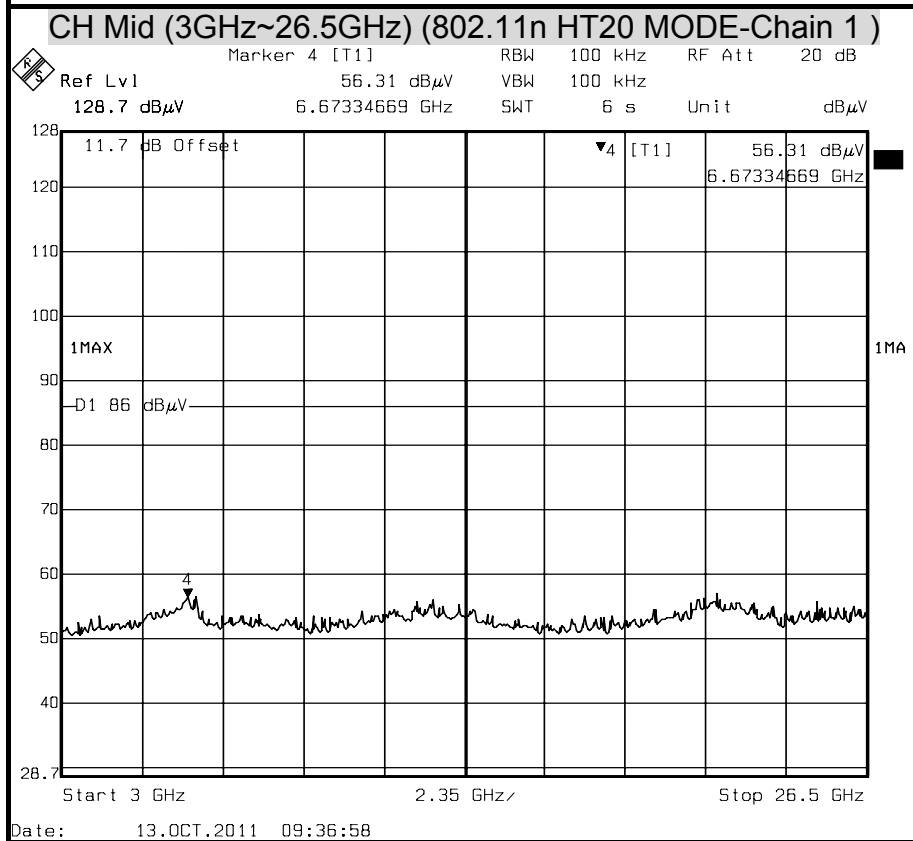
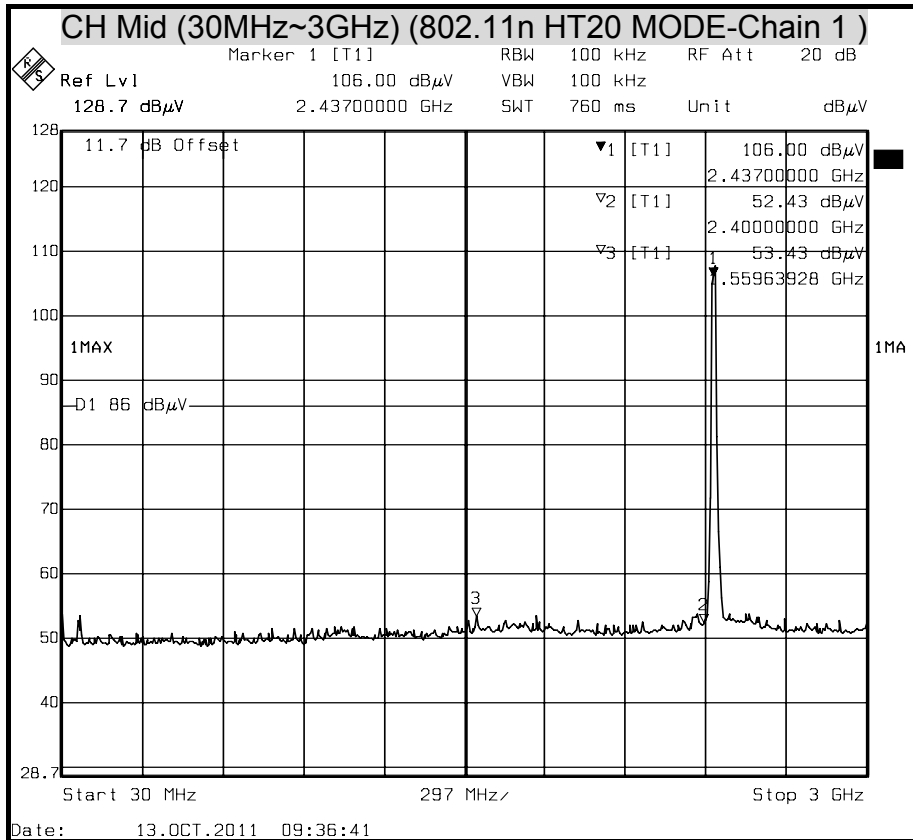

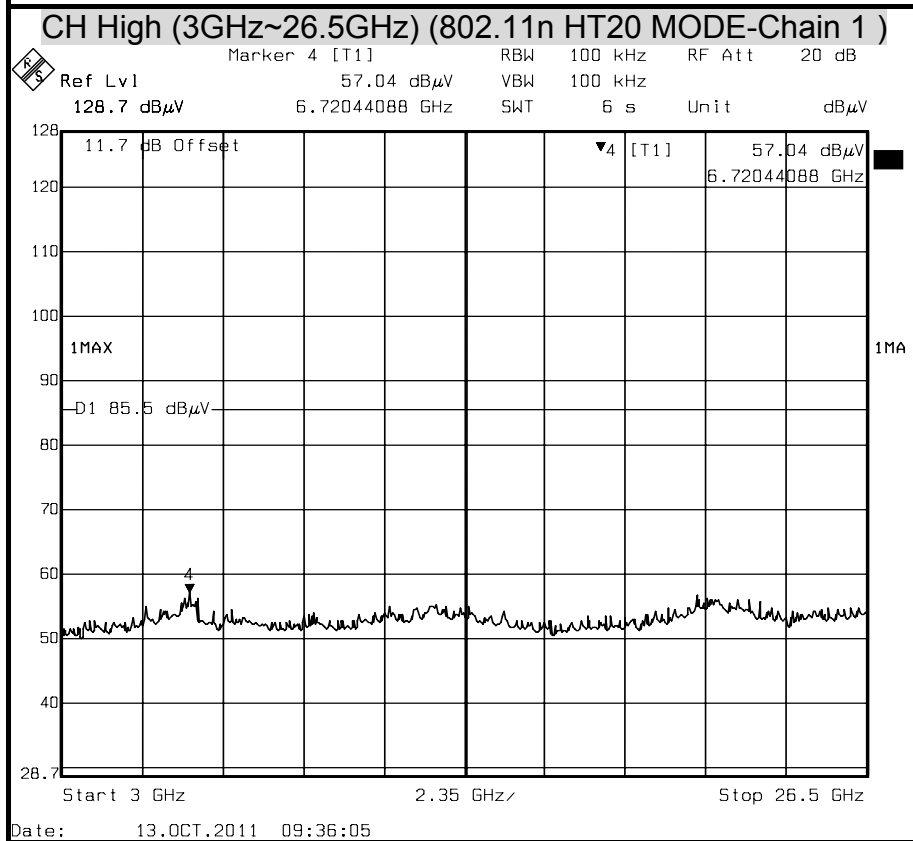
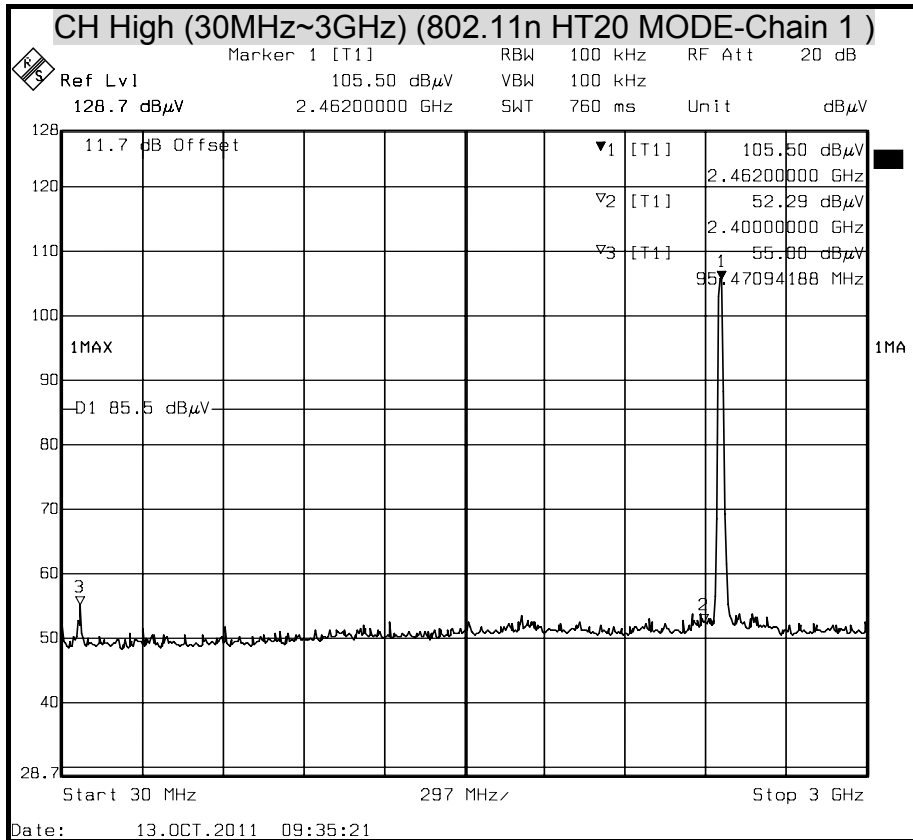



OUT-OF-BAND SPURIOUS EMISSIONS-CONDUCTED MEASUREMENT
(802.11n HT40 MODE)

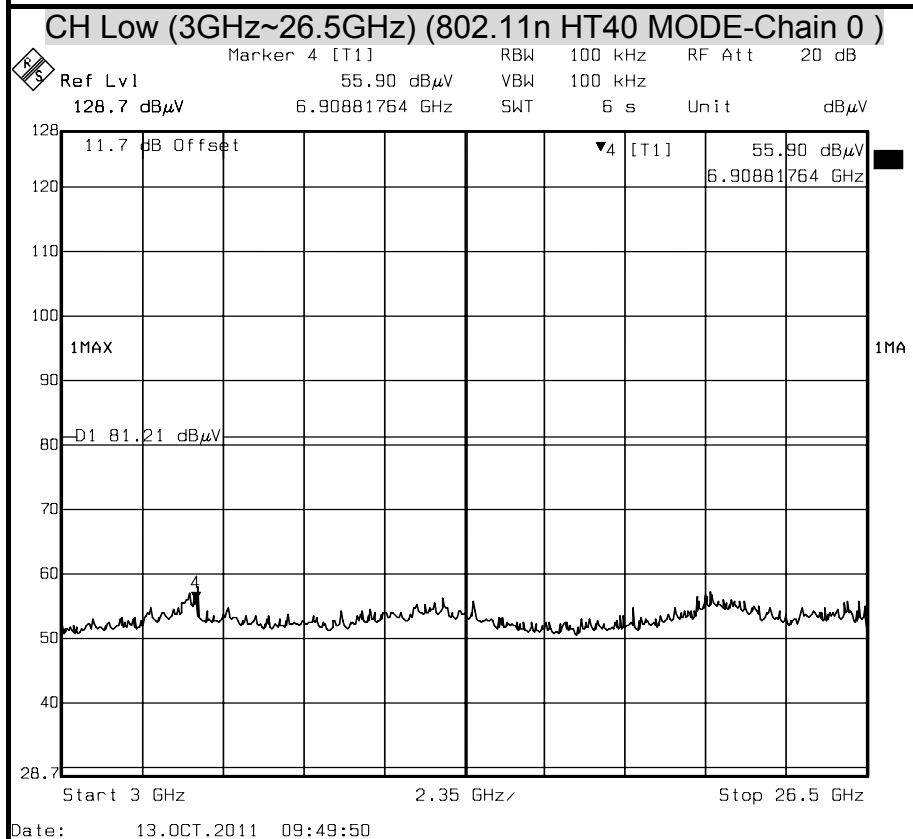
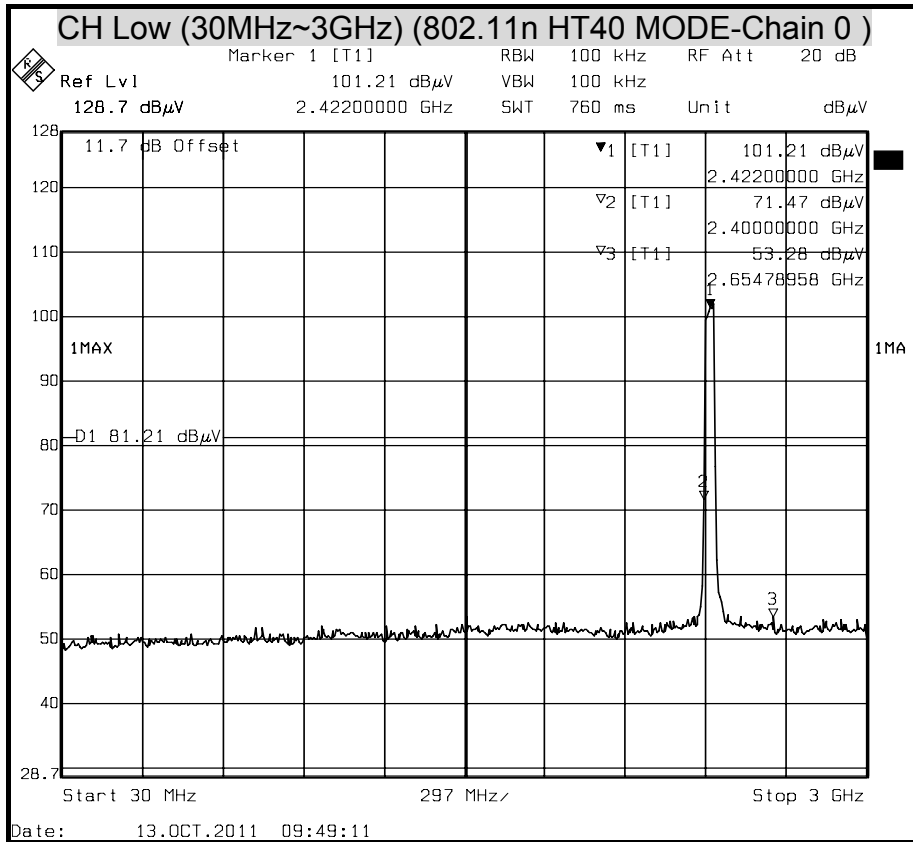

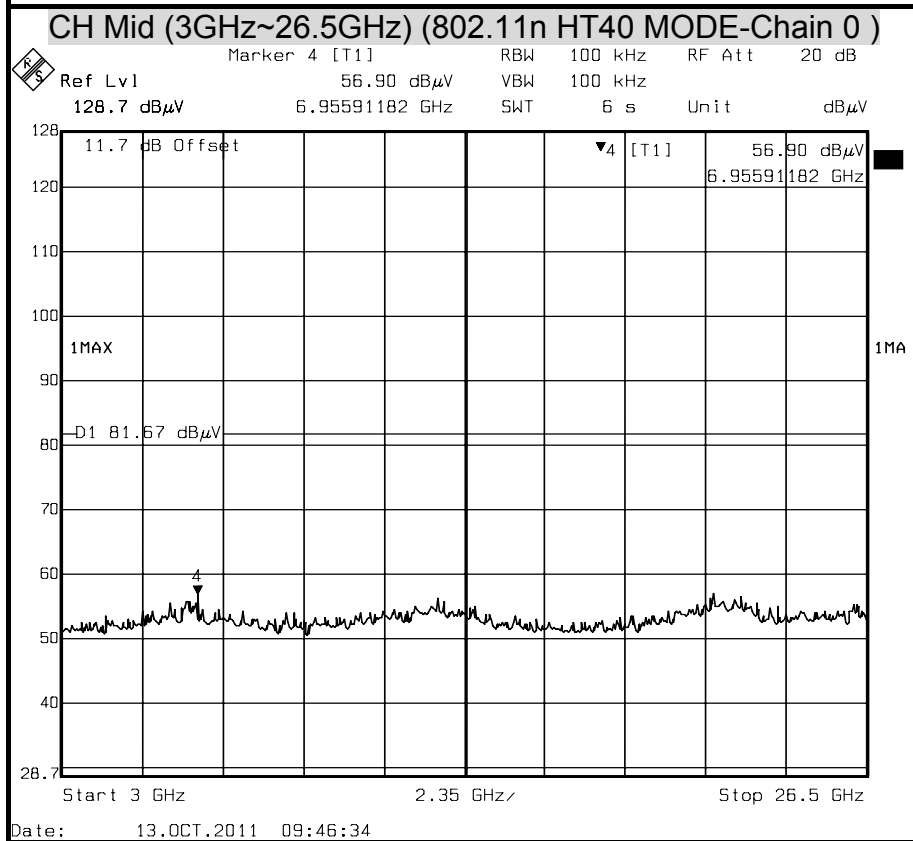
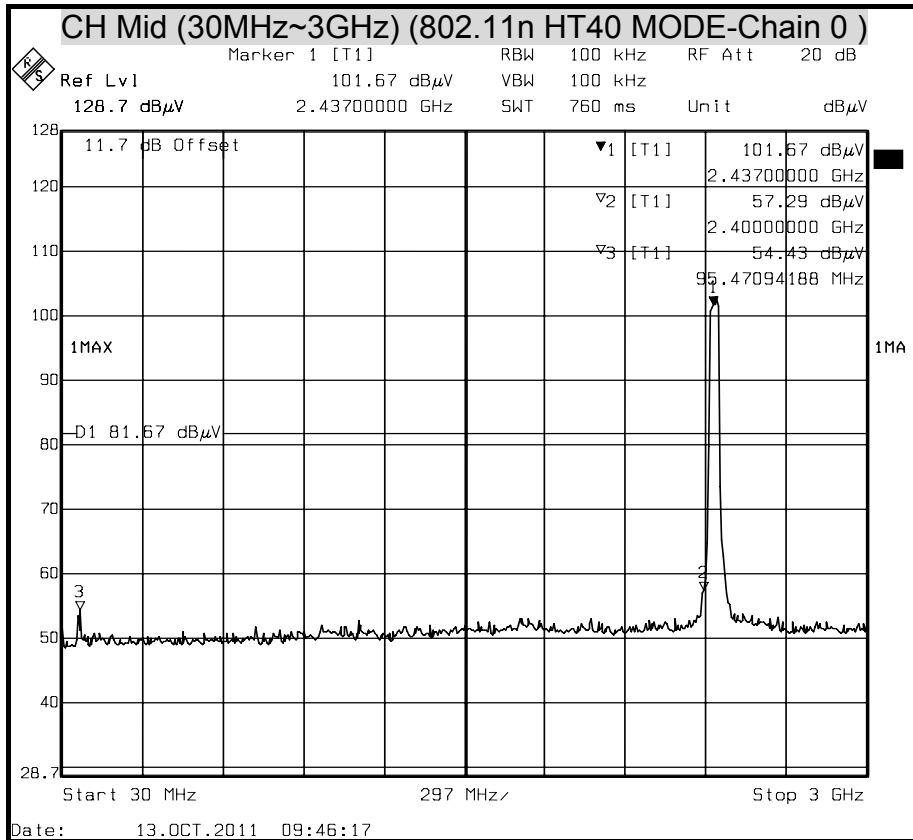

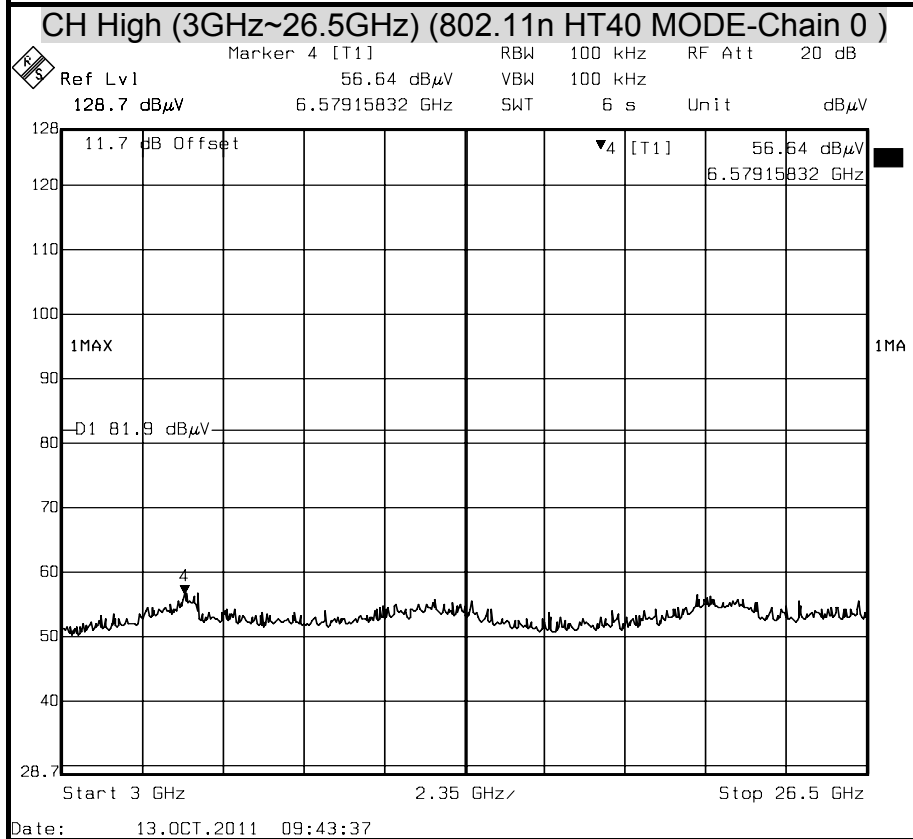
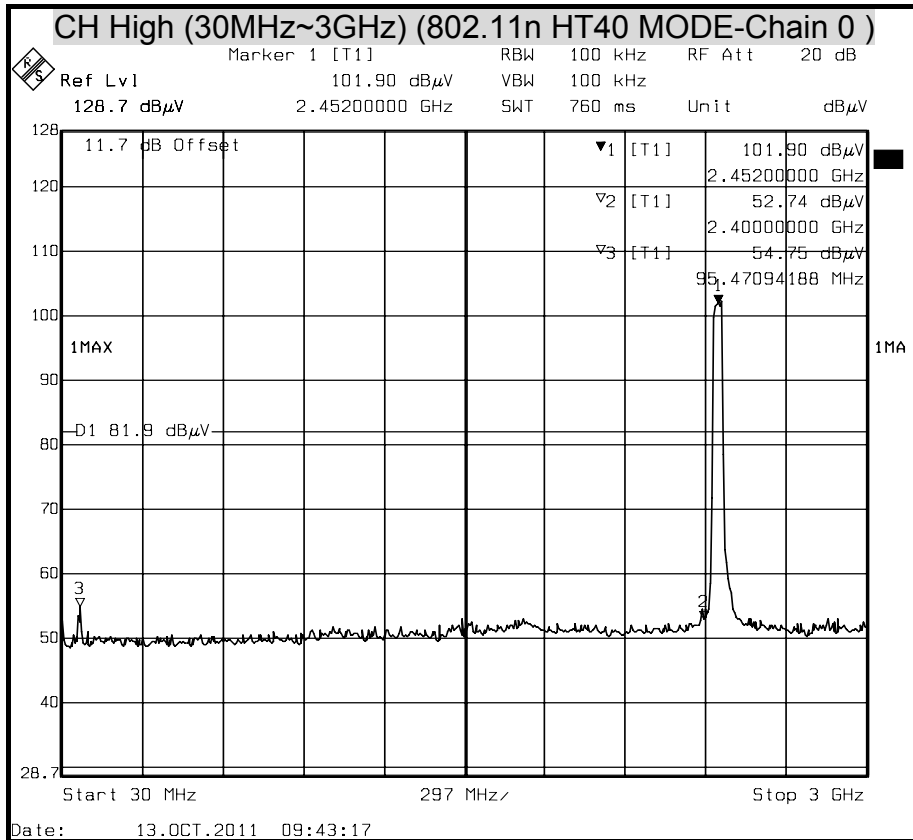



OUT-OF-BAND SPURIOUS EMISSIONS-CONDUCTED MEASUREMENT (802.11n HT40 MODE)

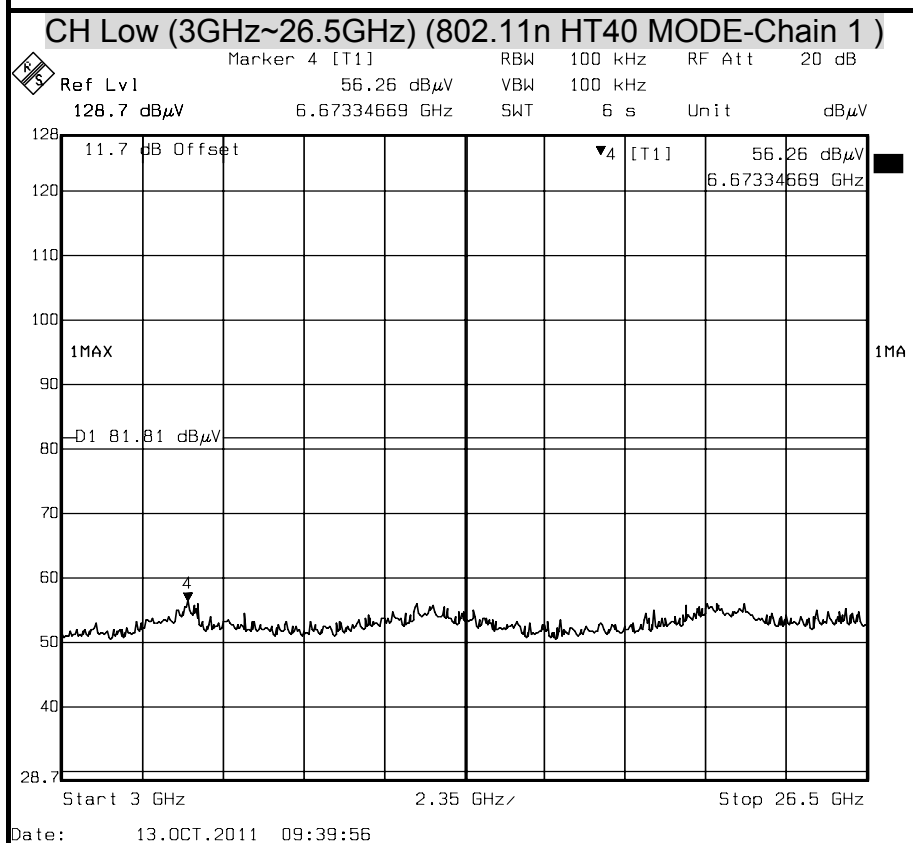
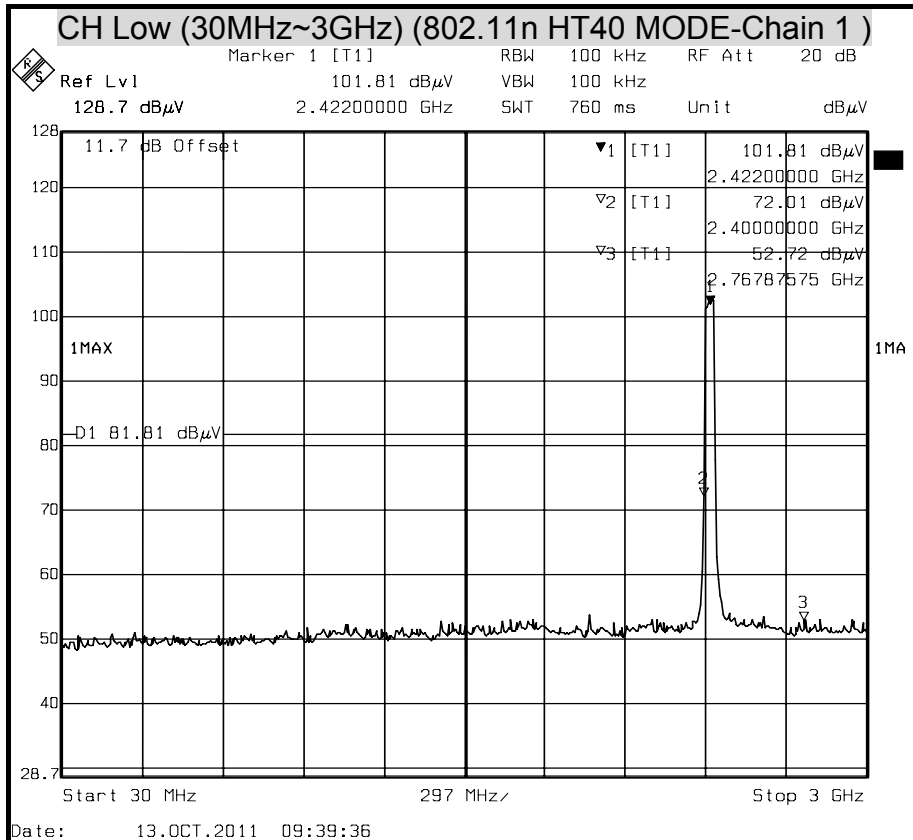

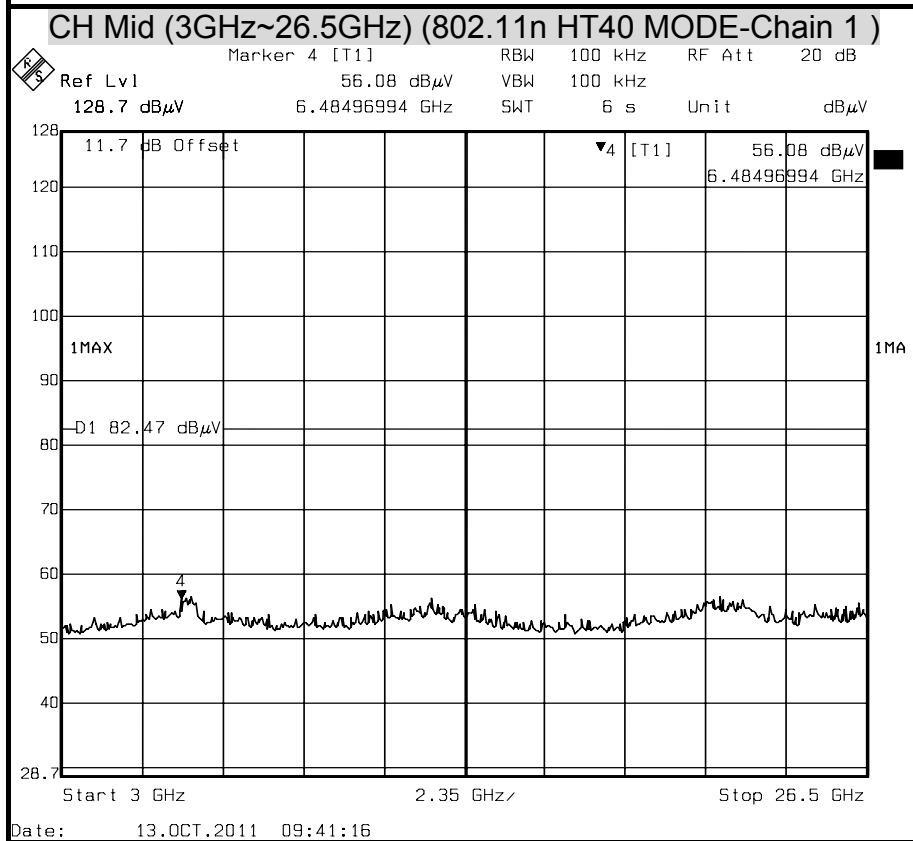
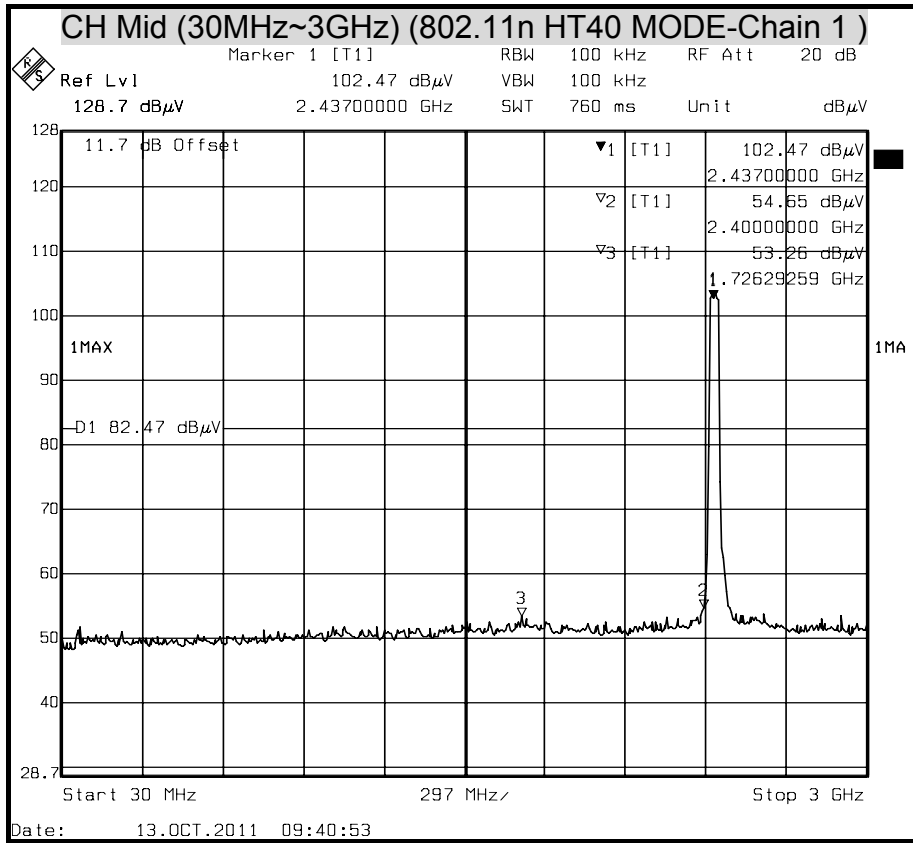

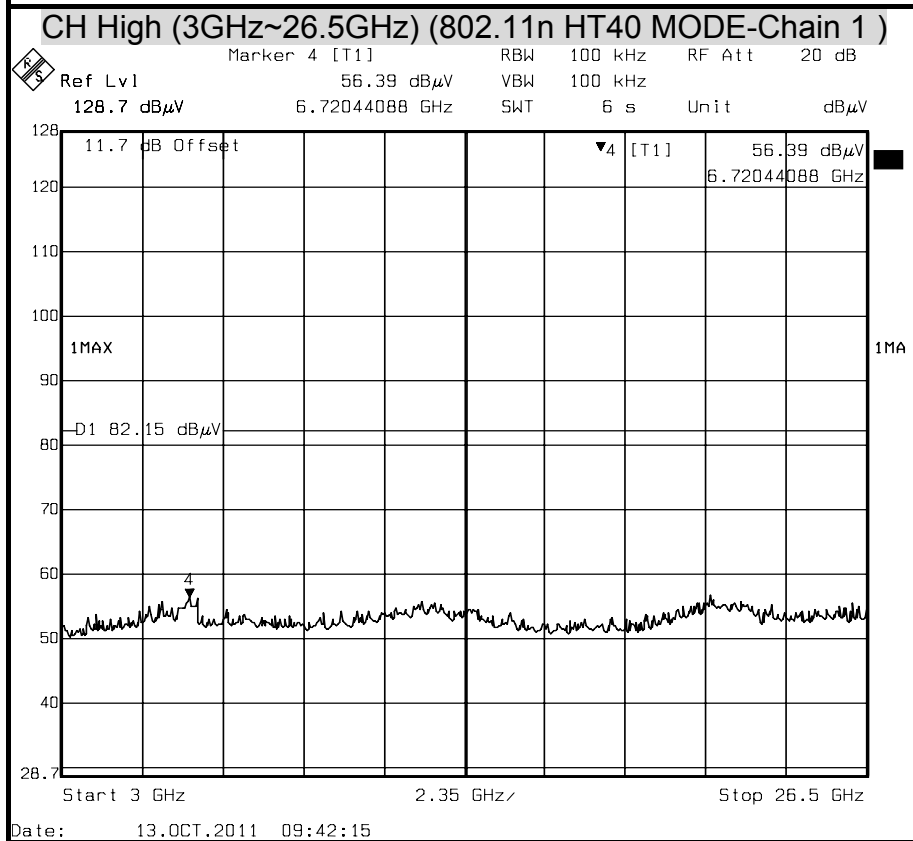
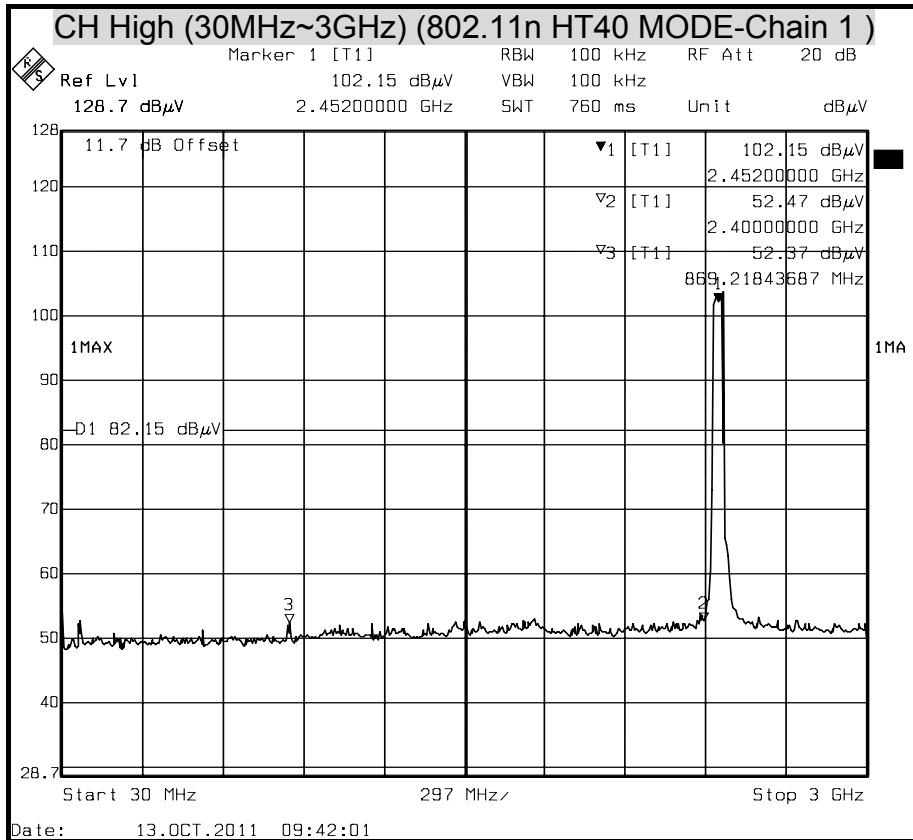



OUT-OF-BAND SPURIOUS EMISSIONS-CONDUCTED MEASUREMENT
(802.11n HT20 Combined Mode)

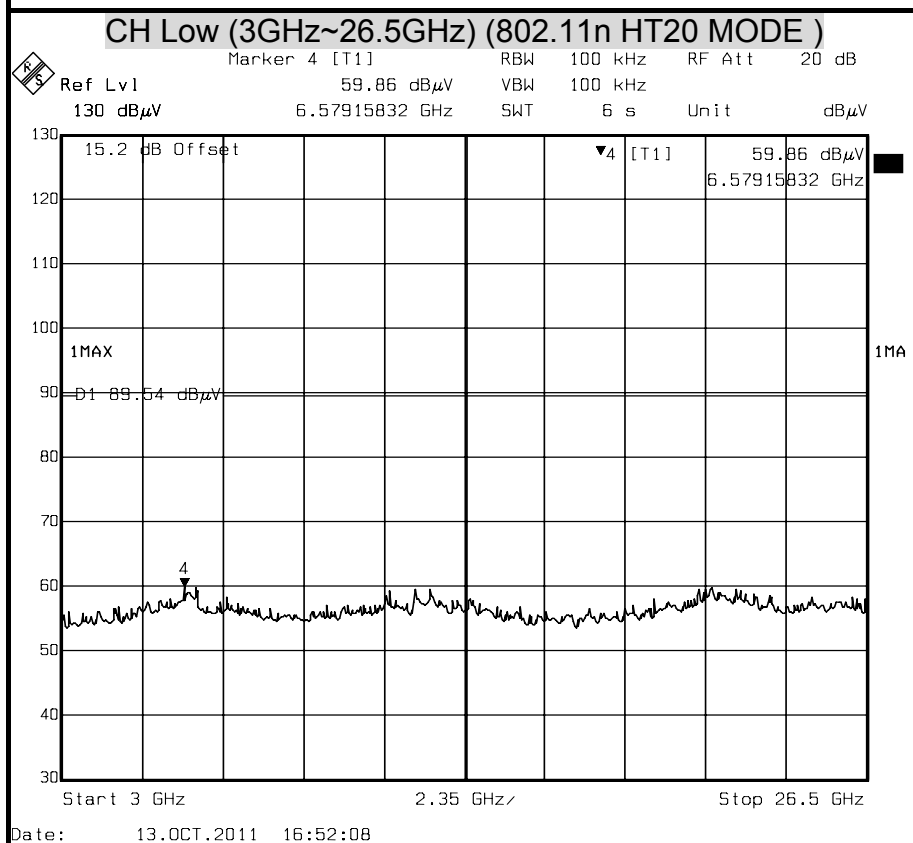
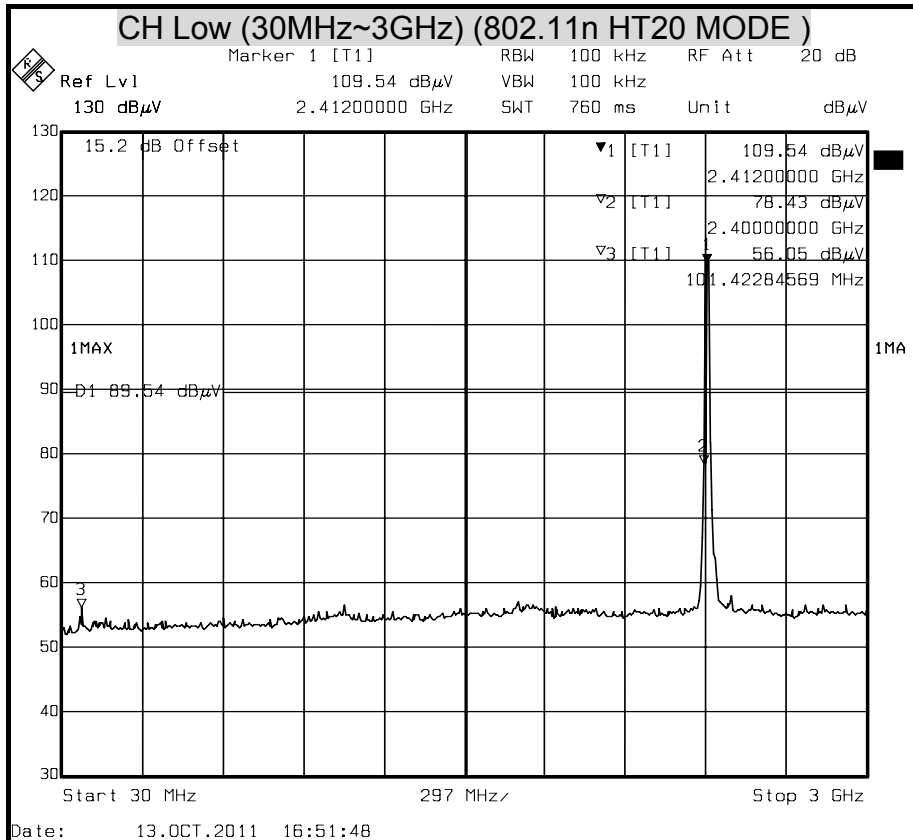

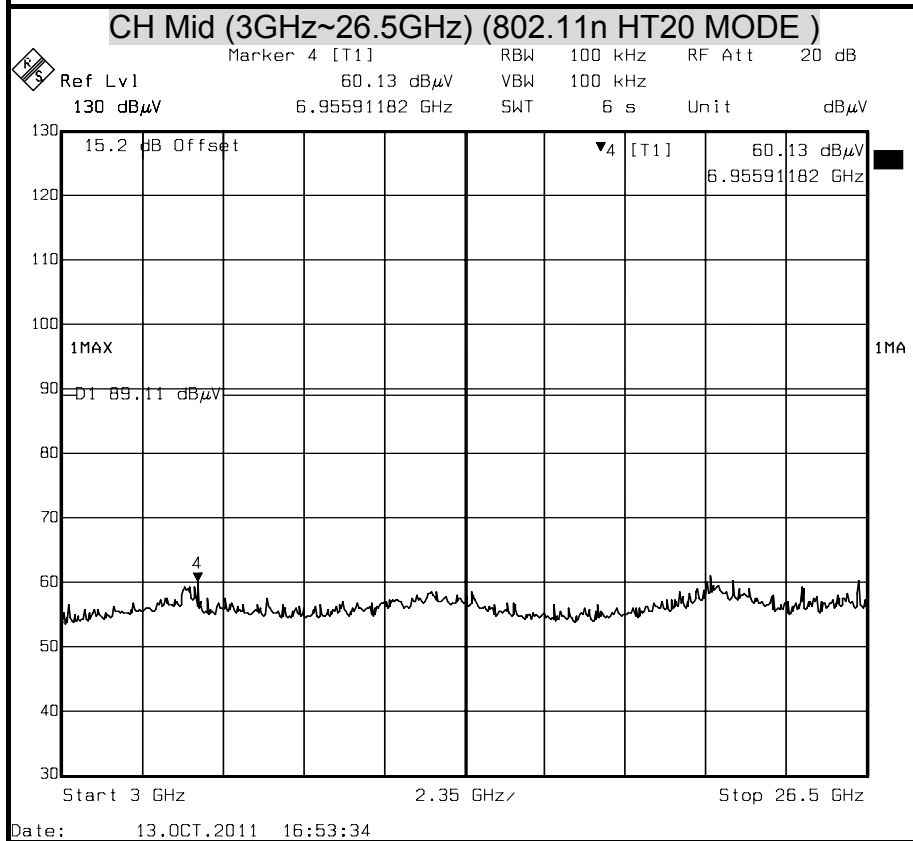
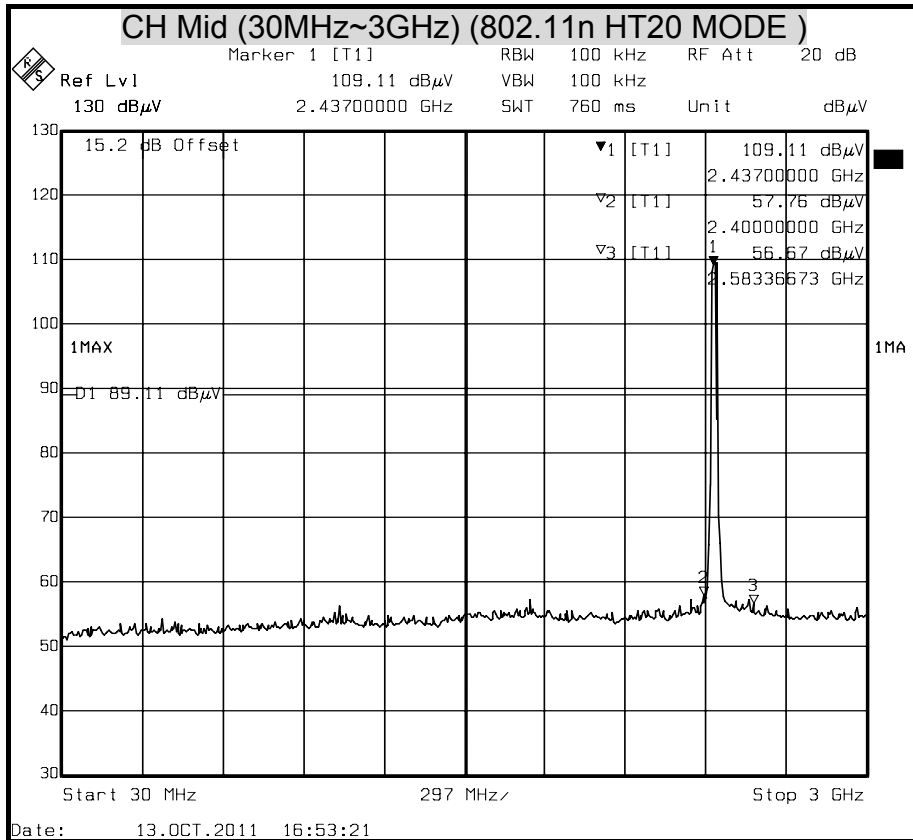

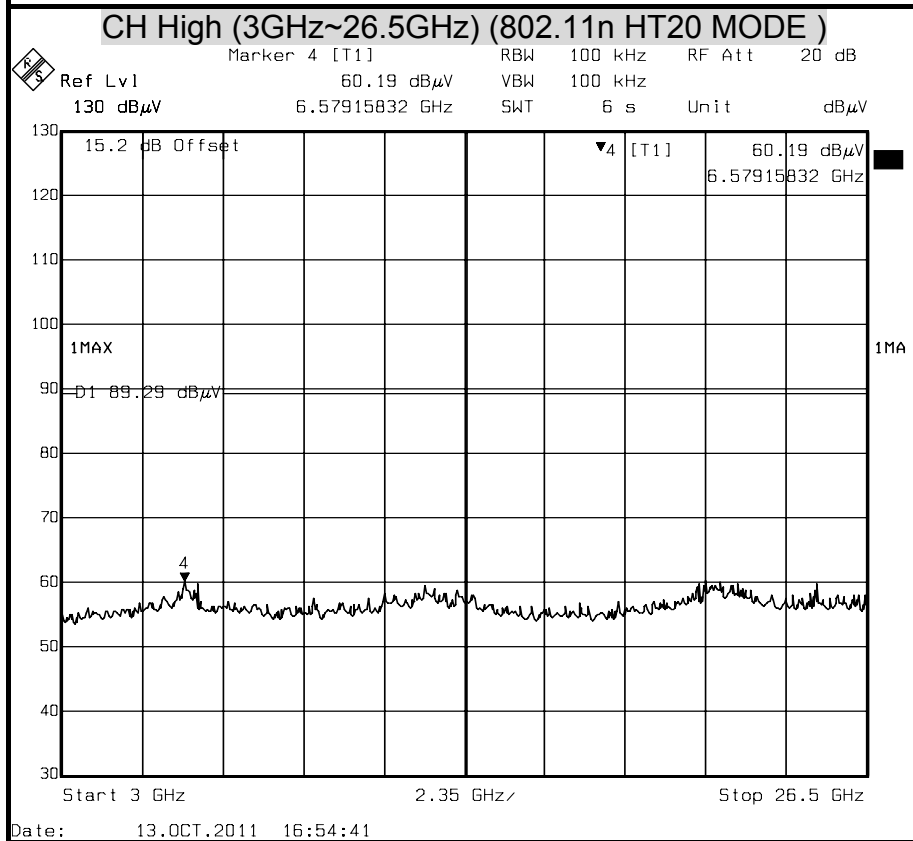
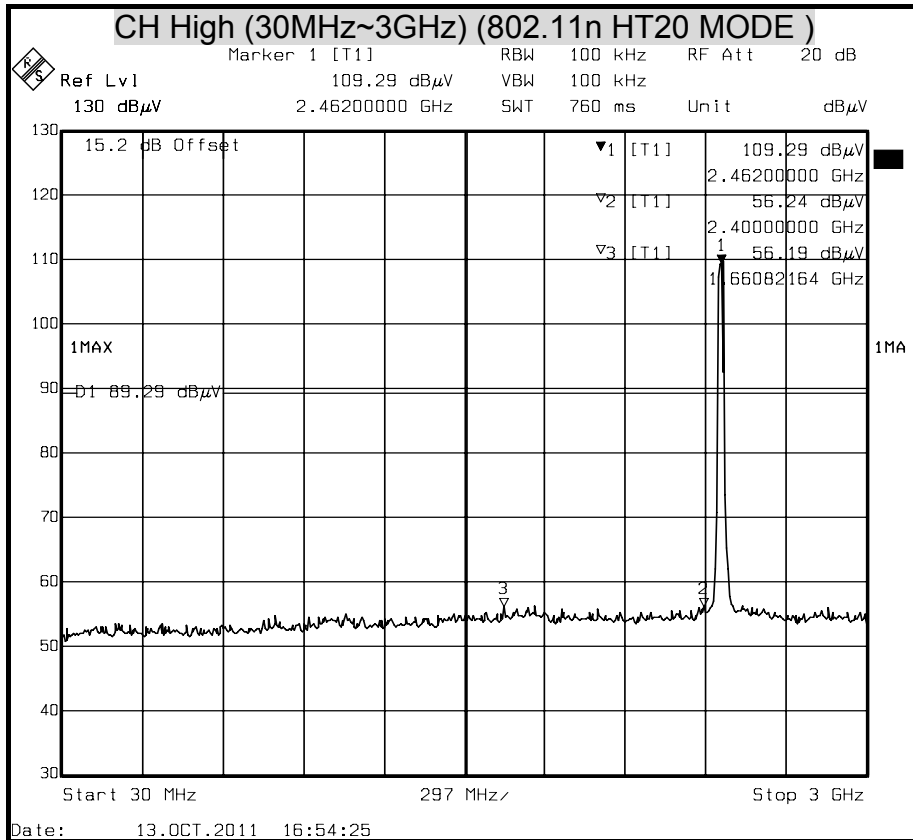

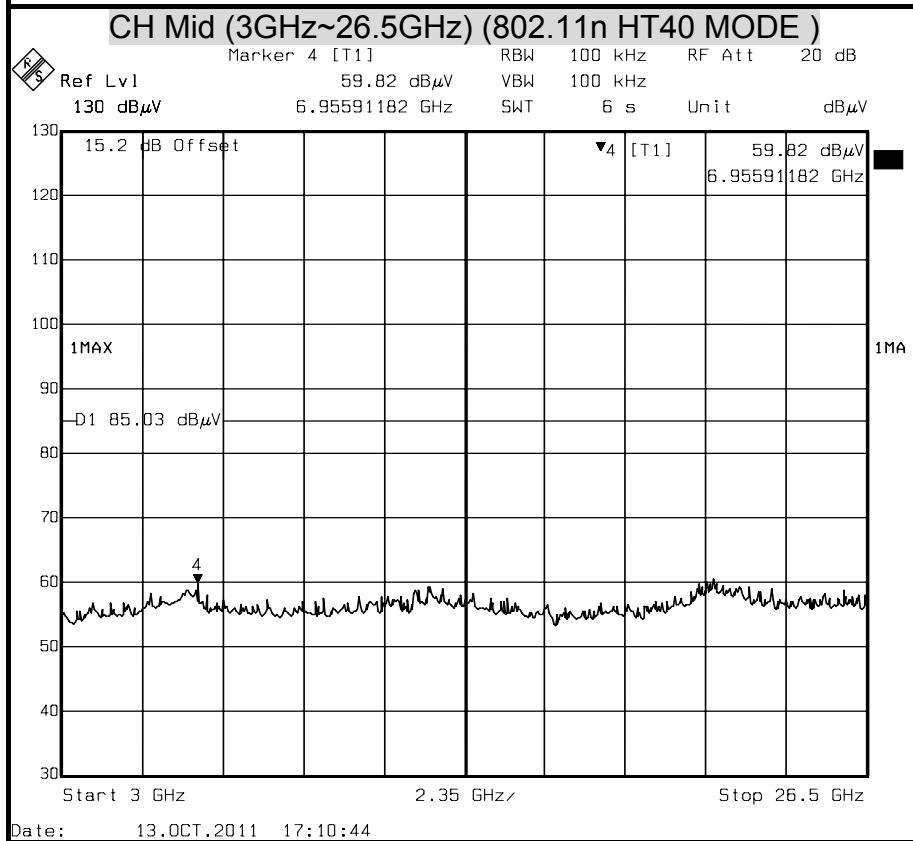
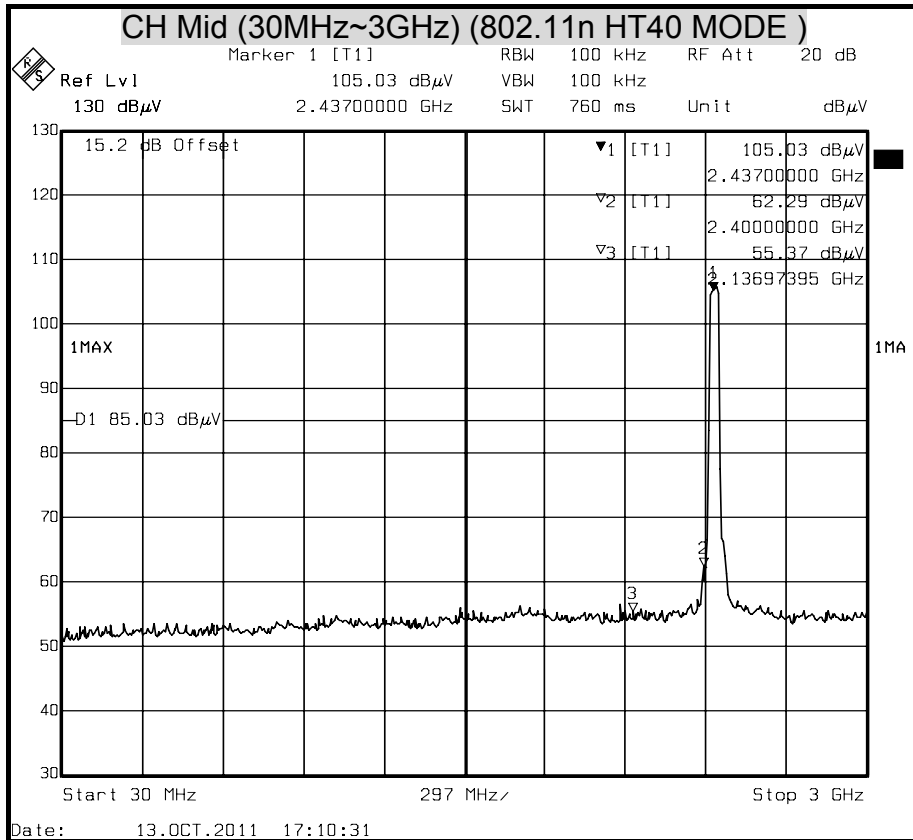

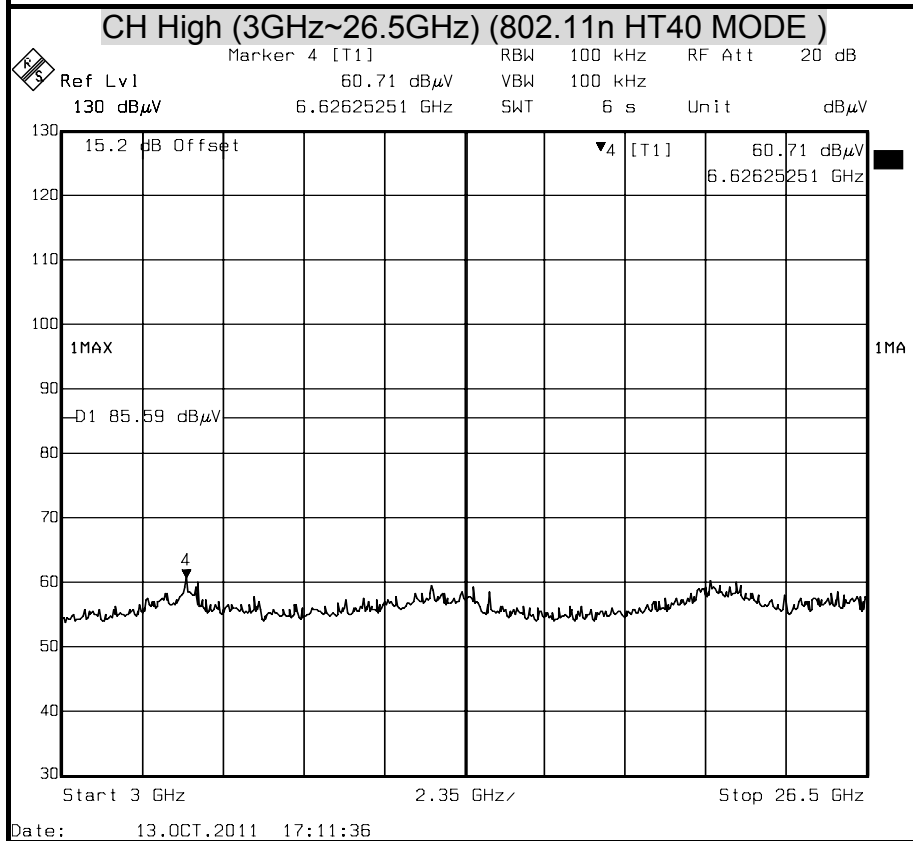
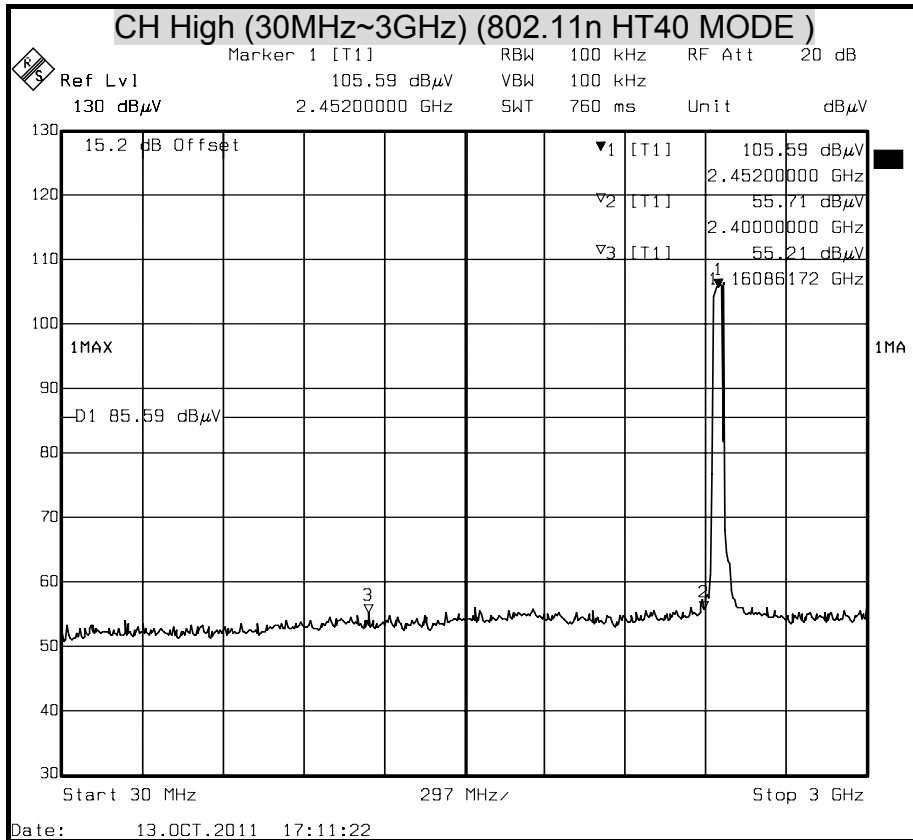



7.6 RADIATED EMISSION

LIMITS

(1) According to § 15.205 (a) Except as shown in paragraph (d) of this section, only spurious emissions are permitted in any of the frequency bands listed below:

MHz	MHz	MHz	GHz
0.090 - 0.110	16.42 - 16.423	399.9 - 410	4.5 - 5.15
¹ 0.495 - 0.505	16.69475 - 16.69525	608 - 614	5.35 - 5.46
2.1735 - 2.1905	16.80425 - 16.80475	960 - 1240	7.25 - 7.75
4.125 - 4.128	25.5 - 25.67	1300 - 1427	8.025 - 8.5
4.17725 - 4.17775	37.5 - 38.25	1435 - 1626.5	9.0 - 9.2
4.20725 - 4.20775	73 - 74.6	1645.5 - 1646.5	9.3 - 9.5
6.215 - 6.218	74.8 - 75.2	1660 - 1710	10.6 - 12.7
6.26775 - 6.26825	108 - 121.94	1718.8 - 1722.2	13.25 - 13.4
6.31175 - 6.31225	123 - 138	2200 - 2300	14.47 - 14.5
8.291 - 8.294	149.9 - 150.05	2310 - 2390	15.35 - 16.2
8.362 - 8.366	156.52475 - 156.52525	2483.5 - 2500	17.7 - 21.4
8.37625 - 8.38675	156.7 - 156.9	2655 - 2900	22.01 - 23.12
8.41425 - 8.41475	162.0125 - 167.17	3260 - 3267	23.6 - 24.0
12.29 - 12.293	167.72 - 173.2	3332 - 3339	31.2 - 31.8
12.51975 - 12.52025	240 - 285	3345.8 - 3338	36.43 - 36.5
12.57675 - 12.57725	322 - 335.4	3600 - 4400	(²)
13.36 - 13.41			

Remark:

- 1. ¹ Until February 1, 1999, this restricted band shall be 0.490-0.510 MHz.
- 2. ² Above 38.6

(2) According to § 15.205 (b) Except as provided in paragraphs (d) and (e) of this section, the field strength of emissions appearing within these frequency bands shall not exceed the limits shown in §15.209. At frequencies equal to or less than 1000 MHz, compliance with the limits in §15.209 shall be demonstrated using measurement instrumentation employing a CISPR quasi-peak detector. Above 1000 MHz, compliance with the emission limits in §15.209 shall be demonstrated based on the average value of the measured emissions. The provisions in §15.35 apply to these measurements.



(3) According to § 15.209 (a) Except as provided elsewhere in this Subpart, the emissions from an intentional radiator shall not exceed the field strength levels specified in the following table :

Frequency (MHz)	Field Strength (microvolts/meter)	Measurement Distance (meters)
0.009 – 0.490	2400/F(KHz)	300
0.490 – 1.705	24000/F(KHz)	30
1.705 – 30.0	30	30
30 - 88	100 **	3
88 - 216	150 **	3
216 - 960	200 **	3
Above 960	500	3

Remark: **Except as provided in paragraph (g), fundamental emissions from intentional radiators operating under this Section shall not be located in the frequency bands 54-72 MHz, 76-88 MHz, 174-216 MHz or 470-806 MHz. However, operation within these frequency bands is permitted under other sections of this Part, e.g., Sections 15.231 and 15.241.

(4) According to § 15.209 (b) In the emission table above, the tighter limit applies at the band edges.



TEST EQUIPMENT

The following test equipments are utilized in making the measurements contained in this report.

Open Area Test Site # 6				
Name of Equipment	Manufacturer	Model	Serial Number	Calibration Due
TYPE N COAXIAL CABLE	SUHNER	CHA9513	6	NOV. 17, 2012
BI-LOG Antenna	Sunol	JB1	A070506-2	OCT. 03, 2012
LOOP ANTENNA	EMCO	6502	8905-2356	JUN. 10, 2012
Pre-Amplifier	HP	8447F	2944A03817	NOV. 23, 2012
EMI Receiver	R&S	ESVS10	833206/012	MAY 10, 2012
RF Cable	SUHNER	SUCOFLEX104PEA	20520/4PEA	NOV. 10, 2012
Horn Antenna	Com-Power	AH-118	071032	DEC. 27, 2012
Spectrum Analyzer	R&S	FSEK 30	835253/002	SEP. 29, 2012
Pre-Amplifier	MITEQ	AFS44-00108650-42-10P-44	1205908	NOV. 23, 2012
3116 Double Ridge Antenna (40G)	ETS-LINDGREN	EMCO-003	00078	NOV. 14, 2012
Turn Table	Yo Chen	001	-----	N.C.R.
Antenna Tower	AR	TP1000A	309874	N.C.R.
Controller	CT	SC101	-----	N.C.R.
RF Swith	E-INSTRUMENT TELH LTD	ERS-180A	EC1204141	N.C.R
Power Meter	Anritsu	ML2487A	6K00003888	MAY 30, 2012
Power Sensor	Anritsu	MA2491A	33265	MAY 30, 2012
Temp./Humidity Chamber	K.SON	THS-M1	242	AUG. 09, 2012
Signal Generator	HP	8673C	2938A00663	SEP. 12, 2012
DC Power Source	LOKO	DSP-5050	L1507009282	N.C.R

Remark: 1. Each piece of equipment is scheduled for calibration once a year.
2. N.C.R = No Calibration Request.



TEST SETUP

The diagram below shows the test setup that is utilized to make the measurements for emission from below 1GHz.

9kHz ~ 30MHz

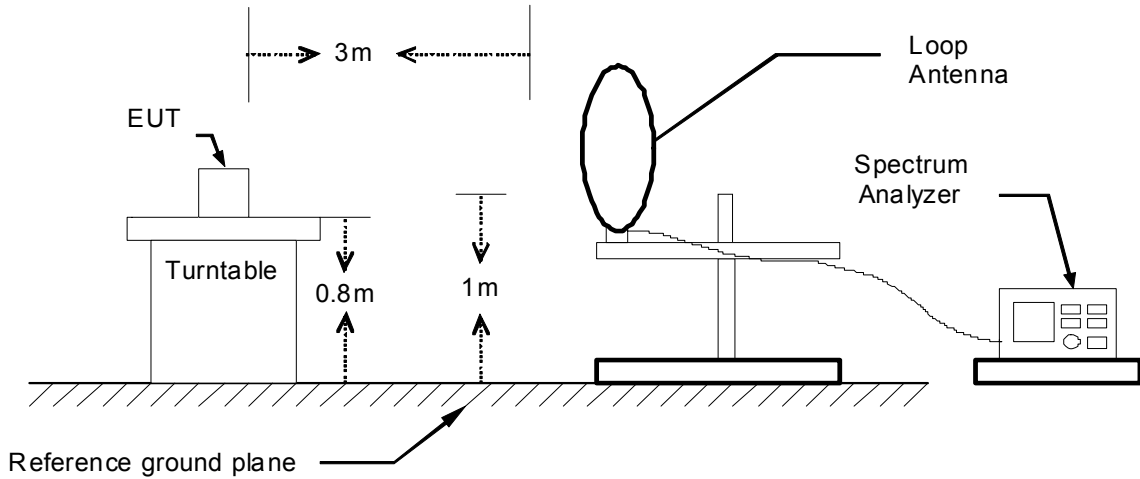

30MHz ~ 1GHz

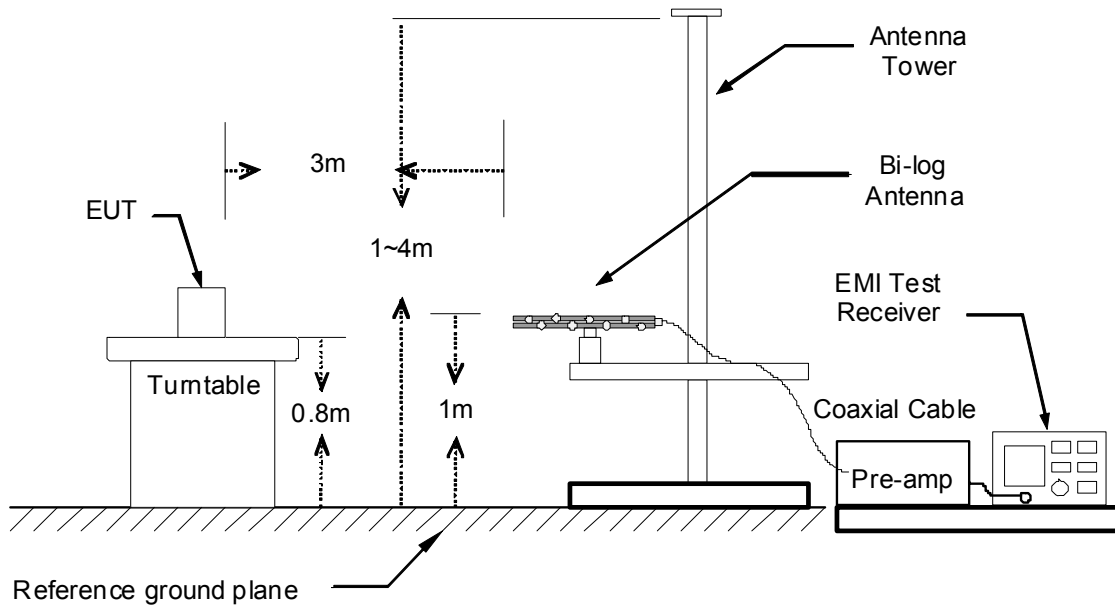



The diagram below shows the test setup that is utilized to make the measurements for emission above 1GHz.

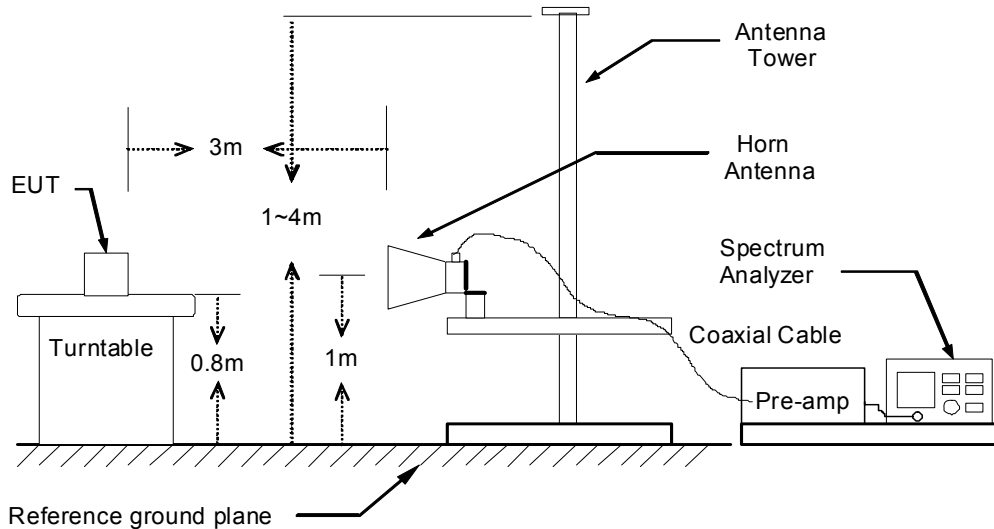

TEST PROCEDURE

1. The EUT was placed on the top of a rotating table 0.8 meters above the ground at a 10 meter open area test site. The table was rotated 360 degrees to determine the position of the highest radiation.
2. While measuring the radiated emission below 1GHz, the EUT was set 3 meters away from the interference-receiving antenna, which was mounted on the top of a variable-height antenna tower. While measuring the radiated emission above 1GHz, the EUT was set 3 meters away from the interference-receiving antenna.
3. The antenna is a broadband antenna, and its height is varied from one meter to four meters above the ground to determine the maximum value of the field strength. Both horizontal and vertical polarization of the antenna are set to make the measurement.
4. For each suspected emission, the EUT was arranged to its worst case and then the antenna was tuned to heights from 1 meter to 4 meters and the table was turned from 0 degrees to 360 degrees to find the maximum reading.
5. The test-receiver system was set to Peak Detect Function and Specified Bandwidth with Maximum Hold Mode.
6. If the emission level of the EUT in peak mode was 10 dB lower than the limit specified, then testing could be stopped and the peak values of the EUT would be reported. Otherwise the emissions that did not have 10 dB margin would be re-tested one by one using peak, quasi-peak or average method as specified and then reported in a data sheet.

Remark :

1. The resolution bandwidth and video bandwidth of test receiver/spectrum analyzer is 120 KHz for Peak detection (PK) and Quasi-peak detection (QP) at frequency below 1GHz.
2. The resolution bandwidth and video bandwidth of test receiver/spectrum analyzer is 1 MHz for Peak detection and frequency above 1GHz.
3. The resolution bandwidth of test receiver/spectrum analyzer is 1 MHz and the video bandwidth is 10 Hz for Average detection (AV) at frequency above 1GHz.



TEST RESULTS

Below 1 GHz (9kHz ~ 30MHz)

No emission found between lowest internal used/generated frequency to 30MHz.

Below 1 GHz (30MHz ~ 1GHz)

Product Name	11n Dual-Band USB Dongle	Test By	John Chen
Model	WU318d	Test Date	2012/10/04
Test Mode	Normal Operation	TEMP & Humidity	28.9°C, 52%

Horizontal

Frequency	Meter Reading	Antenna Factor	Cable Loss	Emission Level	Limits	Margin	Detector Mode
(MHz)	(dBµV)	(dB/M)	(dB)	(dBµV/M)	(dBµV/M)	(dB)	PK/QP
125.00	13.40	14.13	3.12	30.65	43.50	-12.86	QP
160.00	12.60	12.74	3.38	28.72	43.50	-14.78	QP
250.00	14.30	12.80	3.96	31.06	46.00	-14.94	QP
325.00	11.90	14.84	4.35	31.09	46.00	-14.92	QP
500.00	7.90	18.43	5.60	31.93	46.00	-14.07	QP
525.00	11.80	18.72	5.64	36.16	46.00	-9.84	QP
N/A	-----	-----	-----	-----	-----	-----	-----

Vertical

Frequency	Meter Reading	Antenna Factor	Cable Loss	Emission Level	Limits	Margin	Detector Mode
(MHz)	(dBµV)	(dB/M)	(dB)	(dBµV/M)	(dBµV/M)	(dB)	PK/QP
125.00	16.20	14.13	3.12	33.45	43.50	-10.06	QP
160.00	20.10	12.74	3.38	36.22	43.50	-7.28	QP
250.00	19.20	12.80	3.96	35.96	46.00	-10.04	QP
325.00	10.80	14.84	4.35	29.99	46.00	-16.02	QP
500.00	11.90	18.43	5.60	35.93	46.00	-10.07	QP
525.00	16.20	18.72	5.64	40.56	46.00	-5.44	QP
N/A	-----	-----	-----	-----	-----	-----	-----

REMARK: Emission level (dBµV/m) =Antenna Factor (dB/m) + Cable loss (dB) + Meter Reading (dBµV).



Above 1 GHz

Product Name	11n Dual-Band USB Dongle	Test By	John Chen
Model	WU318d	Test Date	Nov. 17, 2011
Test Mode	IEEE 802.11a TX / CH Low	TEMP & Humidity	28.1°C, 54%

Measurement Distance at 3m Horizontal polarity									
Freq.	Reading	AF	Cable Loss	Pre-amp	Filter	Level	Limit	Margin	Mark
(MHz)	(dBµV)	(dB/m)	(dB)	(dB)	(dB)	(dBµV/m)	(dBµV/m)	(dB)	(P/Q/A)
1250.00	58.14	25.65	1.83	39.58	0.74	46.78	74.00	-27.22	P
1250.00	52.09	25.65	1.83	39.58	0.74	40.73	54.00	-13.27	A
* 11489.97	53.41	40.48	6.62	37.43	1.20	64.28	74.00	-9.72	P
* 11489.97	40.34	40.48	6.62	37.43	1.20	51.21	54.00	-2.79	A

Measurement Distance at 3m Vertical polarity									
Freq.	Reading	AF	Cable Loss	Pre-amp	Filter	Level	Limit	Margin	Mark
(MHz)	(dBµV)	(dB/m)	(dB)	(dB)	(dB)	(dBµV/m)	(dBµV/m)	(dB)	(P/Q/A)
1250.01	54.13	25.65	1.83	39.58	0.74	42.77	74.00	-31.23	P
1250.01	49.88	25.65	1.83	39.58	0.74	38.52	54.00	-15.48	A
* 11489.99	55.16	40.48	6.62	37.43	1.20	66.03	74.00	-7.97	P
* 11489.99	40.73	40.48	6.62	37.43	1.20	51.60	54.00	-2.40	A

REMARK:

1. AF: Antenna Factor, Cable: Cable Loss, Pre-Amp: Preamplifier gain, Filter: 2.4GHz~2.5GHz Filter Insertion Loss
2. Spectrum analyzer setting P(Peak): RBW=1MHz, VBW=1MHz, A(Average): RBW=1MHz, VBW=10Hz
3. The result basic equation calculation is as follow:
Level = Reading + AF + Cable - Preamp + Filter, Margin = Level-Limit
4. The other emission levels were 20dB below the limit
5. The test limit distance is 3M limit.



Product Name	11n Dual-Band USB Dongle	Test By	John Chen
Model	WU318d	Test Date	Nov. 17, 2011
Test Mode	IEEE 802.11a TX / CH Middle	TEMP & Humidity	28.1°C, 54%

Measurement Distance at 3m Horizontal polarity									
Freq.	Reading	AF	Cable Loss	Pre-amp	Filter	Level	Limit	Margin	Mark
(MHz)	(dBµV)	(dB/m)	(dB)	(dB)	(dB)	(dBµV/m)	(dBµV/m)	(dB)	(P/Q/A)
1250.00	57.61	25.65	1.83	39.58	0.74	46.25	74.00	-27.75	P
1250.00	51.97	25.65	1.83	39.58	0.74	40.61	54.00	-13.39	A
* 11569.98	53.41	40.57	6.67	37.46	1.14	64.33	74.00	-9.67	P
* 11569.98	40.52	40.57	6.67	37.46	1.14	51.44	54.00	-2.56	A
Measurement Distance at 3m Vertical polarity									
Freq.	Reading	AF	Cable Loss	Pre-amp	Filter	Level	Limit	Margin	Mark
(MHz)	(dBµV)	(dB/m)	(dB)	(dB)	(dB)	(dBµV/m)	(dBµV/m)	(dB)	(P/Q/A)
1250.00	55.74	25.65	1.83	39.58	0.74	44.38	74.00	-29.62	P
1250.00	50.30	25.65	1.83	39.58	0.74	38.94	54.00	-15.06	A
* 11570.00	54.06	40.57	6.67	37.46	1.14	64.98	74.00	-9.02	P
* 11570.00	40.38	40.57	6.67	37.46	1.14	51.30	54.00	-2.70	A

REMARK:

1. AF: Antenna Factor, Cable: Cable Loss, Pre-Amp: Preamplifier gain, Filter: 2.4GHz~2.5GHz Filter Insertion Loss
2. Spectrum analyzer setting P(Peak): RBW=1MHz, VBW=1MHz, A(Average): RBW=1MHz, VBW=10Hz
3. The result basic equation calculation is as follow:
Level = Reading + AF + Cable - Preamp + Filter, Margin = Level-Limit
4. The other emission levels were 20dB below the limit
5. The test limit distance is 3M limit.



Product Name	11n Dual-Band USB Dongle	Test By	John Chen
Model	WU318d	Test Date	Nov. 17, 2011
Test Mode	IEEE 802.11a TX / CH High	TEMP & Humidity	28.1°C, 54%

Measurement Distance at 3m Horizontal polarity									
Freq.	Reading	AF	Cable Loss	Pre-amp	Filter	Level	Limit	Margin	Mark
(MHz)	(dBµV)	(dB/m)	(dB)	(dB)	(dB)	(dBµV/m)	(dBµV/m)	(dB)	(P/Q/A)
1250.00	58.94	25.65	1.83	39.58	0.74	47.58	74.00	-26.42	P
1250.00	52.13	25.65	1.83	39.58	0.74	40.77	54.00	-13.23	A
*11650.01	53.69	40.65	6.71	37.49	1.08	64.65	74.00	-9.35	P
*11650.01	40.46	40.65	6.71	37.49	1.08	51.42	54.00	-2.58	A
Measurement Distance at 3m Vertical polarity									
Freq.	Reading	AF	Cable Loss	Pre-amp	Filter	Level	Limit	Margin	Mark
(MHz)	(dBµV)	(dB/m)	(dB)	(dB)	(dB)	(dBµV/m)	(dBµV/m)	(dB)	(P/Q/A)
1250.00	55.19	25.65	1.83	39.58	0.74	43.83	74.00	-30.17	P
1250.00	50.37	25.65	1.83	39.58	0.74	39.01	54.00	-14.99	A
*11650.00	54.60	40.65	6.71	37.49	1.08	65.56	74.00	-8.44	P
*11650.00	40.48	40.65	6.71	37.49	1.08	51.44	54.00	-2.56	A

REMARK:

1. AF: Antenna Factor, Cable: Cable Loss, Pre-Amp: Preamplifier gain, Filter: 2.4GHz~2.5GHz Filter Insertion Loss
2. Spectrum analyzer setting P(Peak): RBW=1MHz, VBW=1MHz, A(Average): RBW=1MHz, VBW=10Hz
3. The result basic equation calculation is as follow:
Level = Reading + AF + Cable - Preamp + Filter , Margin = Level-Limit
4. The other emission levels were 20dB below the limit
5. The test limit distance is 3M limit.



Product Name	11n Dual-Band USB Dongle	Test By	John Chen
Model	WU318d	Test Date	Nov. 17, 2011
Test Mode	IEEE 802.11n HT20 TX / CH Low	TEMP & Humidity	28.1°C, 54%

Measurement Distance at 3m Horizontal polarity									
Freq.	Reading	AF	Cable Loss	Pre-amp	Filter	Level	Limit	Margin	Mark
(MHz)	(dBµV)	(dB/m)	(dB)	(dB)	(dB)	(dBµV/m)	(dBµV/m)	(dB)	(P/Q/A)
1250.00	57.01	25.65	1.83	39.58	0.74	45.65	74.00	-28.35	P
1250.00	50.67	25.65	1.83	39.58	0.74	39.31	54.00	-14.69	A
* 11490.00	52.31	40.48	6.62	37.43	1.20	63.18	74.00	-10.82	P
* 11490.00	39.86	40.48	6.62	37.43	1.20	50.73	54.00	-3.27	A

Measurement Distance at 3m Vertical polarity									
Freq.	Reading	AF	Cable Loss	Pre-amp	Filter	Level	Limit	Margin	Mark
(MHz)	(dBµV)	(dB/m)	(dB)	(dB)	(dB)	(dBµV/m)	(dBµV/m)	(dB)	(P/Q/A)
1250.00	54.32	25.65	1.83	39.58	0.74	42.96	74.00	-31.04	P
1250.00	49.27	25.65	1.83	39.58	0.74	37.91	54.00	-16.09	A
* 11490.01	53.16	40.48	6.62	37.43	1.20	64.03	74.00	-9.97	P
* 11490.01	40.59	40.48	6.62	37.43	1.20	51.46	54.00	-2.54	A

REMARK:

1. AF: Antenna Factor, Cable: Cable Loss, Pre-Amp: Preamplifier gain, Filter: 2.4GHz~2.5GHz Filter Insertion Loss
2. Spectrum analyzer setting P(Peak): RBW=1MHz, VBW=1MHz, A(Average): RBW=1MHz, VBW=10Hz
3. The result basic equation calculation is as follow:
Level = Reading + AF + Cable – Preamp + Filter , Margin = Level-Limit
4. The other emission levels were 20dB below the limit
5. The test limit distance is 3M limit.



Product Name	11n Dual-Band USB Dongle	Test By	John Chen
Model	WU318d	Test Date	Nov. 17, 2011
Test Mode	IEEE 802.11n HT20 TX / CH Middle	TEMP & Humidity	28.1°C, 54%

Measurement Distance at 3m Horizontal polarity									
Freq.	Reading	AF	Cable Loss	Pre-amp	Filter	Level	Limit	Margin	Mark
(MHz)	(dBµV)	(dB/m)	(dB)	(dB)	(dB)	(dBµV/m)	(dBµV/m)	(dB)	(P/Q/A)
1250.00	59.95	25.65	1.83	39.58	0.74	48.59	74.00	-25.41	P
1250.00	53.16	25.65	1.83	39.58	0.74	41.80	54.00	-12.20	A
* 11570.00	53.16	40.57	6.67	37.46	1.14	64.08	74.00	-9.92	P
* 11570.00	40.22	40.57	6.67	37.46	1.14	51.14	54.00	-2.86	A

Measurement Distance at 3m Vertical polarity									
Freq.	Reading	AF	Cable Loss	Pre-amp	Filter	Level	Limit	Margin	Mark
(MHz)	(dBµV)	(dB/m)	(dB)	(dB)	(dB)	(dBµV/m)	(dBµV/m)	(dB)	(P/Q/A)
1250.00	56.72	25.65	1.83	39.58	0.74	45.36	74.00	-28.64	P
1250.00	51.62	25.65	1.83	39.58	0.74	40.26	54.00	-13.74	A
* 11570.02	54.92	40.57	6.67	37.46	1.14	65.84	74.00	-8.16	P
* 11570.02	40.47	40.57	6.67	37.46	1.14	51.39	54.00	-2.61	A

REMARK:

1. AF: Antenna Factor, Cable: Cable Loss, Pre-Amp: Preamplifier gain, Filter: 2.4GHz~2.5GHz Filter Insertion Loss
2. Spectrum analyzer setting P(Peak): RBW=1MHz, VBW=1MHz, A(Average): RBW=1MHz, VBW=10Hz
3. The result basic equation calculation is as follow:
Level = Reading + AF + Cable – Preamp + Filter , Margin = Level-Limit
4. The other emission levels were 20dB below the limit
5. The test limit distance is 3M limit.



Product Name	11n Dual-Band USB Dongle	Test By	John Chen
Model	WU318d	Test Date	Nov. 17, 2011
Test Mode	IEEE 802.11n HT20 TX / CH High	TEMP & Humidity	28.1°C, 54%

Measurement Distance at 3m Horizontal polarity									
Freq.	Reading	AF	Cable Loss	Pre-amp	Filter	Level	Limit	Margin	Mark
(MHz)	(dBµV)	(dB/m)	(dB)	(dB)	(dB)	(dBµV/m)	(dBµV/m)	(dB)	(P/Q/A)
1250.00	57.81	25.65	1.83	39.58	0.74	46.45	74.00	-27.55	P
1250.00	51.26	25.65	1.83	39.58	0.74	39.90	54.00	-14.10	A
*11650.01	54.39	40.65	6.71	37.49	1.08	65.35	74.00	-8.65	P
*11650.01	40.97	40.65	6.71	37.49	1.08	51.93	54.00	-2.07	A

Measurement Distance at 3m Vertical polarity									
Freq.	Reading	AF	Cable Loss	Pre-amp	Filter	Level	Limit	Margin	Mark
(MHz)	(dBµV)	(dB/m)	(dB)	(dB)	(dB)	(dBµV/m)	(dBµV/m)	(dB)	(P/Q/A)
1249.99	56.02	25.65	1.83	39.58	0.74	44.66	74.00	-29.34	P
1249.99	50.72	25.65	1.83	39.58	0.74	39.36	54.00	-14.64	A
*11649.98	55.19	40.65	6.71	37.48	1.08	66.15	74.00	-7.85	P
*11649.98	40.05	40.65	6.71	37.48	1.08	51.01	54.00	-2.99	A

REMARK:

1. AF: Antenna Factor, Cable: Cable Loss, Pre-Amp: Preamplifier gain, Filter: 2.4GHz~2.5GHz Filter Insertion Loss
2. Spectrum analyzer setting P(Peak): RBW=1MHz, VBW=1MHz, A(Average): RBW=1MHz, VBW=10Hz
3. The result basic equation calculation is as follow:
Level = Reading + AF + Cable – Preamp + Filter , Margin = Level-Limit
4. The other emission levels were 20dB below the limit
5. The test limit distance is 3M limit.



Product Name	11n Dual-Band USB Dongle	Test By	John Chen
Model	WU318d	Test Date	Nov. 17, 2011
Test Mode	IEEE 802.11n HT40 TX / CH Low	TEMP & Humidity	28.1°C, 54%

Measurement Distance at 3m Horizontal polarity									
Freq.	Reading	AF	Cable Loss	Pre-amp	Filter	Level	Limit	Margin	Mark
(MHz)	(dBµV)	(dB/m)	(dB)	(dB)	(dB)	(dBµV/m)	(dBµV/m)	(dB)	(P/Q/A)
1249.99	59.31	25.65	1.83	39.58	0.74	47.95	74.00	-26.05	P
1249.99	53.77	25.65	1.83	39.58	0.74	42.41	54.00	-11.59	A
* 11510.00	53.25	40.51	6.64	37.44	1.19	64.14	74.00	-9.86	P
* 11510.00	40.09	40.51	6.64	37.44	1.19	50.98	54.00	-3.02	A

Measurement Distance at 3m Vertical polarity									
Freq.	Reading	AF	Cable Loss	Pre-amp	Filter	Level	Limit	Margin	Mark
(MHz)	(dBµV)	(dB/m)	(dB)	(dB)	(dB)	(dBµV/m)	(dBµV/m)	(dB)	(P/Q/A)
1250.01	54.19	25.65	1.83	39.58	0.74	42.83	74.00	-31.17	P
1250.01	48.86	25.65	1.83	39.58	0.74	37.50	54.00	-16.50	A
* 11509.99	54.26	40.51	6.64	37.44	1.19	65.15	74.00	-8.85	P
* 11509.99	40.27	40.51	6.64	37.44	1.19	51.16	54.00	-2.84	A

REMARK:

1. AF: Antenna Factor, Cable: Cable Loss, Pre-Amp: Preamplifier gain, Filter: 2.4GHz~2.5GHz Filter Insertion Loss
2. Spectrum analyzer setting P(Peak): RBW=1MHz, VBW=1MHz, A(Average): RBW=1MHz, VBW=10Hz
3. The result basic equation calculation is as follow:
Level = Reading + AF + Cable – Preamp + Filter , Margin = Level-Limit
4. The other emission levels were 20dB below the limit
5. The test limit distance is 3M limit.



Product Name	11n Dual-Band USB Dongle	Test By	John Chen
Model	WU318d	Test Date	Nov. 17, 2011
Test Mode	IEEE 802.11n HT40 TX / CH Middle	TEMP & Humidity	28.1°C, 54%

Measurement Distance at 3m Horizontal polarity									
Freq.	Reading	AF	Cable Loss	Pre-amp	Filter	Level	Limit	Margin	Mark
(MHz)	(dBµV)	(dB/m)	(dB)	(dB)	(dB)	(dBµV/m)	(dBµV/m)	(dB)	(P/Q/A)
1250.00	57.36	25.65	1.83	39.58	0.74	46.00	74.00	-28.00	P
1250.00	51.77	25.65	1.83	39.58	0.74	40.41	54.00	-13.59	A
* 11589.99	54.29	40.59	6.68	37.47	1.13	65.22	74.00	-8.78	P
* 11589.99	39.88	40.59	6.68	37.47	1.13	50.81	54.00	-3.19	A

Measurement Distance at 3m Vertical polarity									
Freq.	Reading	AF	Cable Loss	Pre-amp	Filter	Level	Limit	Margin	Mark
(MHz)	(dBµV)	(dB/m)	(dB)	(dB)	(dB)	(dBµV/m)	(dBµV/m)	(dB)	(P/Q/A)
1250.00	54.26	25.65	1.83	39.58	0.74	42.90	74.00	-31.10	P
1250.00	48.62	25.65	1.83	39.58	0.74	37.26	54.00	-16.74	A
* 11590.00	55.07	40.59	6.68	37.47	1.13	66.00	74.00	-8.00	P
* 11590.00	39.99	40.59	6.68	37.47	1.13	50.92	54.00	-3.08	A

REMARK:

1. AF: Antenna Factor, Cable: Cable Loss, Pre-Amp: Preamplifier gain, Filter: 2.4GHz~2.5GHz Filter Insertion Loss
2. Spectrum analyzer setting P(Peak): RBW=1MHz, VBW=1MHz, A(Average): RBW=1MHz, VBW=10Hz
3. The result basic equation calculation is as follow:
Level = Reading + AF + Cable – Preamp + Filter , Margin = Level-Limit
4. The other emission levels were 20dB below the limit
5. The test limit distance is 3M limit.



Product Name	11n Dual-Band USB Dongle	Test By	John Chen
Model	WU318d	Test Date	Nov. 17, 2011
Test Mode	IEEE 802.11n HT40 TX / CH High	TEMP & Humidity	28.1°C, 54%

Measurement Distance at 3m Horizontal polarity									
Freq.	Reading	AF	Cable Loss	Pre-amp	Filter	Level	Limit	Margin	Mark
(MHz)	(dBμV)	(dB/m)	(dB)	(dB)	(dB)	(dBμV/m)	(dBμV/m)	(dB)	(P/Q/A)
1250.00	57.12	25.65	1.83	39.58	0.74	45.76	74.00	-28.24	P
1250.00	52.79	25.65	1.83	39.58	0.74	41.43	54.00	-12.57	A
*11630.01	52.76	40.63	6.70	37.48	1.10	63.71	74.00	-10.29	P
*11630.01	40.30	40.63	6.70	37.48	1.10	51.25	54.00	-2.75	A

Measurement Distance at 3m Vertical polarity									
Freq.	Reading	AF	Cable Loss	Pre-amp	Filter	Level	Limit	Margin	Mark
(MHz)	(dBμV)	(dB/m)	(dB)	(dB)	(dB)	(dBμV/m)	(dBμV/m)	(dB)	(P/Q/A)
1250.00	54.86	25.65	1.83	39.58	0.74	43.50	74.00	-30.50	P
1250.00	48.71	25.65	1.83	39.58	0.74	37.35	54.00	-16.65	A
*11630.00	53.02	40.63	6.70	37.48	1.10	63.97	74.00	-10.03	P
*11630.00	39.87	40.63	6.70	37.48	1.10	50.82	54.00	-3.18	A

REMARK:

1. AF: Antenna Factor, Cable: Cable Loss, Pre-Amp: Preamplifier gain, Filter: 2.4GHz~2.5GHz Filter Insertion Loss
2. Spectrum analyzer setting P(Peak): RBW=1MHz, VBW=1MHz, A(Average): RBW=1MHz, VBW=10Hz
3. The result basic equation calculation is as follow:
Level = Reading + AF + Cable – Preamp + Filter , Margin = Level-Limit
4. The other emission levels were 20dB below the limit
5. The test limit distance is 3M limit.



Product Name	11n Dual-Band USB Dongle	Test By	John Chen
Model	WU318d	Test Date	SEP. 30, 2011
Test Mode	IEEE 802.11b TX / CH Low	TEMP & Humidity	27.3°C, 54%

Measurement Distance at 3m Horizontal polarity									
Freq.	Reading	AF	Cable Loss	Pre-amp	Filter	Level	Limit	Margin	Mark
(MHz)	(dBµV)	(dB/m)	(dB)	(dB)	(dB)	(dBµV/m)	(dBµV/m)	(dB)	(P/Q/A)
* 1595.94	58.65	27.33	2.22	41.58	0.84	47.45	74.00	-26.55	P
* 1595.94	47.29	27.33	2.22	41.58	0.84	36.09	54.00	-17.91	A
* 4823.96	56.03	33.17	3.73	42.38	0.69	51.24	74.00	-22.76	P
* 4823.96	49.82	33.17	3.73	42.38	0.69	45.03	54.00	-8.97	A

Measurement Distance at 3m Vertical polarity									
Freq.	Reading	AF	Cable Loss	Pre-amp	Filter	Level	Limit	Margin	Mark
(MHz)	(dBµV)	(dB/m)	(dB)	(dB)	(dB)	(dBµV/m)	(dBµV/m)	(dB)	(P/Q/A)
* 1596.06	59.34	27.33	2.22	41.58	0.84	48.14	74.00	-25.86	P
* 1596.06	50.16	27.33	2.22	41.58	0.84	38.96	54.00	-15.04	A
* 4824.09	55.46	33.17	3.73	42.38	0.69	50.67	74.00	-23.33	P
* 4824.09	49.13	33.17	3.73	42.38	0.69	44.34	54.00	-9.66	A

REMARK:

1. AF: Antenna Factor, Cable: Cable Loss, Pre-Amp: Preamplifier gain, Filter: 2.4GHz~2.5GHz Filter Insertion Loss
2. Spectrum analyzer setting P(Peak): RBW=1MHz, VBW=1MHz, A(Average): RBW=1MHz, VBW=10Hz
3. The result basic equation calculation is as follow:
Level = Reading + AF + Cable - Preamp + Filter , Margin = Level-Limit
4. The other emission levels were 20dB below the limit
5. The test limit distance is 3M limit.



Product Name	11n Dual-Band USB Dongle	Test By	John Chen
Model	WU318d	Test Date	SEP. 30, 2011
Test Mode	IEEE 802.11b TX / CH Middle	TEMP & Humidity	27.3°C, 54%

Measurement Distance at 3m Horizontal polarity									
Freq.	Reading	AF	Cable Loss	Pre-amp	Filter	Level	Limit	Margin	Mark
(MHz)	(dBµV)	(dB/m)	(dB)	(dB)	(dB)	(dBµV/m)	(dBµV/m)	(dB)	(P/Q/A)
* 1596.01	58.49	27.33	2.22	41.58	0.84	47.29	74.00	-26.71	P
* 1596.01	47.02	27.33	2.22	41.58	0.84	35.82	54.00	-18.18	A
* 4874.10	56.31	33.32	3.74	42.43	0.71	51.66	74.00	-22.34	P
* 4874.10	50.60	33.32	3.74	42.43	0.71	45.95	54.00	-8.05	A

Measurement Distance at 3m Vertical polarity									
Freq.	Reading	AF	Cable Loss	Pre-amp	Filter	Level	Limit	Margin	Mark
(MHz)	(dBµV)	(dB/m)	(dB)	(dB)	(dB)	(dBµV/m)	(dBµV/m)	(dB)	(P/Q/A)
* 1596.12	59.79	27.33	2.22	41.58	0.84	48.60	74.00	-25.40	P
* 1596.12	50.48	27.33	2.22	41.58	0.84	39.29	54.00	-14.71	A
* 4874.10	55.55	33.32	3.74	42.43	0.71	50.90	74.00	-23.10	P
* 4874.10	49.42	33.32	3.74	42.43	0.71	44.77	54.00	-9.23	A

REMARK:

1. AF: Antenna Factor, Cable: Cable Loss, Pre-Amp: Preamplifier gain, Filter: 2.4GHz~2.5GHz Filter Insertion Loss
2. Spectrum analyzer setting P(Peak): RBW=1MHz, VBW=1MHz, A(Average): RBW=1MHz, VBW=10Hz
3. The result basic equation calculation is as follow:
Level = Reading + AF + Cable – Preamp + Filter , Margin = Level-Limit
4. The other emission levels were 20dB below the limit
5. The test limit distance is 3M limit.



Product Name	11n Dual-Band USB Dongle	Test By	John Chen
Model	WU318d	Test Date	SEP. 30, 2011
Test Mode	IEEE 802.11b TX / CH High	TEMP & Humidity	27.3°C, 54%

Measurement Distance at 3m Horizontal polarity									
Freq.	Reading	AF	Cable Loss	Pre-amp	Filter	Level	Limit	Margin	Mark
(MHz)	(dBµV)	(dB/m)	(dB)	(dB)	(dB)	(dBµV/m)	(dBµV/m)	(dB)	(P/Q/A)
* 1595.98	59.01	27.33	2.22	41.58	0.84	47.81	74.00	-26.19	P
* 1595.98	47.94	27.33	2.22	41.58	0.84	36.74	54.00	-17.26	A
* 4924.03	55.98	33.47	3.76	42.48	0.73	51.46	74.00	-22.54	P
* 4924.03	49.76	33.47	3.76	42.48	0.73	45.24	54.00	-8.76	A

Measurement Distance at 3m Vertical polarity									
Freq.	Reading	AF	Cable Loss	Pre-amp	Filter	Level	Limit	Margin	Mark
(MHz)	(dBµV)	(dB/m)	(dB)	(dB)	(dB)	(dBµV/m)	(dBµV/m)	(dB)	(P/Q/A)
* 1595.97	60.13	27.33	2.22	41.58	0.84	48.93	74.00	-25.07	P
* 1595.97	51.02	27.33	2.22	41.58	0.84	39.82	54.00	-14.18	A
* 4924.03	55.01	33.47	3.76	42.48	0.73	50.49	74.00	-23.51	P
* 4924.03	48.86	33.47	3.76	42.48	0.73	44.34	54.00	-9.66	A

REMARK:

1. AF: Antenna Factor, Cable: Cable Loss, Pre-Amp: Preamplifier gain, Filter: 2.4GHz~2.5GHz Filter Insertion Loss
2. Spectrum analyzer setting P(Peak): RBW=1MHz, VBW=1MHz, A(Average): RBW=1MHz, VBW=10Hz
3. The result basic equation calculation is as follow:
Level = Reading + AF + Cable – Preamp + Filter , Margin = Level-Limit
4. The other emission levels were 20dB below the limit
5. The test limit distance is 3M limit.



Product Name	11n Dual-Band USB Dongle	Test By	John Chen
Model	WU318d	Test Date	SEP. 30, 2011
Test Mode	IEEE 802.11g TX / CH Low	TEMP & Humidity	27.3°C, 54%

Measurement Distance at 3m Horizontal polarity									
Freq.	Reading	AF	Cable Loss	Pre-amp	Filter	Level	Limit	Margin	Mark
(MHz)	(dBµV)	(dB/m)	(dB)	(dB)	(dB)	(dBµV/m)	(dBµV/m)	(dB)	(P/Q/A)
* 1595.91	58.12	27.33	2.22	41.58	0.84	46.92	74.00	-27.08	P
* 1595.91	46.85	27.33	2.22	41.58	0.84	35.65	54.00	-18.35	A
* 4823.99	56.23	33.17	3.73	42.38	0.69	51.44	74.00	-22.56	P
* 4823.99	49.77	33.17	3.73	42.38	0.69	44.98	54.00	-9.02	A

Measurement Distance at 3m Vertical polarity									
Freq.	Reading	AF	Cable Loss	Pre-amp	Filter	Level	Limit	Margin	Mark
(MHz)	(dBµV)	(dB/m)	(dB)	(dB)	(dB)	(dBµV/m)	(dBµV/m)	(dB)	(P/Q/A)
* 1596.24	59.60	27.33	2.22	41.58	0.84	48.41	74.00	-25.59	P
* 1596.24	50.23	27.33	2.22	41.58	0.84	39.04	54.00	-14.96	A
* 4824.02	54.02	33.17	3.73	42.38	0.69	49.23	74.00	-24.77	P
* 4824.02	48.39	33.17	3.73	42.38	0.69	43.60	54.00	-10.40	A

REMARK:

1. AF: Antenna Factor, Cable: Cable Loss, Pre-Amp: Preamplifier gain, Filter: 2.4GHz~2.5GHz Filter Insertion Loss
2. Spectrum analyzer setting P(Peak): RBW=1MHz, VBW=1MHz, A(Average): RBW=1MHz, VBW=10Hz
3. The result basic equation calculation is as follow:
Level = Reading + AF + Cable – Preamp + Filter , Margin = Level-Limit
4. The other emission levels were 20dB below the limit
5. The test limit distance is 3M limit.



Product Name	11n Dual-Band USB Dongle	Test By	John Chen
Model	WU318d	Test Date	SEP. 30, 2011
Test Mode	IEEE 802.11g TX / CH Middle	TEMP & Humidity	27.3°C, 54%

Measurement Distance at 3m Horizontal polarity									
Freq.	Reading	AF	Cable Loss	Pre-amp	Filter	Level	Limit	Margin	Mark
(MHz)	(dBµV)	(dB/m)	(dB)	(dB)	(dB)	(dBµV/m)	(dBµV/m)	(dB)	(P/Q/A)
* 1596.08	59.13	27.33	2.22	41.58	0.84	47.94	74.00	-26.06	P
* 1596.08	47.72	27.33	2.22	41.58	0.84	36.53	54.00	-17.47	A
* 4874.13	56.27	33.32	3.74	42.43	0.71	51.62	74.00	-22.38	P
* 4874.13	49.57	33.32	3.74	42.43	0.71	44.92	54.00	-9.08	A

Measurement Distance at 3m Vertical polarity									
Freq.	Reading	AF	Cable Loss	Pre-amp	Filter	Level	Limit	Margin	Mark
(MHz)	(dBµV)	(dB/m)	(dB)	(dB)	(dB)	(dBµV/m)	(dBµV/m)	(dB)	(P/Q/A)
* 1596.04	59.66	27.33	2.22	41.58	0.84	48.46	74.00	-25.54	P
* 1596.04	50.49	27.33	2.22	41.58	0.84	39.29	54.00	-14.71	A
* 4874.08	54.92	33.32	3.74	42.43	0.71	50.27	74.00	-23.73	P
* 4874.08	48.03	33.32	3.74	42.43	0.71	43.38	54.00	-10.62	A

REMARK:

1. AF: Antenna Factor, Cable: Cable Loss, Pre-Amp: Preamplifier gain, Filter: 2.4GHz~2.5GHz Filter Insertion Loss
2. Spectrum analyzer setting P(Peak): RBW=1MHz, VBW=1MHz, A(Average): RBW=1MHz, VBW=10Hz
3. The result basic equation calculation is as follow:
Level = Reading + AF + Cable - Preamp + Filter, Margin = Level-Limit
4. The other emission levels were 20dB below the limit
5. The test limit distance is 3M limit.



Product Name	11n Dual-Band USB Dongle	Test By	John Chen
Model	WU318d	Test Date	SEP. 30, 2011
Test Mode	IEEE 802.11g TX / CH High	TEMP & Humidity	27.3°C, 54%

Measurement Distance at 3m Horizontal polarity									
Freq.	Reading	AF	Cable Loss	Pre-amp	Filter	Level	Limit	Margin	Mark
(MHz)	(dBµV)	(dB/m)	(dB)	(dB)	(dB)	(dBµV/m)	(dBµV/m)	(dB)	(P/Q/A)
* 1595.97	59.31	27.33	2.22	41.58	0.84	48.11	74.00	-25.89	P
* 1595.97	47.80	27.33	2.22	41.58	0.84	36.60	54.00	-17.40	A
* 4924.01	56.34	33.47	3.76	42.48	0.73	51.82	74.00	-22.18	P
* 4924.01	49.62	33.47	3.76	42.48	0.73	45.10	54.00	-8.90	A

Measurement Distance at 3m Vertical polarity									
Freq.	Reading	AF	Cable Loss	Pre-amp	Filter	Level	Limit	Margin	Mark
(MHz)	(dBµV)	(dB/m)	(dB)	(dB)	(dB)	(dBµV/m)	(dBµV/m)	(dB)	(P/Q/A)
* 1595.96	59.62	27.33	2.22	41.58	0.84	48.42	74.00	-25.58	P
* 1595.96	50.28	27.33	2.22	41.58	0.84	39.08	54.00	-14.92	A
* 4924.05	55.37	33.47	3.76	42.48	0.73	50.85	74.00	-23.15	P
* 4924.05	49.09	33.47	3.76	42.48	0.73	44.57	54.00	-9.43	A

REMARK:

1. AF: Antenna Factor, Cable: Cable Loss, Pre-Amp: Preamplifier gain, Filter: 2.4GHz~2.5GHz Filter Insertion Loss
2. Spectrum analyzer setting P(Peak): RBW=1MHz, VBW=1MHz, A(Average): RBW=1MHz, VBW=10Hz
3. The result basic equation calculation is as follow:
Level = Reading + AF + Cable – Preamp + Filter , Margin = Level-Limit
4. The other emission levels were 20dB below the limit
5. The test limit distance is 3M limit.



Product Name	11n Dual-Band USB Dongle	Test By	John Chen
Model	WU318d	Test Date	SEP. 30, 2011
Test Mode	IEEE 802.11n HT20 TX / CH Low	TEMP & Humidity	27.3°C, 54%

Measurement Distance at 3m Horizontal polarity									
Freq.	Reading	AF	Cable Loss	Pre-amp	Filter	Level	Limit	Margin	Mark
(MHz)	(dBµV)	(dB/m)	(dB)	(dB)	(dB)	(dBµV/m)	(dBµV/m)	(dB)	(P/Q/A)
* 1596.18	59.31	27.33	2.22	41.58	0.84	48.12	74.00	-25.88	P
* 1596.18	48.02	27.33	2.22	41.58	0.84	36.83	54.00	-17.17	A
* 4824.05	56.71	33.17	3.73	42.38	0.69	51.92	74.00	-22.08	P
* 4824.05	48.92	33.17	3.73	42.38	0.69	44.13	54.00	-9.87	A

Measurement Distance at 3m Vertical polarity									
Freq.	Reading	AF	Cable Loss	Pre-amp	Filter	Level	Limit	Margin	Mark
(MHz)	(dBµV)	(dB/m)	(dB)	(dB)	(dB)	(dBµV/m)	(dBµV/m)	(dB)	(P/Q/A)
* 1595.93	60.31	27.33	2.22	41.58	0.84	49.11	74.00	-24.89	P
* 1595.93	50.48	27.33	2.22	41.58	0.84	39.28	54.00	-14.72	A
* 4824.01	54.70	33.17	3.73	42.38	0.69	49.91	74.00	-24.09	P
* 4824.01	47.93	33.17	3.73	42.38	0.69	43.14	54.00	-10.86	A

REMARK:

1. AF: Antenna Factor, Cable: Cable Loss, Pre-Amp: Preamplifier gain, Filter: 2.4GHz~2.5GHz Filter Insertion Loss
2. Spectrum analyzer setting P(Peak): RBW=1MHz, VBW=1MHz, A(Average): RBW=1MHz, VBW=10Hz
3. The result basic equation calculation is as follow:
 $Level = Reading + AF + Cable - Preamp + Filter$, $Margin = Level - Limit$
4. The other emission levels were 20dB below the limit
5. The test limit distance is 3M limit.



Product Name	11n Dual-Band USB Dongle	Test By	John Chen
Model	WU318d	Test Date	SEP. 30, 2011
Test Mode	IEEE 802.11n HT20 TX / CH Middle	TEMP & Humidity	27.3°C, 54%

Measurement Distance at 3m Horizontal polarity									
Freq.	Reading	AF	Cable Loss	Pre-amp	Filter	Level	Limit	Margin	Mark
(MHz)	(dBμV)	(dB/m)	(dB)	(dB)	(dB)	(dBμV/m)	(dBμV/m)	(dB)	(P/Q/A)
* 1595.78	58.17	27.33	2.22	41.58	0.84	46.97	74.00	-27.03	P
* 1595.78	47.33	27.33	2.22	41.58	0.84	36.13	54.00	-17.87	A
* 4874.02	56.19	33.32	3.74	42.43	0.71	51.53	74.00	-22.47	P
* 4874.02	49.25	33.32	3.74	42.43	0.71	44.59	54.00	-9.41	A
Measurement Distance at 3m Vertical polarity									
Freq.	Reading	AF	Cable Loss	Pre-amp	Filter	Level	Limit	Margin	Mark
(MHz)	(dBμV)	(dB/m)	(dB)	(dB)	(dB)	(dBμV/m)	(dBμV/m)	(dB)	(P/Q/A)
* 1595.99	59.71	27.33	2.22	41.58	0.84	48.51	74.00	-25.49	P
* 1595.99	50.20	27.33	2.22	41.58	0.84	39.00	54.00	-15.00	A
* 4874.06	54.32	33.32	3.74	42.43	0.71	49.66	74.00	-24.34	P
* 4874.06	47.85	33.32	3.74	42.43	0.71	43.19	54.00	-10.81	A

REMARK:

1. AF: Antenna Factor, Cable: Cable Loss, Pre-Amp: Preamplifier gain, Filter: 2.4GHz~2.5GHz Filter Insertion Loss
2. Spectrum analyzer setting P(Peak): RBW=1MHz, VBW=1MHz, A(Average): RBW=1MHz, VBW=10Hz
3. The result basic equation calculation is as follow:
Level = Reading + AF + Cable – Preamp + Filter , Margin = Level-Limit
4. The other emission levels were 20dB below the limit
5. The test limit distance is 3M limit.



Product Name	11n Dual-Band USB Dongle	Test By	John Chen
Model	WU318d	Test Date	SEP. 30, 2011
Test Mode	IEEE 802.11n HT20 TX / CH High	TEMP & Humidity	27.3°C, 54%

Measurement Distance at 3m Horizontal polarity									
Freq.	Reading	AF	Cable Loss	Pre-amp	Filter	Level	Limit	Margin	Mark
(MHz)	(dBµV)	(dB/m)	(dB)	(dB)	(dB)	(dBµV/m)	(dBµV/m)	(dB)	(P/Q/A)
* 1596.23	58.62	27.33	2.22	41.58	0.84	47.43	74.00	-26.57	P
* 1596.23	47.31	27.33	2.22	41.58	0.84	36.12	54.00	-17.88	A
* 4924.01	56.40	33.47	3.76	42.48	0.73	51.88	74.00	-22.12	P
* 4924.01	49.82	33.47	3.76	42.48	0.73	45.30	54.00	-8.70	A

Measurement Distance at 3m Vertical polarity									
Freq.	Reading	AF	Cable Loss	Pre-amp	Filter	Level	Limit	Margin	Mark
(MHz)	(dBµV)	(dB/m)	(dB)	(dB)	(dB)	(dBµV/m)	(dBµV/m)	(dB)	(P/Q/A)
* 1596.00	60.31	27.33	2.22	41.58	0.84	49.11	74.00	-24.89	P
* 1596.00	51.22	27.33	2.22	41.58	0.84	40.02	54.00	-13.98	A
* 4924.02	56.08	33.47	3.76	42.48	0.73	51.56	74.00	-22.44	P
* 4924.02	49.49	33.47	3.76	42.48	0.73	44.97	54.00	-9.03	A

REMARK:

1. AF: Antenna Factor, Cable: Cable Loss, Pre-Amp: Preamplifier gain, Filter: 2.4GHz~2.5GHz Filter Insertion Loss
2. Spectrum analyzer setting P(Peak): RBW=1MHz, VBW=1MHz, A(Average): RBW=1MHz, VBW=10Hz
3. The result basic equation calculation is as follow:
Level = Reading + AF + Cable – Preamp + Filter , Margin = Level-Limit
4. The other emission levels were 20dB below the limit
5. The test limit distance is 3M limit.



Product Name	11n Dual-Band USB Dongle	Test By	John Chen
Model	WU318d	Test Date	SEP. 30, 2011
Test Mode	IEEE 802.11n HT40 TX / CH Low	TEMP & Humidity	27.3°C, 54%

Measurement Distance at 3m Horizontal polarity									
Freq.	Reading	AF	Cable Loss	Pre-amp	Filter	Level	Limit	Margin	Mark
(MHz)	(dBµV)	(dB/m)	(dB)	(dB)	(dB)	(dBµV/m)	(dBµV/m)	(dB)	(P/Q/A)
* 1595.97	59.24	27.33	2.22	41.58	0.84	48.04	74.00	-25.96	P
* 1595.97	47.65	27.33	2.22	41.58	0.84	36.45	54.00	-17.55	A
* 4843.96	56.01	33.23	3.74	42.40	0.70	51.27	74.00	-22.73	P
* 4843.96	49.88	33.23	3.74	42.40	0.70	45.14	54.00	-8.86	A

Measurement Distance at 3m Vertical polarity									
Freq.	Reading	AF	Cable Loss	Pre-amp	Filter	Level	Limit	Margin	Mark
(MHz)	(dBµV)	(dB/m)	(dB)	(dB)	(dB)	(dBµV/m)	(dBµV/m)	(dB)	(P/Q/A)
* 1596.13	60.14	27.33	2.22	41.58	0.84	48.95	74.00	-25.05	P
* 1596.13	49.02	27.33	2.22	41.58	0.84	37.83	54.00	-16.17	A
* 4844.09	54.02	33.23	3.74	42.40	0.70	49.29	74.00	-24.71	P
* 4844.09	48.17	33.23	3.74	42.40	0.70	43.44	54.00	-10.56	A

REMARK:

1. AF: Antenna Factor, Cable: Cable Loss, Pre-Amp: Preamplifier gain, Filter: 2.4GHz~2.5GHz Filter Insertion Loss
2. Spectrum analyzer setting P(Peak): RBW=1MHz, VBW=1MHz, A(Average): RBW=1MHz, VBW=10Hz
3. The result basic equation calculation is as follow:
Level = Reading + AF + Cable – Preamp + Filter , Margin = Level-Limit
4. The other emission levels were 20dB below the limit
5. The test limit distance is 3M limit.



Product Name	11n Dual-Band USB Dongle	Test By	John Chen
Model	WU318d	Test Date	SEP. 30, 2011
Test Mode	IEEE 802.11n HT40 TX / CH Middle	TEMP & Humidity	27.3°C, 54%

Measurement Distance at 3m Horizontal polarity									
Freq.	Reading	AF	Cable Loss	Pre-amp	Filter	Level	Limit	Margin	Mark
(MHz)	(dBµV)	(dB/m)	(dB)	(dB)	(dB)	(dBµV/m)	(dBµV/m)	(dB)	(P/Q/A)
* 1595.82	58.65	27.33	2.22	41.58	0.84	47.45	74.00	-26.55	P
* 1595.82	47.29	27.33	2.22	41.58	0.84	36.09	54.00	-17.91	A
* 4874.15	56.03	33.32	3.74	42.43	0.71	51.38	74.00	-22.62	P
* 4874.15	49.82	33.32	3.74	42.43	0.71	45.17	54.00	-8.83	A

Measurement Distance at 3m Vertical polarity									
Freq.	Reading	AF	Cable Loss	Pre-amp	Filter	Level	Limit	Margin	Mark
(MHz)	(dBµV)	(dB/m)	(dB)	(dB)	(dB)	(dBµV/m)	(dBµV/m)	(dB)	(P/Q/A)
* 1596.19	59.14	27.33	2.22	41.58	0.84	47.95	74.00	-26.05	P
* 1596.19	49.26	27.33	2.22	41.58	0.84	38.07	54.00	-15.93	A
* 4874.09	55.01	33.32	3.74	42.43	0.71	50.36	74.00	-23.64	P
* 4874.09	47.68	33.32	3.74	42.43	0.71	43.03	54.00	-10.97	A

REMARK:

1. AF: Antenna Factor, Cable: Cable Loss, Pre-Amp: Preamplifier gain, Filter: 2.4GHz~2.5GHz Filter Insertion Loss
2. Spectrum analyzer setting P(Peak): RBW=1MHz, VBW=1MHz, A(Average): RBW=1MHz, VBW=10Hz
3. The result basic equation calculation is as follow:
Level = Reading + AF + Cable – Preamp + Filter , Margin = Level-Limit
4. The other emission levels were 20dB below the limit
5. The test limit distance is 3M limit.



Product Name	11n Dual-Band USB Dongle	Test By	John Chen
Model	WU318d	Test Date	SEP. 30, 2011
Test Mode	IEEE 802.11n HT40 TX / CH High	TEMP & Humidity	27.3°C, 54%

Measurement Distance at 3m Horizontal polarity									
Freq.	Reading	AF	Cable Loss	Pre-amp	Filter	Level	Limit	Margin	Mark
(MHz)	(dBµV)	(dB/m)	(dB)	(dB)	(dB)	(dBµV/m)	(dBµV/m)	(dB)	(P/Q/A)
* 1596.04	58.32	27.33	2.22	41.58	0.84	47.12	74.00	-26.88	P
* 1596.04	48.41	27.33	2.22	41.58	0.84	37.21	54.00	-16.79	A
* 4904.05	56.73	33.41	3.75	42.46	0.72	52.15	74.00	-21.85	P
* 4904.05	49.62	33.41	3.75	42.46	0.72	45.04	54.00	-8.96	A

Measurement Distance at 3m Vertical polarity									
Freq.	Reading	AF	Cable Loss	Pre-amp	Filter	Level	Limit	Margin	Mark
(MHz)	(dBµV)	(dB/m)	(dB)	(dB)	(dB)	(dBµV/m)	(dBµV/m)	(dB)	(P/Q/A)
* 1595.97	60.15	27.33	2.22	41.58	0.84	48.95	74.00	-25.05	P
* 1595.97	49.37	27.33	2.22	41.58	0.84	38.17	54.00	-15.83	A
* 4904.03	55.37	33.41	3.75	42.46	0.72	50.79	74.00	-23.21	P
* 4904.03	48.68	33.41	3.75	42.46	0.72	44.10	54.00	-9.90	A

REMARK:

1. AF: Antenna Factor, Cable: Cable Loss, Pre-Amp: Preamplifier gain, Filter: 2.4GHz~2.5GHz Filter Insertion Loss
2. Spectrum analyzer setting P(Peak): RBW=1MHz, VBW=1MHz, A(Average): RBW=1MHz, VBW=10Hz
3. The result basic equation calculation is as follow:
Level = Reading + AF + Cable – Preamp + Filter , Margin = Level-Limit
4. The other emission levels were 20dB below the limit
5. The test limit distance is 3M limit.



Detector Mode : Peak Polarity : Vertical

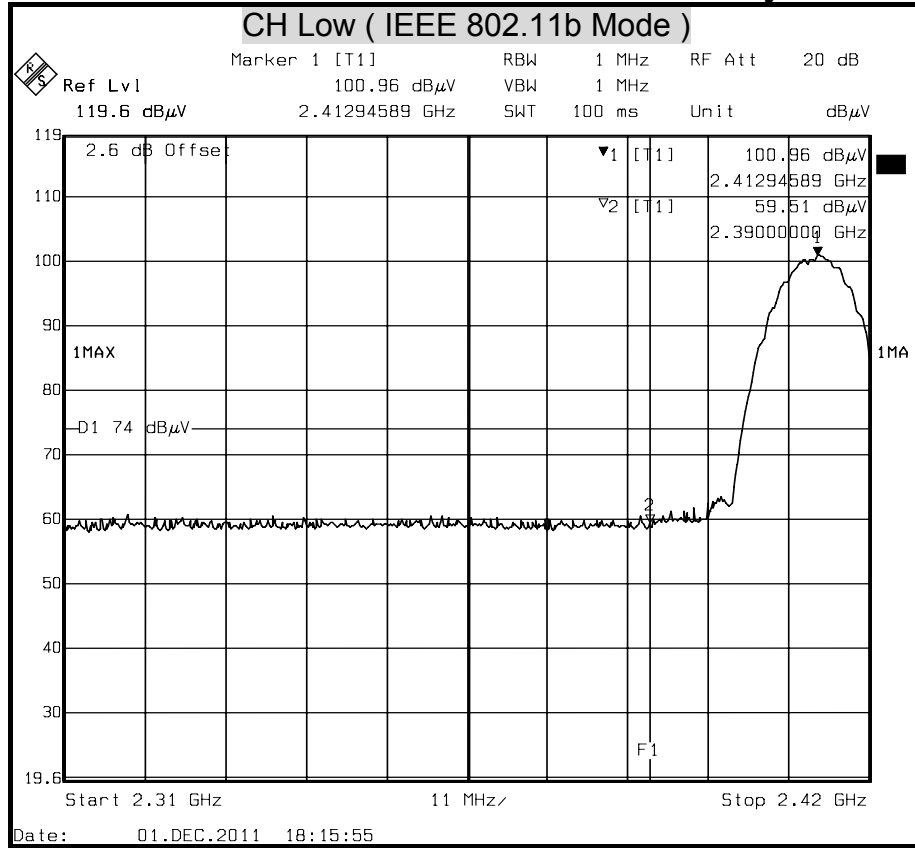

Detector Mode : Average Polarity : Vertical

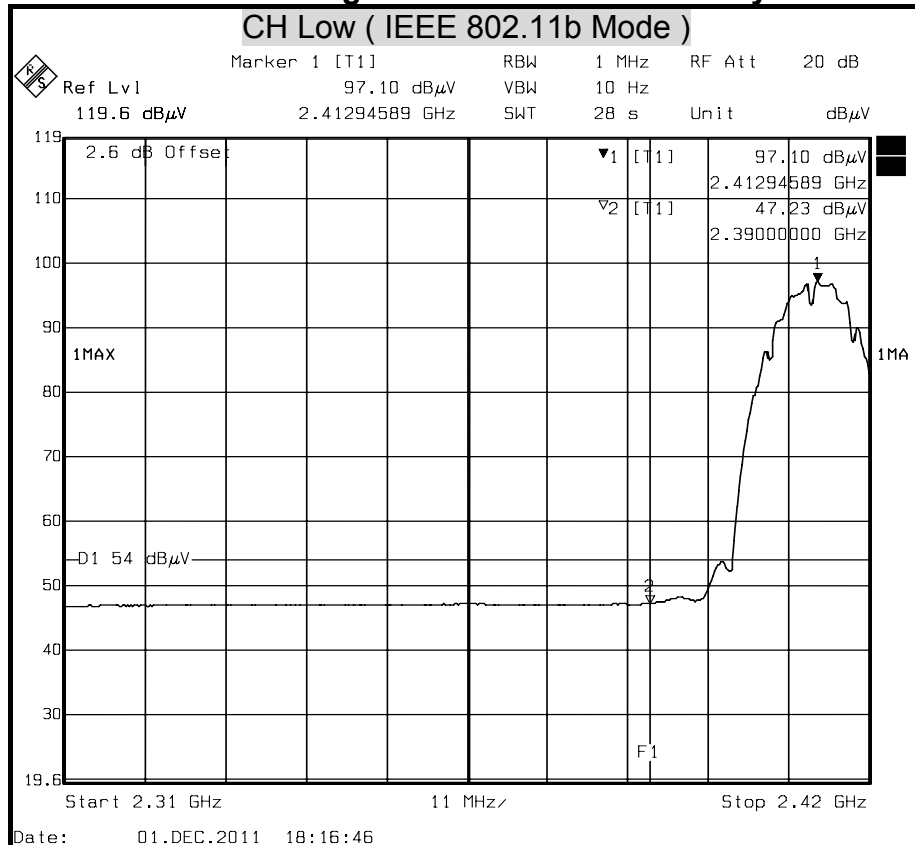



Detector Mode : Peak Polarity : Horizontal

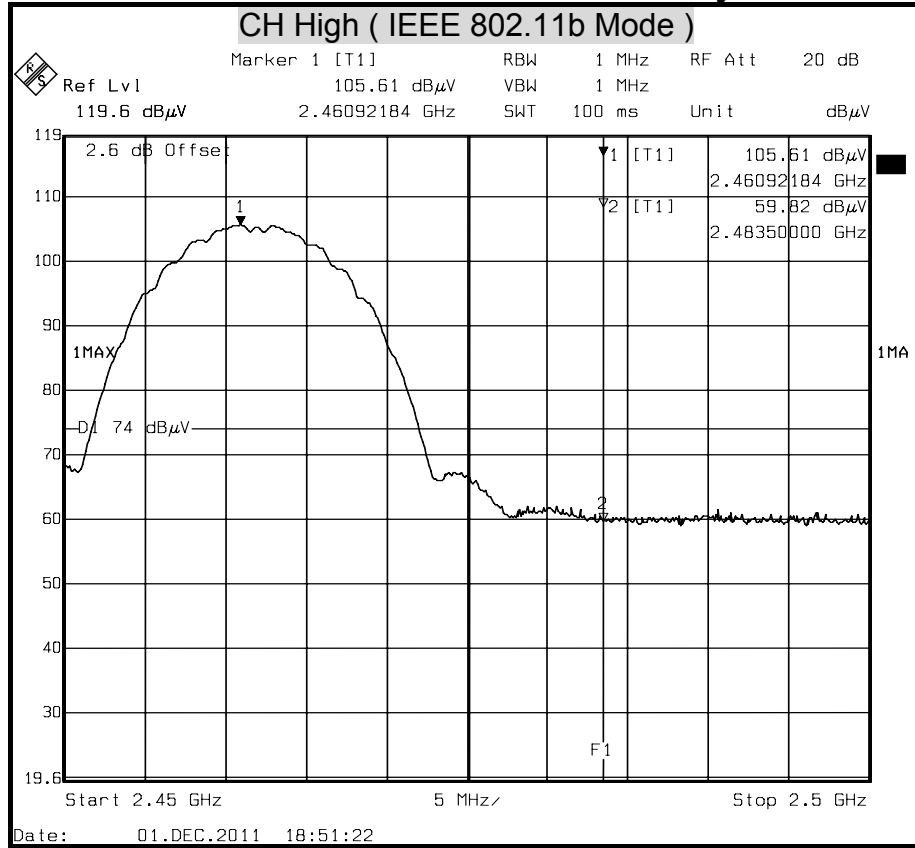

Detector Mode : Average Polarity : Horizontal

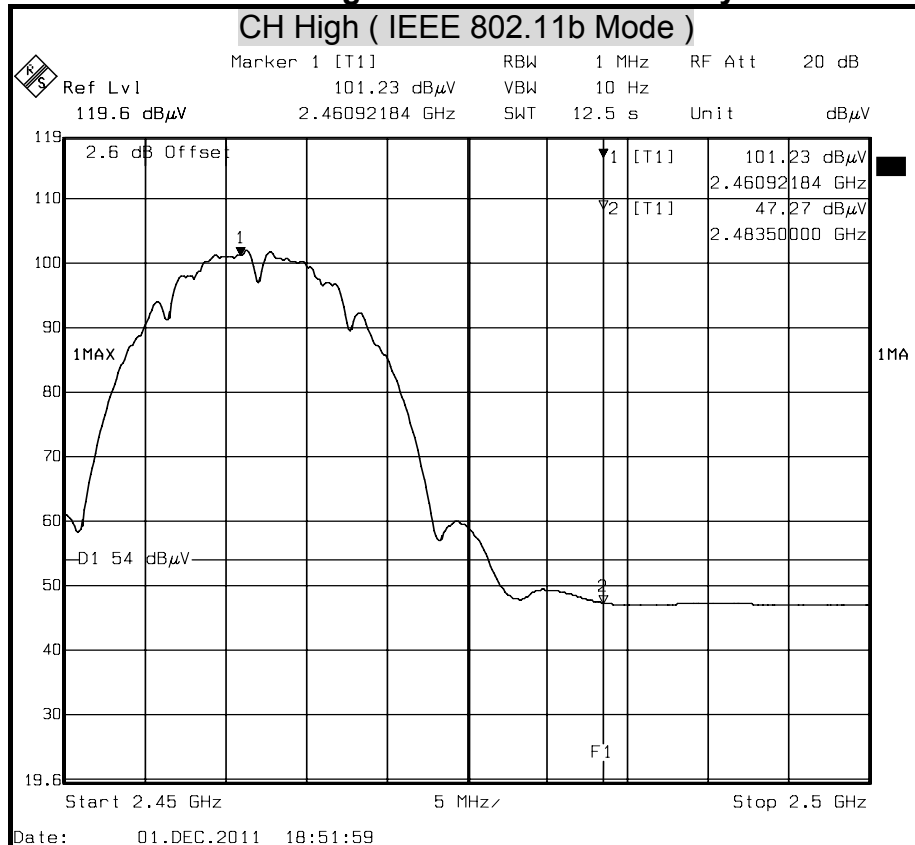



Detector Mode : Peak

Polarity : Vertical

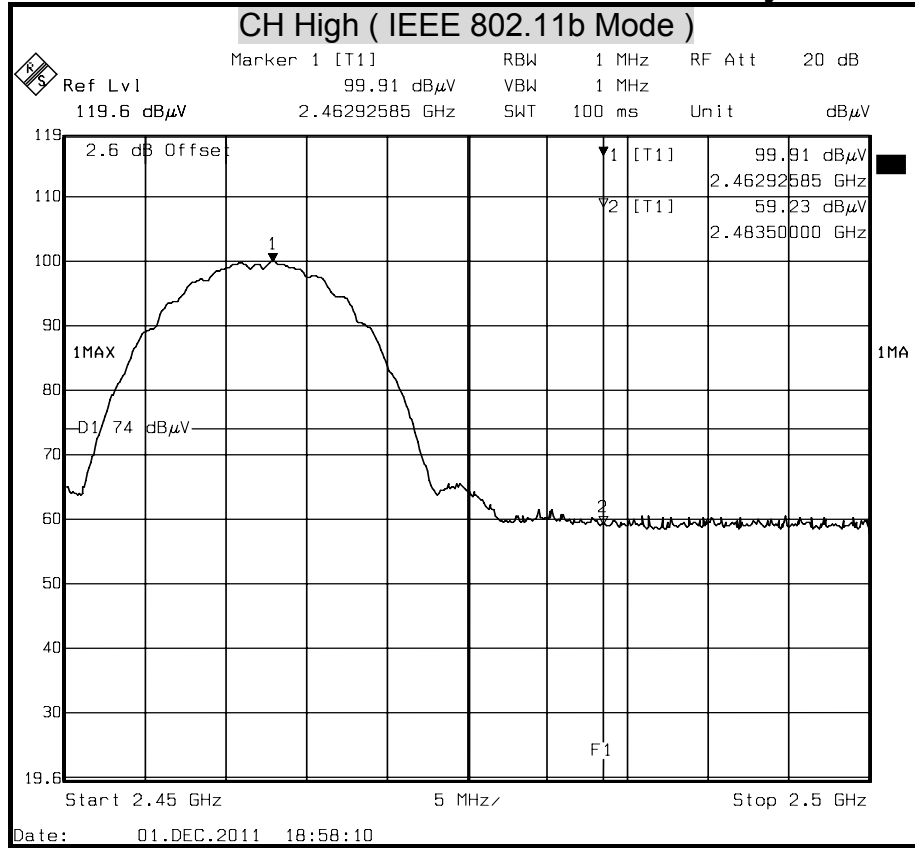

Detector Mode : Average

Polarity : Vertical

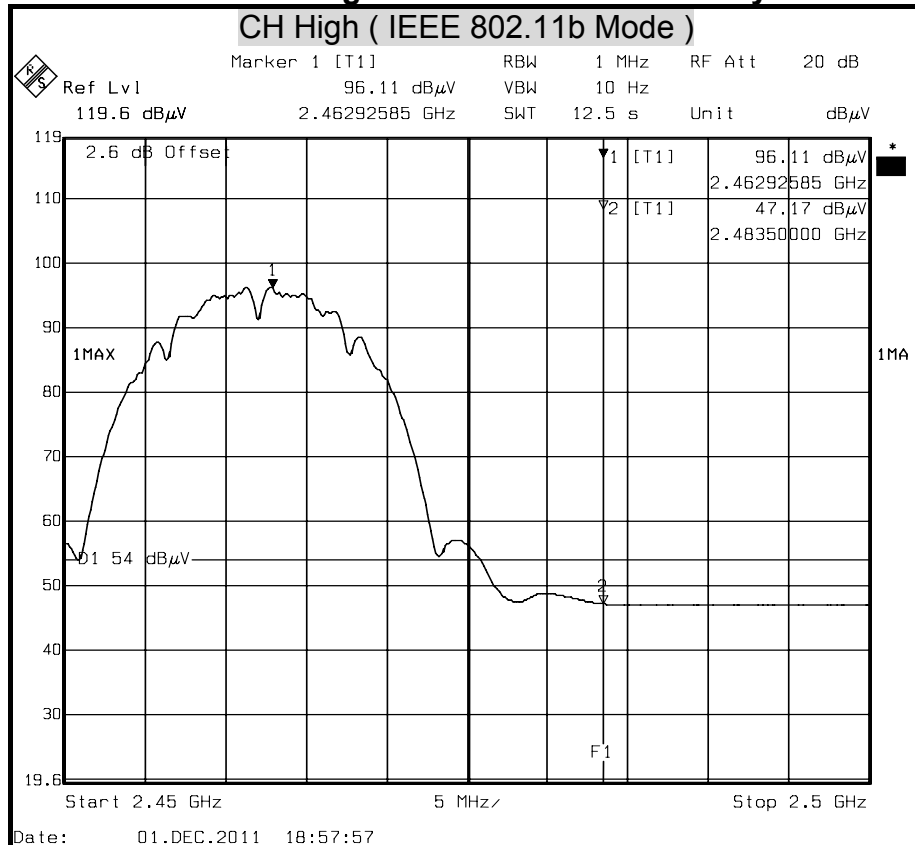



Detector Mode : Peak Polarity : Horizontal

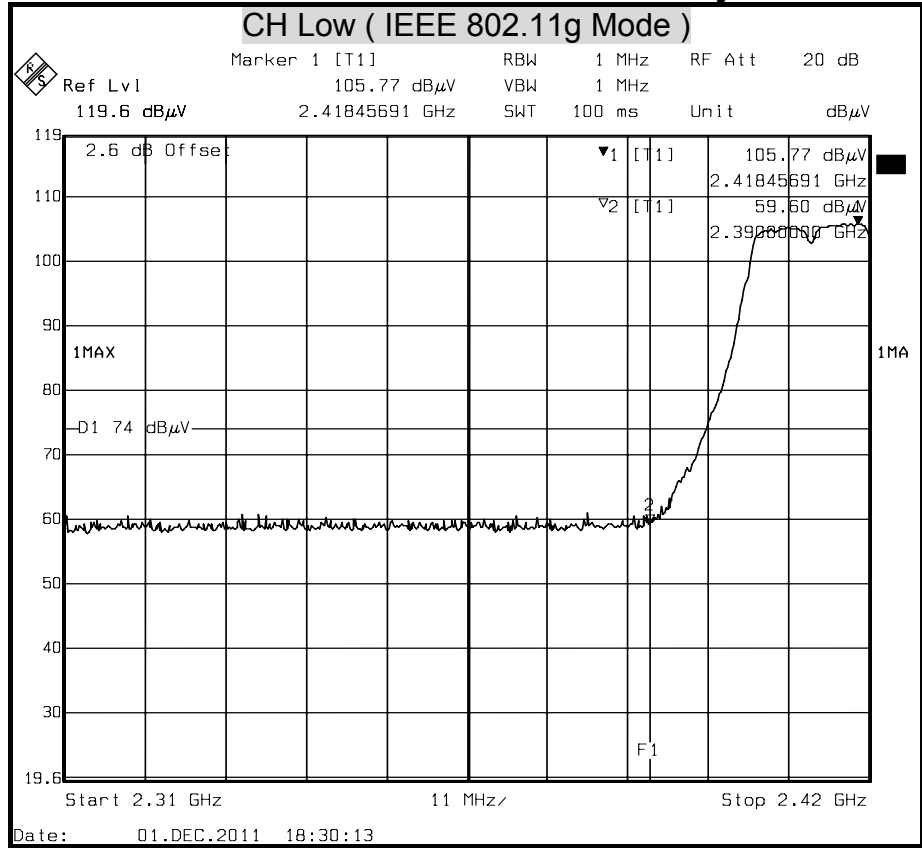

Detector Mode : Average Polarity : Horizontal

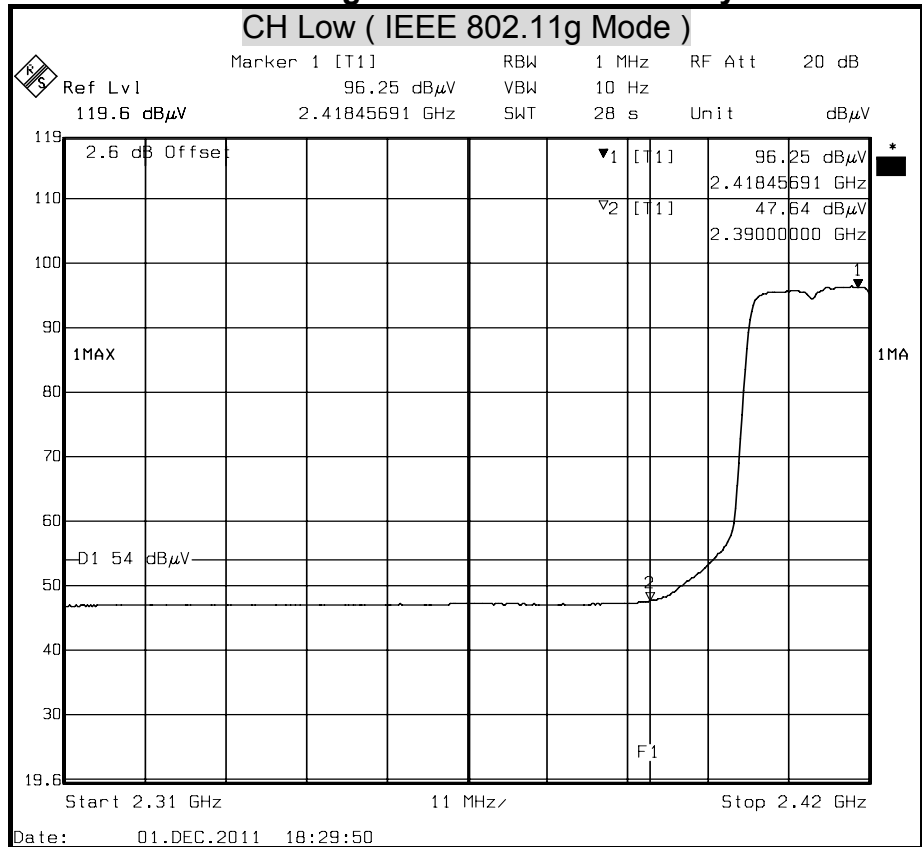



Detector Mode : Peak

Polarity : Vertical

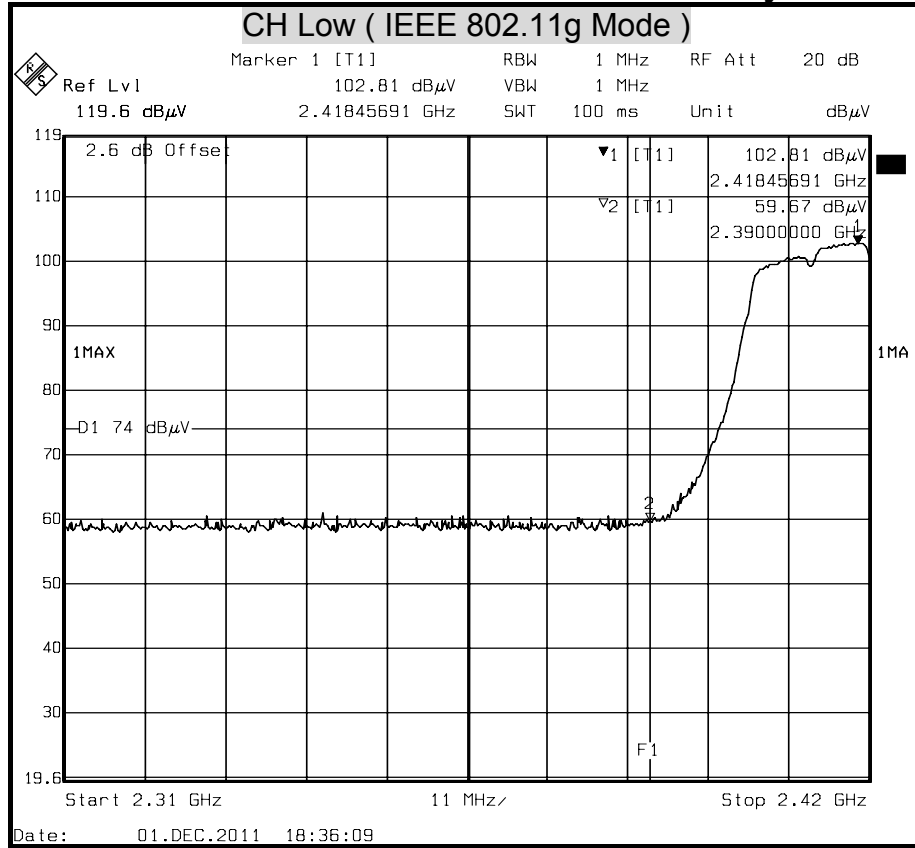

Detector Mode : Average

Polarity : Vertical

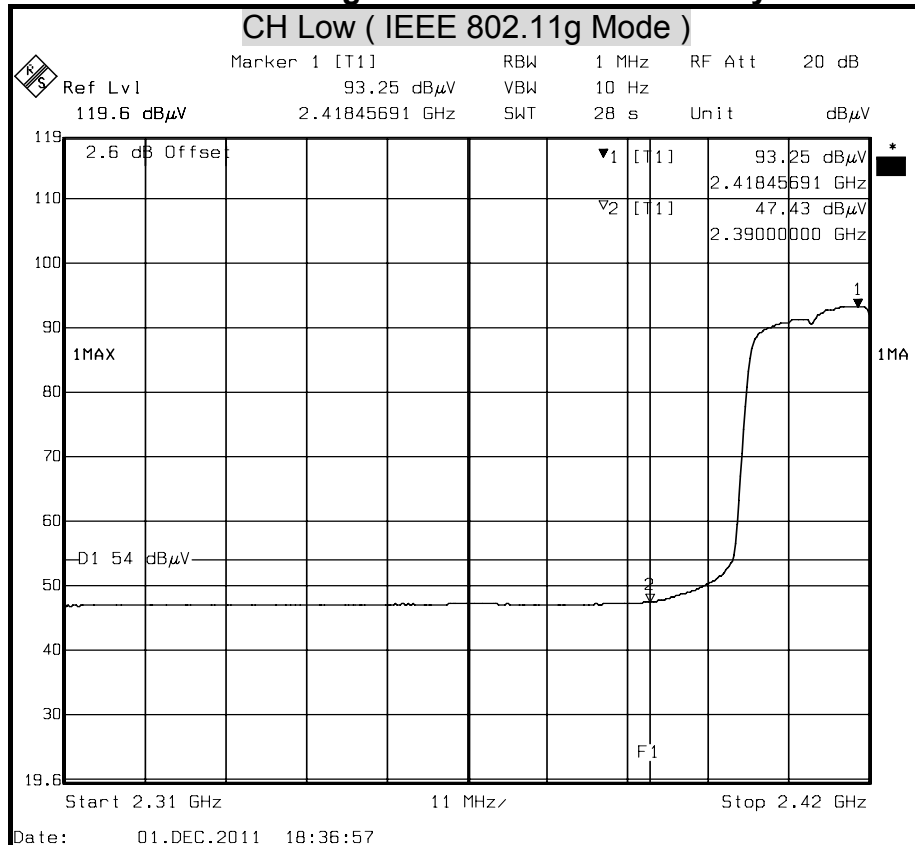



Detector Mode : Peak Polarity : Horizontal

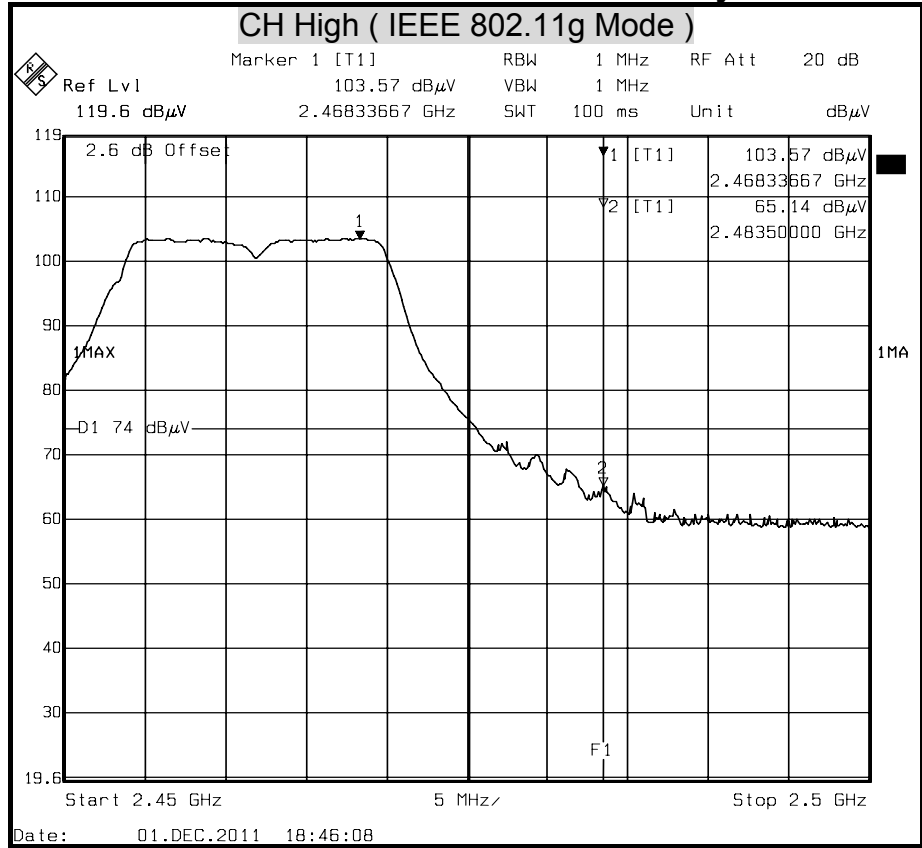

Detector Mode : Average Polarity : Horizontal

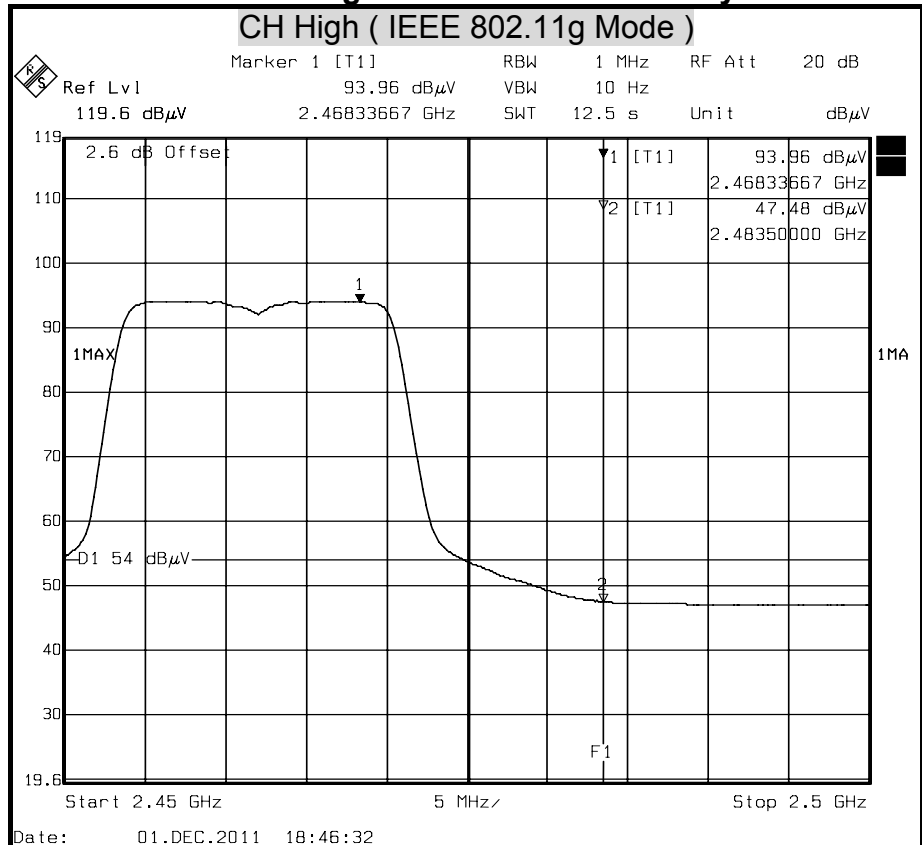



Detector Mode : Peak Polarity : Vertical

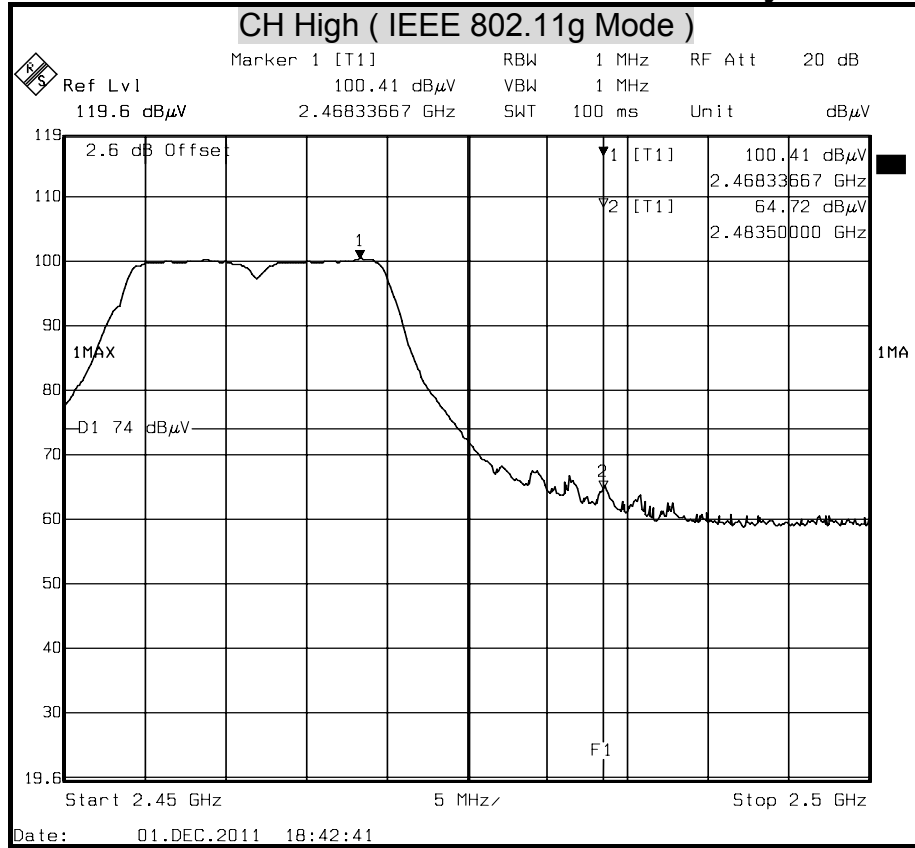

Detector Mode : Average Polarity : Vertical

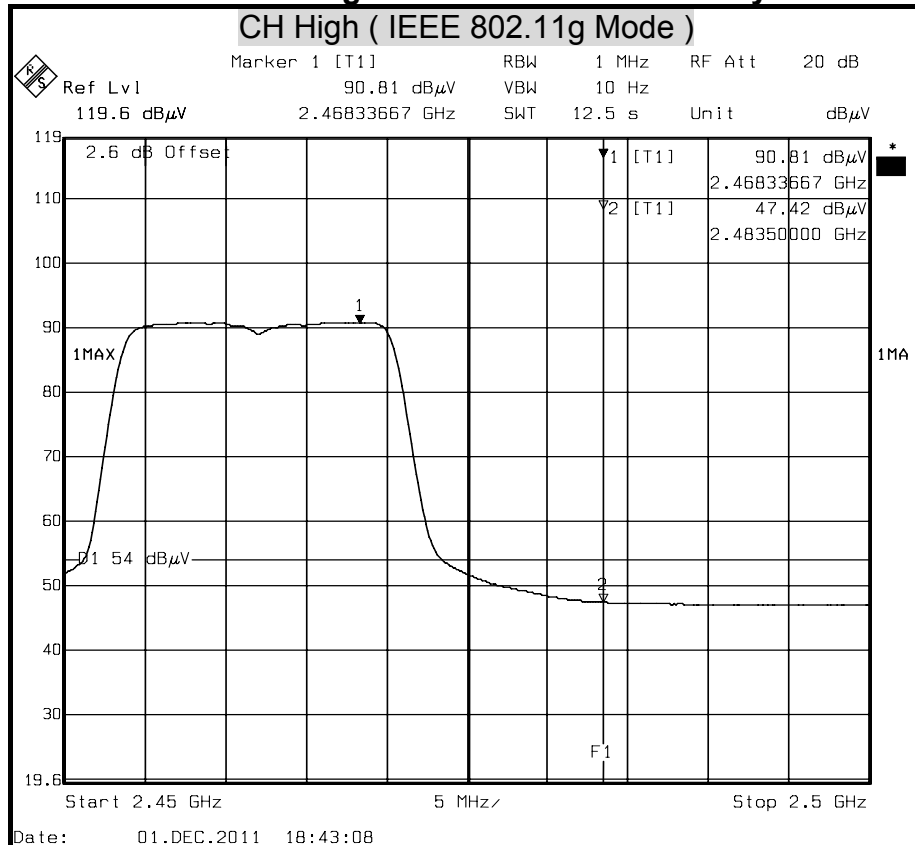



Detector Mode : Peak Polarity : Horizontal

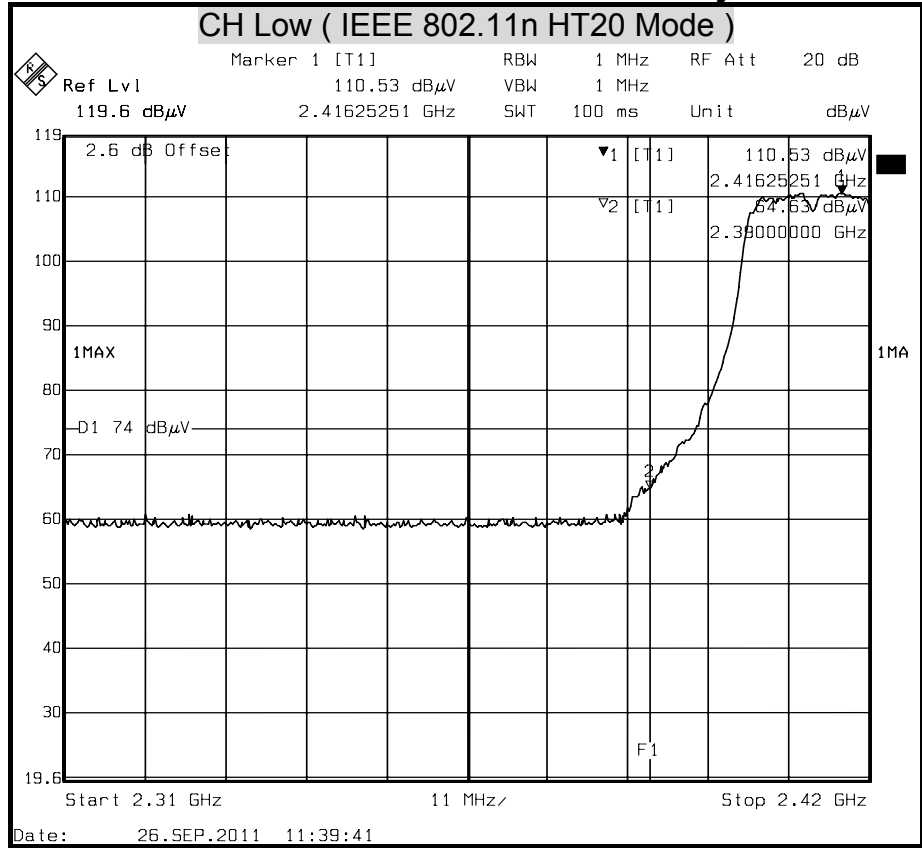

Detector Mode : Average Polarity : Horizontal

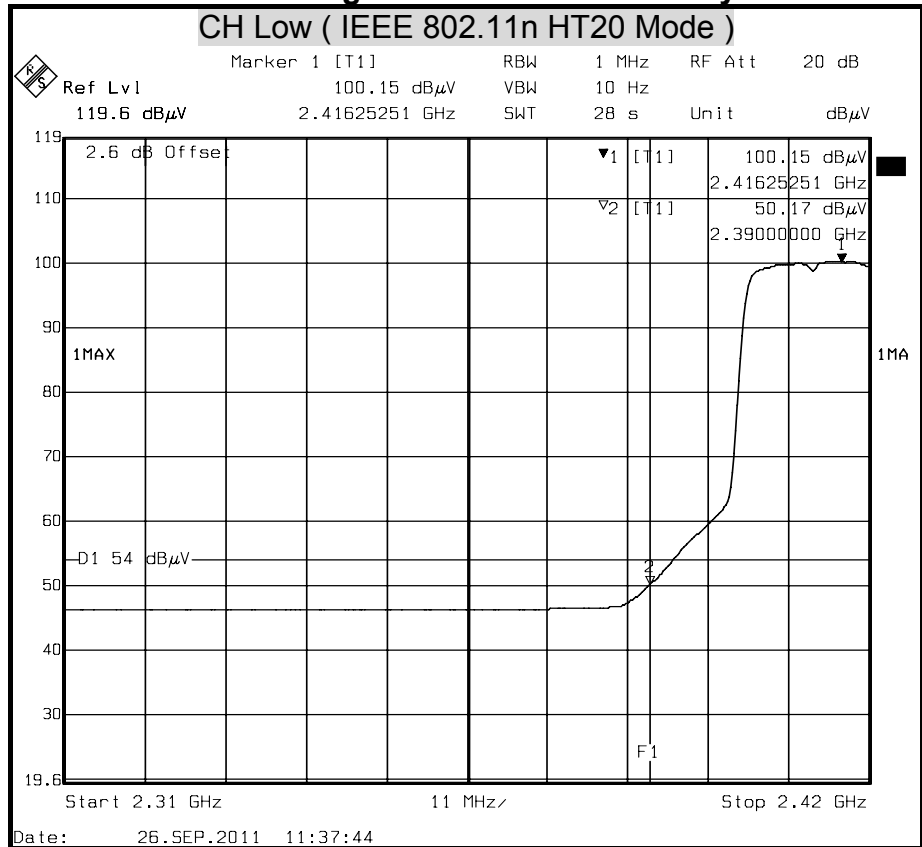



Detector Mode : Peak

Polarity : Vertical

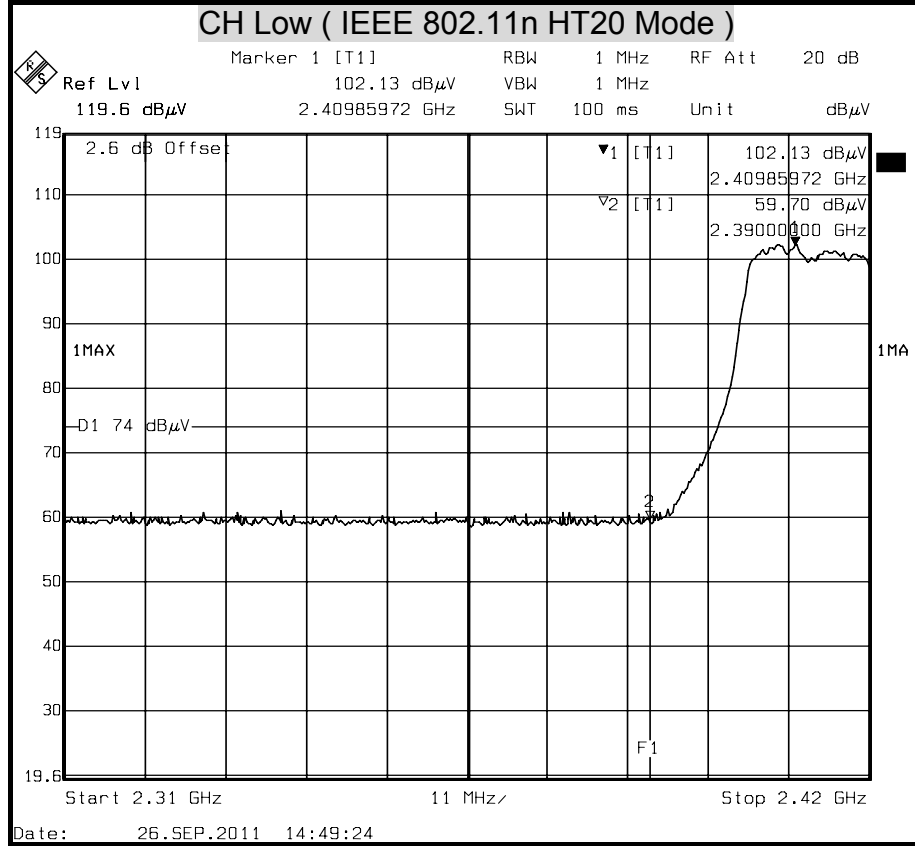

Detector Mode : Average

Polarity : Vertical

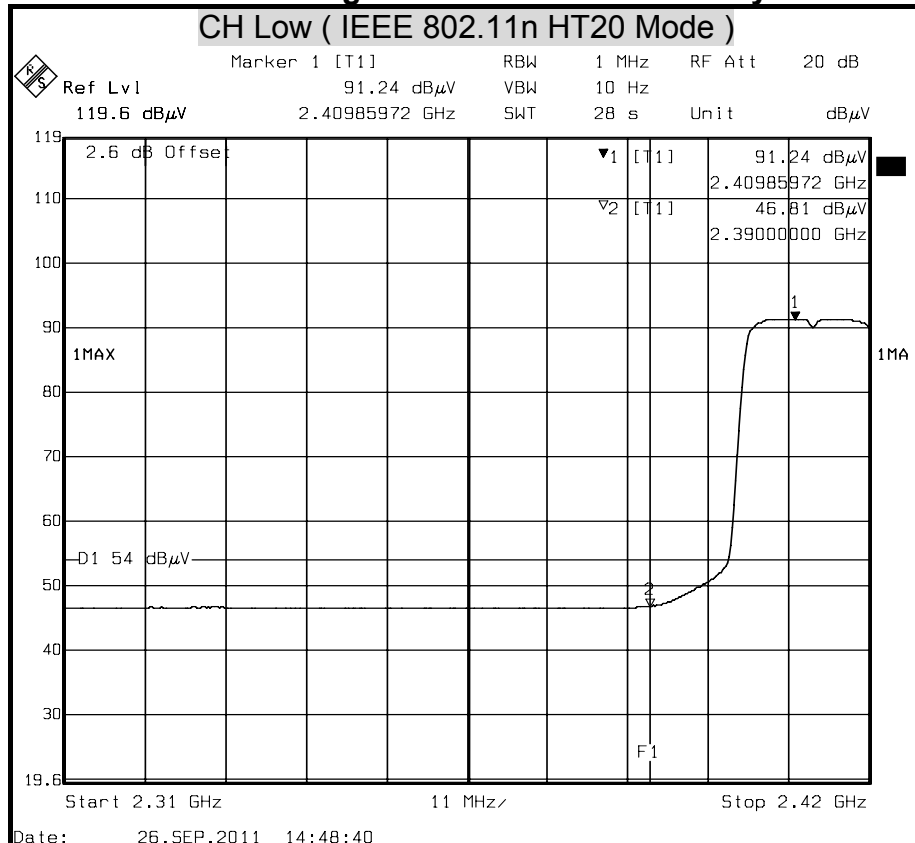



Detector Mode : Peak

Polarity : Horizontal

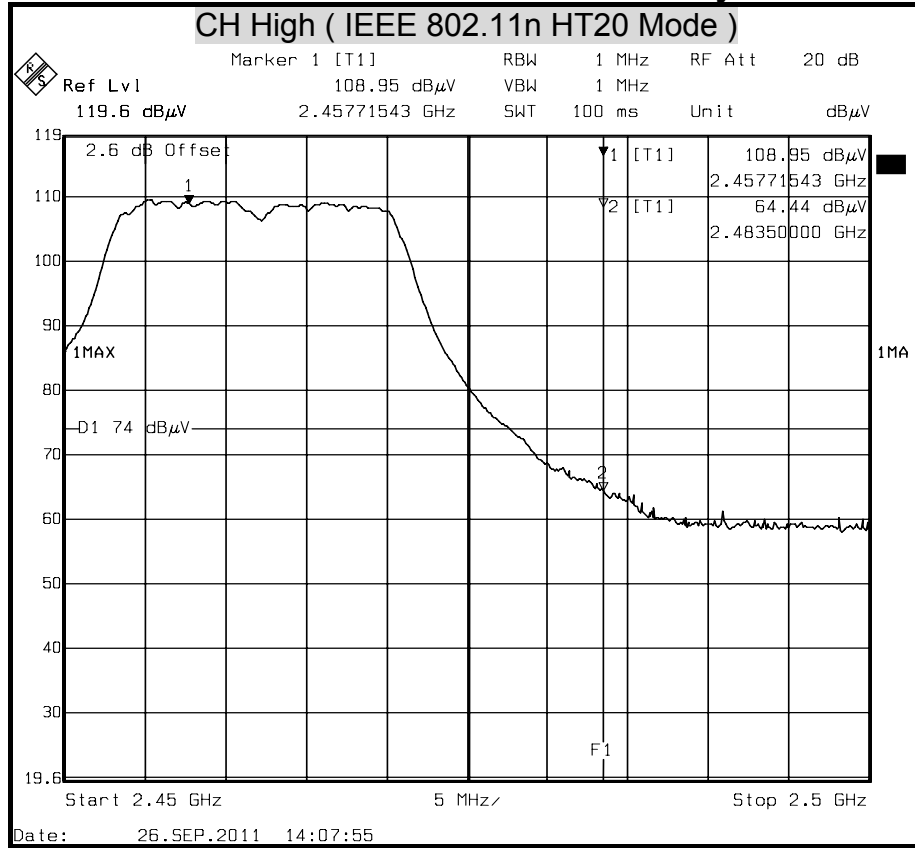

Detector Mode : Average

Polarity : Horizontal

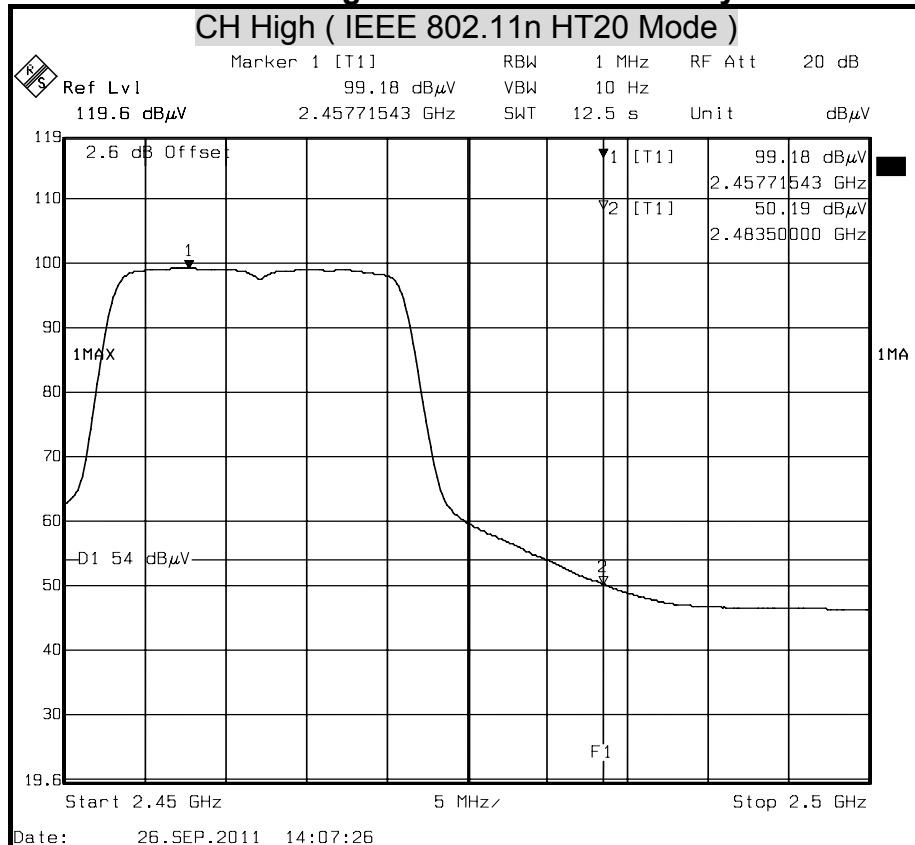



Detector Mode : Peak

Polarity : Vertical

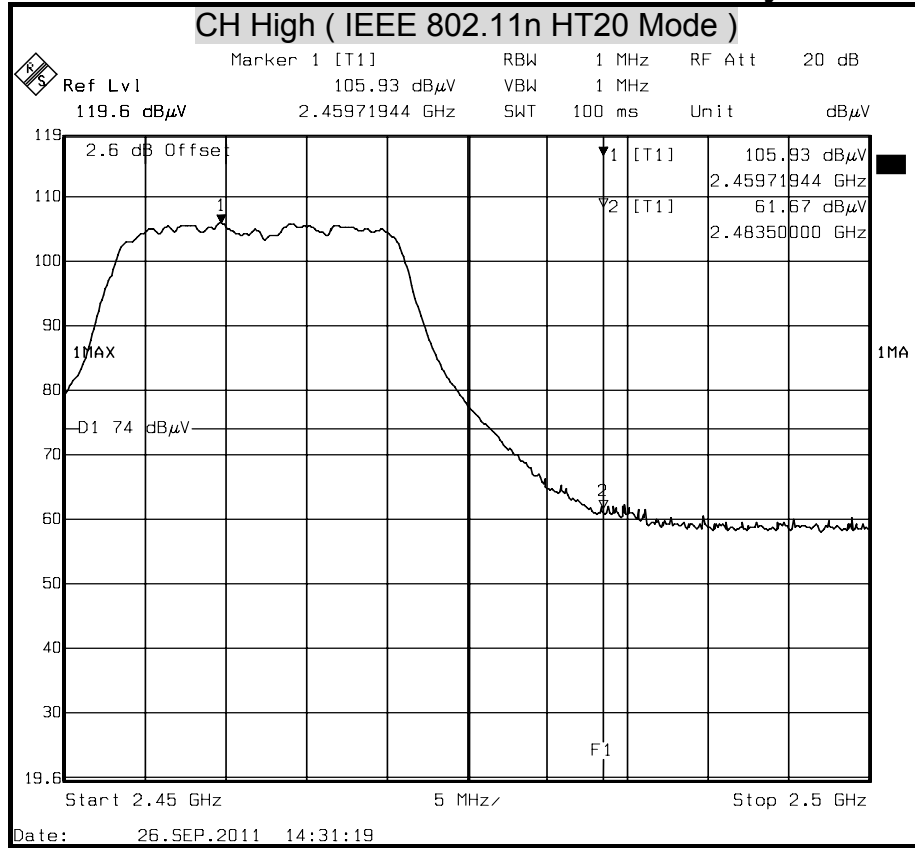

Detector Mode : Average

Polarity : Vertical

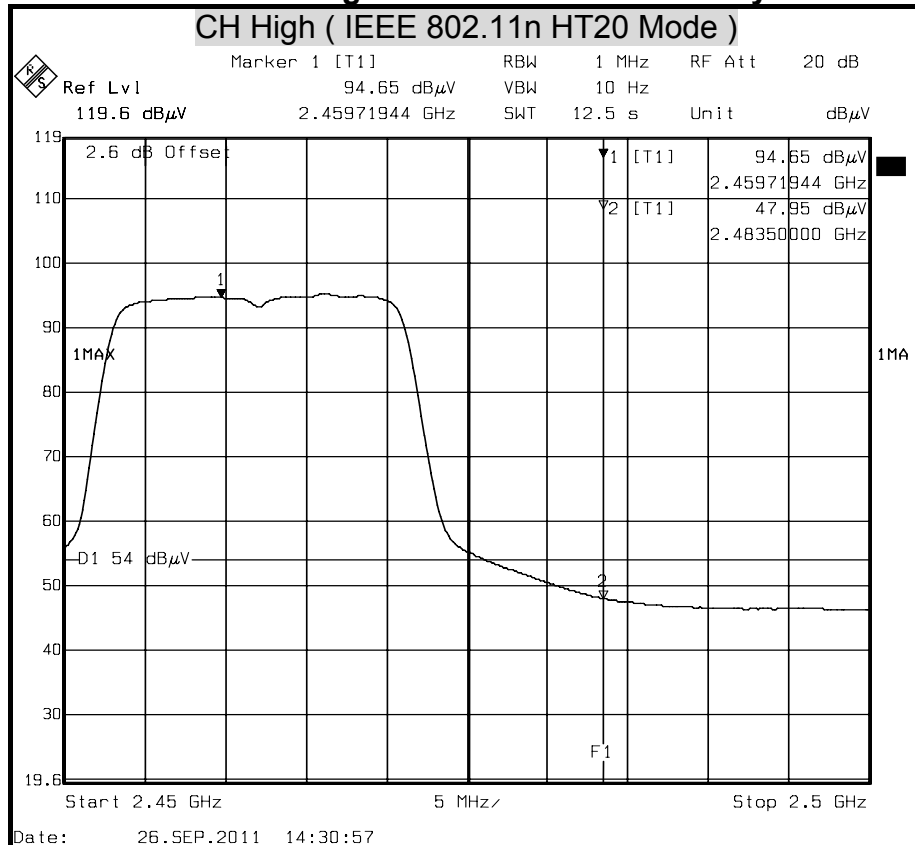



Detector Mode : Peak Polarity : Horizontal

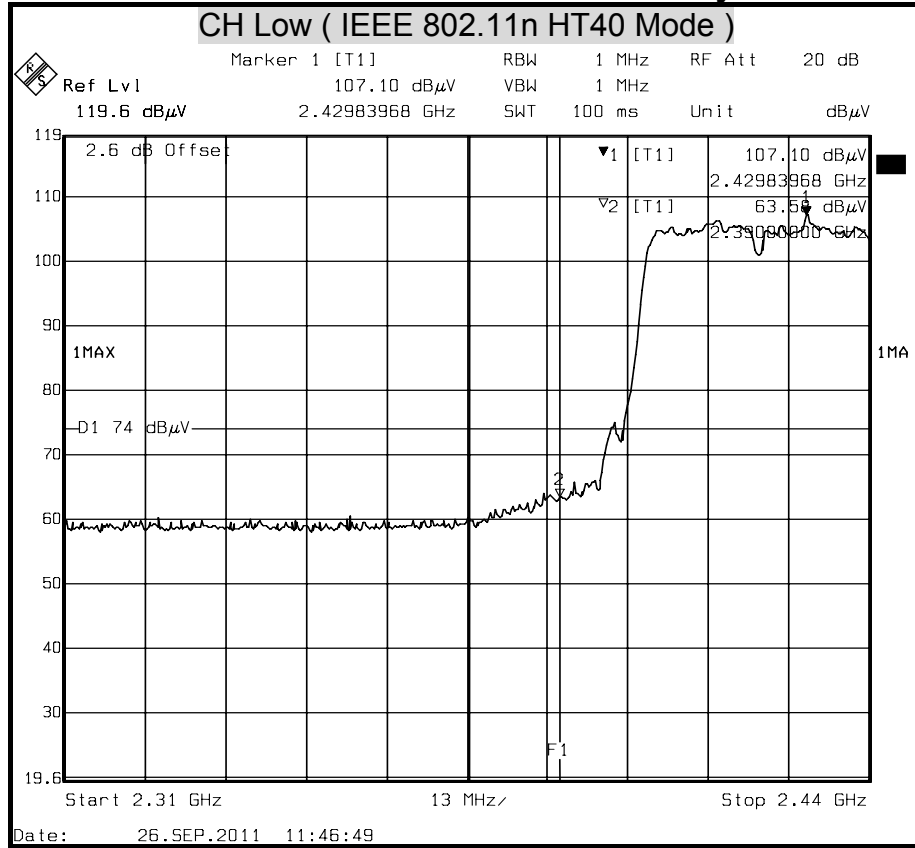

Detector Mode : Average Polarity : Horizontal

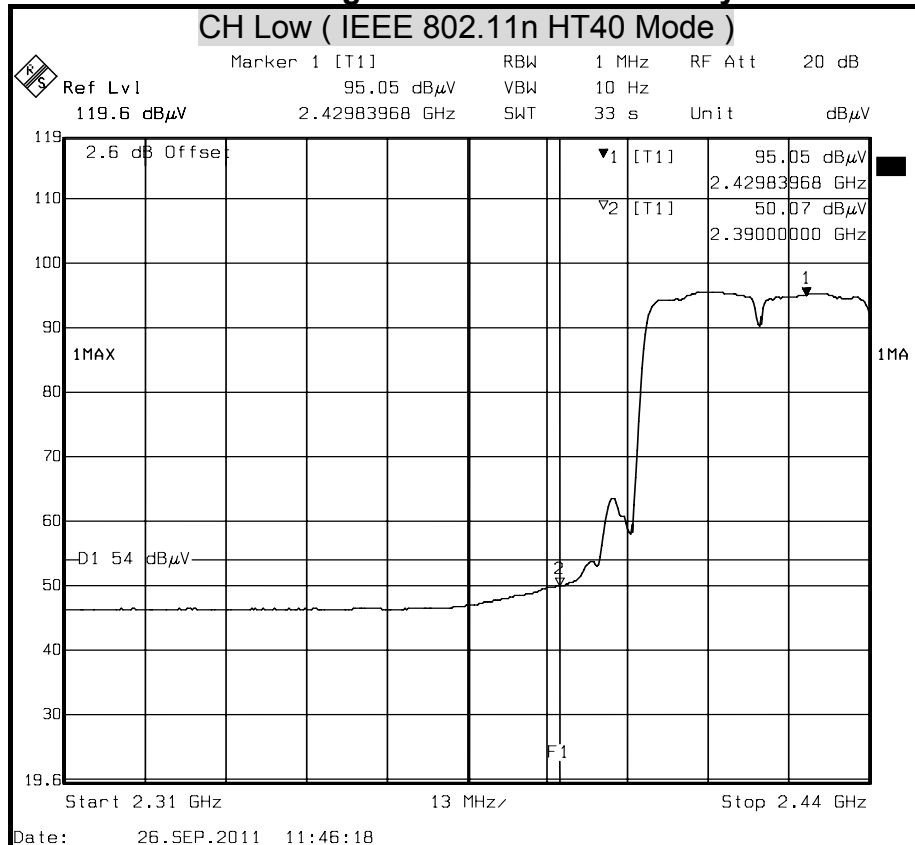



Detector Mode : Peak Polarity : Vertical

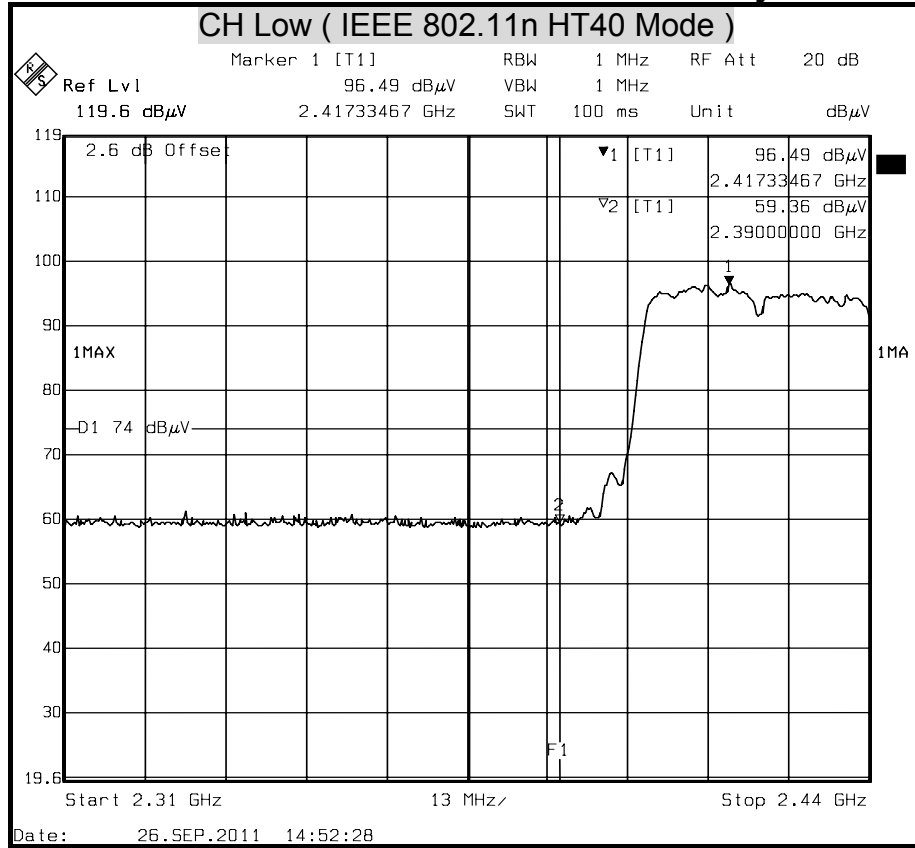

Detector Mode : Average Polarity : Vertical

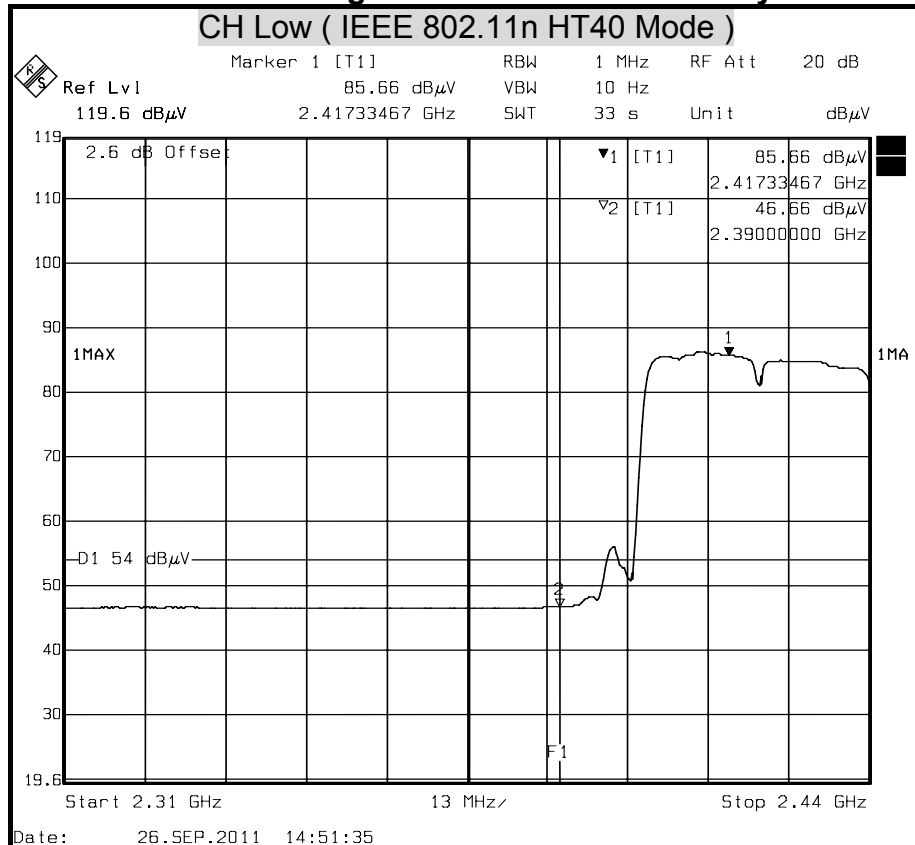



Detector Mode : Peak Polarity : Horizontal

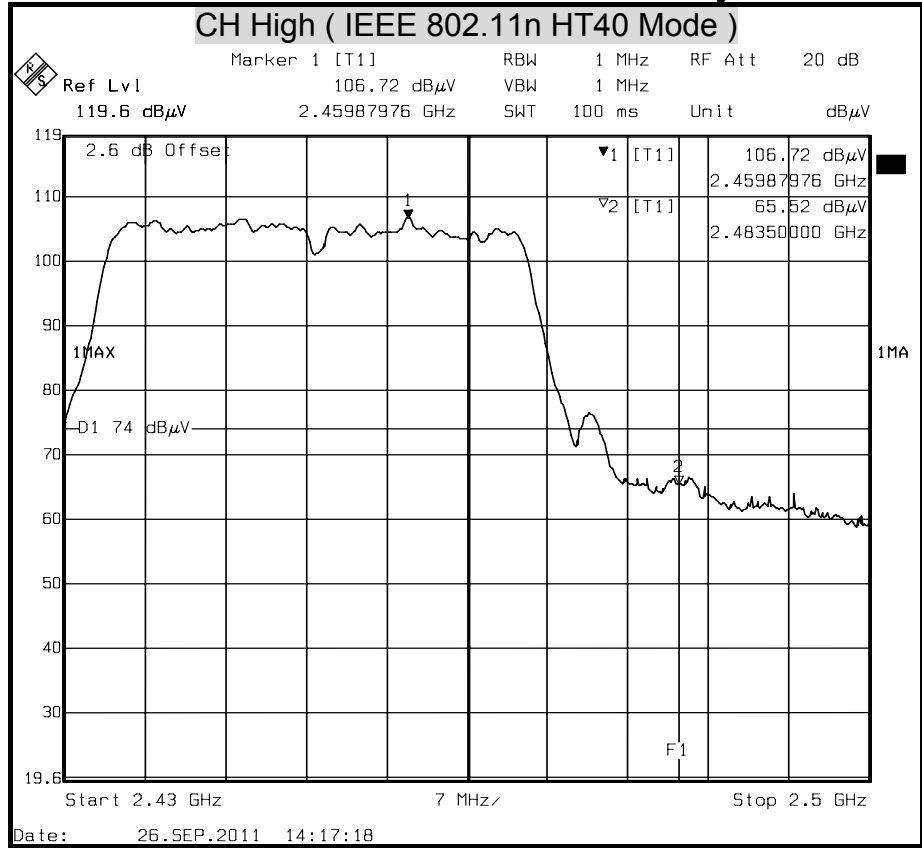

Detector Mode : Average Polarity : Horizontal

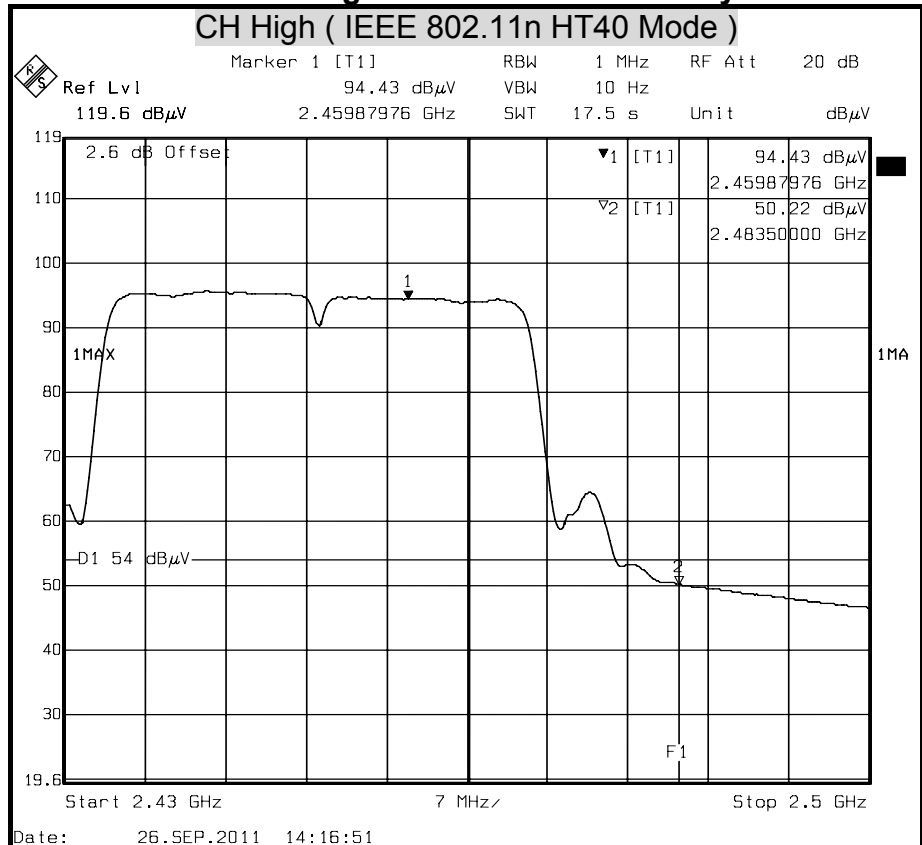



Detector Mode : Peak

Polarity : Vertical

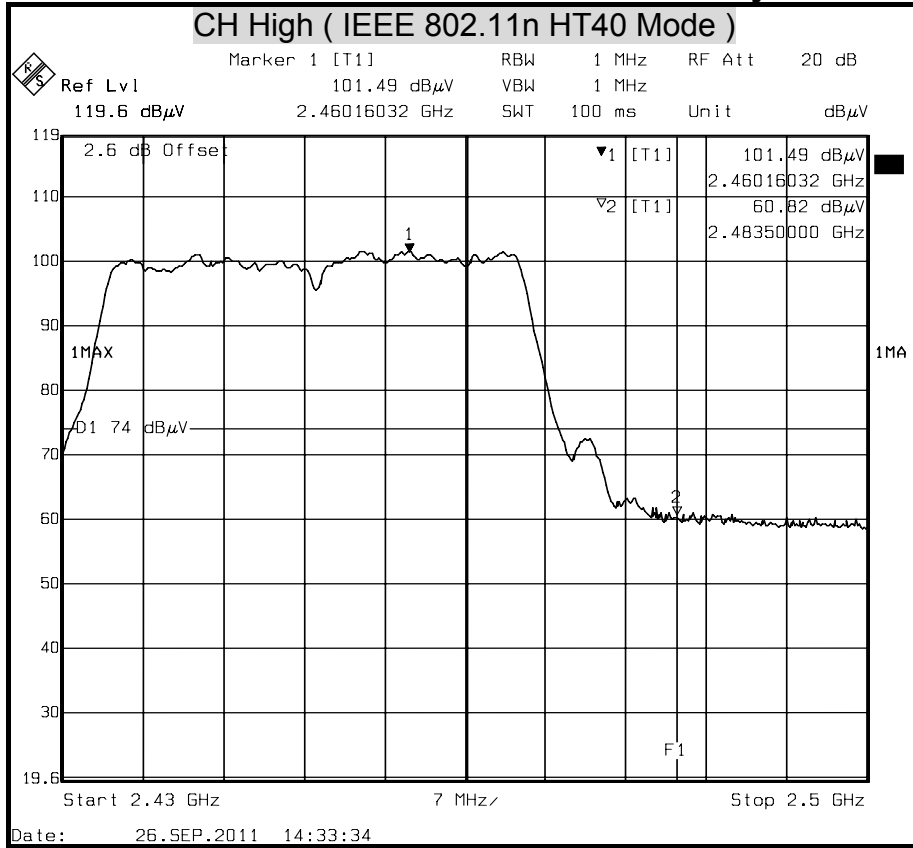

Detector Mode : Average

Polarity : Vertical

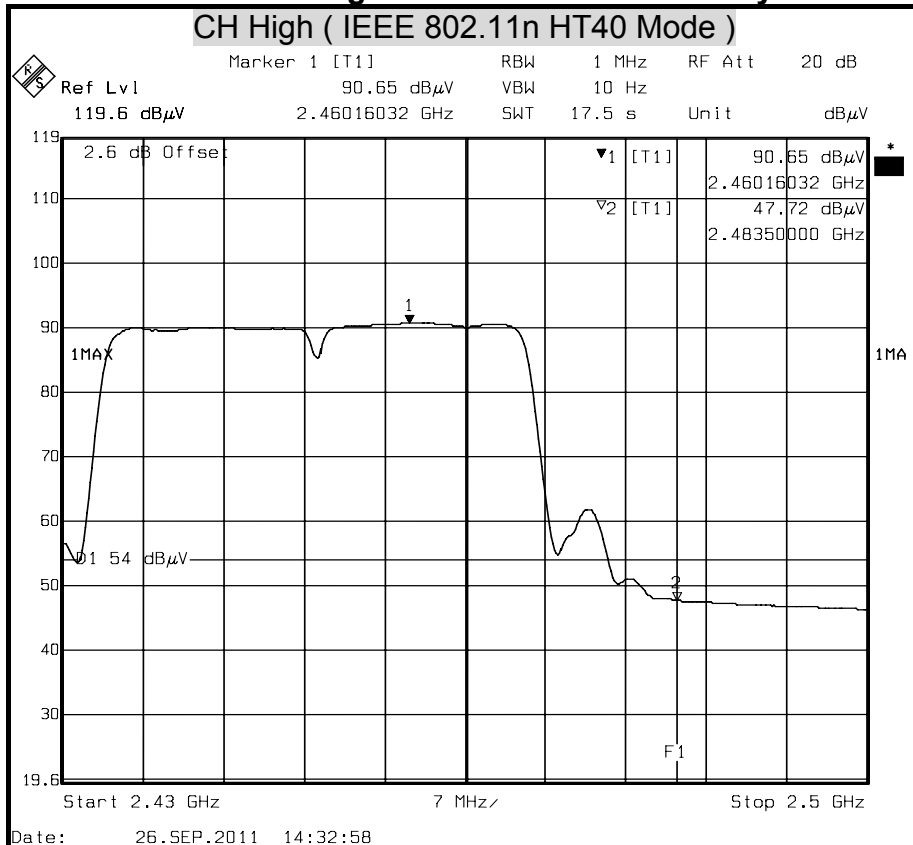



7.7 CONDUCTED EMISSION

LIMITS

§ 15.207 (a) Except as shown in paragraph (b) and (c) this section, for an intentional radiator that is designed to be connected to the public utility (AC) power line, the radio frequency voltage that is conducted back onto the AC power line on any frequency or frequencies within the band 150 kHz to 30 MHz shall not exceed the limits in the following table, as measured using a 50 μH/50 ohms line impedance stabilization network (LISN). Compliance with the provisions of this paragraph shall be based on the measurement of the radio frequency voltage between each power line and ground at the power terminal. The lower limit applies at the boundary between the frequency ranges.

Frequency Range (MHz)	Conducted Limit (dBμv)	
	Quasi-peak	Average
0.15 - 0.50	66 to 56	56 to 46
0.50 - 5.00	56	46
5.00 - 30.0	60	50

TEST EQUIPMENT

Conducted Emission room #1				
Name of Equipment	Manufacturer	Model	Serial Number	Calibration Due
L.I.S.N.	SCHWARZBECK	NNLK 8130	8130124	SEP. 25, 2012
	Rohde & Schwarz	ESH 3-Z5	840062/021	AUG. 02, 2012
TEST RECEIVER	Rohde & Schwarz	ESCS 30	100348	JUL. 03, 2012
BNC COAXIAL CABLE	CCS	BNC50	11	OCT. 30, 2012
Test S/W	e-3 (5.04211c) R&S (2.27)			

Remark: Each piece of equipment is scheduled for calibration once a year.



TEST SETUP

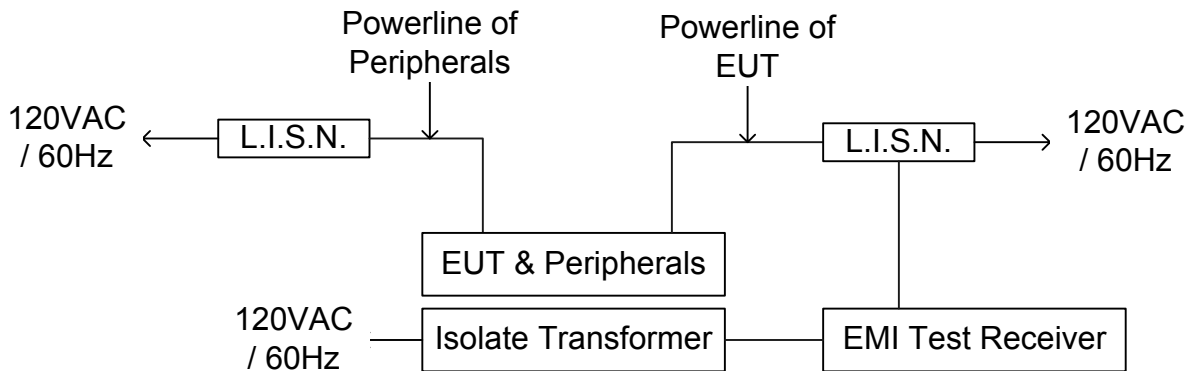
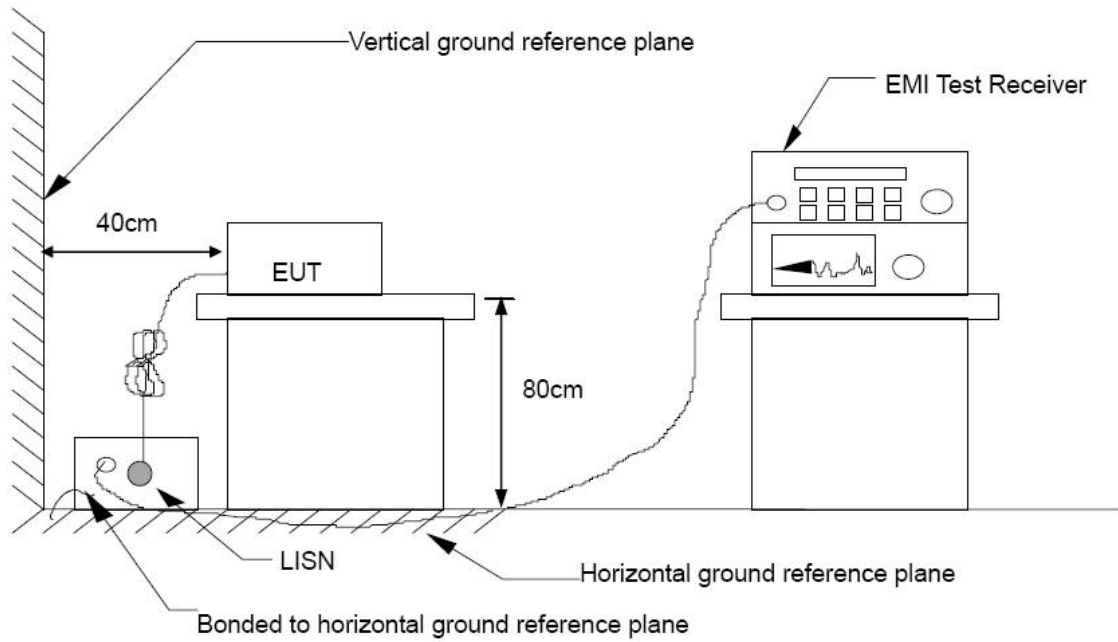



TEST PROCEDURE

The basic test procedure was in accordance with ANSI C63.4:2003.

The test procedure is performed in a 4m × 3m × 2.4m (L×W×H) shielded room.

The EUT along with its peripherals were placed on a 1.0m (W) × 1.5m (L) and 0.8m in height wooden table and the EUT was adjusted to maintain a 0.4 meter space from a vertical reference plane.

The EUT was connected to power mains through a line impedance stabilization network (LISN) which provides 50 ohm coupling impedance for measuring instrument and the chassis ground was bounded to the horizontal ground plane of shielded room. All peripherals were connected to the second LISN and the chassis ground also bounded to the horizontal ground plane of shielded room.

The EUT was located so that the distance between the boundary of the EUT and the closest surface of the LISN is 0.8 m. Where a mains flexible cord was provided by the manufacturer shall be 1 m long, or if in excess of 1 m, the excess cable was folded back and forth as far as possible so as to form a bundle not exceeding 0.4 m in length.



TEST RESULTS

Product Name	11n Dual-Band USB Dongle	Test By	Shiang Su
Model	WU318d	Test Date	SEP. 28, 2011
Test Mode	TX Mode	Temp. & Humidity	24.5°C, 56%

LINE

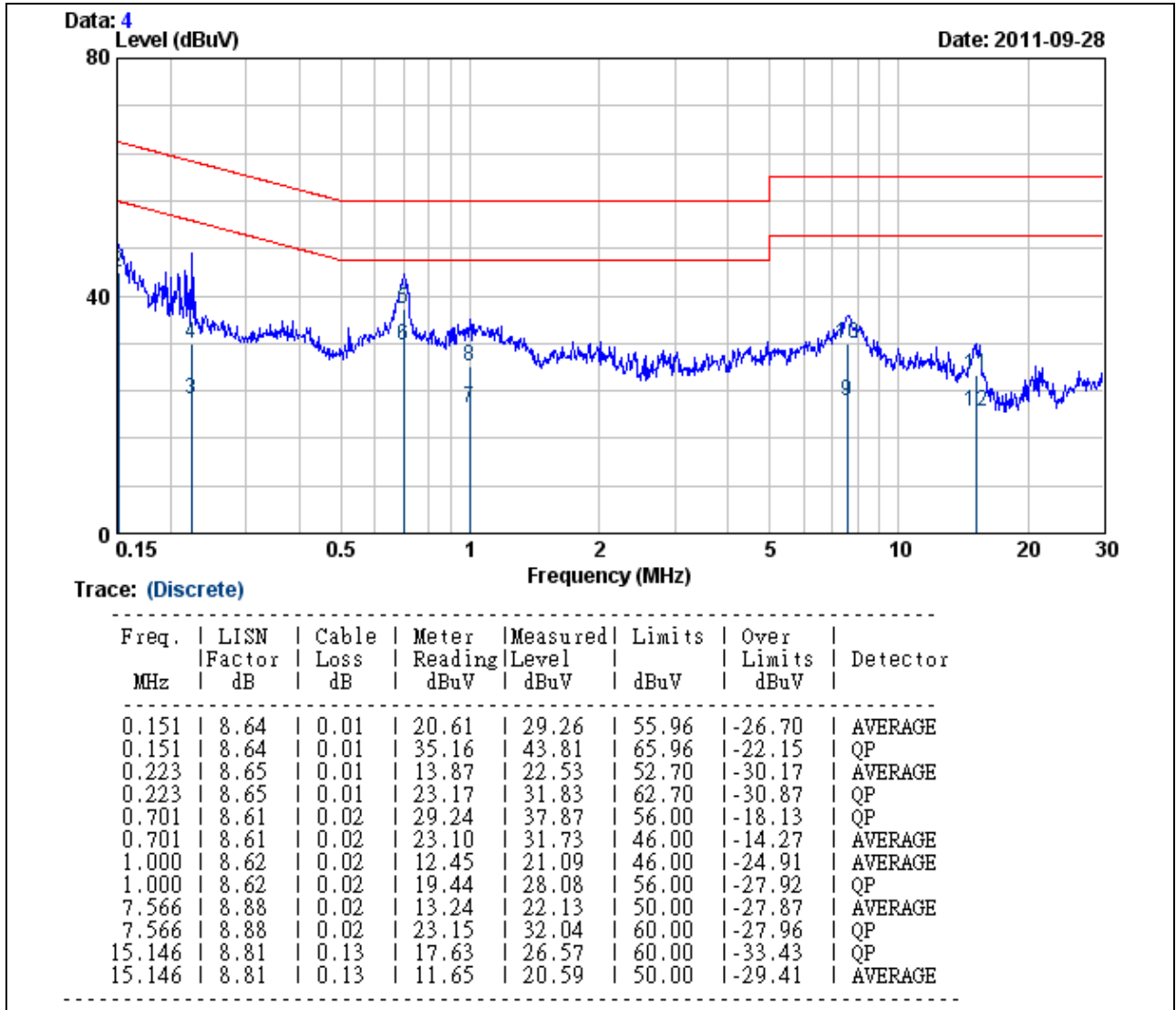

Remark:

1. Correction Factor = Insertion loss + Cable loss
2. Emission level = Reading Value + Correction factor
3. Margin value = Emission level – Limit value



Product Name	11n Dual-Band USB Dongle	Test By	Shiang Su
Model	WU318d	Test Date	Nov. 17, 2011
Test Mode	TX Mode	Temp. & Humidity	24.5°C, 56%

NEUTRAL

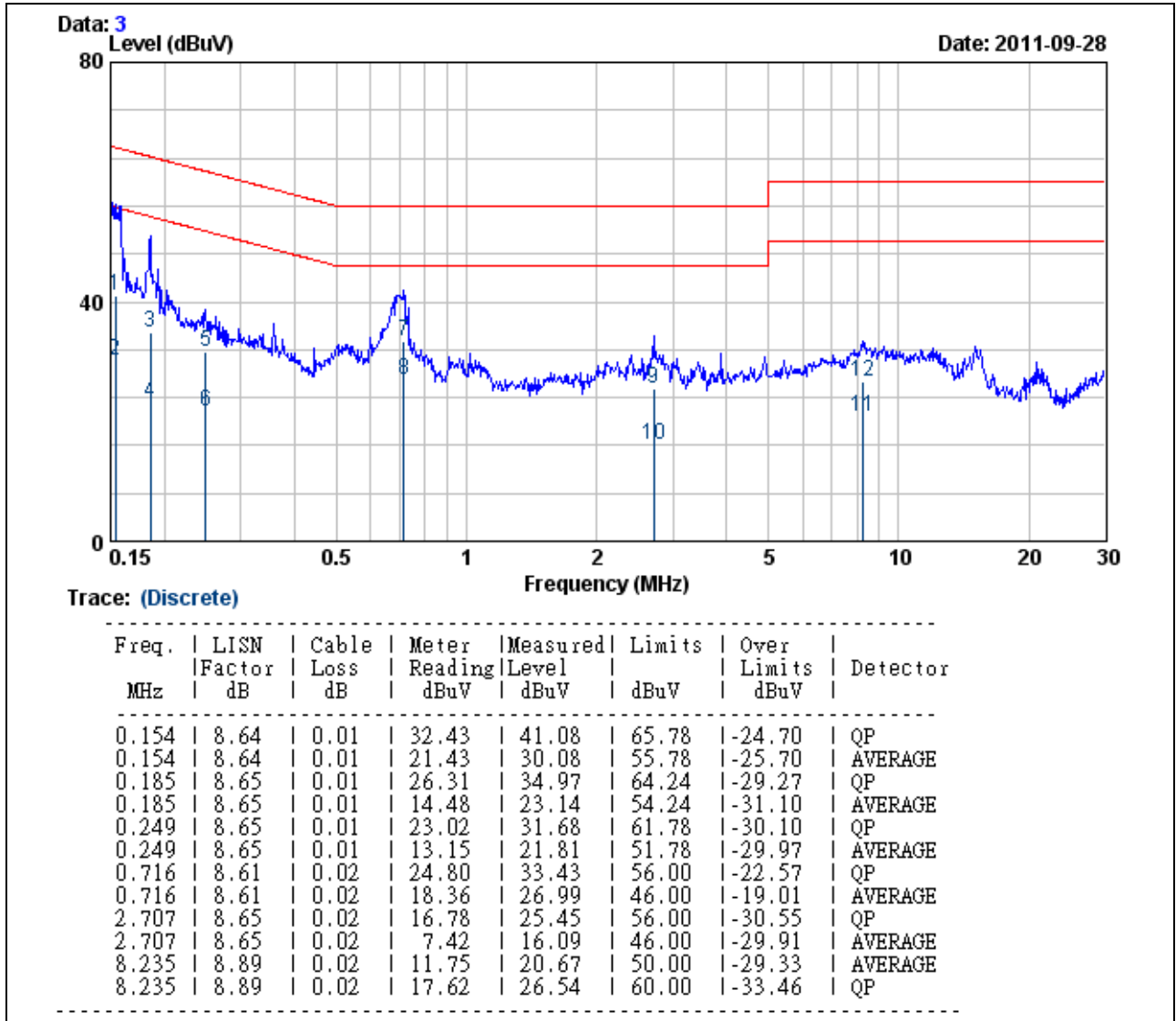

Remark:

1. Correction Factor = Insertion loss + Cable loss
2. Emission level = Reading Value + Correction factor
3. Margin value = Emission level – Limit value



APPENDIX I MAXIMUM PERMISSIBLE EXPOSURE

According to FCC 1.1310 : The criteria listed in the following table shall be used to evaluate the environment impact of human exposure to radio frequency (RF) radiation as specified in 1.1307(b) LIMITS FOR MAXIMUM PERMISSIBLE EXPOSURE (MPE)

Frequency Range (MHz)	Electric Field Strength (V/m)	Magnetic Field Strength (A/m)	Power Density (mW/cm ²)	Average Time
(A) Limits for Occupational / Control Exposures				
300-1,500	--	--	F/300	6
1,500-100,000	--	--	5	6
(B) Limits for General Population / Uncontrol Exposures				
300-1,500	--	--	F/1500	6
1,500-100,000	--	--	1	30

CALCULATIONS

Given $E = \frac{\sqrt{30 \times P \times G}}{d}$ & $S = \frac{E^2}{3770}$

Where *E* = Field strength in Volts / meter

P = Power in Watts

G = Numeric antenna gain

d = Distance in meters

S = Power density in milliwatts / square centimeter

Combining equations and re-arranging the terms to express the distance as a function of the remaining variables yields:

$$S = \frac{30 \times P \times G}{3770d^2}$$

Changing to units of mW and cm, using:

$$P (mW) = P (W) / 1000 \text{ and}$$

$$d (cm) = d(m) / 100$$

Yields

$$S = \frac{30 \times (P / 1000) \times G}{3770 \times (d / 100)^2} = 0.0796 \times \frac{P \times G}{d^2}$$

Where *d* = Distance in cm

P = Power in mW

G = Numeric antenna gain

S = Power density in mW / cm²



LIMIT

Power Density Limit, $S=1.0\text{mW/cm}^2$

TEST RESULTS

※Since the EUT is classed portable device, and the maximum peak power is 28.63 dBm (>13.6dBm), the MPE evaluation is not required and has SAR consideration applied.



APPENDIX II SETUP PHOTOS

RADIATED EMISSION SETUP





RADIATED RF MEASUREMENT SETUP

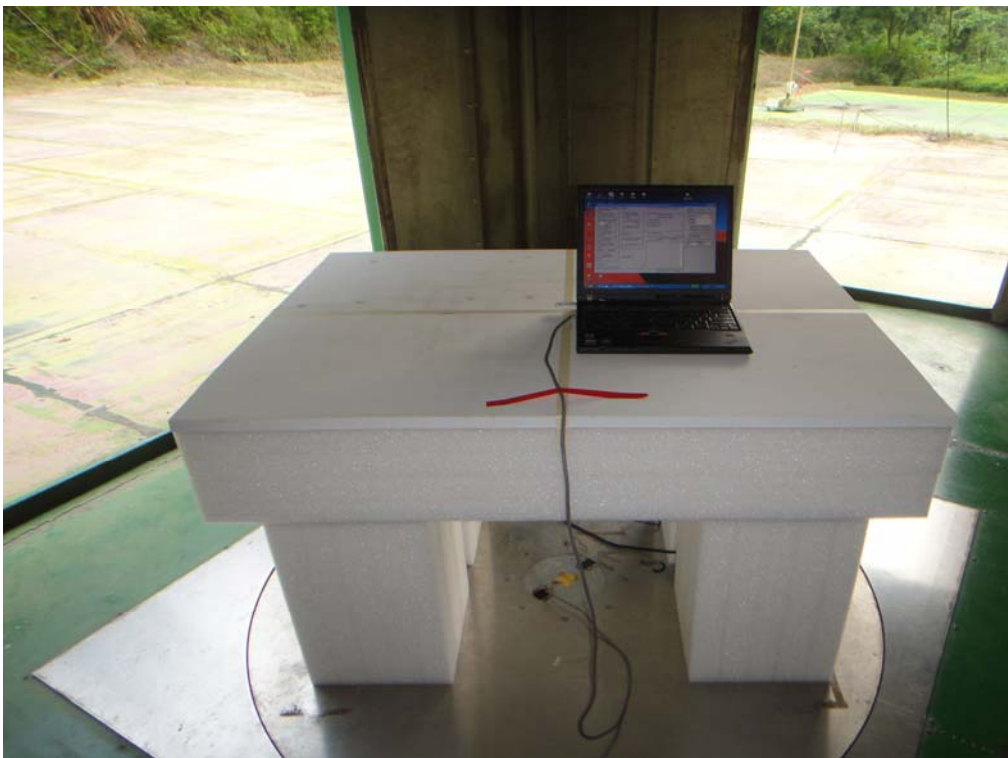

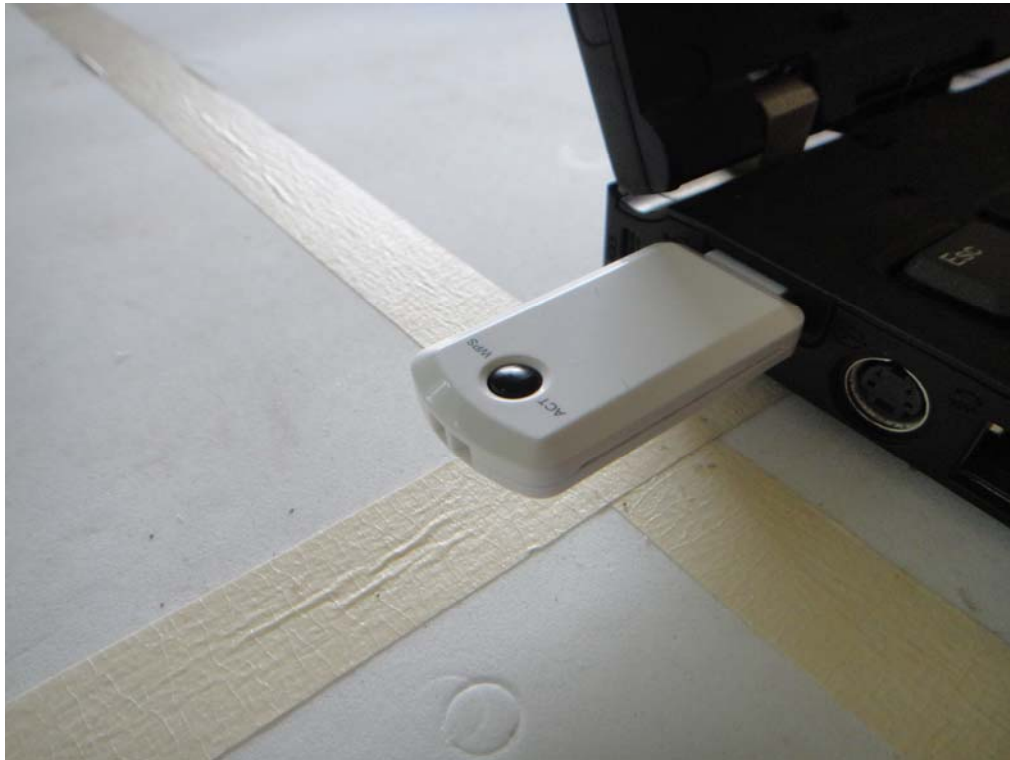

ANTENNA PORT CONDUCTED RF MEASUREMENT SETUP

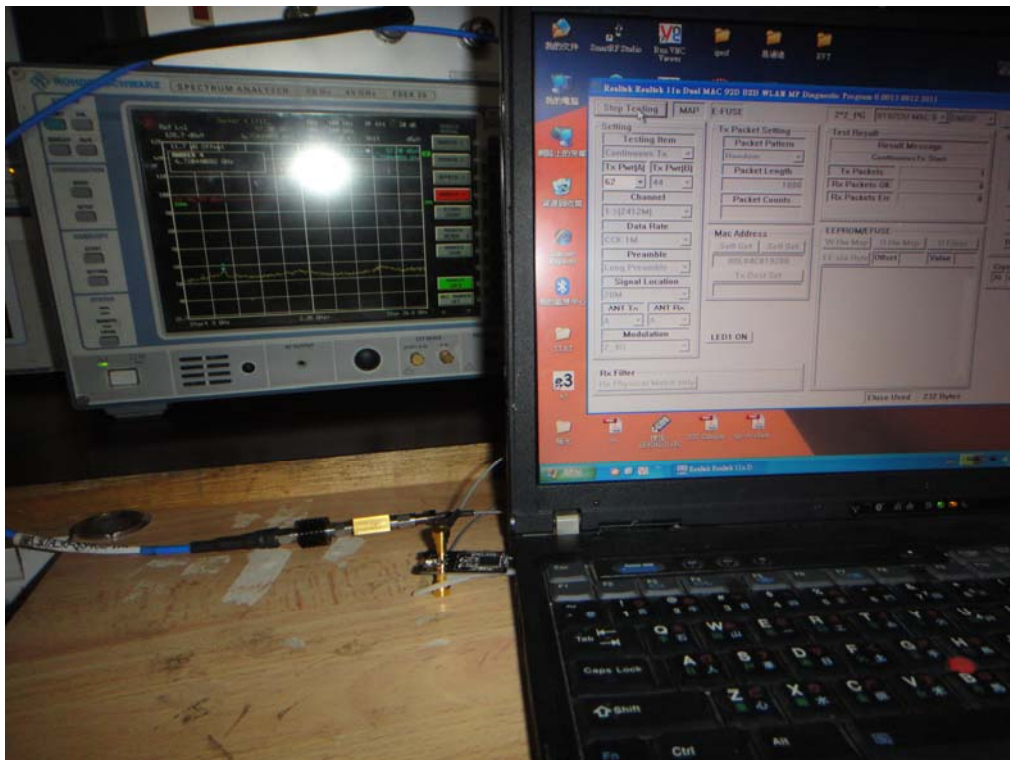



CONDUCTED EMISSION SETUP

