



FCC 47 CFR PART 15 SUBPART C AND ANSI C63.4: 2003

TEST REPORT

For

11n Wall Router

Model Number: WA982n

Brand: E-TOP

Issued for

E-Top Network Technology Inc.

No. 82, Gongye 2nd Rd., Tainan City 70955, Taiwan, R.O.C.

Issued by

Compliance Certification Services Inc.

Tainan Lab.

No.8, Jiucengling, Xinhua Dist., Tainan City 712, Taiwan (R.O.C.)

TEL: 886-6-580-2201

FAX: 886-6-580-2202

Issued Date : November 04, 2011



Note: This report shall not be reproduced except in full, without the written approval of Compliance Certification Services Inc. Ltd. This document may be altered or revised by Compliance Certification Services Inc. personnel only, and shall be noted in the revision section of the document



REVISION HISTORY

Rev.	Issue Date	Revisions	Effect Page	Revised By
00	November 04, 2011	Initial Issue	ALL	Sunny Chang



TABLE OF CONTENTS

1. TEST REPORT CERTIFICATION	4
2. EUT DESCRIPTION	5
3. DESCRIPTION OF TEST MODES	7
4. TEST METHODOLOGY	8
5. FACILITIES AND ACCREDITATIONS.....	8
5.1 FACILITIES	8
5.2 EQUIPMENT	8
5.3 LABORATORY ACCREDITATIONS LISTINGS	8
5.4 TABLE OF ACCREDITATIONS AND LISTINGS	9
6. CALIBRATION AND UNCERTAINTY.....	10
6.1 MEASURING INSTRUMENT CALIBRATION	10
6.2 MEASUREMENT UNCERTAINTY	10
7. SETUP OF EQUIPMENT UNDER TEST.....	11
7.1 SETUP CONFIGURATION OF EUT	11
7.2 SUPPORT EQUIPMENT	12
7.3 EUT OPERATING CONDITION	13
8. APPLICABLE LIMITS AND TEST RESULTS.....	14
8.1 6DB BANDWIDTH	14
8.2 MAXIMUM PEAK OUTPUT POWER.....	25
8.3 MAXIMUM PERMISSIBLE EXPOSURE	29
8.4 POWER SPECTRAL DENSITY	31
8.5 CONDUCTED SPURIOUS EMISSION	33
8.6 RADIATED EMISSIONS	33
8.7 POWERLINE CONDUCTED EMISSIONS.....	33
9. ANTENNA REQUIREMENT	33
9.1 STANDARD APPLICABLE	33
9.2 ANTENNA CONNECTED CONSTRUCTION.....	33
APPENDIX I SETUP PHOTOS	33
APPENDIX II PHOTOGRAPHS OF EUT	A1



1. TEST REPORT CERTIFICATION

Applicant : E-Top Network Technology Inc.
Address : No. 82, Gongye 2nd Rd., Tainan City 70955, Taiwan, R.O.C.
Manufacturer : E-Top Network Technology Inc.
Address : No. 82, Gongye 2nd Rd., Tainan City 70955, Taiwan, R.O.C.
Equipment Under Test : 11n Wall Router
Model Number : WA982n
Data Applies To : N/A
Brand Name : E-TOP
Date of Test : August 03, 2011 ~ October 04, 2011

APPLICABLE STANDARD	
STANDARD	TEST RESULT
FCC Part 15 Subpart C AND ANSI C63.4 : 2003	No non-compliance noted

Approved by:

Reviewed by:

Jeter Wu
Assistant Manager

Eric Huang
Assistant Section Manager



2. EUT DESCRIPTION

Product Name	11n Wall Router
Model Number	WA982n
Data Applies To	N/A
Model Difference	N/A
Brand Name	E-TOP
Received Date	September 14, 2011
Frequency Range	IEEE 802.11b/g, 802.11n HT20 (DTS Band):2412MHz ~ 2462MHz IEEE 802.11n HT40 (DTS Band):2422MHz ~ 2452MHz
Transmit Power	IEEE 802.11b Mode : 14.62dBm (DTS Band) (28.973 mW) IEEE 802.11g Mode : 23.24dBm (DTS Band) (210.86 mW) IEEE 802.11n HT20 Mode : 22.58dBm (DTS Band) (181.13 mW) IEEE 802.11n HT40 Mode : 21.451dBm (DTS Band) (139.64 mW)
Channel Spacing	IEEE 802.11b/g, 802.11n HT20/HT40: 5MHz
Channel Number	IEEE 802.11b/g, 802.11n HT20:11 Channels IEEE 802.11n HT40 :7 Channels
Transmit Data Rate	IEEE 802.11b : 11, 5.5, 2, 1 Mbps IEEE 802.11g : 54, 48, 36, 24, 18, 12, 9, 6 Mbps IEEE 802.11n HT20 : 144.4, 130, 115.6, 86.7, 57.8, 43.3, 28.9, 14.4, 72.2, 65, 21.7, 13, 7.2 Mbps IEEE 802.11n HT40 :300, 270, 240, 180, 120, 90, 60, 30, 150, 135, 45, 27, 15 Mbps
Type of Modulation	IEEE 802.11b : DSSS (CCK, DQPSK, DBPSK)
	IEEE 802.11g : OFDM (64QAM, 16QAM, QPSK, BPSK)
	IEEE 802.11n HT20/40 : OFDM (64QAM, 16QAM, QPSK, BPSK)
Frequency Selection	By software / firmware
Antenna Type	Two antenna Antenna 1 Model: 98152MRSX008 Manufacture: Master Wave Technology Co., Ltd. Connector: RP SMA Plug Type: Dipole Gain: 3dBi Antenna 2 Model: AN-152NRSU00 Manufacture: XinXieTechnology(SHENZHEN) Co., Ltd. Connector: Reverse SMA Plug Type: Co-linear dipole structure Gain: 3dBi



Power Source	Powered from AC Souce 100-240V; 50/60Hz
Temperature Range	0 ~ +40°C

REMARK:

1. The sample selected for test was engineering sample that approximated to production product and was provided by manufacturer.
2. This submittal(s) (test report) is intended for FCC ID: U6A-WA982N filing to comply with Section 15.207, 15.209 and 15.247 of the FCC Part 15, Subpart C Rules.
3. For more details, please refer to the user manual.

Multiple Listing :

Company Name/Address	Brand name	Model	Product Name
E-Top Network Technology Inc. No. 82 ,Gongye 2nd Rd.,Tainan City 70955,Taiwan,R.O.C.	E-TOP	WA982n	11n Wall Router
Amigo Technology Inc. 5F., No.63, Lane 77, Xing-Ai Road, Neihu Dist., Taipei City 114, Taiwan (R.O.C.)	Amigo	WA982n	11n Wall Router
Sapido Technology Inc. No. 383., Sec. 2, Minsheng Rd., West Central District, Tainan 700, Taiwan, R.O.C.	SAPIDO	RB-6132	N+ High Power 3G/4G Wall Router- All Broadbands



3. DESCRIPTION OF TEST MODES

The EUT is a 11n Wall Router. It has one transmitter chain and one receive chain (1x1 configurations). The 1x1 configuration is implemented with one outside chain (Chain 0)

The RF chipset is manufactured by Realtek Semiconductor Corp..

The antenna peak gain 3.0dBi (highest gain) were chosen for full testing.

IEEE 802.11 b ,802.11g ,802.11n HT20 mode (DTS Band)

The EUT had been tested under operating condition.

There are three channels have been tested as following:

Channel	Frequency (MHz)
Low	2412
Middle	2437
High	2462

IEEE 802.11b mode: 1Mbps long data rates (worst case) were chosen for full testing.

IEEE 802.11g mode: 6Mbps data rates (worst case) were chosen for full testing.

IEEE 802.11n HT20 mode: 6.5Mbps data rates (worst case) were chosen for full testing.

IEEE 802.11n HT40 mode (DTS Band)

The EUT had been tested under operating condition.

There are three channels have been tested as following:

Channel	Frequency (MHz)
Low	2422
Middle	2437
High	2452

IEEE 802.11n HT40 mode: 13.5Mbps data rates (worst case) were chosen for full testing.

The worst-case data rates are determined according to the description above, based on the investigations by measuring the PSD, peak power and average power across all the data rates, bandwidths, modulations and spatial stream modes.



4. TEST METHODOLOGY

The tests documented in this report were performed in accordance with ANSI C63.4 and FCC CFR 47 15.207, 15.209 and 15.247.

5. FACILITIES AND ACCREDITATIONS

5.1 FACILITIES

All measurement facilities used to collect the measurement data are located at No.8, Jiucengling, Xinhua Dist., Tainan City 712, Taiwan (R.O.C.)

The sites are constructed in conformance with the requirements of ANSI C63.7:1992, ANSI C63.4: 2003 and CISPR Publication 22.

5.2 EQUIPMENT

Radiated emissions are measured with one or more of the following types of linearly polarized antennas: tuned dipole, biconical, log periodic, bi-log, and/or ridged waveguide, horn. Spectrum analyzers with preselectors and quasi-peak detectors are used to perform radiated measurements.

Conducted emissions are measured with Line Impedance Stabilization Networks and EMI Test Receivers.

Calibrated wideband preamplifiers, coaxial cables, and coaxial attenuators are also used for making measurements.

All receiving equipment conforms to CISPR Publication 16-1, "Radio Interference Measuring Apparatus and Measurement Methods."

5.3 LABORATORY ACCREDITATIONS LISTINGS

The test facilities used to perform radiated and conducted emissions tests are accredited by Taiwan Accreditation Foundation for the specific scope of accreditation under Lab Code: 1109 to perform Electromagnetic Interference tests according to FCC PART 15 AND CISPR 22 requirements. No part of this report may be used to claim or imply product endorsement by TAF or any agency of the Government. In addition, the test facilities are listed with Federal Communications Commission (registration no: TW-1037 and 455173).



5.4 TABLE OF ACCREDITATIONS AND LISTINGS

Our laboratories are accredited and approved by the following accreditation body according to ISO/IEC 17025.

Taiwan	TAF
---------------	-----

The measuring facility of laboratories has been authorized or registered by the following approval agencies.

Canada	Industry Canada
Germany	TUV NORD
Taiwan	BSMI
USA	FCC

Copies of granted accreditation certificates are available for downloading from our web site, <http://www.ccsrf.com>



6. CALIBRATION AND UNCERTAINTY

6.1 MEASURING INSTRUMENT CALIBRATION

The measuring equipment utilized to perform the tests documented in this report has been calibrated in accordance with the manufacturer's recommendations, and is traceable to recognized national standards.

6.2 MEASUREMENT UNCERTAINTY

Where relevant, the following measurement uncertainty levels have been estimated for tests performed on the apparatus:

PARAMETER	UNCERTAINTY
Radiated Emission, 30 to 200 MHz Test Site : OATS-6	±3.59dB
Radiated Emission, 200 to 1000 MHz Test Site : OATS-6	±3.27dB
Radiated Emission, 1 to 26.5 GHz	± 3.20dB
Power Line Conducted Emission	± 2.90dB

This measurement uncertainty is confidence of approximately 95%, k=2



7. SETUP OF EQUIPMENT UNDER TEST

7.1 SETUP CONFIGURATION OF EUT

RF Test Setup:

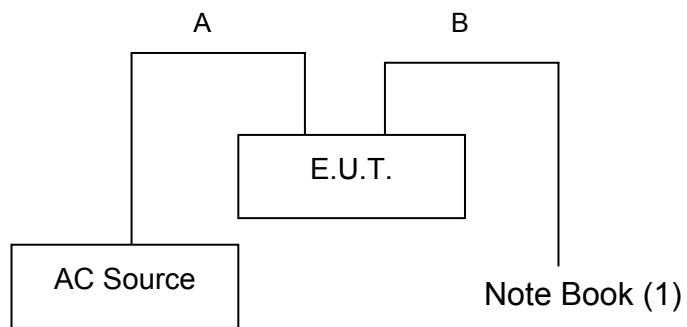

EMI Test Setup:

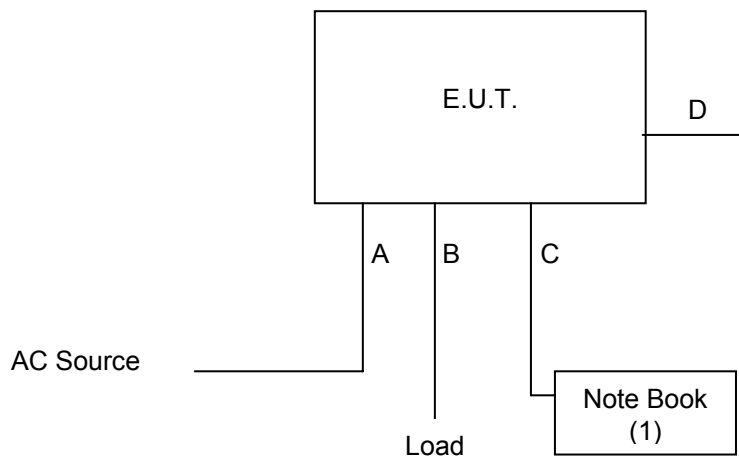



7.2 SUPPORT EQUIPMENT

RF test

No.	Product	Manufacturer	Model No.	Certify No.	Signal cable
1.	Note Book	IBM	T43	DoC	Power cable, unshd, 1.6m

No.	Signal cable description	
A	AC Power	Unshielded, 0.8m, 1pcs.
B	LAN	Unshielded, 10m, 1pcs.

EMI test

No.	Product	Manufacturer	Model No.	Certify No.	Signal cable
1.	Note Book	IBM	R51	DoC	Power cable, unshd, 1.6m

No.	Signal cable description	
A	Power	Unshielded, 1.8m, 1pcs.
B	USB	Shielded, 0.50m, 1pcs.
C	LAN	Unshielded, 10m, 1pcs.
D	LAN	Unshielded, 1m, 1pcs.

REMARK:

1. All the above equipment/cables were placed in worse case positions to maximize emission signals during emission test.
2. Grounding was established in accordance with the manufacturer's requirements and conditions for the intended use.



7.3 EUT OPERATING CONDITION

RF Setup

1. Set up all computers like the setup diagram.
2. The "Realtek MP Test Program" software was used for testing

TX Mode:

- ⇒ **Tx Mode:**CCK 、 OFDM、 HT MixMode (Bandwidth: 20、 40)
- ⇒ **Tx Data Rate:** 1Mbps long (IEEE 802.11b mode , TX)
 - 6Mbps (IEEE 802.11g mode , TX)
 - 6.5Mbps (IEEE 802.11n HT20 mode , TX)
 - 13.5Mbps (IEEE 802.11n HT40 mode, TX)

Power control mode

- Target Power:** IEEE 802.11b Channel Low (2412MHz) = **40**
 - IEEE 802.11b Channel Middle (2437MHz) = **40**
 - IEEE 802.11b Channel High (2462MHz) = **40**
- Target Power:** IEEE 802.11g Channel Low (2412MHz) = **50**
 - IEEE 802.11g Channel Middle (2437MHz) = **50**
 - IEEE 802.11g Channel High (2462MHz) = **50**
- Target Power:** IEEE 802.11n HT20 Channel Low (2412MHz) = **50**
 - IEEE 802.11 n HT20 Channel Middle (2437MHz) = **50**
 - IEEE 802.11 n HT20 Channel High (2462MHz) = **50**
- Target Power:** IEEE 802.11n HT40 Channel Low (2422MHz) = **49**
 - IEEE 802.11 n HT40 Channel Middle (2437MHz) = **49**
 - IEEE 802.11 n HT40 Channel High (2452MHz) = **49**

(2) RX Mode :

Start RX

3. All of the function are under run.
4. Start test.

Normal Link Setup

1. Set up all computers like the setup diagram.
2. All of the function are under run.
3. Notebook PC (2) ping 192.168.0.10 –t to Notebook PC (1).
4. Notebook PC (1) ping 192.168.0.20 –t to Notebook PC (2).
5. Notebook PC (1) ping 192.168.0.50 –t to Wireless Access Point (3).

Start test.



8. APPLICABLE LIMITS AND TEST RESULTS

8.1 6DB BANDWIDTH

LIMIT

§ 15.207(a) (2) For direct sequence systems, the minimum 6dB bandwidth shall be at least 500kHz

TEST EQUIPMENTS

Name of Equipment	Manufacturer	Model	Serial Number	Calibration Due
Spectrum Analyzer	R&S	FSEK 30	835253/002	JUL. 14, 2012

TEST SETUP

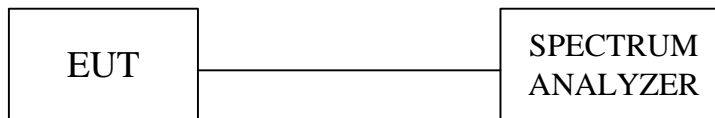

TEST PROCEDURE

The transmitter output was connected to a spectrum analyzer. The bandwidth of the fundamental frequency was measured by spectrum analyzer with 100 KHz RBW and 100 KHz VBW. The 6dB bandwidth is defined as the total spectrum the power of which is higher than peak power minus 6dB.



TEST RESULTS

No non-compliance noted.

IEEE 802.11b mode

Channel	Channel Frequency (MHz)	6dB Bandwidth (kHz)	Minimum Limit (kHz)	Pass / Fail
Low	2412	10321	500	PASS
Middle	2437	10321	500	PASS
High	2462	10321	500	PASS

NOTE :

1. At final test to get the worst-case emission at 1Mbps long.
2. The cable assembly insertion loss of 11.7dB (including 10 dB pad and 1.7 dB cable) was entered as an offset in the spectrum analyzer to allow for direct reading of power.

IEEE 802.11g mode

Channel	Channel Frequency (MHz)	6dB Bandwidth (kHz)	Minimum Limit (kHz)	Pass / Fail
Low	2412	16733	500	PASS
Middle	2437	16733	500	PASS
High	2462	16733	500	PASS

NOTE :

1. At final test to get the worst-case emission at 6Mbps.
2. The cable assembly insertion loss of 11.7dB (including 10 dB pad and 1.7 dB cable) was entered as an offset in the spectrum analyzer to allow for direct reading of power.



IEEE 802.11n HT20 mode

Channel	Channel Frequency (MHz)	6dB Bandwidth (kHz)	Minimum Limit (kHz)	Pass / Fail
Low	2412	17936	500	PASS
Middle	2437	17936	500	PASS
High	2462	17936	500	PASS

NOTE :

1. At final test to get the worst-case emission at 6.5Mbps.
2. The cable assembly insertion loss of 11.7dB (including 10 dB pad and 1.7 dB cable) was entered as an offset in the spectrum analyzer to allow for direct reading of power.

IEEE 802.11n HT40 mode

Channel	Channel Frequency (MHz)	6dB Bandwidth (kHz)	Minimum Limit (kHz)	Pass / Fail
Low	2422	36673	500	PASS
Middle	2437	36673	500	PASS
High	2452	36673	500	PASS

NOTE :

1. At final test to get the worst-case emission at 13.5Mbps.
2. The cable assembly insertion loss of 11.7dB (including 10 dB pad and 1.7 dB cable) was entered as an offset in the spectrum analyzer to allow for direct reading of power.



6dB BANDWIDTH (802.11b MODE)

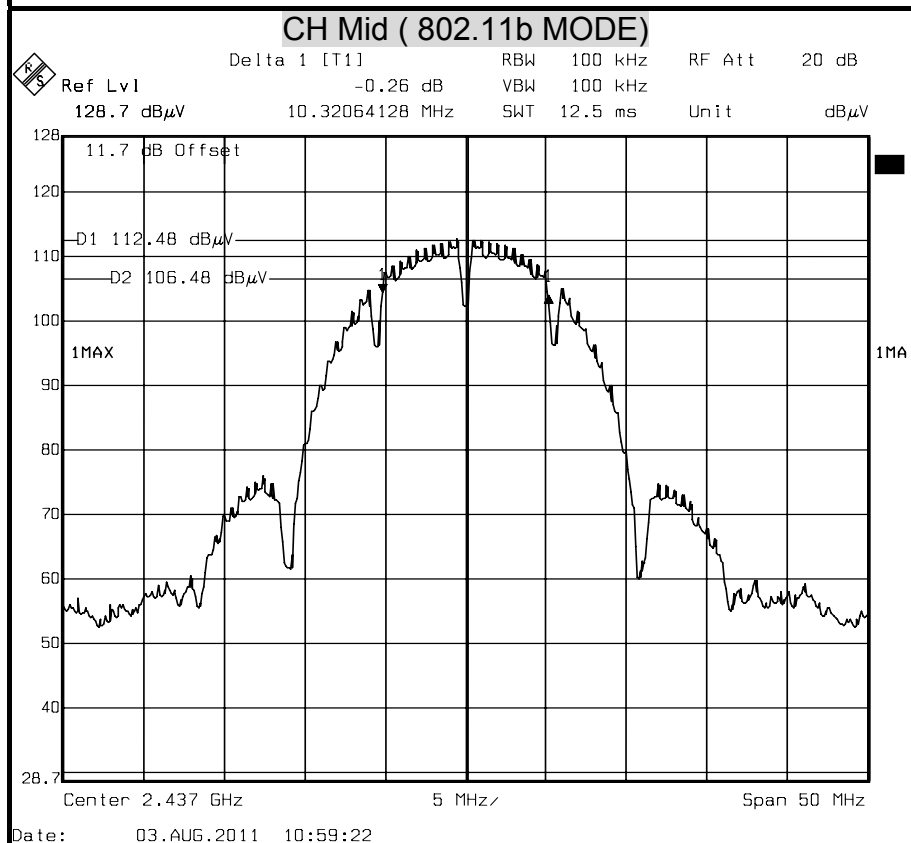
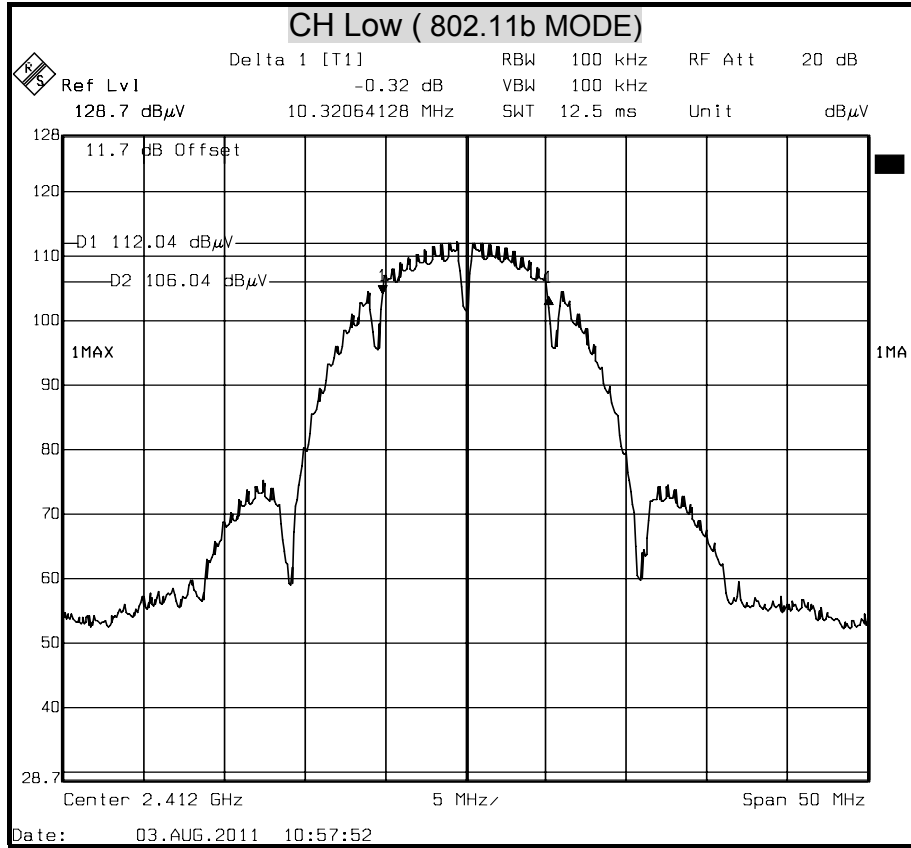

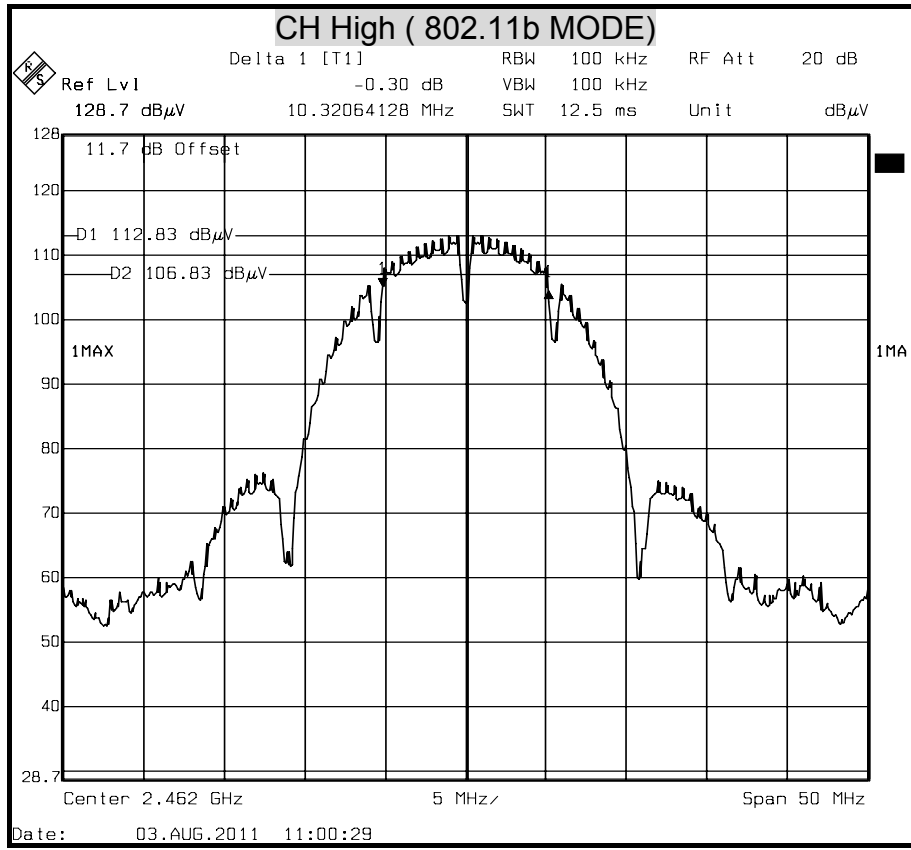



6dB BANDWIDTH (802.11g MODE)

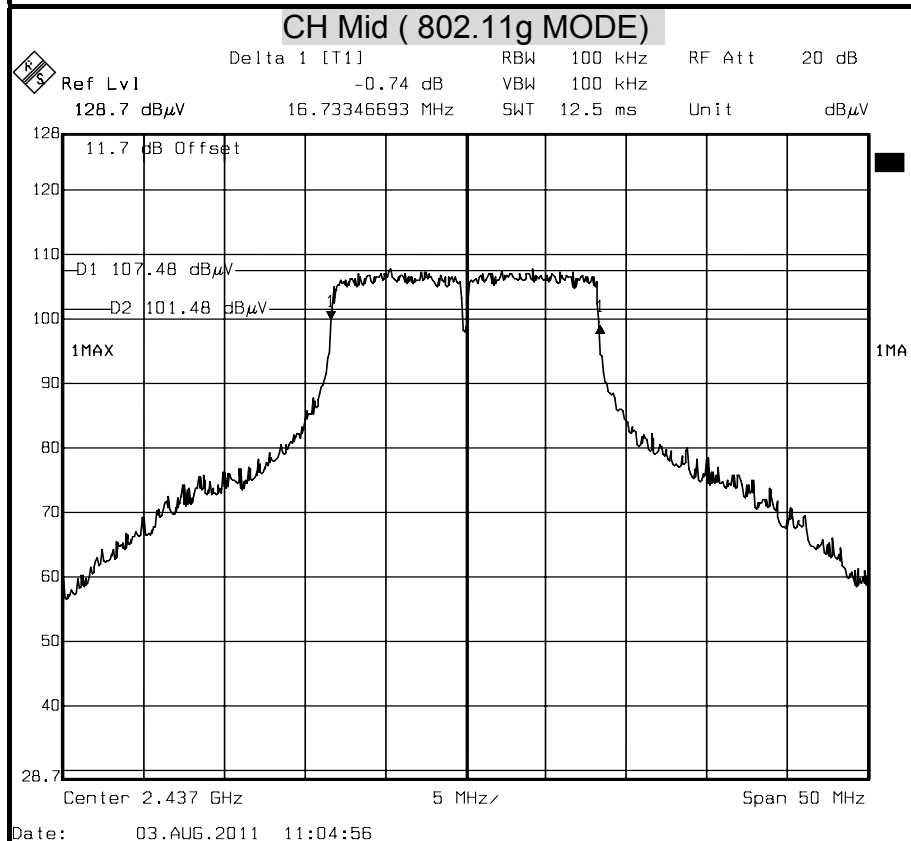
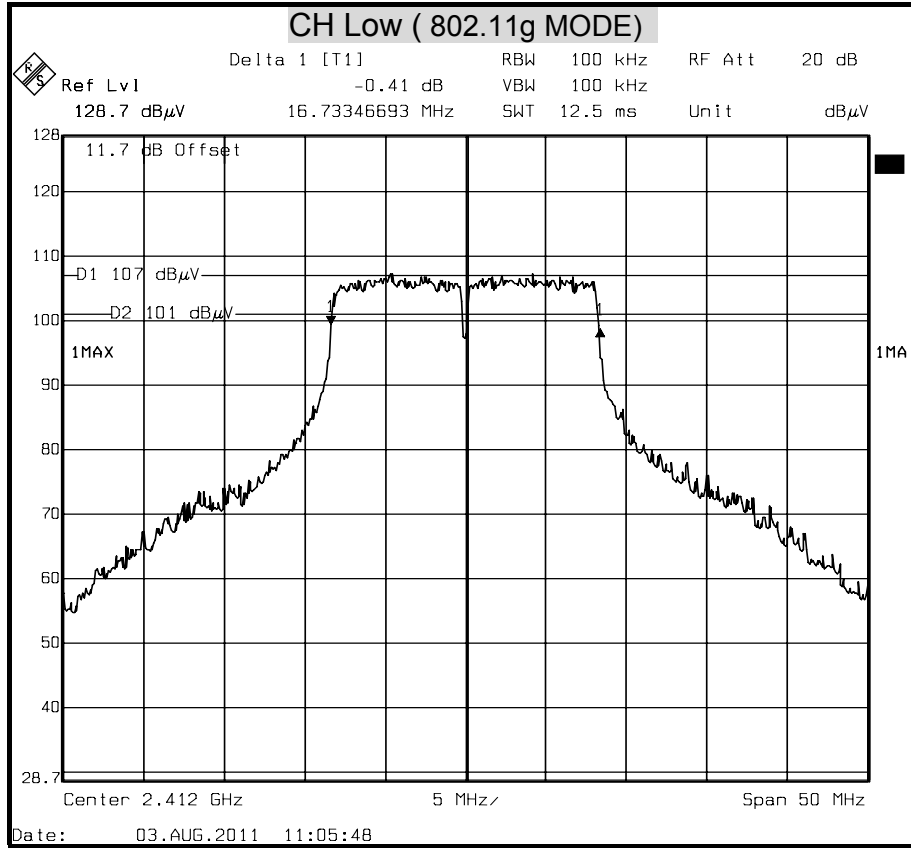

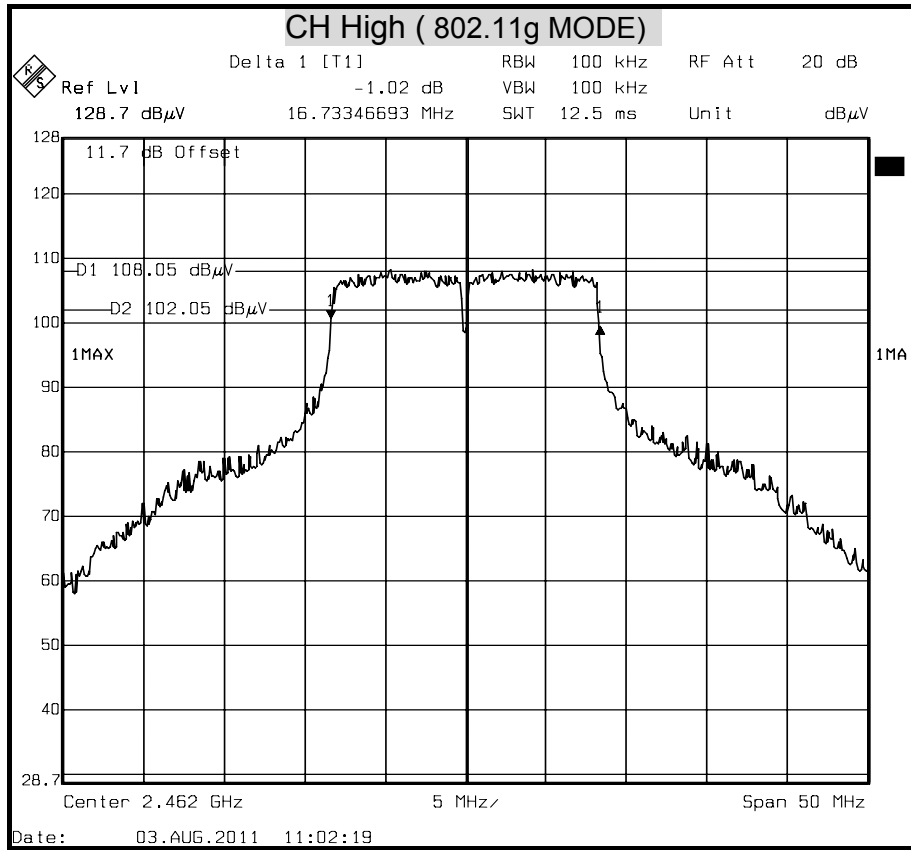



6dB BANDWIDTH (802.11n HT20 MODE)

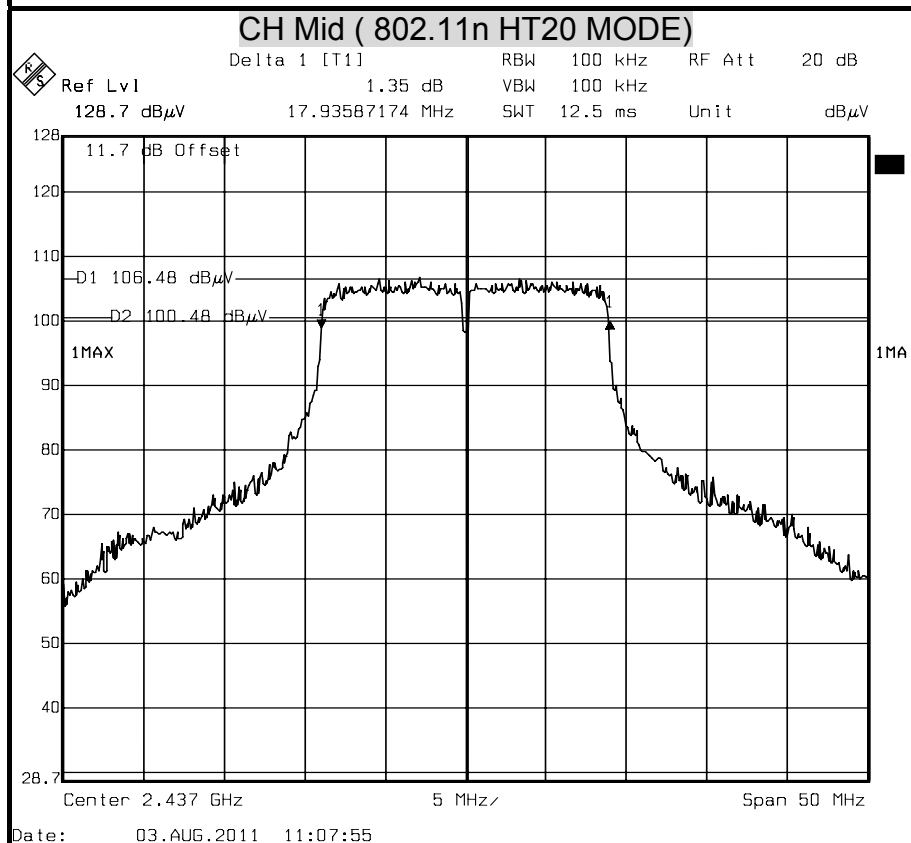
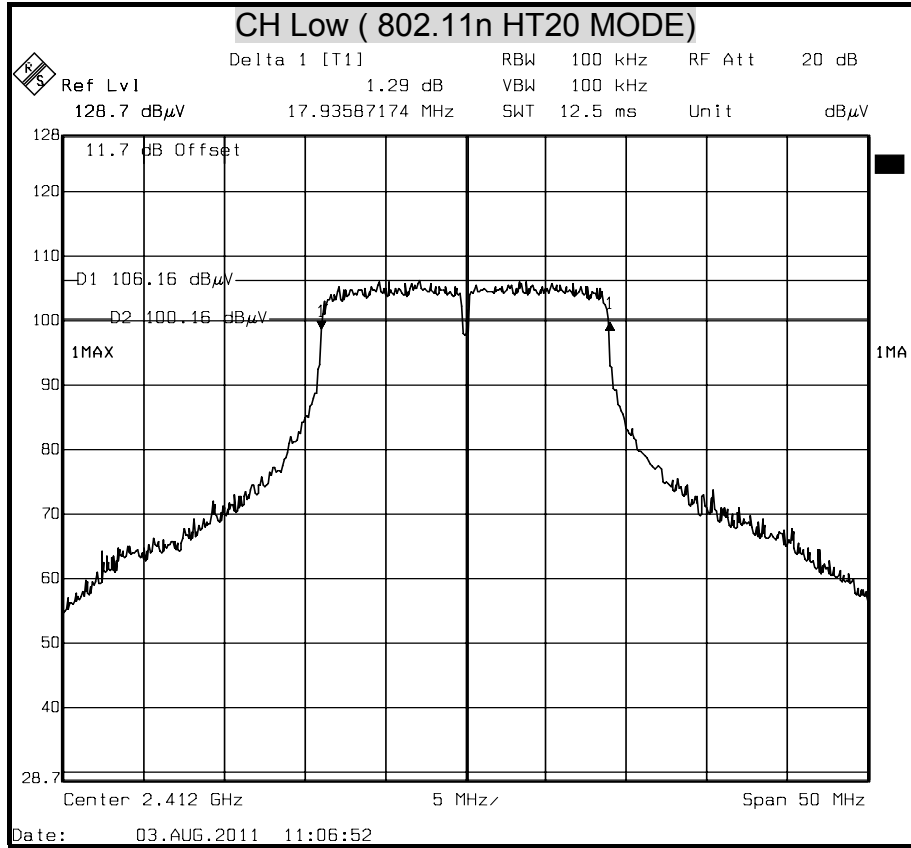

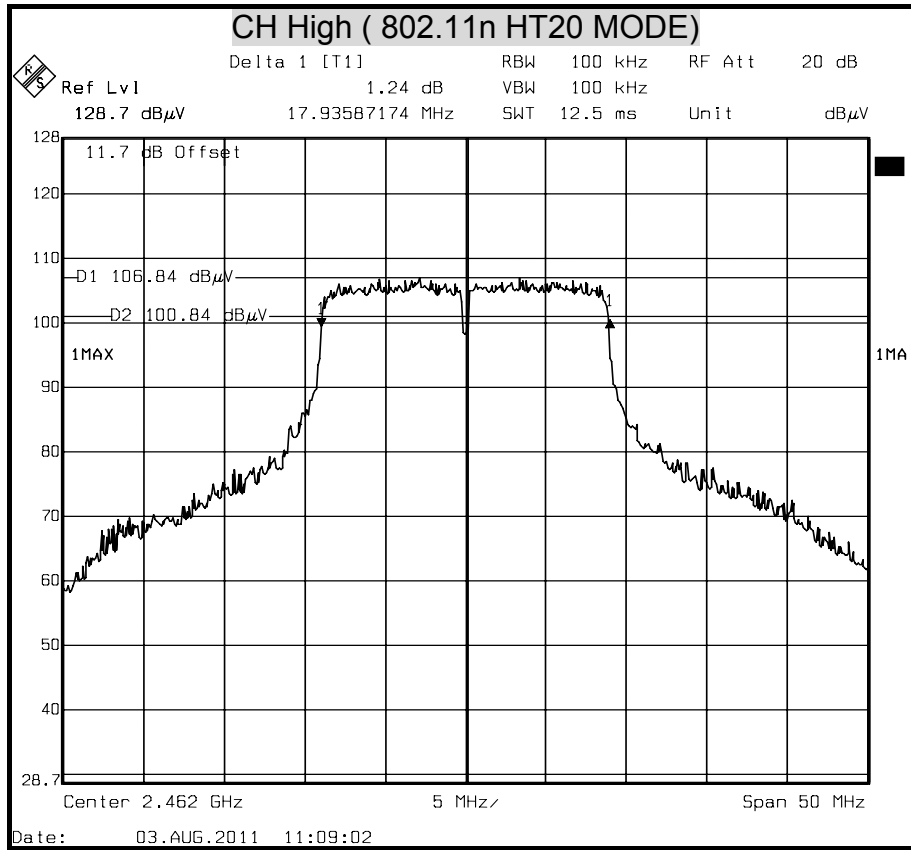



6dB BANDWIDTH (802.11n HT40 MODE)

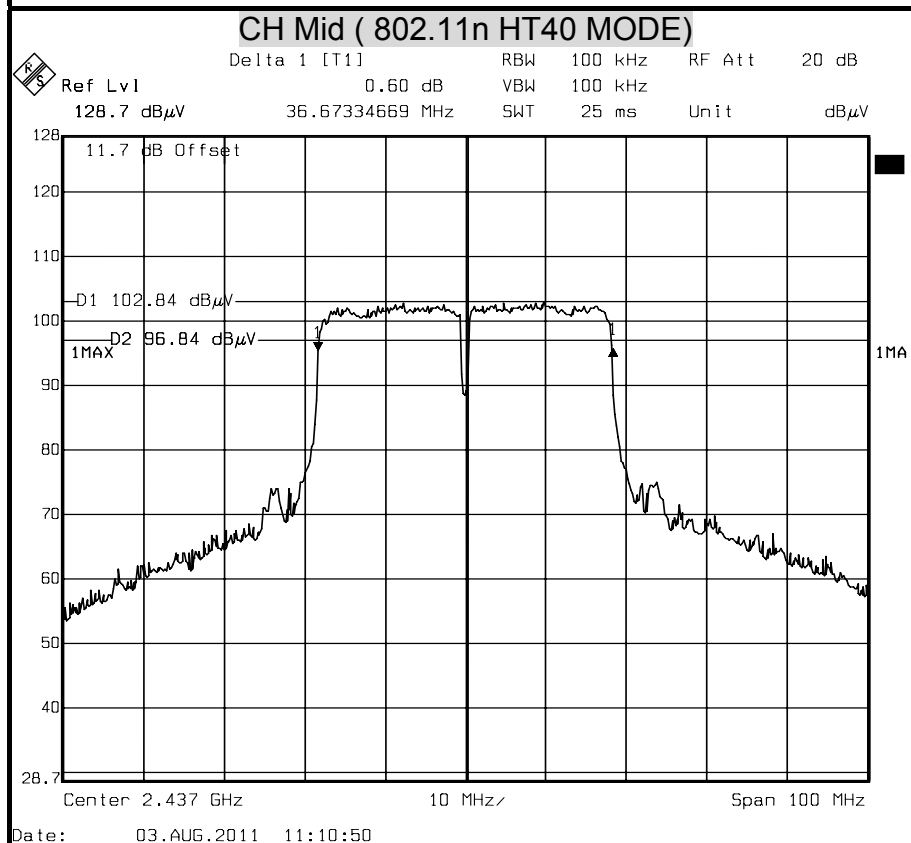
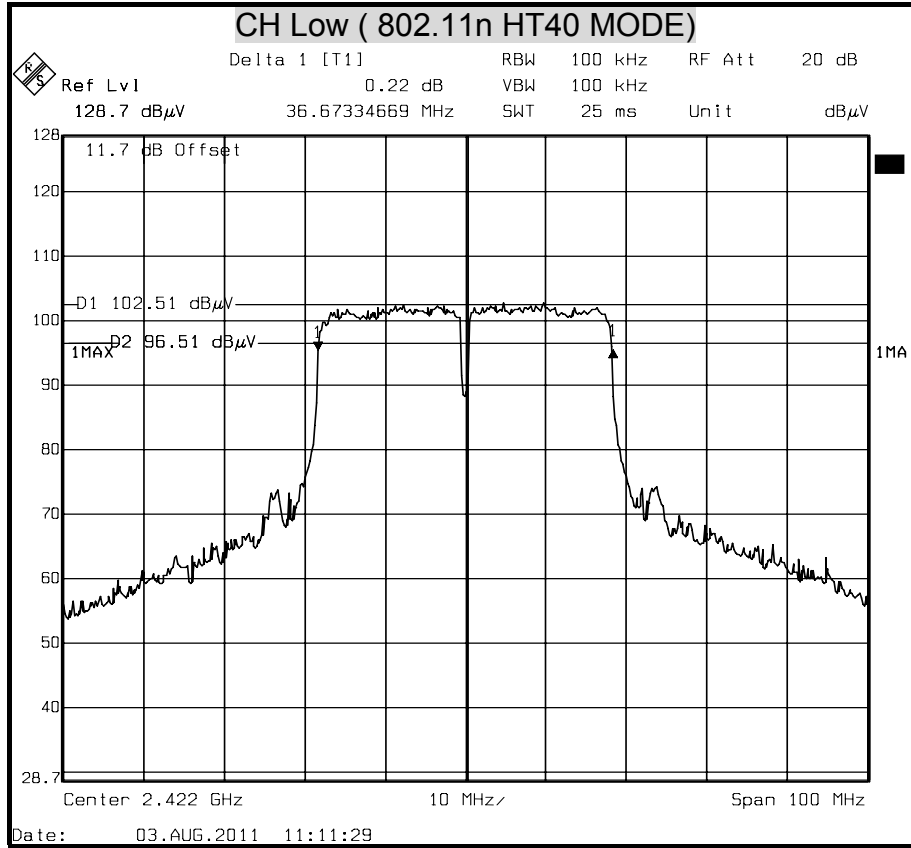

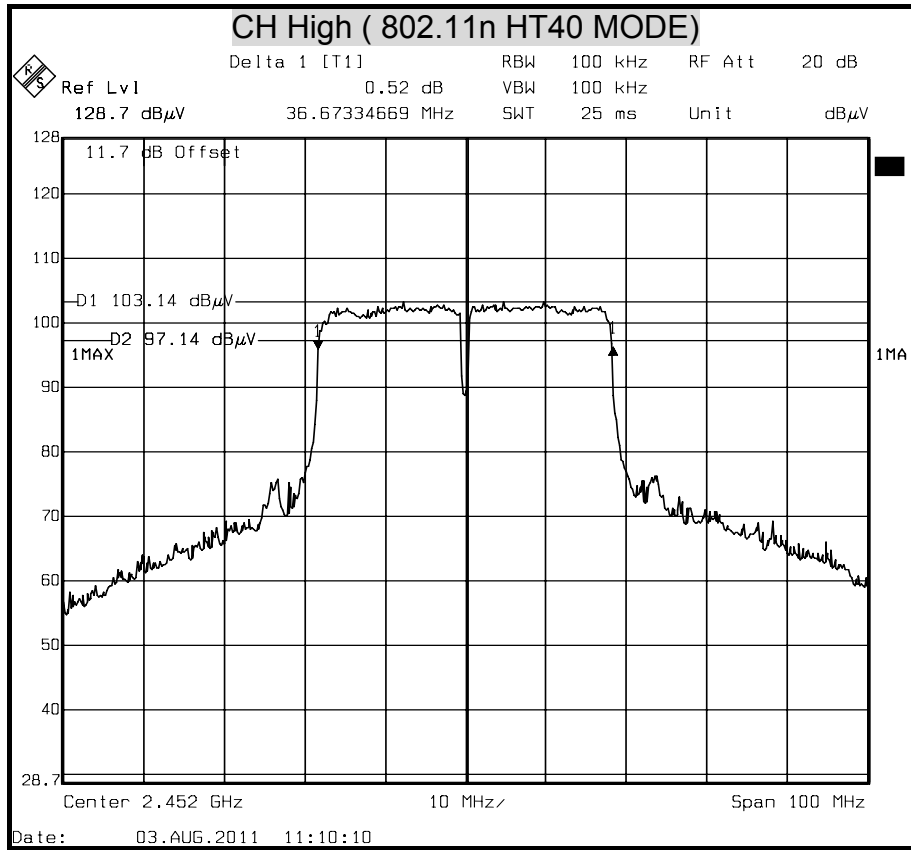



8.2 MAXIMUM PEAK OUTPUT POWER

LIMIT

§ 15.247(b) The maximum peak output power of the intentional radiator shall not exceed the following :

§ 15.247(b) (3) For systems using digital modulation in the 902-928 MHz, 2400-2483.5 MHz, and 5725-5850 MHz bands : 1 watt.

§ 15.247(b) (4) Except as shown in paragraphs (c) of this section , if transmitting antennas of directional gain greater than 6 dBi are used the peak output power from the intentional radiator shall be reduced below the stated values in paragraphs (b)(1) or (b)(2), and (b)(3) of this section , as appropriate, by the amount in dB that the directional gain of the antenna exceeds 6 dBi.

TEST EQUIPMENTS

Name of Equipment	Manufacturer	Model	Serial Number	Calibration Due
Power Meter	Anritsu	ML2487A	6K00003888	MAY 11, 2012

TEST SETUP



TEST PROCEDURE

Connect the EUT to power meter, set the center frequency of the power meter to the channel center frequency. Set the RBW to 1MHz and VBW to 3MHz.

TEST RESULTS

No non-compliance noted



IEEE 802.11b mode

Channel	Channel Frequency (MHz)	Peak Power (dBm)	Peak Power Limit (dBm)	Pass / Fail
Low	2412	14.22	30	PASS
Middle	2437	14.49	30	PASS
High	2462	14.62	30	PASS

NOTE : 1. At final test to get the worst-case emission at 1Mbps long.
2. The cable assembly insertion loss of 11.7dB (including 10 dB pad and 1.7 dB cable) was entered as an offset in the power meter to allow for direct reading of power

IEEE 802.11g mode

Channel	Channel Frequency (MHz)	Peak Power (dBm)	Peak Power Limit (dBm)	Pass / Fail
Low	2412	22.74	30	PASS
Middle	2437	23.09	30	PASS
High	2462	23.24	30	PASS

NOTE : 1. At final test to get the worst-case emission at 6Mbps.
2. The cable assembly insertion loss of 11.7dB (including 10 dB pad and 1.7 dB cable) was entered as an offset in the power meter to allow for direct reading of power



IEEE 802.11n HT20 mode

Channel	Channel Frequency (MHz)	Peak Power (dBm)	Peak Power Limit (dBm)	Pass / Fail
Low	2412	22.07	30	PASS
Middle	2437	22.34	30	PASS
High	2462	22.58	30	PASS

NOTE : 1. At final test to get the worst-case emission at 6.5Mbps.
2. The cable assembly insertion loss of 11.7dB (including 10 dB pad and 1.7 dB cable) was entered as an offset in the power meter to allow for direct reading of power

IEEE 802.11n HT40 mode

Channel	Channel Frequency (MHz)	Peak Power (dBm)	Peak Power Limit (dBm)	Pass / Fail
Low	2422	20.94	30	PASS
Middle	2437	21.05	30	PASS
High	2452	21.45	30	PASS

NOTE : 1. At final test to get the worst-case emission at 13.5Mbps.
2. The cable assembly insertion loss of 11.7dB (including 10 dB pad and 1.7 dB cable) was entered as an offset in the power meter to allow for direct reading of power



Average Power Data

IEEE 802.11b mode

Channel	Channel Frequency (MHz)	Average Power (dBm)
Low	2412	11.84
Middle	2437	12.09
High	2462	12.24

IEEE 802.11g mode

Channel	Channel Frequency (MHz)	Average Power (dBm)
Low	2412	13.36
Middle	2437	13.61
High	2462	13.87

IEEE 802.11n HT20 mode

Channel	Channel Frequency (MHz)	Average Power (dBm)
Low	2412	13.12
Middle	2437	13.33
High	2462	13.52

IEEE 802.11n HT40 mode

Channel	Channel Frequency (MHz)	Average Power (dBm)
Low	2422	11.43
Middle	2437	11.59
High	2452	11.78



8.3 MAXIMUM PERMISSIBLE EXPOSURE

According to FCC 1.1310 : The criteria listed in the following table shall be used to evaluate the environment impact of human exposure to radio frequency (RF) radiation as specified in 1.1307(b) LIMITS FOR MAXIMUM PERMISSIBLE EXPOSURE (MPE)

Frequency Range (MHz)	Electric Field Strength (V/m)	Magnetic Field Strength (A/m)	Power Density (mW/cm ²)	Average Time
(A) Limits for Occupational / Control Exposures				
300-1,500	--	--	F/300	6
1,500-100,000	--	--	5	6
(B) Limits for General Population / Uncontrol Exposures				
300-1,500	--	--	F/1500	6
1,500-100,000	--	--	1	30

CALCULATIONS

Given $E = \frac{\sqrt{30 \times P \times G}}{d}$ & $S = \frac{E^2}{3770}$

Where E = Field strength in Volts / meter

P = Power in Watts

G = Numeric antenna gain

d = Distance in meters

S = Power density in milliwatts / square centimeter

Combining equations and re-arranging the terms to express the distance as a function of the remaining variables yields:

$$S = \frac{30 \times P \times G}{3770d^2}$$

Changing to units of mW and cm, using:

$$P \text{ (mW)} = P \text{ (W)} / 1000 \text{ and}$$

$$d \text{ (cm)} = d \text{ (m)} / 100$$

Yields

$$S = \frac{30 \times (P/1000) \times G}{3770 \times (d/100)^2} = 0.0796 \times \frac{P \times G}{d^2}$$

Where d = Distance in cm

P = Power in mW

G = Numeric antenna gain

S = Power density in mW / cm²



LIMIT

Power Density Limit, S=1.0mW/cm²

TEST RESULTS

No non-compliance noted.

$$S = \frac{30 \times (P/1000) \times G}{3770 \times (d/100)^2} = 0.0796 \times \frac{P \times G}{d^2}$$

G=3.0dBi = 1.995262 mW

- IEEE 802.11b = 0.0796 * 28.9734 * 1.99526231 ÷ 400 = 0.0115
- IEEE 802.11g = 0.0796 * 210.8628 * 1.99526231 ÷ 400 = 0.08372
- IEEE 802.11n HT20 = 0.0796 * 181.1340 * 1.99526231 ÷ 400 = 0.07192
- IEEE 802.11n HT40 = 0.0796 * 139.6368 * 1.99526231 ÷ 400 = 0.05544

Mode	Minimum separation distance (cm)	Output Power (dBm)	Output Power (mw)	Antenna Gain (dBi)	Power Density Limit (mW/cm ²)	Power Density at 20cm (mW/cm ²)
IEEE 802.11b	20	14.62	28.97	3.00	1.00	0.011504
IEEE 802.11g	20	23.24	210.86	3.00	1.00	0.083725
IEEE 802.11n HT20	20	22.58	181.13	3.00	1.00	0.071921
IEEE 802.11n HT40	20	21.45	139.64	3.00	1.00	0.055444

REMARK: For mobile or fixed location transmitters, the maximum power density is 1.0 mW/cm² even if the calculation indicates that the power density would be larger.



8.4 POWER SPECTRAL DENSITY

LIMIT

§ 15.247(e) For digitally modulated systems, the power spectral density conducted from the intentional radiator to the antenna shall not greater than 8 dBm in any 3 kHz band during any time interval of continuous transmission.

TEST EQUIPMENTS

Name of Equipment	Manufacturer	Model	Serial Number	Calibration Due
Spectrum Analyzer	R&S	FSEK 30	835253/002	JUL. 14, 2012

TEST SETUP

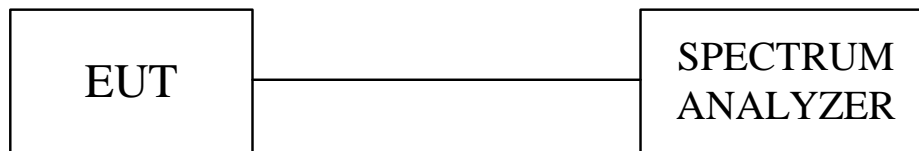

TEST PROCEDURE

The transmitter output was connected to the spectrum analyzer, the bandwidth of the fundamental frequency was measured with the spectrum analyzer using RBW=3KHz and VBW RBW, set sweep time=span / 3KHz.

The power spectral density was measured and recorded.

The sweep time is allowed to be longer than span / 3KHz for a full response of the mixer in the spectrum analyzer.

TEST RESULTS

No non-compliance noted.

**IEEE 802.11b mode**

Channel	Channel Frequency (MHz)	Final RF Power Level in 3KHz BW (dBm)	Maximum Limit (dBm)	Pass / Fail
Low	2412	-13.94	8	PASS
Middle	2437	-13.34	8	PASS
High	2462	-13.23	8	PASS

NOTE : 1. At final test to get the worst-case emission at 1Mbps long.
2. The cable assembly insertion loss of 11.7dB (including 10 dB pad and 1.7 dB cable) was Entered as an offset in the spectrum analyzer to allow for direct reading of power.

IEEE 802.11g mode

Channel	Channel Frequency (MHz)	Final RF Power Level in 3KHz BW (dBm)	Maximum Limit (dBm)	Pass / Fail
Low	2412	-14.20	8	PASS
Middle	2437	-13.84	8	PASS
High	2462	-13.17	8	PASS

NOTE : 1. At final test to get the worst-case emission at 6Mbps.
2. The cable assembly insertion loss of 11.7dB (including 10 dB pad and 1.7 dB cable) was Entered as an offset in the spectrum analyzer to allow for direct reading of power.

IEEE 802.11n HT20 mode

Channel	Channel Frequency (MHz)	Final RF Power Level in 3KHz BW (dBm)	Maximum Limit (dBm)	Pass / Fail
Low	2412	-14.81	8	PASS
Middle	2437	-14.40	8	PASS
High	2462	-13.92	8	PASS

NOTE : 1. At final test to get the worst-case emission at 6.5Mbps.
2. The cable assembly insertion loss of 11.7dB (including 10 dB pad and 1.7 dB cable) was Entered as an offset in the spectrum analyzer to allow for direct reading of power.

IEEE 802.11n HT40 mode

Channel	Channel Frequency (MHz)	Final RF Power Level in 3KHz BW (dBm)	Maximum Limit (dBm)	Pass / Fail
Low	2422	-18.36	8	PASS
Middle	2437	-18.07	8	PASS
High	2452	-17.61	8	PASS

NOTE : 1. At final test to get the worst-case emission at 13.5Mbps.
2. The cable assembly insertion loss of 11.7dB (including 10 dB pad and 1.7 dB cable) was Entered as an offset in the spectrum analyzer to allow for direct reading of power.



POWER SPECTRAL DENSITY (IEEE 802.11b MODE)

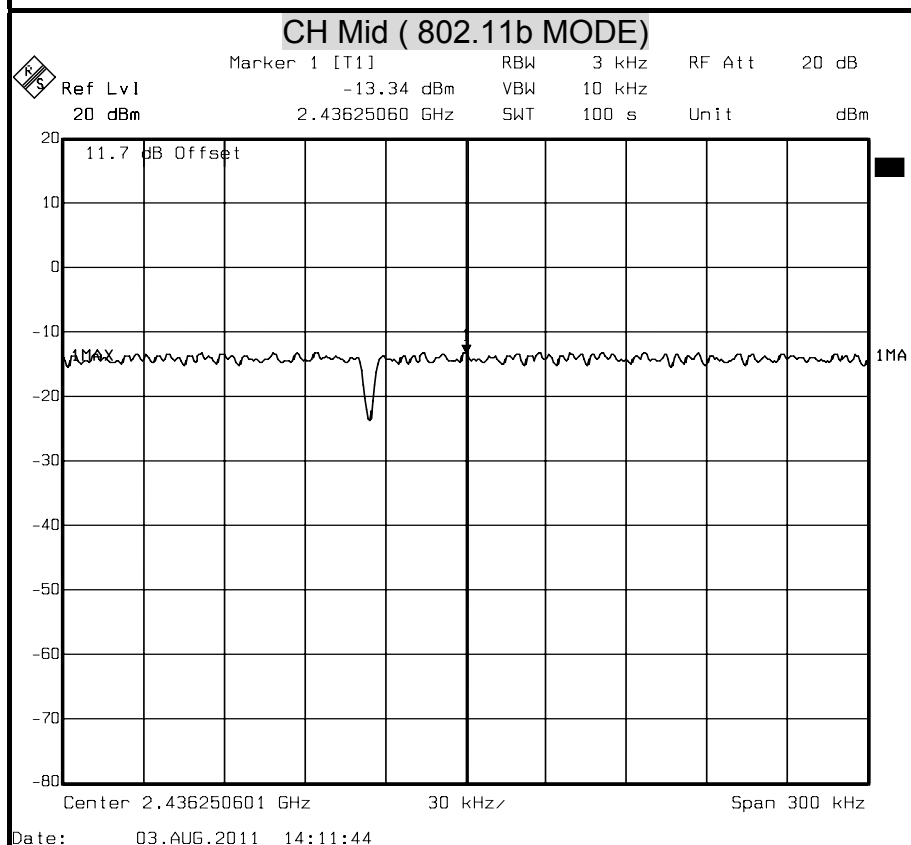
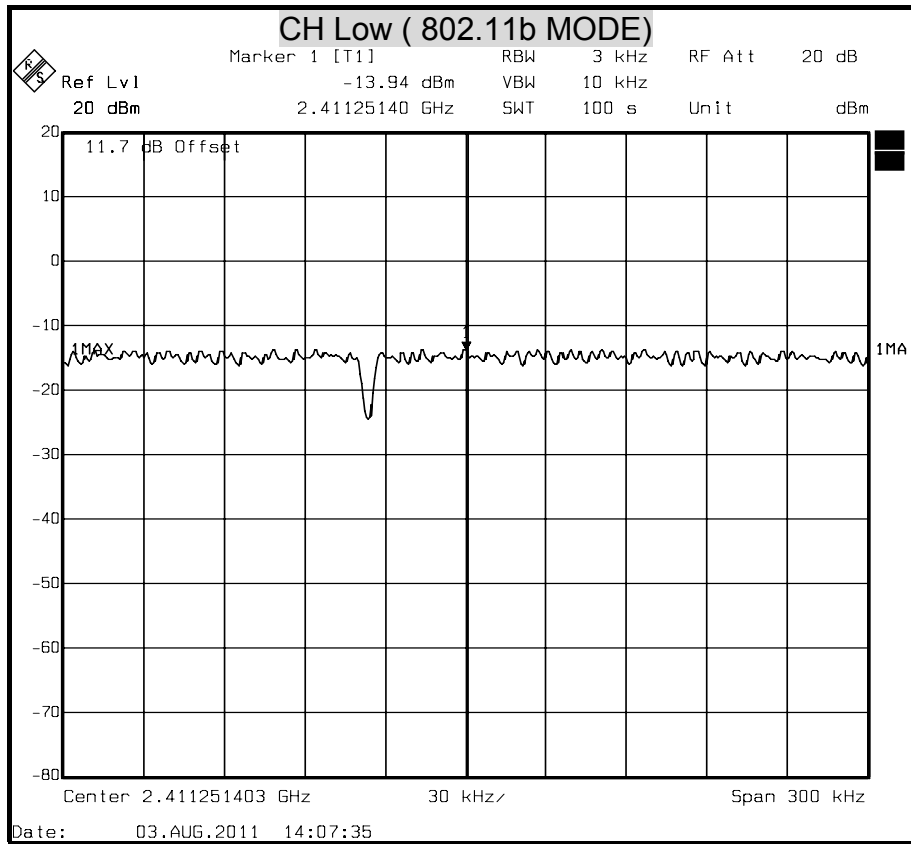

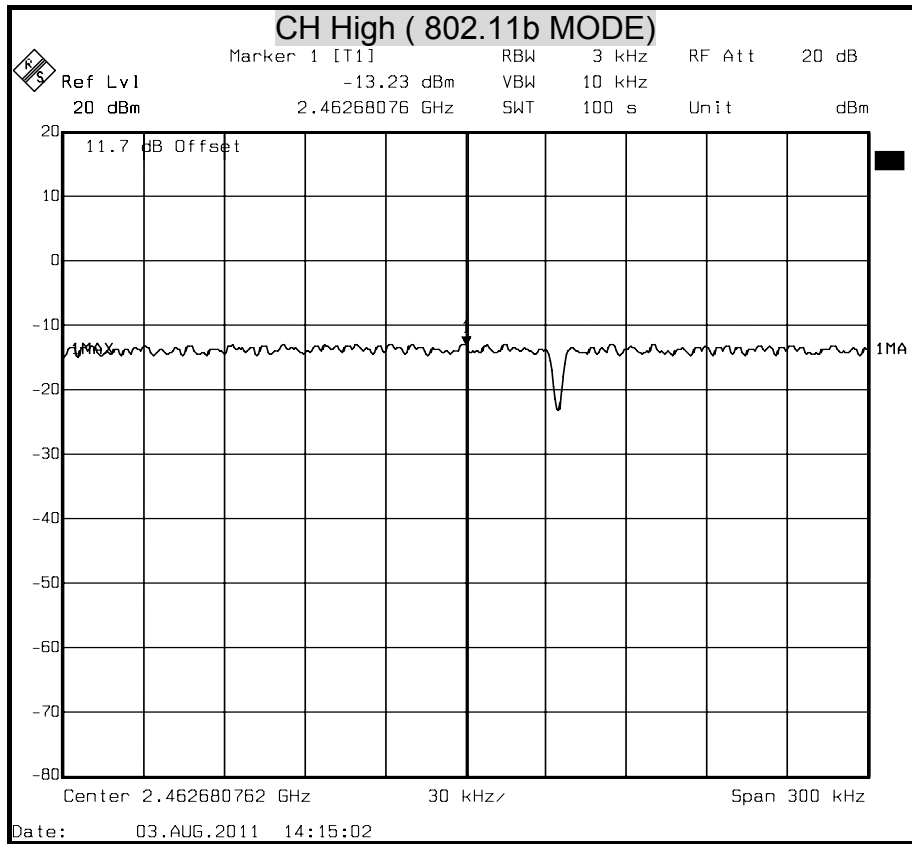



POWER SPECTRAL DENSITY (IEEE 802.11g MODE)

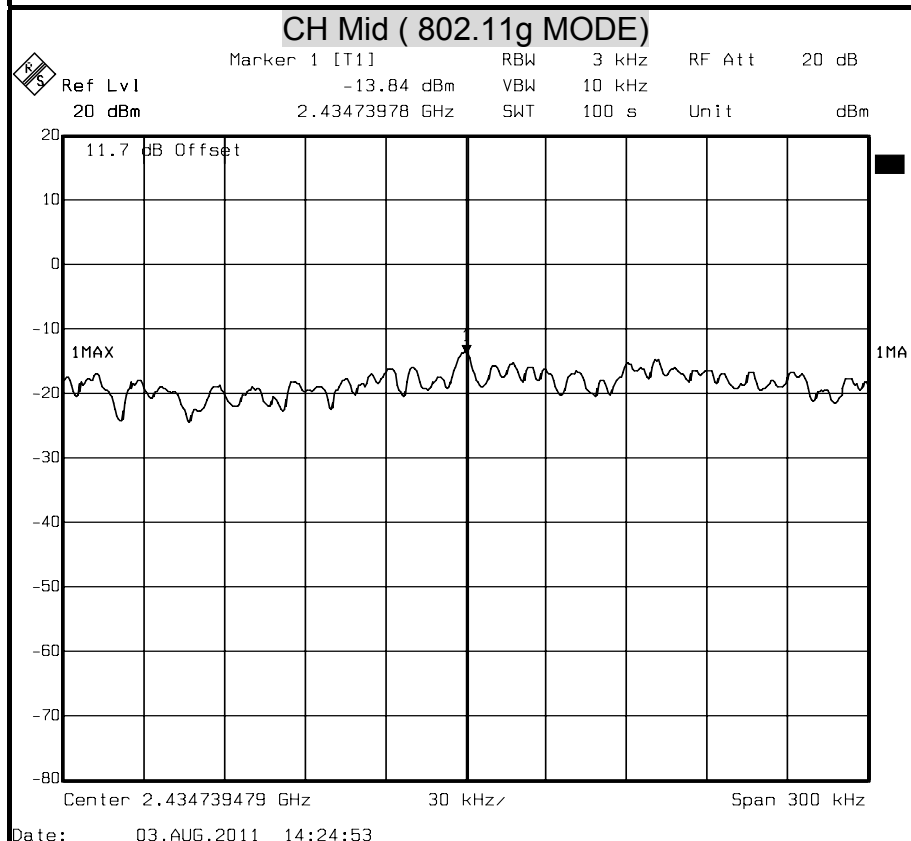
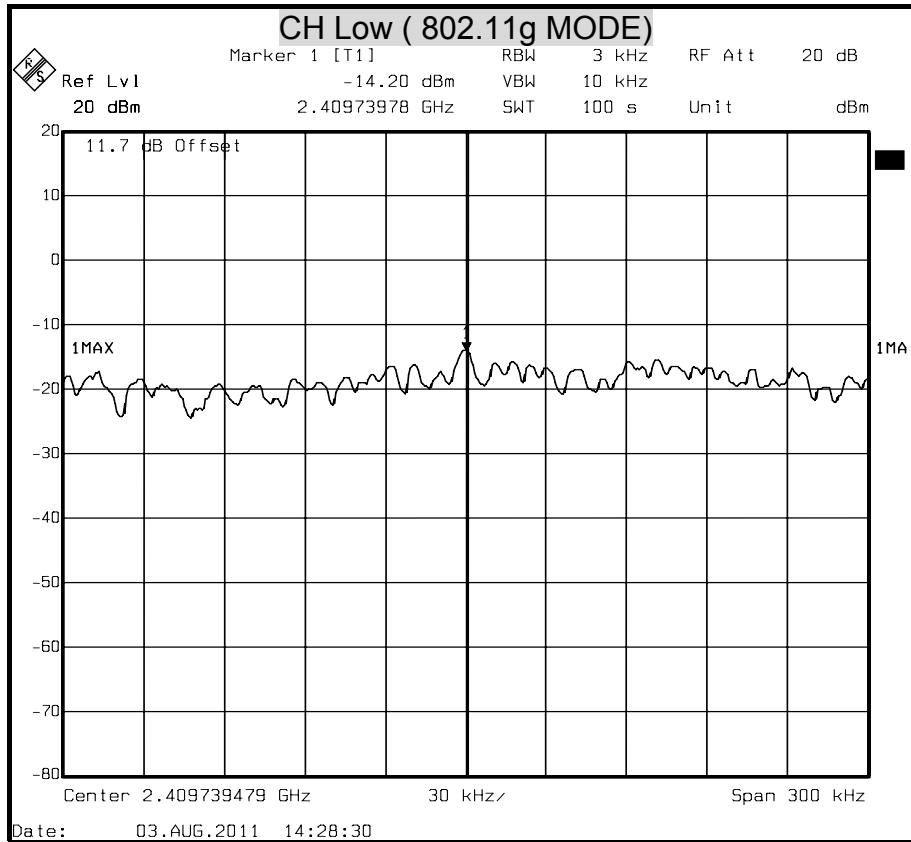

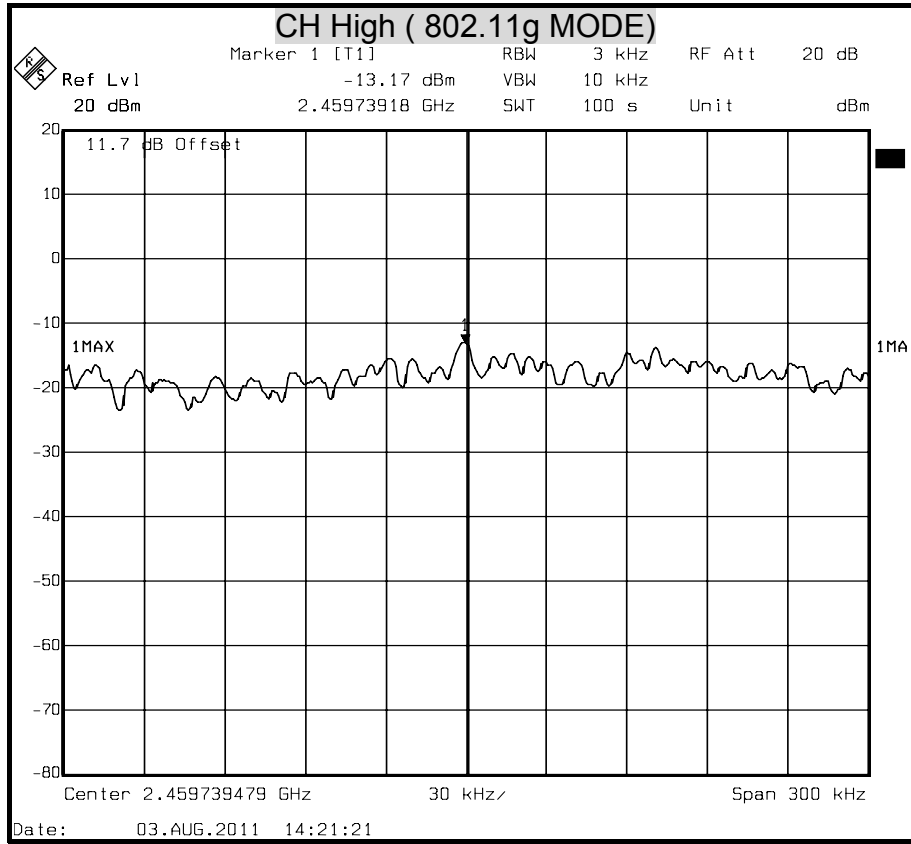



POWER SPECTRAL DENSITY (802.11n HT20 MODE)

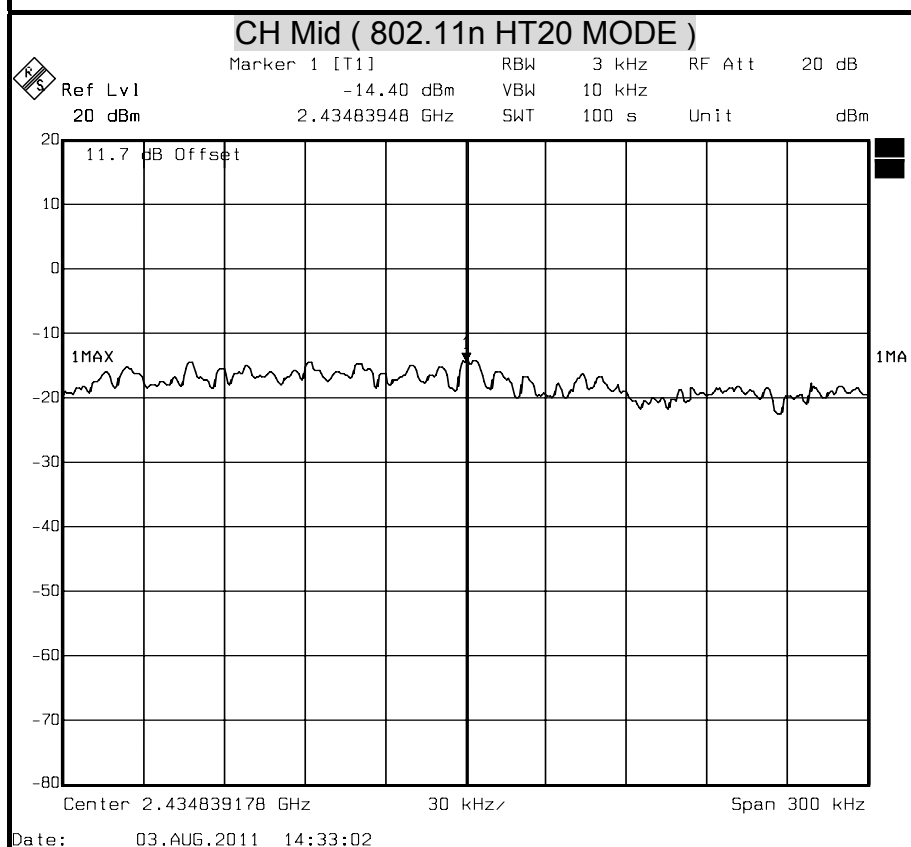
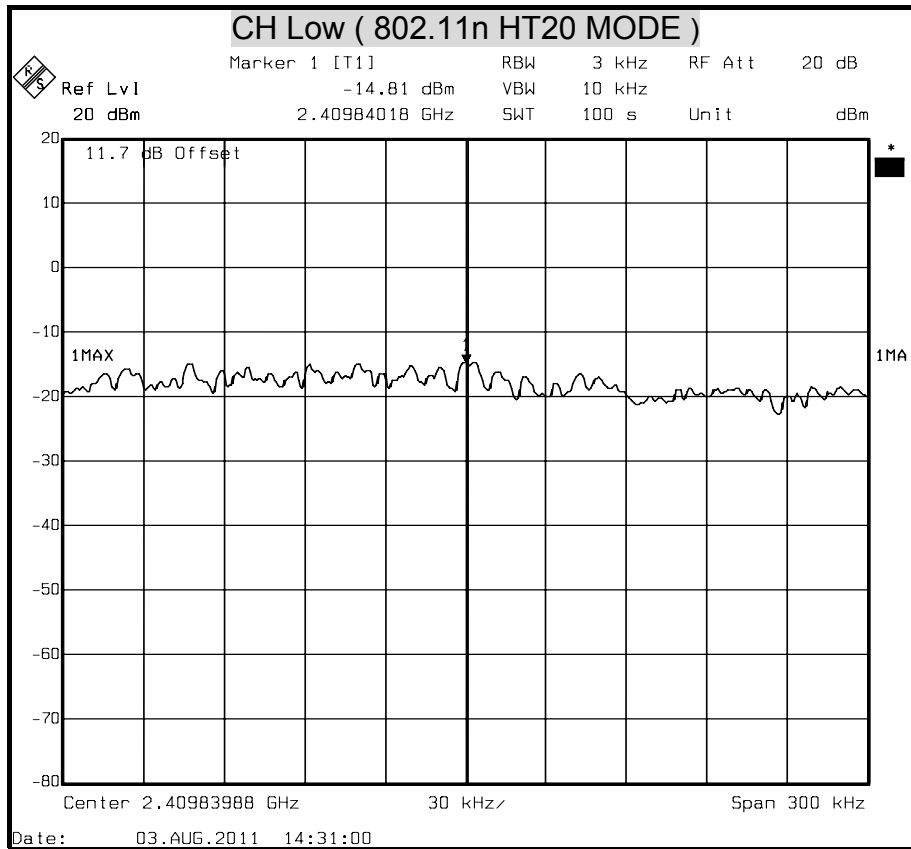

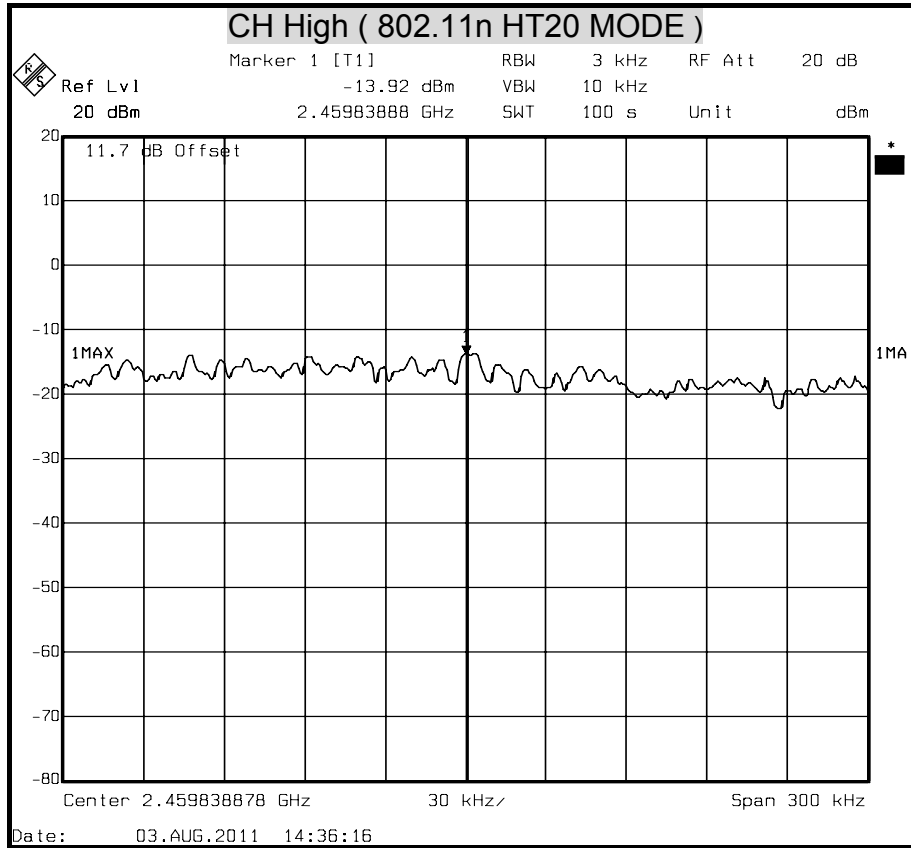



POWER SPECTRAL DENSITY (802.11n HT40 MODE)

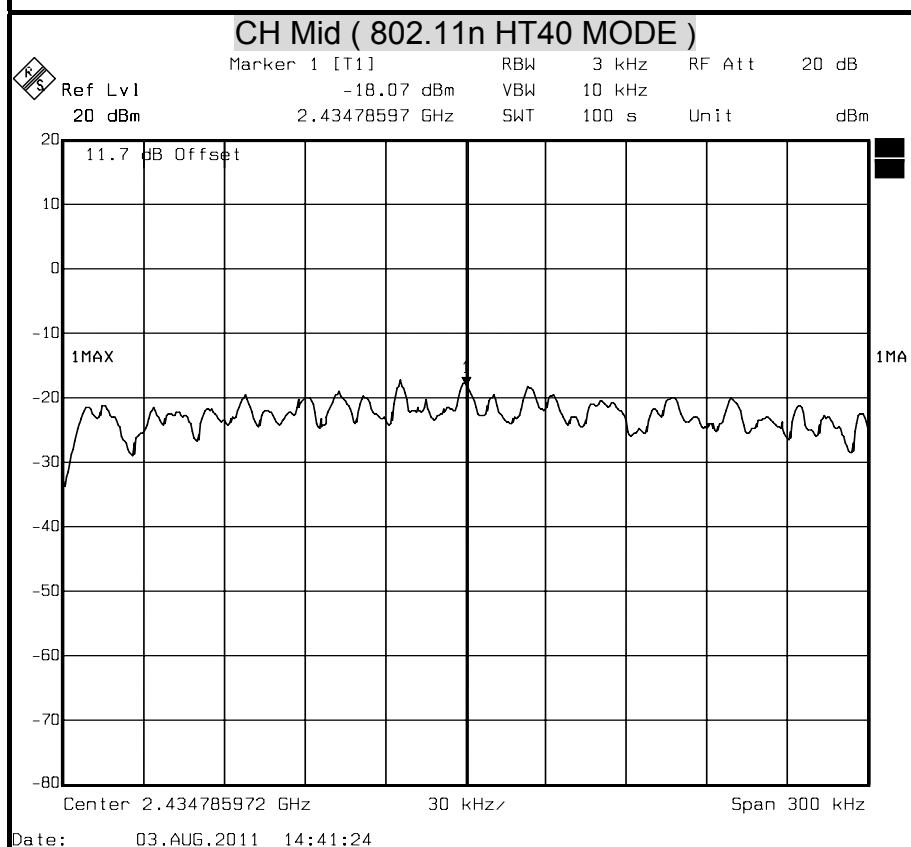
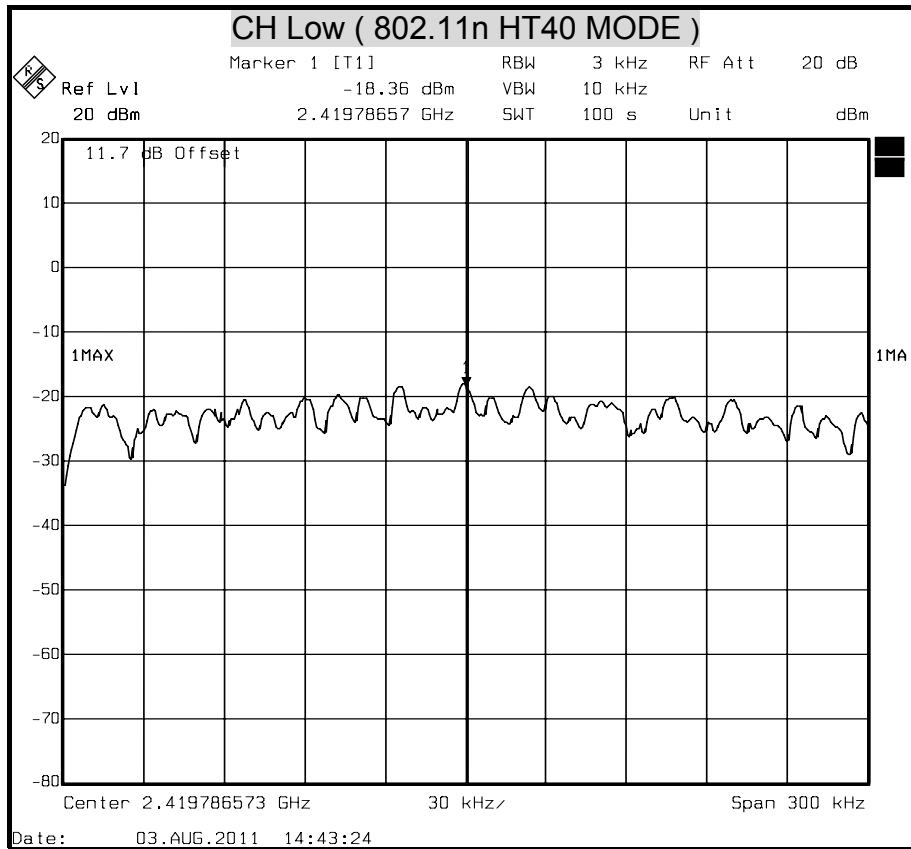

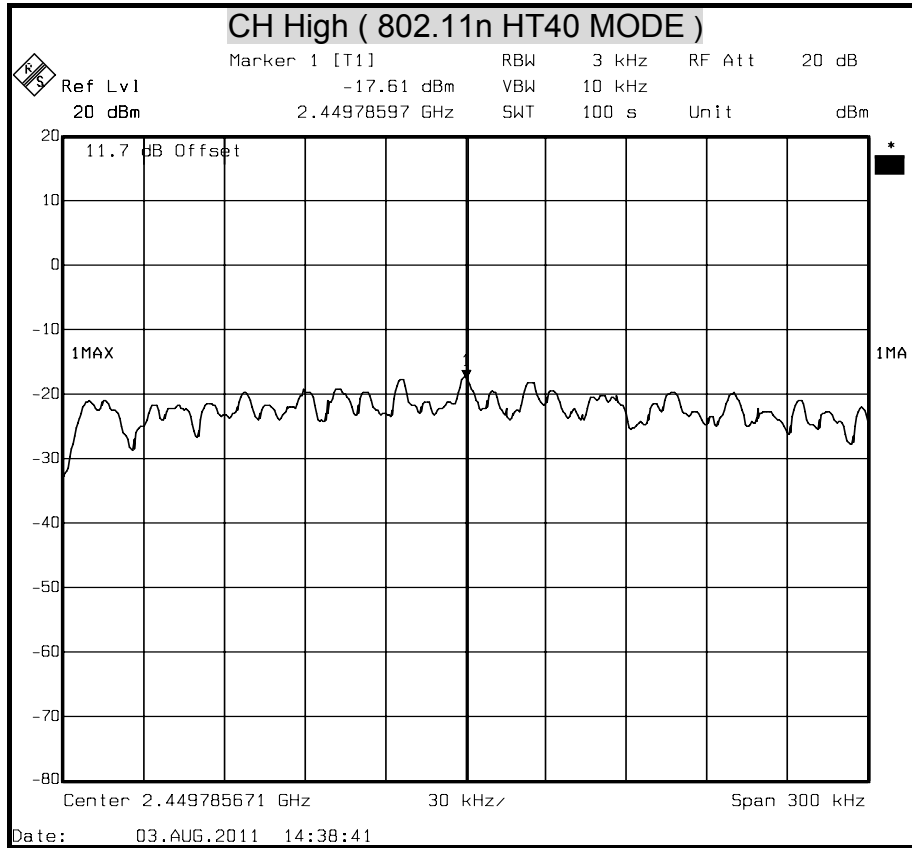



8.5 CONDUCTED SPURIOUS EMISSION

LIMITS

§ 15.247(d) In any 100 kHz bandwidth outside the frequency band in which the spread spectrum intentional radiator is operating, the radio frequency power that is produced by the intentional radiator shall be at least 20 dB below that in the 100 kHz bandwidth within the band that contains the highest level of the desired power, based on either an RF conducted or a radiated measurement. Attenuation below the general limits specified in § 15.209(a) is not required. In addition, radiated emissions which fall in the restricted bands, as defined in § 15.205(a), must also comply with the radiated emission limits specified in § 15.209(a) (see § 15.205(c)).

TEST PROCEDURE

The transmitter output is connected to a spectrum analyzer. The resolution bandwidth is set to 100 kHz. The video bandwidth is set to 100 kHz.

The spectrum from 30 MHz to 26.5 GHz is investigated with the transmitter set to the lowest, middle, and highest channels in the 2.4 GHz band.

TEST SETUP

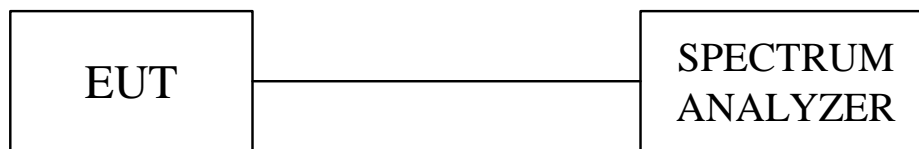

TEST RESULTS

No non-compliance noted.



TEST DATA

IEEE 802.11b mode

Low

Frequency	Offset	Reading	Level	Limit	Margin	Pass/Fail
(MHz)	(dB)	(dBµV)	(dBµV)	(dBµV)	(dB)	
2412	11.7	100.80	112.5	N/A	N/A	--
2400	11.7	63.14	74.84	92.50	-17.66	PASS
2821.4429	11.7	42.06	53.76	92.50	-38.74	PASS
6861.7235	11.7	45.11	56.81	92.50	-35.69	PASS

Mid

Frequency	Offset	Reading	Level	Limit	Margin	Pass/Fail
(MHz)	(dB)	(dBµV)	(dBµV)	(dBµV)	(dB)	
2437	11.7	100.06	111.76	N/A	N/A	---
2400	11.7	42.67	54.37	91.76	-37.39	Pass
2904.7695	11.7	41.76	53.46	91.76	-38.30	Pass
4836.6734	11.7	44.92	56.62	91.76	-35.14	Pass

High

Frequency	Offset	Reading	Level	Limit	Margin	Pass/Fail
(MHz)	(dB)	(dBµV)	(dBµV)	(dBµV)	(dB)	
2462	11.7	101.05	112.75	N/A	N/A	---
2400	11.7	40.79	52.49	92.75	-40.26	Pass
803.74749	11.7	39.87	51.57	92.75	-41.18	Pass
6955.9118	11.7	44.94	56.64	92.75	-36.11	Pass



IEEE 802.11g mode

Low

Frequency (MHz)	Offset (dB)	Reading (dBμV)	Level (dBμV)	Limit (dBμV)	Margin (dB)	Pass/Fail
2412	11.7	95.06	106.76	N/A	N/A	---
2400	11.7	65.36	77.06	86.76	-9.70	Pass
2613.1263	11.7	41.59	53.29	86.76	-33.47	Pass
6720.4409	11.7	44.69	56.39	86.76	-30.37	Pass

Mid

Frequency (MHz)	Offset (dB)	Reading (dBμV)	Level (dBμV)	Limit (dBμV)	Margin (dB)	Pass/Fail
2437	11.7	95.28	106.98	N/A	N/A	---
2400	11.7	42.07	53.77	86.98	-33.21	Pass
2363.1463	11.7	42.53	54.23	86.98	-32.75	Pass
6955.9118	11.7	44.44	56.14	86.98	-30.84	Pass

High

Frequency (MHz)	Offset (dB)	Reading (dBμV)	Level (dBμV)	Limit (dBμV)	Margin (dB)	Pass/Fail
2437	11.7	95.68	107.38	N/A	N/A	---
2400	11.7	40.25	51.95	87.38	-35.43	Pass
2660.7415	11.7	41.63	53.33	87.38	-34.05	Pass
6955.9118	11.7	44.37	56.07	87.38	-31.31	Pass



IEEE 802.1120 mode

Low

Frequency (MHz)	Offset (dB)	Reading (dB μ V)	Level (dB μ V)	Limit (dB μ V)	Margin (dB)	Pass/Fail
2412	11.7	94.29	105.99	N/A	N/A	---
2400	11.7	63.99	75.69	85.99	-10.30	Pass
1654.8697	11.7	41.18	52.88	85.99	-33.11	Pass
6955.9118	11.7	44.97	56.67	85.99	-29.32	Pass

Mid

Frequency (MHz)	Offset (dB)	Reading (dB μ V)	Level (dB μ V)	Limit (dB μ V)	Margin (dB)	Pass/Fail
2437	11.7	94.91	106.61	N/A	N/A	---
2400	11.7	40.61	52.31	86.61	-34.30	Pass
1964.3687	11.7	41.35	53.05	86.61	-33.56	Pass
6955.9118	11.7	45.30	57	86.61	-29.61	Pass

High

Frequency (MHz)	Offset (dB)	Reading (dB μ V)	Level (dB μ V)	Limit (dB μ V)	Margin (dB)	Pass/Fail
2462	11.7	94.98	106.68	N/A	N/A	---
2400	11.7	40.11	51.81	86.68	-34.87	Pass
1941.8944	11.7	41.64	53.34	86.68	-33.34	Pass
6955.9118	11.7	45.06	56.76	86.68	-29.92	Pass



IEEE 802.1140 mode

Low

Frequency	Offset	Reading	Level	Limit	Margin	Pass/Fail
(MHz)	(dB)	(dB μ V)	(dB μ V)	(dB μ V)	(dB)	
2422	11.7	90.41	102.11	N/A	N/A	---
2400	11.7	61.63	73.33	82.11	-8.78	Pass
2952.3848	11.7	41.75	53.45	82.11	-28.66	Pass
6861.7235	11.7	45.43	57.13	82.11	-24.98	Pass

Mid

Frequency	Offset	Reading	Level	Limit	Margin	Pass/Fail
(MHz)	(dB)	(dB μ V)	(dB μ V)	(dB μ V)	(dB)	
2437	11.7	90.84	102.54	N/A	N/A	---
2400	11.7	49.13	60.83	82.54	-21.71	Pass
1053.7275	11.7	41.31	53.01	82.54	-29.53	Pass
6955.9118	11.7	44.98	56.68	82.54	-25.86	Pass

High

Frequency	Offset	Reading	Level	Limit	Margin	Pass/Fail
(MHz)	(dB)	(dB μ V)	(dB μ V)	(dB μ V)	(dB)	
2452	11.7	91.53	103.23	N/A	N/A	---
2400	11.7	42.57	54.27	83.23	-28.96	Pass
1936.6533	11.7	41.20	52.9	83.23	-30.33	Pass
6955.9118	11.7	45.17	56.87	83.23	-26.36	Pass



OUT-OF-BAND SPURIOUS EMISSIONS-CONDUCTED MEASUREMENT

(IEEE 802.11b MODE)

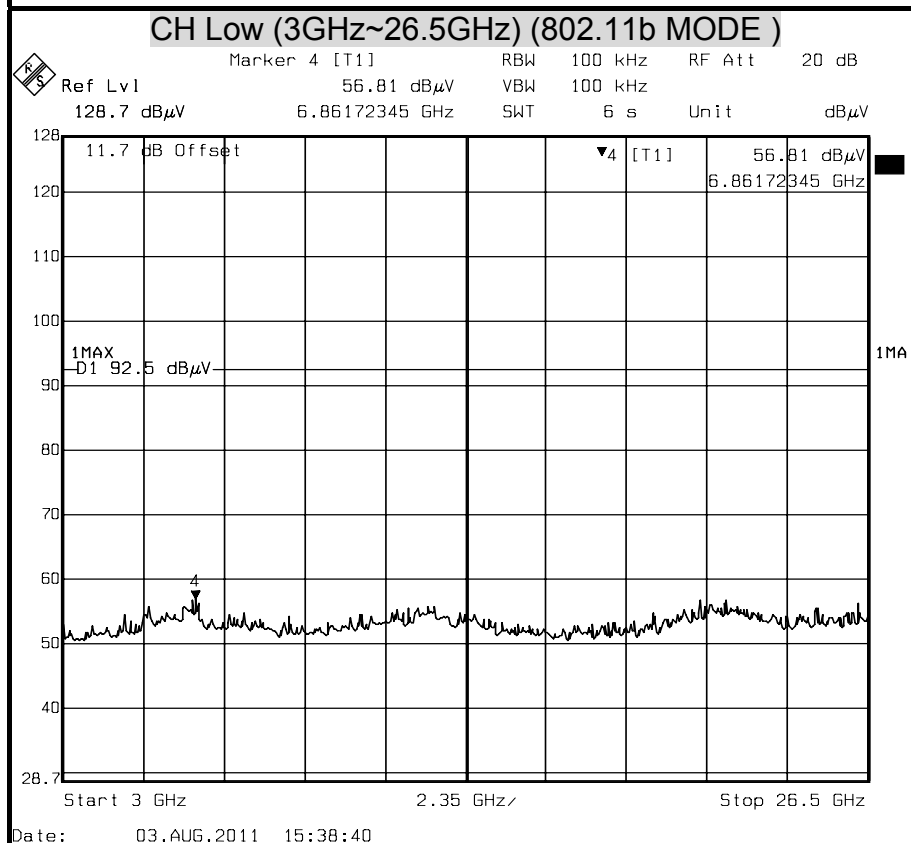
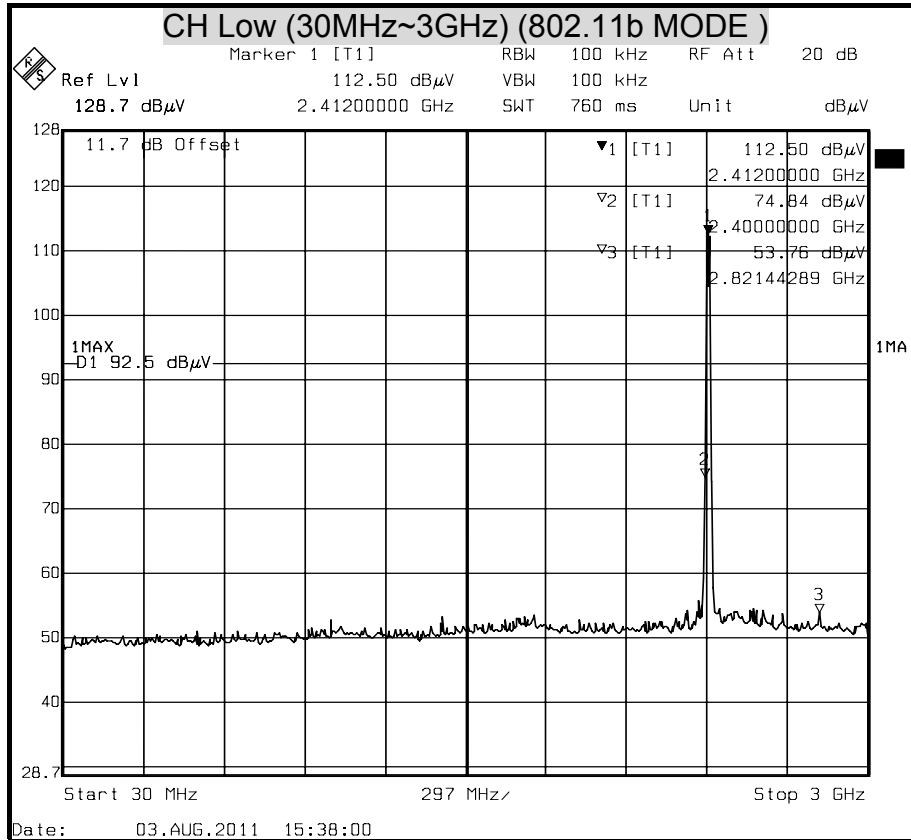

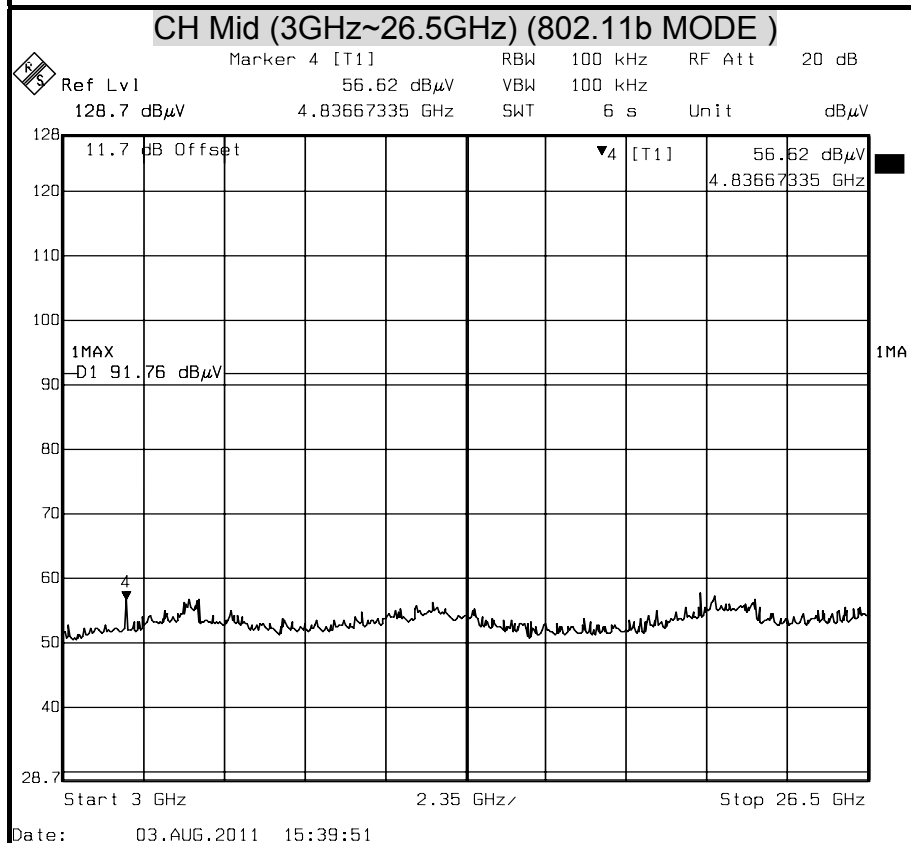
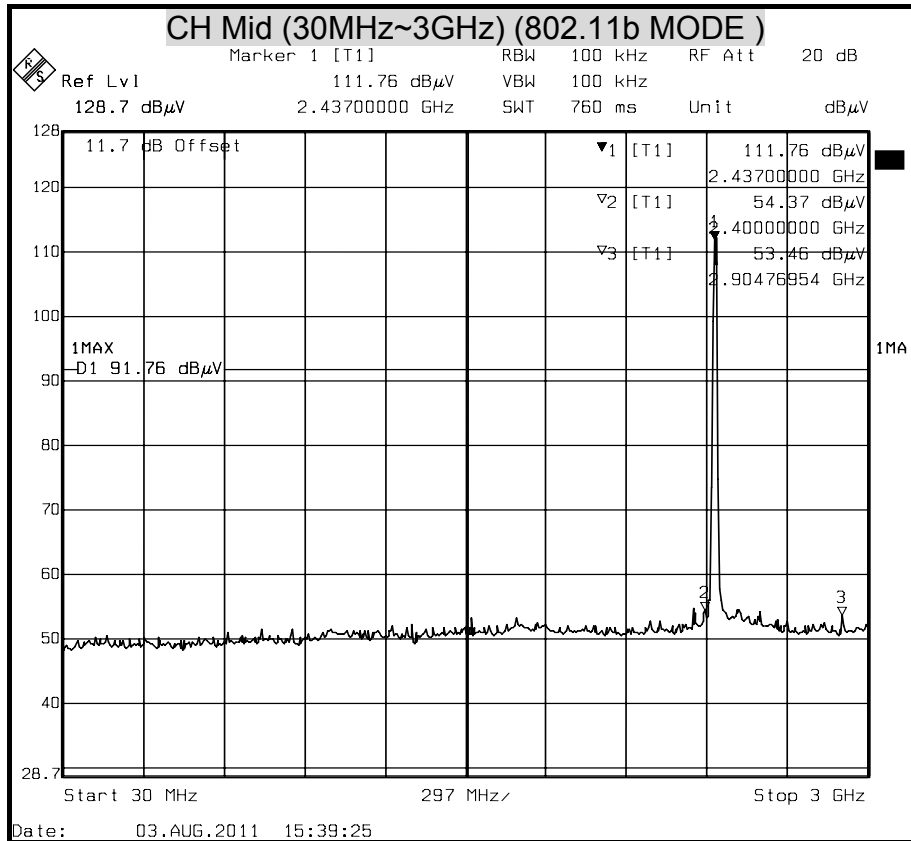

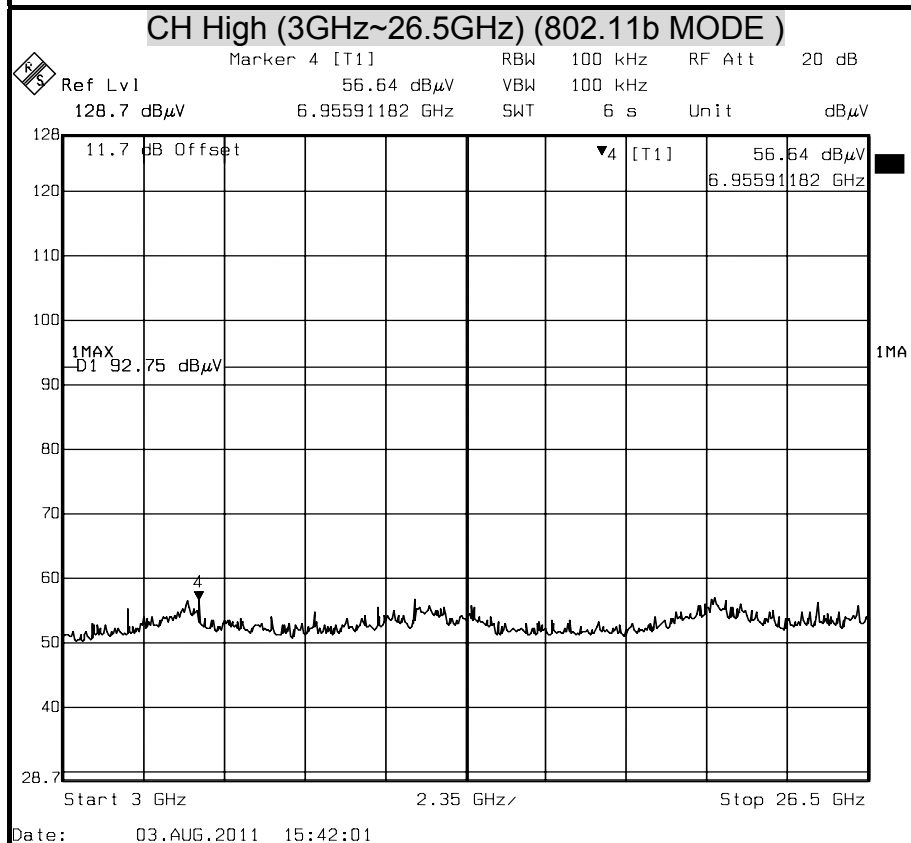
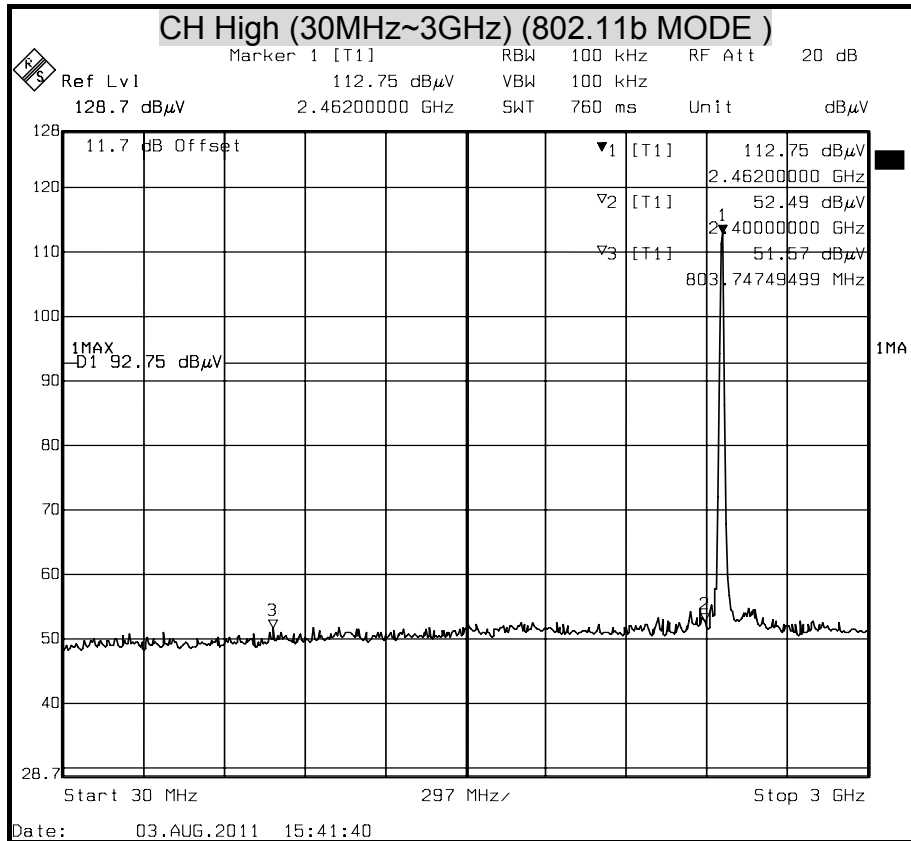

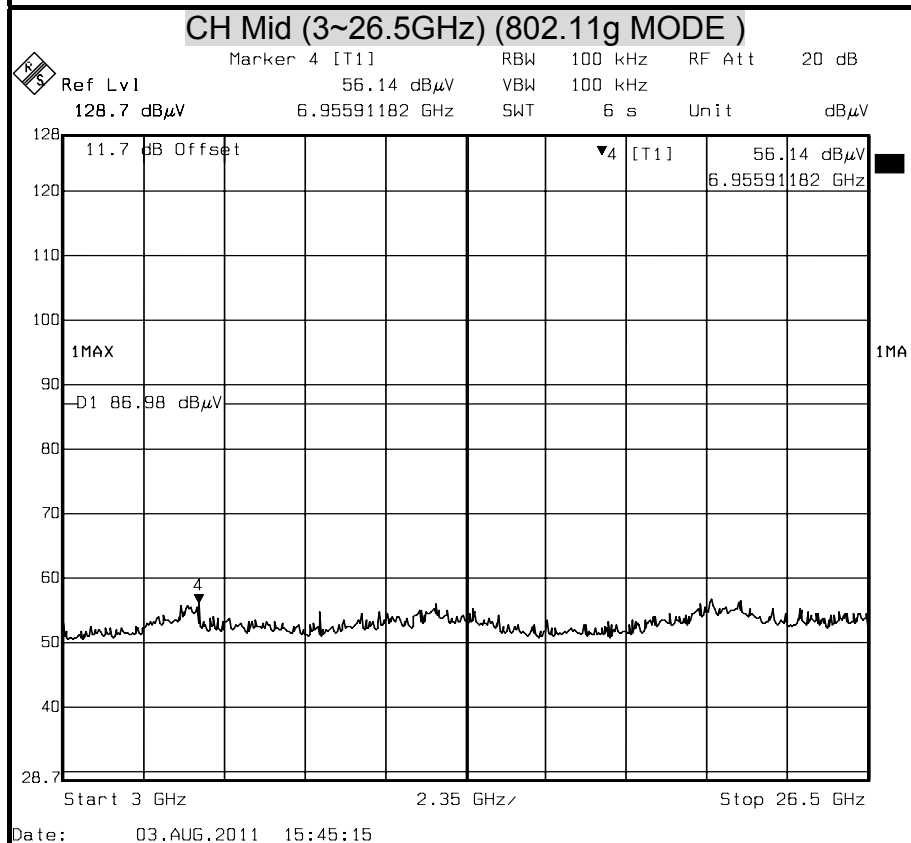
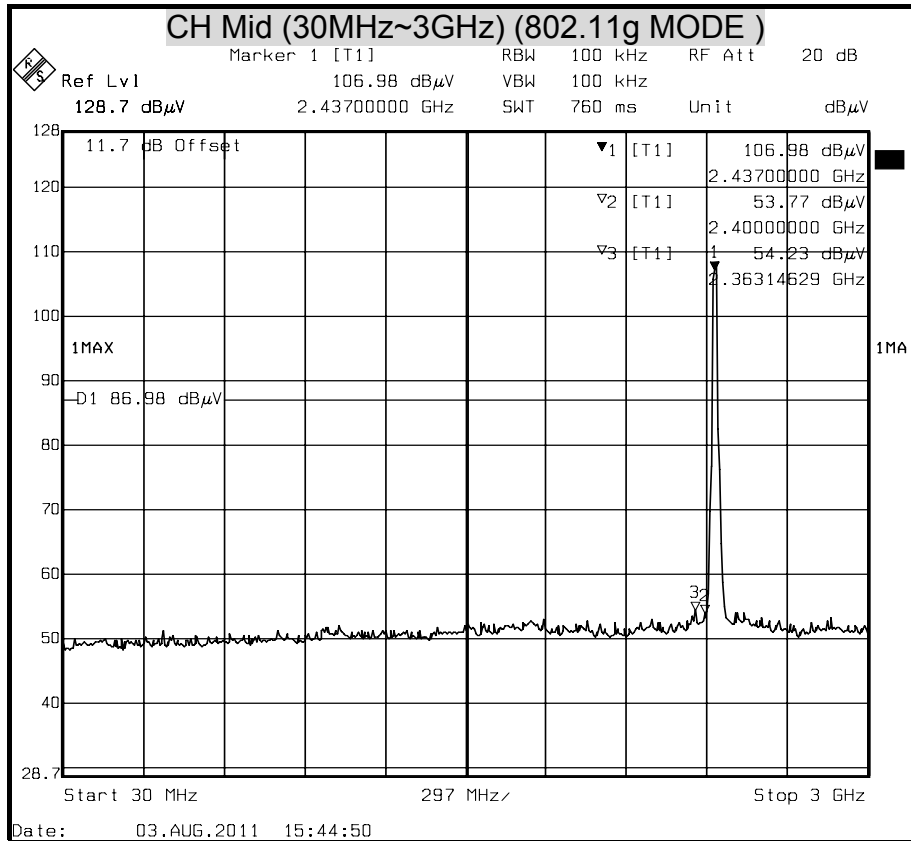

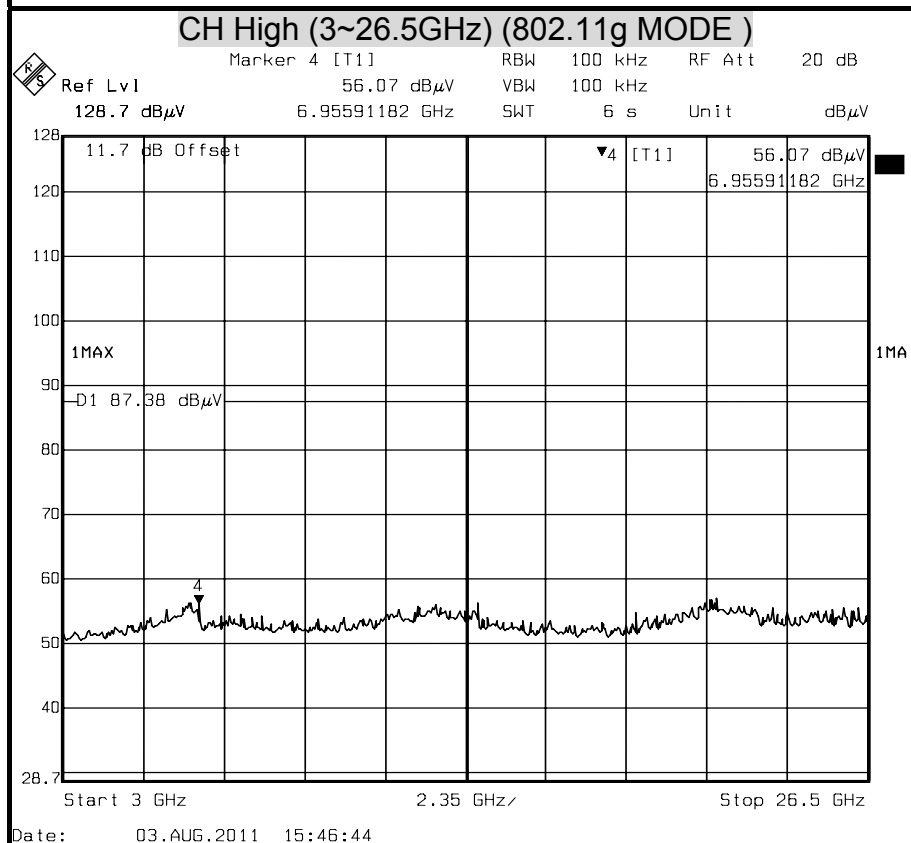
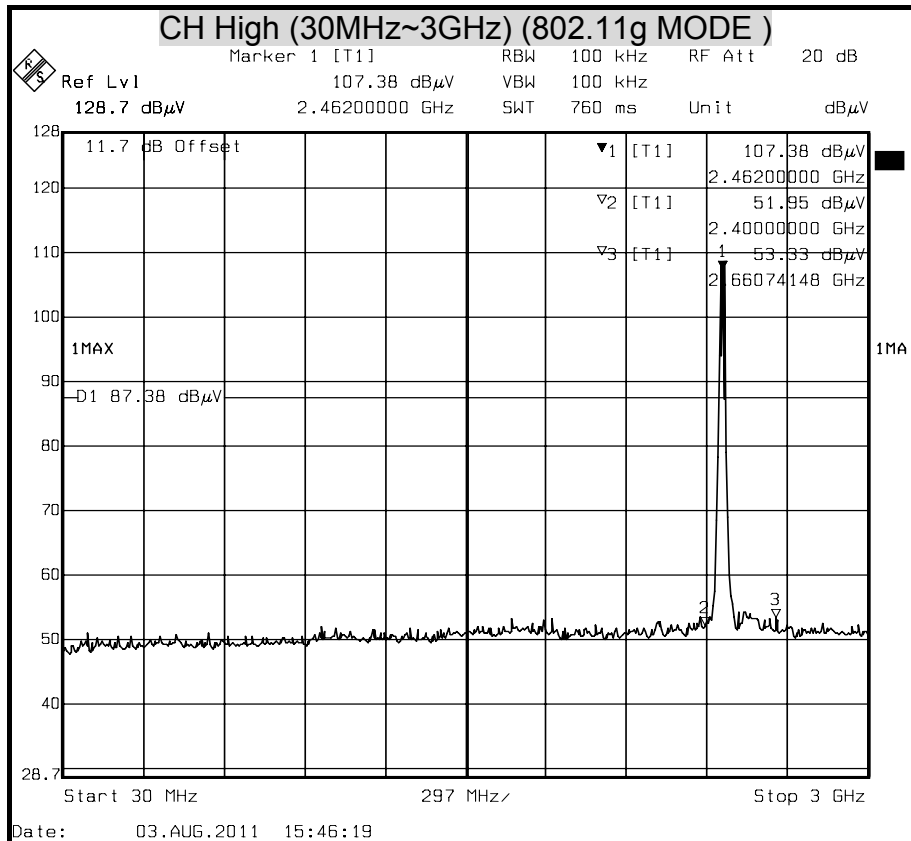

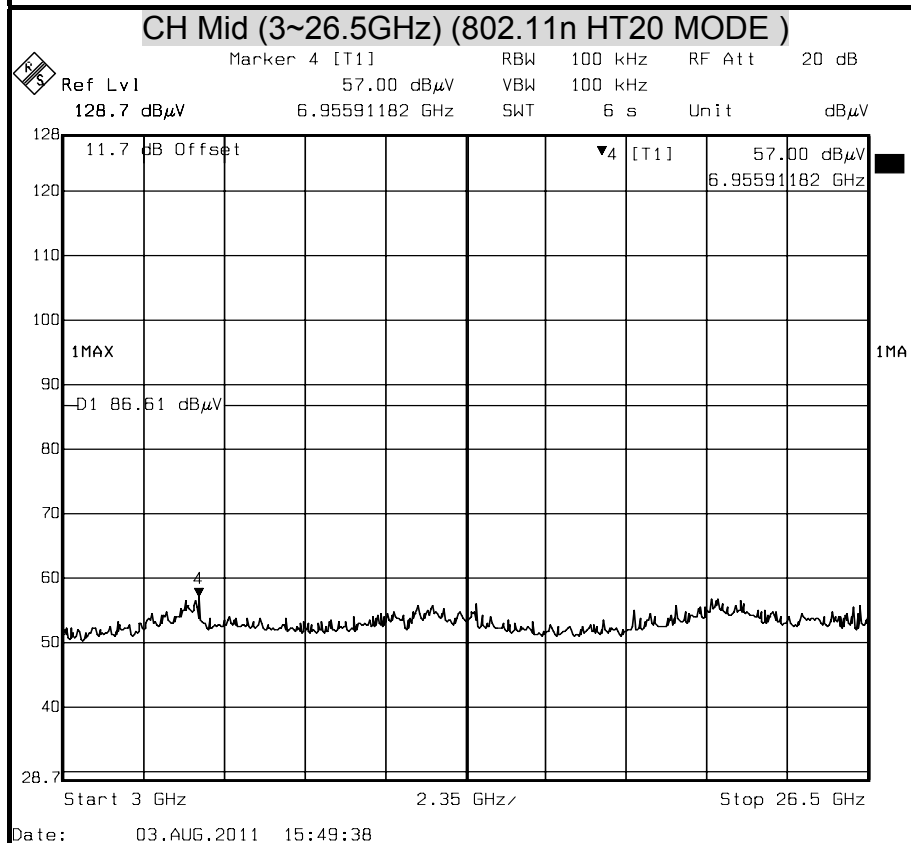
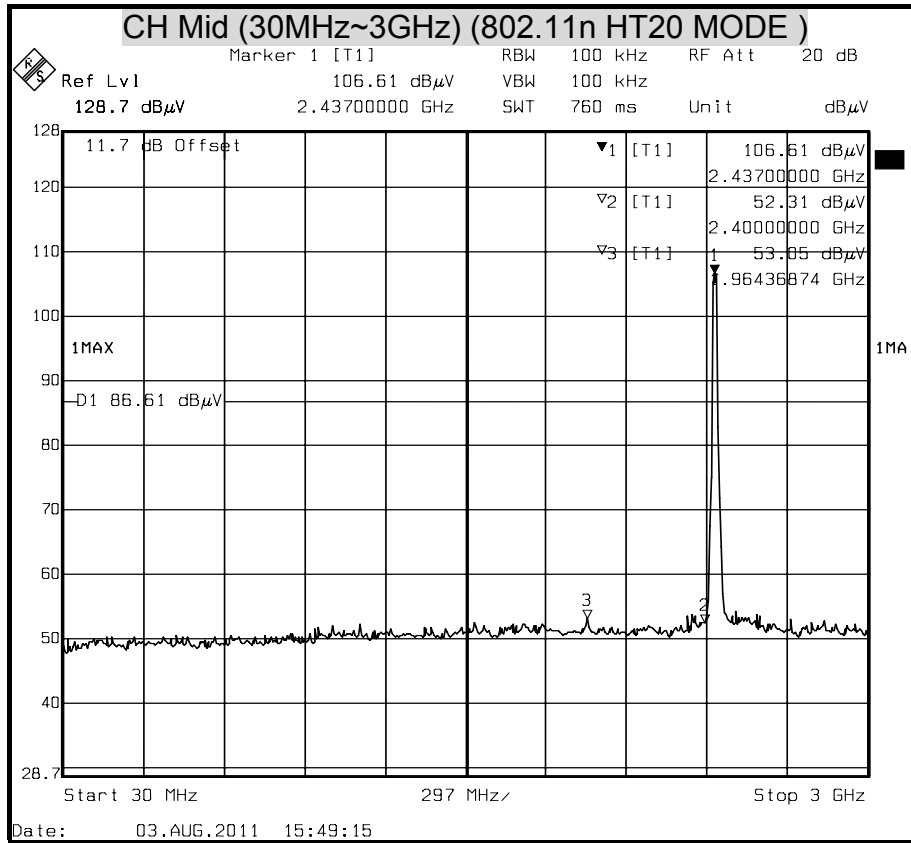

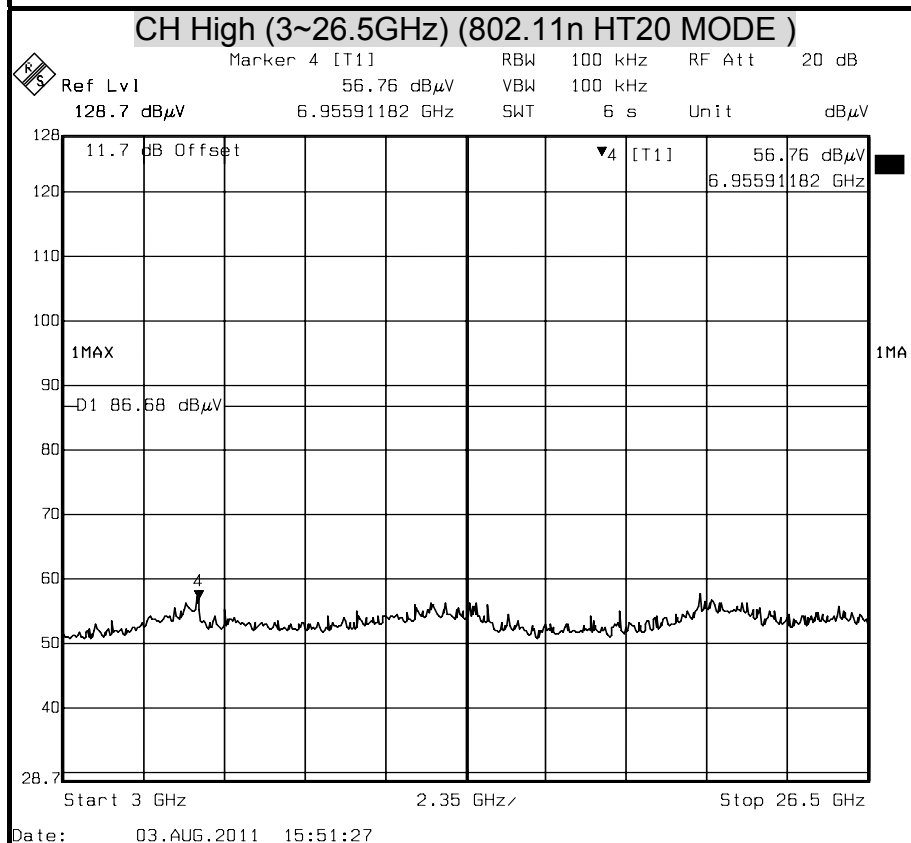
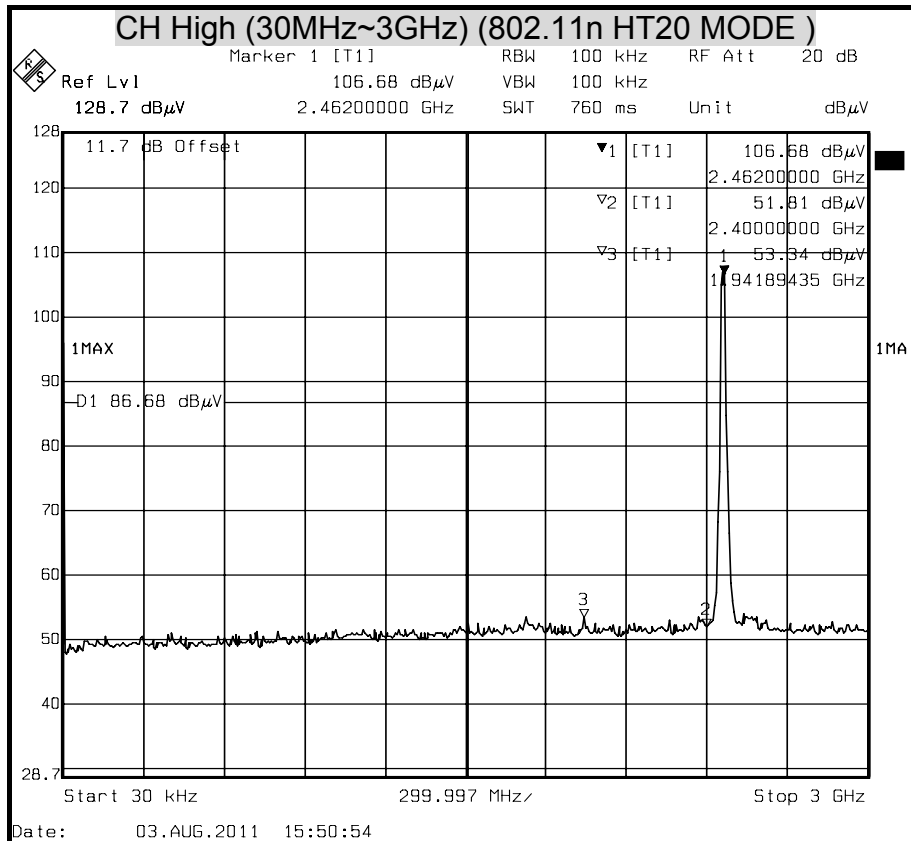



OUT-OF-BAND SPURIOUS EMISSIONS-CONDUCTED MEASUREMENT

(802.11n HT40 MODE)

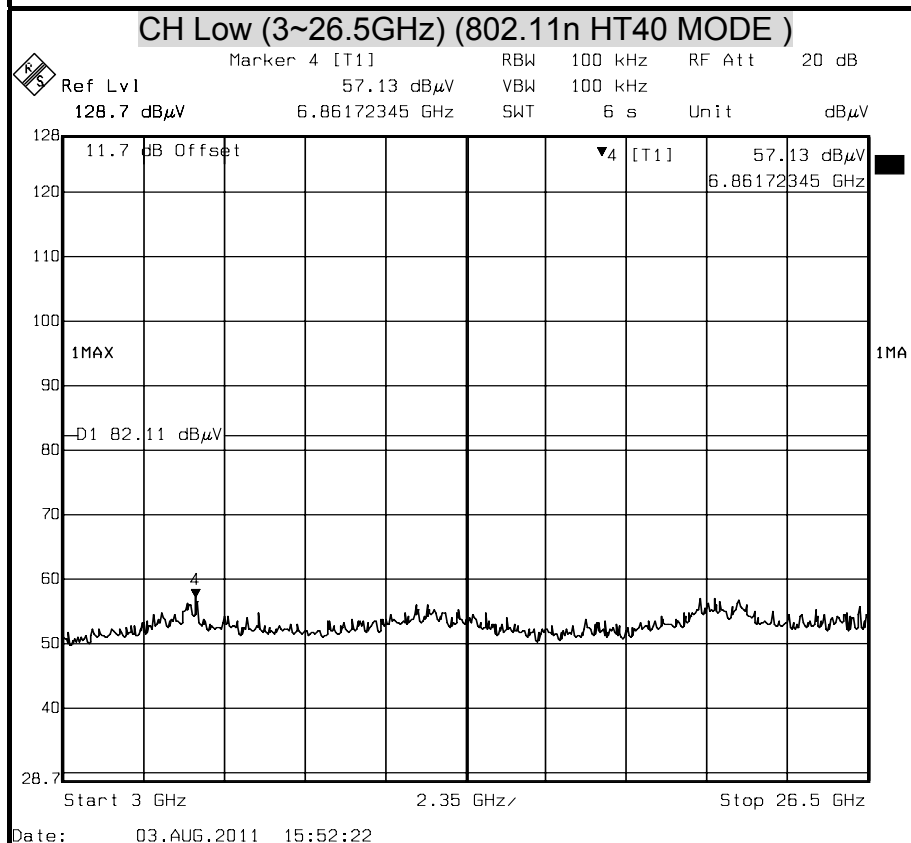
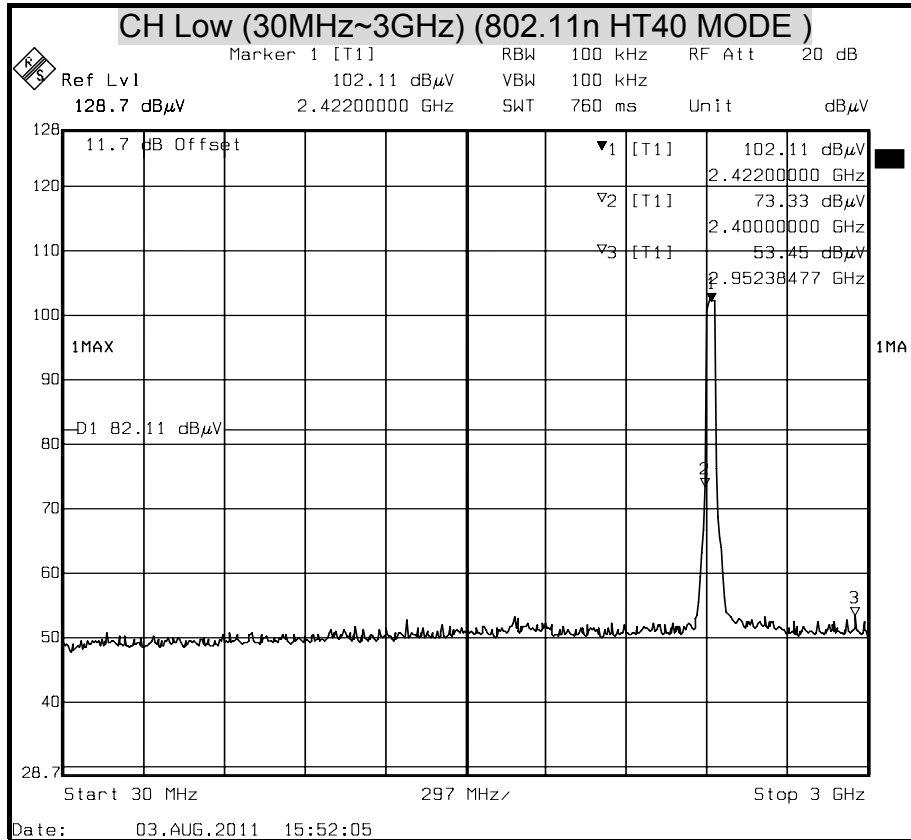

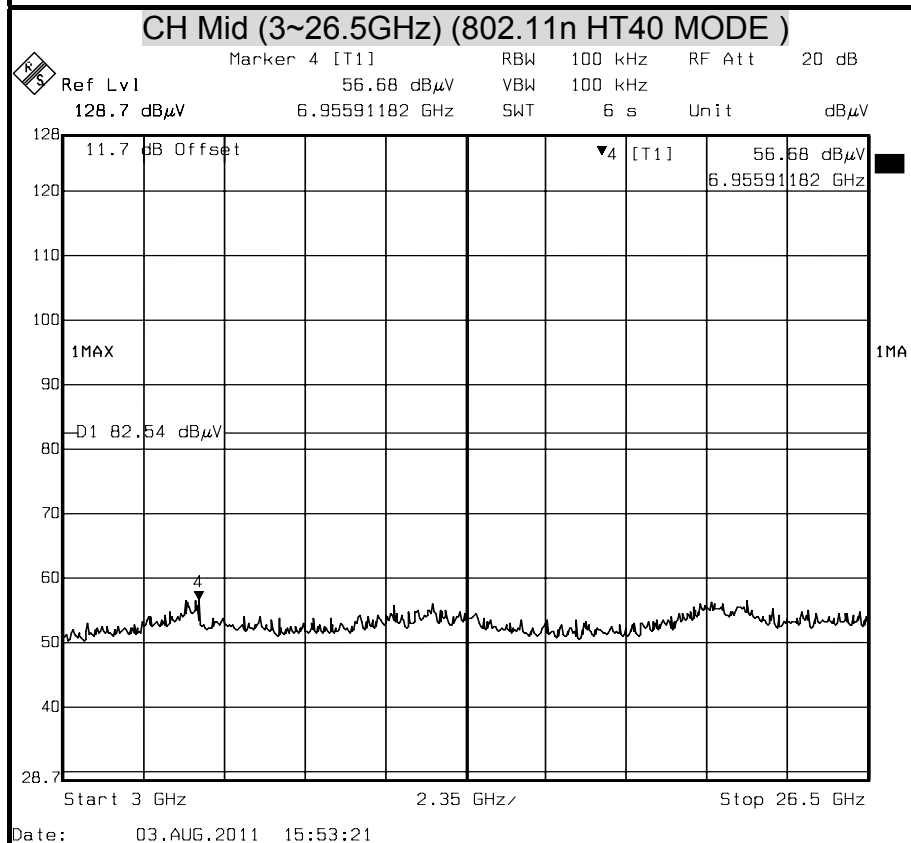
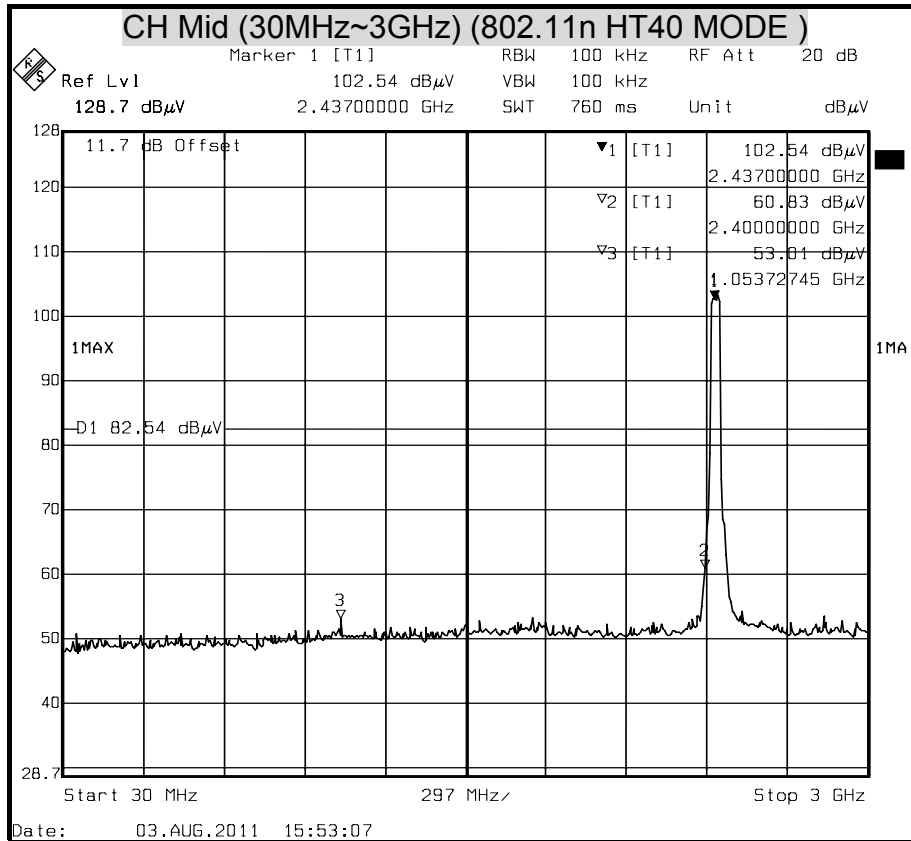

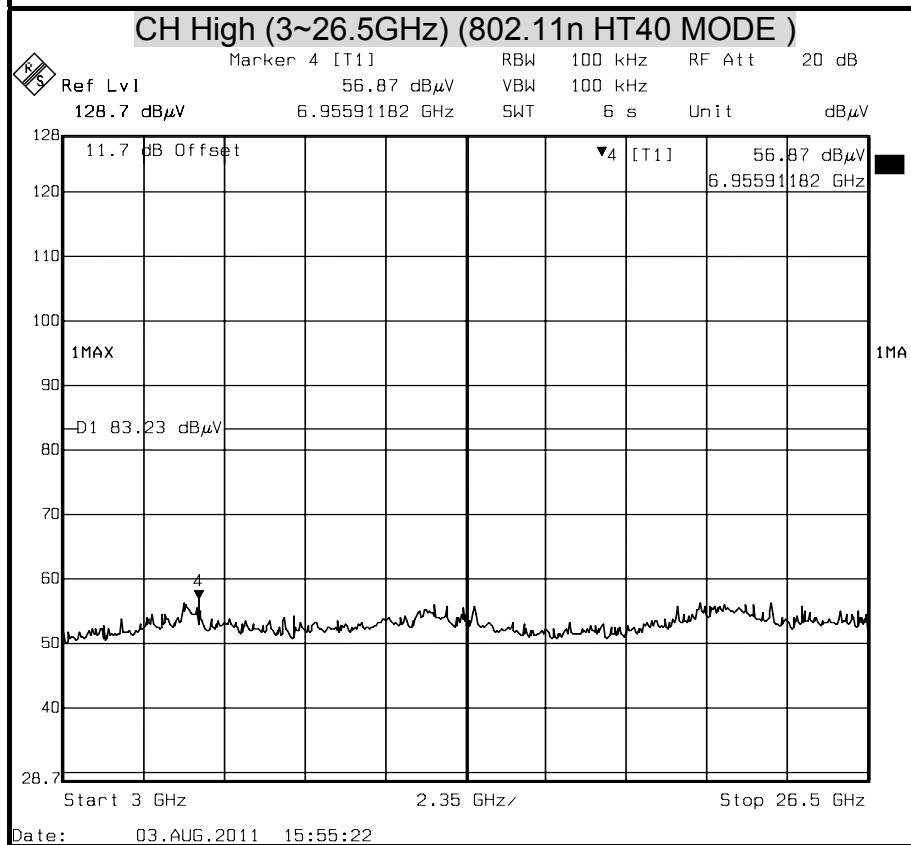
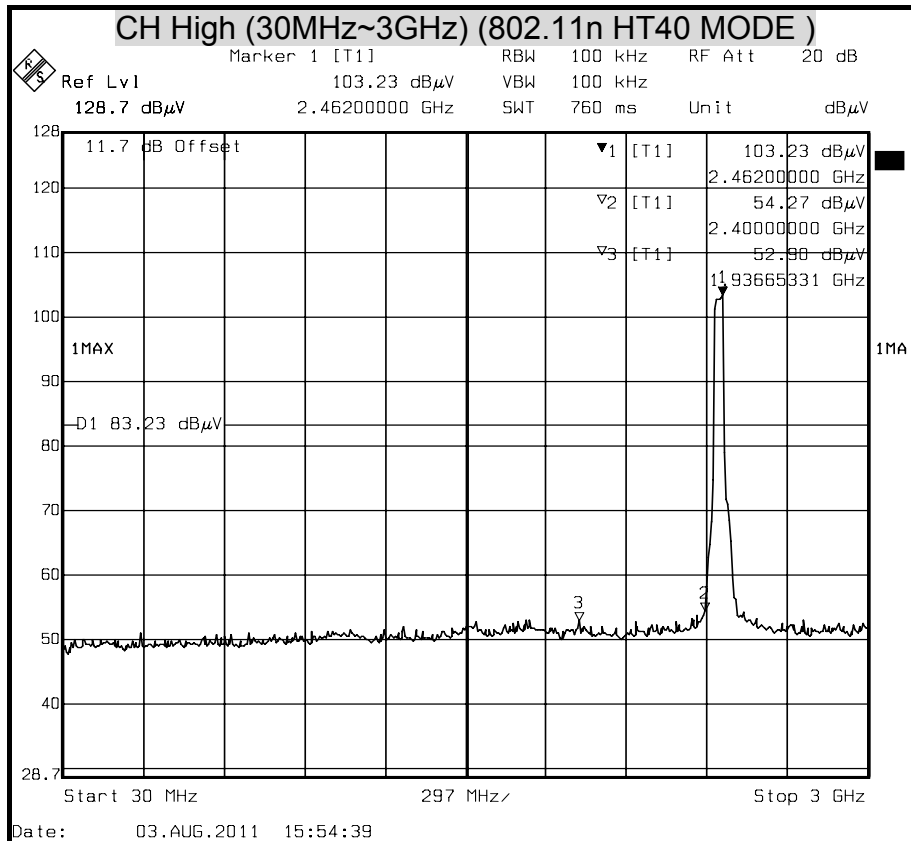



8.6 RADIATED EMISSIONS

8.6.1 TRANSMITTER RADIATED SUPURIOUS EMSSIONS

LIMITS

§ 15.205 (a) Except as shown in paragraph (d) of this section, only spurious emissions are permitted in any of the frequency bands listed below:

MHz	MHz	MHz	GHz
0.090 - 0.110	16.42 - 16.423	399.9 - 410	4.5 - 5.15
¹ 0.495 - 0.505	16.69475 - 16.69525	608 - 614	5.35 - 5.46
2.1735 - 2.1905	16.80425 - 16.80475	960 - 1240	7.25 - 7.75
4.125 - 4.128	25.5 - 25.67	1300 - 1427	8.025 - 8.5
4.17725 - 4.17775	37.5 - 38.25	1435 - 1626.5	9.0 - 9.2
4.20725 - 4.20775	73 - 74.6	1645.5 - 1646.5	9.3 - 9.5
6.215 - 6.218	74.8 - 75.2	1660 -1710	10.6 -12.7
6.26775 - 6.26825	108 -121.94	1718.8 - 1722.2	13.25 -13.4
6.31175 - 6.31225	123 - 138	2200 - 2300	14.47 – 14.5
8.291 - 8.294	149.9 - 150.05	2310 - 2390	15.35 -16.2
8.362 - 8.366	156.52475 - 156.52525	2483.5 - 2500	17.7 - 21.4
8.37625 - 8.38675	156.7 - 156.9	2655 - 2900	22.01 - 23.12
8.41425 - 8.41475	162.0125 - 167.17	3260 - 3267	23.6 - 24.0
12.29 - 12.293	167.72 - 173.2	3332 - 3339	31.2 - 31.8
12.51975 - 12.52025	240 - 285	3345.8 - 3338	36.43 - 36.5
12.57675 - 12.57725	322 -335.4	3600 - 4400	(²)
13.36 - 13.41			

¹ Until February 1, 1999, this restricted band shall be 0.490-0.510 MHz.

² Above 38.6

§ 15.205 (b) Except as provided in paragraphs (d) and (e), the field strength of emissions appearing within these frequency bands shall not exceed the limits shown in Section 15.209. At frequencies equal to or less than 1000 MHz, compliance with the limits in Section 15.209 shall be demonstrated using measurement instrumentation employing a CISPR quasi-peak detector. Above 1000 MHz, compliance with the emission limits in Section 15.209 shall be demonstrated based on the average value of the measured emissions. The provisions in Section 15.35 apply to these measurements.



§ 15.209 (a) Except as provided elsewhere in this Subpart, the emissions from an intentional radiator shall not exceed the field strength levels specified in the following table :

Frequency (MHz)	Field Strength (microvolts/meter)	Measurement Distance (meters)
30 - 88	100 **	3
88 - 216	150 **	3
216 - 960	200 **	3
Above 960	500	3

** Except as provided in paragraph (g), fundamental emissions from intentional radiators operating under this Section shall not be located in the frequency bands 54-72 MHz, 76-88 MHz, 174-216 MHz or 470-806 MHz, However, operation within these frequency bands is permitted under other sections of this Part, e-g, Sections 15.231 and 15.241.

§ 15.209 (b) In the emission table above, the tighter limit applies at the band edges.

TEST EQUIPMENTS

The following test equipments are utilized in making the measurements contained in this report.

Open Area Test Site # 6				
Name of Equipment	Manufacturer	Model	Serial Number	Calibration Due
TYPE N COAXIAL CABLE	SUHNER	CHA9513	6	NOV. 17, 2011
BI-LOG Antenna	Sunol	JB1	A070506-2	OCT. 04, 2012
LOOP ANTENNA	EMCO	6502	8905-2356	JUN. 10, 2012
Pre-Amplifier	HP	8447F	2944A03817	NOV. 23, 2011
EMI Receiver	R&S	ESVS10	833206/012	MAY 10, 2012
RF Cable	SUHNER	SUCOFLEX104PEA	20520/4PEA	NOV. 10, 2011
Horn Antenna	Com-Power	AH-118	071032	DEC. 27, 2011
Spectrum Analyzer	R&S	FSEK 30	835253/002	JUL. 14, 2012
Pre-Amplifier	MITEQ	AFS44-00108650-42-10P-44	1205908	NOV. 23, 2011
3116 Double Ridge Antenna (40G)	ETS-LINDGREN	EMCO-003	00078	NOV. 14, 2011
Turn Table	Yo Chen	001	-----	N.C.R.
Antenna Tower	AR	TP1000A	309874	N.C.R.
Controller	CT	SC101	-----	N.C.R.
RF Swich	E-INSTRUMENT TELH LTD	ERS-180A	EC1204141	N.C.R
Power Meter	Anritsu	ML2487A	6K00003888	MAY 30, 2012
Power Sensor	Anritsu	MA2491A	33265	MAY 30.2012
Temp./Humidity Chamber	K.SON	THS-M1	242	AUG. 09, 2012
Signal Generator	HP	8673C	2938A00663	SEP. 12, 2012
DC Power Source	LOKO	DSP-5050	L1507009282	N.C.R



TEST SETUP

The diagram below shows the test setup that is utilized to make the measurements for emission from 30 to 1GHz.

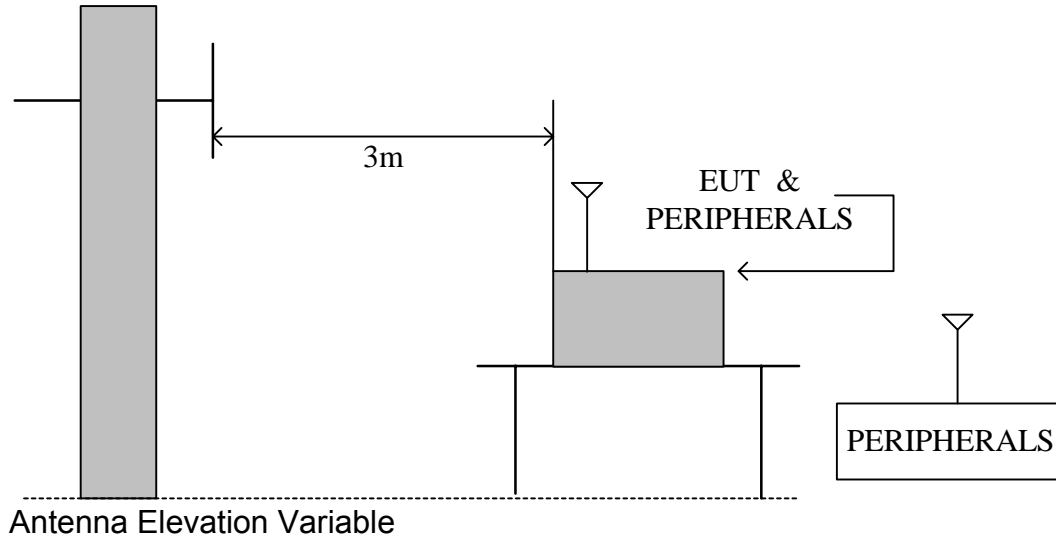

The diagram below shows the test setup that is utilized to make the measurements for emission above 1GHz.

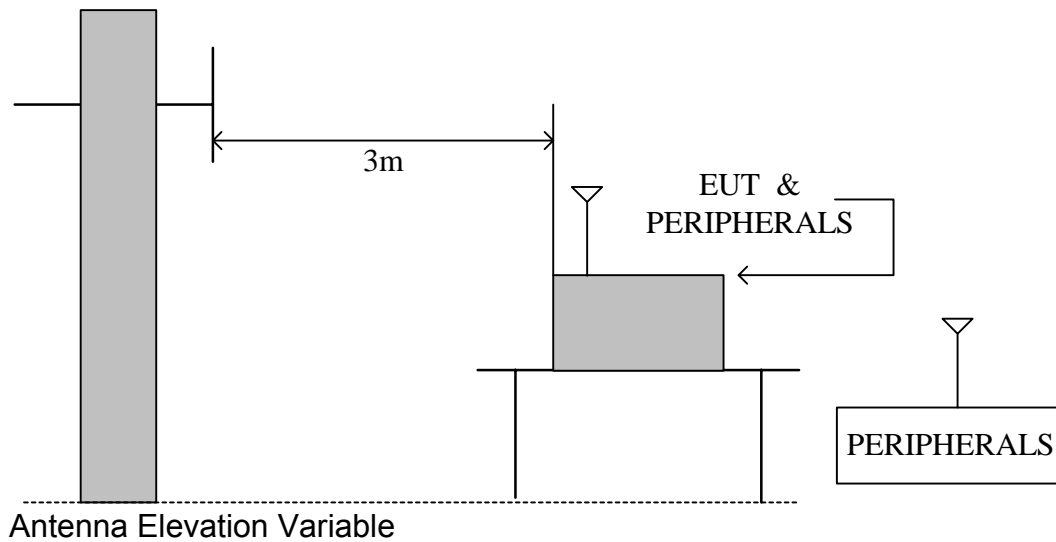



TEST PROCEDURE

- a. The EUT was placed on the top of a rotating table 0.8 meters above the ground at a 10 meter open area test site. The table was rotated 360 degrees to determine the position of the highest radiation.
- b. While measuring the radiated emission below 1GHz, the EUT was set 3 meters away from the interference-receiving antenna, which was mounted on the top of a variable-height antenna tower. While measuring the radiated emission above 1GHz, the EUT was set 3 meters away from the interference-receiving antenna
- c. The antenna is a broadband antenna, and its height is varied from one meter to four meters above the ground to determine the maximum value of the field strength. Both horizontal and vertical polarization of the antenna are set to make the measurement.
- d. For each suspected emission, the EUT was arranged to its worst case and then the antenna was tuned to heights from 1 meter to 4 meters and the table was turned from 0 degrees to 360 degrees to find the maximum reading.
- e. The test-receiver system was set to Peak Detect Function and Specified Bandwidth with Maximum Hold Mode.
- f. If the emission level of the EUT in peak mode was 10 dB lower than the limit specified, then testing could be stopped and the peak values of the EUT would be reported. Otherwise the emissions that did not have 10 dB margin would be re-tested one by one using peak, quasi-peak or average method as specified and then reported in a data sheet.

NOTE :

1. The resolution bandwidth and video bandwidth of test receiver/spectrum analyzer is 120 KHz for Peak detection (PK) and Quasi-peak detection (QP) at frequency below 1GHz.
2. The resolution bandwidth and video bandwidth of test receiver/spectrum analyzer is 1 MHz for Peak detection and frequency above 1GHz.
3. The resolution bandwidth of test receiver/spectrum analyzer is 1 MHz and the video bandwidth is 10 Hz for Average detection (AV) at frequency above 1GHz.
4. **No emission is found between lowest internal used/generated frequency to 30MHz (9kHz~30MHz)**

TEST RESULTS

No non-compliance noted.

**8.6.2 WORST-CASE RADIATED EMISSION BELOW 1 GHz**

Product Name	11n Wall Router	Test Date	2011/09/05
Model	WA982n	Test By	Taiyu Cyu
Test Mode	Normal Operation	TEMP& Humidity	31 , 60%

Horizontal

Freq.	Reading	Antenna	Cable	Measure	Limit	Over	Detector
MHz	Level	Factor	Loss	Level	dBuV/m	Limit	
	dBuV	dB/m	dB	dBuV/m	dBuV/m	dBuV/m	
83.25	5.52	7.72	2.06	15.30	30.00	-14.70	QP
124.30	1.47	13.91	2.66	18.04	30.00	-11.96	QP
156.25	6.06	12.31	3.14	21.52	30.00	-8.48	QP
312.50	6.07	13.80	4.60	24.47	37.00	-12.53	QP
468.75	8.06	17.48	5.85	31.39	37.00	-5.61	QP
625.00	4.75	19.18	6.97	30.90	37.00	-6.10	QP
781.25	4.63	21.09	8.06	33.79	37.00	-3.21	QP
937.48	1.50	22.78	9.18	33.46	37.00	-3.54	QP

Vertical

Freq.	Reading	Antenna	Cable	Measure	Limit	Over	Detector
MHz	Level	Factor	Loss	Level	dBuV/m	Limit	
	dBuV	dB/m	dB	dBuV/m	dBuV/m	dBuV/m	
69.40	14.52	7.96	1.90	24.38	30.00	-5.62	QP
85.50	15.96	7.72	2.10	25.78	30.00	-4.22	QP
121.55	11.03	14.06	2.62	27.70	30.00	-2.30	QP
156.25	10.70	12.31	3.14	26.16	30.00	-3.84	QP
312.50	6.72	13.80	4.60	25.12	37.00	-11.88	QP
468.75	3.20	17.48	5.85	26.53	37.00	-10.47	QP
625.00	6.35	19.18	6.97	32.50	37.00	-4.50	QP
781.25	4.12	21.09	8.06	33.28	37.00	-3.72	QP
937.48	1.35	22.78	9.18	33.31	37.00	-3.69	QP

REMARK: Emission level (dBuV/m) =Antenna Factor (dB/m) + Cable loss (dB) + Meter Reading (dBuV).



8.6.3 TRANSMITTER RADIATED EMISSION ABOVE 1 GHz

Product Name	11n Wall Router	Test Date	2011/08/25
Model	WA982n	Test By	John Chen
Test Mode	IEEE 802.11b TX (CH Low)	TEMP& Humidity	30.4 ,52%

Horizontal

TX / IEEE 802.11b mode / CH Low				Measurement Distance at 3m				Horizontal polarity	
Freq.	Reading	AF	Cable Loss	Pre-amp	Filter	Level	Limit	Margin	Mark
(MHz)	(dBμV)	(dB/m)	(dB)	(dB)	(dB)	(dBμV/m)	(dBμV/m)	(dB)	(P/Q/A)
* 1562.66	60.16	27.08	2.20	41.63	0.82	48.63	74.00	-25.37	P
* 1562.66	51.79	27.08	2.20	41.63	0.82	40.26	54.00	-13.74	A
* 4824.02	57.94	33.17	3.73	42.38	0.69	53.15	74.00	-20.85	P
* 4824.02	54.02	33.17	3.73	42.38	0.69	49.23	54.00	-4.77	A
N/A	-----	-----	-----	-----	-----	-----	-----	-----	P
N/A	-----	-----	-----	-----	-----	-----	-----	-----	A

Product Name	11n Wall Router	Test Date	2011/08/25
Model	WA982n	Test By	John Chen
Test Mode	IEEE 802.11b TX (CH Low)	TEMP& Humidity	30.4 ,52%

Vertical

TX / IEEE 802.11b mode / CH Low				Measurement Distance at 3m				Vertical polarity	
Freq.	Reading	AF	Cable Loss	Pre-amp	Filter	Level	Limit	Margin	Mark
(MHz)	(dBμV)	(dB/m)	(dB)	(dB)	(dB)	(dBμV/m)	(dBμV/m)	(dB)	(P/Q/A)
* 1562.56	58.83	27.08	2.20	41.63	0.82	47.30	74.00	-26.70	P
* 1562.56	50.68	27.08	2.20	41.63	0.82	39.15	54.00	-14.85	A
* 4824.02	58.25	33.17	3.73	42.38	0.69	53.46	74.00	-20.54	P
* 4824.02	54.35	33.17	3.73	42.38	0.69	49.56	54.00	-4.44	A
N/A	-----	-----	-----	-----	-----	-----	-----	-----	P
N/A	-----	-----	-----	-----	-----	-----	-----	-----	A

REMARK:

1. AF: Antenna Factor, Cable: Cable Loss, Pre-Amp: Preamplifier gain, Filter: Band-rejection Filter Insertion Loss
2. Spectrum analyzer setting P(Peak): RBW=1MHz, VBW=1MHz, A(Average): RBW=1MHz, VBW=10Hz
3. The result basic equation calculation is as follow:
Level = Reading + AF + Cable – Preamp + Filter – Dist, Margin = Level-Limit
4. The other emission levels were 20dB below the limit
5. The test limit distance is 3M limit.



Product Name	11n Wall Router	Test Date	2011/08/25
Model	WA982n	Test By	John Chen
Test Mode	IEEE 802.11b TX (CH Middle)	TEMP& Humidity	30.4 ,52%

Horizontal

TX / IEEE 802.11b mode / CH Middle				Measurement Distance at 3m				Horizontal polarity	
Freq.	Reading	AF	Cable Loss	Pre-amp	Filter	Level	Limit	Margin	Mark
(MHz)	(dBμV)	(dB/m)	(dB)	(dB)	(dB)	(dBμV/m)	(dBμV/m)	(dB)	(P/Q/A)
* 1562.63	61.23	27.08	2.20	41.63	0.82	49.70	74.00	-24.30	P
* 1562.63	52.01	27.08	2.20	41.63	0.82	40.48	54.00	-13.52	A
* 4874.05	58.23	33.32	3.74	42.43	0.71	53.57	74.00	-20.43	P
* 4874.05	54.19	33.32	3.74	42.43	0.71	49.53	54.00	-4.47	A
N/A	-----	-----	-----	-----	-----	-----	-----	-----	P
N/A	-----	-----	-----	-----	-----	-----	-----	-----	A

Product Name	11n Wall Router	Test Date	2011/08/25
Model	WA982n	Test By	John Chen
Test Mode	IEEE 802.11b TX (CH Middle)	TEMP& Humidity	30.4 ,52%

Vertical

TX / IEEE 802.11b mode / CH Middle				Measurement Distance at 3m				Vertical polarity	
Freq.	Reading	AF	Cable Loss	Pre-amp	Filter	Level	Limit	Margin	Mark
(MHz)	(dBμV)	(dB/m)	(dB)	(dB)	(dB)	(dBμV/m)	(dBμV/m)	(dB)	(P/Q/A)
* 1562.49	58.99	27.07	2.20	41.63	0.82	47.46	74.00	-26.54	P
* 1562.49	50.74	27.07	2.20	41.63	0.82	39.21	54.00	-14.79	A
* 4874.08	58.54	33.32	3.74	42.43	0.71	53.89	74.00	-20.11	P
* 4874.08	54.62	33.32	3.74	42.43	0.71	49.97	54.00	-4.03	A
N/A	-----	-----	-----	-----	-----	-----	-----	-----	P
N/A	-----	-----	-----	-----	-----	-----	-----	-----	A

REMARK:

1. AF: Antenna Factor, Cable: Cable Loss, Pre-Amp: Preamplifier gain, Filter: Band-rejection Filter Insertion Loss
2. Spectrum analyzer setting P(Peak): RBW=1MHz, VBW=1MHz, A(Average): RBW=1MHz, VBW=10Hz
3. The result basic equation calculation is as follow:
Level = Reading + AF + Cable – Preamp + Filter – Dist, Margin = Level-Limit
4. The other emission levels were 20dB below the limit
5. The test limit distance is 3M limit.



Product Name	11n Wall Router	Test Date	2011/08/25
Model	WA982n	Test By	John Chen
Test Mode	IEEE 802.11b TX (CH High)	TEMP& Humidity	30.4 ,52%

Horizontal

TX / IEEE 802.11b mode / CH High				Measurement Distance at 3m				Horizontal polarity	
Freq.	Reading	AF	Cable Loss	Pre-amp	Filter	Level	Limit	Margin	Mark
(MHz)	(dBμV)	(dB/m)	(dB)	(dB)	(dB)	(dBμV/m)	(dBμV/m)	(dB)	(P/Q/A)
* 1562.63	60.34	27.08	2.20	41.63	0.82	48.81	74.00	-25.19	P
* 1562.63	52.00	27.08	2.20	41.63	0.82	40.47	54.00	-13.53	A
* 4924.00	58.83	33.47	3.76	42.48	0.73	54.31	74.00	-19.69	P
* 4924.00	54.77	33.47	3.76	42.48	0.73	50.25	54.00	-3.75	A
N/A	-----	-----	-----	-----	-----	-----	-----	-----	P
N/A	-----	-----	-----	-----	-----	-----	-----	-----	A

Product Name	11n Wall Router	Test Date	2011/08/25
Model	WA982n	Test By	John Chen
Test Mode	IEEE 802.11b TX (CH High)	TEMP& Humidity	30.4 ,52%

Vertical

TX / IEEE 802.11b mode / CH High				Measurement Distance at 3m				Vertical polarity	
Freq.	Reading	AF	Cable Loss	Pre-amp	Filter	Level	Limit	Margin	Mark
(MHz)	(dBμV)	(dB/m)	(dB)	(dB)	(dB)	(dBμV/m)	(dBμV/m)	(dB)	(P/Q/A)
* 1562.55	59.24	27.08	2.20	41.63	0.82	47.71	74.00	-26.29	P
* 1562.55	50.87	27.08	2.20	41.63	0.82	39.34	54.00	-14.66	A
* 4824.01	59.02	33.17	3.73	42.38	0.69	54.23	74.00	-19.77	P
* 4824.01	54.90	33.17	3.73	42.38	0.69	50.11	54.00	-3.89	A
N/A	-----	-----	-----	-----	-----	-----	-----	-----	P
N/A	-----	-----	-----	-----	-----	-----	-----	-----	A

REMARK:

1. AF: Antenna Factor, Cable: Cable Loss, Pre-Amp: Preamplifier gain, Filter: Band-rejection Filter Insertion Loss
2. Spectrum analyzer setting P(Peak): RBW=1MHz, VBW=1MHz, A(Average): RBW=1MHz, VBW=10Hz
3. The result basic equation calculation is as follow:
Level = Reading + AF + Cable – Preamp + Filter – Dist, Margin = Level-Limit
4. The other emission levels were 20dB below the limit
5. The test limit distance is 3M limit.



Product Name	11n Wall Router	Test Date	2011/08/25
Model	WA982n	Test By	John Chen
Test Mode	IEEE 802.11g TX (CH Low)	TEMP& Humidity	30.4 ,52%

Horizontal

TX / IEEE 802.11g mode / CH Low				Measurement Distance at 3m				Horizontal polarity	
Freq.	Reading	AF	Cable Loss	Pre-amp	Filter	Level	Limit	Margin	Mark
(MHz)	(dB μ V)	(dB/m)	(dB)	(dB)	(dB)	(dB μ V/m)	(dB μ V/m)	(dB)	(P/Q/A)
* 1562.60	60.23	27.08	2.20	41.63	0.82	48.70	74.00	-25.30	P
* 1562.60	51.27	27.08	2.20	41.63	0.82	39.74	54.00	-14.26	A
* 4824.04	56.10	33.17	3.73	42.38	0.69	51.31	74.00	-22.69	P
* 4824.04	43.48	33.17	3.73	42.38	0.69	38.69	54.00	-15.31	A
N/A	-----	-----	-----	-----	-----	-----	-----	-----	P
N/A	-----	-----	-----	-----	-----	-----	-----	-----	A

Product Name	11n Wall Router	Test Date	2011/08/25
Model	WA982n	Test By	John Chen
Test Mode	IEEE 802.11g TX (CH Low)	TEMP& Humidity	30.4 ,52%

Vertical

TX / IEEE 802.11g mode / CH Low				Measurement Distance at 3m				Vertical polarity	
Freq.	Reading	AF	Cable Loss	Pre-amp	Filter	Level	Limit	Margin	Mark
(MHz)	(dB μ V)	(dB/m)	(dB)	(dB)	(dB)	(dB μ V/m)	(dB μ V/m)	(dB)	(P/Q/A)
* 1562.63	58.83	27.08	2.20	41.63	0.82	47.30	74.00	-26.70	P
* 1562.63	50.68	27.08	2.20	41.63	0.82	39.15	54.00	-14.85	A
* 4824.08	58.47	33.17	3.73	42.38	0.69	53.68	74.00	-20.32	P
* 4824.08	45.28	33.17	3.73	42.38	0.69	40.49	54.00	-13.51	A
N/A	-----	-----	-----	-----	-----	-----	-----	-----	P
N/A	-----	-----	-----	-----	-----	-----	-----	-----	A

REMARK:

1. AF: Antenna Factor, Cable: Cable Loss, Pre-Amp: Preamplifier gain, Filter: Band-rejection Filter Insertion Loss
2. Spectrum analyzer setting P(Peak): RBW=1MHz, VBW=1MHz, A(Average): RBW=1MHz, VBW=10Hz
3. The result basic equation calculation is as follow:
Level = Reading + AF + Cable – Preamp + Filter – Dist, Margin = Level-Limit
4. The other emission levels were 20dB below the limit
5. The test limit distance is 3M limit.



Product Name	11n Wall Router	Test Date	2011/08/25
Model	WA982n	Test By	John Chen
Test Mode	IEEE 802.11g TX (CH Middle)	TEMP& Humidity	30.4 ,52%

Horizontal

TX / IEEE 802.11g mode / CH Middle				Measurement Distance at 3m				Horizontal polarity	
Freq.	Reading	AF	Cable Loss	Pre-amp	Filter	Level	Limit	Margin	Mark
(MHz)	(dBμV)	(dB/m)	(dB)	(dB)	(dB)	(dBμV/m)	(dBμV/m)	(dB)	(P/Q/A)
* 1562.67	60.57	27.08	2.20	41.63	0.82	49.04	74.00	-24.96	P
* 1562.67	51.24	27.08	2.20	41.63	0.82	39.71	54.00	-14.29	A
* 4874.10	56.70	33.32	3.74	42.43	0.71	52.05	74.00	-21.95	P
* 4874.10	43.61	33.32	3.74	42.43	0.71	38.96	54.00	-15.04	A
N/A	-----	-----	-----	-----	-----	-----	-----	-----	P
N/A	-----	-----	-----	-----	-----	-----	-----	-----	A

Product Name	11n Wall Router	Test Date	2011/08/25
Model	WA982n	Test By	John Chen
Test Mode	IEEE 802.11g TX (CH Middle)	TEMP& Humidity	30.4 ,52%

Vertical

TX / IEEE 802.11g mode / CH Middle				Measurement Distance at 3m				Vertical polarity	
Freq.	Reading	AF	Cable Loss	Pre-amp	Filter	Level	Limit	Margin	Mark
(MHz)	(dBμV)	(dB/m)	(dB)	(dB)	(dB)	(dBμV/m)	(dBμV/m)	(dB)	(P/Q/A)
* 1562.47	58.26	27.07	2.20	41.63	0.82	46.73	74.00	-27.27	P
* 1562.47	50.14	27.07	2.20	41.63	0.82	38.61	54.00	-15.39	A
* 4874.08	58.69	33.32	3.74	42.43	0.71	54.04	74.00	-19.96	P
* 4874.08	45.57	33.32	3.74	42.43	0.71	40.92	54.00	-13.08	A
N/A	-----	-----	-----	-----	-----	-----	-----	-----	P
N/A	-----	-----	-----	-----	-----	-----	-----	-----	A

REMARK:

1. AF: Antenna Factor, Cable: Cable Loss, Pre-Amp: Preamplifier gain, Filter: Band-rejection Filter Insertion Loss
2. Spectrum analyzer setting P(Peak): RBW=1MHz, VBW=1MHz, A(Average): RBW=1MHz, VBW=10Hz
3. The result basic equation calculation is as follow:
Level = Reading + AF + Cable – Preamp + Filter – Dist, Margin = Level-Limit
4. The other emission levels were 20dB below the limit
5. The test limit distance is 3M limit.



Product Name	11n Wall Router	Test Date	2011/08/25
Model	WA982n	Test By	John Chen
Test Mode	IEEE 802.11g TX (CH High)	TEMP& Humidity	30.4 ,52%

Horizontal

TX / IEEE 802.11g mode / CH High				Measurement Distance at 3m				Horizontal polarity	
Freq.	Reading	AF	Cable Loss	Pre-amp	Filter	Level	Limit	Margin	Mark
(MHz)	(dBμV)	(dB/m)	(dB)	(dB)	(dB)	(dBμV/m)	(dBμV/m)	(dB)	(P/Q/A)
* 1562.66	60.34	27.08	2.20	41.63	0.82	48.81	74.00	-25.19	P
* 1562.66	51.44	27.08	2.20	41.63	0.82	39.91	54.00	-14.09	A
* 4924.03	56.39	33.47	3.76	42.48	0.73	51.87	74.00	-22.13	P
* 4924.03	43.52	33.47	3.76	42.48	0.73	39.00	54.00	-15.00	A
N/A	-----	-----	-----	-----	-----	-----	-----	-----	P
N/A	-----	-----	-----	-----	-----	-----	-----	-----	A

Product Name	11n Wall Router	Test Date	2011/08/25
Model	WA982n	Test By	John Chen
Test Mode	IEEE 802.11g TX (CH High)	TEMP& Humidity	30.4 ,52%

Vertical

TX / IEEE 802.11g mode / CH High				Measurement Distance at 3m				Vertical polarity	
Freq.	Reading	AF	Cable Loss	Pre-amp	Filter	Level	Limit	Margin	Mark
(MHz)	(dBμV)	(dB/m)	(dB)	(dB)	(dB)	(dBμV/m)	(dBμV/m)	(dB)	(P/Q/A)
* 1562.54	58.72	27.08	2.20	41.63	0.82	47.19	74.00	-26.81	P
* 1562.54	50.66	27.08	2.20	41.63	0.82	39.13	54.00	-14.87	A
* 4924.07	59.00	33.47	3.76	42.48	0.73	54.48	74.00	-19.52	P
* 4924.07	45.26	33.47	3.76	42.48	0.73	40.74	54.00	-13.26	A
N/A	-----	-----	-----	-----	-----	-----	-----	-----	P
N/A	-----	-----	-----	-----	-----	-----	-----	-----	A

REMARK:

1. AF: Antenna Factor, Cable: Cable Loss, Pre-Amp: Preamplifier gain, Filter: Band-rejection Filter Insertion Loss
2. Spectrum analyzer setting P(Peak): RBW=1MHz, VBW=1MHz, A(Average): RBW=1MHz, VBW=10Hz
3. The result basic equation calculation is as follow:
Level = Reading + AF + Cable – Preamp + Filter – Dist, Margin = Level-Limit
4. The other emission levels were 20dB below the limit
5. The test limit distance is 3M limit.



Product Name	11n Wall Router	Test Date	2011/08/25
Model	WA982n	Test By	John Chen
Test Mode	IEEE 802.11n HT20 TX (CH Low)	TEMP& Humidity	30.4 ,52%

Horizontal

TX / IEEE 802.11n HT20 mode / CH Low				Measurement Distance at 3m				Horizontal polarity	
Freq.	Reading	AF	Cable Loss	Pre-amp	Filter	Level	Limit	Margin	Mark
(MHz)	(dBμV)	(dB/m)	(dB)	(dB)	(dB)	(dBμV/m)	(dBμV/m)	(dB)	(P/Q/A)
* 1562.58	60.14	27.08	2.20	41.63	0.82	48.61	74.00	-25.39	P
* 1562.58	50.98	27.08	2.20	41.63	0.82	39.45	54.00	-14.55	A
* 4824.07	55.53	33.17	3.73	42.38	0.69	50.74	74.00	-23.26	P
* 4824.07	43.01	33.17	3.73	42.38	0.69	38.22	54.00	-15.78	A
N/A	-----	-----	-----	-----	-----	-----	-----	-----	P
N/A	-----	-----	-----	-----	-----	-----	-----	-----	A

Product Name	11n Wall Router	Test Date	2011/08/25
Model	WA982n	Test By	John Chen
Test Mode	IEEE 802.11n HT20 TX (CH Low)	TEMP& Humidity	30.4 ,52%

Vertical

TX / IEEE 802.11n HT20 mode / CH Low				Measurement Distance at 3m				Vertical polarity	
Freq.	Reading	AF	Cable Loss	Pre-amp	Filter	Level	Limit	Margin	Mark
(MHz)	(dBμV)	(dB/m)	(dB)	(dB)	(dB)	(dBμV/m)	(dBμV/m)	(dB)	(P/Q/A)
* 1562.59	58.74	27.08	2.20	41.63	0.82	47.21	74.00	-26.79	P
* 1562.59	50.69	27.08	2.20	41.63	0.82	39.16	54.00	-14.84	A
* 4824.07	58.34	33.17	3.73	42.38	0.69	53.55	74.00	-20.45	P
* 4824.07	45.36	33.17	3.73	42.38	0.69	40.57	54.00	-13.43	A
N/A	-----	-----	-----	-----	-----	-----	-----	-----	P
N/A	-----	-----	-----	-----	-----	-----	-----	-----	A

REMARK:

1. AF: Antenna Factor, Cable: Cable Loss, Pre-Amp: Preamplifier gain, Filter: Band-rejection Filter Insertion Loss
2. Spectrum analyzer setting P(Peak): RBW=1MHz, VBW=1MHz, A(Average): RBW=1MHz, VBW=10Hz
3. The result basic equation calculation is as follow:
Level = Reading + AF + Cable – Preamp + Filter – Dist, Margin = Level-Limit
4. The other emission levels were 20dB below the limit
5. The test limit distance is 3M limit.



Product Name	11n Wall Router	Test Date	2011/06/08
Model	WA982n	Test By	John Chen
Test Mode	IEEE 802.11n HT20 TX (CH Middle)	TEMP& Humidity	30.4 ,52%

Horizontal

TX / IEEE 802.11n HT20 mode / CH Middle				Measurement Distance at 3m				Horizontal polarity	
Freq.	Reading	AF	Cable Loss	Pre-amp	Filter	Level	Limit	Margin	Mark
(MHz)	(dBμV)	(dB/m)	(dB)	(dB)	(dB)	(dBμV/m)	(dBμV/m)	(dB)	(P/Q/A)
* 1562.61	60.79	27.08	2.20	41.63	0.82	49.26	74.00	-24.74	P
* 1562.61	51.38	27.08	2.20	41.63	0.82	39.85	54.00	-14.15	A
* 4874.04	56.60	33.32	3.74	42.43	0.71	51.94	74.00	-22.06	P
* 4874.04	43.44	33.32	3.74	42.43	0.71	38.78	54.00	-15.22	A
N/A	-----	-----	-----	-----	-----	-----	-----	-----	P
N/A	-----	-----	-----	-----	-----	-----	-----	-----	A

Product Name	11n Wall Router	Test Date	2011/08/25
Model	WA982n	Test By	John Chen
Test Mode	IEEE 802.11n HT20 TX (CH Middle)	TEMP& Humidity	30.4 ,52%

Vertical

TX / IEEE 802.11n HT20 mode / CH Middle				Measurement Distance at 3m				Vertical polarity	
Freq.	Reading	AF	Cable Loss	Pre-amp	Filter	Level	Limit	Margin	Mark
(MHz)	(dBμV)	(dB/m)	(dB)	(dB)	(dB)	(dBμV/m)	(dBμV/m)	(dB)	(P/Q/A)
* 1562.48	58.36	27.07	2.20	41.63	0.82	46.83	74.00	-27.17	P
* 1562.48	50.24	27.07	2.20	41.63	0.82	38.71	54.00	-15.29	A
* 4874.06	58.54	33.32	3.74	42.43	0.71	53.88	74.00	-20.12	P
* 4874.06	45.26	33.32	3.74	42.43	0.71	40.60	54.00	-13.40	A
N/A	-----	-----	-----	-----	-----	-----	-----	-----	P
N/A	-----	-----	-----	-----	-----	-----	-----	-----	A

REMARK:

1. AF: Antenna Factor, Cable: Cable Loss, Pre-Amp: Preamplifier gain, Filter: Band-rejection Filter Insertion Loss
2. Spectrum analyzer setting P(Peak): RBW=1MHz, VBW=1MHz, A(Average): RBW=1MHz, VBW=10Hz
3. The result basic equation calculation is as follow:
Level = Reading + AF + Cable – Preamp + Filter – Dist, Margin = Level-Limit
4. The other emission levels were 20dB below the limit
5. The test limit distance is 3M limit.



Product Name	11n Wall Router	Test Date	2011/08/25
Model	WA982n	Test By	John Chen
Test Mode	IEEE 802.11n HT20 TX (CH High)	TEMP& Humidity	30.4 ,52%

Horizontal

TX / IEEE 802.11n HT20 mode / CH High				Measurement Distance at 3m				Horizontal polarity	
Freq.	Reading	AF	Cable Loss	Pre-amp	Filter	Level	Limit	Margin	Mark
(MHz)	(dBμV)	(dB/m)	(dB)	(dB)	(dB)	(dBμV/m)	(dBμV/m)	(dB)	(P/Q/A)
* 1562.69	60.98	27.08	2.20	41.63	0.82	49.45	74.00	-24.55	P
* 1562.69	51.67	27.08	2.20	41.63	0.82	40.14	54.00	-13.86	A
* 4924.08	56.17	33.47	3.76	42.48	0.73	51.65	74.00	-22.35	P
* 4924.08	43.35	33.47	3.76	42.48	0.73	38.83	54.00	-15.17	A
N/A	-----	-----	-----	-----	-----	-----	-----	-----	P
N/A	-----	-----	-----	-----	-----	-----	-----	-----	A

Product Name	11n Wall Router	Test Date	2011/08/25
Model	WA982n	Test By	John Chen
Test Mode	IEEE 802.11n HT20 TX (CH High)	TEMP& Humidity	30.4 ,52%

Vertical

TX / IEEE 802.11n HT20 mode / CH High				Measurement Distance at 3m				Vertical polarity	
Freq.	Reading	AF	Cable Loss	Pre-amp	Filter	Level	Limit	Margin	Mark
(MHz)	(dBμV)	(dB/m)	(dB)	(dB)	(dB)	(dBμV/m)	(dBμV/m)	(dB)	(P/Q/A)
* 1562.56	59.36	27.08	2.20	41.63	0.82	47.83	74.00	-26.17	P
* 1562.56	51.15	27.08	2.20	41.63	0.82	39.62	54.00	-14.38	A
* 4924.03	58.36	33.47	3.76	42.48	0.73	53.84	74.00	-20.16	P
* 4924.03	44.82	33.47	3.76	42.48	0.73	40.30	54.00	-13.70	A
N/A	-----	-----	-----	-----	-----	-----	-----	-----	P
N/A	-----	-----	-----	-----	-----	-----	-----	-----	A

REMARK:

1. AF: Antenna Factor, Cable: Cable Loss, Pre-Amp: Preamplifier gain, Filter: Band-rejection Filter Insertion Loss
2. Spectrum analyzer setting P(Peak): RBW=1MHz, VBW=1MHz, A(Average): RBW=1MHz, VBW=10Hz
3. The result basic equation calculation is as follow:
Level = Reading + AF + Cable – Preamp + Filter – Dist, Margin = Level-Limit
4. The other emission levels were 20dB below the limit
5. The test limit distance is 3M limit.



Product Name	11n Wall Router	Test Date	2011/08/25
Model	WA982n	Test By	John Chen
Test Mode	IEEE 802.11n HT40 TX (CH Low)	TEMP& Humidity	30.4 ,52%

Horizontal

TX / IEEE 802.11n HT40 mode / CH Low				Measurement Distance at 3m				Horizontal polarity		
Freq.	Reading	AF	Cable Loss	Pre-amp	Filter	Level	Limit	Margin	Mark	
(MHz)	(dBμV)	(dB/m)	(dB)	(dB)	(dB)	(dBμV/m)	(dBμV/m)	(dB)	(P/Q/A)	
* 1562.57	60.12	27.08	2.20	41.63	0.82	48.59	74.00	-25.41	P	
* 1562.57	51.34	27.08	2.20	41.63	0.82	39.81	54.00	-14.19	A	
* 4844.09	55.29	33.23	3.74	42.40	0.70	50.56	74.00	-23.44	P	
* 4844.09	42.06	33.23	3.74	42.40	0.70	37.33	54.00	-16.67	A	
N/A	-----	-----	-----	-----	-----	-----	-----	-----	P	
N/A	-----	-----	-----	-----	-----	-----	-----	-----	A	

Product Name	11n Wall Router	Test Date	2011/08/25
Model	WA982n	Test By	John Chen
Test Mode	IEEE 802.11n HT40 TX (CH Low)	TEMP& Humidity	30.4 ,52%

Vertical

TX / IEEE 802.11n HT40 mode / CH Low				Measurement Distance at 3m				Vertical polarity		
Freq.	Reading	AF	Cable Loss	Pre-amp	Filter	Level	Limit	Margin	Mark	
(MHz)	(dBμV)	(dB/m)	(dB)	(dB)	(dB)	(dBμV/m)	(dBμV/m)	(dB)	(P/Q/A)	
* 1562.72	58.63	27.08	2.20	41.63	0.82	47.10	74.00	-26.90	P	
* 1562.72	50.41	27.08	2.20	41.63	0.82	38.88	54.00	-15.12	A	
* 4844.04	57.68	33.23	3.74	42.40	0.70	52.95	74.00	-21.05	P	
* 4844.04	44.29	33.23	3.74	42.40	0.70	39.56	54.00	-14.44	A	
N/A	-----	-----	-----	-----	-----	-----	-----	-----	P	
N/A	-----	-----	-----	-----	-----	-----	-----	-----	A	

REMARK:

1. AF: Antenna Factor, Cable: Cable Loss, Pre-Amp: Preamplifier gain, Filter: Band-rejection Filter Insertion Loss
2. Spectrum analyzer setting P(Peak): RBW=1MHz, VBW=1MHz, A(Average): RBW=1MHz, VBW=10Hz
3. The result basic equation calculation is as follow:
Level = Reading + AF + Cable – Preamp + Filter – Dist, Margin = Level-Limit
4. The other emission levels were 20dB below the limit
5. The test limit distance is 3M limit.



Product Name	11n Wall Router	Test Date	2011/08/25
Model	WA982n	Test By	John Chen
Test Mode	IEEE 802.11n HT40 TX (CH Middle)	TEMP& Humidity	30.4 ,52%

Horizontal

TX / IEEE 802.11n HT40 mode / CH Middle				Measurement Distance at 3m				Horizontal polarity	
Freq.	Reading	AF	Cable Loss	Pre-amp	Filter	Level	Limit	Margin	Mark
(MHz)	(dBμV)	(dB/m)	(dB)	(dB)	(dB)	(dBμV/m)	(dBμV/m)	(dB)	(P/Q/A)
* 1562.62	61.28	27.08	2.20	41.63	0.82	49.75	74.00	-24.25	P
* 1562.62	52.01	27.08	2.20	41.63	0.82	40.48	54.00	-13.52	A
* 4874.06	55.58	33.32	3.74	42.43	0.71	50.92	74.00	-23.08	P
* 4874.06	42.14	33.32	3.74	42.43	0.71	37.48	54.00	-16.52	A
N/A	-----	-----	-----	-----	-----	-----	-----	-----	P
N/A	-----	-----	-----	-----	-----	-----	-----	-----	A

Product Name	11n Wall Router	Test Date	2011/08/25
Model	WA982n	Test By	John Chen
Test Mode	IEEE 802.11n HT40 TX (CH Middle)	TEMP& Humidity	30.4 ,52%

Vertical

TX / IEEE 802.11n HT40 mode / CH Middle				Measurement Distance at 3m				Vertical polarity	
Freq.	Reading	AF	Cable Loss	Pre-amp	Filter	Level	Limit	Margin	Mark
(MHz)	(dBμV)	(dB/m)	(dB)	(dB)	(dB)	(dBμV/m)	(dBμV/m)	(dB)	(P/Q/A)
* 1562.53	58.71	27.08	2.20	41.63	0.82	47.18	74.00	-26.82	P
* 1562.53	50.36	27.08	2.20	41.63	0.82	38.83	54.00	-15.17	A
* 4874.07	57.36	33.32	3.74	42.43	0.71	52.71	74.00	-21.29	P
* 4874.07	44.26	33.32	3.74	42.43	0.71	39.61	54.00	-14.39	A
N/A	-----	-----	-----	-----	-----	-----	-----	-----	P
N/A	-----	-----	-----	-----	-----	-----	-----	-----	A

REMARK:

1. AF: Antenna Factor, Cable: Cable Loss, Pre-Amp: Preamplifier gain, Filter: Band-rejection Filter Insertion Loss
2. Spectrum analyzer setting P(Peak): RBW=1MHz, VBW=1MHz, A(Average): RBW=1MHz, VBW=10Hz
3. The result basic equation calculation is as follow:
Level = Reading + AF + Cable – Preamp + Filter – Dist, Margin = Level-Limit
4. The other emission levels were 20dB below the limit
5. The test limit distance is 3M limit.



Product Name	11n Wall Router	Test Date	2011/08/25
Model	WA982n	Test By	John Chen
Test Mode	IEEE 802.11n HT40 TX (CH High)	TEMP& Humidity	30.4 ,52%

Horizontal

TX / IEEE 802.11n HT40 mode / CH High				Measurement Distance at 3m				Horizontal polarity	
Freq.	Reading	AF	Cable Loss	Pre-amp	Filter	Level	Limit	Margin	Mark
(MHz)	(dBμV)	(dB/m)	(dB)	(dB)	(dB)	(dBμV/m)	(dBμV/m)	(dB)	(P/Q/A)
* 1562.61	60.74	27.08	2.20	41.63	0.82	49.21	74.00	-24.79	P
* 1562.61	51.69	27.08	2.20	41.63	0.82	40.16	54.00	-13.84	A
* 4904.09	55.80	33.41	3.75	42.46	0.72	51.22	74.00	-22.78	P
* 4904.09	42.73	33.41	3.75	42.46	0.72	38.15	54.00	-15.85	A
N/A	-----	-----	-----	-----	-----	-----	-----	-----	P
N/A	-----	-----	-----	-----	-----	-----	-----	-----	A

Product Name	11n Wall Router	Test Date	2011/08/25
Model	WA982n	Test By	John Chen
Test Mode	IEEE 802.11n HT40 TX (CH High)	TEMP& Humidity	30.4 ,52%

Vertical

TX / IEEE 802.11n HT40 mode / CH High				Measurement Distance at 3m				Vertical polarity	
Freq.	Reading	AF	Cable Loss	Pre-amp	Filter	Level	Limit	Margin	Mark
(MHz)	(dBμV)	(dB/m)	(dB)	(dB)	(dB)	(dBμV/m)	(dBμV/m)	(dB)	(P/Q/A)
* 1562.57	58.36	27.08	2.20	41.63	0.82	46.83	74.00	-27.17	P
* 1562.57	50.05	27.08	2.20	41.63	0.82	38.52	54.00	-15.48	A
* 4904.07	58.52	33.41	3.75	42.46	0.72	53.94	74.00	-20.06	P
* 4904.07	44.85	33.41	3.75	42.46	0.72	40.27	54.00	-13.73	A
N/A	-----	-----	-----	-----	-----	-----	-----	-----	P
N/A	-----	-----	-----	-----	-----	-----	-----	-----	A

REMARK:

1. AF: Antenna Factor, Cable: Cable Loss, Pre-Amp: Preamplifier gain, Filter: Band-rejection Filter Insertion Loss
2. Spectrum analyzer setting P(Peak): RBW=1MHz, VBW=1MHz, A(Average): RBW=1MHz, VBW=10Hz
3. The result basic equation calculation is as follow:
Level = Reading + AF + Cable – Preamp + Filter – Dist, Margin = Level-Limit
4. The other emission levels were 20dB below the limit
5. The test limit distance is 3M limit.



8.6.4 RESTRICTED BAND EDGES

IEEE 802.11b mode

Channel	Polarity	Freq.(MHz)	Level(dBuV)	Limit(dBuV)	Margin(dB)	Detector
LOW	H	2390.00	58.44	74	-15.56	Peak
	H	2390.00	46.38	54	-7.62	Average
	V	2390.00	58.86	74	-15.14	Peak
	V	2390.00	46.89	54	-7.11	Average
HIGH	H	2483.50	59.23	74	-14.77	Peak
	H	2483.50	46.25	54	-7.75	Average
	V	2483.50	58.17	74	-15.83	Peak
	V	2483.50	47.22	54	-6.78	Average

IEEE 802.11g mode

Channel	Polarity	Freq.(MHz)	Level(dBuV)	Limit(dBuV)	Margin(dB)	Detector
LOW	H	2390.00	59.29	74	-14.71	Peak
	H	2390.00	46.95	54	-7.05	Average
	V	2390.00	66.04	74	-7.96	Peak
	V	2390.00	50.05	54	-3.95	Average
HIGH	H	2483.50	59.49	74	-14.51	Peak
	H	2483.50	46.83	54	-7.17	Average
	V	2483.50	62.76	74	-11.24	Peak
	V	2483.50	49.55	54	-4.45	Average



IEEE 802.11n HT20 mode

Channel	Polarity	Freq.(MHz)	Level(dBuV)	Limit(dBuV)	Margin(dB)	Detector
LOW	H	2390.00	59.79	74	-14.21	Peak
	H	2390.00	47.04	54	-6.96	Average
	V	2390.00	69.74	74	-4.26	Peak
	V	2390.00	50.46	54	-3.54	Average
HIGH	H	2483.50	59.27	74	-14.73	Peak
	H	2483.50	46.98	54	-7.02	Average
	V	2483.50	64.41	74	-9.59	Peak
	V	2483.50	49.9	54	-4.10	Average

IEEE 802.11n HT40 mode

Channel	Polarity	Freq.(MHz)	Level(dBuV)	Limit(dBuV)	Margin(dB)	Detector
LOW	H	2390.00	59.55	74	-14.45	Peak
	H	2390.00	47.24	54	-6.76	Average
	V	2390.00	62.61	74	-11.39	Peak
	V	2390.00	49.66	54	-4.34	Average
HIGH	H	2483.50	59.3	74	-14.70	Peak
	H	2483.50	47.21	54	-6.79	Average
	V	2483.50	62.01	74	-11.99	Peak
	V	2483.50	49.1	54	-4.90	Average



Detector mode : Peak

Polarity : Horizontal

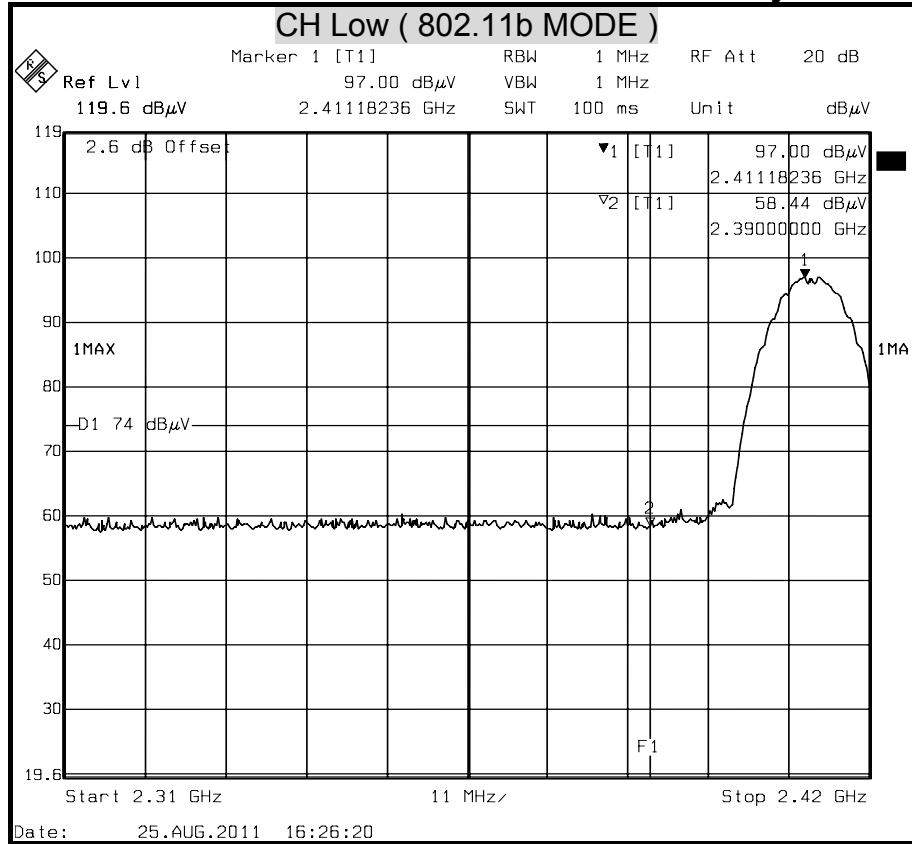

Detector mode : Average

Polarity : Horizontal

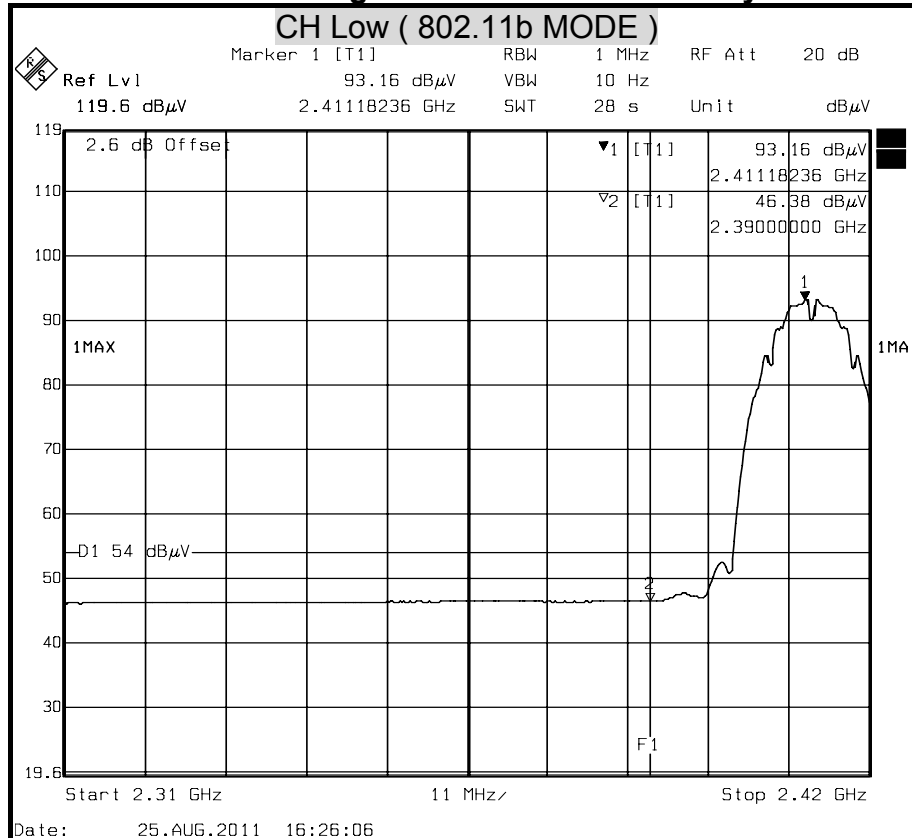



Detector mode : Peak

Polarity : Vertical

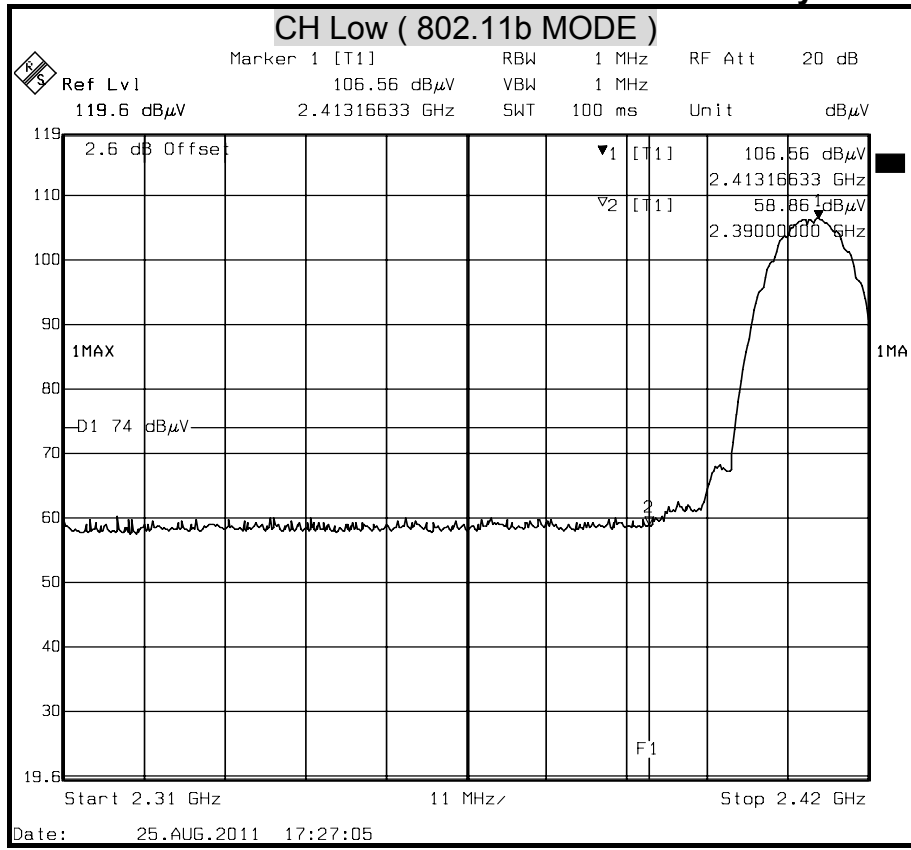

Detector mode : Average

Polarity : Vertical

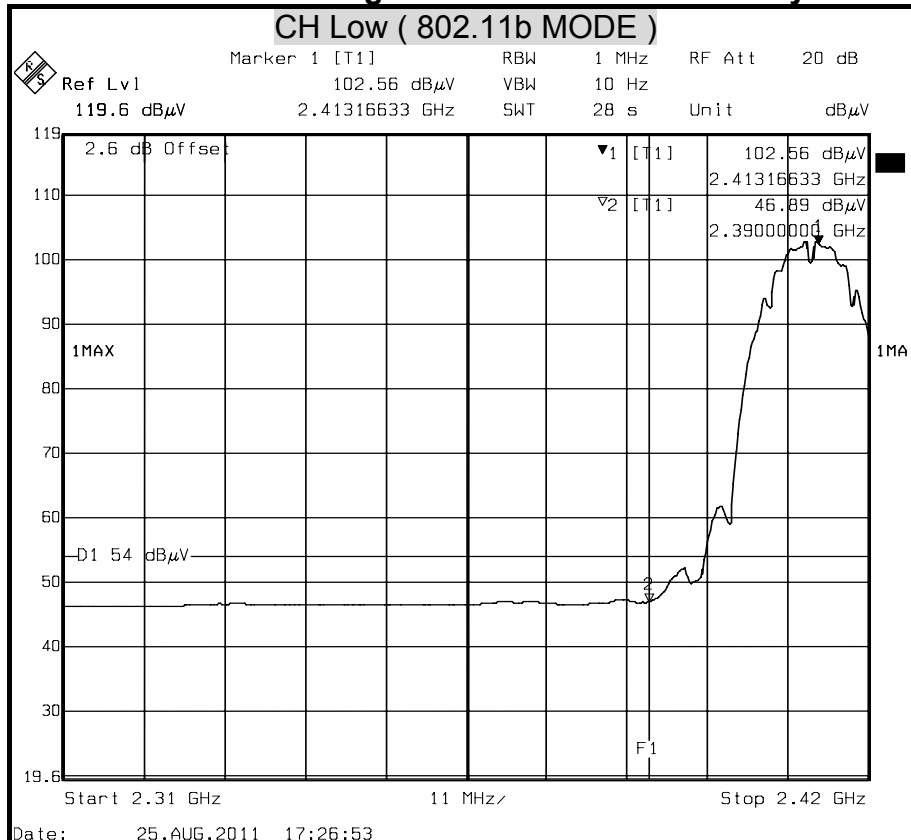



Detector mode : Peak

Polarity : Horizontal

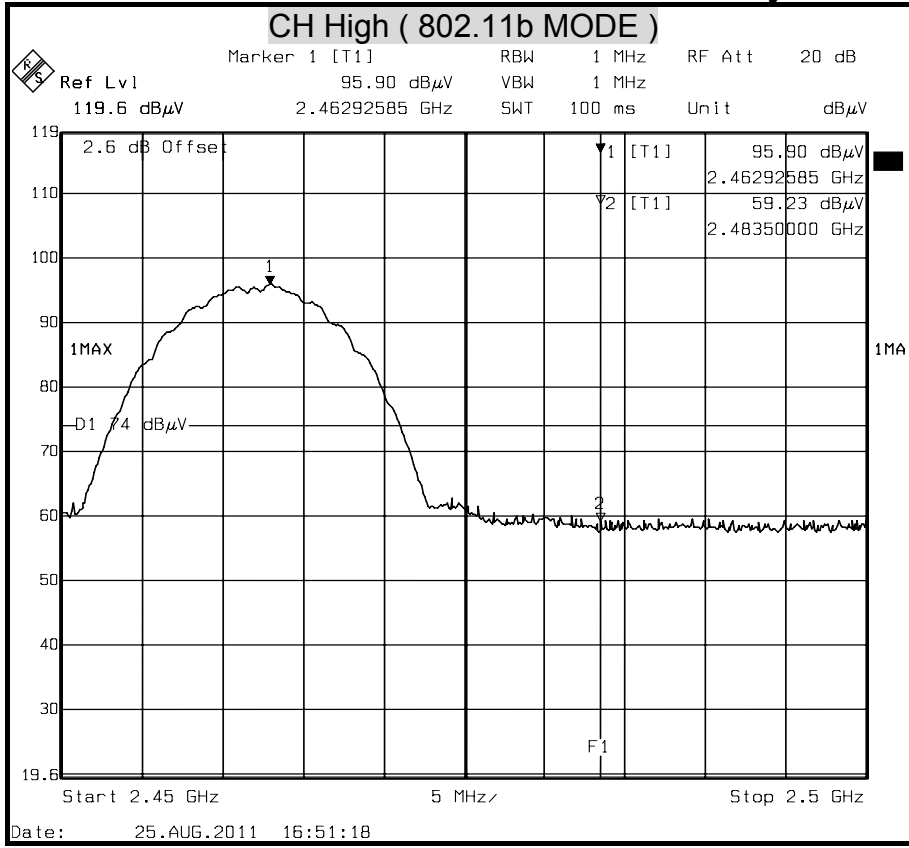

Detector mode : Average

Polarity : Horizontal

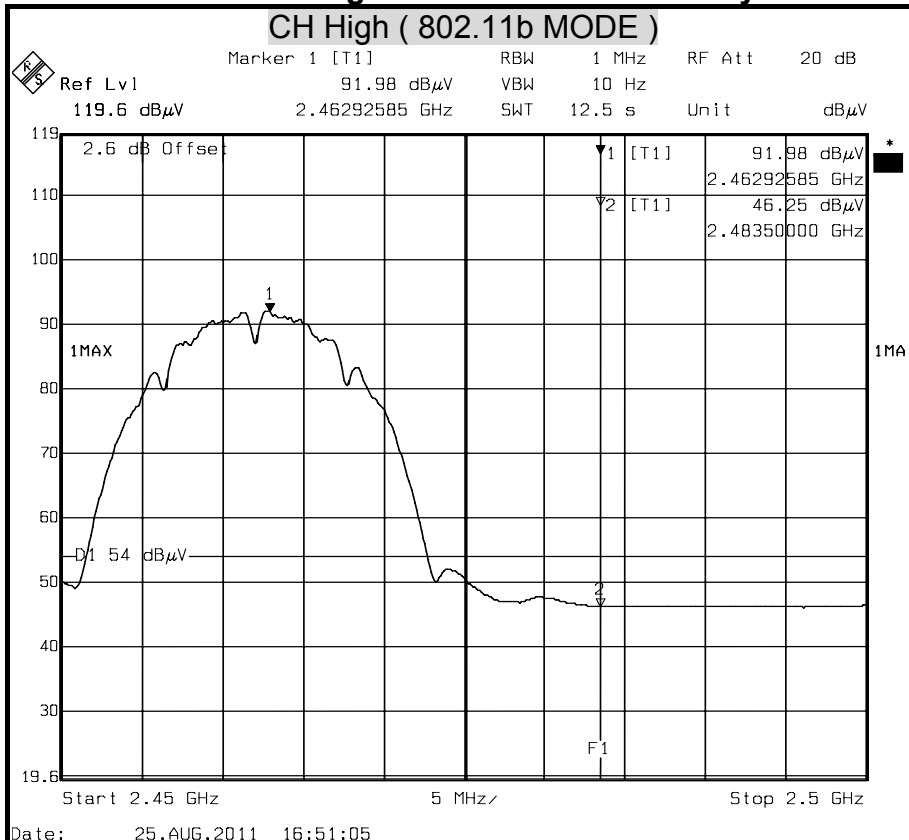



Detector mode : Peak

Polarity : Vertical

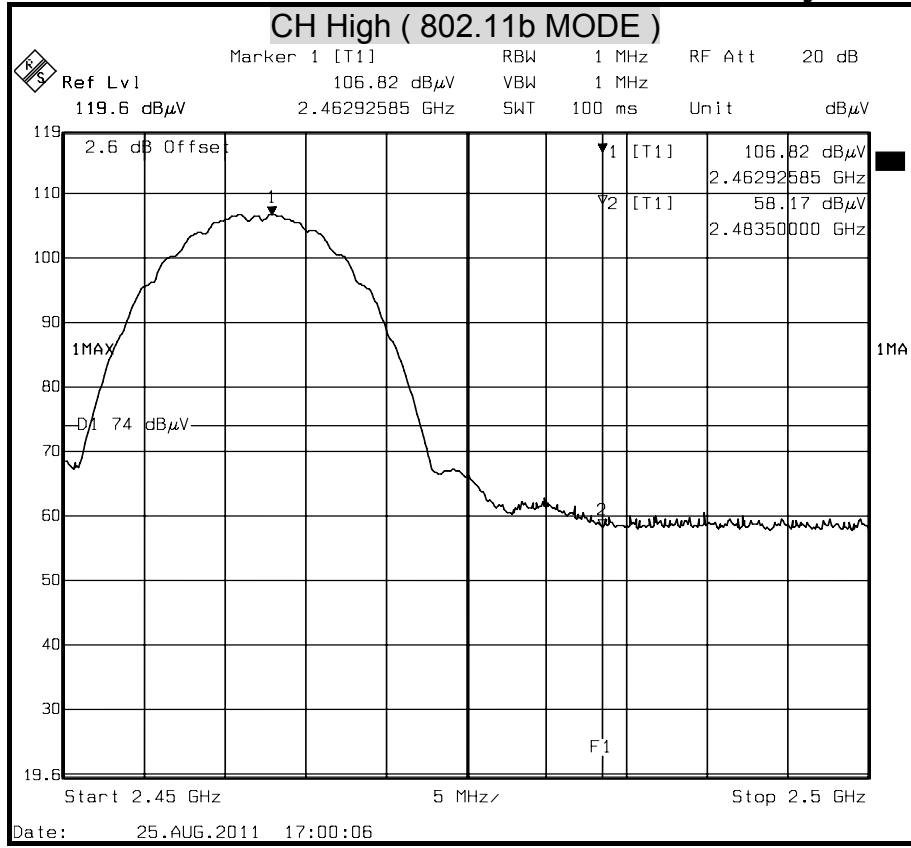

Detector mode : Average

Polarity : Vertical

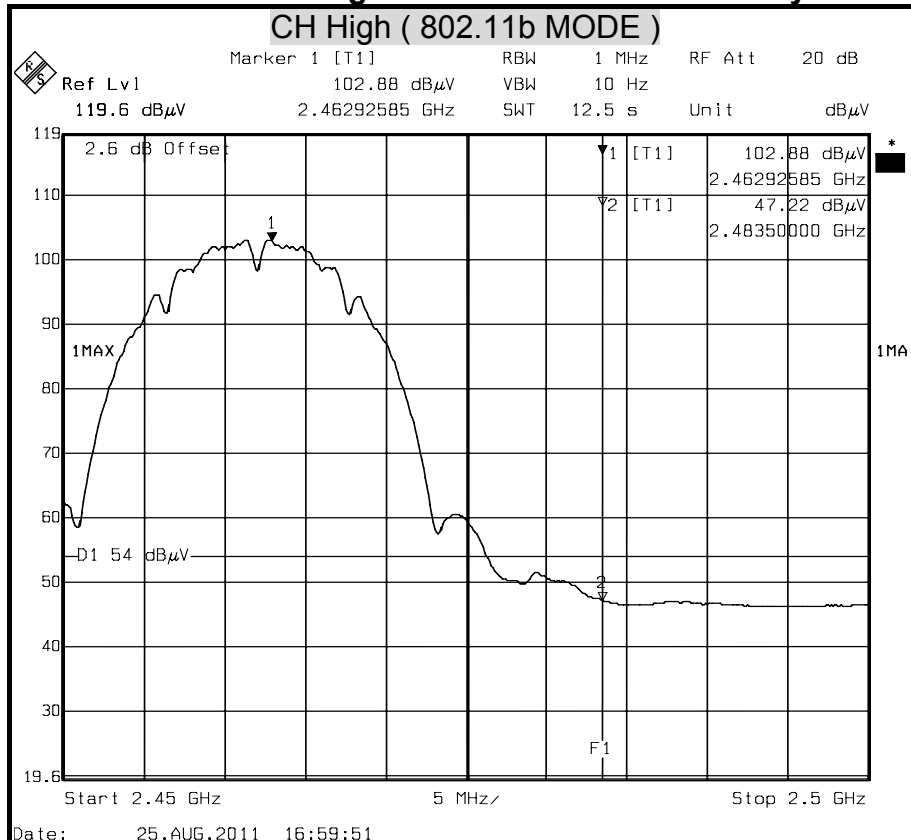



Detector mode : Peak

Polarity : Horizontal

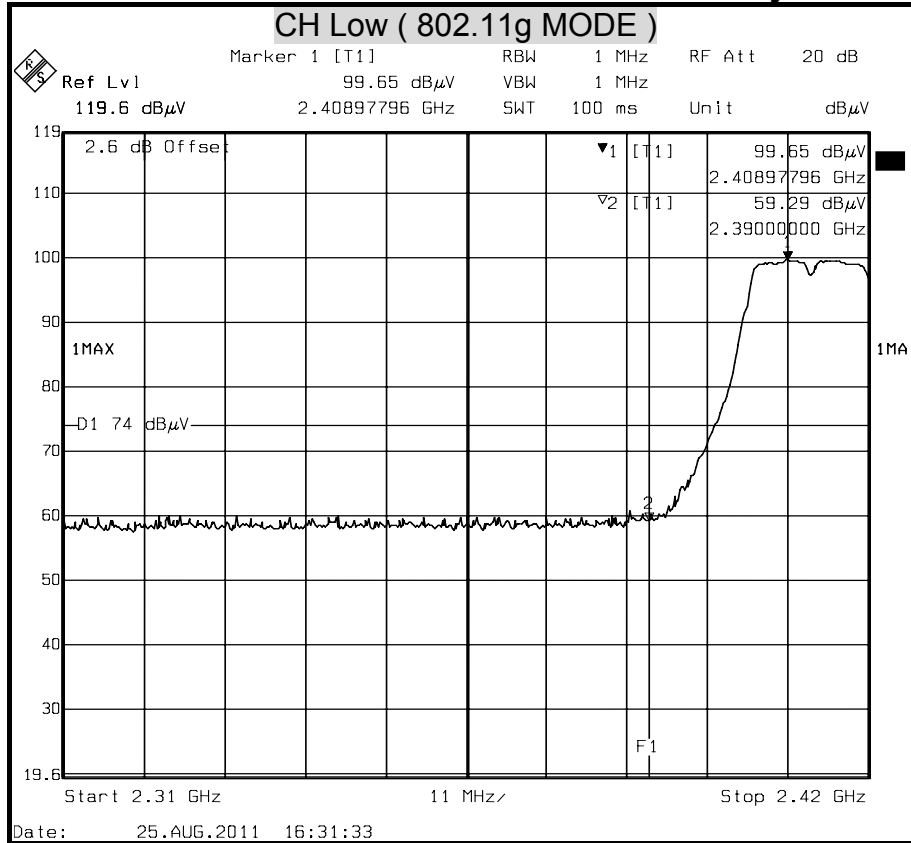

Detector mode : Average

Polarity : Horizontal

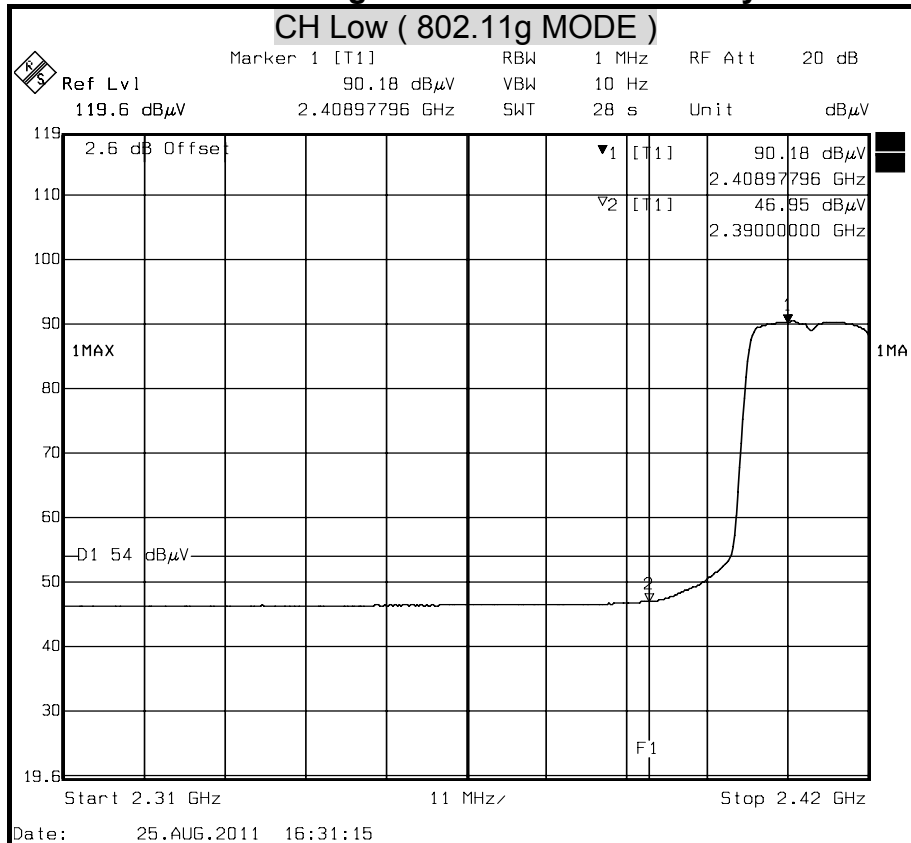



Detector mode : Peak

Polarity : Vertical

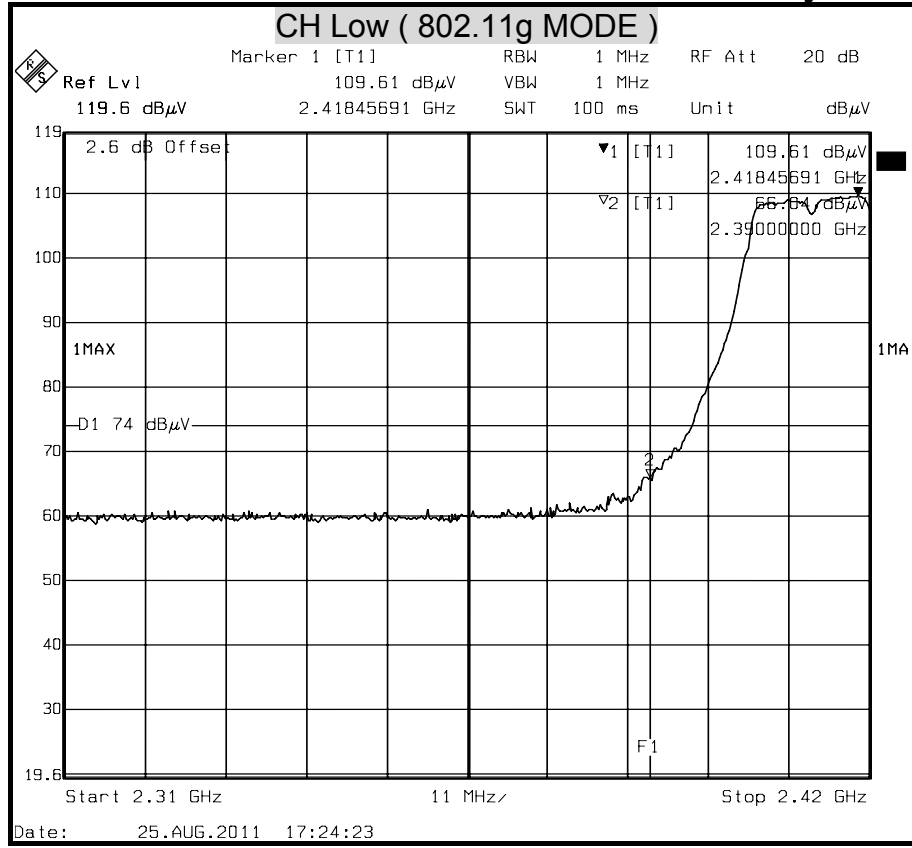

Detector mode : Average

Polarity : Vertical

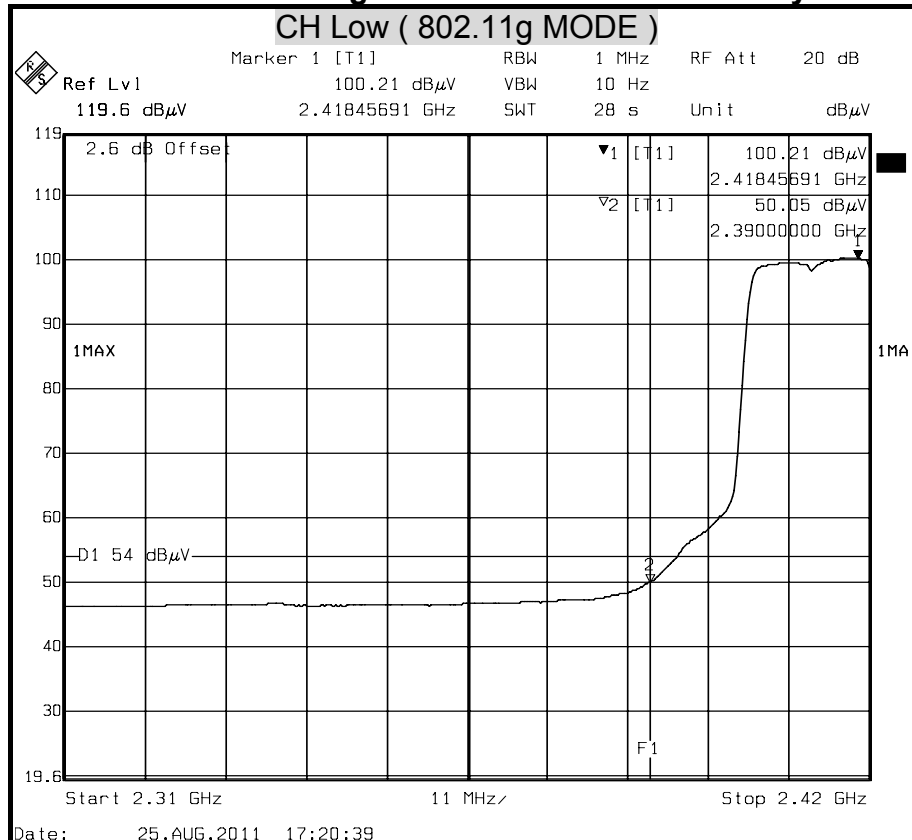



Detector mode : Peak

Polarity : Horizontal

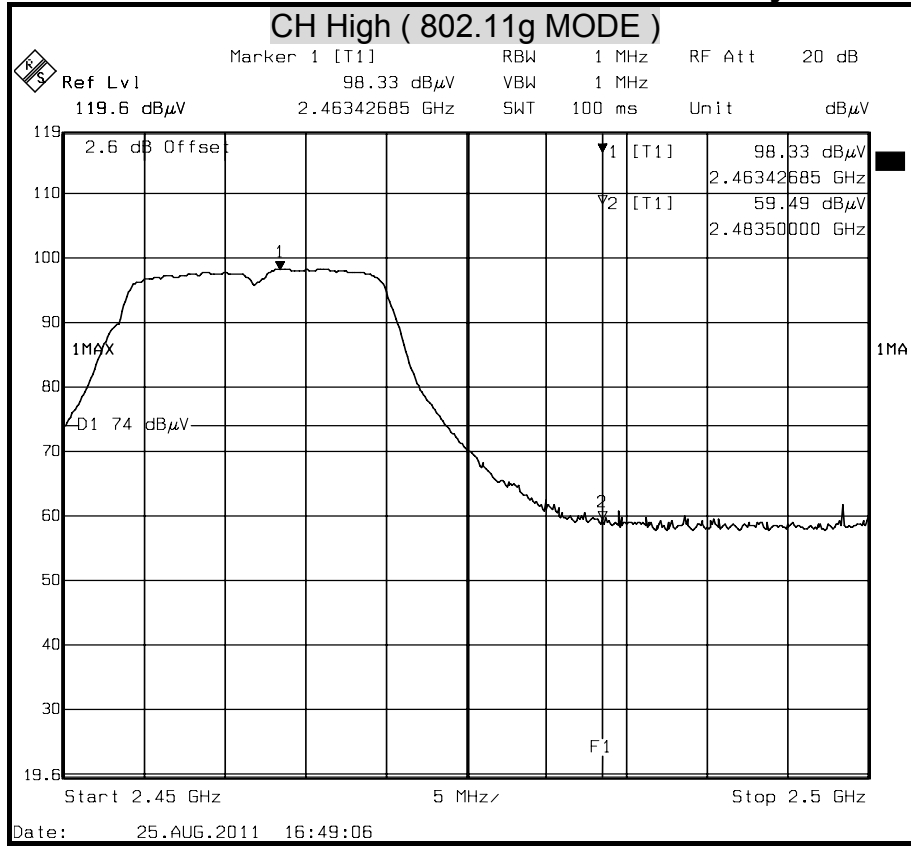

Detector mode : Average

Polarity : Horizontal

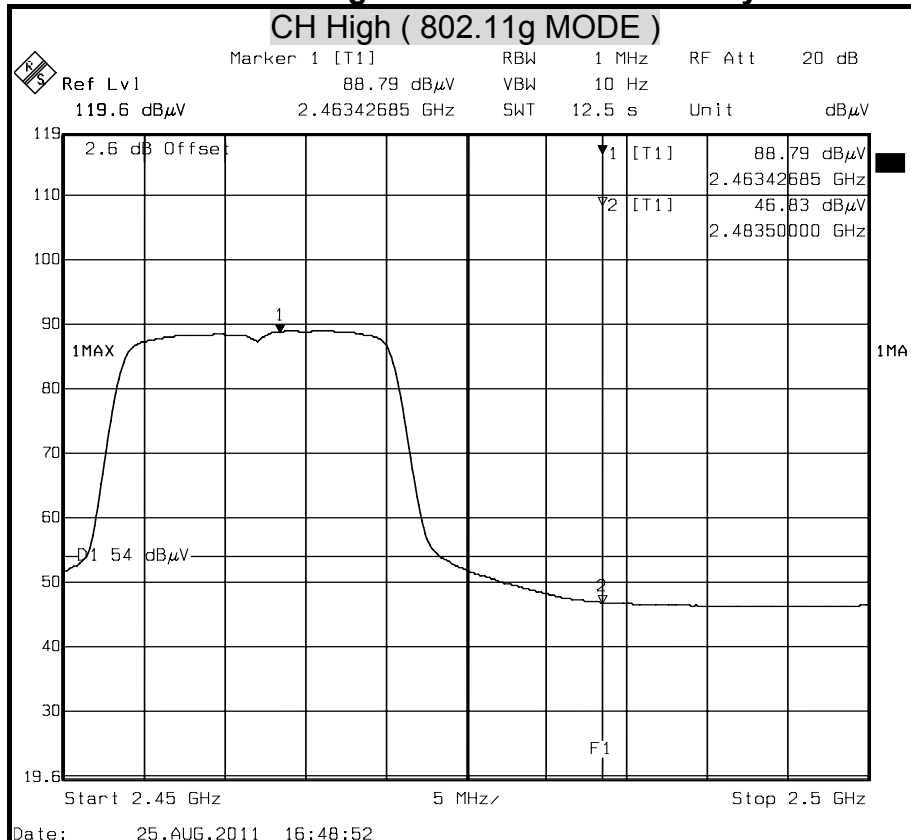



Detector mode : Peak

Polarity : Vertical

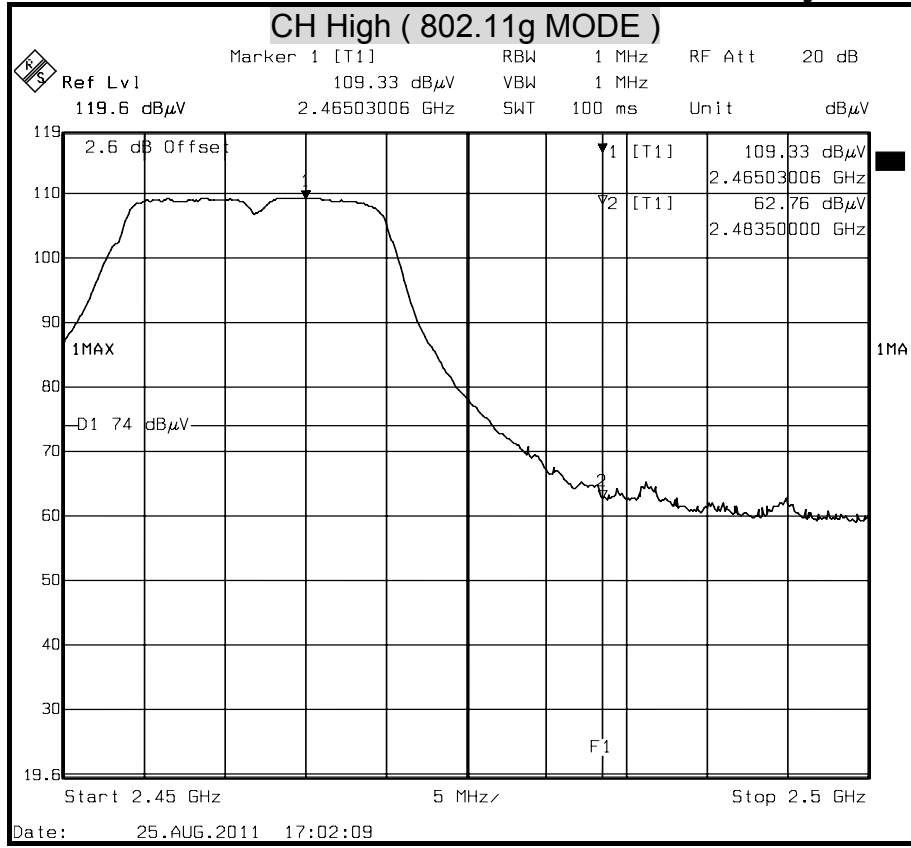

Detector mode : Average

Polarity : Vertical

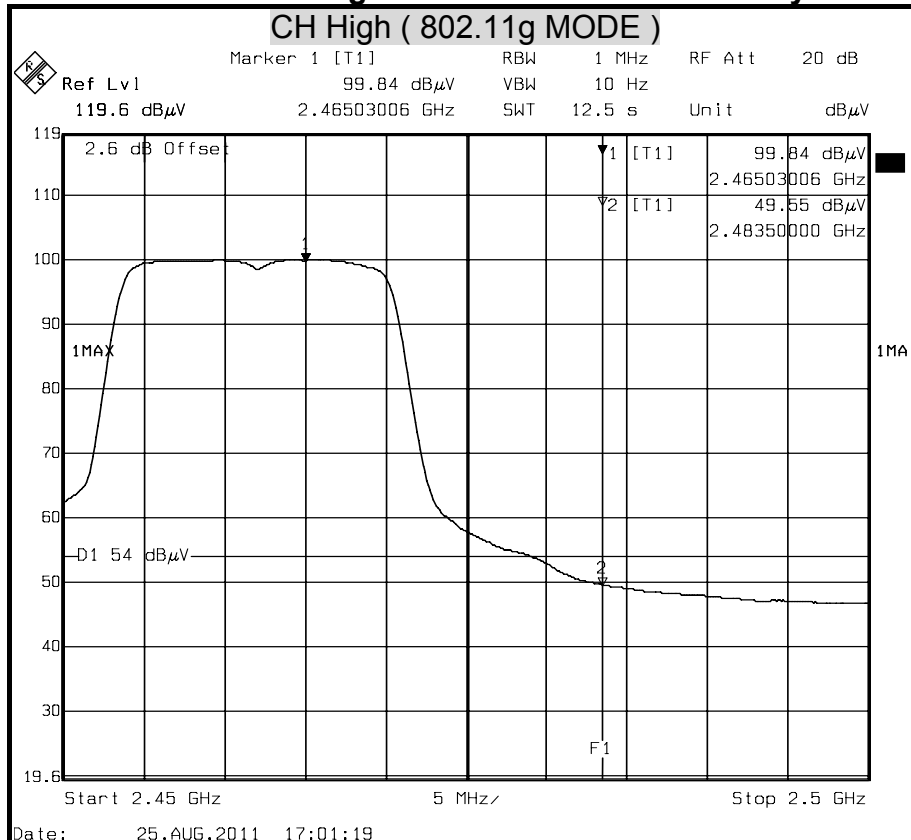



Detector mode : Peak

Polarity : Horizontal

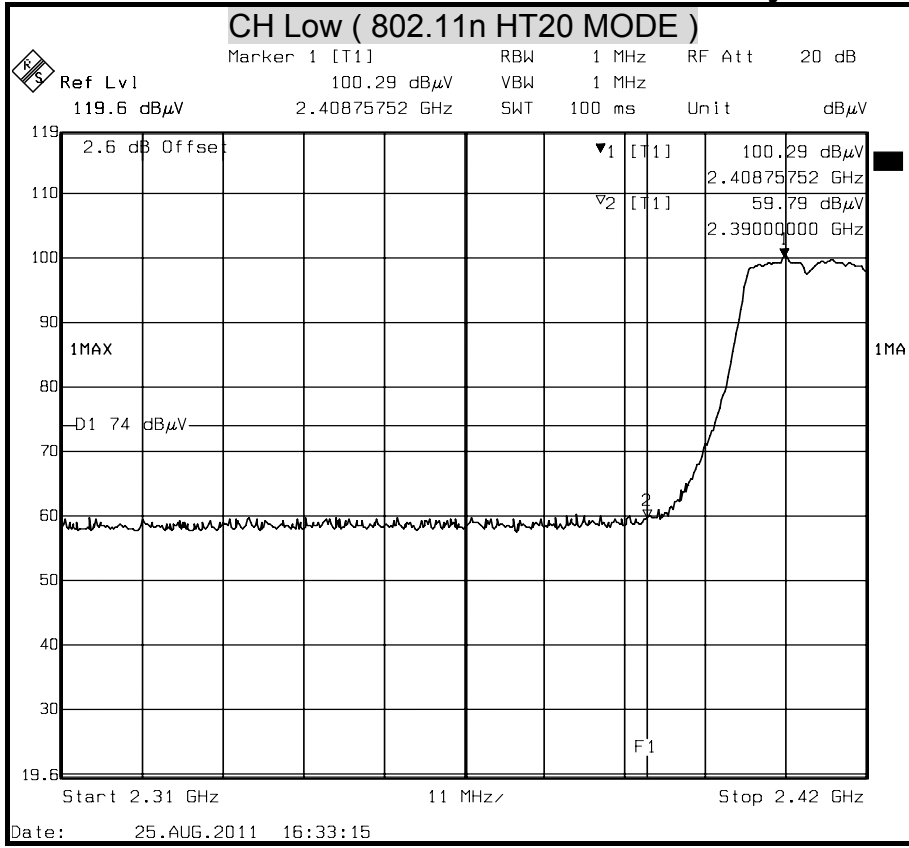

Detector mode : Average

Polarity : Horizontal

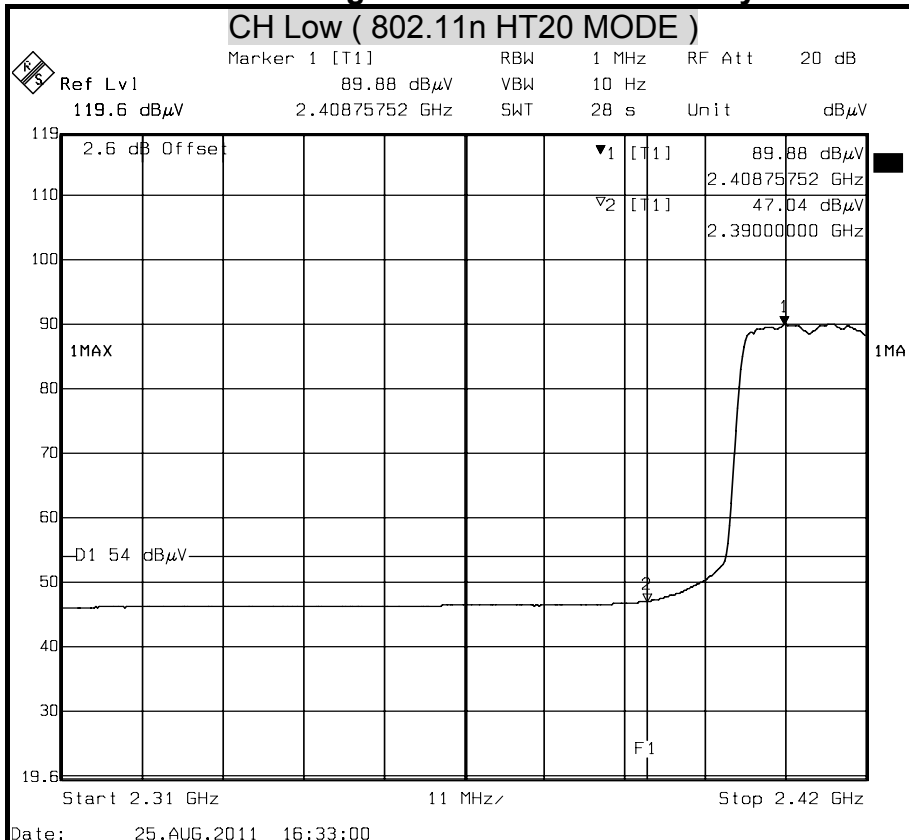



Detector mode : Peak

Polarity : Vertical

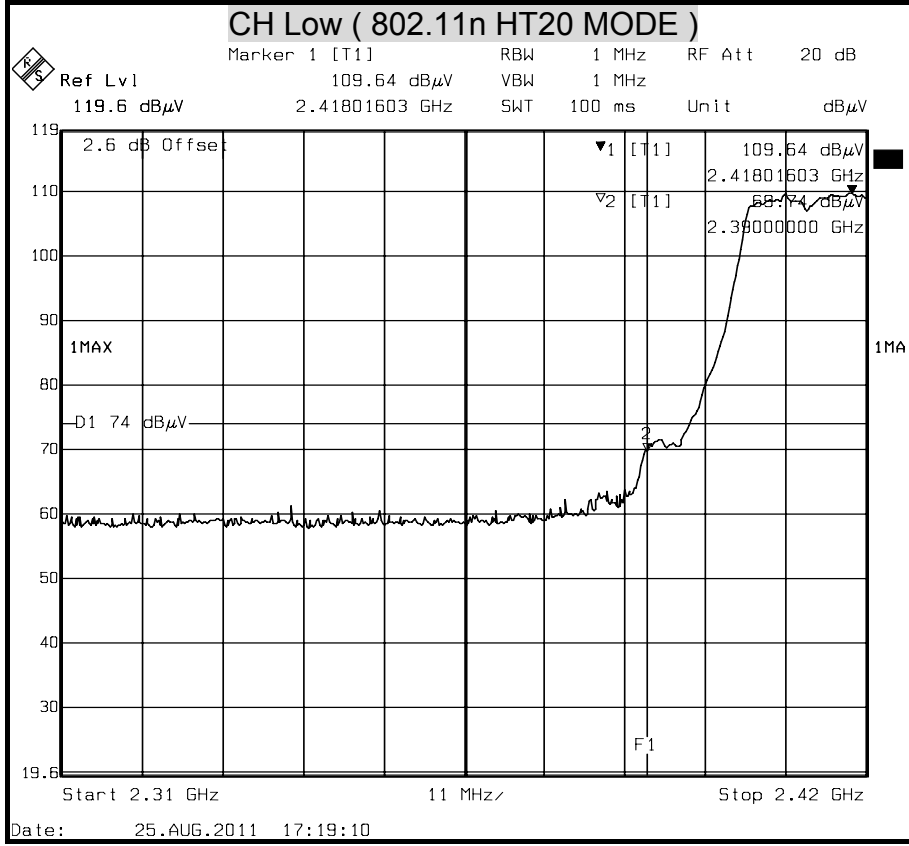

Detector mode : Average

Polarity : Vertical

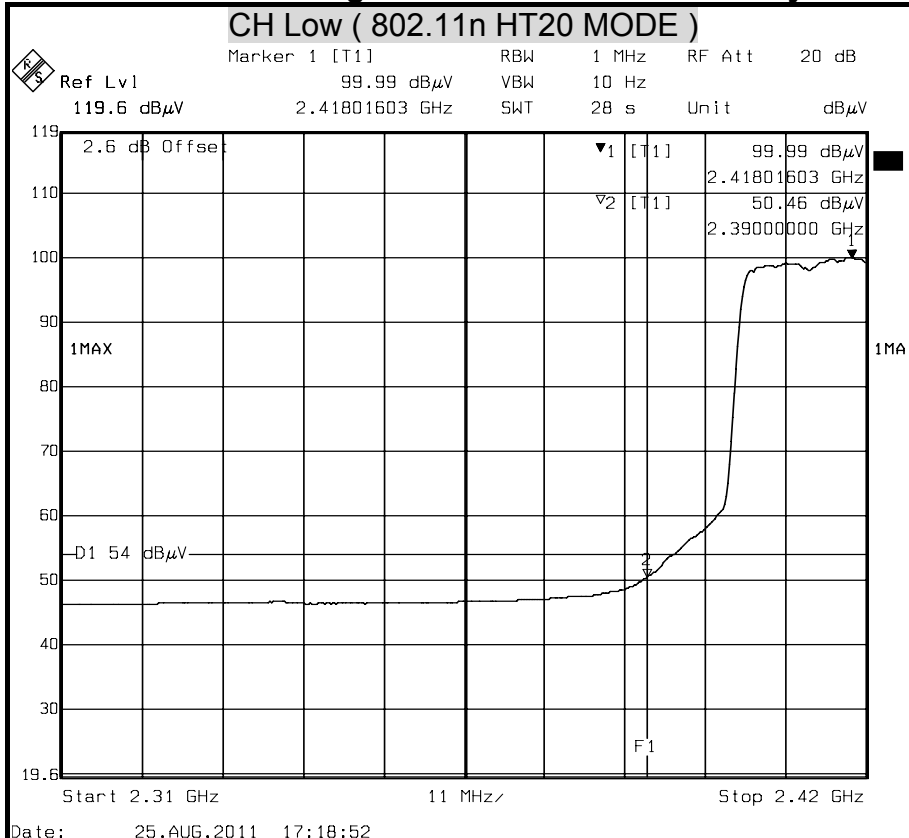



Detector mode : Peak

Polarity : Horizontal

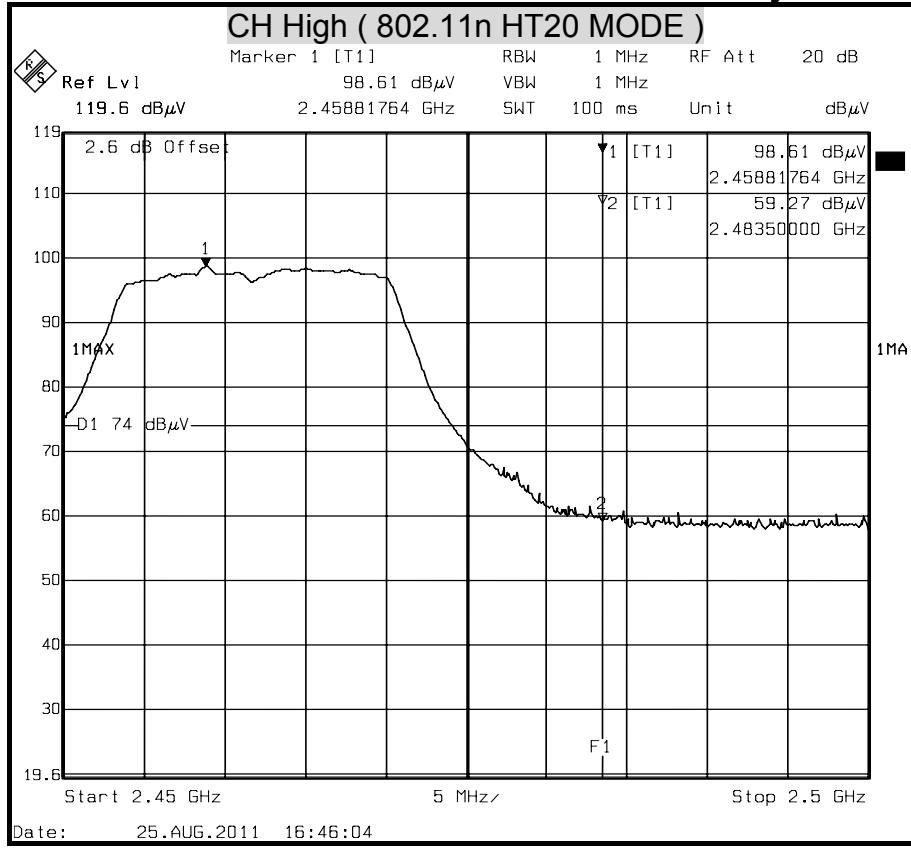

Detector mode : Average

Polarity : Horizontal

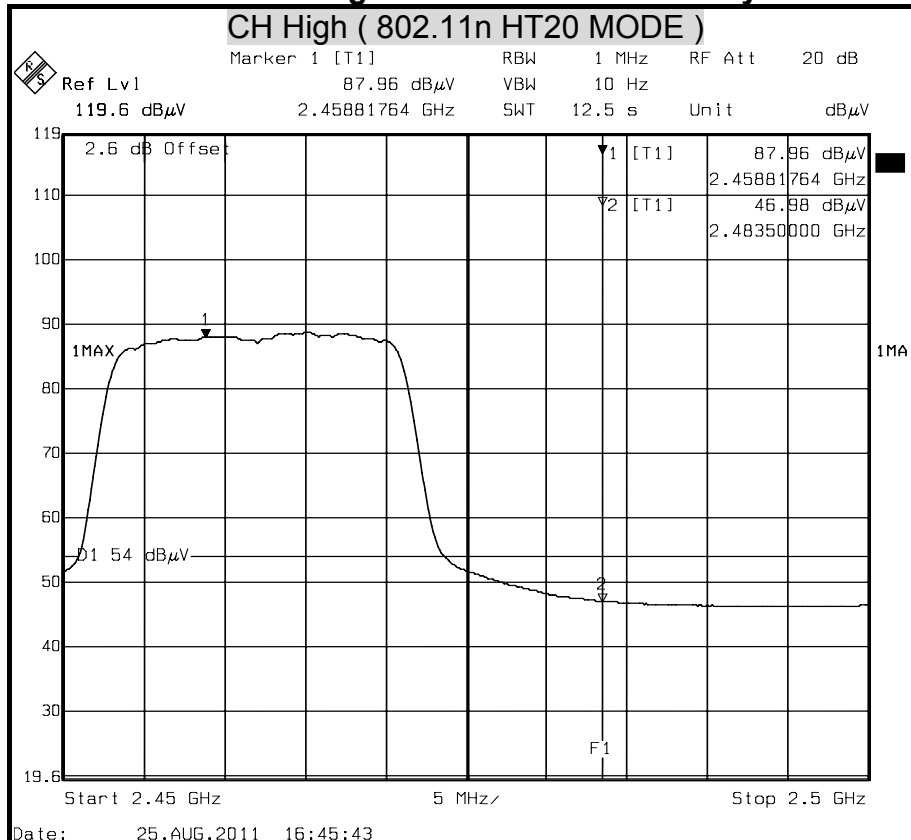



Detector mode : Peak

Polarity : Vertical

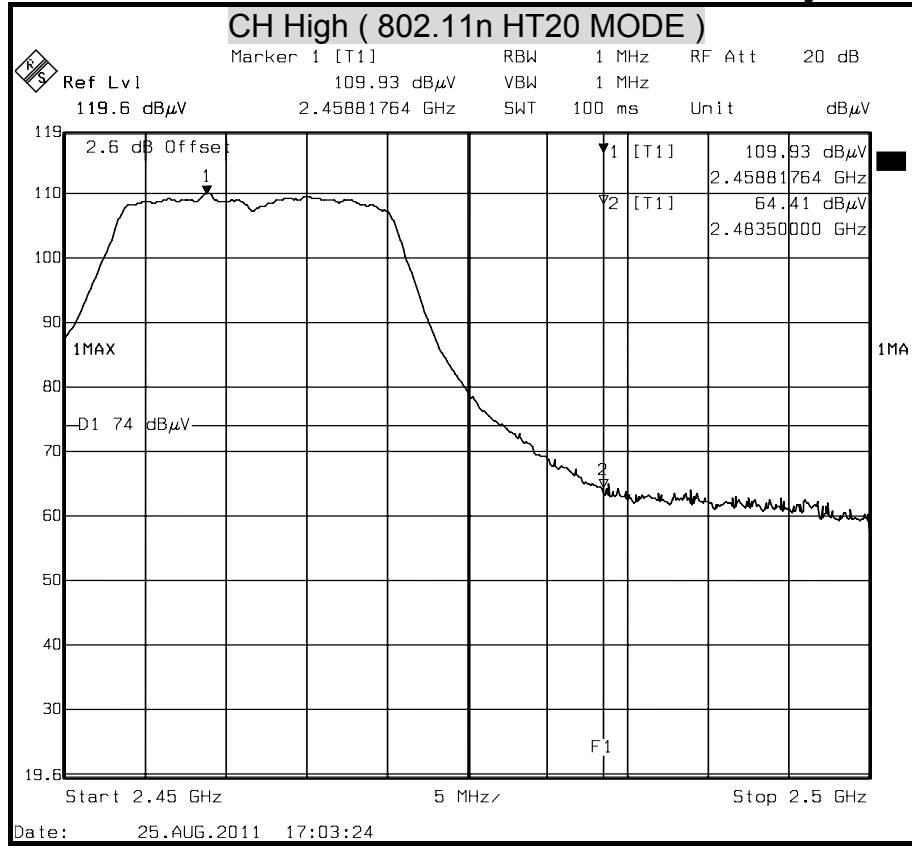

Detector mode : Average

Polarity : Vertical

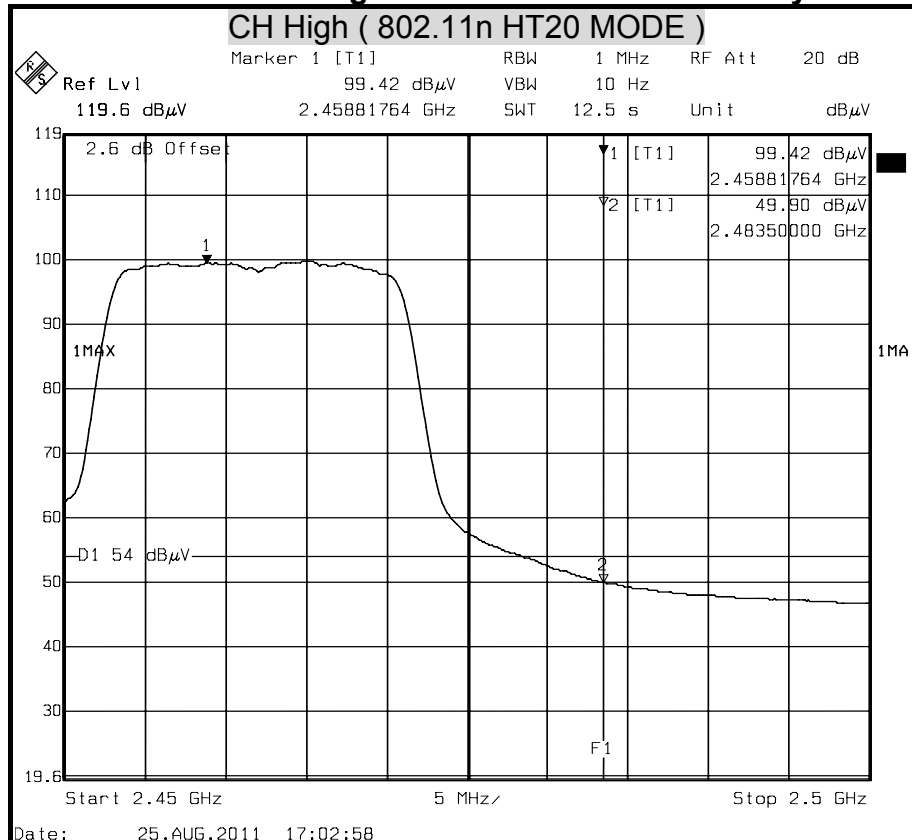



Detector mode : Peak

Polarity : Horizontal

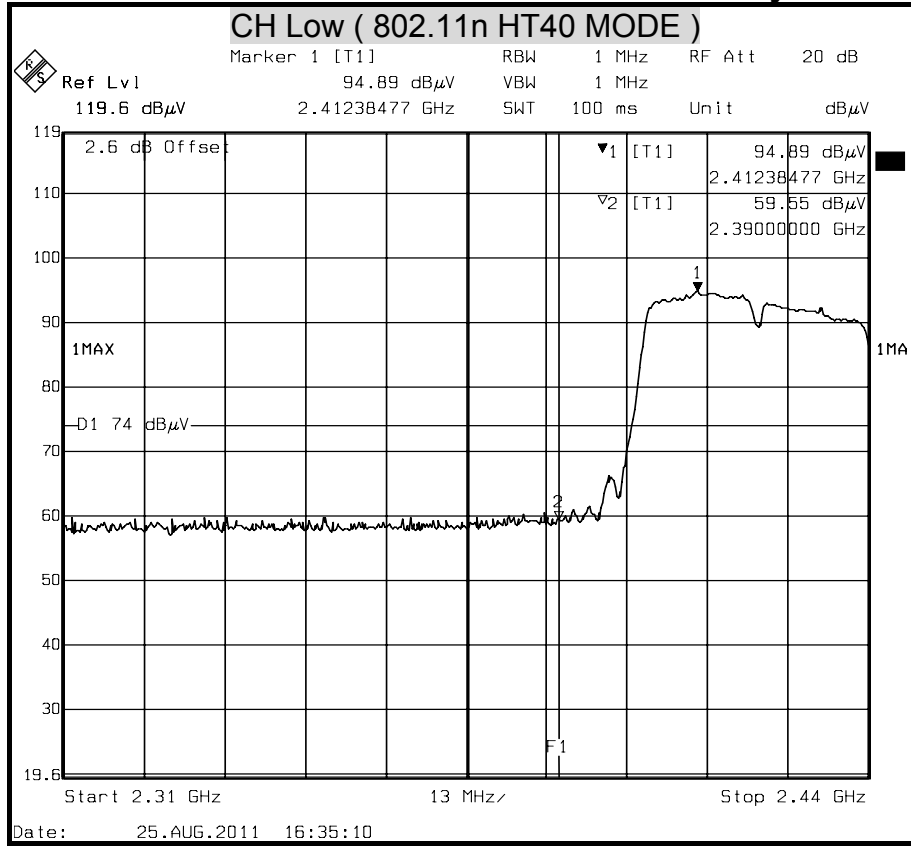

Detector mode : Average

Polarity : Horizontal

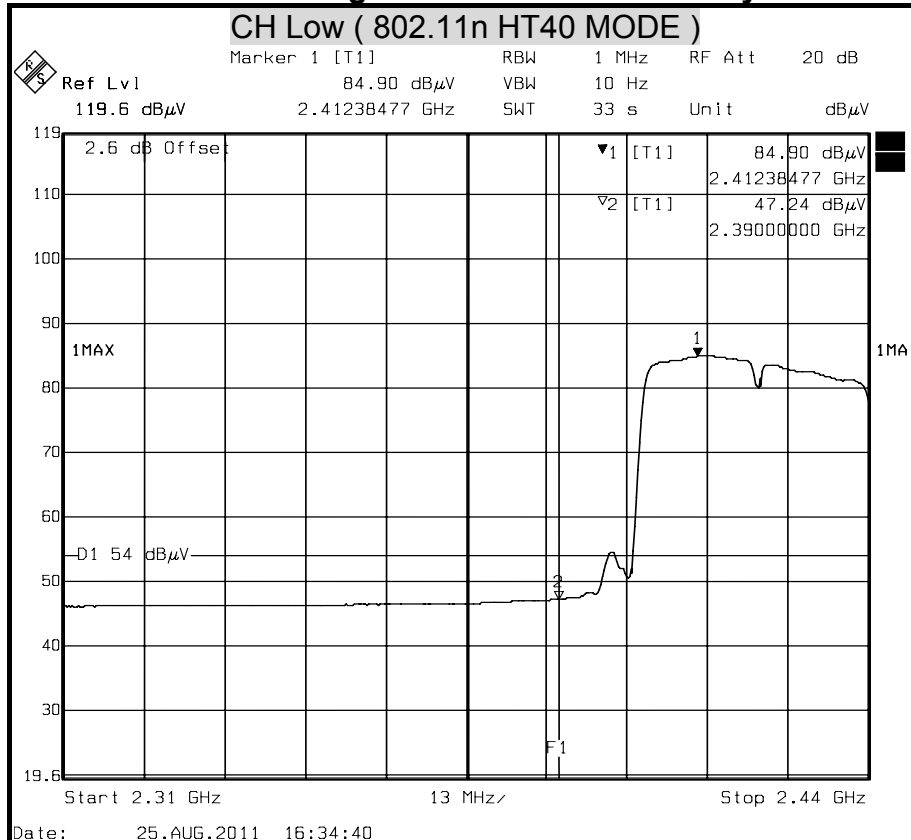



Detector mode : Peak

Polarity : Vertical

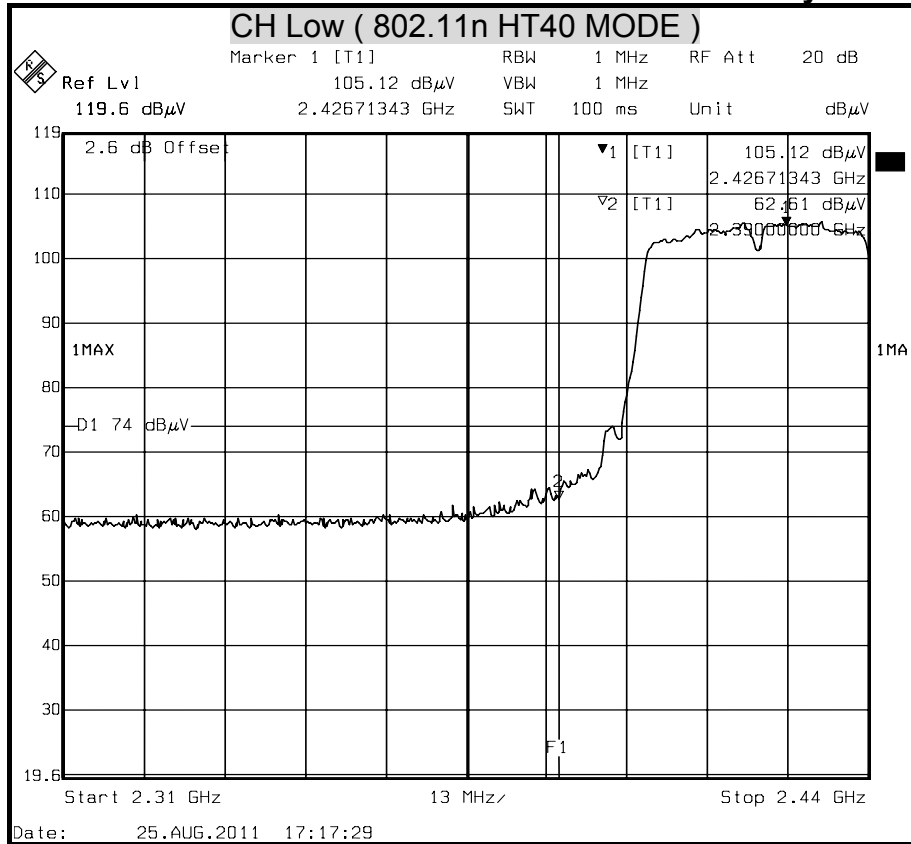

Detector mode : Average

Polarity : Vertical

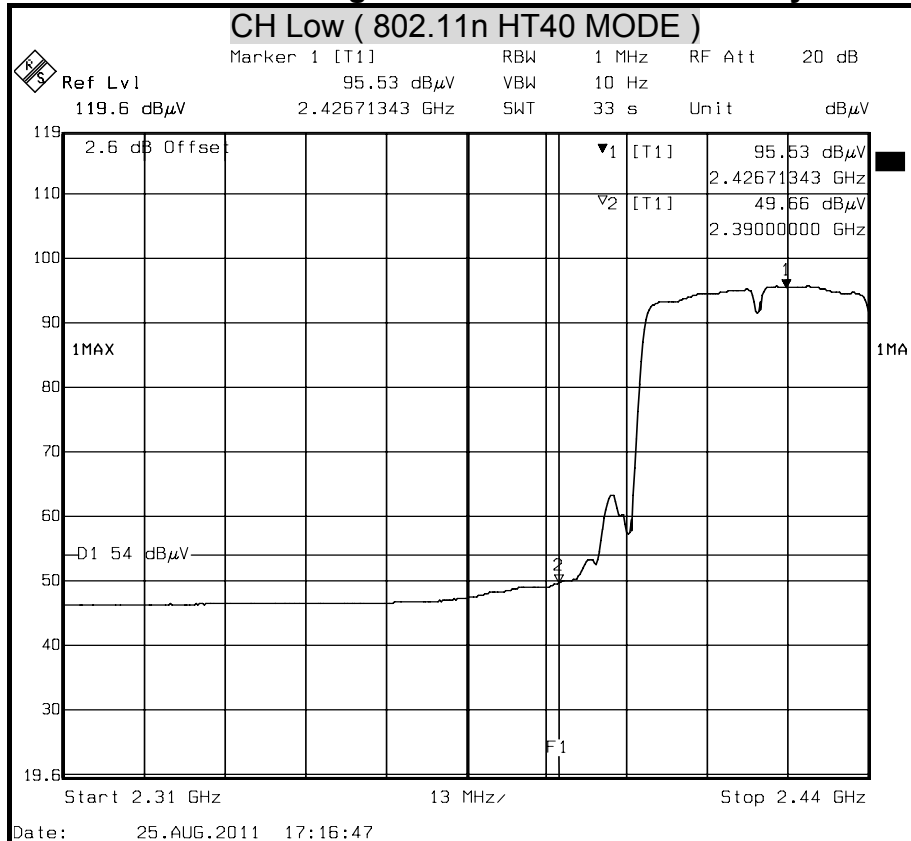



Detector mode : Peak

Polarity : Horizontal

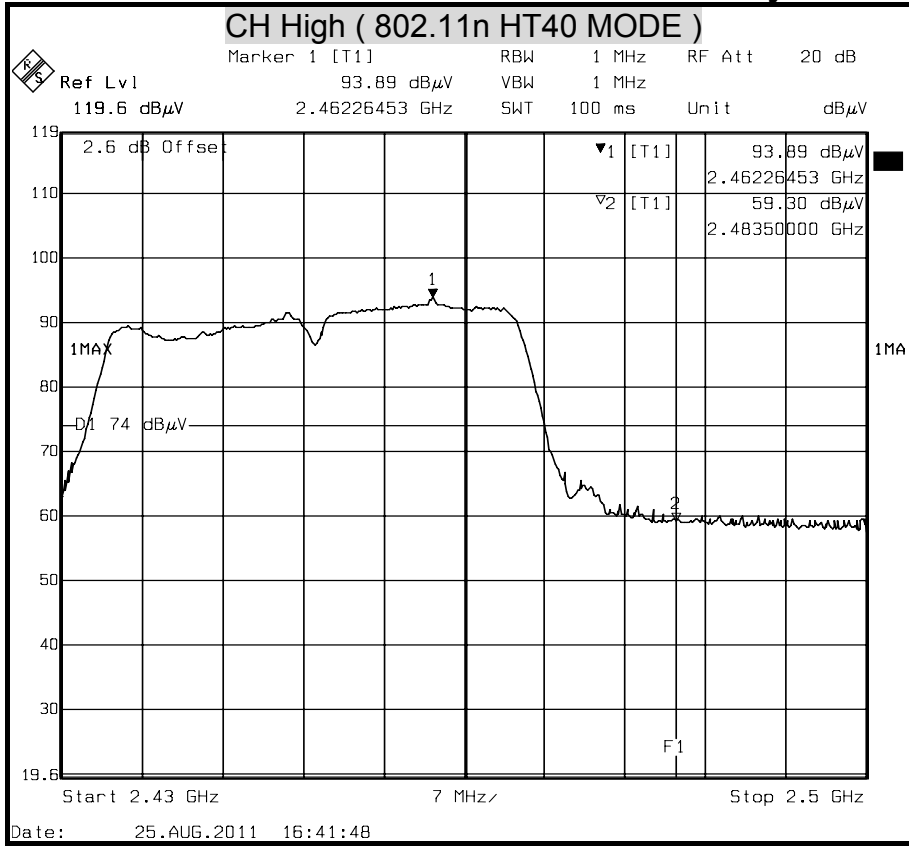

Detector mode : Average

Polarity : Horizontal

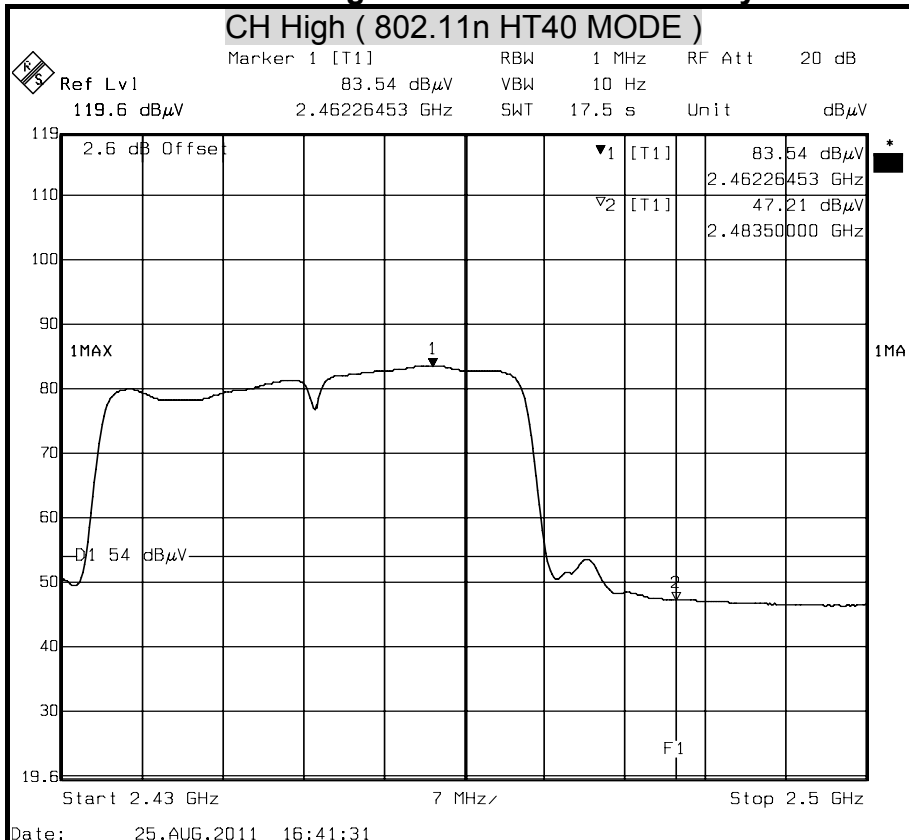



Detector mode : Peak

Polarity : Vertical

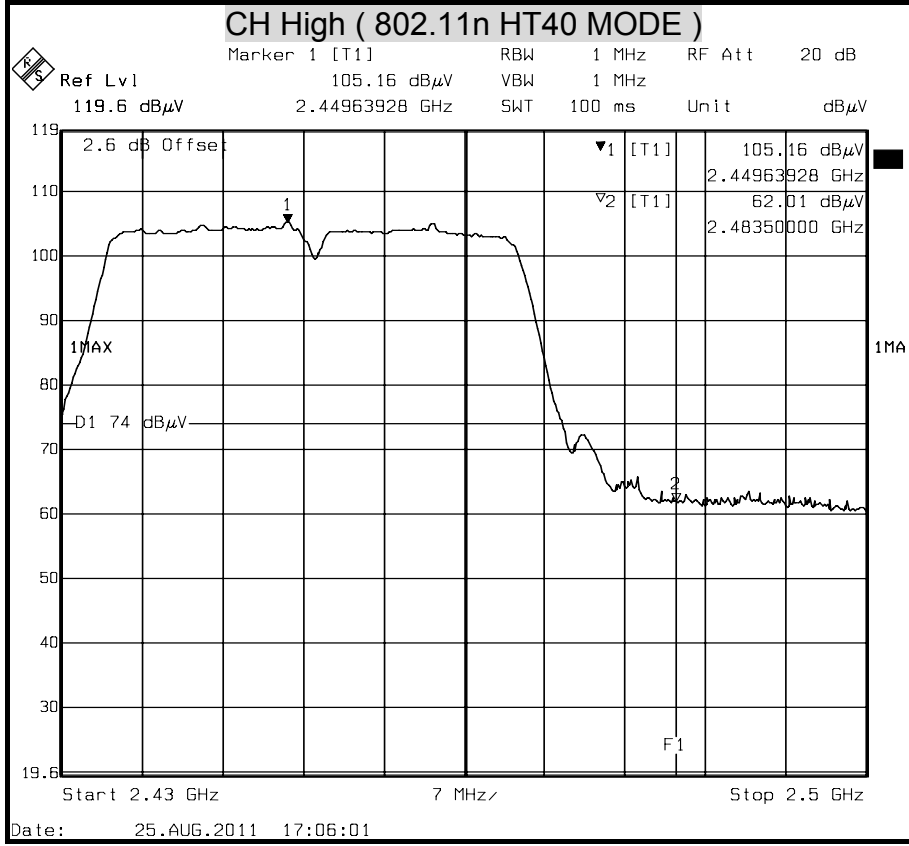

Detector mode : Average

Polarity : Vertical

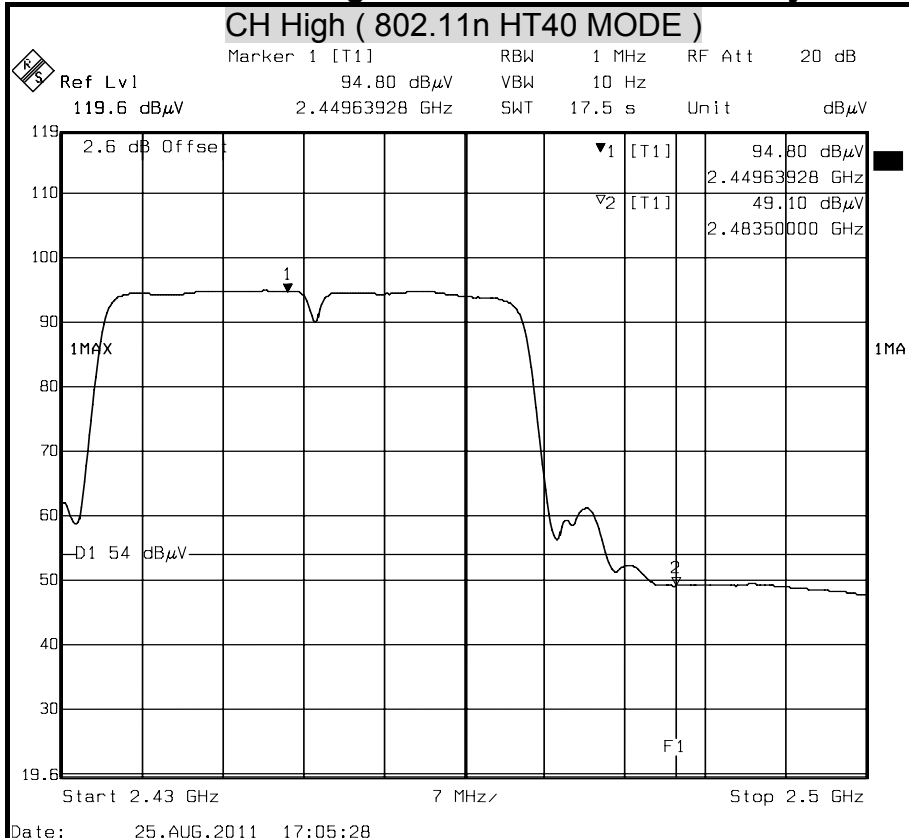



8.7 POWERLINE CONDUCTED EMISSIONS

LIMITS

§ 15.207 (a) Except as shown in paragraph (b) and (c) this section, for an intentional radiator that is designed to be connected to the public utility (AC) power line, the radio frequency voltage that is conducted back onto the AC power line on any frequency or frequencies within the band 150 kHz to 30 MHz shall not exceed the limits in the following table, as measured using a 50 μ H/50 ohms line impedance stabilization network (LISN). Compliance with the provisions of this paragraph shall be based on the measurement of the radio frequency voltage between each power line and ground at the power terminal.

The lower limit applies at the boundary between the frequency ranges.

Frequency of Emission (MHz)	Conducted limit (dB μ v)	
	Quasi-peak	Average
0.15 - 0.5	66 to 56	56 to 46
0.5 - 5	56	46
5 - 30	60	50

TEST EQUIPMENTS

The following test equipments are used during the conducted power line tests :

Conducted Emission room #1				
Name of Equipment	Manufacturer	Model	Serial Number	Calibration Due
L.I.S.N.	SCHWARZBECK	NNLK 8121	8121-446	MAR. 09, 2012 For Insertion loss
TEST RECEIVER	Rohde & Schwarz	ESCS 30	100348	JUL. 13, 2012
TYPE N COAXIAL CABLE	CCS	BNC50	11	OCT. 04, 2011
Test S/W	e-3 (5.04211c) R&S (2.27)			



TEST SETUP

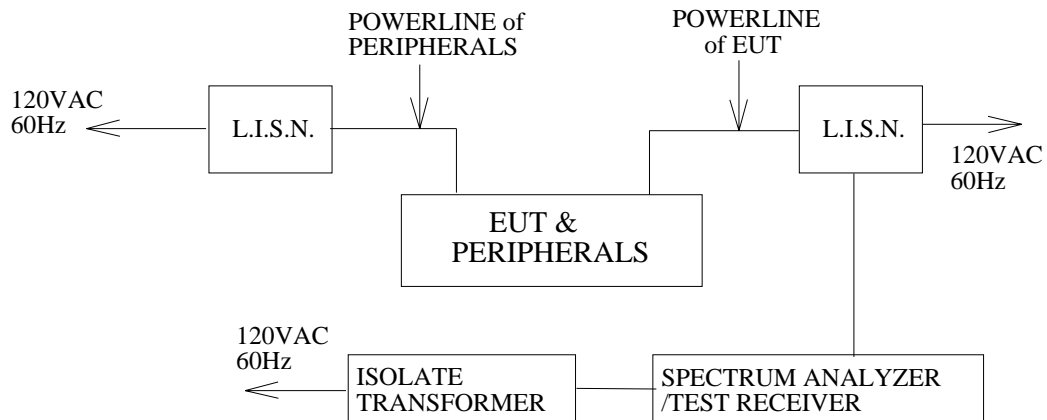

TEST PROCEDURE

The EUT is placed on a non-conducting table 40 cm from the vertical ground plane and 80cm above the horizontal ground plane. The EUT IS CONFIGURED IN ACCORDANCE WITH ANSI C63.4.

The resolution bandwidth is set to 9 kHz for both quasi-peak detection and average detection measurements.

Line conducted data is recorded for both NEUTRAL and LINE.

TEST RESULTS

No non-compliance noted.



CONDUCTED RF VOLTAGE MEASUREMENT

Product Name	11n Wall Router	Test Date	2011/10/04
Model	WA982n	Test By	Shiang Su
Test Mode	Normal Operation	TEMP & Humidity	26.1°C,47%

LINE

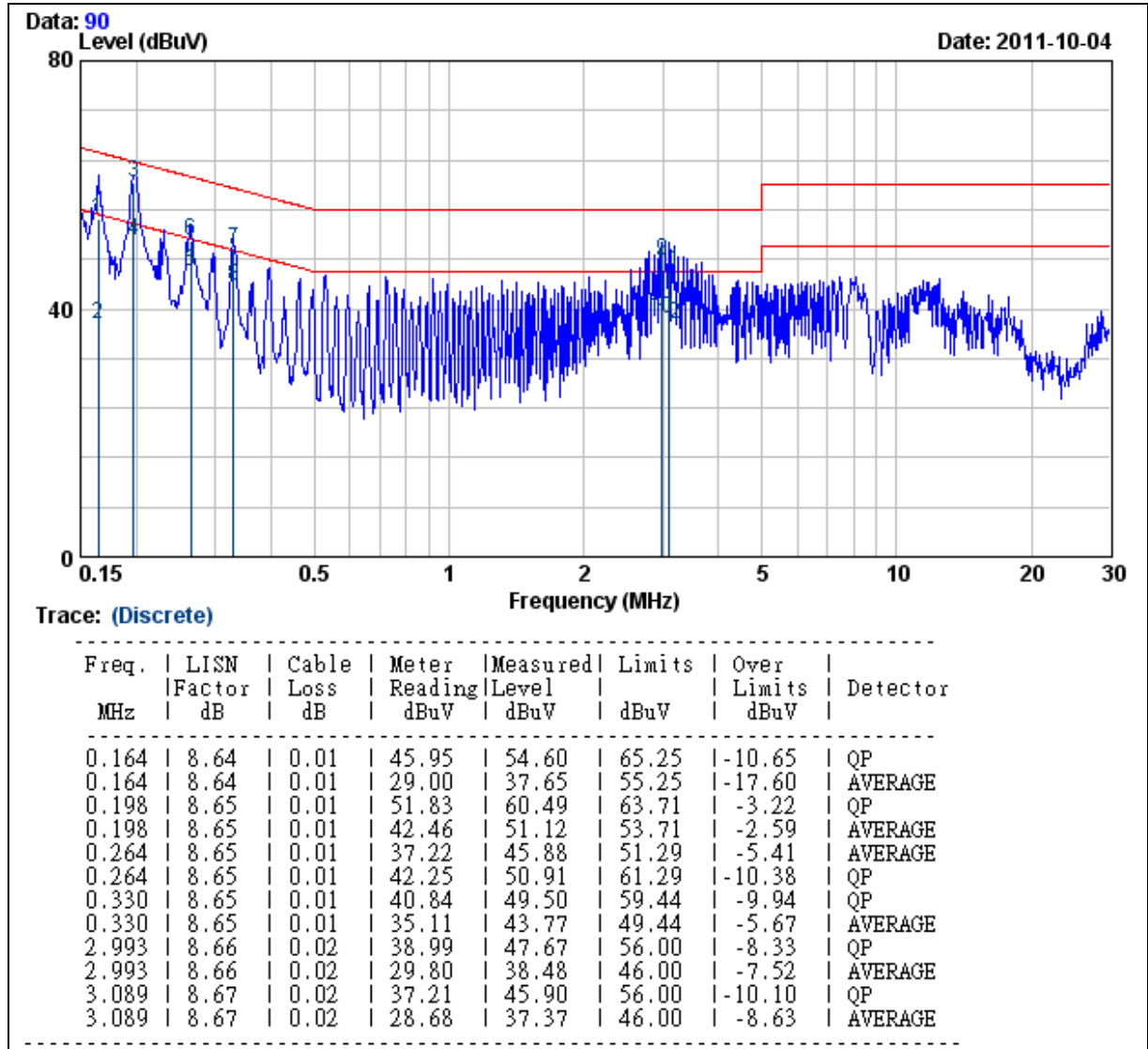

REMARK:

1. Correction Factor = Insertion loss + cable loss
2. Margin value = Emission level – Limit value



Product Name	11n Wall Router	Test Date	2011/10/04
Model	WA982n	Test By	Shiang Su
Test Mode	Normal Operation	TEMP & Humidity	26.1°C, 47%

NEUTRAL

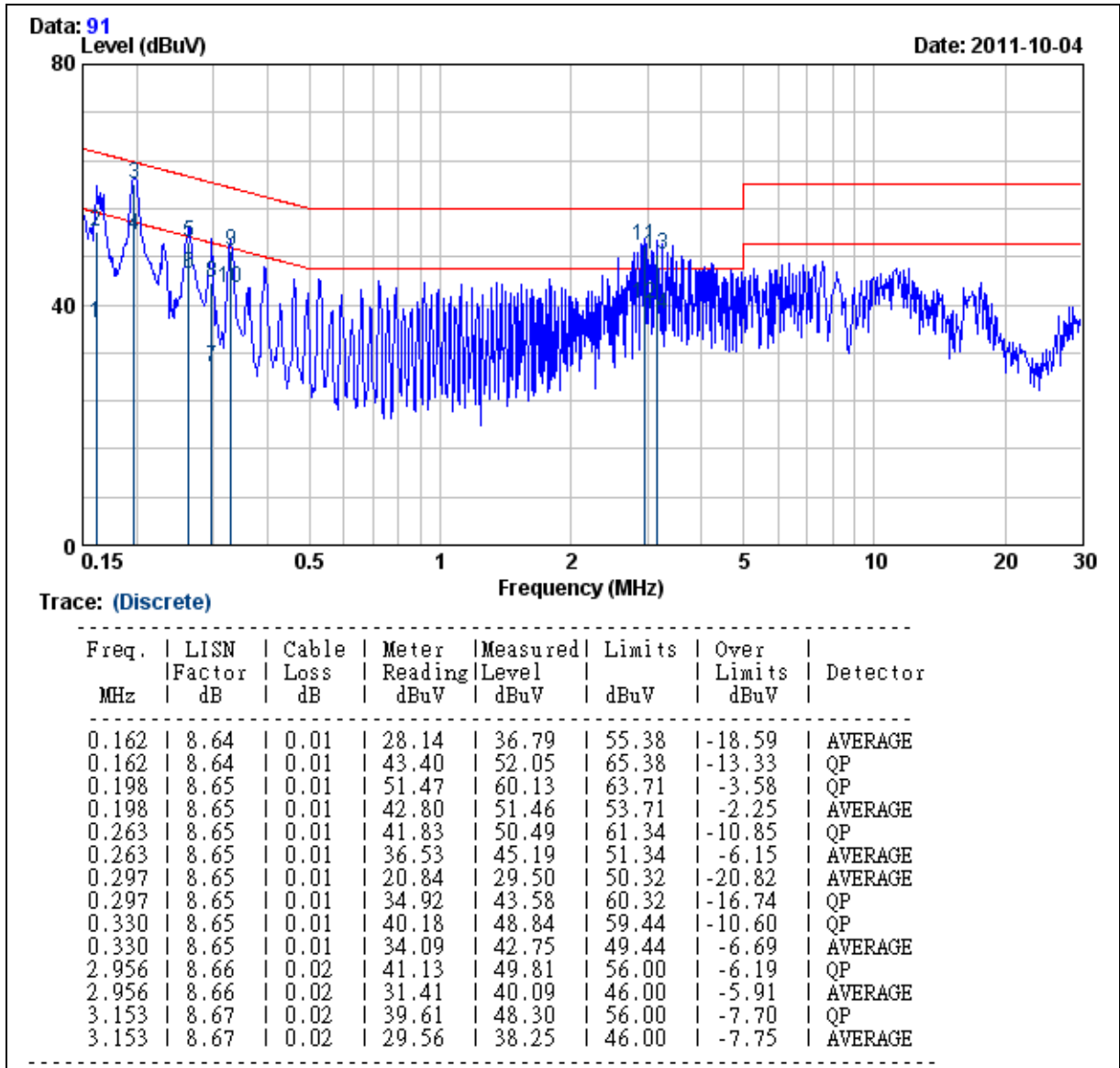

REMARK:

1. Correction Factor = Insertion loss + cable loss
2. Margin value = Emission level – Limit value



9. ANTENNA REQUIREMENT

9.1 STANDARD APPLICABLE

For intentional device, according to FCC 47 CFR Section 15.203, an intentional radiator shall be designed to ensure that no antenna other than that furnished by the responsible party shall be used with the device.

And according to FCC 47 CFR Section 15.247 (b), if transmitting antennas of directional gain greater than 6dBi are used, the power shall be reduced by the amount in dB that the directional gain of the antenna exceeds 6dBi.

9.2 ANTENNA CONNECTED CONSTRUCTION

Two antenna

Antenna 1

Model: 98152MRSX008

Manufacture: Master Wave Technology Co., Ltd.

Connector: RP SMA Plug

Type: Dipole

Gain: 3dBi

Antenna 2

Model: AN-152NRSU00

Manufacture: XinXieTechnology(SHENZHEN) Co., Ltd.

Connector: Reverse SMA Plug

Type: Co-linear dipole structure

Gain: 3dBi