



**FCC 47 CFR PART 15 SUBPART E AND ANSI C63.4:2003  
TEST REPORT**

**For**

**300+300Mbps Gigabit Server Router**

**Model : GS293d**

**Trade Name : E-TOP**

**Issued for**

**E-Top Network Technology Inc.**

No. 82 , Gongye 2nd Rd., Tainan City 70955, Taiwan, R.O.C.

**Issued by**

**Compliance Certification Services Inc.**

**Tainan Lab.**

**No.8,Jiucengling, Xinhua Dist., Tainan City 712, Taiwan (R.O.C.)**

**TEL: 886-6-580-2201**

**FAX: 886-6-580-2202**

**Issued Date: March 01, 2012**

**Note:** This report shall not be reproduced except in full, without the written approval of Compliance Certification Services Inc. This document may be altered or revised by Compliance Certification Services Inc. personnel only, and shall be noted in the revision section of the document. The client should not use it to claim product endorsement by TAF or any government agencies. The test results of this report relate only to the tested sample identified in this report.



## Revision History

Rev.	Issue Date	Revisions	Effect Page	Revised By
00	February 08, 2012	Initial Issue	ALL	Sunny Chang
01	March 01, 2012	Update test methodolog	Page 7	Sunny Chang



**TABLE OF CONTENTS**

TITLE	PAGE NO.
<b>1. TEST REPORT CERTIFICATION .....</b>	<b>4</b>
<b>2. EUT DESCRIPTION .....</b>	<b>5</b>
<b>3. DESCRIPTION OF TEST MODES .....</b>	<b>7</b>
<b>4. TEST METHODOLOGY .....</b>	<b>7</b>
<b>5. FACILITIES AND ACCREDITATION .....</b>	<b>8</b>
5.1 FACILITIES .....	8
5.2 ACCREDITATIONS.....	8
5.3 MEASUREMENT UNCERTAINTY .....	9
<b>6. SETUP OF EQUIPMENT UNDER TEST.....</b>	<b>10</b>
<b>7. FCC PART 15.407 REQUIREMENTS .....</b>	<b>13</b>
7.1 26dB BANDWIDTH .....	13
7.2 MAXIMUM CONDUCTED OUTPUT POWER .....	25
7.3 PEAK POWER SPECTRAL DENSITY .....	39
7.4 PEAK EXCURSION .....	51
7.5 CONDUCTED SPURIOUS EMISSION .....	64
7.6 RADIATED EMISSION.....	75
7.7 CONDUCTED EMISSION .....	93
7.8 FREQUENCY STABILITY .....	93
<b>APPENDIX I MAXIMUM PERMISSIBLE EXPOSURE.....</b>	<b>93</b>
<b>APPENDIX II SETUP PHOTOS .....</b>	<b>93</b>



**1. TEST REPORT CERTIFICATION**

**Applicant** : E-Top Network Technology Inc.  
**Address** : No. 82 , Gongye 2nd Rd., Tainan City 70955, Taiwan, R.O.C.  
**Manufacturer** : E-Top Network Technology Inc.  
**Address** : No. 82 , Gongye 2nd Rd., Tainan City 70955, Taiwan, R.O.C.  
**Equipment Under Test** : 300+300Mbps Gigabit Server Router  
**Model** : GS293d  
**Trade Name** : E-TOP  
**Tested Date** : December 21, 2011 ~ December 30, 2011

APPLICABLE STANDARD	
Standard	Test Result
FCC Part 15 Subpart E AND ANSI C63.4:2003	PASS

WE HEREBY CERTIFY THAT: The above equipment has been tested by Compliance Certification Services Inc., and found compliance with the requirements set forth in the technical standards mentioned above. The results of testing in this report apply only to the product/system, which was tested. Other similar equipment will not necessarily produce the same results due to production tolerance and measurement uncertainties.

*Approved by:*

**Jeter Wu**  
Assistant Manager

*Reviewed by:*

**Eric Huang**  
Assistant Section Manager



**2. EUT DESCRIPTION**

<b>Product Name</b>	300+300Mbps Gigabit Server Router
<b>Model Number</b>	GS293d
<b>Brand Name</b>	E-TOP
<b>Identify Number</b>	T11120230801
<b>Received Date</b>	December 02, 2011
<b>Frequency Range</b>	IEEE 802.11a, 802.11n HT20 : 5180MHz ~ 5240MHz, IEEE 802.11n HT40 : 5190MHz ~ 5230MHz,
<b>Transmit Power</b>	IEEE 802.11a : 10.83 dBm ( 12.106 mW ) IEEE 802.11n HT20 : 11.34 dBm ( 13.6012 mW ) IEEE 802.11n HT40 : 10.68 dBm ( 11.685 mW )
<b>Channel Spacing</b>	IEEE 802.11a, 802.11n HT20 : 20MHz IEEE 802.11n HT40 : 20MHz
<b>Channel Number</b>	IEEE 802.11a, 802.11n HT20 : 4 Channels IEEE 802.11n HT40 : 3 Channels
<b>Transmit Data Rate</b>	IEEE 802.11a : 54, 48, 36, 24, 18, 12, 9, 6 Mbps IEEE 802.11n HT20 : 20 :130,117,104,78, 65, 58.5, 52, 39, 26, 19.5, 13, 6.5 Mbps IEEE 802.11n HT40 : 300, 270,243, 216,162 ,135, 121.5, 108, 81, 54, 40.5, 27, 13.5 Mbps
<b>Type of Modulation</b>	IEEE 802.11a : OFDM (64QAM, 16QAM, QPSK, BPSK) IEEE 802.11n HT20/40 : OFDM (64QAM, 16QAM, QPSK, BPSK)
<b>Antenna Type</b>	<b>Two antennas (2TX2RX)</b> Manufacture: YONG-SHUN TECH. CO., LTD. Type: Co-linear dipole structure Model: AN-151RRSU00 Gain: 5dBi for 2.4GHz, 5dBi for 5GHz Connector: Reverse SMA PLUG
<b>Power Rating</b>	12Vdc; 1A(Powered from Adapter)
<b>Power Source</b>	<b>Powered from adapter</b> Model: JKY36-SP1201000 Input: 100-240Vac, 50/60Hz, 0.5A Output: 12Vdc, 1000mA
<b>Test Voltage</b>	120Vac, 60Hz



Operation Frequency:

IEEE 802.11a, 802.11n HT20

UNLICENSED NATIONAL INFORMATION INFRASTRUCTURE (U-NII)			
CHANNEL	MHz	CHANNEL	MHz
36	5180	44	5220
40	5200	48	5240

IEEE 802.11n HT40

UNLICENSED NATIONAL INFORMATION INFRASTRUCTURE (U-NII)			
CHANNEL	MHz	CHANNEL	MHz
38	5190	46	5230
42	5210		

Remark :

1. The sample selected for test was engineering sample that approximated to production product and was provided by manufacturer.
2. For more details, please refer to the User's manual of the EUT.
3. This submittal(s) (test report) is intended for FCC ID: **U6A-GS293D** filing to comply with Section 15.407, of the FCC Part 15, Subpart E Rules.
4. To add a series model is for business necessary. The different of the each model is shown as bellows:

Multiple listing:

Company Name/Address	Brand name	Model	Product Name
E-Top Network Technology Inc. No. 82 ,Gongye 2nd Rd.,Tainan City 70955, Taiwan, R.O.C.	E-TOP	GS293d	300+300Mbps Gigabit Server Router
Amigo Technology Inc. 5F., No.83, Lane 77, Xing-Ai Road, Neihu Dist., Taipei City 114, Taiwan (R.O.C.)	Amigo	GS293d	300+300Mbps Gigabit Server Router
Sapido Technology Inc. No. 383., Sec. 2, Minsheng Rd., West Central District, Tainan 700, Taiwan, R.O.C.	SAPIDO	GR-1738	Simultaneous Dualband Wireless N Gigabit Router - All Broadbands



### 3. DESCRIPTION OF TEST MODES

#### Conducted Emission / Radiated Emission Test (Below 1 GHz)

1. The following test modes were scanned during the preliminary test:

No.	Pre-Test Mode
1	TX Mode

2. After the preliminary scan, the following test mode was found to produce the highest emission level.

Final Test Mode		
Emission	Radiated Emission	TX Mode
	Conducted Emission	TX Mode

*Remark : Then, the above highest emission mode of the configuration of the EUT and cable was chosen for all final test items.*

#### Conducted / Radiated Emission Test (Above 1 GHz)

##### IEEE 802.11a, 802.11n HT20 mode

The EUT had been tested under operating condition.

There are three channels have been tested as following :

Channel	Frequency (MHz)
Low	5180
Middle	5220
High	5240

IEEE 802.11a mode : 6Mbps data rate (worst case) were chosen for full testing.

IEEE 802.11n HT20 mode : 13Mbps data rate (worst case) were chosen for full testing.

##### IEEE 802.11n HT40 mode

The EUT had been tested under operating condition.

There are three channels have been tested as following :

Channel	Frequency (MHz)
Low	5190
Middle	5210
High	5230

IEEE 802.11n HT40 mode : 13.5Mbps data rate (worst case) were chosen for full testing.

### 4. TEST METHODOLOGY

The tests documented in this report were performed in accordance with ANSI C63.4: 2003 and FCC CFR 47, 15.207, 15.209 , 15.407 ,KDB:662911 and KDB:789033 .



## 5. FACILITIES AND ACCREDITATION

### 5.1 FACILITIES

All measurement facilities used to collect the measurement data are located at No.8, Jiucengling, Xinhua Dist., Tainan City 712, Taiwan (R.O.C.)

The sites are constructed in conformance with the requirements of ANSI C63.7, ANSI C63.4 and CISPR Publication 22.

### 5.2 ACCREDITATIONS

Our laboratories are accredited and approved by the following accreditation body according to ISO/IEC 17025.

<b>Taiwan</b>	TAF
---------------	-----

The measuring facility of laboratories has been authorized or registered by the following approval agencies.

<b>Canada</b>	Industry Canada
<b>Germany</b>	TUV NORD
<b>Taiwan</b>	BSMI
<b>USA</b>	FCC

Copies of granted accreditation certificates are available for downloading from our web site, <http://www.ccsrf.com>





### 5.3 MEASUREMENT UNCERTAINTY

The following table is for the measurement uncertainty, which is calculated as per the document CISPR 16-4-2.

PARAMETER	UNCERTAINTY
Radiated Emission, 30 to 200 MHz Test Site : OATS-6	±3.38dB
Radiated Emission, 200 to 1000 MHz Test Site : OATS-6	±3.04dB
Radiated Emission, 1 to 26.5 GHz	± 3.20dB
Power Line Conducted Emission	± 2.01dB

Uncertainty figures are valid to a confidence level of 95%, K=2

**6. SETUP OF EQUIPMENT UNDER TEST****SUPPORT EQUIPMENT**

For RF test

No.	Product	Manufacturer	Model No.	Certify No.	Signal cable
1	Note Book	IBM	T43	DoC	Power cable, unshd, 1.6m

No.	Signal cable description	
A	DC Power	Unshielded, 1.2m, 1pcs
B	LAN Cable	Unshielded, 1.0m, 1pcs

For EMI test

No.	Product	Manufacturer	Model No.	Certify No.	Signal cable
1	Note Book	IBM	R51	R33026	Power cable, unshd, 1.6m
2	Note Book	IBM	T43	DoC	Power cable, unshd, 1.6m
3	Note Book	IBM	R50E	DoC	Power cable, unshd, 1.6m
4	Flash Disk	Kingston	DTI/512	DoC	N/A
5	3G Modem	NOVATEL	Qualcomm 3G CDMA	PKRNVWMC7 27	N/A
6	HUB	BARRICAD	SMC7008BR	DoC	Power cable, unshd, 1.6m

No.	Signal cable description	
A	DC Power	Unshielded, 1.2m, 1pcs
B	LAN	Unshielded, 2.0m, 3pcs
C	LAN	Unshielded, 10m, 1pcs
D	LAN	Unshielded, 10m, 1pcs



**SETUP DIAGRAM FOR TESTS**

**For RF test**

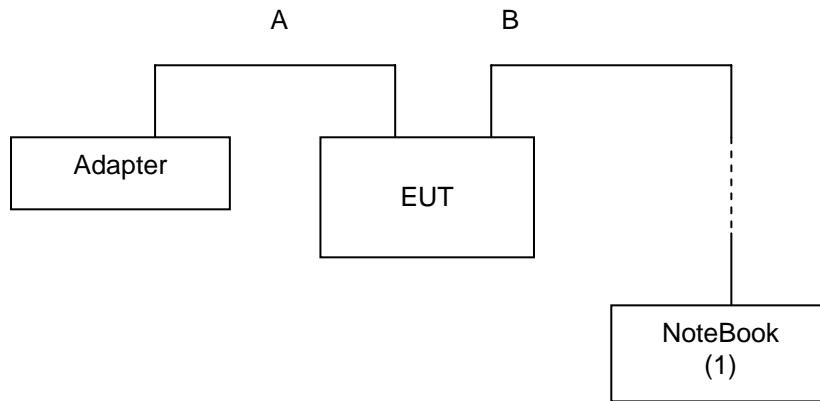

**For EMI test**

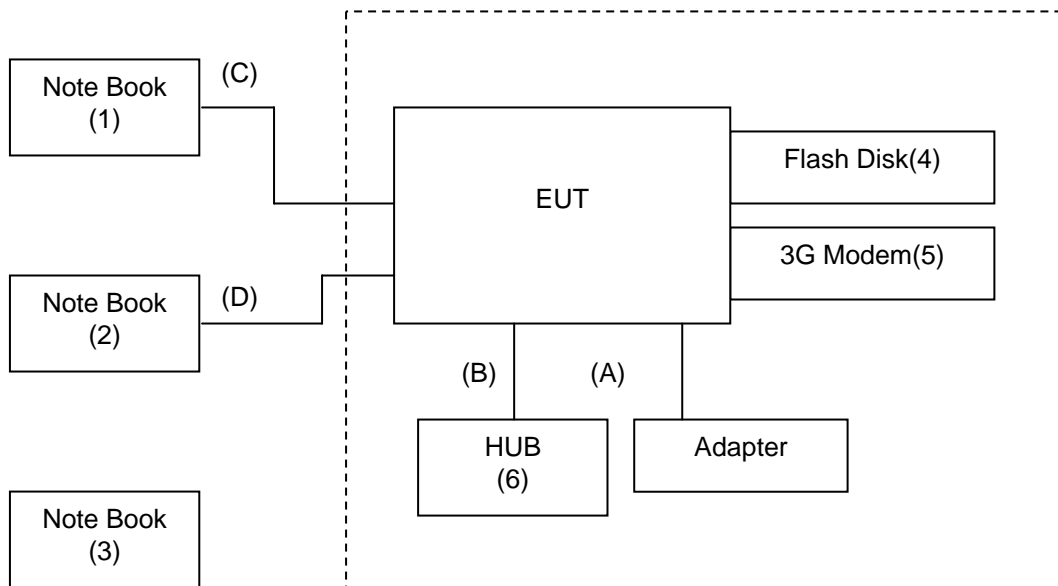



**EUT OPERATING CONDITION**

**RF Setup**

1. Set up all computers like the setup diagram.
2. Reset equipment and burn in the test program "MP\_Test".
3. The "Realtek Test Program for "RTL819x " software was used for testing  
The EUT driver software installed in the host support equipment during testing was Realtek Test Program for RTL819x Drive

**(1)TX Mode:**

- ⇒ **IC Type: RTL\_8192C+D**
- ⇒ **Mode:5G/DualMac**
- ⇒ **Dev:WLAN0**
- ⇒ **Test Item :Continuous TX**
- ⇒ **TX POWER: follow "Power Control"**
- ⇒ **Antenna: A Mode A, HT20、 HT40 Mode AB**
- ⇒ **Tx Data : 6Mbps (IEEE 802.11a mode , TX)**  
**13Mbps (IEEE 802.11n HT20 mode ,chain 0, chain 1 TX)**  
**27Mbps (IEEE 802.11n HT40 mode, chain 0, chain 1 TX)**
- ⇒ **Bandwith: A、 HT20 20MHz, HT40 40MHz**
- ⇒ **Start**

**Target Power:** IEEE 802.11a Channel Low (5180MHz) = **15**  
IEEE 802.11a Channel Middle (5220MHz) = **15**  
IEEE 802.11a Channel High (5240MHz) = **15**

**Target Power:** IEEE 802.11n HT20 Channel Low (5180MHz) = **12 (Chain 0)**  
IEEE 802.11 n HT20 Channel Middle (5220MHz) = **12 (Chain 0)**  
IEEE 802.11 n HT20 Channel High (5240MHz) = **12(Chain 0)**  
IEEE 802.11n HT20 Channel Low (5180MHz) = **08 (Chain 1)**  
IEEE 802.11 n HT20 Channel Middle (5220MHz) = **08 (Chain 1)**  
IEEE 802.11 n HT20 Channel High (5240MHz) = **08 (Chain 1)**

**Target Power:** IEEE 802.11n HT40 Channel Low (5190MHz) = **14 (Chain 0)**  
IEEE 802.11 n HT40 Channel Middle (5210MHz) = **14 (Chain 0)**  
IEEE 802.11n HT40 Channel High (5230MHz) = **14 (Chain 0)**  
IEEE 802.11 n HT40 Channel Low (5190MHz) = **10 (Chain 1)**  
IEEE 802.11n HT40 Channel Middle (5210MHz) = **10 (Chain 1)**  
IEEE 802.11 n HT40 Channel High (5230MHz) = **10 (Chain 1)**

**(2) RX Mode :**

**Test Item packets RX**  
**Start RX**

**(3) Normal Link Setup**

- 1.Set up all computers like the setup diagram.
- 2.All of the function are under run.
- 3.Notebook PC (2) ping 192.168.0.10 -t to Notebook PC (1).
- 4.Notebook PC (1) ping 192.168.0.20 -t to Notebook PC (2).
- 5.Notebook PC (1) ping 192.168.0.50 -t to Wireless Access Point (3).

**Start test.**



## 7. FCC PART 15.407 REQUIREMENTS

### 7.1 26dB BANDWIDTH

#### LIMITS

§ 15.303 © (2), For purposes of this subpart, the emission bandwidth shall be determined by measuring the width of the signal between two points, one below the carrier center frequency and one above the carrier center frequency, that are 26 dB down relative to the maximum level of the modulated carrier. Determination of the emissions bandwidth is based on the use of measurement instrumentation employing a peak detector function with an instrument resolutions bandwidth approximately equal to 1.0 percent of the emission bandwidth of the device under measurement.

#### TEST EQUIPMENT

Name of Equipment	Manufacturer	Model	Serial Number	Calibration Due
Spectrum Analyzer	R&S	FSEK 30	835253/002	SEP. 29, 2012

*Remark: Each piece of equipment is scheduled for calibration once a year*

#### TEST SETUP

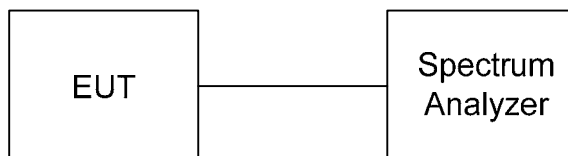

#### TEST PROCEDURE

1. Place the EUT on the table and set it in the transmitting mode.
2. Remove the antenna from the EUT and then connect a low-loss RF cable from the antenna port to the spectrum analyzer.
3. Set the spectrum analyzer as RBW > 1%EBW, VBW > RBW, Span = 50MHz and Sweep = auto.
4. Mark the -26dBc (upper and lower) frequency of the peak value.
5. Repeat until all the rest channels were investigated.



**TEST RESULTS**

**IEEE 802.11a Mode**

Channel	Channel Frequency (MHz)	26dB Bandwidth (MHz)	Pass / Fail
Low	5180	24.449	PASS
Middle	5220	24.248	PASS
High	5240	24.188	PASS

**IEEE 802.11 n HT20 Mode**

Channel	Channel Frequency (MHz)	26dB Bandwidth (MHz)		Pass / Fail
		Chain 0	Chain 1	
Low	5180	24.449	23.246	PASS
Middle	5220	24.349	23.246	PASS
High	5240	23.888	22.886	PASS

**IEEE 802.11 n HT40 Mode**

Channel	Channel Frequency (MHz)	26dB Bandwidth (MHz)		Pass / Fail
		Chain 0	Chain 1	
Low	5190	42.735	42.335	PASS
Middle	5210	42.575	42.174	PASS
High	5230	42.615	42.084	PASS



**26dB BANDWIDTH**

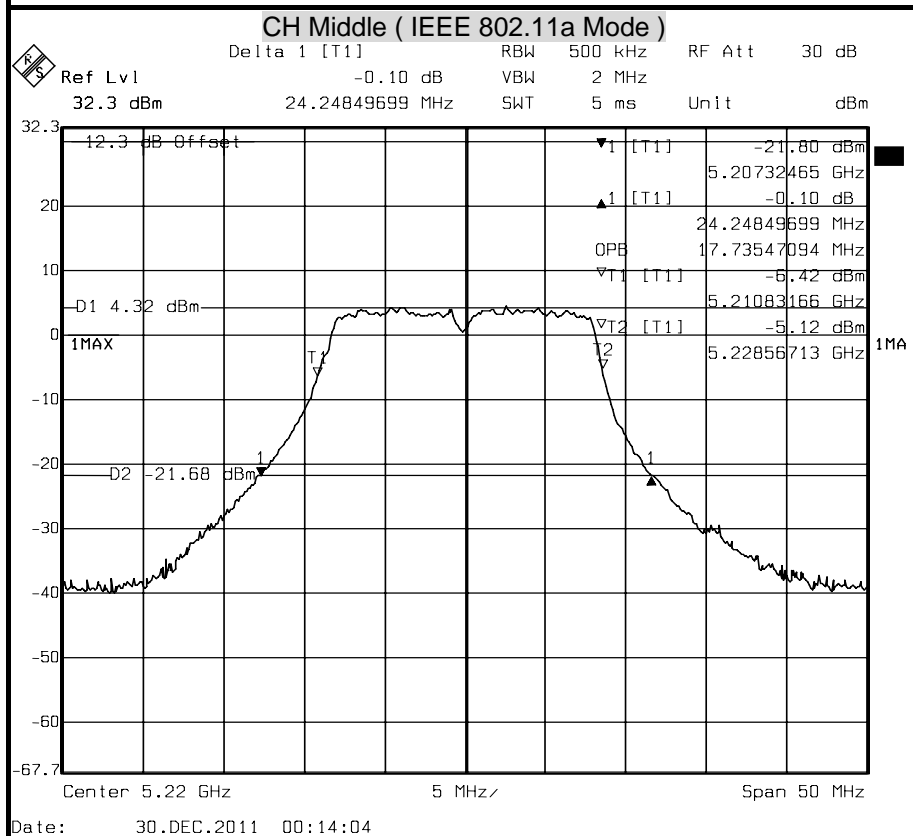
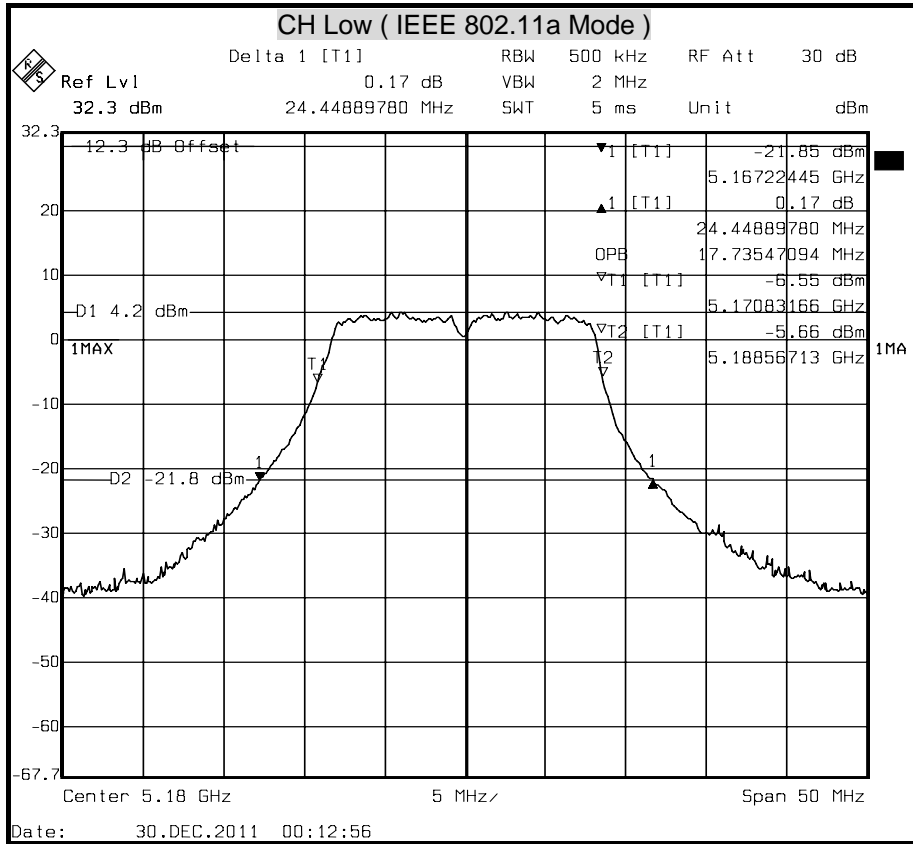

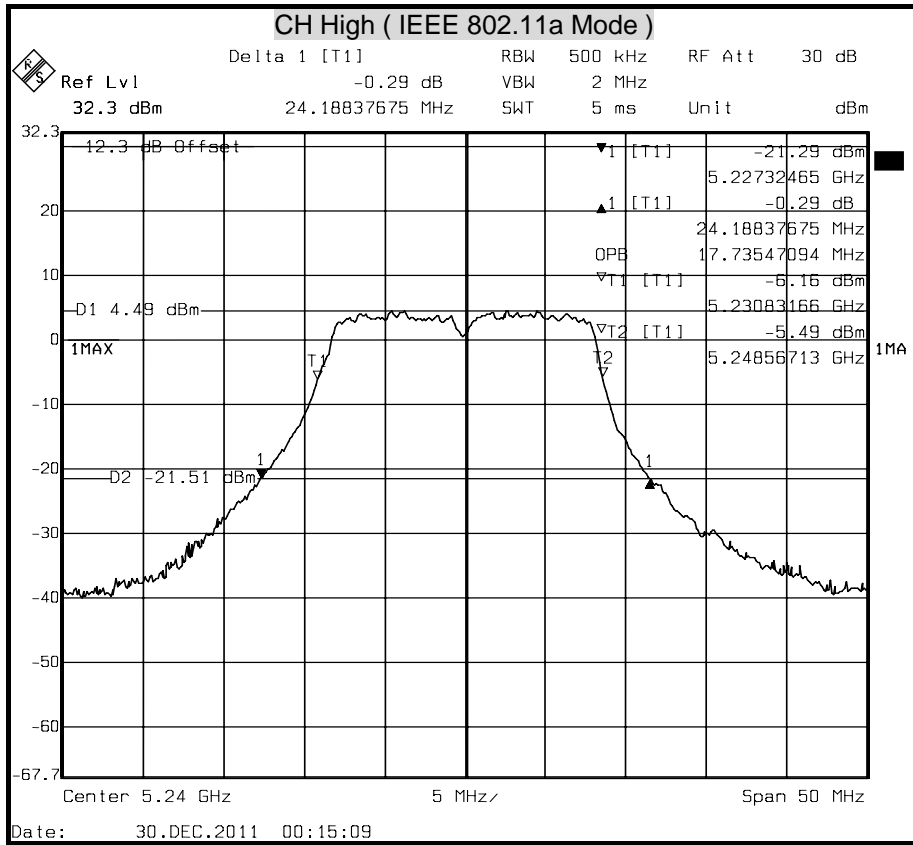



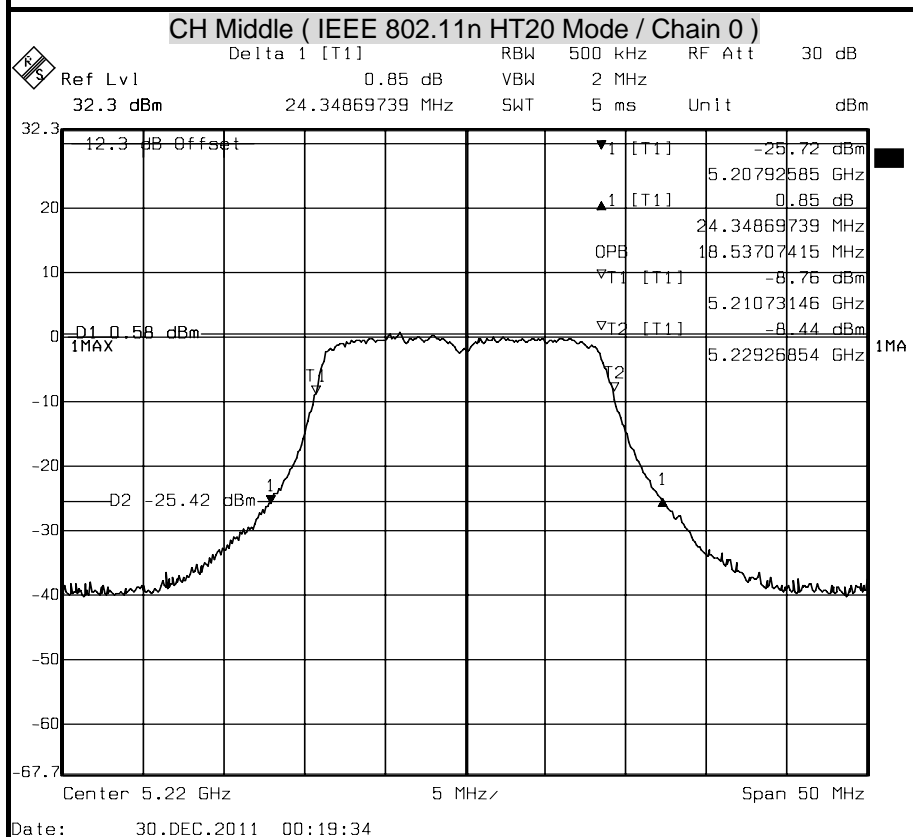
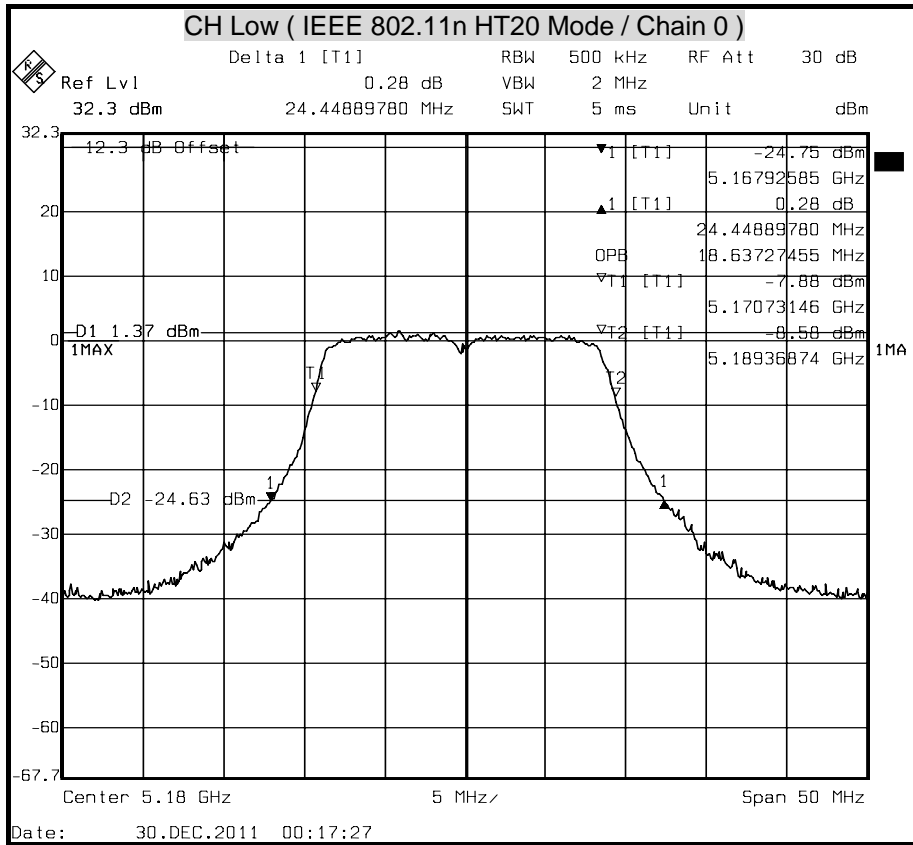

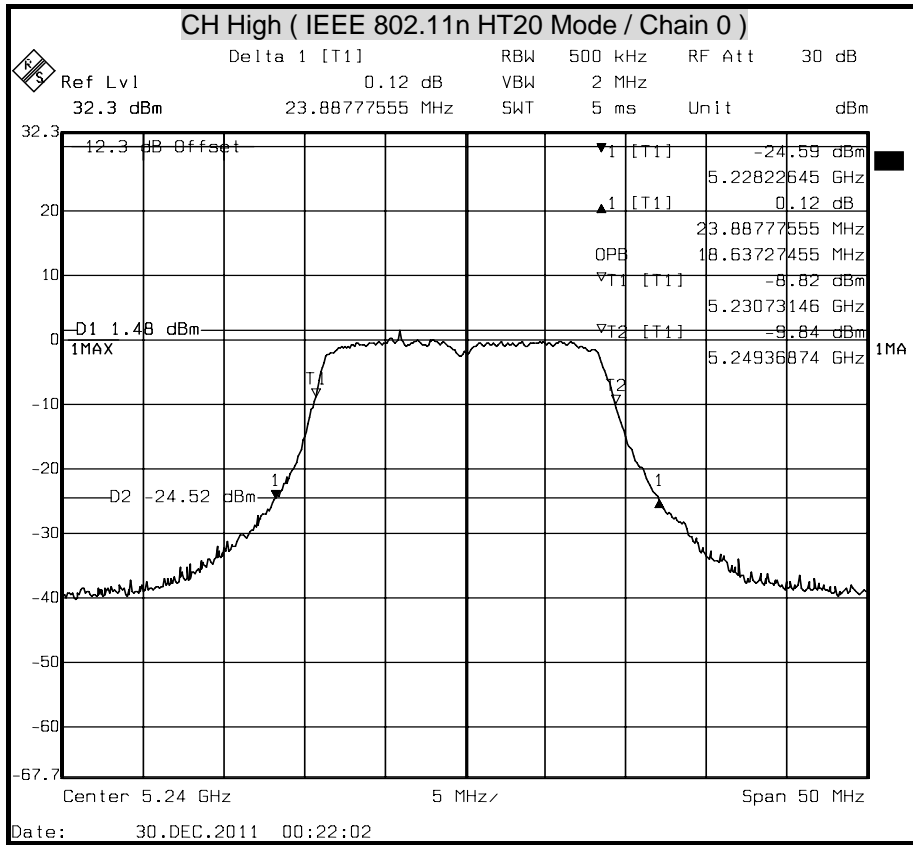

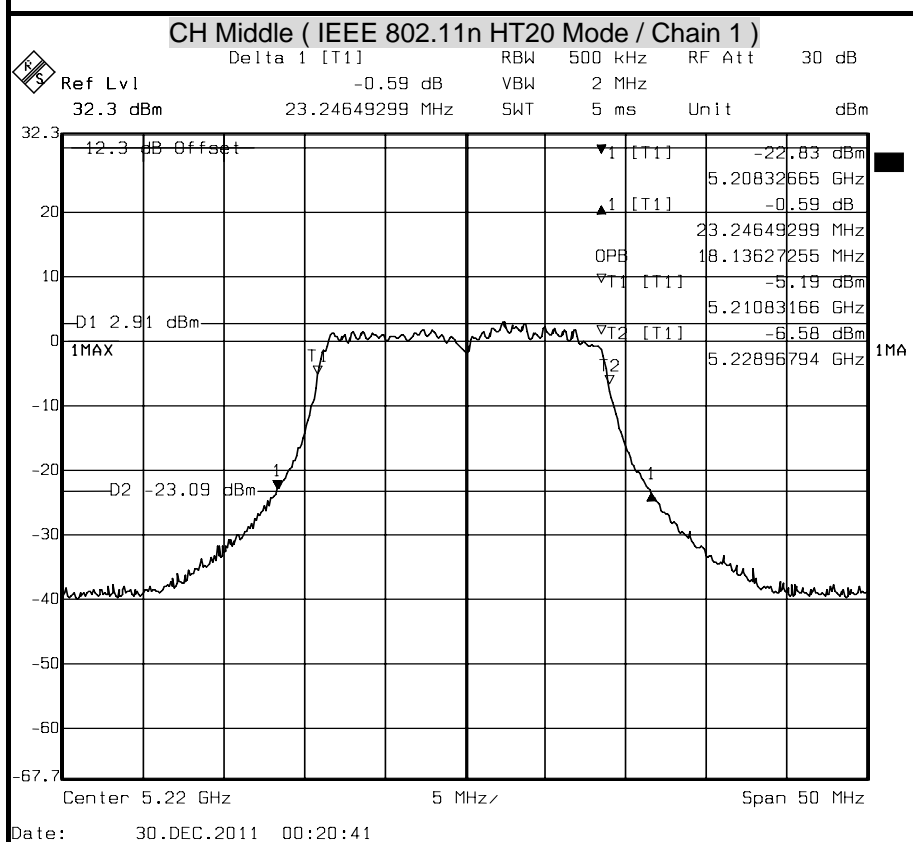
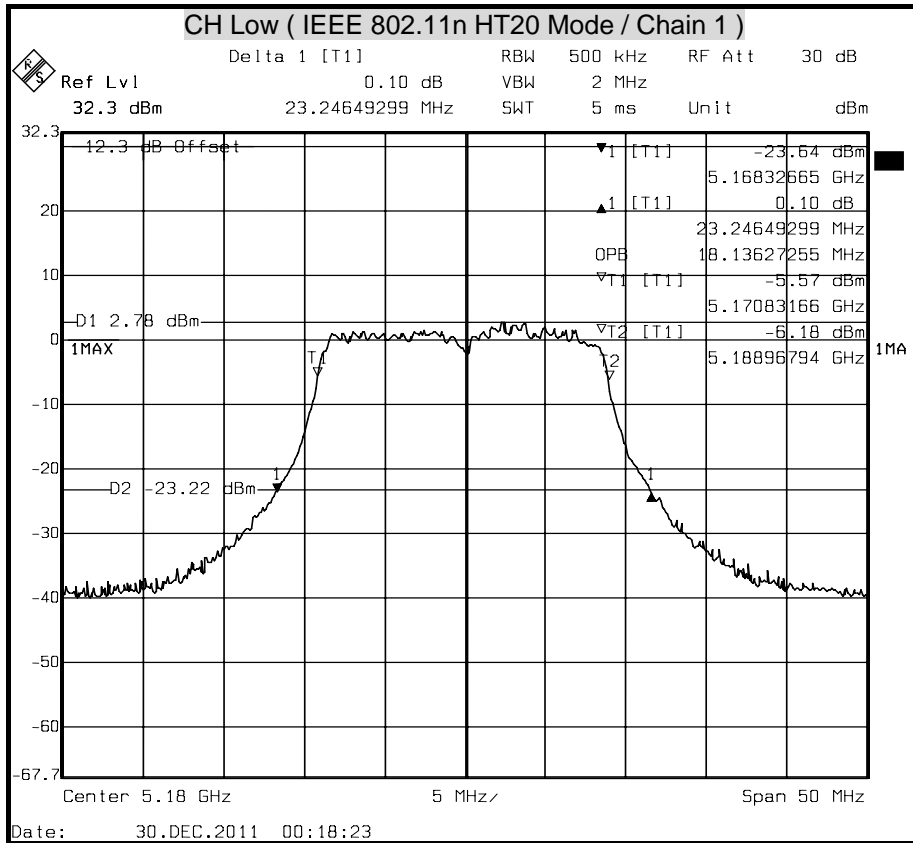

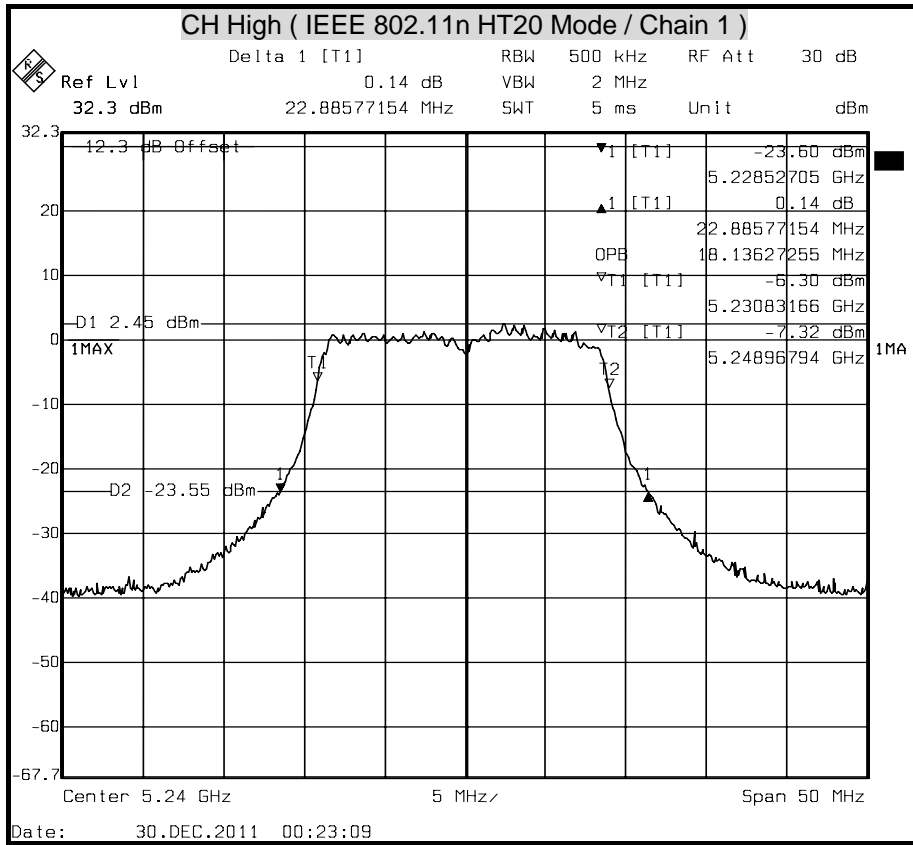

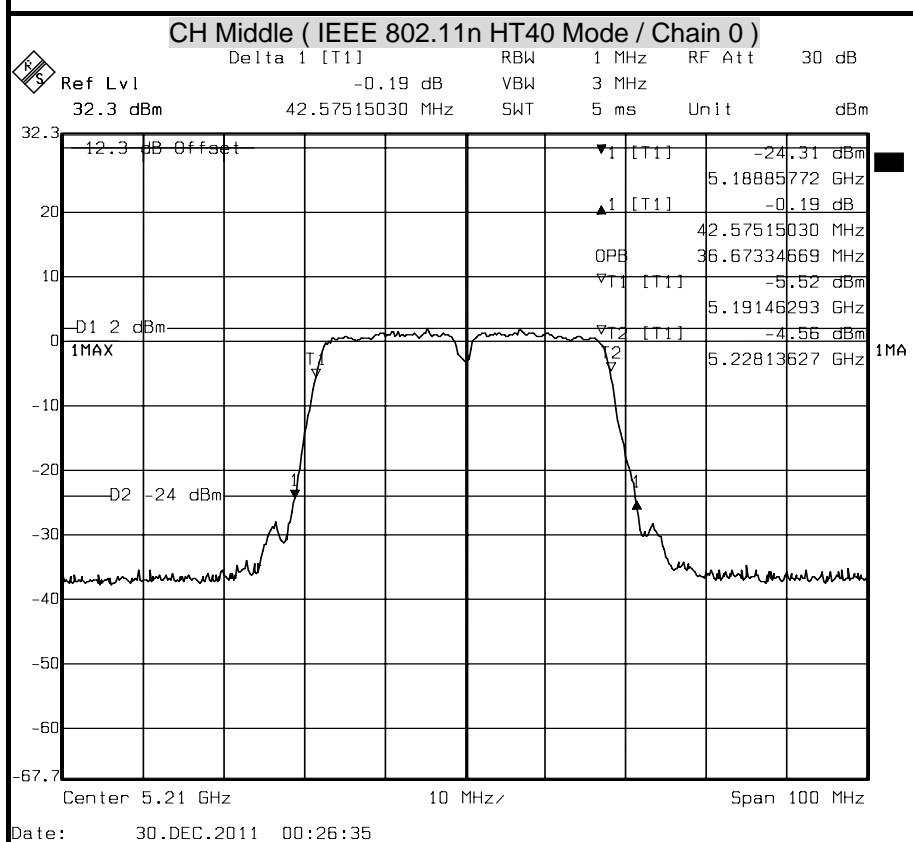
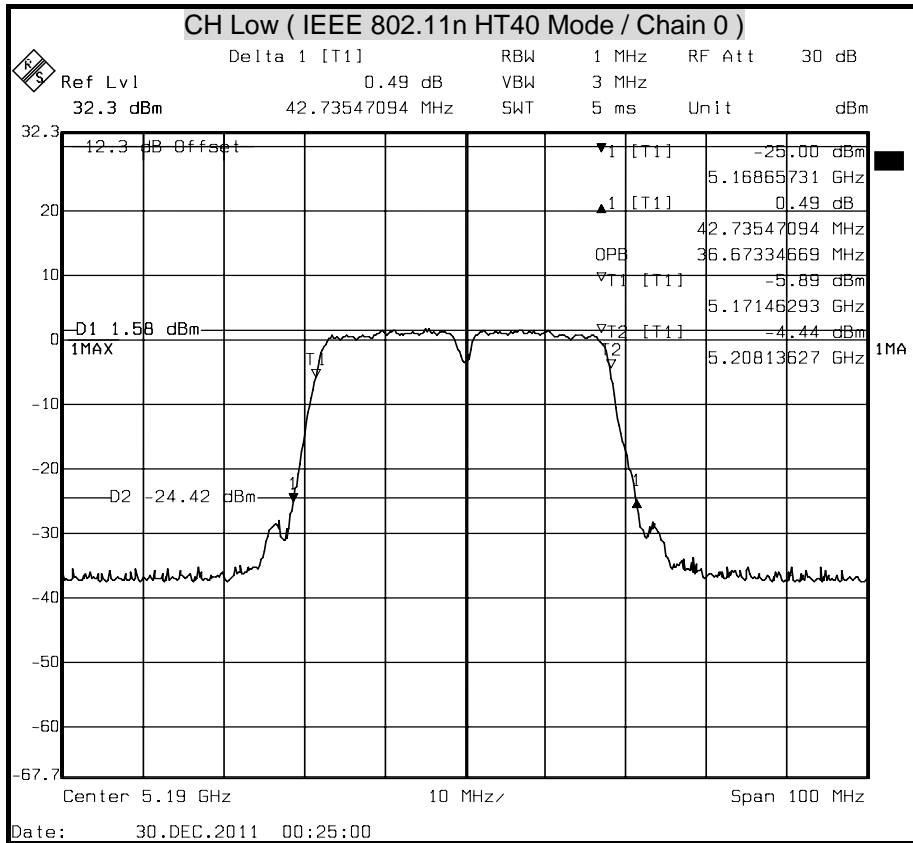

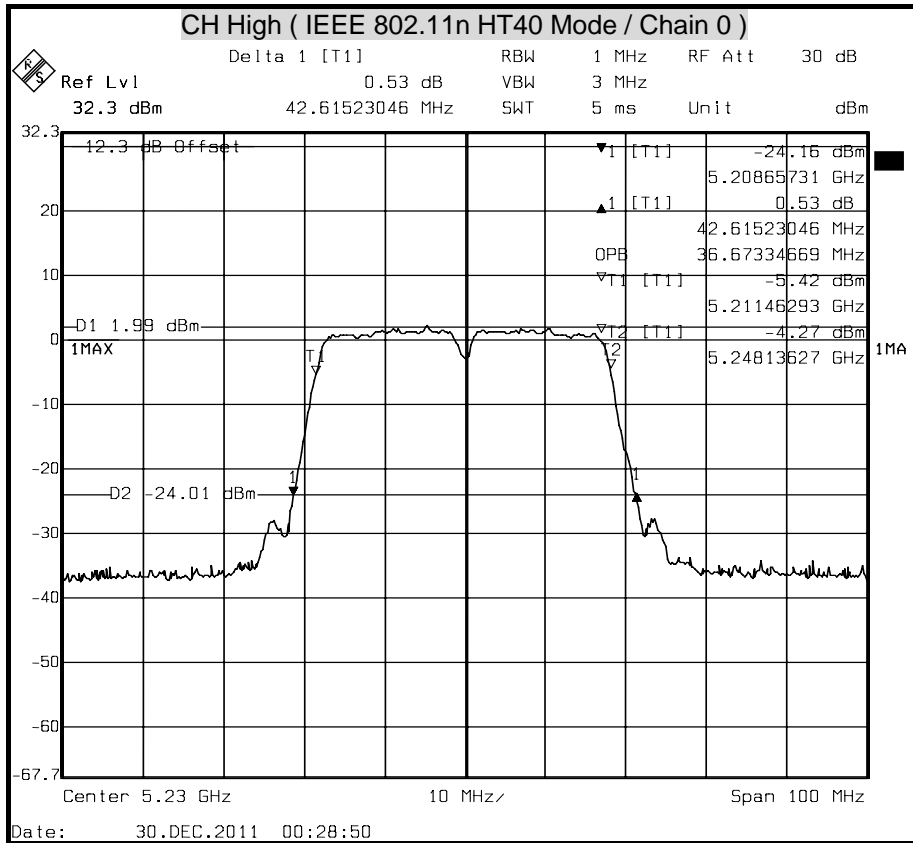

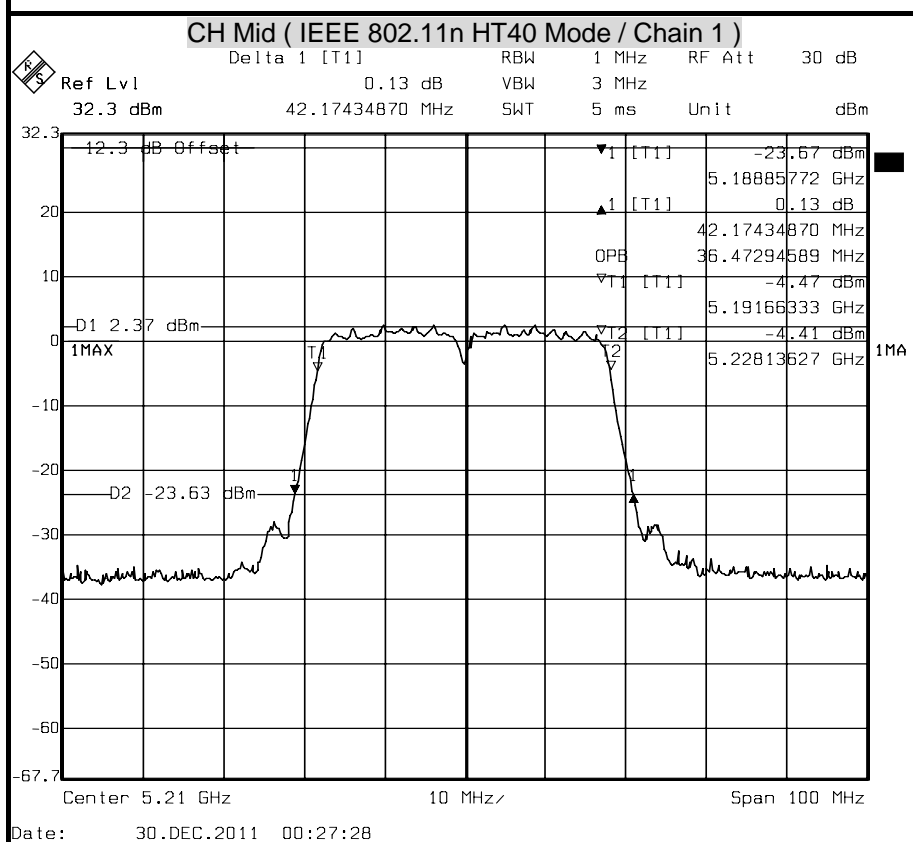
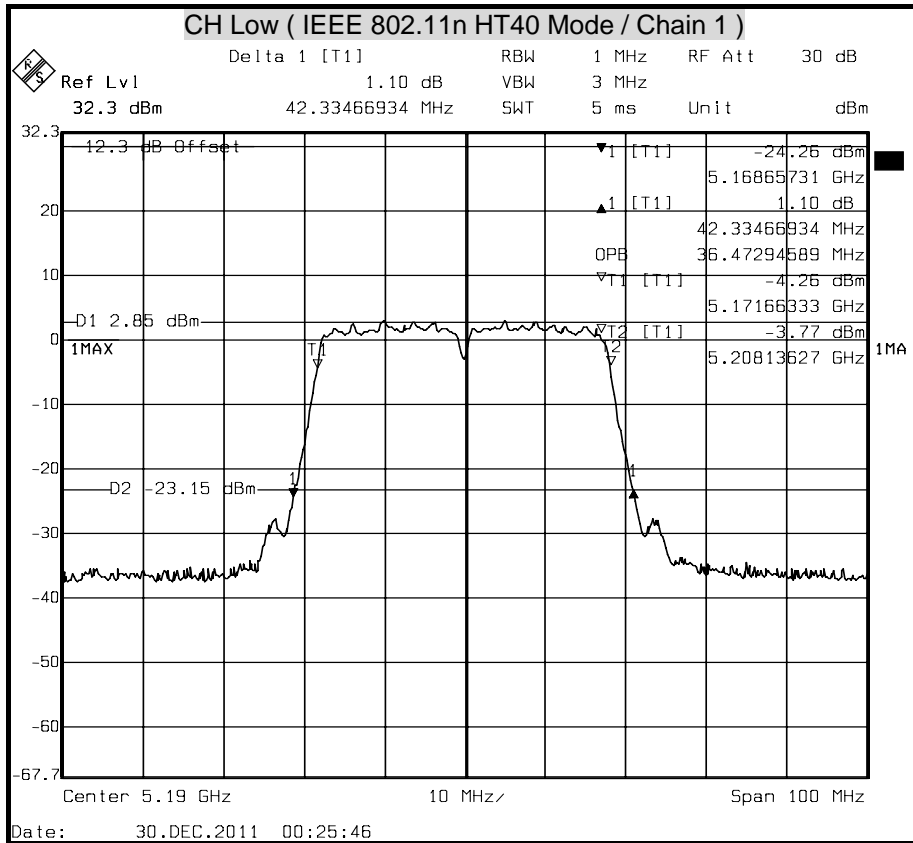

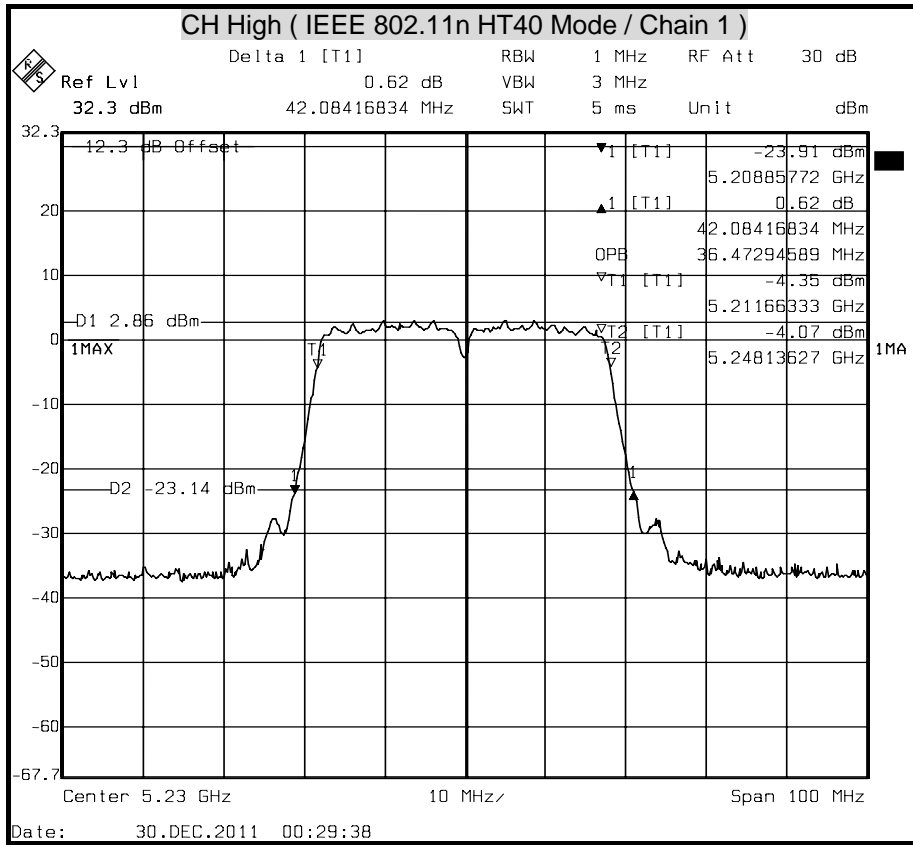





## 7.2 MAXIMUM CONDUCTED OUTPUT POWER

### LIMITS

§ 15.407(a)

- (1) For the band 5.15-5.25 GHz, the peak transmit power over the frequency band of operation shall not exceed the lesser of 50mW (17dBm) or  $4\text{dBm} + 10\log B$ , where B is the 26dB emission bandwidth in MHz. In addition, the peak power spectral density shall not exceed 4dBm in any 1 MHz band.
- (2) For the 5.25-5.35 GHz and 5.47-5.725 GHz bands, the maximum conducted output power over the frequency bands of operation shall not exceed the lesser of 250 mW or  $11\text{ dBm} + 10\log B$ , where B is the 26 dB emission bandwidth in MHz.

If transmitting antennas of directional gain greater than 6dBi are used, both the peak transmit power and the peak power spectral density shall be reduced by the amount in dB that the directional gain of the antenna exceeds 6dBi.



The peak power shall not exceeded the limit as follows:

**IEEE 802.11a mode**

Channel	Channel Frequency (MHz)	26dB Bandwidth (B) (MHz)	10 Log B (dB)	4dBm + 10 Log B (dBm)	Maximum Conducted Output Power Limit (dBm)
Low	5180	24.449	13.88	17.88	17.00
Middle	5220	24.248	13.85	17.85	17.00
High	5240	24.188	13.84	17.84	17.00

**IEEE 802.11n HT20 mode**

Channel	Channel Frequency (MHz)	26dB Bandwidth (B) (MHz)		10 Log B (dB)	4dBm + 10 Log B (dBm)	Maximum Conducted Output Power Limit (dBm)
		Chain 0	Chain 1			
Low	5180	24.449	23.246	13.88	17.88	17.00
Middle	5220	24.349	23.246	13.86	17.86	17.00
High	5240	23.888	22.886	13.78	17.78	17.00

**IEEE 802.11n HT40 mode**

Channel	Channel Frequency (MHz)	26dB Bandwidth (B) (MHz)		10 Log B (dB)	4dBm + 10 Log B (dBm)	Maximum Conducted Output Power Limit (dBm)
		Chain 0	Chain 1			
Low	5190	42.735	42.335	16.31	20.31	17.00
Middle	5210	42.575	42.174	16.29	20.29	17.00
High	5230	42.615	42.084	16.30	20.30	17.00



**TEST EQUIPMENT**

Name of Equipment	Manufacturer	Model	Serial Number	Calibration Due
Spectrum Analyzer	R&S	FSEK 30	835253/002	SEP. 29, 2012

*Remark: Each piece of equipment is scheduled for calibration once a year*

**TEST SETUP**



**TEST PROCEDURE**

Set span to encompass the entire emission bandwidth (EBW) of the signal.

Set RBW = 1 MHz / Set VBW = 3 MHz.

Use sample detector mode if bin width (i.e., span/number of points in spectrum display) < 0.5 RBW. Otherwise use peak detector mode. Use a video trigger with the trigger level set to enable triggering only on full power pulses. Transmitter must operate at full control power for entire sweep of every sweep. If the device transmits continuously, with no off intervals or reduced power intervals, the trigger may be set to “free run”. Trace average 100 traces in power averaging mode. Compute power by integrating the spectrum across the 26 dB EBW of the signal. The integration can be performed using the spectrum analyzer’s band power measurement function with band limits set equal to the EBW band edges or by summing power levels in each 1 MHz band in linear power terms. The 1 MHz band power levels to be summed can be obtained by averaging, in linear power terms, power levels in each frequency bin across the 1 MHz.



**TEST RESULTS**

**IEEE 802.11a Mode**

Channel	Channel Frequency (MHz)	Peak Power		Peak Power Limit (dBm)	Pass / Fail
		(dBm)			
Low	5180	10.83		17	PASS
Middle	5220	10.80		17	PASS
High	5240	10.56		17	PASS

**Remark:**

1. At final test to get the worst-case emission at 6Mbps.
2. The cable assembly insertion loss of 12.3dB (including 10 dB pad and 2.3 dB cable) was Entered as an offset in the spectrum analyzer to allow for direct reading of power.

**IEEE 802.11n HT20 Mode**

Channel	Channel Frequency (MHz)	Peak Power			Peak Power Limit (dBm)	Pass / Fail
		Chain 0	Chain 1	Total		
Low	5180	8.39	8.26	11.34	14.99	PASS
Middle	5220	7.50	7.46	10.49	14.99	PASS
High	5240	7.43	7.55	10.50	14.99	PASS

**Remark:**

1. At final test to get the worst-case emission at 13Mbps.
2. The cable assembly insertion loss of 12.3dB (including 10 dB pad and 2.3 dB cable) was Entered as an offset in the spectrum analyzer to allow for direct reading of power.

**IEEE 802.11n HT40 Mode**

Channel	Channel Frequency (MHz)	Peak Power			Peak Power Limit (dBm)	Pass / Fail
		Chain 0	Chain 1	Total		
Low	5190	8.06	7.20	10.66	14.99	PASS
Middle	5210	8.07	6.79	10.49	14.99	PASS
High	5230	8.19	7.07	10.68	14.99	PASS

**Remark:**

1. At final test to get the worst-case emission at 27Mbps.
2. The cable assembly insertion loss of 12.3dB (including 10 dB pad and 2.3 dB cable) was Entered as an offset in the spectrum analyzer to allow for direct reading of power.



**MAXIMUM CONDUCTED OUTPUT POWER**

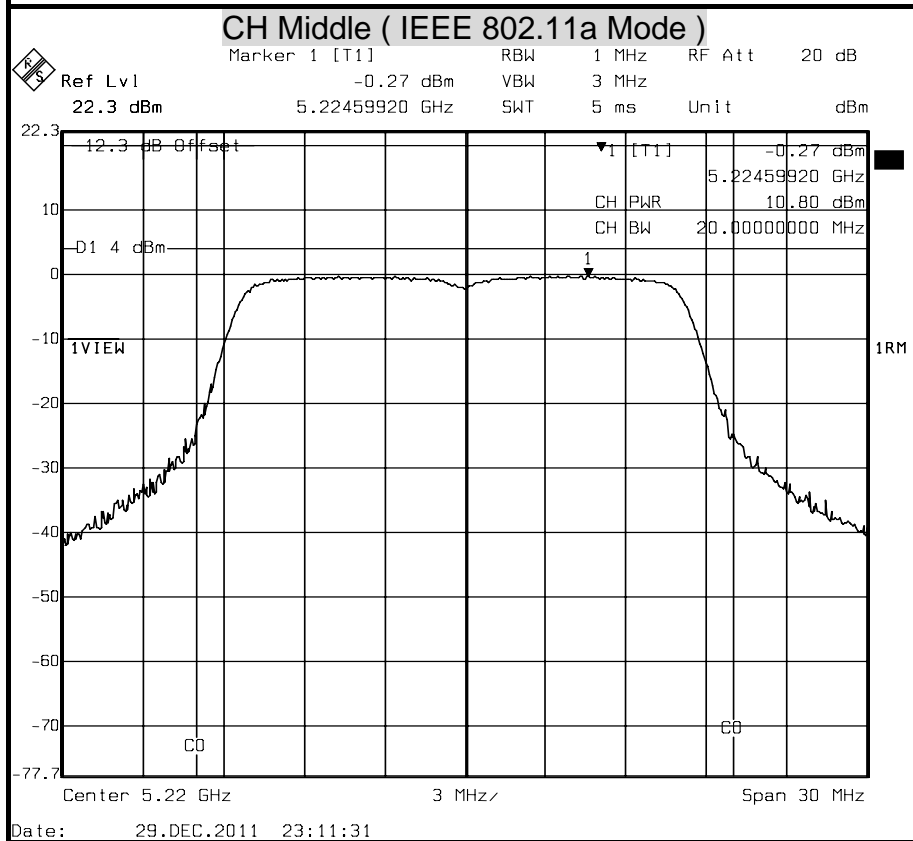
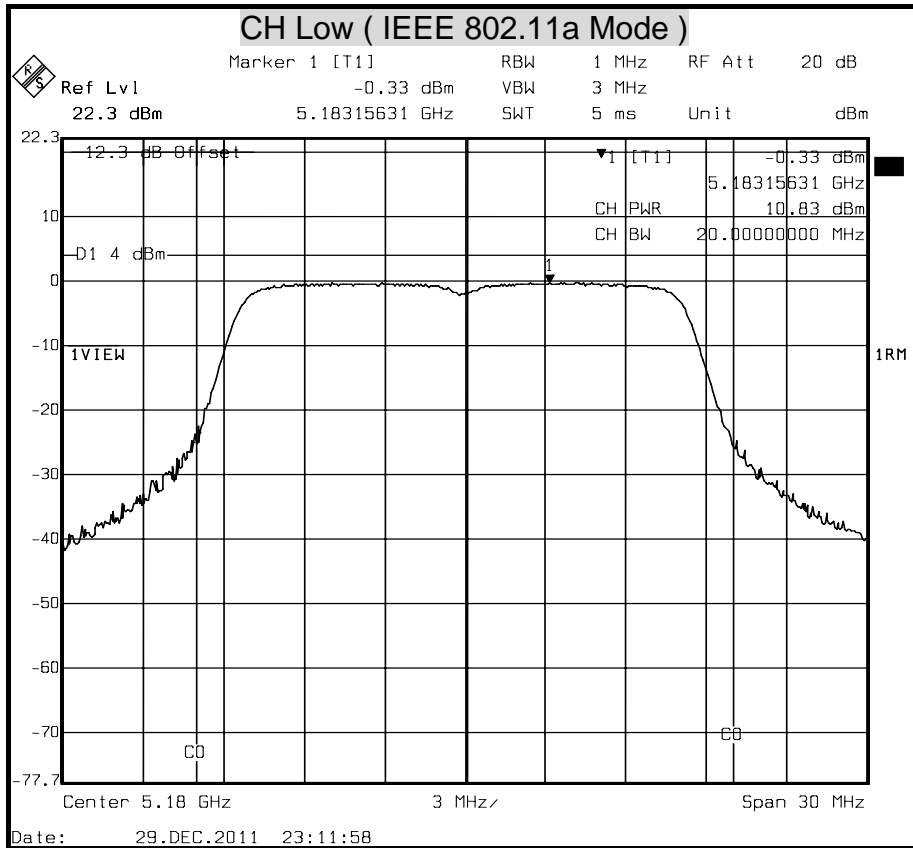

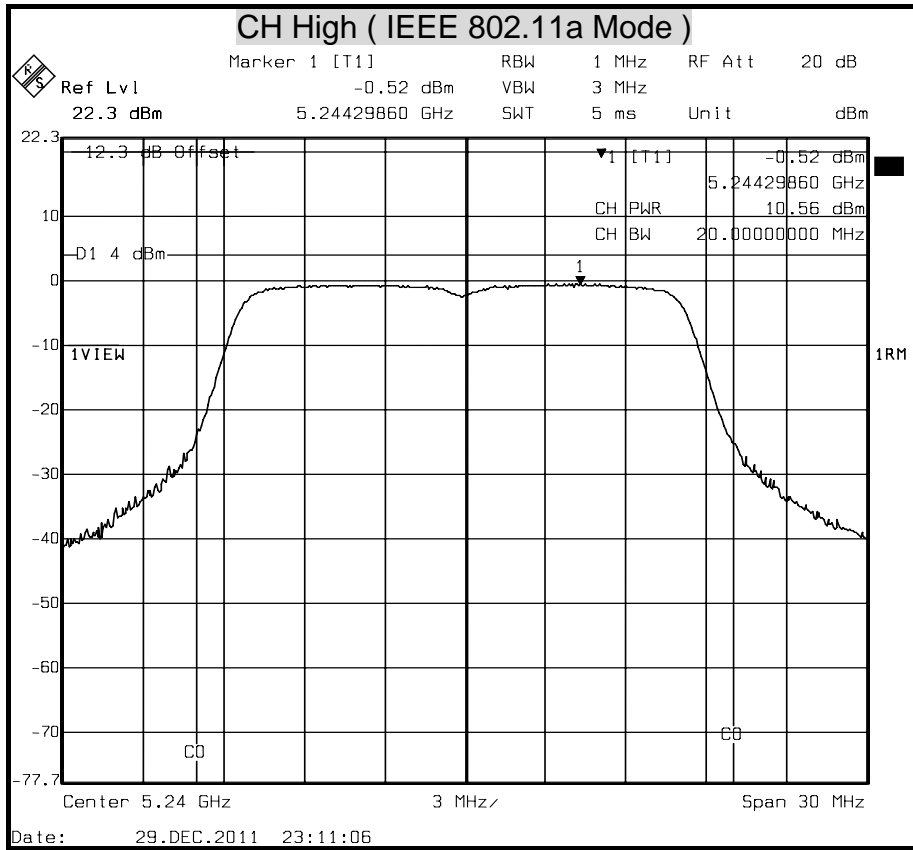

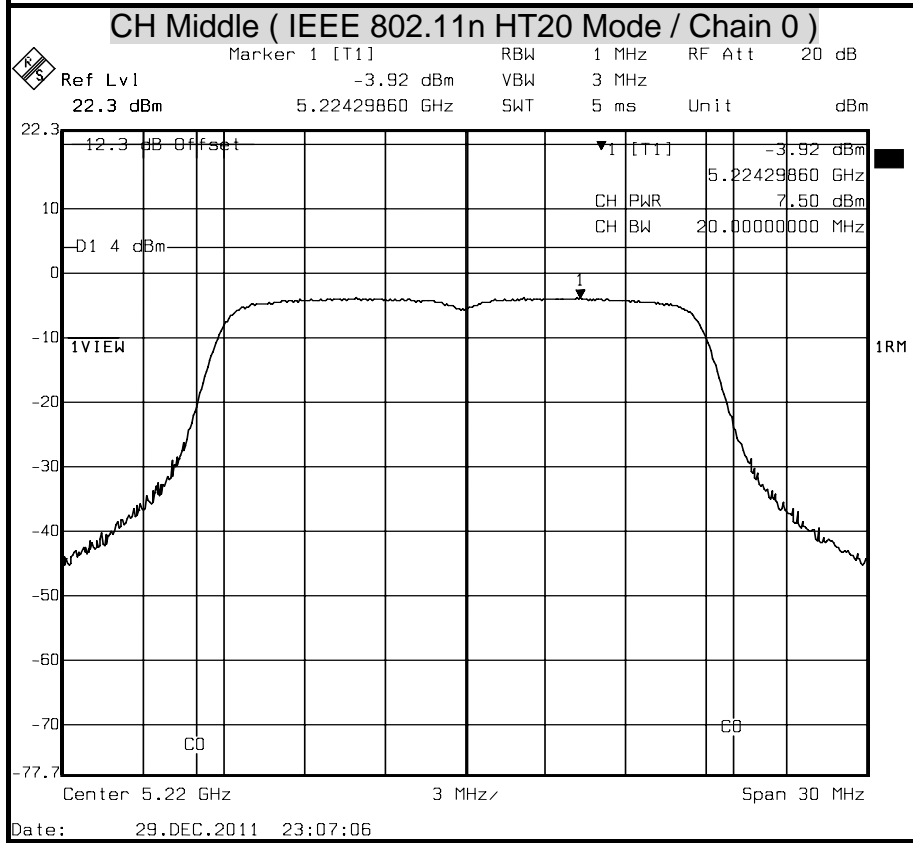
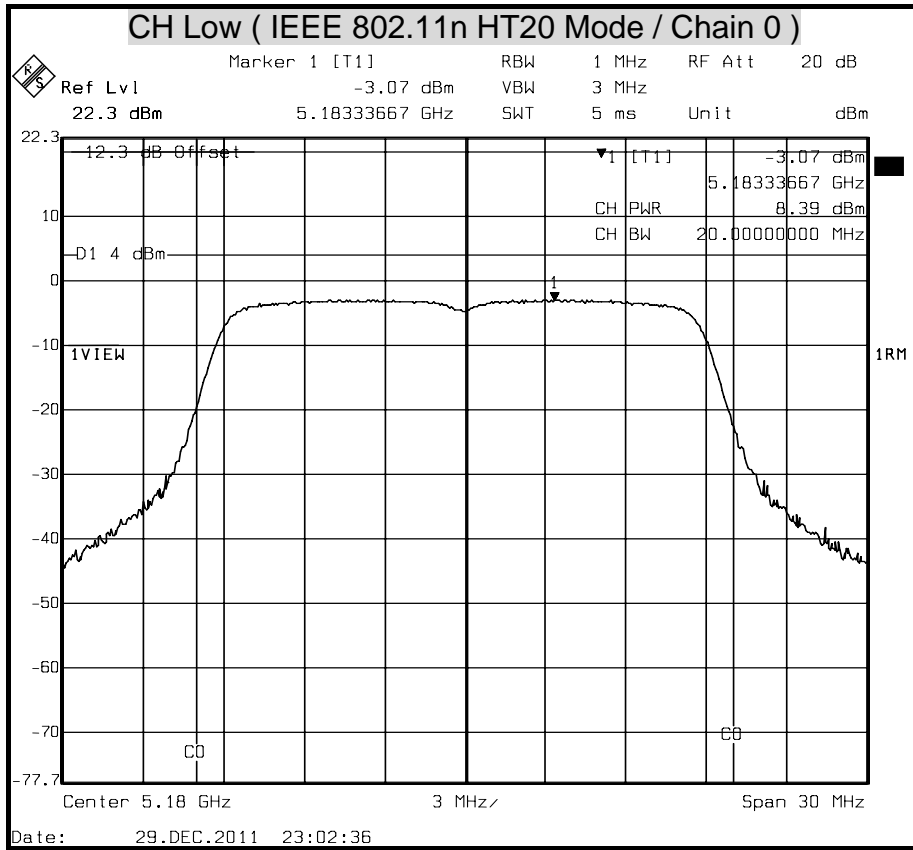

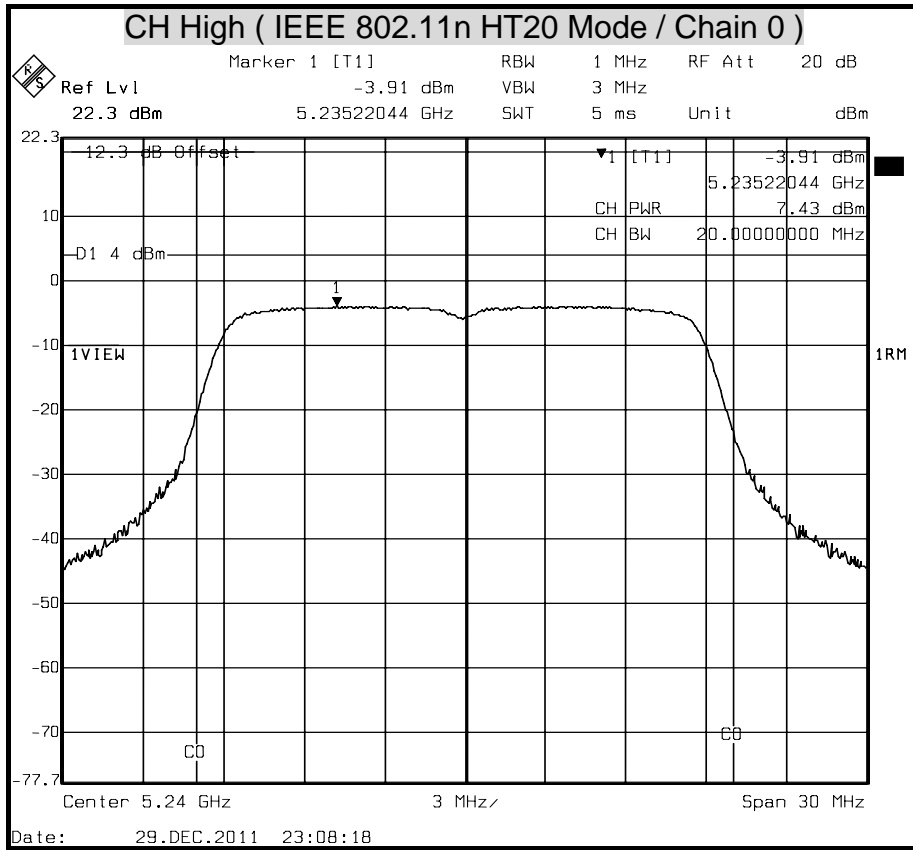



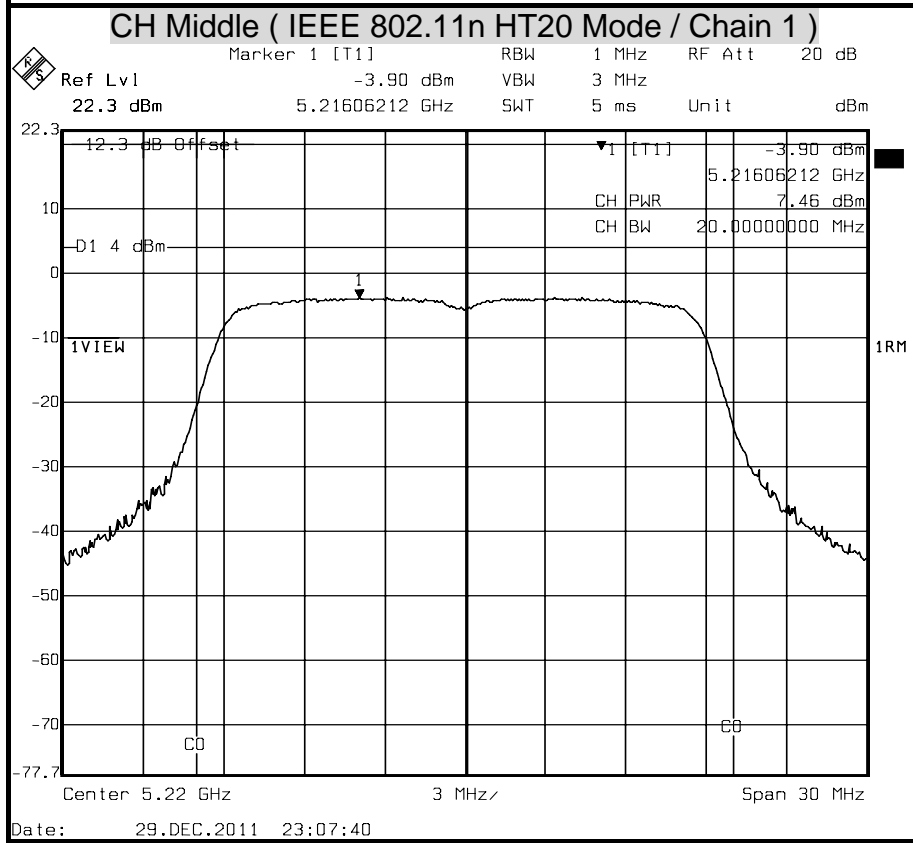
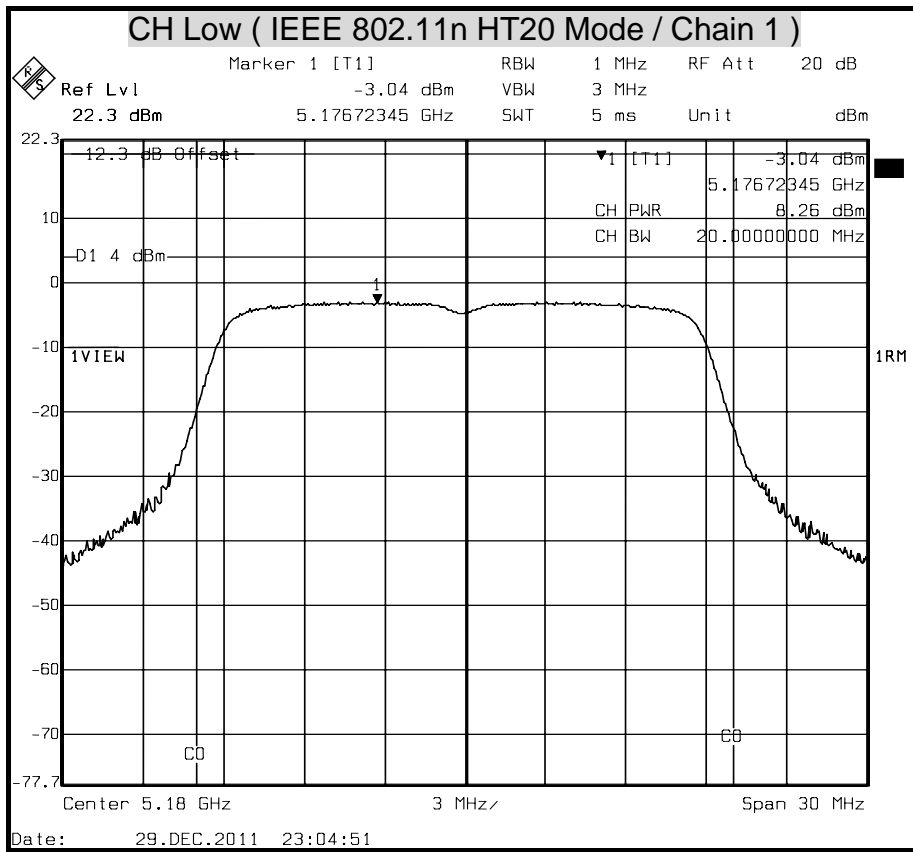

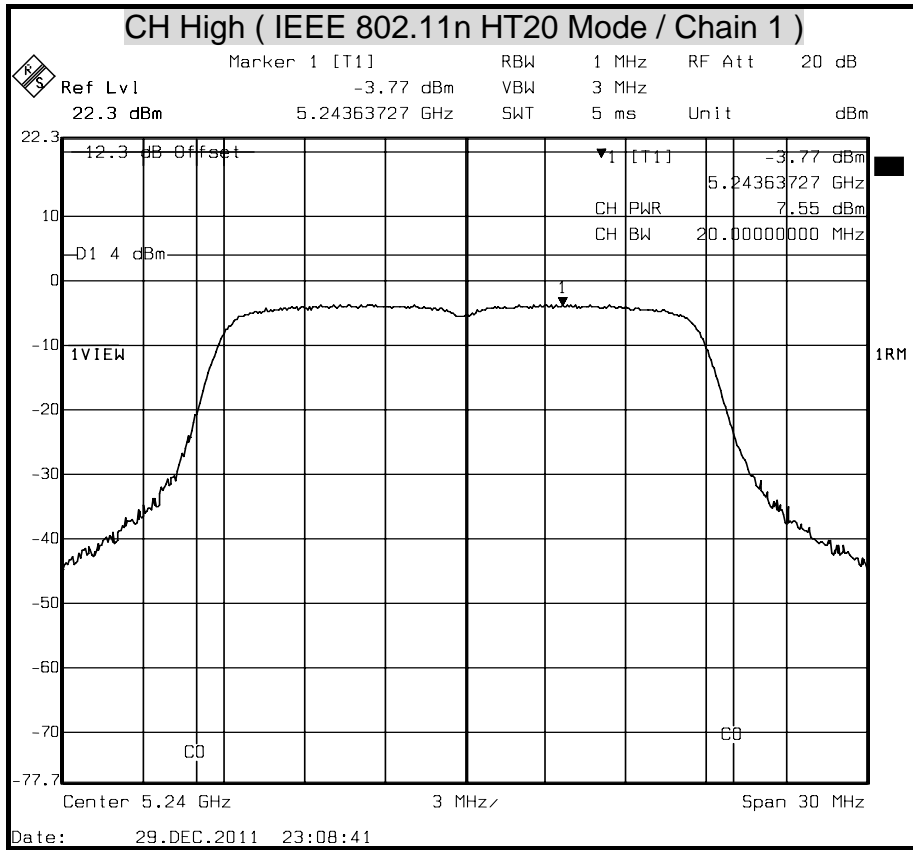

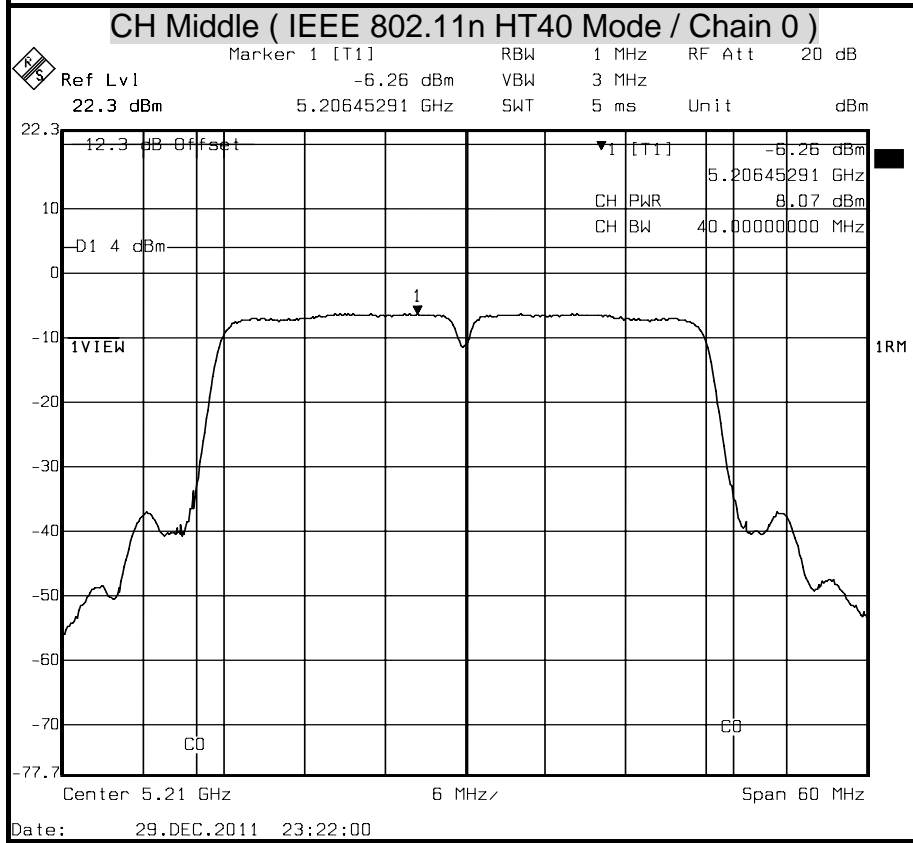
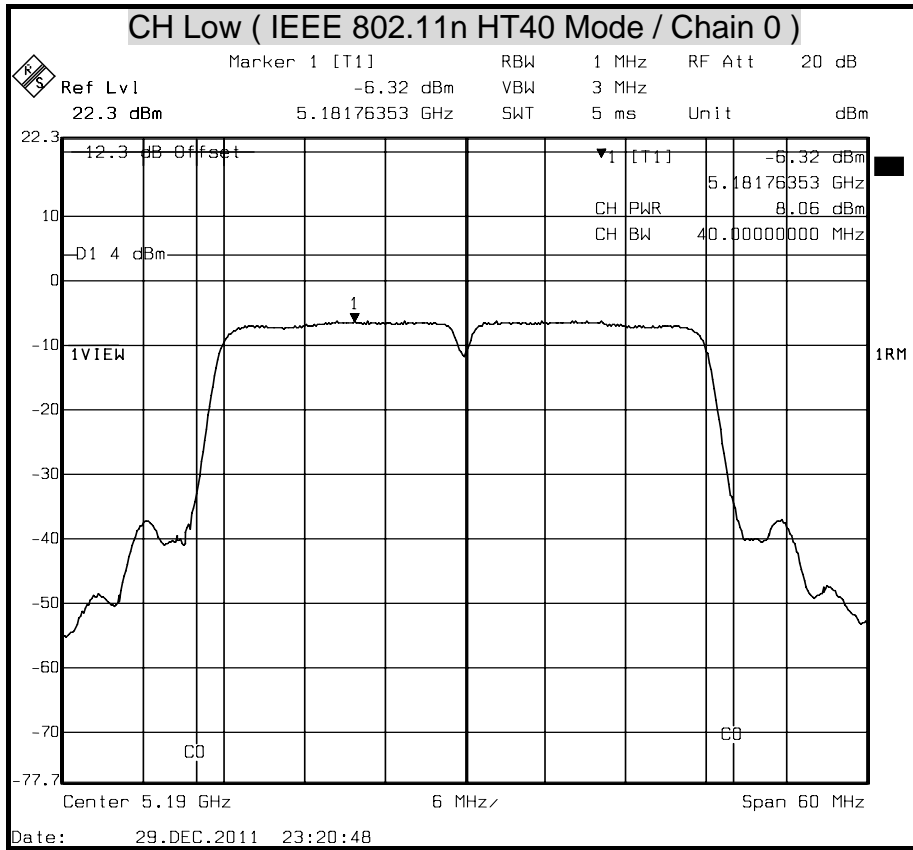

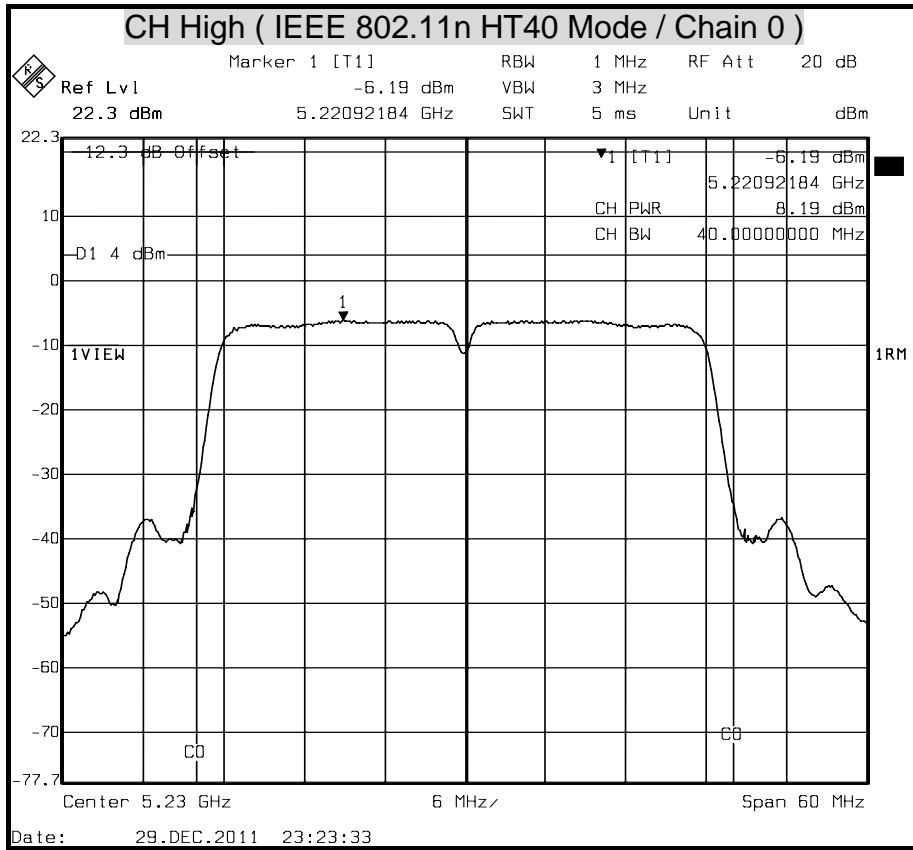

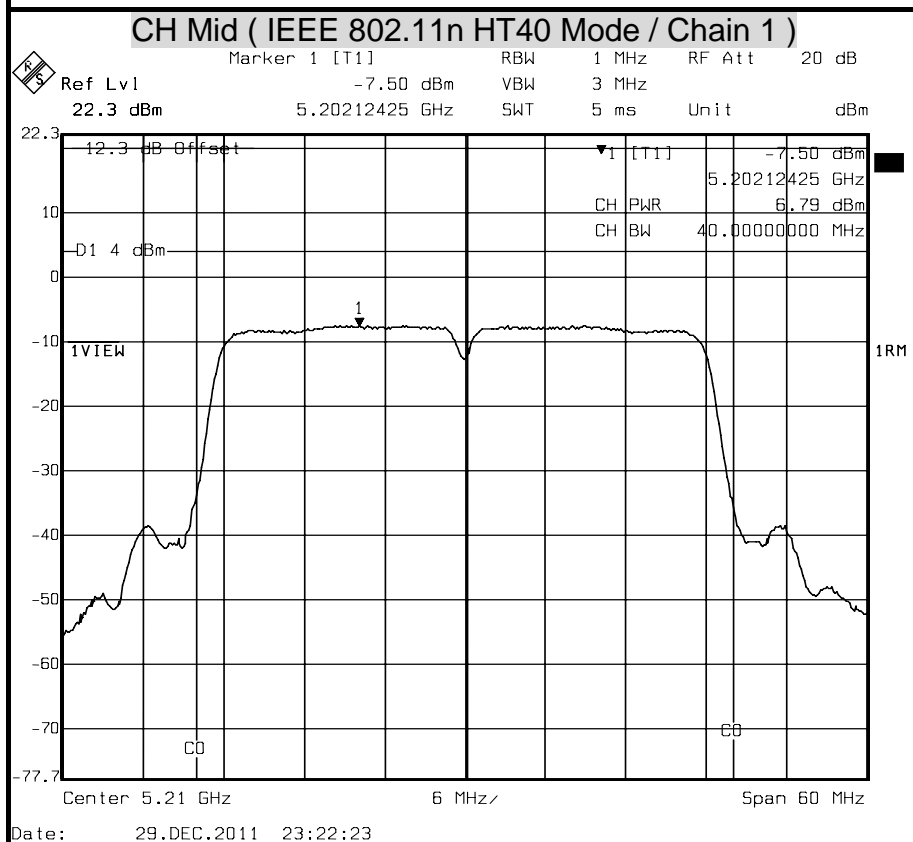
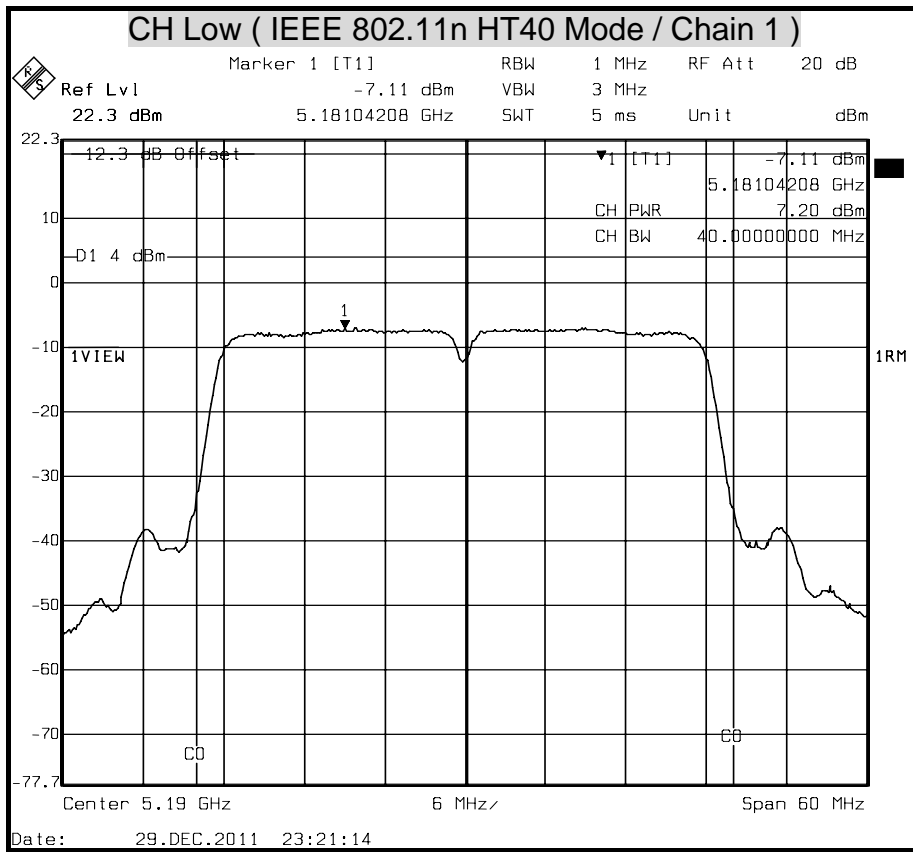

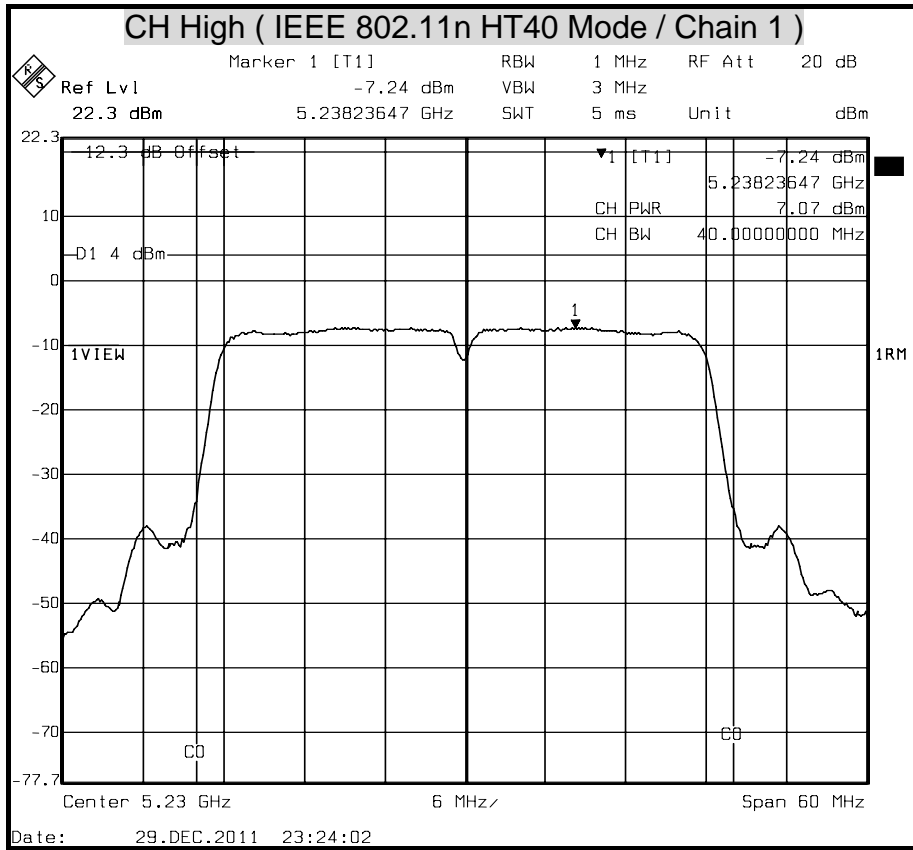



### 7.3 PEAK POWER SPECTRAL DENSITY

#### LIMITS

§ 15.407 (a)

- (1) For the band 5.15-5.25 GHz, the peak power spectral density shall not exceed 4dBm in any 1MHz band.
- (2) For the band 5.25-5.35 GHz and 5.47-5.725 GHz, the peak power spectral density shall not exceed 11dBm in any 1MHz band.

If transmitting antennas of directional gain greater than 6dBi are used, both the peak transmit power and the peak power spectral density shall be reduced by the amount in dB that the directional gain of the antenna exceeds 6dBi.

#### TEST EQUIPMENT

Name of Equipment	Manufacturer	Model	Serial Number	Calibration Due
Spectrum Analyzer	R&S	FSEK 30	835253/002	SEP. 29, 2012

*Remark: Each piece of equipment is scheduled for calibration once a year*

#### TEST SETUP

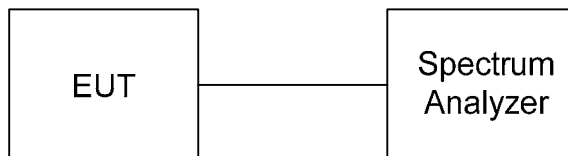

#### TEST PROCEDURE

1. Place the EUT on the table and set it in transmitting mode.  
Remove the antenna from the EUT and then connect a low loss RF cable from the antenna port to the spectrum analyzer.
2. Set the spectrum analyzer as RBW = 1MHz, VBW = 3MHz, Span = Sweep= AUTO
3. Record the max. reading.
4. Repeat the above procedure until the measurements for all frequencies are completed.



**TEST RESULTS**

**IEEE 802.11a Mode**

Channel	Channel Frequency (MHz)	PPSD (dBm)	Limit (dBm)	Margin (dB)	Pass / Fail
Low	5180	-0.33	4.00	-4.33	PASS
Middle	5220	-0.27		-4.27	PASS
High	5240	-0.52		-4.52	PASS

**Remark:**

1. At final test to get the worst-case emission at 6Mbps.
2. The cable assembly insertion loss of 12.3dB (including 10 dB pad and 2.3 dB cable) was Entered as an offset in the spectrum analyzer to allow for direct reading of power.

**IEEE 802.11n HT20 Mode**

Channel	Channel Frequency (MHz)	PPSD (dBm)			Limit (dBm)	Margin (dB)	Pass / Fail
		Chain 0	Chain 1	Tatol			
Low	5180	-3.07	-3.04	-0.04	1.99	-2.03	PASS
Middle	5220	-3.92	-3.90	-0.90		-2.89	PASS
High	5240	-3.91	-3.77	-0.83		-2.82	PASS

**Remark:**

1. At final test to get the worst-case emission at 13Mbps
2. The cable assembly insertion loss of 12.3dB (including 10 dB pad and 2.3 dB cable) was Entered as an offset in the spectrum analyzer to allow for direct reading of power.

**IEEE 802.11n HT40 Mode**

Channel	Channel Frequency (MHz)	PPSD (dBm)			Limit (dBm)	Margin (dB)	Pass / Fail
		Chain 0	Chain 1	Tatol			
Low	5190	-6.32	-7.11	-3.69	1.99	-5.68	PASS
Middle	5210	-6.26	-7.50	-3.83		-5.82	PASS
High	5230	-6.19	-7.24	-3.67		-5.66	PASS

**Remark:**

1. At final test to get the worst-case emission at 27Mbps
2. The cable assembly insertion loss of 12.3dB (including 10 dB pad and 2.3 dB cable) was Entered as an offset in the spectrum analyzer to allow for direct reading of power.





**PEAK POWER SPECTRAL DENSITY**

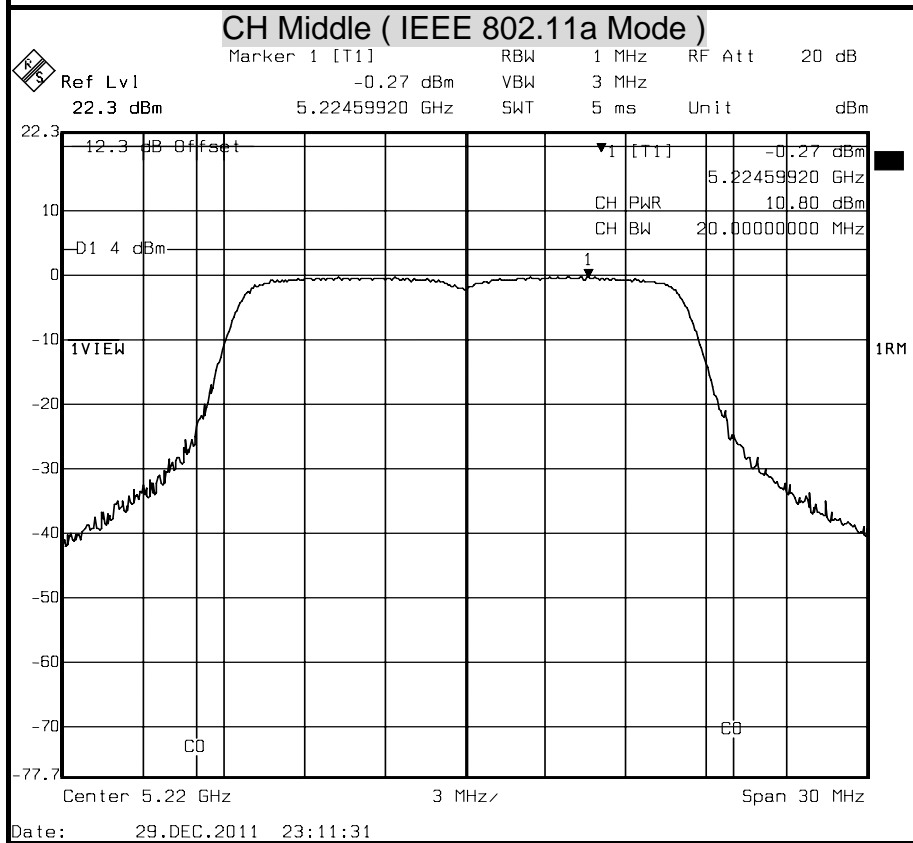
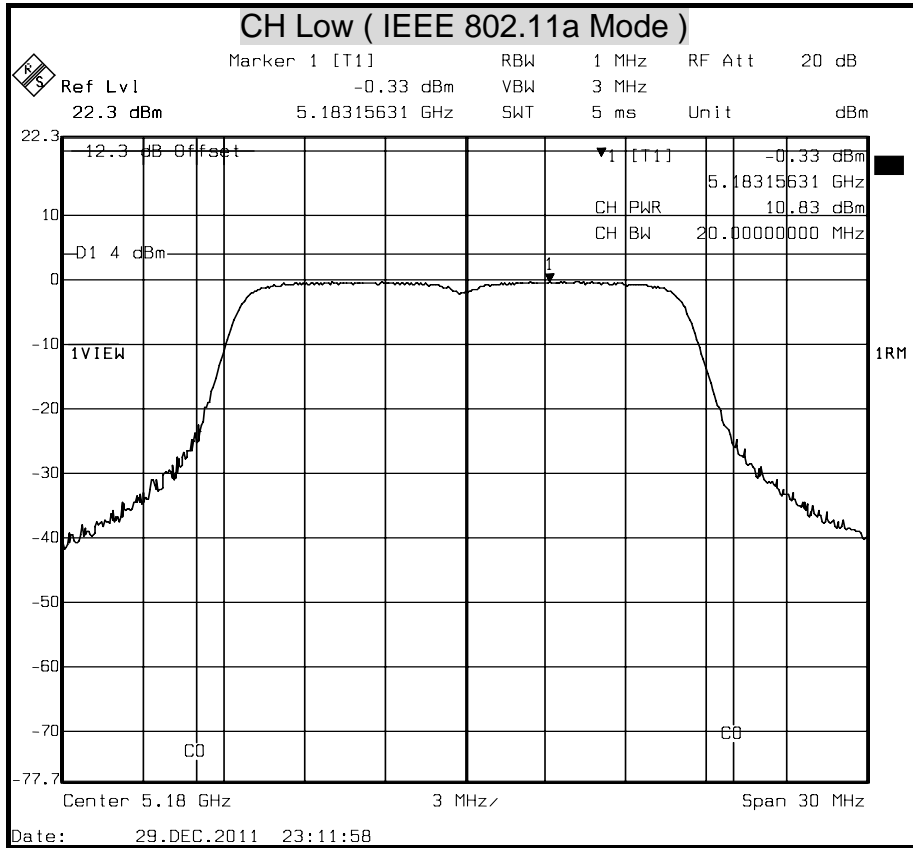

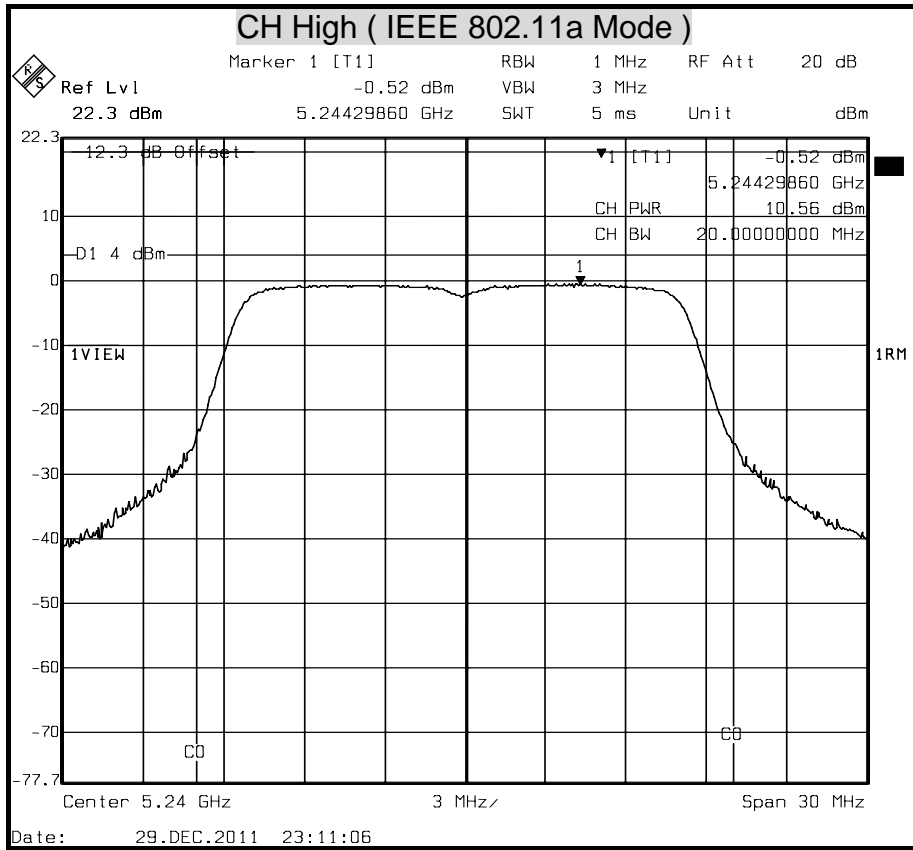

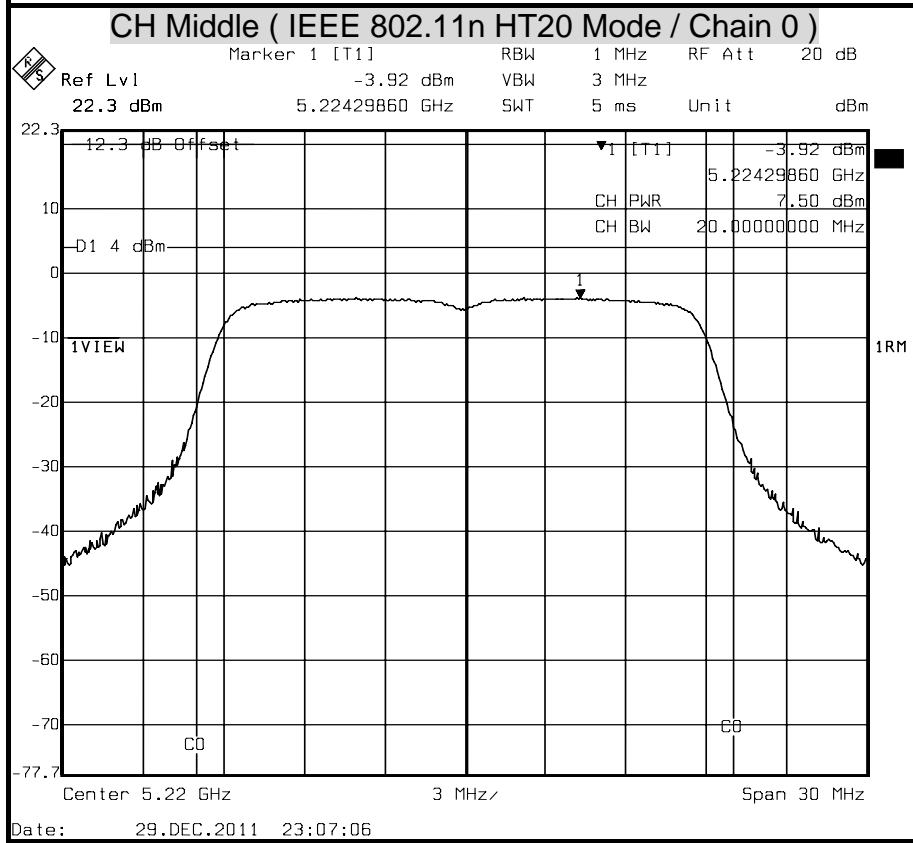
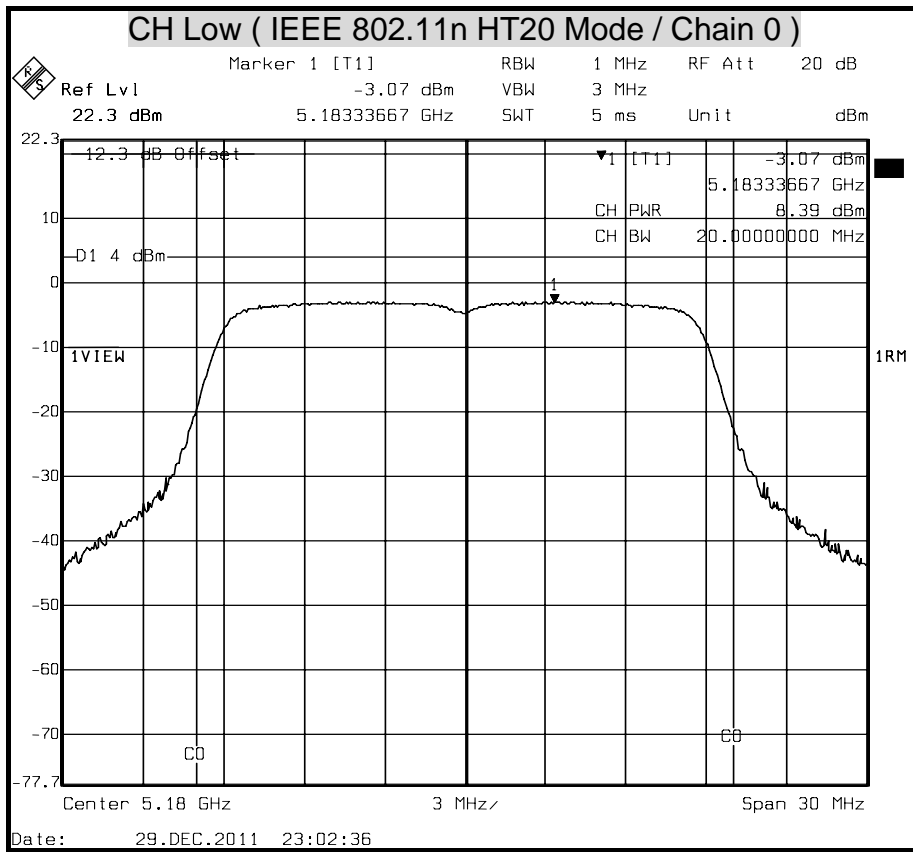

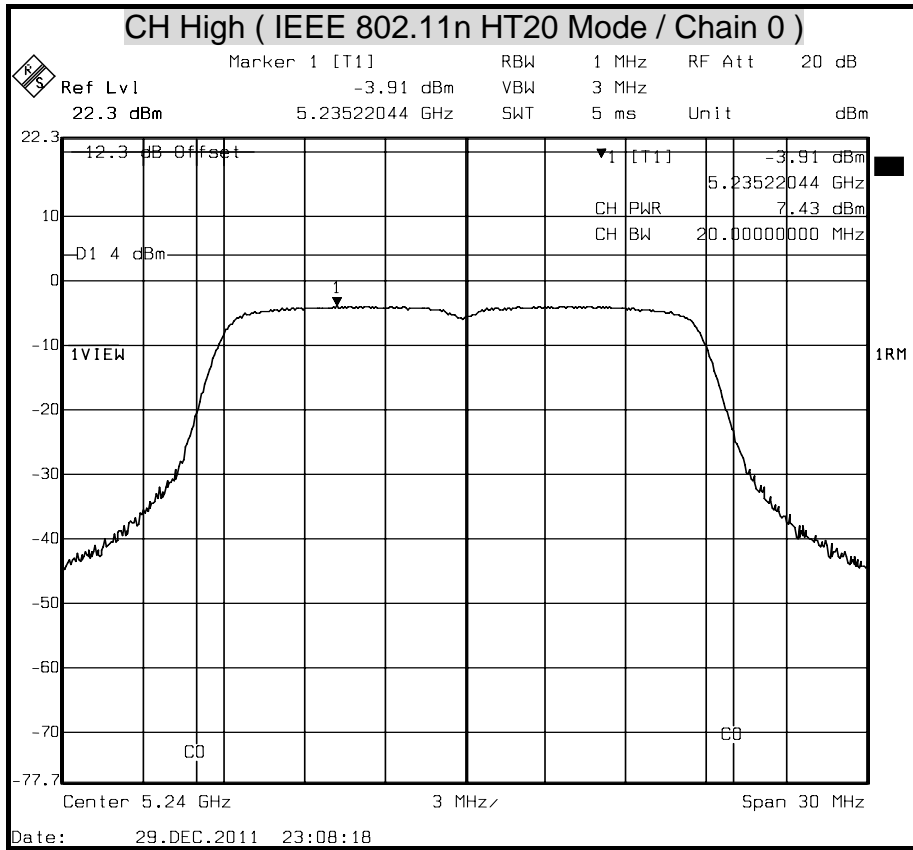

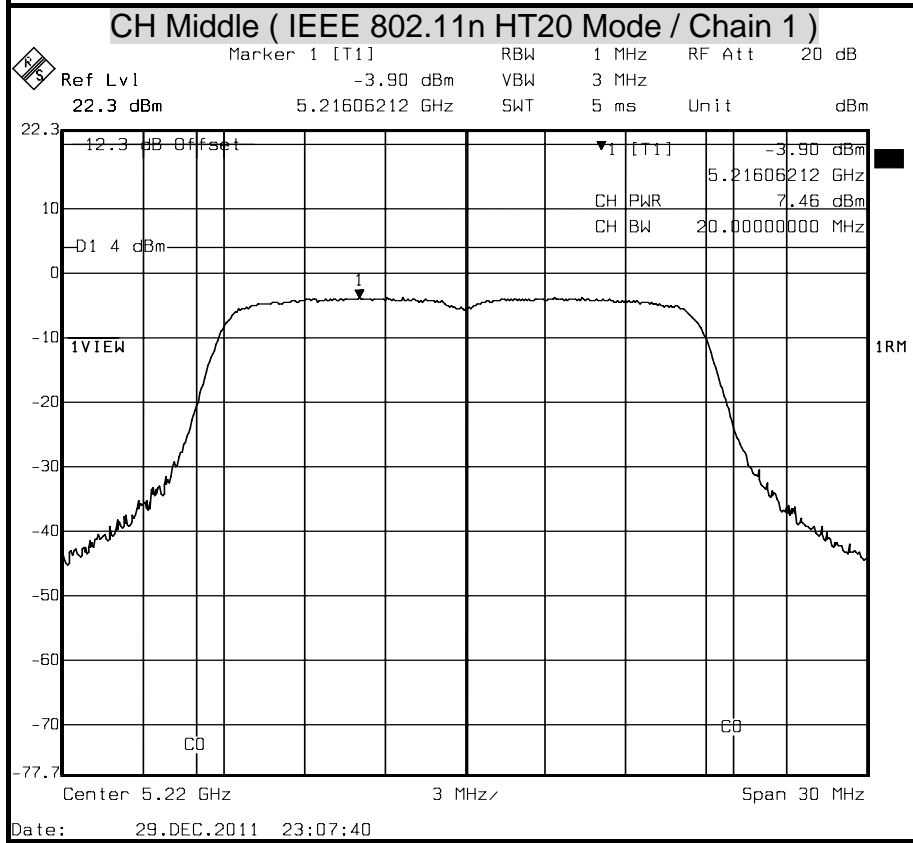
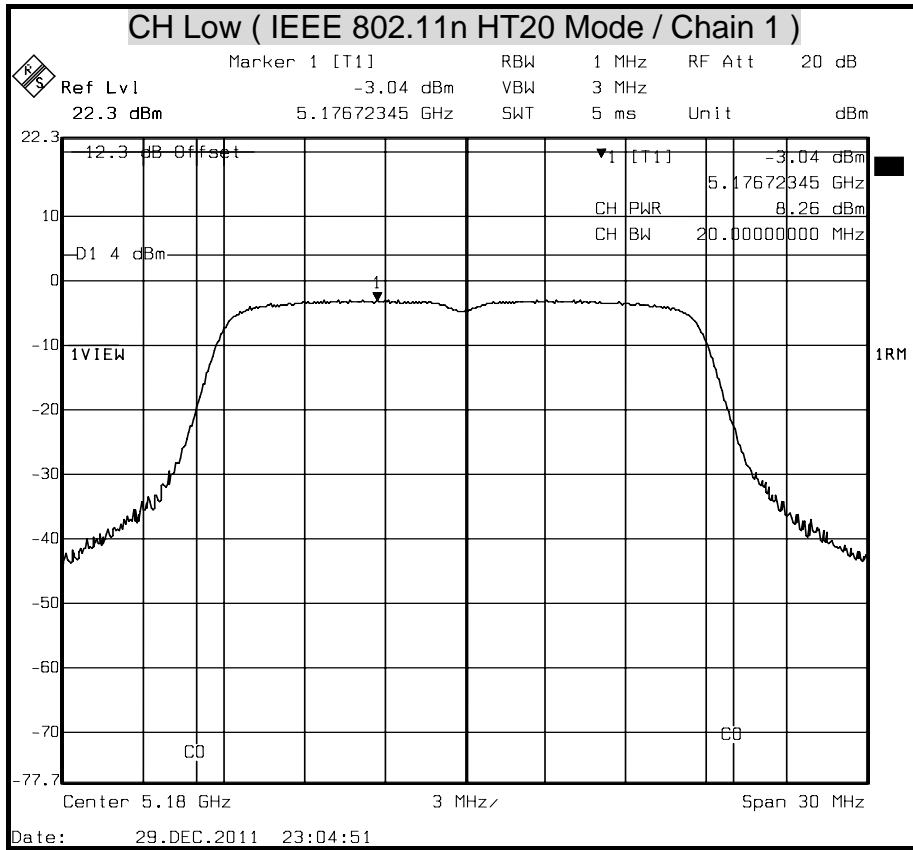

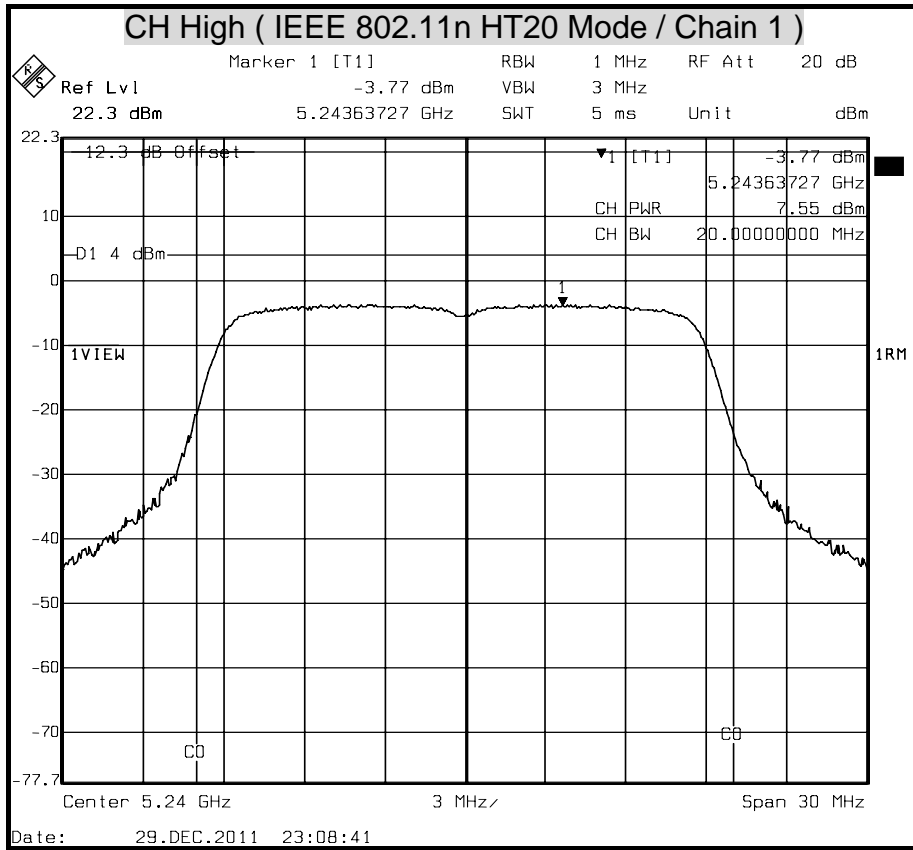

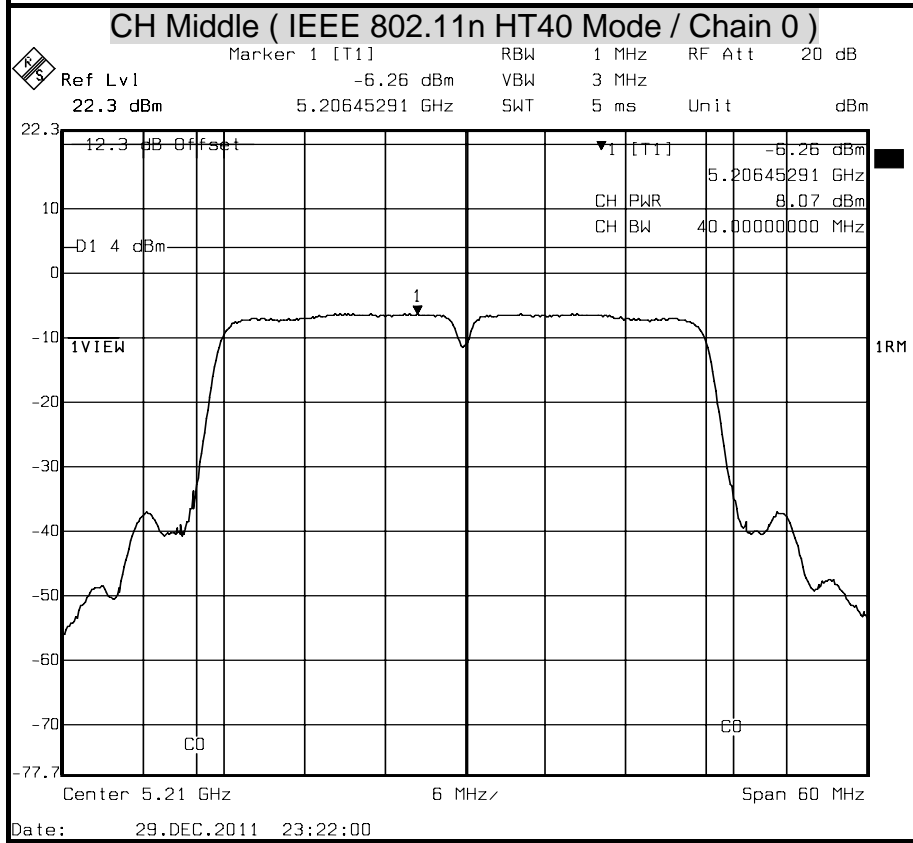
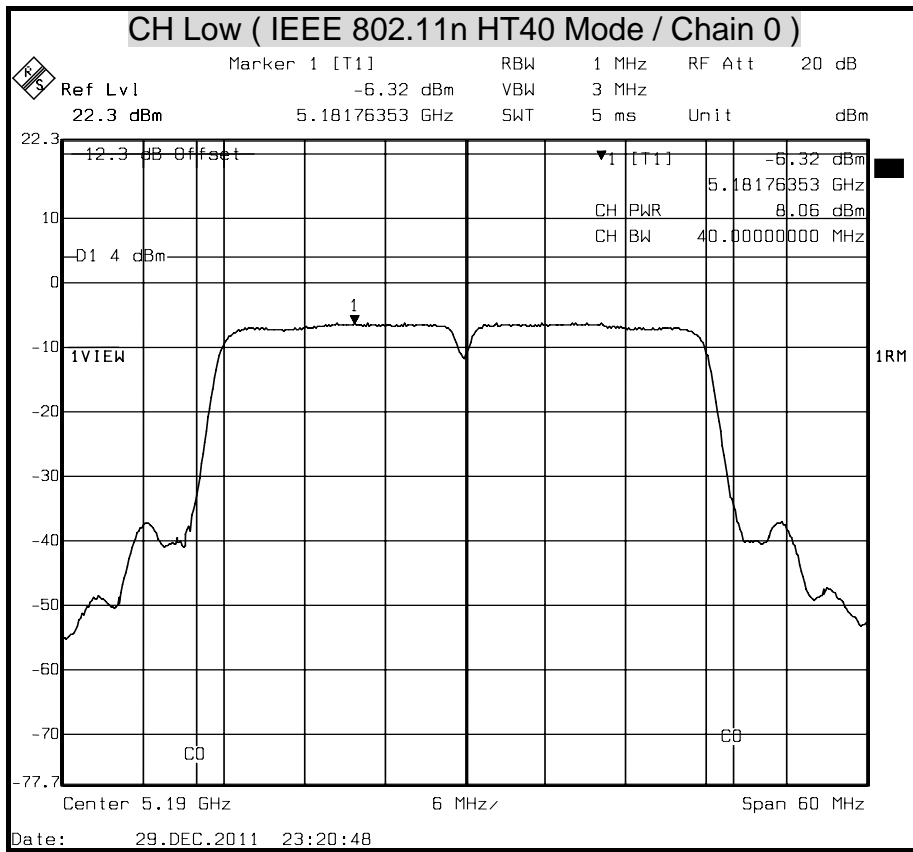

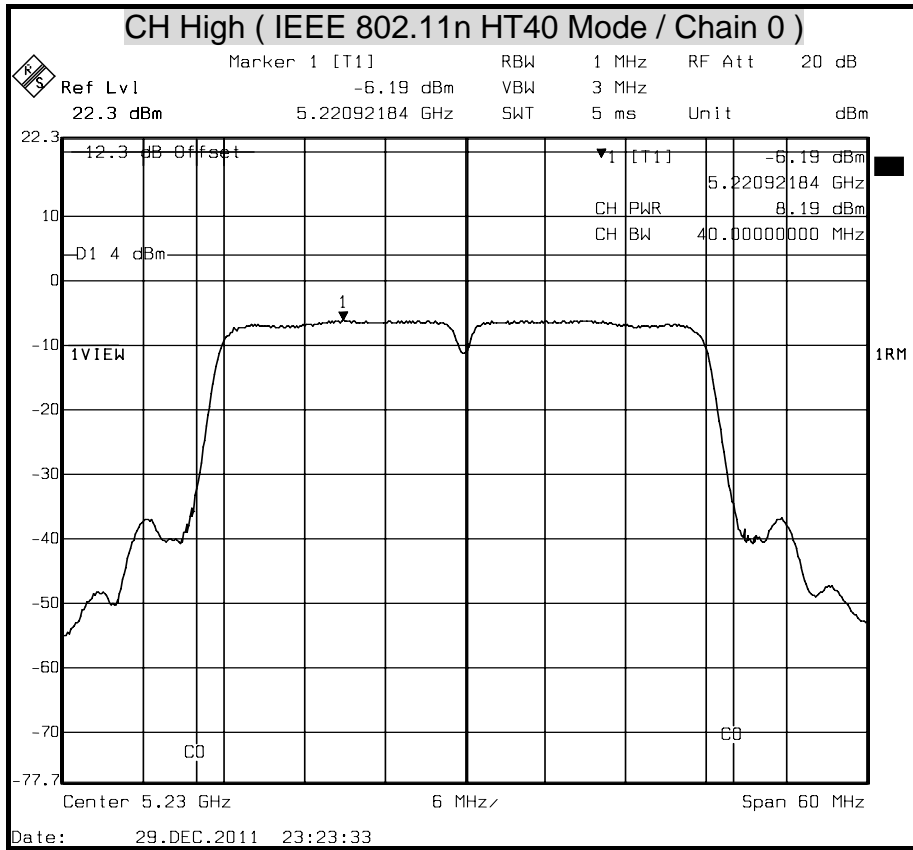



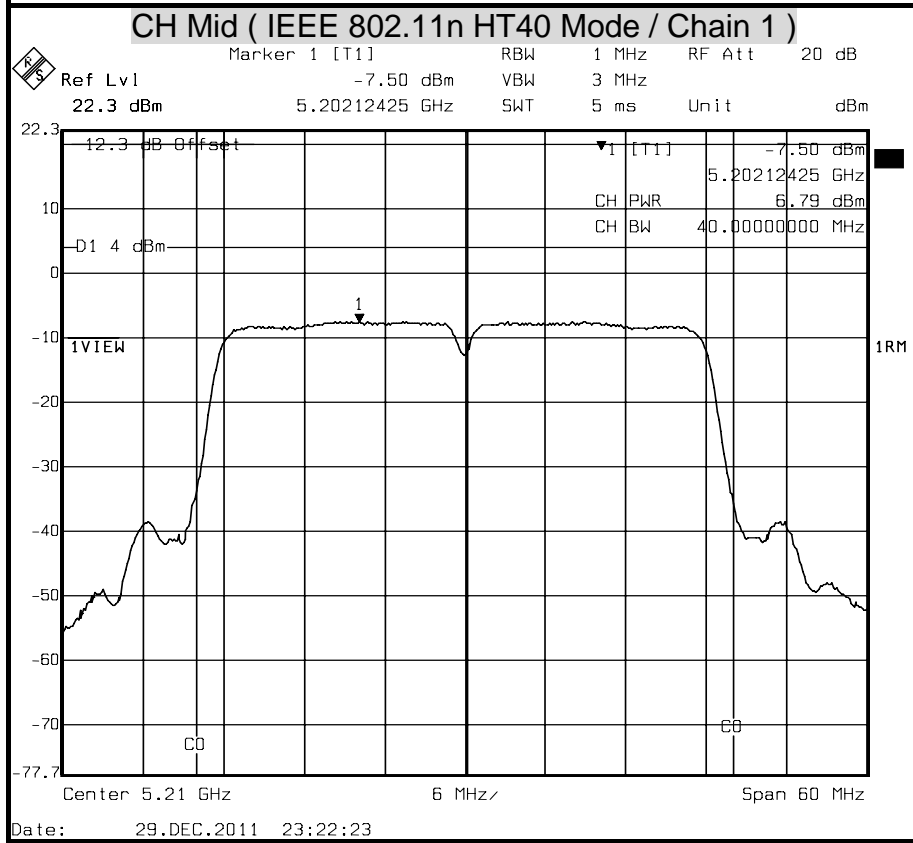
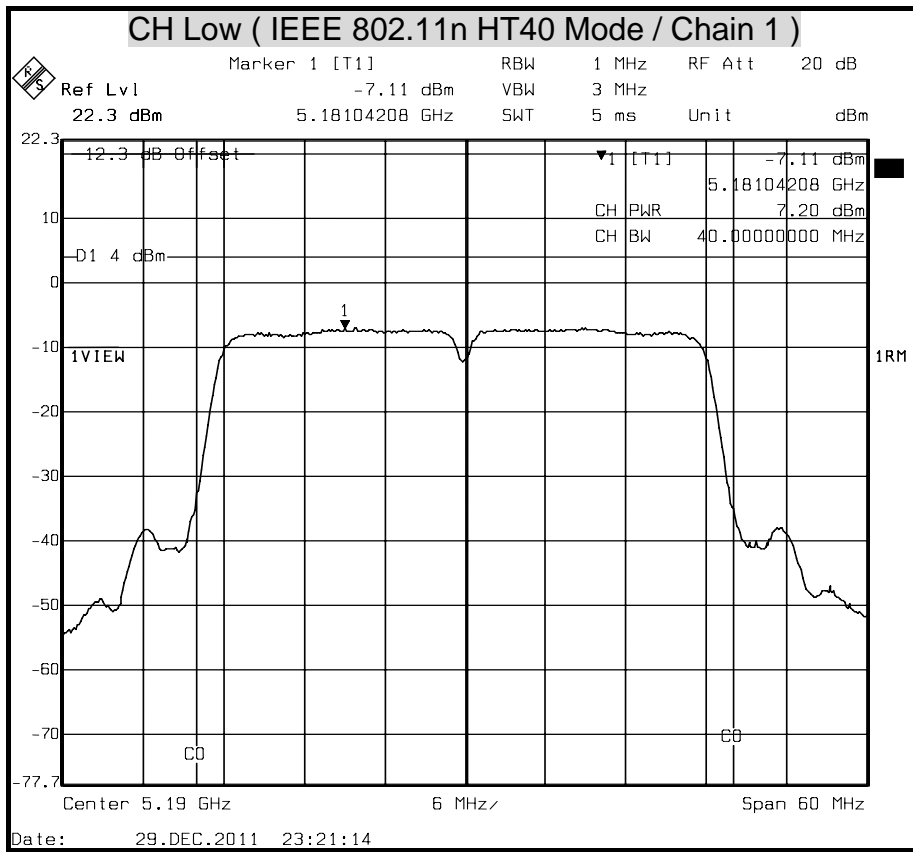

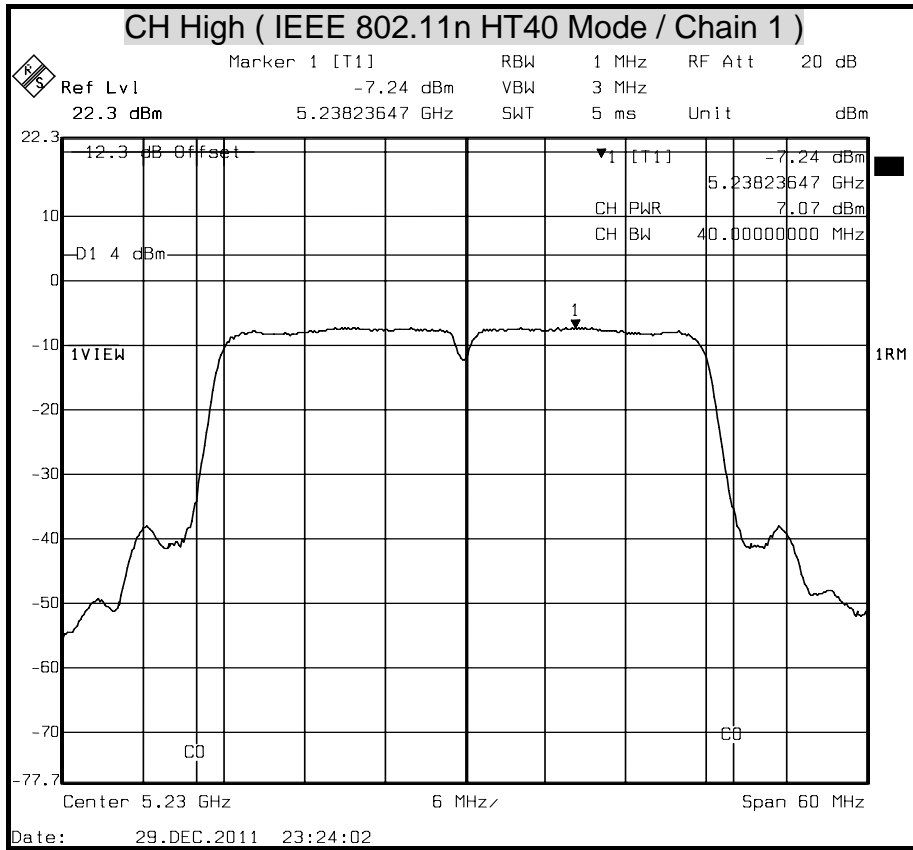



## 7.4 PEAK EXCURSION

### LIMITS

§ 15.407 (a) (6), the ratio of the peak excursion of the modulation envelope (measured using a peak hold function) to the peak transmit power (measured as specified above) shall not exceed 13 dB across any 1 MHz bandwidth or the emission bandwidth whichever is less.

### TEST EQUIPMENT

Name of Equipment	Manufacturer	Model	Serial Number	Calibration Due
Spectrum Analyzer	R&S	FSEK 30	835253/002	SEP. 29, 2012

*Remark: Each piece of equipment is scheduled for calibration once a year*

### TEST SETUP

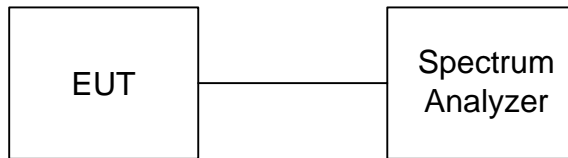

### TEST PROCEDURE

The test is performed in accordance with <FCC Public Notice: APPENDIX A Guidelines for Assessing Unlicensed National Information Infrastructure (U-NII) Devices> – Part 15, Subpart E, August 2002.

1. Place the EUT on the table and set it in transmitting mode.
2. Remove the antenna from the EUT and then connect a low loss RF cable from the antenna port to spectrum.
3. Trace A, Set RBW =1MHz, VBW = 3MHz, Span > 26dB Bandwidth, Max. hold.  
Trace B, Set RBW =1MHz, VBW = 3MHz, Span > 26dB Bandwidth, Setup sample detector and power average mode, to scan 100 times with average.
4. Delta Mark trace A Maximum frequency and trace B same frequency.
5. Repeat the above procedure until measurements for all frequencies were complete.



**TEST RESULTS**

**IEEE 802.11a Mode**

Channel	Channel Frequency (MHz)	Peak Excursion (dB)	Limit (dBm)	Margin (dB)	Pass / Fail
Low	5180	-7.86	13.00	-20.86	PASS
Middle	5220	-7.80		-20.80	PASS
High	5240	-7.80		-20.80	PASS

**Remark:**

1. At final test to get the worst-case emission at 6Mbps.
2. The cable assembly insertion loss of 12.3dB (including 10 dB pad and 2.3 dB cable) was Entered as an offset in the spectrum analyzer to allow for direct reading of power.

**IEEE 802.11n HT20 Mode Chain 0**

Channel	Channel Frequency (MHz)	Peak Excursion (dB)	Limit (dBm)	Margin (dB)	Pass / Fail
Low	5180	-8.00	13.00	-21.00	PASS
Middle	5220	-7.75		-20.75	PASS
High	5240	-8.07		-21.07	PASS

**Remark:**

1. At final test to get the worst-case emission at 13Mbps.
2. The cable assembly insertion loss of 12.3dB (including 10 dB pad and 2.3 dB cable) was Entered as an offset in the spectrum analyzer to allow for direct reading of power.

**IEEE 802.11n HT20 Mode Chain 1**

Channel	Channel Frequency (MHz)	Peak Excursion (dB)	Limit (dBm)	Margin (dB)	Pass / Fail
Low	5180	-7.23	13.00	-20.23	PASS
Middle	5220	-7.37		-20.37	PASS
High	5240	-7.12		-20.12	PASS

**Remark:**

1. At final test to get the worst-case emission at 13Mbps.
2. The cable assembly insertion loss of 12.3dB (including 10 dB pad and 2.3 dB cable) was Entered as an offset in the spectrum analyzer to allow for direct reading of power.



IEEE 802.11n HT40 Mode Chain 0

Channel	Channel Frequency (MHz)	Peak Excursion (dB)	Limit (dBm)	Margin (dB)	Pass / Fail
Low	5190	-8.46	13.00	-21.46	PASS
Middle	5210	-7.80		-20.80	PASS
High	5230	-8.08		-21.08	PASS

Remark:

1. At final test to get the worst-case emission at 27Mbps.
2. The cable assembly insertion loss of 12.3dB (including 10 dB pad and 2.3 dB cable) was Entered as an offset in the spectrum analyzer to allow for direct reading of power.

IEEE 802.11n HT40 Mode Chain 1

Channel	Channel Frequency (MHz)	Peak Excursion (dB)	Limit (dBm)	Margin (dB)	Pass / Fail
Low	5190	-7.64	13.00	-20.64	PASS
Middle	5210	-8.00		-21.00	PASS
High	5230	-7.70		-20.70	PASS

Remark:

1. At final test to get the worst-case emission at 27Mbps.
2. The cable assembly insertion loss of 12.3dB (including 10 dB pad and 2.3 dB cable) was Entered as an offset in the spectrum analyzer to allow for direct reading of power.



**PEAK EXCURSION**

