

Recognized by the
Federal Communications Commission
Anechoic chamber registration no.: 90462 (FCC)
Anechoic chamber registration no.: IC 3463A-1
TCB ID: DE 0001



Accredited by the
German Accreditation Council
DAR-Registration Number
DAT-P-176/94-D1



Independent ETSI
compliance test house



Accredited Bluetooth® Test Facility (BQTF)

Test report no.: 2-4556-01-02_07_Ant18

LANCOM XAP-40-2
Hirschmann BAT54-Rail
FCC ID: U4Y-SE112
IC: 7049A-SE112

*The Bluetooth word mark and logos are owned by the Bluetooth SIG,
Inc. and any use of such marks by Cetecom ICT is under license*

Table of contents

1. ADMINISTRATIVE DATA	3
1.1. ADMINISTRATIVE DATA OF THE TEST FACILITY	3
1.1.1 Identification of the testing laboratory	3
1.1.2 Organizational items.....	3
1.1.3 Applicant´s details	4
1.2. ADMINISTRATIVE DATA OF MANUFACTURER / MEMBER	4
1.3. DESCRIPTION OF THE EQUIPMENT UNDER TEST (EUT)	5
1.3.1 EUT: Type, S/N etc.	5
1.3.2 If RF component testing only, description of additional used HW/SW.....	5
1.3.3 ADDITIONAL EUT INFORMATION	6
1.3.4 EUT operating modes.....	7
1.3.5 Extreme conditions testing values.....	7
2 TEST STANDARD & SUMMARY LIST OF ALL PERFORMED TEST CASES	8
3 RF MEASUREMENT TESTING	9
3.1 DESCRIPTION OF TEST SET-UP.....	9
3.1.1 Radiated measurements	9
3.1.2 Conducted measurements	9
3.1.3 AC-conducted measurements.....	9
3.2 REFERENCED DOCUMENTS	10
3.3 ADDITIONAL COMMENTS	10
3.4 ANTENNA GAIN	10
3.5 MAXIMUM OUTPUT POWER (CONDUCTED) (OFDM) §15.247 (B) (3).....	11
3.6 ANT 18: BAT-ANT-N-14G	13
3.7 MPE CALCULATION.....	20
3.8 DATASHEET ANTENNA.....	21
3.9 TESTEQUIPMENT.....	23
4 PHOTOGRAPHS	27

1. Administrative data

1.1. Administrative data of the test facility

1.1.1 Identification of the testing laboratory

Company name:	Cetecom ICT Services GmbH
Address:	Untertürkheimerstr. 6-10 D-66117 Saarbruecken Germany
Laboratory accreditation:	DAR-Registration No. DAT-P-176/94-D1 Bluetooth Qualification Test Facility (BQTF)
Responsible for testing laboratory:	Harro Ames, Stefan Bös Phone: +49 681 598 0 Fax: +49 681 598 9075 email: info@ict.cetecom.de

..... /
Responsible for testing laboratory
(Harro Ames, Stefan Bös)

1.1.2 Organizational items

Reference No.:	
Order No.:	
Responsible for test report and project leader:	Harro Ames, Stefan Bös
Receipt of EUT:	2007-03-22
Date(s) of test:	2007-03-25 to 2007-04-20
Date of report:	2007-05-11
Number of report pages:	27
Number of diagram pages (annex):	

Version of template:	1.6

..... /
Responsible for test report
(Harro Ames, Stefan Bös)

Note:

The test results of this test report relate exclusively to the item tested as specified in this report. The CETECOM ICT Services GmbH does not assume responsibility for any conclusions and generalizations drawn from the test results with regard to other specimens or samples of the type of the equipment represented by the test item.

The test report may only be reproduced or published in full. Reproduction or publication of extracts from the report requires the prior written approval of the CETECOM ICT Services GmbH.

During the test no hardware and software changes are allowed to be performed at the EUT.

1.1.3 Applicant's details

Applicant's name:	LANCOM Systems GmbH
Address:	Adenauerstr. 20/B2 D-52146 Würselen Germany
Contact person:	Mr. Andre Krautschick Tel: +49 (0)2405 49936-443 Fax: +49(0)2405 49936-99 email: Andre.Krautschick@lancom.de

1.2 Administrative data of manufacturer / member

Manufacturer's name:	- applicant -
Address:	

1.3 Description of the Equipment under test (EUT)

1.3.1 EUT: Type, S/N etc.

Product name	Product ID	Description	S/N serial number	HW hardware status	SW software status
XAP-40-2 BAT54-Rail		Dual WLAN AP	-	-	-
Frequency Band [MHz]	Type of Modulation	Number of channels	Antenna	Power Supply	Temperature Range
ISM 2.400 - 2.483,5	DSSS /OFDM	11	2*2 external antennas	External AC power supply	-20°C - +55°C

1.3.2 If RF component testing only, description of additional used HW/SW

	Product name	Product ID	Description	S/N serial number	HW hardware status	SW software status
1						
2						

1.3.3 Additional EUT information

The sample is a dual access point for dualband use. (2.4 and 5 GHz).

Inside the AP there are two identical RF parts, both are able to work on 2.4 and 5 GHz.

In this report we test the radiated emissions of the AP with external antenna **Ant18 (BAT-ANT-N-14g) at 2.4 GHz.**

We tested spurious emissions and band edge compliance for each antenna type.

The maximal output power can be calculated by the conducted output power and the attached pattern of the antenna.

Other antennas and frequency ranges are tested in separate reports.

The complete test report for the AP at 2.4 GHz is **2-4556-01-02/07** from our house.

Antenna types: (gain according data sheet)

Ant1:	BAT-ANT-8G	2.4 – 2.5 GHz	8.0 dBi
Ant3:	BAT-ANT-TNC_B_D-085-01	2.3 – 2.5 GHz	8.5 dBi
Ant4:	BAT-ANT-TNC_B_D-085-02	2.3 – 2.5 GHz	8.5 dBi
Ant5:	BAT-ANT-TNC-8b/g DS	2.3 – 2.5 GHz	8.5 dBi
Ant9:	Extender I-60AG	2.4 - 2.5 GHz	6.0 dBi
Ant10:	Extender I-180	2.4 - 2.4835 GHz	4.0 dBi
Ant13:	Extender 0-D80g	2.3 - 2.5 GHz	8.5 dBi
Ant14:	Extender 0-360ag	2.3 - 2.5 GHz	6.0 dBi
Ant15:	BAT-ANT-N-6abg	2.4 - 2.5 GHz	6.0 dBi
Ant16:	Extender 0-30	2.4 - 2.4835 GHz	14.0 dBi
Ant18:	BAT-ANT-N-14g	2.4 - 2.7 GHz	14.0 dBi
Ant19:	Extender 0-70	2.4 - 2.4835 GHz	8.5 dBi

To simplify reading the report we use inside the short name of the antennas, ANT1, ANT2 etc.

1.3.4 EUT operating modes

EUT operating mode no.*)	Description of operating modes	Additional information
Op. 0	Normal mode	Normal temperature and power source conditions
Op. 1		low temperature, low power source conditions
Op. 3		low temperature, high power source conditions
Op. 4		high temperature, low power source conditions
Op. 5		high temperature, high power source conditions

*) EUT operating mode no. is used to simplify the test report.

1.3.5 Extreme conditions testing values

Description	Shortcut	Unit	Value
Nominal Temperature / humidity	T _{nom}	°C / %	22°C / 33%
Low Temperature	T _{low}	°C	-20°C
High Temperature	T _{high}	°C	55°C
Nominal Power Source	V _{nom}	V	115V AC
Low Power Source	V _{low}	V	100V AC
High Power Source	V _{high}	V	130V AC

Type of powersource: External AC power supply with 12V DC output, delivered by the customer

2 Test standard & summary list of all performed test cases

TC identifier	Description	verdict	date	Remark
RF-Testing	FCC Part 15 §15.247 - CANADA RSS-210	pass	2007-05-11	

Test Specification Clause	Test Case	Pass	Fail	Not applicable	Not performed
None	Antenna Gain	Yes			
§ 15.247 (b) (3)	Maximum output power (conducted)	Yes			
§ 15.247 (c)(1)(i)	Max. peak output power (radiated)	Yes			
§ 15.205	Band-edge compliance of radiated emissions	Yes			
§ 15.209	Spurious Emission -radiated (Transmitter)	Yes			
§ 15.247 (c)	Spurious Emissions-radiated (Receiver)	Yes			
§ 15.247 (i)	MPE calculation	Yes			

3 RF measurement testing

3.1 Description of test set-up

3.1.1 Radiated measurements

The radiated measurements are performed in vertical and horizontal plane in the frequency range from 9 kHz to 25 GHz in semi-anechoic chambers. The EUT is positioned on a non-conductive support with a height of 0.80 m above a conductive ground plane that covers the whole chamber. The receiving antennas conform with specifications ANSI C63.2-1996 clause 15 and ANSI C63.4-2003 clause 4.1.5. These antennas can be moved over the height range between 1.0 m and 4.0 m in order to search for maximum field strength emitted from EUT. The measurement distances between EUT and receiving antennas are indicated in the test setups for the various frequency ranges. For each measurement, the EUT is rotated in all three axes until the maximum field strength is received. The wanted and unwanted emissions are received by spectrum analysers where the detector modes and resolution bandwidths over various frequency ranges are set according to requirement ANSI C63-4-2003 clause 4.2.

Antennas conform with ANSI C63.2-1996 item 15.

150 kHz - 30 MHz: Quasi Peak measurement, 9kHz Bandwidth, passive loop antenna.

30 MHz - 200 MHz: Quasi Peak measurement, 120KHz Bandwidth, biconical antenna

200MHz - 1GHz: Quasi Peak measurement, 120KHz Bandwidth, log periodic antenna

>1GHz: Average, RBW 1MHz, VBW 10 MHz, waveguide horn with lownoise preamp

3.1.2 Conducted measurements

The EUT's RF signal is coupled out by the antenna connector which is supplied by the manufacturer. The signal is connected to the spectrum analyzer. The specific losses for signal paths are first checked within a calibration. The measurement readings on the spectrum analyzer are corrected by the specific test set-up loss. The attenuator, power divider, signaling unit and the spectrum analyzer are impedance matched on 50 Ohm.

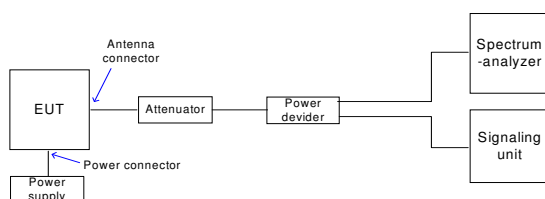

3.1.3 AC-conducted measurements

We used the dedicated power supply delivered by the customer.

3.2 Referenced Documents

none

3.3 Additional comments

none

3.4 Antenna gain

according to data sheets of the antennas

The real gain of the antennas may be lower.

	Ant1	Ant3	Ant4	Ant5	Ant9	Ant10	Ant13	Ant14	Ant15	Ant16	Ant18	Ant19
gain(dBi)	8.0	8.5	8.5	8.5	6.0	4.0	8.5	6.0	6.0	14.0	14.0	8.5

SRD-Testreport

CETECOM ICT Services GmbH Saarbruecken, Germany



Test report No.: 2-4556-01-02_07_Ant18

Date: 2007-05-11

Page 11 of 27

3.5 Maximum output power (conducted) (OFDM)

§15.247 (b) (3)

Plot 1:

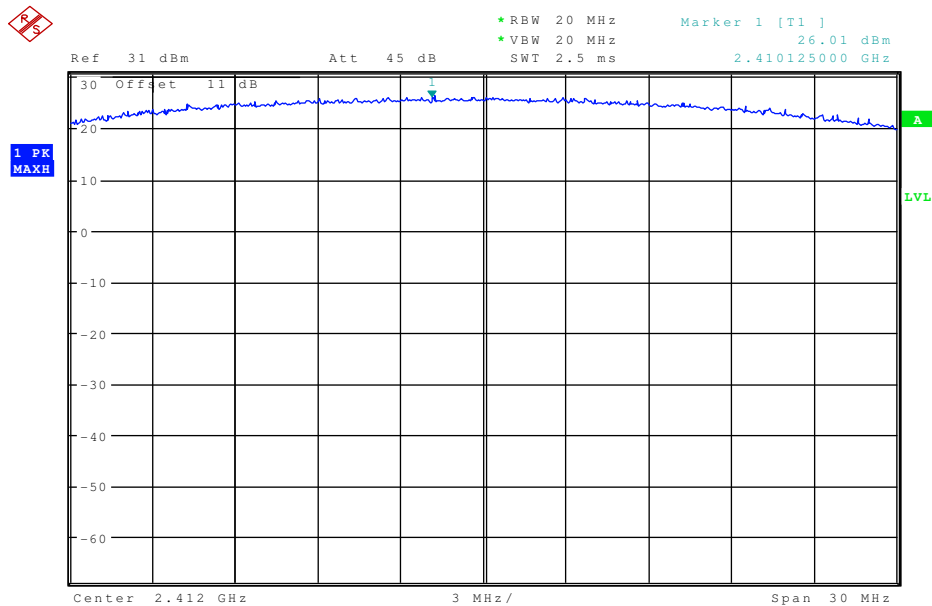

Plot 2:

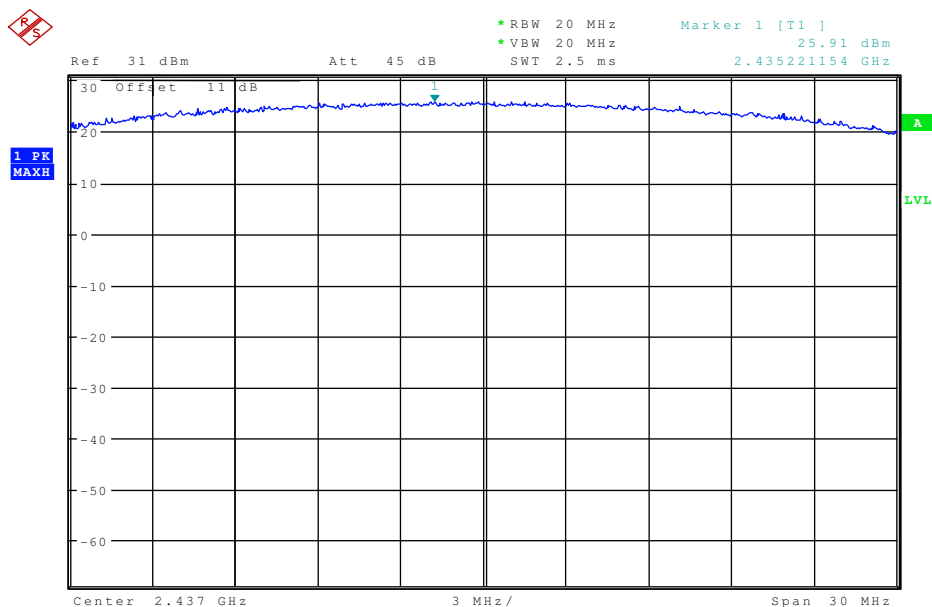

SRD-Testreport

CETECOM ICT Services GmbH Saarbruecken, Germany



Test report No.: 2-4556-01-02_07_Ant18 Date: 2007-05-11 Page 12 of 27

Plot 3:

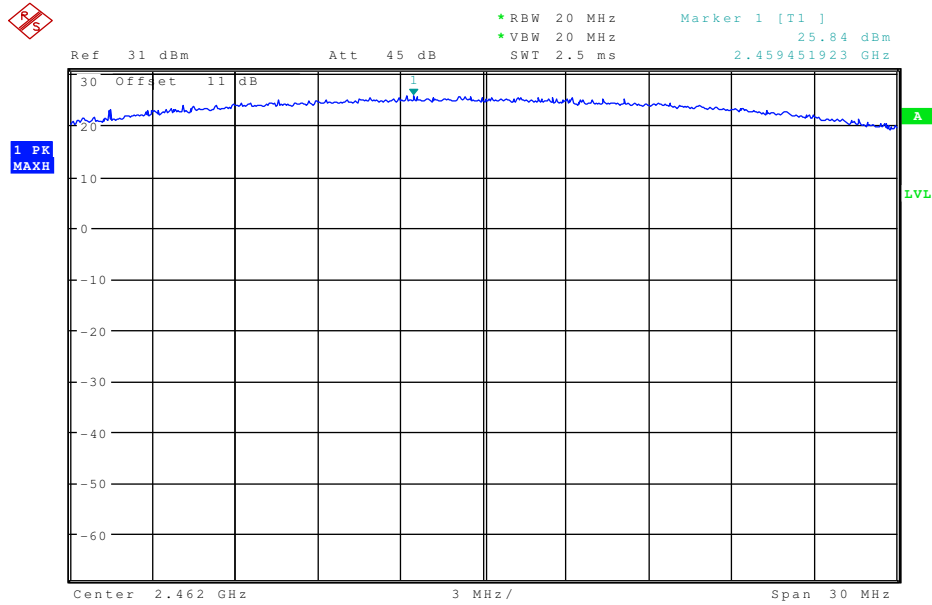

Results:

Test conditions		Max. peak output power [dBm]			
Frequency [MHz]		2412	2437	2462	
T _{nom}	V _{nom}	PK	26.01	25.91	25.84
Measurement uncertainty		±3dB			

Limits:

Under normal test conditions only, for frequency range 2400-2483.5 MHz	Max. 1.0 Watt / 30 dBm
--	------------------------

3.6 Ant 18: BAT-ANT-N-14g

Max. peak output power (radiated) §15.247 (c) (1) (i)

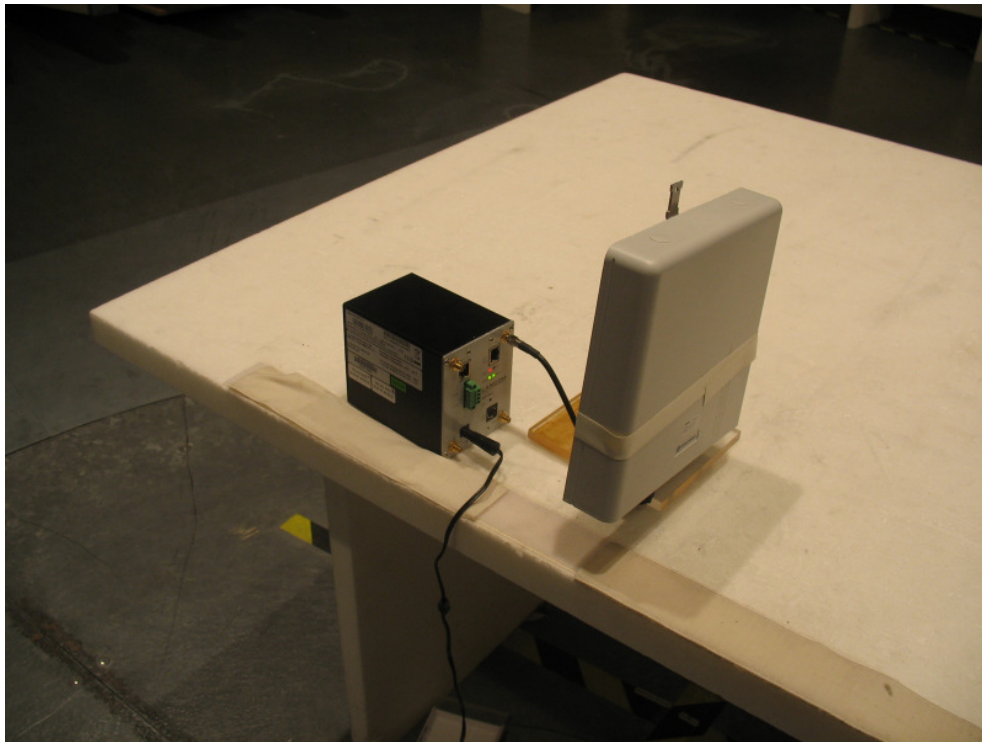

Results: calculated with specified antenna gain (14.0 dBi)

Test conditions		Max. peak output power EIRP [dBm]		
Frequency [MHz]		2412	2437	2462
T _{nom}	DSSS - Conducted	20.63	20.35	20.13
T _{nom}	OFDM - Conducted	26.01	25.91	25.84
T _{nom}	DSSS - Radiated	34.63	34.35	34.13
T _{nom}	OFDM - Radiated	40.01	39.91	39.84
Measurement uncertainty		±3dB		

Limits:

Under normal test conditions only, for frequency range 2400-2483.5 MHz	Conducted: Max. 1.0 Watt / 30 dBm reduced by 1dB for every 3dB that the directional gain of the antenna exceeds 6 dBi (only for fixed point to point operations)
--	--

SRD-Testreport

CETECOM ICT Services GmbH Saarbruecken, Germany



Test report No.: 2-4556-01-02_07_Ant18

Date: 2007-05-11

Page 14 of 27

Spurious Emissions - radiated Transmitter

§15.109 / 209

DSSS and OFDM mode, no difference in result (worst case)

0.03 - 12 GHz vertical / horizontal

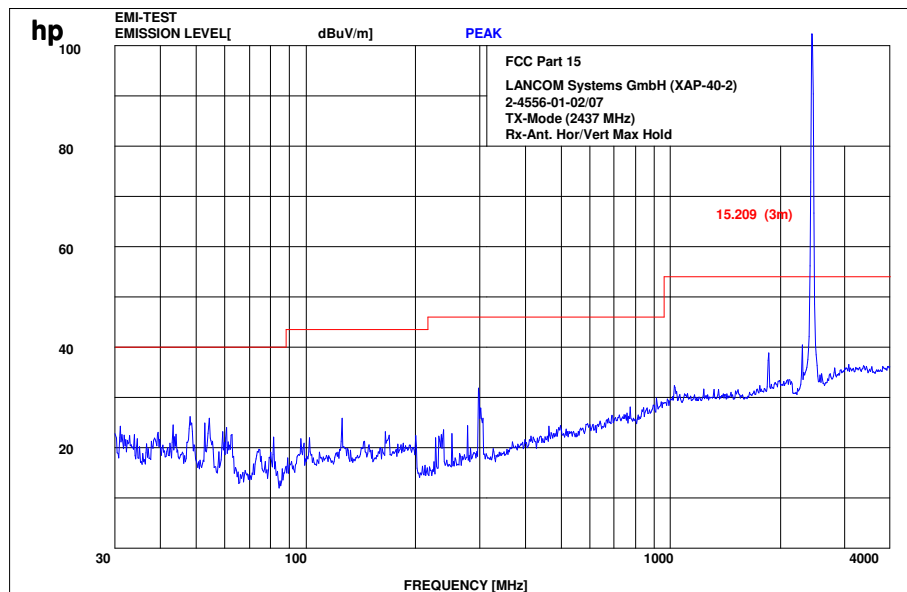
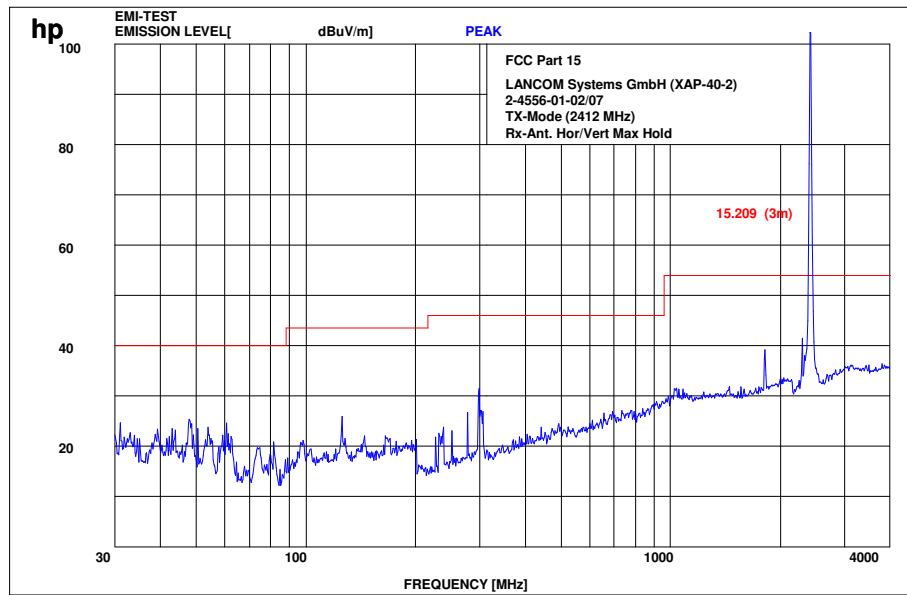

SRD-Testreport

CETECOM ICT Services GmbH Saarbruecken, Germany



Test report No.: 2-4556-01-02_07_Ant18

Date: 2007-05-11

Page 15 of 27

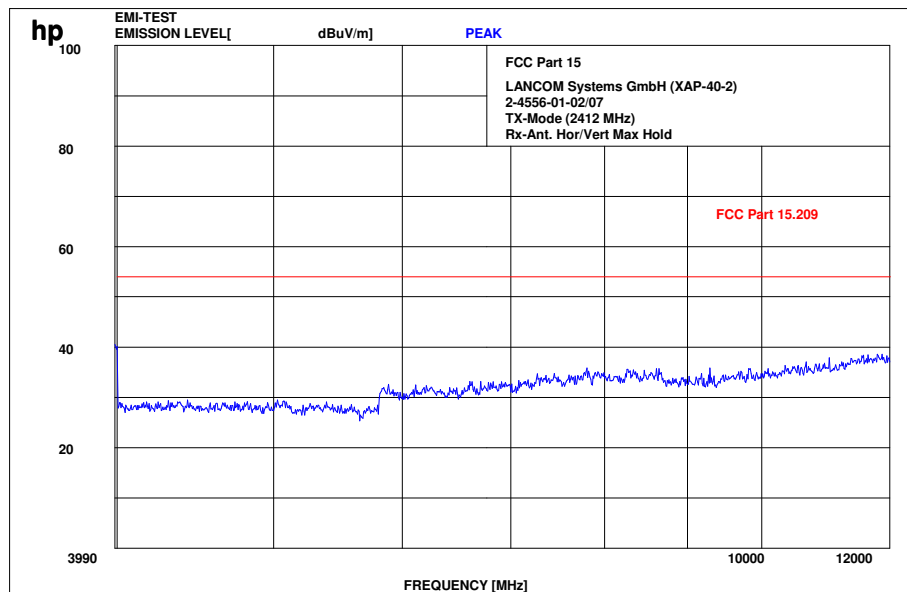
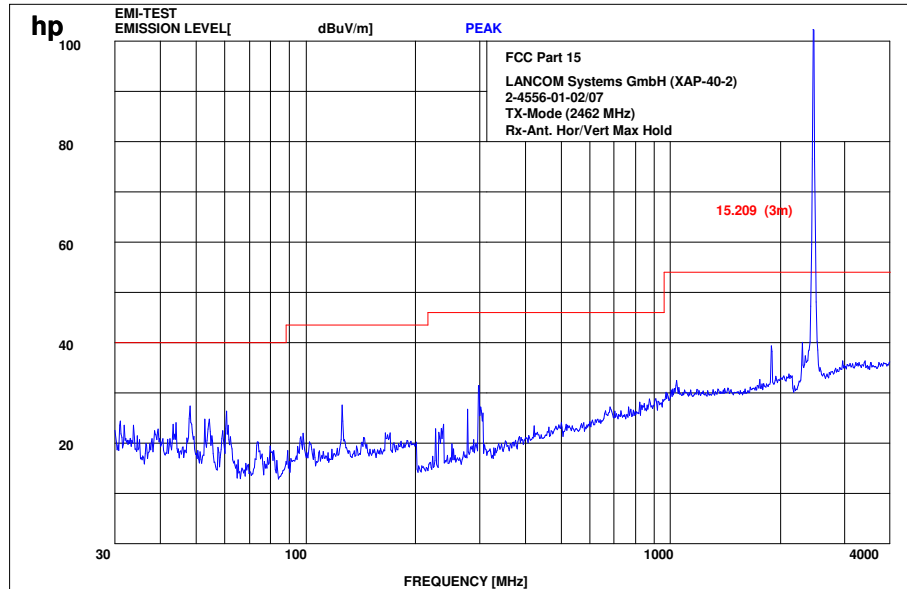

SRD-Testreport

CETECOM ICT Services GmbH Saarbruecken, Germany



Test report No.: 2-4556-01-02_07_Ant18

Date: 2007-05-11

Page 16 of 27

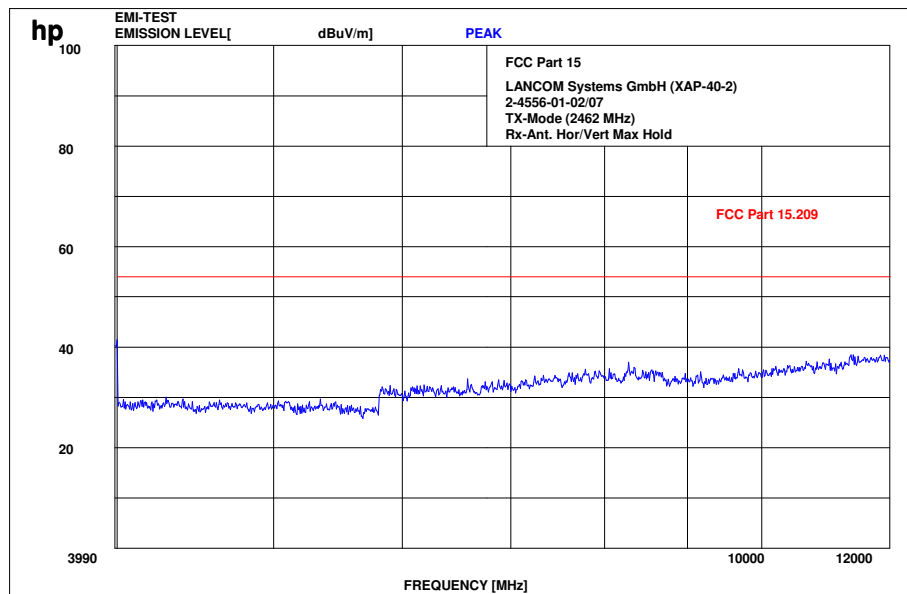
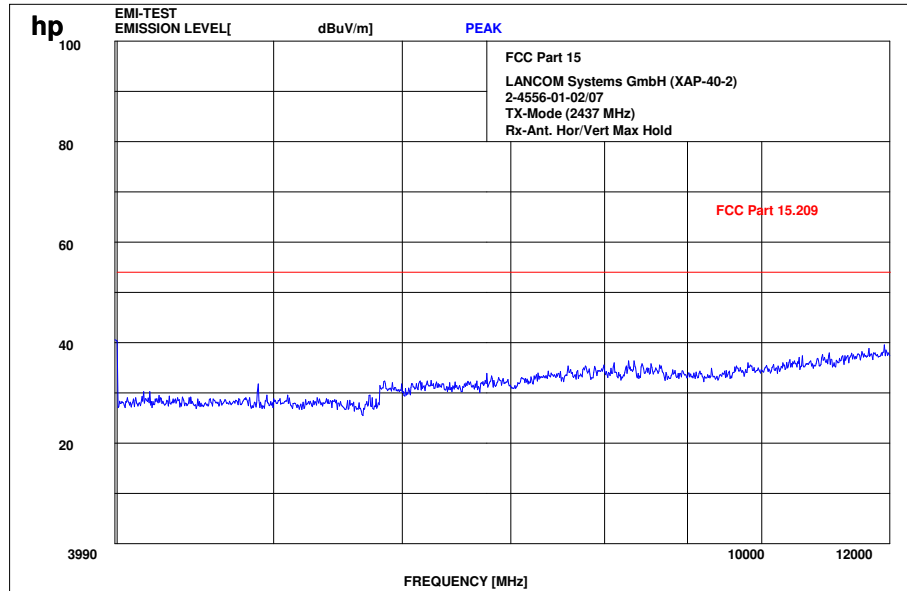

12- 25 GHz (valid for all channels)

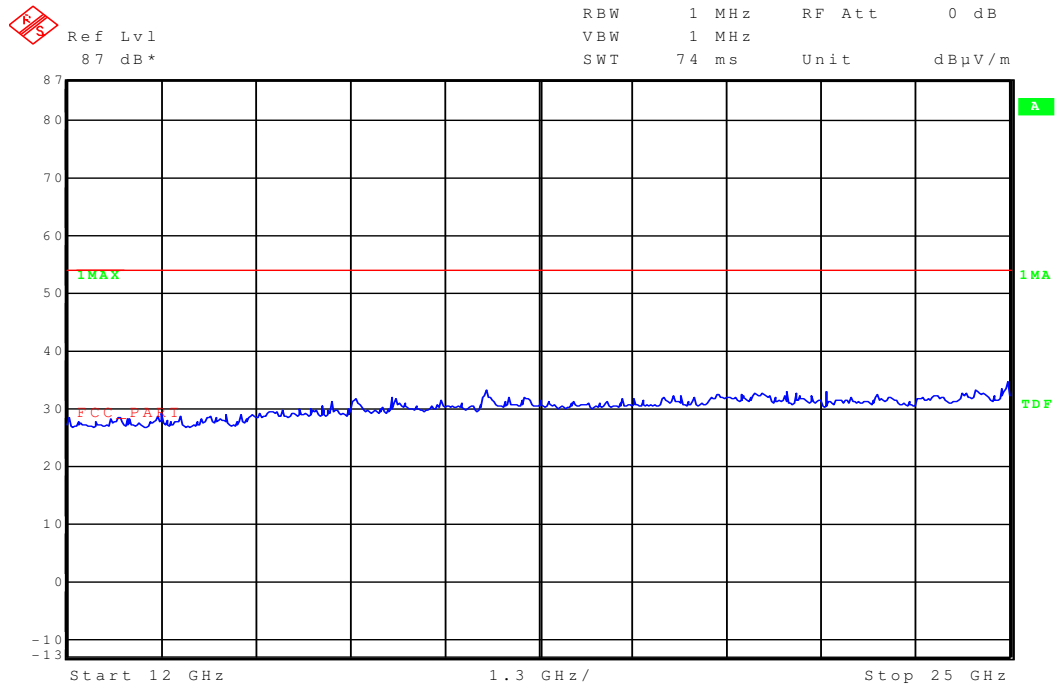

Results:

Spurious Emissions level [$\mu\text{V/m}$]								
2412 MHz			2437 MHz			2462 MHz		
f[MHz]	Detector	Level [$\mu\text{V/m}$]	f[MHz]	Detector	Level [$\mu\text{V/m}$]	f[MHz]	Detector	Level [$\mu\text{V/m}$]
No critical peaks found < 10 dB below limit line								
Measurement uncertainty			± 3 dB					

f < 1 GHz : RBW/VBW: 100 kHz f ≥ 1GHz : RBW/VBW: 1 MHz
 see above plots

Measurement distance see table

Limits : § 15.109 / 209

Frequency (MHz)	Field strength ($\mu\text{V/m}$)	Measurement distance (m)
30 - 88	100 (40 dB $\mu\text{V/m}$)	3
88 - 216	150 (43.5 dB $\mu\text{V/m}$)	3
216 - 960	200 (46 dB $\mu\text{V/m}$)	3
above 960	500 (54 dB $\mu\text{V/m}$)	3

Band edge compliance radiated (OFDM mode, worst case)

Max field strength in 3m distance (single frequency) peak

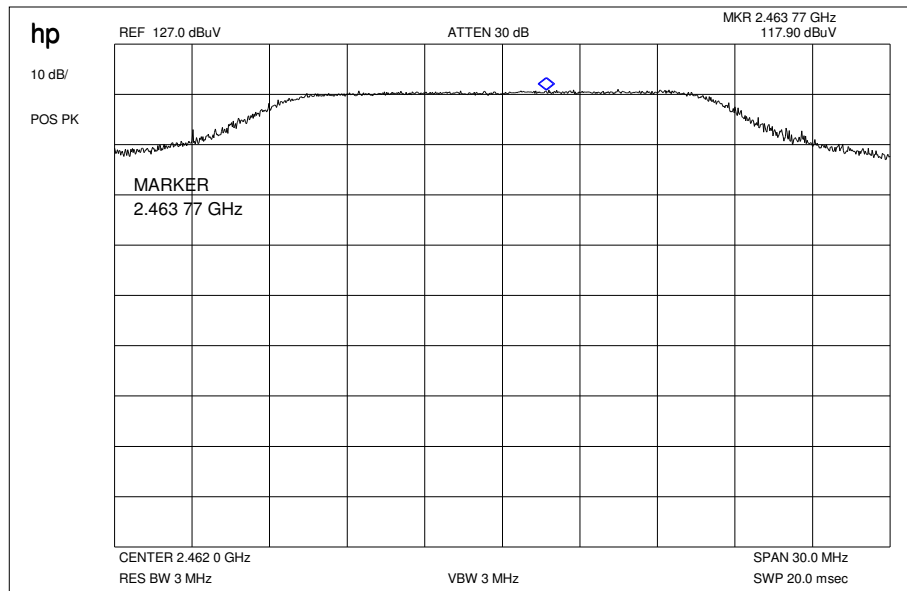

Result: 117.9 dB μ V

Max field strength in 3m distance (single frequency) average,

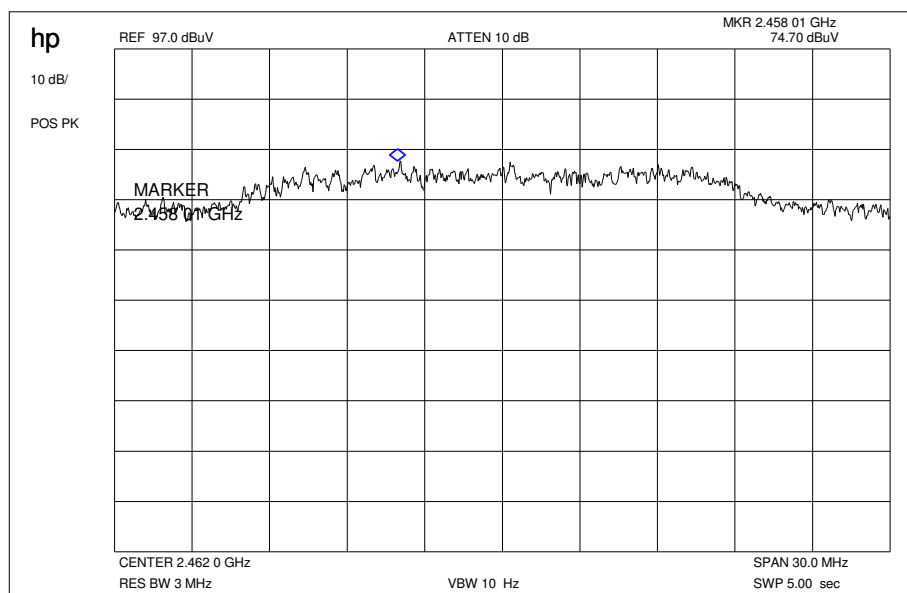

Result: 74.7 dB μ V

Plot 4: Marker-Delta Method RBW/VBW = ~1% of span (not smaller than 30 kHz)

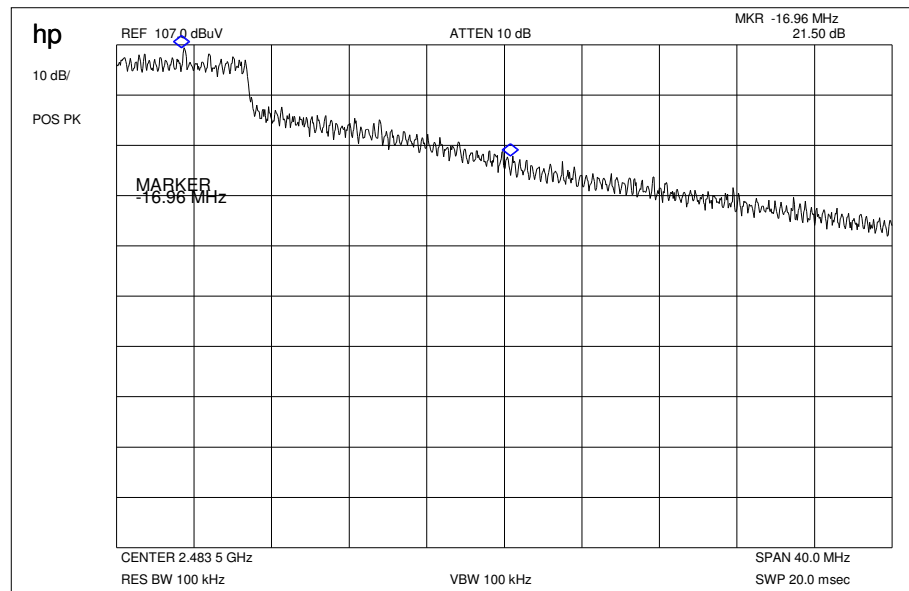

Result:

Marker-Delta-Value : 21.5 dB

This measurement was made to show that the behavior of the system is conform to FCC 15.205 (restricted bands)

Results & Limits:

Radiated field strength

The field strength was measured with an EMI measuring receiver and 1 MHz RBW / VBW for peak and with 1MHz RBW / 10Hz VBW for average at a distance of 3m.

high channel	setup	measured value (3m)	correction factor (3m)	calculated value (3m)
Max. peak value	1 MHz RBW 1 MHz VBW		+16 dB	117.9 dB μ V/m
Max. average value	1 MHz RBW 10 Hz VBW		+16 dB	74.7 dB μ V/m
Delta value	Peak 300 kHz RBW/VBW	21.5 dB		
Value at band edge	limit 54 dB μ V/m			53.2 dB μ V/m
Statement:				Complies

3.7 MPE calculation

These equations are generally accurate in the far field of an antenna but will over predict power density in the near field, where they could be used for making a “worst case” prediction.

$$S = PG/4\pi R^2$$

where S = power density (in appropriate units, e.g. mW/cm²)
P = power input to the antenna (in appropriate units e.g. mW)
G = power gain of the antenna in the direction of interest relative to the isotropic radiator
R = distance to the center of radiation of the antenna (appropriate units e.g. cm)

Or

$$S = EIRP/4\pi R^2$$

where EIRP = equivalent isotropically radiated power

Calculation:

(Calculated for max. EIRP)

EIRP: 40.01 dBm = 10023 mW

Calculation of minimal distance in cm:

distance = $(10023/(4\pi*1mW))^{1/2} = 28.24$ cm

Minimal distance needed: 29 cm

Limit:

1mW/ cm ² is the reference level for general public exposure according to the OET Bulletin 65, Edition 97-01 Table 1.

3.8 Datasheet antenna

HUBER+SUHNER[®] PLANAR ANTENNA FOR WIRELESS COMMUNICATION

SPA 2400/35/14/0/V

Technical Data

Electrical Properties

Frequency range	2400 - 2700 MHz
Impedance	50 Ω
VSWR	1.5
Polarization	linear, vertical
Gain	14.0 dBi
3 dB beamwidth horizontal	35°
3 dB beamwidth vertical	30°
Downtilt	0°
Front to back ratio	20 dB
Max. power	75 W (CW) at 25°C

Mechanical & Environmental Properties

Dimensions	200 x 200 x 43 mm (7.87" x 7.87" x 1.69")
Weight	0.5 kg (1.10 lbs.)
Radome material	ASA
Radome colour	RAL 7035 (light grey)
2002/95/EC (RoHS)	compliant
Operating temperature range	- 40°C to + 80°C
Storage temperature range	- 40°C to + 80°C
Windload	57 N at 160km/h (100mph)

Available Types

Article no.	Article no.	
1324.17.0042	84003299	N female
1324.19.0031	23010607	SMA female
1324.26.0031	23010608	TNC female

Mast mounting material (2 metal bands) included, mast diameter 54-100 mm (2.13" – 3.94")

Mounting Hardware

Article no.	Article no.	
9091.99.0168	23028430	downtilt / sidetilt bracket

Documents

01.02.0777	security instruction
01.02.0970	mounting instruction



Radiation Pattern

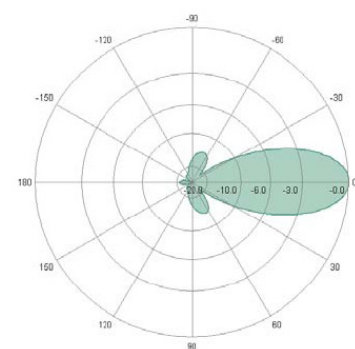

horizontal

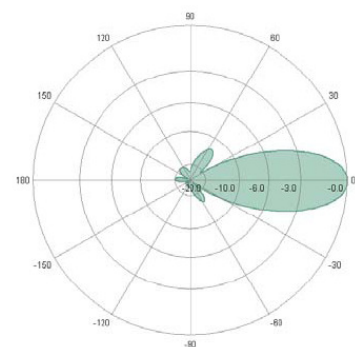

vertical



HUBER+SUHNER[®] PLANAR ANTENNA FOR WIRELESS COMMUNICATION

SPA 2400/35/14/0/V

Dimensions (mm)

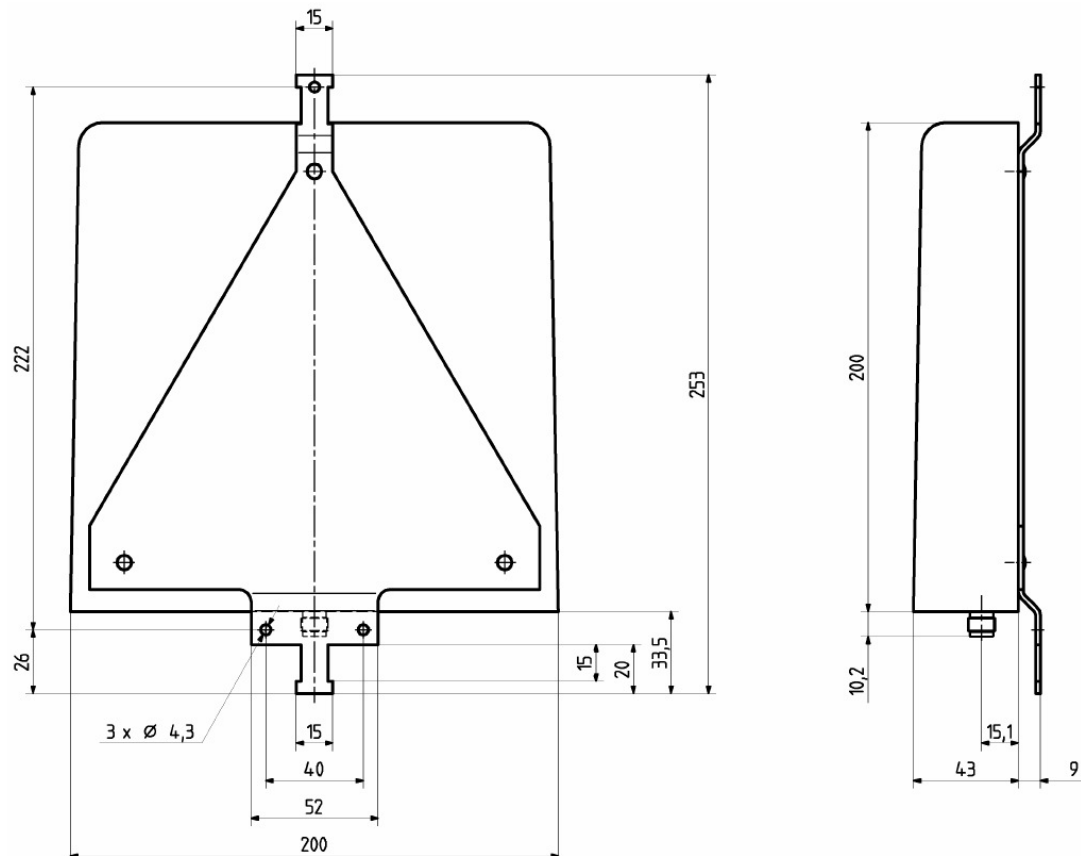

HUBER+SUHNER is certified according to ISO 9001 and ISO 14001

WAIVER!

It is exclusively in written agreements that we provide our customers with warrants and representations as to the technical contained specifications and/or the fitness for any particular purpose. The facts and figures herein are carefully compiled to the best of our knowledge, but they are intended for general informational purposes only.

HUBER+SUHNER – Excellence in Connectivity Solutions

Document no.: 01.02.0897
Issue no.: 8
Supersedes: 04.2006

Uncontrolled Copy

Issued/Checked/Released:
Last amended:

4159/4417/10.2002
4417/07.2006



HUBER+SUHNER

HUBER+SUHNER AG

RF Technology

9100 Herisau, Switzerland

Phone +41 (0)71 353 41 11

Fax +41 (0)71 353 47 51

www.hubersuhner.com

3.9 Testequipment

Anechoic chamber C:

Device	Manufacturer	Type	S/N Number	Inv. No. Cetecom
Spektrum Analyser	HP	8566B	2747A05306	300001000
Spektrum Analyser Display	HP	85662A	2816A16541	300002297
Quasi-Peak-Adapter	HP	85650A	2811A01131	300000999
Power Dupply	HP	6032A	2818A03450	300001040
Power Attenuator	Byrd	8325	1530	300001595
Biconical Antenna	EMCO	3104	3758	300001602
Log. Period. Antenna	EMCO	3146	2130	300001603
Double Ridged Antenna	EMCO	HP 3115P	3088	300001032
Active Loop Antenna	EMCO	6502	2210	300001015
Antenna VDE/FCC		HP11965B		300002298
SRM-Drive	HP	9144A	2823e46556	300001044
Software	HP	EMI		300000983
Busisolator	Kontron			300001056
Absorberhalle	MWB		87400/02	300000996
Salzsäule	Kontron			300001055
Antenna	R&S	HMO20	832211/003	300002243
Indukt. Tast Antenna	R&S	HFH 2 Z4	881468/026	300001464
System-Rack	HP I.V.	85900	*	300000222
Spectrum Analyzer	HP	8566B	2747A05275	300000219
Quasi-Peak-Adapter	HP	85650A	2811A01135	300000216
RF-Preselector	HP	85685A	2837A00779	300000218
Rahmen Antenne	R&S	HFH2-Z2	891847-35	300001169
Leitungsteiler	HP	11850C		300000997
Breitband-Hornantenne EMI	HP	35155P		300002300
PC	HP	Vectra VL		300001688
VHF Meßantenne	Schwarzbeck	VHA 9103		300001778
Spectrum Analyzer Display	HP	85662A	2816A16497	300001690
VHF Meßantenna	Schwarzbeck	VHA 9103		300001780
Biconical Antenna	EMCO	3104 C	9909-4868	300002590

SRD Laboratory:

Device	300001207	Type	S/N Number	Inv. No. Cetecom
Spectrum Analyzer	300001208	494AP	B010241	300000863
Spectrum Analyzer	HP	71210A (70000)	2731A02347	300000321
Spectrum Analyzer Display	HP	70206A	2840A01553	300002017
Reference Frequency	HP	70310A	2736A00707	300002018
Local Oscillator	HP	70900A	2842A02221	300002019
ZF-Modul 10Hz-300 kHz	HP	70902A	2840A02145	300002020
ZF-Modul 100 kHz-3 MHz	HP	70903A	2835A01069	300002021
HF-Teil für 71210A 100Hz- 22GHz	HP	70908A		300002022
Spectrum Analyzer 2	HP	85660B	3138A07614	
Spectrum Analyzer Display 2	HP	85662A	3144A20627	

SRD-Testreport

CETECOM ICT Services GmbH Saarbruecken, Germany



Test report No.: 2-4556-01-02_07_Ant18

Date: 2007-05-11

Page 24 of 27

Signal Generator DC-600 KHz	HP	8904A	2822A01213	300001157
Signal Generator DC-600 KHz	HP	8904A	2822A01214	300001158
Powersupply	HP	6038A	3122A11097	300001204
Netznachbildung	R&S	ESH3-Z5	828576/020	300001210
Amplituden Controller	R&S	SMDU-Z2	871829/051	300002309
Trenntrafo	Erfi	913501		300001205
Trenntrafo	Grundig	RT5A	9242	300001627
Relais Matrix	HP	3488A	2719A15013	300001156
Multimeter	Siemens	Multizet		300001102
Peak Power Calibrator	HP	8900B		300001084
Schallgeber	Schomandl	SG 1	10159	300001209
Schallgeber	Schomandl	SG 2	10176	300002473
Filter	FSY Microwave			300001206
Attenuatorer	Pro Nova			300002476
Klimaschrank	Heraeus Voetsch	VUK04/500		300001012
Spectrum Analyzer 3	HP	8566A	1925A00257	300001098
Spectrum Analyzer Display 3	HP	85662	1925A00860	300002306
Oszilloscope	Tektronix	2432	110261	300001165
Radiocom. Analyzer	R&S	CMTA 54	894043/010	300001175
Powersupply	HP	6038A	2848A07027	300001174
Signal Generator 0.01-1280 MHz	HP	8662A	2224A01012	300001110
Signal Generator (Funktionen)	R&S	AFGU	862490/032	300001201
Trenntrafo	Erfi	MPL	91350	300001155
Relais Matrix	R&S	PSU	893285/020	300001173
Power Meter	HP	436A	2101A12378	300001136
Powersensor	HP	8484A	2237A10156	300001140
Powersensor	HP	8482A	2237A06016	300001139
Relais Matrix	R&S	PSU	282628/004	300001214
Powersupply	Zentro		2007	300001109
Oszilloscope	Tektronix	7633		300001111
Klimaschrank	Heraeus Voetsch	VUK04/500	32926	300001500
Quasi-Peak Adapter	HP	85650A	2811A01204	300002308
Radiocom. Analyzer	R&S	CMTA 84	894199/012	300001176
Oszilloscope	HP	54510A	3022A02062	300001202
Funkmeßplatz	Schomandl	FD1000	34982	300001115
Signal Generator	R&S	SMPC	882416/019	300001162
Frequency counter	HP	5340A	2116A08138	300001104
Power Meter	HP	436A	2031U01461	300001105
Powersensor	HP	8482A		300001106
Powersensor	HP	8484A		300001107
Powersensor	HP	8485A		300001108
Powersupply	HP	6038A	2752A04866	300001161
Reflectionsmeter	R&S	NAP	879191	300001132
Signal Generator NF	R&S	SPN	880139/068	300001142
Trenntrafo	Erfi	MPL	91350	300001151
Attenuator	JFW	30 db	1350h/104	300001703
Attenuator	JFW	10 db	1350h/103	300001704
Attenuator	JFW	20 db	1350h/106	300001705
Attenuator	JFW	20 db	1350h/105	300001766
Filter	Spinner	153755		300001791

SRD-Testreport

CETECOM ICT Services GmbH Saarbruecken, Germany



Test report No.: 2-4556-01-02_07_Ant18

Date: 2007-05-11

Page 25 of 27

Powersensor	HP	8484A	2237A10494	300001666
Powersupply	HP	6038A	3122A11097	300001204
Netznachbildung	R&S	ESH3-Z5	828576/020	300001210
Amplituden Controller	R&S	SMDU-Z2	871829/051	300002309
Trenntrafo	Erfi	913501		300001205
Trenntrafo	Grundig	RT5A	9242	300001627
Relais Matrix	HP	3488A	2719A15013	300001156
Multimeter	Siemens	Multizet		300001102
Peak Power Calibrator	HP	8900B		300001084
Schallgeber	Schomandl	SG 1	10159	300001209
Schallgeber	Schomandl	SG 2	10176	300002473
Filter	FSY Microwave			300001206
Attenuatorer	Pro Nova			300002476
Klimaschrank	Heraeus Voetsch	VUK04/500		300001012
Spectrum Analyzer 3	HP	8566A	1925A00257	300001098
Spectrum Analyzer Display 3	HP	85662	1925A00860	300002306
Oszilloscope	Tektronix	2432	110261	300001165
Radiocom. Analyzer	R&S	CMTA 54	894043/010	300001175
Powersupply	HP	6038A	2848A07027	300001174
Signal Generator 0.01-1280 MHz	HP	8662A	2224A01012	300001110
Signal Generator (Funkions)	R&S	AFGU	862490/032	300001201
Trenntrafo	Erfi	MPL	91350	300001155
Relais Matrix	R&S	PSU	893285/020	300001173
Power Meter	HP	436A	2101A12378	300001136
Powersensor	HP	8484A	2237A10156	300001140
Powersensor	HP	8482A	2237A06016	300001139
Relais Matrix	R&S	PSU	282628/004	300001214
Powersupply	Zentro		2007	300001109
Oszilloscope	Tektronix	7633		300001111
Klimaschrank	Heraeus Voetsch	VUK04/500	32926	300001500
Quasi-Peak Adapter	HP	85650A	2811A01204	300002308
Radiocom. Analyzer	R&S	CMTA 84	894199/012	300001176
Oszilloscope	HP	54510A	3022A02062	300001202
Funkmeßplatz	Schomandl	FD1000	34982	300001115
Signal Generator	R&S	SMPC	882416/019	300001162
Frequency counter	HP	5340A	2116A08138	300001104
Power Meter	HP	436A	2031U01461	300001105
Powersensor	HP	8482A		300001106
Powersensor	HP	8484A		300001107
Powersensor	HP	8485A		300001108
Powersupply	HP	6038A	2752A04866	300001161
Reflectionsmeter	R&S	NAP	879191	300001132
Signal Generator NF	R&S	SPN	880139/068	300001142
Trenntrafo	Erfi	MPL	91350	300001151
Attenuator	JFW	30 db	1350h/104	300001703
Attenuator	JFW	10 db	1350h/103	300001704
Attenuator	JFW	20 db	1350h/106	300001705
Attenuator	JFW	20 db	1350h/105	300001766
Filter	Spinner	153755		300001791
Powersensor	HP	8484A	2237A10494	300001666

Powersensor	HP	8485A	2238A00849	300001668
Bandfilter	Telonic	TTF7255EE	20293-11	300001300
Bandfilter	Telonic	TTF12555EE	20292-6	300001302
Bandfilter	Telonic	TTF25055EE	20291-8	300001304
Bandfilter	Telonic	TTF50055EE	20290-7	300001305
Bandfilter	Telonic	TTF100055EE	20289-7	300001307
Bandfilter	Telonic	TTA300055EESN	20370-2	300001312
Bandstop	Telonic	TTR3753EE1	30013-1	300001314
Bandstop	Telonic	TTR723EE	20417-2	300001316
Bandstop	Telonic	TTR95-3EE	20372-4	300001318
Bandstop	Telonic	TTR1903EE	30036-4	300001320
Bandstop	Telonic	TTR3753EE	20369-5	300001321
Bandstop	Telonic	TTR750-3EE1	90177-1	300002387
Highpass	Pro Nova	HDP120-6GG	ohne	300001348
Highpass	Pro Nova	HMC500-6AA	HJ67-01?	300001350
Highpass	Narda	NHP 9000	0004	300001362
Highpass	Narda	HDP16-6GH	JV70-01	300001364
Highpass	RSD	HDP50-6GH, HDP200-6GG		300001371
Highpass	RSD	2099-02-01		300000370
Signal Generator 0.1-2060 MHz	HP	8657A	2838U00736	300001009
Radio Code Analyzer	Schlumberger	SL4922		300001038
Signal Analyzer	B&K	2033		300001047
Frequency counter	HP	5386A	2704A01243	300000998
Laufzeitelement	WR-Elektronik			300001036
Powersupply Stromversorgung	Systron	M5P 40/15A	828233	300001291
Powersupply	Heiden	1108-32	1701	300001392
Powersupply	Heiden	1108-32	1802	300001383
Powersupply	Heiden	1108-32	003202	300001187
Powersupply	Zentro	LA 2x30/5GB1	2011	300001276
Powersupply	Zentro	LA 2x30/5GB2	2012	300001275
Powersupply	Zentro	LA 30/5GA	2041,2042	300001287
Trenntrafo	Grundig	RT5A	8781	300001277
Trenntrafo	Grundig	RT5A	9242	300001263
Multimeter	Goerz Elektro	Unigor 6e P	911 355	300001625
Multimeter	Goerz Elektro	Unigor 6e P	911 391	300001281
Climatic Box	Heraeus Voetsch	VUK04/500	32679	300000299
Powersensor + Att.	HP	8482B	2703A02586	300001492
Attenuator 30 dB	HP	8498A	1801A02445	300001475
Signal Generator NF	HP		2822A01203	300001004
Attenuator	Spinner	BN 534171 D	51881	300001516
Attenuator coaxial	Bird	8325	2429	300001513
Impulsbegrenzer	R&S	ESH 3 Z2		300001460
4Port Box	R&S	4Port Box	860457/005	300001472
Signal Generator 0.1-4200 MHz	HP	8665A	2833A0011	300002299
Spektrumanalyzer	R&S	FSU50	200012	300003443
Swissphone Freifeld-Messbox	Swissphone Schweiz			300002302
Trenntrafo regelbar	Grundig	RT5H	9242	300001628
Signal Generator	HP	8111A	2215G00867	300001117

4 Photographs

Test site:

