

Recognized by the
Federal Communications Commission
Anechoic chamber registration no.: 90462 (FCC)
Anechoic chamber registration no.: IC 3463A-1
TCB ID: DE 0001



Accredited by the
German Accreditation Council
DAR-Registration Number
DAT-P-176/94-D1



Independent ETSI
compliance test house



Accredited Bluetooth® Test Facility (BQTF)

Test report no.: 2-4556-01-02_07_Ant6_5G

LANCOM XAP-40-2

Hirschmann BAT54-Rail

FCC ID: U4Y-SE112

IC: 7049A-SE112

*The Bluetooth word mark and logos are owned by the Bluetooth SIG,
Inc. and any use of such marks by Cetecom ICT is under license*

Table of contents

1. ADMINISTRATIVE DATA	3
1.1. ADMINISTRATIVE DATA OF THE TEST FACILITY	3
1.1.1 Identification of the testing laboratory	3
1.1.2 Organizational items.....	3
1.1.3 Applicant´s details	4
1.2. ADMINISTRATIVE DATA OF MANUFACTURER / MEMBER	4
1.3. DESCRIPTION OF THE EQUIPMENT UNDER TEST (EUT)	5
1.3.1 EUT: Type, S/N etc.	5
1.3.2 If RF component testing only, description of additional used HW/SW.....	5
1.3.3 ADDITIONAL EUT INFORMATION	6
1.3.4 EUT operating modes.....	7
1.3.5 Extreme conditions testing values.....	7
2 TEST STANDARD & SUMMARY LIST OF ALL PERFORMED TEST CASES	8
3 RF MEASUREMENT TESTING	9
3.1 DESCRIPTION OF TEST SET-UP.....	9
3.1.1 Radiated measurements	9
3.1.2 Conducted measurements	9
3.1.3 AC-conducted measurements.....	9
3.2 REFERENCED DOCUMENTS	10
3.3 ADDITIONAL COMMENTS	10
3.4 ANTENNA GAIN	10
3.5 MAXIMUM OUTPUT POWER (CONDUCTED) (OFDM) § 15.247(B)(3) / 15.407(A)(1)(3).....	11
3.6 ANT 6: BAT-ANT-N-12A.....	13
3.7 MPE.....	18
3.8 DATASHEET ANTENNA.....	19
3.9 TESTEQUIPMENT.....	20
4 PHOTOGRAPHS	24

1. Administrative data

1.1. Administrative data of the test facility

1.1.1 Identification of the testing laboratory

Company name:	Cetecom ICT Services GmbH
Address:	Untertürkheimerstr. 6-10 D-66117 Saarbruecken Germany
Laboratory accreditation:	DAR-Registration No. DAT-P-176/94-D1 Bluetooth Qualification Test Facility (BQTF)
Responsible for testing laboratory:	Harro Ames, Stefan Bös Phone: +49 681 598 0 Fax: +49 681 598 9075 email: info@ict.cetecom.de

..... /
Responsible for testing laboratory
(Harro Ames, Stefan Bös)

1.1.2 Organizational items

Reference No.:	
Order No.:	
Responsible for test report and project leader:	Harro Ames, Stefan Bös
Receipt of EUT:	2007-03-22
Date(s) of test:	2007-03-25 to 2007-04-20
Date of report:	2007-05-11
Number of report pages:	24
Number of diagram pages (annex):	

Version of template:	1.6

..... /
Responsible for test report
(Harro Ames, Stefan Bös)

Note:

The test results of this test report relate exclusively to the item tested as specified in this report. The CETECOM ICT Services GmbH does not assume responsibility for any conclusions and generalizations drawn from the test results with regard to other specimens or samples of the type of the equipment represented by the test item.

The test report may only be reproduced or published in full. Reproduction or publication of extracts from the report requires the prior written approval of the CETECOM ICT Services GmbH.

During the test no hardware and software changes are allowed to be performed at the EUT.

1.1.3 Applicant's details

Applicant's name:	LANCOM Systems GmbH
Address:	Adenauerstr. 20/B2 D-52146 Würselen Germany
Contact person:	Mr. Andre Krautschick Tel: +49 (0)2405 49936-443 Fax: +49(0)2405 49936-99 email: Andre.Krautschick@lancom.de

1.2 Administrative data of manufacturer / member

Manufacturer's name:	- applicant -
Address:	

1.3 Description of the Equipment under test (EUT)

1.3.1 EUT: Type, S/N etc.

Product name	Product ID	Description	S/N serial number	HW hardware status	SW software status
XAP-40-2 BAT54-Rail		Dual WLAN AP	-	-	-
Frequency Band [MHz]	Type of Modulation	Number of channels	Antenna	Power Supply	Temperature Range
ISM 5.745 – 5.825	OFDM	5	2*2 external antennas	External AC power supply	-20°C - +55°C

1.3.2 If RF component testing only, description of additional used HW/SW

	Product name	Product ID	Description	S/N serial number	HW hardware status	SW software status
1						
2						

1.3.3 Additional EUT information

The sample is a dual access point for dualband use. (2.4 and 5 GHz).

Inside the AP there are two identical RF parts, both are able to work on 2.4 and 5 GHz.

In this report we test the radiated emissions of the AP with external antenna **Ant6 (BAT-ANT-N-12A) at the 5 GHz range.**

We tested spurious emissions for each antenna type.

The maximal output power can be calculated by the conducted output power and the attached pattern of the antenna.

Other antennas and frequency ranges are tested in separate reports.

The complete test report for the AP at **5.8 GHz** is **2-4556-01-05/07** from our house.

Antenna types: (gain according data sheet)

Ant2:	BAT-ANT-8A	5.15 – 5.35 GHz	5.0 dBi
		5.35 – 5.875 GHz	8.0 dBi
Ant6:	BAT-ANT-N-12A	5.15 – 5.35 GHz	12.0 dBi
		5.35 – 5.875 GHz	14.0 dBi
Ant7:	BAT-ANT-TNC-10ADS	5.15 – 5.875 GHz	10.0 dBi
Ant8:	BAT-ANT-N-23/9a	5.15 – 5.875 GHz	23.0 dBi
Ant9:	Extender I-60AG	5.15 – 5.875 GHz	8.0 dBi
Ant11:	Extender 0-9a	5.15 – 5.35 GHz	23.0 dBi
		5.47 – 5.875 GHz	23.0 dBi
Ant12:	Extender 0-D60a	5.15 – 5.875 GHz	10.0 dBi
Ant14:	Extender 0-360ag	5.x GHz	7.0 dBi
Ant15:	BAT-ANT-N-6ABG	4.90 – 5.935 GHz	8.0 dBi
Ant17:	Extender 0-18a	5.25 – 5.875 GHz	18.0 dBi

To simplify reading the report we use inside the short name of the antennas, ANT1, ANT2 etc.

1.3.4 EUT operating modes

EUT operating mode no.*)	Description of operating modes	Additional information
Op. 0	Normal mode	Normal temperature and power source conditions
Op. 1		low temperature, low power source conditions
Op. 3		low temperature, high power source conditions
Op. 4		high temperature, low power source conditions
Op. 5		high temperature, high power source conditions

*) EUT operating mode no. is used to simplify the test report.

1.3.5 Extreme conditions testing values

Description	Shortcut	Unit	Value
Nominal Temperature / humidity	T _{nom}	°C / %	22°C / 33%
Low Temperature	T _{low}	°C	-20°C
High Temperature	T _{high}	°C	55°C
Nominal Power Source	V _{nom}	V	115V AC
Low Power Source	V _{low}	V	100V AC
High Power Source	V _{high}	V	130V AC

Type of powersource: External AC power supply with 12V DC output, delivered by the customer

2 Test standard & summary list of all performed test cases

TC identifier	Description	verdict	date	Remark
RF-Testing	FCC Part 15 §15.247 - CANADA RSS-210	pass	2007-05-11	

Test Specification Clause	Test Case	Pass	Fail	Not applicable	Not performed
None	Antenna Gain	Yes			
§ 15.247(b)(3)	Maximum output power (conducted)	Yes			
§ 15.247(b)(4)	Max. peak output power (radiated)	Yes			
§ 15.209	Spurious Emission -radiated (Transmitter)	Yes			
§ 15.247 (i)	Radio frequency energy level (Transmitter)	Yes			

3 RF measurement testing

3.1 Description of test set-up

3.1.1 Radiated measurements

The radiated measurements are performed in vertical and horizontal plane in the frequency range from 9 kHz to 25 GHz in semi-anechoic chambers. The EUT is positioned on a non-conductive support with a height of 0.80 m above a conductive ground plane that covers the whole chamber. The receiving antennas conform with specifications ANSI C63.2-1996 clause 15 and ANSI C63.4-2003 clause 4.1.5. These antennas can be moved over the height range between 1.0 m and 4.0 m in order to search for maximum field strength emitted from EUT. The measurement distances between EUT and receiving antennas are indicated in the test setups for the various frequency ranges. For each measurement, the EUT is rotated in all three axes until the maximum field strength is received. The wanted and unwanted emissions are received by spectrum analysers where the detector modes and resolution bandwidths over various frequency ranges are set according to requirement ANSI C63-4-2003 clause 4.2.

Antennas conform with ANSI C63.2-1996 item 15.

150 kHz - 30 MHz: Quasi Peak measurement, 9kHz Bandwidth, passive loop antenna.

30 MHz - 200 MHz: Quasi Peak measurement, 120KHz Bandwidth, biconical antenna

200MHz - 1GHz: Quasi Peak measurement, 120KHz Bandwidth, log periodic antenna

>1GHz: Average, RBW 1MHz, VBW 10 MHz, waveguide horn with lownoise preamp

3.1.2 Conducted measurements

The EUT's RF signal is coupled out by the antenna connector which is supplied by the manufacturer. The signal is connected to the spectrum analyzer. The specific losses for signal paths are first checked within a calibration. The measurement readings on the spectrum analyzer are corrected by the specific test set-up loss. The attenuator, power divider, signaling unit and the spectrum analyzer are impedance matched on 50 Ohm.

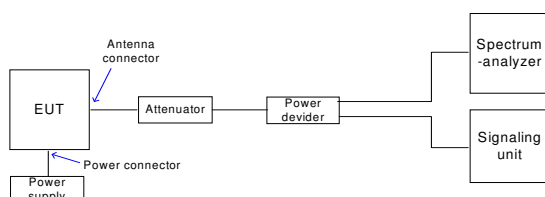

3.1.3 AC-conducted measurements

We used the dedicated power supply delivered by the customer.

3.2 Referenced Documents

none

3.3 Additional comments

none

3.4 Antenna gain

according to data sheets of the antennas

The real gain of the antennas may be lower.

	Ant2	Ant6	Ant7	Ant8	Ant9	Ant11	Ant12	Ant14	Ant15	Ant17
gain(dBi) 5.8 GHz	8.0	14.0	10.0	23.0	8.0	23.0	10.0	7.0	8.0	18.0

3.5 Maximum output power (conducted) (OFDM)

§ 15.247(b)(3) / 15.407(a)(1)(3)

Plot 1:

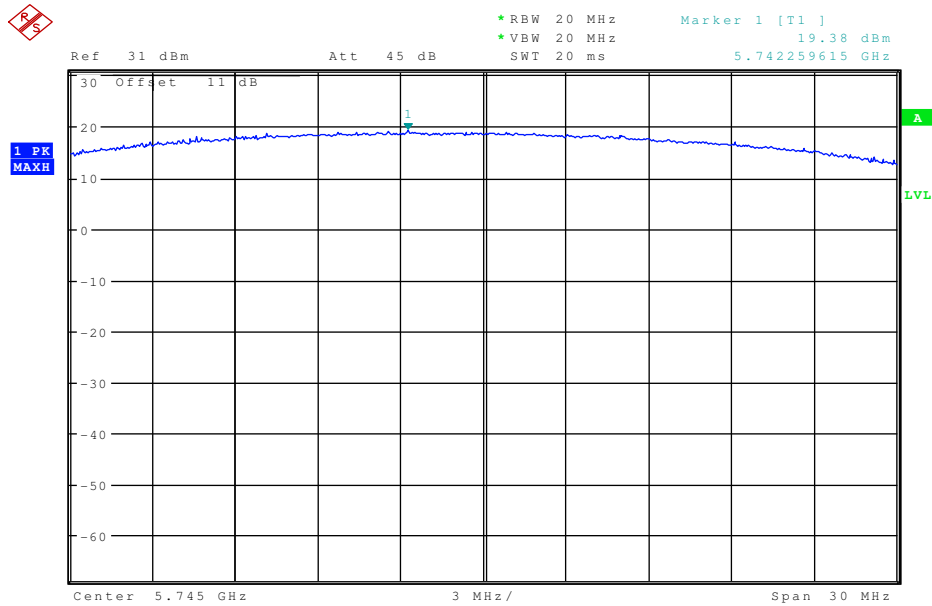

Plot 2:

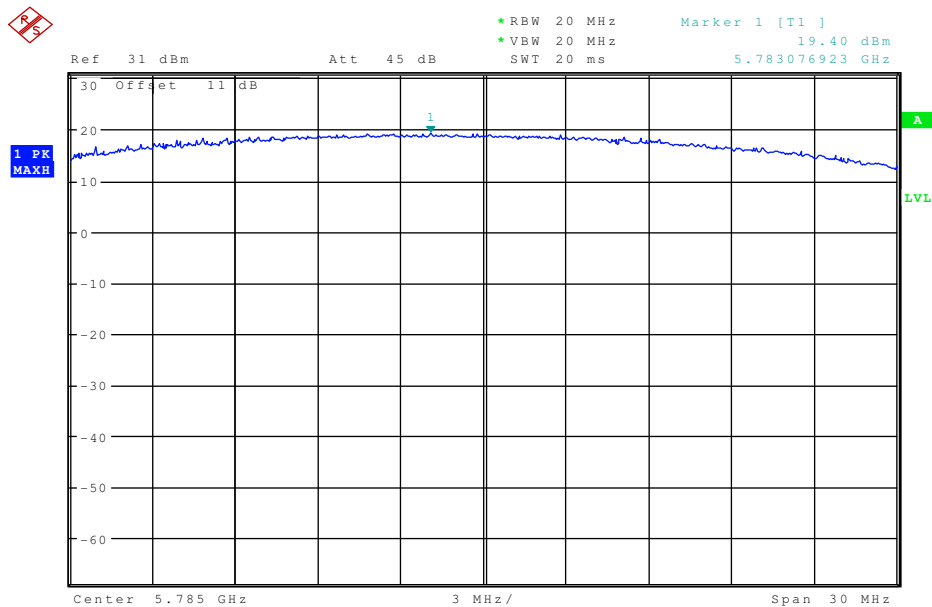

Plot 3:

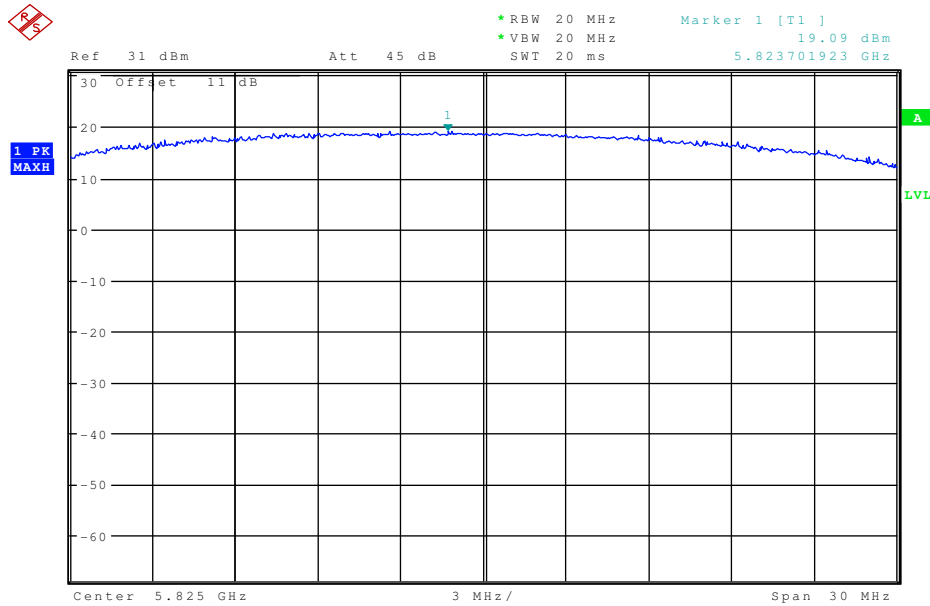

Results:

Test conditions		Max. peak output power [dBm]			
Frequency [MHz]		5745	5785	5825	
T _{nom}	V _{nom}	PK	19.38	19.40	19.09
Measurement uncertainty		±3dB			

Limits:

Under normal test conditions only, for frequency range 5.725 – 5.825 GHz	Max. 1 W (30 dBm) or 17 dBm + 10logB where B is the 26dB-Emission-bandwidth in MHz – whichever is lesser
--	--

3.6 Ant 6: BAT-ANT-N-12A

Max. peak output power (radiated) §15.247 (b) (4)

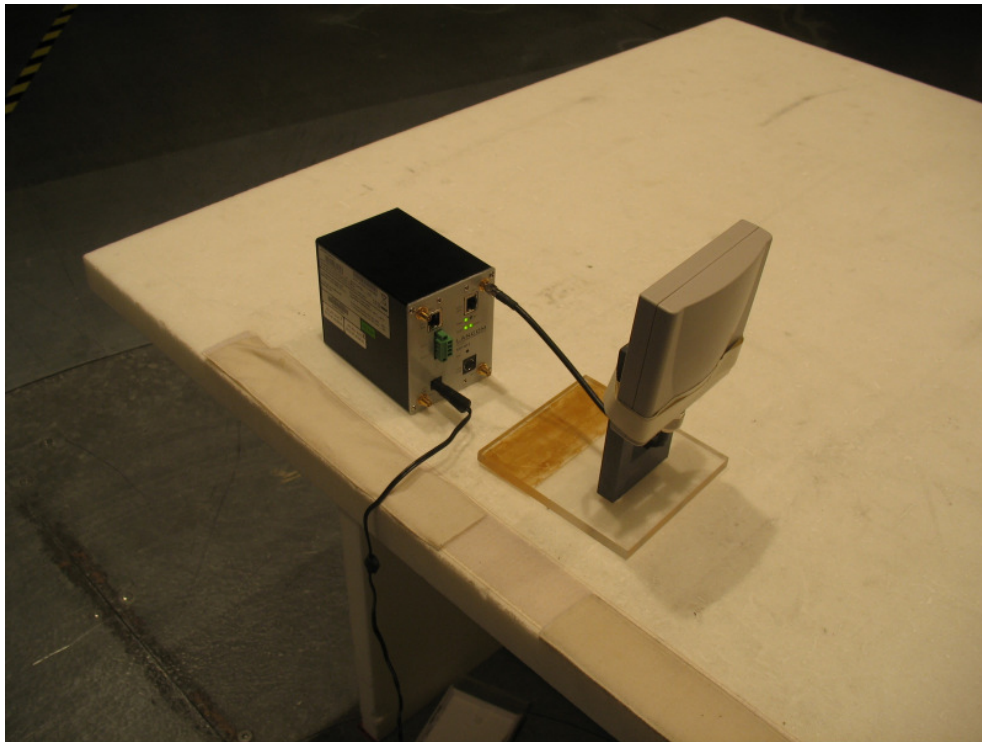

Results: calculated with specified antenna gain (14.0 dBi)

Test conditions		Max. peak output power EIRP [dBm]		
Frequency [MHz]		5745	5785	5825
T _{nom}	OFDM - Conducted	19.38	19.40	19.09
T _{nom}	OFDM - Radiated	33.38	33.40	33.09
Measurement uncertainty		±3dB		

Limits:

Under normal test conditions only, for frequency range 5.725 – 5.850 GHz	Radiated: Max. 30 dBm + directional gain of the antenna If the directional gain of the antenna exceeds 6 dBi the maximum conducted output power (30 dBm) shall be reduced by the amount in dB that the gain exceeds 6 dBi
--	--

SRD-Testreport

CETECOM ICT Services GmbH Saarbruecken, Germany



Test report No.: 2-4556-01-02_07_Ant6_5G

Date: 2007-05-11

Page 14 of 24

Spurious Emissions - radiated

Transmitter

§ 15.209 / 15.247

OFDM mode

0.03 - 12 GHz vertical / horizontal

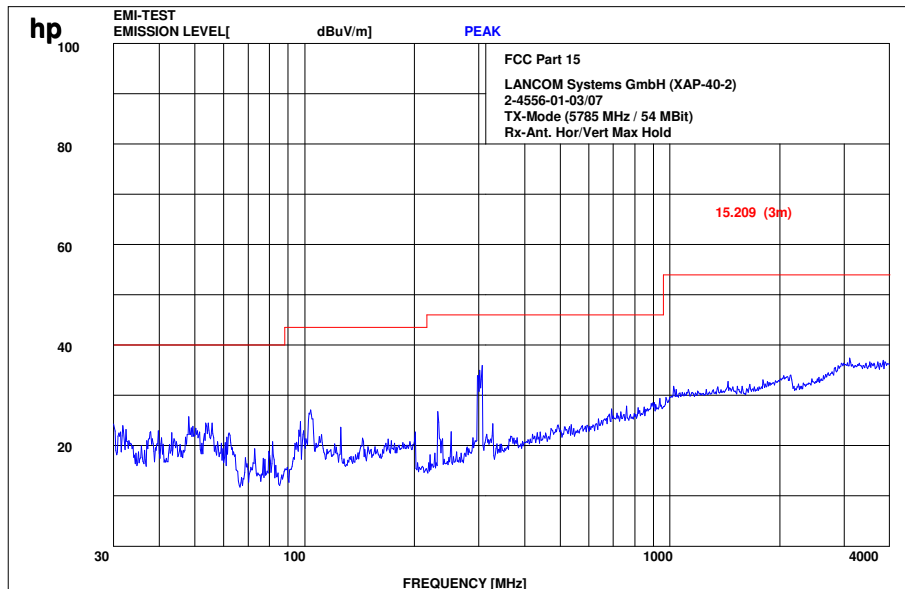
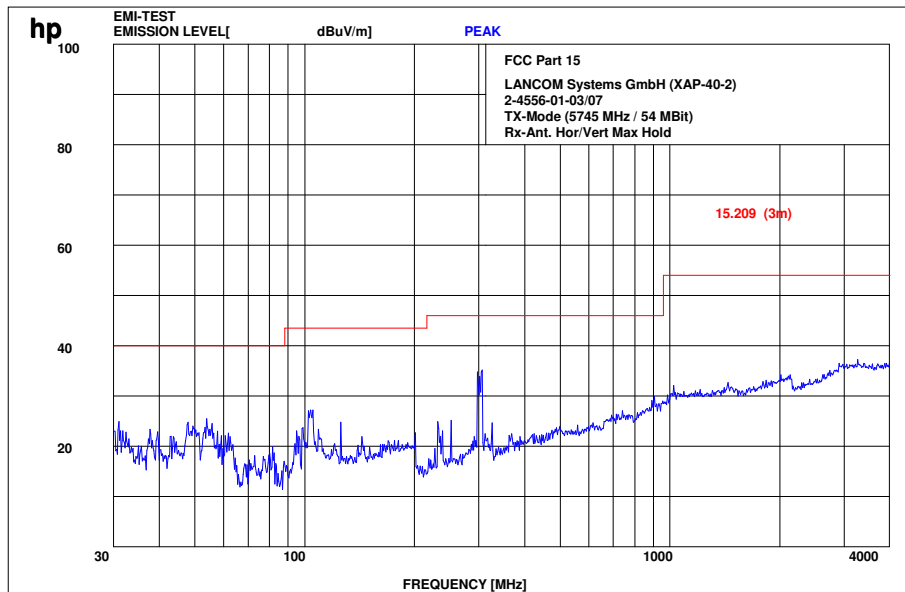

SRD-Testreport

CETECOM ICT Services GmbH Saarbruecken, Germany



Test report No.: 2-4556-01-02_07_Ant6_5G

Date: 2007-05-11

Page 15 of 24

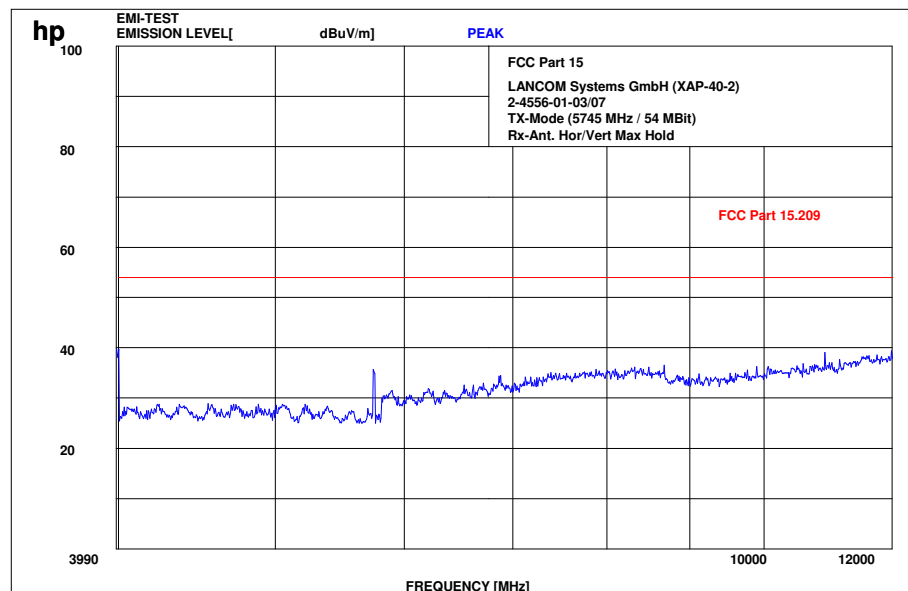
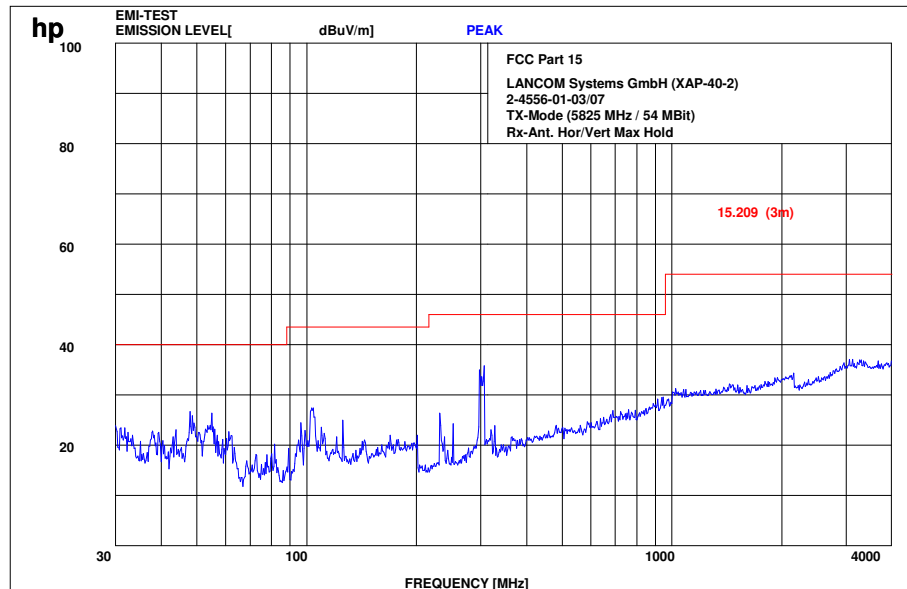

Carrier suppressed with a rejection filter

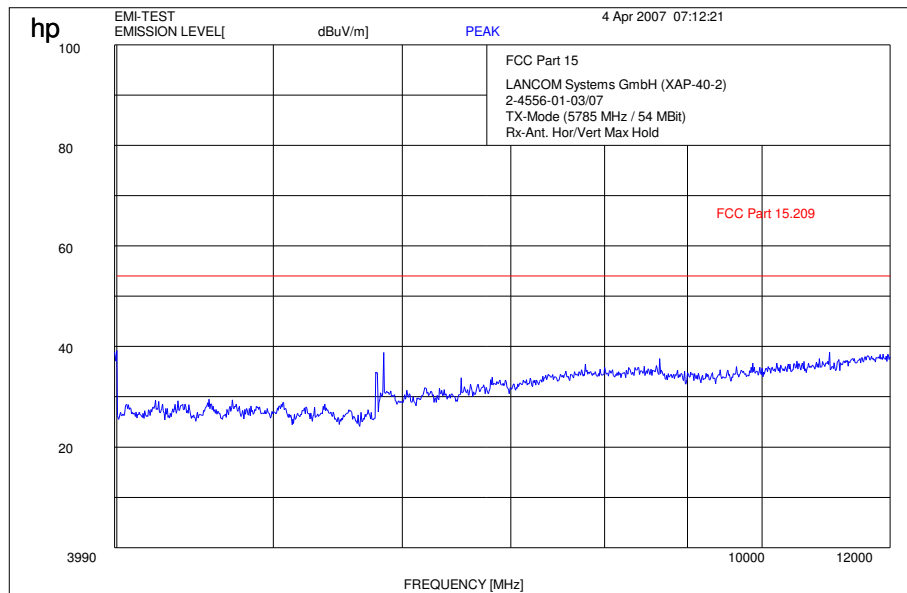

Carrier suppressed with a rejection filter

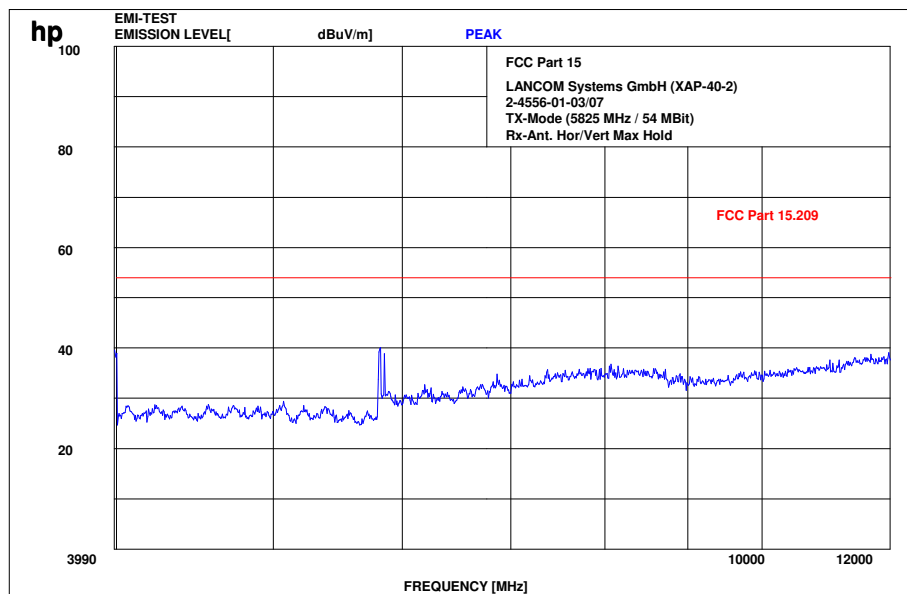

Carrier suppressed with a rejection filter

12- 25 GHz (valid for all channels, worst case)

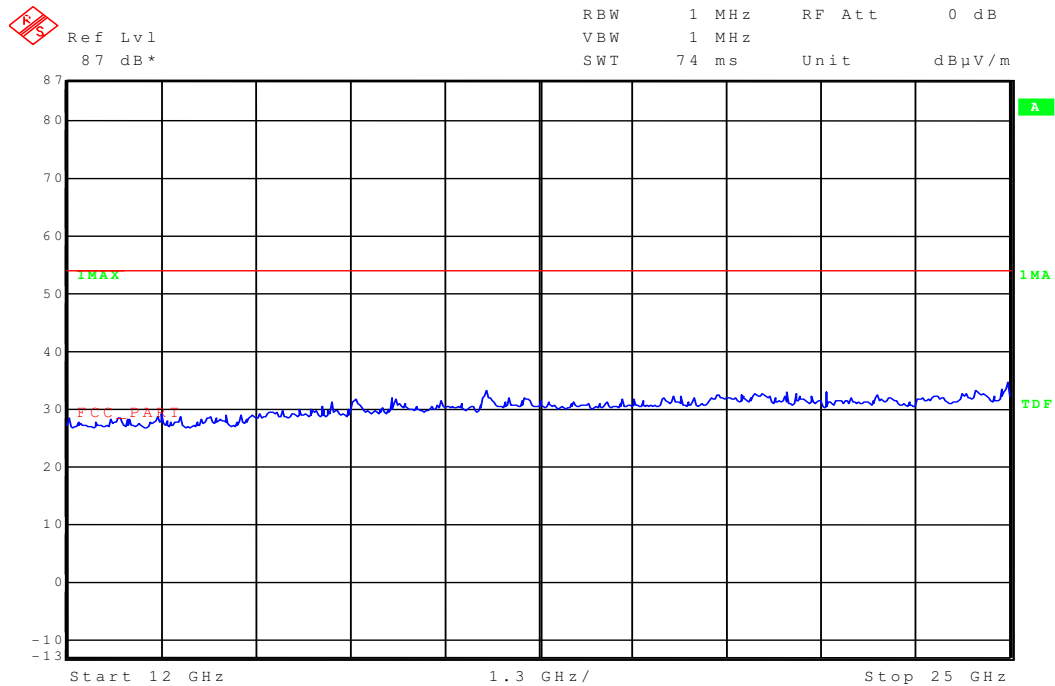

Results:

Spurious Emissions level [$\mu\text{V/m}$]								
5745 MHz			5785 MHz			5825 MHz		
f[MHz]	Detector	Level [$\mu\text{V/m}$]	f[MHz]	Detector	Level [$\mu\text{V/m}$]	f[MHz]	Detector	Level [$\mu\text{V/m}$]
No critical peaks found < 10 dB below limit line								
Measurement uncertainty			± 3 dB					

f < 1 GHz : RBW/VBW: 100 kHz
see above plots

f ≥ 1GHz : RBW/VBW: 1 MHz

Measurement distance see table

Limits : § 15.109 / 209

Frequency (MHz)	Field strength ($\mu\text{V/m}$)	Measurement distance (m)
30 - 88	100 (40 dB $\mu\text{V/m}$)	3
88 - 216	150 (43.5 dB $\mu\text{V/m}$)	3
216 - 960	200 (46 dB $\mu\text{V/m}$)	3
above 960	500 (54 dB $\mu\text{V/m}$)	3

3.7 MPE

These equations are generally accurate in the far field of an antenna but will over predict power density in the near field, where they could be used for making a “worst case” prediction.

$$S = PG/4\pi R^2$$

where S = power density (in appropriate units, e.g. mW/cm²)
P = power input to the antenna (in appropriate units e.g. mW)
G = power gain of the antenna in the direction of interest relative to the isotropic radiator
R = distance to the center of radiation of the antenna (appropriate units e.g. cm)

Or

$$S = EIRP/4\pi R^2$$

where EIRP = equivalent isotropically radiated power

Calculation:

(Calculated for max. EIRP)

EIRP: 33.4 dBm = 2188 mW

calculated at distance of 20 cm:

power density = $2188 / 4\pi 20^2 = 0.435 \text{ mW/ cm}^2$

Limit:

1mW/ cm ² is the reference level for general public exposure according to the OET Bulletin 65, Edition 97-01 Table 1.

3.8 Datasheet antenna



Directional Antenna linear for 5.8 GHz

BAT- ANT- N – 12 A

Order Number: 943 903 320



Electrical Specification

Frequency range	5150 MHz - 5350 MHz	5350 MHz - 5875 MHz
Gain	12 dBi	14 dBi
VSWR	2.0 : 1 Max	2.0 : 1 Max
Polarization	Linear, vertical	Linear, vertical
HPBW / horizontal	25°	25°
HPBW / vertical	30°	25°
Front to back ratio		20 dB
Power handling		5W (CW)
Impedance		50 Ω
Connector		N Jack

Environmental & Mechanical Characteristics

Survival wind speed	216 km/hr
Temperature	- 40° C to +80° C
Humidity	95% @ 55° C
Radome material	ABS, UV resistant
Radome color	Light gray
Weight	107 g
Dimensions	114 x 114 x 40
IP	IP65
Wall and mast mountable	

Cable: 1m with N connectors at both sides.
Attenuation at 5.8 GHz 1dB

Usable system for BAT54M and BAT54-Rail.
Please order cable additionally.

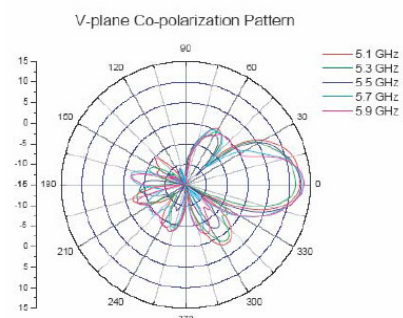
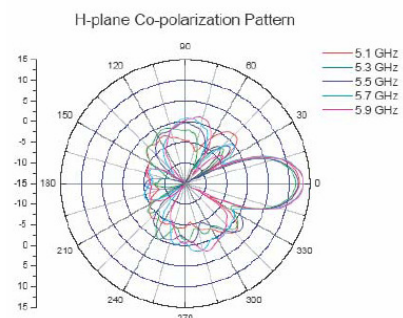
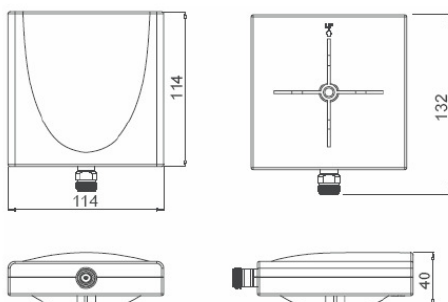

3.9 Testequipment

Anechoic chamber C:

Device	Manufacturer	Type	S/N Number	Inv. No. Cetecom
Spektrum Analyser	HP	8566B	2747A05306	300001000
Spektrum Analyser Display	HP	85662A	2816A16541	300002297
Quasi-Peak-Adapter	HP	85650A	2811A01131	300000999
Power Dupply	HP	6032A	2818A03450	300001040
Power Attenuator	Byrd	8325	1530	300001595
Biconical Antenna	EMCO	3104	3758	300001602
Log. Period. Antenna	EMCO	3146	2130	300001603
Double Ridged Antenna	EMCO	HP 3115P	3088	300001032
Active Loop Antenna	EMCO	6502	2210	300001015
Antenna VDE/FCC		HP11965B		300002298
SRM-Drive	HP	9144A	2823e46556	300001044
Software	HP	EMI		300000983
Busisolator	Kontron			300001056
Absorberhalle	MWB		87400/02	300000996
Salzsäule	Kontron			300001055
Antenna	R&S	HMO20	832211/003	300002243
Indukt.Tast Antenna	R&S	HFH 2 Z4	881468/026	300001464
System-Rack	HP I.V.	85900	*	300000222
Spectrum Analyzer	HP	8566B	2747A05275	300000219
Quasi-Peak-Adapter	HP	85650A	2811A01135	300000216
RF-Preselector	HP	85685A	2837A00779	300000218
Rahmen Antenne	R&S	HFH2-Z2	891847-35	300001169
Leitungsteiler	HP	11850C		300000997
Breitband-Hornantenne EMI	HP	35155P		300002300
PC	HP	Vectra VL		300001688
VHF Meßantenne	Schwarzbeck	VHA 9103		300001778
Spectrum Analyzer Display	HP	85662A	2816A16497	300001690
VHF Meßantenna	Schwarzbeck	VHA 9103		300001780
Biconical Antenna	EMCO	3104 C	9909-4868	300002590

SRD Laboratory:

Device	300001207	Type	S/N Number	Inv. No. Cetecom
Spectrum Analyzer	300001208	494AP	B010241	300000863
Spectrum Analyzer	HP	71210A (70000)	2731A02347	300000321
Spectrum Analyzer Display	HP	70206A	2840A01553	300002017
Reference Frequency	HP	70310A	2736A00707	300002018
Local Oscillator	HP	70900A	2842A02221	300002019
ZF-Modul 10Hz-300 kHz	HP	70902A	2840A02145	300002020
ZF-Modul 100 kHz-3 MHz	HP	70903A	2835A01069	300002021
HF-Teil für 71210A 100Hz- 22GHz	HP	70908A		300002022
Spectrum Analyzer 2	HP	85660B	3138A07614	
Spectrum Analyzer Display 2	HP	85662A	3144A20627	

SRD-Testreport

CETECOM ICT Services GmbH Saarbruecken, Germany



Test report No.: 2-4556-01-02_07_Ant6_5G

Date: 2007-05-11

Page 21 of 24

Signal Generator DC-600 KHz	HP	8904A	2822A01213	300001157
Signal Generator DC-600 KHz	HP	8904A	2822A01214	300001158
Powersupply	HP	6038A	3122A11097	300001204
Netznachbildung	R&S	ESH3-Z5	828576/020	300001210
Amplituden Controller	R&S	SMDU-Z2	871829/051	300002309
Trenntrafo	Erfi	913501		300001205
Trenntrafo	Grundig	RT5A	9242	300001627
Relais Matrix	HP	3488A	2719A15013	300001156
Multimeter	Siemens	Multizet		300001102
Peak Power Calibrator	HP	8900B		300001084
Schallgeber	Schomandl	SG 1	10159	300001209
Schallgeber	Schomandl	SG 2	10176	300002473
Filter	FSY Microwave			300001206
Attenuatorer	Pro Nova			300002476
Klimaschrank	Heraeus Voetsch	VUK04/500		300001012
Spectrum Analyzer 3	HP	8566A	1925A00257	300001098
Spectrum Analyzer Display 3	HP	85662	1925A00860	300002306
Oszilloscope	Tektronix	2432	110261	300001165
Radiocom. Analyzer	R&S	CMTA 54	894043/010	300001175
Powersupply	HP	6038A	2848A07027	300001174
Signal Generator 0.01-1280 MHz	HP	8662A	2224A01012	300001110
Signal Generator (Funktionen)	R&S	AFGU	862490/032	300001201
Trenntrafo	Erfi	MPL	91350	300001155
Relais Matrix	R&S	PSU	893285/020	300001173
Power Meter	HP	436A	2101A12378	300001136
Powersensor	HP	8484A	2237A10156	300001140
Powersensor	HP	8482A	2237A06016	300001139
Relais Matrix	R&S	PSU	282628/004	300001214
Powersupply	Zentro		2007	300001109
Oszilloscope	Tektronix	7633		300001111
Klimaschrank	Heraeus Voetsch	VUK04/500	32926	300001500
Quasi-Peak Adapter	HP	85650A	2811A01204	300002308
Radiocom. Analyzer	R&S	CMTA 84	894199/012	300001176
Oszilloscope	HP	54510A	3022A02062	300001202
Funkmeßplatz	Schomandl	FD1000	34982	300001115
Signal Generator	R&S	SMPC	882416/019	300001162
Frequency counter	HP	5340A	2116A08138	300001104
Power Meter	HP	436A	2031U01461	300001105
Powersensor	HP	8482A		300001106
Powersensor	HP	8484A		300001107
Powersensor	HP	8485A		300001108
Powersupply	HP	6038A	2752A04866	300001161
Reflectionsmeter	R&S	NAP	879191	300001132
Signal Generator NF	R&S	SPN	880139/068	300001142
Trenntrafo	Erfi	MPL	91350	300001151
Attenuator	JFW	30 db	1350h/104	300001703
Attenuator	JFW	10 db	1350h/103	300001704
Attenuator	JFW	20 db	1350h/106	300001705
Attenuator	JFW	20 db	1350h/105	300001766
Filter	Spinner	153755		300001791

SRD-Testreport

CETECOM ICT Services GmbH Saarbruecken, Germany



Test report No.: 2-4556-01-02_07_Ant6_5G

Date: 2007-05-11

Page 22 of 24

Powersensor	HP	8484A	2237A10494	300001666
Powersupply	HP	6038A	3122A11097	300001204
Netznachbildung	R&S	ESH3-Z5	828576/020	300001210
Amplituden Controller	R&S	SMDU-Z2	871829/051	300002309
Trenntrafo	Erfi	913501		300001205
Trenntrafo	Grundig	RT5A	9242	300001627
Relais Matrix	HP	3488A	2719A15013	300001156
Multimeter	Siemens	Multizet		300001102
Peak Power Calibrator	HP	8900B		300001084
Schallgeber	Schomandl	SG 1	10159	300001209
Schallgeber	Schomandl	SG 2	10176	300002473
Filter	FSY Microwave			300001206
Attenuatorer	Pro Nova			300002476
Klimaschrank	Heraeus Voetsch	VUK04/500		300001012
Spectrum Analyzer 3	HP	8566A	1925A00257	300001098
Spectrum Analyzer Display 3	HP	85662	1925A00860	300002306
Oszilloscope	Tektronix	2432	110261	300001165
Radiocom. Analyzer	R&S	CMTA 54	894043/010	300001175
Powersupply	HP	6038A	2848A07027	300001174
Signal Generator 0.01-1280 MHz	HP	8662A	2224A01012	300001110
Signal Generator (Funkions)	R&S	AFGU	862490/032	300001201
Trenntrafo	Erfi	MPL	91350	300001155
Relais Matrix	R&S	PSU	893285/020	300001173
Power Meter	HP	436A	2101A12378	300001136
Powersensor	HP	8484A	2237A10156	300001140
Powersensor	HP	8482A	2237A06016	300001139
Relais Matrix	R&S	PSU	282628/004	300001214
Powersupply	Zentro		2007	300001109
Oszilloscope	Tektronix	7633		300001111
Klimaschrank	Heraeus Voetsch	VUK04/500	32926	300001500
Quasi-Peak Adapter	HP	85650A	2811A01204	300002308
Radiocom. Analyzer	R&S	CMTA 84	894199/012	300001176
Oszilloscope	HP	54510A	3022A02062	300001202
Funkmeßplatz	Schomandl	FD1000	34982	300001115
Signal Generator	R&S	SMPC	882416/019	300001162
Frequency counter	HP	5340A	2116A08138	300001104
Power Meter	HP	436A	2031U01461	300001105
Powersensor	HP	8482A		300001106
Powersensor	HP	8484A		300001107
Powersensor	HP	8485A		300001108
Powersupply	HP	6038A	2752A04866	300001161
Reflectionsmeter	R&S	NAP	879191	300001132
Signal Generator NF	R&S	SPN	880139/068	300001142
Trenntrafo	Erfi	MPL	91350	300001151
Attenuator	JFW	30 db	1350h/104	300001703
Attenuator	JFW	10 db	1350h/103	300001704
Attenuator	JFW	20 db	1350h/106	300001705
Attenuator	JFW	20 db	1350h/105	300001766
Filter	Spinner	153755		300001791
Powersensor	HP	8484A	2237A10494	300001666

SRD-Testreport

CETECOM ICT Services GmbH Saarbruecken, Germany



Test report No.: 2-4556-01-02_07_Ant6_5G

Date: 2007-05-11

Page 23 of 24

Powersensor	HP	8485A	2238A00849	300001668
Bandfilter	Telonic	TTF7255EE	20293-11	300001300
Bandfilter	Telonic	TTF12555EE	20292-6	300001302
Bandfilter	Telonic	TTF25055EE	20291-8	300001304
Bandfilter	Telonic	TTF50055EE	20290-7	300001305
Bandfilter	Telonic	TTF100055EE	20289-7	300001307
Bandfilter	Telonic	TTA300055EESN	20370-2	300001312
Bandstop	Telonic	TTR3753EE1	30013-1	300001314
Bandstop	Telonic	TTR723EE	20417-2	300001316
Bandstop	Telonic	TTR95-3EE	20372-4	300001318
Bandstop	Telonic	TTR1903EE	30036-4	300001320
Bandstop	Telonic	TTR3753EE	20369-5	300001321
Bandstop	Telonic	TTR750-3EE1	90177-1	300002387
Highpass	Pro Nova	HDP120-6GG	ohne	300001348
Highpass	Pro Nova	HMC500-6AA	HJ67-01?	300001350
Highpass	Narda	NHP 9000	0004	300001362
Highpass	Narda	HDP16-6GH	JV70-01	300001364
Highpass	RSD	HDP50-6GH, HDP200-6GG		300001371
Highpass	RSD	2099-02-01		300000370
Signal Generator 0.1-2060 MHz	HP	8657A	2838U00736	300001009
Radio Code Analyzer	Schlumberger	SL4922		300001038
Signal Analyzer	B&K	2033		300001047
Frequency counter	HP	5386A	2704A01243	300000998
Laufzeitelement	WR-Elektronik			300001036
Powersupply Stromversorgung	Systron	M5P 40/15A	828233	300001291
Powersupply	Heiden	1108-32	1701	300001392
Powersupply	Heiden	1108-32	1802	300001383
Powersupply	Heiden	1108-32	003202	300001187
Powersupply	Zentro	LA 2x30/5GB1	2011	300001276
Powersupply	Zentro	LA 2x30/5GB2	2012	300001275
Powersupply	Zentro	LA 30/5GA	2041,2042	300001287
Trenntrafo	Grundig	RT5A	8781	300001277
Trenntrafo	Grundig	RT5A	9242	300001263
Multimeter	Goerz Elektro	Unigor 6e P	911 355	300001625
Multimeter	Goerz Elektro	Unigor 6e P	911 391	300001281
Climatic Box	Heraeus Voetsch	VUK04/500	32679	300000299
Powersensor + Att.	HP	8482B	2703A02586	300001492
Attenuator 30 dB	HP	8498A	1801A02445	300001475
Signal Generator NF	HP		2822A01203	300001004
Attenuator	Spinner	BN 534171 D	51881	300001516
Attenuator coaxial	Bird	8325	2429	300001513
Impulsbegrenzer	R&S	ESH 3 Z2		300001460
4Port Box	R&S	4Port Box	860457/005	300001472
Signal Generator 0.1-4200 MHz	HP	8665A	2833A0011	300002299
Spektrumanalyzer	R&S	FSU50	200012	300003443
Swissphone Freifeld-Messbox	Swissphone Schweiz			300002302
Trenntrafo regelbar	Grundig	RT5H	9242	300001628
Signal Generator	HP	8111A	2215G00867	300001117

4 Photographs

Test site:

