

**PARTIAL TEST REPORT**  
No.: 16-1-0181301T11a

According to:

**FCC Regulations**







Part 15.205  
Part 15.209  
Part 15.247

for

Datalogic S.r.l.

**SKORPIO X4**  
Type:00ANM4HS0GF0A4

FCC ID: U4GSX4WB

Laboratory Accreditation and Listings			
 <p><b>DAkks</b> Deutsche Akkreditierungsstelle D-PL-12047-01-01</p>	 <p>FEDERAL COMMUNICATIONS COMMISSION <b>FC</b> USA MRA US-EU 0003</p>	 <p>Industry Canada Reg. No.: 3462D-2 Reg. No.: 3462D-3</p>	 <p>Voluntary Controls for Electromagnetic Emissions Reg. No.: R-2666 C-2914, T-1967, G-301</p>
 <p><b>WiFi</b> ALLIANCE AUTHORIZED RF LABORATORY</p>	 <p><b>ctia</b> Authorized<sup>TM</sup> Test Lab Lab Code: 20011130-00</p>		
accredited according to DIN EN ISO/IEC 17025			
<p><b>CETECOM GmbH</b> Laboratory Radio Communications &amp; Electromagnetic Compatibility Im Teelbruch 116 • 45219 Essen • Germany Registered in Essen, Germany, Reg. No.: HRB Essen 8984 Tel.: + 49 (0) 20 54 / 95 19-954 • Fax: + 49 (0) 20 54 / 95 19-964 E-mail: info@cetecom.com • Internet: www.cetecom.com</p>			

## Table of contents

<b>1. SUMMARY OF TEST RESULTS</b> .....	<b>3</b>
1.1. Tests measurement overview according to FCC Standard .....	3
<b>2. ADMINISTRATIVE DATA</b> .....	<b>5</b>
2.1. Identification of the testing laboratory .....	5
2.2. Test location .....	5
2.3. Organizational items .....	5
2.4. Applicant’s details .....	5
2.5. Manufacturer’s details .....	5
<b>3. EQUIPMENT UNDER TEST (EUT)</b> .....	<b>6</b>
3.1. Certification Data of Main EUT declared by Applicant .....	6
3.2. Bluetooth FHSS Technical Data of Main EUT as Declared by Applicant .....	7
3.3. EUT: Type, S/N etc. and short descriptions used in this test report .....	8
3.4. Auxiliary Equipment (AE): Type, S/N etc. and short descriptions .....	8
3.5. EUT set-ups .....	8
3.6. EUT operating modes .....	9
3.7. Configuration of cables used for testing .....	9
<b>4. DESCRIPTION OF TEST SYSTEM SET-UP’S</b> .....	<b>10</b>
4.1. Test system set-up for conducted measurements on antenna port .....	10
4.2. Test system set-up for radiated magnetic field measurements below 30 MHz .....	11
4.3. Test system set-up for radiated electric field measurement 30 MHz to 1 GHz .....	12
4.4. Test system set-up for radiated electric field measurement above 1 GHz .....	13
<b>5. MEASUREMENTS</b> .....	<b>14</b>
5.1. RF-Parameter – RF Power conducted.....	14
5.2. General Limit - Radiated field strength emissions below 30 MHz.....	16
5.3. General Limit - Radiated field strength emissions. 30 MHz - 1 GHz.....	18
5.4. General Limit - Radiated emissions. above 1 GHz.....	20
5.5. RF-Parameter - Radiated Band Edge compliance measurements .....	22
5.6. Measurement uncertainties .....	24
<b>6. ABBREVIATIONS USED IN THIS REPORT</b> .....	<b>25</b>
<b>7. ACCREDITATION DETAILS OF CETECOM’S LABORATORIES AND TEST SITES</b> .....	<b>25</b>
<b>8. INSTRUMENTS AND ANCILLARY</b> .....	<b>26</b>
<b>9. VERSIONS OF TEST REPORTS (CHANGE HISTORY)</b> .....	<b>29</b>

<b>Table of Annex</b>			
<b>Annex No.</b>	<b>Contents</b>	<b>Reference Description</b>	<b>Total Pages</b>
<b>Annex 1</b>	Test results	<b>CETECOM_TR16-1-0181301T11a-A1</b>	25
<b>Annex 2</b>	External photographs of EUT	<b>CETECOM_TR16-1-0181301T11a-A2</b>	10
<b>Annex 2</b>	Internal photographs of EUT	<b>CETECOM_TR16-1-0181301T11a-A3</b>	14
<b>Annex 4</b>	Test set-up photographs	<b>CETECOM_TR16-1-0181301T11a-A4</b>	9
The listed attachments are an integral part of this report.			

## 1. Summary of test results

The test results apply exclusively to the test samples as presented in this Report. The CETECOM GmbH does not assume responsibility for any conclusions and generalizations taken in conjunction with other specimens or samples of the type of the item presented to tests.

**The test results apply exclusively to the test samples as presented in this report. The CETECOM GmbH does not assume responsibility for any conclusions and generalizations taken in conjunction with other specimens or samples of the type of the item presented to tests. Also we refer on special conditions which the applicant should fulfill according §2.927 to §2.948, special focus regarding modification of the equipment and availability of sample equipment for market surveillance tests.**

The presented Equipment Under Test (in this report, hereinafter referred as EUT) : **SKORPIO X4** integrates total 1 of pre-certified module **WL18MODGI (FCC ID: Z64-WL18DBMOD)** & supports following technologies :

EUT supported Technologies which are not tested within this test report

EUT supported Technology	Test Report Reference
Bluetooth Low Energy Modes: 2402 – 2480 MHz	CETECOM_TR16-1-0181301T12a
WLAN 802.11b/g/n(HT20) Modes: 2412 – 2462 MHz	CETECOM_TR16-1-0181301T09a
WLAN 802.11a/n(HT20)/n(HT40)Modes: 5150–5850 MHz	CETECOM_TR16-1-0181301T10a

EUT supported Technologies which are tested within this test report

- **2.4 GHz Bluetooth BR & EDR Modes : 2402 – 2480 MHz**

Following test cases have been performed to show compliance with valid Part 15.205/15.209/15.247 of the FCC CFR Title 47 Rules, Edition 4<sup>th</sup> November 2016.

### 1.1. Tests measurement overview according to FCC Standard

Test cases	Port	References and Limits		EUT set-up	EUT op. mode	Result
		FCC Standard	Test limit			
TX-Mode						
20 dB bandwidth	Antenna terminal (conducted)	§15.247 (a)(1)	At least 25 kHz or 2/3 of 20 dB bandwidth	--	--	Remark 2)
Channel carrier frequency separation		§15.247 (a)(1)		--	--	
99% occupied bandwidth	Antenna terminal (conducted)	2.1049(h)	99% Power bandwidth	--	--	Remark 2)
Number of Hopping Channels	Antenna terminal (conducted)	§15.247 (a)(1) (iii)	At least 15 Hopping Channels	--	--	Remark 2)
Channel average Occupancy time and number of channels	Antenna terminal (conducted)	§15.247 (a)(1) (iii)	0.4 seconds	--	--	Remark 2)
Transmitter Peak output power	Antenna terminal (conducted)	§15.247 (a)(1) + (b)(1)	< 125 mW	2	1	Pass
Transmitter frequency stability	Antenna terminal (conducted)	--	Operation within designated operational band	--	--	Not tested

Transmitter Peak output power radiated	Enclosure (radiated)	§15.247 (b)(4)	< 125 mW (EIRP) for antenna with directional gain less 6 dBi	--	--	Remark 2)
Out-Of-Band RF-emissions	Antenna terminal (conducted)	§15.247 (d)	20 dBc Conducted Emissions in restricted bands	--	--	Remark 2)
Band-Edge emissions	Enclosure (radiated)	§15.247 (d)	Emissions in restricted bands must meet the general field strength radiated limits	1	1	Pass
General field strength emissions + restricted bands	Enclosure + Interconnecting cables (radiated)	§15.247 (d) §15.205 §15.209	Emissions in restricted bands must meet the general field-strength radiated limits	1	1	Pass
AC-Power Lines Conducted Emissions	AC-Power lines or Battery Chargers	§15.207(a)	AC Power line conducted limits	--	--	Remark 1)

Remark 1) : Not tested in this report as Bluetooth test configuration was operated using fully charged internal battery  
Refer CETECOM\_TR16-1-0181301T13a

Remark 2): Refer WL18MODGI (FCC ID: Z64-WL18DBMOD) Report No. FR400971A, Rev.01, issue date Dec 19,2014

Specific Absorption Rate (SAR) Measurements (separation distance user to RF-radiating element within 20cm)						
Test cases	Port	References & Limits		EUT set-up	EUT op. mode	Result
		FCC Standard	Test Limit			
Specific Absorption Rate (SAR) requirements	Cabinet + Inter-connecting cables (radiated)	§2.1091 §2.1093 + IEEE 1528-2013 + KDB 865664D01v0r04	<b>Specific Absorption Rate (SAR)</b> for Devices Used by the General Public ( <b>Uncontrolled Environment</b> ) : 1.6 W/Kg as averaged over any 1 g tissue	--	--	Refer test report CTC advanced GmbH Test report no.: 1-2904/16-01-04



Dipl.-Ing. Rachid Acharkaoui  
Responsible for test section

M.Sc. Ajit Phadtare  
Responsible for test report

## 2. Administrative Data

### 2.1. Identification of the testing laboratory

Company name:	CETECOM GmbH
Address:	Im Teelbruch 116 45219 Essen - Kettwig Germany
Responsible for testing laboratory:	Dipl.-Ing. Rachid Acharkaoui
Deputy:	Dipl.-Ing. Niels Jeß

### 2.2. Test location

#### 2.2.1. Test laboratory "CTC"

Company name:	see chapter 2.1. Identification of the testing laboratory
---------------	---

### 2.3. Organizational items

Responsible for test report and Project leader:	M.Sc. Ajit Phadtare
Receipt of EUT:	2017-03-20
Date(s) of test:	2017-04-12 to 2017-04-20
Date of report:	2017-06-28
-----	
Version of template:	13.02

### 2.4. Applicant's details

Applicant's name:	Datalogic S.r.l.
Address:	Via S. Vitalino, 13 40012, Lippo di Calderara di Reno (BO) ITALY
Contact:	Mr. Eucarpio Guarisco

### 2.5. Manufacturer's details

Manufacturer's name:	same as Applicant
Address:	same as Applicant

### 3. Equipment under test (EUT)

#### 3.1. Certification Data of Main EUT declared by Applicant

<b>EUT Model</b>	<b>SKORPIO X4</b>		
<b>EUT Model Type</b>	<b>00ANM4HS0GF0A4</b>		
<b>EUT Type</b>	<b>Portable Mobile Computer</b>		
<b>EUT Applications</b>	<b>Shopping Applications &amp; General Purpose Mobile Computer</b>		
<b>FCC ID</b>	<b>U4GSX4WB</b>		
<b>Additional Information: Integrated Module</b>			
<b>Integrated Module</b>	<b>WL18MODGI</b>		
<b>Module Certification FCC ID</b>	<b>Z64-WL18DBMOD</b>		
<b>Number of Integrated Modules</b>	<b>1</b>		
<b>Additional Information : Supported Technologies</b>			
<b>Technology</b>	<b>Modes</b>	<b>Frequency Range</b>	<b>Remarks</b>
<b>Bluetooth FHSS</b>	<b>Bluetooth BR-EDR</b>	<b>2402 MHz – 2480 MHz</b>	refer chapter 3.2
<b>Bluetooth LE</b>	<b>Bluetooth Low Energy</b>	<b>2402 MHz – 2480 MHz</b>	not tested under this report
<b>WLAN 2.4 GHz</b>	<b>WLAN 802.11b/g/n(HT20)</b>	<b>2412 MHz – 2462 MHz</b>	not tested under this report
<b>WLAN 5 GHz</b>	<b>WLAN 802.11a/n(HT20)/n(HT40)</b>	<b>5150 MHz –5850 MHz</b>	not tested under this report

### 3.2. Bluetooth FHSS Technical Data of Main EUT as Declared by Applicant

EUT Model	SKORPIO X4		
EUT Model Type	00ANM4HS0GF0A4		
EUT Type	Portable Mobile Computer		
EUT Applications	Shopping applications & general purpose mobile computer		
Hardware Version	BETA		
Software Version	Android 4.4.4		
Firmware Version	2.00.29		
Frequency Band	2.4 GHz ISM Band (2400 MHz - 2483.5 MHz)		
Frequency Channels (Range)	Channel 0: 2402 MHz to Channel 78: 2480 MHz		
Number of Channels	79 Frequency Hopping Channels (FHSS)		
Channels Power Settings	+7 dBm (According to Applicant's Declaration Max. Rated Power Values)		
Nominal Channel Bandwidth	1 MHz		
Type of FHSS Modes Modulation   Data Rate   Packet	Basic Rate (BR) Mode : <input checked="" type="checkbox"/> BT 1.0 / BT 1.1: GFSK   1 Mbps   DH1/DH3/DH5	Enhanced Data Rate (EDR) Mode: <input checked="" type="checkbox"/> BT 2.0 / BT 2.1: $\pi/4$ DQPSK   2 Mbps   DH1/2DH3/2DH5 <input checked="" type="checkbox"/> BT 3.0: 8DPSK   3 Mbps   3DH1/3DH3/3DH5	
Antenna Details	Integrated (ANT1 & ANT2)		
Antenna Connections	Primary Antenna : ANT1 (BT FHSS)	Secondary Antenna: ANT2 not used	
Antenna Type	Laird PCBA Antenna		
ANT1 Gain (Peak)	2.95 dBi (2400 MHz – 2500 MHz) (According to Applicant's Declaration)		
ANT2 Gain (Peak)	0.60 dBi (2400 MHz – 2500 MHz) (According to Applicant's Declaration)		
Total Number of Modules	1 (WL18MODGI Module FCC ID: Z64-WL18DBMOD)		
Total Number of Antennas	2	Primary Antenna: ANT1 (BT-FHSS)	Secondary Antenna: ANT2 not used
Test Mode Settings	Datalogic RFTest Application		
MAX Field Strength (Radiated @3m)	Peak Value : 105.892 dB $\mu$ V/m		Average Value: 104.117 dB $\mu$ V/m
Power Supply	<input checked="" type="checkbox"/> Internal Battery : BT-0016   Li-ion 3.7- 4.2VDC 5200mAh (2 Cylindrical Cells)		
Special EMI Components	--		
EUT Sample Type	<input checked="" type="checkbox"/> Production	<input type="checkbox"/> Pre-Production	<input type="checkbox"/> Engineering
Firmware	<input type="checkbox"/> for normal use	<input checked="" type="checkbox"/> Special version for test execution : Datalogic RFTest	
FCC label attached	<input type="checkbox"/> Yes	<input checked="" type="checkbox"/> No	
For further details refer Applicants Declaration & following technical documents			
Description of Reference Document (supplied by applicant)	Version		Total Pages
SKORPIO X4_Test-Tools_Quick_Start_Instructions	Rev: 3 Date: 04/11/2017		43
SKORPIO X4_Operational Description	Rev: 01 Date: 19/06/2017		15
SKORPIO X4_SW Image Update	Rev:2 Date: 09/12/2016		4
SKORPIO X4 Hardware Modifications (BETA Changes)	March 2017		8
Datalogic SKORPIO X4 Antennas Report 5	22-June-2016		15

### 3.3. EUT: Type, S/N etc. and short descriptions used in this test report

Short Description*)	EUT	Type	Serial Number	Hardware Status	Software Status
EUT A	SKORPIO X4	00ANM4HS0GF0A4	Z16P01723	HW Version: BETA P/N: 942600012	SW Version: Android 4.4.4 Firmware Version: 2.00.29
EUT B	SKORPIO X4	00ANM4HS0GF0A4	Z16P01691	HW Version: BETA P/N: 942600012	SW Version: Android 4.4.4 Firmware Version: 2.00.29
EUT C	SKORPIO X4	00ANM4HS0GF0A4	Z16P01724	HW Version: BETA P/N: 942600012	SW Version: Android 4.4.4 Firmware Version: 2.00.29

\*) EUT short description is used to simplify the identification of the EUT in this test report.

### 3.4. Auxiliary Equipment (AE): Type, S/N etc. and short descriptions

AE short description *)	Auxiliary Equipment	Type	S/N serial number	HW hardware status	SW software status
AE 1	--	--	--	--	--

\*) AE short description is used to simplify the identification of the auxiliary equipment in this test report.

### 3.5. EUT set-ups

EUT set-up no. *)	Combination of EUT and AE	Description
set. 1	EUT A	Radiated measurements: 9 kHz – 30 MHz   30 MHz – 1 GHz
	EUT B	Radiated measurements : above 1 GHz
set. 2	EUT C + Cable 1 + Cable 2	Conducted measurements

\*) EUT set-up no. is used to simplify the identification of the EUT set-up in this test report.



### 3.6. EUT operating modes

EUT operating mode no.*)	Description of operating modes	Additional information
op. 1	Bluetooth FHSS Modes*  TX-Fixed Channel (Modulated)	<p>For Bluetooth BR &amp; EDR Modes tests are carried out with different Channels   Modulation   Data Rate Combinations with help of Datalogic RFTest Application.</p> <p>The EUT was put to <b>Fixed Channel (Modulated) Continuous transmissions mode</b> with help of Datalogic RFTest Application</p> <p><b>(Channel Type   Frequency   Power Settings)</b>  <b>Lowest Channel : 0 : 2402 MHz   Power : +7 dBm</b>  <b>Middle Channel :39: 2441 MHz   Power : +7 dBm</b>  <b>Highest Channel :78: 2480 MHz   Power : +7 dBm</b></p> <p>*Other supported wireless technologies were put in idle mode using special test software</p>
op. 2	Bluetooth FHSS Modes*  RX-Fixed Channel (Modulated)	<p>The EUT was put to <b>Fixed Channel (Modulated) Continuous receiving mode</b> with help of Datalogic RFTest Application.</p> <p>*Other supported wireless technologies were put in idle mode using special test software</p>

\*) EUT operating mode no. is used to simplify the test report.

### 3.7. Configuration of cables used for testing

Cable number	Description	Connections	Cable length
Cable 1	RF –SMA Cable	EUT ANT1 to Power Meter	0.08 m
Cable 2	RF –SMA Cable	EUT ANT2 to 50 Ω Termination	0.08 m

## 4. Description of test system set-up's

### 4.1. Test system set-up for conducted measurements on antenna port

#### Bluetooth conducted RF-Setup 1 (BT1 Set-up)

**General description:** The EUT's RF-signal is coupled out by a suitable antenna coupling connector (1). The signal is first attenuated (2) then connected to the power meter (3) for conducted power measurements. The specific attenuation loss is determined prior to the measurement within a set-up attenuation measurement. These are then taken into account by correcting the measurement readings.

**Schematic:**

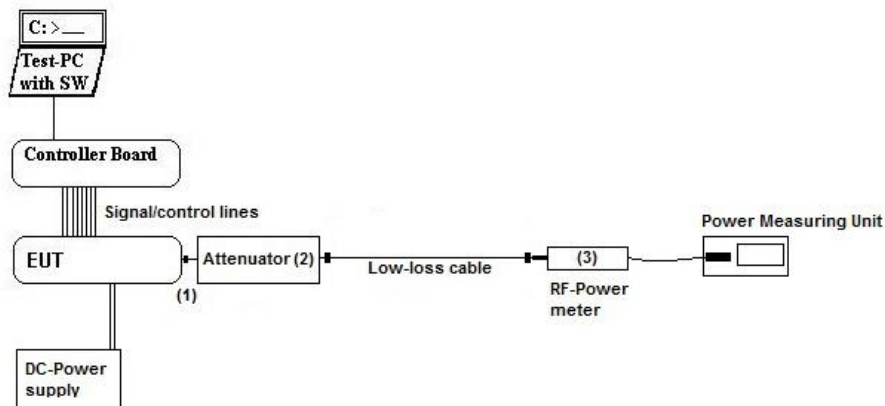

**Testing method:** ANSI C63.10:2013

Used Equipment	Passive Elements	Test Equipment	Remark:
	<input checked="" type="checkbox"/> 20 dB Attenuator	<input checked="" type="checkbox"/> Power Meter	See List of equipment under each test case and chapter 8 for calibration info
	<input checked="" type="checkbox"/> Low loss RF-cables	<input type="checkbox"/> DC-Power Supply	
		<input type="checkbox"/> Spectrum- Analyser	

**Measurement uncertainty** See chapter 5.6

## 4.2. Test system set-up for radiated magnetic field measurements below 30 MHz

**Specification:** ANSI C63.10-2013 chapter 6.4 (§6.4.4.2)

**General Description:** Evaluating the radiated field emissions are done first by an exploratory emission measurement and a final measurement for most critical frequencies determined.

The loop antenna was placed at 1 m height above ground plane and 3 m measurement distance from set-up for investigations. Because of reduced measurement distance, correction data were applied, as stated in chapter “General Limit - Radiated field strength emissions below 30 MHz“. The tests are performed in the semi anechoic room recognized by the regulatory commission.

**Schematic:**

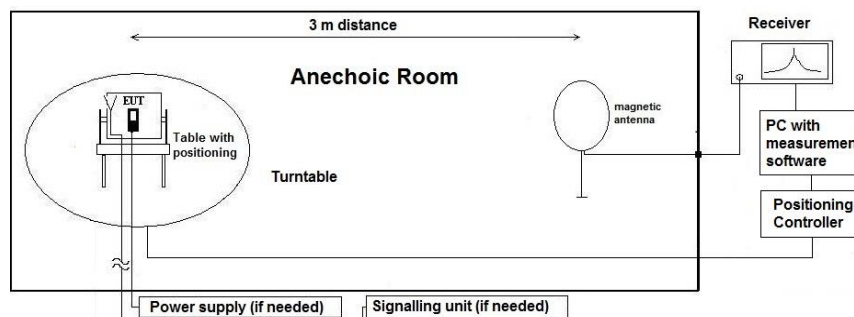

**Testing method:**

### Exploratory, preliminary measurement

The EUT and its associated accessories are placed on a non-conductive position manipulator (tipping device) of 0.8 m height which is placed on the turntable. By rotating the turntable (step 90°, range 0° to 360°) and the EUT itself either on 3-orthogonal axis (portable equipment) or 2-orthogonal axis (defined operational position of EUT), the emission spectrum was recorded. The loop antenna was moved at least to 2-perpendicular axes (antenna vector in direction of EUT and parallel to EUT) in order to maximize the emissions. The results are documented in a diagram. Critical frequencies (low margin to limit) are saved within a data reduction table for further investigations. If various operating modes are supported, further investigations are made to find the worst-case. Also the interconnection cables and equipment position were varied in order to maximize the emissions.

### Final measurement on critical frequencies

Based on the exploratory measurements, the most critical frequencies are re-measured by maintaining the EUT's worst-case operation mode, cable position, etc.

First a frequency zoom around the critical frequency is done to locate the frequency more precisely. After this step, for all identified critical frequencies, the maximum peak was determined.

Following parameters were varied: the turntable angle continuously in the range 0 to 360 degree, the EUT itself either over 3-orthogonal axis (not defined usage position) or 2-orthogonal axis (defined usage position).

On the determined worst-case position, a final measurement with necessary bandwidth and detector according standard has been carried out.

**Formula:**

$$E_C = E_R + AF + C_L + D_F - G_A$$

$$M = L_T - E_C$$

AF = Antenna factor

C<sub>L</sub> = Cable loss

D<sub>F</sub> = Distance correction factor

E<sub>C</sub> = Electrical field – corrected value

E<sub>R</sub> = Receiver reading

G<sub>A</sub> = Gain of pre-amplifier (if used)

L<sub>T</sub> = Limit

M = Margin

All units are dB-units, positive margin means value is below limit.

**Distance correction:**

**Reference for applied correction (extrapolating) factors due to reduced measurement distance:**

ANSI C63.10:2013, §6.4.4.2 - Equations (2) + (3) + (4)

### 4.3. Test system set-up for radiated electric field measurement 30 MHz to 1 GHz

**Specification:** ANSI C63.4-2014 chapter 8.2.3, ANSI C63.10-2013 chapter 6.5

**General Description:** Evaluating the field emissions have to be done first by an exploratory emissions measurement and a final measurement for most critical frequencies. The tests are performed in a NSA-compliant semi anechoic room (SAR) recognized by the regulatory commissions.

**Schematic:**

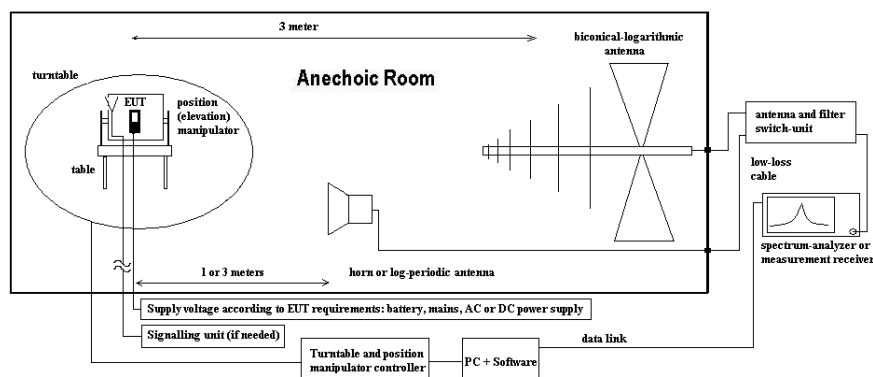

**Testing method:**

#### Exploratory, preliminary measurements

The EUT and its associated accessories are placed on a non-conductive position manipulator (tipping device) of 0.8 m height which is placed on the turntable. By rotating the turntable (range 0° to 360°, step 90°) and the EUT itself either on 3-orthogonal axis (portable equipment) or 2-orthogonal axis (defined operational position of EUT) the emission spectrum and its characteristics was recorded with an EMI-receiver, broadband antenna and software.

Measurement antenna: horizontal and vertical, heights: 1,0 m and 1,82 m as worst-case determined by an exploratory emission measurements. The results are documented in a diagram. Critical frequencies (low margin to limit) are saved within a table for further investigations. If various operating modes are supported, further investigations are made to find the worst-case of them. Also the interconnection cables and equipment position were varied in order to maximize the emissions.

#### Final measurement on critical frequencies

Based on the exploratory measurements, the most critical frequencies are re-measured by maintaining the EUT's worst-case operation mode, cable position, etc. either on 10m OATS or 3m semi-anechoic room.

First a frequency zoom around the critical frequency is done to locate the frequency more precisely. After this step, for all identified critical frequencies, the maximum peak was determined.

Following parameters were varied: the turntable angle continuously in the range 0 to 360 degree, the EUT itself either over 3-orthogonal axis (not defined usage position) or 2-orthogonal axis (defined usage position). The measurement antenna height between 1 m and 4 m.

On the determined worst-case position, a final measurement with necessary bandwidth and detector according standard has been carried out.

**Formula:**

$$E_C = E_R + AF + C_L + D_F - G_A \quad (1)$$

$$M = L_T - E_C \quad (2)$$

AF = Antenna factor

C<sub>L</sub> = Cable loss

D<sub>F</sub> = Distance correction factor (if used)

E<sub>C</sub> = Electrical field – corrected value

E<sub>R</sub> = Receiver reading

G<sub>A</sub> = Gain of pre-amplifier (if used)

L<sub>T</sub> = Limit

M = Margin

All units are dB-units, positive margin means value is below limit.

#### 4.4. Test system set-up for radiated electric field measurement above 1 GHz

**Specification:** ANSI C63.4-2014 chapter 8.3, ANSI C63.10-2013 chapter 6.6.3.3 & 6.6.4

**General Description:** Evaluating the emissions have to be done first by an exploratory emissions measurement and a final measurement for most critical frequencies. The tests are performed in a CISPR 16-1-4:2010 compliant fully anechoic room (FAR) recognized by the regulatory commission. The measurement distance was set to 3 meter for frequencies up to 18 GHz and 2 meter above 18 GHz. A logarithmic periodic antenna is used for the frequency range 30 MHz to 1 GHz. Horn antennas are used for frequency range 1 GHz to 40 GHz. The EUT is aligned within 3 dB beam width of the measurement antenna with three orthogonal axis measurements on the EUT.

**Schematic:**

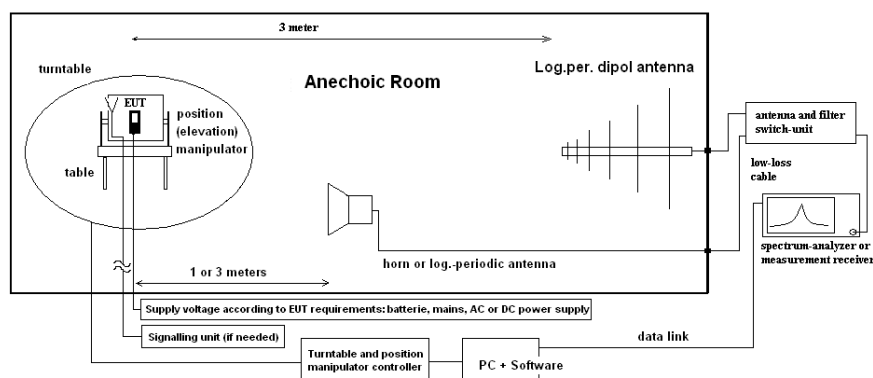

**Testing method:**

**Exploratory, preliminary measurements**

The EUT and its associated accessories are placed on a non-conductive position manipulator (tipping device) of 1.55 m height which is placed on the turntable. By rotating the turntable (range 0° to 360°, step 15°) and the EUT itself either on 3-orthogonal axis (portable equipment) or 2-orthogonal axis (defined operational position of EUT) the emission spectrum and its characteristics was recorded with an EMI-receiver, broadband antenna and software. The measurements are performed in horizontal and vertical polarization of the measurement antennas. The results are documented in a diagram. Critical frequencies (low margin to limit) are saved within a table for further investigations. If various operating modes are supported, further investigations are made to find the worst-case of them. Also the interconnection cables and equipment position were varied in order to maximize the emissions.

**Final measurement on critical frequencies**

Based on the exploratory measurements, the most critical frequencies are re-measured by maintaining the EUT's worst-case operation mode, cable position, etc.

First a frequency zoom around the critical frequency is done to locate the frequency more precisely. After this step, for all identified critical frequencies, the maximum peak was determined. Following parameters were varied: the turntable angle continuously in the range 0 to 360 degree, the EUT itself over 3-orthogonal axis and the height for EUT with large dimensions.

On the determined worst-case position, a final measurement with necessary bandwidth and detector according standard has been carried out. On the determined worst-case position, a final measurement with necessary bandwidth and detector according standard has been carried out.

**Formula:**

$$E_C = E_R + AF + C_L + D_F - G_A \quad (1)$$

$$M = L_T - E_C \quad (2)$$

- $E_C$  = Electrical field – corrected value
- $E_R$  = Receiver reading
- $M$  = Margin
- $L_T$  = Limit
- $AF$  = Antenna factor
- $C_L$  = Cable loss
- $D_F$  = Distance correction factor (if used)
- $G_A$  = Gain of pre-amplifier (if used)

All units are dB-units, positive margin means value is below limit.

## 5. Measurements

### 5.1. RF-Parameter – RF Power conducted

#### 5.1.1. Test location and equipment (for reference numbers please see chapter 'List of test equipment')

test location	<input checked="" type="checkbox"/> CETECOM Essen (Chapter. 2.2.1)	<input type="checkbox"/> 443 System CTC-FAR-EMI-	<input type="checkbox"/> Please see Chapter. 2.2.3
test site	<input type="checkbox"/> 441 EMI SAR	<input type="checkbox"/> 487 SAR NSA	<input type="checkbox"/> 337 OATS
receiver	<input type="checkbox"/> 377 ESCS30	<input type="checkbox"/> 001 ESS	<input checked="" type="checkbox"/> 347 Radio.lab.
spectr. analys.	<input type="checkbox"/> 489 ESU	<input type="checkbox"/> 120 FSEM	<input checked="" type="checkbox"/> 683 FSU 26
power supply	<input type="checkbox"/> 456 EA 3013A	<input type="checkbox"/> 457 EA 3013A	<input type="checkbox"/> 264 FSEK
otherwise	<input checked="" type="checkbox"/> 613 20dB Attenuator	<input checked="" type="checkbox"/> 4.20 V DC (fully charged internal battery)	
Power meter	<input checked="" type="checkbox"/> 600 NRVD Power meter	<input type="checkbox"/> Directional Coupler 1539R-10	
Supply voltage	<input type="checkbox"/> 230 V 50 Hz via public mains	<input checked="" type="checkbox"/> 266 NRV-Z31 Peak Power Sensor	

#### 5.1.2. Requirements:

FCC	<input checked="" type="checkbox"/> §15.247 (a) (1) + (b) (1)
ANSI	<input checked="" type="checkbox"/> C63.10-2013 Chapter 6.101

#### 5.1.3. Reference: EUT antenna characteristics:

- Directional Gain < 6 dBi (measured: difference between measured conducted and radiated eirp. power)
- Directional Gain > 6 dBi (measured / applicant's declaration) -> conducted power reduction necessary

#### 5.1.4. EUT settings:

For FHHS-systems hopping mode was switched-off so fixed three different channels could be measured. The EUT was instructed to send with maximum power (if adjustable) according applicants instructions. Different modulation characteristics have been checked, e.g. data rates which EUT can operate.

#### 5.1.5. Measurement method:

The measurement was performed in non-hopping transmission mode with the carrier set to lowest/middle and highest channel. The power was also checked for different data rates, modulation scheme or packet types if applicable.

#### 5.1.6. Settings on Spectrum-Analyzer:

Center Frequency	Nominal channel frequency
Span	8 MHz
Resolution Bandwidth (RBW)	3 MHz > 20dB-Bandwidth of the signal
Video Bandwidth (VBW)	3 times the resolution bandwidth = 10MHz
Sweep time	coupled
Detector	Peak, Max hold mode
Sweep Mode	Repetitive mode

**5.1.7. Conducted measurement: Max. Peak Power**

- Maximum declared antenna ANT1 gain [isotropical]: 2.95 dBi

Conducted Max Peak Power Measurements [dBm]				
Set-up no.: Op-Mode:	2 1	Low channel = 0 (2402 MHz)	Middle channel = 39 (2441 MHz)	High channel = 78 (2480 MHz)
<b>BR Mode-1Mbps -GFSK</b>		5.40	5.5	5.72
<b>EDR Mode-2Mbps-<math>\pi</math>/4DQPSK</b>		5.51	5.68	5.80
<b>EDR Mode-3Mbps-8 DPSK</b>		5.54	5.74	5.84
<b>Maximum Conducted value</b>				
		<b>5.84 dBm</b>		<b>3.83 mW</b>
<b>Maximum antenna ANT1 gain</b>		2.95 dBi		
<b>Maximum e.i.r.p. value</b>				
		<b>8.79 dBm</b>		<b>7.57 mW</b>
<b>FCC 15.247 Limit</b>				
		<b>20.97 dBm</b>		<b>125 mW</b>
Remark: Measurements results are only valid and compliant with power setting: +7 dBm				

## 5.2. General Limit - Radiated field strength emissions below 30 MHz

### 5.2.1. Test location and equipment

test location	<input checked="" type="checkbox"/> CETECOM Essen (Chapter. 2.2.1)	<input type="checkbox"/> Please see Chapter. 2.2.2	<input type="checkbox"/> Please see Chapter. 2.2.3
test site	<input checked="" type="checkbox"/> 441 EMI SAR	<input type="checkbox"/> 487 SAR NSA	<input type="checkbox"/> 347 Radio.lab.
receiver	<input type="checkbox"/> 377 ESCS30	<input checked="" type="checkbox"/> 001 ESS	<input type="checkbox"/>
spectr. analys.	<input type="checkbox"/> 584 FSU	<input type="checkbox"/> 120 FSEM	<input type="checkbox"/> 264 FSEK
antenna	<input type="checkbox"/> 574 BTA-L	<input type="checkbox"/> 133 EMCO3115	<input type="checkbox"/> 302 BBHA9170
signaling	<input type="checkbox"/> 392 MT8820A	<input type="checkbox"/> 371 CBT32	<input type="checkbox"/> 547 CMU
otherwise	<input type="checkbox"/> 400 FTC40x15E	<input type="checkbox"/> 401 FTC40x15E	<input type="checkbox"/> 110 USB LWL
DC power	<input type="checkbox"/> 671 EA-3013S	<input type="checkbox"/> 457 EA 3013A	<input type="checkbox"/> 459 EA 2032-50
Supply voltage	<input type="checkbox"/> 230 V 50 Hz via public mains		
	<input checked="" type="checkbox"/> 4.2 V DC (fully charged internal battery)		

### 5.2.2. Requirements

FCC	<input checked="" type="checkbox"/> Part 15. Subpart C. §15.205 & §15.209		<input checked="" type="checkbox"/> Part 15.247 (d)
ANSI	C63.10-2013		
Frequency [MHz]	Field strength limit		Distance [m]
	[µV/m]	[dBµV/m]	Remarks
0.009 – 0.490	2400/f (kHz)	67.6 – 20Log(f) (kHz)	300
0.490 – 1.705	24000/f (kHz)	87.6 – 20Log(f) (kHz)	30
1.705 – 30	30	29.5	30

### 5.2.3. Test condition and test set-up

Signal link to test system (if used):	<input type="checkbox"/> air link	<input type="checkbox"/> cable connection	<input type="checkbox"/> none
EUT-grounding	<input checked="" type="checkbox"/> none	<input type="checkbox"/> with power supply	<input type="checkbox"/> additional connection
Equipment set up	<input checked="" type="checkbox"/> table top		<input type="checkbox"/> floor standing
Climatic conditions	Temperature: (22±3°C)		Rel. humidity: (40±20)%
EMI-Receiver or Analyzer Settings	Scan data	<input checked="" type="checkbox"/> 9 – 150 kHz RBW/VBW = 200 Hz Scan step = 80 Hz <input checked="" type="checkbox"/> 150 kHz – 30 MHz RBW/VBW = 9 kHz Scan step = 4 kHz <input type="checkbox"/> other:	
	Scan-Mode Detector Mode: Sweep-Time	<input checked="" type="checkbox"/> 6 dB EMI-Receiver Mode <input type="checkbox"/> 3dB Spectrum analyser Mode Peak (pre-measurement) and Quasi-PK/Average (final if applicable) Repetitive-Scan. max-hold Coupled – calibrated display if continuous signal otherwise adapted to EUT's individual transmission duty-cycle	
General measurement procedures	Please see chapter "Test system set-up radiated magnetic field measurements below 30 MHz"		

### 5.2.4. Radiated Field Strength Emissions – 9 kHz to 30 MHz Results

Radiated Field Strength Emissions – 9 kHz to 30 MHz									
Temperature :+21 °C		Technology: Bluetooth FHSS Modes			TX-Fixed Channel (Modulated)				
Diagram No. (Remark 1)	Test Settings			Set-up no.	OP-mode no.	Used detector			Verdict
	FHSS Mode	Modulation	Data Rate   Test Channel			PK	AV	QP	
2.51	BR Mode	GFSK	1 Mbps   Highest Channel 78: 2480 MHz	1	1	<input checked="" type="checkbox"/>	<input type="checkbox"/>	<input type="checkbox"/>	Pass
2.52	EDR Mode	π/4DQPSK	2 Mbps   Lowest Channel 0: 2402 MHz	1	1	<input checked="" type="checkbox"/>	<input type="checkbox"/>	<input type="checkbox"/>	Pass
2.53	EDR Mode	8DPSK	3 Mbps   Middle Channel 39: 2441 MHz	1	1	<input checked="" type="checkbox"/>	<input type="checkbox"/>	<input type="checkbox"/>	Pass

Remark 1: For further details please refer → Annex 1: Test results - CETECOM\_TR16-1-0181301T11a-A1  
 Remark 2: Measurements results are only valid and compliant with power setting: +7 dBm



### 5.2.5. Correction factors due to reduced meas. distance (f< 30 MHz)

The used correction factors when the measurement distance is reduced compared to regulatory measurement distance. are calculated according Extrapolation formulas valid for EUT's with maximum dimension of 0.625xLambda. Formula 2+3+4 as presented in ANSI C63.10. Chapter 6.4.4 are used for the calculations of proper extrapolation factors.

Frequency -Range	f [kHz/MHz]	Lambda [m]	Far-Field Point [m]	Distance Limit accord. 15.209 [m]	1st Condition (d <sub>meas</sub> < D <sub>near-field</sub> )	2te Condition (Limit distance bigger d <sub>near-field</sub> )	Distance Correction accord. Formula
kHz	9,00E+03	33333,33	5305,17	300	fulfilled	not fulfilled	-80,00
	1,00E+04	30000,00	4774,65		not fulfilled	-80,00	
	2,00E+04	15000,00	2387,33		fulfilled	not fulfilled	-80,00
	3,00E+04	10000,00	1591,55		fulfilled	not fulfilled	-80,00
	4,00E+04	7500,00	1193,66		fulfilled	not fulfilled	-80,00
	5,00E+04	6000,00	954,93		fulfilled	not fulfilled	-80,00
	6,00E+04	5000,00	795,78		fulfilled	not fulfilled	-80,00
	7,00E+04	4285,71	682,09		fulfilled	not fulfilled	-80,00
	8,00E+04	3750,00	596,83		fulfilled	not fulfilled	-80,00
	9,00E+04	3333,33	530,52		fulfilled	not fulfilled	-80,00
	1,00E+05	3000,00	477,47		fulfilled	not fulfilled	-80,00
	1,25E+05	2400,00	381,97		fulfilled	not fulfilled	-80,00
	2,00E+05	1500,00	238,73		fulfilled	fulfilled	-78,02
	3,00E+05	1000,00	159,16		fulfilled	fulfilled	-74,49
	4,00E+05	750,00	119,37		fulfilled	fulfilled	-72,00
	4,90E+05	612,24	97,44		fulfilled	fulfilled	-70,23
	5,00E+05	600,00	95,49		fulfilled	not fulfilled	-40,00
	6,00E+05	500,00	79,58		fulfilled	not fulfilled	-40,00
7,00E+05	428,57	68,21	fulfilled	not fulfilled	-40,00		
8,00E+05	375,00	59,68	fulfilled	not fulfilled	-40,00		
9,00E+05	333,33	53,05	fulfilled	not fulfilled	-40,00		
MHz	1,00	300,00	47,75	30	fulfilled	not fulfilled	-40,00
	1,59	188,50	30,00		fulfilled	not fulfilled	-40,00
	2,00	150,00	23,87		fulfilled	fulfilled	-38,02
	3,00	100,00	15,92		fulfilled	fulfilled	-34,49
	4,00	75,00	11,94		fulfilled	fulfilled	-32,00
	5,00	60,00	9,55		fulfilled	fulfilled	-30,06
	6,00	50,00	7,96		fulfilled	fulfilled	-28,47
	7,00	42,86	6,82		fulfilled	fulfilled	-27,13
	8,00	37,50	5,97		fulfilled	fulfilled	-25,97
	9,00	33,33	5,31		fulfilled	fulfilled	-24,95
	10,00	30,00	4,77		fulfilled	fulfilled	-24,04
	10,60	28,30	4,50		fulfilled	fulfilled	-23,53
	11,00	27,27	4,34		fulfilled	fulfilled	-23,21
	12,00	25,00	3,98		fulfilled	fulfilled	-22,45
	13,56	22,12	3,52		fulfilled	fulfilled	-21,39
	15,00	20,00	3,18		fulfilled	fulfilled	-20,51
	15,92	18,85	3,00		fulfilled	fulfilled	-20,00
	17,00	17,65	2,81		not fulfilled	fulfilled	-20,00
	18,00	16,67	2,65		not fulfilled	fulfilled	-20,00
	20,00	15,00	2,39		not fulfilled	fulfilled	-20,00
	21,00	14,29	2,27		not fulfilled	fulfilled	-20,00
23,00	13,04	2,08	not fulfilled	fulfilled	-20,00		
25,00	12,00	1,91	not fulfilled	fulfilled	-20,00		
27,00	11,11	1,77	not fulfilled	fulfilled	-20,00		
29,00	10,34	1,65	not fulfilled	fulfilled	-20,00		
30,00	10,00	1,59	not fulfilled	fulfilled	-20,00		

### 5.3. General Limit - Radiated field strength emissions. 30 MHz - 1 GHz

#### 5.3.1. Test location and equipment

test location	<input checked="" type="checkbox"/> CETECOM Essen (Chapter. 2.2.1)	<input type="checkbox"/> Please see Chapter. 2.2.2		<input type="checkbox"/> Please see Chapter. 2.2.3	
test site	<input checked="" type="checkbox"/> 441 EMI SAR	<input checked="" type="checkbox"/> 487 SAR NSA			
receiver	<input type="checkbox"/> 377 ESCS30	<input checked="" type="checkbox"/> 001 ESS	<input type="checkbox"/> 489 ESU 40	<input type="checkbox"/> 620 ESU 26	
spectr. analys.	<input type="checkbox"/> 584 FSU	<input type="checkbox"/> 120 FSEM	<input type="checkbox"/> 264 FSEK		
antenna	<input checked="" type="checkbox"/> 574 BTA-L	<input type="checkbox"/> 133 EMCO3115	<input type="checkbox"/> 302 BBHA9170	<input type="checkbox"/> 289 CBL 6141	<input type="checkbox"/> 030 HFH-Z2 <input type="checkbox"/> 477 GPS
signaling	<input type="checkbox"/> 392 MT8820A	<input type="checkbox"/> 371 CBT32	<input type="checkbox"/> 547 CMU	<input type="checkbox"/> 594 CMW	
otherwise	<input type="checkbox"/> 400 FTC40x15E	<input type="checkbox"/> 401 FTC40x15E	<input type="checkbox"/> 110 USB LWL	<input checked="" type="checkbox"/> 482 Filter Matrix	
DC power	<input type="checkbox"/> 671 EA-3013S	<input type="checkbox"/> 457 EA 3013A	<input type="checkbox"/> 459 EA 2032-50	<input type="checkbox"/> 268 EA- 3050	<input type="checkbox"/> 494 AG6632A <input type="checkbox"/> 498 NGPE
Supply voltage	<input type="checkbox"/> 230 V 50 Hz via public mains		<input checked="" type="checkbox"/> 4.2 V DC (fully charged internal battery)		

#### 5.3.2. Requirements/Limits

<b>FCC</b>		<input type="checkbox"/> Part 15 Subpart B, §15.109. class B <input checked="" type="checkbox"/> Part 15 Subpart C, §15.209 @ frequencies defined in §15.205 <input checked="" type="checkbox"/> Part 15.247 (d)	
<b>ANSI</b>		<input type="checkbox"/> C63.4-2014 <input checked="" type="checkbox"/> C63.10-2013	
<b>Limit</b>	Frequency [MHz]	Radiated emissions limits. 3 meters	
		QUASI Peak [ $\mu$ V/m]	QUASI-Peak [dB $\mu$ V/m]
	30 - 88	100	40.0
	88 - 216	150	43.5
	216 - 960	200	46.0
	above 960	500	54.0

#### 5.3.3. Restricted bands of operation (FCC §15.205)

MHz	MHz	MHz	GHz
0.090-0.110	16.42-16.423	399.9-410	4.5-5.15
0.495-0.505	16.69475-16.69525	608-614	5.35-5.46
2.1735-2.1905	16.80425-16.80475	960-1240	7.25-7.75
4.125-4.128	25.5-25.67	1300-1427	8.025-8.5
4.20725-4.20775	37.5-38.25	1645.5-1646.5	9.3-9.5
6.215-6.218	73-74.6	1660-1710	10.6-12.7
6.26775-6.26825	74.8-75.2	1718.8-1722.2	13.25-13.4
6.31175-6.31225	108-121.94	2200-2300	14.47-14.5
8.291-8.294	123-138	2310-2390	15.35-16.2
8.362-8.366	149.9-150.05	2483.5-2500	17.7-21.4
8.37625-8.38675	156.52475-156.52525	2690-2900	22.01-23.12
8.41425-8.41475	156.7-156.9	3260-3267	23.6-24.0
12.29-12.293	162.0125-167.17	3332-3339	31.2-31.8
12.51975-12.52025	167.72-173.2	3345.8-3358	36.43-36.5
12.57675-12.57725	240-285	3600-4400	--
13.36-13.41	322-335.4	--	--

**5.3.4. Test condition and measurement test set-up**

Signal link to test system (if used):		<input type="checkbox"/> air link	<input type="checkbox"/> cable connection	<input type="checkbox"/> none
EUT-grounding		<input type="checkbox"/> none	<input type="checkbox"/> with power supply	<input type="checkbox"/> additional connection
Equipment set up		<input checked="" type="checkbox"/> table top 0.8m height		<input type="checkbox"/> floor standing
Climatic conditions		Temperature: (22±3°C)		Rel. humidity: (40±20)%
EMI-Receiver (Analyzer) Settings	Scan frequency range:	<input checked="" type="checkbox"/> 30 – 1000 MHz <input type="checkbox"/> other:		
	Scan-Mode	<input checked="" type="checkbox"/> 6 dB EMI-Receiver Mode <input type="checkbox"/> 3 dB spectrum analyser mode		
	Detector	Peak / Quasi-peak		
	RBW/VBW	100 kHz/300 kHz		
	Mode:	Repetitive-Scan. max-hold		
Scan step	80 kHz			
Sweep-Time	Coupled – calibrated display if continuous tx-signal otherwise adapted to EUT’s individual duty-cycle			
General measurement procedures		Please see chapter “Test system set-up for electric field measurement in the range 30 MHz to 1 GHz”		

**5.3.5. Radiated Field Strength Emissions – 30 MHz to 1 GHz Results**

Radiated Field Strength Emissions – 30 MHz to 1 GHz							
Temperature :+21 °C		Technology: Bluetooth FHSS Modes			TX-Fixed Channel (Modulated)		
Diagram No. (Remark 1)	Test Settings FHSS Mode   Modulation   Data Rate   Test Channel	Set-up no.	OP-mode no.	Used detector			Verdict
				PK	AV	QP	
3.51	BR Mode   GFSK   1 Mbps   Highest Channel 78: 2480 MHz	1	1	<input checked="" type="checkbox"/>	<input type="checkbox"/>	<input checked="" type="checkbox"/>	Pass
3.52	EDR Mode   $\pi/4$ DQPSK   2 Mbps   Lowest Channel 0: 2402 MHz	1	1	<input checked="" type="checkbox"/>	<input type="checkbox"/>	<input checked="" type="checkbox"/>	Pass
3.53	EDR Mode   8DPSK   3 Mbps   Middle Channel 39: 2441 MHz	1	1	<input checked="" type="checkbox"/>	<input type="checkbox"/>	<input checked="" type="checkbox"/>	Pass
Remark 1: For further details please refer → Annex 1: Test results - CETECOM_TR16-1-0181301T11a-A1 Remark 2: Measurements results are only valid and compliant with power setting: +7 dBm							

## 5.4. General Limit - Radiated emissions. above 1 GHz

### 5.4.1. Test location and equipment FAR

test site	<input type="checkbox"/> 441 EMI SAR	<input type="checkbox"/> 348 EMI cond.	<input checked="" type="checkbox"/> 443 EMI FAR	<input type="checkbox"/> 347 Radio.lab.	<input type="checkbox"/> 337 OATS	<input type="checkbox"/>
spectr. analys.	<input type="checkbox"/> 584 FSU	<input type="checkbox"/> 120 FSEM	<input type="checkbox"/> 264 FSEK	<input checked="" type="checkbox"/> 489 ESU 40	<input type="checkbox"/>	<input type="checkbox"/>
antenna meas	<input type="checkbox"/> 574 BTA-L	<input type="checkbox"/> 289 CBL 6141	<input type="checkbox"/> 608 HL 562	<input checked="" type="checkbox"/> 549 HL025	<input checked="" type="checkbox"/> 302 BBHA9170	<input type="checkbox"/> 477 GPS
antenna meas	<input type="checkbox"/> 123 HUF-Z2	<input type="checkbox"/> 132 HUF-Z3	<input type="checkbox"/> 030 HFH-Z2	<input checked="" type="checkbox"/> 376 BBHA9120E	<input type="checkbox"/>	<input type="checkbox"/>
antenna subst	<input type="checkbox"/> 071 HUF-Z2	<input type="checkbox"/> 020 EMCO3115	<input type="checkbox"/> 063 LP 3146	<input type="checkbox"/> 303 BBHA9170	<input type="checkbox"/>	<input type="checkbox"/>
multimeter	<input type="checkbox"/> 341 Fluke 112	<input type="checkbox"/>	<input type="checkbox"/>	<input type="checkbox"/>	<input type="checkbox"/>	<input type="checkbox"/>
signaling	<input type="checkbox"/> 392 MT8820A	<input type="checkbox"/> 371 CBT32	<input type="checkbox"/> 547 CMU	<input type="checkbox"/> 594 CMW	<input type="checkbox"/>	<input type="checkbox"/>
DCpower	<input type="checkbox"/> 611 E3632A	<input type="checkbox"/> 087 EA3013	<input type="checkbox"/> 354 NGPE 40	<input type="checkbox"/> 349 car battery	<input type="checkbox"/> 350 Car battery	<input type="checkbox"/>
Supply voltage	<input type="checkbox"/> 230 V 50 Hz via public mains		<input checked="" type="checkbox"/> 4.2 V DC (fully charged internal battery)			

### 5.4.2. Requirements/Limits (CLASS B equipment)

<b>FCC</b>	<input type="checkbox"/> Part 15 Subpart B. §15.109 class B <input checked="" type="checkbox"/> Part 15 Subpart C. §15.209 for frequencies defined in §15.205 <input checked="" type="checkbox"/> Part 15.247 (d)			
<b>ANSI</b>	<input type="checkbox"/> C63.4-2014 <input checked="" type="checkbox"/> C63.10-2013			
Frequency [MHz]	Limits			
	AV [µV/m]	AV [dBµV/m]	Peak [µV/m]	Peak [dBµV/m] or [dBm/MHz]
RSS-Gen.. Issue 4. §8.10 - Table 6	500	54.0	5000	74.0 dBµV/m

### 5.4.3. Test condition and measurement test set-up

Signal link to test system (if used):	<input type="checkbox"/> air link	<input type="checkbox"/> cable connection	<input type="checkbox"/> none
EUT-grounding	<input checked="" type="checkbox"/> none	<input type="checkbox"/> with power supply	<input type="checkbox"/> additional connection
Equipment set up	<input checked="" type="checkbox"/> table top 1.5m height		<input type="checkbox"/> floor standing
Climatic conditions	Temperature: (22±3°C)		Rel. humidity: (40±20)%
Spectrum-Analyzer settings	Scan frequency range: <input checked="" type="checkbox"/> 1 – 18 GHz <input checked="" type="checkbox"/> 18 – 25 GHz <input type="checkbox"/> 18 – 40 GHz <input type="checkbox"/> other: Scan-Mode <input checked="" type="checkbox"/> 6 dB EMI-Receiver Mode <input type="checkbox"/> 3 dB Spectrum analyser Mode Detector Peak and Average RBW/VBW 1 MHz / 3 MHz Mode: Repetitive-Scan. max-hold Scan step 400 kHz Sweep-Time Coupled – calibrated display if CW signal otherwise adapted to EUT’s individual duty-cycle		
General measurement procedures	Please see chapter “Test system set-up for radiated electric field measurements above 1 GHz”		

#### 5.4.4. Radiated Field Strength Emissions – 1 GHz to 18 GHz Results

Radiated Field Strength Emissions – 1 GHz to 18 GHz							
Temperature :+21 °C		Technology: Bluetooth FHSS Modes			TX-Fixed Channel (Modulated)		
Diagram No. (Remark 1)	Test Settings FHSS Mode   Modulation   Data Rate   Test Channel	Set-up no.	OP-mode no.	Used detector			Verdict
				PK	AV	QP	
4.51	BR Mode   GFSK   1 Mbps   Highest Channel 78: 2480 MHz	1	1	<input checked="" type="checkbox"/>	<input checked="" type="checkbox"/>	<input type="checkbox"/>	Pass
4.52	EDR Mode   $\pi/4$ DQPSK   2 Mbps   Lowest Channel 0: 2402 MHz	1	1	<input checked="" type="checkbox"/>	<input checked="" type="checkbox"/>	<input type="checkbox"/>	Pass
4.53	EDR Mode   8DPSK   3 Mbps   Middle Channel 39: 2441 MHz	1	1	<input checked="" type="checkbox"/>	<input checked="" type="checkbox"/>	<input type="checkbox"/>	Pass

Remark 1: For further details please refer → Annex 1: Test results - CETECOM\_TR16-1-0181301T11a-A1  
 Remark 2: Measurements results are only valid and compliant with power setting: +7 dBm

#### 5.4.5. Radiated Field Strength Emissions – 18 GHz to 25 GHz Results

Radiated Field Strength Emissions – 18 GHz to 25 GHz							
Temperature :+21 °C		Technology: Bluetooth FHSS Modes			TX-Fixed Channel (Modulated)		
Diagram No. (Remark 1)	Test Settings FHSS Mode   Modulation   Data Rate   Test Channel	Set-up no.	OP-mode no.	Used detector			Verdict
				PK	AV	QP	
4.51a	BR Mode   GFSK   1 Mbps   Highest Channel 78: 2480 MHz	1	1	<input checked="" type="checkbox"/>	<input checked="" type="checkbox"/>	<input type="checkbox"/>	Pass
4.52a	EDR Mode   $\pi/4$ DQPSK   2 Mbps   Lowest Channel 0: 2402 MHz	1	1	<input checked="" type="checkbox"/>	<input checked="" type="checkbox"/>	<input type="checkbox"/>	Pass
4.53a	EDR Mode   8DPSK   3 Mbps   Middle Channel 39: 2441 MHz	1	1	<input checked="" type="checkbox"/>	<input checked="" type="checkbox"/>	<input type="checkbox"/>	Pass

Remark 1: For further details please refer → Annex 1: Test results - CETECOM\_TR16-1-0181301T11a-A1  
 Remark 2: Measurements results are only valid and compliant with power setting: +7 dBm

## 5.5. RF-Parameter - Radiated Band Edge compliance measurements

### 5.5.1. Test location and equipment FAR

test site	<input type="checkbox"/> 441 EMI SAR	<input type="checkbox"/> 348 EMI cond.	<input checked="" type="checkbox"/> 443 EMI FAR	<input type="checkbox"/> 347 Radio.lab.	<input type="checkbox"/> 337 OATS	<input type="checkbox"/>
spectr. analys.	<input type="checkbox"/> 584 FSU	<input type="checkbox"/> 120 FSEM	<input type="checkbox"/> 264 FSEK	<input checked="" type="checkbox"/> 489 ESU 40	<input type="checkbox"/>	<input type="checkbox"/>
antenna meas	<input type="checkbox"/> 574 BTA-L	<input type="checkbox"/> 289 CBL 6141	<input type="checkbox"/> 608 HL 562	<input checked="" type="checkbox"/> 549 HL025	<input checked="" type="checkbox"/> 302 BBHA9170	<input type="checkbox"/> 477 GPS
antenna meas	<input type="checkbox"/> 123 HUF-Z2	<input type="checkbox"/> 132 HUF-Z3	<input type="checkbox"/> 030 HFH-Z2	<input checked="" type="checkbox"/> 376 BBHA9120E	<input type="checkbox"/>	<input type="checkbox"/>
antenna subst	<input type="checkbox"/> 071 HUF-Z2	<input type="checkbox"/> 020 EMCO3115	<input type="checkbox"/> 063 LP 3146	<input type="checkbox"/> 303 BBHA9170	<input type="checkbox"/>	<input type="checkbox"/>
multimeter	<input type="checkbox"/> 341 Fluke 112	<input type="checkbox"/>	<input type="checkbox"/>	<input type="checkbox"/>	<input type="checkbox"/>	<input type="checkbox"/>
signaling	<input type="checkbox"/> 392 MT8820A	<input type="checkbox"/> 371 CBT32	<input type="checkbox"/> 547 CMU	<input type="checkbox"/> 594 CMW	<input type="checkbox"/>	<input type="checkbox"/>
DCpower	<input type="checkbox"/> 611 E3632A	<input type="checkbox"/> 087 EA3013	<input type="checkbox"/> 354 NGPE 40	<input type="checkbox"/> 349 carbattery	<input type="checkbox"/> 350 Car battery	<input type="checkbox"/>
sSupply voltage	<input type="checkbox"/> 230 V 50 Hz via public mains		<input checked="" type="checkbox"/> 4.2 V DC (fully charged internal battery)			

### 5.5.2. Requirements/Limits

<b>FCC</b>	<input type="checkbox"/> Part 15 Subpart B. §15.109 class B <input checked="" type="checkbox"/> Part 15 subpart C. §15.209 @ frequencies defined in §15.205 <input checked="" type="checkbox"/> Part 15.247 (d)
<b>ANSI</b>	<input type="checkbox"/> C63.4-2009 <input type="checkbox"/> C63.4-2014 <input type="checkbox"/> C63.10-2009 <input checked="" type="checkbox"/> C63.10-2013. Chapter 6.10.6

### 5.5.3. Test condition and measurement test set-up

Signal link to test system (if used):	<input type="checkbox"/> air link	<input type="checkbox"/> cable connection	<input checked="" type="checkbox"/> none
EUT-grounding	<input checked="" type="checkbox"/> none	<input type="checkbox"/> with power supply	<input type="checkbox"/> additional connection
Equipment set up	<input checked="" type="checkbox"/> table top 1.5m height		<input type="checkbox"/> floor standing
Climatic conditions	Temperature: (22±3°C)		Rel. humidity: (40±20)%
Spectrum-Analyzer settings	Scan frequency range: <input type="checkbox"/> 1 – 18 GHz <input type="checkbox"/> 18 – 25 GHz <input type="checkbox"/> 18 – 40 GHz <input checked="" type="checkbox"/> other: see diagrams <input type="checkbox"/> 6 dB EMI-Receiver Mode <input checked="" type="checkbox"/> 3 dB Spectrum analyser Mode Peak and Average Left band-edge: 100kHz/300kHz Right band-edge: 1 MHz / 3 MHz Repetitive-Scan. max-hold 40kHz or 400 kHz Coupled – calibrated display if CW signal otherwise adapted to EUT’s individual duty-cycle		
General measurement procedures	Please see chapter “Test system set-up for radiated electric field measurements above 1 GHz” for general measurements procedures in anechoic chamber.		

### 5.5.4. Measurement Method

For uncritical results where a measurement resolution bandwidth of 1MHz can clearly show the compliance without influencing the results, a field strength measurement was performed to show compliance.

For critical results a Marker-Delta marker method was used for showing compliance to restricted bands. The method is according ANSI C63.10:2013. Chapter 6.10.6 “Marker-Delta method”.. The method consists of three independent steps:

- 1. Step:** Prior to the measurement the fundamental radiated In-Band field strength was performed. The determined value is used as reference value.
- 2. Step:** Second step consist of finding the relative attenuation between the fundamental emission and the maximum local out-of-band emission (within 2 MHz range around the band edge either on the band-edge directly or some modulation product if the level is greater than that on the band-edge) when measured with lower resolution bandwidth.
- 3. Step:** The delta value recorded in step 2 will be subtracted from value recorded in step 1. thus giving the required field strength at the band-edge. This value must fulfil the requirements for radiated spurious emissions in restricted bands in FCC §15.205 with the general limits of FCC §15.209.

### 5.5.5. EUT settings

The EUT was set in Hopping OFF mode with maximum power (if adjustable) according to applicants instructions.

### 5.5.6. Results: for non-restricted bands near-by

#### 5.5.6.1. Non-restricted bands near-by - limits according FCC §15.247

Set-up No.:	1
Op. Mode:	1

Diagram No	Channel No.	Restricted band ?	Fundamental Value [dBuV/m]		Peak-Value at Band-Edge [dBuV/m]	Difference [dB]	Limit [dBc]	Margin [dB]	Verdict	Remark: Data Rate   Power   Hopping ?
			Peak-Value	Average-Value						
9.51	0	NO	101,38	96,99	68,90	32,48	20,00	12,48	PASS	BR Mode   GFSK   1 Mbps   +7 dBm   Hopping OFF
9.53	0	NO	99,32	91,90	69,29	30,03	20,00	10,03	PASS	EDR Mode   π/4-DQPSK   2 Mbps   +7 dBm   Hopping OFF
9.55	0	NO	99,85	91,82	70,11	29,74	20,00	9,74	PASS	EDR Mode   8DPSK   3 Mbps   +7 dBm   Hopping OFF

Remark 1: For further details please refer → Annex 1: Test results - CETECOM\_TR16-1-0181301T11a-A1  
 Remark 2: Measurements results are only valid and compliant with power setting: +7 dBm

#### 5.5.6.2. Restricted bands near-by §15.205 with limits accord. FCC §15.209

Set-up No.:	1
Op. Mode:	1

Diagram No	Channel no.	Restricted band ?	Fundamental Value [dBuV/m]		Value at Band-Edge [dBuV/m]		Limits [dBuV/m]		Margin [dB]		Verdict	Remark: Data Rate   Power   Hopping ?
			Peak-Value	Average-Value	Peak -Value	Average -Value	Peak -Value	Average -Value	Peak	Average		
9.52	78	YES	104,45	104,11	57,93	47,15	74,00	54,00	16,07	6,85	PASS	BR Mode   GFSK   1 Mbps   +7 dBm   Hopping OFF
9.54	78	YES	105,76	102,67	59,55	49,02	74,00	54,00	14,45	4,98	PASS	EDR Mode   π/4-DQPSK   2 Mbps   +7 dBm   Hopping OFF
9.56	78	YES	105,89	102,66	61,10	49,40	74,00	54,00	12,90	4,60	PASS	EDR Mode   8DPSK   3 Mbps   +7 dBm   Hopping OFF

Remark 1: For further details please refer → Annex 1: Test results - CETECOM\_TR16-1-0181301T11a-A1  
 Remark 2: Measurements results are only valid and compliant with power setting: +7 dBm

### 5.6. Measurement uncertainties

The reported uncertainties are calculated based on the standard uncertainty multiplied with the appropriate coverage factor **k**, such that a confidence level of approximately 95% is achieved.

For uncertainty determination, each component used in the concrete measurement set-up was taken in account and it's contribution to the overall uncertainty according it's statistical distribution calculated.

Following table shows expectable uncertainties for each measurement type performed.

RF-Measurement	Reference	Frequency range	Calculated uncertainty based on a confidence level of 95%						Remarks
Conducted emissions (U <sub>CISPR</sub> )	CISPR 16-2-1	9 kHz - 150 kHz	4.0 dB						-
		150 kHz - 30 MHz	3.6 dB						
Radiated emissions Enclosure	CISPR 16-2-3	30 MHz - 1 GHz	4.2 dB						E-Field
		1 GHz - 18 GHz	5.1 dB						
Disturbance power	CISPR 16-2-2	30 MHz - 300 MHz	-						-
Power Output radiated	-	30 MHz - 4 GHz	3.17 dB						Substitution method
Power Output conducted	-	Set-up No.	Cel-C1	Cel-C2	BT1	W1	W2	--	-
		9 kHz - 12.75 GHz	N/A	0.60	0.7	0.25	N/A	--	
		12.75 - 26.5GHz	N/A	0.82	--	N/A	N/A	--	
Conducted emissions on RF-port	-	9 kHz - 2.8 GHz	0.70	N/A	0.70	N/A	0.69	--	N/A - not applicable
		2.8 GHz - 12.75GHz	1.48	N/A	1.51	N/A	1.43	--	
		12.75 GHz - 18GHz	1.81	N/A	1.83	N/A	1.77	--	
		18 GHz - 26.5GHz	1.83	N/A	1.85	N/A	1.79	--	
Occupied bandwidth	-	9 kHz - 4 GHz	0.1272 ppm (Delta Marker)						Frequency error
			1.0 dB						Power
Emission bandwidth	-	9 kHz - 4 GHz	0.1272 ppm (Delta Marker)						Frequency error
			See above: 0.70 dB						Power
Frequency stability	-	9 kHz - 20 GHz	0.0636 ppm						-
Radiated emissions Enclosure	-	150 kHz - 30 MHz	5.0 dB						Magnetic field E-field Substitution
		30 MHz - 1 GHz	4.2 dB						
		1 GHz - 20 GHz	3.17 dB						

**Table: measurement uncertainties, valid for conducted/radiated measurements**



## 6. Abbreviations used in this report

The abbreviations	
ANSI	American National Standards Institute
AV . AVG. CAV	Average detector
EIRP	Equivalent isotropically radiated power. determined within a separate measurement
EGPRS	Enhanced General Packet Radio Service
EUT	Equipment Under Test
FCC	Federal Communications Commission. USA
IC	Industry Canada
n.a.	not applicable
Op-Mode	Operating mode of the equipment
PK	Peak
RBW	resolution bandwidth
RF	Radio frequency
RSS	Radio Standards Specification. Documents from Industry Canada
Rx	Receiver
TCH	Traffic channel
Tx	Transmitter
QP	Quasi peak detector
VBW	Video bandwidth
ERP	Effective radiated power

## 7. Accreditation details of CETECOM's laboratories and test sites

Ref.-No.	Accreditation Certificate	Valid for laboratory area or test site	Accreditation Body
-	D-PL-12047-01-01	All laboratories and test sites of CETECOM GmbH. Essen	DAkKS. Deutsche Akkreditierungsstelle GmbH
337 487 558 348 348	(MRA US-EU 0003)	Radiated Measurements 30 MHz to 1 GHz. 3 m / 10 m (OATS) Radiated Measurements 30 MHz to 1 GHz. 3 m (SAR) Radiated Measurements above 1 GHz. 3 m (FAR) Mains Ports Conducted Interference Measurements Telecommunication Ports Conducted Interference Measurment.	FCC. Federal Communications Commission Laboratory Division. USA
337 487 550 558	3462D-1 3462D-2 3462D-2 3462D-3	Radiated Measurements 30 MHz to 1 GHz. 3 m / 10 m (OATS) Radiated Measurements 30 MHz to 1 GHz. 3 m (SAR) Radiated Measurements 1 GHz to 6 GHz. 3 m (SAR) Radiated Measurements above 1 GHz. 3 m (FAR)	IC. Industry Canada Certification and Engineering Bureau
487 550 348 348	R-2666 G-301 C-2914 T-1967	Radiated Measurements 30 MHz to 1 GHz. 3 m (SAR) Radiated Measurements 1 GHz to 6 GHz. 3 m (SAR) Mains Ports Conducted Interference Measurements Telecommunication Ports Conducted Interference Measurment.	VCCI. Voluntary Control Council for Interference by Information Technology Equipment. Japan

OATS = Open Area Test Site. SAR = Semi Anechoic Room. FAR = Fully Anechoic Room

## 8. Instruments and Ancillary

TC”

The “Ref.-No” in the left column of the following tables allows the clear identification of the laboratory equipment.

### 8.1.1. Test software and firmware of equipment

Ref.-No.	Equipment	Type	Serial-No.	Version of Firmware or Software during the test
001	EMI Test Receiver	ESS	825132/017	Firm.= 1.21 , OTP=2.0, GRA=2.0
012	Signal Generator (EMS-cond.)	SMY 01	839069/027	Firm.= V 2.02
013	Power Meter (EMS cond.)	NRVD	839111/003	Firm.= V 1.51
017	Digital Radiocommunication Tester	CMD 60 M	844365/014	Firmware = V 3.52 .22.01.99, DECT = D2.87 13.01.99
053	Audio Analyzer	UPA3	860612/022	Firm. V 4.3
119	RT Harmonics Analyzer dig. Flickermeter	B10	G60547	Firm.= V 3.1DHG
140	Signal Generator	SMHU	831314/006	Firm.= 3.21
261	Thermal Power Sensor	NRV-Z55	825083/0008	EPROM-Datum 02.12.04, SE EE 1 B
262	Power Meter	NRV-S	825770/0010	Firm.= 2.6
263	Signal Generator	SMP 04	826190/0007	Firm.=3.21
295	Racal Digital Radio Test Set	6103	1572	UNIT Firmware= 4.04, SW-Main=4.04, SW-BBP=1.04, SW-DSP=1.02, Hardboot=1.02, Softboot=2.02
298	Univ. Radio Communication Tester	CMU 200	832221/091	R&S Test Firmware =3.53 /3.54 (current Testsoftw. f. all band used
323	Digital Radiocommunication Tester	CMD 55	825878/0034	Firm.= 3.52 .22.01.99
335	CTC-EMS-Conducted	System EMS Conducted	-	EMC 32 V 8.52
340	Digital Radiocommunication Tester	CMD 55	849709/037	Firm.= 3.52 .22.01.99
355	Power Meter	URV 5	891310/027	Firm.= 1.31
365	10V Insertion Unit 50 Ohm	URV5-Z2	100880	Eprom Data = 31.03.08
366	Ultra Compact Simulator	UCS 500 M4	V0531100594	Firm. UCS 500=001925/3.06a02, rc=ISMIEC 4.10
371	Bluetooth Tester	CBT32	100153	CBT V5.30+ SW-Option K55, K57
377	EMI Test Receiver	ESCS 30	100160	Firm.= 2.30, OTP= 02.01, GRA= 02.36
378	Broadband RF Field Monitor	RadiSense III	03D00013SNO-08	Firm.= V.03D13
389	Digital Multimeter	Keithley 2000	0583926	Firm. = A13 (Mainboard) A02 (Display)
392	Radio Communication Tester	MT8820A	6K00000788	Firm.= 4.50 #005, IPL=4.01#001, OS=4.02#001, GSM=4.41#013, W-CDMA= 4.54#004, scenario= 4.52#002
436	Univ. Radio Communication Tester	CMU 200	103083	R&S Test Firmware Base=5.14, Mess-Software= GSM:5.14 WCDMA:5.14 (current Testsoftw. F. all band
441	CTC-SAR-EMI Cable Loss	System EMI field (SAR)	-	EMC 32 Version 8.52
442	CTC-SAR-EMS	System EMS field (SAR)	-	EMC 32 Version 8.40
443	CTC-FAR-EMI-RSE	System CTC-FAR-EMI-RSE	-	Spuri 7.2.5 or EMC 32 Ver. 9.15.00
444	CTC-FAR-EMS field	System-EMS-Field (FAR)	-	EMC 32 Version 9.15.00
460	Univ. Radio Communication Tester	CMU 200	108901	R&S Test Firmware Base=5.14, GSM=5.14 WCDMA=5.14 (current Testsoftw..f. all band to be used,
489	EMI Test Receiver	ESU40	1000-30	Firmware=4.43 SP3, Bios=V5.1-16-3, Spec. =01.00
491	ESD Simulator dito	ESD dito	dito307022	V 2.30
524	Voltage Drop Simulator	VDS 200	0196-16	Software Nr: 000037 Version V4.20a01
526	Burst Generator	EFT 200 A	0496-06	Software Nr. 000034 Version V2.32
527	Micro Pulse Generator	MPG 200 B	0496-05	Software-Nr. 000030 Version V2.43
528	Load Dump Simulator	LD 200B	0496-06	Software-Nr. 000031 Version V2.35a01
546	Univ. Radio Communication Tester	CMU 200	106436	R&S Test Firmware Base=5.14, GSM=5.14 WCDMA=5.14 (current Testsoftw..f. all band to be used
547	Univ. Radio Communication Tester	CMU 200	835390/014	R&S Test Firmware Base=V5.1403 (current Testsoftw., f. all band used, GSM = 5.14 WCDMA: = 5.14
584	Spectrum Analyzer	FSU 8	100248	2.82_SP3
597	Univ. Radio Communication Tester	CMU 200	100347	R&S Test Firmware Base=5.01, GSM=5.02 WCDMA= not installed, Mainboard= µP1=V.850
598	Spectrum Analyzer	FSEM 30	831259/013	Firmware Bios 3.40 , Analyzer 3.40 Sp 2
607	Signal Generator	SMR 20	832033/011	V1.25
620	EMI Test Receiver	ESU 26	100362	4.43_SP3
642	Wideband Radio Communication Tester	CMW 500	126089	Setup V03.26, Test programm component V03.02.20
670	Univ. Radio Communication Tester	CMU 200	106833	µP1 =V8.50, Firmware = V.20
689	Vector Signal Generator	SMU200	100970	02.20.360.142
692	Bluetooth Tester	CBT 32	100236	CBT V 5.40, FW: V.2.41 (FPGA Digital, V. 3.09 FPGA RF)

### 8.1.2. Single instruments and test systems

Ref.-No.	Equipment	Type	Serial-No.	Manufacturer	Interval of calibration	Remark	Cal due
001	EMI Test Receiver	ESS	825132/017	Rohde & Schwarz	12 M	-	16.05.2018
005	AC - LISN (50 Ohm/50µH, test site 1)	ESH2-Z5	861741/005	Rohde & Schwarz	12 M	-	15.05.2018
007	Single-Line V-Network (50 Ohm/5µH)	ESH3-Z6	892563/002	Rohde & Schwarz	12 M	-	17.05.2018
009	Power Meter (EMS-radiated)	NRV	863056/017	Rohde & Schwarz	24 M	-	15.05.2019
016	Line Impedance Simulating Network	Op. 24-D	B6366	Spitzenberger+Spies	36 M	-	30.05.2019
020	Horn Antenna 18 GHz (Subst 1)	3115	9107-3699	EMCO	36/12 M	-	31.07.2017
021	Loop Antenna (H-Field)	6502	9206-2770	EMCO	36 M	-	30.04.2018
030	Loop Antenna (H-field)	HFH-Z2	879604/026	Rohde & Schwarz	36 M	-	30.04.2018
033	RF-current probe (100kHz-30MHz)	ESH2-Z1	879581/18	Rohde & Schwarz	24 M	-	15.05.2019
057	relay-switch-unit (EMS system)	RSU	494440/002	Rohde & Schwarz	pre-m	1a	
060	power amplifier (DC-2kHz)	PAS 5000	B6363	Spitzenberger+Spies	-	3	
066	notch filter (WCDMA; FDD1)	WRCT 1900/2200-5/40-10EEK	5	Wainwright GmbH	12 M	1g	30.06.2017
086	DC - power supply, 0 -10 A	LNG 50-10	-	Heinzinger Electronic	pre-m	2	
087	DC - power supply, 0 -5 A	EA-3013 S	-	Elektro Automatik	pre-m	2	
091	USB-LWL-Converter	OLS-1	007/2006	Ing. Büro Scheiba	-	4	
099	passive voltage probe	ESH2-Z3	299.7810.52	Rohde & Schwarz	36 M	-	30.04.2018
100	passive voltage probe	Probe TK 9416	without	Schwarzbeck	36 M	-	30.04.2018
110	USB-LWL-Converter	OLS-1	-	Ing. Büro Scheiba	-	4	
119	RT Harmonics Analyzer dig. Flickermeter	B10	G60547	BOCONSULT	36 M	-	30.05.2019
133	horn antenna 18 GHz (Meas 1)	3115	9012-3629	EMCO	36 M	1c	10.03.2020
134	horn antenna 18 GHz (Subst 2)	3115	9005-3414	EMCO	36 M	-	10.03.2020
136	adjustable dipole antenna (Dipole 1)	3121C-DB4	9105-0697	EMCO	36 M	-	30.04.2018
140	Signal Generator	SMHU	831314/006	Rohde & Schwarz	24 M	-	30.05.2018
248	attenuator	SMA 6dB 2W	-	Radiall	pre-m	2	
249	attenuator	SMA 10dB 10W	-	Radiall	pre-m	2	
252	attenuator	N 6dB 12W	-	Radiall	pre-m	2	
256	attenuator	SMA 3dB 2W	-	Radiall	pre-m	2	
257	hybrid	4031C	04491	Narda	pre-m	2	
260	hybrid coupler	4032C	11342	Narda	pre-m	2	
261	Thermal Power Sensor	NRV-Z55	825083/0008	Rohde & Schwarz	24 M	-	30.05.2018
262	Power Meter	NRV-S	825770/0010	Rohde & Schwarz	24 M	-	30.05.2018
263	Signal Generator	SMP 04	826190/0007	Rohde & Schwarz	36 M	-	30.05.2019
265	peak power sensor	NRV-Z33, Model 04	840414/009	Rohde & Schwarz	24 M	-	30.05.2018
266	Peak Power Sensor	NRV-Z31, Model 04	843383/016	Rohde & Schwarz	24 M	-	30.05.2018
267	notch filter GSM 850	WRCA 800/960-6EEK	9	Wainwright GmbH	pre-m	2	
270	termination	1418 N	BB6935	Weinschel	pre-m	2	
271	termination	1418 N	BE6384	Weinschel	pre-m	2	
272	attenuator (20 dB) 50 W	Model 47	BF6239	Weinschel	pre-m	2	
273	attenuator (10 dB) 100 W	Model 48	BF9229	Weinschel	pre-m	2	
274	attenuator (10 dB) 50 W	Model 47 (10 dB) 50 W	BG0321	Weinschel	pre-m	2	
275	DC-Block	Model 7003 (N)	C5129	Weinschel	pre-m	2	
276	DC-Block	Model 7006 (SMA)	C7061	Weinschel	pre-m	2	
279	power divider	1515 (SMA)	LH855	Weinschel	pre-m	2	
287	pre-amplifier 25MHz - 4GHz	AMF-2D-100M4G-35-10P	379418	Miteq	12 M	1c	30.06.2017
291	high pass filter GSM 850/900	WHJ 2200-4EE	14	Wainwright GmbH	12 M	1c	30.06.2017
298	Univ. Radio Communication Tester	CMU 200	832221/091	Rohde & Schwarz	pre-m	3	
300	AC LISN (50 Ohm/50µH, 1-phase)	ESH3-Z5	892 239/020	Rohde & Schwarz	12 M	-	17.05.2018
301	attenuator (20 dB) 50W, 18GHz	47-20-33	AW0272	Lucas Weinschel	pre-m	2	
302	horn antenna 40 GHz (Meas 1)	BBHA9170	155	Schwarzbeck	36 M	-	14.03.2020
303	horn antenna 40 GHz (Subst 1)	BBHA9170	156	Schwarzbeck	36 M	-	20.03.2020
331	Climatic Test Chamber -40/+180 Grad	HC 4055	43146	Heraeus Vötsch	24 M	-	30.10.2018
341	Digital Multimeter	Fluke 112	81650455	Fluke	24 M	-	30.05.2018
342	Digital Multimeter	Voltcraft M-4660A	IB 255466	Voltcraft	24 M	-	17.05.2019
347	laboratory site	radio lab.	-	-	-	5	
348	laboratory site	EMI conducted	-	-	-	5	
354	DC - Power Supply 40A	NGPE 40/40	448	Rohde & Schwarz	pre-m	2	
355	Power Meter	URV 5	891310/027	Rohde & Schwarz	24 M	-	30.05.2018
357	power sensor	NRV-Z1	861761/002	Rohde & Schwarz	24 M	-	24.05.2019
371	Bluetooth Tester	CBT32	100153	R&S	36 M	-	30.05.2019
373	Single-Line V-Network (50 Ohm/5µH)	ESH3-Z6	100535	Rohde & Schwarz	12 M	-	17.05.2018
377	EMI Test Receiver	ESCS 30	100160	Rohde & Schwarz	12 M	-	15.05.2018
389	Digital Multimeter	Keithley 2000	0583926	Keithley	24 M	-	30.04.2017
392	Radio Communication Tester	MT8820A	6K00000788	Anritsu	12 M	-	18.05.2018
405	Thermo-/Hygrometer	OPUS 10 THI	126.0604.0003.3.3.3.2	LUFFT Mess u. Regeltechnik	24 M	-	30.03.2019
431	Model 7405	Near-Field Probe Set	9305-2457	EMCO	-	4	
436	Univ. Radio Communication Tester	CMU 200	103083	Rohde & Schwarz	12 M	-	24.05.2018
439	UltraLog-Antenna	HL 562	100248	Rohde & Schwarz	36 M	-	10.03.2020

Ref.-No.	Equipment	Type	Serial-No.	Manufacturer	Interval of calibration	Remark	Cal due
441	CTC-SAR-EMI Cable Loss	System EMI field (SAR) Cable	-	CETECOM	12 M	5	05.06.2017
443	CTC-FAR-EMI-RSE	System CTC-FAR-EMI-RSE	-	ETS-Lindgren / CETECOM	12 M	5	30.06.2017
448	notch filter WCDMA_FDD II	WRCT 1850.0/2170.0-5/40-	5	Wainwright Instruments GmbH	12 M	1c	30.06.2017
449	notch filter WCDMA FDD V	WRCT 824.0/894.0-5/40-8SSK	1	Wainwright	12 M	1c	30.06.2017
454	Oscilloscope	HM 205-3	9210 P 29661	Hameg	-	4	
456	DC-Power supply 0-5 A	EA 3013 S	207810	Elektro Automatik	pre-m	2	
459	DC -Power supply 0-5 A , 0-32 V	EA-PS 2032-50	910722	Elektro Automatik	pre-m	2	
460	Univ. Radio Communication Tester	CMU 200	108901	Rohde & Schwarz	12 M	-	16.06.2018
463	Universal source	HP3245A	2831A03472	Agilent	-	4	
466	Digital Multimeter	Fluke 112	89210157	Fluke USA	24 M	-	30.05.2018
467	Digital Multimeter	Fluke 112	89680306	Fluke USA	36 M	-	30.04.2018
468	Digital Multimeter	Fluke 112	90090455	Fluke USA	36 M	-	30.04.2018
477	ReRadiating GPS-System	AS-47	-	Automotive Cons. Fink	-	3	
480	power meter (Fula)	NRVS	838392/031	Rohde & Schwarz	24 M	-	16.05.2019
482	filter matrix	Filter matrix SAR 1	-	CETECOM (Brl)	-	1d	
484	pre-amplifier 2,5 - 18 GHz	AMF-5D-02501800-25-10P	1244554	Miteq	12 M	-	30.07.2017
487	System CTC NSA-Verification SAR-EMI	System EMI field (SAR) NSA	-	ETS Lindgren / CETECOM	24 M	-	31.07.2017
489	EMI Test Receiver	ESU40	1000-30	Rohde & Schwarz	12 M	-	18.05.2019
502	band reject filter	WRCG 1709/1786-1699/1796-	SN 9	Wainwright	pre-m	2	
503	band reject filter	WRCG 824/849-814/859-	SN 5	Wainwright	pre-m	2	
512	notch filter GSM 850	WRCA 800/960-02/40-6EEK	SN 24	Wainwright	12 M	1c	30.06.2017
517	relais switch matrix	HF Relais Box Keithley	SE 04	Keithley	pre-m	2	
523	Digital Multimeter	L4411A	MY46000154	Agilent	24 M	-	18.05.2019
529	6 dB Broadband resistive power divider	Model 1515	LH 855	Weinschel	pre-m	2	
530	10 dB Broadband resistive power divider	R 416110000	LOT 9828	-	pre-m	2	
546	Univ. Radio Communication Tester	CMU 200	106436	R&S	12 M	-	30.03.2018
547	Univ. Radio Communication Tester	CMU 200	835390/014	Rohde & Schwarz	12 M	-	30.04.2017
549	Log.Per-Antenna	HL025	1000060	Rohde & Schwarz	36/12 M	-	31.07.2018
550	System CTC S-VSWR Verification SAR-EMI	System EMI Field SAR S-VSWR	-	ETS Lindgren/CETECOM	24 M	-	31.07.2017
552	high pass filter 2,8-18GHz	WHKX 2.8/18G-10SS	4	Wainwright	12 M	1c	30.06.2017
557	System CTC-OTA-2	R&S TS8991	-	Rohde & Schwarz	12 M	5	30.09.2016
558	System CTC FAR S-VSWR	System CTC FAR S-VSWR	-	CTC	24 M	-	31.07.2017
574	Biconilog Hybrid Antenna	BTA-L	980026L	Frankonia	36/12 M	-	31.03.2019
584	Spectrum Analyzer	FSU 8	100248	Rohde & Schwarz	pre-m	-	
594	Wideband Radio Communication Tester	CMW 500	101757	Rohde & Schwarz	12 M	-	30.04.2017
597	Univ. Radio Communication Tester	CMU 200	100347	Rohde & Schwarz	pre-m	-	
598	Spectrum Analyzer	FSEM 30	831259/013	Rohde & Schwarz	24 M	-	30.04.2017
600	power meter	NRVD (Reserve)	834501/018	Rohde & Schwarz	24 M	-	17.05.2019
601	medium-sensitivity diode sensor	NRV-Z5 (Reserve)	8435323/003	Rohde & Schwarz	24 M	-	15.05.2019
602	peak power sensor	NRV-Z32 (Reserve)	835080	Rohde & Schwarz	24 M	-	
608	UltraLog-Antenna	HL 562	830547/009	Rohde & Schwarz	36 M	-	31.03.2014
611	DC power supply	E3632A	KR 75305854	Agilent	pre-m	2	
612	DC power supply	E3632A	MY 40001321	Agilent	pre-m	2	
613	Attenuator	R416120000 20dB 10W	Lot. 9828	Radiall	pre-m	2	
616	Digitalmultimeter	Fluke 177	88900339	Fluke	24 M	-	30.05.2018
617	Power Splitter/Combiner	ZFSC-2-2-S+	S F987001108	Mini Circuits	-	2	
618	Power Splitter/Combiner	50PD-634	600994	JFW Industries USA	-	2	
619	Power Splitter/Combiner	50PD-634	600995	JFW Industries, USA	-	3	
620	EMI Test Receiver	ESU 26	100362	Rohde-Schwarz	12 M	-	16.05.2018
621	Step Attenuator 0-139 dB	RSP	100017	Rohde & Schwarz	pre-m	2	
625	Generic Test Load USB	Generic Test Load USB	-	CETECOM	-	2	
627	data logger	OPUS 1	201.0999.9302.6.4.1.4 3	G. Lufft GmbH	24 M	-	30.03.2019
634	Spectrum Analyzer	FSM (HF-Unit)	826188/010	Rohde & Schwarz	pre-m	2	
637	High Speed HDMI with Ethernet 1m	HDMI cable with Ethernet 1m	-	Kogilink	-	2	
638	HDMI Kabel with Ethernet 1,5 m flach	HDMI cable with Ethernet	-	Reichelt	-	2	
640	HDMI cable 2m rund	HDMI cable 2m rund	-	Reichelt	-	2	
641	HDMI cable with Ethernet	Certified HDMI cable with	-	PureLink	-	2	
642	Wideband Radio Communication Tester	CMW 500	126089	Rohde&Schwarz	12 M	-	24.05.2018
644	Amplifier	ZX60-2534M+	SN865701299	Mini-Circuits	-	-	
670	Univ. Radio Communication Tester	CMU 200	106833	Rohde & Schwarz	24 M	-	30.05.2018
671	DC-power supply 0-5 A	EA-3013S	-	Elektro Automatik	pre-m	2	

Ref.-No.	Equipment	Type	Serial-No.	Manufacturer	Interval of calibration	Remark	Cal due
678	Power Meter	NRP	101638	Rohde&Schwarz	pre-m	-	
683	Spectrum Analyzer	FSU 26	200571	Rohde & Schwarz	12 M	-	17.05.2018
686	Field Analyzer	EHP-200A	160WX30702	Narda Safety Test Solutions	24 M	-	29.03.2019
687	Signal Generator	SMF 100A	102073	Rohde&Schwarz	12 M	-	17.05.2018
688	Pre Amp	JS-18004000-40-8P	1750117	Miteq	pre-m	-	
690	Spectrum Analyzer	FSU	100302/026	Rohde&Schwarz	12 M	-	16.05.2018
691	OSP120 Base Unit	OSP120	101183	Rohde & Schwarz	12 M	-	22.05.2018
692	Bluetooth Tester	CBT 32	100236	Rohde & Schwarz	36 M	-	29.05.2020
693	TS8997	CTC-Radio Lab 1_TS8997	-	Rohde&Schwarz	12 M	5	06.06.2017
697	Power Splitter	ZN4PD-642W-S+	165001445	Mini-Circuits	-	2	
701	CMW500 wide. Radio Comm.	CMW500	158150	Rohde & Schwarz	12 M	-	01.05.2017
703	INNCO Antennen Mast	MA 4010-KT080-XPET-ZSS3	MA4170-KT100-XPET-	INNCO	pre-m	-	
704	INNCON Controller	CO 3000-4port	CO3000/933/3841051 6/L	INNCO Systems GmBh	pre-m	-	
711	Harmonic Mixer 90 GHz - 140GHz	RPG FS-Z140	101004	RPG	12 M	-	22.02.2018
712	Harmonic Mixer 75 GHz - 110GHz	FS-Z110	101468	Rohde & Schwarz	12 M	-	22.02.2018
713	Harmonic Mixer, 50 GHz - 75GHz	FS-Z75	101022	Rohde & Schwarz	12 M	-	22.05.2018
714	Signal Analyzer 67GHz	FSW67	104023	Rohde & Schwarz	24 M	-	03.03.2019
715	Harmonic Mixer, 140 GHz - 220GHz	FS-Z220	101009	RPG Radiometer Physics	12 M	-	03.08.2018
716	Harmonic Mixer 220 GHz to 325 GHZ	FS-Z325	101005	RPG Radiometer Physics	12 M	-	13.02.2018
747	Spectrum Analyzer	FSU 26	200152	Rohde & Schwarz	12 M	-	18.05.2018
748	Pickett-Potter Horn Antenna	FH-PP 4060	010001	Radiometer Physics	-	-	
749	Pickett-potter Horn Antenna	FH-PP 60-90	010003	Radiometer Physics	-	-	
750	Pickett-Potter Horn Antenna	FH-PP 140-220	010011	Radiometer Physics	-	-	

### 8.1.3. Legend

Note / remarks	Calibrated during system calibration:
1a	System CTC-SAR-EMS (Ref.-No. 442)
1b	System-CTC-EMS-Conducted (Ref.-No. 335)
1c	System CTC-FAR-EMI-RSE (Ref.-No . 443)
1d	System CTC-SAR-EMI (Ref.-No . 441)
1e	System CTC-OATS (EMI radiated) (Ref.-No. 337)
1 f	System CTC-CTIA-OTA (Ref.-No . 420)
1 g	System CTC-FAR-EMS (Ref.-No . 444)
2	Calibration or equipment check immediately before measurement
3	Regulatory maintained equipment for functional check or support purpose
4	Ancillary equipment without calibration e.g. mechanical equipment or monitoring equipment
5	Test System

Interval of calibration	12 M	12 month
	24 M	24 month
	36 M	36 month
	24/12 M	Calibration every 24 months. between this every 12 months internal validation
	36/12 M	Calibration every 36 months. between this every 12 months internal validation
	Pre-m	Check before starting the measurement
	-	Without calibration

## 9. Versions of test reports (change history)

Version	Applied changes	Date of release
--	Initial release	2017-06-28
--	--	--
--	--	--