

# X3 LABELS LIST

REV	DATE	DESCRIPTION	DESIGN	APP'D

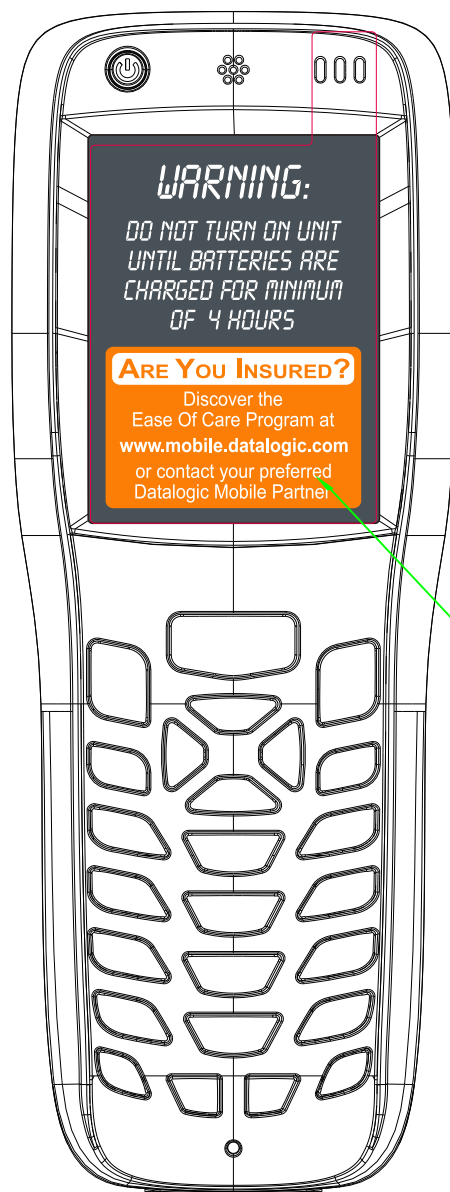

**1** Display Protect film

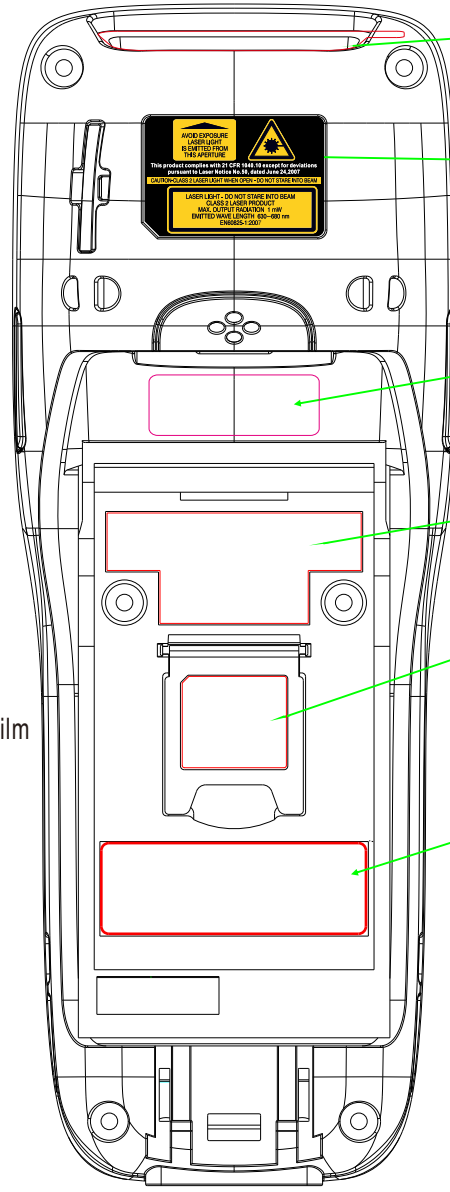

**2** SCAN WINDOW 1D &2D FILM



**3** Laser Warning Label  
24 x 16 mm



*Applicable only for the models with the following readers:*  
-scan engine Motorola SE950  
-imager engine Motorola SE4500.  
No laser warning label is required formodels with SE655 reader

**4** WinCE 5.0 label  
certification label

**5** FCC ID label  
13.7 X 12.0 mm

*Applicable only to the models with 802.11+BT radio.*  
No FCC label is required for batch models.

**7** Model No. label  
35 x 12 mm

 銀鏘科技股份有限公司			
SCALE:	UNIT:	MODEL: <b>X3 Labels List</b>	
FINISH:	MATERIAL:		
DESIGN: Vicki-lin	TITLE:		
CHK:	APPD:		
APPD:	PIN:		REV
AΣ		SHEET   OF	FILE NAME:

<b>SIGN</b>	
P	M

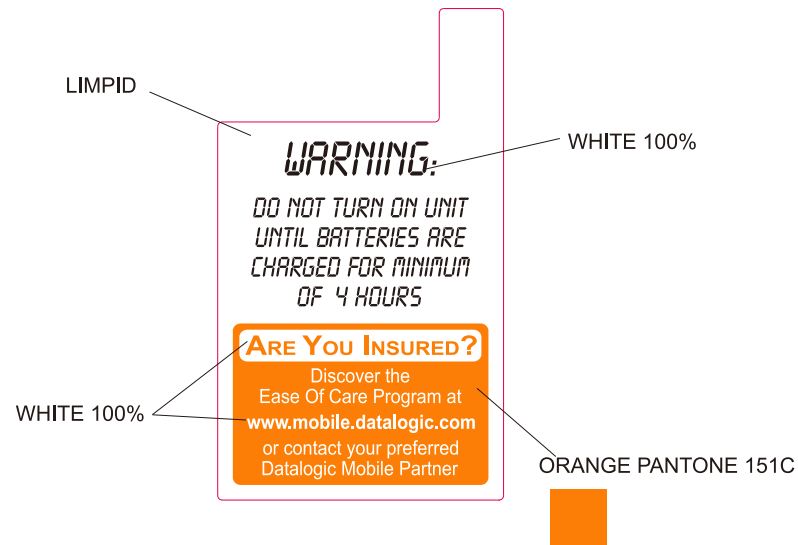
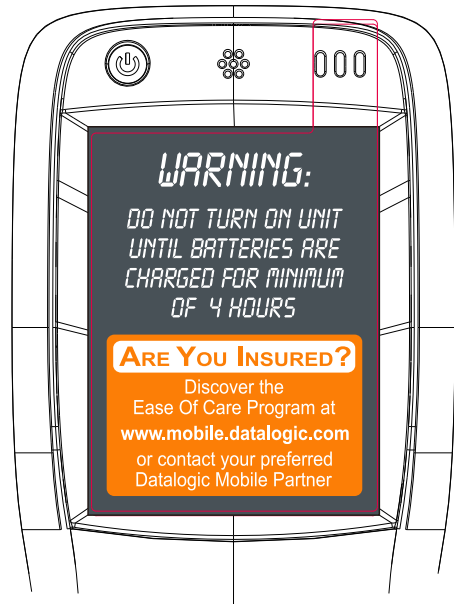

100% Size  
Print Reference

NOTE:  
1. DETAIL PRINTING REFER ARTWORK FILES  
2. Material : PET(OCPF-5015)

正式圖面

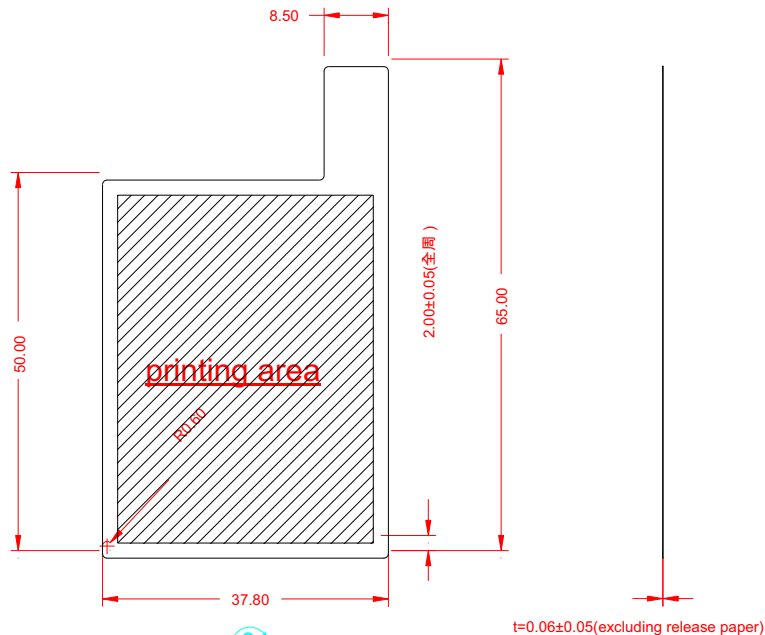

PLASTIC TOLERANCE	
1>=L<=30	±0.10
30<L<=50	±0.15
50<L<=100	±0.20

銀鐸科技股份有限公司			
SCALE: 1:1	UNIT: mm	MODEL: X3	
FINISH:		MATERIAL: PET(OCPF-5015)	
DESIGN: VICKI 20130926		TITLE: DISPLAY PROTECT FILM	
CHK:		P/N: 4G65-ZZ000601	
APPD:		P/N: 4G65-ZZ000601	
A4		SHEET OF 1	REV 01

REV	DATE	DESCRIPTION	DESIGN	APPD

ITFM 3

WERNING LABEL

1:1



100% Size  
Print Reference

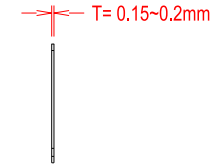
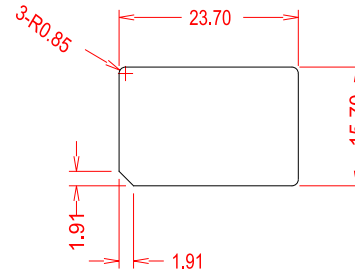

2:1

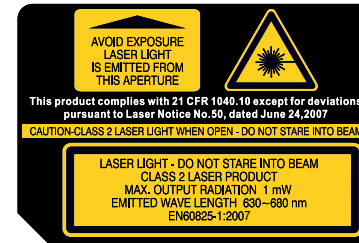

SIGN	
P	M

- - BACKGROUND COLOR PANTONE BLACK 6C
- - BLACK CHARACTERS SWS721 PANTONE BLACK 6C
- - WHITE CHARACTERS SWIS721 BOLD WHITE 100%
- - YELLOW PANTONE 123C

MATER. 3M 3690

Applicable only for the models with the following readers:  
 -scan engine Motorola SE950  
 -imager engine Motorola SE4500.  
 No laser warning label is required for models with SE655 reader

DIMENSIONS WITHOUT TOLERANCE DEGREE:  
 ±0.1

PRECISION DEGREE	DIMENSIONAL GROUPS				
	>0	>6	>30	>120	>315
MEDIUM	±0.1	±0.2	±0.3	±0.5	±0.8
PRECISE	±0.05	±0.1	±0.15	±0.2	±0.3

All materials employed have to be selected among RoHS compliant materials:  
 the EC directives to be referred to are 2002/95/EC and correlated subsequent ones.

REV	DATE	DESCRIPTION	DESIGN	D'APP



銀鐸科技股份有限公司					
:SCALE	1:1	:UNIT	mm	:MODEL	X3
:FINISH			:MATERIAL	MYLAR	
:DESIGN	Vicki-lin		:TITLE	WERNING LABEL	
:CHK			:D'APP	刀模與4G60-BB000501共用 4G65-BB000101	
:A		SHEET 7 of 7	:FILENAME	REV	

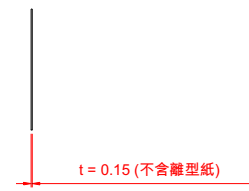
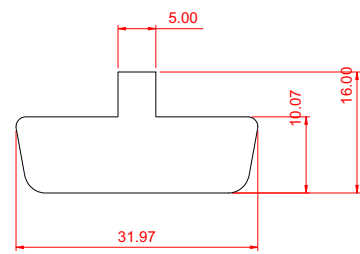

REV	DATE	DESCRIPTION	DESIGN	APP'D



Unspecified  
TOLERANCE=±0.2mm

 銀鐳科技股份有限公司					
SCALE:	1:1	UNIT:	mm	MODEL:	<b>X3</b>
FINISH:	*	MATERIAL:	SELT150		
DESIGN:	Angus 20130806		TITLE:		
CHK:	SCAN WINDOW (PLASTIC) PROTECT FILM				
APP'D:			P/N:	4G65-ZZ000801	
A4		1	1	FILENAME:	REV 01



REV	DATE	DESCRIPTION	DESIGN	APP'D

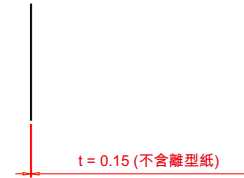
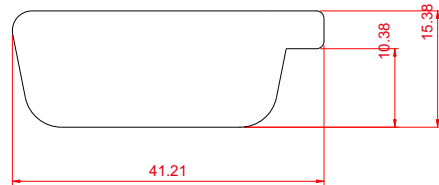

Unspecified  
TOLERANCE=±0.2mm



SCALE:	1:1	UNIT:	mm	MODEL:	X3
*FINISH:		MATERIAL:	SELT150		
DESIGN:		TITLE:	SCAN WINDOW (GLASS) PROTECT FILM		
CHK:	Angus 20130806				
APP'D:		P/N:	4G65-ZZ000701		
A4			1	1	REV 01



REV	DATE	DESCRIPTION	DESIGN	APP'D

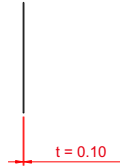
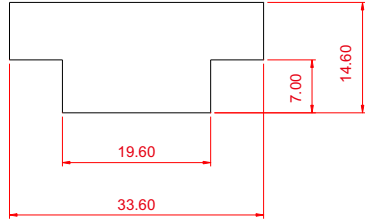

1:1

[P/N:944250001](#)  
[P/N: 944250003](#)

[P/N: 944250002](#)  
[P/N: 944250004](#)  
[P/N: 944250005](#)

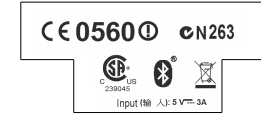

100% Size  
Print Reference

2:1

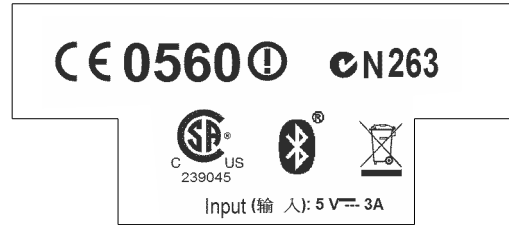
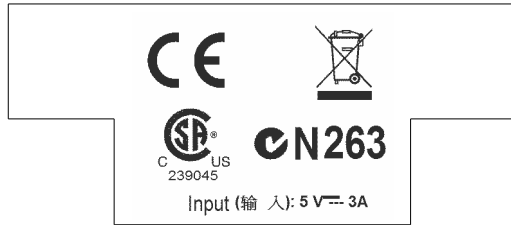

[P/N:944250001](#)  
[P/N: 944250003](#)

[P/N: 944250002](#)  
[P/N: 944250004](#)  
[P/N: 944250005](#)

**Bit** 銀鑄科技股份有限公司

SCALE:	UNIT:	MODEL: <b>X3</b>
FINISH:	MATERIAL: <b>霧麥拉#25+銀消特多龍;#50</b>	
DESIGN: <b>Angus 20130717</b>	TITLE: <b>RATING LABEL</b>	
CHK:		
APP'D:	P/N: <b>4G65-BB000301</b>	
A4		REV <b>01</b>



REV	DATE	DESCRIPTION	DESIGN	APP'D

1:1

2:1

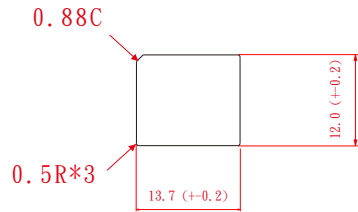

See product manual or package for patent listing **FC**  
 IC: 3862E-MN030  
 FCC ID: U4GN030  
 This device complies with Part 15 of the FCC Rules.  
 Operation is subject to the following two conditions:  
 (1) this device may not cause harmful interference, and (2) this device must accept any interference received, including interference that may cause undesired operation.

100% Size  
Print Reference

Applicable only to the models with 802.11+BT radio.

No FCC label is required for batch models.

t = 0.15 (不含離型紙)  
 13.8 (+0.2) \* 12.1 (+0.2) mm  
 0.5R\*3, 0.88C\*1

Unspecified  
 TOLERANCE = ±0.2mm



SCALE: <b>1:1</b>	UNIT: <b>mm</b>	MODEL: <b>X3</b>
FINISH:	MATERIAL: Semi-bright Silver	
DESIGN: Vicki-lin	TITLE: <b>FCC ID LABEL</b>	
CHK:	P/N: 4G62-BB000201	
APP'D:	FILE NAME:	REV <b>01</b>
A4	SHEET 1 OF 1	

# ITFM 7 Model NO.label For

REV	DATE	DESCRIPTION	DESIGN	APP'D

1:1

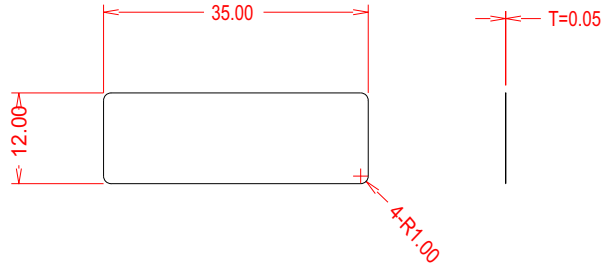

MOD(型号):MEMORX3 P/N: 944250001  
 TYPE:0000LI-2N0-COU1  
 产品名称: 便携式数据终端  
 MFD: June 2013  
 Datalogic ADC S.r.l, via S.  
 Vitalino 13 - 40012, Lippo di  
 Calderara di Reno (BO) - Italy. Made in Taiwan (台湾制造)

MOD(型号):MEMORX3 P/N: 944250005  
 TYPE:00A0WI-2N0-CEU1  
 产品名称: 便携式数据终端  
 MFD: June 2013  
 Datalogic ADC S.r.l, via S.  
 Vitalino 13 - 40012, Lippo di  
 Calderara di Reno (BO) - Italy. Made in Taiwan (台湾制造)

MOD(型号):MEMORX3 P/N: 944250002  
 TYPE:00A0LI-2N0-COU1  
 产品名称: 便携式数据终端  
 MFD: June 2013  
 Datalogic ADC S.r.l, via S.  
 Vitalino 13 - 40012, Lippo di  
 Calderara di Reno (BO) - Italy. Made in Taiwan (台湾制造)

MOD(型号):MEMORX3 P/N: 944250003  
 TYPE:0000LS-2N0-CEU1  
 产品名称: 便携式数据终端  
 MFD: June 2013  
 Datalogic ADC S.r.l, via S.  
 Vitalino 13 - 40012, Lippo di  
 Calderara di Reno (BO) - Italy. Made in Taiwan (台湾制造)

MOD(型号):MEMORX3 P/N: 944250004  
 TYPE:00A0LS-2N0-CEU1  
 产品名称: 便携式数据终端  
 MFD: June 2013  
 Datalogic ADC S.r.l, via S.  
 Vitalino 13 - 40012, Lippo di  
 Calderara di Reno (BO) - Italy. Made in Taiwan (台湾制造)

100% Size  
Print Reference

Note:

New Part No.	Configuration
944250001	MEMORX3 0000LI-2N0-COU1
944250002	MEMORX3 00A0LI-2N0-COU1
944250003	MEMORX3 0000LS-2N0-CEU1
944250004	MEMORX3 00A0LS-2N0-CEU1
944250005	MEMORX3 00A0WI-2N0-CEU1

Configuration Note:

EX:MEMORX3 0000LI-2N0-COU1

LI means Linear Imager (SE655)

0 means batch model

LS means Laser (SE950)

A means WiFi and BT radio

WI means Imager (Se4500)

SIGN

P  
M

2:1

MOD(型号):MEMORX3 P/N: 944250001  
 TYPE:0000LI-2N0-COU1  
 产品名称: 便携式数据终端  
 MFD: June 2013  
 Datalogic ADC S.r.l, via S.  
 Vitalino 13 - 40012, Lippo di  
 Calderara di Reno (BO) - Italy. Made in Taiwan (台湾制造)

MOD(型号):MEMORX3 P/N: 944250002  
 TYPE:00A0LI-2N0-COU1  
 产品名称: 便携式数据终端  
 MFD: June 2013  
 Datalogic ADC S.r.l, via S.  
 Vitalino 13 - 40012, Lippo di  
 Calderara di Reno (BO) - Italy. Made in Taiwan (台湾制造)

MOD(型号):MEMORX3 P/N: 944250003  
 TYPE:0000LS-2N0-CEU1  
 产品名称: 便携式数据终端  
 MFD: June 2013  
 Datalogic ADC S.r.l, via S.  
 Vitalino 13 - 40012, Lippo di  
 Calderara di Reno (BO) - Italy. Made in Taiwan (台湾制造)

MOD(型号):MEMORX3 P/N: 944250004  
 TYPE:00A0LS-2N0-CEU1  
 产品名称: 便携式数据终端  
 MFD: June 2013  
 Datalogic ADC S.r.l, via S.  
 Vitalino 13 - 40012, Lippo di  
 Calderara di Reno (BO) - Italy. Made in Taiwan (台湾制造)

MOD(型号):MEMORX3 P/N: 944250005  
 TYPE:00A0WI-2N0-CEU1  
 产品名称: 便携式数据终端  
 MFD: June 2013  
 Datalogic ADC S.r.l, via S.  
 Vitalino 13 - 40012, Lippo di  
 Calderara di Reno (BO) - Italy. Made in Taiwan (台湾制造)

Tolerance: ± 0.3mm

銀鑽科技股份有限公司			
SCALE: 1:1	UNIT: MM	MODEL: <b>X3</b>	
FINISH:	MATERIAL: Semi-bright Silver		
DESIGN: Vicki-lin	TITLE: Model NO.label For		
CHK:			
APPD:	P/N: 4G62-BB000401		
A&		SHEET ]OF]	FILENAME REV



# IATA labels for BOX

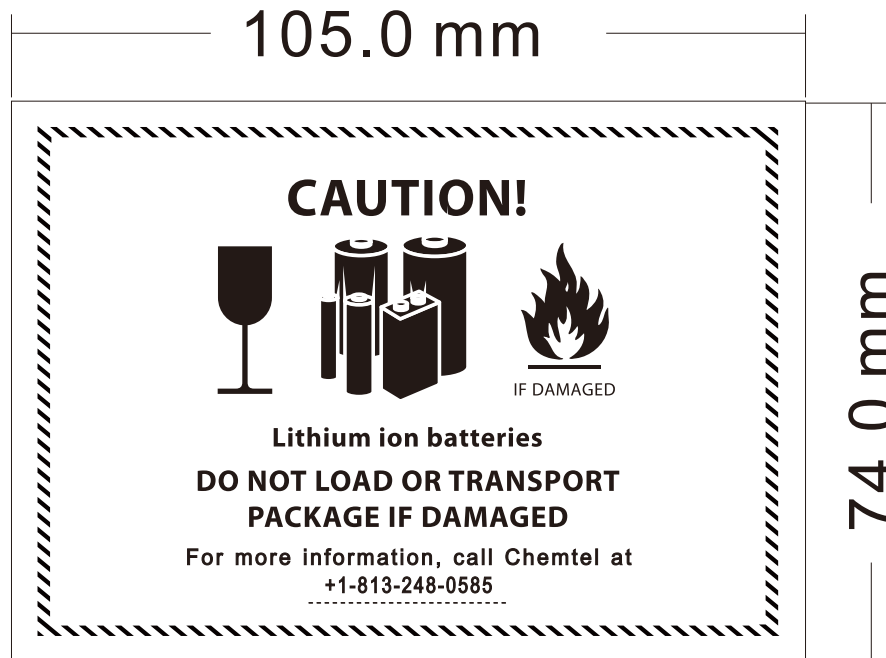



100% Size  
Print Reference

T : 0.07mm  
Tolerance :  $\pm 0.3$ mm

SIGN	
P	M

REV	DATE	DESCRIPTION	DESIGN	APP'D

 銀鑄科技股份有限公司				
SCALE:	1:1	UNIT:	mm	MODEL:
			X3	
FINISH:			MATERIAL:	
DESIGN:			TITLE:	
			IATA labels for BOX	
CHK:			PIN:	
			4G65-BB000401	
APPD:			FILENAME:	
AΣ		SHEET   OF	REV	



# Battery Warning Label FOR CAUTION

REV	DATE	DESCRIPTION	DESIGN	APP'D

120

## CAUTION!

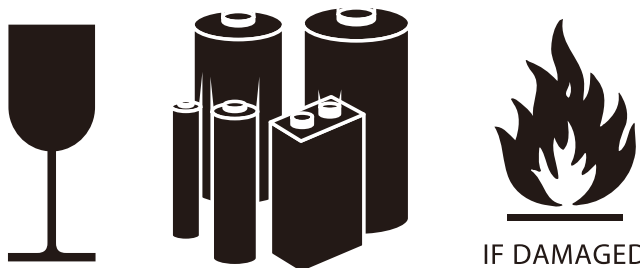

**Lithium ion batteries**

**DO NOT LOAD OR TRANSPORT PACKAGE IF DAMAGED**

For more information, call Chemtel at  
+1-813-248-0585

110

出紙方向  
↓

## CAUTION!

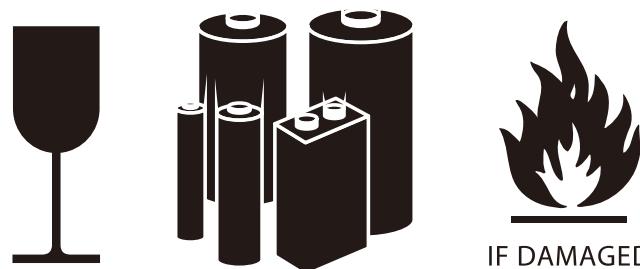

**Lithium ion batteries**

**DO NOT LOAD OR TRANSPORT PACKAGE IF DAMAGED**

For more information, call Chemtel at  
+1-813-248-0585

100% Size

Print Reference



SCALE: <b>1:1</b>	UNIT: <b>mm</b>	MODEL: <b>X3</b>
FINISH:	MATERIAL:	
DESIGN: <b>Vicki-lin</b>	TITLE: <b>Battery Warning Label FOR CAUTION</b>	
CHK:	P/N: <b>4G62-BB001102</b>	
APP'D:	FILENAME:	REV:
A4		

# OVER PACK label FOR CAUTION

REV	DATE	DESCRIPTION	DESIGN	APP'D

120

出紙方向  
↓



50.0 mm



100% Size      Print Reference



SCALE:	1:1	UNIT:	mm	MODEL:	X3
FINISH:		MATERIAL:		TITLE: OVER PACK label FOR CAUTION	
DESIGN:		CHK:		APPD:	
AΣ		SHEET] OF]		FILENAME:	REV

T : 0.07mm  
Tolerance : ± 0.3mm

SIGN	
P	M

# Packaging label- For 944250001~944250005

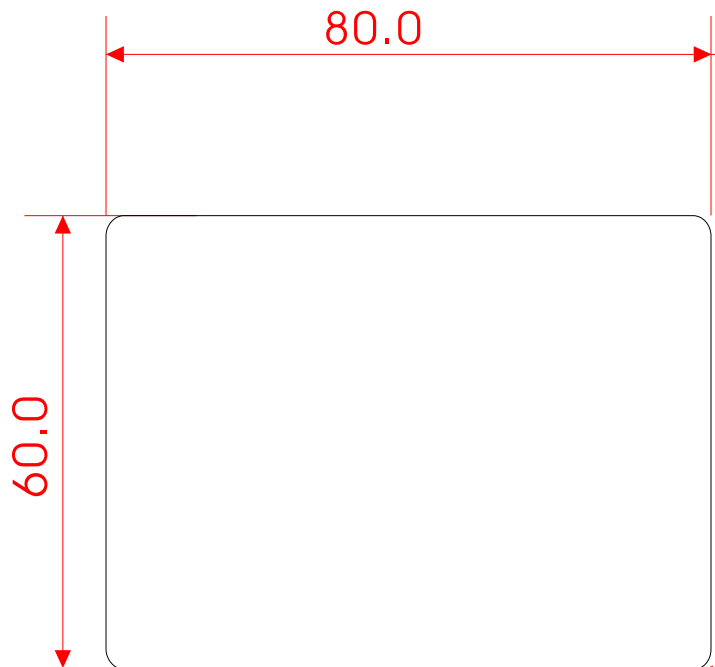

**DATALOGIC**

MEMORX3 00A0WI-2N0-CEU1

P/N 944250005

S/N P13N00001

P/N 944250005-P13N00001 S/N

Made in Taiwan 28 NOV. 2013

**CE 0560** PB

**DATALOGIC**

MEMORX3 0000LI-2N0-COU1

P/N 944250001

S/N P13N00001

P/N 944250001-P13N00001 S/N

Made in Taiwan 28 NOV. 2013

**CE** PB

**DATALOGIC**

MEMORX3 00A0LI-2N0-COU1

P/N 944250002

S/N P13N00001

P/N 944250002-P13N00001 S/N

Made in Taiwan 28 NOV. 2013

**CE 0560** PB

**DATALOGIC**

MEMORX3 0000LS-2N0-CEU1

P/N 944250003

S/N P13N00001

P/N 944250003-P13N00001 S/N

Made in Taiwan 28 NOV. 2013

**CE** PB

**DATALOGIC**

MEMORX3 00A0LS-2N0-CEU1

P/N 944250004

S/N P13N00001

P/N 944250004-P13N00001 S/N

Made in Taiwan 28 NOV. 2013

**CE 0560** PB

<b>Bit</b> 銀鏘科技股份有限公司	
:SCALE <b>1:1</b>	:UNIT <b>mm</b>
:MODEL <b>X3</b>	
:FINISH	:MATERIAL
:DESIGN	:TITLE <b>Packaging label- For 944250001~944250005</b>
:CHK	:P/N
:APPD	FILENAME
AΣ	REV

<b>SIGN</b>	
P	M

T : 0.07mm  
Tolerance : ± 0.3mm





# external package label





















REV	DATE	DESCRIPTION	DESIGN	APP'D

85.0

180.0

Supplier Name		Bitatek CO.,LTD.	
P/O	Item Code	Q'TY:	Item 2D Code
xxxxxxxx	 944250001	20/ pcs	

Carton No: 1/10



 944250001-PXXXXXX1	 944250001-PXXXXXX21
 944250001-PXXXXXX3	 944250001-PXXXXXX23
 944250001-PXXXXXX5	 944250001-PXXXXXX25
 944250001-PXXXXXX7	 944250001-PXXXXXX27
 944250001-PXXXXXX9	 944250001-PXXXXXX29
 944250001-PXXXXXX11	 944250001-PXXXXXX31
 944250001-PXXXXXX13	 944250001-PXXXXXX33
 944250001-PXXXXXX15	 944250001-PXXXXXX35
 944250001-PXXXXXX17	 944250001-PXXXXXX37
 944250001-PXXXXXX19	 944250001-PXXXXXX39

Space between vertical line on left of the packing label and label edge should be 5±3mm;  
Space between horizontal line on bottom of the packing label and label edge should be 2.5±2mm

5±3mm

2.5±2mm



SCALE: <b>1:1</b>	UNIT: <b>mm</b>	MODEL: <b>X3</b>
FINISH:	MATERIAL:	
DESIGN: <b>Vicki-lin</b>	TITLE: <b>external package label</b>	
CHK:	P/N: <b>4G55-BB000501</b>	
APP'D:	RENAME:	REV
A4	 	

# RTTE\_label for WiFi

80.0

60.0

1:1

R2.5

This product is suitable for the use in all EU Countries. In the frequency band 5150-5350MHz, the device is for indoor use only. Dynamic Frequency Selection (DFS) must remain enabled.

This product may be covered by one or more of the following patents:  
 Design patents: AU310182, EP1582024, EP469143, EP2247700, HK0601962.6, JP1325117, KR30/0466667, TWD118829, USD574830, USD643034, USD658174, ZL200630124857.0  
 Utility patents: EP0681257B1, EP0789315B1, EP1128315B1, EP1396811B1, EP1413971B1, IT1396943, US5992740, US6808114, US6997385, US7387246

Datalogic and the Datalogic logo are registered trademarks of Datalogic S.p.A. in many countries, including the U.S.A. and the E.U. and Memor is a trademark of Datalogic ADC, S.r.l

100% Size  
Print Reference

SIGN

P  
M

T : 0.07mm  
Tolerance : ± 0.3mm

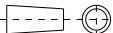
 銀鐸科技股份有限公司			
:SCALE	1:1	:UNIT	MM
:MODEL	<b>X3</b>		
:FINISH	Coated paper		:MATERIAL
:DESIGN	Vicki-lin		:TITLE
:CHK	RTTE_label for WiFi		
:D'APP			:N/P
4A	 SHEET OF 1	FILENAME	REV

REV	DATE	DESCRIPTION	DESIGN	D'APP

# RTTE\_label For Batch

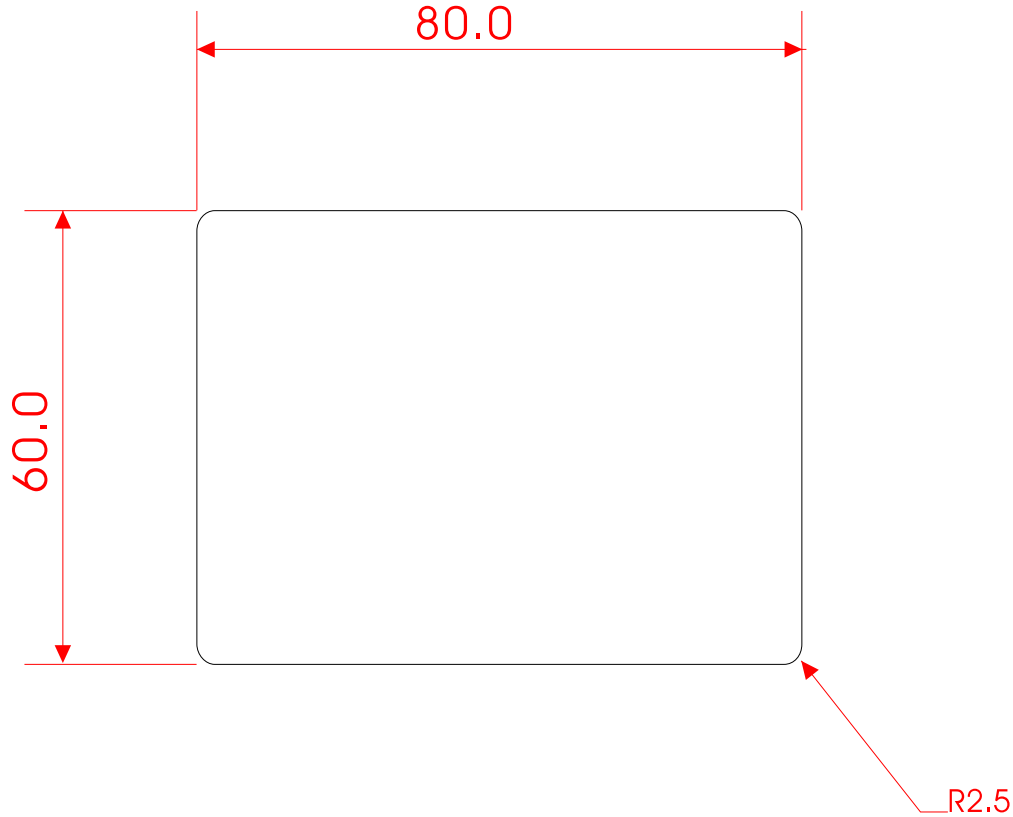

1:1

REV	DATE	DESCRIPTION	DESIGN	D'APP

This product is suitable for the use in all EU Countries.

This product may be covered by one or more of the following patents:  
**Design patents:** AU310182, EP1582024, EP469143, EP2247700, HK0601962.6, JP1325117, KR30/0466667, TWD118829, USD574830, USD643034, USD658174, ZL200630124857.0  
**Utility patents:** EP0681257B1, EP0789315B1, EP1128315B1, EP1396811B1, EP1413971B1, IT1396943, US5992740, US6808114, US6997385, US7387246

Datalogic and the Datalogic logo are registered trademarks of Datalogic S.p.A. in many countries, including the U.S.A. and the E.U. and Memor is a trademark of Datalogic ADC, S.r.l

100% Size  
Print Reference

SIGN	
P	M

T : 0.07mm  
Tolerance : ± 0.3mm

 銀鐸科技股份有限公司					
:SCALE	1:1	:UNIT	MM	:MODEL	<b>X3</b>
:FINISH	Coated paper		:MATERIAL		
:DESIGN	Vicki-lin		:TITLE		<b>RTTE_label For Batch</b>
:CHK			:N/P		
:D'APP			:FILENAME		
4A		SHEET OF 1	:REV		

# X3 Outer Box & Carton Lable List

REV	DATE	DESCRIPTION	DESIGN	APPD

This product is suitable for the use in all EU Countries. In the frequency band 5150-5350MHz, the device is for indoor use only. Dinamic Frequency Selection (DFS) must remain enabled.

This product may be covered by one or more of the following patents:  
 Design patents: AU310182, EP1582024, EP469143, EP2247700, HK0601962.6, JP1325117, KR30/0466667, TW0118829, USD574830, USD643034, USD658174, ZL200630124857.0  
 Utility patents: EP0681257B1, EP0789315B1, EP1128315B1, EP1396811B1, EP1413971B1, IT1396943, US5992740, US6808114, US6997385, US7387246

Datalogic and the Datalogic logo are registered trademarks of Datalogic S.p.A. in many countries, including the U.S.A. and the E.U. and Memor is a trademark of Datalogic ADC, S.r.l

RTTE\_label  
 Leftist side view



74 mm x 105mm IATA label

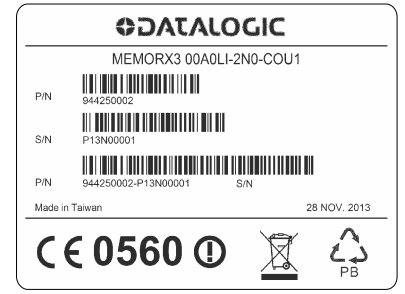

Packaging label  
 Right side view

1st Layer from bottom

1	9
2	10
3	11
4	12
5	13
6	14
7	15
8	16

2nd Layer

17	18
19	20

battery caution label

External package label

battery caution label

External package label

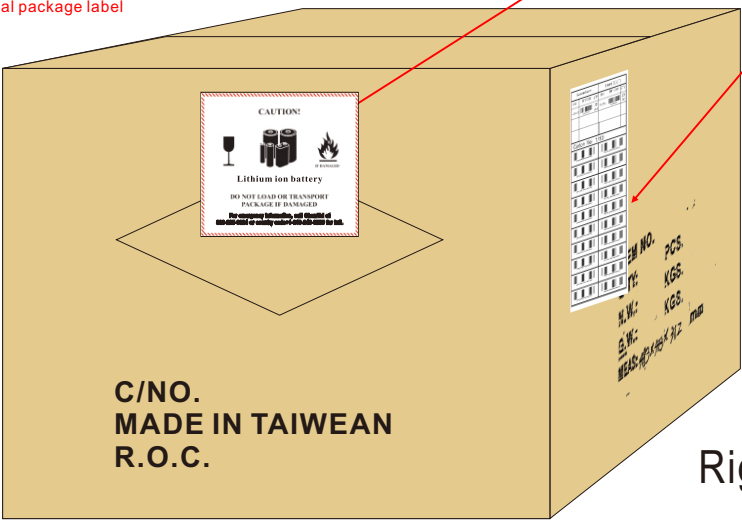

Right side view

SIGN	
P	M

銀鏘科技股份有限公司		
:SCALE	:UNIT	:MODEL <b>X3</b>
:FINISH	:MATERIAL	
:DESIGN Vicki-lin	:TITLE <b>Outer Box &amp; Carton Lable List</b>	
:CHK	:P/N	
:APPD	:P/N	
AΣ	SHEET   OF	FILENAME
		REV



# IATA labels for Battery BOX

REV	DATE	DESCRIPTION	DESIGN	APPD



74 mm x 105mm IATA label

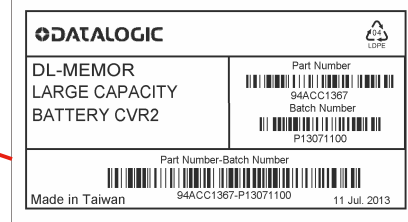
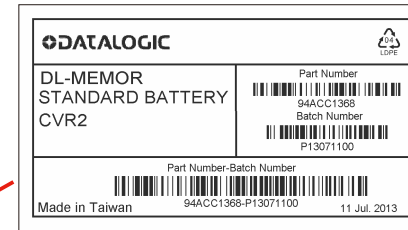
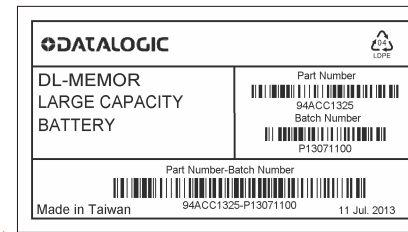
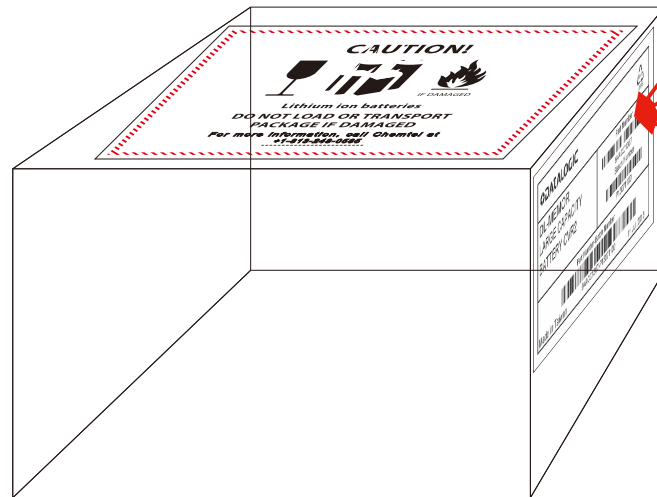

battery Packaging label: 尺寸: 54\*30mm

94ACC1368	DL-MEMOR STANDARD BATTERY CVR2
94ACC1367	DL-MEMOR LARGE CAPACITY BATTERY CVR2
94ACC1325	DL MEMOR LARGE CAPACITY BATTERY

T : 0.07mm

Tolerance : ± 0.3mm

SIGN	
P	M

Bitra 銀鑄科技股份有限公司			
:SCALE	1:1	:UNIT	mm
:MODEL	X3		
:FINISH	:MATERIAL		
:DESIGN	:TITLE		
IATA labels for Battery BOX			
:CHK	:P/N		
:APPD	:P/N		
AΣ	SHEET   OF	FILENAME	REV