



Test report No:
2040625R-RF-US-P09V01

SAR TEST REPORT

Product Name	Mobile Computer
Trademark	Datalogic
Model and /or type reference	MEMOR K
FCC ID	U4GMEMKUS
IC	3862E-MEMKUS
FCC Designation Number	CN1199
ISED CAB identifier	CN0040
Applicant's name / address	Datalogic S.r.l. Via San Vitalino no.13,Calderara di Reno -40012(BO)-Itlay
Manufacturer's name / address	Datalogic S.r.l. Via San Vitalino no.13,Calderara di Reno -40012(BO)-Itlay
Test method requested, standard	FCC KDB Publication 248227 D01v02r02 FCC KDB Publication 447498 D01v06 FCC KDB Publication 865664 D01v01r04 FCC KDB Publication KDB 648474 D04v01r03 IEEE Std. 1528-2013 FCC 47CFR §2.1093 ANSI C95.1-2005 RSS 102: Issue 5 EN 62209-2: 2010
Test Result	Max. SAR Measurement (1g) FCC: Head: 0.870 W/kg Body: 0.975 W/kg Limb SAR (10g): 0.988 W/kg

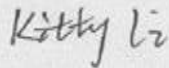

	IC: Head: 0.870 W/kg Body: 0.975 W/kg Limb SAR (10g): 0.988 W/kg
Verdict Summary	IN COMPLIANCE
Documented By (name / position & signature)	Kitty Li/Project Assistant 
Reviewed by (name / position & signature)	Frank He/Technical Supervisor 
Approved by (name / position & signature)	Jack Zhang/Supervisor 
Date of issue	2020-07-21
Report template No	2040625R-RF-US-P09V01

INDEX

Page

COMPETENCES AND GUARANTEES 5

GENERAL CONDITIONS 5

ENVIRONMENTAL CONDITIONS 6

POSSIBLE TEST CASE VERDICTS 6

DOCUMENT HISTORY 7

REMARKS AND COMMENTS 7

1 GENERAL INFORMATION 8

 1.1 General Description of the Item(s) 8

 1.2 Antenna Information 11

 1.3 Antenna Location 12

 1.4 Channel List 13

2 SAR MEASUREMENT SYSTEM 16

 2.1 DASY5 System Description 16

 2.1.1. Applications 17

 2.1.2. Area Scans 17

 2.1.3. Zoom Scan (Cube Scan Averaging) 17

 2.1.4. Uncertainty of Inter-/Extrapolation and Averaging 18

 2.2 DASY5 E-Field Probe 19

 2.3 Boundary Detection Unit and Probe Mounting Device 20

 2.4 DATA Acquisition Electronics (DAE) and Measurement Server 20

 2.5 Robot 21

 2.6 Light Beam Unit 21

 2.7 Device Holder 22

 2.8 SAM Twin Phantom 22

3 TISSUE SIMULATING LIQUID 23

 3.1 The composition of the tissue simulating liquid 23

 3.2 Tissue Calibration Result 24

 3.3 Tissue Dielectric Parameters for Head and Body Phantoms 29

4 SAR MEASUREMENT PROCEDURE 30

 4.1 SAR System Validation 30

 4.1.1. Validation Dipoles 30

4.1.2.	Validation Result	31
4.2	SAR Measurement Procedure	32
4.3	SAR Measurement Procedure	33
4.3.1.	Duty Factor Control	33
4.3.2.	Initial Test Position SAR Test Reduction Procedure	33
5	SAR EXPOSURE LIMITS.....	34
6	TEST EQUIPMENT LIST.....	35
7	MEASUREMENT UNCERTAINTY.....	36
8	CONDUCTED POWER MEASUREMENT	39
9	TEST PROCEDURES	47
9.1	SAR Test Results Summary	47
9.2	Simultaneous Transmission Analysis	54
9.3	Test position and configuration	55
APPENDIX A.	SAR SYSTEM VALIDATION DATA.....	56
APPENDIX B.	SAR MEASUREMENT DATA	56
APPENDIX C.	PROBE CALIBRATION DATA.....	64
APPENDIX D.	DIPOLE CALIBRATION DATA	148
APPENDIX E.	DAE CALIBRATION DATA.....	170

COMPETENCES AND GUARANTEES

DEKRA is a testing laboratory competent to carry out the tests described in this report.

In order to assure the traceability to other national and international laboratories, DEKRA has a calibration and Maintenance program for its measurement equipment.

DEKRA guarantees the reliability of the data presented in this report, which is the result of the measurements and the tests performed to the item under test on the date and under the conditions stated in the report and it is based on the knowlEdge and technical facilities available at DEKRA at the time of performance of the test.

DEKRA is liable to the client for the Maintenance of the confidentiality of all information related to the item under test and the results of the test.

The results presented in this Test Report apply only to the particular item under test established in this document.

IMPORTANT: No parts of this report may be reproduced or quoted out of context, in any form or by any means, except in full, without the previous written permission of DEKRA.

GENERAL CONDITIONS

Test Location	No. 99, Hongye Road, Suzhou Industrial Park Suzhou, 215006, P.R. China
Date(receive sample)	Apr. 15, 2020
Date (start test)	Apr. 22, 2020
Date (finish test)	May. 19, 2020

1. This report is only referred to the item that has undergone the test.
2. This report does not constitute or imply on its own an approval of the product by the Certification Bodies or Competent Authorities.
3. This document is only valid if complete; no partial reproduction can be made without previous written permission of DEKRA.
4. This test report cannot be used partially or in full for publicity and/or promotional purposes without previous written permission of DEKRA.

ENVIRONMENTAL CONDITIONS

The climatic conditions during the tests are within the limits specified by the manufacturer for the operation of the EUT and the test equipment. The climatic conditions during the tests were within the following limits:

Ambient temperature	18 °C – 25 °C
Relative Humidity air	30% - 60%

If explicitly required in the basic standard or applied product / product family standard the climatic values are recorded and documented separately in this test report.

POSSIBLE TEST CASE VERDICTS

Test case does not apply to test object	N/A
Test object does meet requirement	P (Pass) / PASS
Test object does not meet requirement	F (Fail) / FAIL
Not measured	N/M

DOCUMENT HISTORY

Report No.	Version	Description	Issued Date
2040625R-RF-US-P09V01	V1.0	Initial issue of report.	2020-06-05
2040625R-RF-US-P09V01	V1.1	1. Add dipole return loss and impedance 2. Modified Test mode name	2020-07-07
2040625R-RF-US-P09V01	V1.2	Add Limb SAR test data	2020-07-20
2040625R-RF-US-P09V01	V1.3	Add Repeat SAR test data	2020-07-21

REMARKS AND COMMENTS

1. The equipment under test (EUT) does meet the essential requirements of the stated standard(s)/test(s).
2. These test results on a sample of the device are for the purpose of demonstrating Compliance with FCC KDB Publication 248227 D01v02r02, FCC KDB Publication 447498 D01v06, FCC KDB Publication 865664 D01v01r04, FCC KDB Publication KDB 648474 D04v01r03, IEEE Std. 1528-2013, FCC 47CFR §2.1093, ANSI C95.1-2005, RSS 102: Issue 5, EN 62209-2: 2010.
3. The measurement result is considered in conformance with the requirement if it is within the prescribed limit, It is not necessary to account the uncertainty associated with the measurement result, unless the specification, standard or customer have special requirements
4. The test results presented in this report relate only to the object tested.
5. The test results relate only to the samples tested
6. The test report shall not be reproduced without the written approval of DEKRA Testing and Certification (Suzhou) Co., Ltd.
7. This report will not be used for social proof function in China market.

1 General Information

1.1 General Description of the Item(s)

Product name	Mobile Computer
Trademark	Datalogic
Manufacturer	Datalogic S.r.l.
Manufacturer Address.....	Via San Vitalino no.13,Calderara di Reno -40012(BO)-Italy
Software version	0.01.02.20200513
Hardware version.....	V00(US)

Product Name	Mobile Computer
Model No.	MEMOR K
EUT Voltage	3.8 Vdc
Frequency Range	802.11b/g/n(20MHz): 2412~2462MHz 802.11n(40MHz): 2422~2452MHz
Channel Number	802.11b/g/n(20MHz): 11 802.11n(40MHz): 7
Type of Modulation	802.11b: DSSS-DBPSK, DQPSK, CCK 802.11g/n: OFDM-BPSK, QPSK, 16QAM, 64QAM
Data Rate	802.11b: 1/2/5.5/11 Mbps 802.11g: 6/9/12/18/24/36/48/54 Mbps 802.11n: up to 150 Mbps
Channel Control	Auto

Product Name	Mobile Computer		
Model No.	MEMOR K		
EUT Voltage	3.8 Vdc		
Type of Modulation	OFDM-BPSK, QPSK, 16QAM, 64QAM, 256QAM		
Data Rate	802.11a: 6/9/12/18/24/36/48/54Mbps 802.11n: up to 150Mbps 802.11ac: up to 433.3Mbps		
Channel Control	Auto		
Transmit modes	<input checked="" type="checkbox"/> 802.11a	<input checked="" type="checkbox"/> 802.11n(20MHz)	<input checked="" type="checkbox"/> 802.11n(40MHz)



	<input checked="" type="checkbox"/>	802.11ac(20MHz)	<input checked="" type="checkbox"/>	802.11ac(40MHz)	<input checked="" type="checkbox"/>	802.11ac(80MHz)	
Support Bands	<input checked="" type="checkbox"/>	5150MHz~5250MHz	<input type="checkbox"/>	Outdoor AP			
			<input type="checkbox"/>	Indoor AP			
			<input type="checkbox"/>	Fixed point-to-point AP			
			<input checked="" type="checkbox"/>	Mobile and Portable Client			
	<input checked="" type="checkbox"/>	5250MHz~5350MHz					
	<input checked="" type="checkbox"/>	For FCC 5470MHz~5725MHz	<input checked="" type="checkbox"/>	With TDWR Channels			
			<input type="checkbox"/>	Without TDWR Channels			
<input checked="" type="checkbox"/>	For IC 5470MHz~5725MHz	<input type="checkbox"/>	With TDWR Channels				
		<input checked="" type="checkbox"/>	Without TDWR Channels				
<input checked="" type="checkbox"/>	5725MHz~5850MHz						

Product Name	Mobile Computer
Model No.	MEMOR K
EUT Voltage	3.8 Vdc
Test Voltage	3.8 Vdc
Bluetooth Specification	V3.0
Frequency Range	2402- 2480 MHz
Channel Number	V3.0: 79
Channel Separation	V3.0: 1MHz
Type of Modulation	V3.0: GFSK, Pi/4 DQPSK, 8DPSK
Data Rate	V3.0: 1Mbps(GFSK), 2Mbps(Pi/4 DQPSK), 3Mbps(8DPSK)
Antenna Type	Reference to Antenna List
Peak Antenna Gain	Reference to Antenna List

Product Name	Mobile Computer					
Model No.	MEMOR K					
EUT Voltage	3.8 Vdc					
Test Voltage	3.8 Vdc					
Bluetooth Specification	V5.0					
Frequency Range	2402- 2480 MHz					
Channel Number	40					
Channel Separation	2MHz					
Type of Modulation	GFSK					
PHYs	<input checked="" type="checkbox"/>	LE 1M	<input type="checkbox"/>	LE 2M	<input type="checkbox"/>	LE Coded S=2/8
Data Rate	<input checked="" type="checkbox"/>	1 Mbps	<input type="checkbox"/>	2 Mbps	<input type="checkbox"/>	500/125 Kbps

Antenna Type	Reference to Antenna List
Peak Antenna Gain	Reference to Antenna List

Rated power supply	Voltage and Frequency	
	<input type="checkbox"/>	AC: 220 – 240 V, 50/60 Hz
	<input type="checkbox"/>	AC: 100 – 240 V, 50/60 Hz
	<input type="checkbox"/>	DC: 12 V
	<input checked="" type="checkbox"/>	Battery: 3.8 Vdc
	<input type="checkbox"/>	PoE:
Mounting position.....	<input type="checkbox"/>	Table top equipment
	<input type="checkbox"/>	Wall/Ceiling mounted equipment
	<input type="checkbox"/>	Floor standing equipment
	<input checked="" type="checkbox"/>	Hand-held equipment
	<input type="checkbox"/>	Other:

1.2 Antenna Information

Antenna Delivery	<input checked="" type="checkbox"/>	1TX + 1RX	
	<input type="checkbox"/>	2TX + 2RX	
	<input type="checkbox"/>	Others:.....	
Antenna technology	<input checked="" type="checkbox"/>	SISO	
	<input type="checkbox"/>	MIMO	<input type="checkbox"/> CDD
			<input type="checkbox"/> Beam-forming
Antenna Type	<input type="checkbox"/>	External	<input type="checkbox"/> Dipole
			<input type="checkbox"/> PIFA
			<input type="checkbox"/> Sectorized
	<input checked="" type="checkbox"/>	Internal	<input checked="" type="checkbox"/> Metal antenna
			<input type="checkbox"/> PCB
			<input type="checkbox"/> Others.....
Antenna Gain	2400 ~ 2483.5: 0.84dBi		
	5150 ~ 5725: 1.68dBi		
	5725 ~ 5850: 1.34dBi		

1.4 Channel List

IEEE 802.11b/g/n(20MHz)

Working Frequency of Each Channel							
Channel	Frequency	Channel	Frequency	Channel	Frequency	Channel	Frequency
001	2412 MHz	002	2417 MHz	003	2422 MHz	004	2427 MHz
005	2432 MHz	006	2437 MHz	007	2442 MHz	008	2447 MHz
009	2452 MHz	010	2457 MHz	011	2462 MHz	--	--

IEEE 802.11n(40MHz)

Working Frequency of Each Channel							
Channel	Frequency	Channel	Frequency	Channel	Frequency	Channel	Frequency
003	2422 MHz	004	2427 MHz	005	2432 MHz	006	2437 MHz
007	2442 MHz	008	2447 MHz	009	2452 MHz	--	--

IEEE 802.11a/n/ac(20MHz)

Working Frequency of Each Channel							
Channel	Frequency	Channel	Frequency	Channel	Frequency	Channel	Frequency
036	5180 MHz	040	5200 MHz	044	5220 MHz	048	5240 MHz
052	5260 MHz	056	5280 MHz	060	5300 MHz	064	5320 MHz
100	5500 MHz	104	5520 MHz	108	5540 MHz	112	5560 MHz
116	5580 MHz	120	5600 MHz	124	5620 MHz	128	5640 MHz
132	5660 MHz	136	5680 MHz	140	5700 MHz	149	5745 MHz
153	5765 MHz	157	5785 MHz	161	5805 MHz	165	5825 MHz

IEEE 802.11n/ac(40MHz)

Working Frequency of Each Channel							
Channel	Frequency	Channel	Frequency	Channel	Frequency	Channel	Frequency
038	5190 MHz	046	5230 MHz	054	5270 MHz	062	5310 MHz
102	5510 MHz	110	5550 MHz	118	5590 MHz	126	5630 MHz
134	5670 MHz	151	5755 MHz	159	5795 MHz	--	--

IEEE 802.11ac(80MHz)

Working Frequency of Each Channel							
Channel	Frequency	Channel	Frequency	Channel	Frequency	Channel	Frequency
42	5210 MHz	58	5290 MHz	106	5530 MHz	122	5610 MHz
155	5775 MHz	--	--	--	--	--	--

For Bluetooth

Bluetooth Working Frequency of Each Channel: (FHSS)							
Channel	Frequency	Channel	Frequency	Channel	Frequency	Channel	Frequency
00	2402 MHz	01	2403 MHz	02	2404 MHz	03	2405 MHz
04	2406 MHz	05	2407 MHz	06	2408 MHz	07	2409 MHz
08	2410 MHz	09	2411 MHz	10	2412 MHz	11	2413 MHz
12	2414 MHz	13	2415 MHz	14	2416 MHz	15	2417 MHz
16	2418 MHz	17	2419 MHz	18	2420 MHz	19	2421 MHz
20	2422 MHz	21	2423 MHz	22	2424 MHz	23	2425 MHz
24	2426 MHz	25	2427 MHz	26	2428 MHz	27	2429 MHz
28	2430 MHz	29	2431 MHz	30	2432 MHz	31	2433 MHz
32	2434 MHz	33	2435 MHz	34	2436 MHz	35	2437 MHz
36	2438 MHz	37	2439 MHz	38	2440 MHz	39	2441 MHz
40	2442 MHz	41	2443 MHz	42	2444 MHz	43	2445 MHz
44	2446 MHz	45	2447 MHz	46	2448 MHz	47	2449 MHz
48	2450 MHz	49	2451 MHz	50	2452 MHz	51	2453 MHz
52	2454 MHz	53	2455 MHz	54	2456 MHz	55	2457 MHz
56	2458 MHz	57	2459 MHz	58	2460 MHz	59	2461 MHz
60	2462 MHz	61	2463 MHz	62	2464 MHz	63	2465 MHz
64	2466 MHz	65	2467 MHz	66	2468 MHz	67	2469 MHz
68	2470 MHz	69	2471 MHz	70	2472 MHz	71	2473 MHz
72	2474 MHz	73	2475 MHz	74	2476 MHz	75	2477 MHz
76	2478 MHz	77	2479 MHz	78	2480 MHz	N/A	N/A

Bluetooth Working Frequency of Each Channel: (BT 5.0)							
Channel	Frequency	Channel	Frequency	Channel	Frequency	Channel	Frequency
00	2402 MHz	01	2404 MHz	02	2406 MHz	03	2408 MHz
04	2410 MHz	05	2412 MHz	06	2414 MHz	07	2416 MHz
08	2418 MHz	09	2420 MHz	10	2422 MHz	11	2424 MHz
12	2426 MHz	13	2428 MHz	14	2430 MHz	15	2432 MHz
16	2434 MHz	17	2436 MHz	18	2438 MHz	19	2440 MHz
20	2442 MHz	21	2444 MHz	22	2446 MHz	23	2448 MHz
24	2450 MHz	25	2452 MHz	26	2454 MHz	27	2456 MHz
28	2458 MHz	29	2460 MHz	30	2462 MHz	31	2464 MHz
32	2466 MHz	33	2468 MHz	34	2470 MHz	35	2472 MHz
36	2474 MHz	37	2476 MHz	38	2478 MHz	39	2480 MHz

2 SAR MEASUREMENT SYSTEM

2.1 DASY5 System Description

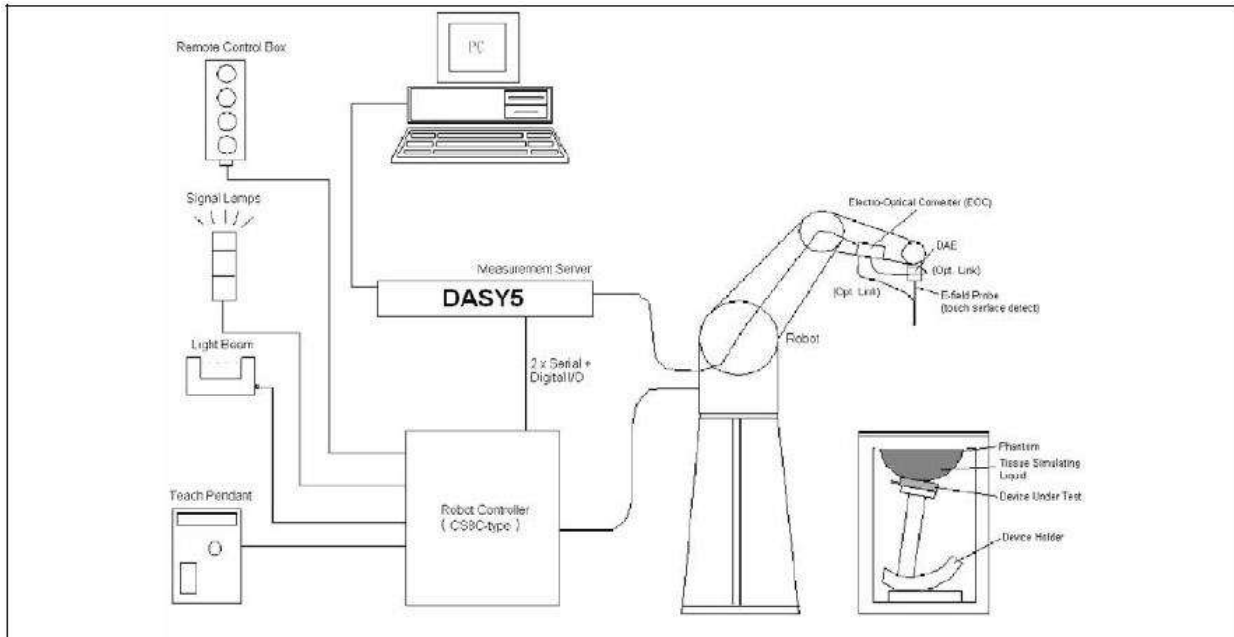

The DASY5 system for performing compliance tests consists of the following items:

1. A standard high precision 6-axis robot with controller, teach pendant and software. An arm extension for accommodating the data acquisition electronics (DAE).
2. A data acquisition electronics (DAE) which performs the signal amplification, signal multiplexing, AD-conversion, offset measurements, mechanical surface detection, collision detection, etc. The unit is battery powered with standard or rechargeable batteries. The signal is optically transmitted to the EOC.
3. The Electro-optical converter (EOC) performs the conversion from optical to electrical signals for the digital communication to the DAE. To use optical surface detection, a special version of the EOC is required. The EOC signal is transmitted to the measurement server.
4. The Light Beam used is for probe alignment. This improves the (absolute) accuracy of the probe positioning.
5. A computer running WinXP and the DASY5 software.
6. Remote control and teach pendant as well as additional circuitry for robot safety such as warning lamps, etc.
7. The phantom, the device holder and other accessories according to the targeted measurement.

2.1.1. Applications

Predefined procedures and evaluations for automated compliance testing with all worldwide standards, e.g., IEEE 1528, OET 65, IEC 62209-1, IEC 62209-2, EN 50360, EN 50383, EN62311 and others.

2.1.2. Area Scans

Area scans are defined prior to the measurement process being executed with a user defined variable spacing between each measurement point (integral) allowing low uncertainty measurements to be conducted. Scans defined for FCC applications utilize a 10mm² step integral, with 1mm interpolation used to locate the peak SAR area used for zoom scan assessments.

When an Area Scan has measured all reachable points, it computes the field maxima found in the scanned area, within a range of the global maximum. The range (in dB) is specified in the standards for compliance testing. For example, a 2 dB range is required in IEEE 1528-2003 and IEC 62209 standards, whereby 3 dB is a requirement when compliance is assessed in accordance with the ARIB standard (Japan).

2.1.3. Zoom Scan (Cube Scan Averaging)

Zoom Scans are used to assess the peak spatial SAR values within a cubic averaging volume containing 1 g and 10 g of simulated tissue. A density of 1000 kg/m³ is used to represent the head and Body tissue density and not the phantom liquid density, in order to be consistent with the definition of the liquid dielectric properties, i.e. the side length of the 1 g cube is 10mm, with the side length of the 10 g cube 21,5mm.

The zoom scan integer steps can be user defined so as to reduce uncertainty, but normal practice for typical test applications utilize a physical step of 7x7x7 (5mmx5mmx5mm) providing a volume of 30mm in the X & Y axis, and 30mm in the Z axis.

2.1.4. Uncertainty of Inter-/Extrapolation and Averaging

In order to evaluate the uncertainty of the interpolation, extrapolation and averaged SAR calculation algorithms of the Postprocessor, DASYS5 allows the generation of measurement grids which are artificially predefined by analytically based test functions. Therefore, the grids of area scans and zoom scans can be filled with uncertainty test data, according to the SAR benchmark functions of IEEE 1528. The three analytical functions shown in equations as below are used to describe the possible range of the expected SAR distributions for the tested handsets. The field gradients are covered by the spatially flat distribution f_1 , the spatially steep distribution f_3 and f_2 accounts for H-field cancellation on the phantom/tissue surface.

$$f_1(x, y, z) = Ae^{-\frac{z}{2a}} \cos^2 \left(\frac{\pi \sqrt{x'^2 + y'^2}}{2 \cdot 5a} \right)$$

$$f_2(x, y, z) = Ae^{-\frac{z}{a}} \frac{a^2}{a^2 + x'^2} \left(3 - e^{-\frac{2z}{a}} \right) \cos^2 \left(\frac{\pi y'}{2 \cdot 3a} \right)$$

$$f_3(x, y, z) = A \frac{a^2}{\frac{a^2}{4} + x'^2 + y'^2} \left(e^{-\frac{2z}{a}} + \frac{a^2}{2(a + 2z)^2} \right)$$

2.2 DASY5 E-Field Probe

The SAR measurement is conducted with the dosimetric probe manufactured by SPEAG. The probe is specially designed and calibrated for use in liquid with high permittivity. The dosimetric probe has special calibration in liquid at different frequency.

SPEAG conducts the probe calibration in compliance with international and national standards (e.g. IEEE 1528, EN 62209-1, IEC 62209, etc.) under ISO 17025. The calibration data are in Appendix D.

Model	EX3DV4	
Construction	Symmetrical design with triangular core Built-in shielding against static charges PEEK enclosure material (resistant to organic solvents, e.g., DGBE)	
Frequency	10 MHz to 6 GHz Linearity: ± 0.2 dB (30 MHz to 6 GHz)	
Directivity	± 0.3 dB in HSL (rotation around probe axis) ± 0.5 dB in tissue material (rotation normal to probe axis)	
Dynamic Range	10 μ W/g to 100 mW/g Linearity: ± 0.2 dB (noise: typically < 1 μ W/g)	
Dimensions	Overall length: 330 mm (Tip: 20 mm) Tip diameter: 2.5 mm (Body: 12 mm) Typical distance from probe tip to dipole centers: 1 mm	
Application	High precision dosimetric measurements in any exposure scenario (e.g., very strong gradient fields). Only probe which enables compliance testing for frequencies up to 6 GHz with precision of better 30%.	

2.3 Boundary Detection Unit and Probe Mounting Device

The DASY probes use a precise connector and an additional holder for the probe, consisting of a plastic tube and a flexible silicon ring to center the probe. The connector at the DAE is flexibly mounted and held in the default position with magnets and springs. Two switching systems in the connector mount detect Frontal and lateral probe collisions and trigger the necessary software response.



2.4 DATA Acquisition Electronics (DAE) and Measurement Server

The data acquisition electronics (DAE) consists of a highly sensitive electrometer-grade preamplifier with auto-zeroing, a channel and gain-switching multiplexer, a fast 16 bit AD-converter and a command decoder and control logic unit.

Transmission to the measurement server is accomplished through an optical downlink for data and status information as well as an optical uplink for commands and the clock.

The input impedance of the DAE4 is 200M Ohm; the inputs are symmetrical and floating. Common mode rejection is above 80dB.



The DASY5 measurement server is based on a PC/104 CPU board with a 400MHz intel ULV Celeron, 128MB chipdisk and 128MB RAM. The necessary circuits for communication with the DAE electronics box, as well as the 16 bit AD converter system for optical detection and digital I/O interface are contained on the DASY5 I/O board, which is directly connected to the PC/104 bus of the CPU board.



2.5 Robot

The DASY5 system uses the high precision robots TX90 XL type out of the newer series from Stäubli SA (France). For the 6-axis controller DASY5 system, the CS8C robot controller version from Stäubli is used. The XL robot series have many features that are important for our application:

- High precision (repeatability 0.02 mm)
- High reliability (industrial design)
- Jerk-free straight movements
- Low ELF interference (the closed metallic construction shields against motor control fields)
- 6-axis controller



2.6 Light Beam Unit

The light beam switch allows automatic "tooling" of the probe. During the process, the actual position of the probe tip with respect to the robot arm is measured, as well as the probe length and the horizontal probe offset. The software then corrects all movements, such that the robot coordinates are valid for the probe tip.

The repeatability of this process is better than 0.1 mm. If a position has been taught with an aligned probe, the same position will be reached with another aligned probe within 0.1 mm, even if the other probe has different dimensions. During probe rotations, the probe tip will keep its actual position.



2.7 Device Holder

The DASY5 device holder is designed to cope with different positions given in the standard. It has two scales for the device rotation (with respect to the Body axis) and the device inclination (with respect to the line between the ear reference points). The rotation center for both scales is the ear reference point (EPR).

Thus the device needs no repositioning when changing the angles.

The DASY5 device holder has been made out of low-loss POM material having the following dielectric parameters: relative permittivity $\epsilon_r = 3$ and loss tangent $\delta = 0.02$. The amount of dielectric material has been reduced in the closest vicinity of the device, since measurements have suggested that the influence of the clamp on the test results could thus be lowered.



2.8 SAM Twin Phantom

The SAM twin phantom is a fiberglass shell phantom with 2mm shell thickness (except the ear region where shell thickness increases to 6mm). It has three measurement areas:

- Left head
- Right head
- Flat phantom



The bottom plate contains three pair of bolts for locking the device holder. The device holder positions are adjusted to the standard measurement positions in the three sections. A white cover is provided to tap the phantom during off-periods to prevent water evaporation and changes in the liquid parameters. On the phantom top, three reference markers are provided to identify the phantom position with respect to the robot.

3 TISSUE SIMULATING LIQUID

3.1 The composition of the tissue simulating liquid

INGREDIENT (% Weight)	2450MHz Body	5250/5600/5750 MHz Body
Water	73.2	75.68
Salt	0.01	0.43
Sugar	0.00	0.00
HEC	0.00	0.00
Preventol	0.00	0.00
DGBE	26.7	4.42
Triton X-100	0.00	19.47

3.2 Tissue Calibration Result

The dielectric parameters of the liquids were verified prior to the SAR evaluation using DASY5 Dielectric Probe Kit and Agilent Vector Network Analyzer E5071C

Head Tissue Simulant Measurement				
Frequency [MHz]	Description	Dielectric Parameters		Tissue Temp. [°C]
		ϵ_r	σ [s/m]	
2450MHz	Reference result ± 5% window	39.2 37.24 to 41.16	1.80 1.71 to 1.89	N/A
	05-12-2020	40.9	1.80	21.0
5250MHz	Reference result ± 5% window	35.9 34.11 to 37.70	4.71 4.47 to 4.95	N/A
	05-12-2020	36.1	4.56	21.0
5600MHz	Reference result ± 5% window	35.5 33.73 to 37.28	5.07 4.82 to 5.32	N/A
	05-12-2020	35.52	4.96	21.0
5750MHz	Reference result ± 5% window	35.4 33.63 to 37.17	5.22 4.96 to 5.48	N/A
	05-12-2020	35.23	5.14	21.0

Body Tissue Simulant Measurement				
Frequency [MHz]	Description	Dielectric Parameters		Tissue Temp. [°C]
		ϵ_r	σ [s/m]	
2450MHz	Reference result ± 5% window	52.7 50.07 to 55.34	1.95 1.85 to 2.05	N/A
	05-14-2020	52.8	1.96	21.0
5250MHz	Reference result ± 5% window	49.0 46.55 to 51.45	5.36 5.09 to 5.63	N/A
	05-14-2020	47.88	5.27	21.0
5600MHz	Reference result ± 5% window	48.5 46.10 to 50.90	5.77 5.48 to 6.06	N/A
	05-14-2020	46.98	5.93	21.0
5750MHz	Reference result ± 5% window	48.3 45.86 to 50.69	5.94 5.65 to 6.24	N/A
	05-14-2020	46.89	6.01	21.0

Head Tissue Simulant Measurement (Test Data: 05-12-2020)								
Frequency [MHz]	Channel	Dielectric Parameters						Tissue Temp. [°C]
		Permittivity ϵ_r	Conductivity σ	Permittivity Target ϵ_r	Conductivity Target σ	Delta (ϵ_r) %	Delta (σ) %	
2412	Low	40.97	1.77	39.25	1.76	4.38	0.57	21.0
2437	Mid	40.94	1.79	39.22	1.79	4.39	0.00	21.0
2441	Mid	40.95	1.79	39.21	1.79	4.44	0.00	21.0
2462	High	40.89	1.81	39.18	1.81	4.36	0.00	21.0
5220	Mid	36.15	4.53	35.94	4.49	0.58	0.89	21.0
5240	High	36.11	4.55	35.92	4.51	0.53	0.89	21.0
5300	Mid	36.02	4.61	35.85	4.57	0.47	0.88	21.0
5500	Low	35.61	4.88	35.63	4.77	-0.06	2.31	21.0
5530	Mid	35.53	4.91	35.60	4.80	-0.20	2.29	21.0
5745	Low	35.24	5.14	35.36	5.02	-0.34	2.39	21.0

Note:

- The delta (ϵ_r) and (σ) are within $\pm 5\%$, delta SAR value was not calculated in this report.
- As per IEC 62209-2 Annex F, the SAR correction factor is given by:

$$\Delta SAR = c_\epsilon \Delta \epsilon_r + c_\sigma \Delta \sigma$$
 For the 1g average SAR C_ϵ and C_σ are given by:

$$C_\epsilon = -7.854 \times 10^{-4} f^3 + 9.402 \times 10^{-3} f^2 - 2.742 \times 10^{-2} f - 0.2026$$

$$C_\sigma = 9.804 \times 10^{-3} f^3 - 8.661 \times 10^{-2} f^2 + 2.981 \times 10^{-2} f + 0.7829$$
 Where f is the frequency in GHz.

Head Tissue Simulant Measurement (Test Data: 05-12-2020)							
Frequency [MHz]	Channel	Dielectric Parameters					Tissue Temp. [°C]
		Delta (ϵ_r) %	Delta (σ) %	C_ϵ	C_σ	Delta SAR%	
2412	Low	4.38	0.57	-0.23	0.49	-0.71	21.0
2437	Mid	4.39	0.00	-0.22	0.48	-0.99	21.0
2441	Mid	4.44	0.00	-0.22	0.48	-1.00	21.0
2462	High	4.36	0.00	-0.22	0.48	-0.98	21.0
5220	Mid	0.58	0.89	-0.20	-0.03	-0.14	21.0
5240	High	0.53	0.89	-0.20	-0.03	-0.13	21.0
5300	Mid	0.47	0.88	-0.20	-0.03	-0.12	21.0
5500	Low	-0.06	2.31	-0.20	-0.04	-0.09	21.0
5530	Mid	-0.20	2.29	-0.20	-0.04	-0.06	21.0
5745	Low	-0.34	2.39	-0.20	-0.05	-0.04	21.0

Note: The Δ SAR refers to the percent change in SAR relative to the percent change in dielectric properties versus the target values. A negative Δ SAR would translate to a lower measured SAR value than what would be measured if using dielectric properties equal to the target values. A positive Δ SAR would translate to a higher measured SAR value than what would be measured if using dielectric properties equal to the target values. SAR correction shall not be made when the Δ SAR has a positive sign to provide a conservative SAR value. The SAR is only corrected when Δ SAR has a negative sign.

Body Tissue Simulant Measurement (Test Data: 05-14-2020)								
Frequency [MHz]	Channel	Dielectric Parameters						Tissue Temp. [°C]
		Permittivity ϵ_r	Conductivity σ	Permittivity Target ϵ_r	Conductivity Target σ	Delta (ϵ_r) %	Delta (σ) %	
2412	Low	52.82	1.91	52.75	1.90	0.13	0.53	21.0
2437	Mid	52.79	1.93	52.72	1.93	0.13	0.00	21.0
2441	Mid	52.78	1.93	52.71	1.94	0.13	-0.52	21.0
2462	High	52.74	1.96	52.68	1.97	0.11	-0.51	21.0
5220	Mid	47.94	5.23	49.07	5.30	-2.30	-1.32	21.0
5240	High	47.9	5.26	49.04	5.33	-2.32	-1.31	21.0
5300	Mid	47.75	5.38	48.95	5.40	-2.45	-0.37	21.0
5500	Low	47.44	5.64	48.65	5.64	-2.49	0.00	21.0
5530	Mid	47.35	5.69	48.61	5.68	-2.59	0.18	21.0
5745	Low	46.9	6.00	48.28	5.93	-2.86	1.18	21.0

Note:

3. The delta (ϵ_r) and (σ) are within $\pm 5\%$, delta SAR value was not calculated in this report.

4. As per IEC 62209-2 Annex F, the SAR correction factor is given by:
 $\Delta SAR = C_\epsilon \Delta \epsilon_r + C_\sigma \Delta \sigma$

For the 1g average SAR C_ϵ and C_σ are given by:
 $C_\epsilon = -7.854 \times 10^{-4} f^3 + 9.402 \times 10^{-3} f^2 - 2.742 \times 10^{-2} f - 0.2026$
 $C_\sigma = 9.804 \times 10^{-3} f^3 - 8.661 \times 10^{-2} f^2 + 2.981 \times 10^{-2} f + 0.7829$

Where f is the frequency in GHz.

Body Tissue Simulant Measurement (Test Data: 05-14-2020)							
Frequency [MHz]	Channel	Dielectric Parameters					Tissue Temp. [°C]
		Delta (ϵ_r) %	Delta (σ) %	C_ϵ	C_σ	Delta SAR%	
2412	Low	0.13	0.53	-0.23	0.49	0.23	21.0
2437	Mid	0.13	0.00	-0.22	0.48	-0.03	21.0
2441	Mid	0.13	-0.52	-0.22	0.48	-0.28	21.0
2462	High	0.11	-0.51	-0.22	0.48	-0.27	21.0
5220	Mid	-2.30	-1.32	-0.20	-0.03	0.50	21.0
5240	High	-2.32	-1.31	-0.20	-0.03	0.50	21.0
5300	Mid	-2.45	-0.37	-0.20	-0.03	0.50	21.0
5500	Low	-2.49	0.00	-0.20	-0.04	0.50	21.0
5530	Mid	-2.59	0.18	-0.20	-0.04	0.51	21.0
5745	Low	-2.86	1.18	-0.20	-0.05	0.51	21.0

Note: The Δ SAR refers to the percent change in SAR relative to the percent change in dielectric properties versus the target values. A negative Δ SAR would translate to a lower measured SAR value than what would be measured if using dielectric properties equal to the target values. A positive Δ SAR would translate to a higher measured SAR value than what would be measured if using dielectric properties equal to the target values. SAR correction shall not be made when the Δ SAR has a positive sign to provide a conservative SAR value. The SAR is only corrected when Δ SAR has a negative sign.

3.3 Tissue Dielectric Parameters for Head and Body Phantoms

The head tissue dielectric parameters recommended by the IEEE SCC-34/SC-2 in P1528 have been incorporated in the following table. These head parameters are derived from planar layer models simulating the highest expected SAR for the dielectric properties and tissue thickness variations in a human head. Other head and Body tissue parameters that have not been specified in P1528 are derived from the tissue dielectric parameters computed from the 4-Cole-Cole equations described in Reference [12] and extrapolated according to the head parameters specified in P1528.

Target Frequency (MHz)	Head		Body	
	ϵ_r	σ (S/m)	ϵ_r	σ (S/m)
150	52.3	0.76	61.9	0.80
300	45.3	0.87	58.2	0.92
450	43.5	0.87	56.7	0.94
835	41.5	0.90	55.2	0.97
900	41.5	0.97	55.0	1.05
915	41.5	0.98	55.0	1.06
1450	40.5	1.20	54.0	1.30
1610	40.3	1.29	53.8	1.40
1800 – 2000	40.0	1.40	53.3	1.52
2450	39.2	1.80	52.7	1.95
3000	38.5	2.40	52.0	2.73
5800	35.3	5.07	48.2	6.00

(ϵ_r = relative permittivity, σ = conductivity and $\rho = 1000 \text{ kg/m}^3$)

4 SAR MEASUREMENT PROCEDURE

4.1 SAR System Validation

4.1.1. Validation Dipoles

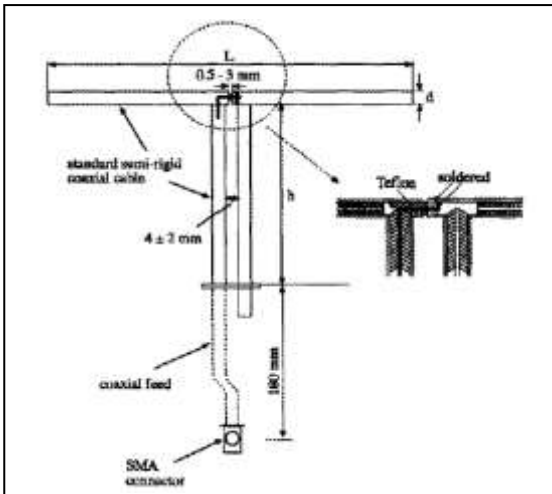

The dipoles used is based on the IEEE-1528 standard, and is complied with mechanical and electrical specifications in line with the requirements of both IEEE and FCC Supplement C. the table below provides details for the mechanical and electrical specifications for the dipoles.

Frequency	L (mm)	h (mm)	d (mm)
2450MHz	53.5	30.4	3.6
5250MHz	20.6	14.2	3.6
5600MHz	20.6	14.2	3.6
5750MHz	20.6	14.2	3.6

4.1.2. Validation Result

System Performance Check Head at 2450MHz, 5250MHz, 5600MHz and 5750MHz				
Validation Dipole: D2450V2, SN: 839; D5GHzV2, SN: 1078				
Frequency [MHz]	Description	SAR [w/kg] 1g	SAR [w/kg] 10g	Tissue Temp. [°C]
2450 MHz	Reference result ± 10% window	51.2 46.08 to 56.32	23.6 21.24 to 25.96	N/A
	05-12-2020	50.8	22.64	21.0
5250 MHz	Reference result ± 10% window	75.5 67.95 to 83.05	21.6 19.44 to 23.76	N/A
	05-12-2020	74.0	20.5	21.0
5600 MHz	Reference result ± 10% window	79.7 71.73 to 87.67	23.0 20.7 to 25.3	N/A
	05-12-2020	72.5	21.2	21.0
5750 MHz	Reference result ± 10% window	78.6 70.74 to 86.46	22.4 20.16 to 24.64	N/A
	05-12-2020	79.8	22.1	21.0

Note: All SAR values are normalized to 1W forward power.

System Performance Check Body at 2450MHz, 5250MHz, 5600MHz and 5750MHz				
Validation Dipole: D2450V2, SN: 839; D5GHzV2, SN: 1078				
Frequency [MHz]	Description	SAR [w/kg] 1g	SAR [w/kg] 10g	Tissue Temp. [°C]
2450 MHz	Reference result ± 10% window	50.8 45.72 to 55.88	23.6 21.15 to 25.85	N/A
	05-14-2020	52.8	24.2	21.0
5250 MHz	Reference result ± 10% window	73.6 66.24 to 80.96	20.9 18.81 to 22.99	N/A
	05-14-2020	76.9	20.1	21.0
5600 MHz	Reference result ± 10% window	77.3 69.57 to 85.03	21.9 19.71 to 24.09	N/A
	05-14-2020	79.4	22.0	21.0
5750 MHz	Reference result ± 10% window	74.4 66.96 to 81.84	20.9 18.81 to 22.99	N/A
	05-14-2020	77.5	20.9	21.0

Note: All SAR values are normalized to 1W forward power.

4.2 SAR Measurement Procedure

The DASY 5 calculates SAR using the following equation,

$$SAR = \frac{\sigma |E|^2}{\rho}$$

σ : represents the simulated tissue conductivity

ρ : represents the tissue density

The EUT is set to transmit at the required power in line with product specification, at each frequency relating to the LOW, MID, and HIGH channel settings.

Pre-scans are made on the device to establish the location for the transmitting antenna, using a large area scan in either air or tissue simulation fluid.

The EUT is placed against the Universal Phantom where the maximum area scan dimensions are larger than the physical size of the resonating antenna. When the scan size is not large enough to cover the peak SAR distribution, it is modified by either extending the area scan size in both the X and Y directions, or the device is shifted within the predefined area.

The area scan is then run to establish the peak SAR location (interpolated resolution set at 1mm²) which is then used to orient the center of the zoom scan. The zoom scan is then executed and the 1g and 10g averages are derived from the zoom scan volume (interpolated resolution set at 1mm³).

4.3 SAR Measurement Procedure

4.3.1. Duty Factor Control

Unless it is permitted by specific KDB procedures or continuous transmission is specifically restricted by the device, the reported SAR must be scaled to 100% transmission duty factor to determine compliance at the maximum tune-up tolerance limit.

4.3.2. Initial Test Position SAR Test Reduction Procedure

DSSS and OFDM configurations are considered separately according to the required SAR procedures. SAR is measured in the initial test position using the 802.11 transmission mode configuration required by the DSSS procedure or initial test configuration and subsequent test configuration(s) according to the OFDM procedures.¹⁶ The initial test position procedure is described in the following:

When the reported SAR of the initial test position is ≤ 0.4 W/kg, further SAR measurement is not required for the other (reMaining) test positions in that exposure configuration and 802.11 transmission mode combinations within the frequency band or aggregated band. SAR is also not required for that exposure configuration in the subsequent test configuration(s).

a) When the reported SAR of the initial test position is > 0.4 W/kg, SAR is repeated for the 802.11 transmission mode configuration tested in the initial test position using subsequent highest extrapolated or estimated 1-g SAR conditions determined by area scans or next closest/smallest test separation distance and maximum RF coupling test positions based on manufacturer justification, on the highest maximum output power channel, until the reported SAR is ≤ 0.8 W/kg or all required test positions (left, right, touch, tilt or subsequent surfaces and Edges) are tested.

b) For all positions/configurations tested using the initial test position and subsequent test positions, when the reported SAR is > 0.8 W/kg, SAR is measured for these test positions/configurations on the subsequent next highest measured output power channel(s) until the reported SAR is ≤ 1.2 W/kg or all required channels are tested.

Additional power measurements may be required for this step, which should be limited to those necessary for identifying the subsequent highest output power channels.

5 SAR EXPOSURE LIMITS

SAR assessments have been made in line with the requirements of IEEE-1528, FCC Supplement C, and comply with ANSI/IEEE C95.1-1992 “Uncontrolled Environments” limits. These limits apply to a location which is deemed as “Uncontrolled Environment” which can be described as a situation where the general public may be exposed to an RF source with no prior knowlEdge or control over their exposure.

Limits for General Population/Uncontrolled Exposure (W/kg)

Type Exposure	Uncontrolled Environment Limit
Spatial Peak SAR (1g cube tissue for brain or Body)	1.6 W/kg
Spatial Average SAR (whole Body)	0.08 W/kg
Spatial Peak SAR (10g for hands, feet, ankles and wrist)	4.00 W/kg

6 TEST EQUIPMENT LIST

Instrument	Manufacturer	Model No.	Serial No.	Cali. Due Date
Stäubli Robot TX60L	Stäubli	TX60L	F10/5C90A1/A/01	N/A
Controller	Stäubli	SP1	S-0034	N/A
Dipole Validation Kits	Speag	D2450V2	839	2021.03.24
Dipole Validation Kits	Speag	D5GHzV2	1078	2021.03.21
SAM Twin Phantom	Speag	SAM	TP-1561/1562	N/A
ELI1 Phantom	Speag	QDOVA002AA	TP:2106	N/A
Device Holder	Speag	SD 000 H01 HA	N/A	N/A
Data Acquisition Electronic	Speag	DAE4	915	2020.06.13
E-Field Probe	Speag	EX3DV4	3710	2021.04.20
SAR Software	Speag	DASY5	V5.2 Build 162	N/A
Power Amplifier	Mini-Circuit	ZVA-183-S+	N657400950	N/A
Directional Coupler	Agilent	778D	20160	N/A
Vector Network	Agilent	E5071C	MY48367267	2021.03.09
Signal Generator	Agilent	E4438C	MY49070163	2021.03.09
Spectrum Analyzer	Agilent	N9010A	MY48030494	2020.09.27
Temperature/Humidity Meter	Zhichen	ZC1-2	N/A	2021.04.16
Temperature Meter	Dretec	O-274	RF-001	2020.11.05

7 MEASUREMENT UNCERTAINTY

DASY5 Uncertainty according to IEEE std. 1528-2013								
Measurement uncertainty for 300 MHz to 3 GHz averaged over 1 gram / 10 gram.								
Error Description	Uncert. value	Prob. Dist.	Div.	(ci) 1g	(ci) 10g	Std. Unc. (1g)	Std. Unc. (10g)	(vi) v _{eff}
Measurement System								
Probe Calibration	±6.0%	N	1	1	1	±6.0%	±6.0%	∞
Axial Isotropy	±4.7%	R	$\sqrt{3}$	0.7	0.7	±1.9%	±1.9%	∞
Hemispherical Isotropy	±9.6%	R	$\sqrt{3}$	0.7	0.7	±3.9%	±3.9%	∞
Boundary Effects	±1.0%	R	$\sqrt{3}$	1	1	±0.6%	±0.6%	∞
Linearity	±4.7%	R	$\sqrt{3}$	1	1	±2.7%	±2.7%	∞
System Detection Limits	±1.0%	R	$\sqrt{3}$	1	1	±0.6%	±0.6%	∞
Readout Electronics	±0.3%	N	1	1	1	±0.3%	±0.3%	∞
Response Time	±0.8%	R	$\sqrt{3}$	1	1	±0.5%	±0.5%	∞
Integration Time	±2.6%	R	$\sqrt{3}$	1	1	±1.5%	±1.5%	∞
RF Ambient Noise	±3.0%	R	$\sqrt{3}$	1	1	±1.7%	±1.7%	∞
RF Ambient Reflections	±3.0%	R	$\sqrt{3}$	1	1	±1.7%	±1.7%	∞
Probe Positioner	±0.4%	R	$\sqrt{3}$	1	1	±0.2%	±0.2%	∞
Probe Positioning	±2.9%	R	$\sqrt{3}$	1	1	±1.7%	±1.7%	∞
Max. SAR Eval.	±1.0%	R	$\sqrt{3}$	1	1	±0.6%	±0.6%	∞
Test Sample Related								
Device Positioning	±2.9%	N	1	1	1	±2.9%	±2.9%	145
Device Holder	±3.6%	N	1	1	1	±3.6%	±3.6%	5
Power Drift	±5.0%	R	$\sqrt{3}$	1	1	±2.9%	±2.9%	∞
Phantom and Setup								
Phantom Uncertainty	±4.0%	R	$\sqrt{3}$	1	1	±2.3%	±2.3%	∞
Liquid Conductivity (target)	±5.0%	R	$\sqrt{3}$	0.64	0.43	±1.8%	±1.2%	∞
Liquid Conductivity (meas.)	±2.5%	N	1	0.64	0.43	±1.6%	±1.1%	∞
Liquid Permittivity (target)	±5.0%	R	$\sqrt{3}$	0.6	0.49	±1.7%	±1.4%	∞
Liquid Permittivity (meas.)	±2.5%	N	1	0.6	0.49	±1.5%	±1.2%	∞
Combined Std. Uncertainty						±11.0%	±10.8%	387
Expanded STD Uncertainty						±22.0%	±21.5%	

DASY5 Uncertainty according to IEEE std. 1528-2013								
Measurement uncertainty for 3 GHz to 6 GHz averaged over 1 gram / 10 gram.								
Error Description	Uncert. value	Prob. Dist.	Div.	(ci) 1g	(ci) 10g	Std. Unc. (1g)	Std. Unc. (10g)	(vi) v _{eff}
Measurement System								
Probe Calibration	±6.55%	N	1	1	1	±6.55%	±6.55%	∞
Axial Isotropy	±4.7%	R	$\sqrt{3}$	0.7	0.7	±1.9%	±1.9%	∞
Hemispherical Isotropy	±9.6%	R	$\sqrt{3}$	0.7	0.7	±3.9%	±3.9%	∞
Boundary Effects	±2.0%	R	$\sqrt{3}$	1	1	±1.2%	±1.2%	∞
Linearity	±4.7%	R	$\sqrt{3}$	1	1	±2.7%	±2.7%	∞
System Detection Limits	±1.0%	R	$\sqrt{3}$	1	1	±0.6%	±0.6%	∞
Readout Electronics	±0.3%	N	1	1	1	±0.3%	±0.3%	∞
Response Time	±0.8%	R	$\sqrt{3}$	1	1	±0.5%	±0.5%	∞
Integration Time	±2.6%	R	$\sqrt{3}$	1	1	±1.5%	±1.5%	∞
RF Ambient Noise	±3.0%	R	$\sqrt{3}$	1	1	±1.7%	±1.7%	∞
RF Ambient Reflections	±3.0%	R	$\sqrt{3}$	1	1	±1.7%	±1.7%	∞
Probe Positioner	±0.8%	R	$\sqrt{3}$	1	1	±0.5%	±0.5%	∞
Probe Positioning	±9.9%	R	$\sqrt{3}$	1	1	±5.7%	±5.7%	∞
Max. SAR Eval.	±4.0%	R	$\sqrt{3}$	1	1	±2.3%	±2.3%	∞
Test Sample Related								
Device Positioning	±2.9%	N	1	1	1	±2.9%	±2.9%	145
Device Holder	±3.6%	N	1	1	1	±3.6%	±3.6%	5
Power Drift	±5.0%	R	$\sqrt{3}$	1	1	±2.9%	±2.9%	∞
Phantom and Setup								
Phantom Uncertainty	±4.0%	R	$\sqrt{3}$	1	1	±2.3%	±2.3%	∞
Liquid Conductivity (target)	±5.0%	R	$\sqrt{3}$	0.64	0.43	±1.8%	±1.2%	∞
Liquid Conductivity (meas.)	±2.5%	N	1	0.64	0.43	±1.6%	±1.1%	∞
Liquid Permittivity (target)	±5.0%	R	$\sqrt{3}$	0.6	0.49	±1.7%	±1.4%	∞
Liquid Permittivity (meas.)	±2.5%	N	1	0.6	0.49	±1.5%	±1.2%	∞
Combined Std. Uncertainty						±12.8%	±12.6%	330
Expanded STD Uncertainty						±25.6%	±25.2%	

Measurement uncertainty evaluation template for system repeatability

Measurement uncertainty for 30 MHz to 6 GHz averaged over 1 gram / 10 gram.

Error Description	Uncert. Value	Prob. Dist.	Div.	(ci) 1g	(ci) 10g	Std. Unc. (1g)	Std. Unc. (10g)	(vi) v _{eff}
Measurement System								
Probe Calibration	±6.5%	N	1	1	1	±6.5%	±6.5%	∞
Axial Isotropy	±4.7%	R	$\sqrt{3}$	0.7	0.7	±1.9%	±1.9%	∞
Hemispherical Isotropy	±9.6%	R	$\sqrt{3}$	0.7	0.7	±3.9%	±3.9%	∞
Boundary Effects	±2.0%	R	$\sqrt{3}$	0	0	±1.2%	±1.2%	∞
Linearity	±4.7%	R	$\sqrt{3}$	1	1	±2.7%	±2.7%	∞
Modulation Response	±2.4%	R	$\sqrt{3}$	0	0	±1.4%	±1.4%	∞
System Detection Limits	±1.0%	R	$\sqrt{3}$	0	0	±0.6%	±0.6%	∞
Readout Electronics	±0.3%	N	1	0	0	±0.3%	±0.3%	∞
Response Time	±0.8%	R	$\sqrt{3}$	0	0	±0.5%	±0.5%	∞
Integration Time	±2.6%	R	$\sqrt{3}$	0	0	±1.5%	±1.5%	∞
RF Ambient Noise	±3.0%	R	$\sqrt{3}$	0	0	±1.7%	±1.7%	∞
RF Ambient Reflections	±3.0%	R	$\sqrt{3}$	0	0	±1.7%	±1.7%	∞
Probe Positioner	±0.8%	R	$\sqrt{3}$	1	1	±0.5%	±0.5%	∞
Probe Positioning	±6.7%	R	$\sqrt{3}$	1	1	±3.9%	±3.9%	∞
Post-processing	±4.0%	R	$\sqrt{3}$	0	0	±2.3%	±2.3%	∞
Test Sample Related								
Test Sample Positioning	±2.9%	N	1	1	1	±2.9%	±2.9%	145
Device Holder	±3.6%	N	1	1	1	±3.6%	±3.6%	5
Power Drift	±0.0%	R	$\sqrt{3}$	1	1	±0.0%	±0.0%	∞
Power Scaling	±5.0%	R	$\sqrt{3}$	1	1	±2.9%	±2.9%	∞
Phantom and Setup								
Phantom Uncertainty	±7.9%	R	$\sqrt{3}$	1	1	±4.6%	±4.6%	∞
SAR correction	±1.9%	R	$\sqrt{3}$	1	1	±1.1%	±0.9%	∞
Liquid Conductivity (meas.)	±2.5%	N	1	0.78	0.71	±2.0%	±1.8%	∞
Liquid Permittivity (meas.)	±2.5%	N	1	0.26	0.26	±0.6%	±0.7%	∞
Temp. unc. - Conductivity	±5.2%	R	$\sqrt{3}$	0.78	0.71	±2.3%	±2.1%	∞
Temp. unc. - Permittivity	±0.8%	R	$\sqrt{3}$	0.23	0.26	±0.1%	±0.1%	∞
Combined Std. Uncertainty						±12.8%	±12.7%	748
Expanded STD Uncertainty						±25.6%	±25.4%	

8 CONDUCTED POWER MEASUREMENT

2.4GHz WLAN Duty Cycle

Test Mode	Tx On (ms)	Tx Off (ms)	Tx On + Tx Off (ms)	Duty Cycle (%)
802.11b	8.38	0.04	8.42	99.5
802.11g	1.38	0.06	1.44	95.8
802.11n(20MHz)	1.265	0.065	1.33	95.1
802.11n(40MHz)	0.624	0.057	0.681	91.6



5GHz WLAN Duty Cycle

Test Mode	Tx On (ms)	Tx Off (ms)	Tx On + Tx Off (ms)	Duty Cycle (%)
802.11a	1.380	0.055	1.435	96.17
802.11n(20MHz)	1.281	0.054	1.335	95.96
802.11n(40MHz)	0.624	0.054	0.678	92.04
802.11ac(20MHz)	1.290	0.070	1.360	94.85
802.11ac(40MHz)	0.642	0.057	0.699	91.85
802.11ac(80MHz)	0.292	0.076	0.368	79.35



802.11 ac(40MHz)



802.11 ac(80MHz)



Bluetooth Duty Cycle

Test Mode	Tx On (ms)	Tx Off (ms)	Tx On + Tx Off (ms)	Duty Cycle (%)
DH5	2.88	3.375	6.255	46.0
2DH5	2.865	3.39	6.255	45.8
3DH5	2.85	3.405	6.255	45.6
LE_1M	2.125	0.378	2.503	84.9

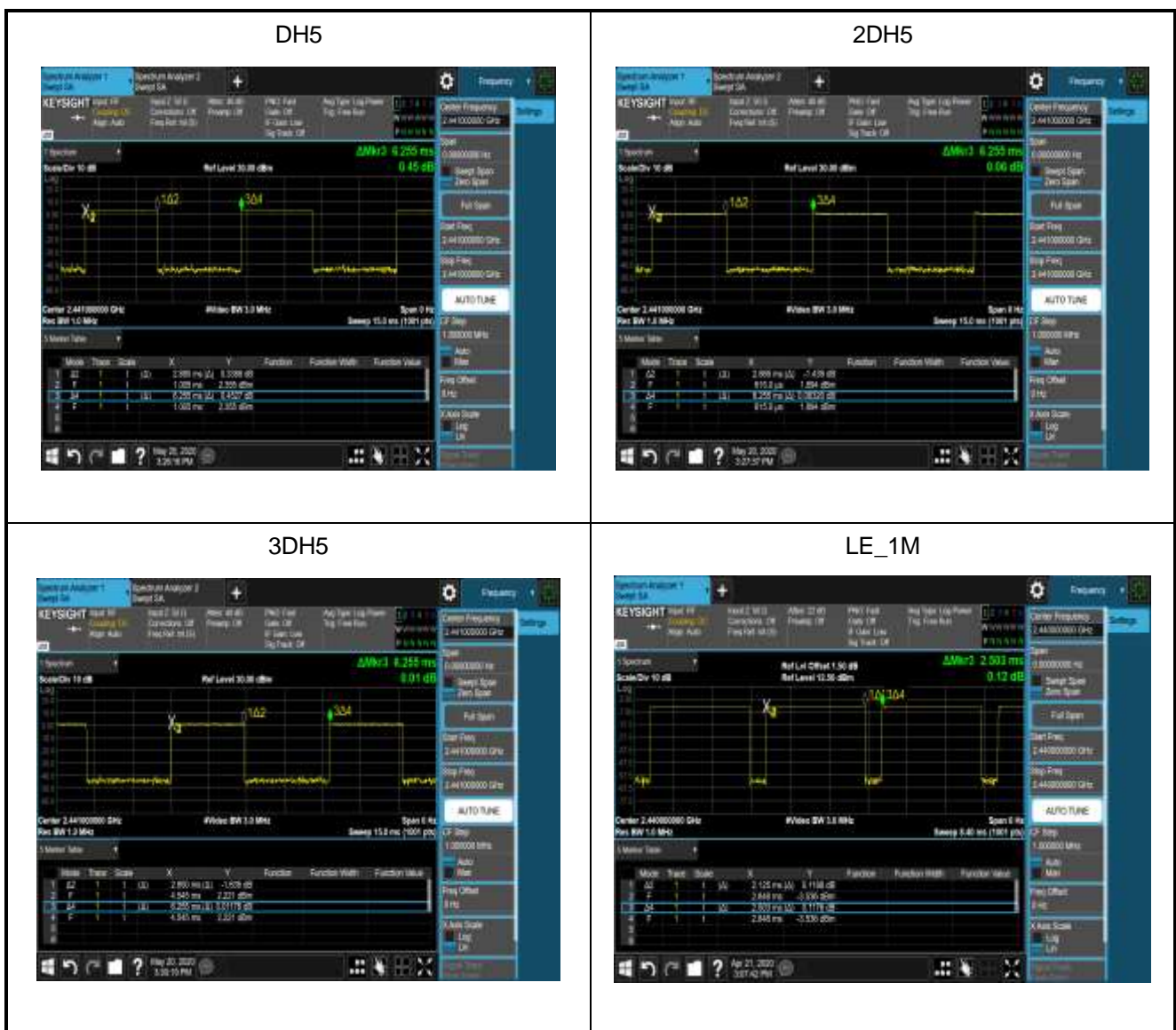

For 2.4G:

Test Mode	Test Conditions	Frequency (MHz)	Avg. Power (dBm)	Duty cycle (%)	Tune-up Power (dBm)	Scaling Factor
802.11b	Tnom (25°C)	2412	19.89	99.5	20.0	1.026
		2437	19.77	99.5	20.0	1.054
		2462	20.39	99.5	20.5	1.026
802.11g	Tnom (25°C)	2412	20.08	95.8	20.5	1.102
		2437	20.05	95.8	20.5	1.109
		2462	18.18	95.8	18.5	1.076
802.11n(20MHz)	Tnom (25°C)	2412	19.86	95.1	20.0	1.033
		2437	19.96	95.1	20.5	1.132
		2462	17.89	95.1	18.0	1.026
802.11n(40MHz)	Tnom (25°C)	2422	17.34	91.6	17.5	1.038
		2437	18.52	91.6	19.0	1.117
		2452	19.91	91.6	20.0	1.021

For 5G

Test Mode	Test Conditions	Frequency (MHz)	Avg. Power (dBm)	Duty cycle (%)	Tune-up Power (dBm)	Scaling Factor
802.11a	Tnom (25°C)	5180	17.03	96.17	17.5	1.114
		5220	17.71	96.17	18.0	1.069
		5240	17.85	96.17	18.0	1.035
		5260	19.32	96.17	19.5	1.042
		5300	19.37	96.17	19.5	1.030
		5320	17.53	96.17	18.0	1.114
		5500	18.69	96.17	19.0	1.074
		5580	17.71	96.17	18.0	1.069
		5700	18.17	96.17	18.5	1.079
		5745	17.34	96.17	17.5	1.038
		5785	17.12	96.17	17.5	1.091
		5825	16.19	96.17	16.5	1.074
802.11n(20MHz)	Tnom (25 °C)	5180	16.89	95.96	17.0	1.026
		5220	18.35	95.96	18.5	1.035
		5240	18.17	95.96	18.5	1.079
		5260	18.53	95.96	19.0	1.114
		5300	18.45	95.96	19.0	1.135
		5320	18.56	95.96	19.0	1.107
		5500	18.61	95.96	19.0	1.094
		5580	18.89	95.96	19.0	1.026
		5700	18.97	95.96	19.0	1.007
		5745	18.88	95.96	19.0	1.028
		5785	18.79	95.96	19.0	1.050
		5825	18.45	95.96	19.0	1.135
802.11n(40MHz)	Tnom (25 °C)	5190	15.01	92.04	15.5	1.119
		5230	17.31	92.04	17.5	1.045
		5270	17.48	92.04	18.0	1.127
		5310	16.48	92.04	17.0	1.127
		5510	17.28	92.04	17.5	1.052
		5550	17.34	92.04	17.5	1.038

		5670	17.89	92.04	18.0	1.026
		5755	17.89	92.04	18.0	1.026
		5795	17.74	92.04	18.0	1.062
802.11ac (20MHz)	Tnom (25°C)	5180	17.87	94.85	18.0	1.030
		5220	18.52	94.85	19.0	1.117
		5240	18.81	94.85	19.0	1.045
		5260	18.93	94.85	19.0	1.016
		5300	18.21	94.85	18.5	1.069
		5320	18.85	94.85	19.0	1.035
		5500	18.82	94.85	19.0	1.042
		5580	18.64	94.85	19.0	1.086
		5700	18.89	94.85	19.0	1.026
		5745	18.91	94.85	19.0	1.021
		5785	18.79	94.85	19.0	1.050
		5825	18.56	94.85	19.0	1.107
802.11ac (40MHz)	Tnom (25 °C)	5190	14.95	91.85	15.5	1.135
		5230	17.71	91.85	18.0	1.069
		5270	17.47	91.85	18.0	1.130
		5310	16.57	91.85	17.0	1.104
		5510	17.27	91.85	17.5	1.054
		5550	17.26	91.85	17.5	1.057
		5670	17.88	91.85	18.0	1.028
		5755	17.57	91.85	18.0	1.104
		5795	17.41	91.85	17.5	1.021
802.11ac (80MHz)	Tnom (25 °C)	5210	13.82	79.35	14.0	1.042
		5290	14.53	79.35	15.0	1.114
		5530	17.66	79.35	18.0	1.081
		5775	17.05	79.35	17.5	1.109

For BT

Test Mode	Test Conditions	Frequency (MHz)	Avg. Power (dBm)	Duty cycle (%)	Tune-up Power (dBm)	Scaling Factor
DH5	Tnom (25°C)	2402	7.34	46.0	7.5	1.038
		2441	8.69	46.0	9.0	1.074
		2480	8.13	46.0	8.5	1.089
2DH5	Tnom (25°C)	2402	6.35	45.8	7.0	1.161
		2441	8.04	45.8	8.5	1.112
		2480	7.52	45.8	8.0	1.117
3DH5	Tnom (25°C)	2402	6.37	45.6	6.5	1.030
		2441	8.20	45.6	8.5	1.072
		2480	7.59	45.6	8.0	1.099
LE_1M	Tnom (25°C)	2402	-5.68	84.9	-5.5	1.042
		2440	-3.02	84.9	-2.5	1.127
		2480	-3.70	84.9	-3.5	1.047

9 TEST PROCEDURES

9.1 SAR Test Results Summary

2.4GHz WLAN SAR Measurement									
Ambient Temperature (°C) : 21.5 ± 2					Relative Humidity (%) : 52				
Liquid Temperature (°C) : 21.0 ± 2					Depth of Liquid (cm):>15				
Product Name: Mobile Computer									
Body SAR: Spacing 10mm									
Test Mode	Side	Frequency (MHz)	Frame Power (dBm)	Power Drift (<±0.2)	SAR 1g (W/kg)	Scaling Factor	Duty factor	Scaled SAR 1g (W/kg)	Limit (W/kg)
802.11b	Side1	2462	20.39	-0.03	0.710	1.026	1.005	0.732	1.6
802.11b	Side2	2462	20.39	0.12	0.073	1.026	1.005	0.075	1.6
802.11b	Side3	2462	20.39	-0.1	0.288	1.026	1.005	0.297	1.6
802.11b	Side4	2462	20.39	0.15	0.046	1.026	1.005	0.047	1.6
802.11b	Front	2462	20.39	-0.04	0.570	1.026	1.005	0.588	1.6
802.11b	Back	2462	20.39	0.08	0.752	1.026	1.005	0.775	1.6
802.11b	Back	2412	19.89	0.06	0.761	1.026	1.005	0.785	1.6
802.11b	Back	2437	19.77	-0.15	0.606	1.054	1.005	0.642	1.6
802.11g	Back	2412	20.08	0.06	0.713	1.102	1.044	0.820	1.6
802.11g	Back	2437	20.05	-0.00	0.707	1.109	1.044	0.819	1.6
802.11g	Back	2462	18.18	-0.08	0.516	1.076	1.044	0.580	1.6
Head SAR									
802.11b	Touch-Left	2462	20.39	-0.17	0.624	1.026	1.005	0.643	1.6
802.11b	Touch-Right	2462	20.39	0.01	0.797	1.026	1.005	0.822	1.6
802.11b	Touch-Right	2412	19.89	-0.02	0.801	1.026	1.005	0.826	1.6
802.11b*	Touch-Right	2412	19.89	-0.02	0.788	1.026	1.005	0.813	1.6
802.11b	Touch-Right	2437	19.77	-0.08	0.790	1.054	1.005	0.837	1.6
802.11g	Touch-Right	2412	20.08	0.06	0.727	1.102	1.005	0.805	1.6
802.11g	Touch-Right	2437	20.05	-0.03	0.735	1.109	1.044	0.851	1.6
802.11g	Touch-Right	2462	18.18	-0.12	0.652	1.076	1.044	0.732	1.6
802.11b	Right-Tilt	2462	20.39	-0.03	0.538	1.026	1.005	0.555	1.6

5GHz WLAN SAR Measurement									
Ambient Temperature (°C) : 21.5 ± 2					Relative Humidity (%): 52				
Liquid Temperature (°C) : 21.0 ± 2					Depth of Liquid (cm):>15				
Product Name: Mobile Computer									
Body SAR: Spacing 10mm									
Test Mode	Side	Frequency (MHz)	Frame Power (dBm)	Power Drift (<±0.2)	SAR 1g (W/kg)	Scaling Factor	Duty factor	Scaled SAR 1g (W/kg)	Limit (W/kg)
802.11a	Side1	5240	17.85	0.03	0.127	1.035	1.040	0.137	1.6
802.11a	Side2	5240	17.85	0.16	0.128	1.035	1.040	0.138	1.6
802.11a	Side3	5240	17.85	0.09	0.740	1.035	1.040	0.797	1.6
802.11a	Side4	5240	17.85	-0.16	0.073	1.035	1.040	0.079	1.6
802.11a	Front	5240	17.85	-0.08	0.348	1.035	1.040	0.375	1.6
802.11a	Back	5240	17.85	-0.17	0.307	1.035	1.040	0.330	1.6
802.11a	Side1	5300	19.37	0.11	0.207	1.030	1.040	0.222	1.6
802.11a	Side2	5300	19.37	-0.02	0.203	1.030	1.040	0.217	1.6
802.11a	Side3	5300	19.37	0.04	0.735	1.030	1.040	0.787	1.6
802.11a	Side4	5300	19.37	-0.06	0.114	1.030	1.040	0.122	1.6
802.11a	Front	5300	19.37	-0.07	0.396	1.030	1.040	0.424	1.6
802.11a	Back	5300	19.37	-0.05	0.301	1.030	1.040	0.322	1.6
802.11a	Side3	5220	17.71	0.04	0.709	1.069	1.040	0.788	1.6
802.11a	Side3	5500	18.69	-0.10	0.728	1.074	1.040	0.813	1.6
802.11a	Side3	5745	17.34	-0.16	0.720	1.038	1.040	0.777	1.6
802.11ac (80MHz)	Side3	5530	17.66	-0.1	0.716	1.081	1.260	0.975	1.6
Head SAR									
802.11a	Touch-Left	5240	17.85	-0.12	0.808	1.035	1.040	0.870	1.6
802.11a*	Touch-Left	5240	17.85	-0.00	0.785	1.035	1.040	0.845	1.6
802.11a	Touch-Right	5240	17.85	-0.08	0.704	1.035	1.040	0.758	1.6
802.11a	Touch-Left	5220	17.71	-0.04	0.604	1.069	1.040	0.672	1.6
802.11a	Touch-Left	5300	19.37	0.08	0.806	1.030	1.040	0.863	1.6
802.11a	Touch-Right	5300	19.37	0.17	0.725	1.030	1.040	0.777	1.6
802.11a	Touch-Left	5500	18.69	0.03	0.606	1.074	1.040	0.677	1.6

802.11a	Touch-Left	5745	17.34	0.12	0.507	1.038	1.040	0.547	1.6
802.11ac (80MHz)	Touch-Left	5530	17.66	-0.19	0.531	1.081	1.260	0.723	1.6
802.11a	Left-Tilt	5240	17.85	0.12	0.548	1.035	1.040	0.590	1.6

Bluetooth SAR Measurement								
Ambient Temperature (°C) : 21.5 ± 2				Relative Humidity (%): 52				
Liquid Temperature (°C) : 21.0 ± 2				Depth of Liquid (cm):>15				
Product Name: Mobile Computer								
Body SAR: Spacing 10mm								
Test Mode	Side	Frequency (MHz)	Frame Power (dBm)	Power Drift (<±0.2)	SAR 1g (W/kg)	Scaling Factor	Scaled SAR 1g (W/kg)	Limit (W/kg)
DH5	Back	2441	8.69	0.19	0.045	1.074	0.048	1.6
Head SAR								
DH5	Touch Right	2441	8.69	0.06	0.045	1.074	0.048	1.6
DH5	Touch Left	2441	8.69	0.15	0.027	1.074	0.029	1.6

Limb SAR Measurement									
Ambient Temperature (°C) : 21.5 ± 2					Relative Humidity (%): 52				
Liquid Temperature (°C) : 21.0 ± 2					Depth of Liquid (cm):>15				
Product Name: Mobile Computer									
2.4GHz WLAN Limb SAR: Spacing 0mm									
Test Mode	Side	Frequency (MHz)	Frame Power (dBm)	Power Drift (<±0.2)	SAR 10g (W/kg)	Scaling Factor	Duty factor	Scaled SAR 10g (W/kg)	Limit (W/kg)
802.11b	Side1	2462	20.39	0.01	0.815	1.026	1.005	0.840	4.0
802.11b	Side2	2462	20.39	-0.13	0.073	1.026	1.005	0.075	4.0
802.11b	Side3	2462	20.39	-0.08	0.270	1.026	1.005	0.278	4.0
802.11b	Side4	2462	20.39	-0.12	0.031	1.026	1.005	0.032	4.0
802.11b	Front	2462	20.39	0.06	0.293	1.026	1.005	0.302	4.0
802.11b	Back	2462	20.39	-0.16	0.589	1.026	1.005	0.607	4.0
802.11g	Back	2412	20.08	0.09	0.827	1.102	1.044	0.951	4.0
802.11g	Back	2437	20.05	0.09	0.853	1.109	1.044	0.988	4.0
802.11g*	Back	2437	20.05	0.01	0.847	1.109	1.044	0.981	4.0
802.11g	Back	2462	18.18	0.01	0.473	1.076	1.044	0.531	4.0
5GHz WLAN Limb SAR: Spacing 0mm									
802.11a	Side1	5300	19.37	0.13	0.074	1.030	1.040	0.079	4.0
802.11a	Side2	5300	19.37	-0.05	0.053	1.030	1.040	0.057	4.0
802.11a	Side3	5300	19.37	-0.16	0.745	1.030	1.040	0.798	4.0
802.11a	Side4	5300	19.37	0.11	0.098	1.030	1.040	0.105	4.0
802.11a	Front	5300	19.37	0.18	0.530	1.030	1.040	0.568	4.0
802.11a	Back	5300	19.37	0.15	0.484	1.030	1.040	0.518	4.0
802.11ac (80MHz)	Side3	5530	17.66	0.04	0.522	1.081	1.260	0.711	4.0

SAR Measurement						
Ambient Temperature (°C) : 21.5 ± 2				Relative Humidity (%): 52		
Liquid Temperature (°C) : 21.0 ± 2				Depth of Liquid (cm):>15		
Product Name: Mobile Computer						
Head SAR						
Test Mode	Side	Frequency (MHz)	Scaled SAR 1g (W/kg)	ΔSAR	Corrected SAR 1g (W/kg)	Limit (W/kg)
802.11b	Touch-Left	2462	0.643	-0.98	0.649	1.6
802.11b	Touch-Right	2462	0.822	-0.98	0.830	1.6
802.11b	Touch-Right	2412	0.826	-0.71	0.832	1.6
802.11b*	Touch-Right	2412	0.813	-0.71	0.819	1.6
802.11b	Touch-Right	2437	0.837	-0.99	0.845	1.6
802.11g	Touch-Right	2412	0.805	-0.71	0.811	1.6
802.11g	Touch-Right	2437	0.851	-0.99	0.859	1.6
802.11g*	Touch-Right	2437	0.835	-0.99	0.843	1.6
802.11g	Touch-Right	2462	0.732	-0.98	0.739	1.6
802.11b	Right-Tilt	2462	0.555	-0.98	0.560	1.6
DH5	Touch Right	2441	0.048	-1.00	0.048	1.6
DH5	Touch Left	2441	0.029	-1.00	0.029	1.6
802.11a	Touch-Left	5240	0.870	-0.13	0.871	1.6
802.11a*	Touch-Left	5240	0.845	-0.13	0.846	1.6
802.11a	Touch-Right	5240	0.758	-0.13	0.759	1.6
802.11a	Touch-Left	5220	0.672	-0.14	0.673	1.6
802.11a	Touch-Left	5300	0.863	-0.12	0.864	1.6
802.11a	Touch-Right	5300	0.777	-0.12	0.778	
802.11a	Touch-Left	5500	0.677	-0.09	0.678	1.6
802.11a	Touch-Left	5745	0.547	-0.04	0.547	1.6
802.11ac (80MHz)	Touch-Left	5530	0.723	-0.06	0.723	1.6
802.11a	Left-Tilt	5240	0.590	-0.13	0.591	1.6
Body SAR: Spacing 10mm						
802.11b	Side1	2462	0.732	-0.27	0.734	1.6
802.11b	Side2	2462	0.075	-0.27	0.075	1.6

802.11b	Side3	2462	0.297	-0.27	0.298	1.6
802.11b	Side4	2462	0.047	-0.27	0.047	1.6
802.11b	Front	2462	0.588	-0.27	0.590	1.6
802.11b	Back	2462	0.775	-0.27	0.777	1.6
802.11b	Back	2437	0.642	-0.03	0.642	1.6
802.11g	Back	2437	0.819	-0.03	0.819	1.6
802.11g	Back	2462	0.580	-0.27	0.582	1.6
DH5	Back	2441	0.048	-0.28	0.048	1.6
Limb SAR						
802.11b	Side1	2462	0.840	-0.27	0.842	4.0
802.11b	Side2	2462	0.075	-0.27	0.075	4.0
802.11b	Side3	2462	0.278	-0.27	0.279	4.0
802.11b	Side4	2462	0.032	-0.27	0.032	4.0
802.11b	Front	2462	0.302	-0.27	0.303	4.0
802.11b	Back	2462	0.607	-0.27	0.609	4.0
802.11g	Back	2437	0.988	-0.03	0.988	4.0
802.11g*	Back	2437	0.981	-0.03	0.981	4.0
802.11g	Back	2462	0.531	-0.27	0.532	4.0

Note: 1: When the reported SAR of the initial test position is > 0.4 W/kg, on the highest maximum output power channel, until the reported SAR is ≤ 0.8 W/kg or all required test positions (Front, Back and Edges) are tested.

2: For all positions/configurations tested using the initial test position and subsequent test positions, when the reported SAR is > 0.8 W/kg, SAR is measured for these test positions/configurations on the subsequent next highest measured output power channel(s) until the reported SAR is ≤ 1.2 W/kg or all required channels are tested.

3: Reported SAR were scaled to the maximum duty factor to demonstrate compliance per FCC KDB 248227 D01 802.11 Wi-Fi SAR v02r02.

4: Tissue correction is only applied when the Δ SAR is negative value according to NOTICE 2012-DRS0529.

5: * - repeated at the highest measured SAR according to the FCC KDB 865664, Because the ratio of largest to smallest SAR for the original and first repeated measurements is < 1.20, there is no need to second repeated measurement.

1) Repeated measurement is not required when the original highest measured SAR is < 0.80 W/kg; steps through 4) do not apply

2) When the original highest measured SAR is ≥ 0.80 W/kg, repeat that measurement once.

- 3) Perform a second repeated measurement only if the ratio of largest to smallest SAR for the original and first repeated measurements is > 1.20 or when the original or repeated measurement is ≥ 1.45 W/kg (~ 10% from the 1-g SAR limit).
- 4) Perform a third repeated measurement only if the original, first or second repeated measurement is ≥ 1.5 W/kg and the ratio of largest to smallest SAR for the original, first and second repeated measurements is > 1.20

Test Mode	Test Position	Frequency (MHz)	Measured SAR 1g (W/kg)	1st Repeated SAR 1g (W/kg)	Ratio	2nd Repeated SAR 1g (W/kg)	3rd Repeated SAR 1g (W/kg)
802.11b	Touch Right	2412	0.801	0.788	1.02	N/A	N/A
802.11a	Touch Left	5240	0.808	0.785	1.03	N/A	N/A

Test Mode	Test Position	Frequency (MHz)	Spacing	Measured SAR 10g (W/kg)	1st Repeated SAR 10g (W/kg)	Ratio	2nd Repeated SAR 1g (W/kg)	3rd Repeated SAR 1g (W/kg)
802.11g	Back	2437	0mm	0.853	0.847	1.01	N/A	N/A

9.2 Simultaneous Transmission Analysis

N/A

9.3 Test position and configuration

1. Liquid tissue depth was at least 15.0 cm for all frequencies.
2. The manufacturer has confirmed that the device(s) tested have the same physical, mechanical and thermal characteristics and are within operational tolerances expected for production units.
3. SAR results were scaled to the maximum allowed power to demonstrate compliance per FCC KDB Publication 447498 D01v06.
4. Reported SAR were scaled to the maximum duty factor to demonstrate compliance per FCC KDB 248227 D01 802.11 Wi-Fi SAR v02r02.
5. SAR was performed with the device configured in the positions according to KDB 447498 D01 SAR Procedures for general, Body SAR was performed with the device to phantom separation distance of 10mm.
6. SAR was performed with the device configured in the positions according to KDB 447498 D01 SAR Procedures for general, Limb SAR was performed with the device to phantom separation distance of 0mm.
7. Because of the Hand-head device, so addition tests are performed at three positions (Front, Back, Edges).

WLAN Notes:

When the maximum extrapolated peak SAR of the zoom scan for the maximum output channel is <1.6 W/kg and the reported 1g averaged SAR is <0.8 W/kg, SAR testing on other default channels is not required.

Appendix A. SAR System Validation Data

Date/Time: 05/14/2020

Test Laboratory: DEKRA Lab

System Check body 2450MHz

DUT: Dipole 2450 MHz D2450V2; Type: D2450V2

Communication System: UID 0, CW; Communication System Band: D2450(2450MHz); Duty Cycle: 1:1;

Frequency: 2450 MHz; Medium parameters used: $f = 2450$ MHz; $\sigma = 1.96$ S/m; $\epsilon_r = 52.8$; $\rho = 1000$ kg/m³ ;

Phantom section: Flat Section ; Input Power=250mW

Ambient temperature (°C): 21.5, Liquid temperature (°C): 21.0

DASY5 Configuration:

- Probe: EX3DV4 - SN3710; ConvF(7.37, 7.37, 7.37); Calibrated: 21/04/2020;
- Sensor-Surface: 4mm (Mechanical Surface Detection)
- Electronics: DAE4 Sn915; Calibrated: 13/06/2019
- Phantom: ELI1; Type: QDOVA002AA; Serial: TP:2106
- Measurement SW: DASY52, Version 52.8 (8); SEMCAD X Version 14.6.10 (7331)

Configuration/System Check body 2450MHz/Area Scan (7x11x1): Measurement grid: dx=10mm, dy=10mm; Maximum value of SAR (measured) = 14.7 W/kg

Configuration/System Check body 2450MHz/Zoom Scan (7x7x7)/Cube 0: Measurement grid: dx=5mm, dy=5mm, dz=5mm; Reference Value = 85.12 V/m; Power Drift = 0.07 dB

Peak SAR (extrapolated) = 30.6 W/kg

SAR(1 g) = 13.2 W/kg; SAR(10 g) = 6.05 W/kg; Maximum value of SAR (measured) = 17.5 W/kg

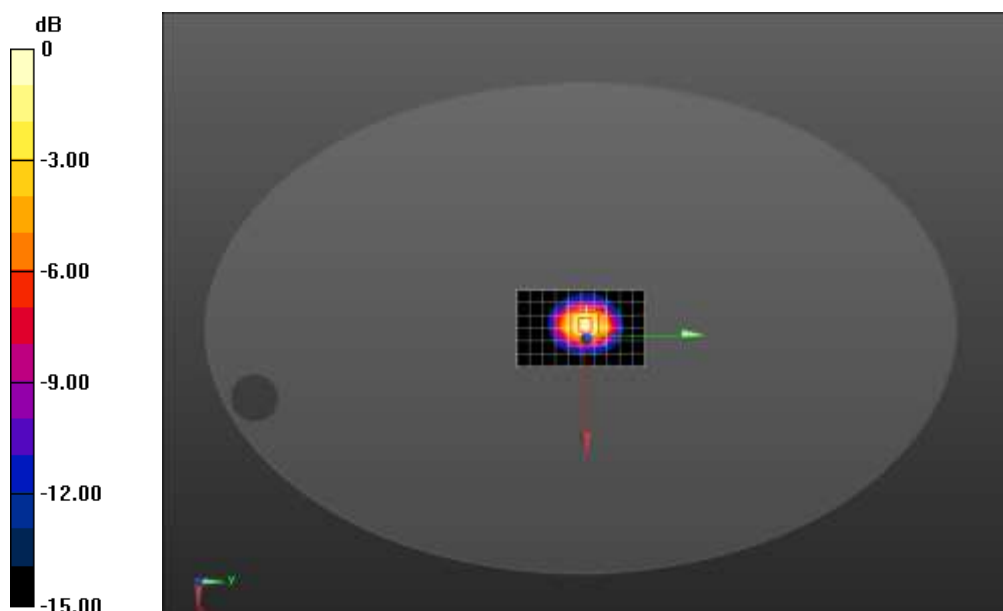

0 dB = 17.5 W/kg = 12.43 dBW/kg

Date/Time: 05/14/2020

Test Laboratory: DEKRA Lab

System Check Body 5250MHz

DUT: Dipole D5GHzV2; Type: D5GHzV2

Communication System: UID 0, CW (0); Communication System Band: 5GHz(5000.0-6000.0MHz); Duty Cycle: 1:1; Frequency: 5250 MHz; Medium parameters used: $f = 5250$ MHz; $\sigma = 5.27$ S/m; $\epsilon_r = 47.88$; $\rho = 1000$ kg/m³; Phantom section: Flat Section; Input Power=100mW

Ambient temperature (°C): 21.5, Liquid temperature (°C): 21.0

DASY5 Configuration:

- Probe: EX3DV4 - SN3710; ConvF(4.57, 4.57, 4.57); Calibrated: 21/04/2020;
- Sensor-Surface: 4mm (Mechanical Surface Detection)
- Electronics: DAE4 Sn915; Calibrated: 13/06/2019
- Phantom: ELI1; Type: QDOVA002AA; Serial: TP:2106
- Measurement SW: DASY52, Version 52.8 (8); SEMCAD X Version 14.6.10 (7331)

Configuration/System Check Body 5250MHz/Area Scan (6x8x1): Measurement grid: dx=10mm, dy=10mm; Maximum value of SAR (measured) = 7.74 W/kg

Configuration/System Check Body 5250MHz/Zoom Scan (7x7x7)/Cube 0: Measurement grid: dx=5mm, dy=5mm, dz=5mm; Reference Value = 44.32 V/m; Power Drift = 0.03 dB

Peak SAR (extrapolated) = 67.8 W/kg

SAR(1 g) = 7.69 W/kg; SAR(10 g) = 2.01 W/kg

Maximum value of SAR (measured) = 11.5 W/kg

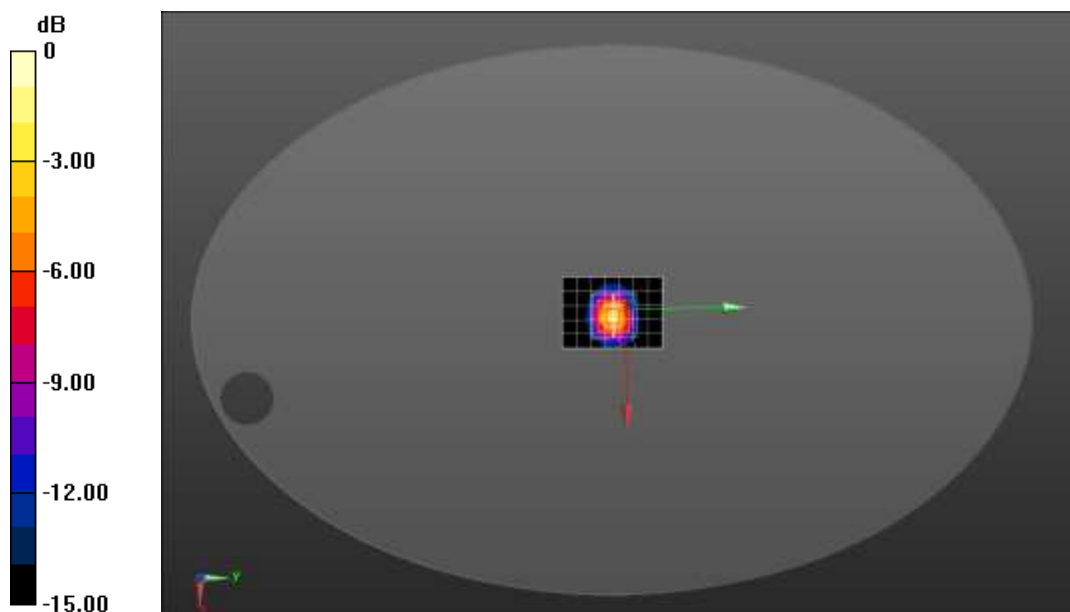

0 dB = 11.5 W/kg = 10.61 dBW/kg

Date/Time: 05/14/2020

Test Laboratory: DEKRA Lab

System Check Body 5600MHz

DUT: Dipole D5GHzV2; Type: D5GHzV2

Communication System: UID 0, CW (0); Communication System Band: 5GHz(5000.0-6000.0MHz); Duty Cycle: 1:1; Frequency: 5600 MHz; Medium parameters used: $f = 5600$ MHz; $\sigma = 5.93$ S/m; $\epsilon_r = 46.98$; $\rho = 1000$ kg/m³; Phantom section: Flat Section; Input Power=100mW

Ambient temperature (°C): 21.5, Liquid temperature (°C): 21.0

DASY5 Configuration:

- Probe: EX3DV4 - SN3710; ConvF(3.98, 3.98, 3.98); Calibrated: 21/04/2020;
- Sensor-Surface: 4mm (Mechanical Surface Detection)
- Electronics: DAE4 Sn915; Calibrated: 13/06/2019
- Phantom: ELI1; Type: QDOVA002AA; Serial: TP:2106
- Measurement SW: DASY52, Version 52.8 (8); SEMCAD X Version 14.6.10 (7331)

Configuration/System Check Body 5600MHz/Area Scan (6x8x1): Measurement grid: dx=10mm, dy=10mm; Maximum value of SAR (measured) = 9.58 W/kg

Configuration/System Check Body 5600MHz/Zoom Scan (7x7x7)/Cube 0: Measurement grid: dx=5mm, dy=5mm, dz=5mm; Reference Value = 39.78 V/m; Power Drift = 0.01 dB

Peak SAR (extrapolated) = 29.6 W/kg

SAR(1 g) = 7.94 W/kg; SAR(10 g) = 2.2 W/kg

Maximum value of SAR (measured) = 11.3 W/kg

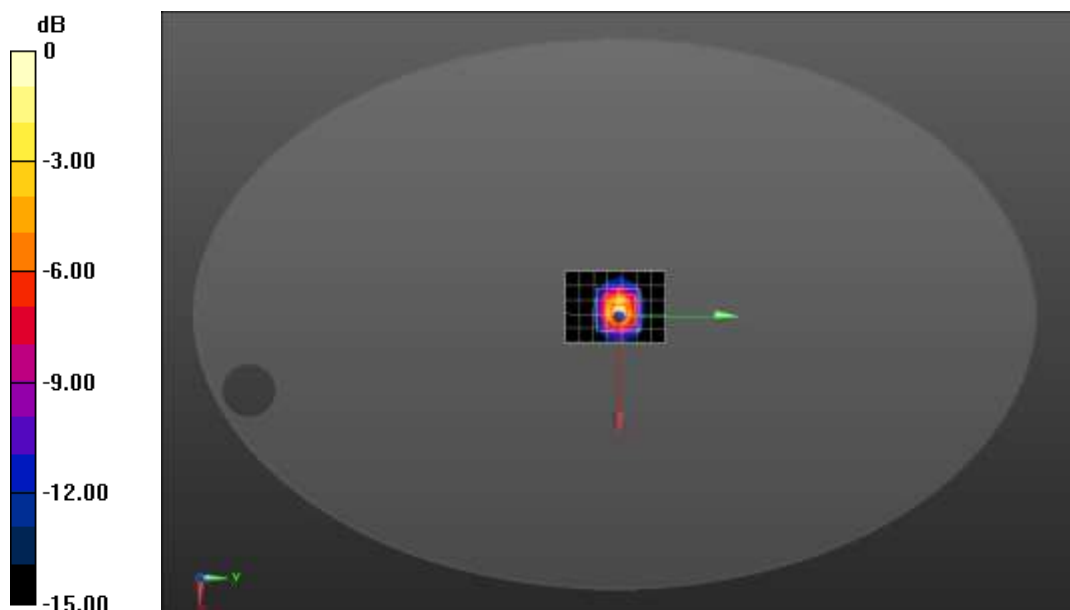

0 dB = 11.3 W/kg = 10.53 dBW/kg

Date/Time: 05/14/2020

Test Laboratory: DEKRA Lab

System Check Body 5750MHz

DUT: Dipole D5GHzV2; Type: D5GHzV2

Communication System: UID 0, CW (0); Communication System Band: 5GHz(5000.0-6000.0MHz); Duty Cycle: 1:1; Frequency: 5750 MHz; Medium parameters used: $f = 5750$ MHz; $\sigma = 6.01$ S/m; $\epsilon_r = 46.89$; $\rho = 1000$ kg/m³; Phantom section: Flat Section; Input Power=100mW

Ambient temperature (°C): 21.5, Liquid temperature (°C): 21.0

DASY5 Configuration:

- Probe: EX3DV4 - SN3710; ConvF(4.01, 4.01, 4.01); Calibrated: 21/04/2020;
- Sensor-Surface: 4mm (Mechanical Surface Detection)
- Electronics: DAE4 Sn915; Calibrated: 13/06/2019
- Phantom: ELI1; Type: QDOVA002AA; Serial: TP:2106
- Measurement SW: DASY52, Version 52.8 (8); SEMCAD X Version 14.6.10 (7331)

Configuration/System Check Body 5750MHz/Area Scan (6x8x1): Measurement grid: dx=10mm, dy=10mm; Maximum value of SAR (measured) = 9.60 W/kg

Configuration/System Check Body 5750MHz/Zoom Scan (7x7x7)/Cube 0: Measurement grid: dx=5mm, dy=5mm, dz=5mm; Reference Value = 39.01 V/m; Power Drift = 0.19 dB

Peak SAR (extrapolated) = 29.1 W/kg

SAR(1 g) = 7.75 W/kg; SAR(10 g) = 2.09 W/kg

Maximum value of SAR (measured) = 10.9 W/kg

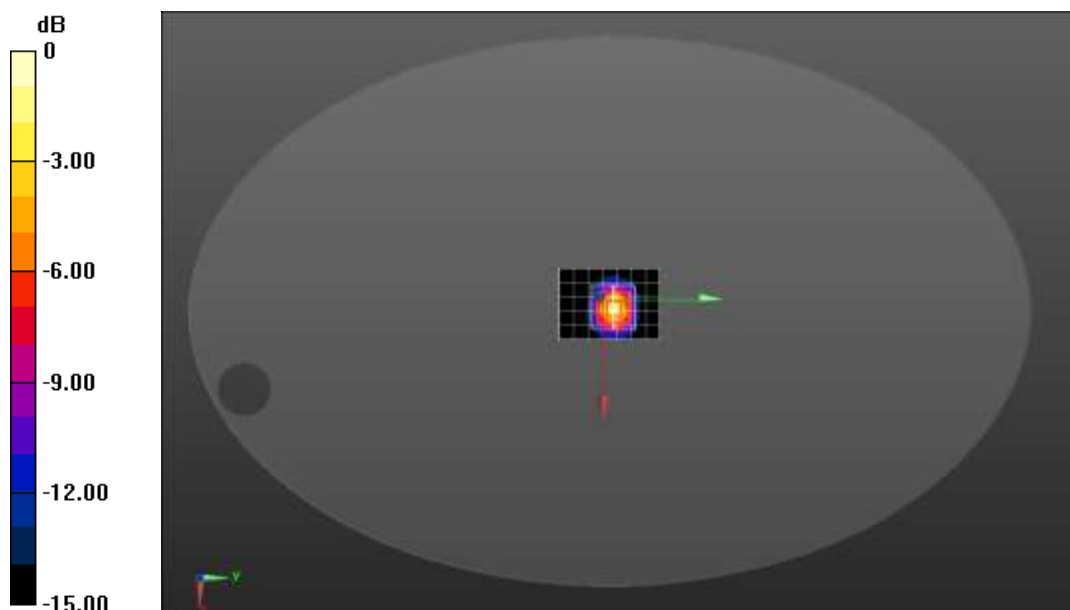

0 dB = 10.9 W/kg = 10.37 dBW/kg

Date/Time: 05/12/2020

Test Laboratory: DEKRA Lab

System Check Head 2450MHz

DUT: Dipole 2450 MHz D2450V2; Type: D2450V2

Communication System: UID 0, CW; Communication System Band: D2450(2450MHz); Duty Cycle: 1:1;

Frequency: 2450 MHz; Medium parameters used: $f = 2450$ MHz; $\sigma = 1.8$ S/m; $\epsilon_r = 40.9$; $\rho = 1000$ kg/m³ ;

Phantom section: Flat Section ; Input Power=250mW

Ambient temperature (°C): 21.5, Liquid temperature (°C): 21.0

DASY5 Configuration:

- Probe: EX3DV4 - SN3710; ConvF(7.42, 7.42, 7.42); Calibrated: 21/04/2020;
- Sensor-Surface: 4mm (Mechanical Surface Detection)
- Electronics: DAE4 Sn915; Calibrated: 13/06/2019
- Phantom: SAM2; Type: SAM; Serial: TP1562
- Measurement SW: DASY52, Version 52.8 (8); SEMCAD X Version 14.6.10 (7331)

Configuration/System Check Body 2450MHz/Area Scan (7x11x1): Measurement grid: dx=10mm, dy=10mm; Maximum value of SAR (measured) = 13.9 W/kg

Configuration/System Check Body 2450MHz/Zoom Scan (7x7x7)/Cube 0: Measurement grid: dx=5mm, dy=5mm, dz=5mm; Reference Value = 64.56 V/m; Power Drift = 0.13 dB

Peak SAR (extrapolated) = 28.1 W/kg

SAR(1 g) = 12.7 W/kg; SAR(10 g) = 5.66 W/kg

Maximum value of SAR (measured) = 14.4 W/kg

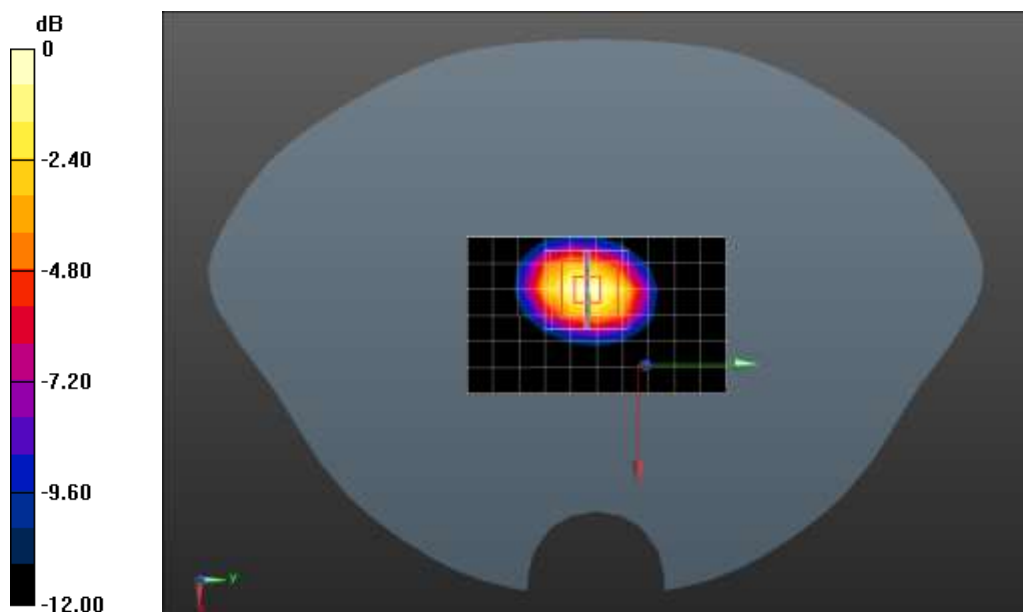

0 dB = 14.4 W/kg = 11.58 dBW/kg

Date/Time: 05/12/2020

Test Laboratory: DEKRA Lab

System Check Head 5250MHz

DUT: Dipole D5GHzV2; Type: D5GHzV2

Communication System: UID 0, CW (0); Communication System Band: 5GHz(5000.0-6000.0MHz); Duty

Cycle: 1:1; Frequency: 5250 MHz; Medium parameters used: $f = 5250$ MHz; $\sigma = 4.56$ S/m; $\epsilon_r = 36.1$; $\rho = 1000$ kg/m³ ; Phantom section: Flat Section ; Input Power=100mW

Ambient temperature (°C): 21.5, Liquid temperature (°C): 21.0

DASY5 Configuration:

- Probe: EX3DV4 - SN3710; ConvF(5.18, 5.18, 5.18); Calibrated: 21/04/2020;
- Sensor-Surface: 4mm (Mechanical Surface Detection)
- Electronics: DAE4 Sn915; Calibrated: 13/06/2019
- Phantom: SAM2; Type: SAM; Serial: TP1562
- Measurement SW: DASY52, Version 52.8 (8); SEMCAD X Version 14.6.10 (7331)

Configuration/System Check Head 5250MHz/Area Scan (6x8x1): Measurement grid: dx=10mm, dy=10mm; Maximum value of SAR (measured) = 11.1 W/kg

Configuration/System Check Head 5250MHz/Zoom Scan (7x7x7)/Cube 0: Measurement grid: dx=5mm, dy=5mm, dz=5mm; Reference Value = 50.03 V/m; Power Drift = -0.07 dB

Peak SAR (extrapolated) = 93.1 W/kg

SAR(1 g) = 7.4 W/kg; SAR(10 g) = 2.05 W/kg

Maximum value of SAR (measured) = 13.1 W/kg

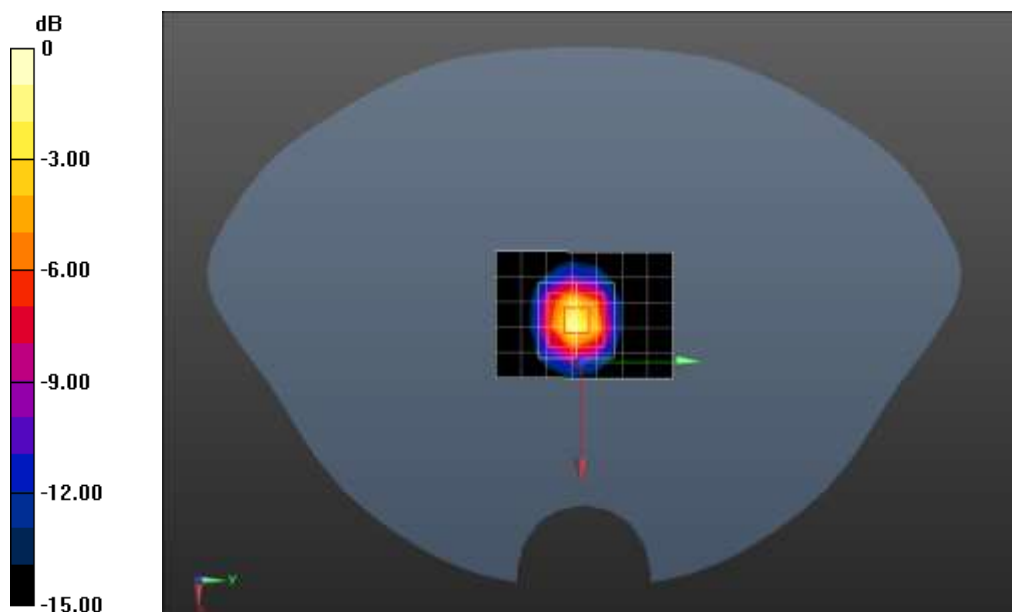

0 dB = 13.1 W/kg = 11.17 dBW/kg

Date/Time: 05/12/2020

Test Laboratory: DEKRA Lab

System Check Head 5600MHz

DUT: Dipole D5GHzV2; Type: D5GHzV2

Communication System: UID 0, CW (0); Communication System Band: 5GHz(5000.0-6000.0MHz); Duty Cycle: 1:1; Frequency: 5600 MHz; Medium parameters used: $f = 5600$ MHz; $\sigma = 4.96$ S/m; $\epsilon_r = 35.52$; $\rho = 1000$ kg/m³; Phantom section: Flat Section; Input Power=100mW

Ambient temperature (°C): 21.5, Liquid temperature (°C): 21.0

DASY5 Configuration:

- Probe: EX3DV4 - SN3710; ConvF(4.66, 4.66, 4.66); Calibrated: 21/04/2020;
- Sensor-Surface: 4mm (Mechanical Surface Detection)
- Electronics: DAE4 Sn915; Calibrated: 13/06/2019
- Phantom: SAM2; Type: SAM; Serial: TP1562
- Measurement SW: DASY52, Version 52.8 (8); SEMCAD X Version 14.6.10 (7331)

Configuration/System Check Head 5600MHz/Area Scan (6x8x1): Measurement grid: dx=10mm, dy=10mm; Maximum value of SAR (measured) = 8.08 W/kg

Configuration/System Check Head 5600MHz/Zoom Scan (7x7x7)/Cube 0: Measurement grid: dx=5mm, dy=5mm, dz=5mm; Reference Value = 37.22 V/m; Power Drift = -0.02 dB

Peak SAR (extrapolated) = 23.7 W/kg

SAR(1 g) = 7.25 W/kg; SAR(10 g) = 2.12 W/kg

Maximum value of SAR (measured) = 9.03 W/kg

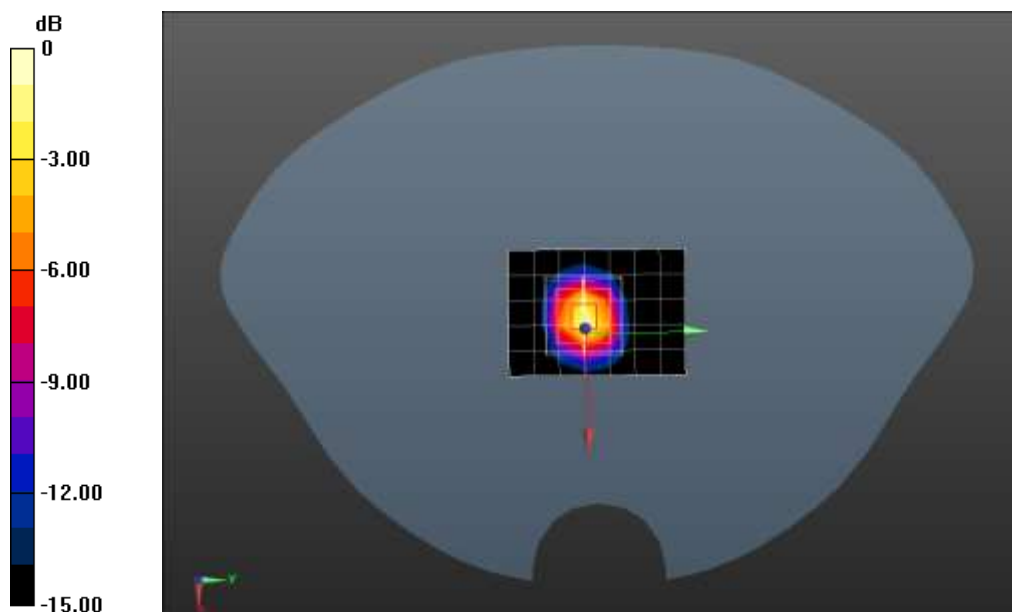

0 dB = 9.03 W/kg = 9.56 dBW/kg

Date/Time: 05/12/2020

Test Laboratory: DEKRA Lab

System Check Head 5750MHz

DUT: Dipole D5GHzV2; Type: D5GHzV2

Communication System: UID 0, CW (0); Communication System Band: 5GHz(5000.0-6000.0MHz); Duty Cycle: 1:1; Frequency: 5750 MHz; Medium parameters used: $f = 5750$ MHz; $\sigma = 5.14$ S/m; $\epsilon_r = 35.23$; $\rho = 1000$ kg/m³; Phantom section: Flat Section; Input Power=100mW

Ambient temperature (°C): 21.5, Liquid temperature (°C): 21.0

DASY5 Configuration:

- Probe: EX3DV4 - SN3710; ConvF(4.77, 4.77, 4.77); Calibrated: 21/04/2020;
- Sensor-Surface: 2mm (Mechanical Surface Detection)
- Electronics: DAE4 Sn915; Calibrated: 13/06/2019
- Phantom: SAM2; Type: SAM; Serial: TP1562
- Measurement SW: DASY52, Version 52.8 (8); SEMCAD X Version 14.6.10 (7331)

Configuration/Head 5750MHz/Area Scan (5x8x1): Measurement grid: dx=10mm, dy=10mm

Maximum value of SAR (measured) = 16.2 W/kg

Configuration/Head 5750MHz/Zoom Scan (8x8x10)/Cube 0: Measurement grid: dx=4mm, dy=4mm, dz=2.5mm; Reference Value = 35.82 V/m; Power Drift = -0.06 dB

Peak SAR (extrapolated) = 35.4 W/kg

SAR(1 g) = 7.98 W/kg; SAR(10 g) = 2.21 W/kg

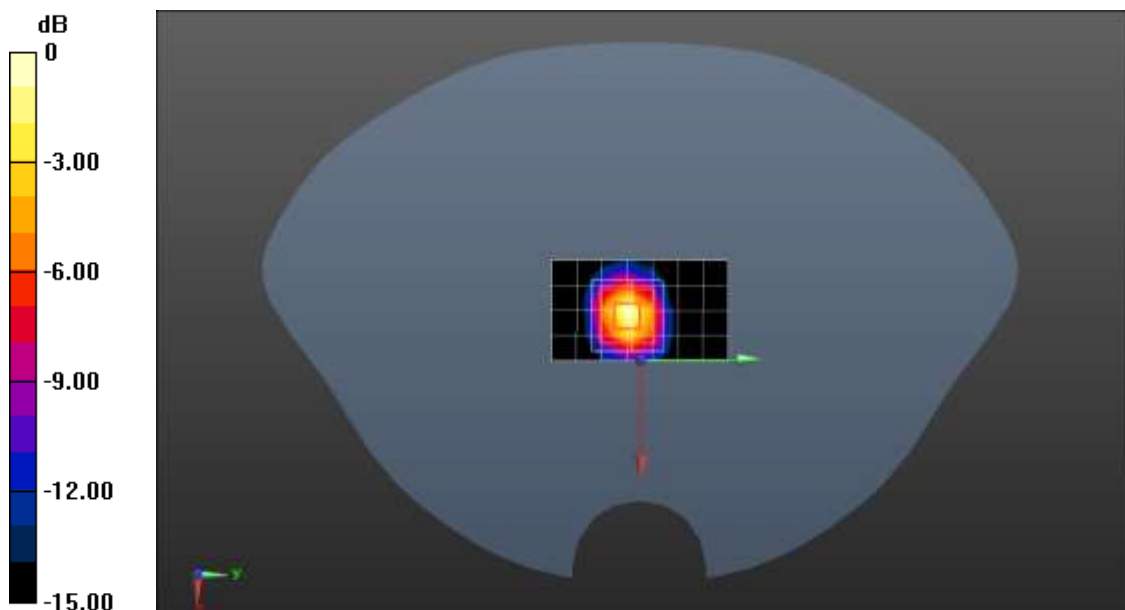

0 dB = 16.2 W/kg = 12.10 dBW/kg

Appendix B. SAR measurement Data

Date/Time: 05/14/2020

Test Laboratory: DEKRA Lab

802.11b 2462MHz body-side1

DUT: Mobile Computer; Type: MEMOR K

Communication System: UID 0, Wi-Fi (0); Communication System Band: 802.11b; Duty Cycle: 1:1.0;

Frequency: 2462 MHz; Medium parameters used: $f = 2462$ MHz; $\sigma = 1.96$ S/m; $\epsilon_r = 52.74$; $\rho = 1000$ kg/m³ ;

Phantom section: Flat Section

Ambient temperature (°C): 21.5, Liquid temperature (°C): 21.0

DASY5 Configuration:

- Probe: EX3DV4 - SN3710; ConvF(7.37, 7.37, 7.37); Calibrated: 21/04/2020;
- Sensor-Surface: 4mm (Mechanical Surface Detection)
- Electronics: DAE4 Sn915; Calibrated: 13/06/2019
- Phantom: ELI1; Type: QDOVA002AA; Serial: TP:2106
- Measurement SW: DASY52, Version 52.8 (8); SEMCAD X Version 14.6.10 (7331)

Configuration/802.11b 2462MHz body-side1/Area Scan (8x11x1): Measurement grid: dx=12mm, dy=12mm; Maximum value of SAR (measured) = 0.890 W/kg

Configuration/802.11b 2462MHz body-side1/Zoom Scan (5x5x7)/Cube 0: Measurement grid: dx=8mm, dy=8mm, dz=5mm; Reference Value = 23.01 V/m; Power Drift = -0.03 dB

Peak SAR (extrapolated) = 2.31 W/kg

SAR(1 g) = 0.728 W/kg; SAR(10 g) = 0.309 W/kg; Maximum value of SAR (measured) = 1.19 W/kg

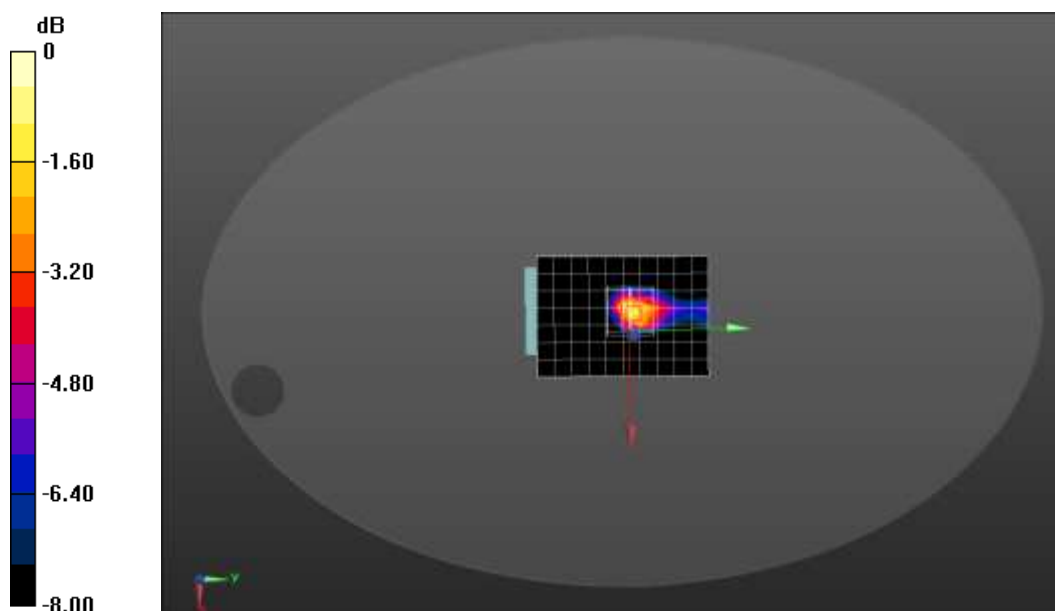

0 dB = 1.19 W/kg = 0.76 dBW/kg

Date/Time: 05/14/2020

Test Laboratory: DEKRA Lab

802.11b 2462MHz body-side2

DUT: Mobile Computer; Type: MEMOR K

Communication System: UID 0, Wi-Fi (0); Communication System Band: 802.11b; Duty Cycle: 1:1.0;

Frequency: 2462 MHz; Medium parameters used: $f = 2462$ MHz; $\sigma = 1.96$ S/m; $\epsilon_r = 52.74$; $\rho = 1000$ kg/m³ ;

Phantom section: Flat Section

Ambient temperature (°C): 21.5, Liquid temperature (°C): 21.0

DASY5 Configuration:

- Probe: EX3DV4 - SN3710; ConvF(7.37, 7.37, 7.37); Calibrated: 21/04/2020;
- Sensor-Surface: 4mm (Mechanical Surface Detection)
- Electronics: DAE4 Sn915; Calibrated: 13/06/2019
- Phantom: ELI1; Type: QDOVA002AA; Serial: TP:2106
- Measurement SW: DASY52, Version 52.8 (8); SEMCAD X Version 14.6.10 (7331)

Configuration/802.11b 2462MHz body-side2/Area Scan (8x11x1): Measurement grid: dx=12mm, dy=12mm; Maximum value of SAR (measured) = 0.0746 W/kg

Configuration/802.11b 2462MHz body-side2/Zoom Scan (5x5x7)/Cube 0: Measurement grid: dx=8mm, dy=8mm, dz=5mm; Reference Value = 5.850 V/m; Power Drift = 0.12 dB

Peak SAR (extrapolated) = 0.125 W/kg

SAR(1 g) = 0.073 W/kg; SAR(10 g) = 0.043 W/kg

Maximum value of SAR (measured) = 0.0775 W/kg

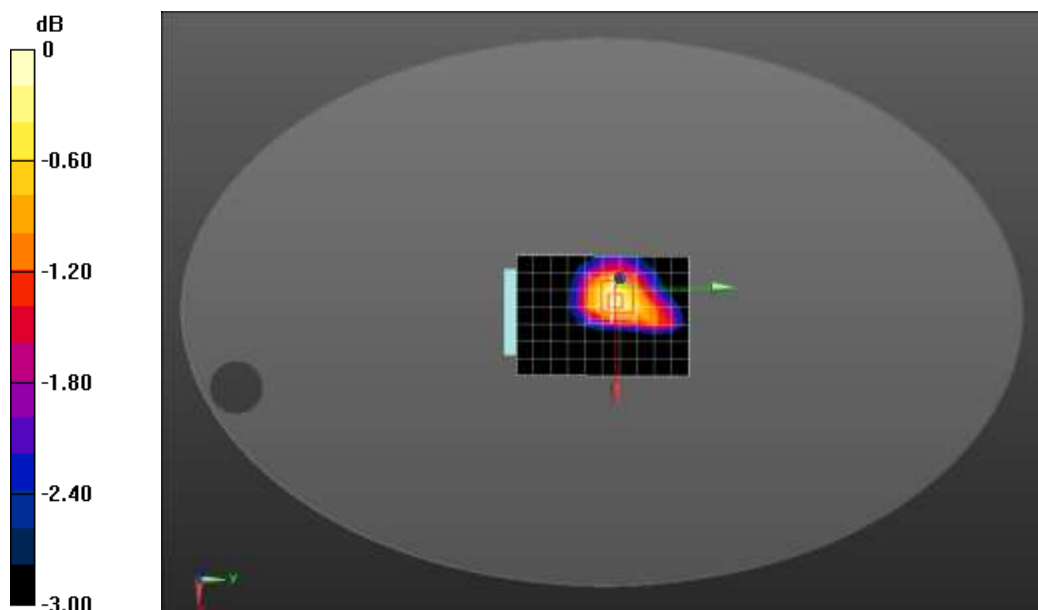

0 dB = 0.0775 W/kg = -11.11 dBW/kg

Date/Time: 05/14/2020

Test Laboratory: DEKRA Lab

802.11b 2462MHz body-side3

DUT: Mobile Computer; Type: MEMOR K

Communication System: UID 0, Wi-Fi (0); Communication System Band: 802.11b; Duty Cycle: 1:1.0;

Frequency: 2462 MHz; Medium parameters used: $f = 2462$ MHz; $\sigma = 1.96$ S/m; $\epsilon_r = 52.74$; $\rho = 1000$ kg/m³ ;

Phantom section: Flat Section

Ambient temperature (°C): 21.5, Liquid temperature (°C): 21.0

DASY5 Configuration:

- Probe: EX3DV4 - SN3710; ConvF(7.37, 7.37, 7.37); Calibrated: 21/04/2020;
- Sensor-Surface: 4mm (Mechanical Surface Detection)
- Electronics: DAE4 Sn915; Calibrated: 13/06/2019
- Phantom: ELI1; Type: QDOVA002AA; Serial: TP:2106
- Measurement SW: DASY52, Version 52.8 (8); SEMCAD X Version 14.6.10 (7331)

Configuration/802.11b 2462MHz body-side3/Area Scan (8x11x1): Measurement grid: dx=12mm, dy=12mm; Maximum value of SAR (measured) = 0.320 W/kg

Configuration/802.11b 2462MHz body-side3/Zoom Scan (5x5x7)/Cube 0: Measurement grid: dx=8mm, dy=8mm, dz=5mm; Reference Value = 13.02 V/m; Power Drift = -0.10 dB

Peak SAR (extrapolated) = 0.558 W/kg

SAR(1 g) = 0.288 W/kg; SAR(10 g) = 0.142 W/kg

Maximum value of SAR (measured) = 0.324 W/kg

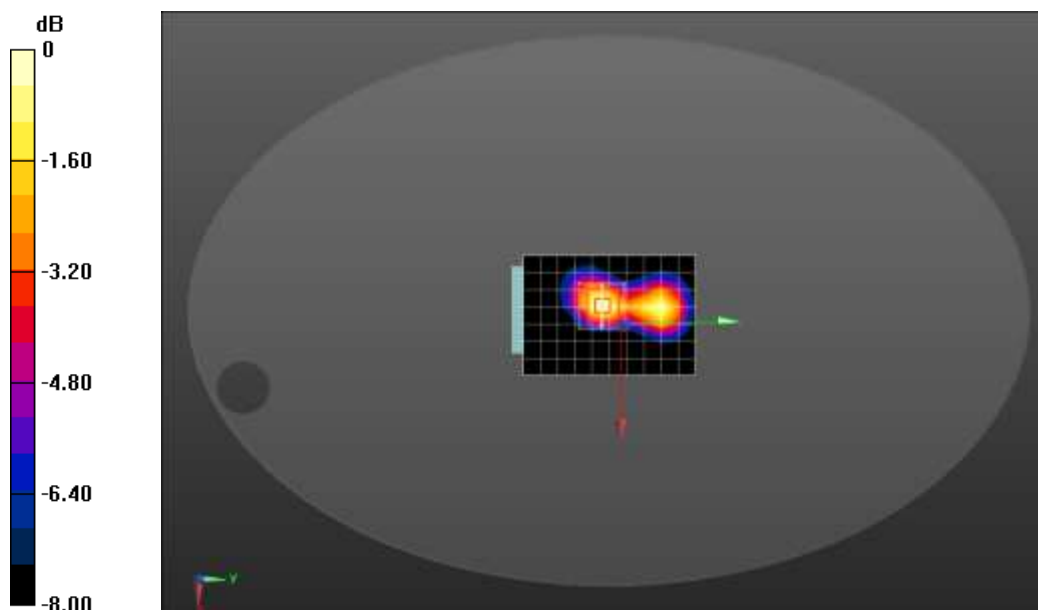

0 dB = 0.324 W/kg = -4.89 dBW/kg

Date/Time: 05/14/2020

Test Laboratory: DEKRA Lab

802.11b 2462MHz body-side4

DUT: Mobile Computer; Type: MEMOR K

Communication System: UID 0, Wi-Fi (0); Communication System Band: 802.11b; Duty Cycle: 1:1.0;

Frequency: 2462 MHz; Medium parameters used: $f = 2462$ MHz; $\sigma = 1.96$ S/m; $\epsilon_r = 52.74$; $\rho = 1000$ kg/m³ ;

Phantom section: Flat Section

Ambient temperature (°C): 21.5, Liquid temperature (°C): 21.0

DASY5 Configuration:

- Probe: EX3DV4 - SN3710; ConvF(7.37, 7.37, 7.37); Calibrated: 21/04/2020;
- Sensor-Surface: 4mm (Mechanical Surface Detection)
- Electronics: DAE4 Sn915; Calibrated: 13/06/2019
- Phantom: ELI1; Type: QDOVA002AA; Serial: TP:2106
- Measurement SW: DASY52, Version 52.8 (8); SEMCAD X Version 14.6.10 (7331)

Configuration/802.11b 2462MHz body-side4/Area Scan (8x11x1): Measurement grid: dx=12mm, dy=12mm; Maximum value of SAR (measured) = 0.0502 W/kg

Configuration/802.11b 2462MHz body-side4/Zoom Scan (5x5x7)/Cube 0: Measurement grid: dx=8mm, dy=8mm, dz=5mm; Reference Value = 4.744 V/m; Power Drift = 0.15 dB

Peak SAR (extrapolated) = 0.0840 W/kg

SAR(1 g) = 0.046 W/kg; SAR(10 g) = 0.026 W/kg

Maximum value of SAR (measured) = 0.0507 W/kg

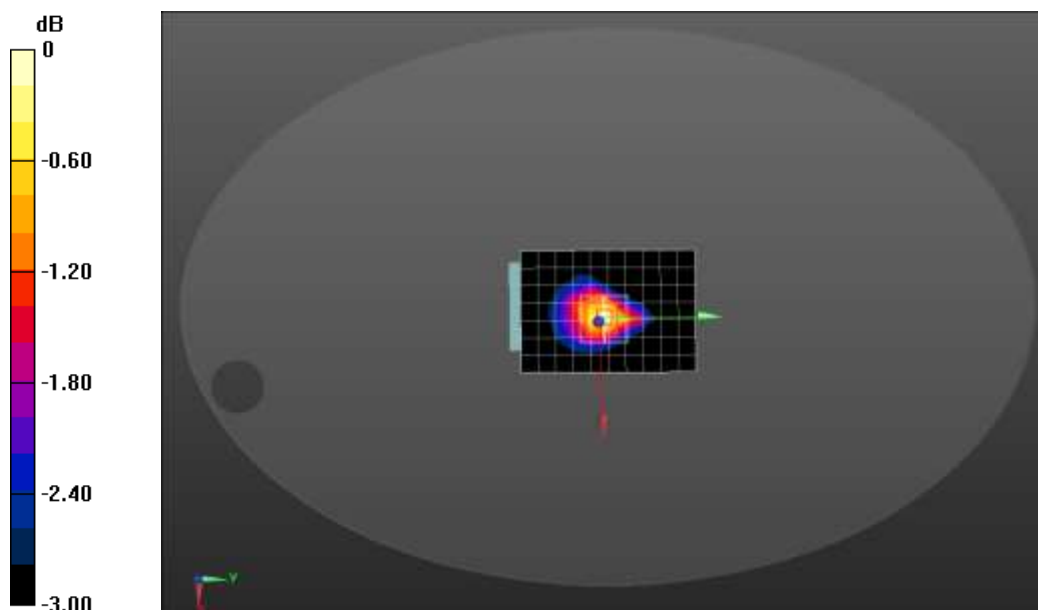

0 dB = 0.0507 W/kg = -12.95 dBW/kg

Date/Time: 05/14/2020

Test Laboratory: DEKRA Lab

802.11b 2462MHz body-front

DUT: Mobile Computer; Type: MEMOR K

Communication System: UID 0, Wi-Fi (0); Communication System Band: 802.11b; Duty Cycle: 1:1.0;

Frequency: 2462 MHz; Medium parameters used: $f = 2462 \text{ MHz}$; $\sigma = 1.96 \text{ S/m}$; $\epsilon_r = 52.74$; $\rho = 1000 \text{ kg/m}^3$;

Phantom section: Flat Section

Ambient temperature (°C): 21.5, Liquid temperature (°C): 21.0

DASY5 Configuration:

- Probe: EX3DV4 - SN3710; ConvF(7.37, 7.37, 7.37); Calibrated: 21/04/2020;
- Sensor-Surface: 4mm (Mechanical Surface Detection)
- Electronics: DAE4 Sn915; Calibrated: 13/06/2019
- Phantom: ELI1; Type: QDOVA002AA; Serial: TP:2106
- Measurement SW: DASY52, Version 52.8 (8); SEMCAD X Version 14.6.10 (7331)

Configuration/802.11b 2462MHz body-front /Area Scan (8x11x1): Measurement grid: dx=12mm, dy=12mm; Maximum value of SAR (measured) = 0.631 W/kg

Configuration/802.11b 2462MHz body-front /Zoom Scan (5x5x7)/Cube 0: Measurement grid: dx=8mm, dy=8mm, dz=5mm; Reference Value = 12.24 V/m; Power Drift = -0.04 dB

Peak SAR (extrapolated) = 1.22 W/kg

SAR(1 g) = 0.570 W/kg; SAR(10 g) = 0.263 W/kg

Maximum value of SAR (measured) = 0.670 W/kg

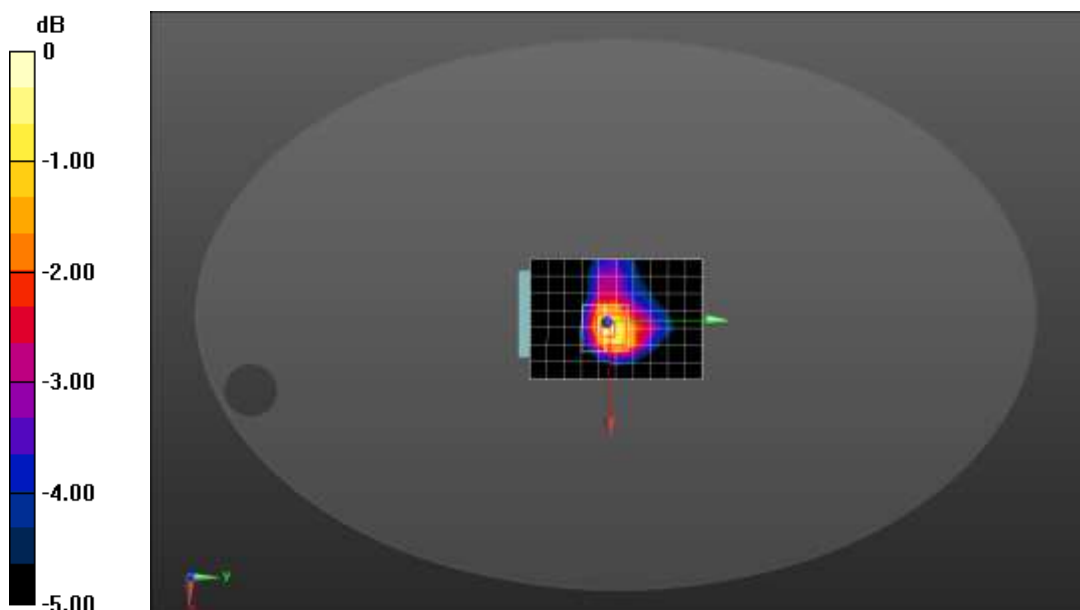

0 dB = 0.670 W/kg = -1.74 dBW/kg

Date/Time: 05/14/2020

Test Laboratory: DEKRA Lab

802.11b 2462MHz body-back

DUT: Mobile Computer; Type: MEMOR K

Communication System: UID 0, Wi-Fi (0); Communication System Band: 802.11b; Duty Cycle: 1:1.0;

Frequency: 2462 MHz; Medium parameters used: $f = 2462 \text{ MHz}$; $\sigma = 1.96 \text{ S/m}$; $\epsilon_r = 52.74$; $\rho = 1000 \text{ kg/m}^3$;

Phantom section: Flat Section

Ambient temperature (°C): 21.5, Liquid temperature (°C): 21.0

DASY5 Configuration:

- Probe: EX3DV4 - SN3710; ConvF(7.37, 7.37, 7.37); Calibrated: 21/04/2020;
- Sensor-Surface: 4mm (Mechanical Surface Detection)
- Electronics: DAE4 Sn915; Calibrated: 13/06/2019
- Phantom: ELI1; Type: QDOVA002AA; Serial: TP:2106
- Measurement SW: DASY52, Version 52.8 (8); SEMCAD X Version 14.6.10 (7331)

Configuration/802.11b 2462MHz body-back /Area Scan (8x11x1): Measurement grid: $dx=12\text{mm}$, $dy=12\text{mm}$; Maximum value of SAR (measured) = 0.949 W/kg

Configuration/802.11b 2462MHz body-back /Zoom Scan (5x5x7)/Cube 0: Measurement grid: $dx=8\text{mm}$, $dy=8\text{mm}$, $dz=5\text{mm}$; Reference Value = 16.50 V/m; Power Drift = 0.08 dB

Peak SAR (extrapolated) = 1.83 W/kg

SAR(1 g) = 0.752 W/kg; SAR(10 g) = 0.375 W/kg

Maximum value of SAR (measured) = 1.03 W/kg

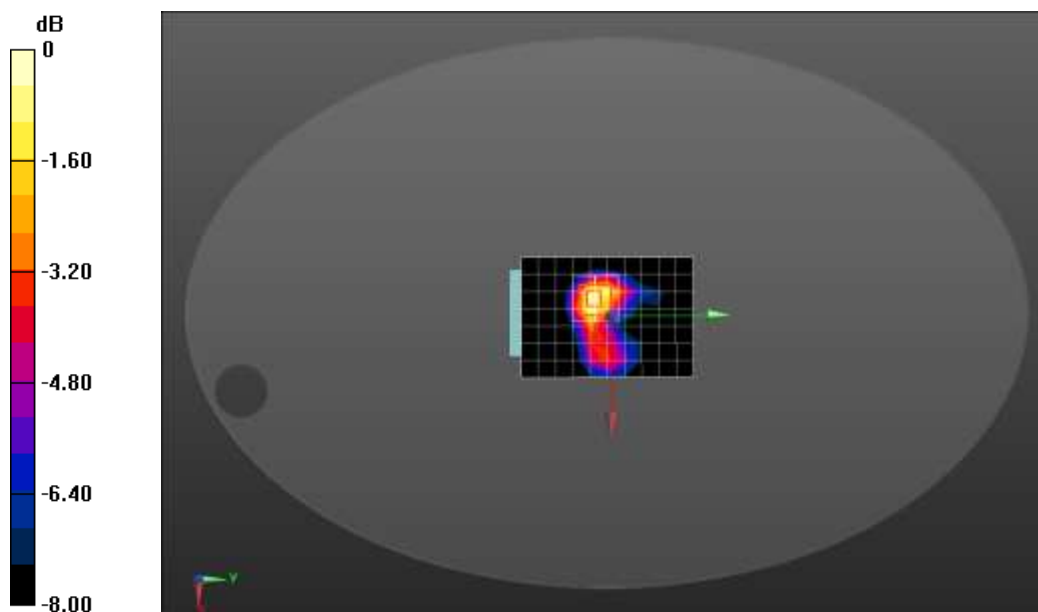

0 dB = 1.03 W/kg = 0.13 dBW/kg

Date/Time: 05/14/2020

Test Laboratory: DEKRA Lab

802.11b 2412MHz body -Back

DUT: Mobile Computer; Type: MEMOR K

Communication System: UID 0, Wi-Fi (0); Communication System Band: 802.11b; Duty Cycle: 1:1.0;

Frequency: 2412 MHz; Medium parameters used: $f = 2412$ MHz; $\sigma = 1.91$ S/m; $\epsilon_r = 52.82$; $\rho = 1000$ kg/m³ ;

Phantom section: Flat Section

Ambient temperature (°C): 21.5, Liquid temperature (°C): 21.0

DASY5 Configuration:

- Probe: EX3DV4 - SN3710; ConvF(7.37, 7.37, 7.37); Calibrated: 21/04/2020;
- Sensor-Surface: 4mm (Mechanical Surface Detection)
- Electronics: DAE4 Sn915; Calibrated: 13/06/2019
- Phantom: ELI1; Type: QDOVA002AA; Serial: TP:2106
- Measurement SW: DASY52, Version 52.8 (8); SEMCAD X Version 14.6.10 (7331)

Configuration/802.11b 2412MHz body- Back /Area Scan (8x11x1): Measurement grid: dx=12mm, dy=12mm; Maximum value of SAR (measured) = 0.851 W/kg

Configuration/802.11b 2412MHz body- Back /Zoom Scan (5x5x7)/Cube 0: Measurement grid: dx=8mm, dy=8mm, dz=5mm; Reference Value = 15.36 V/m; Power Drift = 0.06 dB

Peak SAR (extrapolated) = 1.82 W/kg

SAR(1 g) = 0.761 W/kg; SAR(10 g) = 0.306 W/kg

Maximum value of SAR (measured) = 1.01 W/kg

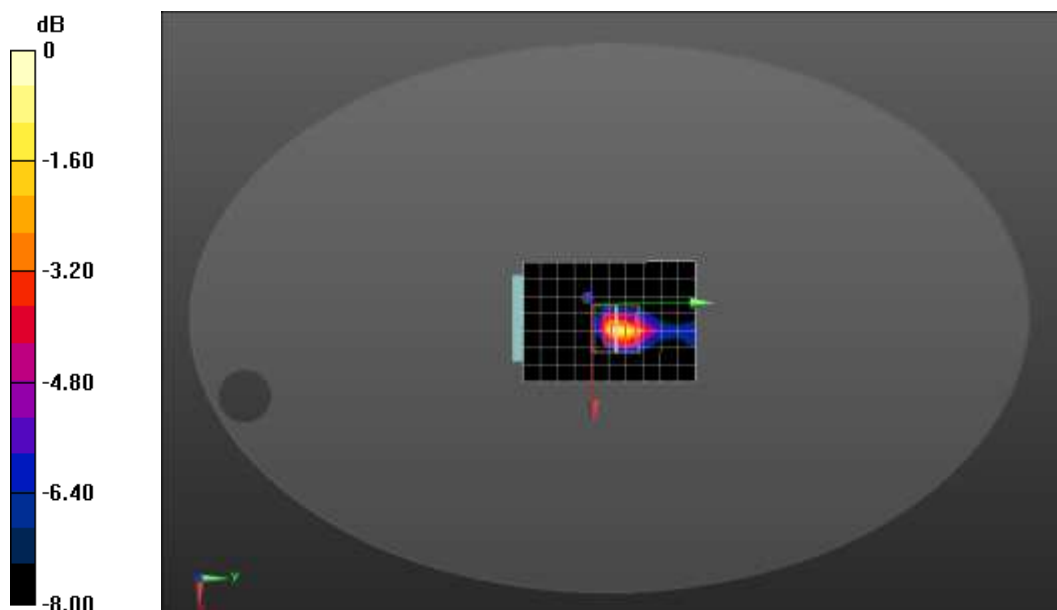

0 dB = 1.01 W/kg = 0.04 dBW/kg

Date/Time: 05/14/2020

Test Laboratory: DEKRA Lab

802.11b 2437MHz body- Back

DUT: Mobile Computer; Type: MEMOR K

Communication System: UID 0, Wi-Fi (0); Communication System Band: 802.11b; Duty Cycle: 1:1.0;

Frequency: 2437 MHz; Medium parameters used: $f = 2437 \text{ MHz}$; $\sigma = 1.93 \text{ S/m}$; $\epsilon_r = 52.79$; $\rho = 1000 \text{ kg/m}^3$;

Phantom section: Flat Section

Ambient temperature (°C): 21.5, Liquid temperature (°C): 21.0

DASY5 Configuration:

- Probe: EX3DV4 - SN3710; ConvF(7.37, 7.37, 7.37); Calibrated: 21/04/2020;
- Sensor-Surface: 4mm (Mechanical Surface Detection)
- Electronics: DAE4 Sn915; Calibrated: 13/06/2019
- Phantom: ELI1; Type: QDOVA002AA; Serial: TP:2106
- Measurement SW: DASY52, Version 52.8 (8); SEMCAD X Version 14.6.10 (7331)

Configuration/802.11b 2437MHz body- Back /Area Scan (8x11x1): Measurement grid: dx=12mm, dy=12mm; Maximum value of SAR (measured) = 0.715 W/kg

Configuration/802.11b 2437MHz body- Back /Zoom Scan (5x5x7)/Cube 0: Measurement grid: dx=8mm, dy=8mm, dz=5mm; Reference Value = 14.75 V/m; Power Drift = -0.15 dB

Peak SAR (extrapolated) = 1.25 W/kg

SAR(1 g) = 0.606 W/kg; SAR(10 g) = 0.278 W/kg

Maximum value of SAR (measured) = 0.696 W/kg

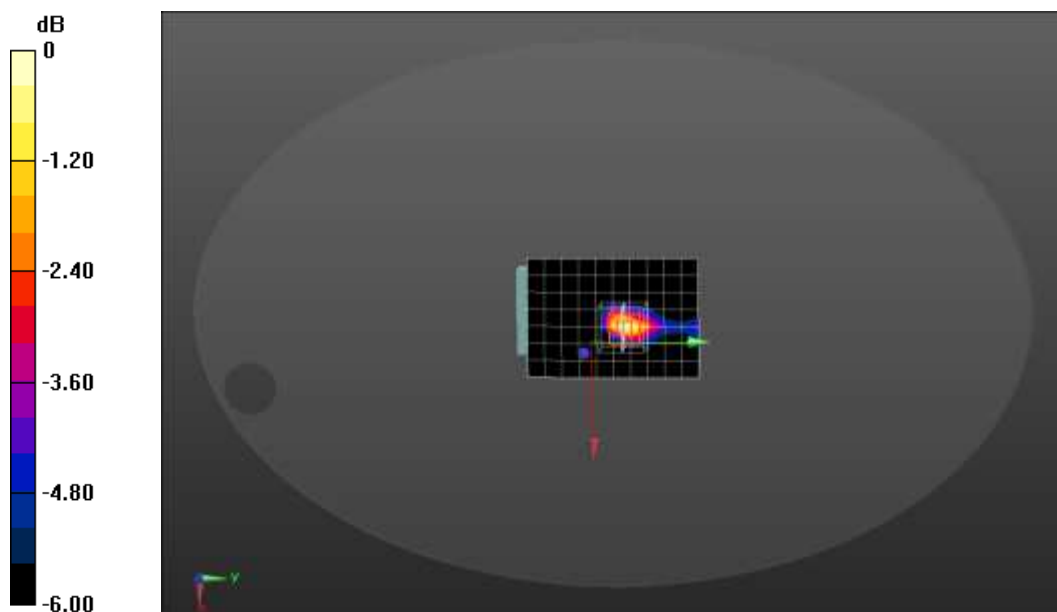

0 dB = 0.696 W/kg = -1.57 dBW/kg

Date/Time: 05/14/2020

Test Laboratory: DEKRA Lab

802.11g 2412MHz body- Back

DUT: Mobile Computer; Type: MEMOR K

Communication System: UID 0, Wi-Fi (0); Communication System Band: 802.11g; Duty Cycle: 1:1.0;

Frequency: 2412 MHz; Medium parameters used: $f = 2412$ MHz; $\sigma = 1.91$ S/m; $\epsilon_r = 52.82$; $\rho = 1000$ kg/m³ ;

Phantom section: Flat Section

Ambient temperature (°C): 21.5, Liquid temperature (°C): 21.0

DASY5 Configuration:

- Probe: EX3DV4 - SN3710; ConvF(7.37, 7.37, 7.37); Calibrated: 21/04/2020;
- Sensor-Surface: 4mm (Mechanical Surface Detection)
- Electronics: DAE4 Sn915; Calibrated: 13/06/2019
- Phantom: ELI1; Type: QDOVA002AA; Serial: TP:2106
- Measurement SW: DASY52, Version 52.8 (8); SEMCAD X Version 14.6.10 (7331)

Configuration/802.11g 2412MHz body- Back /Area Scan (8x11x1): Measurement grid: dx=12mm, dy=12mm; Maximum value of SAR (measured) = 0.834 W/kg

Configuration/802.11g 2412MHz body- Back /Zoom Scan (5x5x7)/Cube 0: Measurement grid: dx=8mm, dy=8mm, dz=5mm; Reference Value = 13.14 V/m; Power Drift = 0.06 dB

Peak SAR (extrapolated) = 1.61 W/kg

SAR(1 g) = 0.713 W/kg; SAR(10 g) = 0.309 W/kg

Maximum value of SAR (measured) = 0.900 W/kg

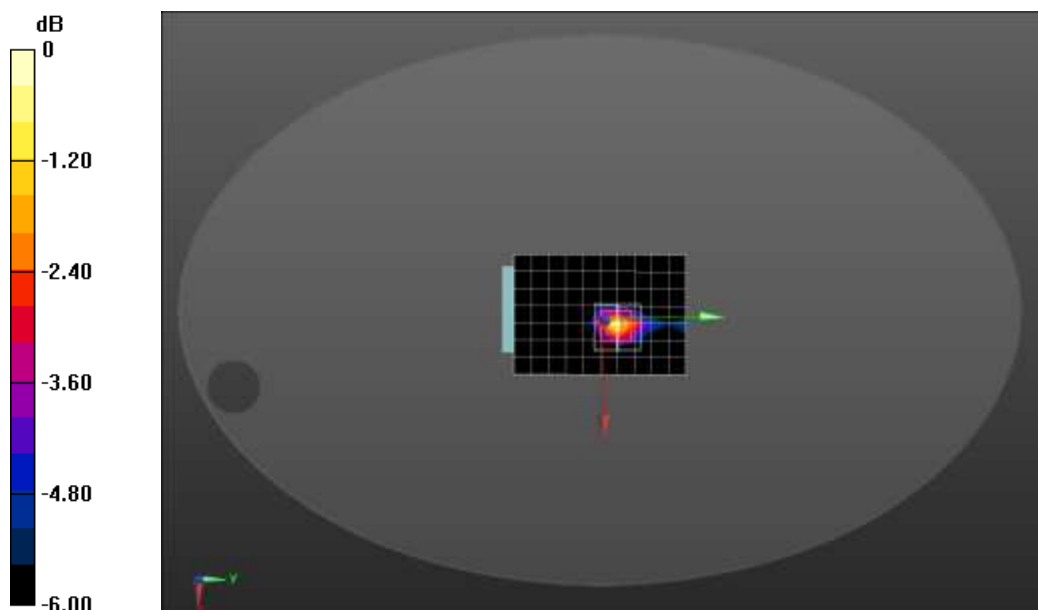

0 dB = 0.900 W/kg = -0.46 dBW/kg

Date/Time: 05/14/2020

Test Laboratory: DEKRA Lab

802.11g 2437MHz body- Back

DUT: Mobile Computer; Type: MEMOR K

Communication System: UID 0, Wi-Fi (0); Communication System Band: 802.11g; Duty Cycle: 1:1.0;

Frequency: 2437 MHz; Medium parameters used: $f = 2437 \text{ MHz}$; $\sigma = 1.93 \text{ S/m}$; $\epsilon_r = 52.79$; $\rho = 1000 \text{ kg/m}^3$;

Phantom section: Flat Section

Ambient temperature (°C): 21.5, Liquid temperature (°C): 21.0

DASY5 Configuration:

- Probe: EX3DV4 - SN3710; ConvF(7.37, 7.37, 7.37); Calibrated: 21/04/2020;
- Sensor-Surface: 4mm (Mechanical Surface Detection)
- Electronics: DAE4 Sn915; Calibrated: 13/06/2019
- Phantom: ELI1; Type: QDOVA002AA; Serial: TP:2106
- Measurement SW: DASY52, Version 52.8 (8); SEMCAD X Version 14.6.10 (7331)

Configuration/802.11g 2437MHz body- Back /Area Scan (8x11x1): Measurement grid: $dx=12\text{mm}$, $dy=12\text{mm}$; Maximum value of SAR (measured) = 0.839 W/kg

Configuration/802.11g 2437MHz body- Back /Zoom Scan (5x5x7)/Cube 0: Measurement grid: $dx=8\text{mm}$, $dy=8\text{mm}$, $dz=5\text{mm}$; Reference Value = 13.56 V/m; Power Drift = -0.00 dB

Peak SAR (extrapolated) = 1.80 W/kg

SAR(1 g) = 0.707 W/kg; SAR(10 g) = 0.298 W/kg

Maximum value of SAR (measured) = 0.989 W/kg

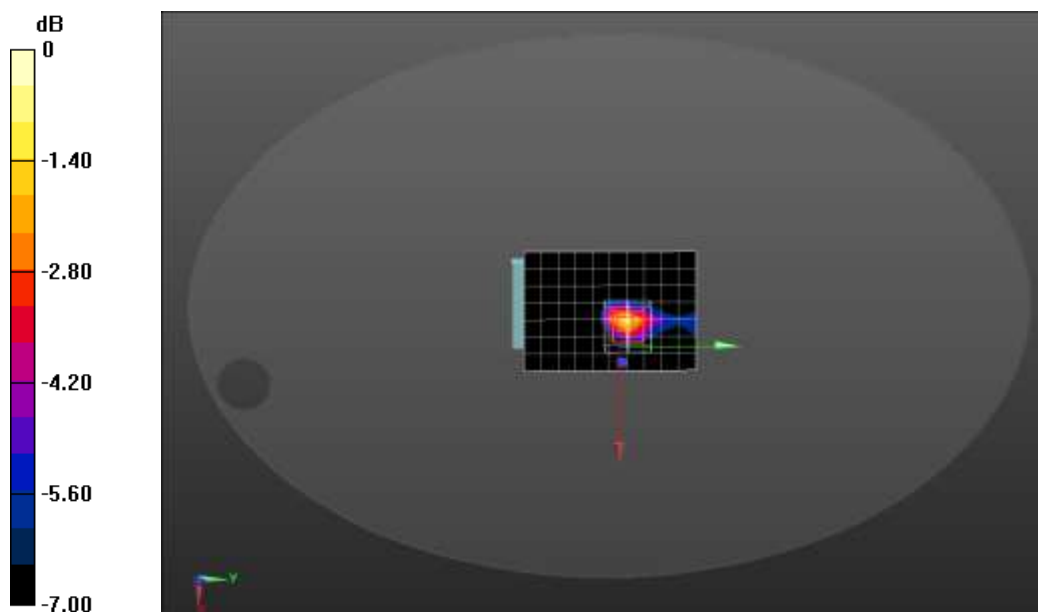

0 dB = 0.989 W/kg = -0.05 dBW/kg

Date/Time: 05/14/2020

Test Laboratory: DEKRA Lab

802.11g 2462MHz body- Back

DUT: Mobile Computer; Type: MEMOR K

Communication System: UID 0, Wi-Fi (0); Communication System Band: 802.11g; Duty Cycle: 1:1.0;

Frequency: 2462 MHz; Medium parameters used: $f = 2462$ MHz; $\sigma = 1.96$ S/m; $\epsilon_r = 52.74$; $\rho = 1000$ kg/m³ ;

Phantom section: Flat Section

Ambient temperature (°C): 21.5, Liquid temperature (°C): 21.0

DASY5 Configuration:

- Probe: EX3DV4 - SN3710; ConvF(7.37, 7.37, 7.37); Calibrated: 21/04/2020;
- Sensor-Surface: 4mm (Mechanical Surface Detection)
- Electronics: DAE4 Sn915; Calibrated: 13/06/2019
- Phantom: ELI1; Type: QDOVA002AA; Serial: TP:2106
- Measurement SW: DASY52, Version 52.8 (8); SEMCAD X Version 14.6.10 (7331)

Configuration/802.11g 2462MHz body- Back /Area Scan (8x11x1): Measurement grid: dx=12mm, dy=12mm; Maximum value of SAR (measured) = 0.562 W/kg

Configuration/802.11g 2462MHz body- Back /Zoom Scan (5x5x7)/Cube 0: Measurement grid: dx=8mm, dy=8mm, dz=5mm; Reference Value = 10.76 V/m; Power Drift = -0.08 dB

Peak SAR (extrapolated) = 1.11 W/kg

SAR(1 g) = 0.516 W/kg; SAR(10 g) = 0.224 W/kg

Maximum value of SAR (measured) = 0.614 W/kg

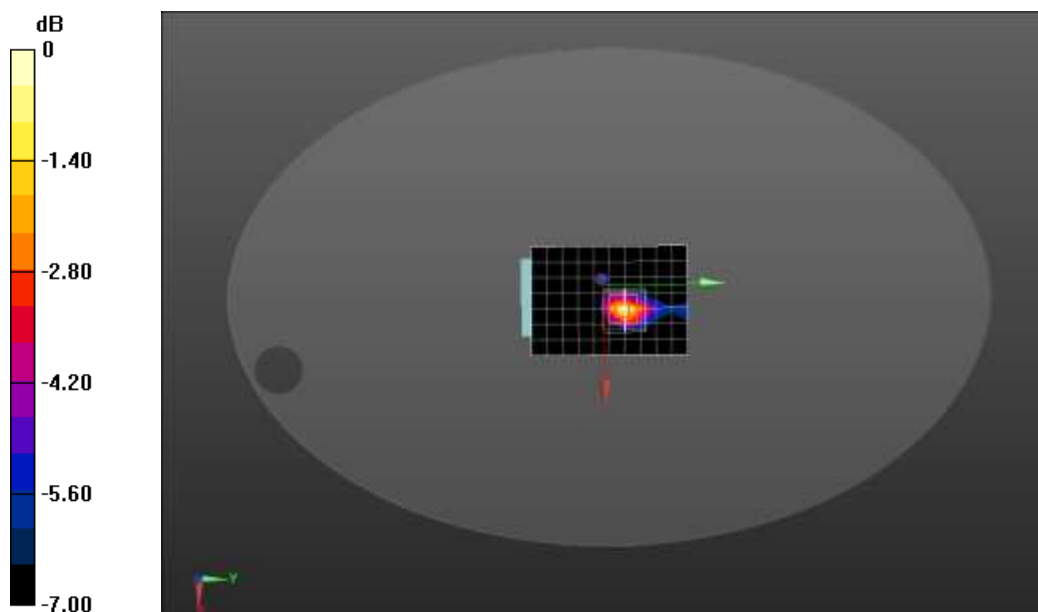

0 dB = 0.614 W/kg = -2.12 dBW/kg

Date/Time: 05/12/2020

Test Laboratory: DEKRA Lab

802.11b 2462MHz Touch-Left

DUT: Mobile Computer; Type: MEMOR K

Communication System: UID 0, Wi-Fi (0); Communication System Band: 802.11b; Duty Cycle: 1:1.0;

Frequency: 2462 MHz; Medium parameters used: $f = 2462$ MHz; $\sigma = 1.81$ S/m; $\epsilon_r = 40.89$; $\rho = 1000$ kg/m³ ;

Phantom section: Left Section

Ambient temperature (°C): 21.5, Liquid temperature (°C): 21.0

DASY5 Configuration:

- Probe: EX3DV4 - SN3710; ConvF(7.42, 7.42, 7.42); Calibrated: 21/04/2020;
- Sensor-Surface: 4mm (Mechanical Surface Detection)
- Electronics: DAE4 Sn915; Calibrated: 13/06/2019
- Phantom: SAM2; Type: SAM; Serial: TP1562
- Measurement SW: DASY52, Version 52.8 (8); SEMCAD X Version 14.6.10 (7331)

Configuration/802.11b 2462MHz Touch-Left/Area Scan (9x10x1): Measurement grid: dx=12mm, dy=12mm; Maximum value of SAR (measured) = 0.628 W/kg

Configuration/802.11b 2462MHz Touch-Left/Zoom Scan (5x5x7)/Cube 0: Measurement grid: dx=8mm, dy=8mm, dz=5mm; Reference Value = 18.30 V/m; Power Drift = -0.17 dB

Peak SAR (extrapolated) = 1.34 W/kg

SAR(1 g) = 0.624 W/kg; SAR(10 g) = 0.316 W/kg

Maximum value of SAR (measured) = 0.687 W/kg

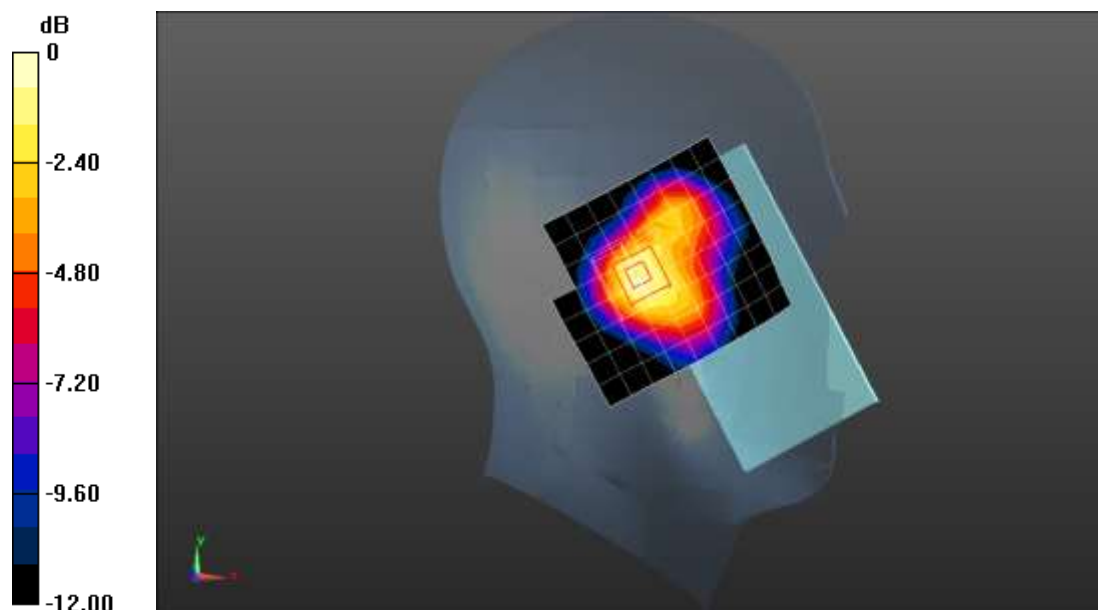

0 dB = 0.687 W/kg = -1.63 dBW/kg

Date/Time: 05/12/2020

Test Laboratory: DEKRA Lab

802.11b 2462MHz Touch-Right

DUT: Mobile Computer; Type: MEMOR K

Communication System: UID 0, Wi-Fi (0); Communication System Band: 802.11b; Duty Cycle: 1:1.0;

Frequency: 2462 MHz; Medium parameters used: $f = 2462$ MHz; $\sigma = 1.81$ S/m; $\epsilon_r = 40.89$; $\rho = 1000$ kg/m³ ;

Phantom section: Right Section

Ambient temperature (°C): 21.5, Liquid temperature (°C): 21.0

DASY5 Configuration:

- Probe: EX3DV4 - SN3710; ConvF(7.42, 7.42, 7.42); Calibrated: 21/04/2020;
- Sensor-Surface: 4mm (Mechanical Surface Detection)
- Electronics: DAE4 Sn915; Calibrated: 13/06/2019
- Phantom: SAM2; Type: SAM; Serial: TP1562
- Measurement SW: DASY52, Version 52.8 (8); SEMCAD X Version 14.6.10 (7331)

Configuration/802.11b 2462MHz Touch-Right//Area Scan (9x10x1): Measurement grid: dx=12mm, dy=12mm; Maximum value of SAR (measured) = 1.28 W/kg

Configuration/802.11b 2462MHz Touch-Right /Zoom Scan (5x5x7)/Cube 0: Measurement grid: dx=8mm, dy=8mm, dz=5mm; Reference Value = 9.974 V/m; Power Drift = 0.01 dB

Peak SAR (extrapolated) = 2.74 W/kg

SAR(1 g) = 0.797 W/kg; SAR(10 g) = 0.328 W/kg

Maximum value of SAR (measured) = 1.25 W/kg

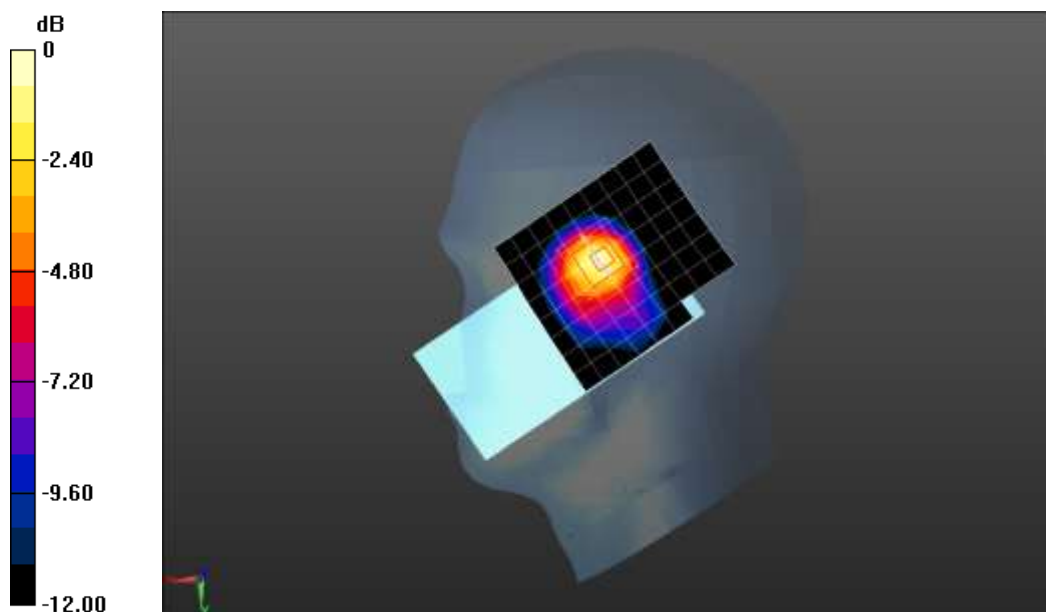

0 dB = 1.25 W/kg = 0.97 dBW/kg

Date/Time: 05/12/2020

Test Laboratory: DEKRA Lab

802.11b 2412MHz Touch-Right

DUT: Mobile Computer; Type: MEMOR K

Communication System: UID 0, Wi-Fi (0); Communication System Band: 802.11b; Duty Cycle: 1:1.0;

Frequency: 2412 MHz; Medium parameters used: $f = 2412$ MHz; $\sigma = 1.77$ S/m; $\epsilon_r = 40.97$; $\rho = 1000$ kg/m³ ;

Phantom section: Right Section

Ambient temperature (°C): 21.5, Liquid temperature (°C): 21.0

DASY5 Configuration:

- Probe: EX3DV4 - SN3710; ConvF(7.42, 7.42, 7.42); Calibrated: 21/04/2020;
- Sensor-Surface: 4mm (Mechanical Surface Detection)
- Electronics: DAE4 Sn915; Calibrated: 13/06/2019
- Phantom: SAM2; Type: SAM; Serial: TP1562
- Measurement SW: DASY52, Version 52.8 (8); SEMCAD X Version 14.6.10 (7331)

Configuration/802.11b 2412MHz Touch-Right/Area Scan (9x10x1): Measurement grid: dx=12mm, dy=12mm; Maximum value of SAR (measured) = 1.01 W/kg

Configuration/802.11b 2412MHz Touch-Right/Zoom Scan (5x5x7)/Cube 0: Measurement grid: dx=8mm, dy=8mm, dz=5mm; Reference Value = 8.778 V/m; Power Drift = -0.02 dB

Peak SAR (extrapolated) = 2.15 W/kg

SAR(1 g) = 0.801 W/kg; SAR(10 g) = 0.320 W/kg

Maximum value of SAR (measured) = 0.970 W/kg

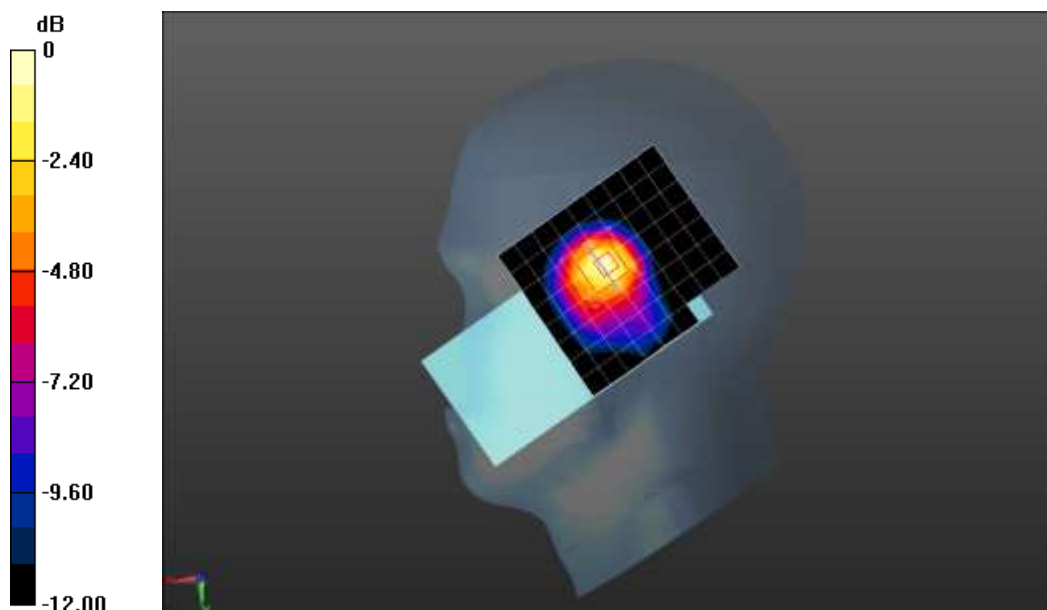

0 dB = 0.970 W/kg = -0.13 dBW/kg

Date/Time: 05/12/2020

Test Laboratory: DEKRA Lab

802.11b 2437MHz Touch-Right

DUT: Mobile Computer; Type: MEMOR K

Communication System: UID 0, Wi-Fi (0); Communication System Band: 802.11b; Duty Cycle: 1:1.0;

Frequency: 2437 MHz; Medium parameters used: $f = 2437$ MHz; $\sigma = 1.79$ S/m; $\epsilon_r = 40.94$; $\rho = 1000$ kg/m³ ;

Phantom section: Right Section

Ambient temperature (°C): 21.5, Liquid temperature (°C): 21.0

DASY5 Configuration:

- Probe: EX3DV4 - SN3710; ConvF(7.42, 7.42, 7.42); Calibrated: 21/04/2020;
- Sensor-Surface: 4mm (Mechanical Surface Detection)
- Electronics: DAE4 Sn915; Calibrated: 13/06/2019
- Phantom: SAM2; Type: SAM; Serial: TP1562
- Measurement SW: DASY52, Version 52.8 (8); SEMCAD X Version 14.6.10 (7331)

Configuration/802.11b 2437MHz Touch-Right/Area Scan (9x10x1): Measurement grid: dx=12mm, dy=12mm; Maximum value of SAR (measured) = 1.19 W/kg

Configuration/802.11b 2437MHz Touch-Right/Zoom Scan (5x5x7)/Cube 0: Measurement grid: dx=8mm, dy=8mm, dz=5mm; Reference Value = 9.158 V/m; Power Drift = -0.08 dB

Peak SAR (extrapolated) = 2.58 W/kg

SAR(1 g) = 0.790 W/kg; SAR(10 g) = 0.307 W/kg

Maximum value of SAR (measured) = 1.17 W/kg

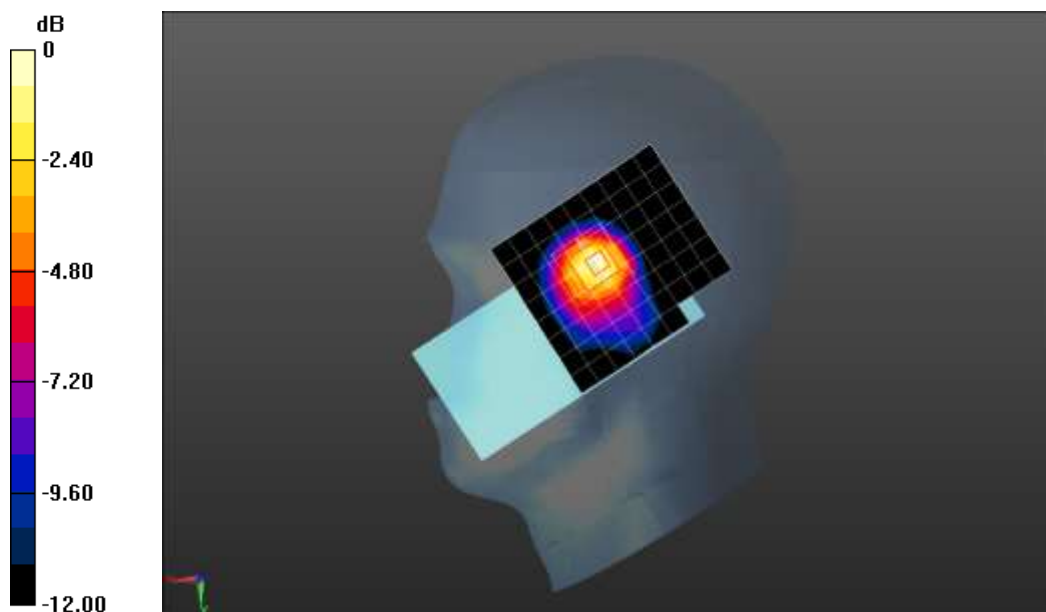

0 dB = 1.17 W/kg = 0.68 dBW/kg

Date/Time: 05/12/2020

Test Laboratory: DEKRA Lab

802.11g 2412MHz Touch-Right

DUT: Mobile Computer; Type: MEMOR K

Communication System: UID 0, Wi-Fi (0); Communication System Band: 802.11g; Duty Cycle: 1:1.0;

Frequency: 2412 MHz; Medium parameters used: $f = 2412$ MHz; $\sigma = 1.77$ S/m; $\epsilon_r = 40.97$; $\rho = 1000$ kg/m³ ;

Phantom section: Right Section

Ambient temperature (°C): 21.5, Liquid temperature (°C): 21.0

DASY5 Configuration:

- Probe: EX3DV4 - SN3710; ConvF(7.42, 7.42, 7.42); Calibrated: 21/04/2020;
- Sensor-Surface: 4mm (Mechanical Surface Detection)
- Electronics: DAE4 Sn915; Calibrated: 13/06/2019
- Phantom: SAM2; Type: SAM; Serial: TP1562
- Measurement SW: DASY52, Version 52.8 (8); SEMCAD X Version 14.6.10 (7331)

Configuration/802.11g 2412MHz Touch-Right/Area Scan (9x10x1): Measurement grid: dx=12mm, dy=12mm; Maximum value of SAR (measured) = 1.00 W/kg

Configuration/802.11g 2412MHz Touch-Right/Zoom Scan (5x5x7)/Cube 0: Measurement grid: dx=8mm, dy=8mm, dz=5mm; Reference Value = 7.409 V/m; Power Drift = 0.06 dB

Peak SAR (extrapolated) = 2.19 W/kg

SAR(1 g) = 0.727 W/kg; SAR(10 g) = 0.302 W/kg

Maximum value of SAR (measured) = 1.03 W/kg

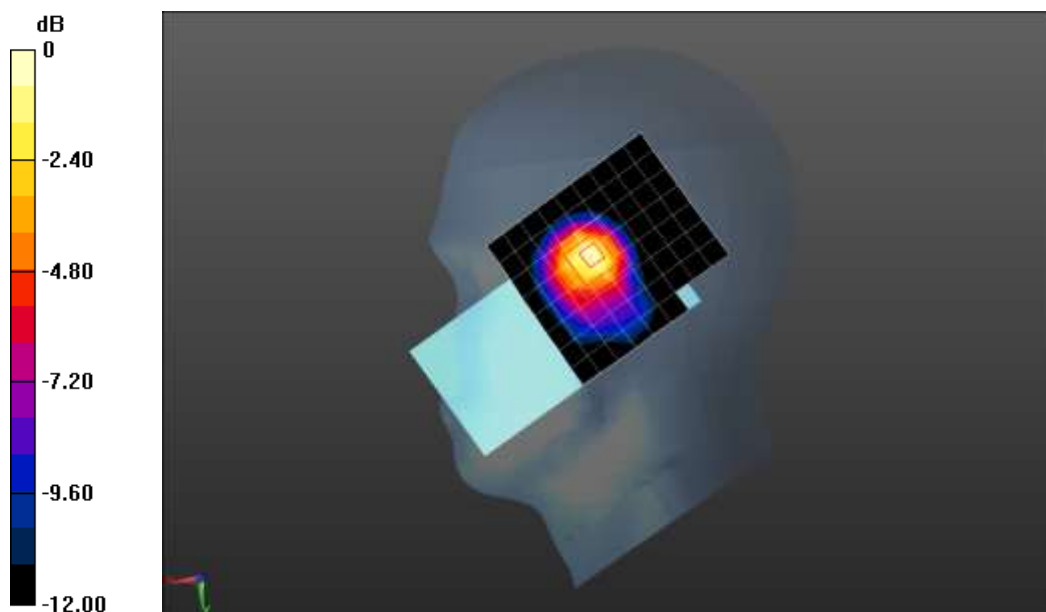

0 dB = 1.03 W/kg = 0.13 dBW/kg

Date/Time: 05/12/2020

Test Laboratory: DEKRA Lab

802.11g 2437MHz Touch-Right

DUT: Mobile Computer; Type: MEMOR K

Communication System: UID 0, Wi-Fi (0); Communication System Band: 802.11g; Duty Cycle: 1:1.0;

Frequency: 2437 MHz; Medium parameters used: $f = 2437$ MHz; $\sigma = 1.79$ S/m; $\epsilon_r = 40.94$; $\rho = 1000$ kg/m³ ;

Phantom section: Right Section

Ambient temperature (°C): 21.5, Liquid temperature (°C): 21.0

DASY5 Configuration:

- Probe: EX3DV4 - SN3710; ConvF(7.42, 7.42, 7.42); Calibrated: 21/04/2020;
- Sensor-Surface: 4mm (Mechanical Surface Detection)
- Electronics: DAE4 Sn915; Calibrated: 13/06/2019
- Phantom: SAM2; Type: SAM; Serial: TP1562
- Measurement SW: DASY52, Version 52.8 (8); SEMCAD X Version 14.6.10 (7331)

Configuration/802.11g 2437MHz Touch-Right/Area Scan (9x10x1): Measurement grid: dx=12mm, dy=12mm; Maximum value of SAR (measured) = 1.17 W/kg

Configuration/802.11g 2437MHz Touch-Right/Zoom Scan (5x5x7)/Cube 0: Measurement grid: dx=8mm, dy=8mm, dz=5mm; Reference Value = 7.984 V/m; Power Drift = -0.03 dB

Peak SAR (extrapolated) = 2.55 W/kg

SAR(1 g) = 0.735 W/kg; SAR(10 g) = 0.304 W/kg

Maximum value of SAR (measured) = 1.21 W/kg

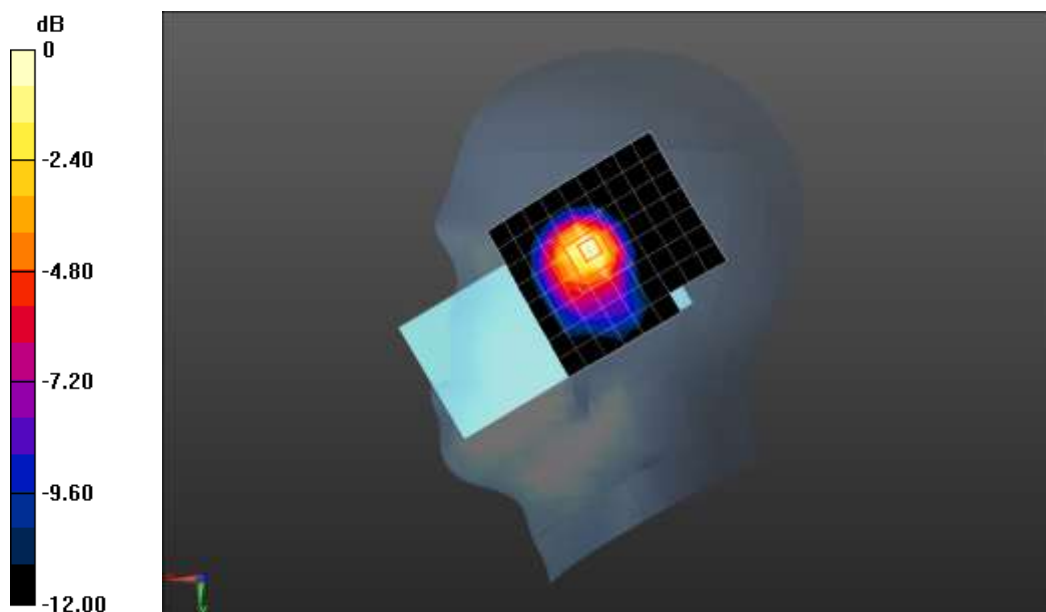

0 dB = 1.21 W/kg = 0.83 dBW/kg

Date/Time: 05/12/2020

Test Laboratory: DEKRA Lab

802.11g 2462MHz Touch-Right

DUT: Mobile Computer; Type: MEMOR K

Communication System: UID 0, Wi-Fi (0); Communication System Band: 802.11g; Duty Cycle: 1:1.0;

Frequency: 2462 MHz; Medium parameters used: $f = 2462$ MHz; $\sigma = 1.81$ S/m; $\epsilon_r = 40.89$; $\rho = 1000$ kg/m³ ;

Phantom section: Right Section

Ambient temperature (°C): 21.5, Liquid temperature (°C): 21.0

DASY5 Configuration:

- Probe: EX3DV4 - SN3710; ConvF(7.42, 7.42, 7.42); Calibrated: 21/04/2020;
- Sensor-Surface: 4mm (Mechanical Surface Detection)
- Electronics: DAE4 Sn915; Calibrated: 13/06/2019
- Phantom: SAM2; Type: SAM; Serial: TP1562
- Measurement SW: DASY52, Version 52.8 (8); SEMCAD X Version 14.6.10 (7331)

Configuration/802.11g 2462MHz Touch-Right/Area Scan (9x10x1): Measurement grid: dx=12mm, dy=12mm; Maximum value of SAR (measured) = 0.694 W/kg

Configuration/802.11g 2462MHz Touch-Right/Zoom Scan (5x5x7)/Cube 0: Measurement grid: dx=8mm, dy=8mm, dz=5mm; Reference Value = 6.230 V/m; Power Drift = -0.12 dB

Peak SAR (extrapolated) = 1.52 W/kg

SAR(1 g) = 0.652 W/kg; SAR(10 g) = 0.300 W/kg

Maximum value of SAR (measured) = 0.720 W/kg

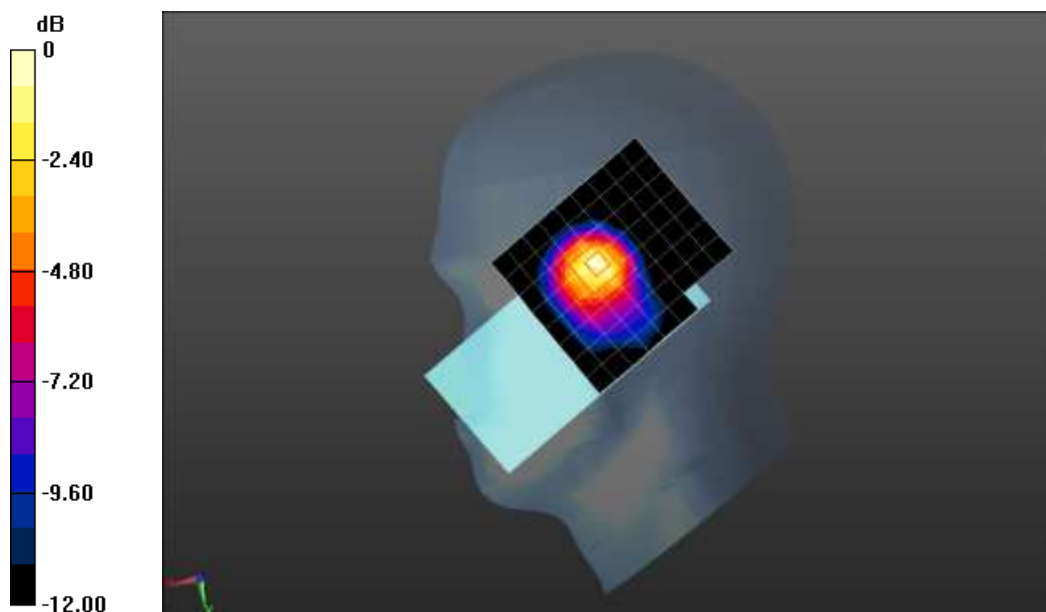

0 dB = 0.720 W/kg = -1.43 dBW/kg

Date/Time: 05/12/2020

Test Laboratory: DEKRA Lab

802.11b 2462MHz Right-tilted 15°

DUT: Mobile Computer; Type: MEMOR K

Communication System: UID 0, Wi-Fi (0); Communication System Band: 802.11b; Duty Cycle: 1:1.0;

Frequency: 2462 MHz; Medium parameters used: $f = 2462$ MHz; $\sigma = 1.81$ S/m; $\epsilon_r = 40.89$; $\rho = 1000$ kg/m³ ;

Phantom section: Right Section

Ambient temperature (°C): 21.5, Liquid temperature (°C): 21.0

DASY5 Configuration:

- Probe: EX3DV4 - SN3710; ConvF(7.42, 7.42, 7.42); Calibrated: 21/04/2020;
- Sensor-Surface: 4mm (Mechanical Surface Detection)
- Electronics: DAE4 Sn915; Calibrated: 13/06/2019
- Phantom: SAM2; Type: SAM; Serial: TP1562
- Measurement SW: DASY52, Version 52.8 (8); SEMCAD X Version 14.6.10 (7331)

Configuration/802.11b 2462MHz Right-tilted 15°/Area Scan (9x11x1): Measurement grid: dx=12mm, dy=12mm; Maximum value of SAR (measured) = 0.604 W/kg

Configuration/802.11b 2462MHz Right- tilted 15°/Zoom Scan (5x5x7)/Cube 0: Measurement grid: dx=8mm, dy=8mm, dz=5mm; Reference Value = 14.91 V/m; Power Drift = -0.03 dB

Peak SAR (extrapolated) = 1.77 W/kg

SAR(1 g) = 0.538 W/kg; SAR(10 g) = 0.218 W/kg

Maximum value of SAR (measured) = 0.855 W/kg

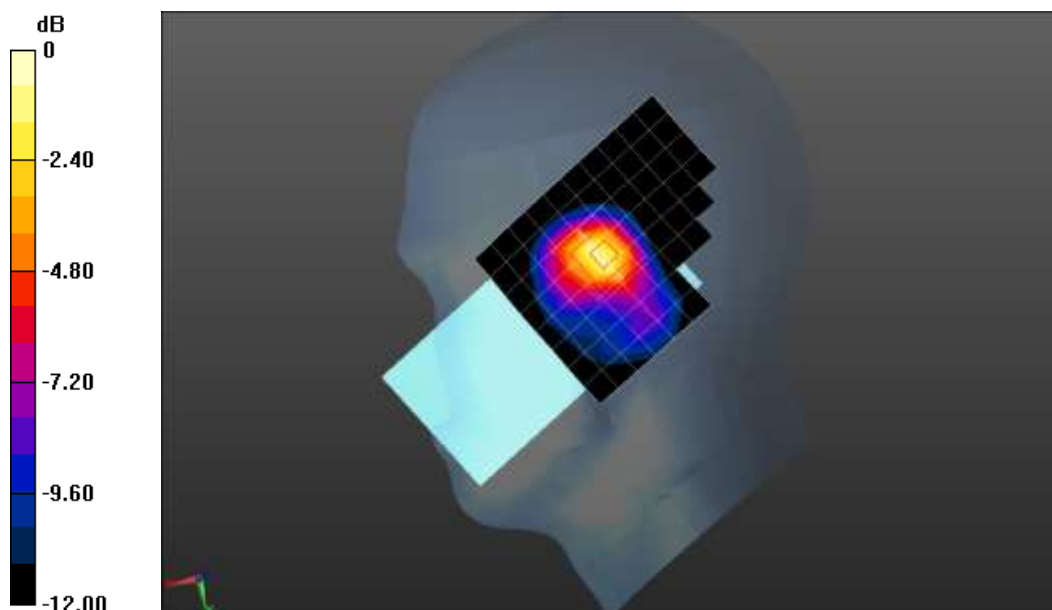

$0 \text{ dB} = 0.855 \text{ W/kg} = -0.68 \text{ dBW/kg}$

Date/Time: 05/14/2020

Test Laboratory: DEKRA Lab

802.11a 5240MHz body-side1

DUT: Mobile Computer; Type: MEMOR K

Communication System: UID 0, CW (0); Communication System Band: 5GHz(5000.0-6000.0MHz); Duty Cycle: 1:1.0; Frequency: 5240 MHz; Medium parameters used: $f = 5240$ MHz; $\sigma = 5.26$ S/m; $\epsilon_r = 47.9$; $\rho = 1000$ kg/m³; Phantom section: Flat Section

Ambient temperature (°C): 21.5, Liquid temperature (°C): 21.0

DASY5 Configuration:

- Probe: EX3DV4 - SN3710; ConvF(4.57, 4.57, 4.57); Calibrated: 21/04/2020;
- Sensor-Surface: 4mm (Mechanical Surface Detection)
- Electronics: DAE4 Sn915; Calibrated: 13/06/2019
- Phantom: ELI1; Type: QDOVA002AA; Serial: TP:2106
- Measurement SW: DASY52, Version 52.8 (8); SEMCAD X Version 14.6.10 (7331)

Configuration/802.11a 5240MHz body-side1/Area Scan (8x11x1): Measurement grid: dx=12mm, dy=12mm; Maximum value of SAR (measured) = 0.145 W/kg

Configuration/802.11a 5240MHz body-side1/Zoom Scan (5x5x7)/Cube 0: Measurement grid: dx=8mm, dy=8mm, dz=5mm; Reference Value = 4.687 V/m; Power Drift = 0.03 dB

Peak SAR (extrapolated) = 0.336 W/kg

SAR(1 g) = 0.127 W/kg; SAR(10 g) = 0.055 W/kg

Maximum value of SAR (measured) = 0.142 W/kg

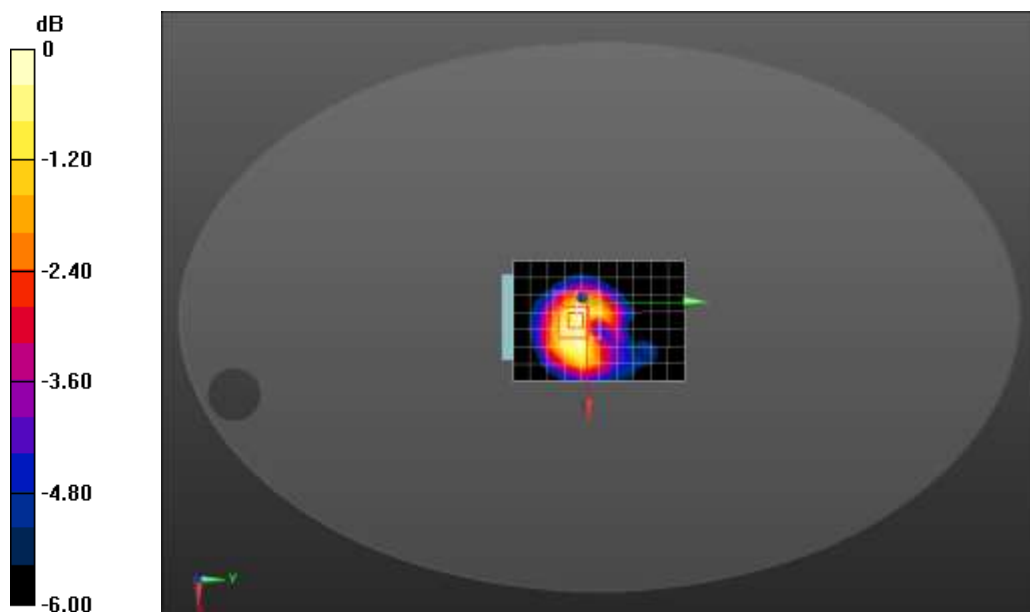

0 dB = 0.142 W/kg = -8.48 dBW/kg

Date/Time: 05/14/2020

Test Laboratory: DEKRA Lab

802.11a 5240MHz body-side2

DUT: Mobile Computer; Type: MEMOR K

Communication System: UID 0, CW (0); Communication System Band: 5GHz(5000.0-6000.0MHz); Duty

Cycle: 1:1.0; Frequency: 5240 MHz; Medium parameters used: $f = 5240$ MHz; $\sigma = 5.26$ S/m; $\epsilon_r = 47.9$; $\rho = 1000$ kg/m³; Phantom section: Flat Section

Ambient temperature (°C): 21.5, Liquid temperature (°C): 21.0

DASY5 Configuration:

- Probe: EX3DV4 - SN3710; ConvF(4.57, 4.57, 4.57); Calibrated: 21/04/2020;
- Sensor-Surface: 4mm (Mechanical Surface Detection)
- Electronics: DAE4 Sn915; Calibrated: 13/06/2019
- Phantom: ELI1; Type: QDOVA002AA; Serial: TP:2106
- Measurement SW: DASY52, Version 52.8 (8); SEMCAD X Version 14.6.10 (7331)

Configuration/802.11a 5240MHz body side2/Area Scan (8x11x1): Measurement grid: dx=12mm, dy=12mm; Maximum value of SAR (measured) = 0.136 W/kg

Configuration/802.11a 5240MHz body side2/Zoom Scan (5x5x7)/Cube 0: Measurement grid: dx=8mm, dy=8mm, dz=5mm; Reference Value = 5.080 V/m; Power Drift = 0.16 dB

Peak SAR (extrapolated) = 0.319 W/kg

SAR(1 g) = 0.128 W/kg; SAR(10 g) = 0.053 W/kg

Maximum value of SAR (measured) = 0.148 W/kg

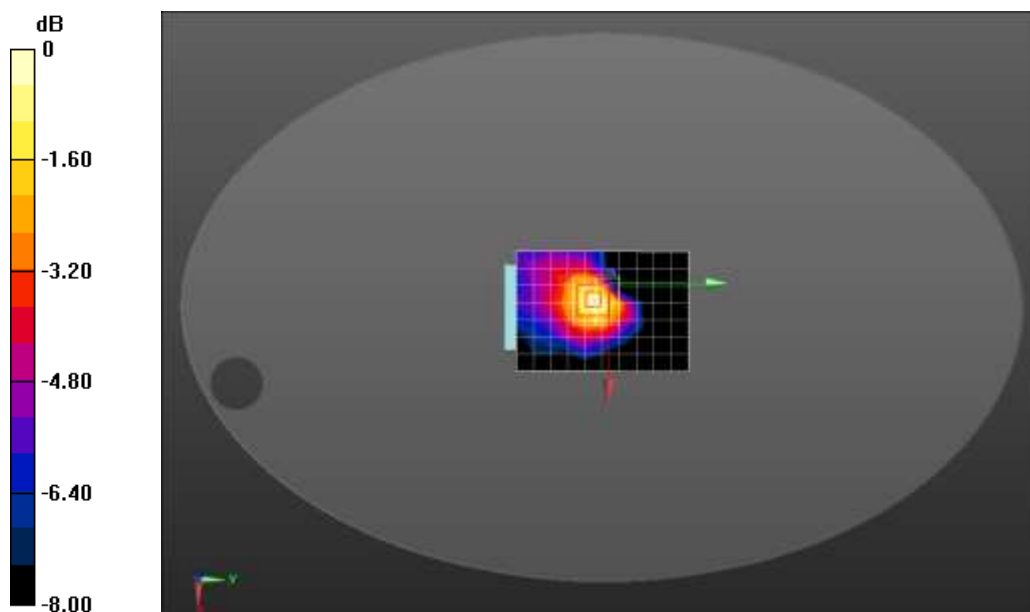

0 dB = 0.148 W/kg = -8.30 dBW/kg

Date/Time: 05/14/2020

Test Laboratory: DEKRA Lab

802.11a 5240MHz body-side3

DUT: Mobile Computer; Type: MEMOR K

Communication System: UID 0, CW (0); Communication System Band: 5GHz(5000.0-6000.0MHz); Duty

Cycle: 1:1.0; Frequency: 5240 MHz; Medium parameters used: $f = 5240$ MHz; $\sigma = 5.26$ S/m; $\epsilon_r = 47.9$; $\rho = 1000$ kg/m³; Phantom section: Flat Section

Ambient temperature (°C): 21.5, Liquid temperature (°C): 21.0

DASY5 Configuration:

- Probe: EX3DV4 - SN3710; ConvF(4.57, 4.57, 4.57); Calibrated: 21/04/2020;
- Sensor-Surface: 4mm (Mechanical Surface Detection)
- Electronics: DAE4 Sn915; Calibrated: 13/06/2019
- Phantom: ELI1; Type: QDOVA002AA; Serial: TP:2106
- Measurement SW: DASY52, Version 52.8 (8); SEMCAD X Version 14.6.10 (7331)

Configuration/802.11a 5240MHz body side3/Area Scan (8x11x1): Measurement grid: dx=12mm, dy=12mm; Maximum value of SAR (measured) = 0.802 W/kg

Configuration/802.11a 5240MHz body side3/Zoom Scan (5x5x7)/Cube 0: Measurement grid: dx=8mm, dy=8mm, dz=5mm; Reference Value = 11.41 V/m; Power Drift = 0.09 dB

Peak SAR (extrapolated) = 3.57 W/kg

SAR(1 g) = 0.740 W/kg; SAR(10 g) = 0.290 W/kg

Maximum value of SAR (measured) = 0.951 W/kg

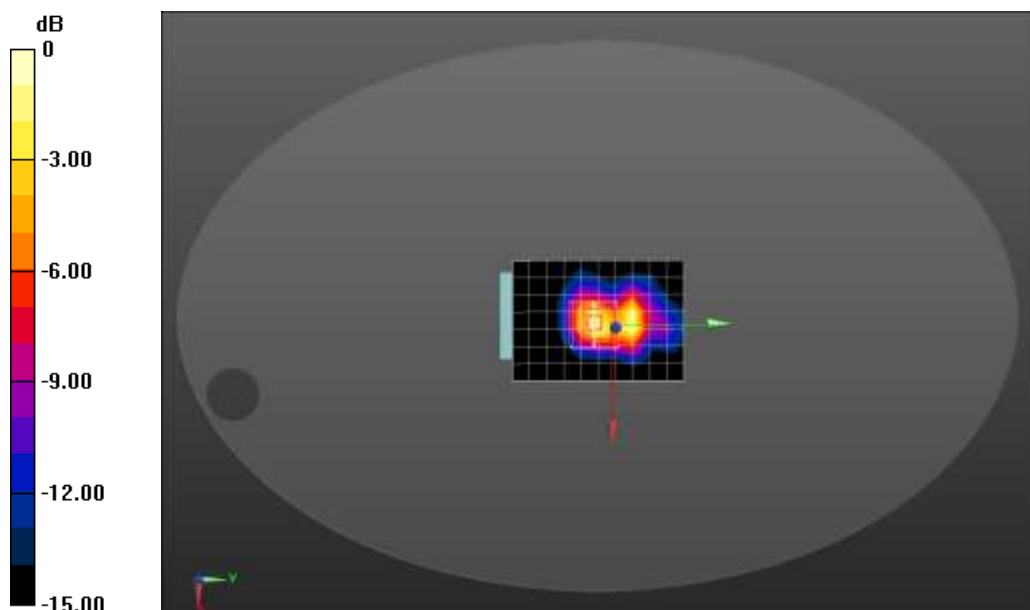

0 dB = 0.951 W/kg = -0.22 dBW/kg

Date/Time: 05/14/2020

Test Laboratory: DEKRA Lab

802.11a 5240MHz body-side4

DUT: Mobile Computer; Type: MEMOR K

Communication System: UID 0, CW (0); Communication System Band: 5GHz(5000.0-6000.0MHz); Duty

Cycle: 1:1.0; Frequency: 5240 MHz; Medium parameters used: $f = 5240$ MHz; $\sigma = 5.26$ S/m; $\epsilon_r = 47.9$; $\rho = 1000$ kg/m³; Phantom section: Flat Section

Ambient temperature (°C): 21.5, Liquid temperature (°C): 21.0

DASY5 Configuration:

- Probe: EX3DV4 - SN3710; ConvF(4.57, 4.57, 4.57); Calibrated: 21/04/2020;
- Sensor-Surface: 4mm (Mechanical Surface Detection)
- Electronics: DAE4 Sn915; Calibrated: 13/06/2019
- Phantom: ELI1; Type: QDOVA002AA; Serial: TP:2106
- Measurement SW: DASY52, Version 52.8 (8); SEMCAD X Version 14.6.10 (7331)

Configuration/802.11a 5240MHz body-side4 /Area Scan (8x11x1): Measurement grid: dx=12mm, dy=12mm; Maximum value of SAR (measured) = 0.082 W/kg

Configuration/802.11a 5240MHz body-side4 /Zoom Scan (5x5x7)/Cube 0: Measurement grid: dx=8mm, dy=8mm, dz=5mm; Reference Value = 3.88 V/m; Power Drift = -0.16 dB

Peak SAR (extrapolated) = 0.24 W/kg

SAR(1 g) = 0.073 W/kg; SAR(10 g) = 0.027 W/kg

Maximum value of SAR (measured) = 0.108 W/kg

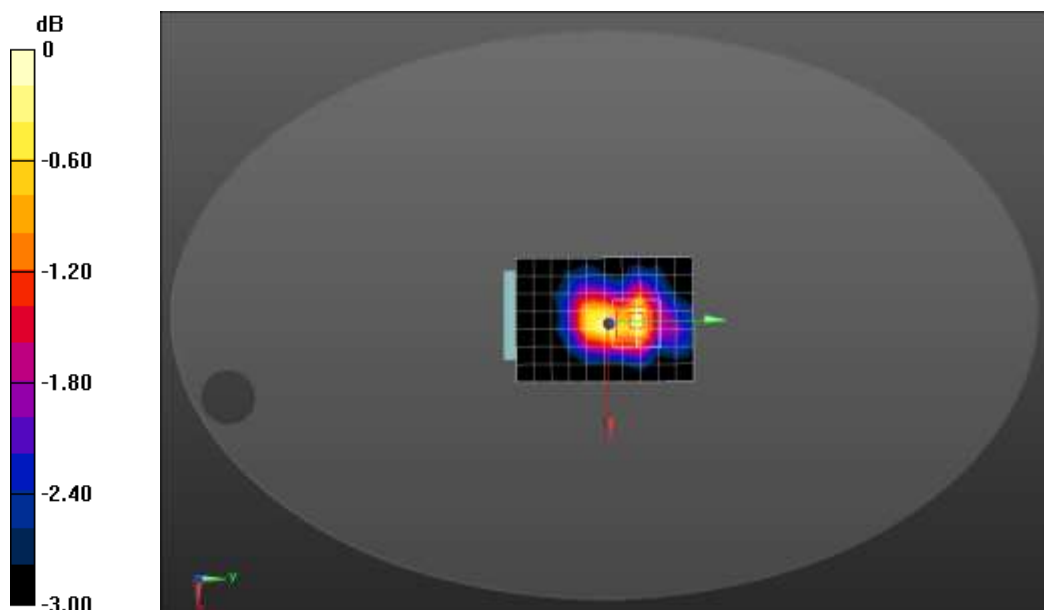

0 dB = 0.108 W/kg = -9.67 dBW/kg

Date/Time: 05/14/2020

Test Laboratory: DEKRA Lab

802.11a 5240MHz body-front

DUT: Mobile Computer; Type: MEMOR K

Communication System: UID 0, CW (0); Communication System Band: 5GHz(5000.0-6000.0MHz); Duty

Cycle: 1:1.0; Frequency: 5240 MHz; Medium parameters used: $f = 5240$ MHz; $\sigma = 5.26$ S/m; $\epsilon_r = 47.9$; $\rho = 1000$ kg/m³; Phantom section: Flat Section

Ambient temperature (°C): 21.5, Liquid temperature (°C): 21.0

DASY5 Configuration:

- Probe: EX3DV4 - SN3710; ConvF(4.57, 4.57, 4.57); Calibrated: 21/04/2020;
- Sensor-Surface: 4mm (Mechanical Surface Detection)
- Electronics: DAE4 Sn915; Calibrated: 13/06/2019
- Phantom: ELI1; Type: QDOVA002AA; Serial: TP:2106
- Measurement SW: DASY52, Version 52.8 (8); SEMCAD X Version 14.6.10 (7331)

Configuration/802.11a 5240MHz body-front /Area Scan (8x11x1): Measurement grid: dx=12mm, dy=12mm; Maximum value of SAR (measured) = 0.361 W/kg

Configuration/802.11a 5240MHz body-front /Zoom Scan (5x5x7)/Cube 0: Measurement grid: dx=8mm, dy=8mm, dz=5mm; Reference Value = 8.328 V/m; Power Drift = -0.08 dB

Peak SAR (extrapolated) = 0.974 W/kg

SAR(1 g) = 0.348 W/kg; SAR(10 g) = 0.137 W/kg

Maximum value of SAR (measured) = 0.415 W/kg

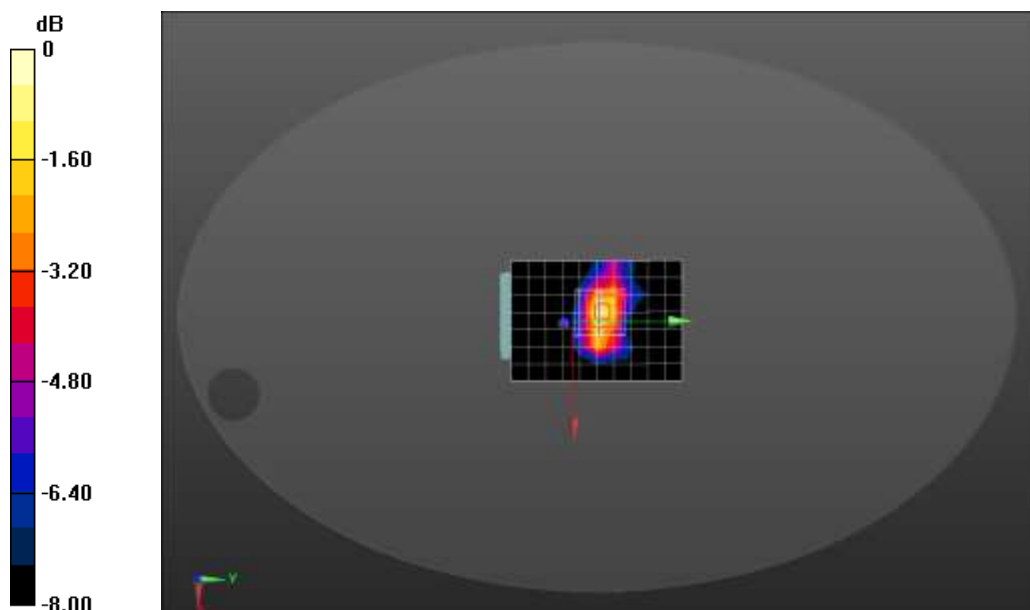

0 dB = 0.415 W/kg = -3.82 dBW/kg

Date/Time: 05/14/2020

Test Laboratory: DEKRA Lab

802.11a 5240MHz body-back

DUT: Mobile Computer; Type: MEMOR K

Communication System: UID 0, CW (0); Communication System Band: 5GHz(5000.0-6000.0MHz); Duty

Cycle: 1:1.0; Frequency: 5240 MHz; Medium parameters used: $f = 5240$ MHz; $\sigma = 5.26$ S/m; $\epsilon_r = 47.9$; $\rho = 1000$ kg/m³; Phantom section: Flat Section

Ambient temperature (°C): 21.5, Liquid temperature (°C): 21.0

DASY5 Configuration:

- Probe: EX3DV4 - SN3710; ConvF(4.57, 4.57, 4.57); Calibrated: 21/04/2020;
- Sensor-Surface: 4mm (Mechanical Surface Detection)
- Electronics: DAE4 Sn915; Calibrated: 13/06/2019
- Phantom: ELI1; Type: QDOVA002AA; Serial: TP:2106
- Measurement SW: DASY52, Version 52.8 (8); SEMCAD X Version 14.6.10 (7331)

Configuration/802.11a 5240MHz body-back /Area Scan (8x11x1): Measurement grid: dx=12mm, dy=12mm; Maximum value of SAR (measured) = 0.276 W/kg

Configuration/802.11a 5240MHz body-back /Zoom Scan (5x5x7)/Cube 0: Measurement grid: dx=8mm, dy=8mm, dz=5mm; Reference Value = 5.702 V/m; Power Drift = -0.17 dB

Peak SAR (extrapolated) = 1.27 W/kg

SAR(1 g) = 0.307 W/kg; SAR(10 g) = 0.109 W/kg

Maximum value of SAR (measured) = 0.309 W/kg

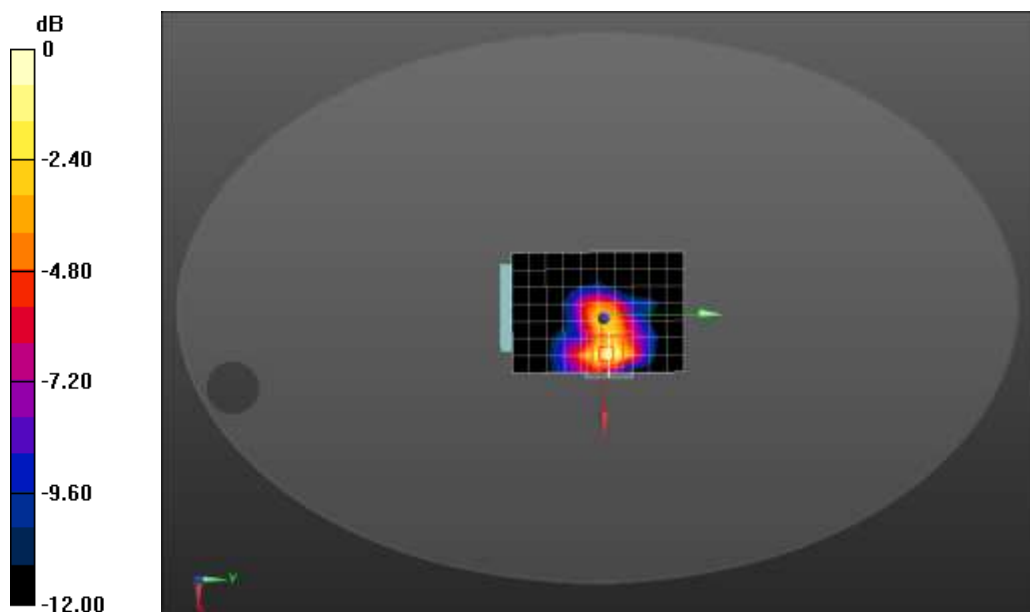

0 dB = 0.309 W/kg = -5.10 dBW/kg

Date/Time: 05/14/2020

Test Laboratory: DEKRA Lab

802.11a 5300MHz body-Side1

DUT: Mobile Computer; Type: MEMOR K

Communication System: UID 0, CW (0); Communication System Band: 5GHz(5000.0-6000.0MHz); Duty

Cycle: 1:1.0; Frequency: 5300 MHz; Medium parameters used: $f = 5300$ MHz; $\sigma = 5.38$ S/m; $\epsilon_r = 47.75$; $\rho = 1000$ kg/m³ ; Phantom section: Flat Section

Ambient temperature (°C): 21.5, Liquid temperature (°C): 21.0

DASY5 Configuration:

- Probe: EX3DV4 - SN3710; ConvF(4.57, 4.57, 4.57); Calibrated: 21/04/2020;
- Sensor-Surface: 4mm (Mechanical Surface Detection)
- Electronics: DAE4 Sn915; Calibrated: 13/06/2019
- Phantom: ELI1; Type: QDOVA002AA; Serial: TP:2106
- Measurement SW: DASY52, Version 52.8 (8); SEMCAD X Version 14.6.10 (7331)

Configuration/802.11a 5300MHz body-side1/Area Scan (8x11x1): Measurement grid: dx=12mm, dy=12mm; Maximum value of SAR (measured) = 0.306 W/kg

Configuration/802.11a 5300MHz body-side1/Zoom Scan (5x5x7)/Cube 0: Measurement grid: dx=8mm, dy=8mm, dz=5mm; Reference Value = 2.136 V/m; Power Drift = 0.11 dB

Peak SAR (extrapolated) = 0.685 W/kg

SAR(1 g) = 0.207 W/kg; SAR(10 g) = 0.077 W/kg

Maximum value of SAR (measured) = 0.414 W/kg

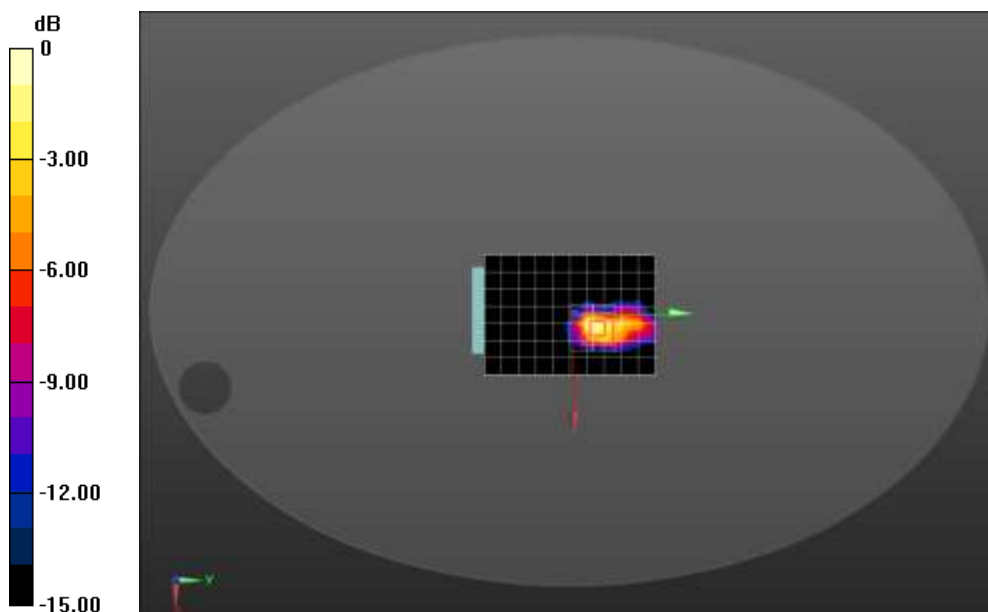

0 dB = 0.414 W/kg = -3.83 dBW/kg

Date/Time: 05/14/2020

Test Laboratory: DEKRA Lab

802.11a 5300MHz body-side2

DUT: Mobile Computer; Type: MEMOR K

Communication System: UID 0, CW (0); Communication System Band: 5GHz(5000.0-6000.0MHz); Duty

Cycle: 1:1.0; Frequency: 5300 MHz; Medium parameters used: $f = 5300$ MHz; $\sigma = 5.38$ S/m; $\epsilon_r = 47.75$; $\rho = 1000$ kg/m³; Phantom section: Flat Section

Ambient temperature (°C): 21.5, Liquid temperature (°C): 21.0

DASY5 Configuration:

- Probe: EX3DV4 - SN3710; ConvF(4.57, 4.57, 4.57); Calibrated: 21/04/2020;
- Sensor-Surface: 4mm (Mechanical Surface Detection)
- Electronics: DAE4 Sn915; Calibrated: 13/06/2019
- Phantom: ELI1; Type: QDOVA002AA; Serial: TP:2106
- Measurement SW: DASY52, Version 52.8 (8); SEMCAD X Version 14.6.10 (7331)

Configuration/802.11a 5300MHz body/Area Scan (8x11x1): Measurement grid: dx=12mm, dy=12mm

Maximum value of SAR (measured) = 0.245 W/kg

Configuration/802.11a 5300MHz body/Zoom Scan (5x5x7)/Cube 0: Measurement grid: dx=8mm, dy=8mm, dz=5mm; Reference Value = 12.12 V/m; Power Drift = -0.02 dB

Peak SAR (extrapolated) = 3.18 W/kg

SAR(1 g) = 0.203 W/kg; SAR(10 g) = 0.079 W/kg

Maximum value of SAR (measured) = 0.395 W/kg

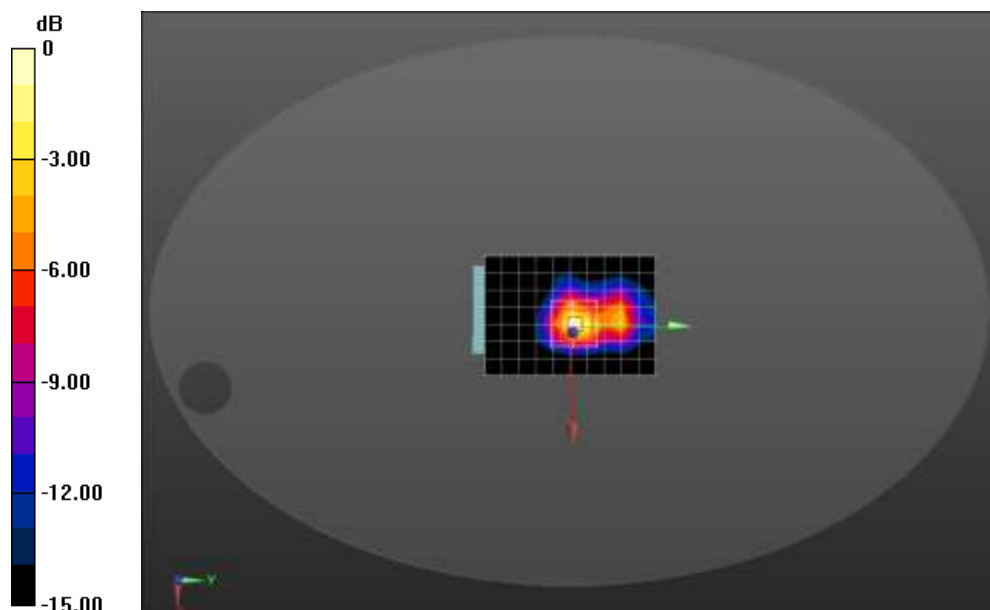

0 dB = 0.395 W/kg = -4.03 dBW/kg

Date/Time: 05/14/2020

Test Laboratory: DEKRA Lab

802.11a 5300MHz body-side3

DUT: Mobile Computer; Type: MEMOR K

Communication System: UID 0, CW (0); Communication System Band: 5GHz(5000.0-6000.0MHz); Duty

Cycle: 1:1.0; Frequency: 5320 MHz; Medium parameters used: $f = 5320$ MHz; $\sigma = 5.38$ S/m; $\epsilon_r = 47.75$; $\rho = 1000$ kg/m³; Phantom section: Flat Section

Ambient temperature (°C): 21.5, Liquid temperature (°C): 21.0

DASY5 Configuration:

- Probe: EX3DV4 - SN3710; ConvF(4.57, 4.57, 4.57); Calibrated: 21/04/2020;
- Sensor-Surface: 4mm (Mechanical Surface Detection)
- Electronics: DAE4 Sn915; Calibrated: 13/06/2019
- Phantom: ELI1; Type: QDOVA002AA; Serial: TP:2106
- Measurement SW: DASY52, Version 52.8 (8); SEMCAD X Version 14.6.10 (7331)

Configuration/802.11a 5320MHz body-side3/Area Scan (8x11x1): Measurement grid: dx=12mm, dy=12mm; Maximum value of SAR (measured) = 1.03 W/kg

Configuration/802.11a 5320MHz body-side3/Zoom Scan (5x5x7)/Cube 0: Measurement grid: dx=8mm, dy=8mm, dz=5mm; Reference Value = 4.201 V/m; Power Drift = 0.02 dB

Peak SAR (extrapolated) = 2.71 W/kg

SAR(1 g) = 0.735 W/kg; SAR(10 g) = 0.337 W/kg

Maximum value of SAR (measured) = 1.17 W/kg

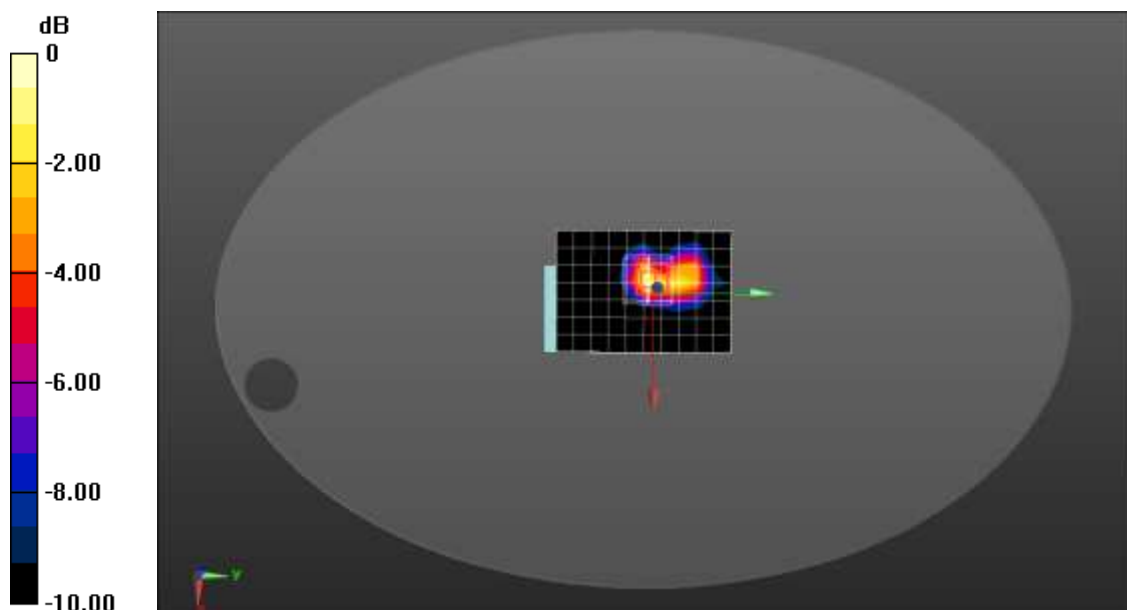

0 dB = 1.17 W/kg = 0.68 dBW/kg

Date/Time: 05/14/2020

Test Laboratory: DEKRA Lab

802.11a 5300MHz body-side4

DUT: Mobile Computer; Type: MEMOR K

Communication System: UID 0, CW (0); Communication System Band: 5GHz(5000.0-6000.0MHz); Duty

Cycle: 1:1.0; Frequency: 5180 MHz; Medium parameters used: $f = 5180$ MHz; $\sigma = 5.38$ S/m; $\epsilon_r = 47.75$; $\rho = 1000$ kg/m³; Phantom section: Flat Section

Ambient temperature (°C): 21.5, Liquid temperature (°C): 21.0

DASY5 Configuration:

- Probe: EX3DV4 - SN3710; ConvF(4.57, 4.57, 4.57); Calibrated: 21/04/2020;
- Sensor-Surface: 4mm (Mechanical Surface Detection)
- Electronics: DAE4 Sn915; Calibrated: 13/06/2019
- Phantom: ELI1; Type: QDOVA002AA; Serial: TP:2106
- Measurement SW: DASY52, Version 52.8 (8); SEMCAD X Version 14.6.10 (7331)

Configuration/802.11a 5180MHz body-side3 /Area Scan (8x11x1): Measurement grid: dx=12mm, dy=12mm; Maximum value of SAR (measured) = 0.142 W/kg

Configuration/802.11a 5180MHz body-side3 /Zoom Scan (5x5x7)/Cube 0: Measurement grid: dx=8mm, dy=8mm, dz=5mm; Reference Value = 5.88 V/m; Power Drift = -0.06 dB

Peak SAR (extrapolated) = 1.94 W/kg

SAR(1 g) = 0.114 W/kg; SAR(10 g) = 0.047 W/kg

Maximum value of SAR (measured) = 0.208 W/kg

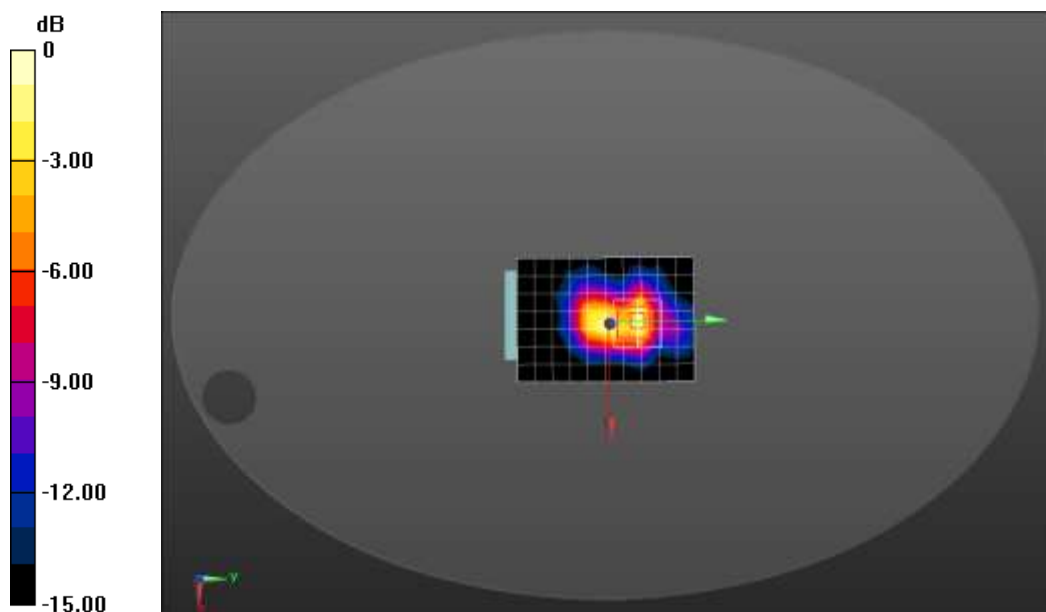

0 dB = 0.208 W/kg = -6.82 dBW/kg

Date/Time: 05/14/2020

Test Laboratory: DEKRA Lab

802.11a 5300MHz body-front

DUT: Mobile Computer; Type: MEMOR K

Communication System: UID 0, CW (0); Communication System Band: 5GHz(5000.0-6000.0MHz); Duty

Cycle: 1:1.0; Frequency: 5300 MHz; Medium parameters used: $f = 5300$ MHz; $\sigma = 5.38$ S/m; $\epsilon_r = 47.75$; $\rho = 1000$ kg/m³ ; Phantom section: Flat Section

Ambient temperature (°C): 21.5, Liquid temperature (°C): 21.0

DASY5 Configuration:

- Probe: EX3DV4 - SN3710; ConvF(4.57, 4.57, 4.57); Calibrated: 21/04/2020;
- Sensor-Surface: 4mm (Mechanical Surface Detection)
- Electronics: DAE4 Sn915; Calibrated: 13/06/2019
- Phantom: ELI1; Type: QDOVA002AA; Serial: TP:2106
- Measurement SW: DASY52, Version 52.8 (8); SEMCAD X Version 14.6.10 (7331)

Configuration/802.11a 5300MHz body-front/Area Scan (8x11x1): Measurement grid: dx=12mm, dy=12mm

Maximum value of SAR (measured) = 0.457 W/kg

Configuration/802.11a 5300MHz body-front/Zoom Scan (5x5x7)/Cube 0: Measurement grid: dx=8mm,

dy=8mm, dz=5mm; Reference Value = 8.205 V/m; Power Drift = -0.07 dB

Peak SAR (extrapolated) = 2.72 W/kg

SAR(1 g) = 0.396 W/kg; SAR(10 g) = 0.126 W/kg

Maximum value of SAR (measured) = 0.512 W/kg

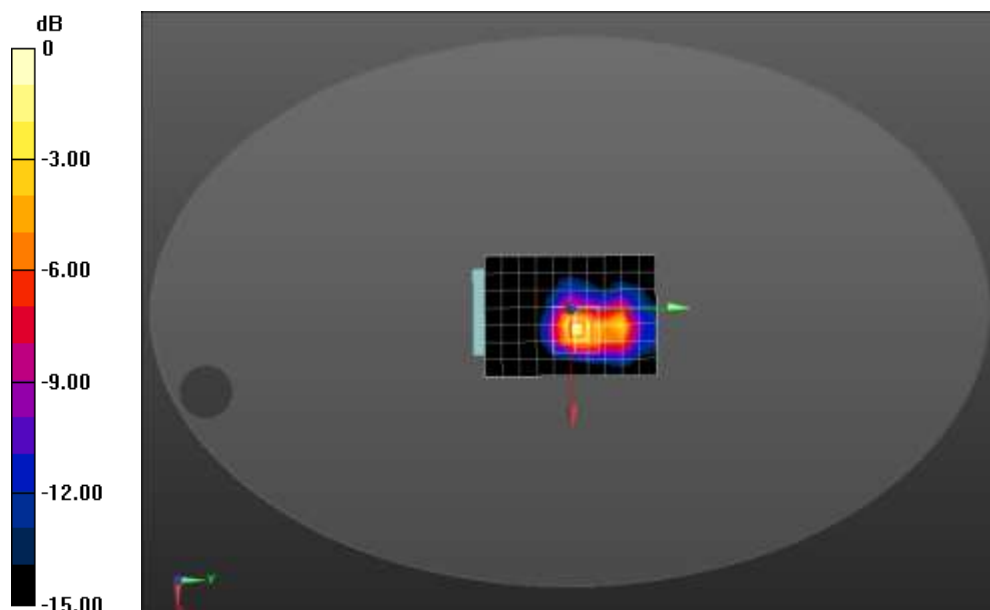

0 dB = 0.512 W/kg = -2.91 dBW/kg

Date/Time: 05/14/2020

Test Laboratory: DEKRA Lab

802.11a 5300MHz body-back

DUT: Mobile Computer; Type: MEMOR K

Communication System: UID 0, CW (0); Communication System Band: 5GHz(5000.0-6000.0MHz); Duty

Cycle: 1:1.0; Frequency: 5300 MHz; Medium parameters used: $f = 5300$ MHz; $\sigma = 5.38$ S/m; $\epsilon_r = 47.75$; $\rho =$

1000 kg/m³ ; Phantom section: Flat Section

Ambient temperature (°C): 21.5, Liquid temperature (°C): 21.0

DASY5 Configuration:

- Probe: EX3DV4 - SN3710; ConvF(4.57, 4.57, 4.57); Calibrated: 21/04/2020;
- Sensor-Surface: 4mm (Mechanical Surface Detection)
- Electronics: DAE4 Sn915; Calibrated: 13/06/2019
- Phantom: ELI1; Type: QDOVA002AA; Serial: TP:2106
- Measurement SW: DASY52, Version 52.8 (8); SEMCAD X Version 14.6.10 (7331)

Configuration/802.11a 5300MHz body-back/Area Scan (8x11x1): Measurement grid: dx=12mm, dy=12mm

Maximum value of SAR (measured) = 0.347 W/kg

Configuration/802.11a 5300MHz body-back/Zoom Scan (5x5x7)/Cube 0: Measurement grid: dx=8mm,

dy=8mm, dz=5mm; Reference Value = 8.812 V/m; Power Drift = -0.05 dB

Peak SAR (extrapolated) = 3.59 W/kg

SAR(1 g) = 0.301 W/kg; SAR(10 g) = 0.124 W/kg

Maximum value of SAR (measured) = 0.532 W/kg

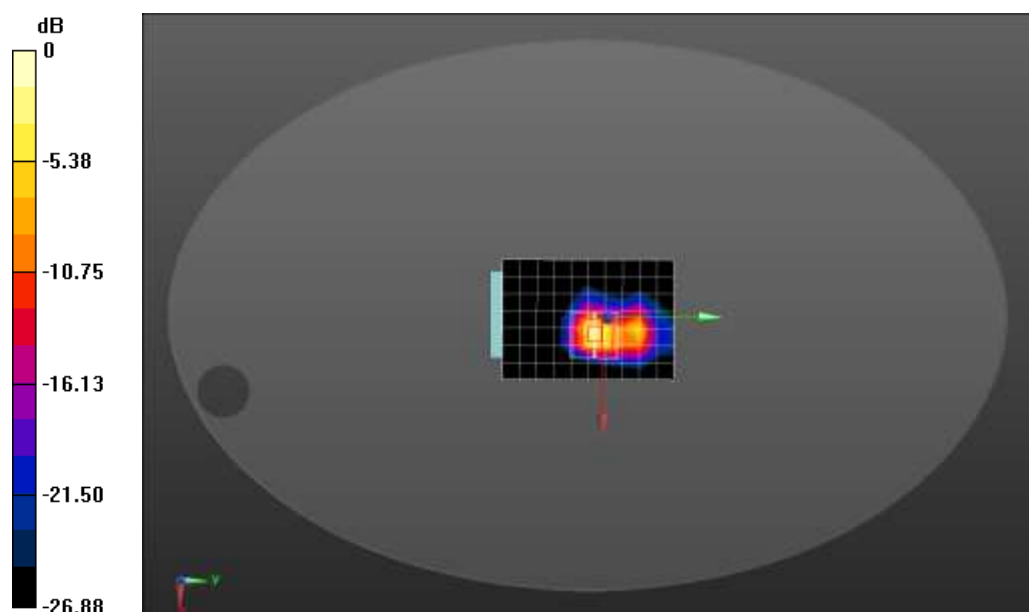

0 dB = 0.532 W/kg = -2.74 dBW/kg

Date/Time: 05/14/2020

Test Laboratory: DEKRA Lab

802.11a 5220MHz body-side3

DUT: Mobile Computer; Type: MEMOR K

Communication System: UID 0, CW (0); Communication System Band: 5GHz(5000.0-6000.0MHz); Duty

Cycle: 1:1.0; Frequency: 5220 MHz; Medium parameters used: $f = 5220$ MHz; $\sigma = 5.23$ S/m; $\epsilon_r = 47.94$; $\rho = 1000$ kg/m³; Phantom section: Flat Section

Ambient temperature (°C): 21.5, Liquid temperature (°C): 21.0

DASY5 Configuration:

- Probe: EX3DV4 - SN3710; ConvF(4.57, 4.57, 4.57); Calibrated: 21/04/2020;
- Sensor-Surface: 4mm (Mechanical Surface Detection)
- Electronics: DAE4 Sn915; Calibrated: 13/06/2019
- Phantom: ELI1; Type: QDOVA002AA; Serial: TP:2106
- Measurement SW: DASY52, Version 52.8 (8); SEMCAD X Version 14.6.10 (7331)

Configuration/802.11a 5220MHz body-side3/Area Scan (8x11x1): Measurement grid: dx=12mm, dy=12mm; Maximum value of SAR (measured) = 0.715 W/kg

Configuration/802.11a 5220MHz body-side3/Zoom Scan (5x5x7)/Cube 0: Measurement grid: dx=8mm, dy=8mm, dz=5mm; Reference Value = 11.25 V/m; Power Drift = 0.04 dB

Peak SAR (extrapolated) = 5.44 W/kg

SAR(1 g) = 0.709 W/kg; SAR(10 g) = 0.312 W/kg

Maximum value of SAR (measured) = 0.875 W/kg

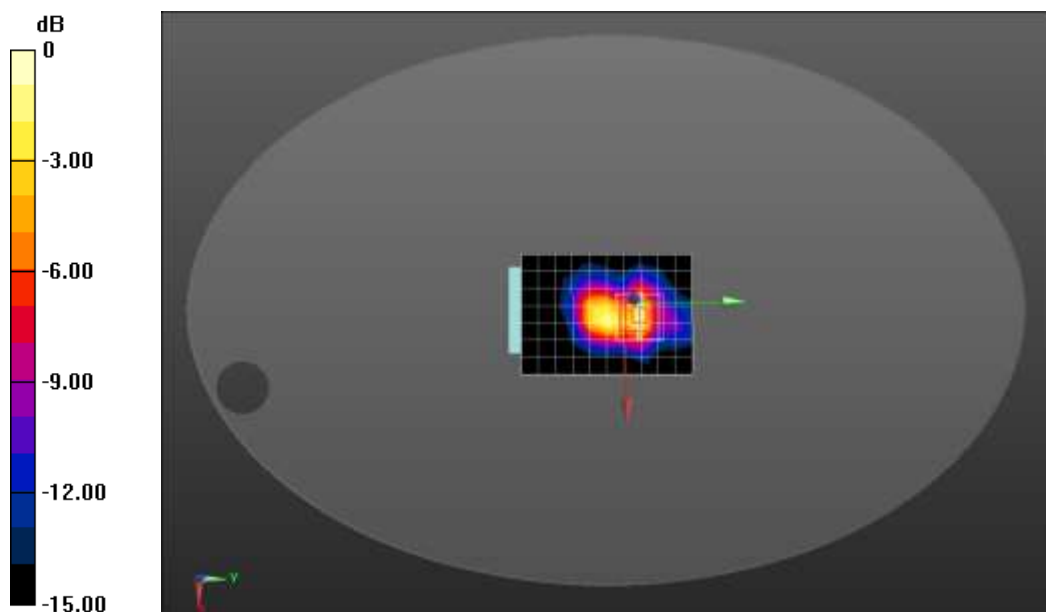

0 dB = 0.875 W/kg = -0.58 dBW/kg

Date/Time: 05/14/2020

Test Laboratory: DEKRA Lab

802.11a 5500MHz body-side3

DUT: Mobile Computer; Type: MEMOR K

Communication System: UID 0, CW (0); Communication System Band: 5GHz(5000.0-6000.0MHz); Duty

Cycle: 1:1.0; Frequency: 5500 MHz; Medium parameters used: $f = 5500$ MHz; $\sigma = 5.64$ S/m; $\epsilon_r = 47.44$; $\rho = 1000$ kg/m³; Phantom section: Flat Section

Ambient temperature (°C): 21.5, Liquid temperature (°C): 21.0

DASY5 Configuration:

- Probe: EX3DV4 - SN3710; ConvF(3.98, 3.98, 3.98); Calibrated: 21/04/2020;
- Sensor-Surface: 4mm (Mechanical Surface Detection)
- Electronics: DAE4 Sn915; Calibrated: 13/06/2019
- Phantom: ELI1; Type: QDOVA002AA; Serial: TP:2106
- Measurement SW: DASY52, Version 52.8 (8); SEMCAD X Version 14.6.10 (7331)

Configuration/802.11a 5500MHz body-side3/Area Scan (8x11x1): Measurement grid: dx=12mm, dy=12mm; Maximum value of SAR (measured) = 0.923 W/kg

Configuration/802.11a 5500MHz body-side3/Zoom Scan (5x5x7)/Cube 0: Measurement grid: dx=8mm, dy=8mm, dz=5mm; Reference Value = 12.22 V/m; Power Drift = -0.10 dB

Peak SAR (extrapolated) = 2.48 W/kg

SAR(1 g) = 0.728 W/kg; SAR(10 g) = 0.282 W/kg

Maximum value of SAR (measured) = 1.06 W/kg

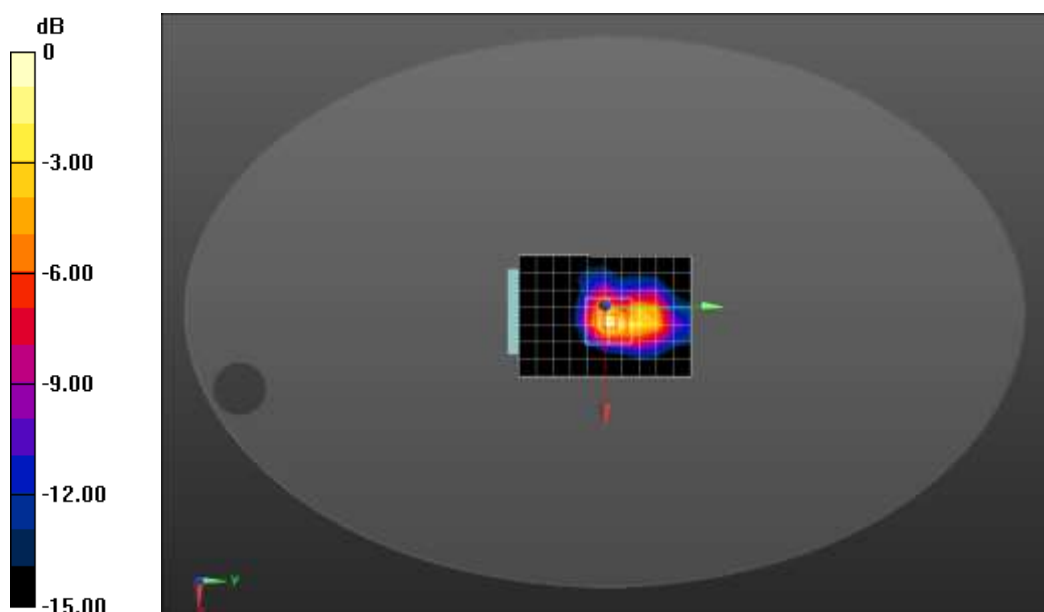

0 dB = 1.06 W/kg = 0.25 dBW/kg

Date/Time: 05/14/2020

Test Laboratory: DEKRA Lab

802.11a 5745MHz body-side3

DUT: Mobile Computer; Type: MEMOR K

Communication System: UID 0, CW (0); Communication System Band: 5GHz(5000.0-6000.0MHz); Duty Cycle: 1:1.0; Frequency: 5745 MHz; Medium parameters used: $f = 5745$ MHz; $\sigma = 6.0$ S/m; $\epsilon_r = 46.9$; $\rho = 1000$ kg/m³; Phantom section: Flat Section

Ambient temperature (°C): 21.5, Liquid temperature (°C): 21.0

DASY5 Configuration:

- Probe: EX3DV4 - SN3710; ConvF(4.01, 4.01, 4.01); Calibrated: 21/04/2020;
- Sensor-Surface: 4mm (Mechanical Surface Detection)
- Electronics: DAE4 Sn915; Calibrated: 13/06/2019
- Phantom: ELI1; Type: QDOVA002AA; Serial: TP:2106
- Measurement SW: DASY52, Version 52.8 (8); SEMCAD X Version 14.6.10 (7331)

Configuration/802.11a 5745MHz body-side3/Area Scan (8x11x1): Measurement grid: dx=12mm, dy=12mm; Maximum value of SAR (measured) = 1.02 W/kg

Configuration/802.11a 5745MHz body-side3/Zoom Scan (5x5x7)/Cube 0: Measurement grid: dx=8mm, dy=8mm, dz=5mm; Reference Value = 12.57 V/m; Power Drift = -0.16 dB

Peak SAR (extrapolated) = 2.85 W/kg

SAR(1 g) = 0.720 W/kg; SAR(10 g) = 0.320 W/kg

Maximum value of SAR (measured) = 1.16 W/kg

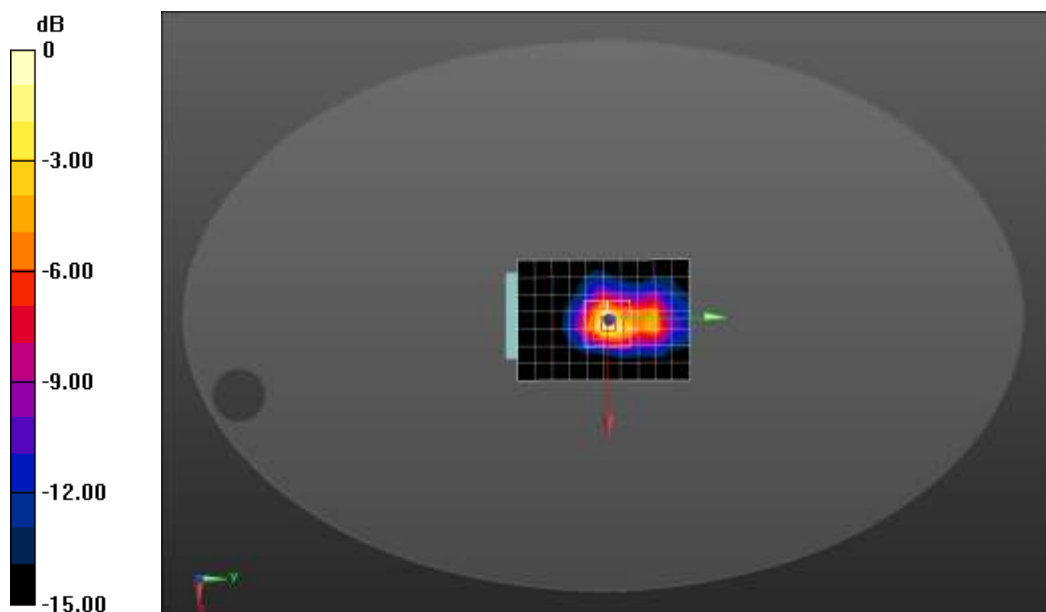

0 dB = 1.16 W/kg = 0.64 dBW/kg

Date/Time: 05/14/2020

Test Laboratory: DEKRA Lab

802.11ac80 5530MHz body-side3

DUT: Mobile Computer; Type: MEMOR K

Communication System: UID 0, CW (0); Communication System Band: 5GHz(5000.0-6000.0MHz); Duty

Cycle: 1:1.0; Frequency: 5530 MHz; Medium parameters used: $f = 5530$ MHz; $\sigma = 5.69$ S/m; $\epsilon_r = 47.35$; $\rho = 1000$ kg/m³; Phantom section: Flat Section

Ambient temperature (°C): 21.5, Liquid temperature (°C): 21.0

DASY5 Configuration:

- Probe: EX3DV4 - SN3710; ConvF(3.98, 3.98, 3.98); Calibrated: 21/04/2020;
- Sensor-Surface: 4mm (Mechanical Surface Detection)
- Electronics: DAE4 Sn915; Calibrated: 13/06/2019
- Phantom: ELI1; Type: QDOVA002AA; Serial: TP:2106
- Measurement SW: DASY52, Version 52.8 (8); SEMCAD X Version 14.6.10 (7331)

Configuration/802.11ac80 5530MHz body-side3/Area Scan (8x9x1): Measurement grid: dx=12mm, dy=12mm; Maximum value of SAR (measured) = 0.843 W/kg

Configuration/802.11ac80 5530MHz body-side3/Zoom Scan (5x5x7)/Cube 0: Measurement grid: dx=8mm, dy=8mm, dz=5mm; Reference Value = 12.38 V/m; Power Drift = -0.10 dB

Peak SAR (extrapolated) = 2.46 W/kg

SAR(1 g) = 0.716 W/kg; SAR(10 g) = 0.283 W/kg

Maximum value of SAR (measured) = 1.04 W/kg

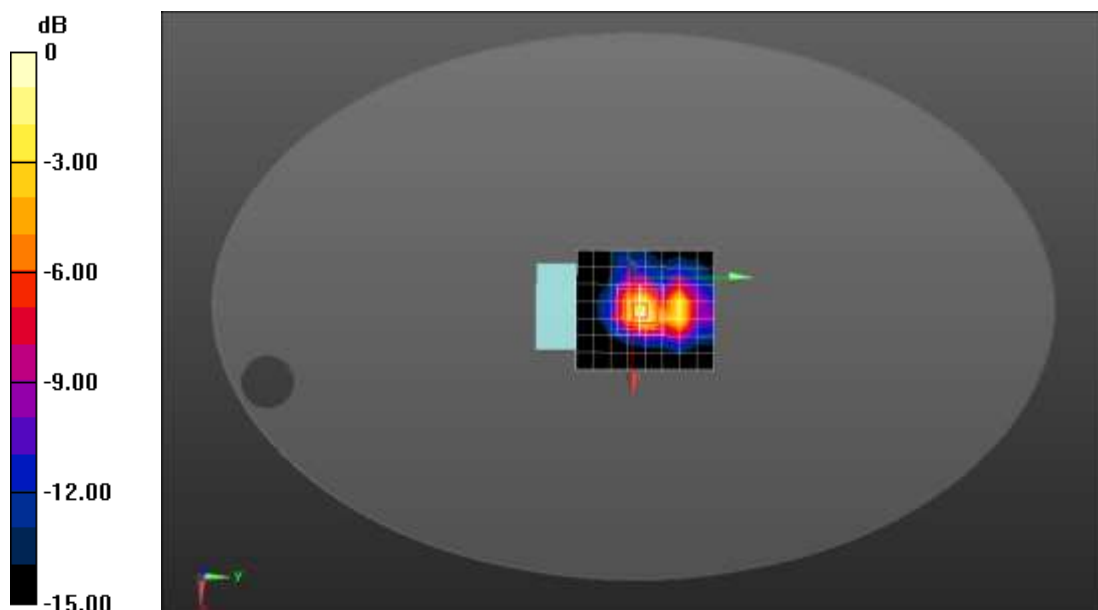

0 dB = 1.04 W/kg = 0.17 dBW/kg

Date/Time: 05/12/2020

Test Laboratory: DEKRA Lab

802.11a 5240MHz Touch-Left

DUT: Mobile Computer; Type: MEMOR K

Communication System: UID 0, CW (0); Communication System Band: 5GHz(5000.0-6000.0MHz); Duty

Cycle: 1:1.0; Frequency: 5240 MHz; Medium parameters used: $f = 5240$ MHz; $\sigma = 4.55$ S/m; $\epsilon_r = 36.11$; $\rho = 1000$ kg/m³; Phantom section: Left Section

Ambient temperature (°C): 21.5, Liquid temperature (°C): 21.0

DASY5 Configuration:

- Probe: EX3DV4 - SN3710; ConvF(5.18, 5.18, 5.18); Calibrated: 21/04/2020;
- Sensor-Surface: 4mm (Mechanical Surface Detection)
- Electronics: DAE4 Sn915; Calibrated: 13/06/2019
- Phantom: SAM2; Type: SAM; Serial: TP1562
- Measurement SW: DASY52, Version 52.8 (8); SEMCAD X Version 14.6.10 (7331)

Configuration/802.11a 5240MHz Touch-Left/Area Scan (9x11x1): Measurement grid: dx=12mm, dy=12mm; Maximum value of SAR (measured) = 0.857 W/kg

Configuration/802.11a 5240MHz Touch-Left/Zoom Scan (5x5x7)/Cube 0: Measurement grid: dx=8mm, dy=8mm, dz=5mm; Reference Value = 7.882 V/m; Power Drift = -0.12 dB

Peak SAR (extrapolated) = 5.29 W/kg

SAR(1 g) = 0.808 W/kg; SAR(10 g) = 0.320 W/kg

Maximum value of SAR (measured) = 0.948 W/kg

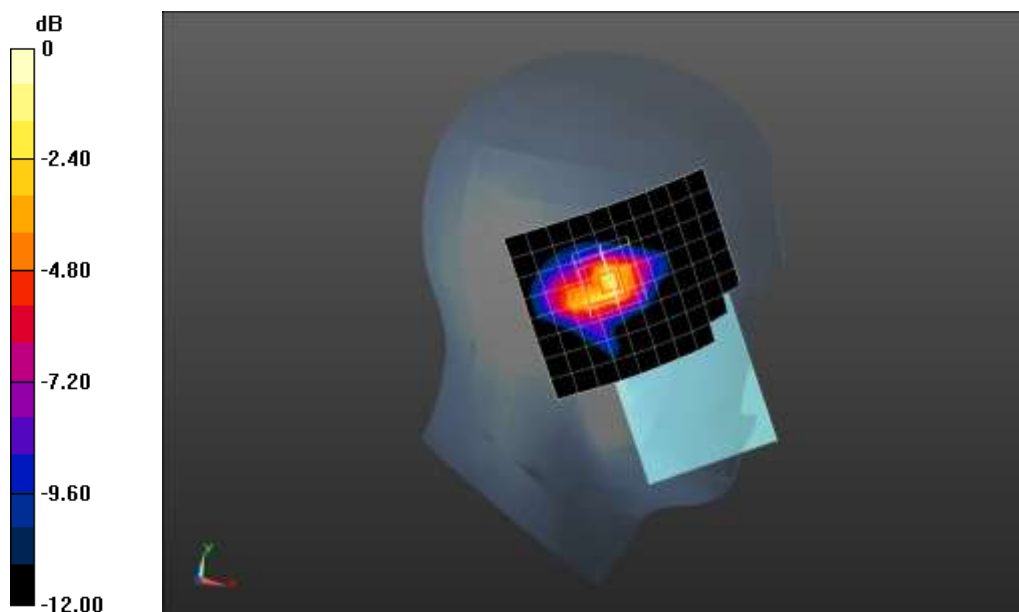

0 dB = 0.948 W/kg = -0.23 dBW/kg

Date/Time: 05/12/2020

Test Laboratory: DEKRA Lab

802.11a 5240MHz Touch-Right

DUT: Mobile Computer; Type: MEMOR K

Communication System: UID 0, CW (0); Communication System Band: 5GHz(5000.0-6000.0MHz); Duty

Cycle: 1:1.0; Frequency: 5240 MHz; Medium parameters used: $f = 5240$ MHz; $\sigma = 4.55$ S/m; $\epsilon_r = 36.11$; $\rho = 1000$ kg/m³; Phantom section: Right Section

Ambient temperature (°C): 21.5, Liquid temperature (°C): 21.0

DASY5 Configuration:

- Probe: EX3DV4 - SN3710; ConvF(5.18, 5.18, 5.18); Calibrated: 21/04/2020;
- Sensor-Surface: 4mm (Mechanical Surface Detection)
- Electronics: DAE4 Sn915; Calibrated: 13/06/2019
- Phantom: SAM2; Type: SAM; Serial: TP1562
- Measurement SW: DASY52, Version 52.8 (8); SEMCAD X Version 14.6.10 (7331)

Configuration/802.11a 5240MHz Touch-Right/Area Scan (9x11x1): Measurement grid: dx=12mm, dy=12mm; Maximum value of SAR (measured) = 1.04 W/kg

Configuration/802.11a 5240MHz Touch-Right/Zoom Scan (5x5x7)/Cube 0: Measurement grid: dx=8mm, dy=8mm, dz=5mm; Reference Value = 10.53 V/m; Power Drift = -0.08 dB

Peak SAR (extrapolated) = 3.08 W/kg

SAR(1 g) = 0.704 W/kg; SAR(10 g) = 0.285 W/kg

Maximum value of SAR (measured) = 1.11 W/kg

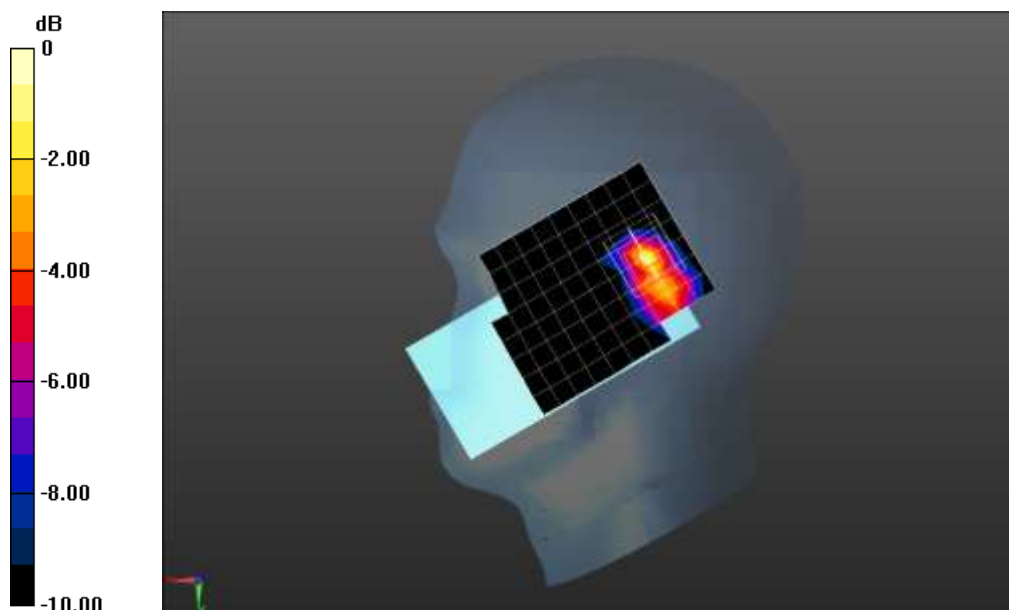

0 dB = 1.11 W/kg = 0.45 dBW/kg

Date/Time: 05/12/2020

Test Laboratory: DEKRA Lab

802.11a 5220MHz Touch-Left

DUT: Mobile Computer; Type: MEMOR K

Communication System: UID 0, CW (0); Communication System Band: 5GHz(5000.0-6000.0MHz); Duty

Cycle: 1:1.0; Frequency: 5220 MHz; Medium parameters used: $f = 5220$ MHz; $\sigma = 4.53$ S/m; $\epsilon_r = 36.15$; $\rho = 1000$ kg/m³; Phantom section: Left Section

Ambient temperature (°C): 21.5, Liquid temperature (°C): 21.0

DASY5 Configuration:

- Probe: EX3DV4 - SN3710; ConvF(5.18, 5.18, 5.18); Calibrated: 21/04/2020;
- Sensor-Surface: 4mm (Mechanical Surface Detection)
- Electronics: DAE4 Sn915; Calibrated: 13/06/2019
- Phantom: SAM2; Type: SAM; Serial: TP1562
- Measurement SW: DASY52, Version 52.8 (8); SEMCAD X Version 14.6.10 (7331)

Configuration/802.11a 5220MHz Touch-Left/Area Scan (9x11x1): Measurement grid: dx=12mm, dy=12mm; Maximum value of SAR (measured) = 0.442 W/kg

Configuration/802.11a 5220MHz Touch-Left/Zoom Scan (5x5x7)/Cube 0: Measurement grid: dx=8mm, dy=8mm, dz=5mm; Reference Value = 10.66 V/m; Power Drift = -0.04 dB

Peak SAR (extrapolated) = 2.72 W/kg

SAR(1 g) = 0.604 W/kg; SAR(10 g) = 0.222 W/kg

Maximum value of SAR (measured) = 0.598 W/kg

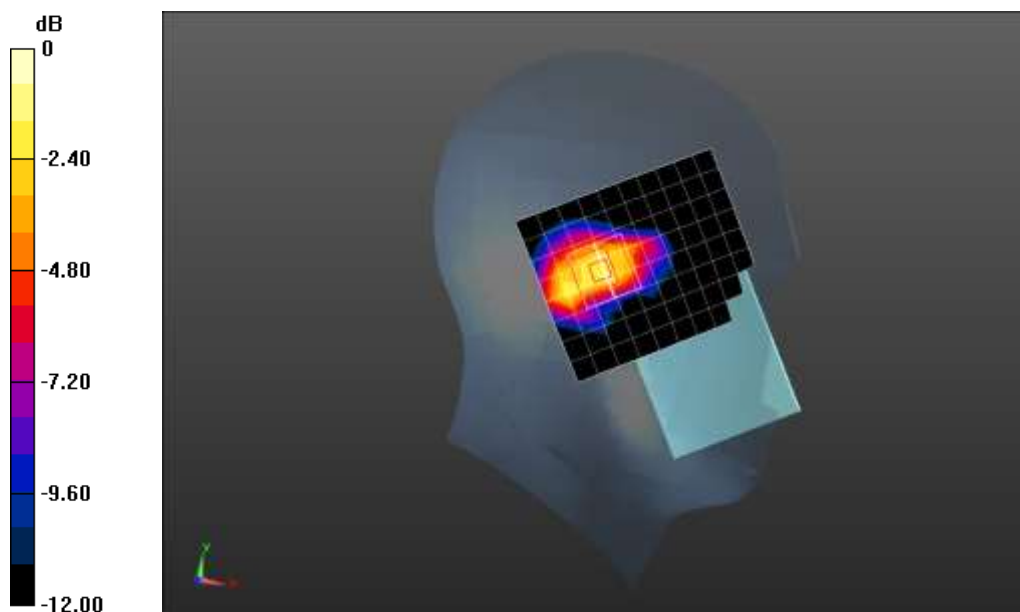

0 dB = 0.598 W/kg = -2.23 dBW/kg

Date/Time: 05/12/2020

Test Laboratory: DEKRA Lab

802.11a 5300MHz Touch-Left

DUT: Mobile Computer; Type: MEMOR K

Communication System: UID 0, CW (0); Communication System Band: 5GHz(5000.0-6000.0MHz); Duty

Cycle: 1:1.0; Frequency: 5300 MHz; Medium parameters used: $f = 5300 \text{ MHz}$; $\sigma = 4.61 \text{ S/m}$; $\epsilon_r = 36.02$; $\rho = 1000 \text{ kg/m}^3$; Phantom section: Left Section

Ambient temperature (°C): 21.5, Liquid temperature (°C): 21.0

DASY5 Configuration:

- Probe: EX3DV4 - SN3710; ConvF(5.18, 5.18, 5.18); Calibrated: 21/04/2020;
- Sensor-Surface: 4mm (Mechanical Surface Detection)
- Electronics: DAE4 Sn915; Calibrated: 13/06/2019
- Phantom: SAM2; Type: SAM; Serial: TP1562
- Measurement SW: DASY52, Version 52.8 (8); SEMCAD X Version 14.6.10 (7331)

Configuration/802.11a 5300MHz Touch-Left/Area Scan (9x11x1): Measurement grid: $dx=12\text{mm}$, $dy=12\text{mm}$; Maximum value of SAR (measured) = 0.877 W/kg

Configuration/802.11a 5300MHz Touch-Left/Zoom Scan (5x5x7)/Cube 0: Measurement grid: $dx=8\text{mm}$, $dy=8\text{mm}$, $dz=5\text{mm}$; Reference Value = 13.04 V/m; Power Drift = 0.08 dB

Peak SAR (extrapolated) = 6.17 W/kg

SAR(1 g) = 0.806 W/kg; SAR(10 g) = 0.346 W/kg

Maximum value of SAR (measured) = 0.990 W/kg

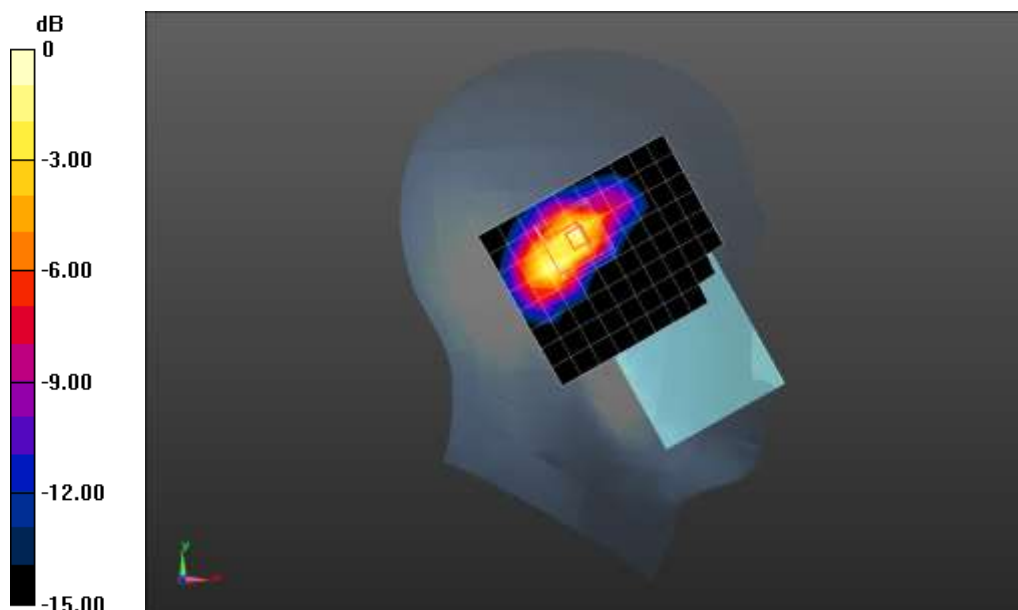

0 dB = 0.990 W/kg = -0.04 dBW/kg

Date/Time: 05/12/2020

Test Laboratory: DEKRA Lab

802.11a 5300MHz Touch-Right

DUT: Mobile Computer; Type: MEMOR K

Communication System: UID 0, CW (0); Communication System Band: 5GHz(5000.0-6000.0MHz); Duty

Cycle: 1:1.0; Frequency: 5300 MHz; Medium parameters used: $f = 5300$ MHz; $\sigma = 4.61$ S/m; $\epsilon_r = 36.02$; $\rho = 1000$ kg/m³; Phantom section: Right Section

Ambient temperature (°C): 21.5, Liquid temperature (°C): 21.0

DASY5 Configuration:

- Probe: EX3DV4 - SN3710; ConvF(5.18, 5.18, 5.18)); Calibrated: 21/04/2020;
- Sensor-Surface: 4mm (Mechanical Surface Detection)
- Electronics: DAE4 Sn915; Calibrated: 13/06/2019
- Phantom: SAM2; Type: SAM; Serial: TP1562
- Measurement SW: DASY52, Version 52.8 (8); SEMCAD X Version 14.6.10 (7331)

Configuration/802.11a 5300MHz body-right/Area Scan (9x10x1): Measurement grid: dx=12mm, dy=12mm

Maximum value of SAR (measured) = 0.747 W/kg

Configuration/802.11a 5300MHz body-right/Zoom Scan (5x5x7)/Cube 0: Measurement grid: dx=8mm,

dy=8mm, dz=5mm; Reference Value = 7.078 V/m; Power Drift = 0.17 dB

Peak SAR (extrapolated) = 1.50 W/kg

SAR(1 g) = 0.725 W/kg; SAR(10 g) = 0.366 W/kg

Maximum value of SAR (measured) = 0.958 W/kg

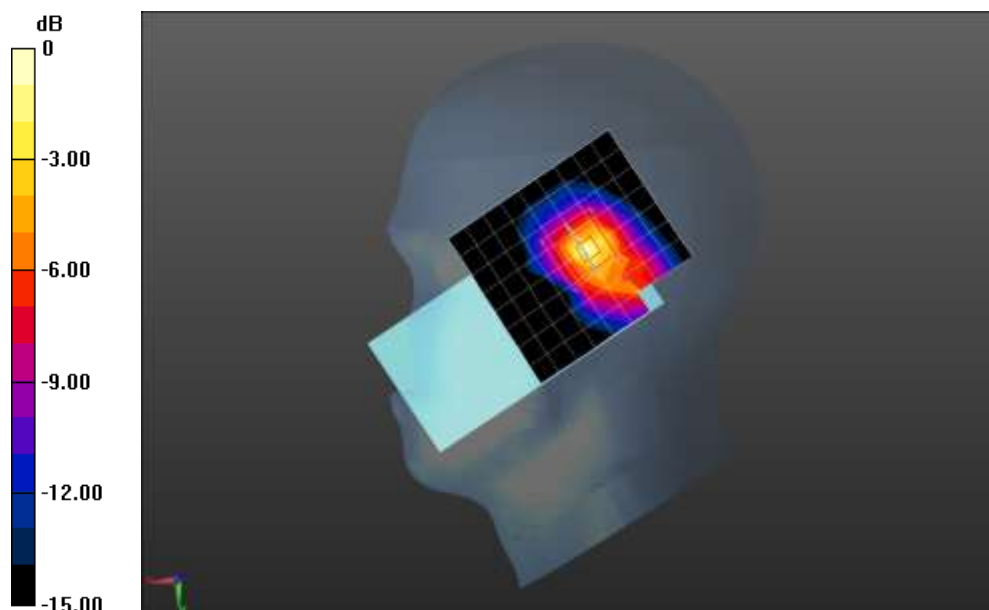

0 dB = 0.958 W/kg = -0.07 dBW/kg

Date/Time: 05/12/2020

Test Laboratory: DEKRA Lab

802.11a 5500MHz Touch-Left

DUT: Mobile Computer; Type: MEMOR K

Communication System: UID 0, CW (0); Communication System Band: 5GHz(5000.0-6000.0MHz); Duty

Cycle: 1:1.0; Frequency: 5500 MHz; Medium parameters used: $f = 5500$ MHz; $\sigma = 4.88$ S/m; $\epsilon_r = 35.61$; $\rho = 1000$ kg/m³; Phantom section: Left Section

Ambient temperature (°C): 21.5, Liquid temperature (°C): 21.0

DASY5 Configuration:

- Probe: EX3DV4 - SN3710; ConvF(4.66, 4.66, 4.66); Calibrated: 21/04/2020;
- Sensor-Surface: 4mm (Mechanical Surface Detection)
- Electronics: DAE4 Sn915; Calibrated: 13/06/2019
- Phantom: SAM2; Type: SAM; Serial: TP1562
- Measurement SW: DASY52, Version 52.8 (8); SEMCAD X Version 14.6.10 (7331)

Configuration/802.11a 5500MHz Touch-Left/Area Scan (9x11x1): Measurement grid: dx=12mm, dy=12mm; Maximum value of SAR (measured) = 0.638 W/kg

Configuration/802.11a 5500MHz Touch-Left/Zoom Scan (5x5x7)/Cube 0: Measurement grid: dx=8mm, dy=8mm, dz=5mm; Reference Value = 6.704 V/m; Power Drift = 0.03 dB

Peak SAR (extrapolated) = 3.18 W/kg

SAR(1 g) = 0.606 W/kg; SAR(10 g) = 0.181 W/kg

Maximum value of SAR (measured) = 0.638 W/kg

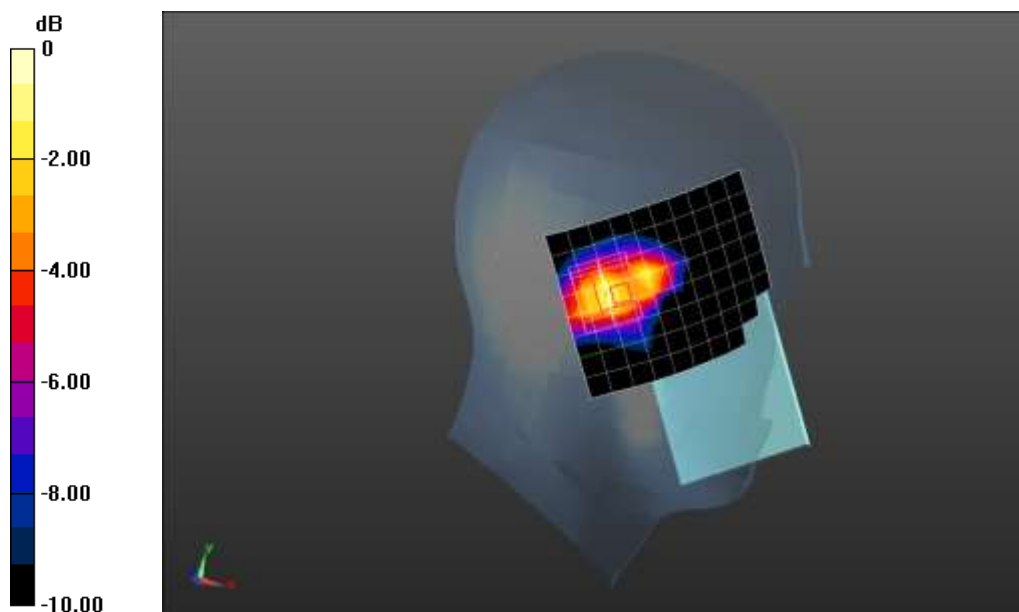

0 dB = 0.638 W/kg = -1.95 dBW/kg

Date/Time: 05/12/2020

Test Laboratory: DEKRA Lab

802.11a 5745MHz Touch-Left

DUT: Mobile Computer; Type: MEMOR K

Communication System: UID 0, CW (0); Communication System Band: 5GHz(5000.0-6000.0MHz); Duty

Cycle: 1:1.0; Frequency: 5745 MHz; Medium parameters used: $f = 5745$ MHz; $\sigma = 5.14$ S/m; $\epsilon_r = 35.24$; $\rho = 1000$ kg/m³; Phantom section: Left Section

Ambient temperature (°C): 21.5, Liquid temperature (°C): 21.0

DASY5 Configuration:

- Probe: EX3DV4 - SN3710; ConvF(4.77, 4.77, 4.77); Calibrated: 21/04/2020;
- Sensor-Surface: 4mm (Mechanical Surface Detection)
- Electronics: DAE4 Sn915; Calibrated: 13/06/2019
- Phantom: SAM2; Type: SAM; Serial: TP1562
- Measurement SW: DASY52, Version 52.8 (8); SEMCAD X Version 14.6.10 (7331)

Configuration/802.11a 5745MHz Touch-Left/Area Scan (9x11x1): Measurement grid: dx=12mm, dy=12mm; Maximum value of SAR (measured) = 0.494 W/kg

Configuration/802.11a 5745MHz Touch-Left/Zoom Scan (5x5x7)/Cube 0: Measurement grid: dx=8mm, dy=8mm, dz=5mm; Reference Value = 6.961 V/m; Power Drift = 0.12 dB

Peak SAR (extrapolated) = 1.23 W/kg

SAR(1 g) = 0.507 W/kg; SAR(10 g) = 0.157 W/kg

Maximum value of SAR (measured) = 0.558 W/kg

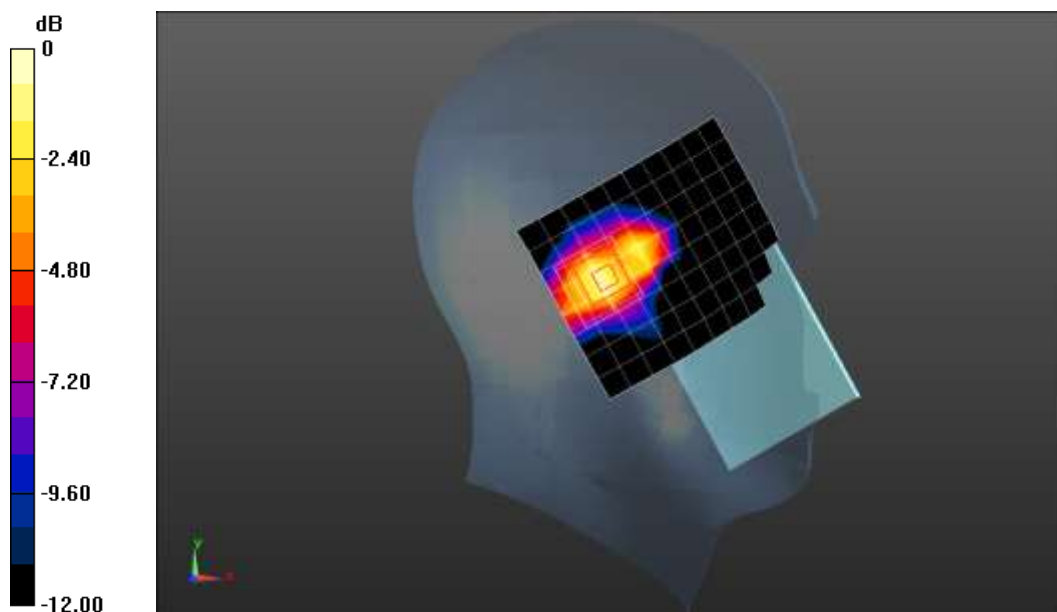

0 dB = 0.558 W/kg = -2.53 dBW/kg

Date/Time: 05/12/2020

Test Laboratory: DEKRA Lab

802.11ac80 5530MHz Touch-Left

DUT: Mobile Computer; Type: MEMOR K

Communication System: UID 0, CW (0); Communication System Band: 5GHz(5000.0-6000.0MHz); Duty

Cycle: 1:1.0; Frequency: 5530 MHz; Medium parameters used: $f = 5530$ MHz; $\sigma = 4.91$ S/m; $\epsilon_r = 35.53$; $\rho = 1000$ kg/m³; Phantom section: Left Section

Ambient temperature (°C): 21.5, Liquid temperature (°C): 21.0

DASY5 Configuration:

- Probe: EX3DV4 - SN3710; ConvF(4.66, 4.66, 4.66); Calibrated: 21/04/2020;
- Sensor-Surface: 4mm (Mechanical Surface Detection)
- Electronics: DAE4 Sn915; Calibrated: 13/06/2019
- Phantom: SAM2; Type: SAM; Serial: TP1562
- Measurement SW: DASY52, Version 52.8 (8); SEMCAD X Version 14.6.10 (7331)

Configuration/802.11a 5530MHz Touch-Left/Area Scan (9x11x1): Measurement grid: dx=12mm, dy=12mm; Maximum value of SAR (measured) = 0.528 W/kg

Configuration/802.11a 5530MHz Touch-Left/Zoom Scan (5x5x7)/Cube 0: Measurement grid: dx=8mm, dy=8mm, dz=5mm; Reference Value = 8.724 V/m; Power Drift = -0.19 dB

Peak SAR (extrapolated) = 1.62 W/kg

SAR(1 g) = 0.531 W/kg; SAR(10 g) = 0.204 W/kg

Maximum value of SAR (measured) = 0.608 W/kg

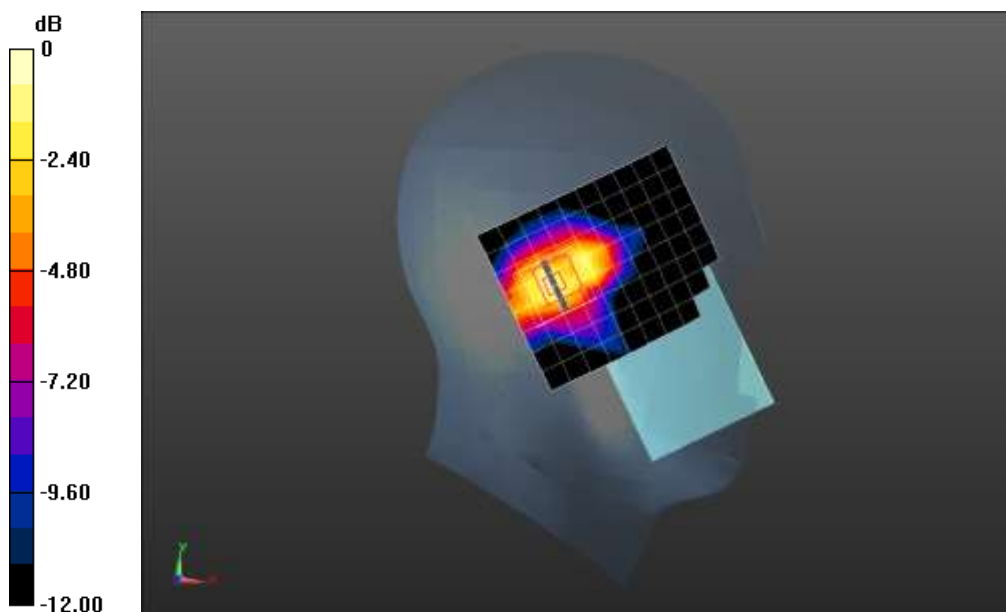

0 dB = 0.608 W/kg = -2.16 dBW/kg

Date/Time: 05/12/2020

Test Laboratory: DEKRA Lab

802.11a 5240MHz Left-tilted 15°

DUT: Mobile Computer; Type: MEMOR K

Communication System: UID 0, CW (0); Communication System Band: 5GHz(5000.0-6000.0MHz); Duty

Cycle: 1:1.0; Frequency: 5240 MHz; Medium parameters used: $f = 5240$ MHz; $\sigma = 4.55$ S/m; $\epsilon_r = 36.11$; $\rho = 1000$ kg/m³; Phantom section: Left Section

Ambient temperature (°C): 21.5, Liquid temperature (°C): 21.0

DASY5 Configuration:

- Probe: EX3DV4 - SN3710; ConvF(5.18, 5.18, 5.18); Calibrated: 21/04/2020;
- Sensor-Surface: 4mm (Mechanical Surface Detection)
- Electronics: DAE4 Sn915; Calibrated: 13/06/2019
- Phantom: SAM2; Type: SAM; Serial: TP1562
- Measurement SW: DASY52, Version 52.8 (8); SEMCAD X Version 14.6.10 (7331)

Configuration/802.11b 5240MHz Left-tilted 15°/Area Scan (9x11x1): Measurement grid: dx=12mm, dy=12mm; Maximum value of SAR (measured) = 0.615 W/kg

Configuration/802.11b 5240MHz Left-tilted 15°/Zoom Scan (5x5x7)/Cube 0: Measurement grid: dx=8mm, dy=8mm, dz=5mm; Reference Value = 11.70 V/m; Power Drift = 0.12 dB

Peak SAR (extrapolated) = 4.65 W/kg

SAR(1 g) = 0.548 W/kg; SAR(10 g) = 0.237 W/kg

Maximum value of SAR (measured) = 0.697 W/kg

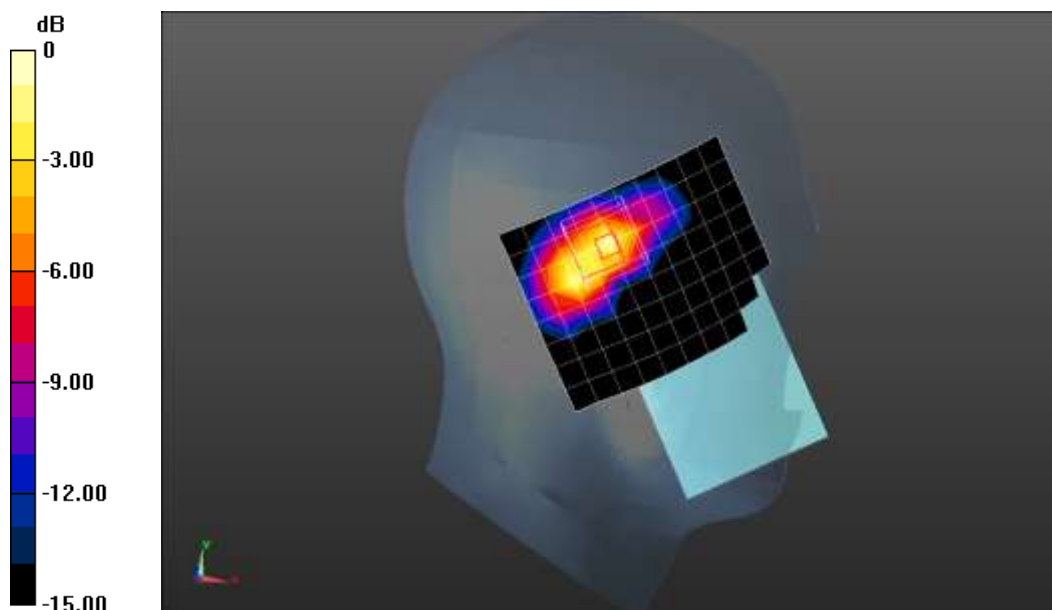

0 dB = 0.697 W/kg = -1.57 dBW/kg

Date/Time: 05/14/2020

Test Laboratory: DEKRA Lab

BT DH5 2441MHz Body-Back

DUT: Mobile Computer; Type: MEMOR K

Communication System: UID 0, Bluetooth (0); Communication System Band: ISM Band; Duty Cycle: 1:1.0;

Frequency: 2441 MHz; Medium parameters used: $f = 2441$ MHz; $\sigma = 1.93$ S/m; $\epsilon_r = 52.78$; $\rho = 1000$ kg/m³ ;

Phantom section: Flat Section

Ambient temperature (°C): 21.5, Liquid temperature (°C): 21.0

DASY5 Configuration:

- Probe: EX3DV4 - SN3710; ConvF(7.37, 7.37, 7.37); Calibrated: 21/04/2020;
- Sensor-Surface: 4mm (Mechanical Surface Detection)
- Electronics: DAE4 Sn915; Calibrated: 13/06/2019
- Phantom: ELI1; Type: QDOVA002AA; Serial: TP:2106
- Measurement SW: DASY52, Version 52.8 (8); SEMCAD X Version 14.6.10 (7331)

Configuration/BT 2441MHz Body Back/Area Scan (8x11x1): Measurement grid: dx=12mm, dy=12mm

Maximum value of SAR (measured) = 0.0542 W/kg

Configuration/BT 2441MHz Body Back/Zoom Scan (5x5x7)/Cube 0: Measurement grid: dx=8mm,

dy=8mm, dz=5mm; Reference Value = 2.176 V/m; Power Drift = 0.19 dB

Peak SAR (extrapolated) = 0.0860 W/kg

SAR(1 g) = 0.045 W/kg; SAR(10 g) = 0.019 W/kg

Maximum value of SAR (measured) = 0.0566 W/kg

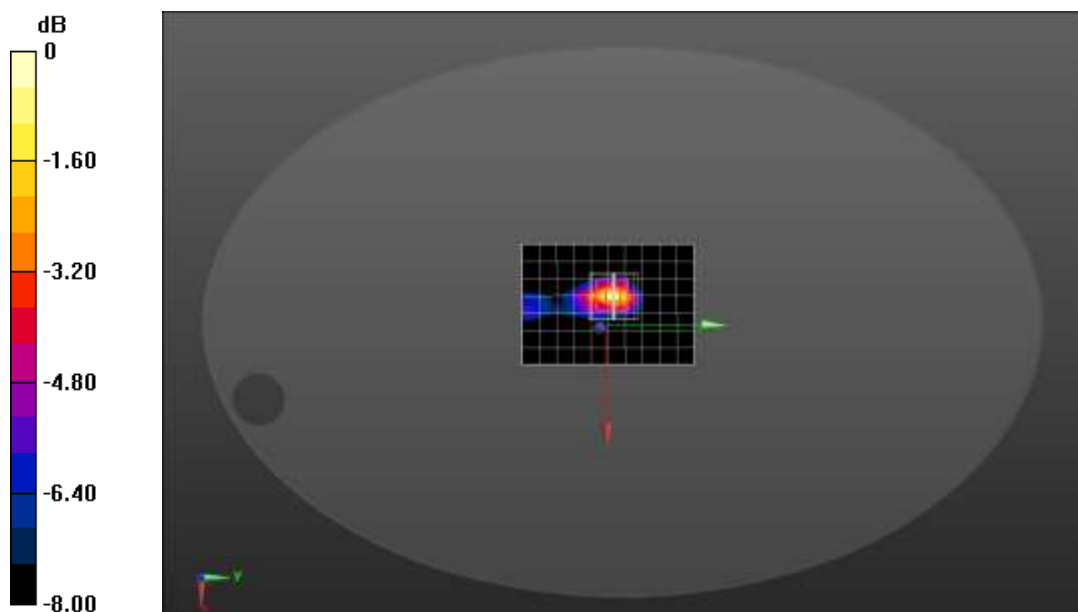

0 dB = 0.0566 W/kg = -12.47 dBW/kg

Date/Time: 05/12/2020

Test Laboratory: DEKRA Lab

BT DH5 2441MHz Touch-Right

DUT: Mobile Computer; Type: MEMOR K

Communication System: UID 0, Bluetooth (0); Communication System Band: ISM Band; Duty Cycle: 1:1.0;

Frequency: 2441 MHz; Medium parameters used: $f = 2441 \text{ MHz}$; $\sigma = 1.79 \text{ S/m}$; $\epsilon_r = 40.95$; $\rho = 1000 \text{ kg/m}^3$;

Phantom section: Right Section

Ambient temperature (°C): 21.5, Liquid temperature (°C): 21.0

DASY5 Configuration:

- Probe: EX3DV4 - SN3710; ConvF(7.42, 7.42, 7.42); Calibrated: 21/04/2020;
- Sensor-Surface: 4mm (Mechanical Surface Detection)
- Electronics: DAE4 Sn915; Calibrated: 13/06/2019
- Phantom: SAM2; Type: SAM; Serial: TP1562
- Measurement SW: DASY52, Version 52.8 (8); SEMCAD X Version 14.6.10 (7331)

Configuration/BT DH5 2441MHz Touch Right/Area Scan (9x10x1): Measurement grid: dx=12mm, dy=12mm; Maximum value of SAR (measured) = 0.0496 W/kg

Configuration/BT DH5 2441MHz Touch Right/Zoom Scan (5x5x7)/Cube 0: Measurement grid: dx=8mm, dy=8mm, dz=5mm; Reference Value = 3.150 V/m; Power Drift = 0.06 dB

Peak SAR (extrapolated) = 0.102 W/kg

SAR(1 g) = 0.045 W/kg; SAR(10 g) = 0.022 W/kg

Maximum value of SAR (measured) = 0.0476 W/kg

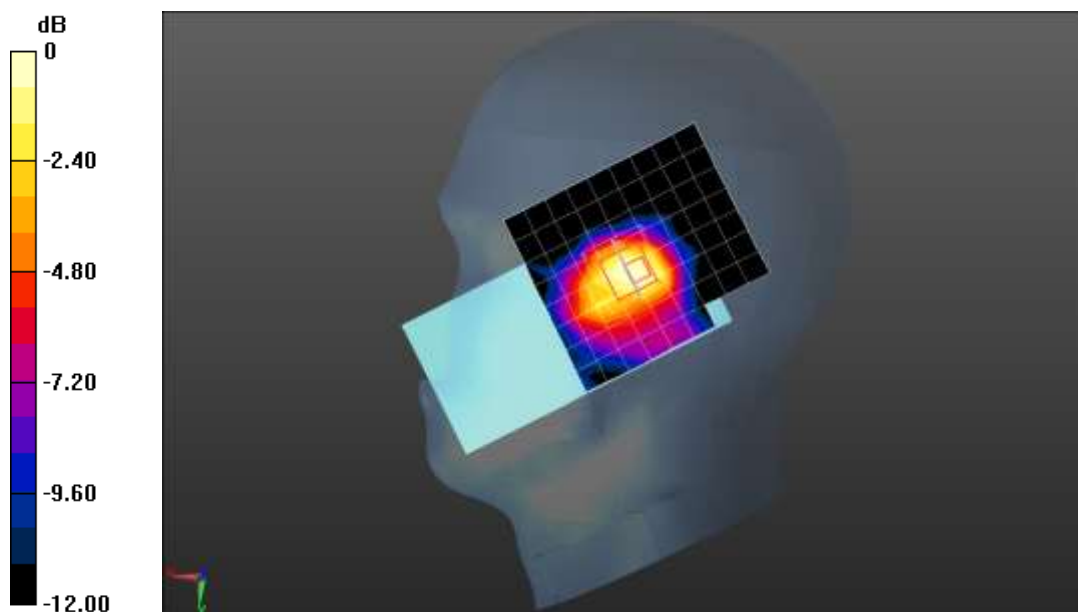

0 dB = 0.0476 W/kg = -13.22 dBW/kg

Date/Time: 05/12/2020

Test Laboratory: DEKRA Lab

BT DH5 2441MHz Touch Left

DUT: Mobile Computer; Type: MEMOR K

Communication System: UID 0, Bluetooth (0); Communication System Band: ISM Band; Duty Cycle: 1:1.0;

Frequency: 2441 MHz; Medium parameters used: $f = 2441$ MHz; $\sigma = 1.79$ S/m; $\epsilon_r = 40.95$; $\rho = 1000$ kg/m³ ;

Phantom section: Left Section; Ambient temperature (°C): 21.5, Liquid temperature (°C): 21.0

DASY5 Configuration:

- Probe: EX3DV4 - SN3710; ConvF(7.42, 7.42, 7.42); Calibrated: 21/04/2020;
- Sensor-Surface: 4mm (Mechanical Surface Detection)
- Electronics: DAE4 Sn915; Calibrated: 13/06/2019
- Phantom: SAM2; Type: SAM; Serial: TP1562
- Measurement SW: DASY52, Version 52.8 (8); SEMCAD X Version 14.6.10 (7331)

Configuration/BT DH5 2441MHz Touch Left/Area Scan (9x10x1): Measurement grid: dx=12mm, dy=12mm; Maximum value of SAR (measured) = 0.0270 W/kg

Configuration/BT DH5 2441MHz Touch Left/Zoom Scan (5x5x7)/Cube 0: Measurement grid: dx=8mm, dy=8mm, dz=5mm; Reference Value = 3.374 V/m; Power Drift = 0.15 dB

Peak SAR (extrapolated) = 0.0620 W/kg

SAR(1 g) = 0.027 W/kg; SAR(10 g) = 0.013 W/kg; Maximum value of SAR (measured) = 0.0298 W/kg

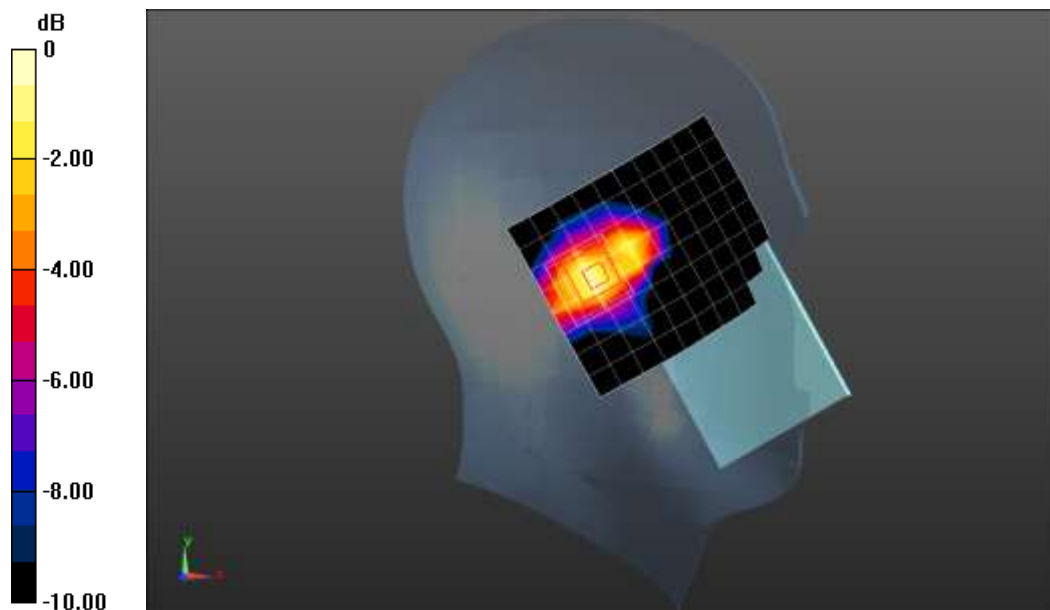

0 dB = 0.0298 W/kg = -15.26 dBW/kg

Limb SAR:

Date/Time: 05/14/2020

Test Laboratory: DEKRA Lab

802.11b 2462MHz side1

DUT: Mobile Computer; Type: MEMOR K

Communication System: UID 0, Wi-Fi (0); Communication System Band: 802.11b; Duty Cycle: 1:1.0;

Frequency: 2462 MHz; Medium parameters used: $f = 2462$ MHz; $\sigma = 1.96$ S/m; $\epsilon_r = 52.74$; $\rho = 1000$ kg/m³ ;

Phantom section: Flat Section

Ambient temperature (°C): 21.5, Liquid temperature (°C): 21.0

DASY5 Configuration:

- Probe: EX3DV4 - SN3710; ConvF(7.37, 7.37, 7.37); Calibrated: 21/04/2020;
- Sensor-Surface: 4mm (Mechanical Surface Detection)
- Electronics: DAE4 Sn915; Calibrated: 13/06/2019
- Phantom: ELI1; Type: QDOVA002AA; Serial: TP:2106
- Measurement SW: DASY52, Version 52.8 (8); SEMCAD X Version 14.6.10 (7331)

Configuration/802.11b 2462MHz trunk/Area Scan (8x11x1): Measurement grid: dx=12mm, dy=12mm;

Maximum value of SAR (measured) = 2.92 W/kg

Configuration/802.11b 2462MHz trunk/Zoom Scan (7x7x5)/Cube 0: Measurement grid: dx=5mm, dy=5mm,

dz=4mm; Reference Value = 18.02 V/m; Power Drift = -0.01 dB

Peak SAR (extrapolated) = 7.20 W/kg

SAR(1 g) = 2.3 W/kg; SAR(10 g) = 0.815 W/kg

Maximum value of SAR (measured) = 2.93 W/kg

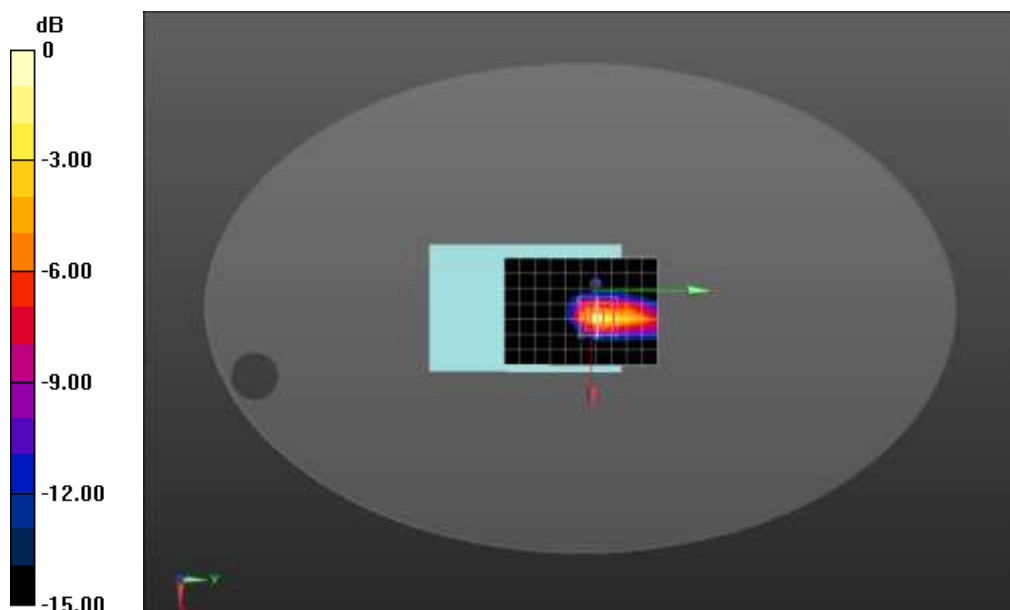

0 dB = 2.93 W/kg = 4.67 dBW/kg

Date/Time: 05/14/2020

Test Laboratory: DEKRA Lab

802.11b 2462MHz side2

DUT: Mobile Computer; Type: MEMOR K

Communication System: UID 0, Wi-Fi (0); Communication System Band: 802.11b; Duty Cycle: 1:1.0;

Frequency: 2462 MHz; Medium parameters used: $f = 2462$ MHz; $\sigma = 1.96$ S/m; $\epsilon_r = 52.74$; $\rho = 1000$ kg/m³ ;

Phantom section: Flat Section

Ambient temperature (°C): 21.5, Liquid temperature (°C): 21.0

DASY5 Configuration:

- Probe: EX3DV4 - SN3710; ConvF(7.37, 7.37, 7.37); Calibrated: 21/04/2020;
- Sensor-Surface: 4mm (Mechanical Surface Detection)
- Electronics: DAE4 Sn915; Calibrated: 13/06/2019
- Phantom: ELI1; Type: QDOVA002AA; Serial: TP:2106
- Measurement SW: DASY52, Version 52.8 (8); SEMCAD X Version 14.6.10 (7331)

Configuration/802.11b 2462MHz trunk/Area Scan (8x11x1): Measurement grid: dx=12mm, dy=12mm

Maximum value of SAR (measured) = 0.172 W/kg

Configuration/802.11b 2462MHz trunk/Zoom Scan (7x7x5)/Cube 0: Measurement grid: dx=5mm, dy=5mm,

dz=4mm; Reference Value = 7.837 V/m; Power Drift = -0.13 dB

Peak SAR (extrapolated) = 0.276 W/kg

SAR(1 g) = 0.145 W/kg; SAR(10 g) = 0.073 W/kg

Maximum value of SAR (measured) = 0.163 W/kg

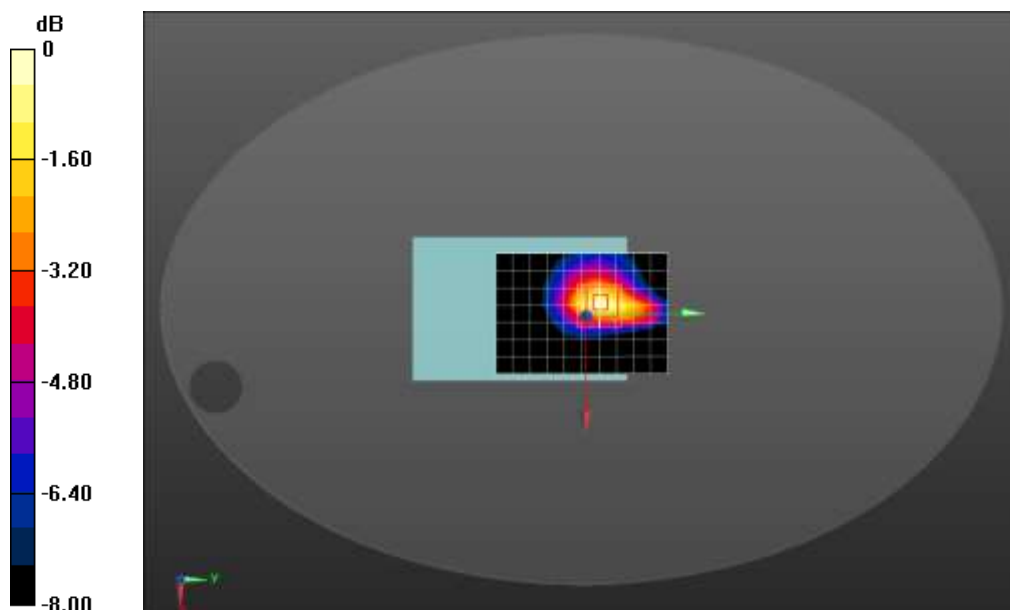

0 dB = 0.163 W/kg = -7.88 dBW/kg

Date/Time: 05/14/2020

Test Laboratory: DEKRA Lab

802.11b 2462MHz side3

DUT: Mobile Computer; Type: MEMOR K

Communication System: UID 0, Wi-Fi (0); Communication System Band: 802.11b; Duty Cycle: 1:1.0;

Frequency: 2462 MHz; Medium parameters used: $f = 2462$ MHz; $\sigma = 1.96$ S/m; $\epsilon_r = 52.74$; $\rho = 1000$ kg/m³ ;

Phantom section: Flat Section

Ambient temperature (°C): 21.5, Liquid temperature (°C): 21.0

DASY5 Configuration:

- Probe: EX3DV4 - SN3710; ConvF(7.37, 7.37, 7.37); Calibrated: 21/04/2020;
- Sensor-Surface: 4mm (Mechanical Surface Detection)
- Electronics: DAE4 Sn915; Calibrated: 13/06/2019
- Phantom: ELI1; Type: QDOVA002AA; Serial: TP:2106
- Measurement SW: DASY52, Version 52.8 (8); SEMCAD X Version 14.6.10 (7331)

Configuration/802.11b 2462MHz trunk/Area Scan (8x10x1): Measurement grid: dx=12mm, dy=12mm

Maximum value of SAR (measured) = 0.626 W/kg

Configuration/802.11b 2462MHz trunk/Zoom Scan (7x7x5)/Cube 0: Measurement grid: dx=5mm, dy=5mm,

dz=4mm; Reference Value = 18.03 V/m; Power Drift = -0.08 dB

Peak SAR (extrapolated) = 1.27 W/kg

SAR(1 g) = 0.602 W/kg; SAR(10 g) = 0.270 W/kg

Maximum value of SAR (measured) = 0.669 W/kg

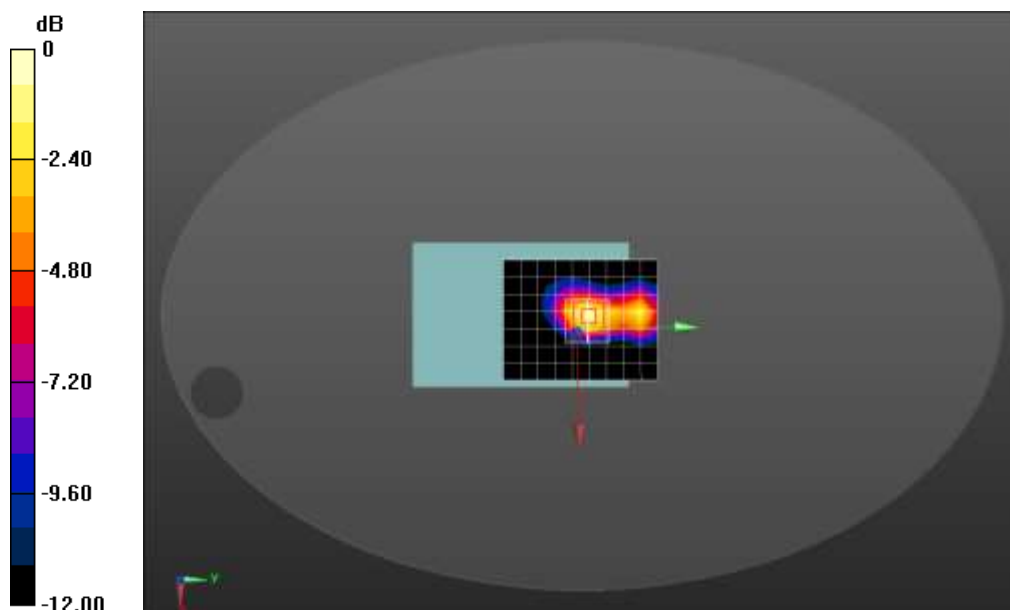

0 dB = 0.669 W/kg = -1.75 dBW/kg

Date/Time: 05/14/2020

Test Laboratory: DEKRA Lab

802.11b 2462MHz side4

DUT: Mobile Computer; Type: MEMOR K

Communication System: UID 0, Wi-Fi (0); Communication System Band: 802.11b; Duty Cycle: 1:1.0;

Frequency: 2462 MHz; Medium parameters used: $f = 2462$ MHz; $\sigma = 1.96$ S/m; $\epsilon_r = 52.74$; $\rho = 1000$ kg/m³ ;

Phantom section: Flat Section

Ambient temperature (°C): 21.5, Liquid temperature (°C): 21.0

DASY5 Configuration:

- Probe: EX3DV4 - SN3710; ConvF(7.37, 7.37, 7.37); Calibrated: 21/04/2020;
- Sensor-Surface: 4mm (Mechanical Surface Detection)
- Electronics: DAE4 Sn915; Calibrated: 13/06/2019
- Phantom: ELI1; Type: QDOVA002AA; Serial: TP:2106
- Measurement SW: DASY52, Version 52.8 (8); SEMCAD X Version 14.6.10 (7331)

Configuration/802.11b 2462MHz trunk/Area Scan (8x13x1): Measurement grid: dx=12mm, dy=12mm

Maximum value of SAR (measured) = 0.0884 W/kg

Configuration/802.11b 2462MHz trunk/Zoom Scan (7x7x5)/Cube 0: Measurement grid: dx=5mm, dy=5mm, dz=4mm; Reference Value = 4.336 V/m; Power Drift = -0.12 dB

Peak SAR (extrapolated) = 0.219 W/kg

SAR(1 g) = 0.074 W/kg; SAR(10 g) = 0.031 W/kg

Maximum value of SAR (measured) = 0.0879 W/kg

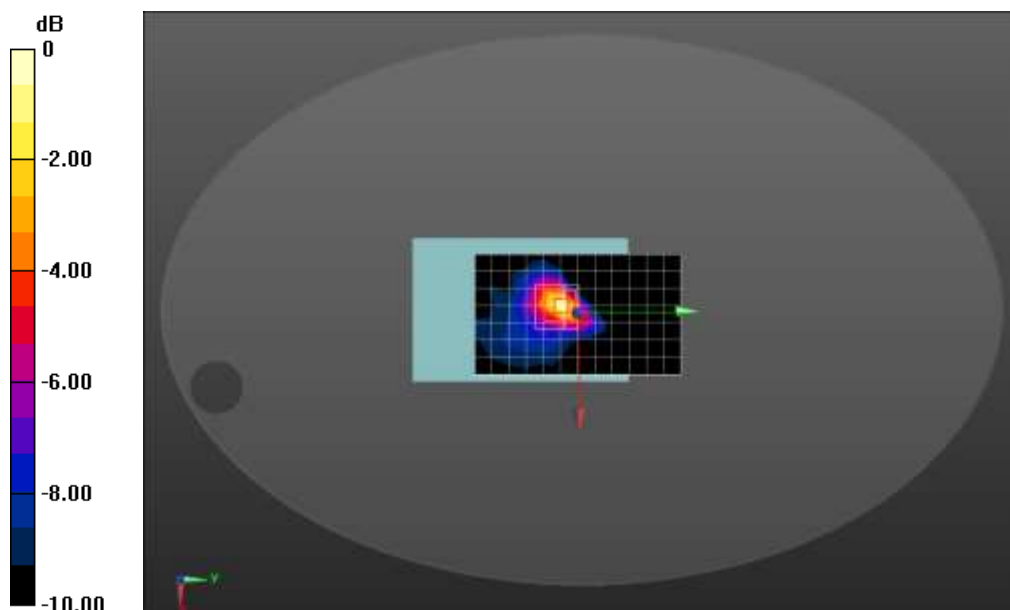

0 dB = 0.0879 W/kg = -10.56 dBW/kg

Date/Time: 05/14/2020

Test Laboratory: DEKRA Lab

802.11b 2462MHz front

DUT: Mobile Computer; Type: MEMOR K

Communication System: UID 0, Wi-Fi (0); Communication System Band: 802.11b; Duty Cycle: 1:1.0;

Frequency: 2462 MHz; Medium parameters used: $f = 2462$ MHz; $\sigma = 1.96$ S/m; $\epsilon_r = 52.74$; $\rho = 1000$ kg/m³ ;

Phantom section: Flat Section

Ambient temperature (°C): 21.5, Liquid temperature (°C): 21.0

DASY5 Configuration:

- Probe: EX3DV4 - SN3710; ConvF(7.37, 7.37, 7.37); Calibrated: 21/04/2020;
- Sensor-Surface: 4mm (Mechanical Surface Detection)
- Electronics: DAE4 Sn915; Calibrated: 13/06/2019
- Phantom: ELI1; Type: QDOVA002AA; Serial: TP:2106
- Measurement SW: DASY52, Version 52.8 (8); SEMCAD X Version 14.6.10 (7331)

Configuration/802.11b 2462MHz trunk/Area Scan (9x11x1): Measurement grid: dx=12mm, dy=12mm

Maximum value of SAR (measured) = 0.667 W/kg

Configuration/802.11b 2462MHz trunk/Zoom Scan (7x7x5)/Cube 0: Measurement grid: dx=5mm, dy=5mm,

dz=4mm; Reference Value = 12.97 V/m; Power Drift = 0.06 dB

Peak SAR (extrapolated) = 1.47 W/kg

SAR(1 g) = 0.627 W/kg; SAR(10 g) = 0.293 W/kg

Maximum value of SAR (measured) = 0.681 W/kg

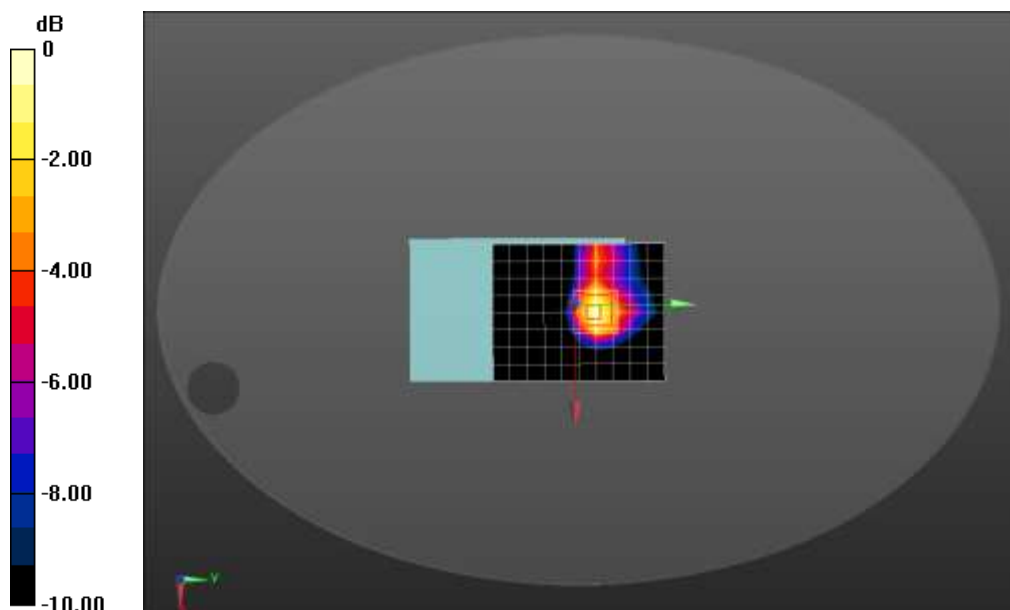

0 dB = 0.681 W/kg = -1.67 dBW/kg

Date/Time: 05/14/2020

Test Laboratory: DEKRA Lab

802.11b 2462MHz back

DUT: Mobile Computer; Type: MEMOR K

Communication System: UID 0, Wi-Fi (0); Communication System Band: 802.11b; Duty Cycle: 1:1.0;

Frequency: 2462 MHz; Medium parameters used: $f = 2462$ MHz; $\sigma = 1.96$ S/m; $\epsilon_r = 52.74$; $\rho = 1000$ kg/m³ ;

Phantom section: Flat Section

Ambient temperature (°C): 21.5, Liquid temperature (°C): 21.0

DASY5 Configuration:

- Probe: EX3DV4 - SN3710; ConvF(7.37, 7.37, 7.37); Calibrated: 21/04/2020;
- Sensor-Surface: 4mm (Mechanical Surface Detection)
- Electronics: DAE4 Sn915; Calibrated: 13/06/2019
- Phantom: ELI1; Type: QDOVA002AA; Serial: TP:2106
- Measurement SW: DASY52, Version 52.8 (8); SEMCAD X Version 14.6.10 (7331)

Configuration/802.11b 2462MHz trunk/Area Scan (9x11x1): Measurement grid: dx=12mm, dy=12mm

Maximum value of SAR (measured) = 1.31 W/kg

Configuration/802.11b 2462MHz trunk/Zoom Scan (7x7x5)/Cube 0: Measurement grid: dx=5mm, dy=5mm,

dz=4mm; Reference Value = 21.41 V/m; Power Drift = -0.16 dB

Peak SAR (extrapolated) = 2.41 W/kg

SAR(1 g) = 1.23 W/kg; SAR(10 g) = 0.589 W/kg

Maximum value of SAR (measured) = 1.40 W/kg

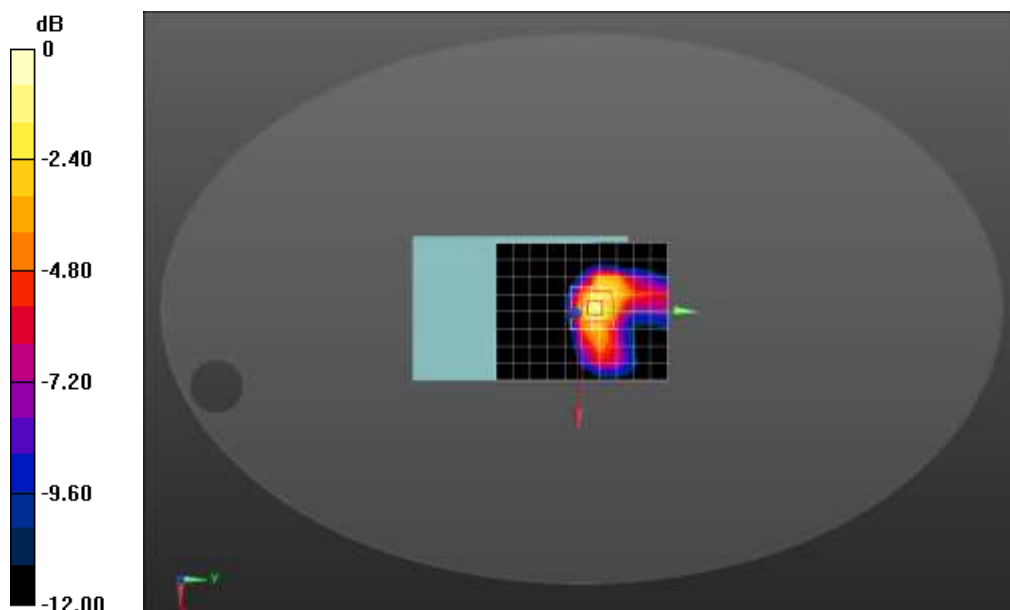

0 dB = 1.40 W/kg = 1.46 dBW/kg

Date/Time: 05/14/2020

Test Laboratory: DEKRA Lab

802.11g 2412MHz side1

DUT: Mobile Computer; Type: MEMOR K

Communication System: UID 0, Wi-Fi (0); Communication System Band: 802.11g; Duty Cycle: 1:1.0;

Frequency: 2412 MHz; Medium parameters used: $f = 2412$ MHz; $\sigma = 1.91$ S/m; $\epsilon_r = 52.82$; $\rho = 1000$ kg/m³ ;

Phantom section: Flat Section

Ambient temperature (°C): 21.5, Liquid temperature (°C): 21.0

DASY5 Configuration:

- Probe: EX3DV4 - SN3710; ConvF(7.37, 7.37, 7.37); Calibrated: 21/04/2020;
- Sensor-Surface: 4mm (Mechanical Surface Detection)
- Electronics: DAE4 Sn915; Calibrated: 13/06/2019
- Phantom: ELI1; Type: QDOVA002AA; Serial: TP:2106
- Measurement SW: DASY52, Version 52.8 (8); SEMCAD X Version 14.6.10 (7331)

Configuration/802.11g 2412MHz trunk/Area Scan (9x11x1): Measurement grid: dx=12mm, dy=12mm

Maximum value of SAR (measured) = 1.95 W/kg

Configuration/802.11g 2412MHz trunk/Zoom Scan (7x7x5)/Cube 0: Measurement grid: dx=5mm, dy=5mm,

dz=4mm; Reference Value = 37.48 V/m; Power Drift = 0.09 dB

Peak SAR (extrapolated) = 8.52 W/kg

SAR(1 g) = 2.75 W/kg; SAR(10 g) = 0.987 W/kg

Maximum value of SAR (measured) = 3.30 W/kg

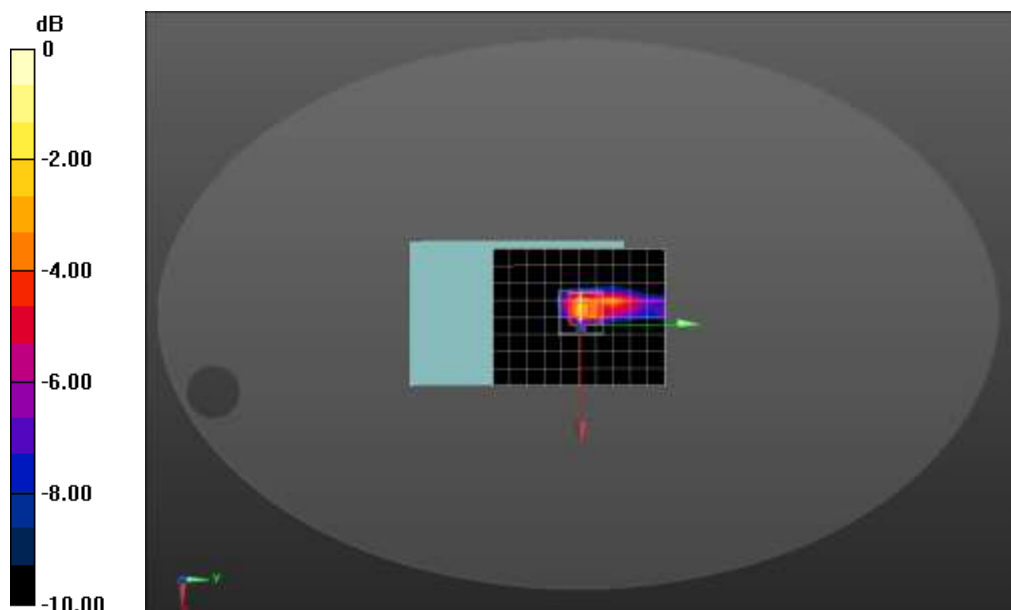

0 dB = 3.30 W/kg = 5.19 dBW/kg

Date/Time: 05/14/2020

Test Laboratory: DEKRA Lab

802.11g 2437MHz side1

DUT: Mobile Computer; Type: MEMOR K

Communication System: UID 0, Wi-Fi (0); Communication System Band: 802.11g; Duty Cycle: 1:1.0;

Frequency: 2437 MHz; Medium parameters used: $f = 2437$ MHz; $\sigma = 1.93$ S/m; $\epsilon_r = 52.79$; $\rho = 1000$ kg/m³ ;

Phantom section: Flat Section

Ambient temperature (°C): 21.5, Liquid temperature (°C): 21.0

DASY5 Configuration:

- Probe: EX3DV4 - SN3710; ConvF(7.37, 7.37, 7.37); Calibrated: 21/04/2020;
- Sensor-Surface: 4mm (Mechanical Surface Detection)
- Electronics: DAE4 Sn915; Calibrated: 13/06/2019
- Phantom: ELI1; Type: QDOVA002AA; Serial: TP:2106
- Measurement SW: DASY52, Version 52.8 (8); SEMCAD X Version 14.6.10 (7331)

Configuration/802.11g 2437MHz trunk/Area Scan (8x10x1): Measurement grid: dx=12mm, dy=12mm

Maximum value of SAR (measured) = 2.84 W/kg

Configuration/802.11g 2437MHz trunk/Zoom Scan (7x7x5)/Cube 0: Measurement grid: dx=5mm, dy=5mm,

dz=4mm; Reference Value = 34.07 V/m; Power Drift = 0.09 dB

Peak SAR (extrapolated) = 7.39 W/kg

SAR(1 g) = 2.39 W/kg; SAR(10 g) = 0.853 W/kg

Maximum value of SAR (measured) = 2.96 W/kg

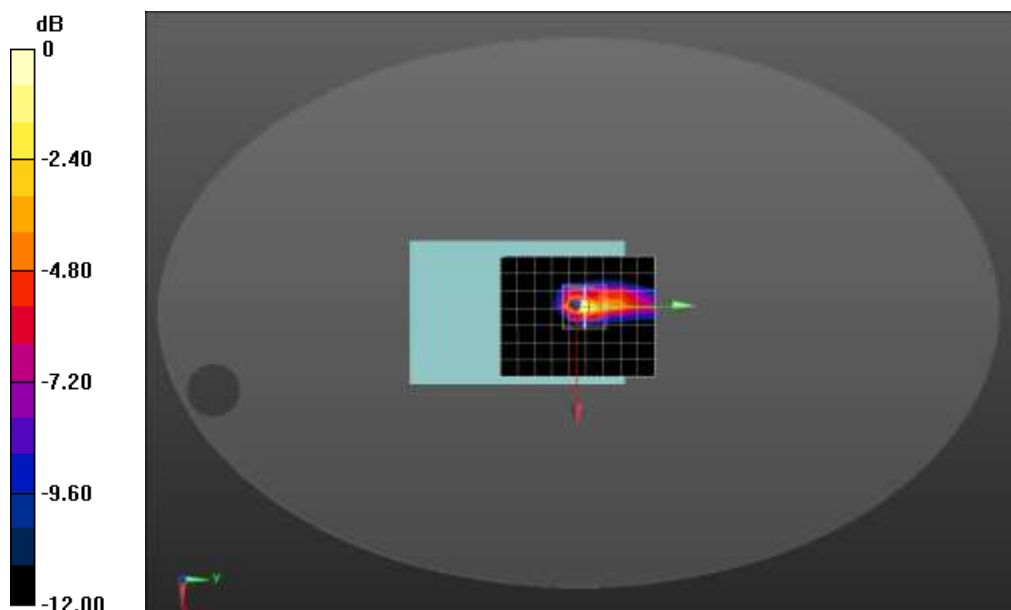

0 dB = 2.96 W/kg = 4.71 dBW/kg

Date/Time: 05/14/2020

Test Laboratory: DEKRA Lab

802.11g 2462MHz side1

DUT: Mobile Computer; Type: MEMOR K

Communication System: UID 0, Wi-Fi (0); Communication System Band: 802.11g; Duty Cycle: 1:1.0;

Frequency: 2462 MHz; Medium parameters used: $f = 2462$ MHz; $\sigma = 1.96$ S/m; $\epsilon_r = 52.74$; $\rho = 1000$ kg/m³ ;

Phantom section: Flat Section

Ambient temperature (°C): 21.5, Liquid temperature (°C): 21.0

DASY5 Configuration:

- Probe: EX3DV4 - SN3710; ConvF(7.37, 7.37, 7.37); Calibrated: 21/04/2020;
- Sensor-Surface: 4mm (Mechanical Surface Detection)
- Electronics: DAE4 Sn915; Calibrated: 13/06/2019
- Phantom: ELI1; Type: QDOVA002AA; Serial: TP:2106
- Measurement SW: DASY52, Version 52.8 (8); SEMCAD X Version 14.6.10 (7331)

Configuration/802.11g 2462MHz trunk/Area Scan (8x11x1): Measurement grid: dx=12mm, dy=12mm

Maximum value of SAR (measured) = 1.64 W/kg

Configuration/802.11g 2462MHz trunk/Zoom Scan (7x7x5)/Cube 0: Measurement grid: dx=5mm, dy=5mm,

dz=4mm; Reference Value = 24.21 V/m; Power Drift = 0.01 dB

Peak SAR (extrapolated) = 4.18 W/kg

SAR(1 g) = 1.33 W/kg; SAR(10 g) = 0.473 W/kg

Maximum value of SAR (measured) = 1.68 W/kg

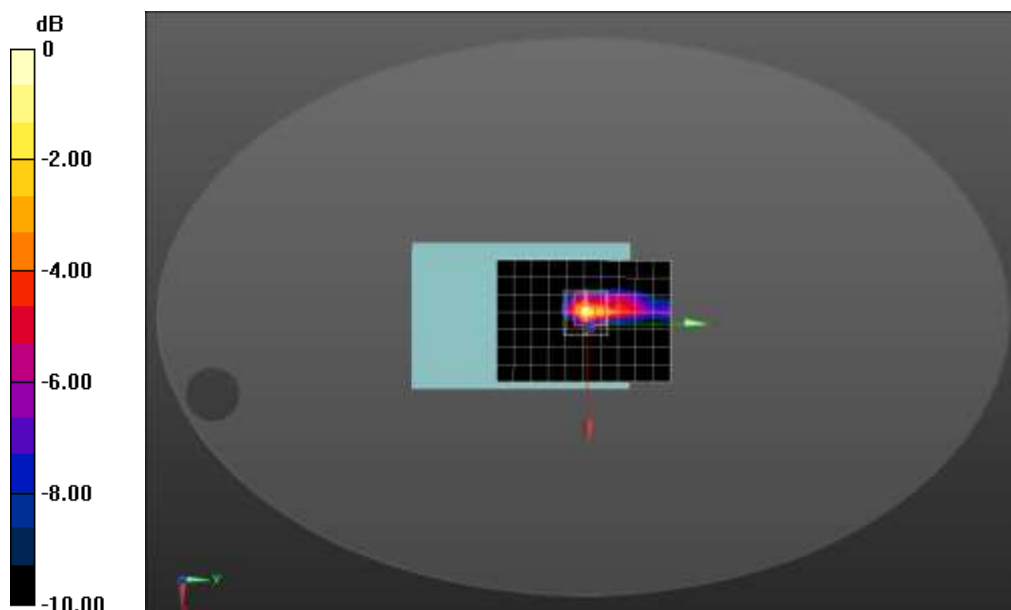

0 dB = 1.68 W/kg = 2.25 dBW/kg

Date/Time: 05/14/2020

Test Laboratory: DEKRA Lab

802.11a 5300MHz side1

DUT: Mobile Computer; Type: MEMOR K

Communication System: UID 0, CW (0); Communication System Band: 5GHz(5000.0-6000.0MHz); Duty Cycle: 1:1.0; Frequency: 5300 MHz; Medium parameters used: $f = 5300 \text{ MHz}$; $\sigma = 5.38 \text{ S/m}$; $\epsilon_r = 47.75$; $\rho = 1000 \text{ kg/m}^3$; Phantom section: Flat Section

Ambient temperature (°C): 21.5, Liquid temperature (°C): 21.0

DASY5 Configuration:

- Probe: EX3DV4 - SN3710; ConvF(4.57, 4.57, 4.57); Calibrated: 21/04/2020;
- Sensor-Surface: 2mm (Mechanical Surface Detection)
- Electronics: DAE4 Sn915; Calibrated: 13/06/2019
- Phantom: ELI1; Type: QDOVA002AA; Serial: TP:2106
- Measurement SW: DASY52, Version 52.8 (8); SEMCAD X Version 14.6.10 (7331)

Configuration/802.11a 5300MHz trunk/Area Scan (11x13x1): Measurement grid: dx=10mm, dy=10mm

Maximum value of SAR (measured) = 0.400 W/kg

Configuration/802.11a 5300MHz trunk/Zoom Scan (7x7x6)/Cube 0: Measurement grid: dx=4mm, dy=4mm, dz=2mm; Reference Value = 2.465 V/m; Power Drift = 0.13 dB

Peak SAR (extrapolated) = 0.819 W/kg

SAR(1 g) = 0.207 W/kg; SAR(10 g) = 0.074 W/kg

Maximum value of SAR (measured) = 0.396 W/kg

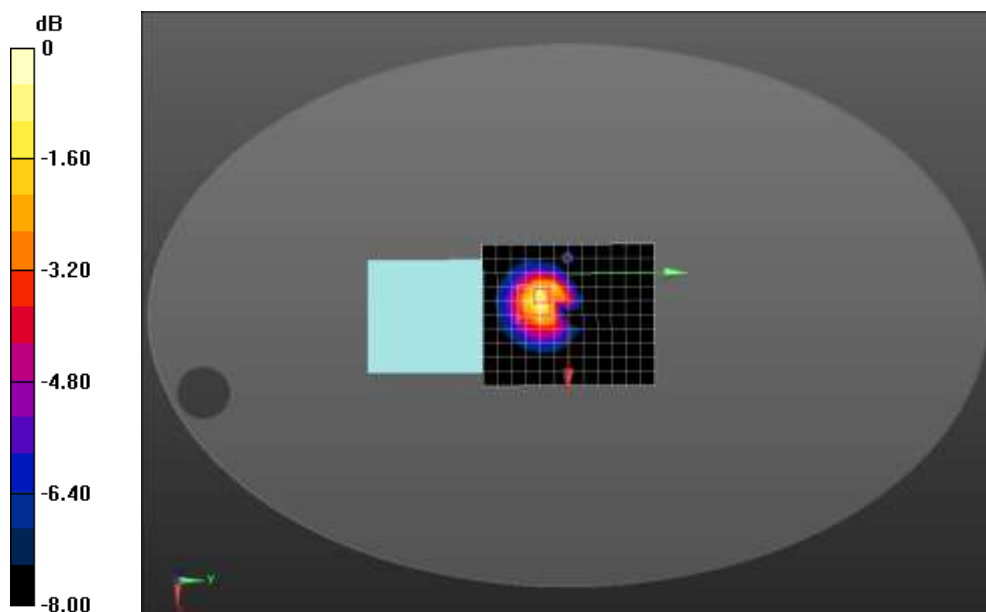

0 dB = 0.396 W/kg = -4.02 dBW/kg

Date/Time: 05/14/2020

Test Laboratory: DEKRA Lab

802.11a 5300MHz side2

DUT: Mobile Computer; Type: MEMOR K

Communication System: UID 0, CW (0); Communication System Band: 5GHz(5000.0-6000.0MHz); Duty Cycle: 1:1.0; Frequency: 5300 MHz; Medium parameters used: $f = 5300 \text{ MHz}$; $\sigma = 5.38 \text{ S/m}$; $\epsilon_r = 47.75$; $\rho = 1000 \text{ kg/m}^3$; Phantom section: Flat Section

Ambient temperature (°C): 21.5, Liquid temperature (°C): 21.0

DASY5 Configuration:

- Probe: EX3DV4 - SN3710; ConvF(4.57, 4.57, 4.57); Calibrated: 21/04/2020;
- Sensor-Surface: 2mm (Mechanical Surface Detection)
- Electronics: DAE4 Sn915; Calibrated: 13/06/2019
- Phantom: ELI1; Type: QDOVA002AA; Serial: TP:2106
- Measurement SW: DASY52, Version 52.8 (8); SEMCAD X Version 14.6.10 (7331)

Configuration/802.11a 5300MHz trunk/Area Scan (11x13x1): Measurement grid: dx=10mm, dy=10mm

Maximum value of SAR (measured) = 0.302 W/kg

Configuration/802.11a 5300MHz trunk/Zoom Scan (7x7x6)/Cube 0: Measurement grid: dx=4mm, dy=4mm, dz=2mm; Reference Value = 4.048 V/m; Power Drift = -0.05 dB

Peak SAR (extrapolated) = 0.600 W/kg

SAR(1 g) = 0.153 W/kg; SAR(10 g) = 0.053 W/kg

Maximum value of SAR (measured) = 0.312 W/kg

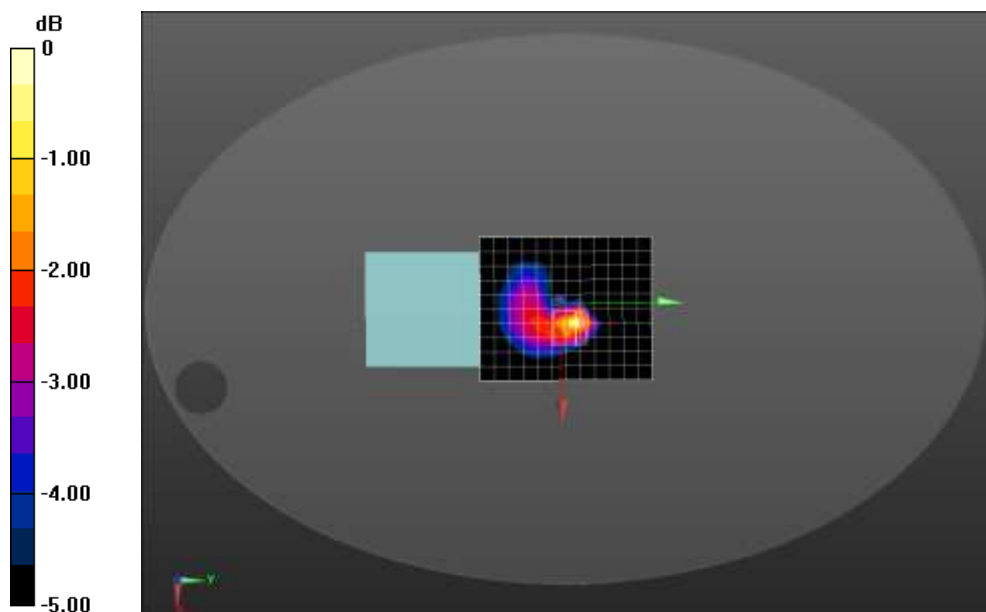

0 dB = 0.312 W/kg = -5.06 dBW/kg

Date/Time: 05/14/2020

Test Laboratory: DEKRA Lab

802.11a 5300MHz side3

DUT: Mobile Computer; Type: MEMOR K

Communication System: UID 0, CW (0); Communication System Band: 5GHz(5000.0-6000.0MHz); Duty

Cycle: 1:1.0; Frequency: 5300 MHz; Medium parameters used: $f = 5300 \text{ MHz}$; $\sigma = 5.38 \text{ S/m}$; $\epsilon_r = 47.75$; $\rho = 1000 \text{ kg/m}^3$; Phantom section: Flat Section

Ambient temperature (°C): 21.5, Liquid temperature (°C): 21.0

DASY5 Configuration:

- Probe: EX3DV4 - SN3710; ConvF(4.57, 4.57, 4.57); Calibrated: 21/04/2020;
- Sensor-Surface: 2mm (Mechanical Surface Detection)
- Electronics: DAE4 Sn915; Calibrated: 13/06/2019
- Phantom: ELI1; Type: QDOVA002AA; Serial: TP:2106
- Measurement SW: DASY52, Version 52.8 (8); SEMCAD X Version 14.6.10 (7331)

Configuration/802.11a 5300MHz trunk/Area Scan (11x13x1): Measurement grid: dx=10mm, dy=10mm

Maximum value of SAR (measured) = 6.04 W/kg

Configuration/802.11a 5300MHz trunk/Zoom Scan (7x7x6)/Cube 0: Measurement grid: dx=4mm, dy=4mm, dz=2mm; Reference Value = 20.56 V/m; Power Drift = -0.16 dB

Peak SAR (extrapolated) = 17.0 W/kg

SAR(1 g) = 3.4 W/kg; SAR(10 g) = 0.745 W/kg

Maximum value of SAR (measured) = 7.83 W/kg

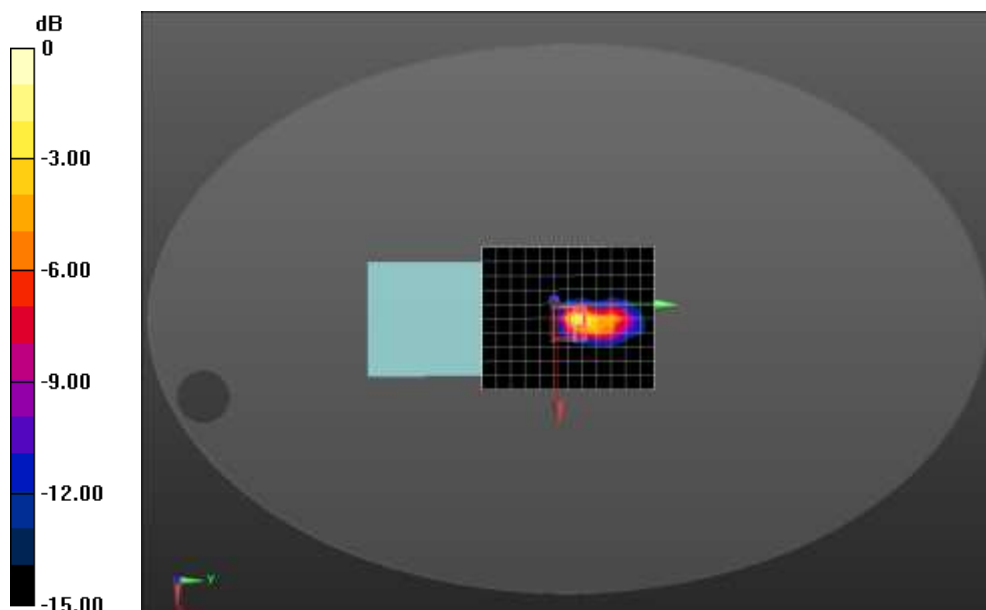

0 dB = 7.83 W/kg = 8.94 dBW/kg

Date/Time: 05/14/2020

Test Laboratory: DEKRA Lab

802.11a 5300MHz side4

DUT: Mobile Computer; Type: MEMOR K

Communication System: UID 0, CW (0); Communication System Band: 5GHz(5000.0-6000.0MHz); Duty

Cycle: 1:1.0; Frequency: 5300 MHz; Medium parameters used: $f = 5300 \text{ MHz}$; $\sigma = 5.38 \text{ S/m}$; $\epsilon_r = 47.75$; $\rho = 1000 \text{ kg/m}^3$; Phantom section: Flat Section

Ambient temperature (°C): 21.5, Liquid temperature (°C): 21.0

DASY5 Configuration:

- Probe: EX3DV4 - SN3710; ConvF(4.57, 4.57, 4.57); Calibrated: 21/04/2020;
- Sensor-Surface: 2mm (Mechanical Surface Detection)
- Electronics: DAE4 Sn915; Calibrated: 13/06/2019
- Phantom: ELI1; Type: QDOVA002AA; Serial: TP:2106
- Measurement SW: DASY52, Version 52.8 (8); SEMCAD X Version 14.6.10 (7331)

Configuration/802.11a 5300MHz trunk/Area Scan (10x13x1): Measurement grid: dx=10mm, dy=10mm

Maximum value of SAR (measured) = 0.496 W/kg

Configuration/802.11a 5300MHz trunk/Zoom Scan (7x7x6)/Cube 0: Measurement grid: dx=4mm, dy=4mm, dz=2mm; Reference Value = 3.321 V/m; Power Drift = 0.11 dB

Peak SAR (extrapolated) = 0.977 W/kg

SAR(1 g) = 0.277 W/kg; SAR(10 g) = 0.098 W/kg

Maximum value of SAR (measured) = 0.517 W/kg

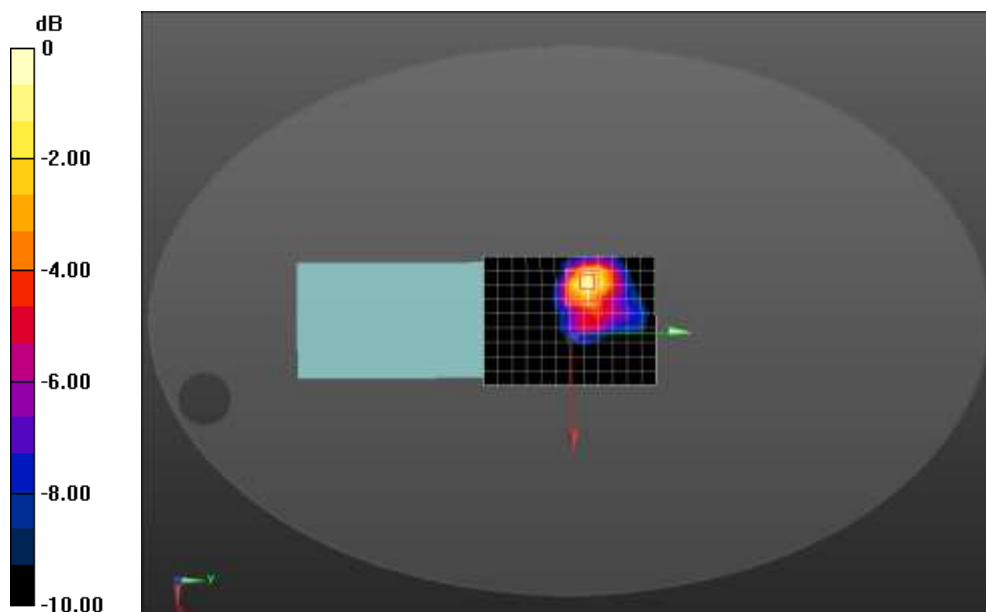

0 dB = 0.517 W/kg = -2.87 dBW/kg

Date/Time: 05/14/2020

Test Laboratory: DEKRA Lab

802.11a 5300MHz front

DUT: Mobile Computer; Type: MEMOR K

Communication System: UID 0, CW (0); Communication System Band: 5GHz(5000.0-6000.0MHz); Duty

Cycle: 1:1.0; Frequency: 5300 MHz; Medium parameters used: $f = 5300 \text{ MHz}$; $\sigma = 5.38 \text{ S/m}$; $\epsilon_r = 47.75$; $\rho = 1000 \text{ kg/m}^3$; Phantom section: Flat Section

Ambient temperature (°C): 21.5, Liquid temperature (°C): 21.0

DASY5 Configuration:

- Probe: EX3DV4 - SN3710; ConvF(4.57, 4.57, 4.57); Calibrated: 21/04/2020;
- Sensor-Surface: 2mm (Mechanical Surface Detection)
- Electronics: DAE4 Sn915; Calibrated: 13/06/2019
- Phantom: ELI1; Type: QDOVA002AA; Serial: TP:2106
- Measurement SW: DASY52, Version 52.8 (8); SEMCAD X Version 14.6.10 (7331)

Configuration/802.11a 5300MHz trunk/Area Scan (11x13x1): Measurement grid: $dx=10\text{mm}$, $dy=10\text{mm}$

Maximum value of SAR (measured) = 4.48 W/kg

Configuration/802.11a 5300MHz trunk/Zoom Scan (7x7x6)/Cube 0: Measurement grid: $dx=4\text{mm}$, $dy=4\text{mm}$, $dz=2\text{mm}$; Reference Value = 11.81 V/m; Power Drift = 0.18 dB

Peak SAR (extrapolated) = 10.4 W/kg

SAR(1 g) = 2.05 W/kg; SAR(10 g) = 0.530 W/kg

Maximum value of SAR (measured) = 4.57 W/kg

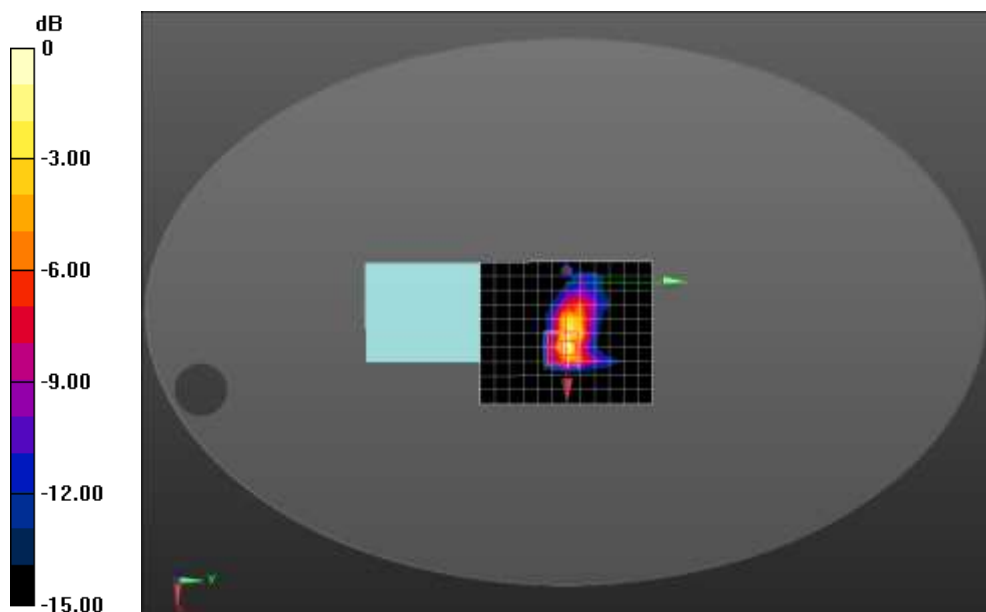

0 dB = 4.57 W/kg = 6.60 dBW/kg

Date/Time: 05/14/2020

Test Laboratory: DEKRA Lab

802.11a 5300MHz back

DUT: Mobile Computer; Type: MEMOR K

Communication System: UID 0, CW (0); Communication System Band: 5GHz(5000.0-6000.0MHz); Duty

Cycle: 1:1.0; Frequency: 5300 MHz; Medium parameters used: $f = 5300 \text{ MHz}$; $\sigma = 5.38 \text{ S/m}$; $\epsilon_r = 47.75$; $\rho = 1000 \text{ kg/m}^3$; Phantom section: Flat Section

Ambient temperature (°C): 21.5, Liquid temperature (°C): 21.0

DASY5 Configuration:

- Probe: EX3DV4 - SN3710; ConvF(4.57, 4.57, 4.57); Calibrated: 21/04/2020;
- Sensor-Surface: 2mm (Mechanical Surface Detection)
- Electronics: DAE4 Sn915; Calibrated: 13/06/2019
- Phantom: ELI1; Type: QDOVA002AA; Serial: TP:2106
- Measurement SW: DASY52, Version 52.8 (8); SEMCAD X Version 14.6.10 (7331)

Configuration/802.11a 5300MHz trunk/Area Scan (11x13x1): Measurement grid: $dx=10\text{mm}$, $dy=10\text{mm}$

Maximum value of SAR (measured) = 2.63 W/kg

Configuration/802.11a 5300MHz trunk/Zoom Scan (7x7x6)/Cube 0: Measurement grid: $dx=4\text{mm}$, $dy=4\text{mm}$, $dz=2\text{mm}$; Reference Value = 4.539 V/m; Power Drift = 0.15 dB

Peak SAR (extrapolated) = 7.49 W/kg

SAR(1 g) = 1.65 W/kg; SAR(10 g) = 0.484 W/kg

Maximum value of SAR (measured) = 3.52 W/kg

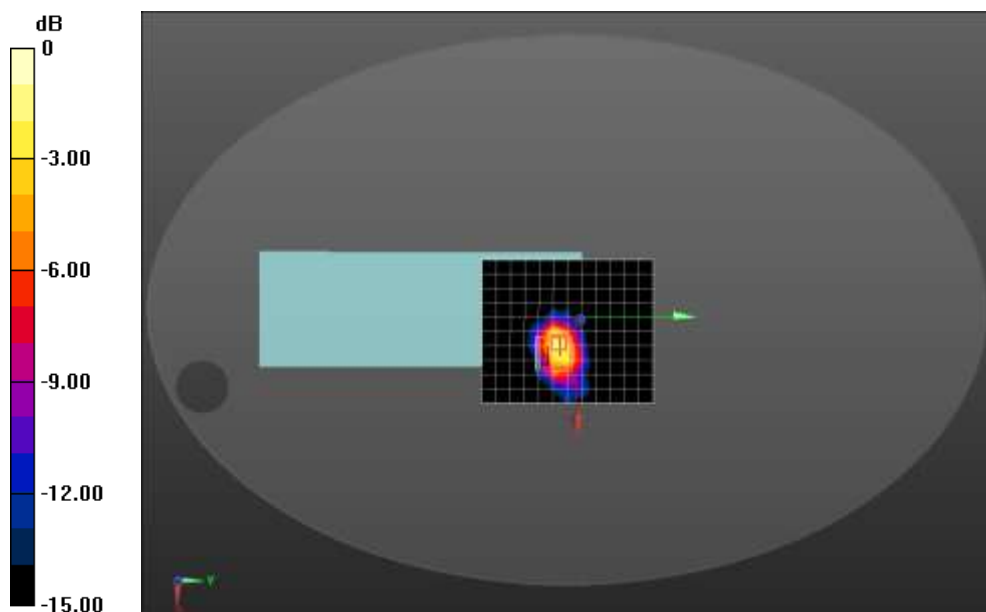

0 dB = 3.52 W/kg = 5.47 dBW/kg

Date/Time: 05/14/2020

Test Laboratory: DEKRA Lab

802.11ac80 5530MHz side3

DUT: Mobile Computer; Type: MEMOR K

Communication System: UID 0, CW (0); Communication System Band: 5GHz(5000.0-6000.0MHz); Duty

Cycle: 1:1.0; Frequency: 5530 MHz; Medium parameters used: $f = 5530$ MHz; $\sigma = 5.69$ S/m; $\epsilon_r = 47.35$; $\rho = 1000$ kg/m³ ; Phantom section: Flat Section

Ambient temperature (°C): 21.5, Liquid temperature (°C): 21.0

DASY5 Configuration:

- Probe: EX3DV4 - SN3710; ConvF(3.98, 3.98, 3.98); Calibrated: 21/04/2020;
- Sensor-Surface: 2mm (Mechanical Surface Detection)
- Electronics: DAE4 Sn915; Calibrated: 13/06/2019
- Phantom: ELI1; Type: QDOVA002AA; Serial: TP:2106
- Measurement SW: DASY52, Version 52.8 (8); SEMCAD X Version 14.6.10 (7331)

Configuration/802.11ac80 5530MHz trunk/Area Scan (12x13x1): Measurement grid: dx=10mm, dy=10mm

Maximum value of SAR (measured) = 4.90 W/kg

Configuration/802.11ac80 5530MHz trunk/Zoom Scan (7x7x6)/Cube 0: Measurement grid: dx=4mm,

dy=4mm, dz=2mm; Reference Value = 9.717 V/m; Power Drift = 0.04 dB

Peak SAR (extrapolated) = 10.5 W/kg

SAR(1 g) = 2.1 W/kg; SAR(10 g) = 0.522 W/kg

Maximum value of SAR (measured) = 4.82 W/kg

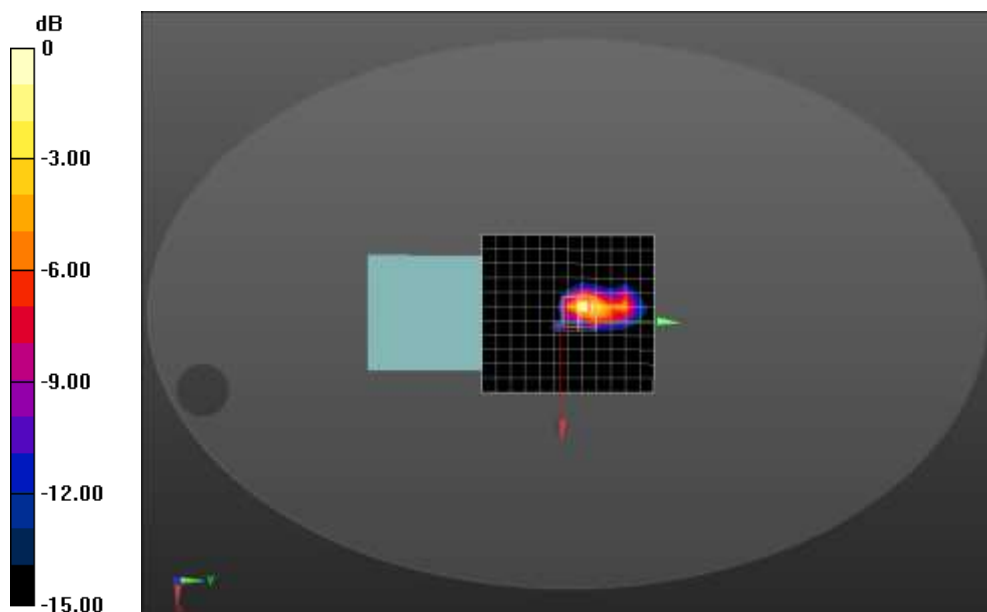

0 dB = 4.82 W/kg = 6.83 dBW/kg

Repeat SAR

Date/Time: 05/12/2020

Test Laboratory: DEKRA Lab

802.11b 2412MHz Touch-Right *

DUT: Mobile Computer; Type: MEMOR K

Communication System: UID 0, Wi-Fi (0); Communication System Band: 802.11g; Duty Cycle: 1:1.0;

Frequency: 2412 MHz; Medium parameters used: $f = 2412$ MHz; $\sigma = 1.77$ S/m; $\epsilon_r = 40.97$; $\rho = 1000$ kg/m³ ;

Phantom section: Right Section

Ambient temperature (°C): 21.5, Liquid temperature (°C): 21.0

DASY5 Configuration:

- Probe: EX3DV4 - SN3710; ConvF(7.42, 7.42, 7.42); Calibrated: 21/04/2020;
- Sensor-Surface: 4mm (Mechanical Surface Detection)
- Electronics: DAE4 Sn915; Calibrated: 13/06/2019
- Phantom: SAM2; Type: SAM; Serial: TP1562
- Measurement SW: DASY52, Version 52.8 (8); SEMCAD X Version 14.6.10 (7331)

Configuration/802.11b 2412MHz touch right/Area Scan (9x10x1): Measurement grid: dx=12mm, dy=12mm; Maximum value of SAR (measured) = 0.811 W/kg

Configuration/802.11b 2412MHz touch right/Zoom Scan (5x5x7)/Cube 0: Measurement grid: dx=8mm, dy=8mm, dz=5mm; Reference Value = 8.62 V/m; Power Drift = -0.02 dB

Peak SAR (extrapolated) = 2.22 W/kg

SAR(1 g) = 0.788 W/kg; SAR(10 g) = 0.296 W/kg

Maximum value of SAR (measured) = 1.09 W/kg

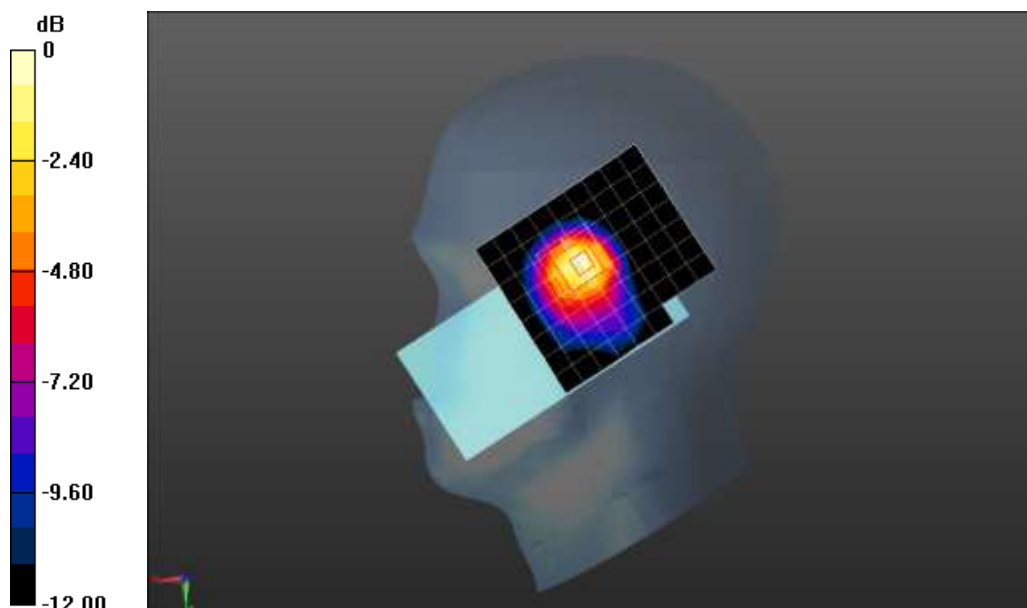

0 dB = 1.09 W/kg = 0.37 dBW/kg

Date/Time: 05/12/2020

Test Laboratory: DEKRA Lab

802.11a 5240MHz Touch-Left *

DUT: Mobile Computer; Type: MEMOR K

Communication System: UID 0, CW (0); Communication System Band: 5GHz(5000.0-6000.0MHz); Duty

Cycle: 1:1.0; Frequency: 5240 MHz; Medium parameters used: $f = 5240$ MHz; $\sigma = 4.55$ S/m; $\epsilon_r = 36.11$; $\rho = 1000$ kg/m³; Phantom section: Left Section

Ambient temperature (°C): 21.5, Liquid temperature (°C): 21.0

DASY5 Configuration:

- Probe: EX3DV4 - SN3710; ConvF(5.18, 5.18, 5.18); Calibrated: 21/04/2020;
- Sensor-Surface: 4mm (Mechanical Surface Detection)
- Electronics: DAE4 Sn915; Calibrated: 13/06/2019
- Phantom: SAM2; Type: SAM; Serial: TP1562
- Measurement SW: DASY52, Version 52.8 (8); SEMCAD X Version 14.6.10 (7331)

Configuration/802.11a 5240MHz Touch-Left/Area Scan (9x11x1): Measurement grid: dx=12mm, dy=12mm; Maximum value of SAR (measured) = 0.868 W/kg

Configuration/802.11a 5240MHz Touch-Left/Zoom Scan (5x5x7)/Cube 0: Measurement grid: dx=8mm, dy=8mm, dz=5mm; Reference Value = 7.188 V/m; Power Drift = -0.00 dB

Peak SAR (extrapolated) = 4.47 W/kg

SAR(1 g) = 0.785 W/kg; SAR(10 g) = 0.292 W/kg

Maximum value of SAR (measured) = 1.10 W/kg

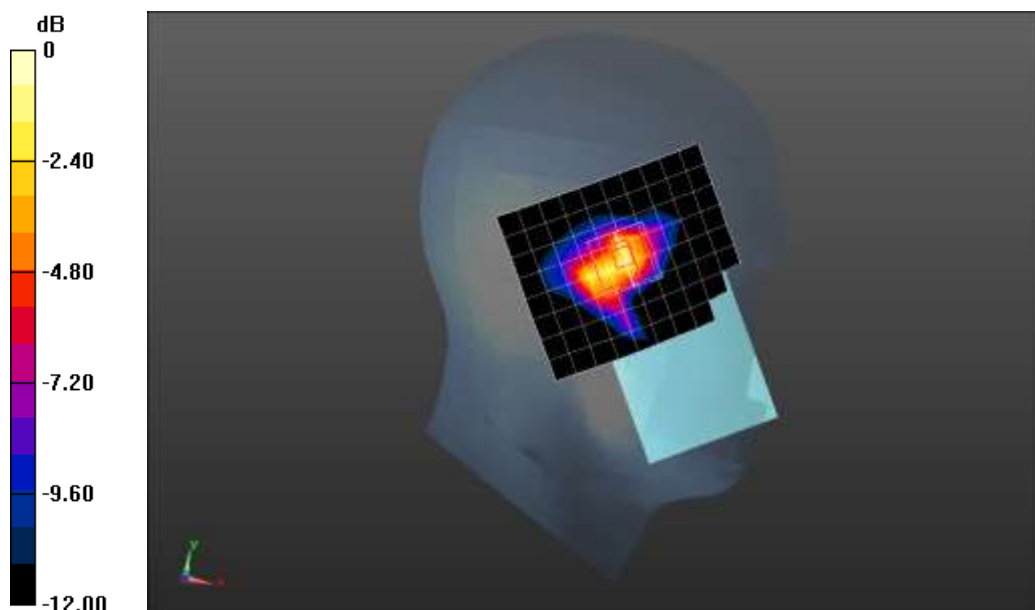

0 dB = 1.10 W/kg = 0.41 dBW/kg

Date/Time: 05/14/2020

Test Laboratory: DEKRA Lab

802.11g 2437MHz Back *

DUT: Mobile Computer; Type: MEMOR K

Communication System: UID 0, Wi-Fi (0); Communication System Band: 802.11g; Duty Cycle: 1:1.0;

Frequency: 2437 MHz; Medium parameters used: $f = 2437 \text{ MHz}$; $\sigma = 1.93 \text{ S/m}$; $\epsilon_r = 52.79$; $\rho = 1000 \text{ kg/m}^3$;

Phantom section: Flat Section

Ambient temperature (°C): 21.5, Liquid temperature (°C): 21.0

DASY5 Configuration:

- Probe: EX3DV4 - SN3710; ConvF(7.37, 7.37, 7.37); Calibrated: 21/04/2020;
- Sensor-Surface: 4mm (Mechanical Surface Detection)
- Electronics: DAE4 Sn915; Calibrated: 13/06/2019
- Phantom: ELI1; Type: QDOVA002AA; Serial: TP:2106
- Measurement SW: DASY52, Version 52.8 (8); SEMCAD X Version 14.6.10 (7331)

Configuration/802.11g 2437MHz Back/Area Scan (8x11x1): Measurement grid: dx=12mm, dy=12mm;

Maximum value of SAR (measured) = 2.59 W/kg

Configuration/802.11g 2437MHz Back/Zoom Scan (7x7x5)/Cube 0: Measurement grid: dx=5mm, dy=5mm, dz=4mm; Reference Value = 34.11 V/m; Power Drift = 0.01 dB

Peak SAR (extrapolated) = 7.04 W/kg

SAR(1 g) = 2.16 W/kg; SAR(10 g) = 0.847 W/kg

Maximum value of SAR (measured) = 2.63 W/kg

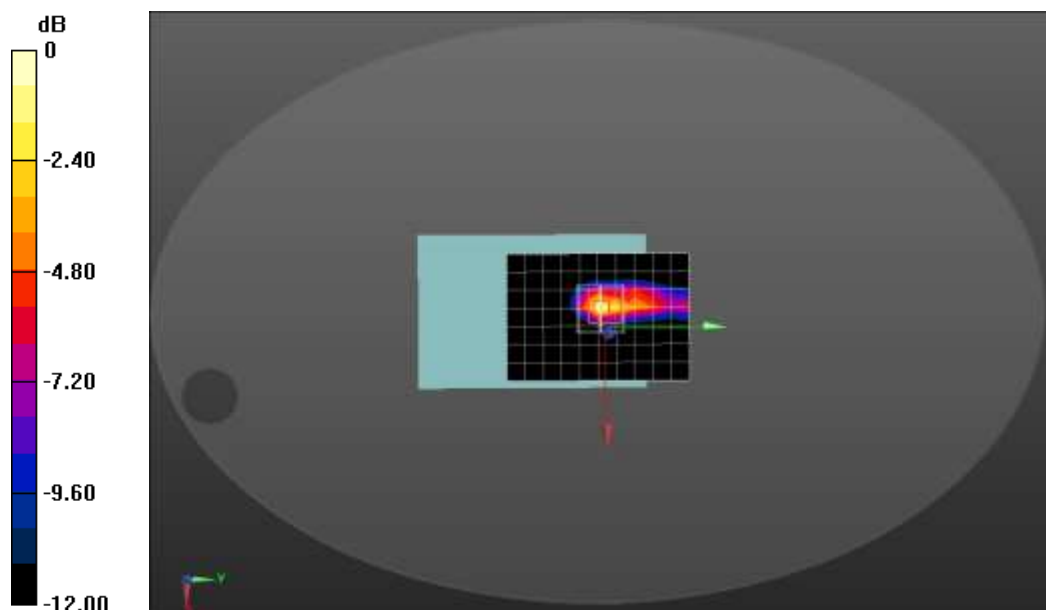

0 dB = 2.63 W/kg = 4.20 dBW/kg

2450MHz Head

Date/Time: 03/23/2020

Calibrated return loss: -24.917 dB; Measured return loss: -24.482dB (within 20%)

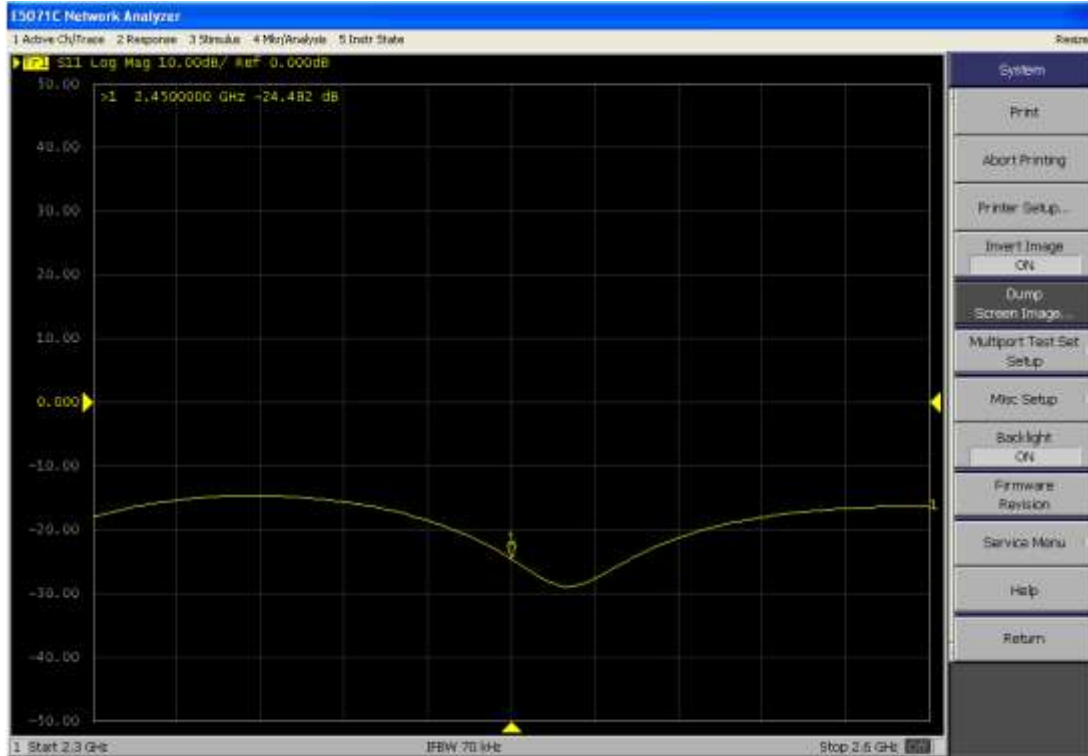

Calibrated impedance: 53.33Ω; Measured impedance: 51.175Ω (within 5Ω)

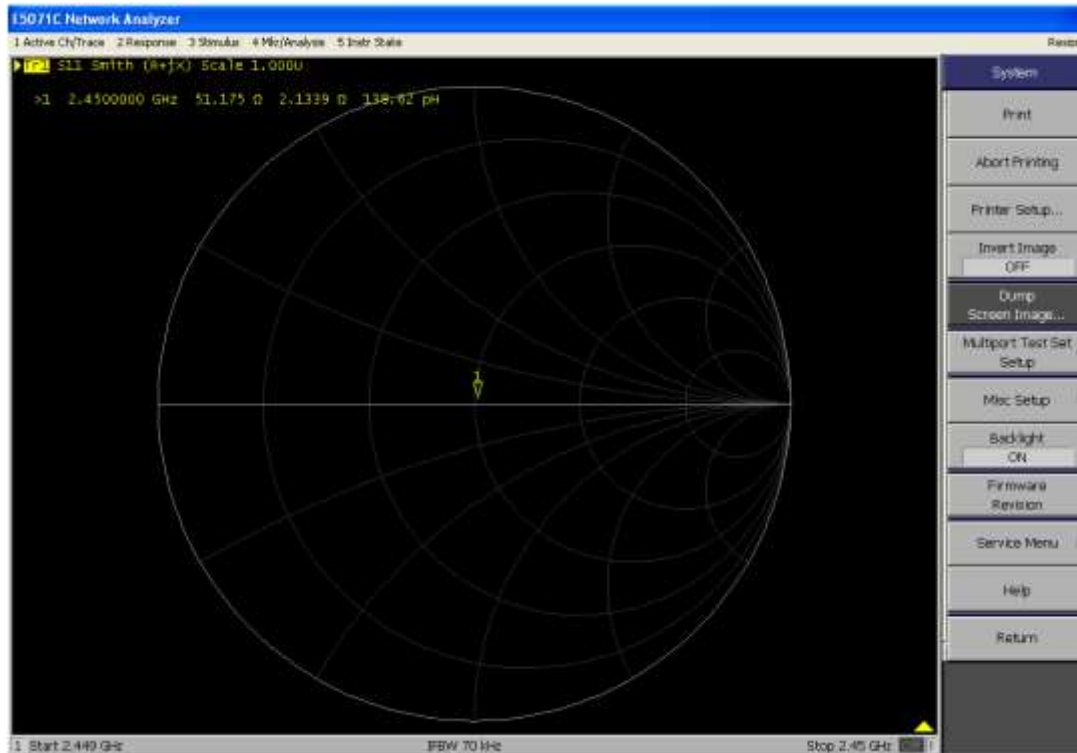

5250MHz Head

Date/Time: 03/23/2020

Calibrated return loss: -26.673 dB; Measured return loss: -24.440dB (within 20%)

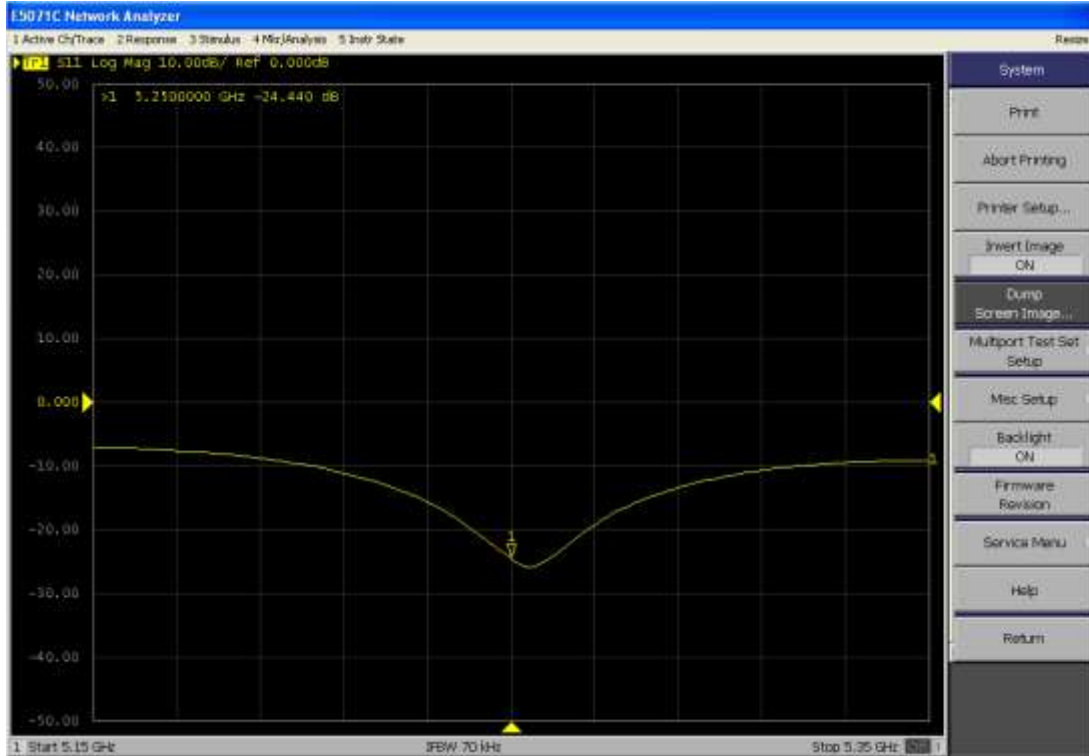

Calibrated impedance: 52.133Ω; Measured impedance: 51.478Ω (within 5Ω)

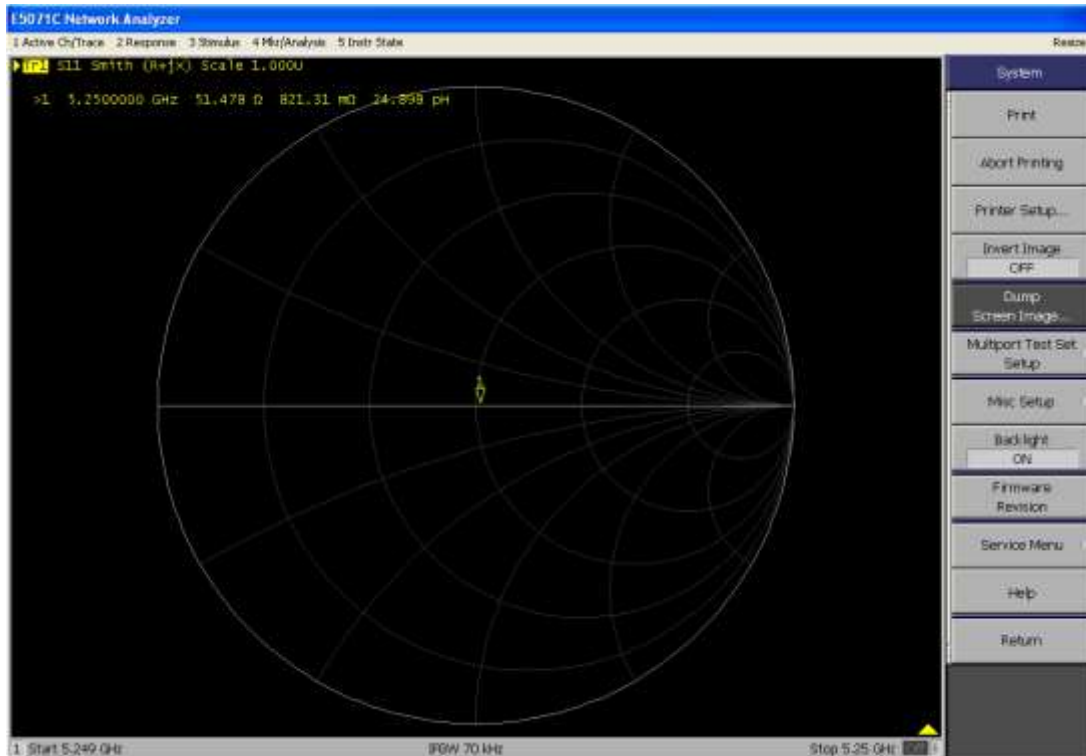

5600MHz Head

Date/Time: 03/23/2020

Calibrated return loss: -21.055 dB; Measured return loss: -22.307dB (within 20%)

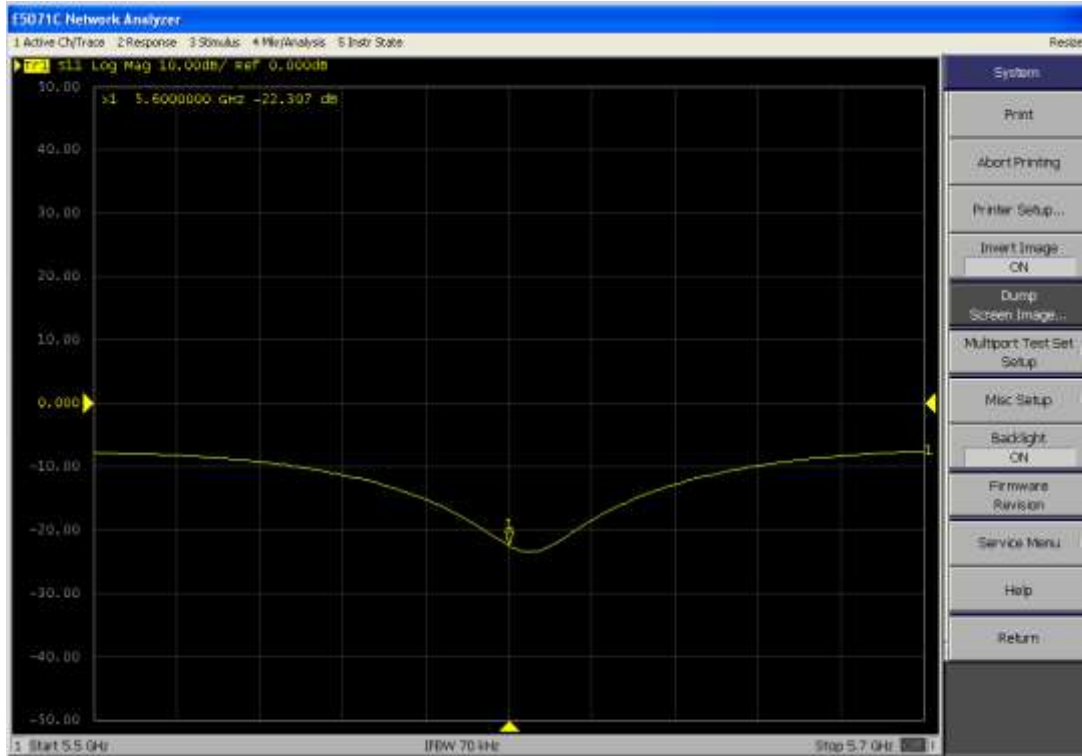

Calibrated impedance: 59.201Ω; Measured impedance: 61.059Ω (within 5Ω)

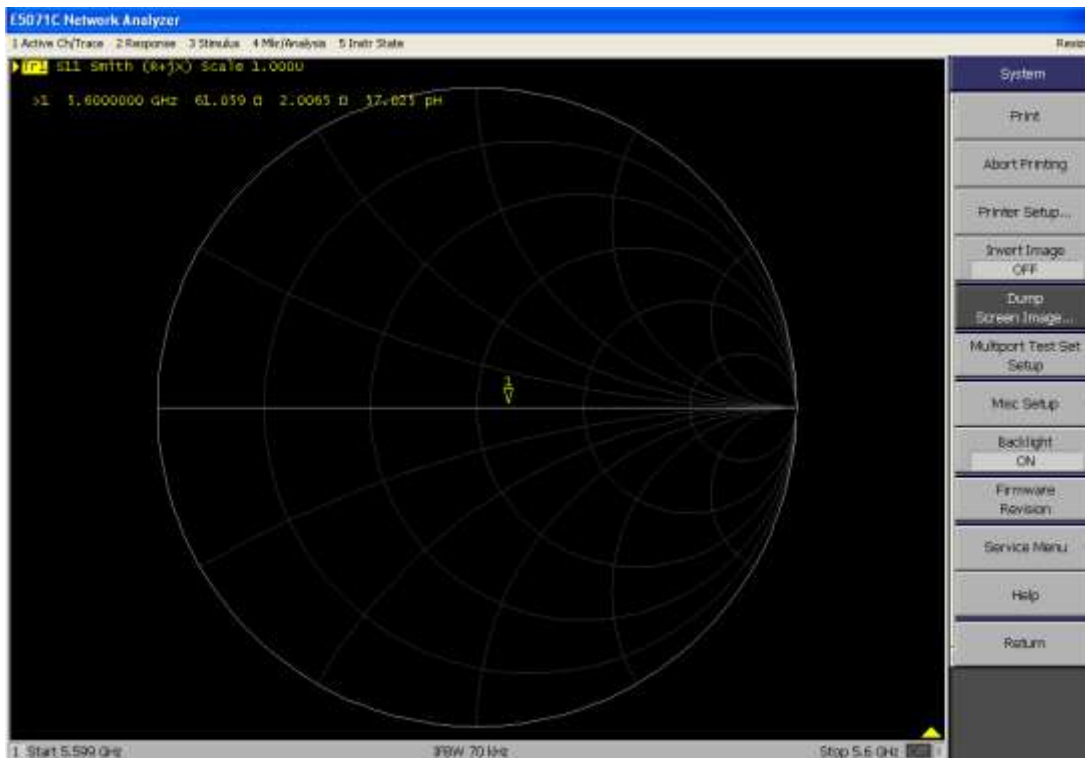

5750MHz Head

Date/Time: 03/23/2020

Calibrated return loss: -30.333 dB; Measured return loss: -31.230dB (within 20%)

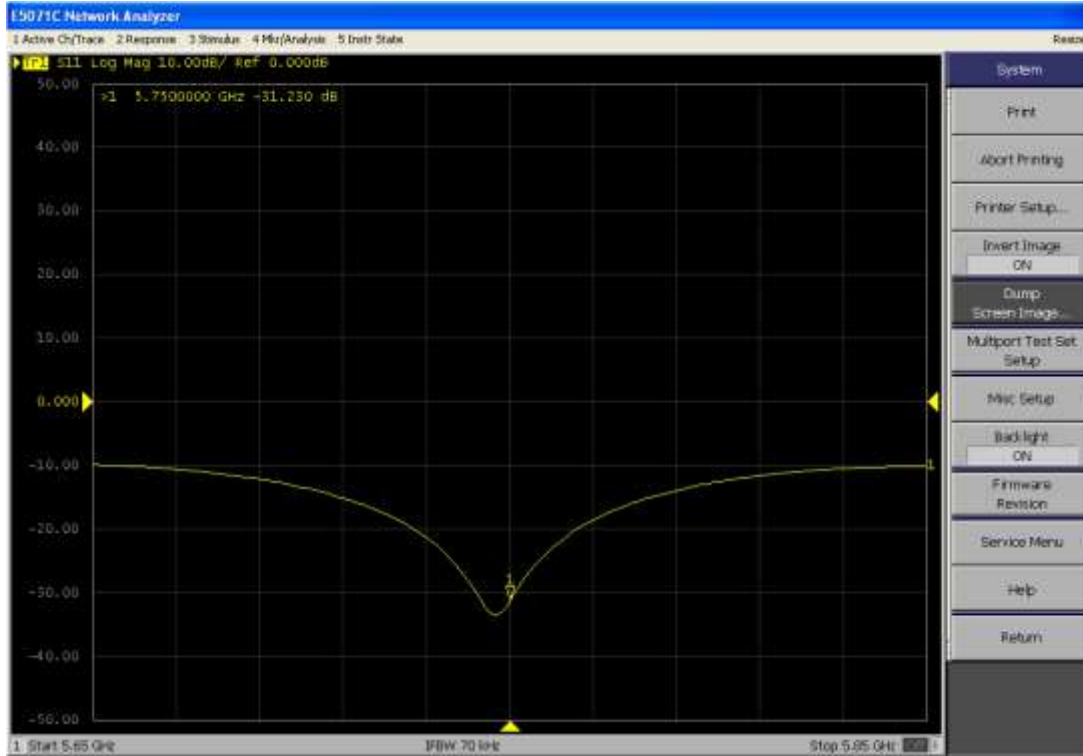

Calibrated impedance: 51.866Ω; Measured impedance: 52.019Ω (within 5Ω)

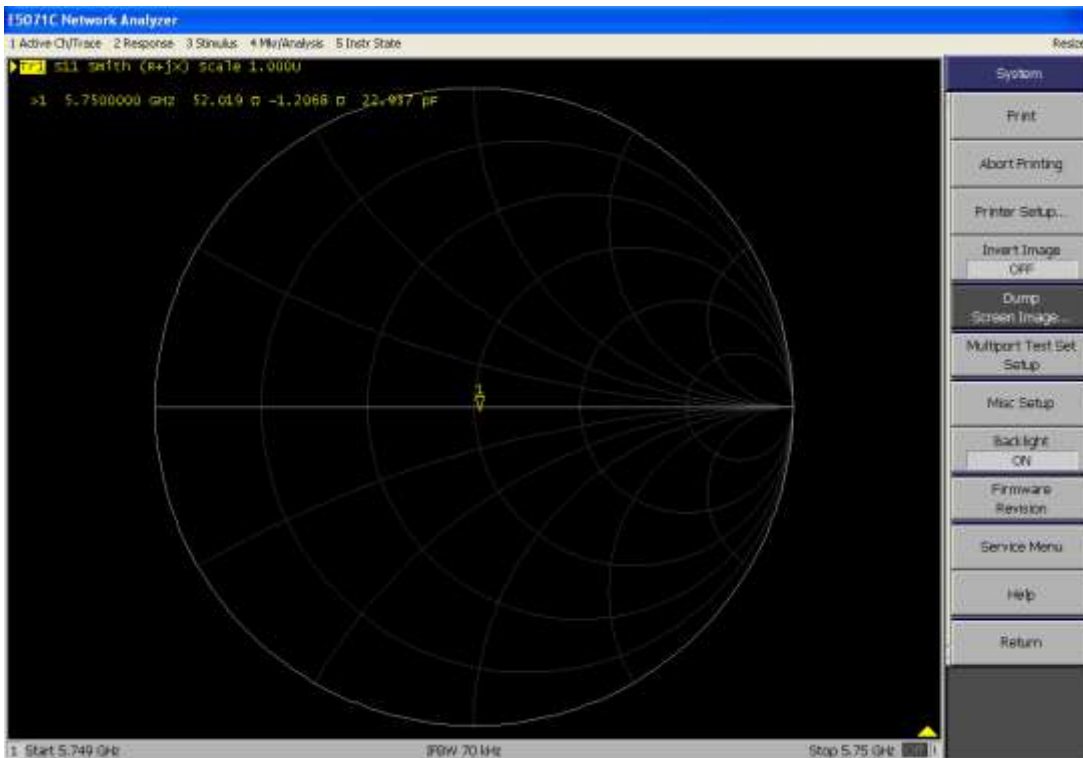

2450MHz Body

Date/Time: 03/23/2020

Calibrated return loss: -24.349 dB; Measured return loss: -23.748dB (within 20%)

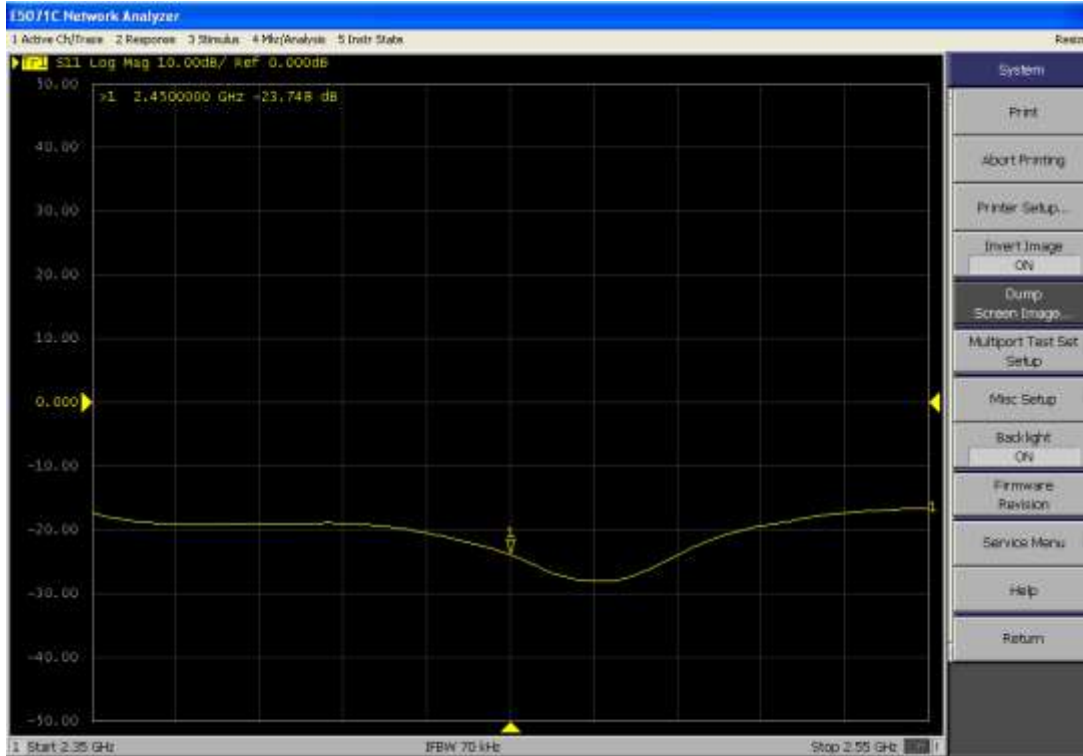

Calibrated impedance: 49.504Ω; Measured impedance: 48.742Ω (within 5Ω)

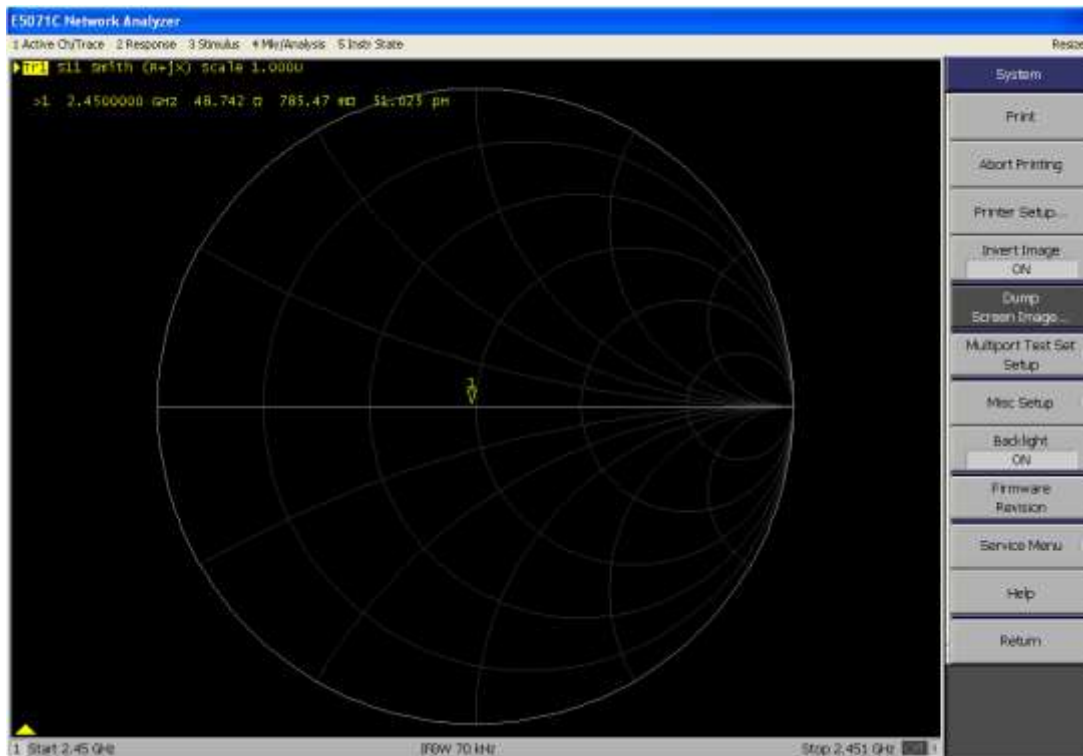

5250 MHz Body

Date/Time: 03/23/2020

Calibrated return loss: -29.514 dB; Measured return loss: -28.297dB (within 20%)

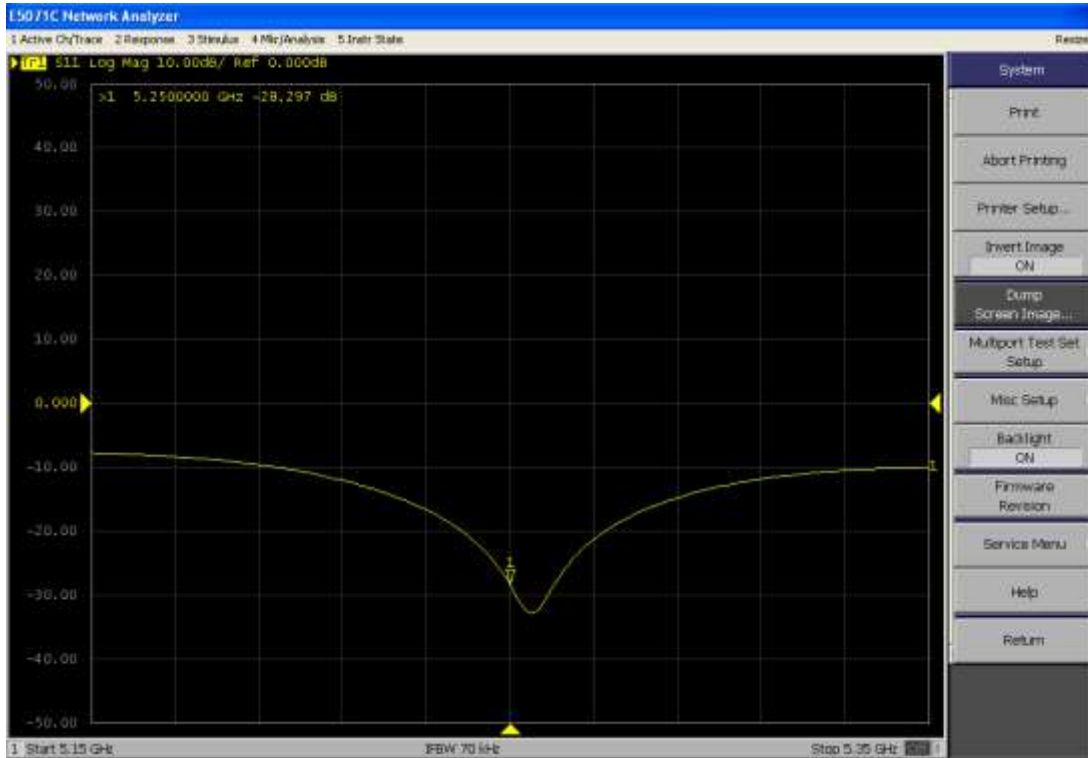

Calibrated impedance: 50.655Ω; Measured impedance: 48.987Ω (within 5Ω)

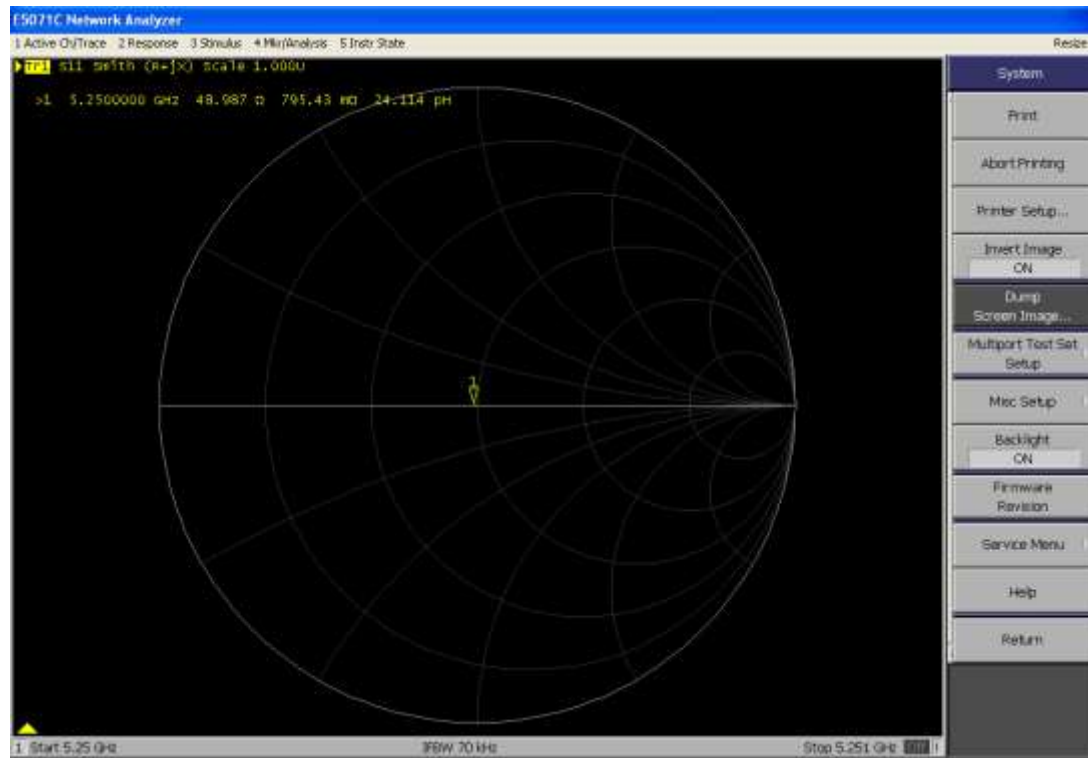

5600 MHz Body

Date/Time: 03/23/2020

Calibrated return loss: -21.701 dB; Measured return loss: -20.814dB (within 20%)

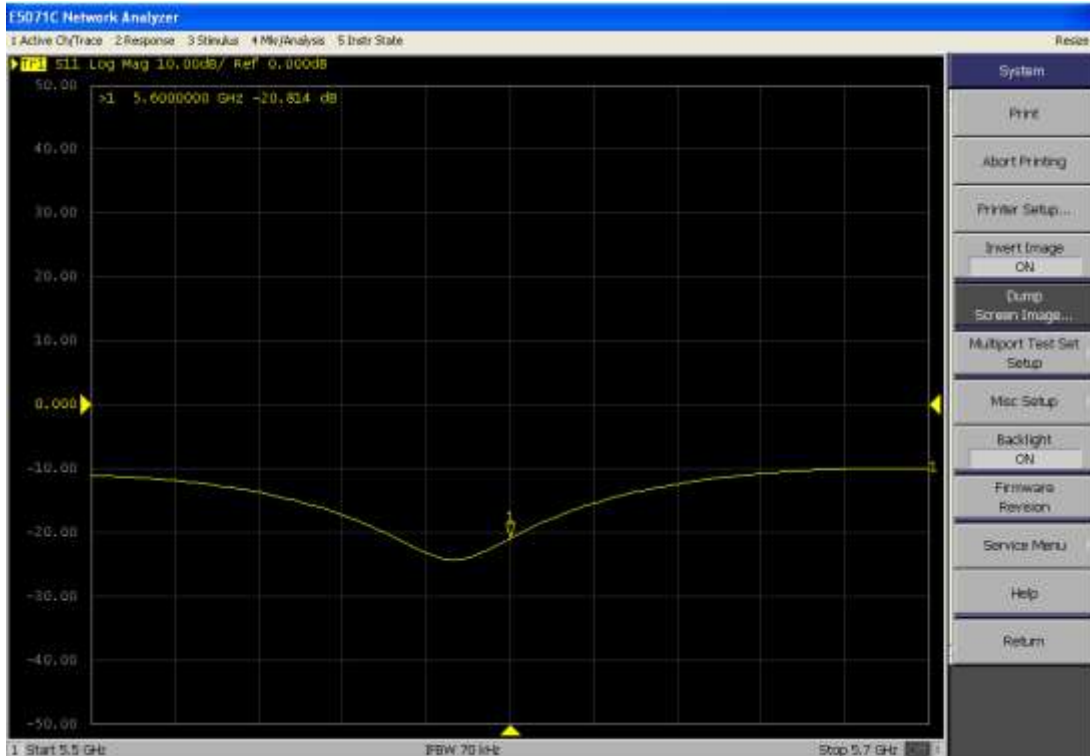

Calibrated impedance: 58.753Ω; Measured impedance: 57.088Ω (within 5Ω)

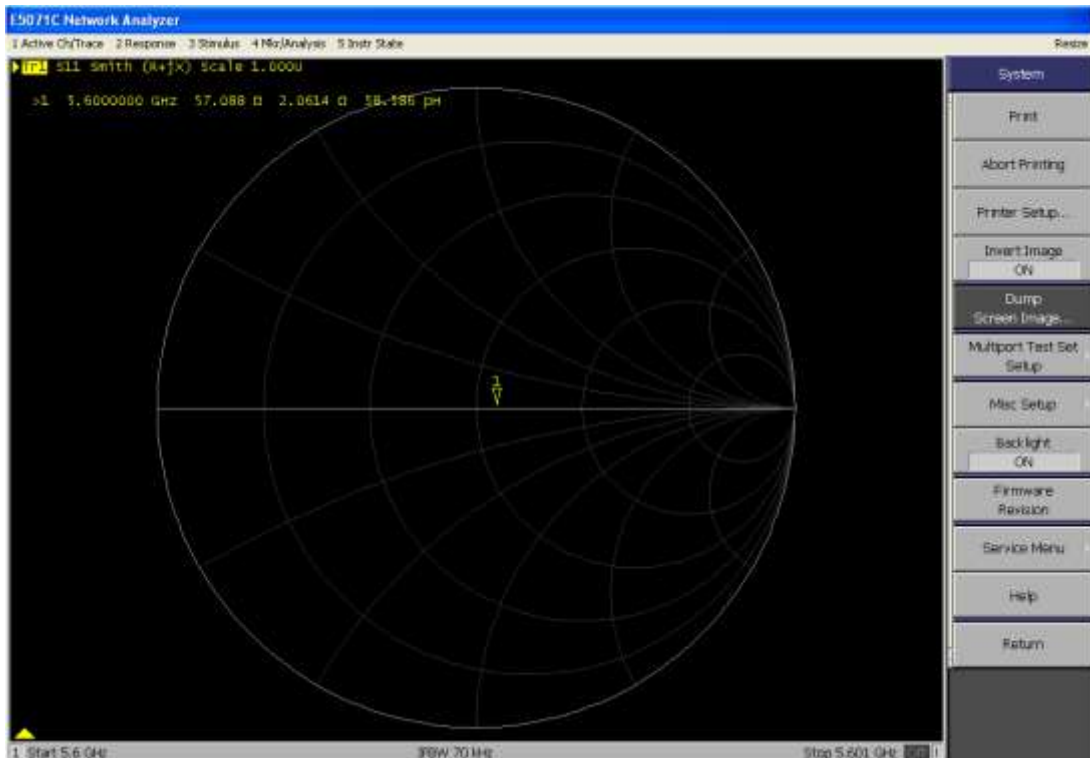

5750 MHz Body

Date/Time: 03/23/2020

Calibrated return loss: -25.524 dB; Measured return loss: -25.082dB (within 20%)

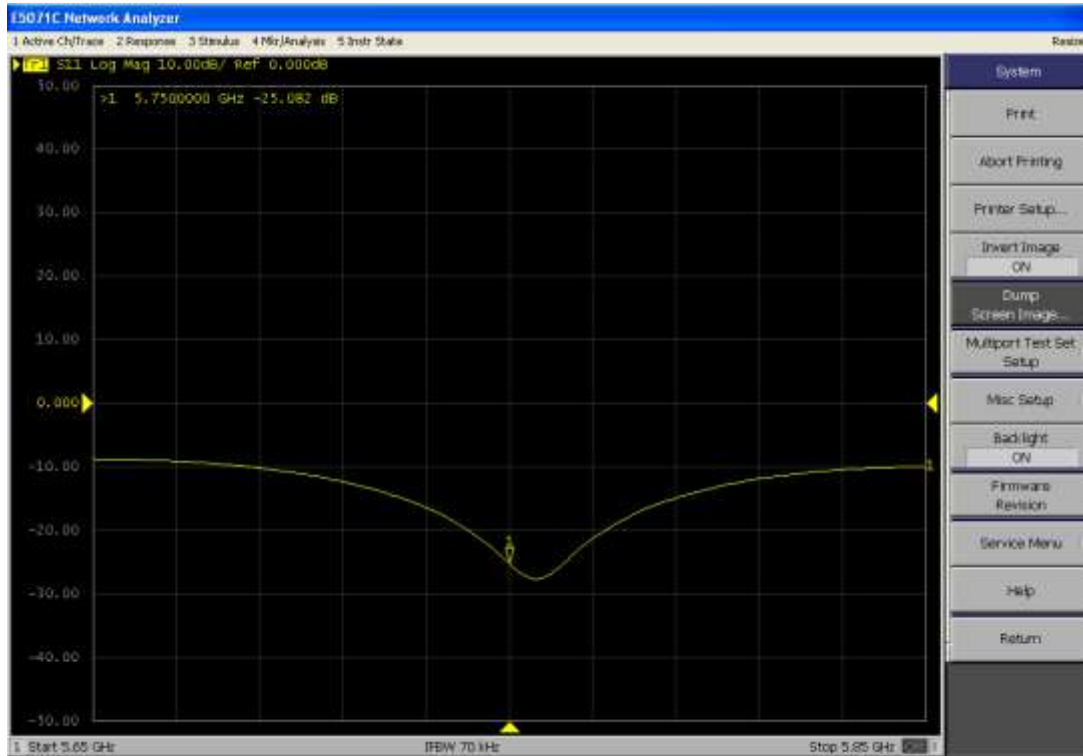

Calibrated impedance: 52.966Ω; Measured impedance: 54.626Ω (within 5Ω)

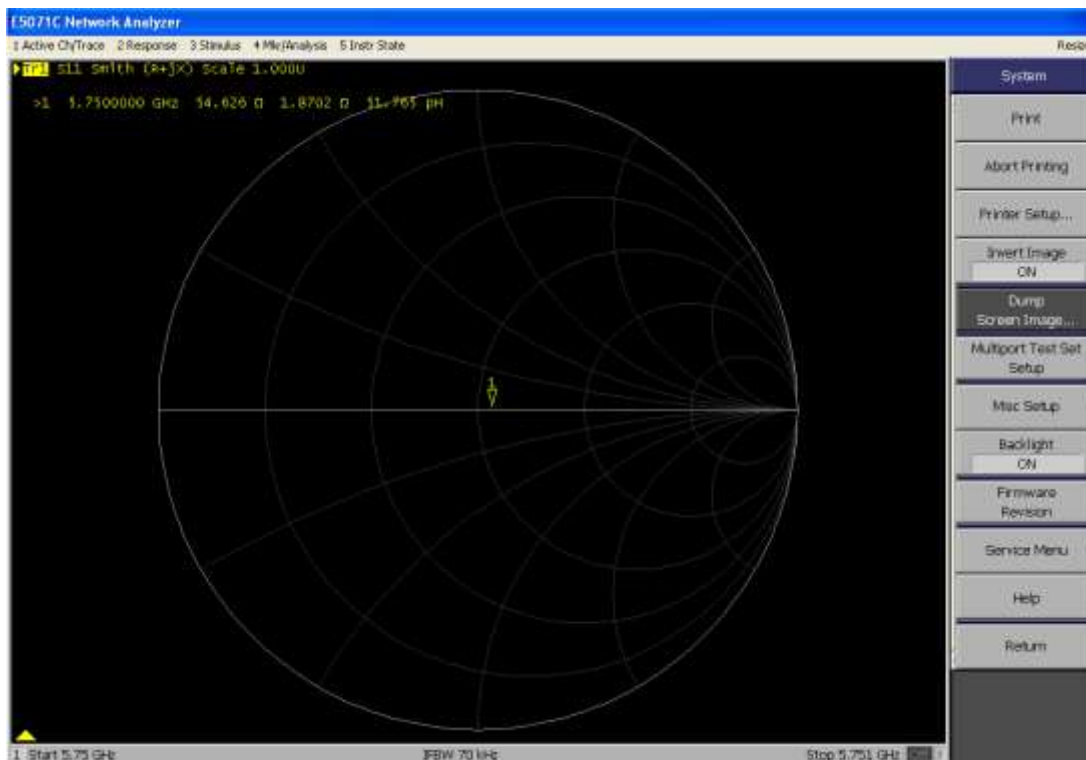

Appendix C. Probe Calibration Data



Client **Dekra-CN** Certificate No: **Z20-60135**

CALIBRATION CERTIFICAT

Object: EX3DV4 - SN : 3710

Calibration Procedure(s): FF-Z11-004-01
 Calibration Procedures for Dosimetric E-field Probes

Calibration date: April 21, 2020

This calibration Certificate documents the traceability to national standards, which realize the physical units of measurements(SI). The measurements and the uncertainties with confidence probability are given on the following pages and are part of the certificate.

All calibrations have been conducted in the closed laboratory facility: environment temperature(22±3)℃ and humidity<70%.

Calibration Equipment used (M&TE critical for calibration)

Primary Standards	ID #	Cal Date(Calibrated by, Certificate No.)	Scheduled Calibration
Power Meter NRP2	101919	18-Jun-19(CTTL, No.J19X05125)	Jun-20
Power sensor NRP-Z91	101547	18-Jun-19(CTTL, No.J19X05125)	Jun-20
Power sensor NRP-Z91	101548	18-Jun-19(CTTL, No.J19X05125)	Jun-20
Reference 10dBAttenuator	18N50W-10dB	10-Feb-20(CTTL, No.J20X00525)	Feb-22
Reference 20dBAttenuator	18N50W-20dB	10-Feb-20(CTTL, No.J20X00526)	Feb-22
Reference Probe EX3DV4	SN 7307	24-May-19(SPEAG, No.EX3-7307_May19/2)	May-20
DAE4	SN 1525	26-Aug-19(SPEAG, No.DAE4-1525_Aug19)	Aug-20

Secondary Standards	ID #	Cal Date(Calibrated by, Certificate No.)	Scheduled Calibration
SignalGenerator MG3700A	6201052605	18-Jun-19(CTTL, No.J19X05127)	Jun-20
Network Analyzer E5071C	MY46110673	10-Feb-20(CTTL, No.J20X00515)	Feb-21

	Name	Function	Signature
Calibrated by:	Yu Zongying	SAR Test Engineer	
Reviewed by:	Lin Hao	SAR Test Engineer	
Approved by:	Qi Dianyuan	SAR Project Leader	

Issued: April 23, 2020

This calibration certificate shall not be reproduced except in full without written approval of the laboratory.



Add: No.51 Xueyuan Road, Haidian District, Beijing, 100191, China
 Tel: +86-10-62304633-2512 Fax: +86-10-62304633-2504
 E-mail: ctl@chinattl.com [Http://www.chinattl.cn](http://www.chinattl.cn)

Glossary:

TSL	tissue simulating liquid
NORM _{x,y,z}	sensitivity in free space
ConvF	sensitivity in TSL / NORM _{x,y,z}
DCP	diode compression point
CF	crest factor (1/duty_cycle) of the RF signal
A,B,C,D	modulation dependent linearization parameters
Polarization Φ	Φ rotation around probe axis
Polarization θ	θ rotation around an axis that is in the plane normal to probe axis (at measurement center), $\theta=0$ is normal to probe axis

Connector Angle information used in DASY system to align probe sensor X to the robot coordinate system

Calibration is Performed According to the Following Standards:

- a) IEEE Std 1528-2013, "IEEE Recommended Practice for Determining the Peak Spatial-Averaged Specific Absorption Rate (SAR) in the Human Head from Wireless Communications Devices: Measurement Techniques", June 2013
- b) IEC 62209-1, "Measurement procedure for the assessment of Specific Absorption Rate (SAR) from hand-held and body-mounted devices used next to the ear (frequency range of 300 MHz to 6 GHz)", July 2016
- c) IEC 62209-2, "Procedure to determine the Specific Absorption Rate (SAR) for wireless communication devices used in close proximity to the human body (frequency range of 30 MHz to 6 GHz)", March 2010
- d) KDB 865664, "SAR Measurement Requirements for 100 MHz to 6 GHz"

Methods Applied and Interpretation of Parameters:

- NORM_{x,y,z}: Assessed for E-field polarization $\theta=0$ (fs900MHz in TEM-cell; f>1800MHz: waveguide). NORM_{x,y,z} are only intermediate values, i.e., the uncertainties of NORM_{x,y,z} does not effect the E^2 -field uncertainty inside TSL (see below ConvF).
- NORM(f)_{x,y,z} = NORM_{x,y,z} * frequency_response (see Frequency Response Chart). This linearization is implemented in DASY4 software versions later than 4.2. The uncertainty of the frequency response is included in the stated uncertainty of ConvF.
- DCP_{x,y,z}: DCP are numerical linearization parameters assessed based on the data of power sweep (no uncertainty required). DCP does not depend on frequency nor media.
- PAR: PAR is the Peak to Average Ratio that is not calibrated but determined based on the signal characteristics.
- Ax,y,z; Bx,y,z; Cx,y,z; VRx,y,z:A,B,C are numerical linearization parameters assessed based on the data of power sweep for specific modulation signal. The parameters do not depend on frequency nor media. VR is the maximum calibration range expressed in RMS voltage across the diode.
- ConvF and Boundary Effect Parameters: Assessed in flat phantom using E-field (or Temperature Transfer Standard for fs800MHz) and inside waveguide using analytical field distributions based on power measurements for f >800MHz. The same setups are used for assessment of the parameters applied for boundary compensation (alpha, depth) of which typical uncertainty valued are given. These parameters are used in DASY4 software to improve probe accuracy close to the boundary. The sensitivity in TSL corresponds to NORM_{x,y,z}* ConvF whereby the uncertainty corresponds to that given for ConvF. A frequency dependent ConvF is used in DASY version 4.4 and higher which allows extending the validity from ± 50 MHz to ± 100 MHz.
- Spherical isotropy (3D deviation from isotropy): in a field of low gradients realized using a flat phantom exposed by a patch antenna.
- Sensor Offset: The sensor offset corresponds to the offset of virtual measurement center from the probe tip (on probe axis). No tolerance required.
- Connector Angle: The angle is assessed using the information gained by determining the NORM_x (no uncertainty required).



Add: No.51 Xueyuan Road, Haidian District, Beijing, 100191, China
 Tel: +86-10-62304633-2512 Fax: +86-10-62304633-2504
 E-mail: ctrl@chinattl.com [Http://www.chinattl.cn](http://www.chinattl.cn)

DASY/EASY – Parameters of Probe: EX3DV4 – SN:3710

Basic Calibration Parameters

	Sensor X	Sensor Y	Sensor Z	Unc (k=2)
Norm($\mu V/(V/m)^2$) ^A	0.37	0.41	0.49	±10.0%
DCP(mV) ^B	102.3	103.2	102.3	

Modulation Calibration Parameters

UID	Communication System Name		A dB	B dB· μV	C	D dB	VR mV	Unc ^E (k=2)
0	CW	X	0.0	0.0	1.0	0.00	142.8	±2.4%
		Y	0.0	0.0	1.0		147.1	
		Z	0.0	0.0	1.0		170.0	

The reported uncertainty of measurement is stated as the standard uncertainty of Measurement multiplied by the coverage factor $k=2$, which for a normal distribution Corresponds to a coverage probability of approximately 95%.

- ^A The uncertainties of Norm X, Y, Z do not affect the E²-field uncertainty inside TSL (see Page 4 and Page 5).
^B Numerical linearization parameter: uncertainty not required.
^E Uncertainty is determined using the max. deviation from linear response applying rectangular distribution and is expressed for the square of the field value.



In Collaboration with
TTL **s p e a g**
CALIBRATION LABORATORY
 Add: No.51 Xueyuan Road, Haidian District, Beijing, 100191, China
 Tel: +86-10-62304633-2512 Fax: +86-10-62304633-2504
 E-mail: ttl@chinattl.com <http://www.chinattl.cn>

DASY/EASY – Parameters of Probe: EX3DV4 – SN:3710

Calibration Parameter Determined in Head Tissue Simulating Media

f [MHz] ^C	Relative Permittivity ^F	Conductivity (S/m) ^F	ConvF X	ConvF Y	ConvF Z	Alpha ^G	Depth ^G (mm)	Unct. (k=2)
750	41.9	0.89	9.55	9.55	9.55	0.40	0.75	±12.1%
835	41.5	0.90	9.28	9.28	9.28	0.14	1.38	±12.1%
900	41.5	0.97	9.27	9.27	9.27	0.14	1.39	±12.1%
1810	40.0	1.40	7.91	7.91	7.91	0.18	1.16	±12.1%
1900	40.0	1.40	7.80	7.80	7.80	0.21	1.10	±12.1%
2450	39.2	1.80	7.42	7.42	7.42	0.46	0.76	±12.1%
2600	39.0	1.96	7.13	7.13	7.13	0.35	0.98	±12.1%
3500	37.9	2.91	6.83	6.83	6.83	0.45	0.94	±13.3%
5250	35.9	4.71	5.18	5.18	5.18	0.45	1.65	±13.3%
5600	35.5	5.07	4.66	4.66	4.66	0.50	1.40	±13.3%
5750	35.4	5.22	4.77	4.77	4.77	0.50	1.45	±13.3%

^C Frequency validity above 300 MHz of ±100MHz only applies for DASY v4.4 and higher (Page 2), else it is restricted to ±50MHz. The uncertainty is the RSS of ConvF uncertainty at calibration frequency and the uncertainty for the indicated frequency band. Frequency validity below 300 MHz is ± 10, 25, 40, 50 and 70 MHz for ConvF assessments at 30, 64, 128, 150 and 220 MHz respectively. Above 5 GHz frequency validity can be extended to ± 110 MHz.

^F At frequency below 3 GHz, the validity of tissue parameters (ϵ and σ) can be relaxed to ±10% if liquid compensation formula is applied to measured SAR values. At frequencies above 3 GHz, the validity of tissue parameters (ϵ and σ) is restricted to ±5%. The uncertainty is the RSS of the ConvF uncertainty for indicated target tissue parameters.

^G Alpha/Depth are determined during calibration. SPEAG warrants that the remaining deviation due to the boundary effect after compensation is always less than ± 1% for frequencies below 3 GHz and below ± 2% for the frequencies between 3-6 GHz at any distance larger than half the probe tip diameter from the boundary.



Add: No.51 Xueyuan Road, Haidian District, Beijing, 100191, China
Tel: +86-10-62304633-2512 Fax: +86-10-62304633-2504
E-mail: ttl@chinattl.com [Http://www.chinattl.cn](http://www.chinattl.cn)

Frequency Response of E-Field (TEM-Cell: ifi110 EXX, Waveguide: R22)

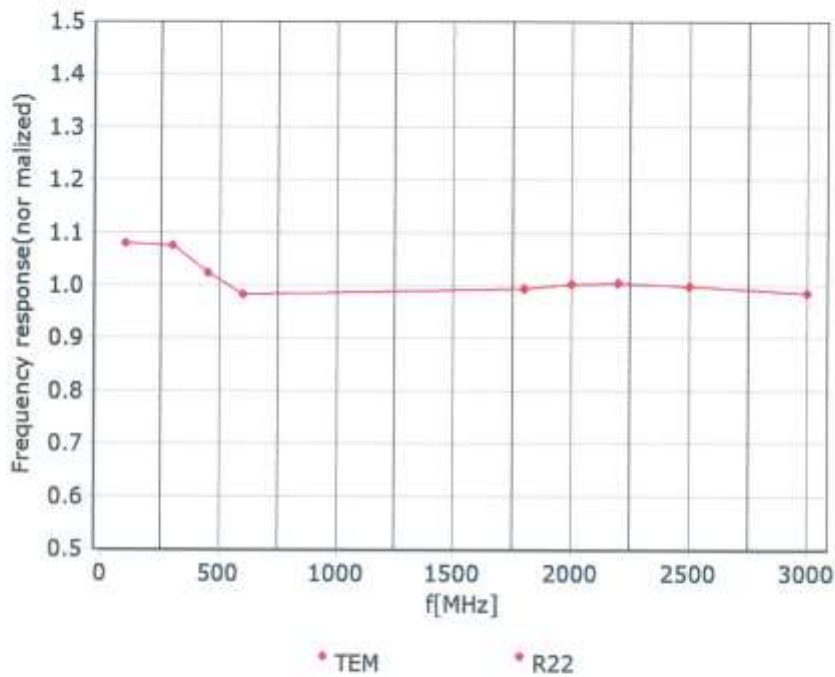

Uncertainty of Frequency Response of E-field: $\pm 7.4\%$ ($k=2$)



Add: No.51 Xueyuan Road, Haidian District, Beijing, 100191, China
 Tel: +86-10-62304633-2512 Fax: +86-10-62304633-2504
 E-mail: cttl@chinattl.com [Http://www.chinattl.cn](http://www.chinattl.cn)

DASY/EASY – Parameters of Probe: EX3DV4 – SN:3710

Calibration Parameter Determined in Body Tissue Simulating Media

f [MHz] ^c	Relative Permittivity ^F	Conductivity (S/m) ^F	ConvF X	ConvF Y	ConvF Z	Alpha ^G	Depth ^G (mm)	Unct. (k=2)
750	55.5	0.96	9.65	9.65	9.65	0.40	0.80	±12.1%
835	55.2	0.97	9.31	9.31	9.31	0.17	1.41	±12.1%
900	55.0	1.05	9.25	9.25	9.25	0.23	1.14	±12.1%
1810	53.3	1.52	7.66	7.66	7.66	0.17	1.37	±12.1%
1900	53.3	1.52	7.59	7.59	7.59	0.19	1.32	±12.1%
2450	52.7	1.95	7.37	7.37	7.37	0.50	0.81	±12.1%
2600	52.5	2.16	7.18	7.18	7.18	0.62	0.72	±12.1%
3500	52.3	3.31	6.36	6.36	6.36	0.40	1.20	±13.3%
5250	48.9	5.36	4.57	4.57	4.57	0.50	1.75	±13.3%
5600	48.5	5.77	3.98	3.98	3.98	0.60	1.65	±13.3%
5750	48.3	5.94	4.01	4.01	4.01	0.60	1.65	±13.3%

^c Frequency validity above 300 MHz of ±100MHz only applies for DASY v4.4 and higher (Page 2), else it is restricted to ±50MHz. The uncertainty is the RSS of ConvF uncertainty at calibration frequency and the uncertainty for the indicated frequency band. Frequency validity below 300 MHz is ± 10, 25, 40, 50 and 70 MHz for ConvF assessments at 30, 64, 128, 150 and 220 MHz respectively. Above 5 GHz frequency validity can be extended to ± 110 MHz.

^F At frequency below 3 GHz, the validity of tissue parameters (ϵ and σ) can be relaxed to ±10% if liquid compensation formula is applied to measured SAR values. At frequencies above 3 GHz, the validity of tissue parameters (ϵ and σ) is restricted to ±5%. The uncertainty is the RSS of the ConvF uncertainty for indicated target tissue parameters.

^G Alpha/Depth are determined during calibration. SPEAG warrants that the remaining deviation due to the boundary effect after compensation is always less than ± 1% for frequencies below 3 GHz and below ± 2% for the frequencies between 3-6 GHz at any distance larger than half the probe tip diameter from the boundary.



Add: No.51 Xueyuan Road, Haidian District, Beijing, 100191, China
 Tel: +86-10-62304633-2512 Fax: +86-10-62304633-2504
 E-mail: ttl@chinattl.com <http://www.chinattl.cn>

Receiving Pattern (Φ), $\theta=0^\circ$

f=600 MHz, TEM

f=1800 MHz, R22

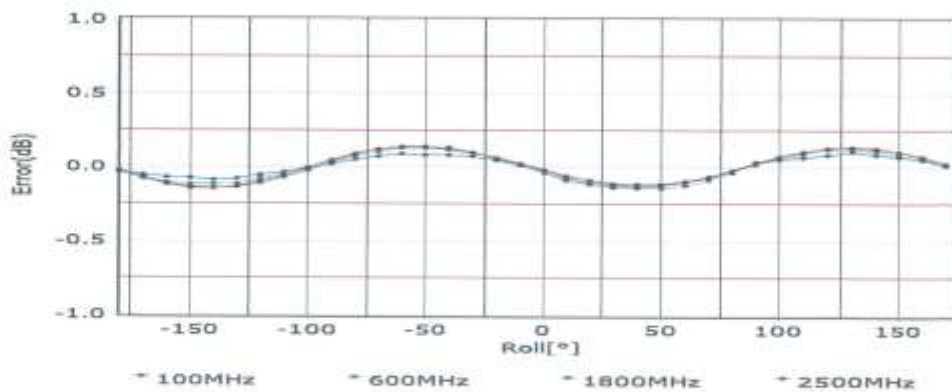
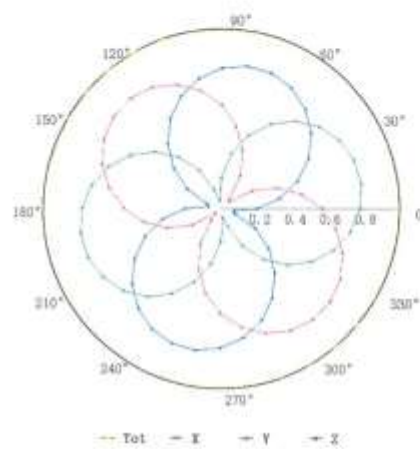
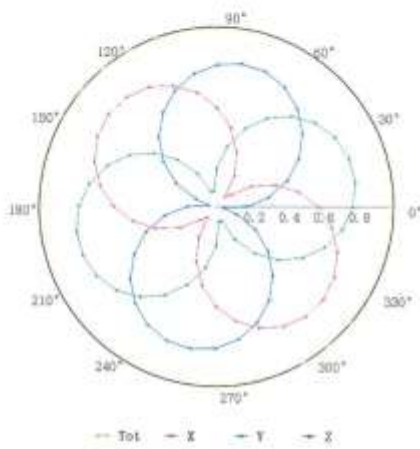

Uncertainty of Axial Isotropy Assessment: $\pm 1.2\%$ ($k=2$)



Add: No.51 Xueyuan Road, Haidian District, Beijing, 100191, China
 Tel: +86-10-62304633-2512 Fax: +86-10-62304633-2504
 E-mail: cntl@chinattl.com [Http://www.chinattl.cn](http://www.chinattl.cn)

Dynamic Range f(SAR_{head}) (TEM cell, f = 900 MHz)

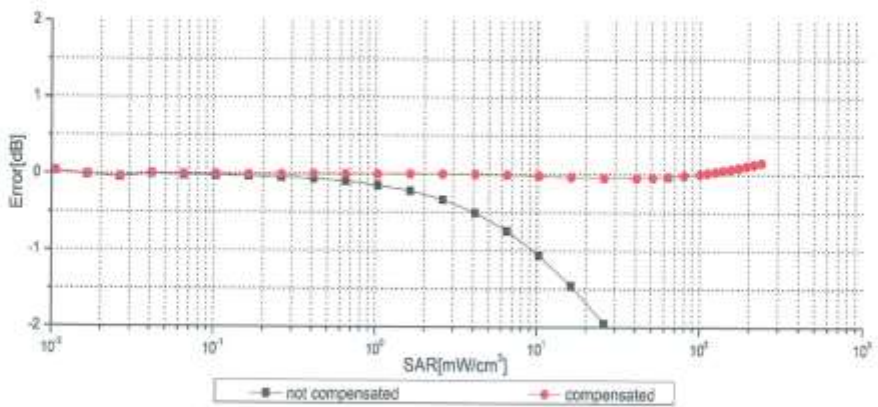
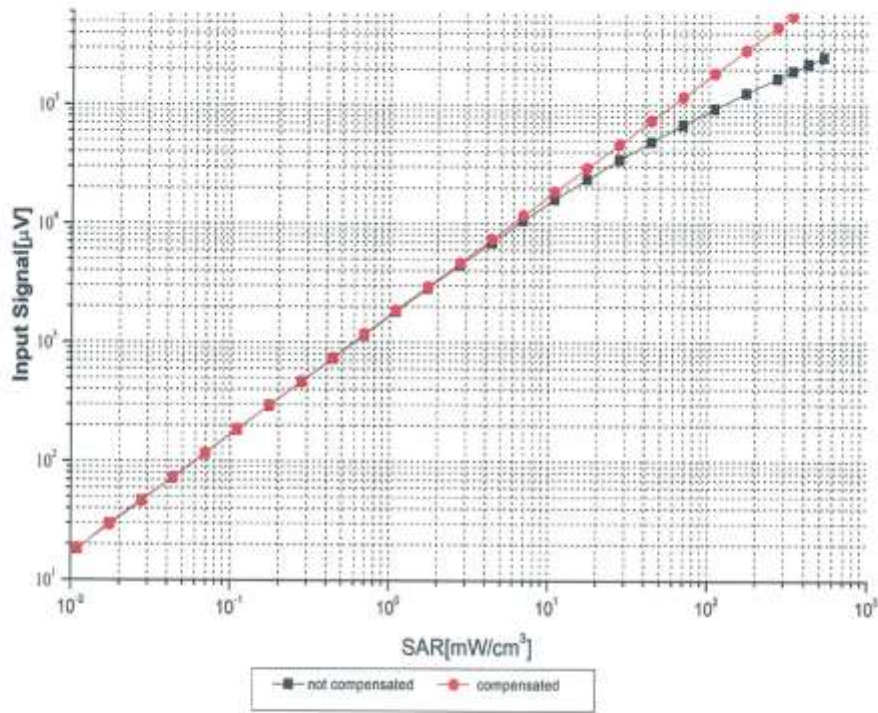

Uncertainty of Linearity Assessment: ±0.9% (k=2)



Add: No.51 Xueyuan Road, Haidian District, Beijing, 100191, China
Tel: +86-10-62304633-2512 Fax: +86-10-62304633-2504
E-mail: cttl@chinattl.com <http://www.chinattl.cn>

Conversion Factor Assessment

f=750 MHz,WGLS R9(H_convF)

f=1810 MHz,WGLS R22(H_convF)

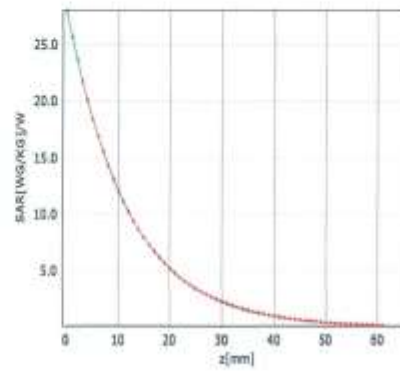
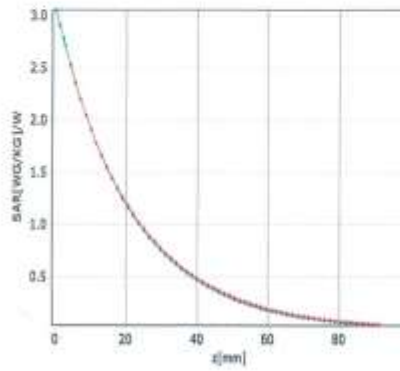

* analytical * measured

* analytical * measured

Deviation from Isotropy in Liquid

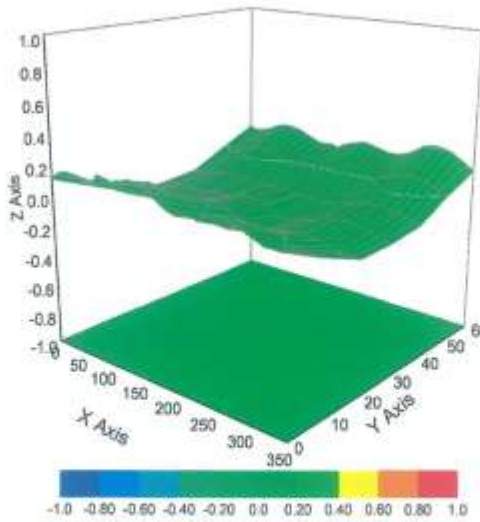

Uncertainty of Spherical Isotropy Assessment: $\pm 3.2\%$ ($k=2$)



Add: No.51 Xueyuan Road, Haidian District, Beijing, 100191, China
Tel: +86-10-62304633-2512 Fax: +86-10-62304633-2504
E-mail: ttl@chinattl.com [Http://www.chinattl.cn](http://www.chinattl.cn)

DASY/EASY – Parameters of Probe: EX3DV4 – SN:3710

Other Probe Parameters

Sensor Arrangement	Triangular
Connector Angle (°)	81.2
Mechanical Surface Detection Mode	enabled
Optical Surface Detection Mode	disable
Probe Overall Length	337mm
Probe Body Diameter	10mm
Tip Length	10mm
Tip Diameter	2.5mm
Probe Tip to Sensor X Calibration Point	1mm
Probe Tip to Sensor Y Calibration Point	1mm
Probe Tip to Sensor Z Calibration Point	1mm
Recommended Measurement Distance from Surface	1.4mm

Appendix D. Dipole Calibration Data

In Collaboration with

CALIBRATION LABORATORY

中国认可
国际互认
校准
CALIBRATION
CNAS L0570

Add: No.51 Xueyuan Road, Haidian District, Beijing, 100191, China
 Tel: +86-10-62304633-2079 Fax: +86-10-62304633-2504
 E-mail: ctlt@chinattl.com http://www.chinattl.cn

Client **Dekra-CN**
Certificate No: **Z19-60093**

CALIBRATION CERTIFICATE

Object: **D2450V2 - SN: 839**

Calibration Procedure(s): **FF-Z11-003-01**
 Calibration Procedures for dipole validation kits

Calibration date: **March 25, 2019**

This calibration Certificate documents the traceability to national standards, which realize the physical units of measurements(SI). The measurements and the uncertainties with confidence probability are given on the following pages and are part of the certificate.

All calibrations have been conducted in the closed laboratory facility: environment temperature(22±3)℃ and humidity<70%.

Calibration Equipment used (M&TE critical for calibration)

Primary Standards	ID #	Cal Date(Calibrated by, Certificate No.)	Scheduled Calibration
Power Meter NRP2	106277	20-Aug-18 (CTTL, No.J18X06862)	Aug-19
Power sensor NRP8S	104291	20-Aug-18 (CTTL, No.J18X06862)	Aug-19
Reference Probe EX3DV4	SN 3617	31-Jan-19(SPEAG,No.EX3-3617_Jan19)	Jan-20
DAE4	SN 1331	06-Feb-19(SPEAG,No.DAE4-1331_Feb19)	Feb-20
Secondary Standards	ID #	Cal Date(Calibrated by, Certificate No.)	Scheduled Calibration
Signal Generator E4438C	MY49071430	23-Jan-19 (CTTL, No.J19X00336)	Jan-20
NetworkAnalyzer E5071C	MY46110673	24-Jan-19 (CTTL, No.J19X00547)	Jan-20

	Name	Function	Signature
Calibrated by:	Zhao Jing	SAR Test Engineer	
Reviewed by:	Lin Hao	SAR Test Engineer	
Approved by:	Qi Dianyuan	SAR Project Leader	

Issued: March 28, 2019

This calibration certificate shall not be reproduced except in full without written approval of the laboratory.



In Collaboration with
s p e a g
CALIBRATION LABORATORY

Add: No.51 Xueyuan Road, Haidian District, Beijing, 100191, China
Tel: +86-10-62304633-2079 Fax: +86-10-62304633-2504
E-mail: cntl@chinattl.com http://www.chinattl.cn

Glossary:

TSL	tissue simulating liquid
ConvF	sensitivity in TSL / NORMx,y,z
N/A	not applicable or not measured

Calibration is Performed According to the Following Standards:

- IEEE Std 1528-2013, "IEEE Recommended Practice for Determining the Peak Spatial-Averaged Specific Absorption Rate (SAR) in the Human Head from Wireless Communications Devices: Measurement Techniques", June 2013
- IEC 62209-1, "Measurement procedure for assessment of specific absorption rate of human exposure to radio frequency fields from hand-held and body-mounted wireless communication devices- Part 1: Device used next to the ear (Frequency range of 300MHz to 6GHz)", July 2016
- IEC 62209-2, "Procedure to measure the Specific Absorption Rate (SAR) For wireless communication devices used in close proximity to the human body (frequency range of 30MHz to 6GHz)", March 2010
- KDB865664, SAR Measurement Requirements for 100 MHz to 6 GHz

Additional Documentation:

- DASY4/5 System Handbook

Methods Applied and Interpretation of Parameters:

- Measurement Conditions:* Further details are available from the Validation Report at the end of the certificate. All figures stated in the certificate are valid at the frequency indicated.
- Antenna Parameters with TSL:* The dipole is mounted with the spacer to position its feed point exactly below the center marking of the flat phantom section, with the arms oriented parallel to the body axis.
- Feed Point Impedance and Return Loss:* These parameters are measured with the dipole positioned under the liquid filled phantom. The impedance stated is transformed from the measurement at the SMA connector to the feed point. The Return Loss ensures low reflected power. No uncertainty required.
- Electrical Delay:* One-way delay between the SMA connector and the antenna feed point. No uncertainty required.
- SAR measured:* SAR measured at the stated antenna input power.
- SAR normalized:* SAR as measured, normalized to an input power of 1 W at the antenna connector.
- SAR for nominal TSL parameters:* The measured TSL parameters are used to calculate the nominal SAR result.

The reported uncertainty of measurement is stated as the standard uncertainty of Measurement multiplied by the coverage factor $k=2$, which for a normal distribution Corresponds to a coverage probability of approximately 95%.



In Collaboration with
s p e a g
CALIBRATION LABORATORY

Add: No.51 Xueyuan Road, Haidian District, Beijing, 100191, China
Tel: +86-10-62304633-2079 Fax: +86-10-62304633-2504
E-mail: ctt@chinattl.com http://www.chinattl.cn

Measurement Conditions

DASY system configuration, as far as not given on page 1.

DASY Version	DASY52	52.10.2.1495
Extrapolation	Advanced Extrapolation	
Phantom	Triple Flat Phantom 5.1C	
Distance Dipole Center - TSL	10 mm	with Spacer
Zoom Scan Resolution	dx, dy, dz = 5 mm	
Frequency	2450 MHz ± 1 MHz	

Head TSL parameters

The following parameters and calculations were applied:

	Temperature	Permittivity	Conductivity
Nominal Head TSL parameters	22.0 °C	39.2	1.80 mho/m
Measured Head TSL parameters	(22.0 ± 0.2) °C	39.6 ± 6 %	1.84 mho/m ± 6 %
Head TSL temperature change during test	<1.0 °C	---	---

SAR result with Head TSL

SAR averaged over 1 cm ³ (1 g) of Head TSL	Condition	
SAR measured	250 mW input power	12.9 W/kg
SAR for nominal Head TSL parameters	normalized to 1W	51.2 W/kg ± 18.8 % (k=2)
SAR averaged over 10 cm ³ (10 g) of Head TSL	Condition	
SAR measured	250 mW input power	5.92 W/kg
SAR for nominal Head TSL parameters	normalized to 1W	23.6 W/kg ± 18.7 % (k=2)

Body TSL parameters

The following parameters and calculations were applied:

	Temperature	Permittivity	Conductivity
Nominal Body TSL parameters	22.0 °C	52.7	1.95 mho/m
Measured Body TSL parameters	(22.0 ± 0.2) °C	53.8 ± 6 %	2.00 mho/m ± 6 %
Body TSL temperature change during test	<1.0 °C	---	---

SAR result with Body TSL

SAR averaged over 1 cm ³ (1 g) of Body TSL	Condition	
SAR measured	250 mW input power	12.8 W/kg
SAR for nominal Body TSL parameters	normalized to 1W	50.8 W/kg ± 18.8 % (k=2)
SAR averaged over 10 cm ³ (10 g) of Body TSL	Condition	
SAR measured	250 mW input power	5.89 W/kg
SAR for nominal Body TSL parameters	normalized to 1W	23.5 W/kg ± 18.7 % (k=2)



In Collaboration with
s p e a g
 CALIBRATION LABORATORY

Add: No.51 Xueyuan Road, Haidian District, Beijing, 100191, China
 Tel: +86-10-62304633-2079 Fax: +86-10-62304633-2504
 E-mail: cttl@chinattl.com http://www.chinattl.cn

Appendix (Additional assessments outside the scope of CNAS L0570)

Antenna Parameters with Head TSL

Impedance, transformed to feed point	53.3Ω+ 4.84 jΩ
Return Loss	- 24.9dB

Antenna Parameters with Body TSL

Impedance, transformed to feed point	49.5Ω+ 8.02 jΩ
Return Loss	- 24.3dB

General Antenna Parameters and Design

Electrical Delay (one direction)	1.026 ns
----------------------------------	----------

After long term use with 100W radiated power, only a slight warming of the dipole near the feedpoint can be measured.

The dipole is made of standard semirigid coaxial cable. The center conductor of the feeding line is directly connected to the second arm of the dipole. The antenna is therefore short-circuited for DC-signals. On some of the dipoles, small end caps are added to the dipole arms in order to improve matching when loaded according to the position as explained in the "Measurement Conditions" paragraph. The SAR data are not affected by this change. The overall dipole length is still according to the Standard. No excessive force must be applied to the dipole arms, because they might bend or the soldered connections near the feedpoint may be damaged.

Additional EUT Data

Manufactured by	SPEAG
-----------------	-------



In Collaboration with
s p e a g
CALIBRATION LABORATORY

Add: No.51 Xueyuan Road, Haidian District, Beijing, 100191, China
Tel: +86-10-62304633-2079 Fax: +86-10-62304633-2504
E-mail: cttl@chinattl.com http://www.chinattl.cn

DASY5 Validation Report for Head TSL

Date: 03.25.2019

Test Laboratory: CTTL, Beijing, China

DUT: Dipole 2450 MHz; Type: D2450V2; Serial: D2450V2 - SN: 839

Communication System: UID 0, CW; Frequency: 2450 MHz; Duty Cycle: 1:1

Medium parameters used: $f = 2450$ MHz; $\sigma = 1.841$ S/m; $\epsilon_r = 39.63$; $\rho = 1000$ kg/m³

Phantom section: Right Section

DASY5 Configuration:

- Probe: EX3DV4 - SN3617; ConvF(7.62, 7.62, 7.62) @ 2450 MHz; Calibrated: 1/31/2019
- Sensor-Surface: 1.4mm (Mechanical Surface Detection)
- Electronics: DAE4 Sn1331; Calibrated: 2/6/2019
- Phantom: MFP_V5.1C ; Type: QD 000 P51CA; Serial: 1062
- Measurement SW: DASY52, Version 52.10 (2); SEMCAD X Version 14.6.12 (7450)

Dipole Calibration/Zoom Scan (7x7x7) (7x7x7)/Cube 0: Measurement grid: dx=5mm, dy=5mm, dz=5mm

Reference Value = 103.8 V/m; Power Drift = 0.06 dB

Peak SAR (extrapolated) = 27.6 W/kg

SAR(1 g) = 12.9 W/kg; SAR(10 g) = 5.92 W/kg

Maximum value of SAR (measured) = 22.0 W/kg

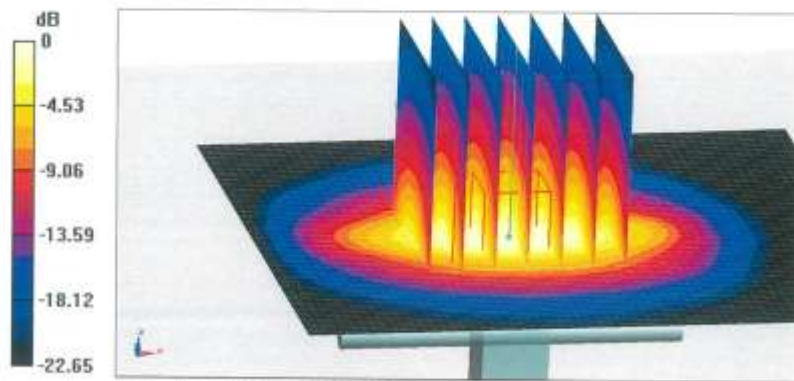



In Collaboration with
s p e a g
CALIBRATION LABORATORY

Add: No.51 Xueyuan Road, Haidian District, Beijing, 100191, China
Tel: +86-10-62304633-2079 Fax: +86-10-62304633-2504
E-mail: cntl@chinattl.com http://www.chinattl.cn

Impedance Measurement Plot for Head TSL

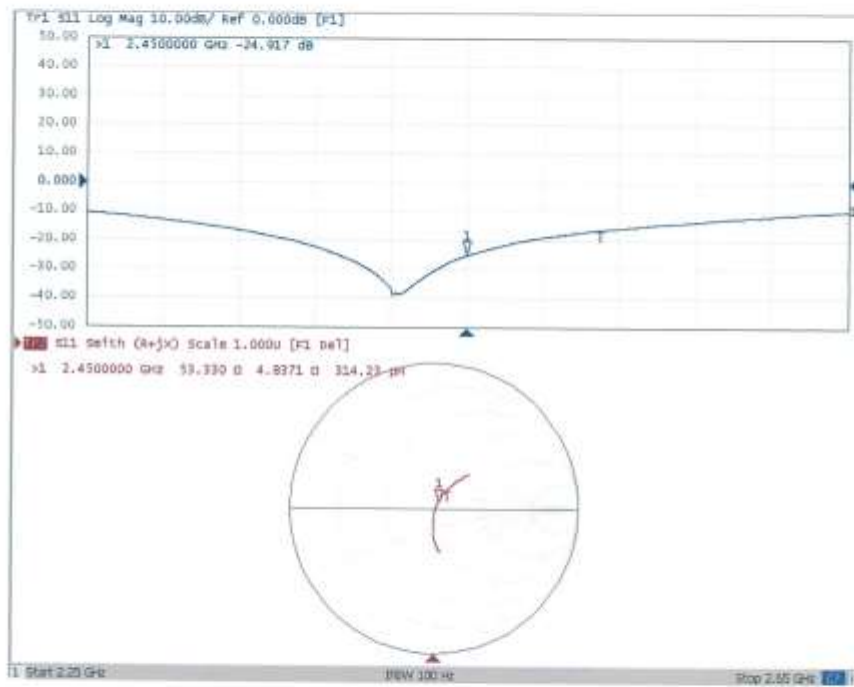



In Collaboration with
s p e a g
CALIBRATION LABORATORY

Add: No.51 Xueyuan Road, Haidian District, Beijing, 100191, China
Tel: +86-10-62304633-2079 Fax: +86-10-62304633-2504
E-mail: cttb@chinattl.com http://www.chinattl.cn

DASY5 Validation Report for Body TSL

Date: 03.25.2019

Test Laboratory: CTTL, Beijing, China

DUT: Dipole 2450 MHz; Type: D2450V2; Serial: D2450V2 - SN: 839

Communication System: UID 0, CW; Frequency: 2450 MHz; Duty Cycle: 1:1

Medium parameters used: $f = 2450$ MHz; $\sigma = 2.003$ S/m; $\epsilon_r = 53.78$; $\rho = 1000$ kg/m³

Phantom section: Center Section

DASY5 Configuration:

- Probe: EX3DV4 - SN3617; ConvF(7.79, 7.79, 7.79) @ 2450 MHz; Calibrated: 1/31/2019
- Sensor-Surface: 1.4mm (Mechanical Surface Detection)
- Electronics: DAE4 Sn1331; Calibrated: 2/6/2019
- Phantom: MFP_V5.1C ; Type: QD 000 P51CA; Serial: 1062
- Measurement SW: DASY52, Version 52.10 (2); SEMCAD X Version 14.6.12 (7450)

Dipole Calibration/Zoom Scan (7x7x7) (7x7x7)/Cube 0: Measurement grid: dx=5mm, dy=5mm, dz=5mm

Reference Value = 94.90 V/m; Power Drift = 0.02 dB

Peak SAR (extrapolated) = 27.0 W/kg

SAR(1 g) = 12.8 W/kg; SAR(10 g) = 5.89 W/kg

Maximum value of SAR (measured) = 21.4 W/kg

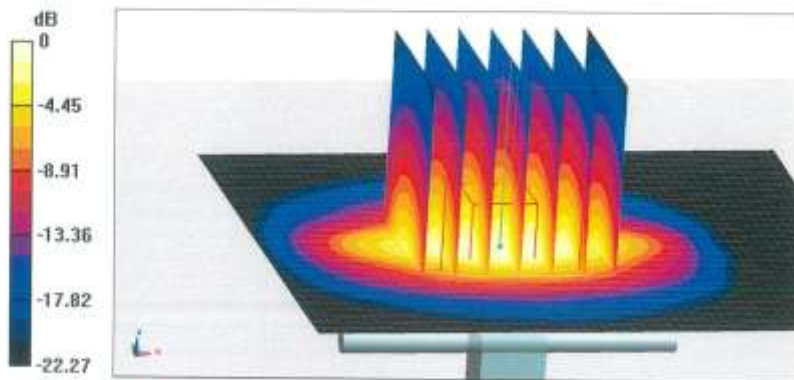



Add: No.51 Xueyuan Road, Haidian District, Beijing, 100191, China
Tel: +86-10-62304633-2079 Fax: +86-10-62304633-2504
E-mail: cntl@chinattl.com http://www.chinattl.cn

Impedance Measurement Plot for Body TSL

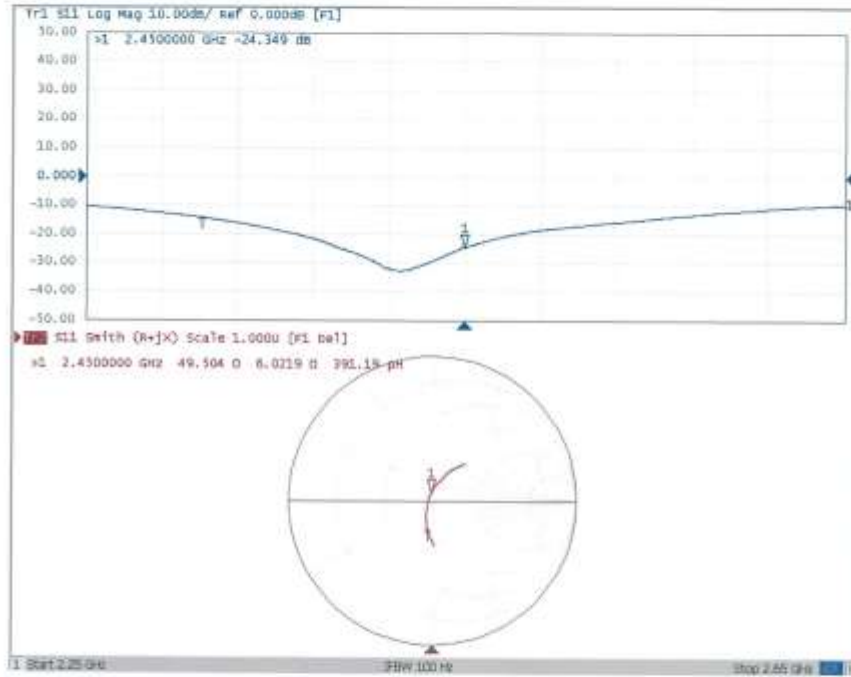



In Collaboration with
s p e a g
CALIBRATION LABORATORY

Add: No.51 Xueyuan Road, Haidian District, Beijing, 100191, China
Tel: +86-10-62304633-2512 Fax: +86-10-62304633-2504
E-mail: cttl@chinattl.com http://www.chinattl.cn



中国认可
国际互认
校准
CALIBRATION
CNAS L0570

Client **Dekra-CN**

Certificate No: **Z19-60096**

CALIBRATION CERTIFICATE

Object: **D5GHzV2 - SN: 1078**

Calibration Procedure(s): **FF-Z11-003-01**
Calibration Procedures for dipole validation kits

Calibration date: **March 22, 2019**

This calibration Certificate documents the traceability to national standards, which realize the physical units of measurements(SI). The measurements and the uncertainties with confidence probability are given on the following pages and are part of the certificate.

All calibrations have been conducted in the closed laboratory facility: environment temperature(22±3)°C and humidity<70%.

Calibration Equipment used (M&TE critical for calibration)

Primary Standards	ID #	Cal Date(Calibrated by, Certificate No.)	Scheduled Calibration
Power Meter NRP2	106277	20-Aug-18 (CTTL, No.J18X06862)	Aug-19
Power sensor NRP8S	104291	20-Aug-18 (CTTL, No.J18X06862)	Aug-19
ReferenceProbe EX3DV4 DAE4	SN 7514	27-Aug-18(SPEAG,No.EX3-7514_Aug18/2)	Aug-19
	SN 1331	06-Feb-19(SPEAG,No.DAE4-1331_Feb19)	Feb-20
Secondary Standards	ID #	Cal Date(Calibrated by, Certificate No.)	Scheduled Calibration
Signal Generator E4438C	MY49071430	23-Jan-19 (CTTL, No.J19X00336)	Jan-20
NetworkAnalyzerE5071C	MY46110673	24-Jan-19 (CTTL, No.J19X00547)	Jan-20

	Name	Function	Signature
Calibrated by:	Zhao Jing	SAR Test Engineer	
Reviewed by:	Lin Hao	SAR Test Engineer	
Approved by:	Qi Dianyuan	SAR Project Leader	

Issued: March 26, 2019

This calibration certificate shall not be reproduced except in full without written approval of the laboratory.



Add: No.51 Xueyuan Road, Haidian District, Beijing, 100191, China
Tel: +86-10-62304633-2512 Fax: +86-10-62304633-2504
E-mail: entl@chinattl.com <http://www.chinattl.cn>

Glossary:

TSL	tissue simulating liquid
ConvF	sensitivity in TSL / NORM _{x,y,z}
N/A	not applicable or not measured

Calibration is Performed According to the Following Standards:

- a) IEEE Std 1528-2013, "IEEE Recommended Practice for Determining the Peak Spatial-Averaged Specific Absorption Rate (SAR) in the Human Head from Wireless Communications Devices: Measurement Techniques", June 2013
- b) IEC 62209-1, "Measurement procedure for assessment of specific absorption rate of human exposure to radio frequency fields from hand-held and body-mounted wireless communication devices- Part 1: Device used next to the ear (Frequency range of 300MHz to 6GHz)", July 2016
- c) IEC 62209-2, "Procedure to measure the Specific Absorption Rate (SAR) For wireless communication devices used in close proximity to the human body (frequency range of 30MHz to 6GHz)", March 2010
- d) KDB865664, SAR Measurement Requirements for 100 MHz to 6 GHz

Additional Documentation:

- e) DASY4/5 System Handbook

Methods Applied and Interpretation of Parameters:

- *Measurement Conditions:* Further details are available from the Validation Report at the end of the certificate. All figures stated in the certificate are valid at the frequency indicated.
- *Antenna Parameters with TSL:* The dipole is mounted with the spacer to position its feed point exactly below the center marking of the flat phantom section, with the arms oriented parallel to the body axis.
- *Feed Point Impedance and Return Loss:* These parameters are measured with the dipole positioned under the liquid filled phantom. The impedance stated is transformed from the measurement at the SMA connector to the feed point. The Return Loss ensures low reflected power. No uncertainty required.
- *Electrical Delay:* One-way delay between the SMA connector and the antenna feed point. No uncertainty required.
- *SAR measured:* SAR measured at the stated antenna input power.
- *SAR normalized:* SAR as measured, normalized to an input power of 1 W at the antenna connector.
- *SAR for nominal TSL parameters:* The measured TSL parameters are used to calculate the nominal SAR result.

The reported uncertainty of measurement is stated as the standard uncertainty of Measurement multiplied by the coverage factor $k=2$, which for a normal distribution Corresponds to a coverage probability of approximately 95%.



Add: No.51 Xueyuan Road, Haidian District, Beijing, 100191, China
 Tel: +86-10-62304633-2512 Fax: +86-10-62304633-2504
 E-mail: ttl@chinattl.com http://www.chinattl.cn

Measurement Conditions

DASY system configuration, as far as not given on page 1.

DASY Version	DASY52	52.10.2.1495
Extrapolation	Advanced Extrapolation	
Phantom	Triple Flat Phantom 5.1C	
Distance Dipole Center - TSL	10 mm	with Spacer
Zoom Scan Resolution	dx, dy = 4 mm, dz = 1.4 mm	Graded Ratio = 1.4 (Z direction)
Frequency	5250 MHz ± 1 MHz 5600 MHz ± 1 MHz 5750 MHz ± 1 MHz	

Head TSL parameters at 5250 MHz

The following parameters and calculations were applied.

	Temperature	Permittivity	Conductivity
Nominal Head TSL parameters	22.0 °C	35.9	4.71 mho/m
Measured Head TSL parameters	(22.0 ± 0.2) °C	34.8 ± 6 %	4.65 mho/m ± 6 %
Head TSL temperature change during test	<1.0 °C	---	---

SAR result with Head TSL at 5250 MHz

SAR averaged over 1 cm ³ (1 g) of Head TSL	Condition	
SAR measured	100 mW input power	7.60 W/kg
SAR for nominal Head TSL parameters	normalized to 1W	75.5 W/kg ± 24.4 % (k=2)
SAR averaged over 10 cm ³ (10 g) of Head TSL	Condition	
SAR measured	100 mW input power	2.18 W/kg
SAR for nominal Head TSL parameters	normalized to 1W	21.6 W/kg ± 24.2 % (k=2)



Add: No.51 Xueyuan Road, Haidian District, Beijing, 100191, China
 Tel: +86-10-62304633-2512 Fax: +86-10-62304633-2504
 E-mail: ttl@chinattl.com http://www.chinattl.cn

Head TSL parameters at 5600 MHz

The following parameters and calculations were applied.

	Temperature	Permittivity	Conductivity
Nominal Head TSL parameters	22.0 °C	35.5	5.07 mho/m
Measured Head TSL parameters	(22.0 ± 0.2) °C	34.5 ± 6 %	5.06 mho/m ± 6 %
Head TSL temperature change during test	<1.0 °C	---	---

SAR result with Head TSL at 5600 MHz

SAR averaged over 1 cm ³ (1 g) of Head TSL	Condition	
SAR measured	100 mW input power	8.02 W/kg
SAR for nominal Head TSL parameters	normalized to 1W	79.7 W/kg ± 24.4 % (k=2)
SAR averaged over 10 cm ³ (10 g) of Head TSL	Condition	
SAR measured	100 mW input power	2.32 W/kg
SAR for nominal Head TSL parameters	normalized to 1W	23.0 W/kg ± 24.2 % (k=2)

Head TSL parameters at 5750 MHz

The following parameters and calculations were applied.

	Temperature	Permittivity	Conductivity
Nominal Head TSL parameters	22.0 °C	35.4	5.22 mho/m
Measured Head TSL parameters	(22.0 ± 0.2) °C	34.4 ± 6 %	5.24 mho/m ± 6 %
Head TSL temperature change during test	<1.0 °C	---	---

SAR result with Head TSL at 5750 MHz

SAR averaged over 1 cm ³ (1 g) of Head TSL	Condition	
SAR measured	100 mW input power	7.90 W/kg
SAR for nominal Head TSL parameters	normalized to 1W	78.6 W/kg ± 24.4 % (k=2)
SAR averaged over 10 cm ³ (10 g) of Head TSL	Condition	
SAR measured	100 mW input power	2.26 W/kg
SAR for nominal Head TSL parameters	normalized to 1W	22.4 W/kg ± 24.2 % (k=2)



Add: No.51 Xueyuan Road, Haidian District, Beijing, 100191, China
 Tel: +86-10-62304633-2512 Fax: +86-10-62304633-2504
 E-mail: cttl@chinattl.com http://www.chinattl.cn

Body TSL parameters at 5250 MHz

The following parameters and calculations were applied.

	Temperature	Permittivity	Conductivity
Nominal Body TSL parameters	22.0 °C	48.9	5.36 mho/m
Measured Body TSL parameters	(22.0 ± 0.2) °C	48.2 ± 6 %	5.45 mho/m ± 6 %
Body TSL temperature change during test	<1.0 °C	----	----

SAR result with Body TSL at 5250 MHz

SAR averaged over 1 cm ³ (1 g) of Body TSL	Condition	
SAR measured	100 mW input power	7.38 W/kg
SAR for nominal Body TSL parameters	normalized to 1W	73.6 W/kg ± 24.4 % (k=2)
SAR averaged over 10 cm ³ (10 g) of Body TSL	Condition	
SAR measured	100 mW input power	2.10 W/kg
SAR for nominal Body TSL parameters	normalized to 1W	20.9 W/kg ± 24.2 % (k=2)

Body TSL parameters at 5600 MHz

The following parameters and calculations were applied.

	Temperature	Permittivity	Conductivity
Nominal Body TSL parameters	22.0 °C	48.5	5.77 mho/m
Measured Body TSL parameters	(22.0 ± 0.2) °C	47.6 ± 6 %	5.91 mho/m ± 6 %
Body TSL temperature change during test	<1.0 °C	----	----

SAR result with Body TSL at 5600 MHz

SAR averaged over 1 cm ³ (1 g) of Body TSL	Condition	
SAR measured	100 mW input power	7.75 W/kg
SAR for nominal Body TSL parameters	normalized to 1W	77.3 W/kg ± 24.4 % (k=2)
SAR averaged over 10 cm ³ (10 g) of Body TSL	Condition	
SAR measured	100 mW input power	2.20 W/kg
SAR for nominal Body TSL parameters	normalized to 1W	21.9 W/kg ± 24.2 % (k=2)



Add: No.51 Xueyuan Road, Haidian District, Beijing, 100191, China
 Tel: +86-10-62304633-2512 Fax: +86-10-62304633-2504
 E-mail: cttl@chinattl.com http://www.chinattl.cn

Body TSL parameters at 5750 MHz

The following parameters and calculations were applied.

	Temperature	Permittivity	Conductivity
Nominal Body TSL parameters	22.0 °C	48.3	5.94 mho/m
Measured Body TSL parameters	(22.0 ± 0.2) °C	47.2 ± 6 %	6.11 mho/m ± 6 %
Body TSL temperature change during test	<1.0 °C	---	---

SAR result with Body TSL at 5750 MHz

SAR averaged over 1 cm ³ (1 g) of Body TSL	Condition	
SAR measured	100 mW input power	7.46 W/kg
SAR for nominal Body TSL parameters	normalized to 1W	74.4 W/kg ± 24.4 % (k=2)
SAR averaged over 10 cm ³ (10 g) of Body TSL	Condition	
SAR measured	100 mW input power	2.10 W/kg
SAR for nominal Body TSL parameters	normalized to 1W	20.9 W/kg ± 24.2 % (k=2)



Add: No.51 Xueyuan Road, Haidian District, Beijing, 100191, China
 Tel: +86-10-62304633-2512 Fax: +86-10-62304633-2504
 E-mail: ttl@chinattl.com http://www.chinattl.cn

Appendix (Additional assessments outside the scope of CNAS L0570)

Antenna Parameters with Head TSL at 5250 MHz

Impedance, transformed to feed point	52.1Ω - 4.23jΩ
Return Loss	- 26.7dB

Antenna Parameters with Head TSL at 5600 MHz

Impedance, transformed to feed point	59.2Ω - 3.00jΩ
Return Loss	- 21.1dB

Antenna Parameters with Head TSL at 5750 MHz

Impedance, transformed to feed point	51.9Ω + 2.48jΩ
Return Loss	- 30.3dB

Antenna Parameters with Body TSL at 5250 MHz

Impedance, transformed to feed point	50.7Ω - 3.30jΩ
Return Loss	- 29.5dB

Antenna Parameters with Body TSL at 5600 MHz

Impedance, transformed to feed point	58.8Ω - 1.83jΩ
Return Loss	- 21.7dB

Antenna Parameters with Body TSL at 5750 MHz

Impedance, transformed to feed point	53.0Ω + 4.58jΩ
Return Loss	- 25.5dB



In Collaboration with
s p e a g
CALIBRATION LABORATORY

Add: No.51 Xueyuan Road, Haidian District, Beijing, 100191, China
Tel: +86-10-62304633-2512 Fax: +86-10-62304633-2504
E-mail: cttl@chinattl.com <http://www.chinattl.cn>

General Antenna Parameters and Design

Electrical Delay (one direction)	1.062 ns
----------------------------------	----------

After long term use with 100W radiated power, only a slight warming of the dipole near the feedpoint can be measured.

The dipole is made of standard semirigid coaxial cable. The center conductor of the feeding line is directly connected to the second arm of the dipole. The antenna is therefore short-circuited for DC-signals. On some of the dipoles, small end caps are added to the dipole arms in order to improve matching when loaded according to the position as explained in the "Measurement Conditions" paragraph. The SAR data are not affected by this change. The overall dipole length is still according to the Standard. No excessive force must be applied to the dipole arms, because they might bend or the soldered connections near the feedpoint may be damaged.

Additional EUT Data

Manufactured by	SPEAG
-----------------	-------



Add: No.51 Xueyuan Road, Haidian District, Beijing, 100191, China
Tel: +86-10-62304633-2512 Fax: +86-10-62304633-2504
E-mail: ctfl@chinattl.com http://www.chinattl.cn

DASY5 Validation Report for Head TSL

Date: 03.20.2019

Test Laboratory: CTTL, Beijing, China

DUT: Dipole 5GHz; Type: D5GHzV2; Serial: D5GHzV2 - SN: 1078

Communication System: CW; Frequency: 5250 MHz, Frequency: 5600 MHz,
Frequency: 5750 MHz,

Medium parameters used: $f = 5250$ MHz; $\sigma = 4.652$ S/m; $\epsilon_r = 34.84$; $\rho = 1000$ kg/m³,
Medium parameters used: $f = 5600$ MHz; $\sigma = 5.063$ S/m; $\epsilon_r = 34.48$; $\rho = 1000$ kg/m³,
Medium parameters used: $f = 5750$ MHz; $\sigma = 5.236$ S/m; $\epsilon_r = 34.35$; $\rho = 1000$ kg/m³,

Phantom section: Center Section

DASY5 Configuration:

- Probe: EX3DV4 - SN7514; ConvF(5.02, 5.02, 5.02) @ 5250 MHz; Calibrated: 8/27/2018, ConvF(4.41, 4.41, 4.41) @ 5600 MHz; Calibrated: 8/27/2018, ConvF(4.47, 4.47, 4.47) @ 5750 MHz; Calibrated: 8/27/2018,
- Sensor-Surface: 1.4mm (Mechanical Surface Detection)
- Electronics: DAE4 Sn1331; Calibrated: 2/6/2019
- Phantom: MFP_V5.1C ; Type: QD 000 P51CA; Serial: 1062
- Measurement SW: DASY52, Version 52.10 (2); SEMCAD X Version 14.6.12 (7450)

Dipole Calibration /Pin=100mW, d=10mm, f=5250 MHz/Zoom Scan,

dist=1.4mm (8x8x7)/Cube 0: Measurement grid: dx=4mm, dy=4mm, dz=1.4mm

Reference Value = 67.01 V/m; Power Drift = -0.03 dB

Peak SAR (extrapolated) = 31.1 W/kg

SAR(1 g) = 7.6 W/kg; SAR(10 g) = 2.18 W/kg

Maximum value of SAR (measured) = 17.8 W/kg

Dipole Calibration /Pin=100mW, d=10mm, f=5600 MHz/Zoom Scan,

dist=1.4mm (8x8x7)/Cube 0: Measurement grid: dx=4mm, dy=4mm, dz=1.4mm

Reference Value = 68.43 V/m; Power Drift = 0.02 dB

Peak SAR (extrapolated) = 35.7 W/kg

SAR(1 g) = 8.02 W/kg; SAR(10 g) = 2.32 W/kg

Maximum value of SAR (measured) = 19.5 W/kg

Dipole Calibration /Pin=100mW, d=10mm, f=5750 MHz/Zoom Scan,

dist=1.4mm (8x8x7)/Cube 0: Measurement grid: dx=4mm, dy=4mm, dz=1.4mm

Reference Value = 63.10 V/m; Power Drift = 0.00 dB

Peak SAR (extrapolated) = 36.7 W/kg

SAR(1 g) = 7.9 W/kg; SAR(10 g) = 2.26 W/kg

Maximum value of SAR (measured) = 19.0 W/kg



Add: No.51 Xueyuan Road, Haidian District, Beijing, 100191, China
Tel: +86-10-62304633-2512 Fax: +86-10-62304633-2504
E-mail: cttl@chinattl.com http://www.chinattl.cn

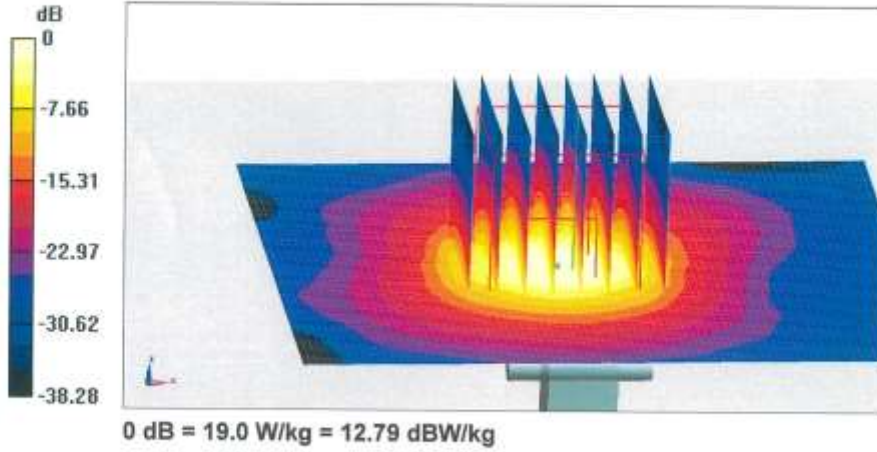



Add: No.51 Xueyun Road, Haidian District, Beijing, 100191, China
 Tel: +86-10-62304633-2512 Fax: +86-10-62304633-2504
 E-mail: cttl@chinattl.com http://www.chinattl.cn

Impedance Measurement Plot for Head TSL

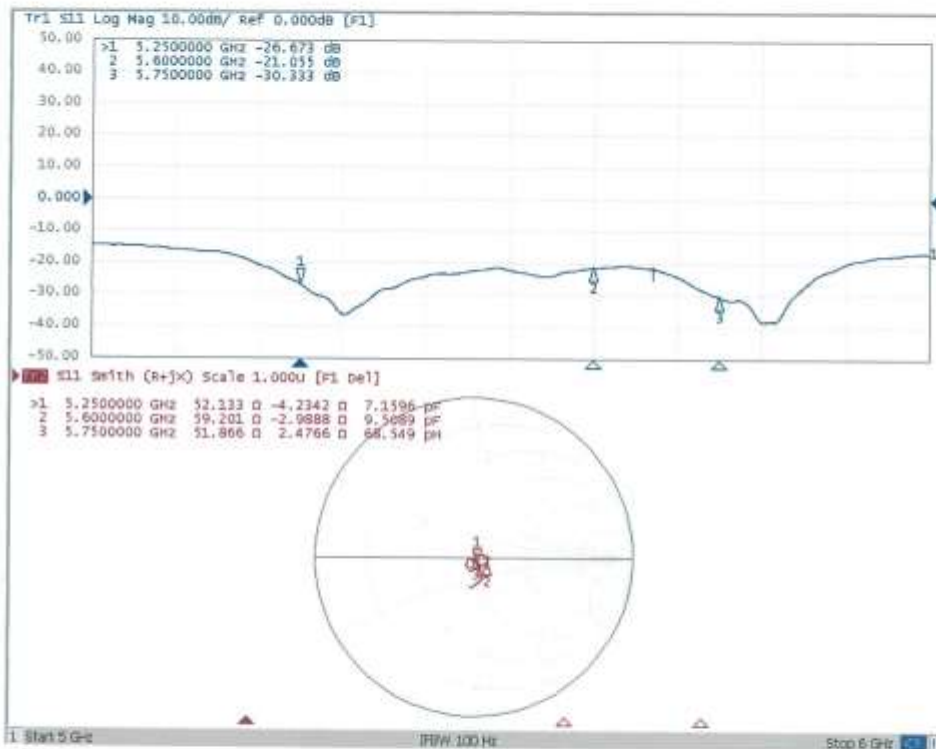



Add: No.51 Xueyuan Road, Haidian District, Beijing, 100191, China
Tel: +86-10-62304633-2512 Fax: +86-10-62304633-2504
E-mail: cttl@chinattl.com http://www.chinattl.cn

DASY5 Validation Report for Body TSL

Date: 03.21.2019

Test Laboratory: CTTL, Beijing, China

DUT: Dipole 5GHz; Type: D5GHzV2; Serial: D5GHzV2 - SN: 1078

Communication System: CW; Frequency: 5250 MHz, Frequency: 5600 MHz, Frequency: 5750 MHz,

Medium parameters used: $f = 5250$ MHz; $\sigma = 5.446$ S/m; $\epsilon_r = 48.2$; $\rho = 1000$ kg/m³,
Medium parameters used: $f = 5600$ MHz; $\sigma = 5.906$ S/m; $\epsilon_r = 47.56$; $\rho = 1000$ kg/m³,
Medium parameters used: $f = 5750$ MHz; $\sigma = 6.107$ S/m; $\epsilon_r = 47.22$; $\rho = 1000$ kg/m³,

Phantom section: Right Section

DASY5 Configuration:

- Probe: EX3DV4 - SN7514; ConvF(4.54, 4.54, 4.54) @ 5250 MHz; Calibrated: 8/27/2018, ConvF(4, 4, 4) @ 5600 MHz; Calibrated: 8/27/2018, ConvF(3.98, 3.98, 3.98) @ 5750 MHz; Calibrated: 8/27/2018,
- Sensor-Surface: 1.4mm (Mechanical Surface Detection)
- Electronics: DAE4 Sn1331; Calibrated: 2/6/2019
- Phantom: MFP_V5.1C ; Type: QD 000 P51CA; Serial: 1062
- Measurement SW: DASY52, Version 52.10 (2); SEMCAD X Version 14.6.12 (7450)

Dipole Calibration /Pin=100mW, d=10mm, f=5250 MHz/Zoom Scan, dist=1.4mm (8x8x7)/Cube 0: Measurement grid: dx=4mm, dy=4mm, dz=1.4mm
Reference Value = 59.53 V/m; Power Drift = 0.04 dB
Peak SAR (extrapolated) = 29.8 W/kg
SAR(1 g) = 7.38 W/kg; SAR(10 g) = 2.1 W/kg
Maximum value of SAR (measured) = 17.1 W/kg

Dipole Calibration /Pin=100mW, d=10mm, f=5600 MHz/Zoom Scan, dist=1.4mm (8x8x7)/Cube 0: Measurement grid: dx=4mm, dy=4mm, dz=1.4mm
Reference Value = 61.54 V/m; Power Drift = 0.03 dB
Peak SAR (extrapolated) = 34.1 W/kg
SAR(1 g) = 7.75 W/kg; SAR(10 g) = 2.2 W/kg
Maximum value of SAR (measured) = 18.9 W/kg

Dipole Calibration /Pin=100mW, d=10mm, f=5750 MHz/Zoom Scan, dist=1.4mm (8x8x7)/Cube 0: Measurement grid: dx=4mm, dy=4mm, dz=1.4mm
Reference Value = 60.01 V/m; Power Drift = 0.03 dB
Peak SAR (extrapolated) = 34.6 W/kg
SAR(1 g) = 7.46 W/kg; SAR(10 g) = 2.1 W/kg
Maximum value of SAR (measured) = 19.0 W/kg



Add: No.51 Xueyun Road, Haidian District, Beijing, 100191, China
Tel: +86-10-62304633-2512 Fax: +86-10-62304633-2504
E-mail: cttl@chinattl.com http://www.chinattl.cn

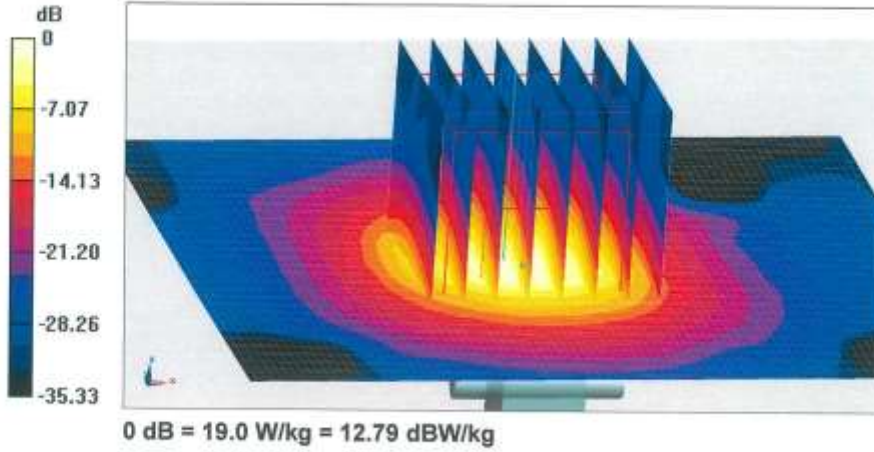



Add: No.51 Xueyuan Road, Haidian District, Beijing, 100191, China
Tel: +86-10-62304633-2512 Fax: +86-10-62304633-2504
E-mail: cttl@chinattl.com http://www.chinattl.cn

Impedance Measurement Plot for Body TSL

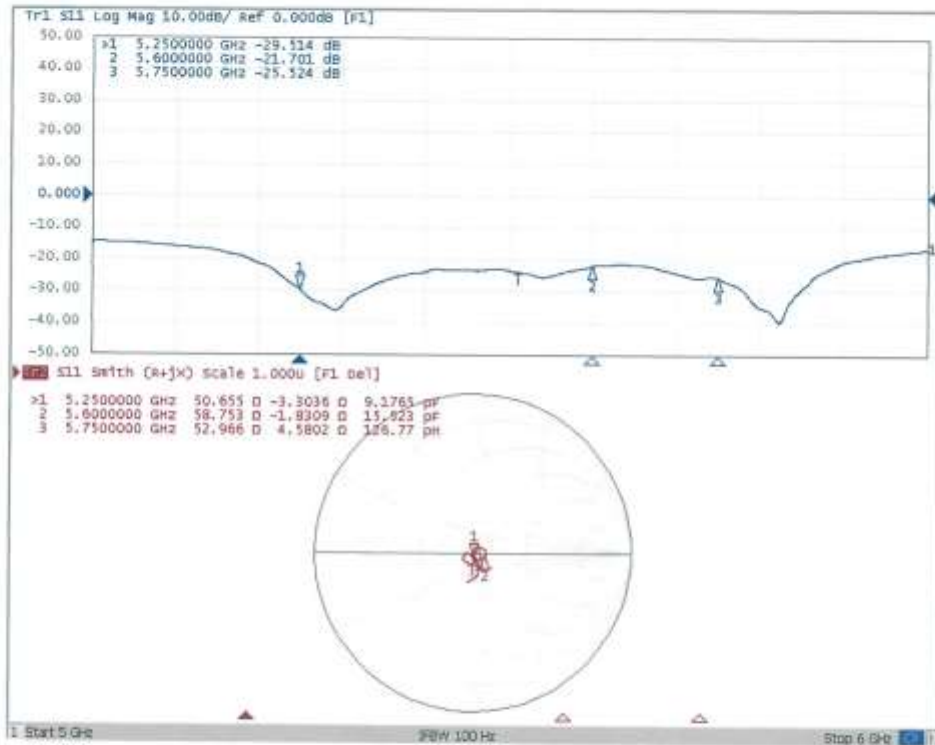

Appendix E. DAE Calibration Data



Client : **Auden** Certificate No: **Z19-60216**

CALIBRATION CERTIFICATE			
Object	DAE4 - SN: 915		
Calibration Procedure(s)	FF-Z11-002-01 Calibration Procedure for the Data Acquisition Electronics (DAEx)		
Calibration date:	June 13, 2019		
<p>This calibration Certificate documents the traceability to national standards, which realize the physical units of measurements(SI). The measurements and the uncertainties with confidence probability are given on the following pages and are part of the certificate.</p> <p>All calibrations have been conducted in the closed laboratory facility: environment temperature(22±3)℃ and humidity<70%.</p> <p>Calibration Equipment used (M&TE critical for calibration)</p>			
Primary Standards	ID #	Cal Date(Calibrated by, Certificate No.)	Scheduled Calibration
Process Calibrator 753	1971018	20-Jun-18 (CTTL, No.J18X05034)	Jun-19
Calibrated by:	Name	Function	Signature
	Yu Zongying	SAR Test Engineer	
Reviewed by:	Lin Hao	SAR Test Engineer	
Approved by:	Qi Dianyuan	SAR Project Leader	
			Issued: June 15, 2019
This calibration certificate shall not be reproduced except in full without written approval of the laboratory.			



Add: No.51 Xueyuan Road, Haidian District, Beijing, 100191, China
Tel: +86-10-62304633-2512 Fax: +86-10-62304633-2504
E-mail: cttl@chinattl.com Http://www.chinattl.cn

Glossary:

DAE data acquisition electronics
Connector angle information used in DASY system to align probe sensor X to the robot coordinate system.

Methods Applied and Interpretation of Parameters:

- *DC Voltage Measurement:* Calibration Factor assessed for use in DASY system by comparison with a calibrated instrument traceable to national standards. The figure given corresponds to the full scale range of the voltmeter in the respective range.
- *Connector angle:* The angle of the connector is assessed measuring the angle mechanically by a tool inserted. Uncertainty is not required.
- The report provide only calibration results for DAE, it does not contain other performance test results.



Add: No.51 Xueyuan Road, Haidian District, Beijing, 100191, China
Tel: +86-10-62304633-2512 Fax: +86-10-62304633-2504
E-mail: ttl@chinattl.com Http://www.chinattl.cn

DC Voltage Measurement

A/D - Converter Resolution nominal
High Range: 1LSB = 6.1μV, full range = -100...+300 mV
Low Range: 1LSB = 61nV, full range = -1...+3mV
DASY measurement parameters: Auto Zero Time: 3 sec; Measuring time: 3 sec

Calibration Factors	X	Y	Z
High Range	404.268 ± 0.15% (k=2)	404.397 ± 0.15% (k=2)	404.752 ± 0.15% (k=2)
Low Range	3.98191 ± 0.7% (k=2)	3.99822 ± 0.7% (k=2)	3.99012 ± 0.7% (k=2)

Connector Angle

Connector Angle to be used in DASY system	116° ± 1°
---	-----------