

## Annex D

Appendix to Test Report No.: 1-3959/17-01-02



### Testing Laboratory

**CTC advanced GmbH**

Untertürkheimer Straße 6 – 10

66117 Saarbrücken/Germany

Phone: + 49 681 5 98 - 0

Fax: + 49 681 5 98 - 9075

Internet: <http://www.ctcadvanced.com>

e-mail: [mail@ctcadvanced.com](mailto:mail@ctcadvanced.com)

**Accredited Test Laboratory:**

The testing laboratory (area of testing) is accredited according to DIN EN ISO/IEC 17025 (2005) by the Deutsche Akkreditierungsstelle GmbH (DAkkS)

The accreditation is valid for the scope of testing procedures as stated in the accreditation certificate with the registration number: D-PL-12076-01-01

**Appendix with Calibration data, Phantom certificate and system check information**

**1 Table of contents**

1 Table of contents ..... 2

2 Calibration report “Probe ES3DV3” ..... 3

3 Calibration report “Probe EX3DV4” ..... 14

4 Calibration report “2450 MHz System validation dipole” ..... 25

5 Calibration report “5GHz System check dipole” ..... 33

6 Calibration certificate of Data Acquisition Unit (DAE) ..... 52

7 Calibration certificate of Data Acquisition Unit (DAE) ..... 53

8 Certificate of “SAM Twin Phantom V4.0/V4.0C” ..... 54

9 Application Note System Performance Check ..... 55

    9.1 Purpose of system performance check ..... 55

    9.2 System Performance check procedure ..... 55

    9.3 Uncertainty Budget ..... 56

    9.4 Power set-up for validation ..... 60

    9.5 Laboratory reflection ..... 61

    9.6 Additional system checks ..... 61

**2 Calibration report "Probe ES3DV3"**

**Calibration Laboratory of  
Schmid & Partner  
Engineering AG**  
Zeughausstrasse 43, 8004 Zurich, Switzerland



**S** Schweizerischer Kalibrierdienst  
**C** Service suisse d'étalonnage  
**S** Servizio svizzero di taratura  
**S** Swiss Calibration Service

Accredited by the Swiss Accreditation Service (SAS)  
The Swiss Accreditation Service is one of the signatories to the EA  
Multilateral Agreement for the recognition of calibration certificates

Accreditation No.: **SCS 0108**

Client **CTC advanced GmbH**

Certificate No: **ES-3320\_Jan17**

**CALIBRATION CERTIFICATE**

Object: **ES3DV3 - SN:3320**

Calibration procedure(s): **QA CAL-01.v9, QA CAL-12.v9, QA CAL-23.v5, QA CAL-25.v6  
Calibration procedure for dosimetric E-field probes**

Calibration date: **January 12, 2017**

This calibration certificate documents the traceability to national standards, which realize the physical units of measurements (SI).  
The measurements and the uncertainties with confidence probability are given on the following pages and are part of the certificate.

All calibrations have been conducted in the closed laboratory facility: environment temperature (22 ± 3)°C and humidity < 70%.

Calibration Equipment used (M&TE critical for calibration)

| Primary Standards          | ID               | Cal Date (Certificate No.)        | Scheduled Calibration  |
|----------------------------|------------------|-----------------------------------|------------------------|
| Power meter NRP            | SN: 104778       | 06-Apr-16 (No. 217-02288/02289)   | Apr-17                 |
| Power sensor NRP-Z91       | SN: 103244       | 06-Apr-16 (No. 217-02288)         | Apr-17                 |
| Power sensor NRP-Z91       | SN: 103245       | 06-Apr-16 (No. 217-02289)         | Apr-17                 |
| Reference 20 dB Attenuator | SN: S5277 (20x)  | 05-Apr-16 (No. 217-02293)         | Apr-17                 |
| Reference Probe ES3DV2     | SN: 3013         | 31-Dec-16 (No. ES3-3013_Dec16)    | Dec-17                 |
| DAE4                       | SN: 660          | 7-Dec-16 (No. DAE4-660_Dec16)     | Dec-17                 |
| Secondary Standards        | ID               | Check Date (in house)             | Scheduled Check        |
| Power meter E4419B         | SN: GB41293874   | 06-Apr-16 (in house check Jun-16) | In house check: Jun-18 |
| Power sensor E4412A        | SN: MY41498087   | 06-Apr-16 (in house check Jun-16) | In house check: Jun-18 |
| Power sensor E4412A        | SN: 000110210    | 06-Apr-16 (in house check Jun-16) | In house check: Jun-18 |
| RF generator HP 8648C      | SN: US3642U01700 | 04-Aug-99 (in house check Jun-16) | In house check: Jun-18 |
| Network Analyzer HP 8753E  | SN: US37390585   | 18-Oct-01 (in house check Oct-16) | In house check: Oct-17 |

|                | Name            | Function              | Signature |
|----------------|-----------------|-----------------------|-----------|
| Calibrated by: | Claudio Leubler | Laboratory Technician |           |
| Approved by:   | Katja Pokovic   | Technical Manager     |           |

Issued: January 16, 2017

This calibration certificate shall not be reproduced except in full without written approval of the laboratory.

Calibration Laboratory of  
 Schmid & Partner  
 Engineering AG  
 Zeughausstrasse 43, 8004 Zurich, Switzerland



S Schweizerischer Kalibrierdienst  
 C Service suisse d'étalonnage  
 S Servizio svizzero di taratura  
 S Swiss Calibration Service

Accredited by the Swiss Accreditation Service (SAS)

Accreditation No.: **SCS 0108**

The Swiss Accreditation Service is one of the signatories to the EA  
 Multilateral Agreement for the recognition of calibration certificates

#### Glossary:

|                          |  |
|--------------------------|--|
| TSL                      | tissue simulating liquid   |
| NORM <sub>x,y,z</sub>    | sensitivity in free space  |
| ConvF                    | sensitivity in TSL / NORM <sub>x,y,z</sub>   |
| DCP                      | diode compression point  |
| CF                       | crest factor (1/duty_cycle) of the RF signal   |
| A, B, C, D               | modulation dependent linearization parameters  |
| Polarization $\varphi$   | $\varphi$ rotation around probe axis   |
| Polarization $\vartheta$ | $\vartheta$ rotation around an axis that is in the plane normal to probe axis (at measurement center), i.e., $\vartheta = 0$ is normal to probe axis |
| Connector Angle          | information used in DASY system to align probe sensor X to the robot coordinate system   |

#### Calibration is Performed According to the Following Standards:

- IEEE Std 1528-2013, "IEEE Recommended Practice for Determining the Peak Spatial-Averaged Specific Absorption Rate (SAR) in the Human Head from Wireless Communications Devices: Measurement Techniques", June 2013
- IEC 62209-1, "Procedure to measure the Specific Absorption Rate (SAR) for hand-held devices used in close proximity to the ear (frequency range of 300 MHz to 3 GHz)", February 2005
- IEC 62209-2, "Procedure to determine the Specific Absorption Rate (SAR) for wireless communication devices used in close proximity to the human body (frequency range of 30 MHz to 6 GHz)", March 2010
- KDB 865664, "SAR Measurement Requirements for 100 MHz to 6 GHz"

#### Methods Applied and Interpretation of Parameters:

- NORM<sub>x,y,z</sub>**: Assessed for E-field polarization  $\vartheta = 0$  ( $f \leq 900$  MHz in TEM-cell;  $f > 1800$  MHz: R22 waveguide). NORM<sub>x,y,z</sub> are only intermediate values, i.e., the uncertainties of NORM<sub>x,y,z</sub> does not affect the E<sup>2</sup>-field uncertainty inside TSL (see below ConvF).
- NORM(f)<sub>x,y,z</sub> = NORM<sub>x,y,z</sub> \* frequency\_response** (see Frequency Response Chart). This linearization is implemented in DASY4 software versions later than 4.2. The uncertainty of the frequency response is included in the stated uncertainty of ConvF.
- DCP<sub>x,y,z</sub>**: DCP are numerical linearization parameters assessed based on the data of power sweep with CW signal (no uncertainty required). DCP does not depend on frequency nor media.
- PAR**: PAR is the Peak to Average Ratio that is not calibrated but determined based on the signal characteristics
- A<sub>x,y,z</sub>; B<sub>x,y,z</sub>; C<sub>x,y,z</sub>; D<sub>x,y,z</sub>; VR<sub>x,y,z</sub>**: A, B, C, D are numerical linearization parameters assessed based on the data of power sweep for specific modulation signal. The parameters do not depend on frequency nor media. VR is the maximum calibration range expressed in RMS voltage across the diode.
- ConvF and Boundary Effect Parameters**: Assessed in flat phantom using E-field (or Temperature Transfer Standard for  $f \leq 800$  MHz) and inside waveguide using analytical field distributions based on power measurements for  $f > 800$  MHz. The same setups are used for assessment of the parameters applied for boundary compensation (alpha, depth) of which typical uncertainty values are given. These parameters are used in DASY4 software to improve probe accuracy close to the boundary. The sensitivity in TSL corresponds to NORM<sub>x,y,z</sub> \* ConvF whereby the uncertainty corresponds to that given for ConvF. A frequency dependent ConvF is used in DASY version 4.4 and higher which allows extending the validity from  $\pm 50$  MHz to  $\pm 100$  MHz.
- Spherical isotropy (3D deviation from isotropy)**: in a field of low gradients realized using a flat phantom exposed by a patch antenna.
- Sensor Offset**: The sensor offset corresponds to the offset of virtual measurement center from the probe tip (on probe axis). No tolerance required.
- Connector Angle**: The angle is assessed using the information gained by determining the NORM<sub>x</sub> (no uncertainty required).

ES3DV3 – SN:3320

January 12, 2017

# Probe ES3DV3

## SN:3320

Manufactured: January 10, 2012

Calibrated: January 12, 2017

Calibrated for DASY/EASY Systems

(Note: non-compatible with DASY2 system!)

ES3DV3- SN:3320

January 12, 2017

## DASY/EASY - Parameters of Probe: ES3DV3 - SN:3320

### Basic Calibration Parameters

|   | Sensor X | Sensor Y | Sensor Z | Unc (k=2) |
|---|----------|----------|----------|-----------|
| Norm ( $\mu\text{V}/(\text{V}/\text{m})^2$ ) <sup>A</sup> | 1.22     | 1.04     | 1.13     | ± 10.1 %  |
| DCP (mV) <sup>B</sup>                                     | 102.6    | 104.7    | 102.6    |           |

### Modulation Calibration Parameters

| UID | Communication System Name |   | A<br>dB | B<br>dB $\sqrt{\mu\text{V}}$ | C   | D<br>dB | VR<br>mV | Unc <sup>E</sup><br>(k=2) |
|-----|---------------------------|---|---------|------------------------------|-----|---------|----------|---------------------------|
| 0   | CW                        | X | 0.0     | 0.0                          | 1.0 | 0.00    | 178.5    | ±3.3 %                    |
|     |                           | Y | 0.0     | 0.0                          | 1.0 |         | 192.5    |                           |
|     |                           | Z | 0.0     | 0.0                          | 1.0 |         | 192.0    |                           |

The reported uncertainty of measurement is stated as the standard uncertainty of measurement multiplied by the coverage factor k=2, which for a normal distribution corresponds to a coverage probability of approximately 95%.

<sup>A</sup> The uncertainties of Norm X,Y,Z do not affect the E<sup>2</sup>-field uncertainty inside TSL (see Pages 5 and 6).

<sup>B</sup> Numerical linearization parameter; uncertainty not required.

<sup>E</sup> Uncertainty is determined using the max. deviation from linear response applying rectangular distribution and is expressed for the square of the field value.



## DASY/EASY - Parameters of Probe: ES3DV3 - SN:3320

### Calibration Parameter Determined in Head Tissue Simulating Media

| f (MHz) <sup>C</sup> | Relative Permittivity <sup>F</sup> | Conductivity (S/m) <sup>F</sup> | ConvF X | ConvF Y | ConvF Z | Alpha <sup>G</sup> | Depth <sup>G</sup> (mm) | Unc (k=2) |
|----------------------|------------------------------------|---------------------------------|---------|---------|---------|--------------------|-------------------------|-----------|
| 450                  | 43.5                               | 0.87                            | 7.11    | 7.11    | 7.11    | 0.19               | 1.20                    | ± 13.3 %  |
| 750                  | 41.9                               | 0.89                            | 6.78    | 6.78    | 6.78    | 0.55               | 1.49                    | ± 12.0 %  |
| 835                  | 41.5                               | 0.90                            | 6.58    | 6.58    | 6.58    | 0.80               | 1.22                    | ± 12.0 %  |
| 900                  | 41.5                               | 0.97                            | 6.50    | 6.50    | 6.50    | 0.46               | 1.65                    | ± 12.0 %  |
| 1450                 | 40.5                               | 1.20                            | 5.89    | 5.89    | 5.89    | 0.80               | 1.11                    | ± 12.0 %  |
| 1640                 | 40.3                               | 1.29                            | 5.53    | 5.53    | 5.53    | 0.54               | 1.38                    | ± 12.0 %  |
| 1750                 | 40.1                               | 1.37                            | 5.41    | 5.41    | 5.41    | 0.80               | 1.18                    | ± 12.0 %  |
| 1900                 | 40.0                               | 1.40                            | 5.19    | 5.19    | 5.19    | 0.75               | 1.23                    | ± 12.0 %  |
| 2450                 | 39.2                               | 1.80                            | 4.67    | 4.67    | 4.67    | 0.70               | 1.39                    | ± 12.0 %  |

<sup>C</sup> Frequency validity above 300 MHz of ± 100 MHz only applies for DASY v4.4 and higher (see Page 2), else it is restricted to ± 50 MHz. The uncertainty is the RSS of the ConvF uncertainty at calibration frequency and the uncertainty for the indicated frequency band. Frequency validity below 300 MHz is ± 10, 25, 40, 50 and 70 MHz for ConvF assessments at 30, 64, 128, 150 and 220 MHz respectively. Above 5 GHz frequency validity can be extended to ± 110 MHz.

<sup>F</sup> At frequencies below 3 GHz, the validity of tissue parameters ( $\epsilon$  and  $\sigma$ ) can be relaxed to ± 10% if liquid compensation formula is applied to measured SAR values. At frequencies above 3 GHz, the validity of tissue parameters ( $\epsilon$  and  $\sigma$ ) is restricted to ± 5%. The uncertainty is the RSS of the ConvF uncertainty for indicated target tissue parameters.

<sup>G</sup> Alpha/Depth are determined during calibration. SPEAG warrants that the remaining deviation due to the boundary effect after compensation is always less than ± 1% for frequencies below 3 GHz and below ± 2% for frequencies between 3-6 GHz at any distance larger than half the probe tip diameter from the boundary.

ES3DV3- SN:3320

January 12, 2017

## DASY/EASY - Parameters of Probe: ES3DV3 - SN:3320

### Calibration Parameter Determined in Body Tissue Simulating Media

| f (MHz) <sup>C</sup> | Relative Permittivity <sup>F</sup> | Conductivity (S/m) <sup>F</sup> | ConvF X | ConvF Y | ConvF Z | Alpha <sup>G</sup> | Depth <sup>G</sup> (mm) | Unc (k=2) |
|----------------------|------------------------------------|---------------------------------|---------|---------|---------|--------------------|-------------------------|-----------|
| 450                  | 56.7                               | 0.94                            | 7.20    | 7.20    | 7.20    | 0.12               | 1.20                    | ± 13.3 %  |
| 750                  | 55.5                               | 0.96                            | 6.44    | 6.44    | 6.44    | 0.49               | 1.51                    | ± 12.0 %  |
| 835                  | 55.2                               | 0.97                            | 6.38    | 6.38    | 6.38    | 0.80               | 1.16                    | ± 12.0 %  |
| 900                  | 55.0                               | 1.05                            | 6.37    | 6.37    | 6.37    | 0.80               | 1.19                    | ± 12.0 %  |
| 1450                 | 54.0                               | 1.30                            | 5.57    | 5.57    | 5.57    | 0.80               | 1.10                    | ± 12.0 %  |
| 1640                 | 53.8                               | 1.40                            | 5.51    | 5.51    | 5.51    | 0.46               | 1.67                    | ± 12.0 %  |
| 1750                 | 53.4                               | 1.49                            | 5.07    | 5.07    | 5.07    | 0.47               | 1.75                    | ± 12.0 %  |
| 1900                 | 53.3                               | 1.52                            | 4.85    | 4.85    | 4.85    | 0.80               | 1.25                    | ± 12.0 %  |
| 2150                 | 53.1                               | 1.66                            | 4.85    | 4.85    | 4.85    | 0.65               | 1.48                    | ± 12.0 %  |
| 2450                 | 52.7                               | 1.95                            | 4.54    | 4.54    | 4.54    | 0.77               | 1.24                    | ± 12.0 %  |

<sup>C</sup> Frequency validity above 300 MHz of  $\pm 100$  MHz only applies for DASY v4.4 and higher (see Page 2), else it is restricted to  $\pm 50$  MHz. The uncertainty is the RSS of the ConvF uncertainty at calibration frequency and the uncertainty for the indicated frequency band. Frequency validity below 300 MHz is  $\pm 10$ , 25, 40, 50 and 70 MHz for ConvF assessments at 30, 64, 128, 150 and 220 MHz respectively. Above 5 GHz frequency validity can be extended to  $\pm 110$  MHz.

<sup>F</sup> At frequencies below 3 GHz, the validity of tissue parameters ( $\epsilon$  and  $\sigma$ ) can be relaxed to  $\pm 10\%$  if liquid compensation formula is applied to measured SAR values. At frequencies above 3 GHz, the validity of tissue parameters ( $\epsilon$  and  $\sigma$ ) is restricted to  $\pm 5\%$ . The uncertainty is the RSS of the ConvF uncertainty for indicated target tissue parameters.

<sup>G</sup> Alpha/Depth are determined during calibration. SPEAG warrants that the remaining deviation due to the boundary effect after compensation is always less than  $\pm 1\%$  for frequencies below 3 GHz and below  $\pm 2\%$  for frequencies between 3-6 GHz at any distance larger than half the probe tip diameter from the boundary.



ES3DV3- SN:3320

January 12, 2017

### Frequency Response of E-Field (TEM-Cell:ifi110 EXX, Waveguide: R22)

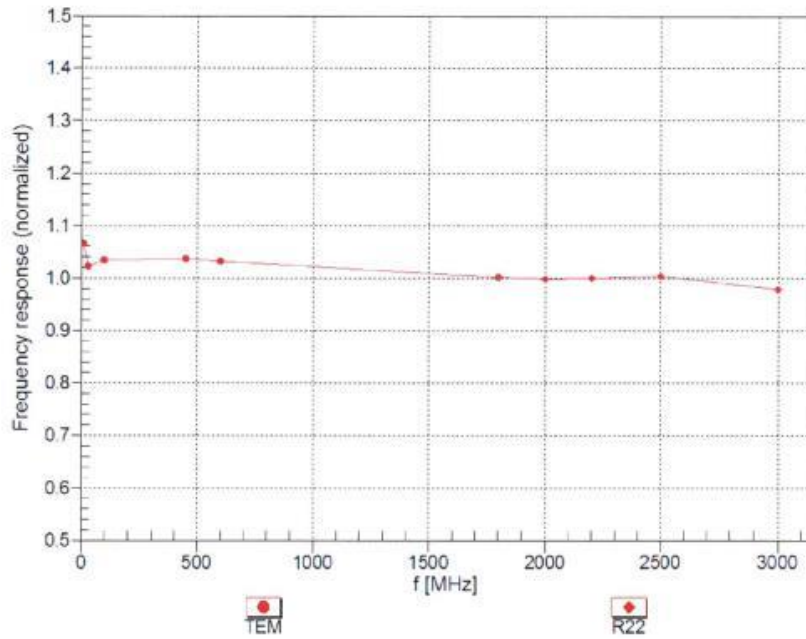

Uncertainty of Frequency Response of E-field:  $\pm 6.3\%$  (k=2)

ES3DV3- SN:3320

January 12, 2017

### Receiving Pattern ( $\phi$ ), $\vartheta = 0^\circ$

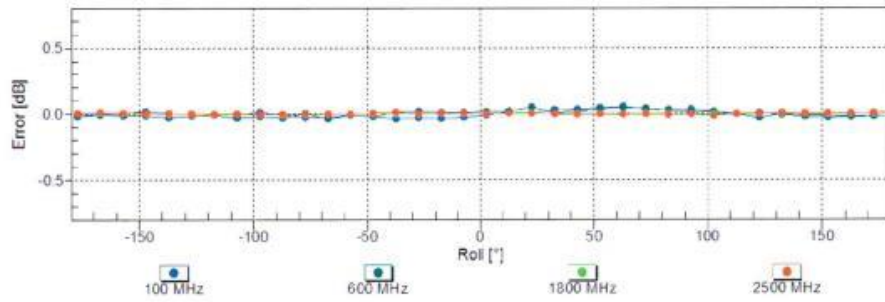
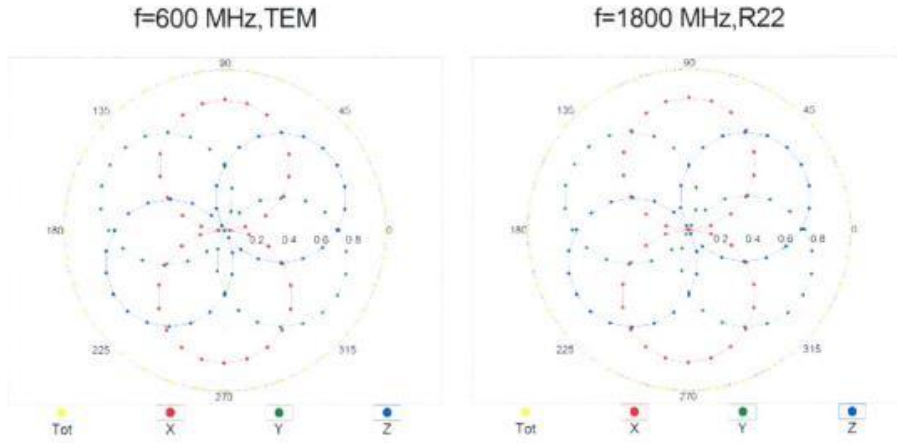

Uncertainty of Axial Isotropy Assessment:  $\pm 0.5\%$  (k=2)

ES3DV3– SN:3320

January 12, 2017

### Dynamic Range $f(\text{SAR}_{\text{head}})$ (TEM cell, $f_{\text{eval}} = 1900 \text{ MHz}$ )

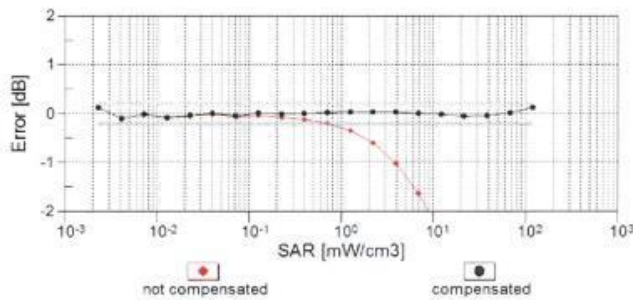
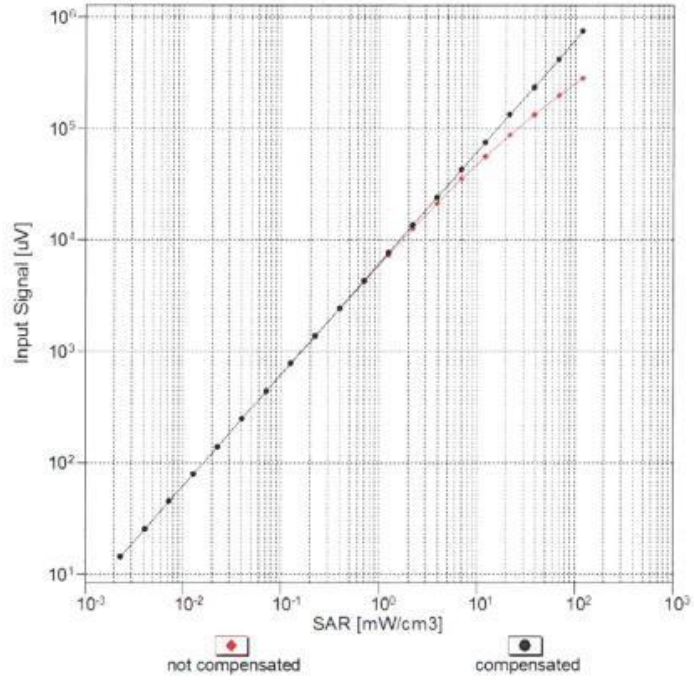

Uncertainty of Linearity Assessment:  $\pm 0.6\%$  ( $k=2$ )

ES3DV3- SN:3320

January 12, 2017

### Conversion Factor Assessment

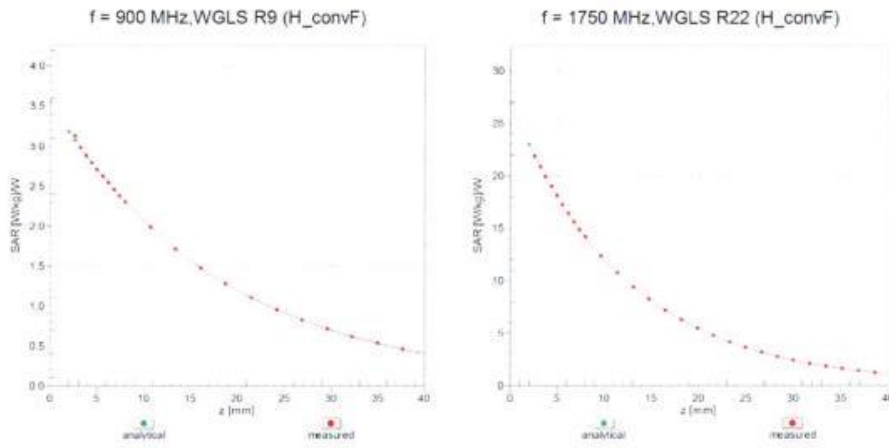

### Deviation from Isotropy in Liquid Error ( $\phi, \vartheta$ ), $f = 900$ MHz

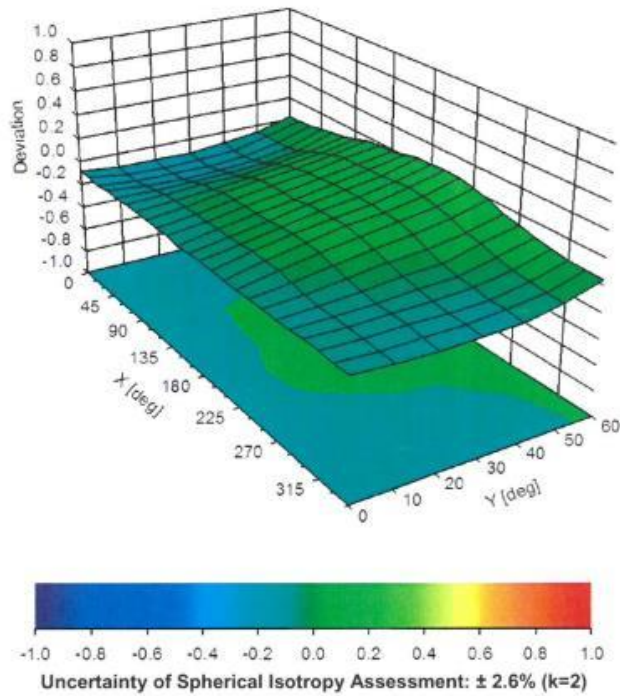

ES3DV3- SN:3320

January 12, 2017

## DASY/EASY - Parameters of Probe: ES3DV3 - SN:3320

### Other Probe Parameters

|   |            |
|---|------------|
| Sensor Arrangement                            | Triangular |
| Connector Angle (°)                           | 72.8       |
| Mechanical Surface Detection Mode             | enabled    |
| Optical Surface Detection Mode                | disabled   |
| Probe Overall Length                          | 337 mm     |
| Probe Body Diameter                           | 10 mm      |
| Tip Length                                    | 10 mm      |
| Tip Diameter                                  | 4 mm       |
| Probe Tip to Sensor X Calibration Point       | 2 mm       |
| Probe Tip to Sensor Y Calibration Point       | 2 mm       |
| Probe Tip to Sensor Z Calibration Point       | 2 mm       |
| Recommended Measurement Distance from Surface | 3 mm       |

**3 Calibration report "Probe EX3DV4"**

**Calibration Laboratory of  
Schmid & Partner  
Engineering AG**  
Zeughausstrasse 43, 8004 Zurich, Switzerland



**S** Schweizerischer Kalibrierdienst  
**C** Service suisse d'étalonnage  
**S** Servizio svizzero di taratura  
**S** Swiss Calibration Service

Accredited by the Swiss Accreditation Service (SAS)  
The Swiss Accreditation Service is one of the signatories to the EA  
Multilateral Agreement for the recognition of calibration certificates

Accreditation No.: **SCS 0108**

Client **CTC advanced GmbH**

Certificate No: **EX3-3944\_May17**

**CALIBRATION CERTIFICATE**

Object: **EX3DV4 - SN:3944**

Calibration procedure(s): **QA CAL-01.v9, QA CAL-14.v4, QA CAL-23.v5, QA CAL-25.v6  
Calibration procedure for dosimetric E-field probes**

Calibration date: **May 12, 2017**

This calibration certificate documents the traceability to national standards, which realize the physical units of measurements (SI).  
The measurements and the uncertainties with confidence probability are given on the following pages and are part of the certificate.

All calibrations have been conducted in the closed laboratory facility: environment temperature (22 ± 3)°C and humidity < 70%.

Calibration Equipment used (M&TE critical for calibration)

| Primary Standards          | ID               | Cal Date (Certificate No.)        | Scheduled Calibration  |
|----------------------------|------------------|-----------------------------------|------------------------|
| Power meter NRP            | SN: 104778       | 04-Apr-17 (No. 217-02521/02522)   | Apr-18                 |
| Power sensor NRP-Z91       | SN: 103244       | 04-Apr-17 (No. 217-02521)         | Apr-18                 |
| Power sensor NRP-Z91       | SN: 103245       | 04-Apr-17 (No. 217-02525)         | Apr-18                 |
| Reference 20 dB Attenuator | SN: S5277 (20x)  | 07-Apr-17 (No. 217-02528)         | Apr-18                 |
| Reference Probe ES3DV2     | SN: 3013         | 31-Dec-16 (No. ES3-3013_Dec16)    | Dec-17                 |
| DAE4                       | SN: 660          | 7-Dec-16 (No. DAE4-660_Dec16)     | Dec-17                 |
| Secondary Standards        | ID               | Check Date (in house)             | Scheduled Check        |
| Power meter E4419B         | SN: GB41293874   | 06-Apr-16 (in house check Jun-16) | In house check: Jun-18 |
| Power sensor E4412A        | SN: MY41498087   | 06-Apr-16 (in house check Jun-16) | In house check: Jun-18 |
| Power sensor E4412A        | SN: 000110210    | 06-Apr-16 (in house check Jun-16) | In house check: Jun-18 |
| RF generator HP 8648C      | SN: US3642U01700 | 04-Aug-99 (in house check Jun-16) | In house check: Jun-18 |
| Network Analyzer HP 8753E  | SN: US37390585   | 18-Oct-01 (in house check Oct-16) | In house check: Oct-17 |

|                |                       |                                   |               |
|----------------|-----------------------|-----------------------------------|---------------|
| Calibrated by: | Name<br>Leif Klysner  | Function<br>Laboratory Technician | Signature<br> |
| Approved by:   | Name<br>Katja Pokovic | Function<br>Technical Manager     | Signature<br> |

Issued: May 13, 2017

This calibration certificate shall not be reproduced except in full without written approval of the laboratory.



Calibration Laboratory of  
Schmid & Partner  
Engineering AG  
Zeughausstrasse 43, 8004 Zurich, Switzerland



S Schweizerischer Kalibrierdienst  
C Service suisse d'étalonnage  
S Servizio svizzero di taratura  
S Swiss Calibration Service

Accredited by the Swiss Accreditation Service (SAS)

Accreditation No.: SCS 0108

The Swiss Accreditation Service is one of the signatories to the EA  
Multilateral Agreement for the recognition of calibration certificates

#### Glossary:

|                          |   |
|--------------------------|---|
| TSL                      | tissue simulating liquid  |
| NORM <sub>x,y,z</sub>    | sensitivity in free space   |
| ConvF                    | sensitivity in TSL / NORM <sub>x,y,z</sub>  |
| DCP                      | diode compression point   |
| CF                       | crest factor (1/duty_cycle) of the RF signal  |
| A, B, C, D               | modulation dependent linearization parameters   |
| Polarization $\varphi$   | $\varphi$ rotation around probe axis  |
| Polarization $\vartheta$ | $\vartheta$ rotation around an axis that is in the plane normal to probe axis (at measurement center),<br>i.e., $\vartheta = 0$ is normal to probe axis |
| Connector Angle          | information used in DASY system to align probe sensor X to the robot coordinate system  |

#### Calibration is Performed According to the Following Standards:

- IEEE Std 1528-2013, "IEEE Recommended Practice for Determining the Peak Spatial-Averaged Specific Absorption Rate (SAR) in the Human Head from Wireless Communications Devices: Measurement Techniques", June 2013
- IEC 62209-1, "Procedure to measure the Specific Absorption Rate (SAR) for hand-held devices used in close proximity to the ear (frequency range of 300 MHz to 3 GHz)", February 2005
- IEC 62209-2, "Procedure to determine the Specific Absorption Rate (SAR) for wireless communication devices used in close proximity to the human body (frequency range of 30 MHz to 6 GHz)", March 2010
- KDB 865664, "SAR Measurement Requirements for 100 MHz to 6 GHz"

#### Methods Applied and Interpretation of Parameters:

- NORM<sub>x,y,z</sub>**: Assessed for E-field polarization  $\vartheta = 0$  ( $f \leq 900$  MHz in TEM-cell;  $f > 1800$  MHz: R22 waveguide). NORM<sub>x,y,z</sub> are only intermediate values, i.e., the uncertainties of NORM<sub>x,y,z</sub> does not affect the E<sup>2</sup>-field uncertainty inside TSL (see below ConvF).
- NORM(f)<sub>x,y,z</sub> = NORM<sub>x,y,z</sub> \* frequency\_response** (see Frequency Response Chart). This linearization is implemented in DASY4 software versions later than 4.2. The uncertainty of the frequency response is included in the stated uncertainty of ConvF.
- DCP<sub>x,y,z</sub>**: DCP are numerical linearization parameters assessed based on the data of power sweep with CW signal (no uncertainty required). DCP does not depend on frequency nor media.
- PAR**: PAR is the Peak to Average Ratio that is not calibrated but determined based on the signal characteristics
- A<sub>x,y,z</sub>; B<sub>x,y,z</sub>; C<sub>x,y,z</sub>; D<sub>x,y,z</sub>; VR<sub>x,y,z</sub>; A, B, C, D** are numerical linearization parameters assessed based on the data of power sweep for specific modulation signal. The parameters do not depend on frequency nor media. VR is the maximum calibration range expressed in RMS voltage across the diode.
- ConvF and Boundary Effect Parameters**: Assessed in flat phantom using E-field (or Temperature Transfer Standard for  $f \leq 800$  MHz) and inside waveguide using analytical field distributions based on power measurements for  $f > 800$  MHz. The same setups are used for assessment of the parameters applied for boundary compensation (alpha, depth) of which typical uncertainty values are given. These parameters are used in DASY4 software to improve probe accuracy close to the boundary. The sensitivity in TSL corresponds to NORM<sub>x,y,z</sub> \* ConvF whereby the uncertainty corresponds to that given for ConvF. A frequency dependent ConvF is used in DASY version 4.4 and higher which allows extending the validity from  $\pm 50$  MHz to  $\pm 100$  MHz.
- Spherical isotropy (3D deviation from isotropy)**: in a field of low gradients realized using a flat phantom exposed by a patch antenna.
- Sensor Offset**: The sensor offset corresponds to the offset of virtual measurement center from the probe tip (on probe axis). No tolerance required.
- Connector Angle**: The angle is assessed using the information gained by determining the NORM<sub>x</sub> (no uncertainty required).

EX3DV4 – SN:3944

May 12, 2017

# Probe EX3DV4

## SN:3944

Manufactured: May 2, 2013  
Calibrated: May 12, 2017

Calibrated for DASY/EASY Systems  
(Note: non-compatible with DASY2 system!)

EX3DV4-- SN:3944

May 12, 2017

## DASY/EASY - Parameters of Probe: EX3DV4 - SN:3944

### Basic Calibration Parameters

|   | Sensor X | Sensor Y | Sensor Z | Unc (k=2) |
|---|----------|----------|----------|-----------|
| Norm ( $\mu\text{V}/(\text{V}/\text{m})^2$ ) <sup>A</sup> | 0.55     | 0.62     | 0.41     | ± 10.1 %  |
| DCP (mV) <sup>B</sup>                                     | 100.5    | 98.9     | 102.6    |           |

### Modulation Calibration Parameters

| UID | Communication System Name |   | A<br>dB | B<br>dB $\sqrt{\mu\text{V}}$ | C   | D<br>dB | VR<br>mV | Unc<br>(k=2) <sup>E</sup> |
|-----|---------------------------|---|---------|------------------------------|-----|---------|----------|---------------------------|
| 0   | CW                        | X | 0.0     | 0.0                          | 1.0 | 0.00    | 152.1    | ±2.5 %                    |
|     |                           | Y | 0.0     | 0.0                          | 1.0 |         | 154.8    |                           |
|     |                           | Z | 0.0     | 0.0                          | 1.0 |         | 148.3    |                           |

The reported uncertainty of measurement is stated as the standard uncertainty of measurement multiplied by the coverage factor k=2, which for a normal distribution corresponds to a coverage probability of approximately 95%.

<sup>A</sup> The uncertainties of Norm X,Y,Z do not affect the E<sup>2</sup>-field uncertainty inside TSL (see Pages 5 and 6).

<sup>B</sup> Numerical linearization parameter: uncertainty not required.

<sup>E</sup> Uncertainty is determined using the max. deviation from linear response applying rectangular distribution and is expressed for the square of the field value.

EX3DV4- SN:3944

May 12, 2017

## DASY/EASY - Parameters of Probe: EX3DV4 - SN:3944

### Calibration Parameter Determined in Head Tissue Simulating Media

| f (MHz) <sup>C</sup> | Relative Permittivity <sup>F</sup> | Conductivity (S/m) <sup>F</sup> | ConvF X | ConvF Y | ConvF Z | Alpha <sup>G</sup> | Depth (mm) <sup>G</sup> | Unc (k=2) |
|----------------------|------------------------------------|---------------------------------|---------|---------|---------|--------------------|-------------------------|-----------|
| 750                  | 41.9                               | 0.89                            | 10.73   | 10.73   | 10.73   | 0.60               | 0.82                    | ± 12.0 %  |
| 850                  | 41.5                               | 0.92                            | 10.45   | 10.45   | 10.45   | 0.42               | 0.93                    | ± 12.0 %  |
| 900                  | 41.5                               | 0.97                            | 10.31   | 10.31   | 10.31   | 0.46               | 0.85                    | ± 12.0 %  |
| 1750                 | 40.1                               | 1.37                            | 8.87    | 8.87    | 8.87    | 0.26               | 0.80                    | ± 12.0 %  |
| 1900                 | 40.0                               | 1.40                            | 8.65    | 8.65    | 8.65    | 0.29               | 0.80                    | ± 12.0 %  |
| 2450                 | 39.2                               | 1.80                            | 7.83    | 7.83    | 7.83    | 0.33               | 0.80                    | ± 12.0 %  |
| 2600                 | 39.0                               | 1.96                            | 7.55    | 7.55    | 7.55    | 0.36               | 0.85                    | ± 12.0 %  |
| 3500                 | 37.9                               | 2.91                            | 7.43    | 7.43    | 7.43    | 0.25               | 1.20                    | ± 13.1 %  |
| 5200                 | 36.0                               | 4.66                            | 5.59    | 5.59    | 5.59    | 0.35               | 1.80                    | ± 13.1 %  |
| 5300                 | 35.9                               | 4.76                            | 5.37    | 5.37    | 5.37    | 0.35               | 1.80                    | ± 13.1 %  |
| 5500                 | 35.6                               | 4.96                            | 5.28    | 5.28    | 5.28    | 0.35               | 1.80                    | ± 13.1 %  |
| 5600                 | 35.5                               | 5.07                            | 4.97    | 4.97    | 4.97    | 0.40               | 1.80                    | ± 13.1 %  |
| 5800                 | 35.3                               | 5.27                            | 4.98    | 4.98    | 4.98    | 0.40               | 1.80                    | ± 13.1 %  |

<sup>C</sup> Frequency validity above 300 MHz of ± 100 MHz only applies for DASY v4.4 and higher (see Page 2), else it is restricted to ± 50 MHz. The uncertainty is the RSS of the ConvF uncertainty at calibration frequency and the uncertainty for the indicated frequency band. Frequency validity below 300 MHz is ± 10, 25, 40, 50 and 70 MHz for ConvF assessments at 30, 64, 128, 150 and 220 MHz respectively. Above 5 GHz frequency validity can be extended to ± 110 MHz.

<sup>F</sup> At frequencies below 3 GHz, the validity of tissue parameters ( $\epsilon$  and  $\sigma$ ) can be relaxed to ± 10% if liquid compensation formula is applied to measured SAR values. At frequencies above 3 GHz, the validity of tissue parameters ( $\epsilon$  and  $\sigma$ ) is restricted to ± 5%. The uncertainty is the RSS of the ConvF uncertainty for indicated target tissue parameters.

<sup>G</sup> Alpha/Depth are determined during calibration. SPEAG warrants that the remaining deviation due to the boundary effect after compensation is always less than ± 1% for frequencies below 3 GHz and below ± 2% for frequencies between 3-6 GHz at any distance larger than half the probe tip diameter from the boundary.

EX3DV4– SN:3944

May 12, 2017

## DASY/EASY - Parameters of Probe: EX3DV4 - SN:3944

### Calibration Parameter Determined in Body Tissue Simulating Media

| f (MHz) <sup>C</sup> | Relative Permittivity <sup>F</sup> | Conductivity (S/m) <sup>F</sup> | ConvF X | ConvF Y | ConvF Z | Alpha <sup>G</sup> | Depth (mm) <sup>G</sup> | Unc (k=2) |
|----------------------|------------------------------------|---------------------------------|---------|---------|---------|--------------------|-------------------------|-----------|
| 750                  | 55.5                               | 0.96                            | 10.44   | 10.44   | 10.44   | 0.47               | 0.81                    | ± 12.0 %  |
| 850                  | 55.2                               | 0.99                            | 10.30   | 10.30   | 10.30   | 0.46               | 0.80                    | ± 12.0 %  |
| 900                  | 55.0                               | 1.05                            | 10.06   | 10.06   | 10.06   | 0.39               | 0.92                    | ± 12.0 %  |
| 1750                 | 53.4                               | 1.49                            | 8.51    | 8.51    | 8.51    | 0.34               | 0.80                    | ± 12.0 %  |
| 1900                 | 53.3                               | 1.52                            | 8.19    | 8.19    | 8.19    | 0.34               | 0.80                    | ± 12.0 %  |
| 2450                 | 52.7                               | 1.95                            | 7.86    | 7.86    | 7.86    | 0.36               | 0.80                    | ± 12.0 %  |
| 2600                 | 52.5                               | 2.16                            | 7.59    | 7.59    | 7.59    | 0.30               | 0.80                    | ± 12.0 %  |
| 3500                 | 51.3                               | 3.31                            | 7.07    | 7.07    | 7.07    | 0.27               | 1.20                    | ± 13.1 %  |
| 5200                 | 49.0                               | 5.30                            | 5.08    | 5.08    | 5.08    | 0.35               | 1.90                    | ± 13.1 %  |
| 5300                 | 48.9                               | 5.42                            | 4.82    | 4.82    | 4.82    | 0.35               | 1.90                    | ± 13.1 %  |
| 5500                 | 48.6                               | 5.65                            | 4.42    | 4.42    | 4.42    | 0.35               | 1.90                    | ± 13.1 %  |
| 5600                 | 48.5                               | 5.77                            | 4.24    | 4.24    | 4.24    | 0.40               | 1.90                    | ± 13.1 %  |
| 5800                 | 48.2                               | 6.00                            | 4.36    | 4.36    | 4.36    | 0.40               | 1.90                    | ± 13.1 %  |

<sup>C</sup> Frequency validity above 300 MHz of ± 100 MHz only applies for DASY v4.4 and higher (see Page 2), else it is restricted to ± 50 MHz. The uncertainty is the RSS of the ConvF uncertainty at calibration frequency and the uncertainty for the indicated frequency band. Frequency validity below 300 MHz is ± 10, 25, 40, 50 and 70 MHz for ConvF assessments at 30, 64, 128, 150 and 220 MHz respectively. Above 5 GHz frequency validity can be extended to ± 110 MHz.

<sup>F</sup> At frequencies below 3 GHz, the validity of tissue parameters ( $\epsilon$  and  $\sigma$ ) can be relaxed to ± 10% if liquid compensation formula is applied to measured SAR values. At frequencies above 3 GHz, the validity of tissue parameters ( $\epsilon$  and  $\sigma$ ) is restricted to ± 5%. The uncertainty is the RSS of the ConvF uncertainty for indicated target tissue parameters.

<sup>G</sup> Alpha/Depth are determined during calibration. SPEAG warrants that the remaining deviation due to the boundary effect after compensation is always less than ± 1% for frequencies below 3 GHz and below ± 2% for frequencies between 3-6 GHz at any distance larger than half the probe tip diameter from the boundary.



EX3DV4- SN:3944

May 12, 2017

### Frequency Response of E-Field (TEM-Cell:ifi110 EXX, Waveguide: R22)

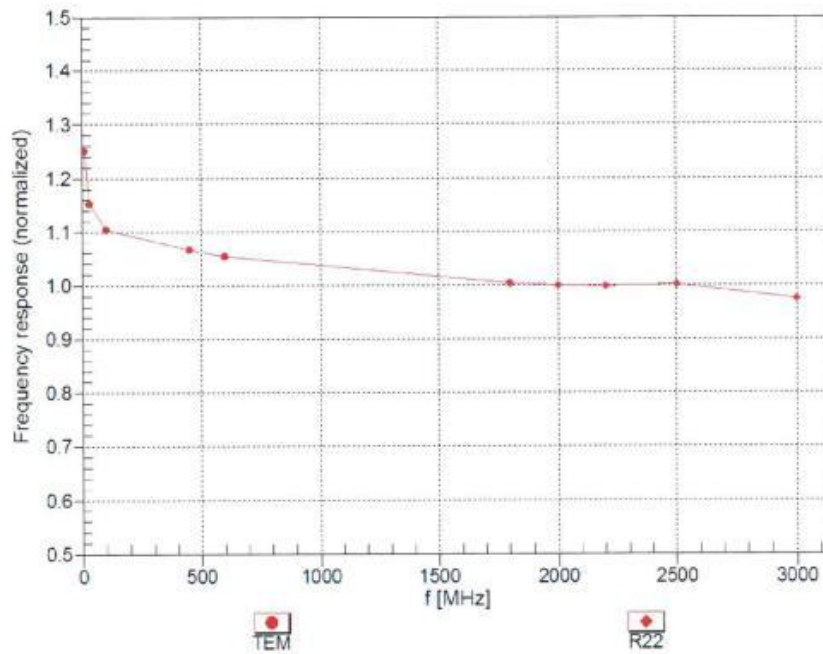

Uncertainty of Frequency Response of E-field:  $\pm 6.3\%$  (k=2)



EX3DV4- SN:3944

May 12, 2017

### Receiving Pattern ( $\phi$ ), $\vartheta = 0^\circ$

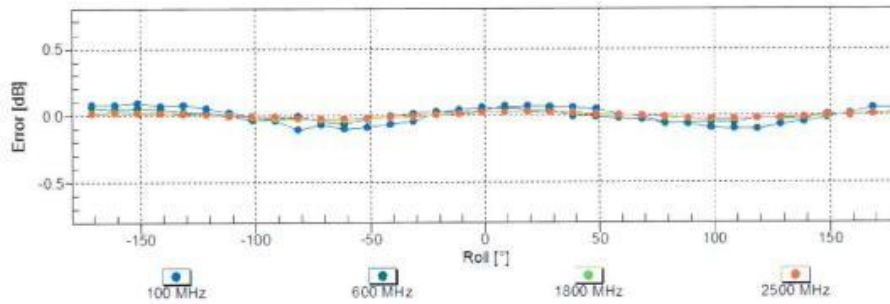
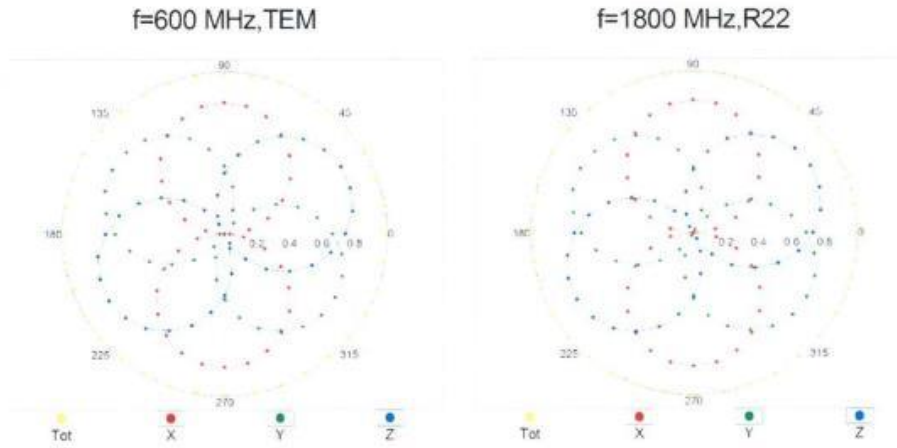

Uncertainty of Axial Isotropy Assessment:  $\pm 0.5\%$  ( $k=2$ )

EX3DV4- SN:3944

May 12, 2017

**Dynamic Range f(SAR<sub>head</sub>)**  
(TEM cell , f<sub>eval</sub>= 1900 MHz)

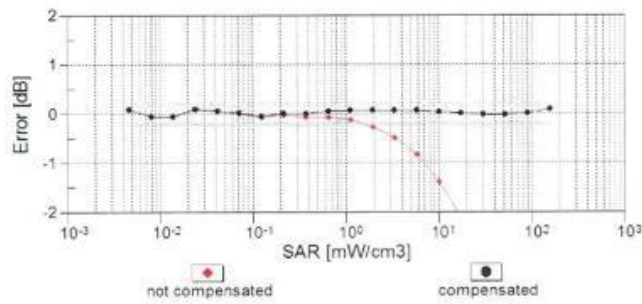
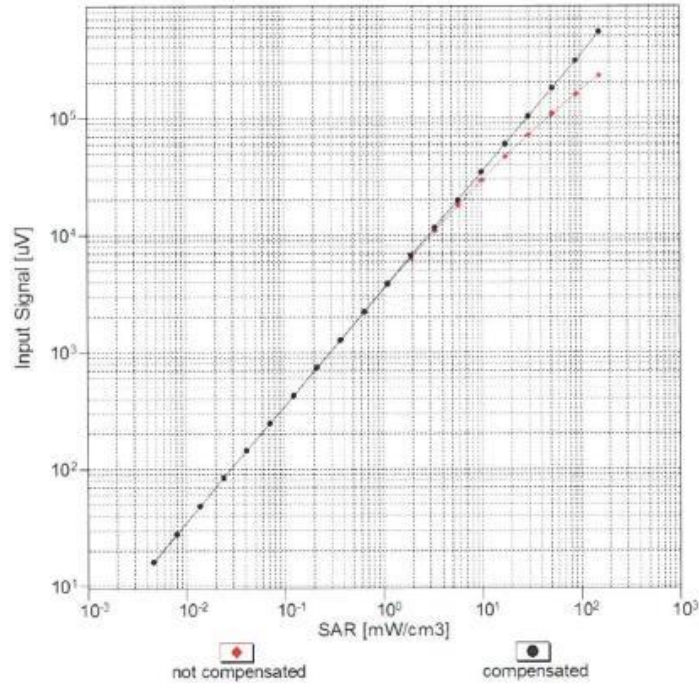

Uncertainty of Linearity Assessment: ± 0.6% (k=2)

EX3DV4- SN:3944

May 12, 2017

### Conversion Factor Assessment

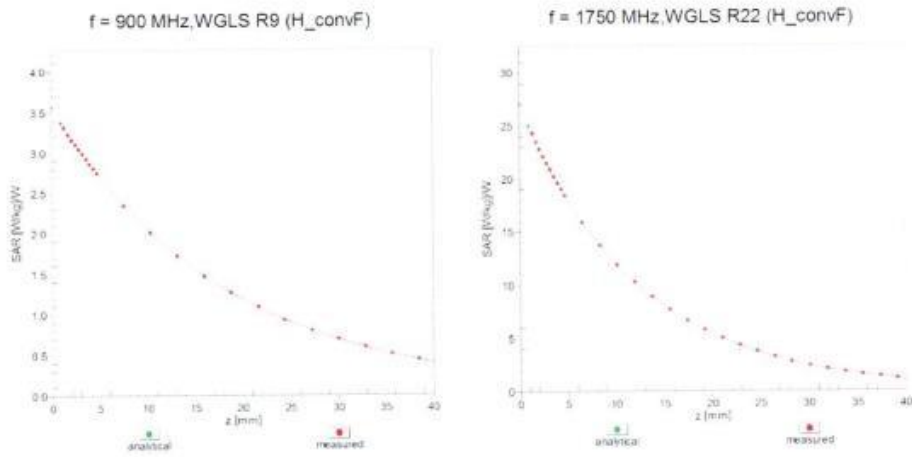

### Deviation from Isotropy in Liquid Error ( $\phi, \theta$ ), f = 900 MHz

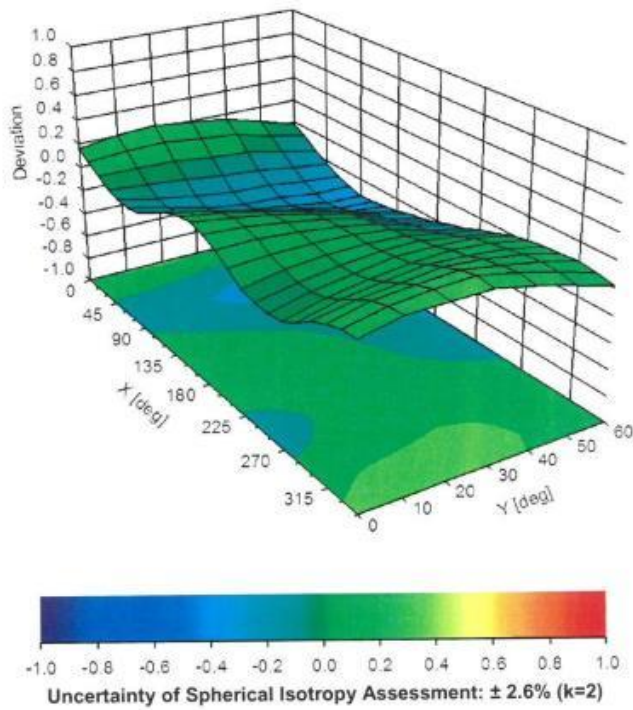

EX3DV4- SN:3944

May 12, 2017

## DASY/EASY - Parameters of Probe: EX3DV4 - SN:3944

### Other Probe Parameters

|   |            |
|---|------------|
| Sensor Arrangement                            | Triangular |
| Connector Angle (°)                           | -1.4       |
| Mechanical Surface Detection Mode             | enabled    |
| Optical Surface Detection Mode                | disabled   |
| Probe Overall Length                          | 337 mm     |
| Probe Body Diameter                           | 10 mm      |
| Tip Length                                    | 9 mm       |
| Tip Diameter                                  | 2.5 mm     |
| Probe Tip to Sensor X Calibration Point       | 1 mm       |
| Probe Tip to Sensor Y Calibration Point       | 1 mm       |
| Probe Tip to Sensor Z Calibration Point       | 1 mm       |
| Recommended Measurement Distance from Surface | 1.4 mm     |

**4 Calibration report “2450 MHz System validation dipole”**

**Calibration Laboratory of  
Schmid & Partner  
Engineering AG**  
Zeughausstrasse 43, 8004 Zurich, Switzerland





**S** Schweizerischer Kalibrierdienst  
**C** Service suisse d'étalonnage  
**S** Servizio svizzero di taratura  
**S** Swiss Calibration Service

Accredited by the Swiss Accreditation Service (SAS)  
The Swiss Accreditation Service is one of the signatories to the EA  
Multilateral Agreement for the recognition of calibration certificates

Accreditation No.: **SCS 0108**

Client **Cetecom**

Certificate No: **D2450V2-710\_Aug16**

| CALIBRATION CERTIFICATE  |  |                                   |  |
|--|--|-----------------------------------|--|
| Object   | D2450V2 - SN:710   |                                   |  |
| Calibration procedure(s)   | QA CAL-05.v9<br>Calibration procedure for dipole validation kits above 700 MHz |                                   |  |
| Calibration date:  | August 15, 2016  |                                   |  |
| <p>This calibration certificate documents the traceability to national standards, which realize the physical units of measurements (SI).<br/>The measurements and the uncertainties with confidence probability are given on the following pages and are part of the certificate.</p> <p>All calibrations have been conducted in the closed laboratory facility: environment temperature (22 ± 3)°C and humidity &lt; 70%.</p> <p>Calibration Equipment used (M&amp;TE critical for calibration)</p> |  |                                   |  |
| <b>Primary Standards</b>   | <b>ID #</b>  | <b>Cal Date (Certificate No.)</b> | <b>Scheduled Calibration</b>   |
| Power meter NRP  | SN: 104778   | 06-Apr-16 (No. 217-02288/02289)   | Apr-17   |
| Power sensor NRP-Z91   | SN: 103244   | 06-Apr-16 (No. 217-02288)         | Apr-17   |
| Power sensor NRP-Z91   | SN: 103245   | 06-Apr-16 (No. 217-02289)         | Apr-17   |
| Reference 20 dB Attenuator   | SN: 5058 (20k)   | 05-Apr-16 (No. 217-02292)         | Apr-17   |
| Type-N mismatch combination  | SN: 5047.2 / 06327   | 05-Apr-16 (No. 217-02295)         | Apr-17   |
| Reference Probe EX3DV4   | SN: 7349   | 15-Jun-16 (No. EX3-7349_Jun16)    | Jun-17   |
| DAE4   | SN: 601  | 30-Dec-15 (No. DAE4-601_Dec15)    | Dec-16   |
| <b>Secondary Standards</b>   | <b>ID #</b>  | <b>Check Date (in house)</b>      | <b>Scheduled Check</b>   |
| Power meter EPM-442A   | SN: GB37480704   | 07-Oct-15 (No. 217-02222)         | In house check: Oct-16   |
| Power sensor HP 8481A  | SN: US37292783   | 07-Oct-15 (No. 217-02222)         | In house check: Oct-16   |
| Power sensor HP 8481A  | SN: MY41092317   | 07-Oct-15 (No. 217-02223)         | In house check: Oct-16   |
| RF generator R&S SMT-06  | SN: 100972   | 15-Jun-15 (in house check Jun-15) | In house check: Oct-16   |
| Network Analyzer HP 8753E  | SN: US37390585   | 18-Oct-01 (in house check Oct-15) | In house check: Oct-16   |
| Calibrated by:   | Name<br>Michael Weber  | Function<br>Laboratory Technician | Signature<br> |
| Approved by:   | Name<br>Katja Pokovic  | Technical Manager                 |               |
|  |  |                                   | Issued: August 22, 2016  |
| This calibration certificate shall not be reproduced except in full without written approval of the laboratory.  |  |                                   |  |



**Calibration Laboratory of**  
 Schmid & Partner  
 Engineering AG  
 Zeughausstrasse 43, 8004 Zurich, Switzerland



**S** Schweizerischer Kalibrierdienst  
**C** Service suisse d'étalonnage  
**S** Servizio svizzero di taratura  
**S** Swiss Calibration Service

Accredited by the Swiss Accreditation Service (SAS)

Accreditation No.: SCS 0108

The Swiss Accreditation Service is one of the signatories to the EA Multilateral Agreement for the recognition of calibration certificates

#### Glossary:

|       |                                 |
|-------|---------------------------------|
| TSL   | tissue simulating liquid        |
| ConvF | sensitivity in TSL / NORM x,y,z |
| N/A   | not applicable or not measured  |

#### Calibration is Performed According to the Following Standards:

- IEEE Std 1528-2013, "IEEE Recommended Practice for Determining the Peak Spatial-Averaged Specific Absorption Rate (SAR) in the Human Head from Wireless Communications Devices: Measurement Techniques", June 2013
- IEC 62209-1, "Procedure to measure the Specific Absorption Rate (SAR) for hand-held devices used in close proximity to the ear (frequency range of 300 MHz to 3 GHz)", February 2005
- IEC 62209-2, "Procedure to determine the Specific Absorption Rate (SAR) for wireless communication devices used in close proximity to the human body (frequency range of 30 MHz to 6 GHz)", March 2010
- KDB 865664, "SAR Measurement Requirements for 100 MHz to 6 GHz"

#### Additional Documentation:

- DASY4/5 System Handbook

#### Methods Applied and Interpretation of Parameters:

- Measurement Conditions:** Further details are available from the Validation Report at the end of the certificate. All figures stated in the certificate are valid at the frequency indicated.
- Antenna Parameters with TSL:** The dipole is mounted with the spacer to position its feed point exactly below the center marking of the flat phantom section, with the arms oriented parallel to the body axis.
- Feed Point Impedance and Return Loss:** These parameters are measured with the dipole positioned under the liquid filled phantom. The impedance stated is transformed from the measurement at the SMA connector to the feed point. The Return Loss ensures low reflected power. No uncertainty required.
- Electrical Delay:** One-way delay between the SMA connector and the antenna feed point. No uncertainty required.
- SAR measured:** SAR measured at the stated antenna input power.
- SAR normalized:** SAR as measured, normalized to an input power of 1 W at the antenna connector.
- SAR for nominal TSL parameters:** The measured TSL parameters are used to calculate the nominal SAR result.

The reported uncertainty of measurement is stated as the standard uncertainty of measurement multiplied by the coverage factor  $k=2$ , which for a normal distribution corresponds to a coverage probability of approximately 95%.



### Measurement Conditions

DASY system configuration, as far as not given on page 1.

|                              |                        |             |
|------------------------------|------------------------|-------------|
| DASY Version                 | DASY5                  | V52.8.8     |
| Extrapolation                | Advanced Extrapolation |             |
| Phantom                      | Modular Flat Phantom   |             |
| Distance Dipole Center - TSL | 10 mm                  | with Spacer |
| Zoom Scan Resolution         | dx, dy, dz = 5 mm      |             |
| Frequency                    | 2450 MHz $\pm$ 1 MHz   |             |

### Head TSL parameters

The following parameters and calculations were applied.

|   | Temperature         | Permittivity   | Conductivity         |
|---|---------------------|----------------|----------------------|
| Nominal Head TSL parameters             | 22.0 °C             | 39.2           | 1.80 mho/m           |
| Measured Head TSL parameters            | (22.0 $\pm$ 0.2) °C | 38.2 $\pm$ 6 % | 1.88 mho/m $\pm$ 6 % |
| Head TSL temperature change during test | < 0.5 °C            | ----           | ----                 |

### SAR result with Head TSL

| SAR averaged over 1 cm <sup>3</sup> (1 g) of Head TSL | Condition          |  |
|---|--------------------|--|
| SAR measured  | 250 mW input power | 13.5 W/kg                                      |
| SAR for nominal Head TSL parameters                   | normalized to 1W   | <b>52.6 W/kg <math>\pm</math> 17.0 % (k=2)</b> |

| SAR averaged over 10 cm <sup>3</sup> (10 g) of Head TSL | condition          |  |
|---|--------------------|--|
| SAR measured  | 250 mW input power | 6.30 W/kg                                      |
| SAR for nominal Head TSL parameters                     | normalized to 1W   | <b>24.8 W/kg <math>\pm</math> 16.5 % (k=2)</b> |

### Body TSL parameters

The following parameters and calculations were applied.

|   | Temperature         | Permittivity   | Conductivity         |
|---|---------------------|----------------|----------------------|
| Nominal Body TSL parameters             | 22.0 °C             | 52.7           | 1.95 mho/m           |
| Measured Body TSL parameters            | (22.0 $\pm$ 0.2) °C | 52.0 $\pm$ 6 % | 2.04 mho/m $\pm$ 6 % |
| Body TSL temperature change during test | < 0.5 °C            | ----           | ----                 |

### SAR result with Body TSL

| SAR averaged over 1 cm <sup>3</sup> (1 g) of Body TSL | Condition          |  |
|---|--------------------|--|
| SAR measured  | 250 mW input power | 13.1 W/kg                                      |
| SAR for nominal Body TSL parameters                   | normalized to 1W   | <b>51.1 W/kg <math>\pm</math> 17.0 % (k=2)</b> |

| SAR averaged over 10 cm <sup>3</sup> (10 g) of Body TSL | condition          |  |
|---|--------------------|--|
| SAR measured  | 250 mW input power | 6.13 W/kg                                      |
| SAR for nominal Body TSL parameters                     | normalized to 1W   | <b>24.2 W/kg <math>\pm</math> 16.5 % (k=2)</b> |

### Appendix (Additional assessments outside the scope of SCS 0108)

#### Antenna Parameters with Head TSL

|                                      |                                |
|--------------------------------------|--------------------------------|
| Impedance, transformed to feed point | 51.9 $\Omega$ + 2.6 j $\Omega$ |
| Return Loss                          | - 30.0 dB                      |

#### Antenna Parameters with Body TSL

|                                      |                                |
|--------------------------------------|--------------------------------|
| Impedance, transformed to feed point | 48.2 $\Omega$ + 3.1 j $\Omega$ |
| Return Loss                          | - 28.8 dB                      |

#### General Antenna Parameters and Design

|                                  |          |
|----------------------------------|----------|
| Electrical Delay (one direction) | 1.157 ns |
|----------------------------------|----------|

After long term use with 100W radiated power, only a slight warming of the dipole near the feedpoint can be measured.

The dipole is made of standard semirigid coaxial cable. The center conductor of the feeding line is directly connected to the second arm of the dipole. The antenna is therefore short-circuited for DC-signals. On some of the dipoles, small end caps are added to the dipole arms in order to improve matching when loaded according to the position as explained in the "Measurement Conditions" paragraph. The SAR data are not affected by this change. The overall dipole length is still according to the Standard.

No excessive force must be applied to the dipole arms, because they might bend or the soldered connections near the feedpoint may be damaged.

#### Additional EUT Data

|                 |               |
|-----------------|---------------|
| Manufactured by | SPEAG         |
| Manufactured on | July 05, 2002 |

**DASY5 Validation Report for Head TSL**

Date: 15.08.2016

Test Laboratory: SPEAG, Zurich, Switzerland

**DUT: Dipole 2450 MHz D2450V2; Type: D2450V2; Serial: D2450V2 - SN:710**

Communication System: UID 0 - CW; Frequency: 2450 MHz

Medium parameters used:  $f = 2450$  MHz;  $\sigma = 1.88$  S/m;  $\epsilon_r = 38.2$ ;  $\rho = 1000$  kg/m<sup>3</sup>

Phantom section: Flat Section

Measurement Standard: DASY5 (IEEE/IEC/ANSI C63.19-2011)

DASY52 Configuration:

- Probe: EX3DV4 - SN7349; ConvF(7.72, 7.72, 7.72); Calibrated: 15.06.2016;
- Sensor-Surface: 1.4mm (Mechanical Surface Detection)
- Electronics: DAE4 Sn601; Calibrated: 30.12.2015
- Phantom: Flat Phantom 5.0 (front); Type: QD000P50AA; Serial: 1001
- DASY52 52.8.8(1258); SEMCAD X 14.6.10(7372)

**Dipole Calibration for Head Tissue/Pin=250 mW, d=10mm/Zoom Scan (7x7x7)/Cube 0:**

Measurement grid: dx=5mm, dy=5mm, dz=5mm

Reference Value = 115.2 V/m; Power Drift = 0.00 dB

Peak SAR (extrapolated) = 27.4 W/kg

**SAR(1 g) = 13.5 W/kg; SAR(10 g) = 6.3 W/kg**

Maximum value of SAR (measured) = 22.6 W/kg

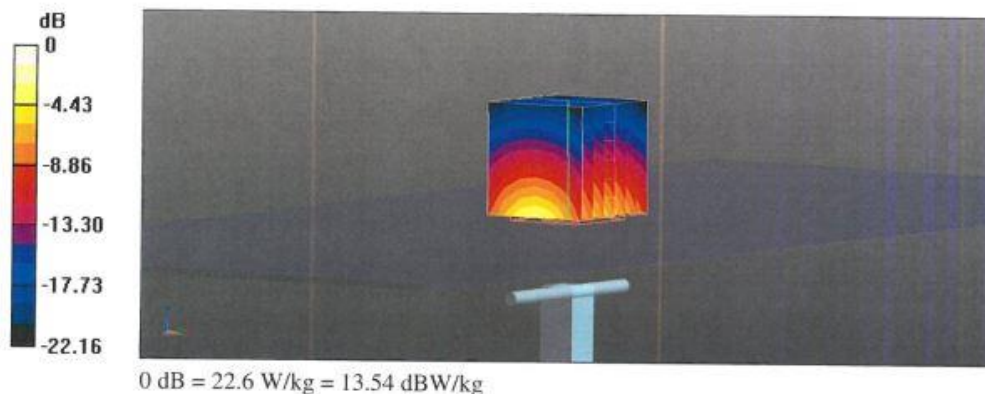

### Impedance Measurement Plot for Head TSL

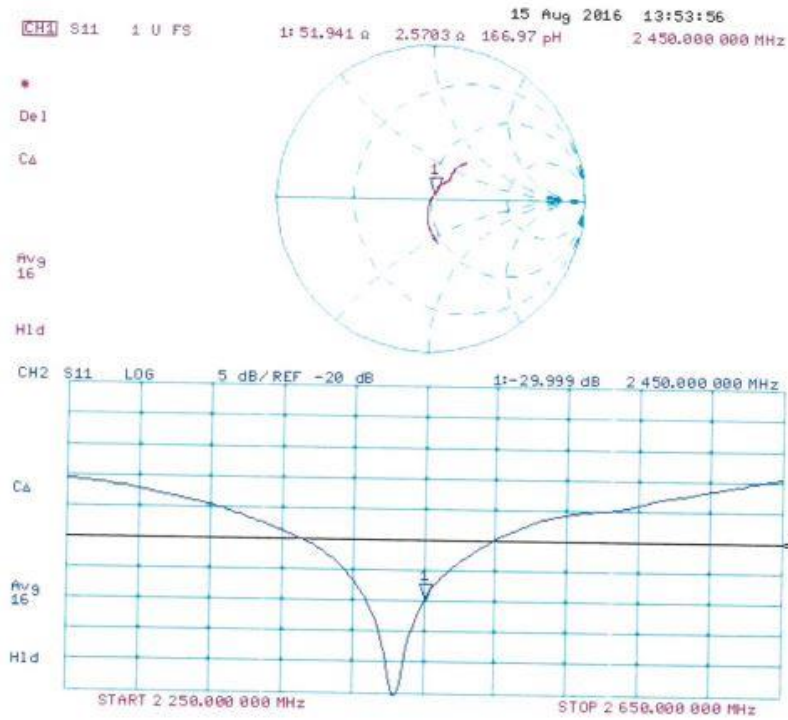

**DASY5 Validation Report for Body TSL**

Date: 12.08.2016

Test Laboratory: SPEAG, Zurich, Switzerland

**DUT: Dipole 2450 MHz D2450V2; Type: D2450V2; Serial: D2450V2 - SN:710**

Communication System: UID 0 - CW; Frequency: 2450 MHz

Medium parameters used:  $f = 2450$  MHz;  $\sigma = 2.04$  S/m;  $\epsilon_r = 52$ ;  $\rho = 1000$  kg/m<sup>3</sup>

Phantom section: Flat Section

Measurement Standard: DASY5 (IEEE/IEC/ANSI C63.19-2011)

DASY52 Configuration:

- Probe: EX3DV4 - SN7349; ConvF(7.79, 7.79, 7.79); Calibrated: 15.06.2016;
- Sensor-Surface: 1.4mm (Mechanical Surface Detection)
- Electronics: DAE4 Sn601; Calibrated: 30.12.2015
- Phantom: Flat Phantom 5.0 (back); Type: QD000P50AA; Serial: 1002
- DASY52 52.8.8(1258); SEMCAD X 14.6.10(7372)

**Dipole Calibration for Body Tissue/Pin=250 mW, d=10mm/Zoom Scan (7x7x7)/Cube 0:**

Measurement grid: dx=5mm, dy=5mm, dz=5mm

Reference Value = 106.3 V/m; Power Drift = -0.03 dB

Peak SAR (extrapolated) = 26.0 W/kg

**SAR(1 g) = 13.1 W/kg; SAR(10 g) = 6.13 W/kg**

Maximum value of SAR (measured) = 21.1 W/kg

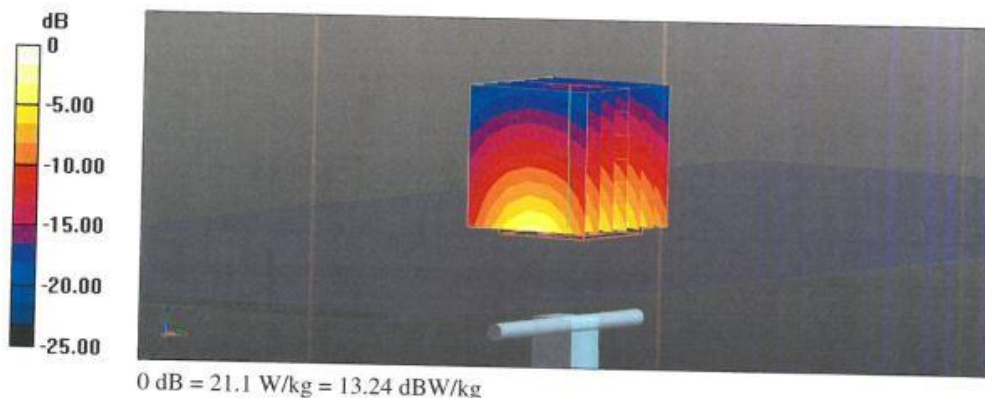



### Impedance Measurement Plot for Body TSL

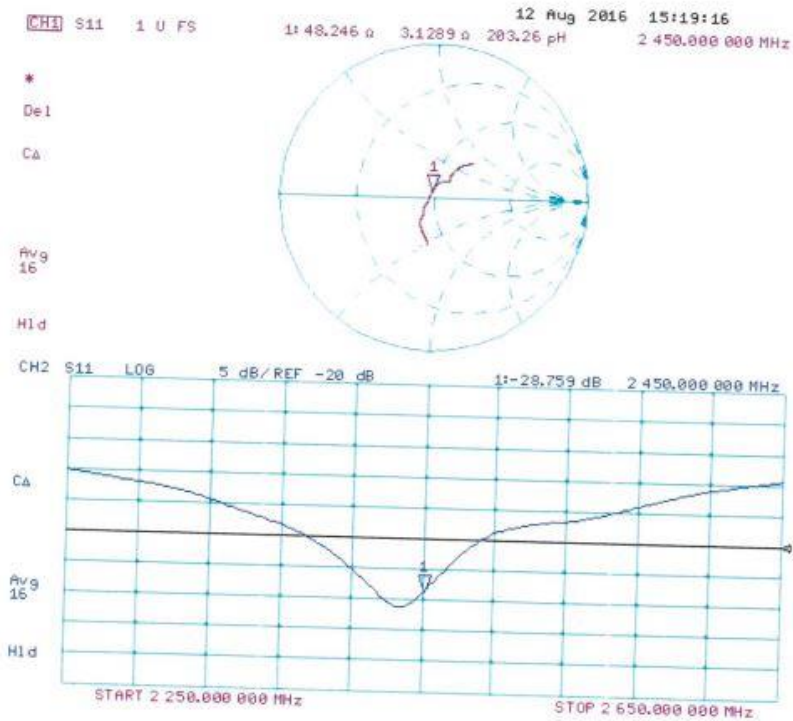



**5 Calibration report "5GHz System check dipole"**

**Calibration Laboratory of  
Schmid & Partner  
Engineering AG**  
Zeughausstrasse 43, 8004 Zurich, Switzerland



**S** Schweizerischer Kalibrierdienst  
**C** Service suisse d'étalonnage  
**S** Servizio svizzero di taratura  
**S** Swiss Calibration Service

Accredited by the Swiss Accreditation Service (SAS)  
The Swiss Accreditation Service is one of the signatories to the EA  
Multilateral Agreement for the recognition of calibration certificates

Accreditation No.: **SCS 0108**

Client **Cetecom**

Certificate No: **D5GHzV2-1055\_Aug15**

**CALIBRATION CERTIFICATE**

Object: **D5GHzV2 - SN: 1055**

Calibration procedure(s): **QA CAL-22.v2  
Calibration procedure for dipole validation kits between 3-6 GHz**

Calibration date: **August 14, 2015**

This calibration certificate documents the traceability to national standards, which realize the physical units of measurements (SI).  
The measurements and the uncertainties with confidence probability are given on the following pages and are part of the certificate.

All calibrations have been conducted in the closed laboratory facility: environment temperature (22 ± 3)°C and humidity < 70%.

Calibration Equipment used (M&TE critical for calibration)

| Primary Standards           | ID #               | Cal Date (Certificate No.)        | Scheduled Calibration  |
|-----------------------------|--------------------|-----------------------------------|------------------------|
| Power meter EPM-442A        | GB37480704         | 07-Oct-14 (No. 217-02020)         | Oct-15                 |
| Power sensor HP 8481A       | US37292783         | 07-Oct-14 (No. 217-02020)         | Oct-15                 |
| Power sensor HP 8481A       | MY41092317         | 07-Oct-14 (No. 217-02021)         | Oct-15                 |
| Reference 20 dB Attenuator  | SN: 5058 (20k)     | 01-Apr-15 (No. 217-02131)         | Mar-16                 |
| Type-N mismatch combination | SN: 5047.2 / 06327 | 01-Apr-15 (No. 217-02134)         | Mar-16                 |
| Reference Probe EX3DV4      | SN: 3503           | 30-Dec-14 (No. EX3-3503_Dec14)    | Dec-15                 |
| DAE4                        | SN: 601            | 18-Aug-14 (No. DAE4-601_Aug14)    | Aug-15                 |
| Secondary Standards         | ID #               | Check Date (in house)             | Scheduled Check        |
| RF generator R&S SMT-06     | 100005             | 04-Aug-99 (in house check Oct-13) | In house check: Oct-16 |
| Network Analyzer HP 8753E   | US37390585 S4206   | 18-Oct-01 (in house check Oct-14) | In house check: Oct-15 |

|                |                               |  |               |
|----------------|-------------------------------|--|---------------|
| Calibrated by: | Name<br><b>Jeton Kastrati</b> | Function<br><b>Laboratory Technician</b> | Signature<br> |
| Approved by:   | Name<br><b>Katja Pokovic</b>  | Function<br><b>Technical Manager</b>     | Signature<br> |

Issued: August 14, 2015

This calibration certificate shall not be reproduced except in full without written approval of the laboratory.

**Calibration Laboratory of**  
 Schmid & Partner  
 Engineering AG  
 Zeughausstrasse 43, 8004 Zurich, Switzerland



**S** Schweizerischer Kalibrierdienst  
**C** Service suisse d'étalonnage  
**S** Servizio svizzero di taratura  
**S** Swiss Calibration Service

Accredited by the Swiss Accreditation Service (SAS)  
 The Swiss Accreditation Service is one of the signatories to the EA  
 Multilateral Agreement for the recognition of calibration certificates

Accreditation No.: **SCS 0108**

**Glossary:**

|       |                                 |
|-------|---------------------------------|
| TSL   | tissue simulating liquid        |
| ConvF | sensitivity in TSL / NORM x,y,z |
| N/A   | not applicable or not measured  |

**Calibration is Performed According to the Following Standards:**

- IEEE Std 1528-2013, "IEEE Recommended Practice for Determining the Peak Spatial-Averaged Specific Absorption Rate (SAR) in the Human Head from Wireless Communications Devices: Measurement Techniques", June 2013
- IEC 62209-2, "Procedure to determine the Specific Absorption Rate (SAR) for wireless communication devices used in close proximity to the human body (frequency range of 30 MHz to 6 GHz)", March 2010
- KDB 865664, "SAR Measurement Requirements for 100 MHz to 6 GHz"

**Additional Documentation:**

- DASY4/5 System Handbook

**Methods Applied and Interpretation of Parameters:**

- Measurement Conditions:* Further details are available from the Validation Report at the end of the certificate. All figures stated in the certificate are valid at the frequency indicated.
- Antenna Parameters with TSL:* The dipole is mounted with the spacer to position its feed point exactly below the center marking of the flat phantom section, with the arms oriented parallel to the body axis.
- Feed Point Impedance and Return Loss:* These parameters are measured with the dipole positioned under the liquid filled phantom. The impedance stated is transformed from the measurement at the SMA connector to the feed point. The Return Loss ensures low reflected power. No uncertainty required.
- Electrical Delay:* One-way delay between the SMA connector and the antenna feed point. No uncertainty required.
- SAR measured:* SAR measured at the stated antenna input power.
- SAR normalized:* SAR as measured, normalized to an input power of 1 W at the antenna connector.
- SAR for nominal TSL parameters:* The measured TSL parameters are used to calculate the nominal SAR result.

The reported uncertainty of measurement is stated as the standard uncertainty of measurement multiplied by the coverage factor  $k=2$ , which for a normal distribution corresponds to a coverage probability of approximately 95%.

**Measurement Conditions**

DASY system configuration, as far as not given on page 1.

|                              |  |                                  |
|------------------------------|--|----------------------------------|
| DASY Version                 | DASY5  | V52.8.8                          |
| Extrapolation                | Advanced Extrapolation                                   |                                  |
| Phantom                      | Modular Flat Phantom V5.0                                |                                  |
| Distance Dipole Center - TSL | 10 mm  | with Spacer                      |
| Zoom Scan Resolution         | dx, dy = 4.0 mm, dz = 1.4 mm                             | Graded Ratio = 1.4 (Z direction) |
| Frequency                    | 5200 MHz ± 1 MHz<br>5500 MHz ± 1 MHz<br>5800 MHz ± 1 MHz |                                  |

**Head TSL parameters at 5200 MHz**

The following parameters and calculations were applied.

|   | Temperature     | Permittivity | Conductivity     |
|---|-----------------|--------------|------------------|
| Nominal Head TSL parameters             | 22.0 °C         | 36.0         | 4.66 mho/m       |
| Measured Head TSL parameters            | (22.0 ± 0.2) °C | 35.5 ± 6 %   | 4.53 mho/m ± 6 % |
| Head TSL temperature change during test | < 0.5 °C        | ----         | ----             |

**SAR result with Head TSL at 5200 MHz**

| SAR averaged over 1 cm <sup>3</sup> (1 g) of Head TSL | Condition          |                                 |
|---|--------------------|---------------------------------|
| SAR measured  | 100 mW input power | 8.28 W/kg                       |
| SAR for nominal Head TSL parameters                   | normalized to 1W   | <b>82.5 W/kg ± 19.9 % (k=2)</b> |

| SAR averaged over 10 cm <sup>3</sup> (10 g) of Head TSL | condition          |                                 |
|---|--------------------|---------------------------------|
| SAR measured  | 100 mW input power | 2.37 W/kg                       |
| SAR for nominal Head TSL parameters                     | normalized to 1W   | <b>23.6 W/kg ± 19.5 % (k=2)</b> |

### Head TSL parameters at 5500 MHz

The following parameters and calculations were applied.

|   | Temperature     | Permittivity | Conductivity     |
|---|-----------------|--------------|------------------|
| Nominal Head TSL parameters             | 22.0 °C         | 35.6         | 4.96 mho/m       |
| Measured Head TSL parameters            | (22.0 ± 0.2) °C | 35.1 ± 6 %   | 4.82 mho/m ± 6 % |
| Head TSL temperature change during test | < 0.5 °C        | ----         | ----             |

### SAR result with Head TSL at 5500 MHz

| SAR averaged over 1 cm <sup>3</sup> (1 g) of Head TSL | Condition          |                                   |
|---|--------------------|-----------------------------------|
| SAR measured  | 100 mW input power | 8.75 W/kg                         |
| SAR for nominal Head TSL parameters                   | normalized to 1W   | <b>87.1 W / kg ± 19.9 % (k=2)</b> |

| SAR averaged over 10 cm <sup>3</sup> (10 g) of Head TSL | condition          |                                 |
|---|--------------------|---------------------------------|
| SAR measured  | 100 mW input power | 2.49 W/kg                       |
| SAR for nominal Head TSL parameters                     | normalized to 1W   | <b>24.8 W/kg ± 19.5 % (k=2)</b> |

### Head TSL parameters at 5800 MHz

The following parameters and calculations were applied.

|   | Temperature     | Permittivity | Conductivity     |
|---|-----------------|--------------|------------------|
| Nominal Head TSL parameters             | 22.0 °C         | 35.3         | 5.27 mho/m       |
| Measured Head TSL parameters            | (22.0 ± 0.2) °C | 34.7 ± 6 %   | 5.14 mho/m ± 6 % |
| Head TSL temperature change during test | < 0.5 °C        | ----         | ----             |

### SAR result with Head TSL at 5800 MHz

| SAR averaged over 1 cm <sup>3</sup> (1 g) of Head TSL | Condition          |                                 |
|---|--------------------|---------------------------------|
| SAR measured  | 100 mW input power | 8.32 W/kg                       |
| SAR for nominal Head TSL parameters                   | normalized to 1W   | <b>82.8 W/kg ± 19.9 % (k=2)</b> |

| SAR averaged over 10 cm <sup>3</sup> (10 g) of Head TSL | condition          |                                 |
|---|--------------------|---------------------------------|
| SAR measured  | 100 mW input power | 2.36 W/kg                       |
| SAR for nominal Head TSL parameters                     | normalized to 1W   | <b>23.5 W/kg ± 19.5 % (k=2)</b> |



**Body TSL parameters at 5200 MHz**

The following parameters and calculations were applied.

|   | Temperature     | Permittivity | Conductivity     |
|---|-----------------|--------------|------------------|
| Nominal Body TSL parameters             | 22.0 °C         | 49.0         | 5.30 mho/m       |
| Measured Body TSL parameters            | (22.0 ± 0.2) °C | 47.9 ± 6 %   | 5.43 mho/m ± 6 % |
| Body TSL temperature change during test | < 0.5 °C        | ----         | ----             |

**SAR result with Body TSL at 5200 MHz**

| SAR averaged over 1 cm <sup>3</sup> (1 g) of Body TSL | Condition          |                                 |
|---|--------------------|---------------------------------|
| SAR measured  | 100 mW input power | 7.69 W/kg                       |
| SAR for nominal Body TSL parameters                   | normalized to 1W   | <b>76.6 W/kg ± 19.9 % (k=2)</b> |

| SAR averaged over 10 cm <sup>3</sup> (10 g) of Body TSL | condition          |                                 |
|---|--------------------|---------------------------------|
| SAR measured  | 100 mW input power | 2.16 W/kg                       |
| SAR for nominal Body TSL parameters                     | normalized to 1W   | <b>21.5 W/kg ± 19.5 % (k=2)</b> |

**Body TSL parameters at 5500 MHz**

The following parameters and calculations were applied.

|   | Temperature     | Permittivity | Conductivity     |
|---|-----------------|--------------|------------------|
| Nominal Body TSL parameters             | 22.0 °C         | 48.6         | 5.65 mho/m       |
| Measured Body TSL parameters            | (22.0 ± 0.2) °C | 47.3 ± 6 %   | 5.82 mho/m ± 6 % |
| Body TSL temperature change during test | < 0.5 °C        | ----         | ----             |

**SAR result with Body TSL at 5500 MHz**

| SAR averaged over 1 cm <sup>3</sup> (1 g) of Body TSL | Condition          |                                 |
|---|--------------------|---------------------------------|
| SAR measured  | 100 mW input power | 8.42 W/kg                       |
| SAR for nominal Body TSL parameters                   | normalized to 1W   | <b>83.8 W/kg ± 19.9 % (k=2)</b> |

| SAR averaged over 10 cm <sup>3</sup> (10 g) of Body TSL | condition          |                                 |
|---|--------------------|---------------------------------|
| SAR measured  | 100 mW input power | 2.34 W/kg                       |
| SAR for nominal Body TSL parameters                     | normalized to 1W   | <b>23.3 W/kg ± 19.5 % (k=2)</b> |

**Body TSL parameters at 5800 MHz**

The following parameters and calculations were applied.

|   | Temperature     | Permittivity | Conductivity     |
|---|-----------------|--------------|------------------|
| Nominal Body TSL parameters             | 22.0 °C         | 48.2         | 6.00 mho/m       |
| Measured Body TSL parameters            | (22.0 ± 0.2) °C | 46.9 ± 6 %   | 6.23 mho/m ± 6 % |
| Body TSL temperature change during test | < 0.5 °C        | ----         | ----             |

**SAR result with Body TSL at 5800 MHz**

| SAR averaged over 1 cm <sup>3</sup> (1 g) of Body TSL | Condition          |                                 |
|---|--------------------|---------------------------------|
| SAR measured  | 100 mW input power | 8.06 W/kg                       |
| SAR for nominal Body TSL parameters                   | normalized to 1W   | <b>80.3 W/kg ± 19.9 % (k=2)</b> |

| SAR averaged over 10 cm <sup>3</sup> (10 g) of Body TSL | condition          |                                 |
|---|--------------------|---------------------------------|
| SAR measured  | 100 mW input power | 2.23 W/kg                       |
| SAR for nominal Body TSL parameters                     | normalized to 1W   | <b>22.2 W/kg ± 19.5 % (k=2)</b> |



### Appendix (Additional assessments outside the scope of SCS 0108)

#### Antenna Parameters with Head TSL at 5200 MHz

|                                      |                                |
|--------------------------------------|--------------------------------|
| Impedance, transformed to feed point | 51.3 $\Omega$ - 8.6 j $\Omega$ |
| Return Loss                          | - 21.3 dB                      |

#### Antenna Parameters with Head TSL at 5500 MHz

|                                      |                                |
|--------------------------------------|--------------------------------|
| Impedance, transformed to feed point | 51.8 $\Omega$ - 5.7 j $\Omega$ |
| Return Loss                          | - 24.7 dB                      |

#### Antenna Parameters with Head TSL at 5800 MHz

|                                      |                                |
|--------------------------------------|--------------------------------|
| Impedance, transformed to feed point | 55.3 $\Omega$ - 1.7 j $\Omega$ |
| Return Loss                          | - 25.6 dB                      |

#### Antenna Parameters with Body TSL at 5200 MHz

|                                      |                                |
|--------------------------------------|--------------------------------|
| Impedance, transformed to feed point | 51.9 $\Omega$ - 7.5 j $\Omega$ |
| Return Loss                          | - 22.4 dB                      |

#### Antenna Parameters with Body TSL at 5500 MHz

|                                      |                                |
|--------------------------------------|--------------------------------|
| Impedance, transformed to feed point | 52.8 $\Omega$ - 3.0 j $\Omega$ |
| Return Loss                          | - 28.0 dB                      |

#### Antenna Parameters with Body TSL at 5800 MHz

|                                      |                                |
|--------------------------------------|--------------------------------|
| Impedance, transformed to feed point | 56.6 $\Omega$ + 0.3 j $\Omega$ |
| Return Loss                          | - 24.1 dB                      |

#### General Antenna Parameters and Design

|                                  |          |
|----------------------------------|----------|
| Electrical Delay (one direction) | 1.204 ns |
|----------------------------------|----------|

After long term use with 100W radiated power, only a slight warming of the dipole near the feedpoint can be measured.

The dipole is made of standard semirigid coaxial cable. The center conductor of the feeding line is directly connected to the second arm of the dipole. The antenna is therefore short-circuited for DC-signals. On some of the dipoles, small end caps are added to the dipole arms in order to improve matching when loaded according to the position as explained in the "Measurement Conditions" paragraph. The SAR data are not affected by this change. The overall dipole length is still according to the Standard.

No excessive force must be applied to the dipole arms, because they might bend or the soldered connections near the feedpoint may be damaged.

#### Additional EUT Data

|                 |               |
|-----------------|---------------|
| Manufactured by | SPEAG         |
| Manufactured on | June 09, 2006 |

Antenna Parameters with Head TSL at 5200 MHz

|                                      | From cal. data  | Measured        |
|--------------------------------------|-----------------|-----------------|
| Impedance; transformed to feed point | 51.3 Ω - 8.6 jΩ | 48.8 Ω - 7.6 jΩ |
| Return Loss                          | - 21.3 dB       | - 22.16 dB      |

24 Oct 2016 12:56:03  
 CH1 S11 1 U FS 1: 48.785 n -7.5820 n 4.0367 pF 5 200.000 000 MHz

Ap

Cor

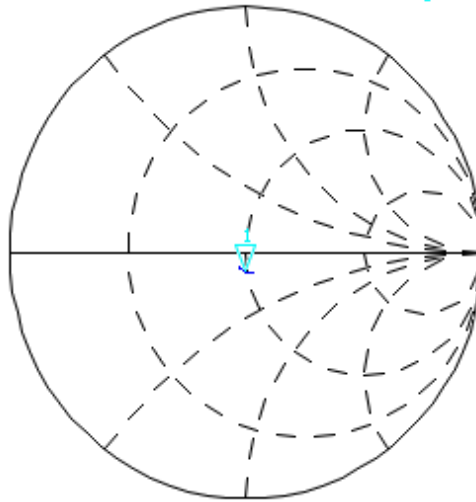

↑

CH2 S11 LOG 5 dB/ REF -20 dB 1: -22.216 dB 5 200.000 000 MHz

Cor

↑

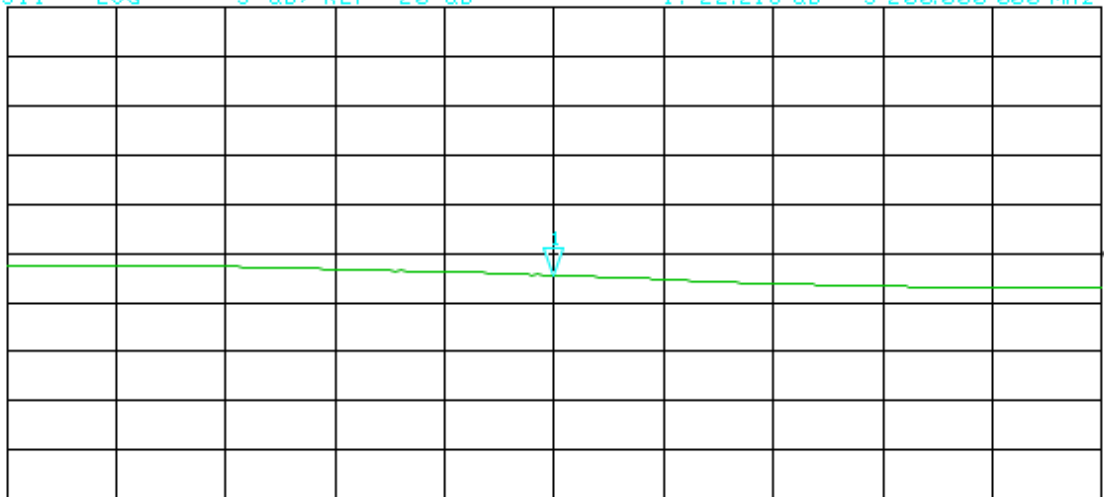

START 5 150.000 000 MHz

STOP 5 250.000 000 MHz

Antenna Parameters with Head TSL at 5500 MHz

|                                      | From cal. data  | Measured        |
|--------------------------------------|-----------------|-----------------|
| Impedance; transformed to feed point | 51.8 Ω - 5.7 jΩ | 52.3 Ω - 4.9 jΩ |
| Return Loss                          | - 24.7 dB       | - 25.5 dB       |

24 Oct 2016 13:41:53

CH1 S11 1 U FS 1:52.322n -4.9473n 5.8491 pF 5 500.000 000 MHz

Ap

Cor

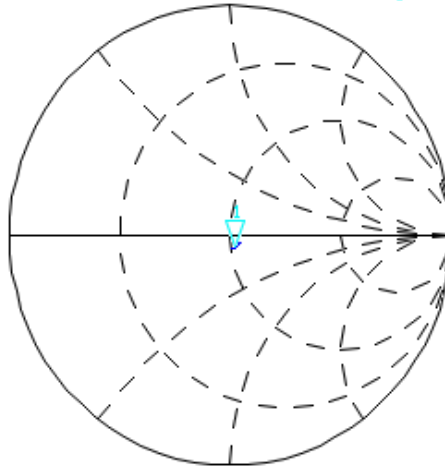

f

CH2 S11 LOG 5 dB/ REF -20 dB 1:-25.452 dB 5 500.000 000 MHz

MARKER 1  
5.5 GHz

Cor

f

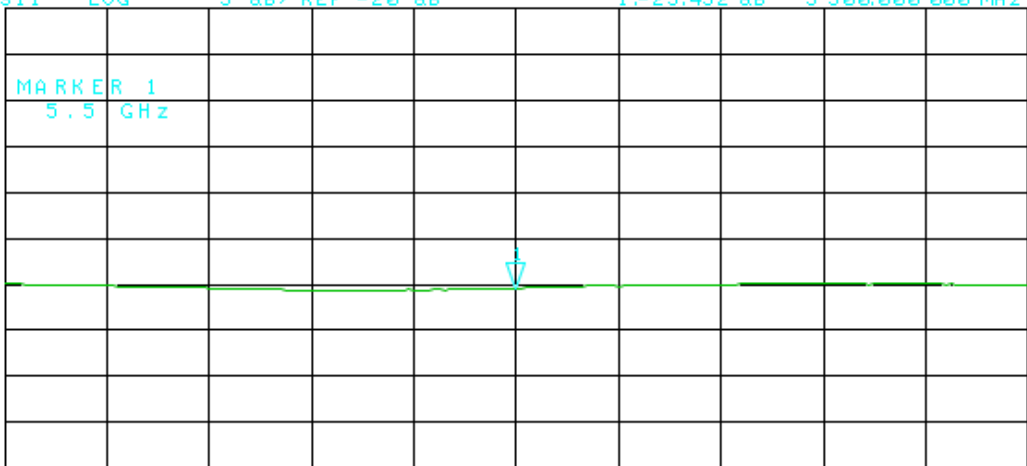

START 5 450.000 000 MHz

STOP 5 550.000 000 MHz

Antenna Parameters with Head TSL at 5800 MHz

|                                      | From cal. data                 | Measured                       |
|--------------------------------------|--------------------------------|--------------------------------|
| Impedance; transformed to feed point | 55.3 $\Omega$ - 1.7 j $\Omega$ | 53.4 $\Omega$ - 3.9 j $\Omega$ |
| Return Loss                          | - 25.6 dB                      | - 25.9 dB                      |

24 Oct 2016 13:35:46  
 CH1 S11 1 U FS 1:53.4140 -3.94920 6.9483 pF 5 800.000 000 MHz

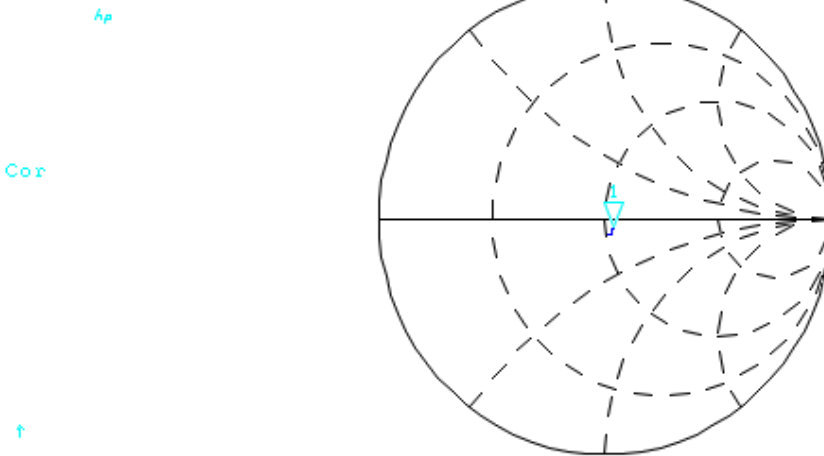

CH2 S11 LOG 5 dB/REF -20 dB 1:-25.940 dB 5 800.000 000 MHz

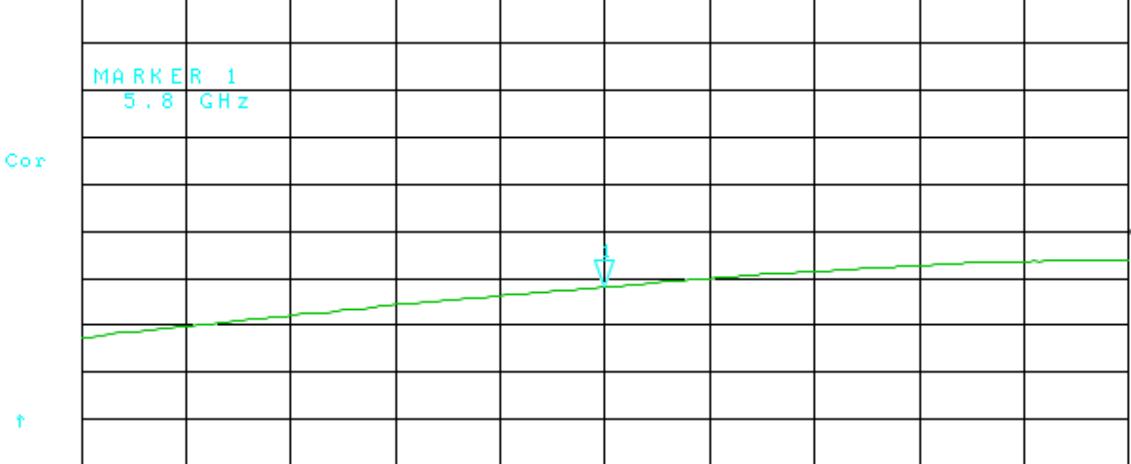

CENTER 5 800.000 000 MHz

SPAN 100.000 000 MHz

Antenna Parameters with Body TSL at 5200 MHz

|                                      | From cal. data  | Measured        |
|--------------------------------------|-----------------|-----------------|
| Impedance; transformed to feed point | 51.9 Ω - 7.5 jΩ | 49.2 Ω - 8.1 jΩ |
| Return Loss                          | - 22.4 dB       | - 21.7 dB       |

24 Oct 2016 12:58:44  
 CH1 S11 1 U FS 1:49.244n -8.1367n 3.7616 pF 5 200.000 000 MHz

Ap

Cor

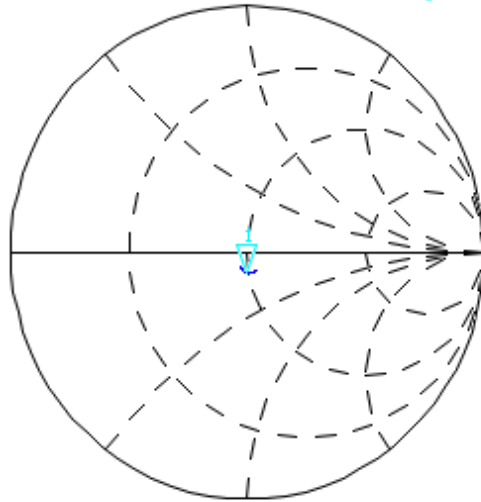

f

CH2 S11 LOG 5 dB/ REF -20 dB 1:-21.714 dB 5 200.000 000 MHz

Cor

f

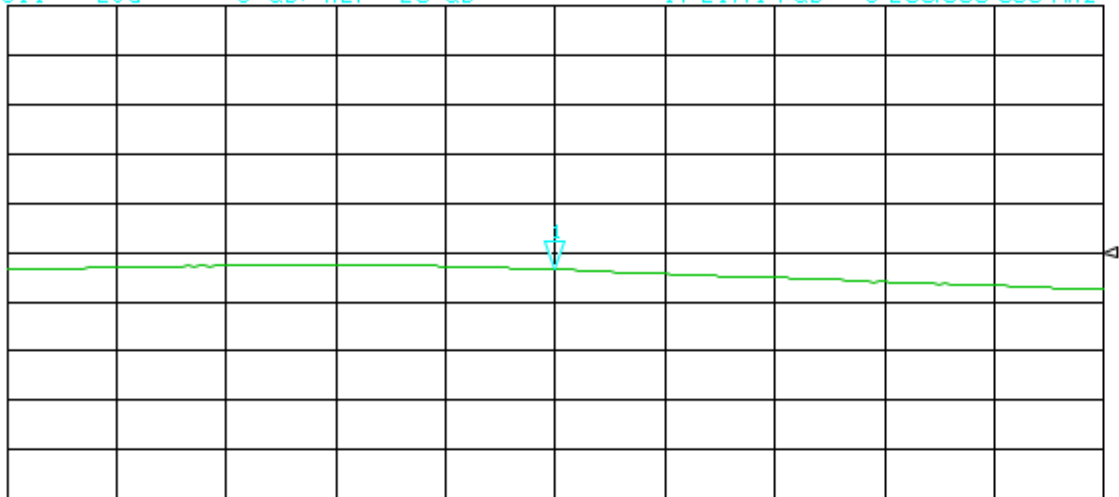

START 5 150.000 000 MHz

STOP 5 250.000 000 MHz

Antenna Parameters with Body TSL at 5500 MHz

|                                      | From cal. data  | Measured        |
|--------------------------------------|-----------------|-----------------|
| Impedance; transformed to feed point | 52.8 Ω - 3.0 jΩ | 50.7 Ω - 3.8 jΩ |
| Return Loss                          | - 28.0 dB       | - 28.4 dB       |

24 Oct 2016 13:44:10  
 CH1 S11 1 U FS 1:50.711n -3.7539n 7.7086 pF 5 500.000 000 MHz

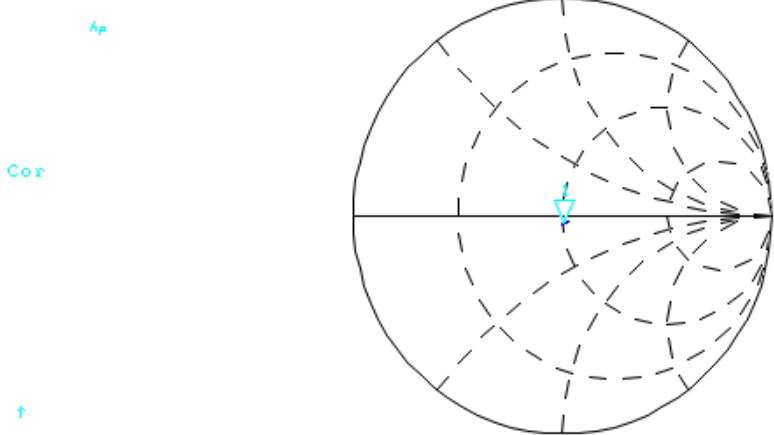

CH2 S11 LOG 5 dB/ REF -20 dB 1:-28.420 dB 5 500.000 000 MHz

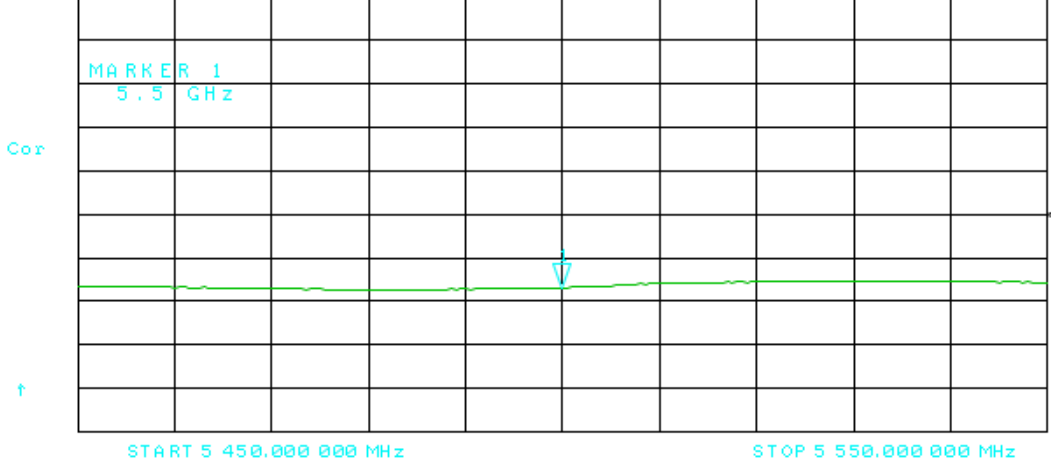



Antenna Parameters with Body TSL at 5800 MHz

|                                      | From cal. data  | Measured        |
|--------------------------------------|-----------------|-----------------|
| Impedance; transformed to feed point | 56.6 Ω - 0.3 jΩ | 54.7 Ω - 1.7 jΩ |
| Return Loss                          | - 24.1 dB       | - 26.4 dB       |

24 Oct 2016 13:37:38  
 CH1 S11 1 U FS 1: 54.703 Ω -1.7363 Ω 15.804 pF 5 800.000 000 MHz

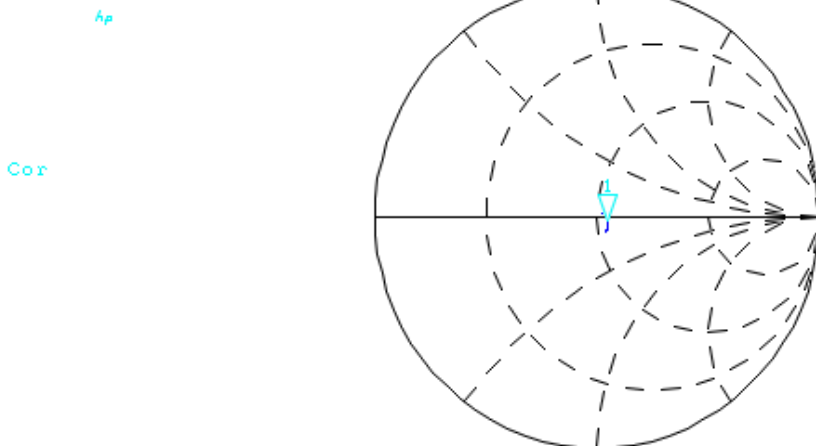

CH2 S11 LOG 5 dB/ REF -20 dB 1: -26.396 dB 5 800.000 000 MHz

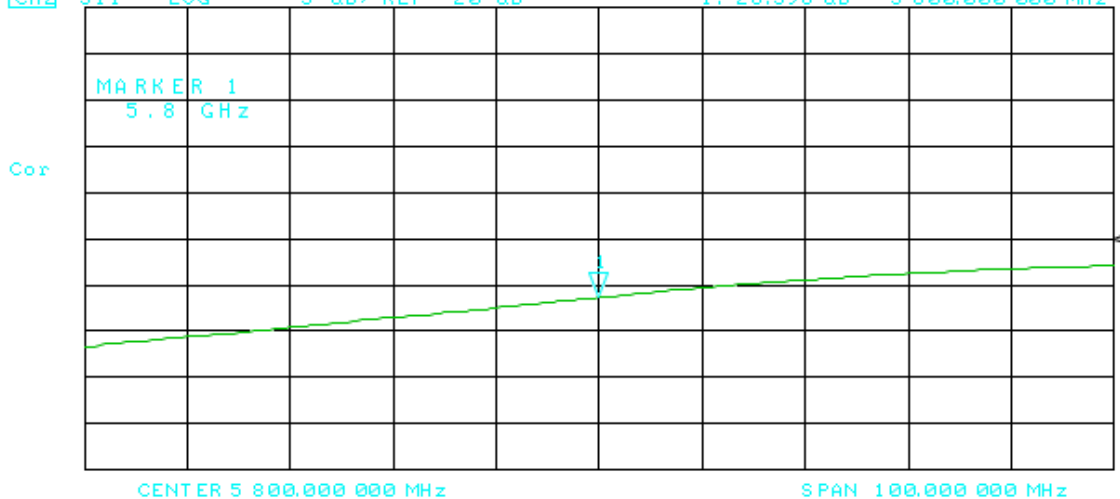

**DASY5 Validation Report for Head TSL**

Date: 13.08.2015

Test Laboratory: SPEAG, Zurich, Switzerland

**DUT: Dipole 5GHz; Type: D5GHzV2; Serial: D5GHzV2 - SN: 1055**

Communication System: UID 0 - CW; Frequency: 5200 MHz, Frequency: 5500 MHz, Frequency: 5800 MHz  
 Medium parameters used:  $f = 5200$  MHz;  $\sigma = 4.53$  S/m;  $\epsilon_r = 35.5$ ;  $\rho = 1000$  kg/m<sup>3</sup>, Medium parameters used:  $f = 5500$  MHz;  $\sigma = 4.82$  S/m;  $\epsilon_r = 35.1$ ;  $\rho = 1000$  kg/m<sup>3</sup>, Medium parameters used:  $f = 5800$  MHz;  $\sigma = 5.14$  S/m;  $\epsilon_r = 34.7$ ;  $\rho = 1000$  kg/m<sup>3</sup>

Phantom section: Flat Section

Measurement Standard: DASY5 (IEEE/IEC/ANSI C63.19-2011)

DASY52 Configuration:

- Probe: EX3DV4 - SN3503; ConvF(5.51, 5.51, 5.51); Calibrated: 30.12.2014, ConvF(5.12, 5.12, 5.12); Calibrated: 30.12.2014, ConvF(4.9, 4.9, 4.9); Calibrated: 30.12.2014;
- Sensor-Surface: 1.4mm (Mechanical Surface Detection)
- Electronics: DAE4 Sn601; Calibrated: 18.08.2014
- Phantom: Flat Phantom 5.0 (front); Type: QD000P50AA; Serial: 1001
- DASY52 52.8.8(1222); SEMCAD X 14.6.10(7331)

**Dipole Calibration for Head Tissue/Pin=100mW, dist=10mm, f=5200 MHz/Zoom Scan,****dist=1.4mm (8x8x7)/Cube 0:** Measurement grid: dx=4mm, dy=4mm, dz=1.4mm

Reference Value = 66.35 V/m; Power Drift = -0.01 dB

Peak SAR (extrapolated) = 30.2 W/kg

**SAR(1 g) = 8.28 W/kg; SAR(10 g) = 2.37 W/kg**

Maximum value of SAR (measured) = 19.1 W/kg

**Dipole Calibration for Head Tissue/Pin=100mW, dist=10mm, f=5500 MHz/Zoom Scan,****dist=1.4mm (8x8x7)/Cube 0:** Measurement grid: dx=4mm, dy=4mm, dz=1.4mm

Reference Value = 66.35 V/m; Power Drift = 0.06 dB

Peak SAR (extrapolated) = 34.7 W/kg

**SAR(1 g) = 8.75 W/kg; SAR(10 g) = 2.49 W/kg**

Maximum value of SAR (measured) = 20.8 W/kg

**Dipole Calibration for Head Tissue/Pin=100mW, dist=10mm, f=5800 MHz/Zoom Scan,****dist=1.4mm (8x8x7)/Cube 0:** Measurement grid: dx=4mm, dy=4mm, dz=1.4mm

Reference Value = 63.65 V/m; Power Drift = 0.07 dB

Peak SAR (extrapolated) = 34.4 W/kg

**SAR(1 g) = 8.32 W/kg; SAR(10 g) = 2.36 W/kg**

Maximum value of SAR (measured) = 20.2 W/kg

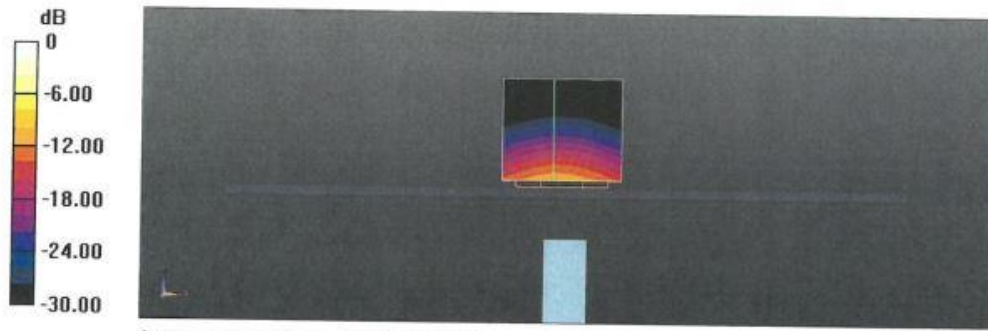

0 dB = 19.1 W/kg = 12.81 dBW/kg

**Impedance Measurement Plot for Head TSL**

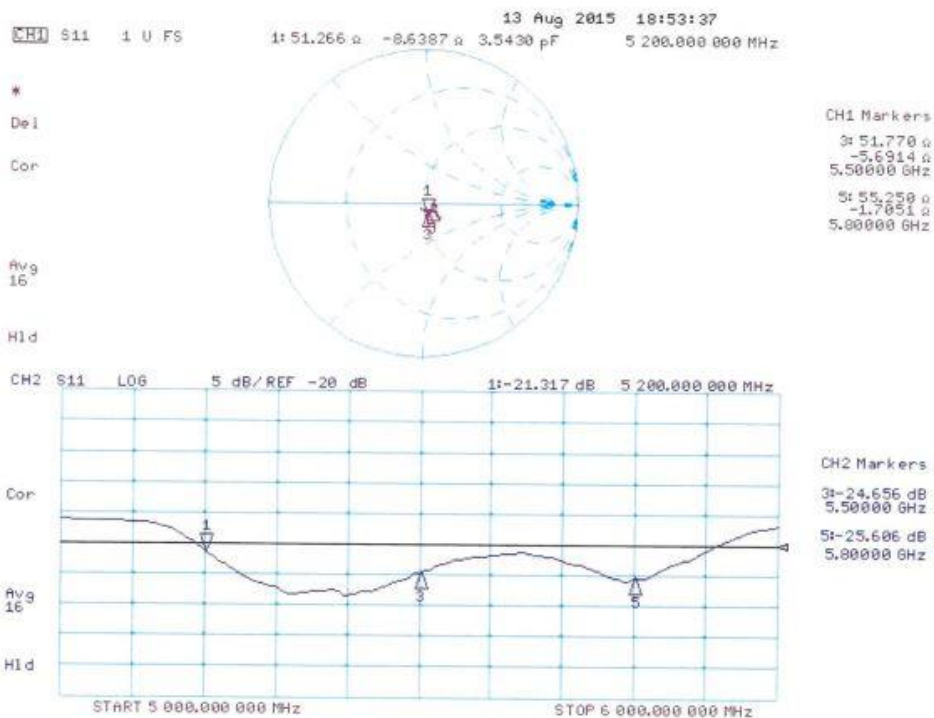

## DASY5 Validation Report for Body TSL

Date: 14.08.2015

Test Laboratory: SPEAG, Zurich, Switzerland

**DUT: Dipole 5GHz; Type: D5GHzV2; Serial: D5GHzV2 - SN: 1055**

Communication System: UID 0 - CW; Frequency: 5200 MHz, Frequency: 5500 MHz, Frequency: 5800 MHz  
 Medium parameters used:  $f = 5200$  MHz;  $\sigma = 5.43$  S/m;  $\epsilon_r = 47.9$ ;  $\rho = 1000$  kg/m<sup>3</sup>, Medium parameters used:  $f = 5500$  MHz;  $\sigma = 5.82$  S/m;  $\epsilon_r = 47.3$ ;  $\rho = 1000$  kg/m<sup>3</sup>, Medium parameters used:  $f = 5800$  MHz;  $\sigma = 6.23$  S/m;  $\epsilon_r = 46.9$ ;  $\rho = 1000$  kg/m<sup>3</sup>

Phantom section: Flat Section

Measurement Standard: DASY5 (IEEE/IEC/ANSI C63.19-2011)

DASY52 Configuration:

- Probe: EX3DV4 - SN3503; ConvF(4.95, 4.95, 4.95); Calibrated: 30.12.2014, ConvF(4.45, 4.45, 4.45); Calibrated: 30.12.2014, ConvF(4.32, 4.32, 4.32); Calibrated: 30.12.2014;
- Sensor-Surface: 1.4mm (Mechanical Surface Detection)
- Electronics: DAE4 Sn601; Calibrated: 18.08.2014
- Phantom: Flat Phantom 5.0 (back); Type: QD000P50AA; Serial: 1002
- DASY52 52.8.8(1222); SEMCAD X 14.6.10(7331)

### Dipole Calibration for Body Tissue/Pin=100mW, dist=10mm, f=5200 MHz/Zoom Scan,

**dist=1.4mm (8x8x7)/Cube 0:** Measurement grid: dx=4mm, dy=4mm, dz=1.4mm

Reference Value = 59.81 V/m; Power Drift = -0.02 dB

Peak SAR (extrapolated) = 29.7 W/kg

SAR(1 g) = 7.69 W/kg; SAR(10 g) = 2.16 W/kg

Maximum value of SAR (measured) = 17.5 W/kg

### Dipole Calibration for Body Tissue/Pin=100mW, dist=10mm, f=5500 MHz/Zoom Scan,

**dist=1.4mm (8x8x7)/Cube 0:** Measurement grid: dx=4mm, dy=4mm, dz=1.4mm

Reference Value = 60.49 V/m; Power Drift = -0.00 dB

Peak SAR (extrapolated) = 35.7 W/kg

SAR(1 g) = 8.42 W/kg; SAR(10 g) = 2.34 W/kg

Maximum value of SAR (measured) = 20.0 W/kg

### Dipole Calibration for Body Tissue/Pin=100mW, dist=10mm, f=5800 MHz/Zoom Scan,

**dist=1.4mm (8x8x7)/Cube 0:** Measurement grid: dx=4mm, dy=4mm, dz=1.4mm

Reference Value = 57.86 V/m; Power Drift = -0.02 dB

Peak SAR (extrapolated) = 37.0 W/kg

SAR(1 g) = 8.06 W/kg; SAR(10 g) = 2.23 W/kg

Maximum value of SAR (measured) = 19.7 W/kg

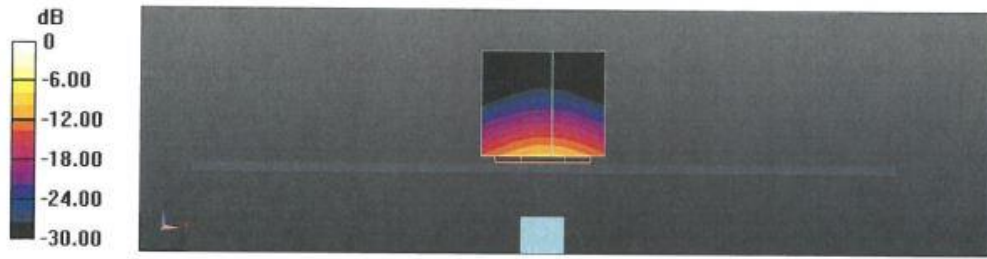



### Impedance Measurement Plot for Body TSL

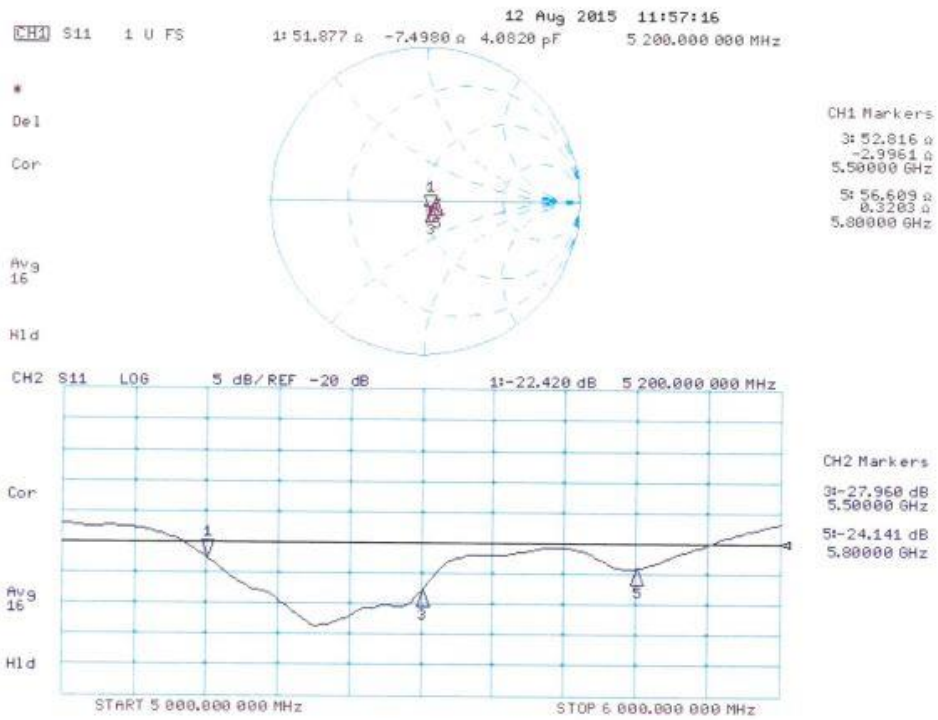

**6 Calibration certificate of Data Acquisition Unit (DAE)**

**Calibration Laboratory of  
Schmid & Partner  
Engineering AG**  
Zeughausstrasse 43, 8004 Zurich, Switzerland



**S** Schweizerischer Kalibrierdienst  
**S** Service suisse d'étalonnage  
**C** Servizio svizzero di taratura  
**S** Swiss Calibration Service

Accredited by the Swiss Accreditation Service (SAS)  
The Swiss Accreditation Service is one of the signatories to the EA  
Multilateral Agreement for the recognition of calibration certificates

Accreditation No.: **SCS 0108**

Client **CTC advanced GmbH**

Certificate No: **DAE3-413\_Jan17**

**CALIBRATION CERTIFICATE**

Object **DAE3 - SD 000 D03 AA - SN: 413**

Calibration procedure(s) **QA CAL-06.v29  
Calibration procedure for the data acquisition electronics (DAE)**

Calibration date: **January 11, 2017**

This calibration certificate documents the traceability to national standards, which realize the physical units of measurements (SI).  
The measurements and the uncertainties with confidence probability are given on the following pages and are part of the certificate.

All calibrations have been conducted in the closed laboratory facility: environment temperature (22 ± 3)°C and humidity < 70%.

Calibration Equipment used (M&TE critical for calibration)

| Primary Standards             | ID #               | Cal Date (Certificate No.) | Scheduled Calibration  |
|-------------------------------|--------------------|----------------------------|------------------------|
| Keithley Multimeter Type 2001 | SN: 0810278        | 09-Sep-16 (No:19065)       | Sep-17                 |
| Secondary Standards           | ID #               | Check Date (in house)      | Scheduled Check        |
| Auto DAE Calibration Unit     | SE UWS 053 AA 1001 | 05-Jan-16 (in house check) | In house check: Jan-17 |
| Calibrator Box V2.1           | SE UMS 006 AA 1002 | 05-Jan-16 (in house check) | In house check: Jan-17 |

|                |                       |                          |               |
|----------------|-----------------------|--------------------------|---------------|
| Calibrated by: | Name<br>Eric Hainfeld | Function<br>Technician   | Signature<br> |
| Approved by:   | Fin Bomholt           | Deputy Technical Manager |               |

Issued: January 13, 2017

This calibration certificate shall not be reproduced except in full without written approval of the laboratory.

**7 Calibration certificate of Data Acquisition Unit (DAE)**

**Calibration Laboratory of  
Schmid & Partner  
Engineering AG**  
Zeughausstrasse 43, 8004 Zurich, Switzerland



**S** Schweizerischer Kalibrierdienst  
**C** Service suisse d'étalonnage  
**S** Servizio svizzero di taratura  
**S** Swiss Calibration Service

Accredited by the Swiss Accreditation Service (SAS)  
The Swiss Accreditation Service is one of the signatories to the EA  
Multilateral Agreement for the recognition of calibration certificates

Accreditation No.: **SCS 0108**

Client **CTC advanced GmbH**

Certificate No: **DAE3-477\_May17**

| CALIBRATION CERTIFICATE   |   |                            |                        |                   |      |                            |                       |                               |             |                      |        |                     |      |                       |                 |  |                    |                            |                        |                    |                            |                        |
|---|---|----------------------------|------------------------|-------------------|------|----------------------------|-----------------------|-------------------------------|-------------|----------------------|--------|---------------------|------|-----------------------|-----------------|--|--------------------|----------------------------|------------------------|--------------------|----------------------------|------------------------|
| Object  | DAE3 - SD 000 D03 AA - SN: 477  |                            |                        |                   |      |                            |                       |                               |             |                      |        |                     |      |                       |                 |  |                    |                            |                        |                    |                            |                        |
| Calibration procedure(s)  | QA CAL-06.v29<br>Calibration procedure for the data acquisition electronics (DAE) |                            |                        |                   |      |                            |                       |                               |             |                      |        |                     |      |                       |                 |  |                    |                            |                        |                    |                            |                        |
| Calibration date:   | May 12, 2017  |                            |                        |                   |      |                            |                       |                               |             |                      |        |                     |      |                       |                 |  |                    |                            |                        |                    |                            |                        |
| <p>This calibration certificate documents the traceability to national standards, which realize the physical units of measurements (SI). The measurements and the uncertainties with confidence probability are given on the following pages and are part of the certificate.</p> <p>All calibrations have been conducted in the closed laboratory facility: environment temperature (22 ± 3)°C and humidity &lt; 70%.</p> <p>Calibration Equipment used (M&amp;TE critical for calibration)</p> <table border="1"> <thead> <tr> <th>Primary Standards</th> <th>ID #</th> <th>Cal Date (Certificate No.)</th> <th>Scheduled Calibration</th> </tr> </thead> <tbody> <tr> <td>Keithley Multimeter Type 2001</td> <td>SN: 0810278</td> <td>09-Sep-16 (No:19065)</td> <td>Sep-17</td> </tr> <tr> <th>Secondary Standards</th> <th>ID #</th> <th>Check Date (in house)</th> <th>Scheduled Check</th> </tr> <tr> <td rowspan="2">Auto DAE Calibration Unit<br/>Calibrator Box V2.1</td> <td>SE UWS 053 AA 1001</td> <td>05-Jan-17 (in house check)</td> <td>In house check: Jan-18</td> </tr> <tr> <td>SE UMS 006 AA 1002</td> <td>05-Jan-17 (in house check)</td> <td>In house check: Jan-18</td> </tr> </tbody> </table> |   |                            |                        | Primary Standards | ID # | Cal Date (Certificate No.) | Scheduled Calibration | Keithley Multimeter Type 2001 | SN: 0810278 | 09-Sep-16 (No:19065) | Sep-17 | Secondary Standards | ID # | Check Date (in house) | Scheduled Check | Auto DAE Calibration Unit<br>Calibrator Box V2.1 | SE UWS 053 AA 1001 | 05-Jan-17 (in house check) | In house check: Jan-18 | SE UMS 006 AA 1002 | 05-Jan-17 (in house check) | In house check: Jan-18 |
| Primary Standards   | ID #  | Cal Date (Certificate No.) | Scheduled Calibration  |                   |      |                            |                       |                               |             |                      |        |                     |      |                       |                 |  |                    |                            |                        |                    |                            |                        |
| Keithley Multimeter Type 2001   | SN: 0810278   | 09-Sep-16 (No:19065)       | Sep-17                 |                   |      |                            |                       |                               |             |                      |        |                     |      |                       |                 |  |                    |                            |                        |                    |                            |                        |
| Secondary Standards   | ID #  | Check Date (in house)      | Scheduled Check        |                   |      |                            |                       |                               |             |                      |        |                     |      |                       |                 |  |                    |                            |                        |                    |                            |                        |
| Auto DAE Calibration Unit<br>Calibrator Box V2.1  | SE UWS 053 AA 1001  | 05-Jan-17 (in house check) | In house check: Jan-18 |                   |      |                            |                       |                               |             |                      |        |                     |      |                       |                 |  |                    |                            |                        |                    |                            |                        |
|   | SE UMS 006 AA 1002  | 05-Jan-17 (in house check) | In house check: Jan-18 |                   |      |                            |                       |                               |             |                      |        |                     |      |                       |                 |  |                    |                            |                        |                    |                            |                        |
| Calibrated by:  | Name<br>Adrian Gehring  | Function<br>Technician     | Signature<br>          |                   |      |                            |                       |                               |             |                      |        |                     |      |                       |                 |  |                    |                            |                        |                    |                            |                        |
| Approved by:  | Fin Bomholt   | Deputy Technical Manager   |                        |                   |      |                            |                       |                               |             |                      |        |                     |      |                       |                 |  |                    |                            |                        |                    |                            |                        |
| This calibration certificate shall not be reproduced except in full without written approval of the laboratory.   |   |                            | Issued: May 12, 2017   |                   |      |                            |                       |                               |             |                      |        |                     |      |                       |                 |  |                    |                            |                        |                    |                            |                        |

## 8 Certificate of "SAM Twin Phantom V4.0/V4.0C"

## Schmid & Partner Engineering AG

Zeughausstrasse 43, 8004 Zurich, Switzerland, Phone +41 1 245 97 00, Fax +41 1 245 97 79

### Certificate of conformity / First Article Inspection

|                       |  |
|-----------------------|--|
| Item                  | SAM Twin Phantom V4.0  |
| Type No               | QD 000 P40 BA  |
| Series No             | TP-1002 and higher   |
| Manufacturer / Origin | Untersee Composites<br>Hauptstr. 69<br>CH-8559 Fruthwilen<br>Switzerland |

#### Tests

The series production process used allows the limitation to test of first articles. Complete tests were made on the pre-series Type No. QD 000 P40 AA, Serial No. TP-1001 and on the series first article Type No. QD 000 P40 BA, Serial No. TP-1006. Certain parameters have been retested using further series units (called samples).

| Test                 | Requirement   | Details  | Units tested                 |
|----------------------|---|--|------------------------------|
| Shape                | Compliance with the geometry according to the CAD model.                                | IT'IS CAD File (*)   | First article,<br>Samples    |
| Material thickness   | Compliant with the requirements according to the standards                              | 2mm +/- 0.2mm in specific areas                                      | First article,<br>Samples    |
| Material parameters  | Dielectric parameters for required frequencies  | 200 MHz – 3 GHz<br>Relative permittivity < 5<br>Loss tangent < 0.05. | Material sample<br>TP 104-5  |
| Material resistivity | The material has been tested to be compatible with the liquids defined in the standards | Liquid type HSL 1800 and others according to the standard.           | Pre-series,<br>First article |

#### Standards

- [1] CENELEC EN 50361
- [2] IEEE P1528-200x draft 6.5
- [3] IEC PT 62209 draft 0.9
- (\*) The IT'IS CAD file is derived from [2] and is also within the tolerance requirements of the shapes of [1] and [3].

#### Conformity

Based on the sample tests above, we certify that this item is in compliance with the uncertainty requirements of SAR measurements specified in standard [1] and draft standards [2] and [3].

Date 18.11.2001

Signature / Stamp

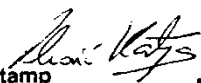

**Schmid & Partner  
Engineering AG**



Zeughausstrasse 43, CH-8004 Zurich  
Tel. +41 1 245 97 00, Fax +41 1 245 97 79

## 9 Application Note System Performance Check

### 9.1 Purpose of system performance check

The system performance check verifies that the system operates within its specifications. System and operator errors can be detected and corrected. It is recommended that the system performance check is performed prior to any usage of the system in order to guarantee reproducible results.

The measurement of the Specific Absorption Rate (SAR) is a complicated task and the result depends on the proper functioning of many components and the correct settings of many parameters. Faulty results due to drift, failures or incorrect parameters might not be recognized, since they often look similar in distribution to the correct ones. The Dosimetric Assessment System DASY5 incorporates a system performance check procedure to test the proper functioning of the system. The system performance check uses normal SAR measurements in a simplified setup (the flat section of the SAM Twin Phantom) with a well characterized source (a matched dipole at a specified distance). This setup was selected to give a high sensitivity to all parameters that might fail or vary over time (e.g., probe, liquid parameters, and software settings) and a low sensitivity to external effects inherent in the system (e.g., positioning uncertainty of the device holder). The system performance check does not replace the calibration of the components. The accuracy of the system performance check is not sufficient for calibration purposes. It is possible to calculate the field quite accurately in this simple setup; however, due to the open field situation some factors (e.g., laboratory reflections) cannot be accounted for. Calibrations in the flat phantom are possible with transfer calibration methods, using either temperature probes or calibrated E-field probes. The system performance check also does not test the system performance for arbitrary field situations encountered during real measurements of mobile phones. These checks are performed at SPEAG by testing the components under various conditions (e.g., spherical isotropy measurements in liquid, linearity measurements, temperature variations, etc.), the results of which are used for an error estimation of the system. The system performance check will indicate situations where the system uncertainty is exceeded due to drift or failure.

### 9.2 System Performance check procedure

#### Preparation

The conductivity should be measured before the validation and the measured liquid parameters must be entered in the software. If the measured values differ from targeted values in the dipole document, the liquid composition should be adjusted. If the validation is performed with slightly different (measured) liquid parameters, the expected SAR will also be different. See the application note about SAR sensitivities for an estimate of possible SAR deviations. Note that the liquid parameters are temperature dependent with approximately – 0.5% decrease in permittivity and + 1% increase in conductivity for a temperature decrease of 1° C. The dipole must be placed beneath the flat phantom section of the Generic Twin Phantom with the correct distance holder in place. The distance holder should touch the phantom surface with a light pressure at the reference marking (little hole) and be oriented parallel to the long side of the phantom. Accurate positioning is not necessary, since the system will search for the peak SAR location, except that the dipole arms should be parallel to the surface. The device holder for mobile phones can be left in place but should be rotated away from the dipole. The forward power into the dipole at the dipole SMA connector should be determined as accurately as possible. The actual dipole input power level can be between 20mW and several watts. The result can later be normalized to any power level. It is strongly recommended to note the actually used power level in the „comment“-window of the measurement file; otherwise you lose this crucial information for later reference.

### System Performance Check

The DASY5 installation includes predefined files with recommended procedures for measurements and validation. They are read-only document files and destined as fully defined but unmeasured masks, so you must save the finished validation under a different name. The validation document requires the Generic Twin Phantom, so this phantom must be properly installed in your system. (You can create your own measurement procedures by opening a new document or editing an existing document file). Before you start the validation, you just have to tell the system with which components (probe, medium, and device) you are performing the validation; the system will take care of all parameters. After the validation, which will take about 20 minutes, the results of each task are displayed in the document window. Selecting all measured tasks and opening the predefined "validation" graphic format displays all necessary information for validation. A description of the different measurement tasks in the predefined document is given below, together with the information that can be deduced from their results:

- The „reference“ and „drift“ measurements are located at the beginning and end of the batch process. They measure the field drift at one single point in the liquid over the complete procedure. The indicated drift is mainly the variation of the amplifier output power. If it is too high (above  $\pm 0.1\text{dB}$ ) the validation should be repeated; some amplifiers have very high drift during warm-up. A stable amplifier gives drift results in the DASY5 system below  $\pm 0.02\text{ dB}$ .
- The „area scan“ measures the SAR above the dipole on a parallel plane to the surface. It is used to locate the approximate location of the peak SAR with 2D spline interpolation. The proposed scan uses large grid spacing for faster measurement; due to the symmetric field the peak detection is reliable. If a finer graphic is desired, the grid spacing can be reduced. Grid spacing and orientation have no influence on the SAR result.
- The zoom scan job measures the field in a volume around the peak SAR value assessed in the previous „area“ scan (for more information see the application note on SAR evaluation).

If the validation measurements give reasonable results, the peak 1g and 10g spatial SAR values averaged between the two cubes and normalized to 1W dipole input power give the reference data for comparisons. The next section analyzes the expected uncertainties of these values. Section 6 describes some additional checks for further information or troubleshooting.

### 9.3 Uncertainty Budget

Please note that in the following Tables, the tolerance of the following uncertainty components depends on the actual equipment and setup at the user location and need to be either assessed or verified on-site by the end user of the DASY5 system:

- RF ambient conditions
- Dipole Axis to Liquid Distance
- Input power and SAR drift measurement
- Liquid permittivity - measurement uncertainty
- Liquid conductivity - measurement uncertainty

Note: All errors are given in percent of SAR, so 0.1 dB corresponds to 2.3%. The field error would be half of that. The liquid parameter assessment give the targeted values from the dipole document. All errors are given in percent of SAR, so 0.1dB corresponds to 2.3%. The field error would be half of that.



## System validation

In the table below, the system validation uncertainty with respect to the analytically assessed SAR value of a dipole source as given in the IEEE1528 standard is given. This uncertainty is smaller than the expected uncertainty for mobile phone measurements due to the simplified setup and the symmetric field distribution.

| Uncertainty Budget for System Validation<br>for the 0.3 - 6 GHz range |                   |                          |         |       |       |                      |            |                      |  |
|---|-------------------|--------------------------|---------|-------|-------|----------------------|------------|----------------------|--|
| Source of uncertainty   | Uncertainty Value | Probability Distribution | Divisor | $c_i$ | $c_i$ | Standard Uncertainty |            | $v_i^2$ or $v_{eff}$ |  |
|   |                   |                          |         | (1g)  | (10g) | ± %, (1g)            | ± %, (10g) |                      |  |
| <b>Measurement System</b>   |                   |                          |         |       |       |                      |            |                      |  |
| Probe calibration   | ± 6.6 %           | Normal                   | 1       | 1     | 1     | ± 6.6 %              | ± 6.6 %    | ∞                    |  |
| Axial isotropy  | ± 4.7 %           | Rectangular              | √ 3     | 1     | 1     | ± 2.7 %              | ± 2.7 %    | ∞                    |  |
| Hemispherical isotropy  | ± 9.6 %           | Rectangular              | √ 3     | 0     | 0     | ± 0.0 %              | ± 0.0 %    | ∞                    |  |
| Boundary effects  | ± 1.0 %           | Rectangular              | √ 3     | 1     | 1     | ± 0.6 %              | ± 0.6 %    | ∞                    |  |
| Probe linearity   | ± 4.7 %           | Rectangular              | √ 3     | 1     | 1     | ± 2.7 %              | ± 2.7 %    | ∞                    |  |
| System detection limits   | ± 1.0 %           | Rectangular              | √ 3     | 1     | 1     | ± 0.6 %              | ± 0.6 %    | ∞                    |  |
| Readout electronics   | ± 0.3 %           | Normal                   | 1       | 1     | 1     | ± 0.3 %              | ± 0.3 %    | ∞                    |  |
| Response time   | ± 0.0 %           | Rectangular              | √ 3     | 1     | 1     | ± 0.0 %              | ± 0.0 %    | ∞                    |  |
| Integration time  | ± 0.0 %           | Rectangular              | √ 3     | 1     | 1     | ± 0.0 %              | ± 0.0 %    | ∞                    |  |
| RF ambient conditions   | ± 1.0 %           | Rectangular              | √ 3     | 1     | 1     | ± 0.6 %              | ± 0.6 %    | ∞                    |  |
| Probe positioner  | ± 0.8 %           | Rectangular              | √ 3     | 1     | 1     | ± 0.5 %              | ± 0.5 %    | ∞                    |  |
| Probe positioning   | ± 6.7 %           | Rectangular              | √ 3     | 1     | 1     | ± 3.9 %              | ± 3.9 %    | ∞                    |  |
| Max. SAR evaluation   | ± 2.0 %           | Rectangular              | √ 3     | 1     | 1     | ± 1.2 %              | ± 1.2 %    | ∞                    |  |
| <b>Dipole Related</b>   |                   |                          |         |       |       |                      |            |                      |  |
| Dev. of exp. dipole   | ± 5.5 %           | Rectangular              | √ 3     | 1     | 1     | ± 3.2 %              | ± 3.2 %    | ∞                    |  |
| Dipole Axis to Liquid Dist.   | ± 2.0 %           | Rectangular              | √ 3     | 1     | 1     | ± 1.2 %              | ± 1.2 %    | ∞                    |  |
| Input power & SAR drift   | ± 3.4 %           | Rectangular              | √ 3     | 1     | 1     | ± 2.0 %              | ± 2.0 %    | ∞                    |  |
| <b>Phantom and Set-up</b>   |                   |                          |         |       |       |                      |            |                      |  |
| Phantom uncertainty   | ± 4.0 %           | Rectangular              | √ 3     | 1     | 1     | ± 2.3 %              | ± 2.3 %    | ∞                    |  |
| SAR correction  | ± 1.9 %           | Rectangular              | √ 3     | 1     | 0.84  | ± 1.1 %              | ± 0.9 %    | ∞                    |  |
| Liquid conductivity (meas.)   | ± 5.0 %           | Normal                   | 1       | 0.78  | 0.71  | ± 3.9 %              | ± 3.6 %    | ∞                    |  |
| Liquid permittivity (meas.)   | ± 5.0 %           | Normal                   | 1       | 0.26  | 0.26  | ± 1.3 %              | ± 1.3 %    | ∞                    |  |
| Temp. unc. - Conductivity   | ± 1.7 %           | Rectangular              | √ 3     | 0.78  | 0.71  | ± 0.8 %              | ± 0.7 %    | ∞                    |  |
| Temp. unc. - Permittivity   | ± 0.3 %           | Rectangular              | √ 3     | 0.23  | 0.26  | ± 0.0 %              | ± 0.0 %    | ∞                    |  |
| <b>Combined Uncertainty</b>   |                   |                          |         |       |       | ± 10.7 %             | ± 10.6 %   | 330                  |  |
| <b>Expanded Std. Uncertainty</b>                                      |                   |                          |         |       |       | ± 21.4 %             | ± 21.1 %   |                      |  |

Table 1: Measurement uncertainties of the System Validation with DASY5 (0.3-6GHz). The RF ambient noise uncertainty has been reduced to ±1.0, considering input power levels are ≥ 250mW.

**Performance check repeatability**

The repeatability check of the validation is insensitive to external effects and gives an indication of the variations in the DASY5 measurement system, provided that the same power reading setup is used for all validations. The repeatability estimates for frequencies below and above 3GHz are given in the following tables:

| Repeatability Budget for System Check<br>for the 0.3 - 3 GHz range |                   |                          |         |                |                |                      |            |                                |
|--|-------------------|--------------------------|---------|----------------|----------------|----------------------|------------|--------------------------------|
| Source of uncertainty  | Uncertainty Value | Probability Distribution | Divisor | c <sub>i</sub> | c <sub>i</sub> | Standard Uncertainty |            | v <sub>i</sub> <sup>2</sup> or |
|  |                   |                          |         | (1g)           | (10g)          | ± %, (1g)            | ± %, (10g) | v <sub>eff</sub>               |
| <b>Measurement System</b>  |                   |                          |         |                |                |                      |            |                                |
| Repeatability of probe cal.  | ± 1.8 %           | Normal                   | 1       | 1              | 1              | ± 1.8 %              | ± 1.8 %    | ∞                              |
| Axial isotropy   | ± 0.0 %           | Rectangular              | √ 3     | 1              | 1              | ± 0.0 %              | ± 0.0 %    | ∞                              |
| Hemispherical isotropy   | ± 0.0 %           | Rectangular              | √ 3     | 1              | 1              | ± 0.0 %              | ± 0.0 %    | ∞                              |
| Boundary effects   | ± 0.0 %           | Rectangular              | √ 3     | 1              | 1              | ± 0.0 %              | ± 0.0 %    | ∞                              |
| Probe linearity  | ± 0.0 %           | Rectangular              | √ 3     | 1              | 1              | ± 0.0 %              | ± 0.0 %    | ∞                              |
| System detection limits  | ± 0.0 %           | Rectangular              | √ 3     | 1              | 1              | ± 0.0 %              | ± 0.0 %    | ∞                              |
| Modulation response  | ± 0.0 %           | Rectangular              | √ 3     | 1              | 1              | ± 0.0 %              | ± 0.0 %    | ∞                              |
| Readout electronics  | ± 0.0 %           | Normal                   | 1       | 1              | 1              | ± 0.0 %              | ± 0.0 %    | ∞                              |
| Response time  | ± 0.0 %           | Rectangular              | √ 3     | 1              | 1              | ± 0.0 %              | ± 0.0 %    | ∞                              |
| Integration time   | ± 0.0 %           | Rectangular              | √ 3     | 1              | 1              | ± 0.0 %              | ± 0.0 %    | ∞                              |
| RF ambient noise   | ± 0.0 %           | Rectangular              | √ 3     | 1              | 1              | ± 0.0 %              | ± 0.0 %    | ∞                              |
| RF ambient positioning   | ± 0.0 %           | Rectangular              | √ 3     | 1              | 1              | ± 0.0 %              | ± 0.0 %    | ∞                              |
| Probe positioner   | ± 0.4 %           | Rectangular              | √ 3     | 1              | 1              | ± 0.2 %              | ± 0.2 %    | ∞                              |
| Probe positioning  | ± 2.9 %           | Rectangular              | √ 3     | 1              | 1              | ± 1.7 %              | ± 1.7 %    | ∞                              |
| Max. SAR evaluation  | ± 0.0 %           | Rectangular              | √ 3     | 1              | 1              | ± 0.0 %              | ± 0.0 %    | ∞                              |
| <b>Dipole Related</b>  |                   |                          |         |                |                |                      |            |                                |
| Dev. of experimental dipole  | ± 0.0 %           | Rectangular              | √ 3     | 1              | 1              | ± 0.0 %              | ± 0.0 %    | ∞                              |
| Dipole axis to liquid dist.  | ± 2.0 %           | Rectangular              | √ 3     | 1              | 1              | ± 1.2 %              | ± 1.2 %    | ∞                              |
| Input power & SAR drift  | ± 3.4 %           | Rectangular              | √ 3     | 1              | 1              | ± 2.0 %              | ± 2.0 %    | ∞                              |
| <b>Phantom and Set-up</b>  |                   |                          |         |                |                |                      |            |                                |
| Phantom uncertainty  | ± 4.0 %           | Rectangular              | √ 3     | 1              | 1              | ± 2.3 %              | ± 2.3 %    | ∞                              |
| SAR correction   | ± 1.9 %           | Rectangular              | √ 3     | 1              | 0.84           | ± 1.1 %              | ± 0.9 %    | ∞                              |
| Liquid conductivity (meas.)  | ± 5.0 %           | Normal                   | 1       | 0.78           | 0.71           | ± 3.9 %              | ± 3.6 %    | ∞                              |
| Liquid permittivity (meas.)  | ± 5.0 %           | Normal                   | 1       | 0.26           | 0.26           | ± 1.3 %              | ± 1.3 %    | ∞                              |
| Temp. unc. - Conductivity  | ± 1.7 %           | Rectangular              | √ 3     | 0.78           | 0.71           | ± 0.8 %              | ± 0.7 %    | ∞                              |
| Temp. unc. - Permittivity  | ± 0.3 %           | Rectangular              | √ 3     | 0.23           | 0.26           | ± 0.0 %              | ± 0.0 %    | ∞                              |
| <b>Combined Uncertainty</b>  |                   |                          |         |                |                | ± 5.9 %              | ± 5.7 %    |                                |
| <b>Expanded Std. Uncertainty</b>                                   |                   |                          |         |                |                | ± 11.9 %             | ± 11.4 %   |                                |

Table 2: Repeatability of the System Check with DASY5 (0.3-3GHz)

| Repeatability Budget for System Check<br>for the 3 - 6 GHz range |                   |  |                          |         |       |       |                      |            |                      |   |
|--|-------------------|--|--------------------------|---------|-------|-------|----------------------|------------|----------------------|---|
| Source of uncertainty  | Uncertainty Value |  | Probability Distribution | Divisor | $c_i$ | $c_i$ | Standard Uncertainty |            | $v_i^2$ or $v_{eff}$ |   |
|  |                   |  |                          |         | (1g)  | (10g) | ± %, (1g)            | ± %, (10g) |                      |   |
| <b>Measurement System</b>  |                   |  |                          |         |       |       |                      |            |                      |   |
| Repeatability of probe cal.                                      | ± 1.8 %           |  | Normal                   | 1       | 1     | 1     | ± 1.8 %              | ± 1.8 %    |                      | ∞ |
| Axial isotropy   | ± 0.0 %           |  | Rectangular              | √ 3     | 1     | 1     | ± 0.0 %              | ± 0.0 %    |                      | ∞ |
| Hemispherical isotropy   | ± 0.0 %           |  | Rectangular              | √ 3     | 1     | 1     | ± 0.0 %              | ± 0.0 %    |                      | ∞ |
| Boundary effects   | ± 0.0 %           |  | Rectangular              | √ 3     | 1     | 1     | ± 0.0 %              | ± 0.0 %    |                      | ∞ |
| Probe linearity  | ± 0.0 %           |  | Rectangular              | √ 3     | 1     | 1     | ± 0.0 %              | ± 0.0 %    |                      | ∞ |
| System detection limits  | ± 0.0 %           |  | Rectangular              | √ 3     | 1     | 1     | ± 0.0 %              | ± 0.0 %    |                      | ∞ |
| Modulation response  | ± 0.0 %           |  | Rectangular              | √ 3     | 1     | 1     | ± 0.0 %              | ± 0.0 %    |                      | ∞ |
| Readout electronics  | ± 0.0 %           |  | Normal                   | 1       | 1     | 1     | ± 0.0 %              | ± 0.0 %    |                      | ∞ |
| Response time  | ± 0.0 %           |  | Rectangular              | √ 3     | 1     | 1     | ± 0.0 %              | ± 0.0 %    |                      | ∞ |
| Integration time   | ± 0.0 %           |  | Rectangular              | √ 3     | 1     | 1     | ± 0.0 %              | ± 0.0 %    |                      | ∞ |
| RF ambient noise   | ± 0.0 %           |  | Rectangular              | √ 3     | 1     | 1     | ± 0.0 %              | ± 0.0 %    |                      | ∞ |
| RF ambient positioning   | ± 0.0 %           |  | Rectangular              | √ 3     | 1     | 1     | ± 0.0 %              | ± 0.0 %    |                      | ∞ |
| Probe positioner   | ± 0.8 %           |  | Rectangular              | √ 3     | 1     | 1     | ± 0.5 %              | ± 0.5 %    |                      | ∞ |
| Probe positioning  | ± 6.7 %           |  | Rectangular              | √ 3     | 1     | 1     | ± 3.9 %              | ± 3.9 %    |                      | ∞ |
| Max. SAR evaluation  | ± 0.0 %           |  | Rectangular              | √ 3     | 1     | 1     | ± 0.0 %              | ± 0.0 %    |                      | ∞ |
| <b>Dipole Related</b>  |                   |  |                          |         |       |       |                      |            |                      |   |
| Dev. of experimental dipole                                      | ± 0.0 %           |  | Rectangular              | √ 3     | 1     | 1     | ± 0.0 %              | ± 0.0 %    |                      | ∞ |
| Dipole axis to liquid dist.                                      | ± 2.0 %           |  | Rectangular              | √ 3     | 1     | 1     | ± 1.2 %              | ± 1.2 %    |                      | ∞ |
| Input power & SAR drift  | ± 3.4 %           |  | Rectangular              | √ 3     | 1     | 1     | ± 2.0 %              | ± 2.0 %    |                      | ∞ |
| <b>Phantom and Set-up</b>  |                   |  |                          |         |       |       |                      |            |                      |   |
| Phantom uncertainty  | ± 4.0 %           |  | Rectangular              | √ 3     | 1     | 1     | ± 2.3 %              | ± 2.3 %    |                      | ∞ |
| SAR correction   | ± 1.9 %           |  | Rectangular              | √ 3     | 1     | 0.84  | ± 1.1 %              | ± 0.9 %    |                      | ∞ |
| Liquid conductivity (meas.)                                      | ± 5.0 %           |  | Normal                   | 1       | 0.78  | 0.71  | ± 3.9 %              | ± 3.6 %    |                      | ∞ |
| Liquid permittivity (meas.)                                      | ± 5.0 %           |  | Normal                   | 1       | 0.26  | 0.26  | ± 1.3 %              | ± 1.3 %    |                      | ∞ |
| Temp. unc. - Conductivity  | ± 1.7 %           |  | Rectangular              | √ 3     | 0.78  | 0.71  | ± 0.8 %              | ± 0.7 %    |                      | ∞ |
| Temp. unc. - Permittivity  | ± 0.3 %           |  | Rectangular              | √ 3     | 0.23  | 0.26  | ± 0.0 %              | ± 0.0 %    |                      | ∞ |
| <b>Combined Uncertainty</b>                                      |                   |  |                          |         |       |       | ± 6.9 %              | ± 6.7 %    |                      |   |
| <b>Expanded Std. Uncertainty</b>                                 |                   |  |                          |         |       |       | ± 13.8 %             | ± 13.4 %   |                      |   |

Table 3: Repeatability of the System Check with DASYS (3-6GHz)

Note: Worst case probe calibration uncertainty has been applied for all probes used during the measurements.

The expected repeatability deviation is low. Excessive drift (e.g., drift in liquid parameters), partial system failures or incorrect parameter settings (e.g., wrong probe or device settings) will lead to unexpectedly high repeatability deviations. The repeatability gives an indication that the system operates within its initial specifications. Excessive drift, system failure and operator errors are easily detected.

## 9.4 Power set-up for validation

The uncertainty of the dipole input power is a significant contribution to the absolute uncertainty and the expected deviation in interlaboratory comparisons. The values in Section 2 for a typical and a sophisticated setup are just average values. Refer to the manual of the power meter and the detector head for the evaluation of the uncertainty in your system. The uncertainty also depends on the source matching and the general setup. Below follows the description of a recommended setup and procedures to increase the accuracy of the power reading:

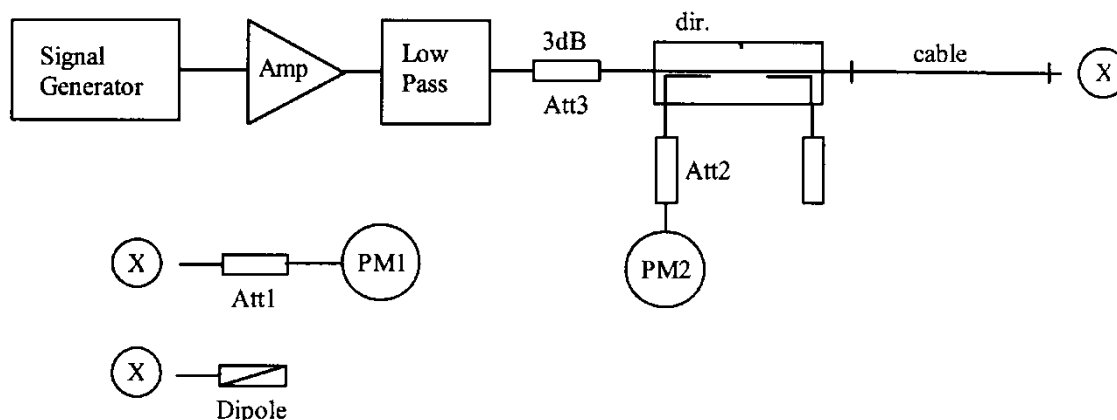

The figure shows the recommended setup. The PM1 (incl. Att1) measures the forward power at the location of the validation dipole connector. The signal generator is adjusted for the desired forward power at the dipole connector and the power meter PM2 is read at that level. After connecting the cable to the dipole, the signal generator is readjusted for the same reading at power meter PM2. If the signal generator does not allow a setting in 0.01dB steps, the remaining difference at PM2 must be noted and considered in the normalization of the validation results. The requirements for the components are:

- The signal generator and amplifier should be stable (after warm-up). The forward power to the dipole should be above 10mW to avoid the influence of measurement noise. If the signal generator can deliver 15dBm or more, an amplifier is not necessary. Some high power amplifiers should not be operated at a level far below their maximum output power level (e.g. a 100W power amplifier operated at 250mW output can be quite noisy). An attenuator between the signal generator and amplifier is recommended to protect the amplifier input.
- The low pass filter after the amplifier reduces the effect of harmonics and noise from the amplifier. For most amplifiers in normal operation the filter is not necessary.
- The attenuator after the amplifier improves the source matching and the accuracy of the power head. (See power meter manual.) It can also be used also to make the amplifier operate at its optimal output level for noise and stability. In a setup without directional coupler, this attenuator should be at least 10dB.
- The directional coupler (recommended <sup>3</sup> 20dB) is used to monitor the forward power and adjust the signal generator output for constant forward power. A medium quality coupler is sufficient because the loads (dipole and power head) are well matched. (If the setup is used for reflective loads, a high quality coupler with respect to directivity and output matching is necessary to avoid additional errors.)
- The power meter PM2 should have a low drift and a resolution of 0.01dBm, but otherwise its accuracy has no impact on the power setting. Calibration is not required.
- The cable between the coupler and dipole must be of high quality, without large attenuation and phase changes when it is moved. Otherwise, the power meter head PM1 should be brought to the location of the dipole for measuring.
- The power meter PM1 and attenuator Att1 must be high quality components. They should be calibrated, preferably together. The attenuator (<sup>3</sup>10dB) improves the accuracy of the power reading. (Some higher power heads come with a built-in calibrated attenuator.) The exact attenuation of the attenuator at the frequency used must be known; many attenuators are up to 0.2dB off from the specified value.
- Use the same power level for the power setup with power meter PM1 as for the actual measurement to avoid linearity and range switching errors in the power meter PM2. If the validation is performed at various power levels, do the power setting procedure at each level.

- The dipole must be connected directly to the cable at location “X”. If the power meter has a different connector system, use high quality couplers. Preferably, use the couplers at the attenuator Att1 and calibrate the attenuator with the coupler.
- Always remember: We are measuring power, so 1% is equivalent to 0.04dB.

## 9.5 Laboratory reflection

In near-field situations, the absorption is predominantly caused by induction effects from the magnetic near-field. The absorption from reflected fields in the laboratory is negligible. On the other hand, the magnetic field around the dipole depends on the currents and therefore on the feed point impedance. The feed point impedance of the dipole is mainly determined from the proximity of the absorbing phantom, but reflections in the laboratory can change the impedance slightly. A 1% increase in the real part of the feed point impedance will produce approximately a 1% decrease in the SAR for the same forward power. The possible influence of laboratory reflections should be investigated during installation. The validation setup is suitable for this check, since the validation is sensitive to laboratory reflections. The same tests can be performed with a mobile phone, but most phones are less sensitive to reflections due to the shorter distance to the phantom. The fastest way to check for reflection effects is to position the probe in the phantom above the feed point and start a continuous field measurement in the DASY5 multi-meter window. Placing absorbers in front of possible reflectors (e.g. on the ground near the dipole or in front of a metallic robot socket) will reveal their influence immediately. A 10dB absorber (e.g. ferrite tiles or flat absorber mats) is probably sufficient, as the influence of the reflections is small anyway. If you place the absorber too near the dipole, the absorber itself will interact with the reactive near-field. Instead of measuring the SAR, it is also possible to monitor the dipole impedance with a network analyzer for reflection effects. The network analyzer must be calibrated at the SMA connector and the electrical delay (two times the forward delay in the dipole document) must be set in the NWA for comparisons with the reflection data in the dipole document. If the absorber has a significant influence on the results, the absorber should be left in place for validation or measurements. The reference data in the dipole document are produced in a low reflection environment.

## 9.6 Additional system checks

While the validation gives a good check of the DASY5 system components, it does not include all parameters necessary for real phone measurements (e.g. device modulation or device positioning). For system validation (repeatability) or comparisons between laboratories a reference device can be useful. This can be any mobile phone with a stable output power (preferably a device whose output power can be set through the keyboard). For comparisons, the same device should be sent around, since the SAR variations between samples can be large. Several measurement possibilities in the DASY5 software allow additional tests of the performance of the DASY5 system and components. These tests can be useful to localize component failures:

- The validation can be performed at different power levels to check the noise level or the correct compensation of the diode compression in the probe.
- If a pulsed signal with high peak power levels is fed to the dipole, the performance of the diode compression compensation can be tested. The correct crest factor parameter in the DASY5 software must be set (see manual). The system should give the same SAR output for the same averaged input power.
- The probe isotropy can be checked with a 1D-probe rotation scan above the feed point. The automatic probe alignment procedure must be passed through for accurate probe rotation movements (optional DASY5 feature with a robot-mounted light beam unit). Otherwise the probe tip might move on a small circle during rotation, producing some additional isotropy errors in gradient fields.