

# FCC Test Report

**FCC ID** : SQG-SSD45N  
**Equipment** : Radio Module  
**Model No.** : SSD45N  
**Brand Name** : Laird Technologies  
**Applicant** : Laird Technologies  
**Address** : 11160 Thompson Ave. / Lenexa, Kansas /  
66219 / USA  
**Standard** : 47 CFR FCC Part 15.407  
**Received Date** : May 08, 2013  
**Tested Date** : May 08 ~ Jul. 23, 2013

We, International Certification Corp., would like to declare that the tested sample has been evaluated and in compliance with the requirement of the above standards. The test results contained in this report refer exclusively to the product. It may be duplicated completely for legal use with the approval of the applicant. It shall not be reproduced except in full without the written approval of our laboratory.

Approved & Reviewed by:

  
\_\_\_\_\_  
Gary Chang / Manager



---

## Table of Contents

<b>1</b>	<b>GENERAL DESCRIPTION .....</b>	<b>5</b>
1.1	Information.....	5
1.2	Local Support Equipment List .....	7
1.3	Test Setup Chart .....	7
1.4	The Equipment List .....	8
1.5	Testing Applied Standards .....	9
1.6	Measurement Uncertainty .....	9
<b>2</b>	<b>TEST CONFIGURATION .....</b>	<b>10</b>
2.1	Testing Condition .....	10
2.2	The Worst Test Modes and Channel Details .....	10
<b>3</b>	<b>TRANSMITTER TEST RESULTS.....</b>	<b>11</b>
3.1	Conducted Emissions.....	11
3.2	Emission Bandwidth .....	14
3.3	RF Output Power.....	16
3.4	Peak Power Spectral Density.....	18
3.5	Peak Excursion.....	20
3.6	Transmitter Radiated and Band Edge Emissions .....	23
3.7	Frequency Stability.....	140

---

## Release Record

Report No.	Version	Description	Issued Date
FR442904AN	Rev. 01	Initial issue	May 13, 2014

## Summary of Test Results

FCC Rules	Test Items	Measured	Result
15.207	Conducted Emissions	[dBuV]: 0.156MHz 41.84 (Margin -13.85dB) - AV	Pass
15.407(b) 15.209	Radiated Emissions	[dBuV/m at 3m]: 5725.00MHz 53.00 (Margin -1.00dB) - AV	Pass
15.407(a)	Emission Bandwidth	Meet the requirement of limit	Pass
15.407(a)	RF Output Power	Power [dBm]: 5150~5250 MHz : 16.55 5250~5350 MHz : 16.82 5470~5725 MHz : 17.91	Pass
15.407(a)	Peak Power Spectral Density	Meet the requirement of limit	Pass
15.407(a)	Peak Excursion	Meet the requirement of limit	Pass
15.407(g)	Frequency Stability	Meet the requirement of limit	Pass
15.203	Antenna Requirement	Meet the requirement of limit	Pass

# 1 General Description

## 1.1 Information

### 1.1.1 Specification of the Equipment under Test (EUT)

RF General Information					
Frequency Range (MHz)	IEEE Std. 802.11	Ch. Freq. (MHz)	Channel Number	Transmit Chains (N <sub>TX</sub> )	Data Rate / MCS
5150-5250 5250-5350 5470-5725	a	5180-5240 5260-5320 5500-5700	36-48 [4] 52-64 [4] 100-140 [8]	1	6-54 Mbps
5150-5250 5250-5350 5470-5725	n (HT20)	5180-5240 5260-5320 5500-5700	36-48 [4] 52-64 [4] 100-140 [8]	1	MCS 0-7

Note 1: RF output power specifies that Maximum Conducted Output Power.  
Note 2: 802.11a/n uses a combination of OFDM-BPSK, QPSK, 16QAM, 64QAM modulation.

### 1.1.2 Antenna Details

Ant. No.	Brand / Model	Type	Connector	Operating Frequencies (MHz) / Antenna Gain (dBi)				
				2400~2483.5	5150~5250	5250~5350	5470~5725	5725~5850
1	MAG.LAYERS EDA-1513-25GR 2-B2-CY	Dipole	SMA Jack Reverse	2	2	2	2	2
2	MAG.LAYERS PCA-4606-2G4C 1-A13-CY	PCB Dipole	UFL	2.21	2.21	2.21	2.21	2.21
3	Larid NanoBlade-IP04	PCB Dipole	UFL	2	3.9	3.9	4	4
4	Larid MAF95310 Mini NanoBlade Flex	PCB Dipole	UFL	2.79	3.38	3.38	3.38	3.38
5	Laird NanoBlue-IP04	PCB Dipole	UFL	2	---	---	---	-
6	Ethertronics WLAN_1000146	PIFA	UFL	2.5	3.5	3.5	3.5	3.5

### 1.1.3 EUT Operational Condition

<b>Supply Voltage</b>	<input type="checkbox"/> AC mains	<input checked="" type="checkbox"/> DC (3.3Vdc)	
<b>Type of DC Source</b>	<input type="checkbox"/> Internal DC supply	<input type="checkbox"/> External DC adapter	<input checked="" type="checkbox"/> From Host

### 1.1.4 Accessories

N/A

### 1.1.5 Channel List

Frequency band (MHz)	
802.11 a / n HT20	
Channel	Frequency(MHz)
36	5180
40	5200
44	5220
48	5240
52	5260
56	5280
60	5300
64	5320
100	5500
104	5520
108	5540
112	5560
116	5580
132	5660
136	5680
140	5700

### 1.1.6 Test Tool and Duty Cycle

<b>Test Tool</b>	ART V0.2
<b>Duty Cycle Of Test Signal (%)</b>	99.30% - IEEE 802.11a 99.62% - IEEE 802.11n (HT20)
<b>Duty Factor</b>	0.03 - IEEE 802.11a 0.02 - IEEE 802.11n (HT20)

### 1.1.7 Power Setting

Modulation Mode	Test Frequency (MHz)								
	a / n HT20								
	5180	5200	5240	5260	5300	5320	5500	5580	5700
a	18	17.5	19	19.5	19.5	19.5	21.5	21.5	20.5
n (HT20)	17.5	17	18.5	19	19	19	21.5	21.5	20.5

## 1.2 Local Support Equipment List

Support Equipment List					
No.	Equipment	Brand	Model	FCC ID	Signal cable / Length (m)
1	Notebook	DELL	E6430	DoC	---
2	45 Series Pluggable module	Laird Technologies	MSD45N	SQG-MSD45N	---
3	Testing board	---	---	---	---

Note: Item 2-3 are provided by applicant.

## 1.3 Test Setup Chart

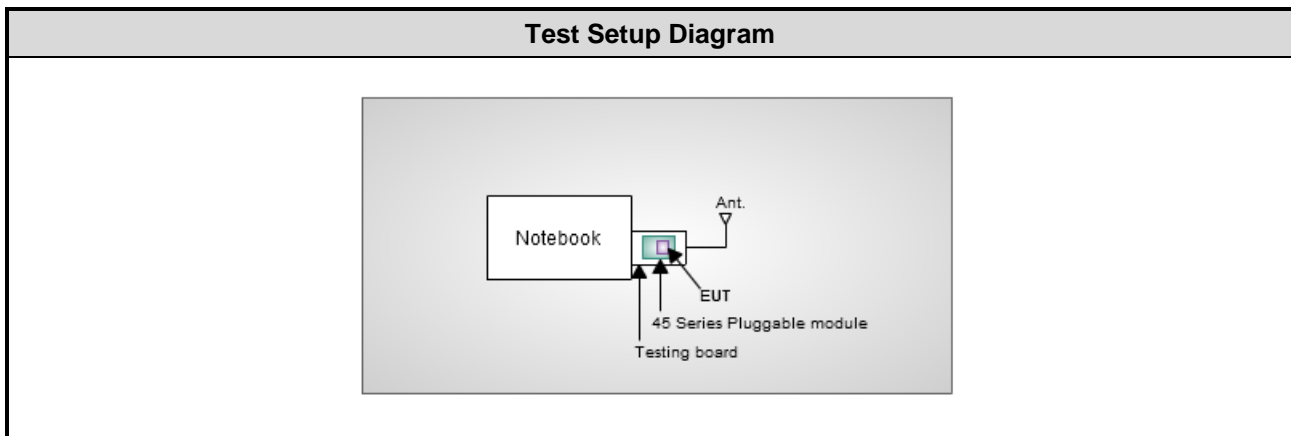

## 1.4 The Equipment List

<b>Test Item</b>	Conducted Emission				
<b>Test Site</b>	Conduction room 1 / (CO01-WS)				
<b>Instrument</b>	<b>Manufacturer</b>	<b>Model No.</b>	<b>Serial No.</b>	<b>Calibration Date</b>	<b>Calibration Until</b>
EMC Receiver	R&S	ESCS 30	100169	Oct. 02, 2012	Oct. 01, 2013
LISN	SCHWARZBECK MESS-ELEKTRONIK	Schwarzbeck 8127	8127-667	Dec. 04, 2012	Dec. 03, 2013
LISN (Support Unit)	SCHWARZBECK MESS-ELEKTRONIK	Schwarzbeck 8127	8127-666	Dec. 04, 2012	Dec. 03, 2013
50 ohm terminal (Support Unit)	NA	50	04	Apr. 22, 2013	Apr. 21, 2014
Note: Calibration Interval of instruments listed above is one year.					

<b>Test Item</b>	Radiated Emission above 1GHz				
<b>Test Site</b>	966 chamber1 / (03CH01-WS)				
<b>Instrument</b>	<b>Manufacturer</b>	<b>Model No.</b>	<b>Serial No.</b>	<b>Calibration Date</b>	<b>Calibration Until</b>
3m semi-anechoic chamber	CHAMPRO	SAC-03	03CH01-WS	Jan. 04, 2013	Jan. 03, 2014
Spectrum Analyzer	R&S	FSV40	101498	Jan. 24, 2013	Jan. 23, 2014
Receiver	R&S	ESR3	101658	Jan. 28, 2013	Jan. 27, 2014
Bilog Antenna	SCHWARZBECK	VULB9168	VULB9168-522	Jan. 11, 2013	Jan. 10, 2014
Horn Antenna 1G-18G	SCHWARZBECK	BBHA 9120 D	BBHA 9120 D 1096	Feb. 18, 2013	Feb. 17, 2014
Horn Antenna 18G-40G	SCHWARZBECK	BBHA 9170	BBHA 9170517	Jan. 14, 2013	Jan. 13, 2014
Amplifier	Burgeon	BPA-530	100219	Nov. 28, 2012	Nov. 27, 2013
Amplifier	Agilent	83017A	MY39501308	Dec. 18, 2012	Dec. 17, 2013
RF Cable	HUBER+SUHNER	SUCOFLEX104	MY16014/4	Dec. 25, 2012	Dec. 24, 2013
RF Cable	HUBER+SUHNER	SUCOFLEX104	MY16019/4	Dec. 25, 2012	Dec. 24, 2013
RF Cable	HUBER+SUHNER	SUCOFLEX104	MY16139/4	Dec. 25, 2012	Dec. 24, 2013
RF Cable-R03m	Woken	CFD400NL-LW	CFD400NL-001	Dec. 25, 2012	Dec. 24, 2013
RF Cable-R10m	Woken	CFD400NL-LW	CFD400NL-002	Dec. 25, 2012	Dec. 24, 2013
control	EM Electronics	EM1000	60612	N/A	N/A
Note: Calibration Interval of instruments listed above is one year.					

Loop Antenna	R&S	HFH2-Z2	100330	Nov. 15, 2012	Nov. 14, 2014
Amplifier	MITEQ	AMF-6F-260400	9121372	Apr. 19, 2013	Apr. 18, 2015
Note: Calibration Interval of instruments listed above is two year.					



<b>Test Item</b>	RF Conducted				
<b>Test Site</b>	(TH01-WS)				
<b>Instrument</b>	<b>Manufacturer</b>	<b>Model No.</b>	<b>Serial No.</b>	<b>Calibration Date</b>	<b>Calibration Until</b>
Spectrum Analyzer	R&S	FSV 40	101063	Feb. 18, 2013	Feb. 17, 2014
TEMP&HUMIDITY CHAMBER	GIANT FORCE	GCT-225-40-SP-SD	MAF1212-002	Nov. 29, 2012	Nov. 28, 2013
Power Meter	Anritsu	ML2495A	1241002	Oct. 15, 2012	Oct. 14, 2013
Power Sensor	Anritsu	MA2411B	1027366	Oct. 24, 2012	Oct. 23, 2013
Signal Generator	R&S	SMB100A	175727	Jan. 14, 2013	Jan. 13, 2014
Note: Calibration Interval of instruments listed above is one year.					

## 1.5 Testing Applied Standards

According to the specification of EUT, the EUT must comply with following standards and KDB documents.

47 CFR FCC Part 15.407

ANSI C63.10-2009

FCC KDB 789033 D01 General UNII Test procedures v01r03

Note: The EUT has been tested and complied with FCC part 15B requirement. FCC Part 15B test results are issued to another report.

## 1.6 Measurement Uncertainty

ISO/IEC 17025 requires that an estimate of the measurement uncertainties associated with the emissions test results be included in the report. The measurement uncertainties given below are based on a 95% confidence level (based on a coverage factor (k=2))

Measurement Uncertainty	
Parameters	Uncertainty
Bandwidth	±74.147 Hz
Conducted power	±0.717 dB
Power density	±2.687 dB
Frequency error	±74.147 Hz
Temperature	±0.3 °C
AC conducted emission	±2.43 dB
Radiated emission	±2.49 dB

## 2 Test Configuration

### 2.1 Testing Condition

Test Item	Test Site	Ambient Condition	Tested By
AC Conduction	CO01-WS	23°C / 63%	Peter Ling
Radiated Emissions	03CH01-WS	25°C / 65%	Aska Huang Haru Yang
RF Conducted	TH01-WS	22°C / 62%	Felix Sung

➤ FCC site registration No.: 657002

➤ IC site registration No.: 10807A-1

### 2.2 The Worst Test Modes and Channel Details

Test item	Mode	Test Frequency (MHz)	Data rate (Mbps) / MCS	Test Configuration
Conducted Emissions	HT20	5240	MCS 0	1
Radiated Emissions <1GHz	HT20	5240	MCS 0	1, 2, 3
Radiated Emissions >1GHz	11a	5180 / 5200 / 5240	6	1, 2, 3
	11a	5260 / 5300 / 5320	6	
	11a	5500 / 5580 / 5700	6	
	HT20	5180 / 5200 / 5240	MCS 0	
	HT20	5260 / 5300 / 5320	MCS 0	
	HT20	5500 / 5580 / 5700	MCS 0	
RF Output Power Emission Bandwidth Peak Power Spectral Density	11a	5180 / 5200 / 5240	6	1
	11a	5260 / 5300 / 5320	6	
	11a	5500 / 5580 / 5700	6	
	HT20	5180 / 5200 / 5240	MCS 0	
	HT20	5260 / 5300 / 5320	MCS 0	
	HT20	5500 / 5580 / 5700	MCS 0	
Peak Excursion	11a	5240 / 5260 / 5580	6	1
	HT20	5240 / 5260 / 5580	MCS 0	
Frequency Stability	Un-modulation	5320	---	1

**NOTE:**

1. 3 types antenna are used for this device, highest gain antenna of each type is selected to perform radiated emission test as below test configuration
  - 1) Configuration 1 : Dipole antenna (Antenna No.1) , Y-plane
  - 2) Configuration 2 : PCB Dipole antenna (Antenna No.3) , Y-plane
  - 3) Configuration 3 : PIFA antenna (Antenna No.6), Y-plane

## 3 Transmitter Test Results

### 3.1 Conducted Emissions

#### 3.1.1 Limit of Conducted Emissions

Conducted Emissions Limit		
Frequency Emission (MHz)	Quasi-Peak	Average
0.15-0.5	66 - 56 *	56 - 46 *
0.5-5	56	46
5-30	60	50

Note 1: \* Decreases with the logarithm of the frequency.

#### 3.1.2 Test Procedures

1. The device is placed on a test table, raised 80 cm above the reference ground plane. The vertical conducting plane is located 40 cm to the rear of the device.
2. The device is connected to line impedance stabilization network (LISN) and other accessories are connected to other LISN. Measured levels of AC power line conducted emission are across the 50  $\Omega$  LISN port.
3. AC conducted emission measurements is made over frequency range from 150 kHz to 30 MHz.
4. This measurement was performed with AC 120V / 60Hz.

#### 3.1.3 Test Setup



- Note: 1. Support units were connected to second LISN.  
 2. Both of LISNs (AMN) are 80 cm from EUT and at least 80 cm from other units and other metal planes

### 3.1.4 Test Result of Conducted Emissions

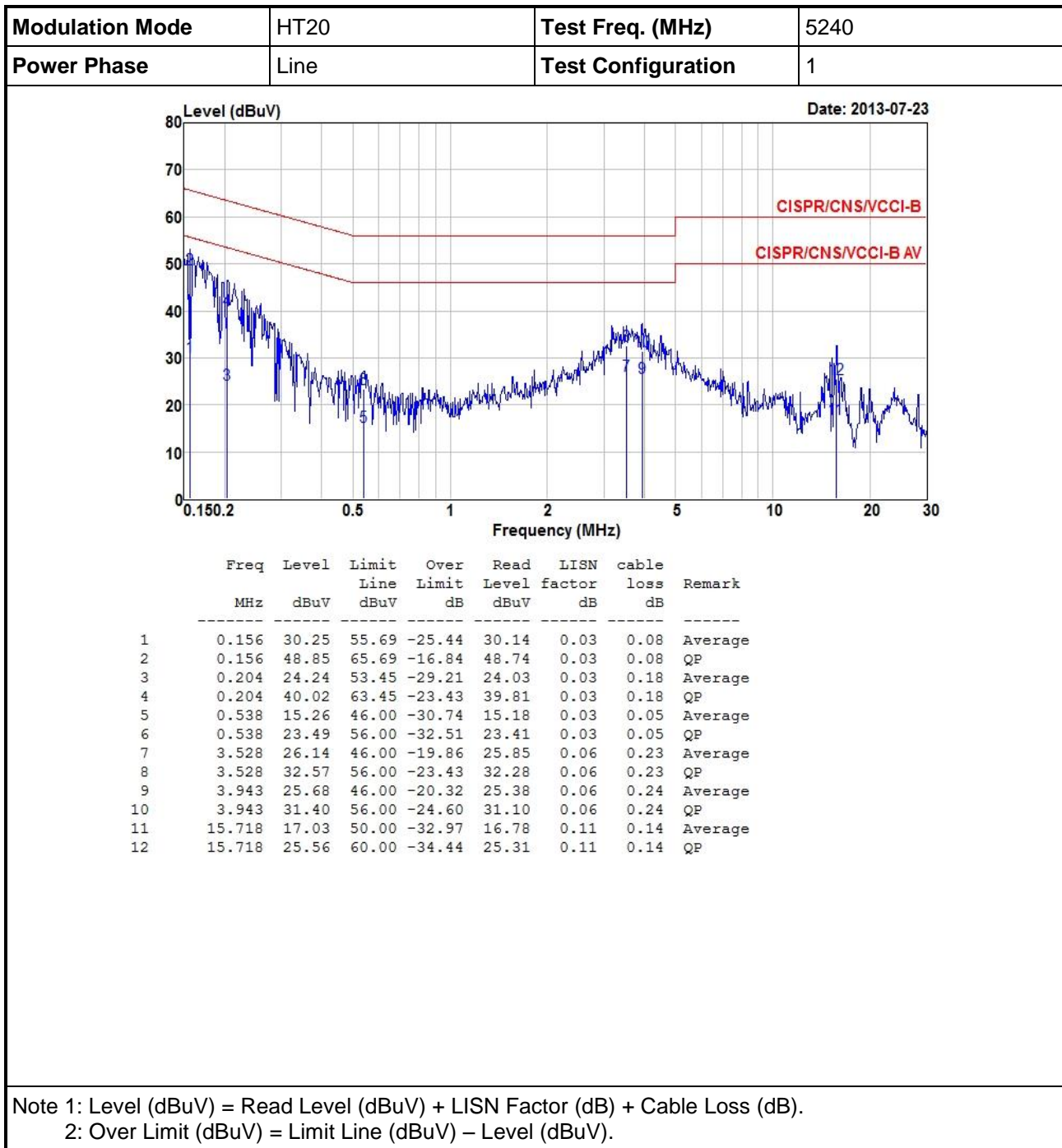

<b>Modulation Mode</b>	HT20	<b>Test Freq. (MHz)</b>	5240
<b>Power Phase</b>	Neutral	<b>Test Configuration</b>	1

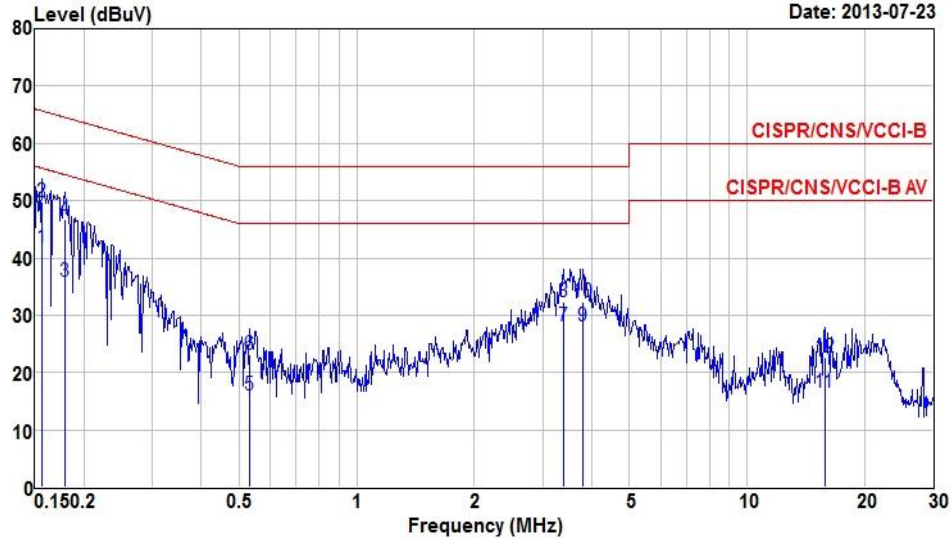

	Freq	Level	Limit	Over	Read	LISN	cable	Remark
	MHz	dBuV	Line	Limit	Level	factor	loss	
			dBuV	dB	dBuV	dB	dB	
1	0.156	41.84	55.69	-13.85	41.74	0.02	0.08	Average
2	0.156	49.81	65.69	-15.88	49.71	0.02	0.08	QP
3	0.179	35.82	54.55	-18.73	35.67	0.02	0.13	Average
4	0.179	46.68	64.55	-17.87	46.53	0.02	0.13	QP
5	0.532	16.02	46.00	-29.98	15.95	0.02	0.05	Average
6	0.532	23.23	56.00	-32.77	23.16	0.02	0.05	QP
7	3.381	28.19	46.00	-17.81	27.92	0.05	0.22	Average
8	3.381	32.25	56.00	-23.75	31.98	0.05	0.22	QP
9	3.799	28.08	46.00	-17.92	27.80	0.05	0.23	Average
10	3.799	32.25	56.00	-23.75	31.97	0.05	0.23	QP
11	15.801	16.62	50.00	-33.38	16.37	0.11	0.14	Average
12	15.801	22.78	60.00	-37.22	22.53	0.11	0.14	QP

Note 1: Level (dBuV) = Read Level (dBuV) + LISN Factor (dB) + Cable Loss (dB).  
 2: Over Limit (dBuV) = Limit Line (dBuV) – Level (dBuV).

## 3.2 Emission Bandwidth

### 3.2.1 Test Procedures

1. Set RBW = approximately 1% of the emission bandwidth.
2. Set the VBW > RBW, Detector = Peak.
3. Trace mode = max hold.
4. Measure the maximum width of the emission that is 26 dB down from the peak of the emission.

### 3.2.2 Test Setup

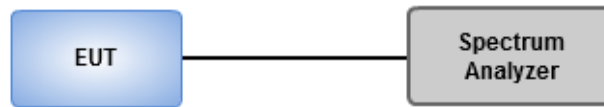

### 3.2.3 Test Result of Emission Bandwidth

Modulation Mode	N <sub>TX</sub>	Freq. (MHz)	26dB Bandwidth (MHz)				99% Bandwidth (MHz)				Limit (dBm)	
			Chain 0	Chain 1	Chain 2	Chain 3	Chain 0	Chain 1	Chain 2	Chain 3	26dB BW	99% BW
11a	1	5180	23.54	---	---	---	17.02	---	---	---	17.00	16.31
11a	1	5200	23.77	---	---	---	16.90	---	---	---	17.00	16.28
11a	1	5240	27.48	---	---	---	17.08	---	---	---	17.00	16.32
HT20	1	5180	24.52	---	---	---	17.95	---	---	---	17.00	16.54
HT20	1	5200	24.46	---	---	---	17.95	---	---	---	17.00	16.54
HT20	1	5240	29.62	---	---	---	18.23	---	---	---	17.00	16.61
11a	1	5260	28.58	---	---	---	17.19	---	---	---	24.00	23.35
11a	1	5300	25.16	---	---	---	16.96	---	---	---	24.00	23.29
11a	1	5320	24.64	---	---	---	16.96	---	---	---	24.00	23.29
HT20	1	5260	29.74	---	---	---	18.12	---	---	---	24.00	23.58
HT20	1	5300	31.42	---	---	---	18.12	---	---	---	24.00	23.58
HT20	1	5320	25.45	---	---	---	18.00	---	---	---	24.00	23.55
11a	1	5500	30.32	---	---	---	17.13	---	---	---	24.00	23.34
11a	1	5580	28.58	---	---	---	17.13	---	---	---	24.00	23.34
11a	1	5700	27.48	---	---	---	17.02	---	---	---	24.00	23.31
HT20	1	5500	31.13	---	---	---	18.12	---	---	---	24.00	23.58
HT20	1	5580	30.32	---	---	---	18.12	---	---	---	24.00	23.58
HT20	1	5700	25.45	---	---	---	18.00	---	---	---	24.00	23.55

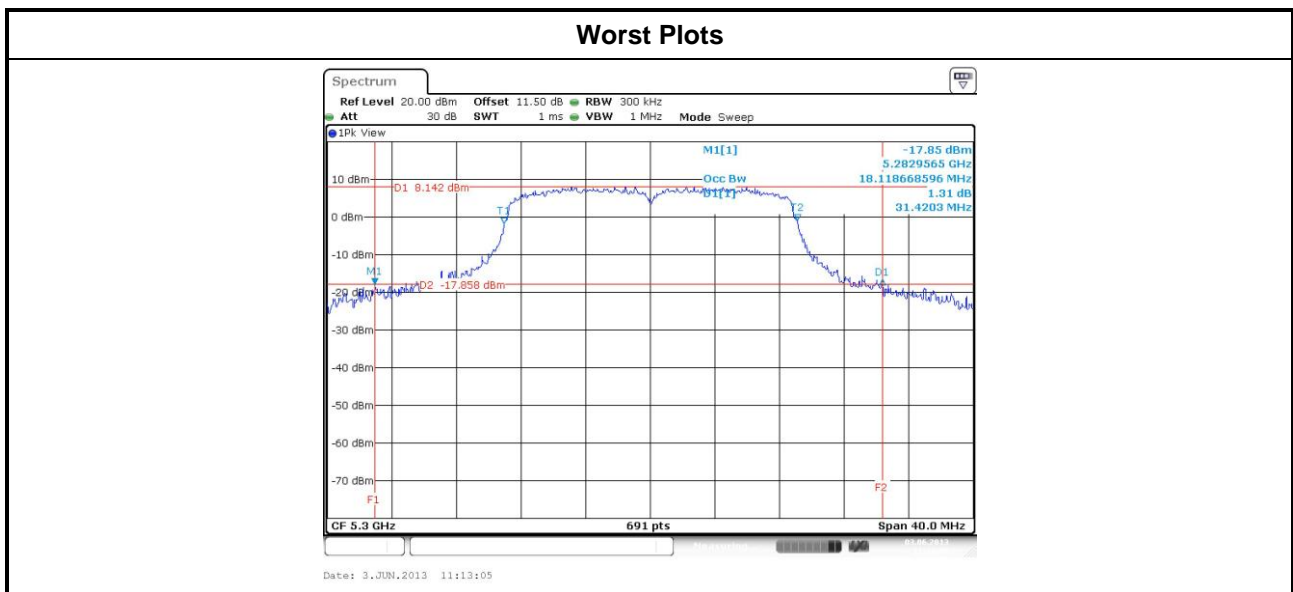

### 3.3 RF Output Power

#### 3.3.1 Limit of RF Output Power

	Frequency Band (GHz)	Limit
<input checked="" type="checkbox"/>	5.15~5.25	50mW or 4dBm+10 log B
<input checked="" type="checkbox"/>	5.25~5.35	250mW or 11dBm+10 log B
<input checked="" type="checkbox"/>	5.47~5.725	250mW or 11dBm+10 log B

Note: "B" is the 26dB emission bandwidth in MHz.

#### 3.3.2 Test Procedures

- Method PM-G ( Measurement using a gated RF average power meter )**
  - Measurements may is performed using a wideband gated RF power meter provided that the gate parameters are adjusted such that the power is measured only when the EUT is transmitting at its maximum power control level. Since the measurement is made only during the ON time of the transmitter, no duty cycle correction factor is required.

#### 3.3.3 Test Setup

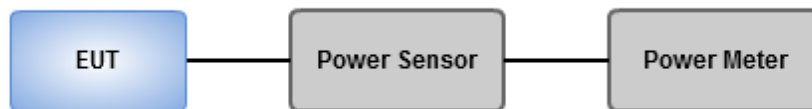



### 3.3.4 Test Result of Maximum Conducted Output Power

Modulation Mode	N <sub>TX</sub>	Freq. (MHz)	Average Power (dBm)				Total Power (mW)	Total Power (dBm)	Limit (dBm)
			Chain 0	Chain 1	Chain 2	Chain 3			
11a	1	5180	15.82	---	---	---	38.19	15.82	17.00
11a	1	5200	15.25	---	---	---	33.5	15.25	17.00
11a	1	5240	16.54	---	---	---	45.08	16.54	17.00
HT20	1	5180	15.86	---	---	---	38.55	15.86	17.00
HT20	1	5200	15.21	---	---	---	33.19	15.21	17.00
HT20	1	5240	16.55	---	---	---	45.19	16.55	17.00
11a	1	5260	16.82	---	---	---	48.08	16.82	24.00
11a	1	5300	16.23	---	---	---	41.98	16.23	24.00
11a	1	5320	15.83	---	---	---	38.28	15.83	24.00
HT20	1	5260	16.61	---	---	---	45.81	16.61	24.00
HT20	1	5300	16.31	---	---	---	42.76	16.31	24.00
HT20	1	5320	15.72	---	---	---	37.33	15.72	24.00
11a	1	5500	17.83	---	---	---	60.67	17.83	24.00
11a	1	5580	17.91	---	---	---	61.8	17.91	24.00
11a	1	5700	17.05	---	---	---	50.7	17.05	24.00
HT20	1	5500	17.73	---	---	---	59.29	17.73	24.00
HT20	1	5580	17.82	---	---	---	60.53	17.82	24.00
HT20	1	5700	16.95	---	---	---	49.55	16.95	24.00

## 3.4 Peak Power Spectral Density

### 3.4.1 Limit of Peak Power Spectral Density

	Frequency Band (GHz)	Limit (dBm)
<input checked="" type="checkbox"/>	5.15~5.25	4
<input checked="" type="checkbox"/>	5.25~5.35	11
<input checked="" type="checkbox"/>	5.47~5.725	11

### 3.4.2 Test Procedures

Method SA-1

1. Set RBW = 1 MHz, VBW = 3 MHz, Sweep time = auto, Detector = RMS.
2. Trace average 100 traces.
3. Use the peak marker function to determine the maximum amplitude level.

Method SA-2

1. Set RBW = 1 MHz, VBW = 3 MHz, Sweep time = auto, Detector = RMS.
2. Trace average at 100 traces
3. Use the peak marker function to determine the maximum amplitude level.
4. Add  $10 \log(1/x)$ , where x is the duty cycle

Method SA-2 Alternative

1. Set RBW = 1 MHz, VBW = 3 MHz, Detector = RMS.
2. Set sweep time  $\geq 10 * (\text{number of points in sweep}) * (\text{total on/off period of the transmitted signal})$ .
3. Perform a single sweep.
4. Use the peak marker function to determine the maximum amplitude level.
5. Add  $10 \log(1/x)$ , where x is the duty cycle.

Note: 11a and HT20 uses Method SA-1, HT40 uses Method SA-2 Alternative.

### 3.4.3 Test Setup

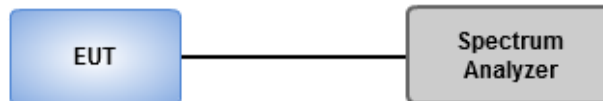

### 3.4.4 Test Result of Peak Power Spectral Density

Modulation Mode	N <sub>TX</sub>	Freq. (MHz)	PSD (dBm)	Duty Factor	Total PSD (dBm)	Limit (dBm)
11a	1	5180	2.97	0	2.97	4
11a	1	5200	3.01	0	3.01	4
11a	1	5240	3.73	0	3.73	4
HT20	1	5180	3.34	0	3.34	4
HT20	1	5200	2.77	0	2.77	4
HT20	1	5240	3.80	0	3.80	4
11a	1	5260	4.15	0	4.15	11
11a	1	5300	3.24	0	3.24	11
11a	1	5320	3.24	0	3.24	11
HT20	1	5260	3.85	0	3.85	11
HT20	1	5300	3.79	0	3.79	11
HT20	1	5320	3.02	0	3.02	11
11a	1	5500	5.29	0	5.29	11
11a	1	5580	5.25	0	5.25	11
11a	1	5700	4.13	0	4.13	11
HT20	1	5500	5.12	0	5.12	11
HT20	1	5580	5.34	0	5.34	11
HT20	1	5700	4.27	0	4.27	11

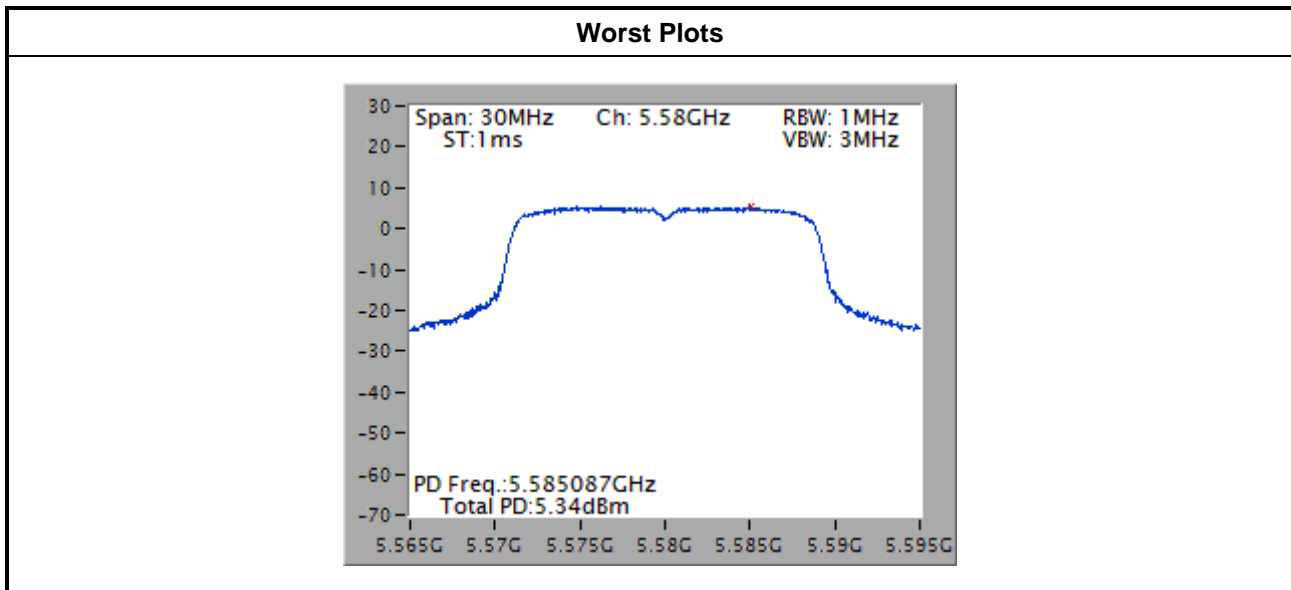

## 3.5 Peak Excursion

### 3.5.1 Peak Excursion Limit

Peak excursion of the modulation envelope shall not exceed 13 dB across any 1 MHz bandwidth.

### 3.5.2 Test Procedures

1. Set RBW = 1 MHz, VBW = 3 MHz, Detector = peak.
2. Trace mode = max-hold. Allow the sweeps to continue until the trace stabilizes.
3. Use the peak search function to find the peak of the spectrum.
4. Use the procedure of section 3.4.2 to measure the PPSD.
5. Compute the ratio of the maximum of the peak-max-hold spectrum to the PPSD

### 3.5.3 Test Setup

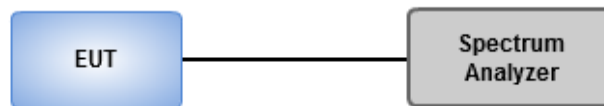

### 3.5.4 Test Result of Peak Excursion

Mode	Modulation Mode	N <sub>TX</sub>	Freq. (MHz)	Measured value(dB)	Duty factor (dB)	Peak Excursion (dB)	Limit
11a	BPSK	1	5240	8.08	0.00	8.08	13
11a	QPSK	1	5240	8.26	0.00	8.26	13
11a	16QAM	1	5240	9.22	0.16	9.06	13
11a	64QAM	1	5240	8.99	0.35	8.64	13
HT20	BPSK	1	5240	7.96	0.00	7.96	13
HT20	QPSK	1	5240	8.65	0.00	8.65	13
HT20	16QAM	1	5240	9.39	0.10	9.29	13
HT20	64QAM	1	5240	9.32	0.34	8.98	13
11a	BPSK	1	5260	7.23	0.00	7.23	13
11a	QPSK	1	5260	8.66	0.00	8.66	13
11a	16QAM	1	5260	8.43	0.16	8.27	13
11a	64QAM	1	5260	9.02	0.35	8.67	13
HT20	BPSK	1	5260	7.85	0.00	7.85	13
HT20	QPSK	1	5260	8.33	0.00	8.33	13
HT20	16QAM	1	5260	9.36	0.10	9.26	13
HT20	64QAM	1	5260	8.53	0.34	8.19	13
11a	BPSK	1	5580	7.86	0.00	7.86	13
11a	QPSK	1	5580	7.63	0.00	7.63	13
11a	16QAM	1	5580	8.21	0.16	8.05	13
11a	64QAM	1	5580	8.57	0.35	8.22	13
HT20	BPSK	1	5580	7.68	0.00	7.68	13
HT20	QPSK	1	5580	8.16	0.00	8.16	13
HT20	16QAM	1	5580	9.44	0.10	9.34	13
HT20	64QAM	1	5580	8.71	0.34	8.37	13

Note: Measured value = Peak-max-hold spectrum to the maximum of the average spectrum for continuous transmission. Since the duty cycle is < 98 %, duty factor is required to average spectrum  
Peak exclusion = Measured value – duty factor

### Worst Plots

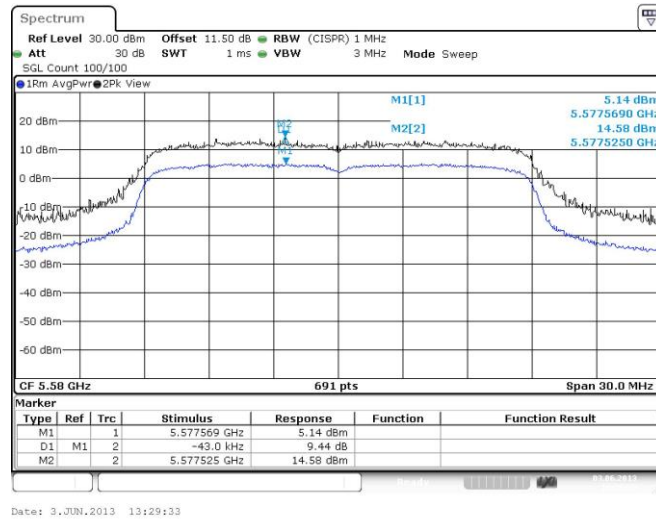

Note1: Peak exclusion = Peak value –PPSD

Note2: If duty cycle of test signal is < 98%, duty factor is required to PPSD

Peak exclusion = Peak value – (PPSD + duty factor)

### 3.6 Transmitter Radiated and Band Edge Emissions

#### 3.6.1 Limit of Transmitter Radiated and Band Edge Emissions

Restricted Band Emissions Limit			
Frequency Range (MHz)	Field Strength (uV/m)	Field Strength (dBuV/m)	Measure Distance (m)
0.009~0.490	2400/F(kHz)	48.5 - 13.8	300
0.490~1.705	24000/F(kHz)	33.8 - 23	30
1.705~30.0	30	29	30
30~88	100	40	3
88~216	150	43.5	3
216~960	200	46	3
Above 960	500	54	3

**Note 1:**  
Qusai-Peak value is measured for frequency below 1GHz except for 9–90 kHz, 110–490 kHz frequency band. Peak and average value are measured for frequency above 1GHz. The limit on average radio frequency emission is as above table. The limit on peak radio frequency emissions is 20 dB above the maximum permitted average emission limit

**Note 2:**  
Measurements may be performed at a distance other than what is specified provided. When performing measurements at a distance other than that specified, the results shall be extrapolated to the specified distance using an extrapolation factor as below, Frequency at or above 30 MHz: 20 dB/decade Frequency below 30 MHz: 40 dB/decade.

Un-restricted band emissions above 1GHz Limit	
Operating Band	Limit
5.15 - 5.25 GHz	e.i.r.p. -27 dBm [68.2 dBuV/m@3m]
5.25 - 5.35 GHz	e.i.r.p. -27 dBm [68.2 dBuV/m@3m]
5.47 - 5.725 GHz	e.i.r.p. -27 dBm [68.2 dBuV/m@3m]
5.725 - 5.825 GHz	5.715 5.725 GHz: e.i.r.p. -17 dBm [78.2 dBuV/m@3m] 5.825 5.835 GHz: e.i.r.p. -17 dBm [78.2 dBuV/m@3m] Other un-restricted band: e.i.r.p. -27 dBm [68.2 dBuV/m@3m]

**Note 1:** Measurements may be performed at a distance other than the limit distance provided they are not performed in the near field and the emissions to be measured can be detected by the measurement equipment. When performing measurements at a distance other than that specified, the results shall be extrapolated to the specified distance using an extrapolation factor of 20 dB/decade (inverse of linear distance for field-strength measurements, inverse of linear distance-squared for power-density measurements).

### 3.6.2 Test Procedures

1. Measurement is made at a semi-anechoic chamber that incorporates a turntable allowing a EUT rotation of 360°. A continuously-rotating, remotely-controlled turntable is installed at the test site to support the EUT and facilitate determination of the direction of maximum radiation for each EUT emission frequency. The EUT is placed at a height of 0.8 m test table above the ground plane.
2. Measurement is made with the antenna positioned in both the horizontal and vertical planes of polarization. The measurement antenna is varied in height (1m ~ 4m) above the reference ground plane to obtain the maximum signal strength. Distance between EUT and antenna is 3 m.
3. This investigation is performed with the EUT rotated 360°, the antenna height scanned between 1 m and 4 m, and the antenna rotated to repeat the measurements for both the horizontal and vertical antenna polarizations.

Note:

1. 120kHz measurement bandwidth of test receiver and Quasi-peak detector is for radiated emission below 1GHz.
2. RBW=1MHz, VBW=3MHz and Peak detector is for peak measured value of radiated emission above 1GHz.
3. RBW=1MHz, VBW=1/T and Peak detector is for average measured value of radiated emission above 1GHz.



### 3.6.3 Test Setup

#### Radiated Emissions below 1 GHz

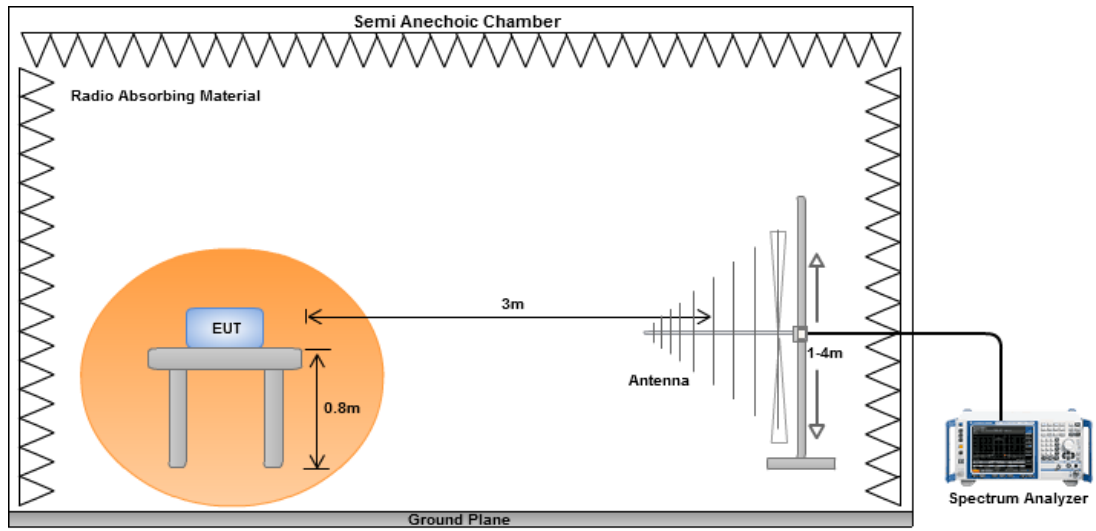

#### Radiated Emissions above 1 GHz

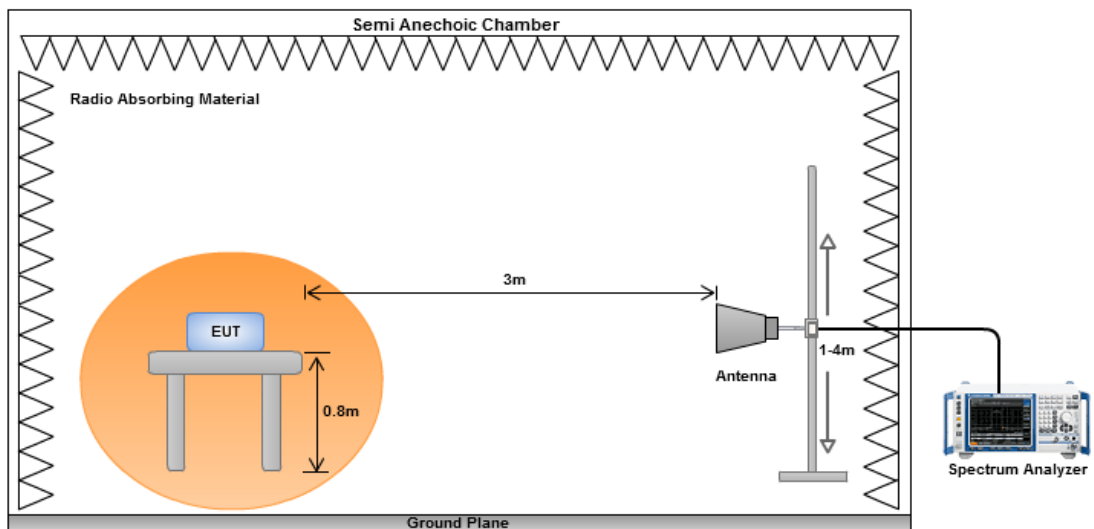

### 3.6.4 Transmitter Radiated Unwanted Emissions (Below 1GHz)

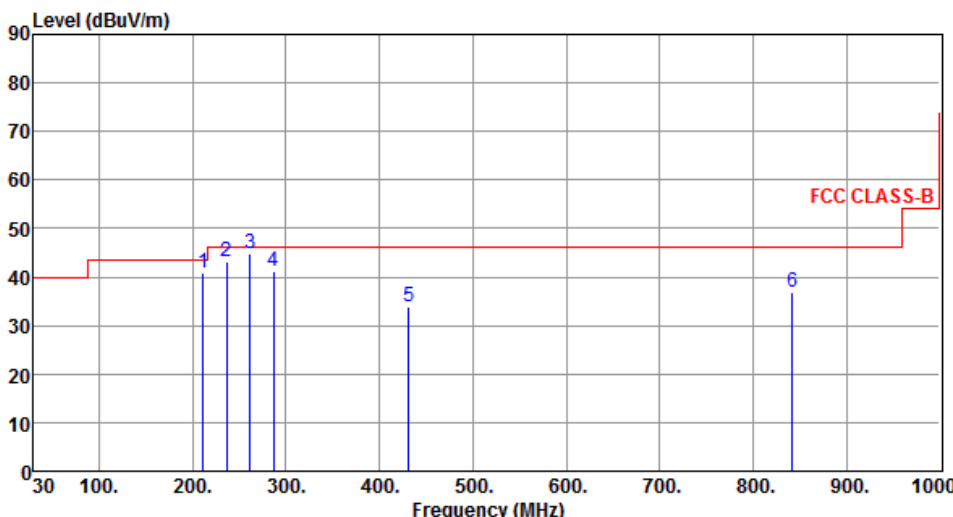
Modulation Mode	HT20	Test Freq. (MHz)	5240																																																																								
Polarization	Horizontal	Test Configuration	1																																																																								
 <p>The graph plots Level (dBuV/m) on the y-axis (0 to 90) against Frequency (MHz) on the x-axis (30 to 1000). A red line represents the FCC CLASS-B limit, which is constant at 46 dBuV/m from 30 MHz to 100 MHz, then steps up to 50 dBuV/m from 100 MHz to 1000 MHz. Six blue vertical lines represent emission peaks, labeled 1 through 6, with their respective frequencies and levels indicated in the table below.</p>																																																																											
	<table border="1"> <thead> <tr> <th>Freq.</th> <th>Emission level</th> <th>Limit</th> <th>Margin</th> <th>SA reading</th> <th>Factor</th> <th>Remark</th> <th>ANT High</th> <th>Turn Table</th> </tr> <tr> <th>MHz</th> <th>dBuV/m</th> <th>dBuV/m</th> <th>dB</th> <th>dBuV</th> <th>dB</th> <th></th> <th>cm</th> <th>deg</th> </tr> </thead> <tbody> <tr> <td>1</td> <td>211.43</td> <td>40.87</td> <td>43.50</td> <td>-2.63</td> <td>60.28</td> <td>-19.41</td> <td>Peak</td> <td>---</td> </tr> <tr> <td>2</td> <td>236.32</td> <td>43.26</td> <td>46.00</td> <td>-2.74</td> <td>61.64</td> <td>-18.38</td> <td>Peak</td> <td>---</td> </tr> <tr> <td>3</td> <td>261.92</td> <td>44.78</td> <td>46.00</td> <td>-1.22</td> <td>62.25</td> <td>-17.47</td> <td>QP</td> <td>---</td> </tr> <tr> <td>4</td> <td>286.93</td> <td>41.23</td> <td>46.00</td> <td>-4.77</td> <td>57.67</td> <td>-16.44</td> <td>Peak</td> <td>---</td> </tr> <tr> <td>5</td> <td>431.67</td> <td>33.94</td> <td>46.00</td> <td>-12.06</td> <td>46.82</td> <td>-12.88</td> <td>Peak</td> <td>---</td> </tr> <tr> <td>6</td> <td>841.82</td> <td>36.71</td> <td>46.00</td> <td>-9.29</td> <td>42.95</td> <td>-6.24</td> <td>Peak</td> <td>---</td> </tr> </tbody> </table>	Freq.	Emission level	Limit	Margin	SA reading	Factor	Remark	ANT High	Turn Table	MHz	dBuV/m	dBuV/m	dB	dBuV	dB		cm	deg	1	211.43	40.87	43.50	-2.63	60.28	-19.41	Peak	---	2	236.32	43.26	46.00	-2.74	61.64	-18.38	Peak	---	3	261.92	44.78	46.00	-1.22	62.25	-17.47	QP	---	4	286.93	41.23	46.00	-4.77	57.67	-16.44	Peak	---	5	431.67	33.94	46.00	-12.06	46.82	-12.88	Peak	---	6	841.82	36.71	46.00	-9.29	42.95	-6.24	Peak	---		
Freq.	Emission level	Limit	Margin	SA reading	Factor	Remark	ANT High	Turn Table																																																																			
MHz	dBuV/m	dBuV/m	dB	dBuV	dB		cm	deg																																																																			
1	211.43	40.87	43.50	-2.63	60.28	-19.41	Peak	---																																																																			
2	236.32	43.26	46.00	-2.74	61.64	-18.38	Peak	---																																																																			
3	261.92	44.78	46.00	-1.22	62.25	-17.47	QP	---																																																																			
4	286.93	41.23	46.00	-4.77	57.67	-16.44	Peak	---																																																																			
5	431.67	33.94	46.00	-12.06	46.82	-12.88	Peak	---																																																																			
6	841.82	36.71	46.00	-9.29	42.95	-6.24	Peak	---																																																																			
<p>Note 1: Emission Level (dBuV/m) = SA Reading (dBuV/m) + Factor* (dB)            *Factor includes antenna factor , cable loss and amplifier gain            Note 2: Margin (dB) = Emission level (dBuV/m) – Limit (dBuV/m).            Note 3: All spurious emissions below 30MHz are more than 20 dB below the limit.</p>																																																																											

<b>Modulation Mode</b>	HT20	<b>Test Freq. (MHz)</b>	5240
<b>Polarization</b>	Vertical	<b>Test Configuration</b>	1

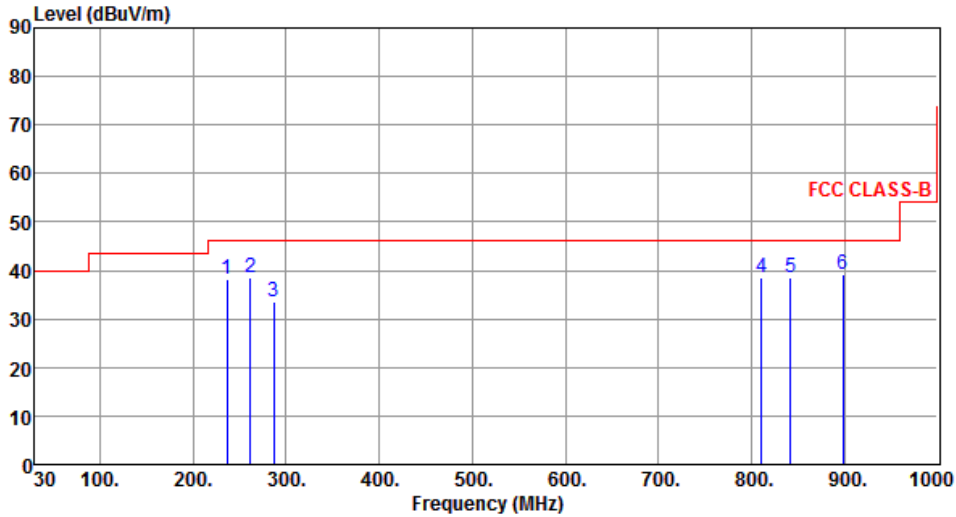

	Freq. MHz	Emission level dBuV/m	Limit dBuV/m	Margin dB	SA reading dBuV	Factor dB	Remark	ANT High cm	Turn Table deg
1	236.14	38.27	46.00	-7.73	56.66	-18.39	Peak	---	---
2	261.62	38.39	46.00	-7.61	55.88	-17.49	Peak	---	---
3	286.54	33.64	46.00	-12.36	50.09	-16.45	Peak	---	---
4	810.69	38.43	46.00	-7.57	45.06	-6.63	Peak	---	---
5	841.97	38.55	46.00	-7.45	44.79	-6.24	Peak	---	---
6	898.47	39.26	46.00	-6.74	44.79	-5.53	Peak	---	---

Note 1: Emission Level (dBuV/m) = SA Reading (dBuV/m) + Factor\* (dB)

\*Factor includes antenna factor , cable loss and amplifier gain

Note 2: Margin (dB) = Emission level (dBuV/m) – Limit (dBuV/m).

Note 3: All spurious emissions below 30MHz are more than 20 dB below the limit.

<b>Modulation Mode</b>	HT20	<b>Test Freq. (MHz)</b>	5240
<b>Polarization</b>	Horizontal	<b>Test Configuration</b>	2

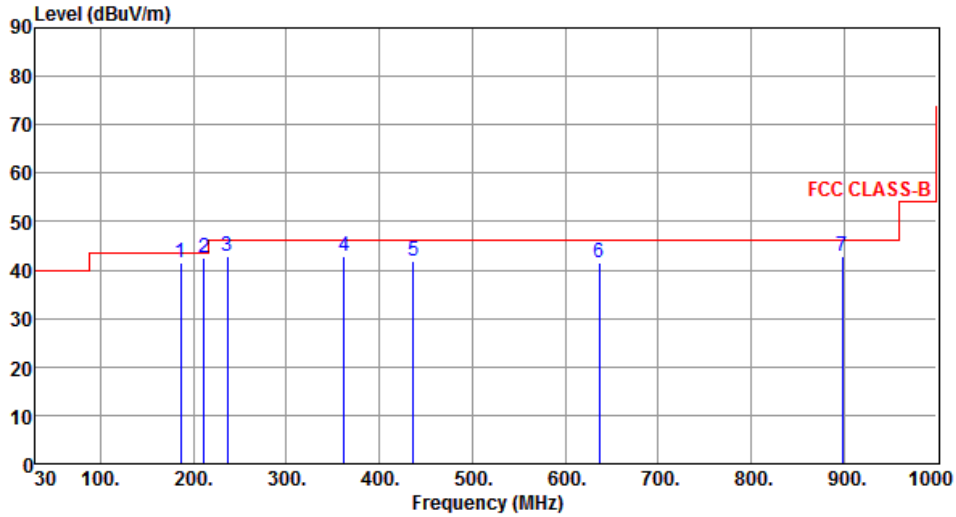

	Freq. MHz	Emission level dBuV/m	Limit dBuV/m	Margin dB	SA reading dBuV	Factor dB	Remark	ANT High cm	Turn Table deg
1	186.34	41.39	43.50	-2.11	60.22	-18.83	Peak	---	---
2	211.63	42.47	43.50	-1.03	61.88	-19.41	QP	---	---
3	236.45	42.84	46.00	-3.16	61.21	-18.37	Peak	---	---
4	361.92	42.76	46.00	-3.24	57.36	-14.60	Peak	---	---
5	436.47	41.92	46.00	-4.08	54.69	-12.77	Peak	---	---
6	636.34	41.52	46.00	-4.48	50.75	-9.23	Peak	---	---
7	898.68	42.96	46.00	-3.04	48.49	-5.53	Peak	---	---

Note 1: Emission Level (dBuV/m) = SA Reading (dBuV/m) + Factor\* (dB)

\*Factor includes antenna factor , cable loss and amplifier gain

Note 2: Margin (dB) = Emission level (dBuV/m) – Limit (dBuV/m).

Note 3: All spurious emissions below 30MHz are more than 20 dB below the limit.

<b>Modulation Mode</b>	HT20	<b>Test Freq. (MHz)</b>	5240
<b>Polarization</b>	Vertical	<b>Test Configuration</b>	2

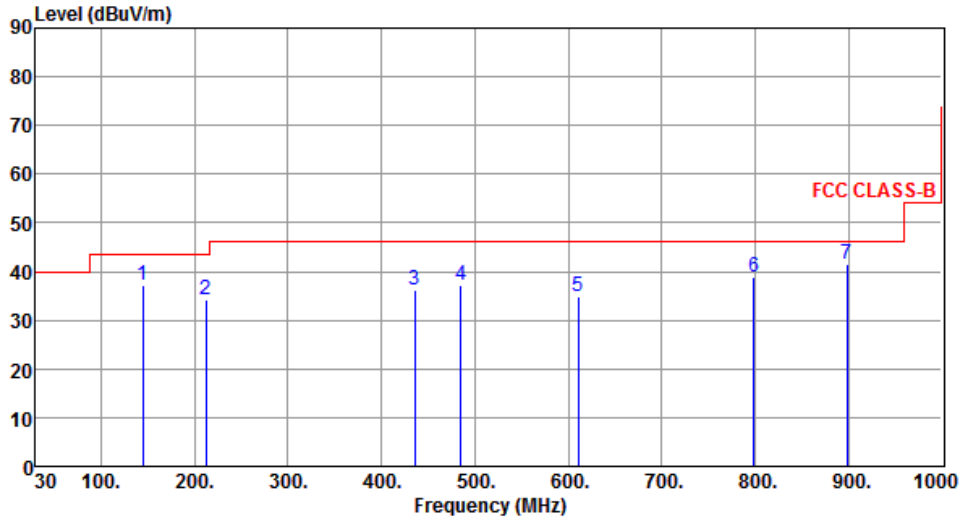

	Freq. MHz	Emission level dBuV/m	Limit dBuV/m	Margin dB	SA reading dBuV	Factor dB	Remark	ANT High cm	Turn Table deg
1	144.68	37.07	43.50	-6.43	54.15	-17.08	Peak	---	---
2	211.95	34.26	43.50	-9.24	53.66	-19.40	Peak	---	---
3	435.73	36.22	46.00	-9.78	49.00	-12.78	Peak	---	---
4	485.27	37.16	46.00	-8.84	49.07	-11.91	Peak	---	---
5	610.52	34.83	46.00	-11.17	44.42	-9.59	Peak	---	---
6	798.41	38.74	46.00	-7.26	45.51	-6.77	Peak	---	---
7	898.27	41.38	46.00	-4.62	46.91	-5.53	Peak	---	---

Note 1: Emission Level (dBuV/m) = SA Reading (dBuV/m) + Factor\* (dB)

\*Factor includes antenna factor , cable loss and amplifier gain

Note 2: Margin (dB) = Emission level (dBuV/m) – Limit (dBuV/m).

Note 3: All spurious emissions below 30MHz are more than 20 dB below the limit.

<b>Modulation Mode</b>	HT20	<b>Test Freq. (MHz)</b>	5240
<b>Polarization</b>	Horizontal	<b>Test Configuration</b>	3

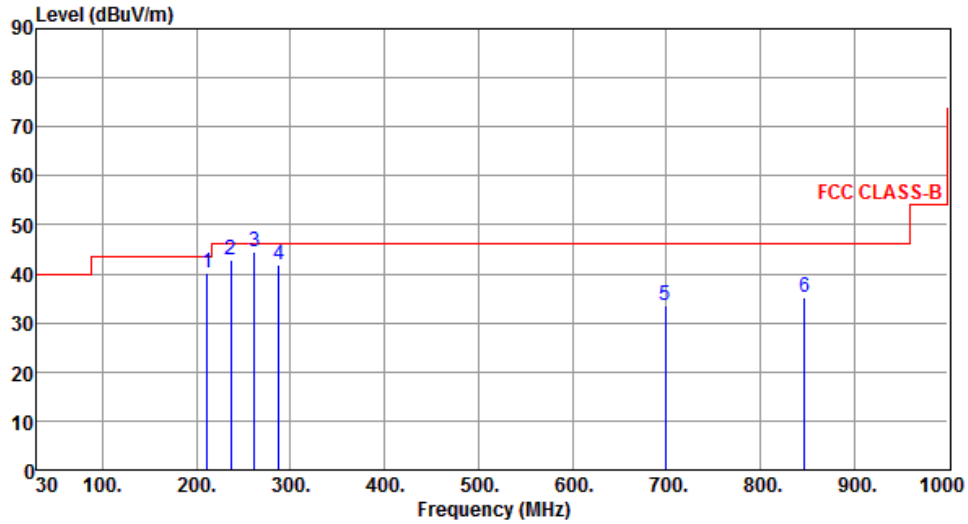

	Freq. MHz	Emission level dBuV/m	Limit dBuV/m	Margin dB	SA reading dBuV	Factor dB	Remark	ANT High cm	Turn Table deg
1	211.46	40.32	43.50	-3.18	59.73	-19.41	Peak	---	---
2	236.12	42.73	46.00	-3.27	61.12	-18.39	Peak	---	---
3	261.76	44.57	46.00	-1.43	62.05	-17.48	QP	---	---
4	287.31	41.68	46.00	-4.32	58.11	-16.43	Peak	---	---
5	698.87	33.44	46.00	-12.56	41.70	-8.26	Peak	---	---
6	846.92	35.16	46.00	-10.84	41.33	-6.17	Peak	---	---

Note 1: Emission Level (dBuV/m) = SA Reading (dBuV/m) + Factor\* (dB)

\*Factor includes antenna factor , cable loss and amplifier gain

Note 2: Margin (dB) = Emission level (dBuV/m) – Limit (dBuV/m).

Note 3: All spurious emissions below 30MHz are more than 20 dB below the limit.

<b>Modulation Mode</b>	HT20	<b>Test Freq. (MHz)</b>	5240
<b>Polarization</b>	Vertical	<b>Test Configuration</b>	3

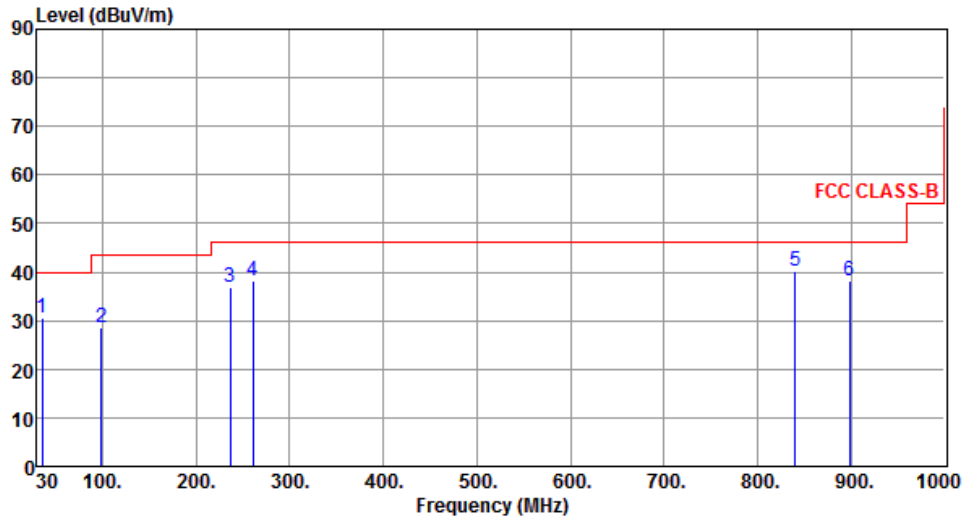

	Freq. MHz	Emission level dBuV/m	Limit dBuV/m	Margin dB	SA reading dBuV	Factor dB	Remark	ANT High cm	Turn Table deg
1	35.13	30.39	40.00	-9.61	47.80	-17.41	Peak	---	---
2	98.72	28.47	43.50	-15.03	50.26	-21.79	Peak	---	---
3	236.56	36.93	46.00	-9.07	55.29	-18.36	Peak	---	---
4	260.75	38.16	46.00	-7.84	55.69	-17.53	Peak	---	---
5	840.52	40.13	46.00	-5.87	46.38	-6.25	Peak	---	---
6	898.64	38.25	46.00	-7.75	43.78	-5.53	Peak	---	---

Note 1: Emission Level (dBuV/m) = SA Reading (dBuV/m) + Factor\* (dB)

\*Factor includes antenna factor , cable loss and amplifier gain

Note 2: Margin (dB) = Emission level (dBuV/m) – Limit (dBuV/m).

Note 3: All spurious emissions below 30MHz are more than 20 dB below the limit.

### 3.6.5 Transmitter Radiated Unwanted Emissions (Above 1GHz) for 11a

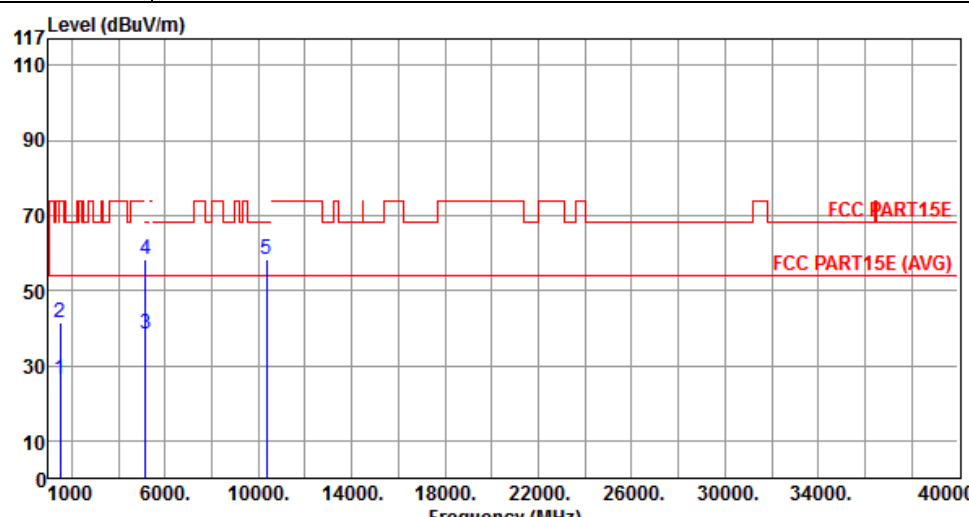
Polarization	Horizontal		Test Freq. (MHz)	5180					
Test Configuration	1								
									
	Freq. MHz	Emission level dBuV/m	Limit dBuV/m	Margin dB	SA reading dBuV	Factor dB	Remark	ANT High cm	Turn Table deg
1	1495.00	26.20	54.00	-27.80	32.78	-6.58	Average	---	---
2	1495.00	41.41	74.00	-32.59	47.99	-6.58	Peak	---	---
3	5150.00	38.22	54.00	-15.78	33.28	4.94	Average	---	---
4	5150.00	58.10	74.00	-15.90	53.16	4.94	Peak	---	---
5	10360.00	58.26	68.30	-10.04	43.55	14.71	Peak	---	---
<p>Note 1: "&gt;20dB" means spurious emission levels that exceed the level of 20 dB below the applicable limit.            Note 2: For restricted bands, the peak measurement is fully sufficient, as the max field strength as measured with the Peak-Detector meets the AV-Limit so that the AV level does not need to be reported in addition.</p>									



<b>Polarization</b>	Vertical	<b>Test Freq. (MHz)</b>	5180
<b>Test Configuration</b>	1		

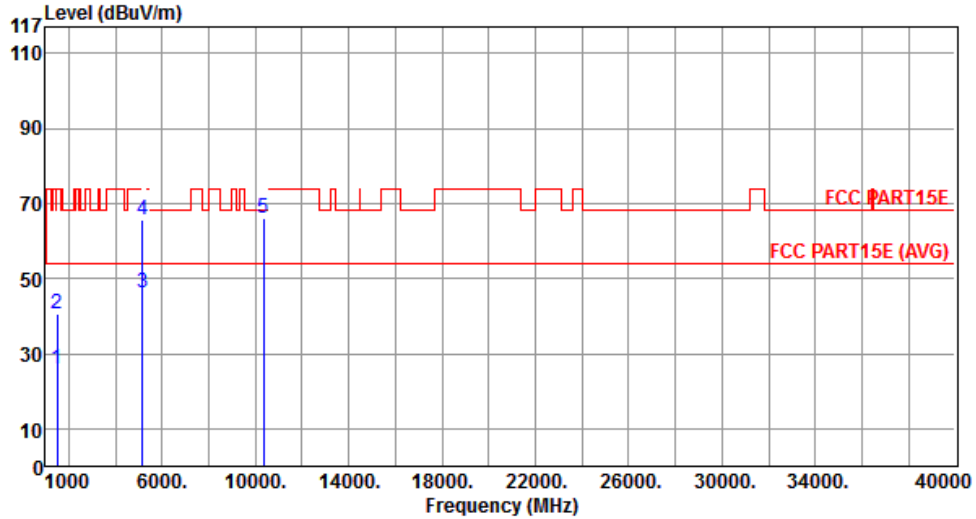

	Freq. MHz	Emission level dBuV/m	Limit dBuV/m	Margin dB	SA reading dBuV	Factor dB	Remark	ANT High cm	Turn Table deg
1	1495.00	25.84	54.00	-28.16	32.42	-6.58	Average	---	---
2	1495.00	40.71	74.00	-33.29	47.29	-6.58	Peak	---	---
3	5150.00	46.33	54.00	-7.67	41.39	4.94	Average	---	---
4	5150.00	65.60	74.00	-8.40	60.66	4.94	Peak	---	---
5	10360.00	66.09	68.30	-2.21	51.38	14.71	Peak	---	---

Note 1: ">20dB" means spurious emission levels that exceed the level of 20 dB below the applicable limit.  
 Note 2: For restricted bands, the peak measurement is fully sufficient, as the max field strength as measured with the Peak-Detector meets the AV-Limit so that the AV level does not need to be reported in addition.

<b>Polarization</b>	Horizontal	<b>Test Freq. (MHz)</b>	5200
<b>Test Configuration</b>	1		

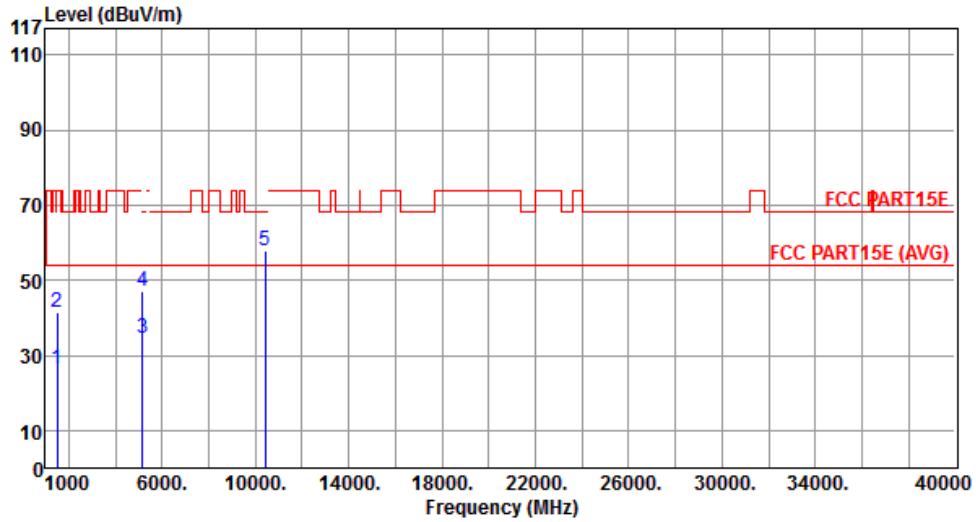

	Freq. MHz	Emission level dBuV/m	Limit dBuV/m	Margin dB	SA reading dBuV	Factor dB	Remark	ANT High cm	Turn Table deg
1	1495.00	26.33	54.00	-27.67	32.91	-6.58	Average	---	---
2	1495.00	41.45	74.00	-32.55	48.03	-6.58	Peak	---	---
3	5150.00	34.62	54.00	-19.38	29.68	4.94	Average	---	---
4	5150.00	46.96	74.00	-27.04	42.02	4.94	Peak	---	---
5	10400.00	57.85	68.30	-10.45	43.10	14.75	Peak	---	---

Note 1: ">20dB" means spurious emission levels that exceed the level of 20 dB below the applicable limit.  
 Note 2: For restricted bands, the peak measurement is fully sufficient, as the max field strength as measured with the Peak-Detector meets the AV-Limit so that the AV level does not need to be reported in addition.

<b>Polarization</b>	Vertical	<b>Test Freq. (MHz)</b>	5200
<b>Test Configuration</b>	1		

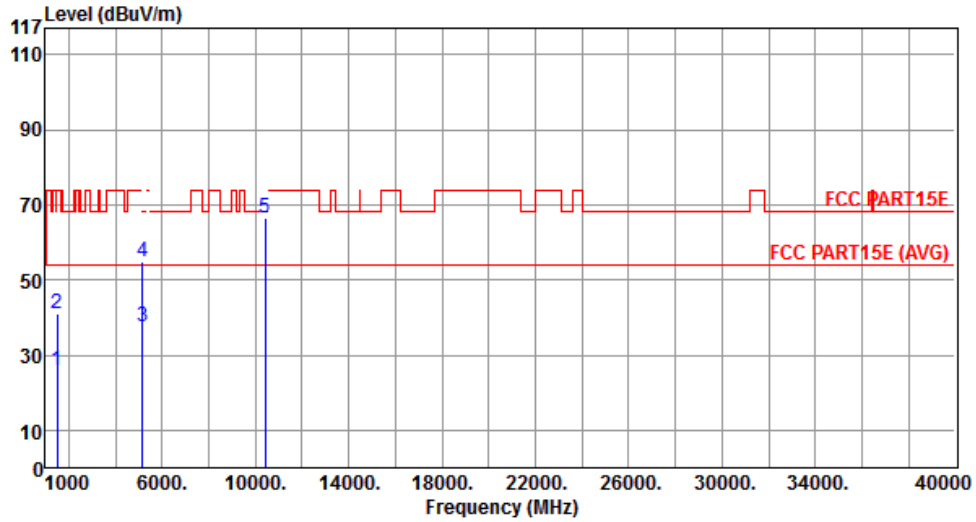

	Freq. MHz	Emission level dBuV/m	Limit dBuV/m	Margin dB	SA reading dBuV	Factor dB	Remark	ANT High cm	Turn Table deg
1	1495.00	26.00	54.00	-28.00	32.58	-6.58	Average	---	---
2	1495.00	41.05	74.00	-32.95	47.63	-6.58	Peak	---	---
3	5150.00	37.46	54.00	-16.54	32.52	4.94	Average	---	---
4	5150.00	54.81	74.00	-19.19	49.87	4.94	Peak	---	---
5	10400.00	66.40	68.30	-1.90	51.65	14.75	Peak	---	---

Note 1: ">20dB" means spurious emission levels that exceed the level of 20 dB below the applicable limit.  
 Note 2: For restricted bands, the peak measurement is fully sufficient, as the max field strength as measured with the Peak-Detector meets the AV-Limit so that the AV level does not need to be reported in addition.

<b>Polarization</b>	Horizontal	<b>Test Freq. (MHz)</b>	5240
<b>Test Configuration</b>	1		

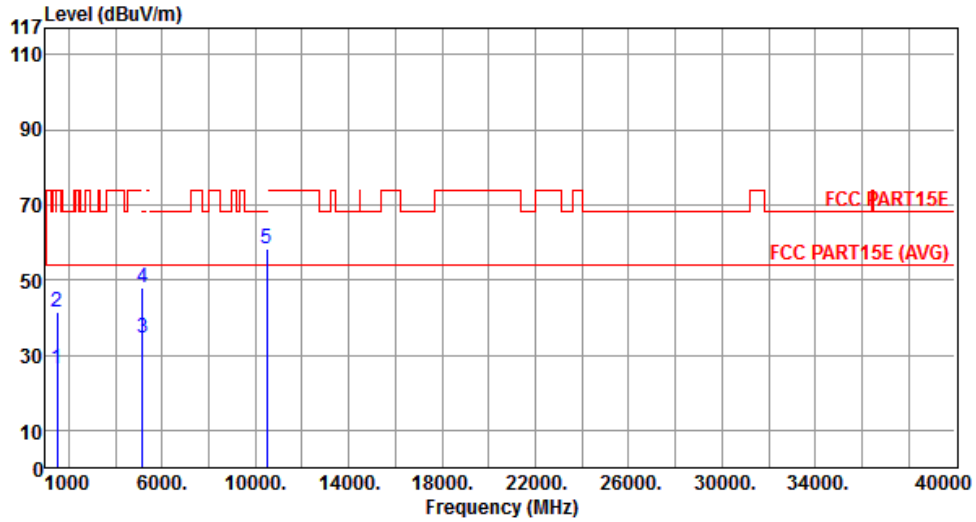

	Freq. MHz	Emission level dBuV/m	Limit dBuV/m	Margin dB	SA reading dBuV	Factor dB	Remark	ANT High cm	Turn Table deg
1	1495.00	26.26	54.00	-27.74	32.84	-6.58	Average	---	---
2	1495.00	41.45	74.00	-32.55	48.03	-6.58	Peak	---	---
3	5150.00	34.37	54.00	-19.63	29.43	4.94	Average	---	---
4	5150.00	47.90	74.00	-26.10	42.96	4.94	Peak	---	---
5	10480.00	58.32	68.30	-9.98	43.48	14.84	Peak	---	---

Note 1: ">20dB" means spurious emission levels that exceed the level of 20 dB below the applicable limit.  
 Note 2: For restricted bands, the peak measurement is fully sufficient, as the max field strength as measured with the Peak-Detector meets the AV-Limit so that the AV level does not need to be reported in addition.

<b>Polarization</b>	Vertical	<b>Test Freq. (MHz)</b>	5240
<b>Test Configuration</b>	1		

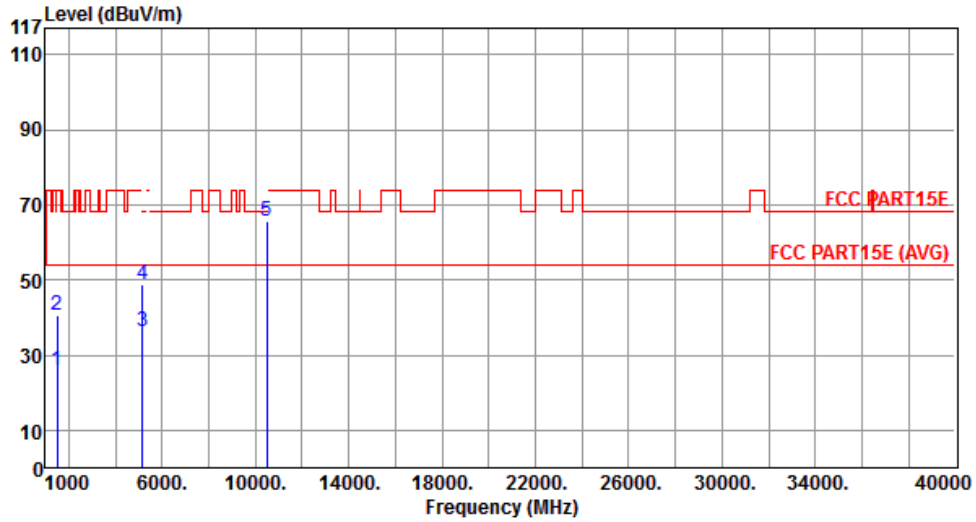

	Freq. MHz	Emission level dBuV/m	Limit dBuV/m	Margin dB	SA reading dBuV	Factor dB	Remark	ANT High cm	Turn Table deg
1	1495.00	25.99	54.00	-28.01	32.57	-6.58	Average	---	---
2	1495.00	40.78	74.00	-33.22	47.36	-6.58	Peak	---	---
3	5150.00	36.09	54.00	-17.91	31.15	4.94	Average	---	---
4	5150.00	48.77	74.00	-25.23	43.83	4.94	Peak	---	---
5	10480.00	65.55	68.30	-2.75	50.71	14.84	Peak	---	---

Note 1: ">20dB" means spurious emission levels that exceed the level of 20 dB below the applicable limit.  
 Note 2: For restricted bands, the peak measurement is fully sufficient, as the max field strength as measured with the Peak-Detector meets the AV-Limit so that the AV level does not need to be reported in addition.

<b>Polarization</b>	Horizontal	<b>Test Freq. (MHz)</b>	5260
<b>Test Configuration</b>	1		

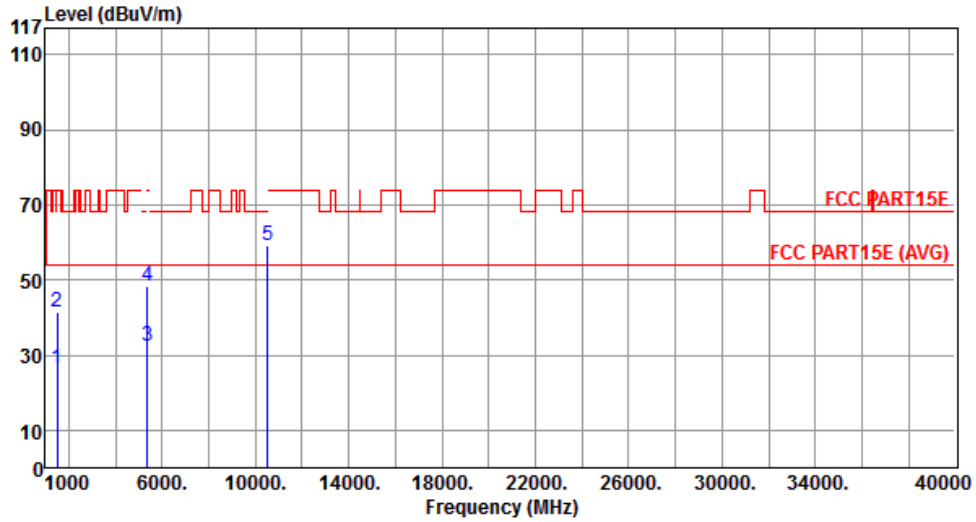

	Freq. MHz	Emission level dBuV/m	Limit dBuV/m	Margin dB	SA reading dBuV	Factor dB	Remark	ANT High cm	Turn Table deg
1	1495.00	26.28	54.00	-27.72	32.86	-6.58	Average	---	---
2	1495.00	41.65	74.00	-32.35	48.23	-6.58	Peak	---	---
3	5350.00	32.21	54.00	-21.79	27.12	5.09	Average	---	---
4	5350.00	48.27	74.00	-25.73	43.18	5.09	Peak	---	---
5	10520.00	58.98	68.30	-9.32	44.11	14.87	Peak	---	---

Note 1: ">20dB" means spurious emission levels that exceed the level of 20 dB below the applicable limit.  
 Note 2: For restricted bands, the peak measurement is fully sufficient, as the max field strength as measured with the Peak-Detector meets the AV-Limit so that the AV level does not need to be reported in addition.

<b>Polarization</b>	Vertical	<b>Test Freq. (MHz)</b>	5260
<b>Test Configuration</b>	1		

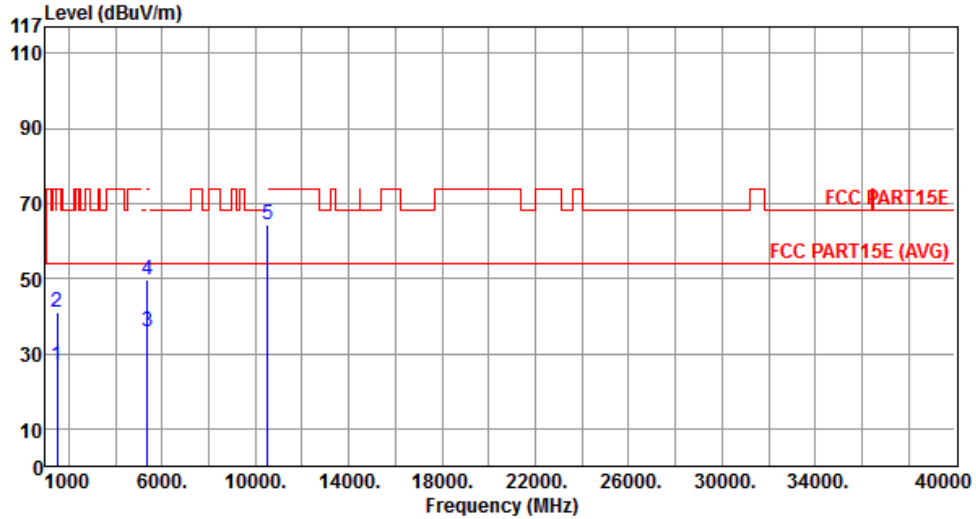

	Freq. MHz	Emission level dBuV/m	Limit dBuV/m	Margin dB	SA reading dBuV	Factor dB	Remark	ANT High cm	Turn Table deg
1	1495.00	26.59	54.00	-27.41	33.17	-6.58	Average	---	---
2	1495.00	41.06	74.00	-32.94	47.64	-6.58	Peak	---	---
3	5350.00	35.77	54.00	-18.23	30.68	5.09	Average	---	---
4	5350.00	49.64	74.00	-24.36	44.55	5.09	Peak	---	---
5	10520.00	64.37	68.30	-3.93	49.50	14.87	Peak	---	---

Note 1: ">20dB" means spurious emission levels that exceed the level of 20 dB below the applicable limit.  
 Note 2: For restricted bands, the peak measurement is fully sufficient, as the max field strength as measured with the Peak-Detector meets the AV-Limit so that the AV level does not need to be reported in addition.

<b>Polarization</b>	Horizontal	<b>Test Freq. (MHz)</b>	5300
<b>Test Configuration</b>	1		

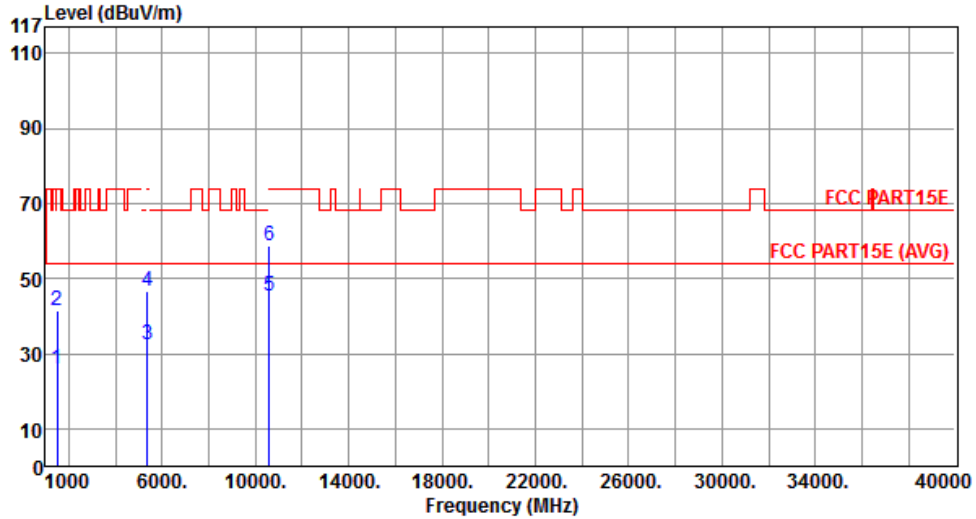

	Freq. MHz	Emission level dBuV/m	Limit dBuV/m	Margin dB	SA reading dBuV	Factor dB	Remark	ANT High cm	Turn Table deg
1	1495.00	25.93	54.00	-28.07	32.51	-6.58	Average	---	---
2	1495.00	41.48	74.00	-32.52	48.06	-6.58	Peak	---	---
3	5350.00	32.38	54.00	-21.62	27.29	5.09	Average	---	---
4	5350.00	46.53	74.00	-27.47	41.44	5.09	Peak	---	---
5	10600.00	45.20	54.00	-8.80	30.26	14.94	Average	---	---
6	10600.00	58.65	74.00	-15.35	43.71	14.94	Peak	---	---

Note 1: ">20dB" means spurious emission levels that exceed the level of 20 dB below the applicable limit.  
 Note 2: For restricted bands, the peak measurement is fully sufficient, as the max field strength as measured with the Peak-Detector meets the AV-Limit so that the AV level does not need to be reported in addition.



<b>Polarization</b>	Vertical	<b>Test Freq. (MHz)</b>	5300
<b>Test Configuration</b>	1		

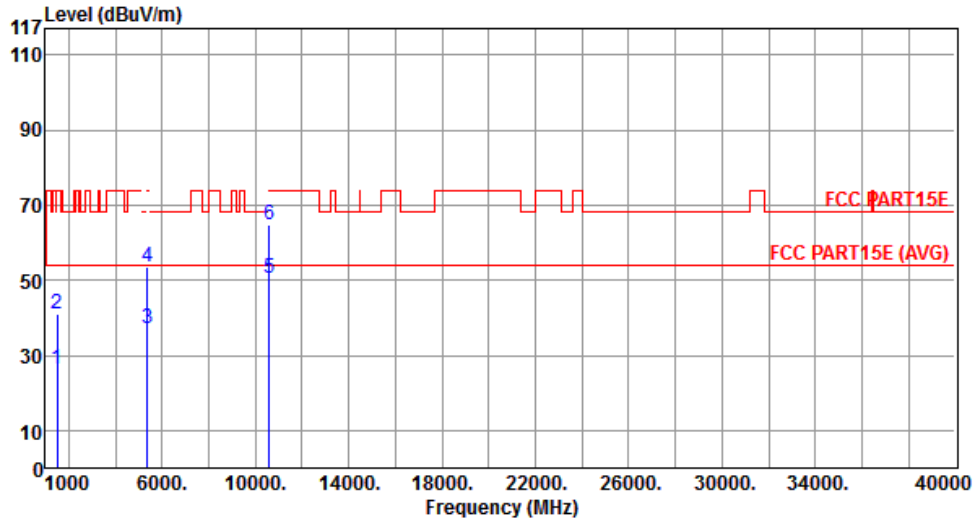

	Freq. MHz	Emission level dBuV/m	Limit dBuV/m	Margin dB	SA reading dBuV	Factor dB	Remark	ANT High cm	Turn Table deg
1	1495.00	26.36	54.00	-27.64	32.94	-6.58	Average	---	---
2	1495.00	40.80	74.00	-33.20	47.38	-6.58	Peak	---	---
3	5350.00	37.04	54.00	-16.96	31.95	5.09	Average	---	---
4	5350.00	53.73	74.00	-20.27	48.64	5.09	Peak	---	---
5	10600.00	50.31	54.00	-3.69	35.37	14.94	Average	---	---
6	10600.00	64.74	74.00	-9.26	49.80	14.94	Peak	---	---

Note 1: ">20dB" means spurious emission levels that exceed the level of 20 dB below the applicable limit.  
 Note 2: For restricted bands, the peak measurement is fully sufficient, as the max field strength as measured with the Peak-Detector meets the AV-Limit so that the AV level does not need to be reported in addition.

<b>Polarization</b>	Horizontal	<b>Test Freq. (MHz)</b>	5320
<b>Test Configuration</b>	1		

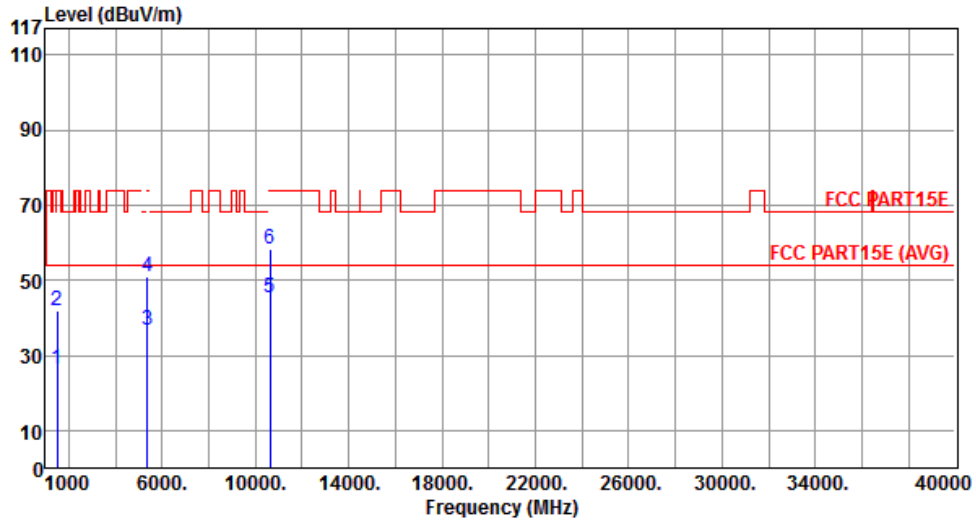

	Freq. MHz	Emission level dBuV/m	Limit dBuV/m	Margin dB	SA reading dBuV	Factor dB	Remark	ANT High cm	Turn Table deg
1	1495.00	26.13	54.00	-27.87	32.71	-6.58	Average	---	---
2	1495.00	42.00	74.00	-32.00	48.58	-6.58	Peak	---	---
3	5350.00	36.72	54.00	-17.28	31.63	5.09	Average	---	---
4	5350.00	51.13	74.00	-22.87	46.04	5.09	Peak	---	---
5	10640.00	45.55	54.00	-8.45	30.57	14.98	Average	---	---
6	10640.00	58.27	74.00	-15.73	43.29	14.98	Peak	---	---

Note 1: ">20dB" means spurious emission levels that exceed the level of 20 dB below the applicable limit.  
 Note 2: For restricted bands, the peak measurement is fully sufficient, as the max field strength as measured with the Peak-Detector meets the AV-Limit so that the AV level does not need to be reported in addition.

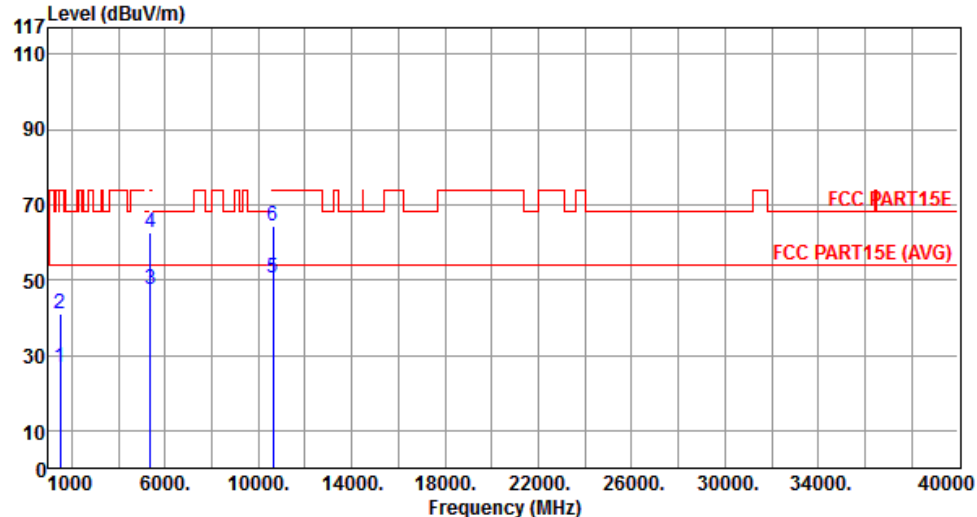
<b>Polarization</b>	Vertical	<b>Test Freq. (MHz)</b>	5320						
<b>Test Configuration</b>	1								
									
	Freq.	Emission level	Limit	Margin	SA reading	Factor	Remark	ANT High	Turn Table
	MHz	dBuV/m	dBuV/m	dB	dBuV	dB		cm	deg
1	1495.00	26.80	54.00	-27.20	33.38	-6.58	Average	---	---
2	1495.00	40.94	74.00	-33.06	47.52	-6.58	Peak	---	---
3	5350.00	47.30	54.00	-6.70	42.21	5.09	Average	---	---
4	5350.00	62.65	74.00	-11.35	57.56	5.09	Peak	---	---
5	10640.00	50.66	54.00	-3.34	35.68	14.98	Average	---	---
6	10640.00	64.41	74.00	-9.59	49.43	14.98	Peak	---	---

Note 1: ">20dB" means spurious emission levels that exceed the level of 20 dB below the applicable limit.  
 Note 2: For restricted bands, the peak measurement is fully sufficient, as the max field strength as measured with the Peak-Detector meets the AV-Limit so that the AV level does not need to be reported in addition.

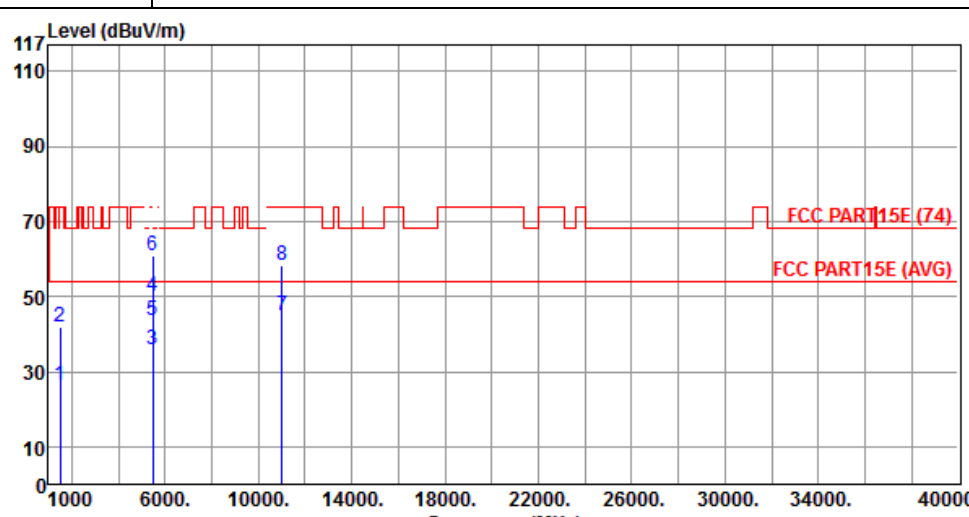
<b>Polarization</b>	Horizontal	<b>Test Freq. (MHz)</b>	5500						
<b>Test Configuration</b>	1								
									
	Freq. MHz	Emission level dBuV/m	Limit dBuV/m	Margin dB	SA reading dBuV	Factor dB	Remark	ANT High cm	Turn Table deg
1	1495.00	26.32	54.00	-27.68	32.90	-6.58	Average	---	---
2	1495.00	41.97	74.00	-32.03	48.55	-6.58	Peak	---	---
3	5460.00	36.03	54.00	-17.97	30.85	5.18	Average	---	---
4	5460.00	50.22	74.00	-23.78	45.04	5.18	Peak	---	---
5	5470.00	43.64	54.00	-10.36	38.45	5.19	Average	---	---
6	5470.00	61.02	74.00	-12.98	55.83	5.19	Peak	---	---
7	11000.00	44.81	54.00	-9.19	29.53	15.28	Average	---	---
8	11000.00	58.07	74.00	-15.93	42.79	15.28	Peak	---	---
<p>Note 1: "&gt;20dB" means spurious emission levels that exceed the level of 20 dB below the applicable limit.          Note 2: For restricted bands, the peak measurement is fully sufficient, as the max field strength as measured with the Peak-Detector meets the AV-Limit so that the AV level does not need to be reported in addition.</p>									

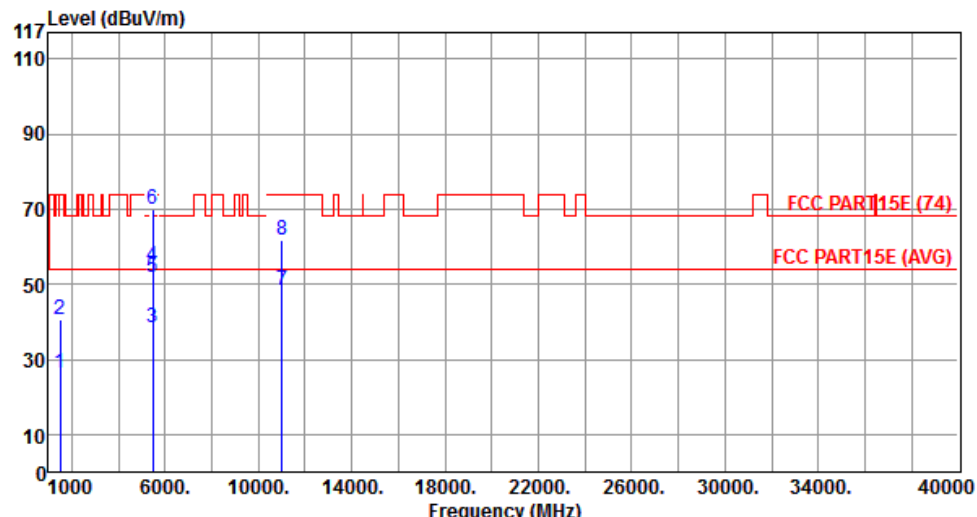
<b>Polarization</b>	Vertical	<b>Test Freq. (MHz)</b>	5500						
<b>Test Configuration</b>	1								
									
	Freq.	Emission level	Limit	Margin	SA reading	Factor	Remark	ANT High	Turn Table
	MHz	dBuV/m	dBuV/m	dB	dBuV	dB		cm	deg
1	1495.00	26.27	54.00	-27.73	32.85	-6.58	Average	---	---
2	1495.00	40.73	74.00	-33.27	47.31	-6.58	Peak	---	---
3	5460.00	38.28	54.00	-15.72	33.10	5.18	Average	---	---
4	5460.00	54.63	74.00	-19.37	49.45	5.18	Peak	---	---
5	5470.00	51.86	54.00	-2.14	46.67	5.19	Average	---	---
6	5470.00	70.06	74.00	-3.94	64.87	5.19	Peak	---	---
7	11000.00	48.22	54.00	-5.78	32.94	15.28	Average	---	---
8	11000.00	61.67	74.00	-12.33	46.39	15.28	Peak	---	---
<p>Note 1: "&gt;20dB" means spurious emission levels that exceed the level of 20 dB below the applicable limit.          Note 2: For restricted bands, the peak measurement is fully sufficient, as the max field strength as measured with the Peak-Detector meets the AV-Limit so that the AV level does not need to be reported in addition.</p>									

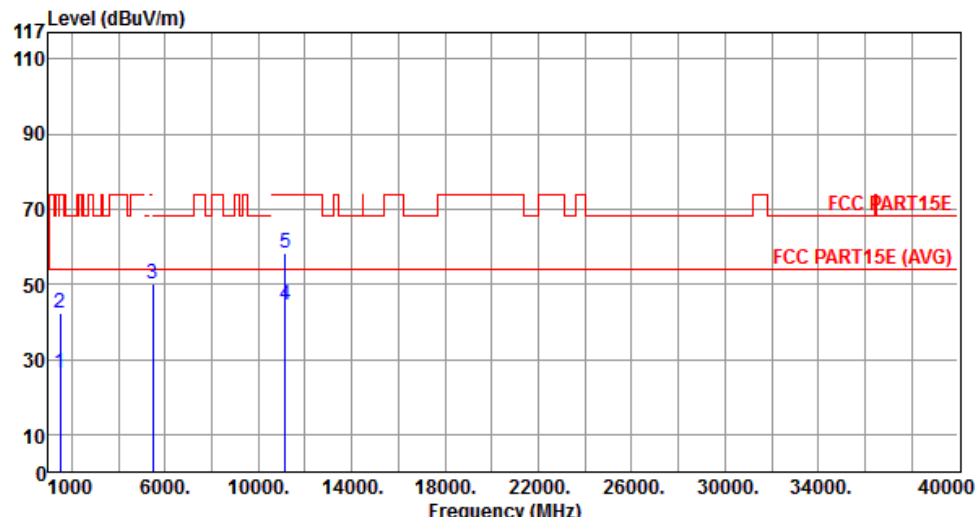
<b>Polarization</b>	Horizontal	<b>Test Freq. (MHz)</b>	5580						
<b>Test Configuration</b>	1								
									
	Freq.	Emission level	Limit	Margin	SA reading	Factor	Remark	ANT High	Turn Table
	MHz	dBuV/m	dBuV/m	dB	dBuV	dB		cm	deg
1	1495.00	26.16	54.00	-27.84	32.74	-6.58	Average	---	---
2	1495.00	42.37	74.00	-31.63	48.95	-6.58	Peak	---	---
3	5470.00	50.00	68.30	-18.30	44.81	5.19	Peak	---	---
4	11160.00	44.39	54.00	-9.61	29.21	15.18	Average	---	---
5	11160.00	58.38	74.00	-15.62	43.20	15.18	Peak	---	---
<p>Note 1: "&gt;20dB" means spurious emission levels that exceed the level of 20 dB below the applicable limit.          Note 2: For restricted bands, the peak measurement is fully sufficient, as the max field strength as measured with the Peak-Detector meets the AV-Limit so that the AV level does not need to be reported in addition.</p>									

<b>Polarization</b>	Vertical	<b>Test Freq. (MHz)</b>	5580
<b>Test Configuration</b>	1		

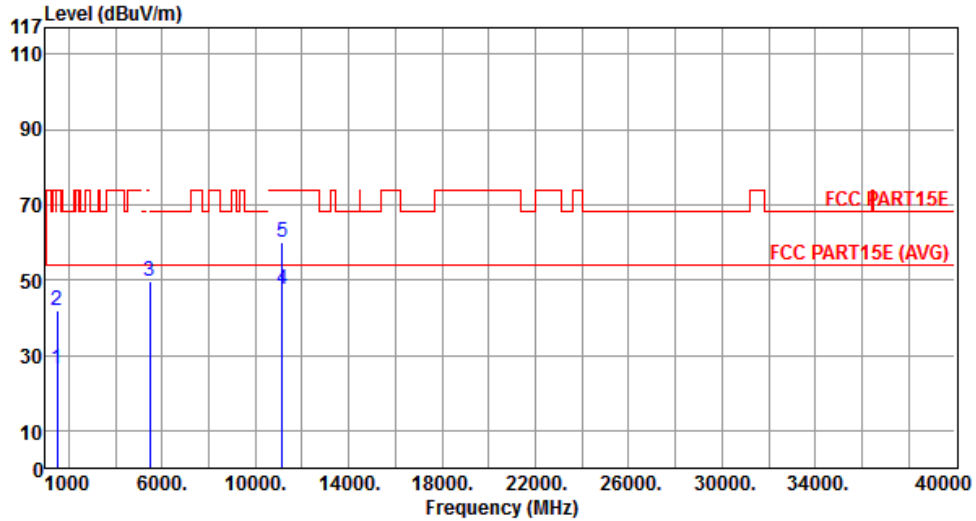

	Freq. MHz	Emission level dBuV/m	Limit dBuV/m	Margin dB	SA reading dBuV	Factor dB	Remark	ANT High cm	Turn Table deg
1	1495.00	26.48	54.00	-27.52	33.06	-6.58	Average	---	---
2	1495.00	41.67	74.00	-32.33	48.25	-6.58	Peak	---	---
3	5470.00	49.55	68.30	-18.75	44.36	5.19	Peak	---	---
4	11160.00	47.56	54.00	-6.44	32.38	15.18	Average	---	---
5	11160.00	60.16	74.00	-13.84	44.98	15.18	Peak	---	---

Note 1: ">20dB" means spurious emission levels that exceed the level of 20 dB below the applicable limit.  
 Note 2: For restricted bands, the peak measurement is fully sufficient, as the max field strength as measured with the Peak-Detector meets the AV-Limit so that the AV level does not need to be reported in addition.

<b>Polarization</b>	Horizontal	<b>Test Freq. (MHz)</b>	5700
<b>Test Configuration</b>	1		

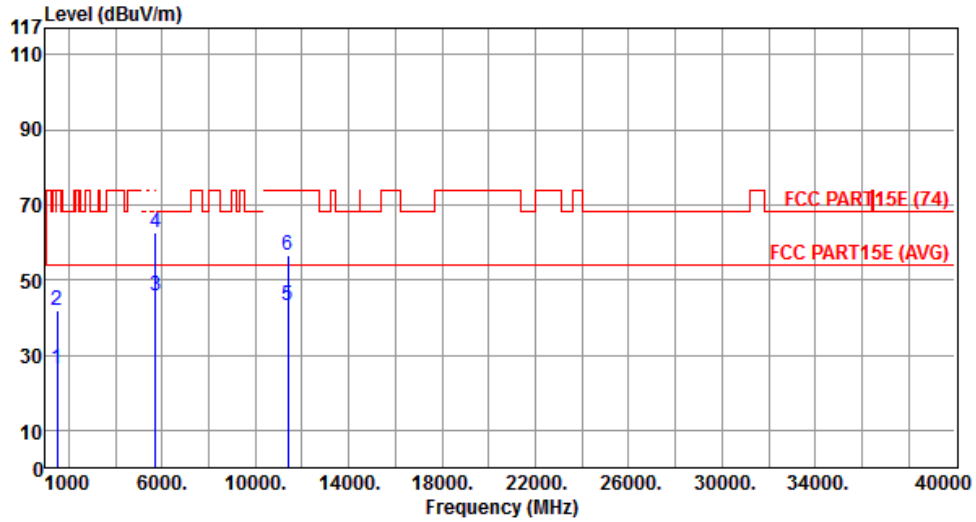

	Freq. MHz	Emission level dBuV/m	Limit dBuV/m	Margin dB	SA reading dBuV	Factor dB	Remark	ANT High cm	Turn Table deg
1	1495.00	26.39	54.00	-27.61	32.97	-6.58	Average	---	---
2	1495.00	41.94	74.00	-32.06	48.52	-6.58	Peak	---	---
3	5725.00	45.77	54.00	-8.23	40.21	5.56	Average	---	---
4	5725.00	62.50	74.00	-11.50	56.94	5.56	Peak	---	---
5	11400.00	43.13	54.00	-10.87	28.10	15.03	Average	---	---
6	11400.00	56.70	74.00	-17.30	41.67	15.03	Peak	---	---

Note 1: ">20dB" means spurious emission levels that exceed the level of 20 dB below the applicable limit.  
 Note 2: For restricted bands, the peak measurement is fully sufficient, as the max field strength as measured with the Peak-Detector meets the AV-Limit so that the AV level does not need to be reported in addition.



<b>Polarization</b>	Vertical	<b>Test Freq. (MHz)</b>	5700
<b>Test Configuration</b>	1		

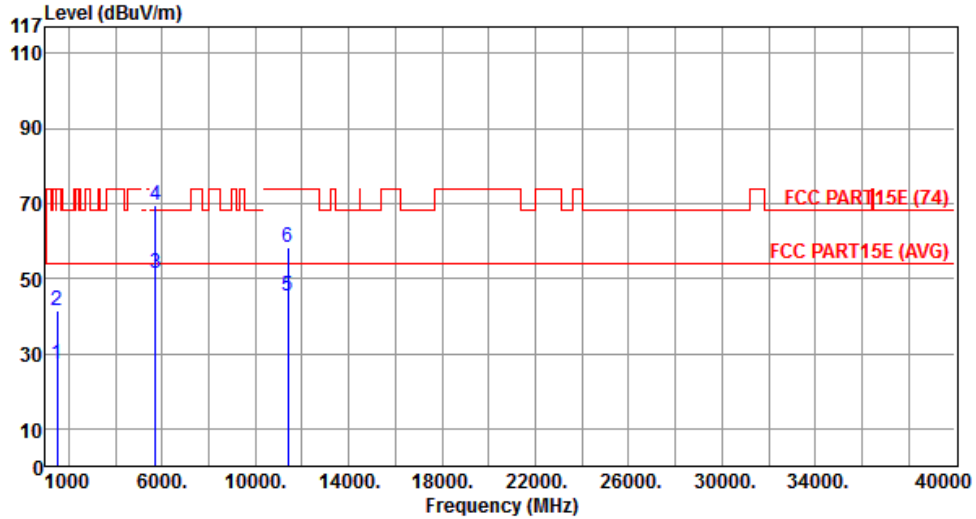

	Freq. MHz	Emission level dBuV/m	Limit dBuV/m	Margin dB	SA reading dBuV	Factor dB	Remark	ANT High cm	Turn Table deg
1	1495.00	27.06	54.00	-26.94	33.64	-6.58	Average	---	---
2	1495.00	41.64	74.00	-32.36	48.22	-6.58	Peak	---	---
3	5725.00	51.34	54.00	-2.66	45.78	5.56	Average	---	---
4	5725.00	69.51	74.00	-4.49	63.95	5.56	Peak	---	---
5	11400.00	45.28	54.00	-8.72	30.25	15.03	Average	---	---
6	11400.00	58.19	74.00	-15.81	43.16	15.03	Peak	---	---

Note 1: ">20dB" means spurious emission levels that exceed the level of 20 dB below the applicable limit.  
 Note 2: For restricted bands, the peak measurement is fully sufficient, as the max field strength as measured with the Peak-Detector meets the AV-Limit so that the AV level does not need to be reported in addition.

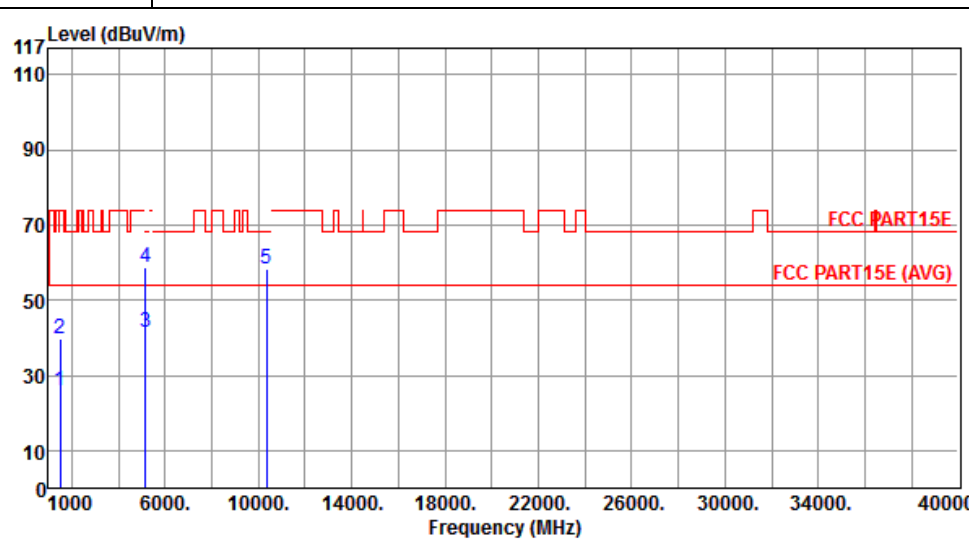
<b>Polarization</b>	Horizontal	<b>Test Freq. (MHz)</b>	5180						
<b>Test Configuration</b>	2								
									
	Freq.	Emission level	Limit	Margin	SA reading	Factor	Remark	ANT High	Turn Table
	MHz	dBuV/m	dBuV/m	dB	dBuV	dB		cm	deg
1	1495.00	25.69	54.00	-28.31	32.27	-6.58	Average	---	---
2	1495.00	39.77	74.00	-34.23	46.35	-6.58	Peak	---	---
3	5150.00	41.52	54.00	-12.48	36.58	4.94	Average	---	---
4	5150.00	58.51	74.00	-15.49	53.57	4.94	Peak	---	---
5	10360.00	58.43	68.30	-9.87	43.72	14.71	Peak	---	---
<p>Note 1: "&gt;20dB" means spurious emission levels that exceed the level of 20 dB below the applicable limit.          Note 2: For restricted bands, the peak measurement is fully sufficient, as the max field strength as measured with the Peak-Detector meets the AV-Limit so that the AV level does not need to be reported in addition.</p>									

<b>Polarization</b>	Vertical	<b>Test Freq. (MHz)</b>	5180
<b>Test Configuration</b>	2		

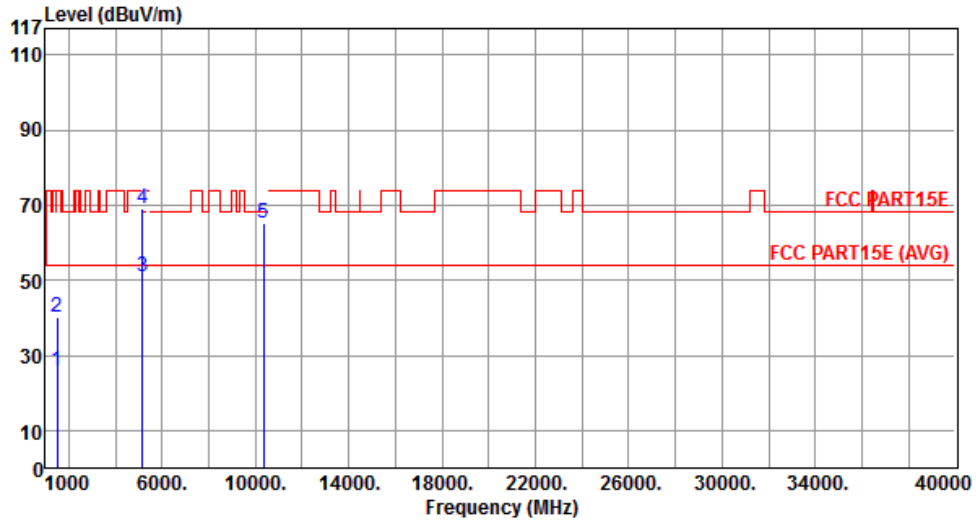

	Freq. MHz	Emission level dBuV/m	Limit dBuV/m	Margin dB	SA reading dBuV	Factor dB	Remark	ANT High cm	Turn Table deg
1	1495.00	25.91	54.00	-28.09	32.49	-6.58	Average	---	---
2	1495.00	40.25	74.00	-33.75	46.83	-6.58	Peak	---	---
3	5150.00	50.73	54.00	-3.27	45.79	4.94	Average	---	---
4	5150.00	69.12	74.00	-4.88	64.18	4.94	Peak	---	---
5	10360.00	65.17	68.30	-3.13	50.46	14.71	Peak	---	---

Note 1: ">20dB" means spurious emission levels that exceed the level of 20 dB below the applicable limit.  
 Note 2: For restricted bands, the peak measurement is fully sufficient, as the max field strength as measured with the Peak-Detector meets the AV-Limit so that the AV level does not need to be reported in addition.

<b>Polarization</b>	Horizontal	<b>Test Freq. (MHz)</b>	5200
<b>Test Configuration</b>	2		

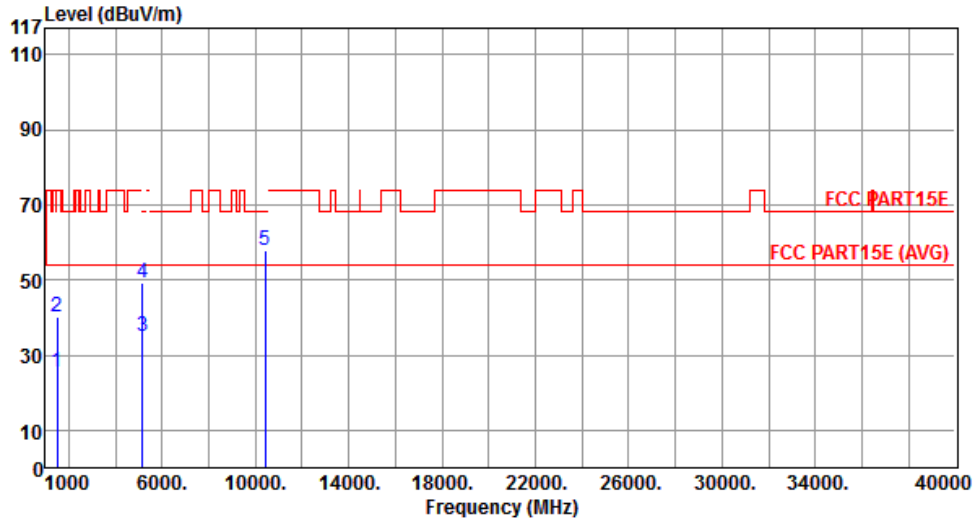

	Freq. MHz	Emission level dBuV/m	Limit dBuV/m	Margin dB	SA reading dBuV	Factor dB	Remark	ANT High cm	Turn Table deg
1	1495.00	25.54	54.00	-28.46	32.12	-6.58	Average	---	---
2	1495.00	40.00	74.00	-34.00	46.58	-6.58	Peak	---	---
3	5150.00	35.01	54.00	-18.99	30.07	4.94	Average	---	---
4	5150.00	49.37	74.00	-24.63	44.43	4.94	Peak	---	---
5	10400.00	57.84	68.30	-10.46	43.09	14.75	Peak	---	---

Note 1: ">20dB" means spurious emission levels that exceed the level of 20 dB below the applicable limit.  
 Note 2: For restricted bands, the peak measurement is fully sufficient, as the max field strength as measured with the Peak-Detector meets the AV-Limit so that the AV level does not need to be reported in addition.

<b>Polarization</b>	Vertical	<b>Test Freq. (MHz)</b>	5200
<b>Test Configuration</b>	2		

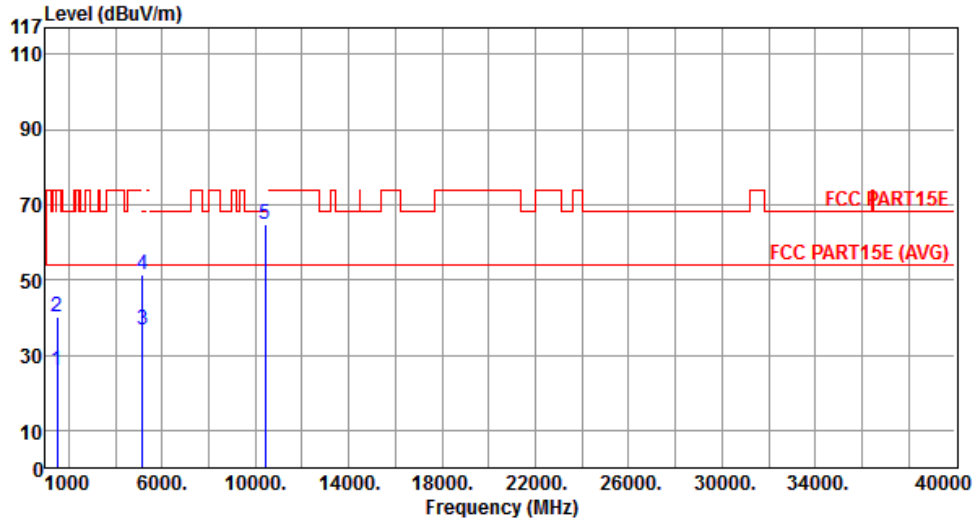

	Freq. MHz	Emission level dBuV/m	Limit dBuV/m	Margin dB	SA reading dBuV	Factor dB	Remark	ANT High cm	Turn Table deg
1	1495.00	26.00	54.00	-28.00	32.58	-6.58	Average	---	---
2	1495.00	40.36	74.00	-33.64	46.94	-6.58	Peak	---	---
3	5150.00	36.83	54.00	-17.17	31.89	4.94	Average	---	---
4	5150.00	51.45	74.00	-22.55	46.51	4.94	Peak	---	---
5	10400.00	64.59	68.30	-3.71	49.84	14.75	Peak	---	---

Note 1: ">20dB" means spurious emission levels that exceed the level of 20 dB below the applicable limit.  
 Note 2: For restricted bands, the peak measurement is fully sufficient, as the max field strength as measured with the Peak-Detector meets the AV-Limit so that the AV level does not need to be reported in addition.

<b>Polarization</b>	Horizontal	<b>Test Freq. (MHz)</b>	5240
<b>Test Configuration</b>	2		

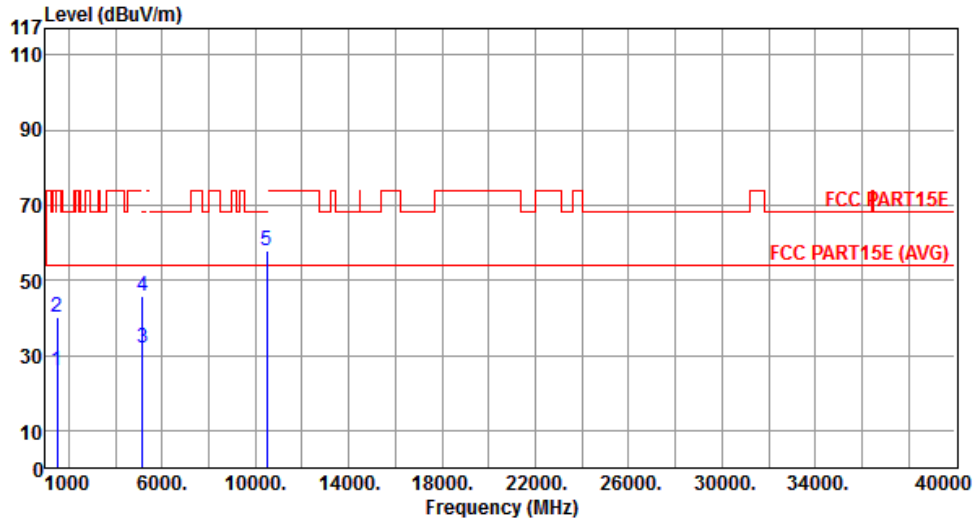

	Freq. MHz	Emission level dBuV/m	Limit dBuV/m	Margin dB	SA reading dBuV	Factor dB	Remark	ANT High cm	Turn Table deg
1	1495.00	25.81	54.00	-28.19	32.39	-6.58	Average	---	---
2	1495.00	40.09	74.00	-33.91	46.67	-6.58	Peak	---	---
3	5150.00	31.97	54.00	-22.03	27.03	4.94	Average	---	---
4	5150.00	45.91	74.00	-28.09	40.97	4.94	Peak	---	---
5	10488.00	57.82	68.30	-10.48	42.98	14.84	Peak	---	---

Note 1: ">20dB" means spurious emission levels that exceed the level of 20 dB below the applicable limit.  
 Note 2: For restricted bands, the peak measurement is fully sufficient, as the max field strength as measured with the Peak-Detector meets the AV-Limit so that the AV level does not need to be reported in addition.

<b>Polarization</b>	Vertical	<b>Test Freq. (MHz)</b>	5240
<b>Test Configuration</b>	2		

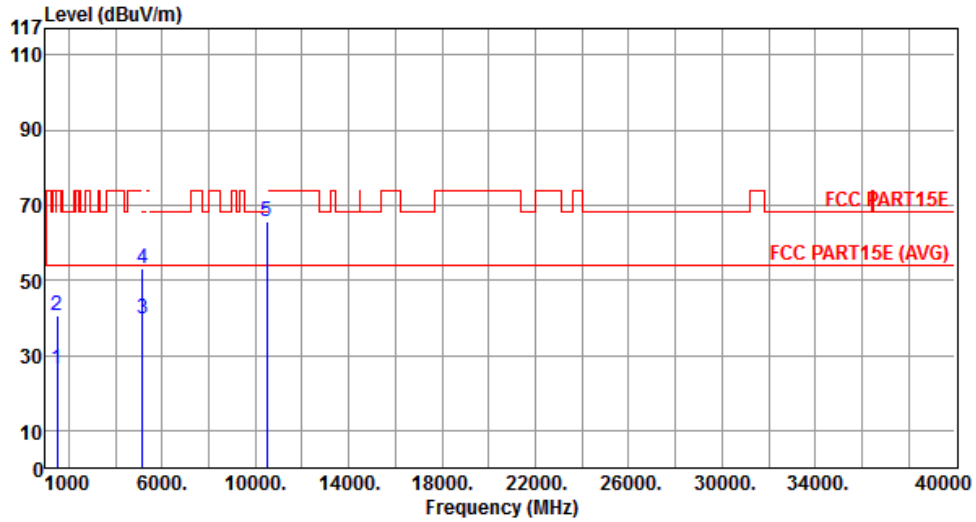

	Freq. MHz	Emission level dBuV/m	Limit dBuV/m	Margin dB	SA reading dBuV	Factor dB	Remark	ANT High cm	Turn Table deg
1	1495.00	26.20	54.00	-27.80	32.78	-6.58	Average	---	---
2	1495.00	40.47	74.00	-33.53	47.05	-6.58	Peak	---	---
3	5150.00	39.80	54.00	-14.20	34.86	4.94	Average	---	---
4	5150.00	53.13	74.00	-20.87	48.19	4.94	Peak	---	---
5	10480.00	65.80	68.30	-2.50	50.96	14.84	Peak	---	---

Note 1: ">20dB" means spurious emission levels that exceed the level of 20 dB below the applicable limit.  
 Note 2: For restricted bands, the peak measurement is fully sufficient, as the max field strength as measured with the Peak-Detector meets the AV-Limit so that the AV level does not need to be reported in addition.

<b>Polarization</b>	Horizontal	<b>Test Freq. (MHz)</b>	5260
<b>Test Configuration</b>	2		

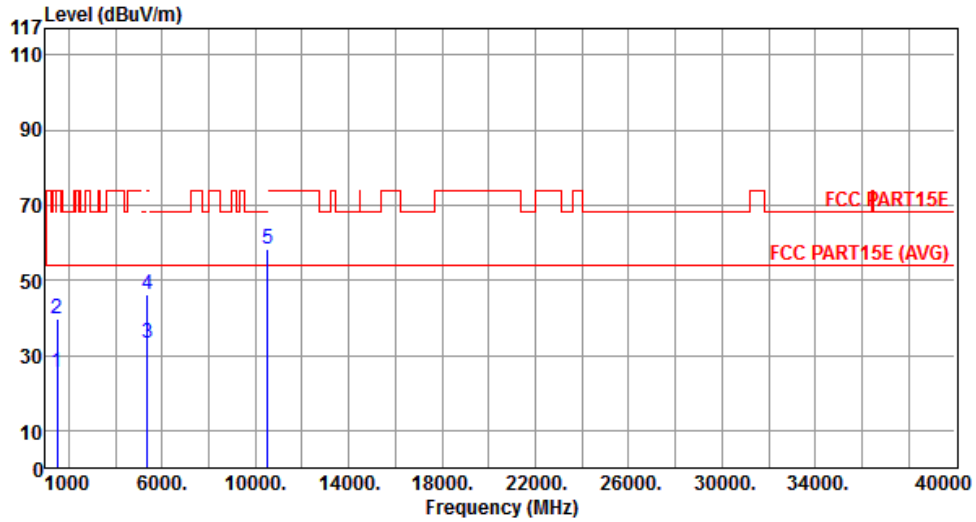

	Freq. MHz	Emission level dBuV/m	Limit dBuV/m	Margin dB	SA reading dBuV	Factor dB	Remark	ANT High cm	Turn Table deg
1	1495.00	25.61	54.00	-28.39	32.19	-6.58	Average	---	---
2	1495.00	39.70	74.00	-34.30	46.28	-6.58	Peak	---	---
3	5350.00	33.05	54.00	-20.95	27.96	5.09	Average	---	---
4	5350.00	46.01	74.00	-27.99	40.92	5.09	Peak	---	---
5	10520.00	58.31	68.30	-9.99	43.44	14.87	Peak	---	---

Note 1: ">20dB" means spurious emission levels that exceed the level of 20 dB below the applicable limit.  
 Note 2: For restricted bands, the peak measurement is fully sufficient, as the max field strength as measured with the Peak-Detector meets the AV-Limit so that the AV level does not need to be reported in addition.



<b>Polarization</b>	Vertical	<b>Test Freq. (MHz)</b>	5260
<b>Test Configuration</b>	2		

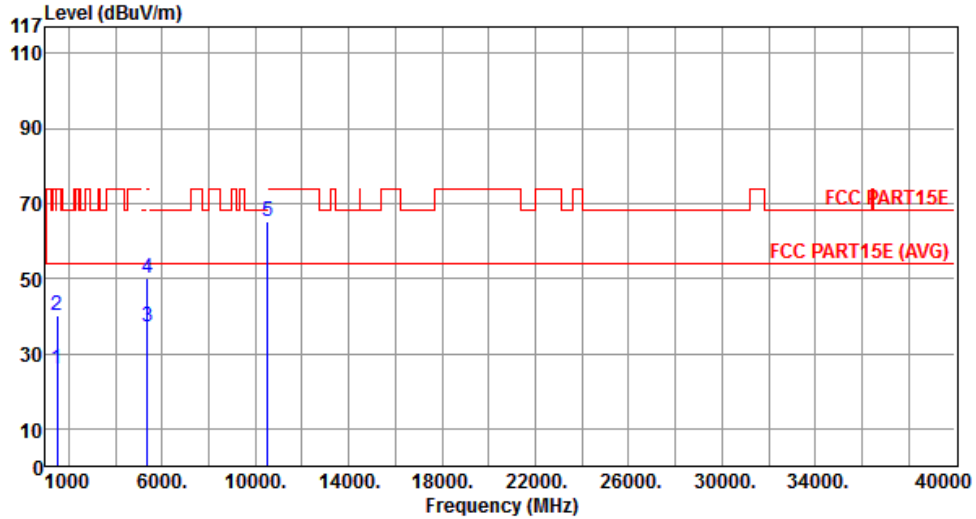

	Freq. MHz	Emission level dBuV/m	Limit dBuV/m	Margin dB	SA reading dBuV	Factor dB	Remark	ANT High cm	Turn Table deg
1	1495.00	25.99	54.00	-28.01	32.57	-6.58	Average	---	---
2	1495.00	40.05	74.00	-33.95	46.63	-6.58	Peak	---	---
3	5350.00	37.09	54.00	-16.91	32.00	5.09	Average	---	---
4	5350.00	50.04	74.00	-23.96	44.95	5.09	Peak	---	---
5	10520.00	65.03	68.30	-3.27	50.16	14.87	Peak	---	---

Note 1: ">20dB" means spurious emission levels that exceed the level of 20 dB below the applicable limit.  
 Note 2: For restricted bands, the peak measurement is fully sufficient, as the max field strength as measured with the Peak-Detector meets the AV-Limit so that the AV level does not need to be reported in addition.

<b>Polarization</b>	Horizontal	<b>Test Freq. (MHz)</b>	5300
<b>Test Configuration</b>	2		

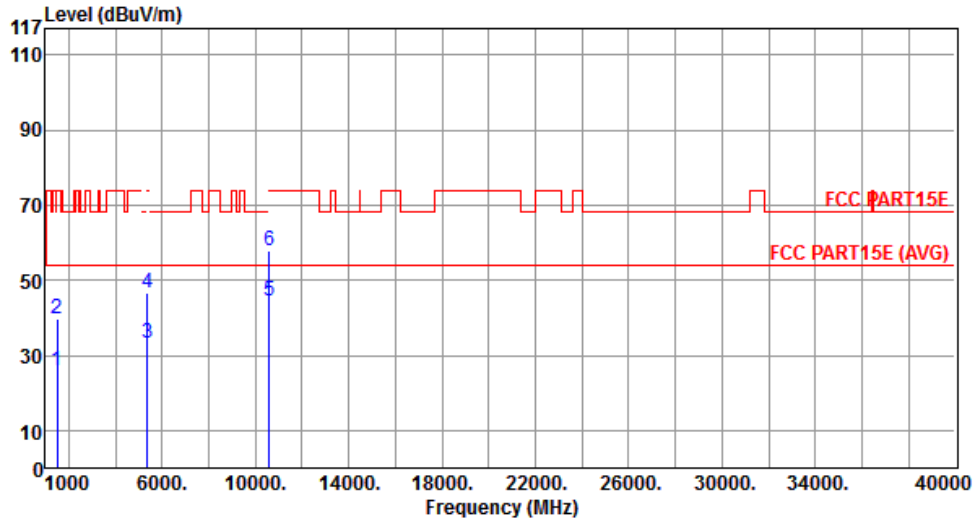

	Freq. MHz	Emission level dBuV/m	Limit dBuV/m	Margin dB	SA reading dBuV	Factor dB	Remark	ANT High cm	Turn Table deg
1	1495.00	25.78	54.00	-28.22	32.36	-6.58	Average	---	---
2	1495.00	39.89	74.00	-34.11	46.47	-6.58	Peak	---	---
3	5350.00	33.39	54.00	-20.61	28.30	5.09	Average	---	---
4	5350.00	46.51	74.00	-27.49	41.42	5.09	Peak	---	---
5	10600.00	44.61	54.00	-9.39	29.67	14.94	Average	---	---
6	10600.00	57.96	74.00	-16.04	43.02	14.94	Peak	---	---

Note 1: ">20dB" means spurious emission levels that exceed the level of 20 dB below the applicable limit.  
 Note 2: For restricted bands, the peak measurement is fully sufficient, as the max field strength as measured with the Peak-Detector meets the AV-Limit so that the AV level does not need to be reported in addition.

<b>Polarization</b>	Vertical	<b>Test Freq. (MHz)</b>	5300
<b>Test Configuration</b>	2		

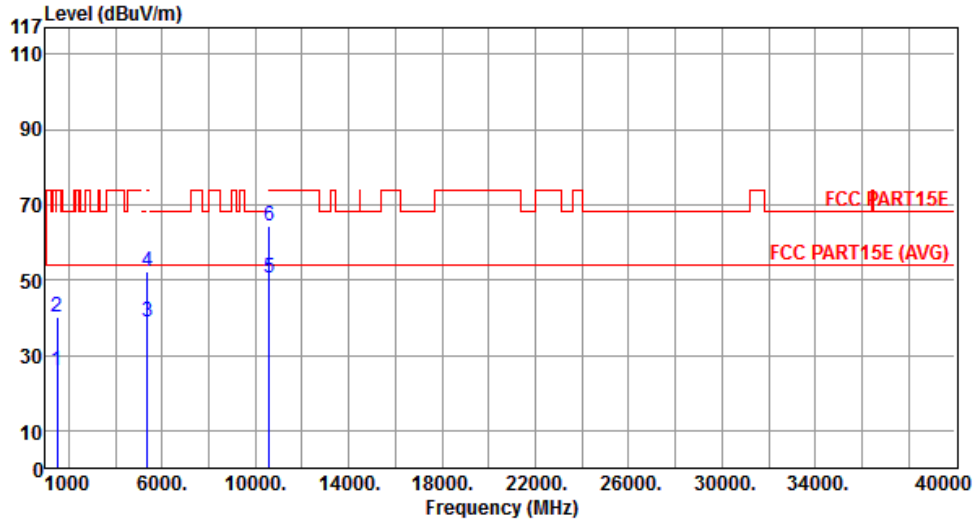

	Freq. MHz	Emission level dBuV/m	Limit dBuV/m	Margin dB	SA reading dBuV	Factor dB	Remark	ANT High cm	Turn Table deg
1	1495.00	26.11	54.00	-27.89	32.69	-6.58	Average	---	---
2	1495.00	40.33	74.00	-33.67	46.91	-6.58	Peak	---	---
3	5350.00	39.04	54.00	-14.96	33.95	5.09	Average	---	---
4	5350.00	52.23	74.00	-21.77	47.14	5.09	Peak	---	---
5	10600.00	50.55	54.00	-3.45	35.61	14.94	Average	---	---
6	10600.00	64.53	74.00	-9.47	49.59	14.94	Peak	---	---

Note 1: ">20dB" means spurious emission levels that exceed the level of 20 dB below the applicable limit.  
 Note 2: For restricted bands, the peak measurement is fully sufficient, as the max field strength as measured with the Peak-Detector meets the AV-Limit so that the AV level does not need to be reported in addition.

<b>Polarization</b>	Horizontal	<b>Test Freq. (MHz)</b>	5320
<b>Test Configuration</b>	2		

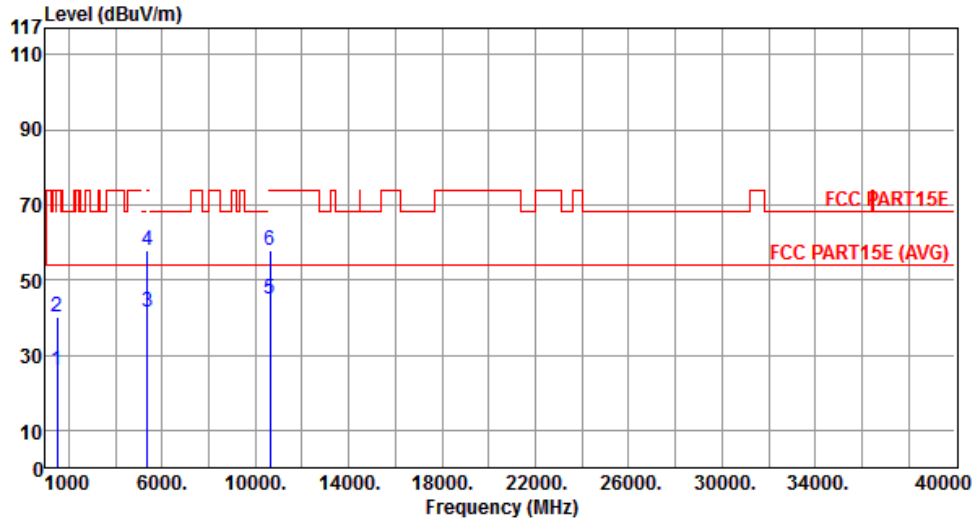

	Freq. MHz	Emission level dBuV/m	Limit dBuV/m	Margin dB	SA reading dBuV	Factor dB	Remark	ANT High cm	Turn Table deg
1	1495.00	25.80	54.00	-28.20	32.38	-6.58	Average	---	---
2	1495.00	39.96	74.00	-34.04	46.54	-6.58	Peak	---	---
3	5350.00	41.57	54.00	-12.43	36.48	5.09	Average	---	---
4	5350.00	57.89	74.00	-16.11	52.80	5.09	Peak	---	---
5	10640.00	45.11	54.00	-8.89	30.13	14.98	Average	---	---
6	10640.00	57.94	74.00	-16.06	42.96	14.98	Peak	---	---

Note 1: ">20dB" means spurious emission levels that exceed the level of 20 dB below the applicable limit.  
 Note 2: For restricted bands, the peak measurement is fully sufficient, as the max field strength as measured with the Peak-Detector meets the AV-Limit so that the AV level does not need to be reported in addition.

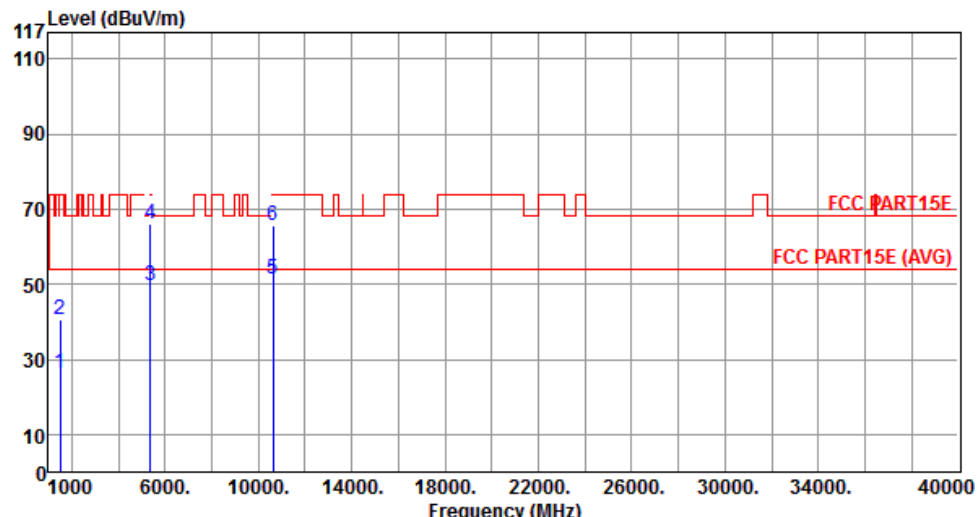
<b>Polarization</b>	Vertical	<b>Test Freq. (MHz)</b>	5320						
<b>Test Configuration</b>	2								
									
	Freq.	Emission level	Limit	Margin	SA reading	Factor	Remark	ANT High	Turn Table
	MHz	dBuV/m	dBuV/m	dB	dBuV	dB		cm	deg
1	1495.00	26.27	54.00	-27.73	32.85	-6.58	Average	---	---
2	1495.00	40.38	74.00	-33.62	46.96	-6.58	Peak	---	---
3	5350.00	49.66	54.00	-4.34	44.57	5.09	Average	---	---
4	5350.00	65.96	74.00	-8.04	60.87	5.09	Peak	---	---
5	10640.00	51.58	54.00	-2.42	36.60	14.98	Average	---	---
6	10640.00	65.82	74.00	-8.18	50.84	14.98	Peak	---	---
<p>Note 1: "&gt;20dB" means spurious emission levels that exceed the level of 20 dB below the applicable limit.          Note 2: For restricted bands, the peak measurement is fully sufficient, as the max field strength as measured with the Peak-Detector meets the AV-Limit so that the AV level does not need to be reported in addition.</p>									

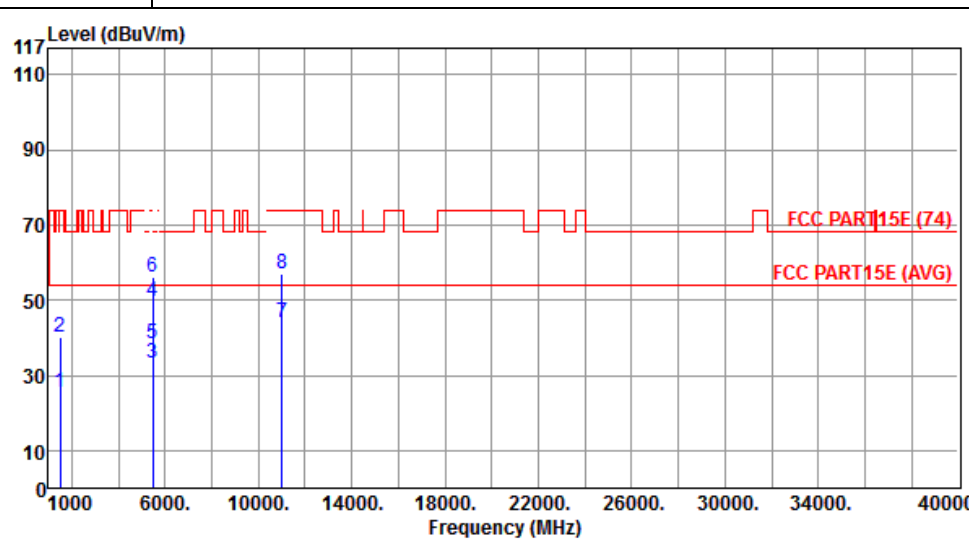
<b>Polarization</b>	Horizontal	<b>Test Freq. (MHz)</b>	5500						
<b>Test Configuration</b>	2								
									
	Freq.	Emission level	Limit	Margin	SA reading	Factor	Remark	ANT High	Turn Table
	MHz	dBuV/m	dBuV/m	dB	dBuV	dB		cm	deg
1	1495.00	25.61	54.00	-28.39	32.19	-6.58	Average	---	---
2	1495.00	40.00	74.00	-34.00	46.58	-6.58	Peak	---	---
3	5460.00	33.28	54.00	-20.72	28.10	5.18	Average	---	---
4	5460.00	49.57	74.00	-24.43	44.39	5.18	Peak	---	---
5	5470.00	38.39	54.00	-15.61	33.20	5.19	Average	---	---
6	5470.00	55.96	74.00	-18.04	50.77	5.19	Peak	---	---
7	11000.00	44.13	54.00	-9.87	28.85	15.28	Average	---	---
8	11000.00	56.99	74.00	-17.01	41.71	15.28	Peak	---	---
<p>Note 1: "&gt;20dB" means spurious emission levels that exceed the level of 20 dB below the applicable limit.          Note 2: For restricted bands, the peak measurement is fully sufficient, as the max field strength as measured with the Peak-Detector meets the AV-Limit so that the AV level does not need to be reported in addition.</p>									

<b>Polarization</b>	Vertical	<b>Test Freq. (MHz)</b>	5500
<b>Test Configuration</b>	2		

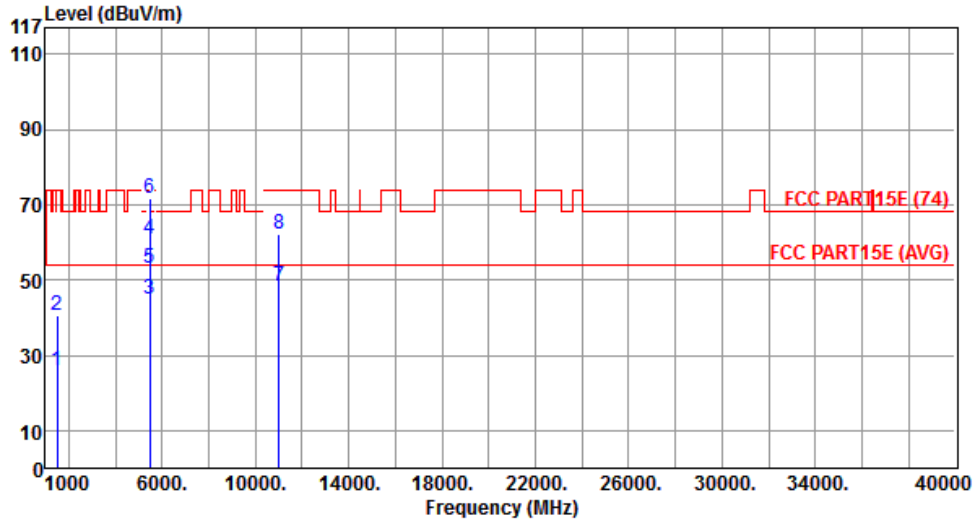

	Freq. MHz	Emission level dBuV/m	Limit dBuV/m	Margin dB	SA reading dBuV	Factor dB	Remark	ANT High cm	Turn Table deg
1	1495.00	26.09	54.00	-27.91	32.67	-6.58	Average	---	---
2	1495.00	40.66	74.00	-33.34	47.24	-6.58	Peak	---	---
3	5460.00	44.88	54.00	-9.12	39.70	5.18	Average	---	---
4	5460.00	60.98	74.00	-13.02	55.80	5.18	Peak	---	---
5	5470.00	52.94	54.00	-1.06	47.75	5.19	Average	---	---
6	5470.00	71.79	74.00	-2.21	66.60	5.19	Peak	---	---
7	11000.00	48.40	54.00	-5.60	33.12	15.28	Average	---	---
8	11000.00	62.25	74.00	-11.75	46.97	15.28	Peak	---	---

Note 1: ">20dB" means spurious emission levels that exceed the level of 20 dB below the applicable limit.  
 Note 2: For restricted bands, the peak measurement is fully sufficient, as the max field strength as measured with the Peak-Detector meets the AV-Limit so that the AV level does not need to be reported in addition.

<b>Polarization</b>	Horizontal	<b>Test Freq. (MHz)</b>	5580
---------------------	------------	-------------------------	------

<b>Test Configuration</b>	2
---------------------------	---

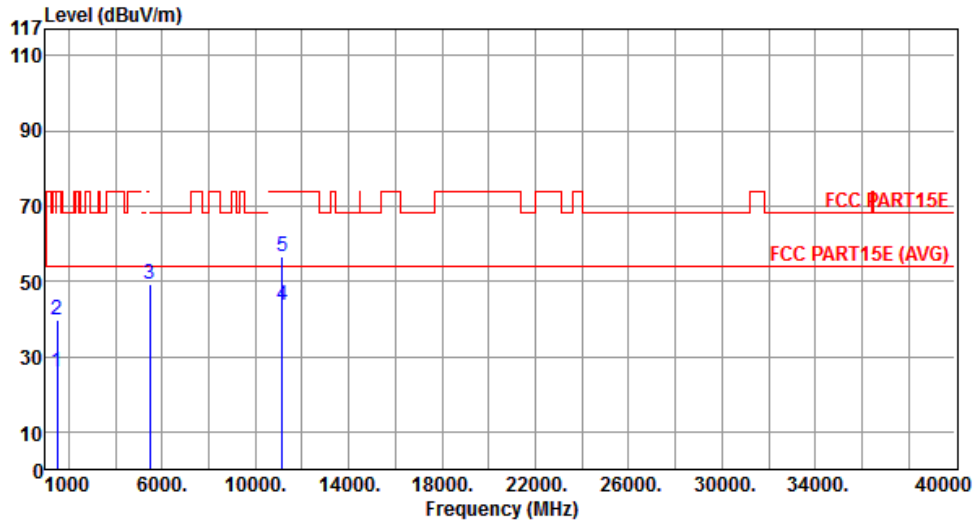

	Freq. MHz	Emission level dBuV/m	Limit dBuV/m	Margin dB	SA reading dBuV	Factor dB	Remark	ANT High cm	Turn Table deg
1	1495.00	25.76	54.00	-28.24	32.34	-6.58	Average	---	---
2	1495.00	39.61	74.00	-34.39	46.19	-6.58	Peak	---	---
3	5470.00	49.30	68.30	-19.00	44.11	5.19	Peak	---	---
4	11160.00	43.46	54.00	-10.54	28.28	15.18	Average	---	---
5	11160.00	56.65	74.00	-17.35	41.47	15.18	Peak	---	---

Note 1: ">20dB" means spurious emission levels that exceed the level of 20 dB below the applicable limit.  
 Note 2: For restricted bands, the peak measurement is fully sufficient, as the max field strength as measured with the Peak-Detector meets the AV-Limit so that the AV level does not need to be reported in addition.



<b>Polarization</b>	Vertical	<b>Test Freq. (MHz)</b>	5580
<b>Test Configuration</b>	2		

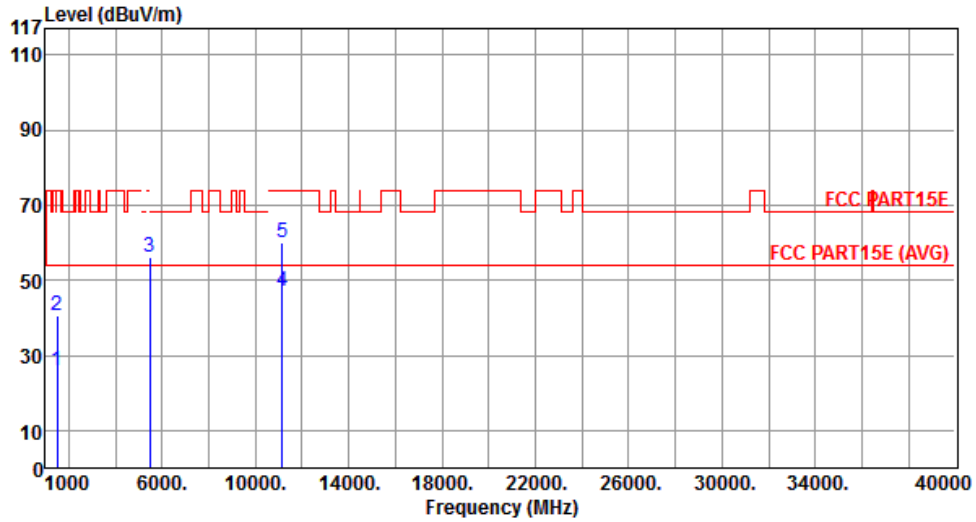

	Freq. MHz	Emission level dBuV/m	Limit dBuV/m	Margin dB	SA reading dBuV	Factor dB	Remark	ANT High cm	Turn Table deg
1	1495.00	25.93	54.00	-28.07	32.51	-6.58	Average	---	---
2	1495.00	40.70	74.00	-33.30	47.28	-6.58	Peak	---	---
3	5470.00	56.18	68.30	-12.12	50.99	5.19	Peak	---	---
4	11160.00	46.90	54.00	-7.10	31.72	15.18	Average	---	---
5	11160.00	60.16	74.00	-13.84	44.98	15.18	Peak	---	---

Note 1: ">20dB" means spurious emission levels that exceed the level of 20 dB below the applicable limit.  
 Note 2: For restricted bands, the peak measurement is fully sufficient, as the max field strength as measured with the Peak-Detector meets the AV-Limit so that the AV level does not need to be reported in addition.

<b>Polarization</b>	Horizontal	<b>Test Freq. (MHz)</b>	5700
<b>Test Configuration</b>	2		

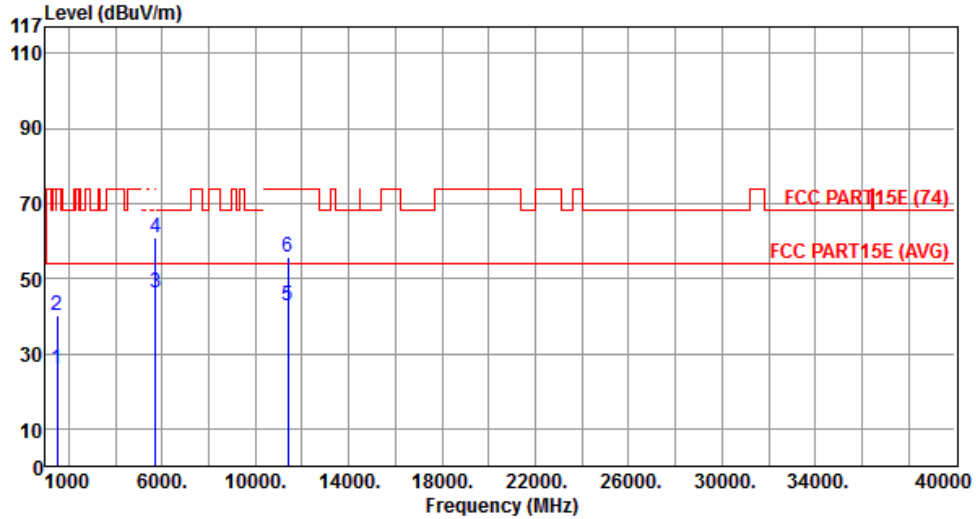

	Freq. MHz	Emission level dBuV/m	Limit dBuV/m	Margin dB	SA reading dBuV	Factor dB	Remark	ANT High cm	Turn Table deg
1	1495.00	25.83	54.00	-28.17	32.41	-6.58	Average	---	---
2	1495.00	40.26	74.00	-33.74	46.84	-6.58	Peak	---	---
3	5725.00	46.08	54.00	-7.92	40.52	5.56	Average	---	---
4	5725.00	60.93	74.00	-13.07	55.37	5.56	Peak	---	---
5	11400.00	42.58	54.00	-11.42	27.55	15.03	Average	---	---
6	11400.00	55.77	74.00	-18.23	40.74	15.03	Peak	---	---

Note 1: ">20dB" means spurious emission levels that exceed the level of 20 dB below the applicable limit.  
 Note 2: For restricted bands, the peak measurement is fully sufficient, as the max field strength as measured with the Peak-Detector meets the AV-Limit so that the AV level does not need to be reported in addition.

<b>Polarization</b>	Vertical	<b>Test Freq. (MHz)</b>	5700
<b>Test Configuration</b>	2		

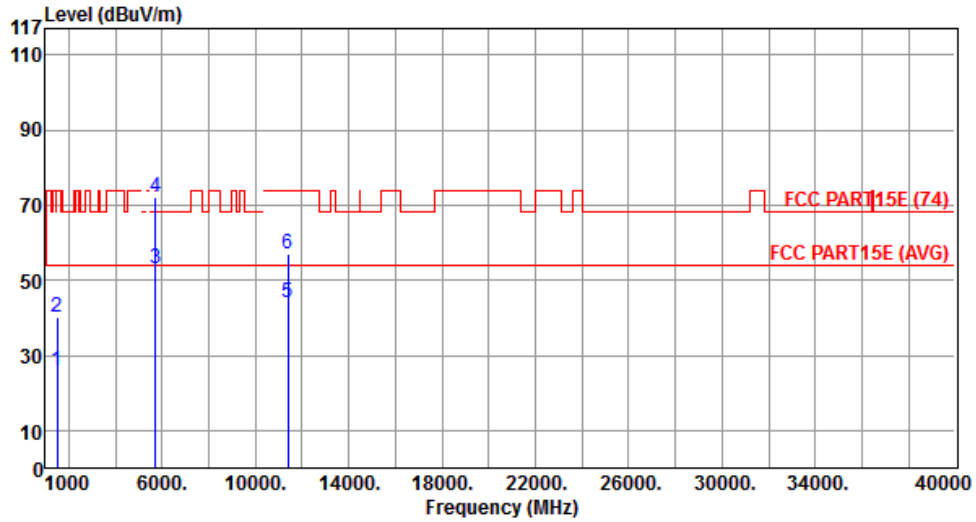

	Freq. MHz	Emission level dBuV/m	Limit dBuV/m	Margin dB	SA reading dBuV	Factor dB	Remark	ANT High cm	Turn Table deg
1	1495.00	26.11	54.00	-27.89	32.69	-6.58	Average	---	---
2	1495.00	40.16	74.00	-33.84	46.74	-6.58	Peak	---	---
3	5725.00	53.00	54.00	-1.00	47.44	5.56	Average	---	---
4	5725.00	72.09	74.00	-1.91	66.53	5.56	Peak	---	---
5	11400.00	43.93	54.00	-10.07	28.90	15.03	Average	---	---
6	11400.00	57.02	74.00	-16.98	41.99	15.03	Peak	---	---

Note 1: ">20dB" means spurious emission levels that exceed the level of 20 dB below the applicable limit.  
 Note 2: For restricted bands, the peak measurement is fully sufficient, as the max field strength as measured with the Peak-Detector meets the AV-Limit so that the AV level does not need to be reported in addition.

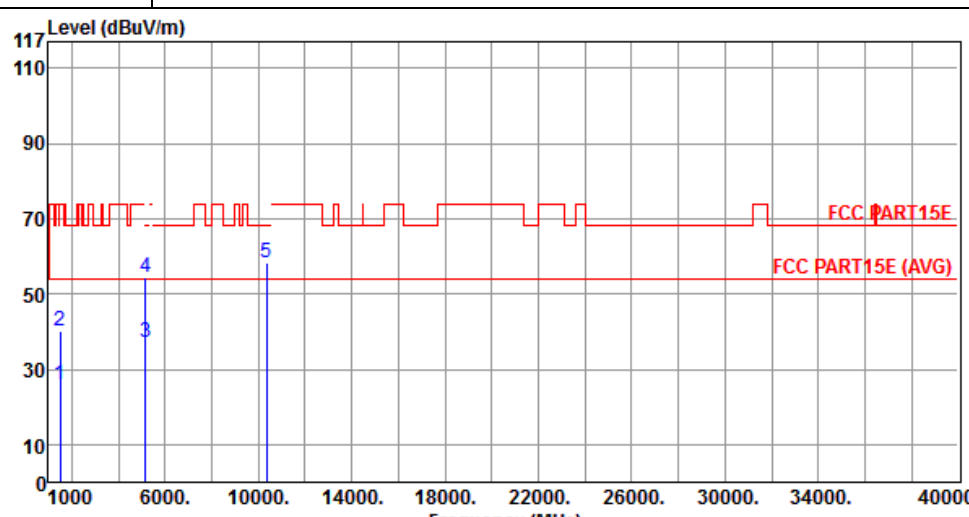
<b>Polarization</b>	Horizontal	<b>Test Freq. (MHz)</b>	5180						
<b>Test Configuration</b>	3								
									
	Freq.	Emission level	Limit	Margin	SA reading	Factor	Remark	ANT High	Turn Table
	MHz	dBuV/m	dBuV/m	dB	dBuV	dB		cm	deg
1	1495.00	25.75	54.00	-28.25	32.33	-6.58	Average	---	---
2	1495.00	39.99	74.00	-34.01	46.57	-6.58	Peak	---	---
3	5150.00	37.18	54.00	-16.82	32.24	4.94	Average	---	---
4	5150.00	54.51	74.00	-19.49	49.57	4.94	Peak	---	---
5	10360.00	58.22	68.30	-10.08	43.51	14.71	Peak	---	---
<p>Note 1: "&gt;20dB" means spurious emission levels that exceed the level of 20 dB below the applicable limit.          Note 2: For restricted bands, the peak measurement is fully sufficient, as the max field strength as measured with the Peak-Detector meets the AV-Limit so that the AV level does not need to be reported in addition.</p>									

<b>Polarization</b>	Vertical	<b>Test Freq. (MHz)</b>	5180
<b>Test Configuration</b>	3		

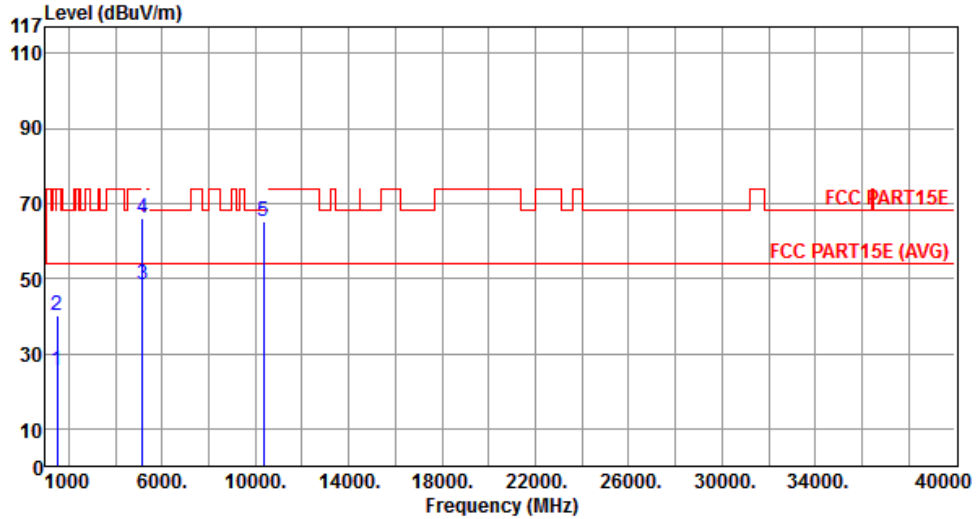

	Freq. MHz	Emission level dBuV/m	Limit dBuV/m	Margin dB	SA reading dBuV	Factor dB	Remark	ANT High cm	Turn Table deg
1	1495.00	25.57	54.00	-28.43	32.15	-6.58	Average	---	---
2	1495.00	40.01	74.00	-33.99	46.59	-6.58	Peak	---	---
3	5150.00	48.48	54.00	-5.52	43.54	4.94	Average	---	---
4	5150.00	66.13	74.00	-7.87	61.19	4.94	Peak	---	---
5	10360.00	65.37	68.30	-2.93	50.66	14.71	Peak	---	---

Note 1: ">20dB" means spurious emission levels that exceed the level of 20 dB below the applicable limit.  
 Note 2: For restricted bands, the peak measurement is fully sufficient, as the max field strength as measured with the Peak-Detector meets the AV-Limit so that the AV level does not need to be reported in addition.

<b>Polarization</b>	Horizontal	<b>Test Freq. (MHz)</b>	5200
<b>Test Configuration</b>	3		

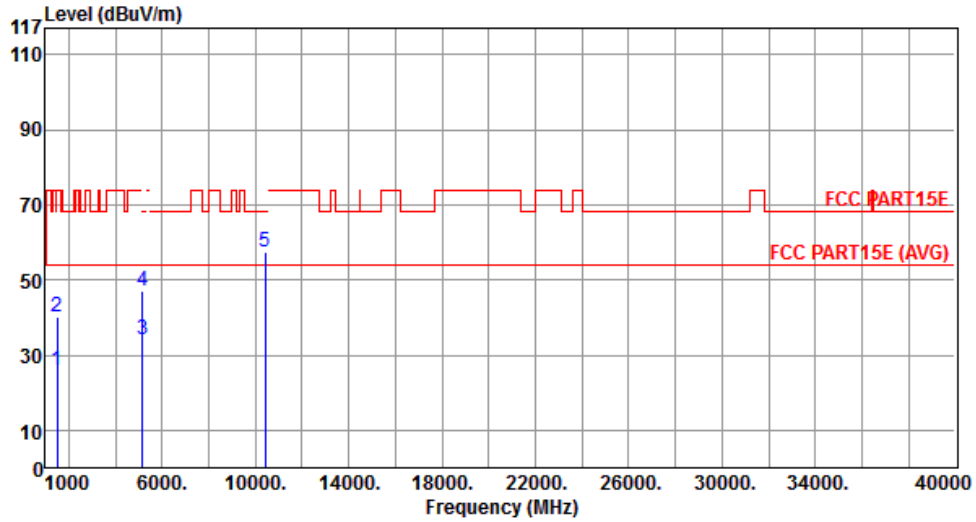

	Freq. MHz	Emission level dBuV/m	Limit dBuV/m	Margin dB	SA reading dBuV	Factor dB	Remark	ANT High cm	Turn Table deg
1	1495.00	25.75	54.00	-28.25	32.33	-6.58	Average	---	---
2	1495.00	40.06	74.00	-33.94	46.64	-6.58	Peak	---	---
3	5150.00	34.09	54.00	-19.91	29.15	4.94	Average	---	---
4	5150.00	47.13	74.00	-26.87	42.19	4.94	Peak	---	---
5	10400.00	57.60	68.30	-10.70	42.85	14.75	Peak	---	---

Note 1: ">20dB" means spurious emission levels that exceed the level of 20 dB below the applicable limit.  
 Note 2: For restricted bands, the peak measurement is fully sufficient, as the max field strength as measured with the Peak-Detector meets the AV-Limit so that the AV level does not need to be reported in addition.

<b>Polarization</b>	Vertical	<b>Test Freq. (MHz)</b>	5200
<b>Test Configuration</b>	3		

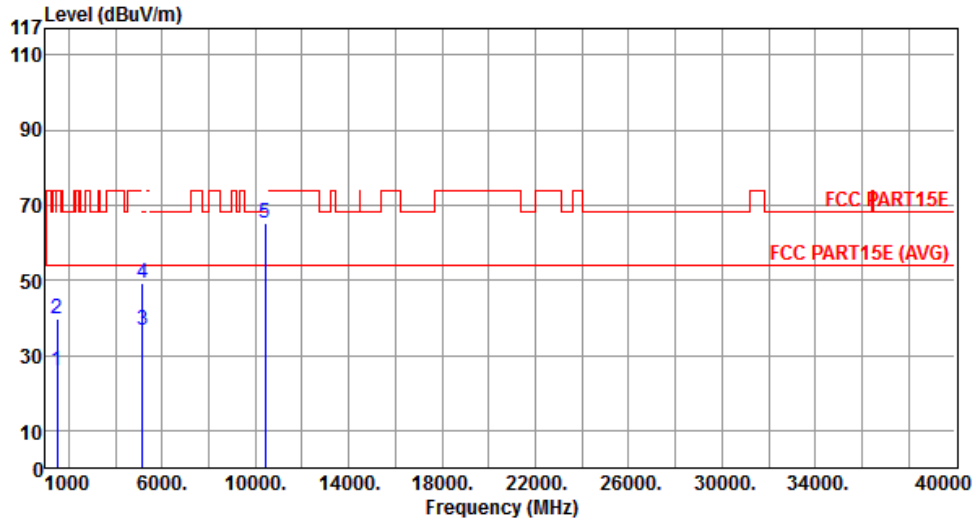

	Freq. MHz	Emission level dBuV/m	Limit dBuV/m	Margin dB	SA reading dBuV	Factor dB	Remark	ANT High cm	Turn Table deg
1	1495.00	25.87	54.00	-28.13	32.45	-6.58	Average	---	---
2	1495.00	39.79	74.00	-34.21	46.37	-6.58	Peak	---	---
3	5150.00	36.75	54.00	-17.25	31.81	4.94	Average	---	---
4	5150.00	49.08	74.00	-24.92	44.14	4.94	Peak	---	---
5	10400.00	65.40	68.30	-2.90	50.65	14.75	Peak	---	---

Note 1: ">20dB" means spurious emission levels that exceed the level of 20 dB below the applicable limit.  
 Note 2: For restricted bands, the peak measurement is fully sufficient, as the max field strength as measured with the Peak-Detector meets the AV-Limit so that the AV level does not need to be reported in addition.

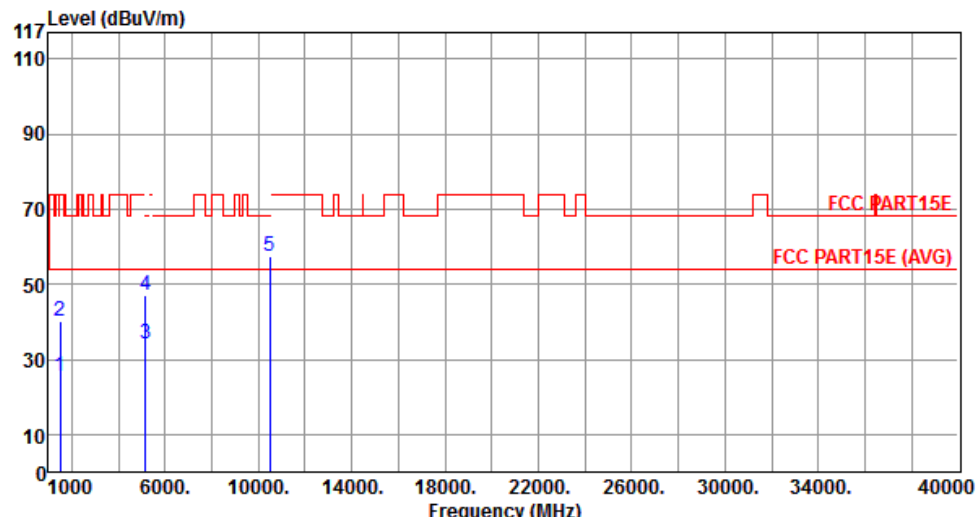
<b>Polarization</b>	Horizontal	<b>Test Freq. (MHz)</b>	5240						
<b>Test Configuration</b>	3								
									
	Freq.	Emission level	Limit	Margin	SA reading	Factor	Remark	ANT High	Turn Table
	MHz	dBuV/m	dBuV/m	dB	dBuV	dB		cm	deg
1	1495.00	25.61	54.00	-28.39	32.19	-6.58	Average	---	---
2	1495.00	40.01	74.00	-33.99	46.59	-6.58	Peak	---	---
3	5150.00	34.22	54.00	-19.78	29.28	4.94	Average	---	---
4	5150.00	47.23	74.00	-26.77	42.29	4.94	Peak	---	---
5	10480.00	57.32	68.30	-10.98	42.48	14.84	Peak	---	---
<p>Note 1: "&gt;20dB" means spurious emission levels that exceed the level of 20 dB below the applicable limit.          Note 2: For restricted bands, the peak measurement is fully sufficient, as the max field strength as measured with the Peak-Detector meets the AV-Limit so that the AV level does not need to be reported in addition.</p>									

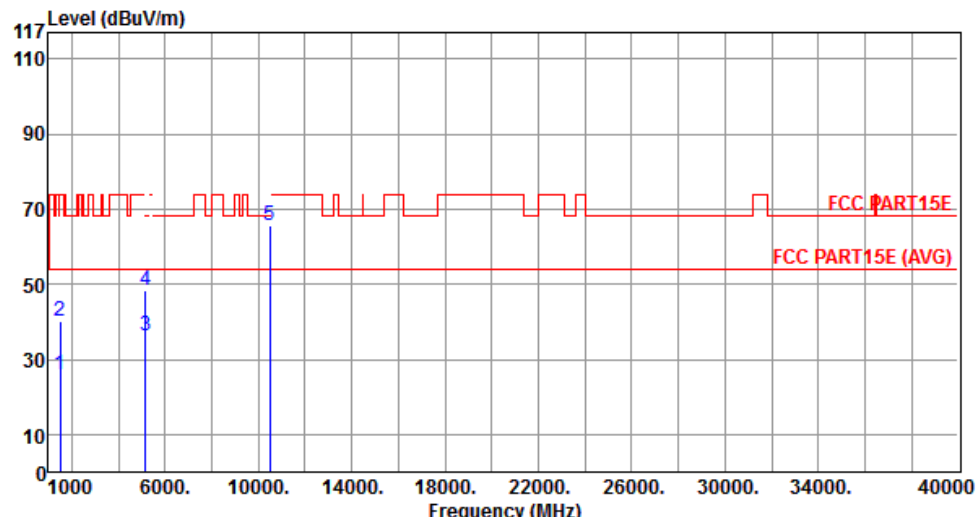

<b>Polarization</b>	Vertical	<b>Test Freq. (MHz)</b>	5240						
<b>Test Configuration</b>	3								
									
	Freq.	Emission level	Limit	Margin	SA reading	Factor	Remark	ANT High	Turn Table
	MHz	dBuV/m	dBuV/m	dB	dBuV	dB		cm	deg
1	1495.00	25.71	54.00	-28.29	32.29	-6.58	Average	---	---
2	1495.00	39.96	74.00	-34.04	46.54	-6.58	Peak	---	---
3	5150.00	36.11	54.00	-17.89	31.17	4.94	Average	---	---
4	5150.00	48.26	74.00	-25.74	43.32	4.94	Peak	---	---
5	10480.00	65.79	68.30	-2.51	50.95	14.84	Peak	---	---
<p>Note 1: "&gt;20dB" means spurious emission levels that exceed the level of 20 dB below the applicable limit.          Note 2: For restricted bands, the peak measurement is fully sufficient, as the max field strength as measured with the Peak-Detector meets the AV-Limit so that the AV level does not need to be reported in addition.</p>									

<b>Polarization</b>	Horizontal	<b>Test Freq. (MHz)</b>	5260
<b>Test Configuration</b>	3		

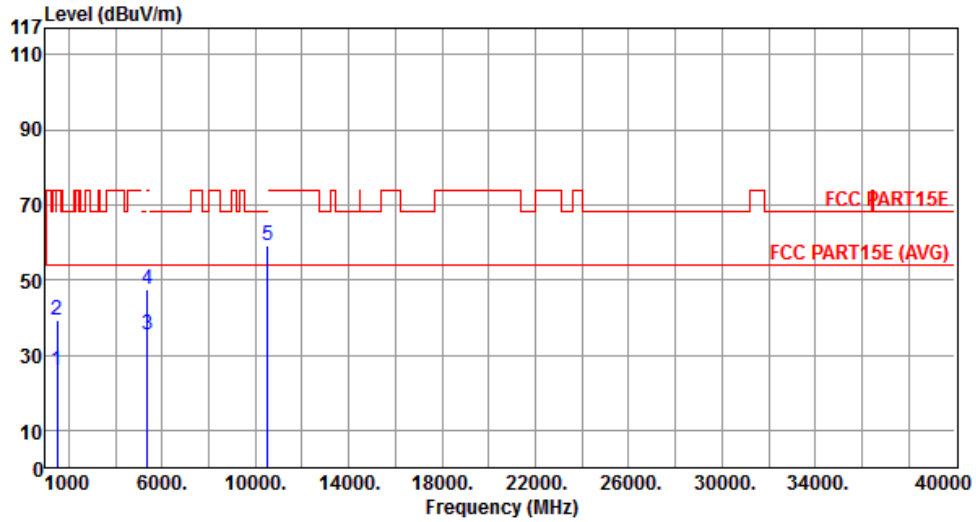

	Freq. MHz	Emission level dBuV/m	Limit dBuV/m	Margin dB	SA reading dBuV	Factor dB	Remark	ANT High cm	Turn Table deg
1	1495.00	25.80	54.00	-28.20	32.38	-6.58	Average	---	---
2	1495.00	39.24	74.00	-34.76	45.82	-6.58	Peak	---	---
3	5350.00	35.51	54.00	-18.49	30.42	5.09	Average	---	---
4	5350.00	47.53	74.00	-26.47	42.44	5.09	Peak	---	---
5	10520.00	59.09	68.30	-9.21	44.22	14.87	Peak	---	---

Note 1: ">20dB" means spurious emission levels that exceed the level of 20 dB below the applicable limit.  
 Note 2: For restricted bands, the peak measurement is fully sufficient, as the max field strength as measured with the Peak-Detector meets the AV-Limit so that the AV level does not need to be reported in addition.

<b>Polarization</b>	Vertical	<b>Test Freq. (MHz)</b>	5260
<b>Test Configuration</b>	3		

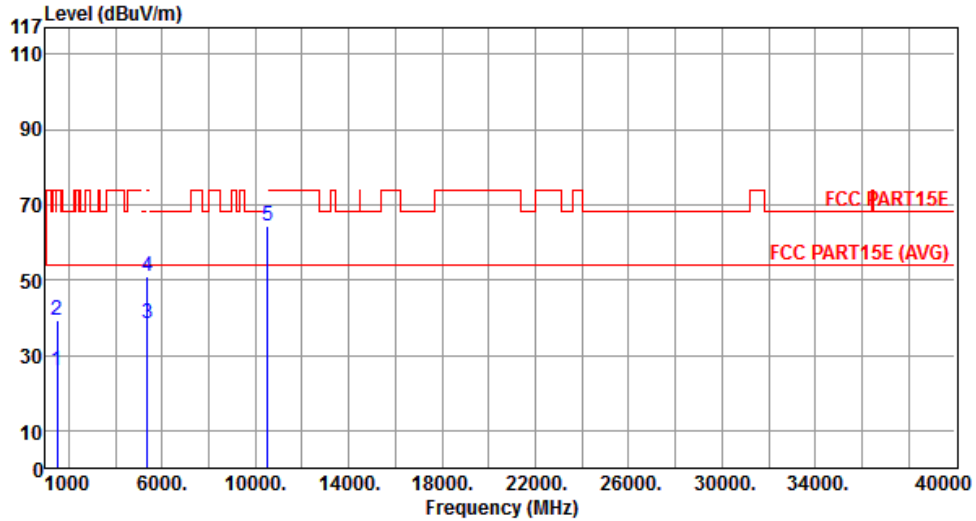

	Freq. MHz	Emission level dBuV/m	Limit dBuV/m	Margin dB	SA reading dBuV	Factor dB	Remark	ANT High cm	Turn Table deg
1	1495.00	25.86	54.00	-28.14	32.44	-6.58	Average	---	---
2	1495.00	39.37	74.00	-34.63	45.95	-6.58	Peak	---	---
3	5350.00	38.39	54.00	-15.61	33.30	5.09	Average	---	---
4	5350.00	50.88	74.00	-23.12	45.79	5.09	Peak	---	---
5	10520.00	64.35	68.30	-3.95	49.48	14.87	Peak	---	---

Note 1: ">20dB" means spurious emission levels that exceed the level of 20 dB below the applicable limit.  
 Note 2: For restricted bands, the peak measurement is fully sufficient, as the max field strength as measured with the Peak-Detector meets the AV-Limit so that the AV level does not need to be reported in addition.

<b>Polarization</b>	Horizontal	<b>Test Freq. (MHz)</b>	5300
<b>Test Configuration</b>	3		

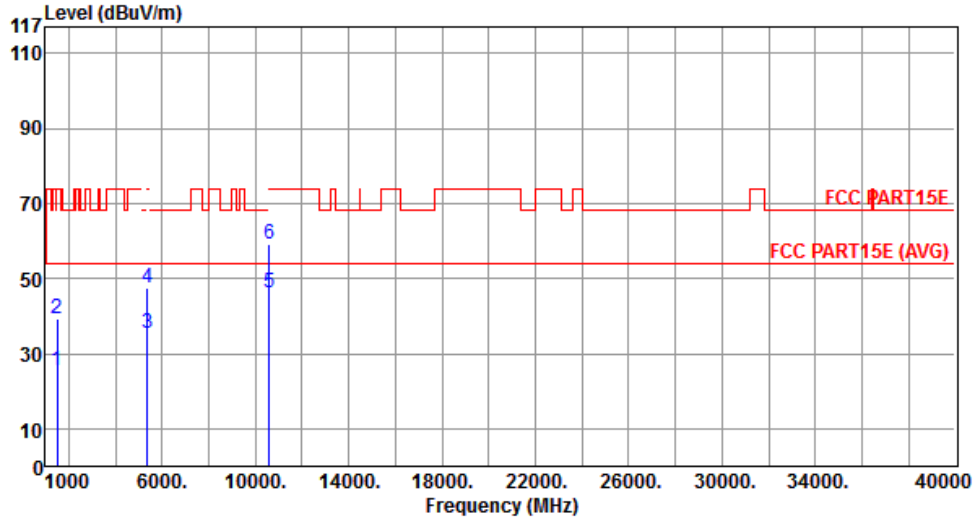

	Freq. MHz	Emission level dBuV/m	Limit dBuV/m	Margin dB	SA reading dBuV	Factor dB	Remark	ANT High cm	Turn Table deg
1	1495.00	25.68	54.00	-28.32	32.26	-6.58	Average	---	---
2	1495.00	39.16	74.00	-34.84	45.74	-6.58	Peak	---	---
3	5350.00	35.41	54.00	-18.59	30.32	5.09	Average	---	---
4	5350.00	47.55	74.00	-26.45	42.46	5.09	Peak	---	---
5	10600.00	46.05	54.00	-7.95	31.11	14.94	Average	---	---
6	10600.00	59.19	74.00	-14.81	44.25	14.94	Peak	---	---

Note 1: ">20dB" means spurious emission levels that exceed the level of 20 dB below the applicable limit.  
 Note 2: For restricted bands, the peak measurement is fully sufficient, as the max field strength as measured with the Peak-Detector meets the AV-Limit so that the AV level does not need to be reported in addition.

<b>Polarization</b>	Vertical	<b>Test Freq. (MHz)</b>	5300
---------------------	----------	-------------------------	------

<b>Test Configuration</b>	3
---------------------------	---

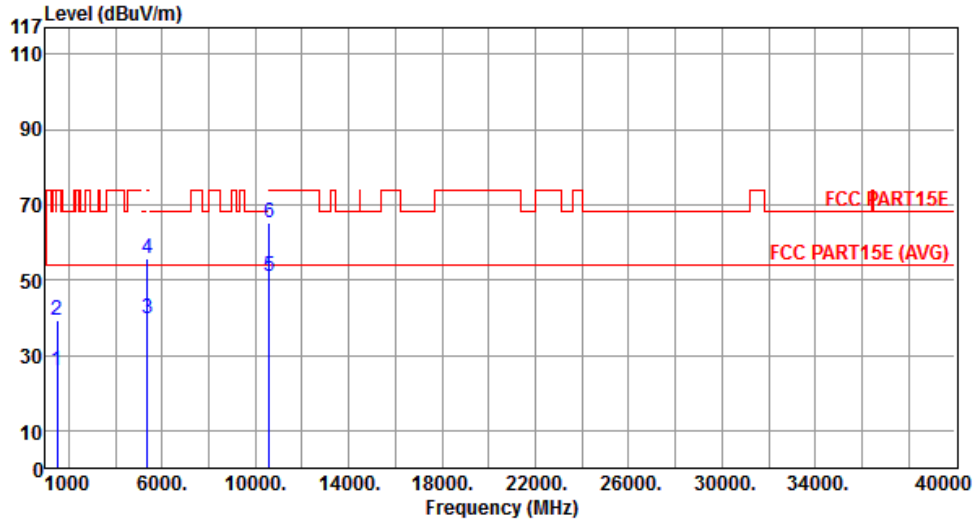

	Freq. MHz	Emission level dBuV/m	Limit dBuV/m	Margin dB	SA reading dBuV	Factor dB	Remark	ANT High cm	Turn Table deg
1	1495.00	25.90	54.00	-28.10	32.48	-6.58	Average	---	---
2	1495.00	39.24	74.00	-34.76	45.82	-6.58	Peak	---	---
3	5350.00	39.58	54.00	-14.42	34.49	5.09	Average	---	---
4	5350.00	55.83	74.00	-18.17	50.74	5.09	Peak	---	---
5	10600.00	50.94	54.00	-3.06	36.00	14.94	Average	---	---
6	10600.00	65.33	74.00	-8.67	50.39	14.94	Peak	---	---

Note 1: ">20dB" means spurious emission levels that exceed the level of 20 dB below the applicable limit.  
 Note 2: For restricted bands, the peak measurement is fully sufficient, as the max field strength as measured with the Peak-Detector meets the AV-Limit so that the AV level does not need to be reported in addition.

<b>Polarization</b>	Horizontal	<b>Test Freq. (MHz)</b>	5320
<b>Test Configuration</b>	3		

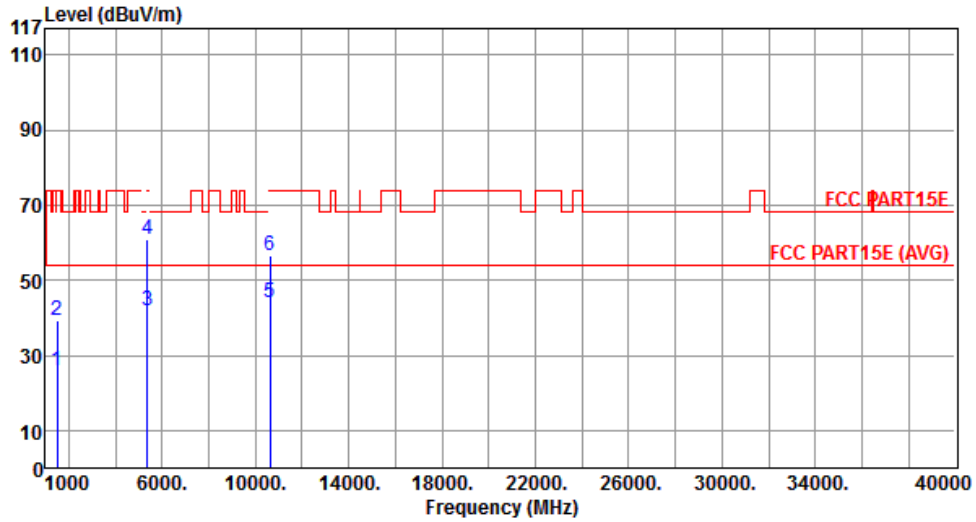

	Freq. MHz	Emission level dBuV/m	Limit dBuV/m	Margin dB	SA reading dBuV	Factor dB	Remark	ANT High cm	Turn Table deg
1	1495.00	25.90	54.00	-28.10	32.48	-6.58	Average	---	---
2	1495.00	39.43	74.00	-34.57	46.01	-6.58	Peak	---	---
3	5350.00	41.94	54.00	-12.06	36.85	5.09	Average	---	---
4	5350.00	60.76	74.00	-13.24	55.67	5.09	Peak	---	---
5	10640.00	43.86	54.00	-10.14	28.88	14.98	Average	---	---
6	10640.00	56.48	74.00	-17.52	41.50	14.98	Peak	---	---

Note 1: ">20dB" means spurious emission levels that exceed the level of 20 dB below the applicable limit.  
 Note 2: For restricted bands, the peak measurement is fully sufficient, as the max field strength as measured with the Peak-Detector meets the AV-Limit so that the AV level does not need to be reported in addition.

<b>Polarization</b>	Vertical	<b>Test Freq. (MHz)</b>	5320
<b>Test Configuration</b>	3		

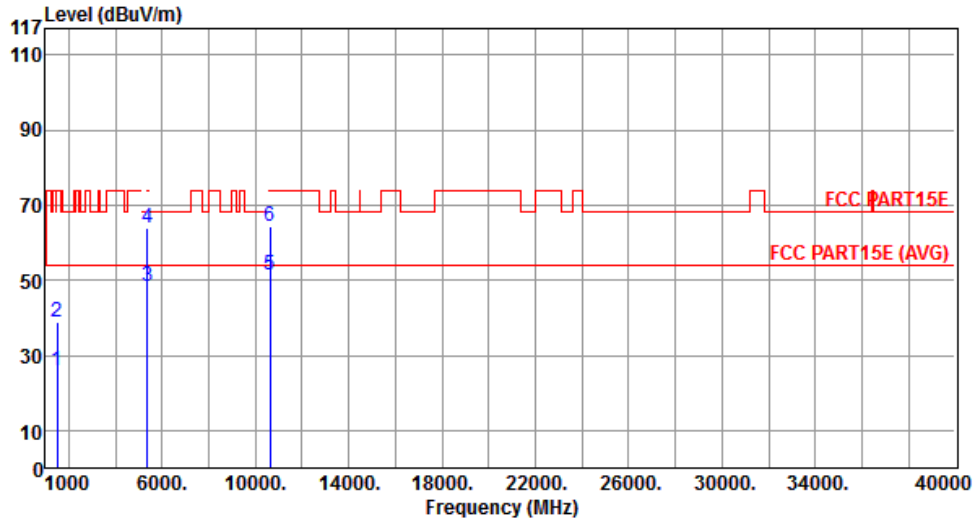

	Freq. MHz	Emission level dBuV/m	Limit dBuV/m	Margin dB	SA reading dBuV	Factor dB	Remark	ANT High cm	Turn Table deg
1	1495.00	25.83	54.00	-28.17	32.41	-6.58	Average	---	---
2	1495.00	38.99	74.00	-35.01	45.57	-6.58	Peak	---	---
3	5350.00	48.22	54.00	-5.78	43.13	5.09	Average	---	---
4	5350.00	63.77	74.00	-10.23	58.68	5.09	Peak	---	---
5	10640.00	51.21	54.00	-2.79	36.23	14.98	Average	---	---
6	10640.00	64.13	74.00	-9.87	49.15	14.98	Peak	---	---

Note 1: ">20dB" means spurious emission levels that exceed the level of 20 dB below the applicable limit.  
 Note 2: For restricted bands, the peak measurement is fully sufficient, as the max field strength as measured with the Peak-Detector meets the AV-Limit so that the AV level does not need to be reported in addition.

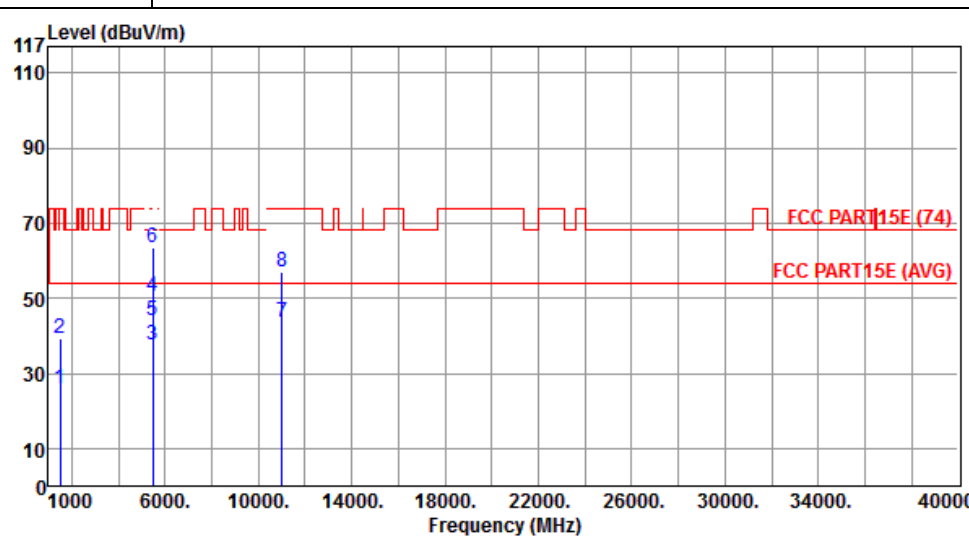
<b>Polarization</b>	Horizontal	<b>Test Freq. (MHz)</b>	5500						
<b>Test Configuration</b>	3								
									
	Freq.	Emission	Limit	Margin	SA	Factor	Remark	ANT	Turn
	MHz	level	dBuV/m	dB	reading	dB		High	Table
								cm	deg
1	1495.00	25.85	54.00	-28.15	32.43	-6.58	Average	---	---
2	1495.00	39.10	74.00	-34.90	45.68	-6.58	Peak	---	---
3	5460.00	37.63	54.00	-16.37	32.45	5.18	Average	---	---
4	5460.00	50.36	74.00	-23.64	45.18	5.18	Peak	---	---
5	5470.00	44.12	54.00	-9.88	38.93	5.19	Average	---	---
6	5470.00	63.60	74.00	-10.40	58.41	5.19	Peak	---	---
7	11000.00	43.71	54.00	-10.29	28.43	15.28	Average	---	---
8	11000.00	56.83	74.00	-17.17	41.55	15.28	Peak	---	---

Note 1: ">20dB" means spurious emission levels that exceed the level of 20 dB below the applicable limit.  
 Note 2: For restricted bands, the peak measurement is fully sufficient, as the max field strength as measured with the Peak-Detector meets the AV-Limit so that the AV level does not need to be reported in addition.



<b>Polarization</b>	Vertical	<b>Test Freq. (MHz)</b>	5500
---------------------	----------	-------------------------	------

<b>Test Configuration</b>	3
---------------------------	---

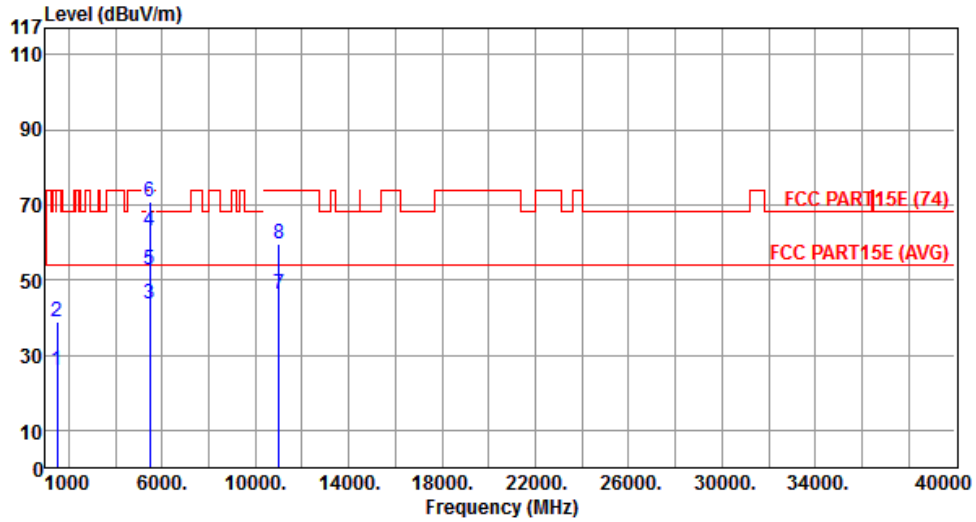

	Freq. MHz	Emission level dBuV/m	Limit dBuV/m	Margin dB	SA reading dBuV	Factor dB	Remark	ANT High cm	Turn Table deg
1	1495.00	25.83	54.00	-28.17	32.41	-6.58	Average	---	---
2	1495.00	38.97	74.00	-35.03	45.55	-6.58	Peak	---	---
3	5460.00	43.55	54.00	-10.45	38.37	5.18	Average	---	---
4	5460.00	62.87	74.00	-11.13	57.69	5.18	Peak	---	---
5	5470.00	52.52	54.00	-1.48	47.33	5.19	Average	---	---
6	5470.00	70.83	74.00	-3.17	65.64	5.19	Peak	---	---
7	11000.00	46.40	54.00	-7.60	31.12	15.28	Average	---	---
8	11000.00	59.46	74.00	-14.54	44.18	15.28	Peak	---	---

Note 1: ">20dB" means spurious emission levels that exceed the level of 20 dB below the applicable limit.  
 Note 2: For restricted bands, the peak measurement is fully sufficient, as the max field strength as measured with the Peak-Detector meets the AV-Limit so that the AV level does not need to be reported in addition.

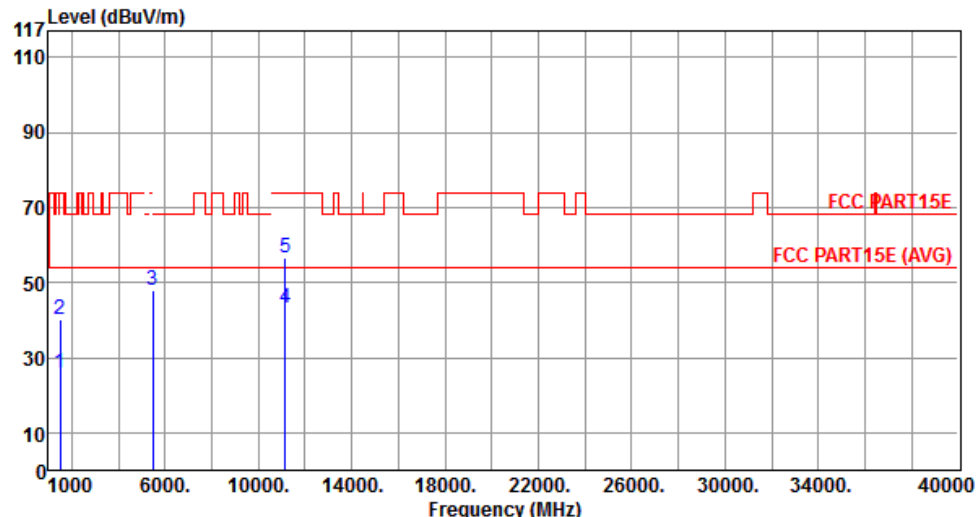
<b>Polarization</b>	Horizontal	<b>Test Freq. (MHz)</b>	5580						
<b>Test Configuration</b>	3								
									
	Freq.	Emission level	Limit	Margin	SA reading	Factor	Remark	ANT High	Turn Table
	MHz	dBuV/m	dBuV/m	dB	dBuV	dB		cm	deg
1	1495.00	25.75	54.00	-28.25	32.33	-6.58	Average	---	---
2	1495.00	39.99	74.00	-34.01	46.57	-6.58	Peak	---	---
3	5470.00	47.83	68.30	-20.47	42.64	5.19	Peak	---	---
4	11160.00	43.34	54.00	-10.66	28.16	15.18	Average	---	---
5	11160.00	56.56	74.00	-17.44	41.38	15.18	Peak	---	---
<p>Note 1: "&gt;20dB" means spurious emission levels that exceed the level of 20 dB below the applicable limit.          Note 2: For restricted bands, the peak measurement is fully sufficient, as the max field strength as measured with the Peak-Detector meets the AV-Limit so that the AV level does not need to be reported in addition.</p>									

<b>Polarization</b>	Vertical	<b>Test Freq. (MHz)</b>	5580
<b>Test Configuration</b>	3		

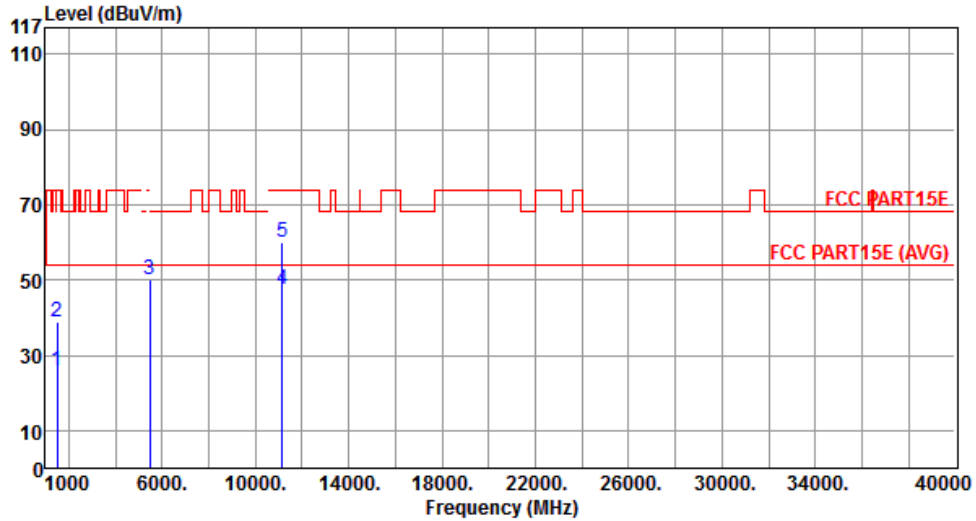

	Freq. MHz	Emission level dBuV/m	Limit dBuV/m	Margin dB	SA reading dBuV	Factor dB	Remark	ANT High cm	Turn Table deg
1	1495.00	25.77	54.00	-28.23	32.35	-6.58	Average	---	---
2	1495.00	39.04	74.00	-34.96	45.62	-6.58	Peak	---	---
3	5470.00	50.07	68.30	-18.23	44.88	5.19	Peak	---	---
4	11160.00	47.29	54.00	-6.71	32.11	15.18	Average	---	---
5	11160.00	59.86	74.00	-14.14	44.68	15.18	Peak	---	---

Note 1: ">20dB" means spurious emission levels that exceed the level of 20 dB below the applicable limit.  
 Note 2: For restricted bands, the peak measurement is fully sufficient, as the max field strength as measured with the Peak-Detector meets the AV-Limit so that the AV level does not need to be reported in addition.

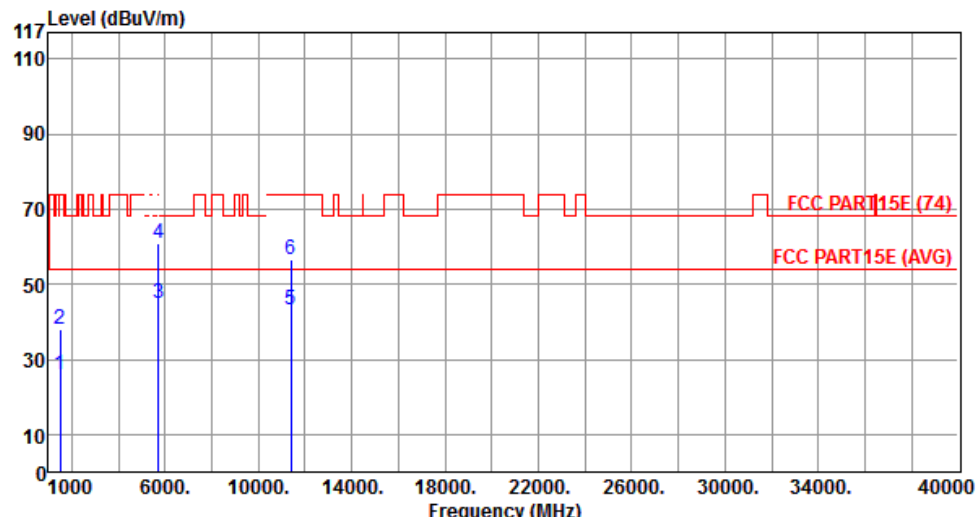
<b>Polarization</b>	Horizontal	<b>Test Freq. (MHz)</b>	5700						
<b>Test Configuration</b>	3								
									
	Freq.	Emission level	Limit	Margin	SA reading	Factor	Remark	ANT High	Turn Table
	MHz	dBuV/m	dBuV/m	dB	dBuV	dB		cm	deg
1	1495.00	25.70	54.00	-28.30	32.28	-6.58	Average	---	---
2	1495.00	38.10	74.00	-35.90	44.68	-6.58	Peak	---	---
3	5725.00	45.10	54.00	-8.90	39.54	5.56	Average	---	---
4	5725.00	61.04	74.00	-12.96	55.48	5.56	Peak	---	---
5	11400.00	43.25	54.00	-10.75	28.22	15.03	Average	---	---
6	11400.00	56.38	74.00	-17.62	41.35	15.03	Peak	---	---
<p>Note 1: "&gt;20dB" means spurious emission levels that exceed the level of 20 dB below the applicable limit.          Note 2: For restricted bands, the peak measurement is fully sufficient, as the max field strength as measured with the Peak-Detector meets the AV-Limit so that the AV level does not need to be reported in addition.</p>									

<b>Polarization</b>	Vertical	<b>Test Freq. (MHz)</b>	5700
---------------------	----------	-------------------------	------

<b>Test Configuration</b>	3
---------------------------	---

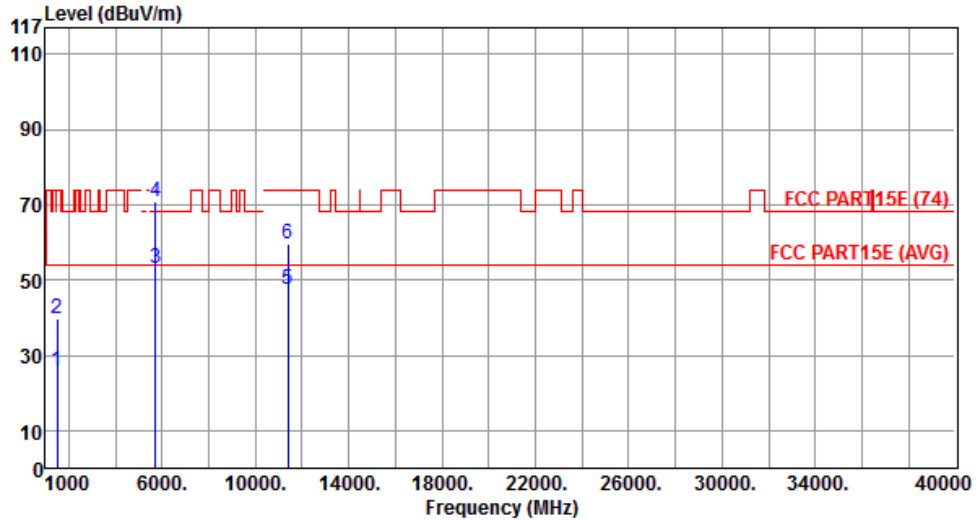

	Freq. MHz	Emission level dBuV/m	Limit dBuV/m	Margin dB	SA reading dBuV	Factor dB	Remark	ANT High cm	Turn Table deg
1	1495.00	25.97	54.00	-28.03	32.55	-6.58	Average	---	---
2	1495.00	39.79	74.00	-34.21	46.37	-6.58	Peak	---	---
3	5725.00	52.90	54.00	-1.10	47.34	5.56	Average	---	---
4	5725.00	70.79	74.00	-3.21	65.23	5.56	Peak	---	---
5	11400.00	47.58	54.00	-6.42	32.55	15.03	Average	---	---
6	11400.00	59.62	74.00	-14.38	44.59	15.03	Peak	---	---

Note 1: ">20dB" means spurious emission levels that exceed the level of 20 dB below the applicable limit.  
 Note 2: For restricted bands, the peak measurement is fully sufficient, as the max field strength as measured with the Peak-Detector meets the AV-Limit so that the AV level does not need to be reported in addition.

### 3.6.6 Transmitter Radiated Unwanted Emissions (Above 1GHz) for HT20

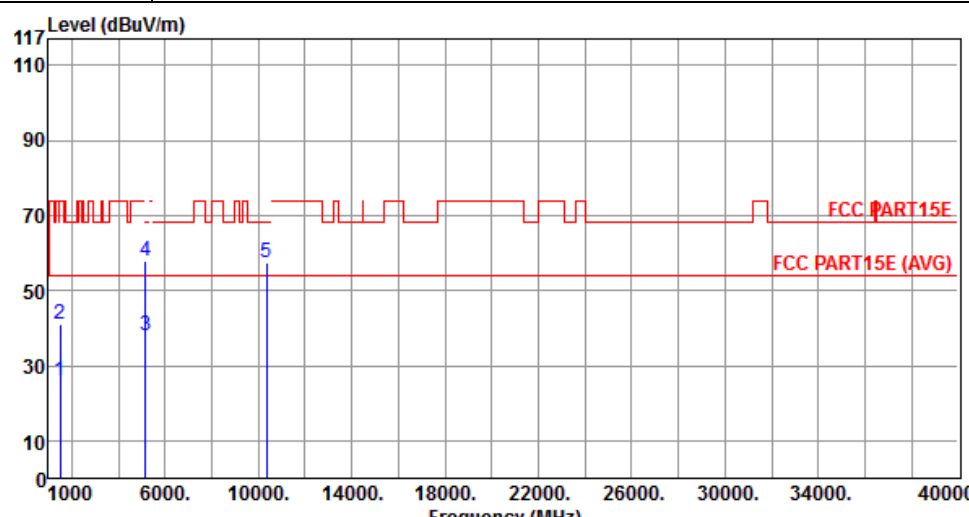
Polarization	Horizontal		Test Freq. (MHz)	5180					
Test Configuration	1								
									
	Freq.	Emission level	Limit	Margin	SA	Factor	Remark	ANT	Turn
	MHz	dBuV/m	dBuV/m	dB	reading	dB		High	Table
					dBuV			cm	deg
1	1495.00	25.98	54.00	-28.02	32.56	-6.58	Average	---	---
2	1495.00	40.85	74.00	-33.15	47.43	-6.58	Peak	---	---
3	5150.00	37.90	54.00	-16.10	32.96	4.94	Average	---	---
4	5150.00	57.95	74.00	-16.05	53.01	4.94	Peak	---	---
5	10360.00	57.64	68.30	-10.66	42.93	14.71	Peak	---	---

Note 1: ">20dB" means spurious emission levels that exceed the level of 20 dB below the applicable limit.  
 Note 2: For restricted bands, the peak measurement is fully sufficient, as the max field strength as measured with the Peak-Detector meets the AV-Limit so that the AV level does not need to be reported in addition.

<b>Polarization</b>	Vertical	<b>Test Freq. (MHz)</b>	5180
<b>Test Configuration</b>	1		

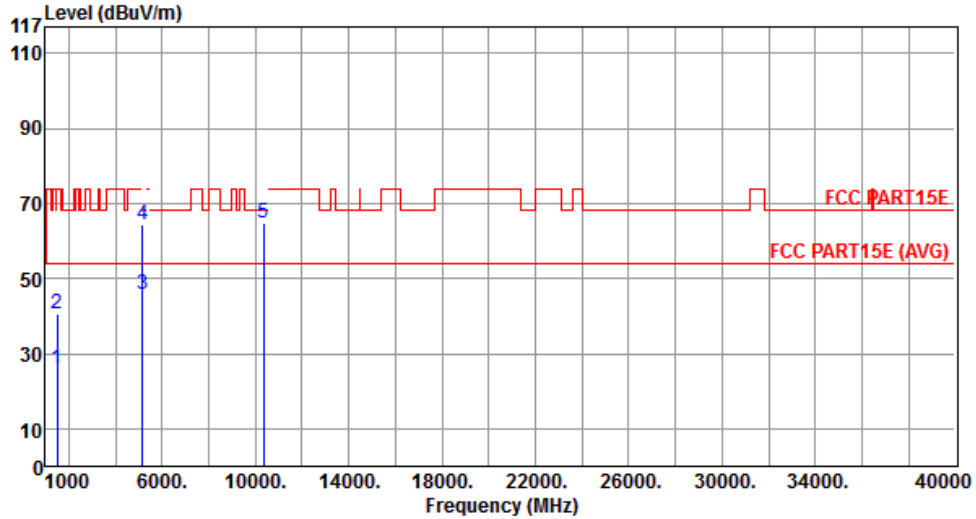

	Freq. MHz	Emission level dBuV/m	Limit dBuV/m	Margin dB	SA reading dBuV	Factor dB	Remark	ANT High cm	Turn Table deg
1	1495.00	25.80	54.00	-28.20	32.38	-6.58	Average	---	---
2	1495.00	40.56	74.00	-33.44	47.14	-6.58	Peak	---	---
3	5150.00	45.76	54.00	-8.24	40.82	4.94	Average	---	---
4	5150.00	64.32	74.00	-9.68	59.38	4.94	Peak	---	---
5	10360.00	64.72	68.30	-3.58	50.01	14.71	Peak	---	---

Note 1: ">20dB" means spurious emission levels that exceed the level of 20 dB below the applicable limit.  
 Note 2: For restricted bands, the peak measurement is fully sufficient, as the max field strength as measured with the Peak-Detector meets the AV-Limit so that the AV level does not need to be reported in addition.

<b>Polarization</b>	Horizontal	<b>Test Freq. (MHz)</b>	5200
<b>Test Configuration</b>	1		

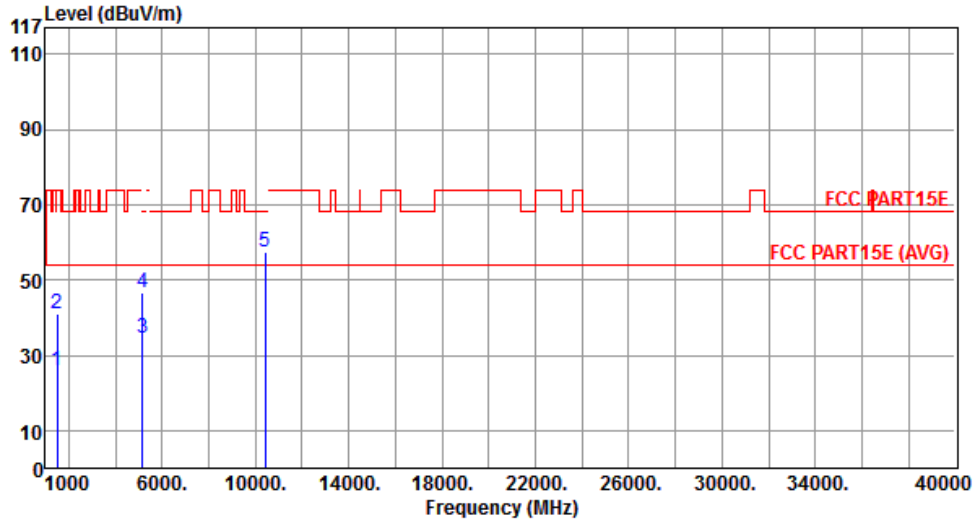

	Freq. MHz	Emission level dBuV/m	Limit dBuV/m	Margin dB	SA reading dBuV	Factor dB	Remark	ANT High cm	Turn Table deg
1	1495.00	26.05	54.00	-27.95	32.63	-6.58	Average	---	---
2	1495.00	41.01	74.00	-32.99	47.59	-6.58	Peak	---	---
3	5150.00	34.36	54.00	-19.64	29.42	4.94	Average	---	---
4	5150.00	46.62	74.00	-27.38	41.68	4.94	Peak	---	---
5	10400.00	57.51	68.30	-10.79	42.76	14.75	Peak	---	---

Note 1: ">20dB" means spurious emission levels that exceed the level of 20 dB below the applicable limit.  
 Note 2: For restricted bands, the peak measurement is fully sufficient, as the max field strength as measured with the Peak-Detector meets the AV-Limit so that the AV level does not need to be reported in addition.



<b>Polarization</b>	Vertical	<b>Test Freq. (MHz)</b>	5200
<b>Test Configuration</b>	1		

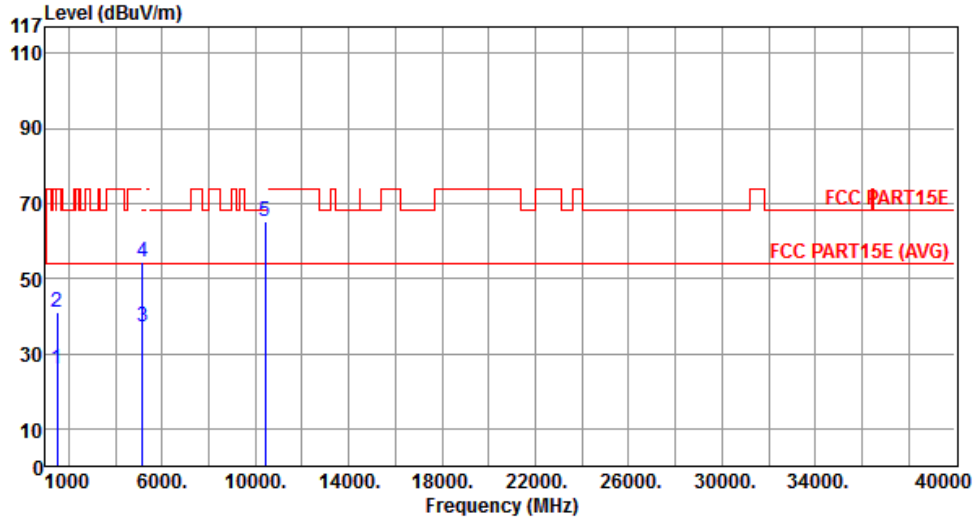

	Freq. MHz	Emission level dBuV/m	Limit dBuV/m	Margin dB	SA reading dBuV	Factor dB	Remark	ANT High cm	Turn Table deg
1	1495.00	25.83	54.00	-28.17	32.41	-6.58	Average	---	---
2	1495.00	40.80	74.00	-33.20	47.38	-6.58	Peak	---	---
3	5150.00	37.23	54.00	-16.77	32.29	4.94	Average	---	---
4	5150.00	54.45	74.00	-19.55	49.51	4.94	Peak	---	---
5	10400.00	65.17	68.30	-3.13	50.42	14.75	Peak	---	---

Note 1: ">20dB" means spurious emission levels that exceed the level of 20 dB below the applicable limit.  
 Note 2: For restricted bands, the peak measurement is fully sufficient, as the max field strength as measured with the Peak-Detector meets the AV-Limit so that the AV level does not need to be reported in addition.

<b>Polarization</b>	Horizontal	<b>Test Freq. (MHz)</b>	5240
<b>Test Configuration</b>	1		

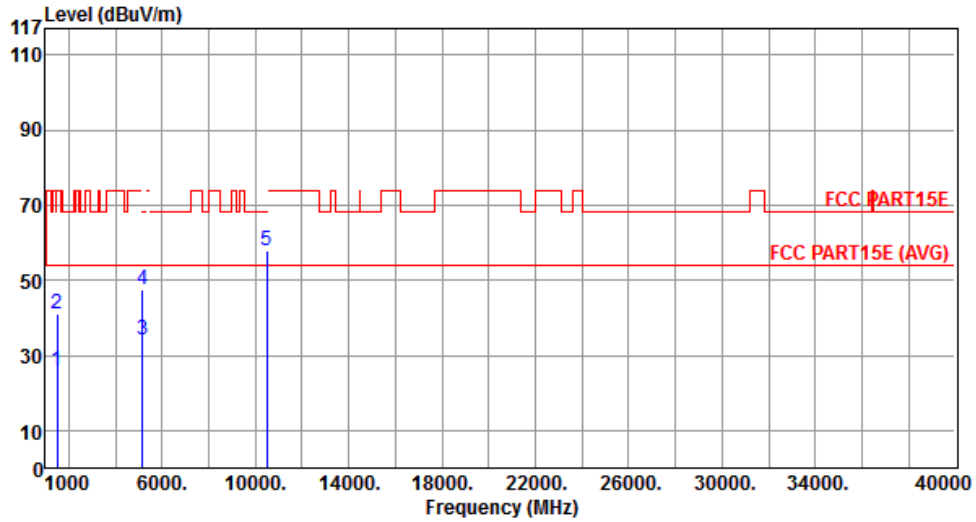

	Freq. MHz	Emission level dBuV/m	Limit dBuV/m	Margin dB	SA reading dBuV	Factor dB	Remark	ANT High cm	Turn Table deg
1	1495.00	25.79	54.00	-28.21	32.37	-6.58	Average	---	---
2	1495.00	40.98	74.00	-33.02	47.56	-6.58	Peak	---	---
3	5150.00	34.15	54.00	-19.85	29.21	4.94	Average	---	---
4	5150.00	47.30	74.00	-26.70	42.36	4.94	Peak	---	---
5	10480.00	57.99	68.30	-10.31	43.15	14.84	Peak	---	---

Note 1: ">20dB" means spurious emission levels that exceed the level of 20 dB below the applicable limit.  
 Note 2: For restricted bands, the peak measurement is fully sufficient, as the max field strength as measured with the Peak-Detector meets the AV-Limit so that the AV level does not need to be reported in addition.

<b>Polarization</b>	Vertical	<b>Test Freq. (MHz)</b>	5240
<b>Test Configuration</b>	1		

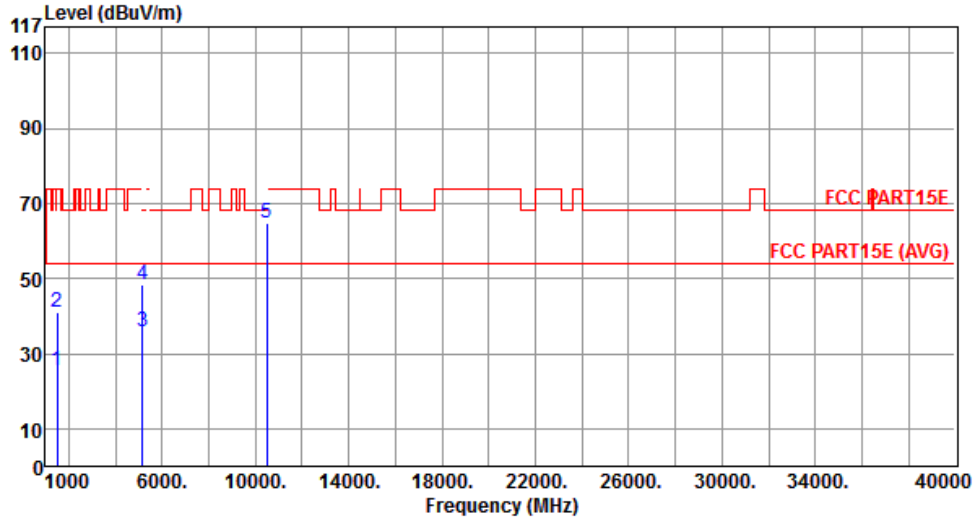

	Freq. MHz	Emission level dBuV/m	Limit dBuV/m	Margin dB	SA reading dBuV	Factor dB	Remark	ANT High cm	Turn Table deg
1	1495.00	25.61	54.00	-28.39	32.19	-6.58	Average	---	---
2	1495.00	41.10	74.00	-32.90	47.68	-6.58	Peak	---	---
3	5150.00	35.90	54.00	-18.10	30.96	4.94	Average	---	---
4	5150.00	48.52	74.00	-25.48	43.58	4.94	Peak	---	---
5	10480.00	64.76	68.30	-3.54	49.92	14.84	Peak	---	---

Note 1: ">20dB" means spurious emission levels that exceed the level of 20 dB below the applicable limit.  
 Note 2: For restricted bands, the peak measurement is fully sufficient, as the max field strength as measured with the Peak-Detector meets the AV-Limit so that the AV level does not need to be reported in addition.

<b>Polarization</b>	Horizontal	<b>Test Freq. (MHz)</b>	5260
<b>Test Configuration</b>	1		

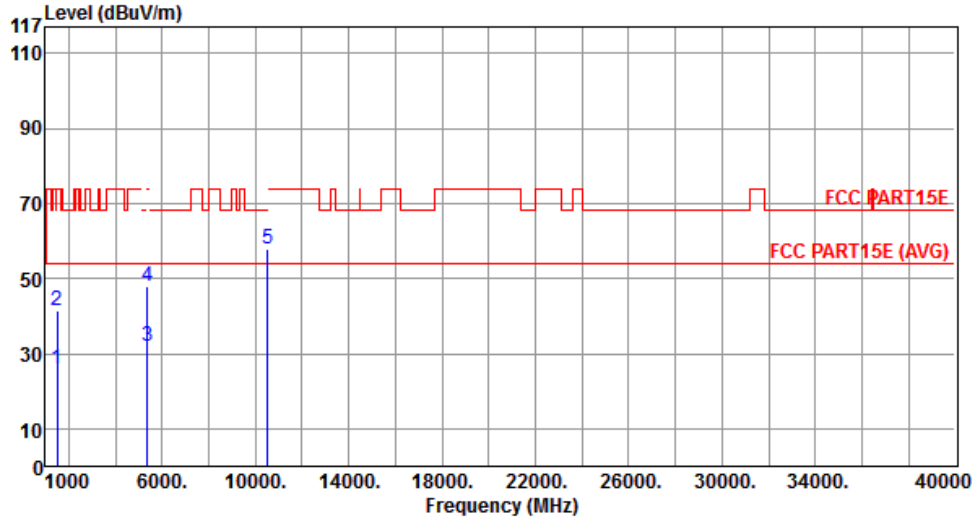

	Freq. MHz	Emission level dBuV/m	Limit dBuV/m	Margin dB	SA reading dBuV	Factor dB	Remark	ANT High cm	Turn Table deg
1	1495.00	26.10	54.00	-27.90	32.68	-6.58	Average	---	---
2	1495.00	41.26	74.00	-32.74	47.84	-6.58	Peak	---	---
3	5350.00	32.12	54.00	-21.88	27.03	5.09	Average	---	---
4	5350.00	48.05	74.00	-25.95	42.96	5.09	Peak	---	---
5	10520.00	58.03	68.30	-10.27	43.16	14.87	Peak	---	---

Note 1: ">20dB" means spurious emission levels that exceed the level of 20 dB below the applicable limit.  
 Note 2: For restricted bands, the peak measurement is fully sufficient, as the max field strength as measured with the Peak-Detector meets the AV-Limit so that the AV level does not need to be reported in addition.

<b>Polarization</b>	Vertical	<b>Test Freq. (MHz)</b>	5260
<b>Test Configuration</b>	1		

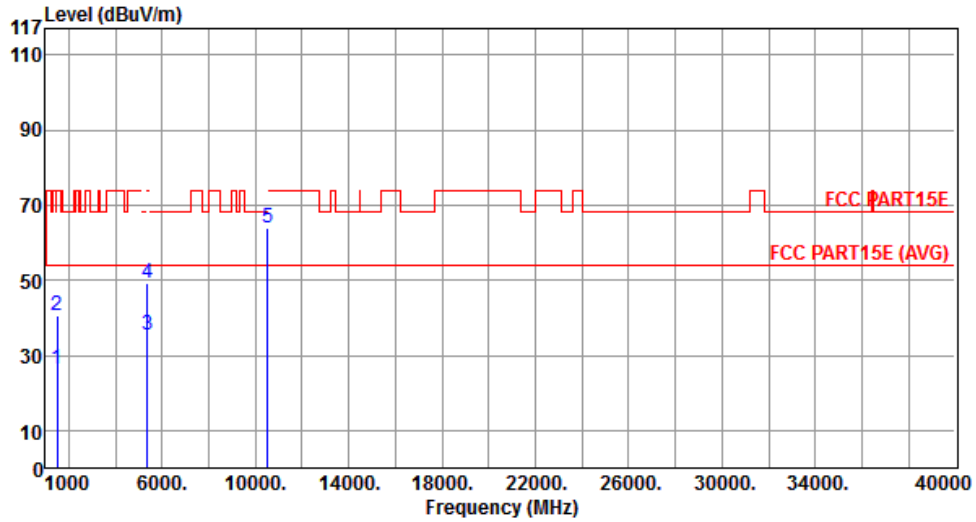

	Freq. MHz	Emission level dBuV/m	Limit dBuV/m	Margin dB	SA reading dBuV	Factor dB	Remark	ANT High cm	Turn Table deg
1	1495.00	26.48	54.00	-27.52	33.06	-6.58	Average	---	---
2	1495.00	40.66	74.00	-33.34	47.24	-6.58	Peak	---	---
3	5350.00	35.31	54.00	-18.69	30.22	5.09	Average	---	---
4	5350.00	49.25	74.00	-24.75	44.16	5.09	Peak	---	---
5	10520.00	63.85	68.30	-4.45	48.98	14.87	Peak	---	---

Note 1: ">20dB" means spurious emission levels that exceed the level of 20 dB below the applicable limit.  
 Note 2: For restricted bands, the peak measurement is fully sufficient, as the max field strength as measured with the Peak-Detector meets the AV-Limit so that the AV level does not need to be reported in addition.

<b>Polarization</b>	Horizontal	<b>Test Freq. (MHz)</b>	5300
<b>Test Configuration</b>	1		

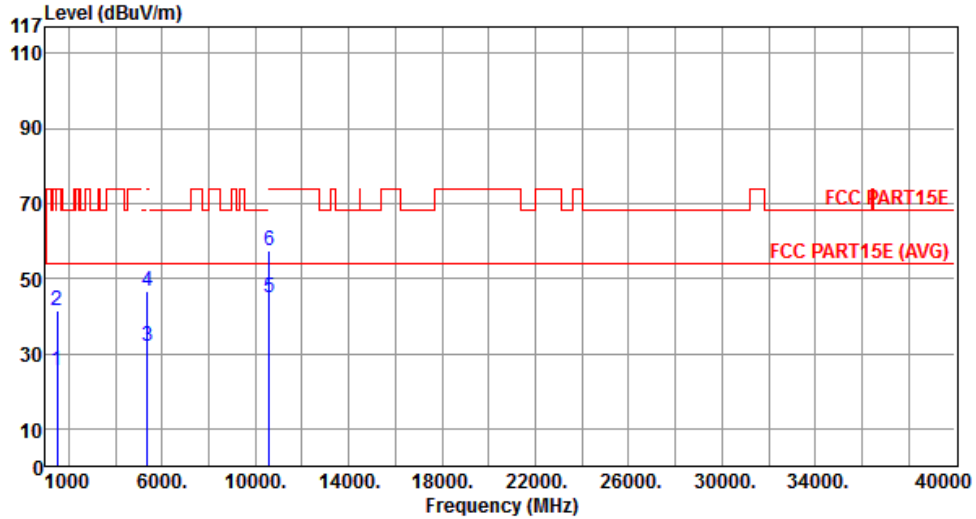

	Freq. MHz	Emission level dBuV/m	Limit dBuV/m	Margin dB	SA reading dBuV	Factor dB	Remark	ANT High cm	Turn Table deg
1	1495.00	25.55	54.00	-28.45	32.13	-6.58	Average	---	---
2	1495.00	41.26	74.00	-32.74	47.84	-6.58	Peak	---	---
3	5350.00	32.09	54.00	-21.91	27.00	5.09	Average	---	---
4	5350.00	46.65	74.00	-27.35	41.56	5.09	Peak	---	---
5	10600.00	44.78	54.00	-9.22	29.84	14.94	Average	---	---
6	10600.00	57.31	74.00	-16.69	42.37	14.94	Peak	---	---

Note 1: ">20dB" means spurious emission levels that exceed the level of 20 dB below the applicable limit.  
 Note 2: For restricted bands, the peak measurement is fully sufficient, as the max field strength as measured with the Peak-Detector meets the AV-Limit so that the AV level does not need to be reported in addition.

<b>Polarization</b>	Vertical	<b>Test Freq. (MHz)</b>	5300
<b>Test Configuration</b>	1		

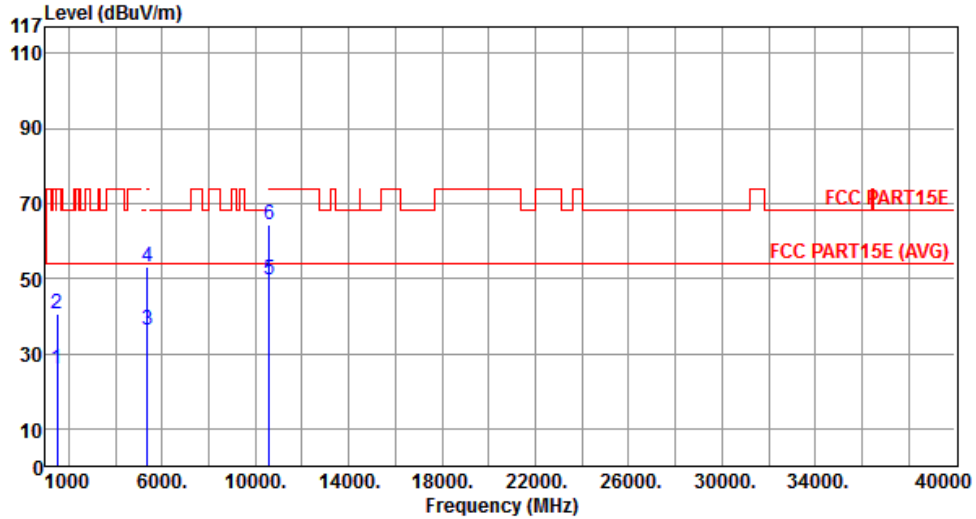

	Freq. MHz	Emission level dBuV/m	Limit dBuV/m	Margin dB	SA reading dBuV	Factor dB	Remark	ANT High cm	Turn Table deg
1	1495.00	25.99	54.00	-28.01	32.57	-6.58	Average	---	---
2	1495.00	40.67	74.00	-33.33	47.25	-6.58	Peak	---	---
3	5350.00	36.33	54.00	-17.67	31.24	5.09	Average	---	---
4	5350.00	53.26	74.00	-20.74	48.17	5.09	Peak	---	---
5	10600.00	49.77	54.00	-4.23	34.83	14.94	Average	---	---
6	10600.00	64.15	74.00	-9.85	49.21	14.94	Peak	---	---

Note 1: ">20dB" means spurious emission levels that exceed the level of 20 dB below the applicable limit.  
 Note 2: For restricted bands, the peak measurement is fully sufficient, as the max field strength as measured with the Peak-Detector meets the AV-Limit so that the AV level does not need to be reported in addition.

<b>Polarization</b>	Horizontal	<b>Test Freq. (MHz)</b>	5320
<b>Test Configuration</b>	1		

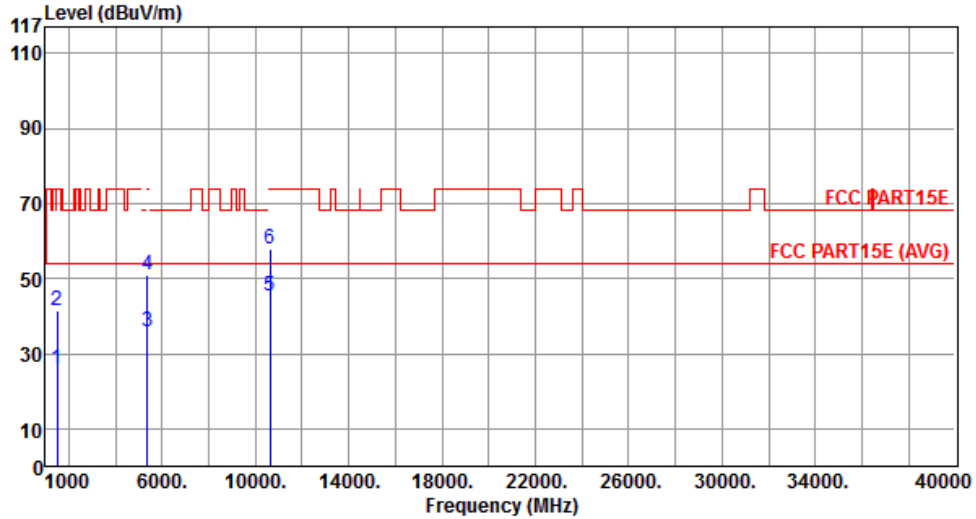

	Freq. MHz	Emission level dBuV/m	Limit dBuV/m	Margin dB	SA reading dBuV	Factor dB	Remark	ANT High cm	Turn Table deg
1	1495.00	25.83	54.00	-28.17	32.41	-6.58	Average	---	---
2	1495.00	41.66	74.00	-32.34	48.24	-6.58	Peak	---	---
3	5350.00	35.94	54.00	-18.06	30.85	5.09	Average	---	---
4	5350.00	50.76	74.00	-23.24	45.67	5.09	Peak	---	---
5	10640.00	45.12	54.00	-8.88	30.14	14.98	Average	---	---
6	10640.00	57.77	74.00	-16.23	42.79	14.98	Peak	---	---

Note 1: ">20dB" means spurious emission levels that exceed the level of 20 dB below the applicable limit.  
 Note 2: For restricted bands, the peak measurement is fully sufficient, as the max field strength as measured with the Peak-Detector meets the AV-Limit so that the AV level does not need to be reported in addition.



<b>Polarization</b>	Vertical	<b>Test Freq. (MHz)</b>	5320
<b>Test Configuration</b>	1		

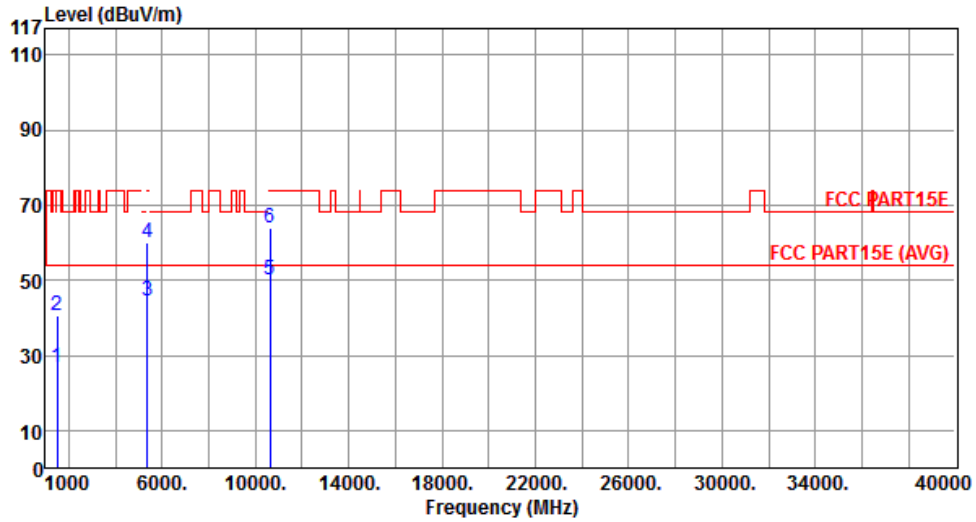

	Freq. MHz	Emission level dBuV/m	Limit dBuV/m	Margin dB	SA reading dBuV	Factor dB	Remark	ANT High cm	Turn Table deg
1	1495.00	26.56	54.00	-27.44	33.14	-6.58	Average	---	---
2	1495.00	40.75	74.00	-33.25	47.33	-6.58	Peak	---	---
3	5350.00	44.36	54.00	-9.64	39.27	5.09	Average	---	---
4	5350.00	59.91	74.00	-14.09	54.82	5.09	Peak	---	---
5	10640.00	50.29	54.00	-3.71	35.31	14.98	Average	---	---
6	10640.00	63.72	74.00	-10.28	48.74	14.98	Peak	---	---

Note 1: ">20dB" means spurious emission levels that exceed the level of 20 dB below the applicable limit.  
 Note 2: For restricted bands, the peak measurement is fully sufficient, as the max field strength as measured with the Peak-Detector meets the AV-Limit so that the AV level does not need to be reported in addition.

<b>Polarization</b>	Horizontal	<b>Test Freq. (MHz)</b>	5500
<b>Test Configuration</b>	1		

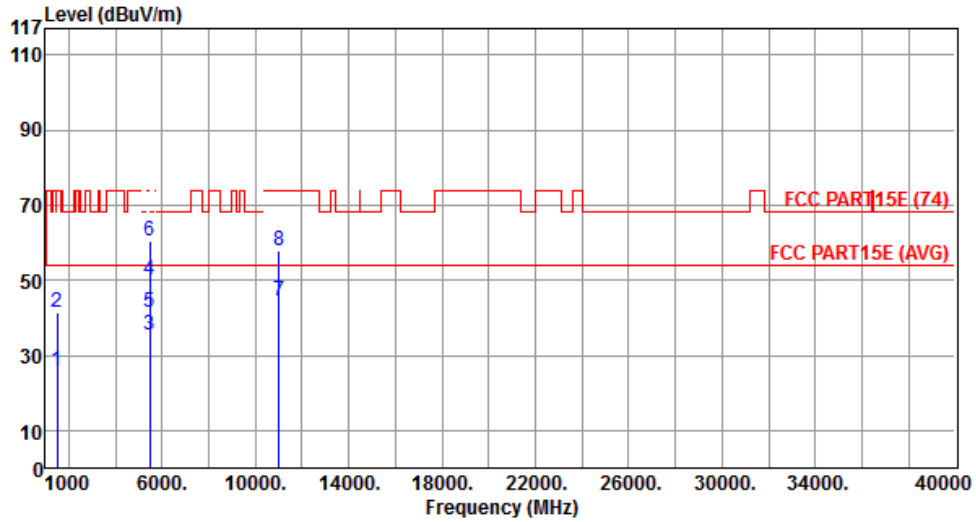

	Freq. MHz	Emission level dBuV/m	Limit dBuV/m	Margin dB	SA reading dBuV	Factor dB	Remark	ANT High cm	Turn Table deg
1	1495.00	25.95	54.00	-28.05	32.53	-6.58	Average	---	---
2	1495.00	41.66	74.00	-32.34	48.24	-6.58	Peak	---	---
3	5460.00	35.54	54.00	-18.46	30.36	5.18	Average	---	---
4	5460.00	49.87	74.00	-24.13	44.69	5.18	Peak	---	---
5	5470.00	41.60	54.00	-12.40	36.41	5.19	Average	---	---
6	5470.00	60.36	74.00	-13.64	55.17	5.19	Peak	---	---
7	11000.00	44.42	54.00	-9.58	29.14	15.28	Average	---	---
8	11000.00	57.66	74.00	-16.34	42.38	15.28	Peak	---	---

Note 1: ">20dB" means spurious emission levels that exceed the level of 20 dB below the applicable limit.  
 Note 2: For restricted bands, the peak measurement is fully sufficient, as the max field strength as measured with the Peak-Detector meets the AV-Limit so that the AV level does not need to be reported in addition.

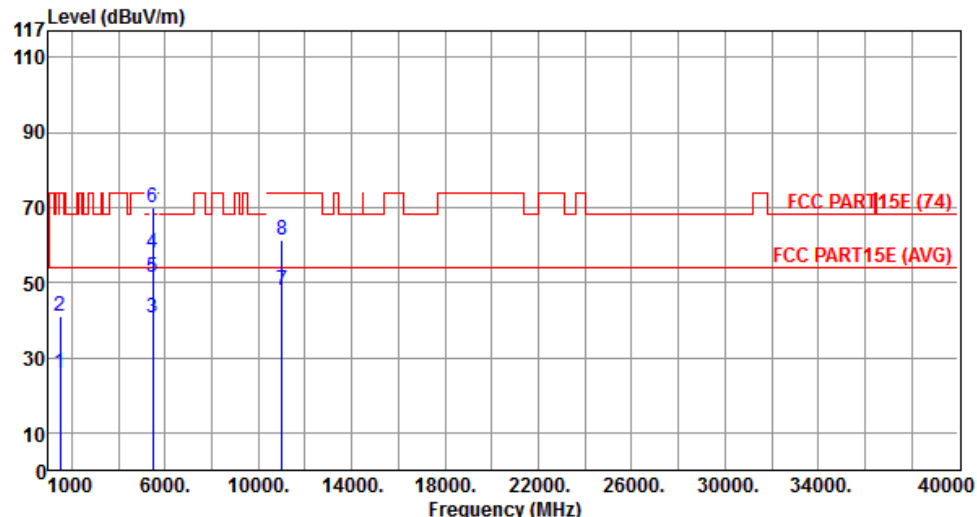
<b>Polarization</b>	Vertical	<b>Test Freq. (MHz)</b>	5500						
<b>Test Configuration</b>	1								
									
	Freq.	Emission level	Limit	Margin	SA reading	Factor	Remark	ANT High	Turn Table
	MHz	dBuV/m	dBuV/m	dB	dBuV	dB		cm	deg
1	1495.00	26.06	54.00	-27.94	32.64	-6.58	Average	---	---
2	1495.00	41.00	74.00	-33.00	47.58	-6.58	Peak	---	---
3	5460.00	40.65	54.00	-13.35	35.47	5.18	Average	---	---
4	5460.00	57.69	74.00	-16.31	52.51	5.18	Peak	---	---
5	5470.00	51.33	54.00	-2.67	46.14	5.19	Average	---	---
6	5470.00	69.74	74.00	-4.26	64.55	5.19	Peak	---	---
7	11000.00	47.80	54.00	-6.20	32.52	15.28	Average	---	---
8	11000.00	61.13	74.00	-12.87	45.85	15.28	Peak	---	---
<p>Note 1: "&gt;20dB" means spurious emission levels that exceed the level of 20 dB below the applicable limit.          Note 2: For restricted bands, the peak measurement is fully sufficient, as the max field strength as measured with the Peak-Detector meets the AV-Limit so that the AV level does not need to be reported in addition.</p>									

<b>Polarization</b>	Horizontal	<b>Test Freq. (MHz)</b>	5580
<b>Test Configuration</b>	1		

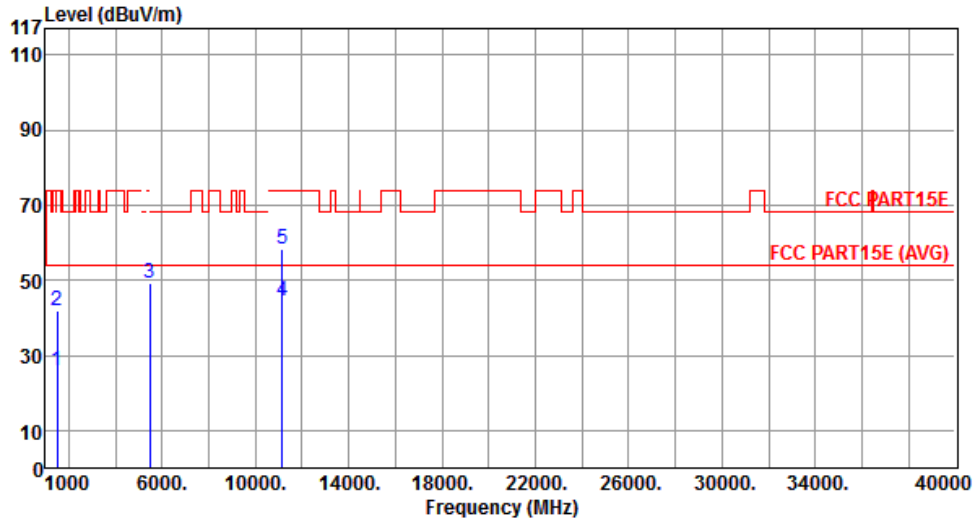

	Freq. MHz	Emission level dBuV/m	Limit dBuV/m	Margin dB	SA reading dBuV	Factor dB	Remark	ANT High cm	Turn Table deg
1	1495.00	25.79	54.00	-28.21	32.37	-6.58	Average	---	---
2	1495.00	41.81	74.00	-32.19	48.39	-6.58	Peak	---	---
3	5470.00	49.31	68.30	-18.99	44.12	5.19	Peak	---	---
4	11160.00	44.56	54.00	-9.44	29.38	15.18	Average	---	---
5	11160.00	58.14	74.00	-15.86	42.96	15.18	Peak	---	---

Note 1: ">20dB" means spurious emission levels that exceed the level of 20 dB below the applicable limit.  
 Note 2: For restricted bands, the peak measurement is fully sufficient, as the max field strength as measured with the Peak-Detector meets the AV-Limit so that the AV level does not need to be reported in addition.

<b>Polarization</b>	Vertical	<b>Test Freq. (MHz)</b>	5580
<b>Test Configuration</b>	1		

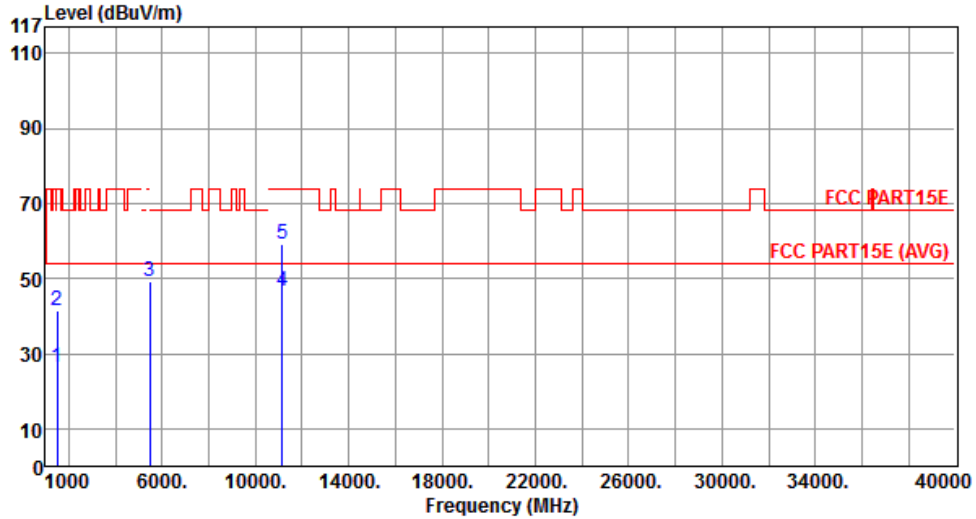

	Freq. MHz	Emission level dBuV/m	Limit dBuV/m	Margin dB	SA reading dBuV	Factor dB	Remark	ANT High cm	Turn Table deg
1	1495.00	26.29	54.00	-27.71	32.87	-6.58	Average	---	---
2	1495.00	41.26	74.00	-32.74	47.84	-6.58	Peak	---	---
3	5470.00	49.10	68.30	-19.20	43.91	5.19	Peak	---	---
4	11160.00	46.46	54.00	-7.54	31.28	15.18	Average	---	---
5	11160.00	59.34	74.00	-14.66	44.16	15.18	Peak	---	---

Note 1: ">20dB" means spurious emission levels that exceed the level of 20 dB below the applicable limit.  
 Note 2: For restricted bands, the peak measurement is fully sufficient, as the max field strength as measured with the Peak-Detector meets the AV-Limit so that the AV level does not need to be reported in addition.

<b>Polarization</b>	Horizontal	<b>Test Freq. (MHz)</b>	5700
<b>Test Configuration</b>	1		

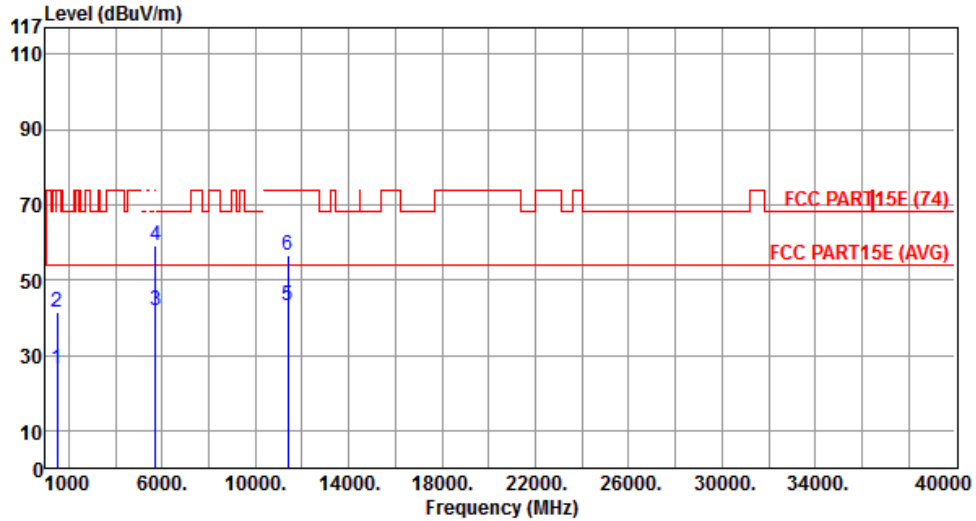

	Freq. MHz	Emission level dBuV/m	Limit dBuV/m	Margin dB	SA reading dBuV	Factor dB	Remark	ANT High cm	Turn Table deg
1	1495.00	26.15	54.00	-27.85	32.73	-6.58	Average	---	---
2	1495.00	41.57	74.00	-32.43	48.15	-6.58	Peak	---	---
3	5725.00	42.03	54.00	-11.97	36.47	5.56	Average	---	---
4	5725.00	59.21	74.00	-14.79	53.65	5.56	Peak	---	---
5	11400.00	42.99	54.00	-11.01	27.96	15.03	Average	---	---
6	11400.00	56.56	74.00	-17.44	41.53	15.03	Peak	---	---

Note 1: ">20dB" means spurious emission levels that exceed the level of 20 dB below the applicable limit.  
 Note 2: For restricted bands, the peak measurement is fully sufficient, as the max field strength as measured with the Peak-Detector meets the AV-Limit so that the AV level does not need to be reported in addition.

<b>Polarization</b>	Vertical	<b>Test Freq. (MHz)</b>	5700
<b>Test Configuration</b>	1		

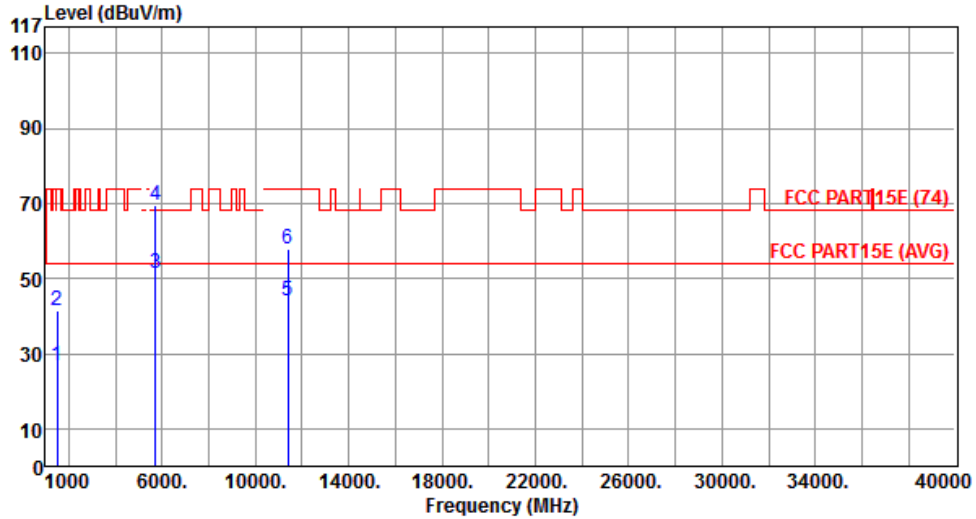

	Freq. MHz	Emission level dBuV/m	Limit dBuV/m	Margin dB	SA reading dBuV	Factor dB	Remark	ANT High cm	Turn Table deg
1	1495.00	26.67	54.00	-27.33	33.25	-6.58	Average	---	---
2	1495.00	41.55	74.00	-32.45	48.13	-6.58	Peak	---	---
3	5725.00	51.21	54.00	-2.79	45.65	5.56	Average	---	---
4	5725.00	69.53	74.00	-4.47	63.97	5.56	Peak	---	---
5	11400.00	43.85	54.00	-10.15	28.82	15.03	Average	---	---
6	11400.00	57.67	74.00	-16.33	42.64	15.03	Peak	---	---

Note 1: ">20dB" means spurious emission levels that exceed the level of 20 dB below the applicable limit.  
 Note 2: For restricted bands, the peak measurement is fully sufficient, as the max field strength as measured with the Peak-Detector meets the AV-Limit so that the AV level does not need to be reported in addition.

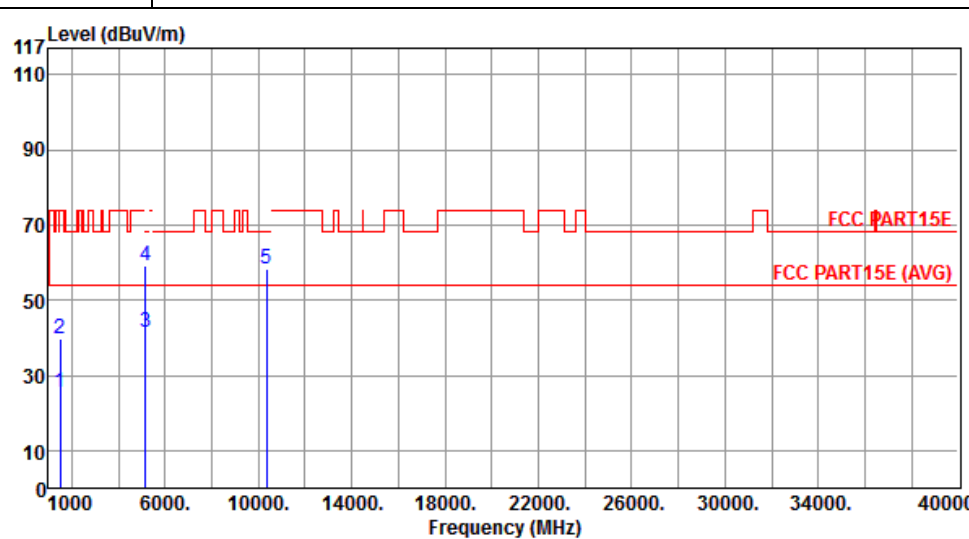
<b>Polarization</b>	Horizontal	<b>Test Freq. (MHz)</b>	5180						
<b>Test Configuration</b>	2								
									
	Freq.	Emission level	Limit	Margin	SA reading	Factor	Remark	ANT High	Turn Table
	MHz	dBuV/m	dBuV/m	dB	dBuV	dB		cm	deg
1	1495.00	25.58	54.00	-28.42	32.16	-6.58	Average	---	---
2	1495.00	39.90	74.00	-34.10	46.48	-6.58	Peak	---	---
3	5150.00	41.37	54.00	-12.63	36.43	4.94	Average	---	---
4	5150.00	59.10	74.00	-14.90	54.16	4.94	Peak	---	---
5	10360.00	58.27	68.30	-10.03	43.56	14.71	Peak	---	---

Note 1: ">20dB" means spurious emission levels that exceed the level of 20 dB below the applicable limit.  
 Note 2: For restricted bands, the peak measurement is fully sufficient, as the max field strength as measured with the Peak-Detector meets the AV-Limit so that the AV level does not need to be reported in addition.



<b>Polarization</b>	Vertical	<b>Test Freq. (MHz)</b>	5180
<b>Test Configuration</b>	2		

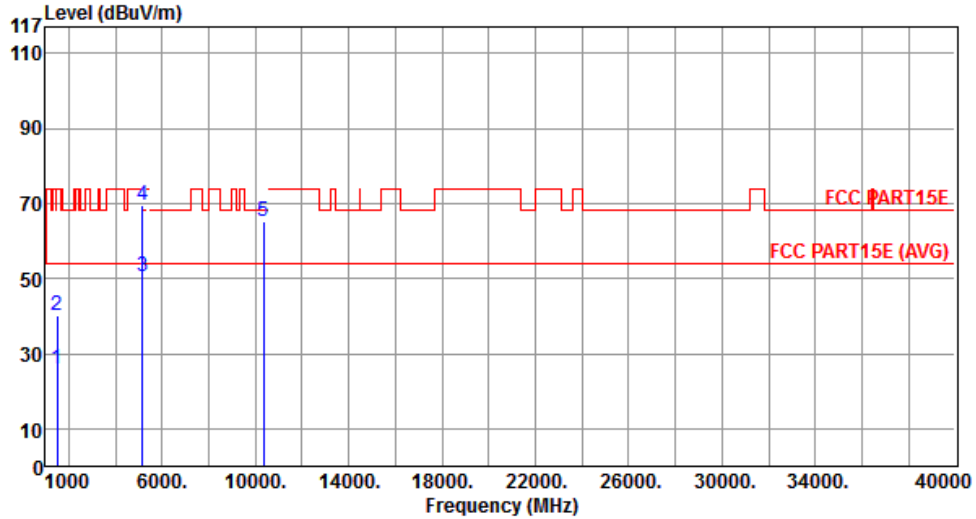

	Freq. MHz	Emission level dBuV/m	Limit dBuV/m	Margin dB	SA reading dBuV	Factor dB	Remark	ANT High cm	Turn Table deg
1	1495.00	25.80	54.00	-28.20	32.38	-6.58	Average	---	---
2	1495.00	40.14	74.00	-33.86	46.72	-6.58	Peak	---	---
3	5150.00	50.45	54.00	-3.55	45.51	4.94	Average	---	---
4	5150.00	69.61	74.00	-4.39	64.67	4.94	Peak	---	---
5	10360.00	65.30	68.30	-3.00	50.59	14.71	Peak	---	---

Note 1: ">20dB" means spurious emission levels that exceed the level of 20 dB below the applicable limit.  
 Note 2: For restricted bands, the peak measurement is fully sufficient, as the max field strength as measured with the Peak-Detector meets the AV-Limit so that the AV level does not need to be reported in addition.

<b>Polarization</b>	Horizontal	<b>Test Freq. (MHz)</b>	5200
<b>Test Configuration</b>	2		

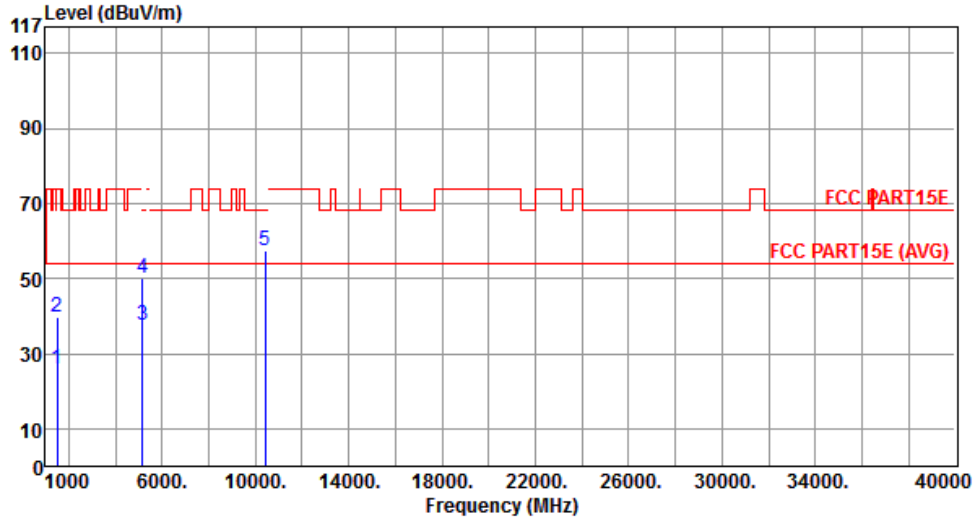

	Freq. MHz	Emission level dBuV/m	Limit dBuV/m	Margin dB	SA reading dBuV	Factor dB	Remark	ANT High cm	Turn Table deg
1	1495.00	25.76	54.00	-28.24	32.34	-6.58	Average	---	---
2	1495.00	39.71	74.00	-34.29	46.29	-6.58	Peak	---	---
3	5150.00	37.36	54.00	-16.64	32.42	4.94	Average	---	---
4	5150.00	49.90	74.00	-24.10	44.96	4.94	Peak	---	---
5	10400.00	57.59	68.30	-10.71	42.84	14.75	Peak	---	---

Note 1: ">20dB" means spurious emission levels that exceed the level of 20 dB below the applicable limit.

Note 2: For restricted bands, the peak measurement is fully sufficient, as the max field strength as measured with the Peak-Detector meets the AV-Limit so that the AV level does not need to be reported in addition.

<b>Polarization</b>	Vertical	<b>Test Freq. (MHz)</b>	5200
<b>Test Configuration</b>	2		

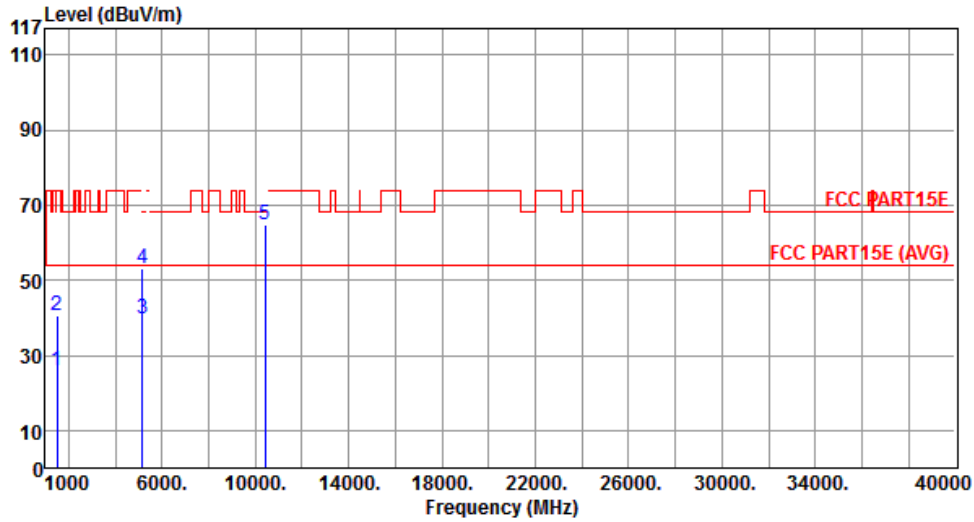

	Freq. MHz	Emission level dBuV/m	Limit dBuV/m	Margin dB	SA reading dBuV	Factor dB	Remark	ANT High cm	Turn Table deg
1	1495.00	26.07	54.00	-27.93	32.65	-6.58	Average	---	---
2	1495.00	40.63	74.00	-33.37	47.21	-6.58	Peak	---	---
3	5150.00	39.63	54.00	-14.37	34.69	4.94	Average	---	---
4	5150.00	53.12	74.00	-20.88	48.18	4.94	Peak	---	---
5	10400.00	64.97	68.30	-3.33	50.22	14.75	Peak	---	---

Note 1: ">20dB" means spurious emission levels that exceed the level of 20 dB below the applicable limit.  
 Note 2: For restricted bands, the peak measurement is fully sufficient, as the max field strength as measured with the Peak-Detector meets the AV-Limit so that the AV level does not need to be reported in addition.

<b>Polarization</b>	Horizontal	<b>Test Freq. (MHz)</b>	5240
<b>Test Configuration</b>	2		

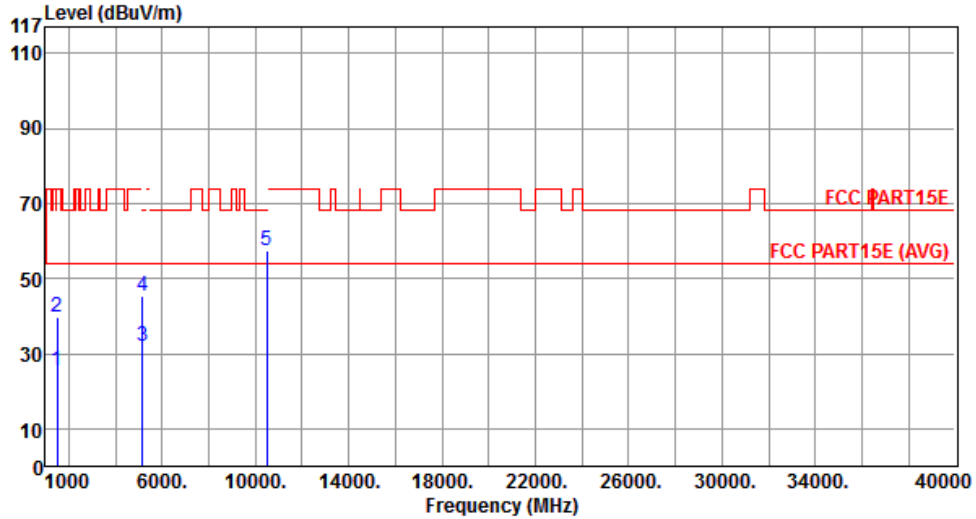

	Freq. MHz	Emission level dBuV/m	Limit dBuV/m	Margin dB	SA reading dBuV	Factor dB	Remark	ANT High cm	Turn Table deg
1	1495.00	25.46	54.00	-28.54	32.04	-6.58	Average	---	---
2	1495.00	39.75	74.00	-34.25	46.33	-6.58	Peak	---	---
3	5150.00	32.08	54.00	-21.92	27.14	4.94	Average	---	---
4	5150.00	45.47	74.00	-28.53	40.53	4.94	Peak	---	---
5	10480.00	57.27	68.30	-11.03	42.43	14.84	Peak	---	---

Note 1: ">20dB" means spurious emission levels that exceed the level of 20 dB below the applicable limit.  
 Note 2: For restricted bands, the peak measurement is fully sufficient, as the max field strength as measured with the Peak-Detector meets the AV-Limit so that the AV level does not need to be reported in addition.

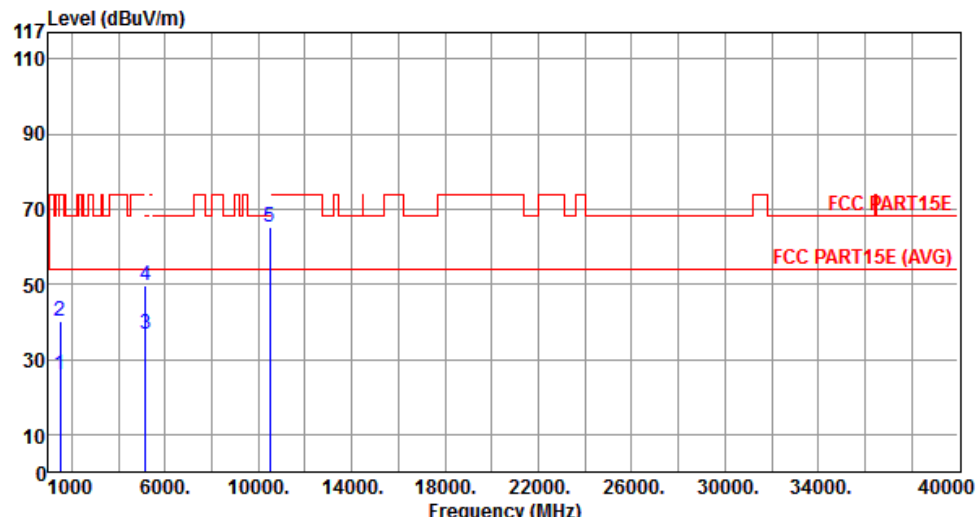
<b>Polarization</b>	Vertical	<b>Test Freq. (MHz)</b>	5240						
<b>Test Configuration</b>	2								
									
	Freq.	Emission level	Limit	Margin	SA reading	Factor	Remark	ANT High	Turn Table
	MHz	dBuV/m	dBuV/m	dB	dBuV	dB		cm	deg
1	1495.00	25.89	54.00	-28.11	32.47	-6.58	Average	---	---
2	1495.00	40.26	74.00	-33.74	46.84	-6.58	Peak	---	---
3	5150.00	36.56	54.00	-17.44	31.62	4.94	Average	---	---
4	5150.00	49.70	74.00	-24.30	44.76	4.94	Peak	---	---
5	10480.00	65.15	68.30	-3.15	50.31	14.84	Peak	---	---
<p>Note 1: "&gt;20dB" means spurious emission levels that exceed the level of 20 dB below the applicable limit.          Note 2: For restricted bands, the peak measurement is fully sufficient, as the max field strength as measured with the Peak-Detector meets the AV-Limit so that the AV level does not need to be reported in addition.</p>									

<b>Polarization</b>	Horizontal	<b>Test Freq. (MHz)</b>	5260
<b>Test Configuration</b>	2		

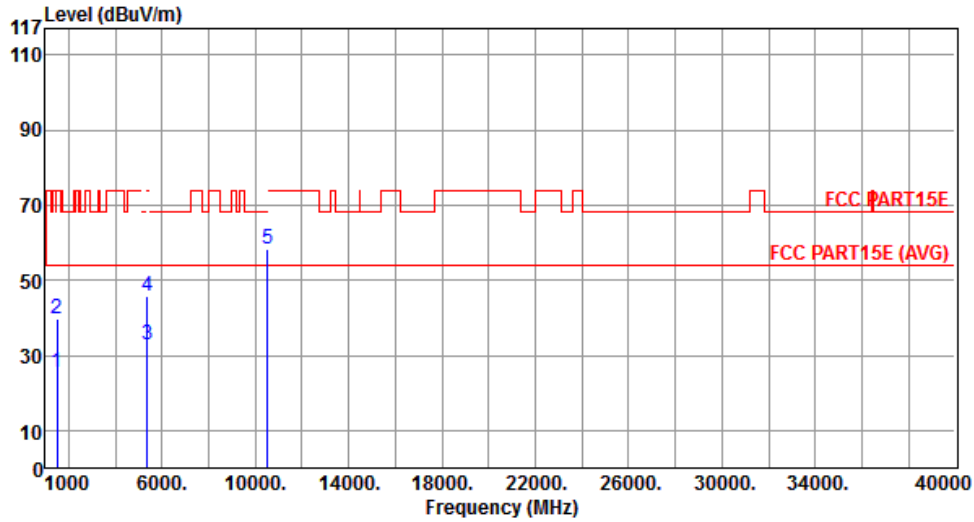

	Freq. MHz	Emission level dBuV/m	Limit dBuV/m	Margin dB	SA reading dBuV	Factor dB	Remark	ANT High cm	Turn Table deg
1	1495.00	25.66	54.00	-28.34	32.24	-6.58	Average	---	---
2	1495.00	39.79	74.00	-34.21	46.37	-6.58	Peak	---	---
3	5350.00	32.63	54.00	-21.37	27.54	5.09	Average	---	---
4	5350.00	45.82	74.00	-28.18	40.73	5.09	Peak	---	---
5	10520.00	58.13	68.30	-10.17	43.26	14.87	Peak	---	---

Note 1: ">20dB" means spurious emission levels that exceed the level of 20 dB below the applicable limit.  
 Note 2: For restricted bands, the peak measurement is fully sufficient, as the max field strength as measured with the Peak-Detector meets the AV-Limit so that the AV level does not need to be reported in addition.

<b>Polarization</b>	Vertical	<b>Test Freq. (MHz)</b>	5260
<b>Test Configuration</b>	2		

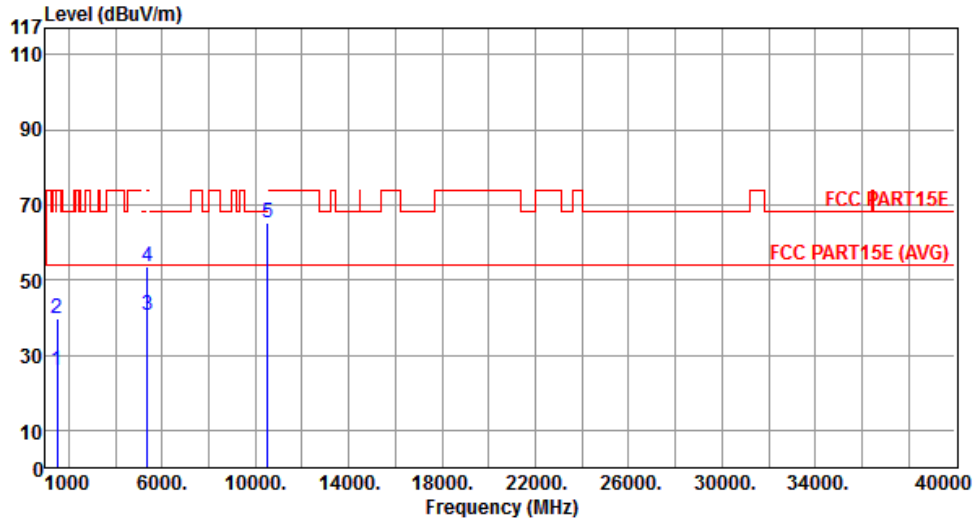

	Freq. MHz	Emission level dBuV/m	Limit dBuV/m	Margin dB	SA reading dBuV	Factor dB	Remark	ANT High cm	Turn Table deg
1	1495.00	25.91	54.00	-28.09	32.49	-6.58	Average	---	---
2	1495.00	39.70	74.00	-34.30	46.28	-6.58	Peak	---	---
3	5350.00	40.46	54.00	-13.54	35.37	5.09	Average	---	---
4	5350.00	53.35	74.00	-20.65	48.26	5.09	Peak	---	---
5	10520.00	65.04	68.30	-3.26	50.17	14.87	Peak	---	---

Note 1: ">20dB" means spurious emission levels that exceed the level of 20 dB below the applicable limit.  
 Note 2: For restricted bands, the peak measurement is fully sufficient, as the max field strength as measured with the Peak-Detector meets the AV-Limit so that the AV level does not need to be reported in addition.

<b>Polarization</b>	Horizontal	<b>Test Freq. (MHz)</b>	5300
<b>Test Configuration</b>	2		

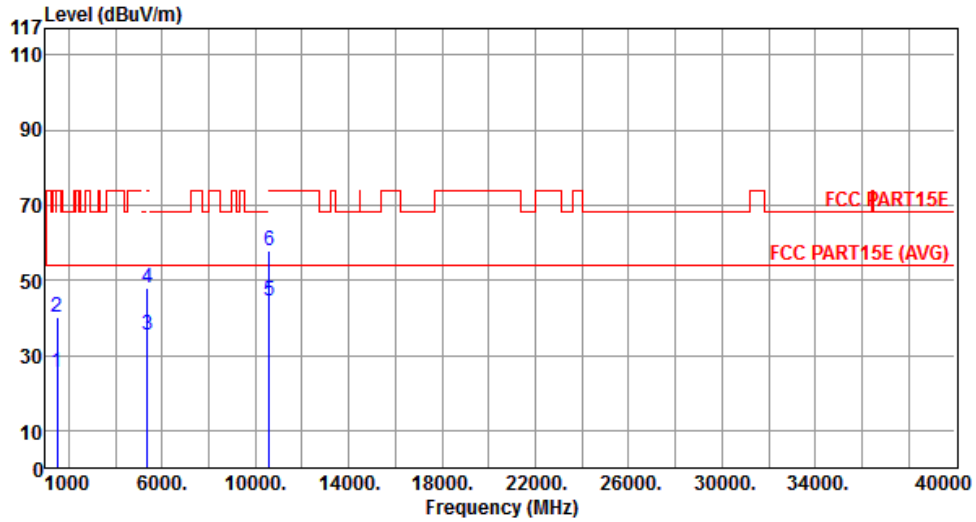

	Freq. MHz	Emission level dBuV/m	Limit dBuV/m	Margin dB	SA reading dBuV	Factor dB	Remark	ANT High cm	Turn Table deg
1	1495.00	25.61	54.00	-28.39	32.19	-6.58	Average	---	---
2	1495.00	40.00	74.00	-34.00	46.58	-6.58	Peak	---	---
3	5350.00	35.20	54.00	-18.80	30.11	5.09	Average	---	---
4	5350.00	48.05	74.00	-25.95	42.96	5.09	Peak	---	---
5	10600.00	44.28	54.00	-9.72	29.34	14.94	Average	---	---
6	10600.00	57.82	74.00	-16.18	42.88	14.94	Peak	---	---

Note 1: ">20dB" means spurious emission levels that exceed the level of 20 dB below the applicable limit.  
 Note 2: For restricted bands, the peak measurement is fully sufficient, as the max field strength as measured with the Peak-Detector meets the AV-Limit so that the AV level does not need to be reported in addition.



<b>Polarization</b>	Vertical	<b>Test Freq. (MHz)</b>	5300
<b>Test Configuration</b>	2		

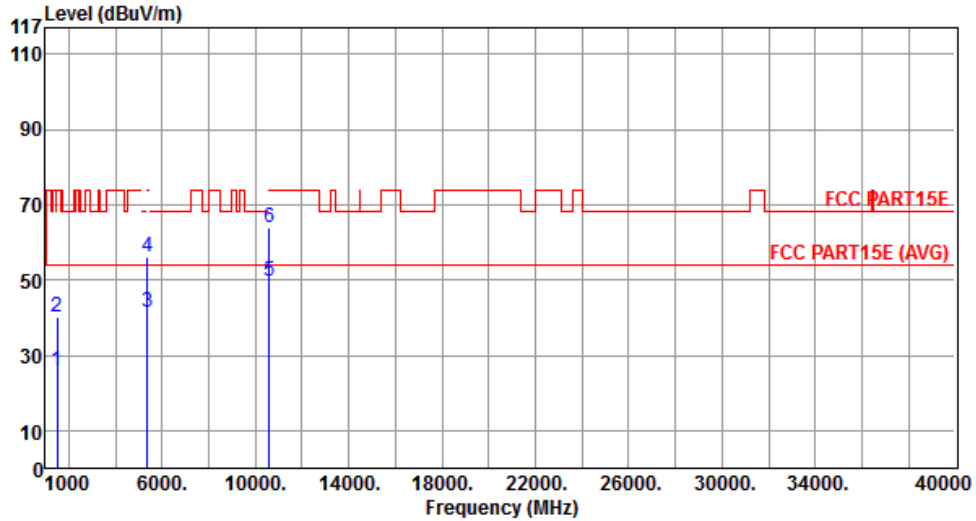

	Freq. MHz	Emission level dBuV/m	Limit dBuV/m	Margin dB	SA reading dBuV	Factor dB	Remark	ANT High cm	Turn Table deg
1	1495.00	25.95	54.00	-28.05	32.53	-6.58	Average	---	---
2	1495.00	40.17	74.00	-33.83	46.75	-6.58	Peak	---	---
3	5350.00	41.60	54.00	-12.40	36.51	5.09	Average	---	---
4	5350.00	55.98	74.00	-18.02	50.89	5.09	Peak	---	---
5	10600.00	49.70	54.00	-4.30	34.76	14.94	Average	---	---
6	10600.00	64.06	74.00	-9.94	49.12	14.94	Peak	---	---

Note 1: ">20dB" means spurious emission levels that exceed the level of 20 dB below the applicable limit.  
 Note 2: For restricted bands, the peak measurement is fully sufficient, as the max field strength as measured with the Peak-Detector meets the AV-Limit so that the AV level does not need to be reported in addition.

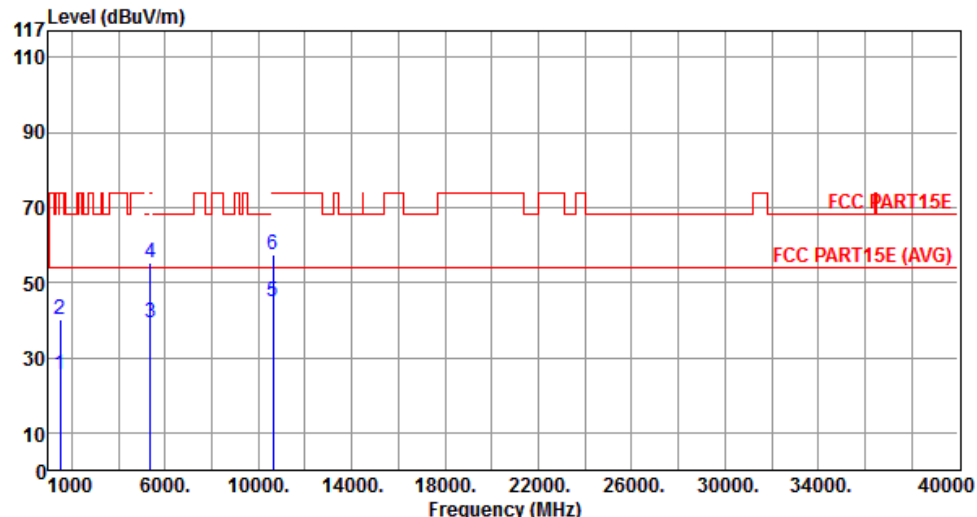
<b>Polarization</b>	Horizontal	<b>Test Freq. (MHz)</b>	5320						
<b>Test Configuration</b>	2								
									
	Freq.	Emission level	Limit	Margin	SA reading	Factor	Remark	ANT High	Turn Table
	MHz	dBuV/m	dBuV/m	dB	dBuV	dB		cm	deg
1	1495.00	25.67	54.00	-28.33	32.25	-6.58	Average	---	---
2	1495.00	40.20	74.00	-33.80	46.78	-6.58	Peak	---	---
3	5350.00	39.37	54.00	-14.63	34.28	5.09	Average	---	---
4	5350.00	55.25	74.00	-18.75	50.16	5.09	Peak	---	---
5	10640.00	44.85	54.00	-9.15	29.87	14.98	Average	---	---
6	10640.00	57.51	74.00	-16.49	42.53	14.98	Peak	---	---
<p>Note 1: "&gt;20dB" means spurious emission levels that exceed the level of 20 dB below the applicable limit.          Note 2: For restricted bands, the peak measurement is fully sufficient, as the max field strength as measured with the Peak-Detector meets the AV-Limit so that the AV level does not need to be reported in addition.</p>									

<b>Polarization</b>	Vertical	<b>Test Freq. (MHz)</b>	5320
<b>Test Configuration</b>	2		

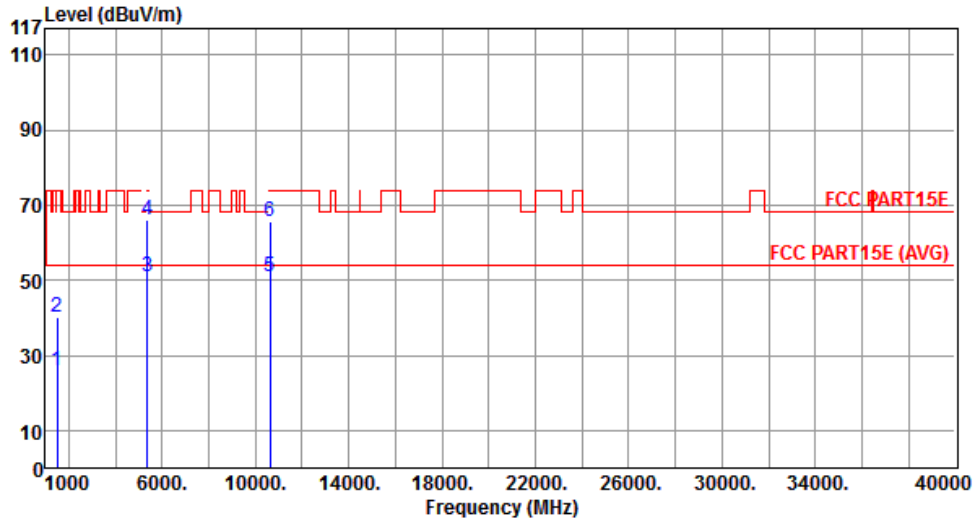

	Freq. MHz	Emission level dBuV/m	Limit dBuV/m	Margin dB	SA reading dBuV	Factor dB	Remark	ANT High cm	Turn Table deg
1	1495.00	26.11	54.00	-27.89	32.69	-6.58	Average	---	---
2	1495.00	40.14	74.00	-33.86	46.72	-6.58	Peak	---	---
3	5350.00	50.77	74.00	-3.23	45.68	5.09	Average	---	---
4	5350.00	65.94	74.00	-8.06	60.85	5.09	Peak	---	---
5	10640.00	51.11	54.00	-2.89	36.13	14.98	Average	---	---
6	10640.00	65.47	74.00	-8.53	50.49	14.98	Peak	---	---

Note 1: ">20dB" means spurious emission levels that exceed the level of 20 dB below the applicable limit.

Note 2: For restricted bands, the peak measurement is fully sufficient, as the max field strength as measured with the Peak-Detector meets the AV-Limit so that the AV level does not need to be reported in addition.

<b>Polarization</b>	Horizontal	<b>Test Freq. (MHz)</b>	5500
<b>Test Configuration</b>	2		

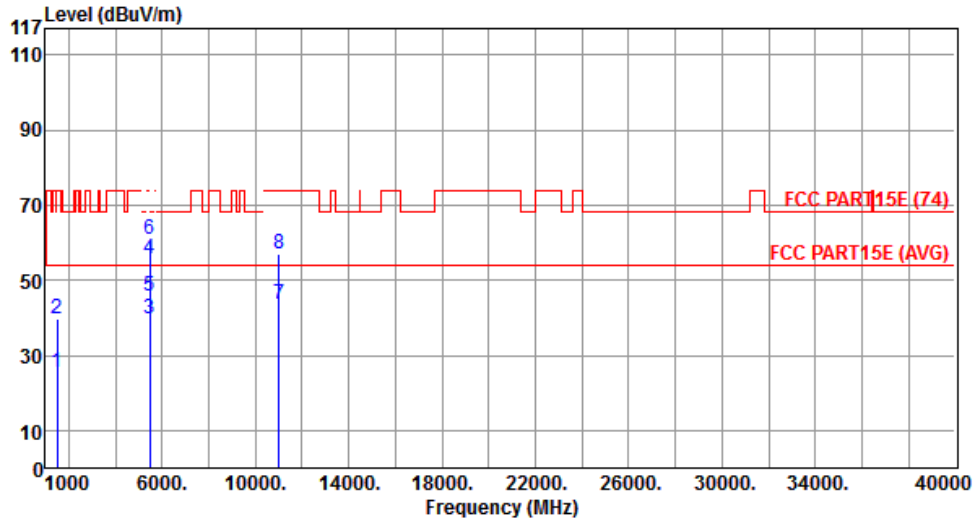

	Freq. MHz	Emission level dBuV/m	Limit dBuV/m	Margin dB	SA reading dBuV	Factor dB	Remark	ANT High cm	Turn Table deg
1	1495.00	25.48	54.00	-28.52	32.06	-6.58	Average	---	---
2	1495.00	39.83	74.00	-34.17	46.41	-6.58	Peak	---	---
3	5460.00	39.73	54.00	-14.27	34.55	5.18	Average	---	---
4	5460.00	55.49	74.00	-18.51	50.31	5.18	Peak	---	---
5	5470.00	45.58	54.00	-8.42	40.39	5.19	Average	---	---
6	5470.00	60.88	74.00	-13.12	55.69	5.19	Peak	---	---
7	11000.00	43.66	54.00	-10.34	28.38	15.28	Average	---	---
8	11000.00	56.80	74.00	-17.20	41.52	15.28	Peak	---	---

Note 1: ">20dB" means spurious emission levels that exceed the level of 20 dB below the applicable limit.  
 Note 2: For restricted bands, the peak measurement is fully sufficient, as the max field strength as measured with the Peak-Detector meets the AV-Limit so that the AV level does not need to be reported in addition.

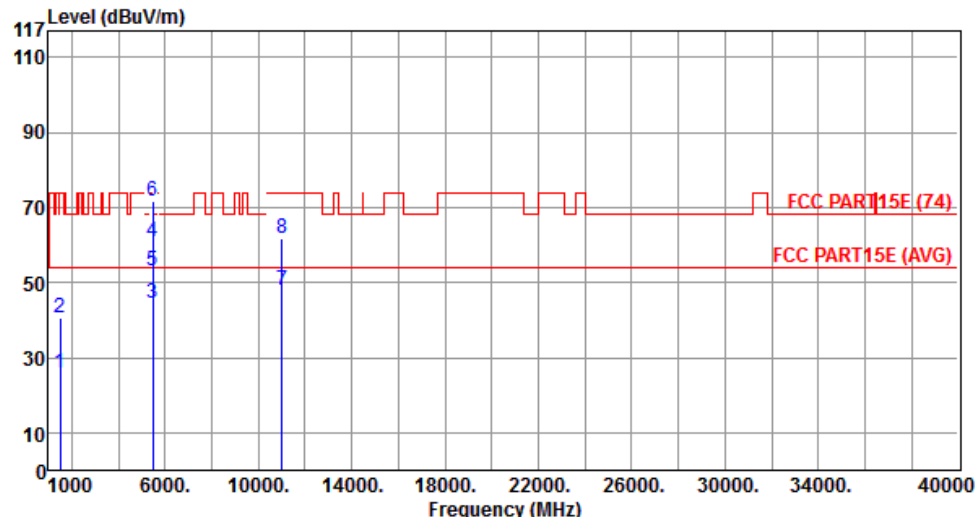
<b>Polarization</b>	Vertical	<b>Test Freq. (MHz)</b>	5500						
<b>Test Configuration</b>	2								
									
	Freq.	Emission level	Limit	Margin	SA reading	Factor	Remark	ANT High	Turn Table
	MHz	dBuV/m	dBuV/m	dB	dBuV	dB		cm	deg
1	1495.00	25.95	54.00	-28.05	32.53	-6.58	Average	---	---
2	1495.00	40.51	74.00	-33.49	47.09	-6.58	Peak	---	---
3	5460.00	44.60	54.00	-9.40	39.42	5.18	Average	---	---
4	5460.00	60.86	74.00	-13.14	55.68	5.18	Peak	---	---
5	5470.00	52.94	54.00	-1.06	47.75	5.19	Average	---	---
6	5470.00	71.48	74.00	-2.52	66.29	5.19	Peak	---	---
7	11000.00	47.85	54.00	-6.15	32.57	15.28	Average	---	---
8	11000.00	61.63	74.00	-12.37	46.35	15.28	Peak	---	---

Note 1: ">20dB" means spurious emission levels that exceed the level of 20 dB below the applicable limit.  
 Note 2: For restricted bands, the peak measurement is fully sufficient, as the max field strength as measured with the Peak-Detector meets the AV-Limit so that the AV level does not need to be reported in addition.

<b>Polarization</b>	Horizontal	<b>Test Freq. (MHz)</b>	5580
<b>Test Configuration</b>	2		

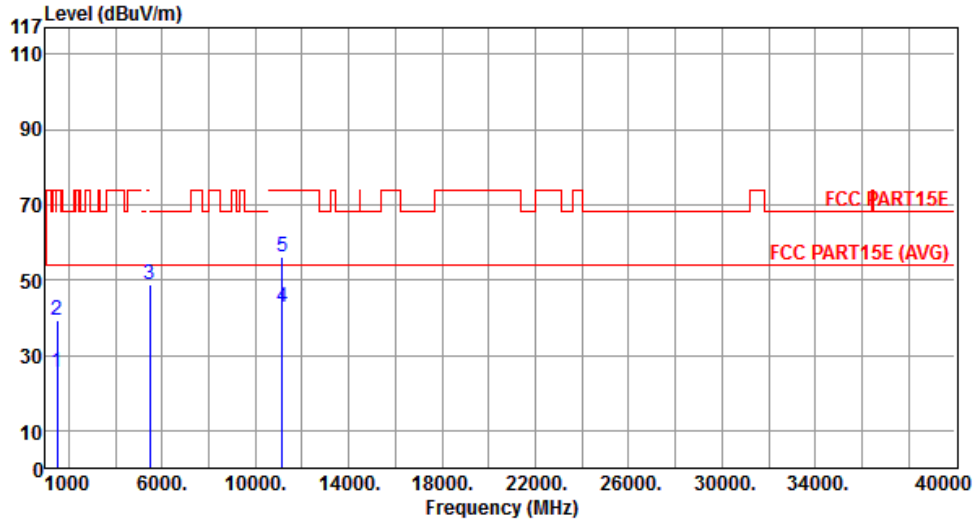

	Freq. MHz	Emission level dBuV/m	Limit dBuV/m	Margin dB	SA reading dBuV	Factor dB	Remark	ANT High cm	Turn Table deg
1	1495.00	25.68	54.00	-28.32	32.26	-6.58	Average	---	---
2	1495.00	39.46	74.00	-34.54	46.04	-6.58	Peak	---	---
3	5470.00	48.86	68.30	-19.44	43.67	5.19	Peak	---	---
4	11160.00	42.83	54.00	-11.17	27.65	15.18	Average	---	---
5	11160.00	56.16	74.00	-17.84	40.98	15.18	Peak	---	---

Note 1: ">20dB" means spurious emission levels that exceed the level of 20 dB below the applicable limit.  
 Note 2: For restricted bands, the peak measurement is fully sufficient, as the max field strength as measured with the Peak-Detector meets the AV-Limit so that the AV level does not need to be reported in addition.

<b>Polarization</b>	Vertical	<b>Test Freq. (MHz)</b>	5580
<b>Test Configuration</b>	2		

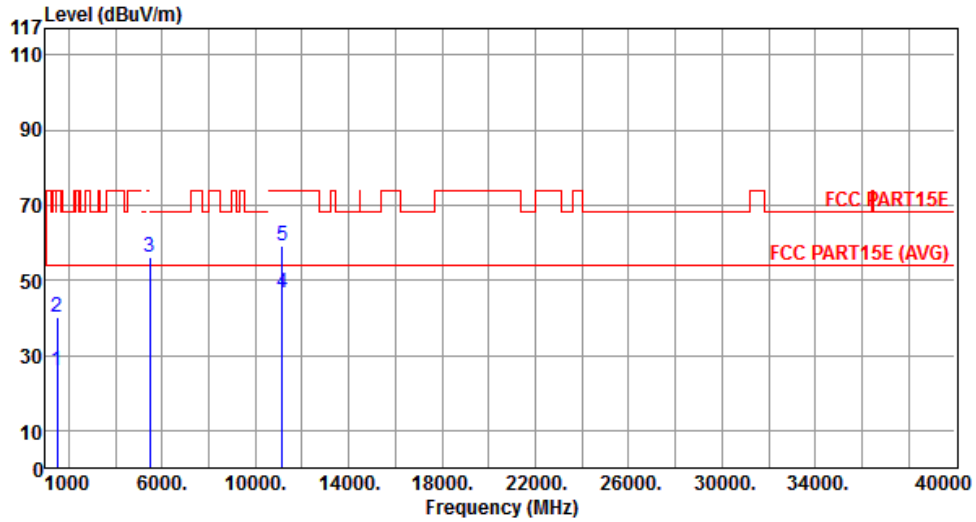

	Freq. MHz	Emission level dBuV/m	Limit dBuV/m	Margin dB	SA reading dBuV	Factor dB	Remark	ANT High cm	Turn Table deg
1	1495.00	25.85	54.00	-28.15	32.43	-6.58	Average	---	---
2	1495.00	40.09	74.00	-33.91	46.67	-6.58	Peak	---	---
3	5470.00	56.18	68.30	-12.12	50.99	5.19	Peak	---	---
4	11160.00	46.46	54.00	-7.54	31.28	15.18	Average	---	---
5	11160.00	59.30	74.00	-14.70	44.12	15.18	Peak	---	---

Note 1: ">20dB" means spurious emission levels that exceed the level of 20 dB below the applicable limit.  
 Note 2: For restricted bands, the peak measurement is fully sufficient, as the max field strength as measured with the Peak-Detector meets the AV-Limit so that the AV level does not need to be reported in addition.

<b>Polarization</b>	Horizontal	<b>Test Freq. (MHz)</b>	5700
<b>Test Configuration</b>	2		

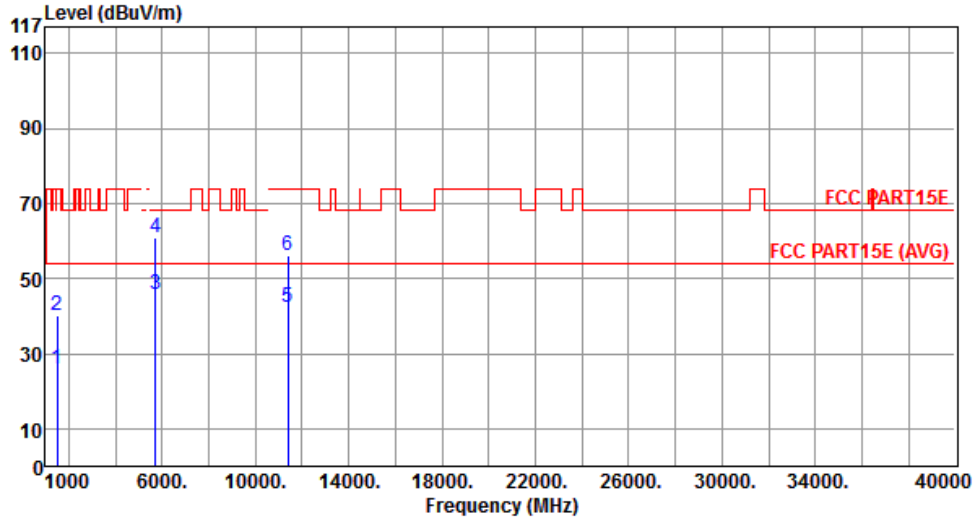

	Freq. MHz	Emission level dBuV/m	Limit dBuV/m	Margin dB	SA reading dBuV	Factor dB	Remark	ANT High cm	Turn Table deg
1	1495.00	25.71	54.00	-28.29	32.29	-6.58	Average	---	---
2	1495.00	39.99	74.00	-34.01	46.57	-6.58	Peak	---	---
3	5725.00	45.94	54.00	-8.06	40.38	5.56	Average	---	---
4	5725.00	60.94	68.30	-7.36	55.38	5.56	Peak	---	---
5	11400.00	42.44	54.00	-11.56	27.41	15.03	Average	---	---
6	11400.00	55.92	74.00	-18.08	40.89	15.03	Peak	---	---

Note 1: ">20dB" means spurious emission levels that exceed the level of 20 dB below the applicable limit.  
 Note 2: For restricted bands, the peak measurement is fully sufficient, as the max field strength as measured with the Peak-Detector meets the AV-Limit so that the AV level does not need to be reported in addition.



<b>Polarization</b>	Vertical	<b>Test Freq. (MHz)</b>	5700
<b>Test Configuration</b>	2		

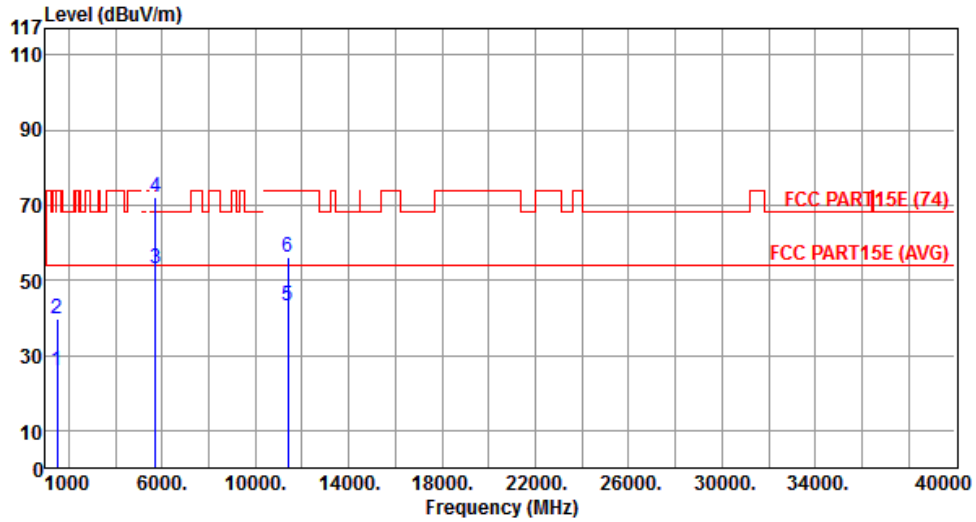

	Freq. MHz	Emission level dBuV/m	Limit dBuV/m	Margin dB	SA reading dBuV	Factor dB	Remark	ANT High cm	Turn Table deg
1	1495.00	25.96	54.00	-28.04	32.54	-6.58	Average	---	---
2	1495.00	39.80	74.00	-34.20	46.38	-6.58	Peak	---	---
3	5725.00	52.98	74.00	-1.02	47.42	5.56	Average	---	---
4	5725.00	72.12	74.00	-1.88	66.56	5.56	Peak	---	---
5	11400.00	43.30	54.00	-10.70	28.27	15.03	Average	---	---
6	11400.00	56.16	74.00	-17.84	41.13	15.03	Peak	---	---

Note 1: ">20dB" means spurious emission levels that exceed the level of 20 dB below the applicable limit.  
 Note 2: For restricted bands, the peak measurement is fully sufficient, as the max field strength as measured with the Peak-Detector meets the AV-Limit so that the AV level does not need to be reported in addition.

<b>Polarization</b>	Horizontal	<b>Test Freq. (MHz)</b>	5180
<b>Test Configuration</b>	3		

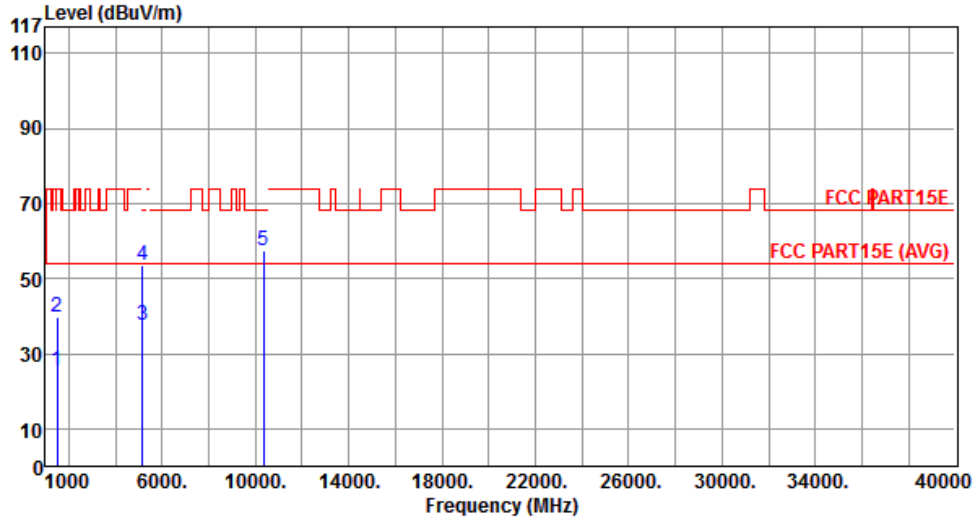

	Freq. MHz	Emission level dBuV/m	Limit dBuV/m	Margin dB	SA reading dBuV	Factor dB	Remark	ANT High cm	Turn Table deg
1	1495.00	25.55	54.00	-28.45	32.13	-6.58	Average	---	---
2	1495.00	39.92	74.00	-34.08	46.50	-6.58	Peak	---	---
3	5150.00	37.68	54.00	-16.32	32.74	4.94	Average	---	---
4	5150.00	53.49	74.00	-20.51	48.55	4.94	Peak	---	---
5	10360.00	57.55	68.30	-10.75	42.84	14.71	Peak	---	---

Note 1: ">20dB" means spurious emission levels that exceed the level of 20 dB below the applicable limit.  
 Note 2: For restricted bands, the peak measurement is fully sufficient, as the max field strength as measured with the Peak-Detector meets the AV-Limit so that the AV level does not need to be reported in addition.

<b>Polarization</b>	Vertical	<b>Test Freq. (MHz)</b>	5180
<b>Test Configuration</b>	3		

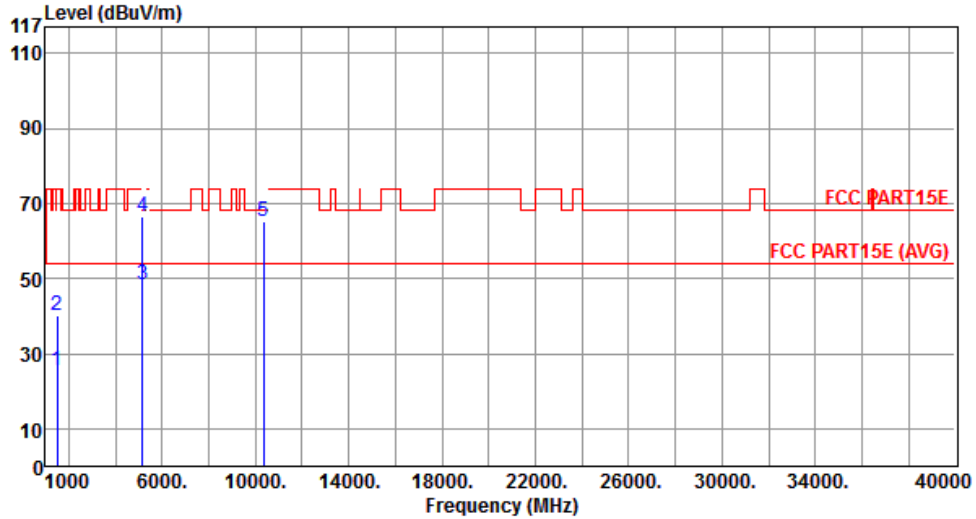

	Freq. MHz	Emission level dBuV/m	Limit dBuV/m	Margin dB	SA reading dBuV	Factor dB	Remark	ANT High cm	Turn Table deg
1	1495.00	25.62	54.00	-28.38	32.20	-6.58	Average	---	---
2	1495.00	40.26	74.00	-33.74	46.84	-6.58	Peak	---	---
3	5150.00	48.41	54.00	-5.59	43.47	4.94	Average	---	---
4	5150.00	66.33	74.00	-7.67	61.39	4.94	Peak	---	---
5	10360.00	65.26	68.30	-3.04	50.55	14.71	Peak	---	---

Note 1: ">20dB" means spurious emission levels that exceed the level of 20 dB below the applicable limit.  
 Note 2: For restricted bands, the peak measurement is fully sufficient, as the max field strength as measured with the Peak-Detector meets the AV-Limit so that the AV level does not need to be reported in addition.

<b>Polarization</b>	Horizontal	<b>Test Freq. (MHz)</b>	5200
<b>Test Configuration</b>	3		

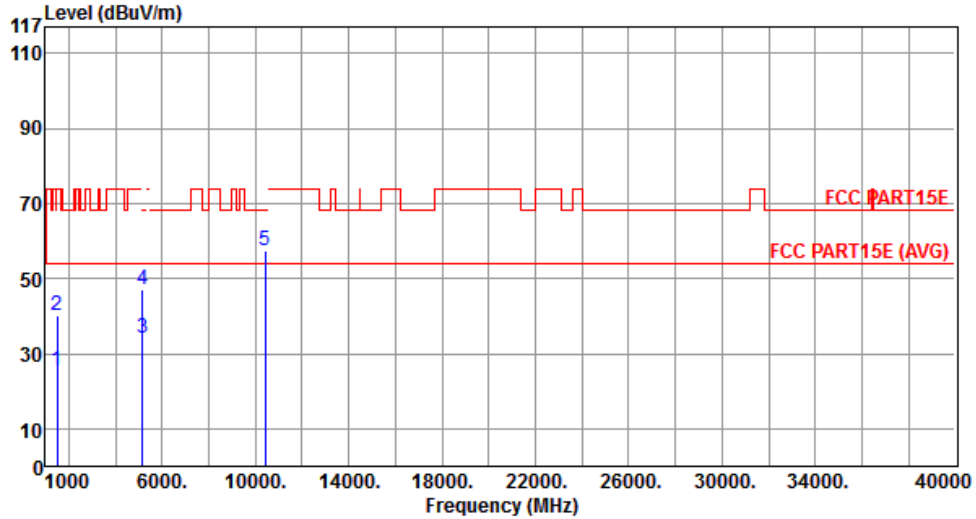

	Freq. MHz	Emission level dBuV/m	Limit dBuV/m	Margin dB	SA reading dBuV	Factor dB	Remark	ANT High cm	Turn Table deg
1	1495.00	25.66	54.00	-28.34	32.24	-6.58	Average	---	---
2	1495.00	39.99	74.00	-34.01	46.57	-6.58	Peak	---	---
3	5150.00	34.26	54.00	-19.74	29.32	4.94	Average	---	---
4	5150.00	47.18	74.00	-26.82	42.24	4.94	Peak	---	---
5	10400.00	57.30	68.30	-11.00	42.55	14.75	Peak	---	---

Note 1: ">20dB" means spurious emission levels that exceed the level of 20 dB below the applicable limit.  
 Note 2: For restricted bands, the peak measurement is fully sufficient, as the max field strength as measured with the Peak-Detector meets the AV-Limit so that the AV level does not need to be reported in addition.

<b>Polarization</b>	Vertical	<b>Test Freq. (MHz)</b>	5200
<b>Test Configuration</b>	3		

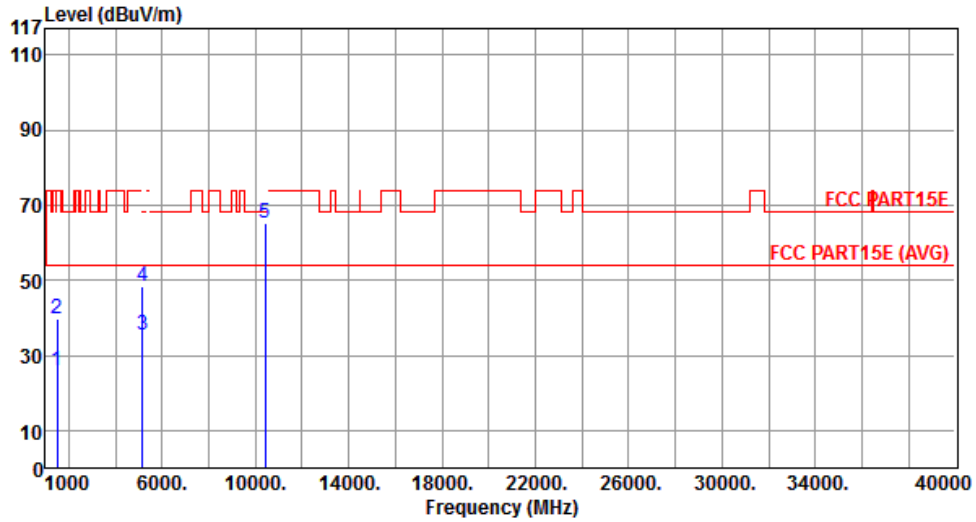

	Freq. MHz	Emission level dBuV/m	Limit dBuV/m	Margin dB	SA reading dBuV	Factor dB	Remark	ANT High cm	Turn Table deg
1	1495.00	25.96	54.00	-28.04	32.54	-6.58	Average	---	---
2	1495.00	39.66	74.00	-34.34	46.24	-6.58	Peak	---	---
3	5150.00	35.55	54.00	-18.45	30.61	4.94	Average	---	---
4	5150.00	48.26	74.00	-25.74	43.32	4.94	Peak	---	---
5	10400.00	65.24	68.30	-3.06	50.49	14.75	Peak	---	---

Note 1: ">20dB" means spurious emission levels that exceed the level of 20 dB below the applicable limit.  
 Note 2: For restricted bands, the peak measurement is fully sufficient, as the max field strength as measured with the Peak-Detector meets the AV-Limit so that the AV level does not need to be reported in addition.

<b>Polarization</b>	Horizontal	<b>Test Freq. (MHz)</b>	5240
<b>Test Configuration</b>	3		

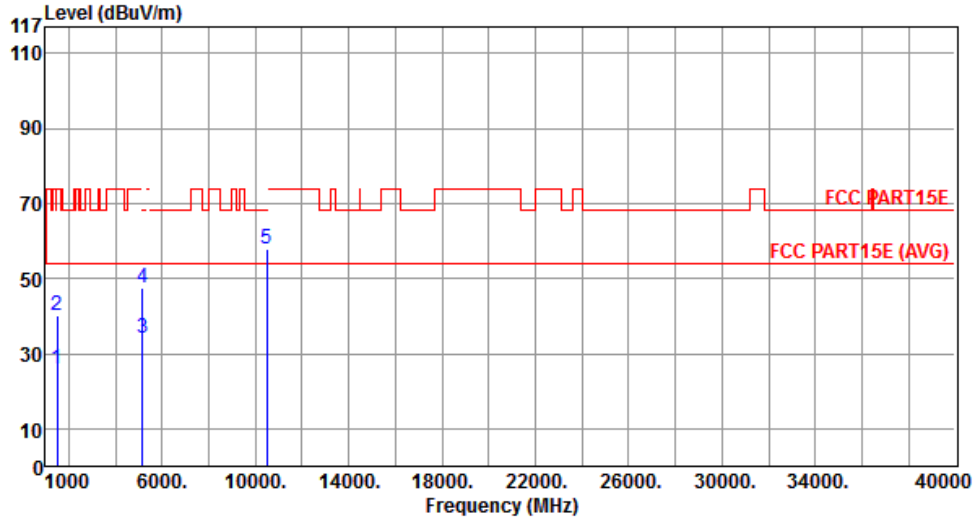

	Freq. MHz	Emission level dBuV/m	Limit dBuV/m	Margin dB	SA reading dBuV	Factor dB	Remark	ANT High cm	Turn Table deg
1	1495.00	25.85	54.00	-28.15	32.43	-6.58	Average	---	---
2	1495.00	40.23	74.00	-33.77	46.81	-6.58	Peak	---	---
3	5150.00	34.26	54.00	-19.74	29.32	4.94	Average	---	---
4	5150.00	47.31	74.00	-26.69	42.37	4.94	Peak	---	---
5	10480.00	57.96	68.30	-10.34	43.12	14.84	Peak	---	---

Note 1: ">20dB" means spurious emission levels that exceed the level of 20 dB below the applicable limit.  
 Note 2: For restricted bands, the peak measurement is fully sufficient, as the max field strength as measured with the Peak-Detector meets the AV-Limit so that the AV level does not need to be reported in addition.

<b>Polarization</b>	Vertical	<b>Test Freq. (MHz)</b>	5240
---------------------	----------	-------------------------	------

<b>Test Configuration</b>	3
---------------------------	---

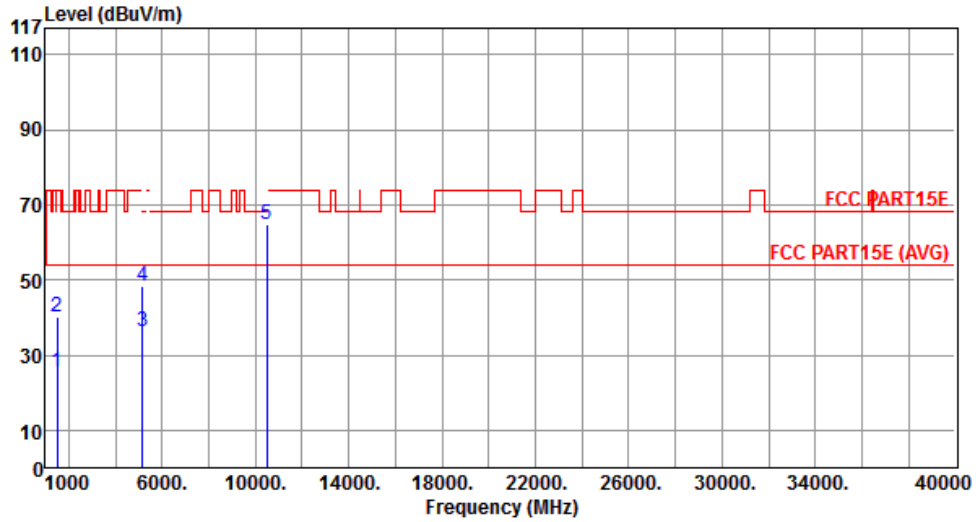

	Freq. MHz	Emission level dBuV/m	Limit dBuV/m	Margin dB	SA reading dBuV	Factor dB	Remark	ANT High cm	Turn Table deg
1	1495.00	25.66	54.00	-28.34	32.24	-6.58	Average	---	---
2	1495.00	40.21	74.00	-33.79	46.79	-6.58	Peak	---	---
3	5150.00	36.25	54.00	-17.75	31.31	4.94	Average	---	---
4	5150.00	48.31	74.00	-25.69	43.37	4.94	Peak	---	---
5	10480.00	64.92	68.30	-3.38	50.08	14.84	Peak	---	---

Note 1: ">20dB" means spurious emission levels that exceed the level of 20 dB below the applicable limit.  
 Note 2: For restricted bands, the peak measurement is fully sufficient, as the max field strength as measured with the Peak-Detector meets the AV-Limit so that the AV level does not need to be reported in addition.

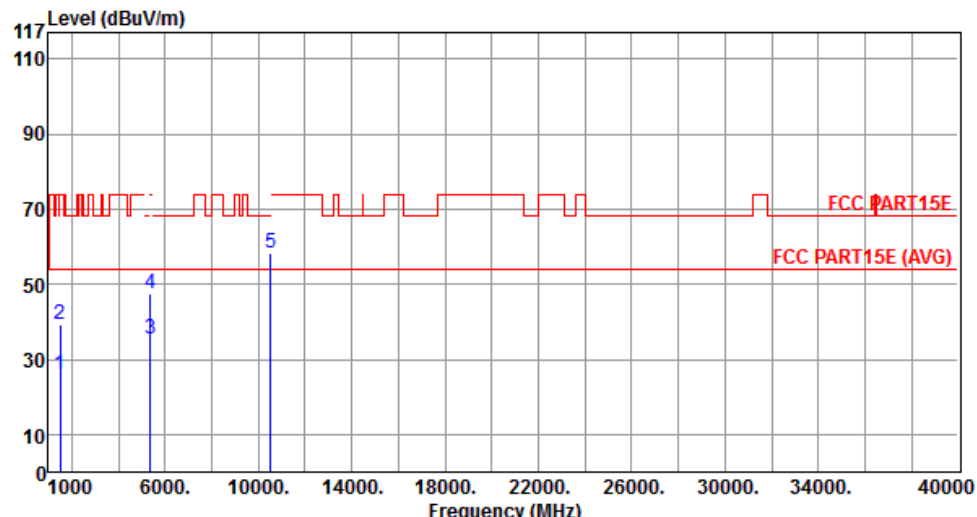
<b>Polarization</b>	Horizontal	<b>Test Freq. (MHz)</b>	5260						
<b>Test Configuration</b>	3								
									
	Freq.	Emission level	Limit	Margin	SA reading	Factor	Remark	ANT High	Turn Table
	MHz	dBuV/m	dBuV/m	dB	dBuV	dB		cm	deg
1	1495.00	25.93	54.00	-28.07	32.51	-6.58	Average	---	---
2	1495.00	39.45	74.00	-34.55	46.03	-6.58	Peak	---	---
3	5350.00	35.61	54.00	-18.39	30.52	5.09	Average	---	---
4	5350.00	47.56	74.00	-26.44	42.47	5.09	Peak	---	---
5	10520.00	58.26	68.30	-10.04	43.39	14.87	Peak	---	---
<p>Note 1: "&gt;20dB" means spurious emission levels that exceed the level of 20 dB below the applicable limit.  Note 2: For restricted bands, the peak measurement is fully sufficient, as the max field strength as measured with the Peak-Detector meets the AV-Limit so that the AV level does not need to be reported in addition.</p>									



<b>Polarization</b>	Vertical	<b>Test Freq. (MHz)</b>	5260
<b>Test Configuration</b>	3		

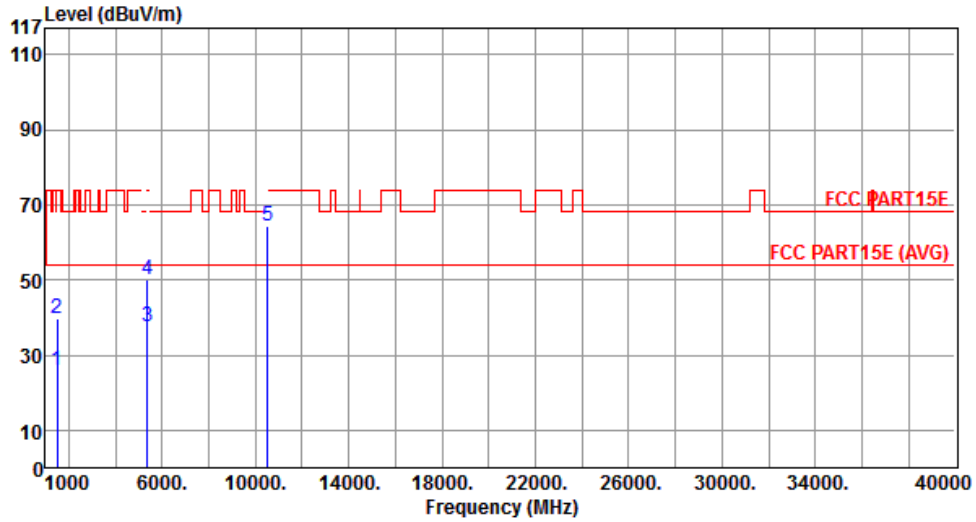

	Freq. MHz	Emission level dBuV/m	Limit dBuV/m	Margin dB	SA reading dBuV	Factor dB	Remark	ANT High cm	Turn Table deg
1	1495.00	25.96	54.00	-28.04	32.54	-6.58	Average	---	---
2	1495.00	39.82	74.00	-34.18	46.40	-6.58	Peak	---	---
3	5350.00	37.45	54.00	-16.55	32.36	5.09	Average	---	---
4	5350.00	49.92	74.00	-24.08	44.83	5.09	Peak	---	---
5	10520.00	64.22	68.30	-4.08	49.35	14.87	Peak	---	---

Note 1: ">20dB" means spurious emission levels that exceed the level of 20 dB below the applicable limit.  
 Note 2: For restricted bands, the peak measurement is fully sufficient, as the max field strength as measured with the Peak-Detector meets the AV-Limit so that the AV level does not need to be reported in addition.

<b>Polarization</b>	Horizontal	<b>Test Freq. (MHz)</b>	5300
<b>Test Configuration</b>	3		

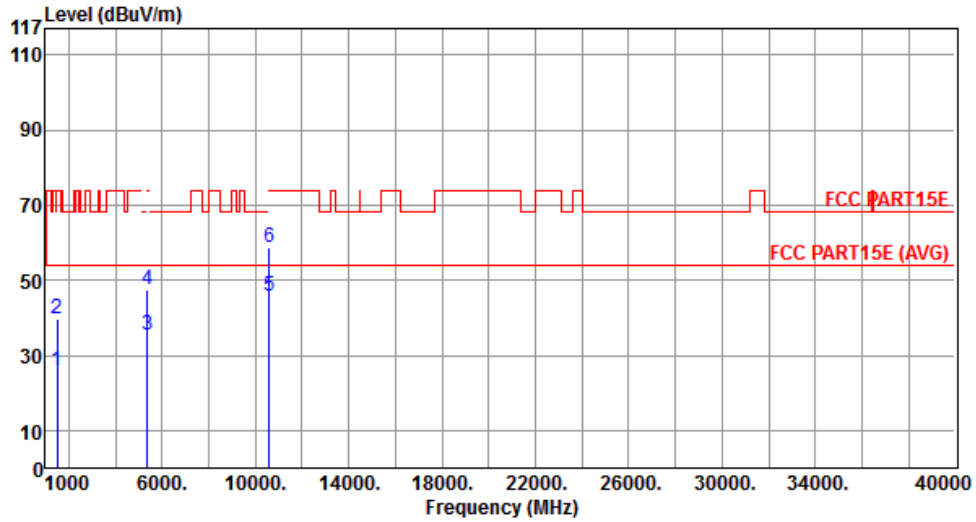

	Freq. MHz	Emission level dBuV/m	Limit dBuV/m	Margin dB	SA reading dBuV	Factor dB	Remark	ANT High cm	Turn Table deg
1	1495.00	25.71	54.00	-28.29	32.29	-6.58	Average	---	---
2	1495.00	39.63	74.00	-34.37	46.21	-6.58	Peak	---	---
3	5350.00	35.51	54.00	-18.49	30.42	5.09	Average	---	---
4	5350.00	47.61	74.00	-26.39	42.52	5.09	Peak	---	---
5	10600.00	45.85	54.00	-8.15	30.91	14.94	Average	---	---
6	10600.00	58.60	74.00	-15.40	43.66	14.94	Peak	---	---

Note 1: ">20dB" means spurious emission levels that exceed the level of 20 dB below the applicable limit.  
 Note 2: For restricted bands, the peak measurement is fully sufficient, as the max field strength as measured with the Peak-Detector meets the AV-Limit so that the AV level does not need to be reported in addition.

<b>Polarization</b>	Vertical	<b>Test Freq. (MHz)</b>	5300
<b>Test Configuration</b>	3		

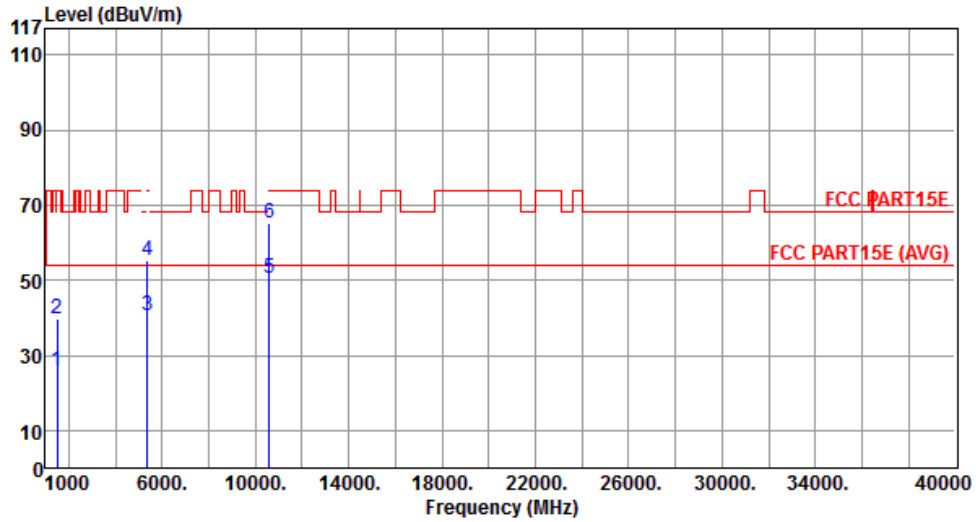

	Freq. MHz	Emission level dBuV/m	Limit dBuV/m	Margin dB	SA reading dBuV	Factor dB	Remark	ANT High cm	Turn Table deg
1	1495.00	26.11	54.00	-27.89	32.69	-6.58	Average	---	---
2	1495.00	39.56	74.00	-34.44	46.14	-6.58	Peak	---	---
3	5350.00	40.44	54.00	-13.56	35.35	5.09	Average	---	---
4	5350.00	55.25	74.00	-18.75	50.16	5.09	Peak	---	---
5	10600.00	50.55	54.00	-3.45	35.61	14.94	Average	---	---
6	10600.00	64.99	74.00	-9.01	50.05	14.94	Peak	---	---

Note 1: ">20dB" means spurious emission levels that exceed the level of 20 dB below the applicable limit.

Note 2: For restricted bands, the peak measurement is fully sufficient, as the max field strength as measured with the Peak-Detector meets the AV-Limit so that the AV level does not need to be reported in addition.

<b>Polarization</b>	Horizontal	<b>Test Freq. (MHz)</b>	5320
---------------------	------------	-------------------------	------

<b>Test Configuration</b>	3
---------------------------	---

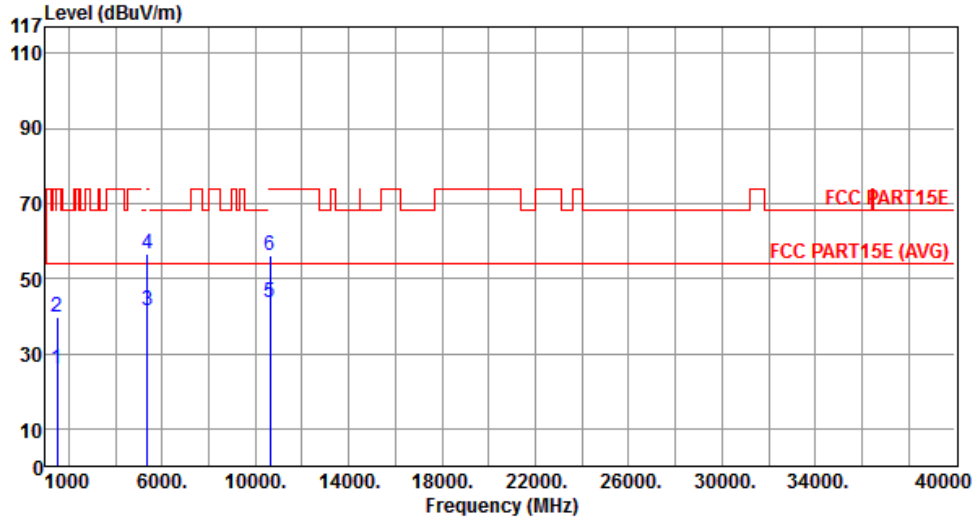

	Freq. MHz	Emission level dBuV/m	Limit dBuV/m	Margin dB	SA reading dBuV	Factor dB	Remark	ANT High cm	Turn Table deg
1	1495.00	25.85	54.00	-28.15	32.43	-6.58	Average	---	---
2	1495.00	39.55	74.00	-34.45	46.13	-6.58	Peak	---	---
3	5350.00	41.47	54.00	-12.53	36.38	5.09	Average	---	---
4	5350.00	56.57	74.00	-17.43	51.48	5.09	Peak	---	---
5	10640.00	43.57	54.00	-10.43	28.59	14.98	Average	---	---
6	10640.00	56.26	74.00	-17.74	41.28	14.98	Peak	---	---

Note 1: ">20dB" means spurious emission levels that exceed the level of 20 dB below the applicable limit.  
 Note 2: For restricted bands, the peak measurement is fully sufficient, as the max field strength as measured with the Peak-Detector meets the AV-Limit so that the AV level does not need to be reported in addition.

<b>Polarization</b>	Vertical	<b>Test Freq. (MHz)</b>	5320
<b>Test Configuration</b>	3		

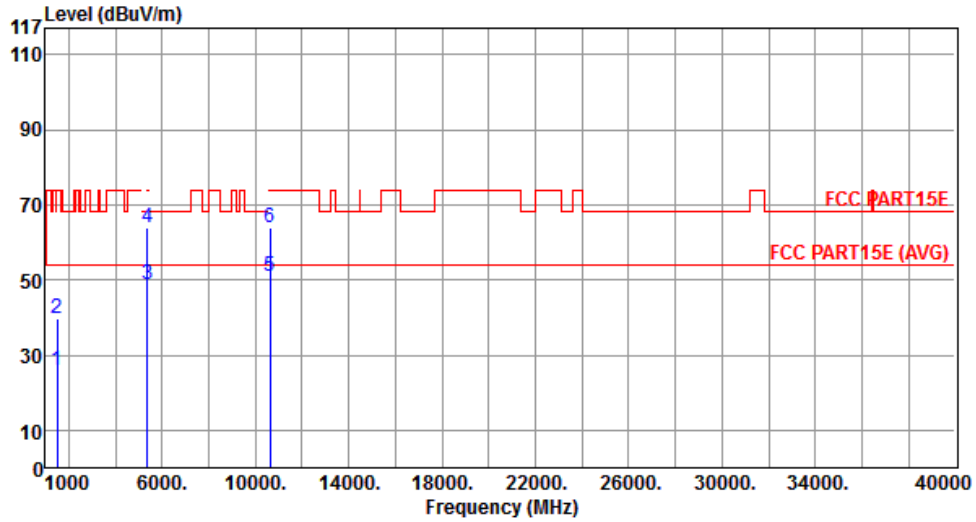

	Freq. MHz	Emission level dBuV/m	Limit dBuV/m	Margin dB	SA reading dBuV	Factor dB	Remark	ANT High cm	Turn Table deg
1	1495.00	25.97	54.00	-28.03	32.55	-6.58	Average	---	---
2	1495.00	39.57	74.00	-34.43	46.15	-6.58	Peak	---	---
3	5350.00	48.64	54.00	-5.36	43.55	5.09	Average	---	---
4	5350.00	63.73	74.00	-10.27	58.64	5.09	Peak	---	---
5	10640.00	50.85	54.00	-3.15	35.87	14.98	Average	---	---
6	10640.00	63.97	74.00	-10.03	48.99	14.98	Peak	---	---

Note 1: ">20dB" means spurious emission levels that exceed the level of 20 dB below the applicable limit.  
 Note 2: For restricted bands, the peak measurement is fully sufficient, as the max field strength as measured with the Peak-Detector meets the AV-Limit so that the AV level does not need to be reported in addition.

<b>Polarization</b>	Horizontal	<b>Test Freq. (MHz)</b>	5500
<b>Test Configuration</b>	3		

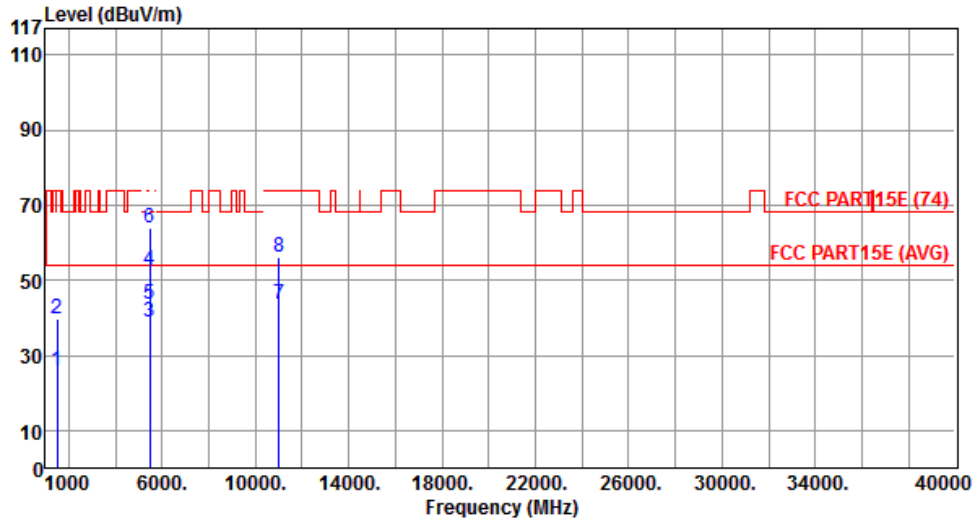

	Freq. MHz	Emission level dBuV/m	Limit dBuV/m	Margin dB	SA reading dBuV	Factor dB	Remark	ANT High cm	Turn Table deg
1	1495.00	25.69	54.00	-28.31	32.27	-6.58	Average	---	---
2	1495.00	39.57	74.00	-34.43	46.15	-6.58	Peak	---	---
3	5460.00	38.73	54.00	-15.27	33.55	5.18	Average	---	---
4	5460.00	52.57	74.00	-21.43	47.39	5.18	Peak	---	---
5	5470.00	43.78	54.00	-10.22	38.59	5.19	Average	---	---
6	5470.00	63.87	74.00	-10.13	58.68	5.19	Peak	---	---
7	11000.00	43.53	54.00	-10.47	28.25	15.28	Average	---	---
8	11000.00	56.23	74.00	-17.77	40.95	15.28	Peak	---	---

Note 1: ">20dB" means spurious emission levels that exceed the level of 20 dB below the applicable limit.

Note 2: For restricted bands, the peak measurement is fully sufficient, as the max field strength as measured with the Peak-Detector meets the AV-Limit so that the AV level does not need to be reported in addition.

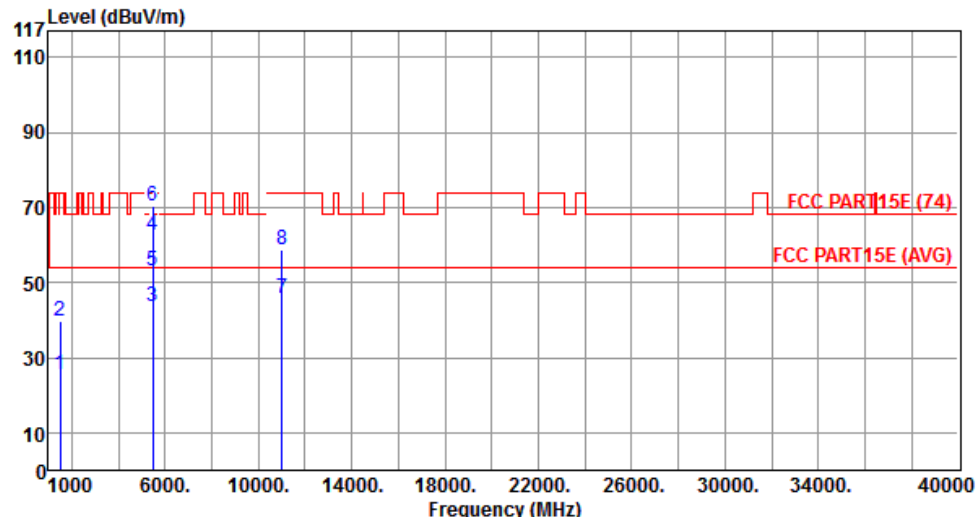
<b>Polarization</b>	Vertical	<b>Test Freq. (MHz)</b>	5500						
<b>Test Configuration</b>	3								
									
	Freq.	Emission level	Limit	Margin	SA reading	Factor	Remark	ANT High	Turn Table
	MHz	dBuV/m	dBuV/m	dB	dBuV	dB		cm	deg
1	1495.00	25.36	54.00	-28.64	31.94	-6.58	Average	---	---
2	1495.00	39.57	74.00	-34.43	46.15	-6.58	Peak	---	---
3	5460.00	43.44	54.00	-10.56	38.26	5.18	Average	---	---
4	5460.00	62.53	74.00	-11.47	57.35	5.18	Peak	---	---
5	5470.00	52.96	54.00	-1.04	47.77	5.19	Average	---	---
6	5470.00	70.54	74.00	-3.46	65.35	5.19	Peak	---	---
7	11000.00	45.60	54.00	-8.40	30.32	15.28	Average	---	---
8	11000.00	58.68	74.00	-15.32	43.40	15.28	Peak	---	---
<p>Note 1: "&gt;20dB" means spurious emission levels that exceed the level of 20 dB below the applicable limit.          Note 2: For restricted bands, the peak measurement is fully sufficient, as the max field strength as measured with the Peak-Detector meets the AV-Limit so that the AV level does not need to be reported in addition.</p>									

<b>Polarization</b>	Horizontal	<b>Test Freq. (MHz)</b>	5580
---------------------	------------	-------------------------	------

<b>Test Configuration</b>	3
---------------------------	---

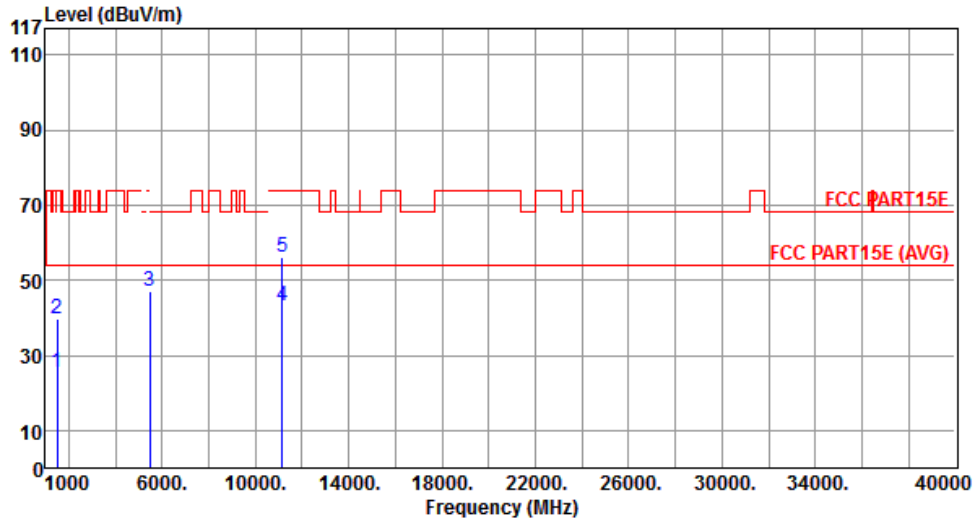

	Freq. MHz	Emission level dBuV/m	Limit dBuV/m	Margin dB	SA reading dBuV	Factor dB	Remark	ANT High cm	Turn Table deg
1	1495.00	25.68	54.00	-28.32	32.26	-6.58	Average	---	---
2	1495.00	39.87	74.00	-34.13	46.45	-6.58	Peak	---	---
3	5470.00	47.26	68.30	-21.04	42.07	5.19	Peak	---	---
4	11160.00	43.06	54.00	-10.94	27.88	15.18	Average	---	---
5	11160.00	56.11	74.00	-17.89	40.93	15.18	Peak	---	---

Note 1: ">20dB" means spurious emission levels that exceed the level of 20 dB below the applicable limit.

Note 2: For restricted bands, the peak measurement is fully sufficient, as the max field strength as measured with the Peak-Detector meets the AV-Limit so that the AV level does not need to be reported in addition.



<b>Polarization</b>	Vertical	<b>Test Freq. (MHz)</b>	5580
<b>Test Configuration</b>	3		

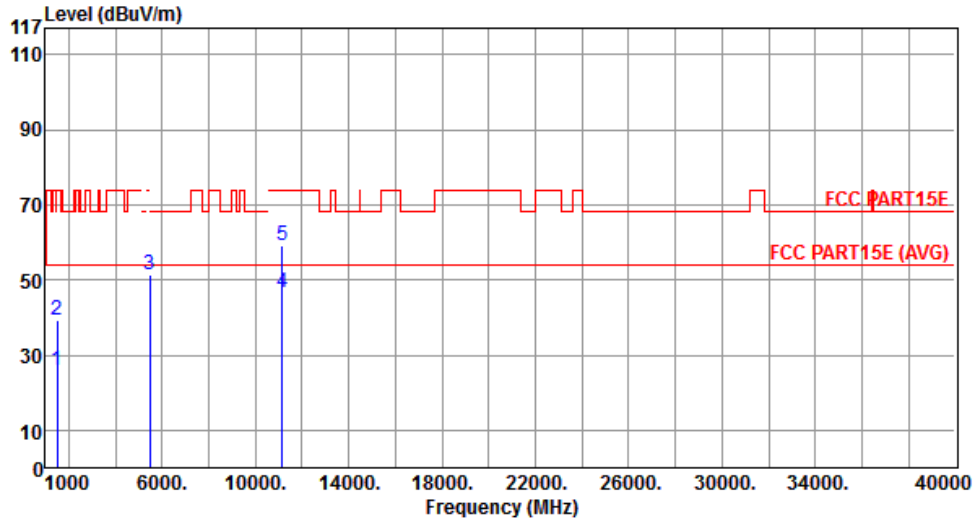

	Freq. MHz	Emission level dBuV/m	Limit dBuV/m	Margin dB	SA reading dBuV	Factor dB	Remark	ANT High cm	Turn Table deg
1	1495.00	25.82	54.00	-28.18	32.40	-6.58	Average	---	---
2	1495.00	39.42	74.00	-34.58	46.00	-6.58	Peak	---	---
3	5470.00	51.26	68.30	-17.04	46.07	5.19	Peak	---	---
4	11160.00	46.58	54.00	-7.42	31.40	15.18	Average	---	---
5	11160.00	59.36	74.00	-14.64	44.18	15.18	Peak	---	---

Note 1: ">20dB" means spurious emission levels that exceed the level of 20 dB below the applicable limit.  
 Note 2: For restricted bands, the peak measurement is fully sufficient, as the max field strength as measured with the Peak-Detector meets the AV-Limit so that the AV level does not need to be reported in addition.

<b>Polarization</b>	Horizontal	<b>Test Freq. (MHz)</b>	5700
---------------------	------------	-------------------------	------

<b>Test Configuration</b>	3
---------------------------	---

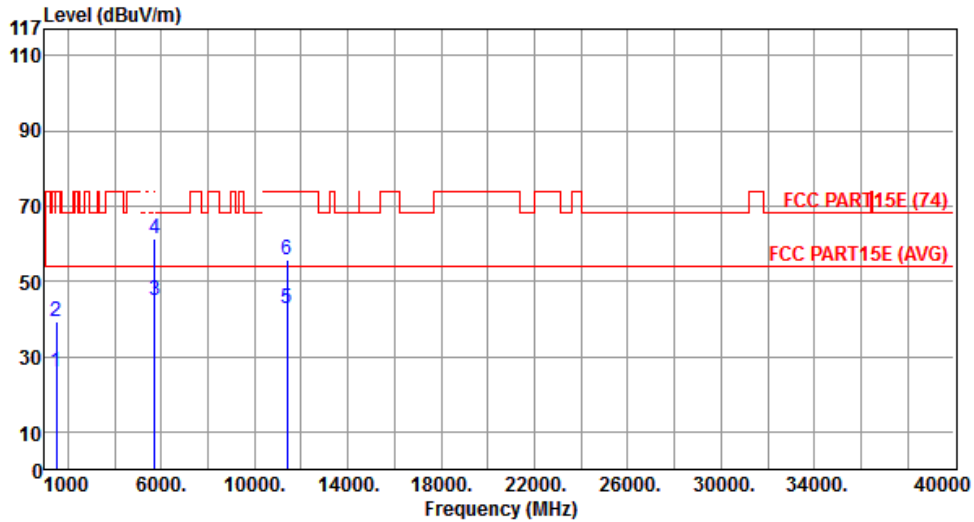

	Freq. MHz	Emission level dBuV/m	Limit dBuV/m	Margin dB	SA reading dBuV	Factor dB	Remark	ANT High cm	Turn Table deg
1	1495.00	25.93	54.00	-28.07	32.51	-6.58	Average	---	---
2	1495.00	39.41	74.00	-34.59	45.99	-6.58	Peak	---	---
3	5725.00	44.96	54.00	-9.04	39.40	5.56	Average	---	---
4	5725.00	61.24	74.00	-12.76	55.68	5.56	Peak	---	---
5	11400.00	42.77	54.00	-11.23	27.74	15.03	Average	---	---
6	11400.00	55.81	74.00	-18.19	40.78	15.03	Peak	---	---

Note 1: ">20dB" means spurious emission levels that exceed the level of 20 dB below the applicable limit.  
 Note 2: For restricted bands, the peak measurement is fully sufficient, as the max field strength as measured with the Peak-Detector meets the AV-Limit so that the AV level does not need to be reported in addition.

<b>Polarization</b>	Vertical	<b>Test Freq. (MHz)</b>	5700
---------------------	----------	-------------------------	------

<b>Test Configuration</b>	3
---------------------------	---

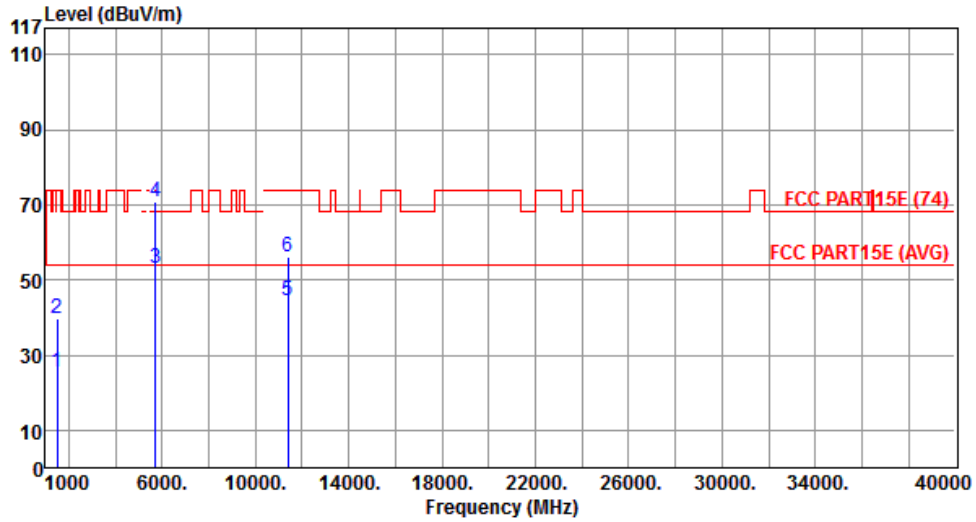

	Freq. MHz	Emission level dBuV/m	Limit dBuV/m	Margin dB	SA reading dBuV	Factor dB	Remark	ANT High cm	Turn Table deg
1	1495.00	25.66	54.00	-28.34	32.24	-6.58	Average	---	---
2	1495.00	39.57	74.00	-34.43	46.15	-6.58	Peak	---	---
3	5725.00	52.91	54.00	-1.09	47.35	5.56	Average	---	---
4	5725.00	70.94	74.00	-3.06	65.38	5.56	Peak	---	---
5	11400.00	44.59	54.00	-9.41	29.56	15.03	Average	---	---
6	11400.00	55.95	74.00	-18.05	40.92	15.03	Peak	---	---

Note 1: ">20dB" means spurious emission levels that exceed the level of 20 dB below the applicable limit.  
 Note 2: For restricted bands, the peak measurement is fully sufficient, as the max field strength as measured with the Peak-Detector meets the AV-Limit so that the AV level does not need to be reported in addition.

## 3.7 Frequency Stability

### 3.7.1 Limit of Frequency Stability

Manufacturers of U-NII devices are responsible for ensuring frequency stability such that an emission is maintained within the band of operation under all conditions of normal operation as specified in the user's manual.

### 3.7.2 Test Procedures

1. The EUT is installed in an environment test chamber with external power source.
2. Set the chamber to operate at 50 centigrade and external power source to output at nominal voltage of EUT.
3. A sufficient stabilization period at each temperature is used prior to each frequency measurement.
4. When temperature is stabled, measure the frequency stability.
5. The test shall be performed under -30 to 50 centigrade and 85 to 115 percent of the nominal voltage. Change setting of chamber and external power source to complete all conditions.

### 3.7.3 Test Setup

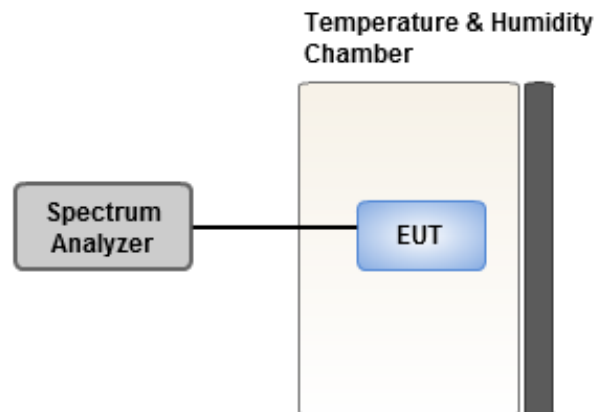

### 3.7.4 Test Result of Frequency Stability

Frequency: 5320 MHz	Frequency Drift (ppm)			
	0 minute	2 minutes	5 minutes	10 minutes
T20°C Vmax	2.74	3.14	2.69	2.23
T20°C Vmin	2.16	2.48	2.69	1.82
T70°C Vnom	2.37	2.67	2.52	1.23
T60°C Vnom	1.29	1.56	1.23	1.58
T50°C Vnom	1.59	1.62	1.71	2.93
T40°C Vnom	3.65	3.74	3.79	3.65
T30°C Vnom	1.88	2.42	1.37	2.24
T20°C Vnom	3.60	4.25	4.28	3.35
T10°C Vnom	5.85	5.67	5.99	5.86
T0°C Vnom	4.12	4.78	4.42	4.31
T-10°C Vnom	4.19	4.56	3.91	3.89
T-20°C Vnom	4.92	5.17	5.07	4.21
T-30°C Vnom	4.88	4.88	5.38	4.89
Vnom [V]: 110		Vmax [V]: 126.5		Vmin [V]: 93.5
Tnom [°C]: 20		Tmax [°C]: 70		Tmin [°C]: -30

==END==