

**Table 13.25: SAR Values(CDMA BC0-Head)**

Frequency		Mode /Band	Side	Test Position	Figure No.	Measured average power (dBm)	Maximum allowed Power (dBm)	Scaling factor	Measured SAR(1g) (W/kg)	Reported SAR(1g) (W/kg)	Power Drift (dB)
MHz	Ch.										
836.52	384	1xRTT	Left	Touch	/	24.35	25	1.161	0.179	0.208	-0.01
836.52	384	1xRTT	Left	Tilt	/	24.35	25	1.161	0.0751	0.087	-0.13
836.52	384	1xRTT	Right	Touch	/	24.35	25	1.161	0.179	0.208	-0.19
836.52	384	1xRTT	Right	Tilt	/	24.35	25	1.161	0.0965	0.112	0.08
836.52	384	1xEV-DO-0	Left	Touch	/	24.55	25	1.109	0.215	0.238	0.07
836.52	384	1xEV-DO-0	Left	Tilt	/	24.55	25	1.109	0.149	0.165	-0.12
836.52	384	1xEV-DO-0	Right	Touch	/	24.55	25	1.109	0.246	0.273	-0.01
836.52	384	1xEV-DO-0	Right	Tilt	/	24.55	25	1.109	0.155	0.172	-0.04
836.52	384	1xEV-DO-A	Left	Touch	/	23.43	24	1.140	0.214	0.244	0.13
836.52	384	1xEV-DO-A	Left	Tilt	/	23.43	24	1.140	0.148	0.169	0.07
836.52	384	1xEV-DO-A	Right	Touch	25	23.43	24	1.140	0.244	0.278	-0.01
836.52	384	1xEV-DO-A	Right	Tilt	/	23.43	24	1.140	0.154	0.176	-0.13

**Table 13.26: SAR Values (CDMA BC0 Band-Body)**

Frequency		Mode /Band	Service /Headset	Test Position	Spacing (mm)	Figure No.	Measured average power (dBm)	Maximum allowed Power (dBm)	Scaling factor	Measured SAR(1g) (W/kg)	Reported SAR(1g) (W/kg)	Power Drift (dB)
MHz	Ch.											
<b>Hotspot &amp; Body worn</b>												
836.52	384	CDMA BC0	1xEV-DO-0	Toward Phantom	10	26	24.55	25	1.109	0.398	0.441	-0.05
836.52	384	CDMA BC0	1xEV-DO-0	Toward Ground	10	/	24.55	25	1.109	0.341	0.378	0.07
<b>Hotspot</b>												
836.52	384	CDMA BC0	1xEV-DO-0	Toward Left	10	/	24.55	25	1.109	0.219	0.243	-0.12
836.52	384	CDMA BC0	1xEV-DO-0	Toward Right	10	/	24.55	25	1.109	0.398	0.441	0.15
836.52	384	CDMA BC0	1xEV-DO-0	Toward Bottom	10	/	24.55	25	1.109	0.268	0.297	-0.04

**Table 13.27: SAR Values(CDMA BC1-Head)**

Frequency		Mode /Band	Side	Test Position	Figure No.	Measured average power (dBm)	Maximum allowed Power (dBm)	Scaling factor	Measured SAR(1g) (W/kg)	Reported SAR(1g) (W/kg)	Power Drift (dB)
MHz	Ch.										
1880	600	1xRTT	Left	Touch	/	23.69	24.5	1.205	0.33	0.398	-0.16
1880	600	1xRTT	Left	Tilt	/	23.69	24.5	1.205	0.115	0.139	0.01
1880	600	1xRTT	Right	Touch	/	23.69	24.5	1.205	0.225	0.271	0.06
1880	600	1xRTT	Right	Tilt	/	23.69	24.5	1.205	0.129	0.155	0.01
1880	600	1xEV-DO-0	Left	Touch	/	23.81	24.5	1.172	0.15	0.176	0.03
1880	600	1xEV-DO-0	Left	Tilt	/	23.81	24.5	1.172	0.062	0.073	-0.12
1880	600	1xEV-DO-0	Right	Touch	/	23.81	24.5	1.172	0.324	0.380	0.01
1880	600	1xEV-DO-0	Right	Tilt	/	23.81	24.5	1.172	0.152	0.178	-0.16
1880	600	1xEV-DO-A	Left	Touch	/	23.61	24.5	1.227	0.31	0.381	0.01
1880	600	1xEV-DO-A	Left	Tilt	/	23.61	24.5	1.227	0.057	0.070	0.06
1880	600	1xEV-DO-A	Right	Touch	27	23.61	24.5	1.227	0.336	0.412	0.01
1880	600	1xEV-DO-A	Right	Tilt	/	23.61	24.5	1.227	0.156	0.191	0.03

**Table 13.28: SAR Values (CDMA BC1 Band-Body)**

Frequency		Mode /Band	Service /Headset	Test Position	Spacing (mm)	Figure No.	Measured average power (dBm)	Maximum allowed Power (dBm)	Scaling factor	Measured SAR(1g) (W/kg)	Reported SAR(1g) (W/kg)	Power Drift (dB)
MHz	Ch.											
<b>Hotspot &amp; Body worn</b>												
1880	600	CDMA BC1	1xEV-DO-0	Toward Phantom	10	/	23.81	24.5	1.172	0.609	0.714	0.03
1880	600	CDMA BC1	1xEV-DO-0	Toward Ground	10	/	23.81	24.5	1.172	0.61	0.715	-0.12
<b>Hotspot</b>												
1880	600	CDMA BC1	1xEV-DO-0	Toward Left	10	/	23.81	24.5	1.172	0.237	0.291	0.01
1880	600	CDMA BC1	1xEV-DO-0	Toward Right	10	/	23.81	24.5	1.172	0.115	0.141	-0.16
1880	600	CDMA BC1	1xEV-DO-0	Toward Bottom	10	28	23.81	24.5	1.172	1.02	1.250	-0.11
1851.25	25	CDMA BC1	1xEV-DO-0	Toward Bottom	10	/	23.79	24.5	1.178	0.897	1.103	0.03
1908.75	1175	CDMA BC1	1xEV-DO-0	Toward Bottom	10	/	23.78	24.5	1.180	0.97	1.196	-0.10
<b>Repeated</b>												
1880	600	CDMA BC1	1xEV-DO-0	Toward Bottom	10	/	23.81	24.5	1.172	1.01	1.184	-0.12

**Table 13.29: SAR Values (WiFi 802.11b - Head)**

Frequency		Mode /Band	Side	Test Position	Figure No.	Measured average power (dBm)	Maximum allowed Power (dBm)	Scaling factor	Measured SAR(1g) (W/kg)	Reported SAR(1g) (W/kg)	Power Drift (dB)
MHz	Ch.										
2462	11	WiFi 2450	Left	Touch	Fig.29	17.14	17.5	1.086	0.329	0.357	0.11
2462	11	WiFi 2450	Left	Tilt	/	17.14	17.5	1.086	0.231	0.251	0.05
2462	11	WiFi 2450	Right	Touch	/	17.14	17.5	1.086	0.143	0.155	-0.12
2462	11	WiFi 2450	Right	Tilt	/	17.14	17.5	1.086	0.116	0.126	0.04

**Table 13.30: SAR Values (WiFi 802.11b - Body)**

Frequency		Mode /Band	Service /Headset	Test Position	Spacing (mm)	Figure No.	Measured average power (dBm)	Maximum allowed Power (dBm)	Scaling factor	Measured SAR(1g) (W/kg)	Reported SAR(1g) (W/kg)	Power Drift (dB)
MHz	Ch.											
Hotspot & Body worn												
2462	11	WiFi 2450	802.11b	Toward Phantom	10	/	17.14	17.5	1.086	0.097	0.105	0.16
2462	11	WiFi 2450	802.11b	Toward Ground	10	/	17.14	17.5	1.086	0.313	0.340	0.12
Hotspot												
2462	11	WiFi 2450	802.11b	Toward Left	10	/	17.14	17.5	1.086	0.006	0.007	0.06
2462	11	WiFi 2450	802.11b	Toward Right	10	30	17.14	17.5	1.086	0.452	0.491	0.14
2462	11	WiFi 2450	802.11b	Toward Top	10	/	17.14	17.5	1.086	0.13	0.141	-0.15

Table 13.31: SAR Values for limb

Frequency		Configuration		Test Position	Spacing (mm)	Figure No.	Measured average power (dBm)	Maximum allowed Power (dBm)	Scaling factor	Measured SAR(10g) (W/kg)	Reported SAR(10g) (W/kg)	Power Drift (dB)
MHz	Ch.											
836.6	190	GPRS 4TS	Class12	Toward Ground	0	31	30.28	30.5	1.052	1.04	1.094	-0.01
1880	661	GPRS 4TS	Class12	Toward Ground	0	32	27.02	27.5	1.117	0.611	0.682	-0.16
1880	9400	Band II	12.2kbps RMC	Toward Ground	0	33	23.4	24	1.148	0.925	1.062	-0.07
1732.6	1413	Band IV	12.2kbps RMC	Toward Ground	0	34	23.6	24	1.096	1.15	1.261	-0.02
836.6	4175	Band V	12.2kbps RMC	Toward Ground	0	35	23.59	24	1.099	0.587	0.645	-0.01
1732.5	20175	QPSK_20MHz_1RB_50 offset Middle		Toward Ground	0	36	22.58	23.5	1.236	1.66	2.052	0
1732.5	20175	QPSK_20MHz_50RB_0 offset Middle		Toward Ground	0	/	21.60	23	1.380	1.34	1.850	-0.03
836.5	20525	QPSK_10MHz_1RB_25 offset Middle		Toward Ground	0	37	23.67	24.5	1.211	0.575	0.696	-0.02
836.5	20525	QPSK_10MHz_25RB_0 offset Middle		Toward Ground	0	/	22.69	24	1.352	0.444	0.600	-0.03
2560	21350	QPSK_20MHz_1RB_50 offset High		Toward Ground	0	38	22.93	23.5	1.140	0.549	0.626	0.02
2560	21350	QPSK_20MHz_50RB_25 offset High		Toward Ground	0	/	21.94	23	1.276	0.435	0.555	0.09
707.5	23095	QPSK_10MHz_1RB_25 offset Middle		Toward Ground	0	39	23.17	24	1.211	0.324	0.392	-0.01
707.5	23095	QPSK_10MHz_25RB_0 offset Middle		Toward Ground	0	/	22.14	23.5	1.368	0.266	0.364	0.03
782	23230	QPSK_10MHz_1RB_25 offset Middle		Toward Ground	0	40	22.80	23.5	1.175	0.449	0.528	-0.02
782	23230	QPSK_10MHz_25RB_25 offset Middle		Toward Ground	0	/	21.84	23	1.306	0.378	0.494	-0.01
1882.5	26365	QPSK_20MHz_1RB_50 offset Middle		Toward Phantom	0	41	23.17	24	1.211	1.36	1.647	-0.12
1882.5	26365	QPSK_20MHz_50RB_0 offset Middle		Toward Phantom	0	/	22.30	23.5	1.318	0.883	1.164	0.05
841.5	26965	QPSK_15MHz_1RB_38 offset High		Toward Ground	0	/	23.82	24	1.042	0.574	0.598	0.02
841.5	26965	QPSK_15MHz_36RB_0 offset High		Toward Ground	0	42	22.87	24	1.297	0.468	0.607	0.02

836.52	384	CDMA BC0	1xEV-DO-0	Toward Ground	0	43	24.55	25	1.109	1.07	1.187	0.03
1880	600	CDMA BC1	1xEV-DO-0	Toward Phantom	0	44	23.81	24.5	1.172	1.23	1.442	-0.03
2462	11	WiFi 2450	802.11b	Toward Ground	0	45	17.17	17.5	1.086	0.888	0.964	-0.07

**Table 13.32: SAR Values (LTE Band 25-Body) for limb**

Frequency		Configuration	Test Position	Spacing (mm)	Figure No.	Measured average power (dBm)	Maximum allowed Power (dBm)	Scaling factor	Measured SAR(10g) (W/kg)	Reported SAR(10g) (W/kg)	Power Drift (dB)
MHz	Ch.										
<b>Hotspot &amp; Body worn</b>											
1882.5	26365	QPSK_20MHz_1RB_50 offset Middle	Toward Phantom	0	41	23.17	24	1.211	1.36	1.647	-0.12
1882.5	26365	QPSK_20MHz_1RB_50 offset Middle	Toward Ground	0	/	23.17	24	1.211	0.667	0.807	0.02
1882.5	26365	QPSK_20MHz_50RB_0 offset Middle	Toward Phantom	0	/	22.30	23.5	1.318	0.883	1.164	0.05
1882.5	26365	QPSK_20MHz_50RB_0 offset Middle	Toward Ground	0	/	22.30	23.5	1.318	0.558	0.736	0.14
<b>Hotspot</b>											
1882.5	26365	QPSK_20MHz_1RB_50 offset Middle	Toward Left	0	/	23.17	24	1.211	0.43	0.521	0.08
1882.5	26365	QPSK_20MHz_1RB_50 offset Middle	Toward Right	0	/	23.17	24	1.211	0.149	0.180	-0.04
1882.5	26365	QPSK_20MHz_1RB_50 offset Middle	Toward Bottom	0	/	23.17	24	1.211	1.3	1.574	-0.13
1882.5	26365	QPSK_20MHz_50RB_0 offset Middle	Toward Left	0	/	22.30	23.5	1.318	0.377	0.497	0.16
1882.5	26365	QPSK_20MHz_50RB_0 offset Middle	Toward Right	0	/	22.30	23.5	1.318	0.13	0.171	-0.14
1882.5	26365	QPSK_20MHz_50RB_0 offset Middle	Toward Bottom	0	/	22.30	23.5	1.318	0.902	1.189	-0.04



**Table 13.33: SAR Values (CDMA BC1 Band-Body) for limb**

Frequency		Mode /Band	Service /Headset	Test Position	Spacing (mm)	Figure No.	Measured average power (dBm)	Maximum allowed Power (dBm)	Scaling factor	Measured SAR(10g) (W/kg)	Reported SAR(10g) (W/kg)	Power Drift (dB)
MHz	Ch.											
<b>Hotspot &amp; Body worn</b>												
1880	600	CDMA BC1	1xEV-DO-0	Toward Phantom	0	44	23.81	24.5	1.172	1.23	1.442	-0.03
1880	600	CDMA BC1	1xEV-DO-0	Toward Ground	0	/	23.81	24.5	1.172	1.08	1.266	0.07
<b>Hotspot</b>												
1880	600	CDMA BC1	1xEV-DO-0	Toward Left	0	/	23.81	24.5	1.172	0.469	0.550	-0.07
1880	600	CDMA BC1	1xEV-DO-0	Toward Right	0	/	23.81	24.5	1.172	0.117	0.137	0.03
1880	600	CDMA BC1	1xEV-DO-0	Toward Bottom	0	/	23.81	24.5	1.172	0.403	0.472	-0.06

### 13.2 SAR Result for I19D00091-SAR01

Frequency		Configuration		Test Position	Spacing (mm)	Figure No.	Measured average power (dBm)	Maximum allowed Power (dBm)	Scaling factor	Measured SAR(10g) (W/kg)	Reported SAR(10g) (W/kg)	Power Drift (dB)
MHz	Ch.											
836.6	190	GPRS 4TS	Class12	Toward Phantom	10	1	30.28	30.5	1.052	0.577	0.607	0.08
1909.8	810	GPRS 4TS	Class12	Toward Bottom	10	3	26.56	27.5	1.242	0.612	0.760	0.05
1880	9400	Band II	12.2kbps RMC	Toward Bottom	10	5	23.4	24	1.148	0.42	0.482	-0.03
1732.6	1413	Band IV	12.2kbps RMC	Toward Phantom	10	7	23.6	24	1.096	0.438	0.480	0.11
836.6	4183	Band V	12.2kbps RMC	Toward Phantom	10	9	23.59	24	1.099	0.267	0.293	0.04
1732.5	20175	QPSK_20MHz_1RB_50 offset Middle		Toward Phantom	10	11	22.98	23.5	1.127	0.485	0.547	-0.00
836.5	20525	QPSK_10MHz_1RB_25 offset Middle		Toward Phantom	10	13	23.67	24.5	1.211	0.25	0.303	0.03
2560	21350	QPSK_20MHz_1RB_50 offset High		Toward Bottom	10	/	22.93	23.5	1.140	1.05	1.197	0.04
2510	20850	QPSK_20MHz_1RB_50 offset Low		Toward Bottom	10	15	22.72	23.5	1.197	1.04	1.245	0.09
2535	21100	QPSK_20MHz_1RB_50 offset Middle		Toward Bottom	10	/	22.80	23.5	1.175	0.918	1.079	0.02
2560	21350	QPSK_20MHz_100RB_0 offset High		Toward Bottom	10	/	22.93	23.5	1.140	1.01	1.152	-0.01
707.5	23095	QPSK_10MHz_1RB_25 offset Middle		Toward Ground	10	17	23.17	24	1.211	0.179	0.217	0.07
782	23230	QPSK_10MHz_1RB_25 offset Middle		Toward Ground	10	19	22.80	23.5	1.175	0.184	0.216	0.01
1882.5	26365	QPSK_20MHz_1RB_50 offset Middle		Toward Bottom	10	21	23.17	24	1.211	0.595	0.720	0.13
841.5	26965	QPSK_15MHz_1RB_38 offset High		Toward Ground	10	23	23.82	24	1.042	0.215	0.224	0.03
836.52	384	CDMA BC0	1xEV-DO-0	Toward Phantom	10	25	24.55	25	1.109	0.353	0.392	0.08
1880	600	CDMA BC1	1xEV-DO-0	Toward Bottom	10	/	23.81	24.5	1.172	1.11	1.301	-0.01
1851.25	25	CDMA BC1	1xEV-DO-0	Toward Bottom	10	/	23.79	24.5	1.178	0.964	1.135	0.03
1908.75	1175	CDMA BC1	1xEV-DO-0	Toward Bottom	10	27	23.78	24.5	1.180	1.27	1.499	-0.02

2462	11	WiFi 2450	802.11b	Toward Right	10	29	17.14	17.5	1.086	0.258	0.280	0.01
5530	106	WIFI 5G	802.11ac	Head Left	Cheek	33	14.57	15	1.104	0.338	0.373	0.08
5755	155	WIFI 5G	802.11ac	Toward Right	10	31	13.65	14	1.084	0.329	0.357	0.08
Repeated												
2560	21350	QPSK_20MHz_1RB_ 50 offset High		Toward Bottom	10	/	22.93	23.5	1.140	1.05	1.197	0.03
1908.75	1175	CDMA BC1	1xEV-DO-0	Toward Bottom	10	/	23.78	24.5	1.180	1.2	1.416	0.02

Frequency		Configuration		Test Position	Spacing (mm)	Figure No.	Measured average power (dBm)	Maximum allowed Power (dBm)	Scaling factor	Measured SAR(10g) (W/kg)	Reported SAR(10g) (W/kg)	Power Drift (dB)
MHz	Ch.											
836.6	190	GPRS 4TS	Class12	Toward Ground	0	2	30.28	30.5	1.052	1.76	1.851	-0.06
1880	661	GPRS 4TS	Class12	Toward Ground	0	4	27.02	27.5	1.117	0.821	0.917	0.05
1880	9400	Band II	12.2kbps RMC	Toward Ground	0	6	23.4	24	1.148	0.926	1.063	0.01
1732.6	1413	Band IV	12.2kbps RMC	Toward Ground	0	8	23.6	24	1.096	1.12	1.228	0.09
836.6	4175	Band V	12.2kbps RMC	Toward Ground	0	10	23.59	24	1.099	0.675	0.742	0.03
1732.5	20175	QPSK_20MHz_1RB_50 offset Middle		Toward Ground	0	12	22.58	23.5	1.236	1.08	1.335	0.01
836.5	20525	QPSK_10MHz_1RB_25 offset Middle		Toward Ground	0	14	23.67	24.5	1.211	0.605	0.732	-0.02
2560	21350	QPSK_20MHz_1RB_50 offset High		Toward Ground	0	16	22.93	23.5	1.140	0.82	0.935	0.08
707.5	23095	QPSK_10MHz_1RB_25 offset Middle		Toward Ground	0	18	23.17	24	1.211	0.4	0.484	0.02
782	23230	QPSK_10MHz_1RB_25 offset Middle		Toward Ground	0	20	22.80	23.5	1.175	0.459	0.539	-0.05
1882.5	26365	QPSK_20MHz_1RB_50 offset Middle		Toward Phantom	0	22	23.17	24	1.211	0.916	1.109	0.05
841.5	26965	QPSK_15MHz_36RB_0 offset High		Toward Ground	0	24	22.87	24	1.297	0.583	0.756	0.01
836.52	384	CDMA BC0	1xEV-DO-0	Toward Ground	0	26	24.55	25	1.109	0.948	1.051	0.02
1880	600	CDMA BC1	1xEV-DO-0	Toward Phantom	0	28	23.81	24.5	1.172	1.7	1.993	0.05
2462	11	WiFi 2450	802.11b	Toward Ground	0	30	17.17	17.5	1.079	0.583	0.629	0.06
5530	106	WiFi 5G	802.11ac	Toward Ground	0	32	14.57	15	1.104	0.484	0.534	0.10

## 14. Evaluation of Simultaneous

**Table14.1 Simultaneous transmission SAR**

Standalone SAR for 2G(W/Kg)					
Test Position			GSM 850	GSM 1900	Highest SAR
Head	Left	Cheek	0.205	0.509	0.509
		Tilt 15°	0.136	0.141	0.141
	Right	Cheek	0.248	0.184	0.248
		Tilt 15°	0.151	0.093	0.151
Hotspot &Body-worn 10 mm	Phantom Side		0.607 (Current)	0.563	0.607 (Current)
	Ground Side		0.464	0.526	0.526
Hotspot 10 mm	Left Side		0.203	0.306	0.306
	Right Side		0.391	0.152	0.391
	Top Side		--	--	--
	Bottom Side		0.338	1.106	1.106
Limb	--		<b>1.851 (Current)</b>	<b>0.917 (Current)</b>	<b>1.851 (Current)</b>

Standalone SAR for 3G(W/Kg)								
Test Position			WCDMA Band II	WCDMA Band IV	WCDMA Band V	BC0	BC1	Highest SAR
Head	Left	Cheek	0.313	0.454	0.165	0.244	0.398	0.454
		Tilt 15°	0.056	0.192	0.114	0.169	0.139	0.192
	Right	Cheek	0.133	0.261	0.210	0.278	0.412	0.412
		Tilt 15°	0.054	0.138	0.114	0.176	0.191	0.191
Hotspot &Body-worn 10 mm	Phantom Side		0.478	0.663	0.293 (Current)	0.441	0.714	0.714
	Ground Side		0.361	0.454	0.170	0.378	0.715	0.715
Hotspot 10 mm	Left Side		0.217	0.418	0.087	0.243	0.291	0.418
	Right Side		0.104	0.220	0.188	0.441	0.141	0.441
	Top Side		--	--	--	--	--	--
	Bottom Side		0.526	0.371	0.135	0.297	1.499 (Current)	1.499 (Current)

Limb	--	1.063 (Current)	1.261	0.742 (Current)	1.187	1.993 (Current)	1.993 (Current)
------	----	--------------------	-------	--------------------	-------	--------------------	-----------------

Standalone SAR for 4G (W/Kg)										
Test Position			LTE Band 4	LTE Band 5	LTE Band7	LTE Band 12	LTE Band 13	LTE Band 25	LTE Band 26	Highest SAR
Head	Left	Cheek	0.801	0.167	0.029	0.165	0.188	0.507	0.151	0.801
		Tilt 15°	0.277	0.153	0.013	0.119	0.162	0.118	0.119	0.277
	Right	Cheek	0.509	0.226	0.025	0.156	0.216	0.213	0.189	0.509
		Tilt 15°	0.205	0.145	0.015	0.106	0.156	0.095	0.105	0.205
Hotspot &Body- worn 10 mm	Phantom Side		1.172	0.324	0.129	0.197	0.316	0.787	0.203	1.172
	Ground Side		0.854	0.318	0.311	0.225	0.324	0.757	0.207	0.854
Hotspot 10 mm	Left Side		0.599	0.157	0.022	0.161	0.172	0.298	0.118	0.599
	Right Side		0.363	0.269	0.012	0.179	0.314	0.136	0.166	0.363
	Top Side		--	--	--	--	--	--	--	
	Bottom Side		0.892	0.214	1.245 (Current)	0.043	0.099	1.283	0.224 (Current)	1.283
Limb	--		2.052	0.732 (Current)	0.935 (Current)	0.484 (Current)	0.539 (Current)	1.647	0.756 (Current)	2.052

Simultaneous multi-band transmission										
Test Position			2G	3G	4G	2.4GHz		5GHz	SUM	
						BT	WiFi	WiFi	2.4GHz	5GHz
Head(1g)	Left	Cheek	0.509	0.454	0.801	0.133	0.357	0.747	1.158	1.548
		Tilt 15°	0.141	0.192	0.277	0.133	0.251	0.58	0.528	0.857
	Right	Cheek	0.248	0.412	0.509	0.133	0.155	0.737	0.664	1.246
		Tilt 15°	0.151	0.191	0.205	0.133	0.126	0.617	0.331	0.822
Hotspot &Body- worn 10 mm(1g)	Phantom Side		0.607 (Current)	0.714	1.172	0.066	0.105	0.396	1.277	1.568
	Ground Side		0.526	0.715	0.854	0.066	0.340	0.737	1.194	1.591
Hotspot 10 mm(1g)	Left Side		0.306	0.418	0.599	0.066	0.007	--	0.606	0.599
	Right Side		0.391	0.441	0.363	0.066	0.491	0.762	0.932	1.203

	Top Side	--	--		0.066	0.141	0.491	0.141	0.491
	Bottom Side	1.106	1.499 (Current)	1.283	0.066	--	--	1.565 (Current)	1.499 (Current)
Limb (10g)	--	<b>1.851</b> <b>(Current)</b>	1.993 (Current)	2.052	0.027	0.964	0.901	3.016	2.953

According to the conducted power measurement result, we can draw the conclusion that: stand-alone SAR for WiFi should be performed. Then, simultaneous transmission SAR for WiFi/BT is considered with measurement results of GSM/WCDMA/LTE/CDMA and WiFi/BT. According to the above table, the sum of reported SAR values for GSM/WCDMA/LTE/CDMA and WiFi < 1.6W/kg. So the simultaneous transmission SAR is not required for WiFi/BT transmitter.

## 15. SAR Measurement Variability

SAR measurement variability must be assessed for each frequency band, which is determined by the SAR probe calibration point and tissue-equivalent medium used for the device measurements. When both head and body tissue-equivalent media are required for SAR measurements in a frequency band, the variability measurement procedures should be applied to the tissue medium with the highest measured SAR, using the highest measured SAR configuration for that tissue-equivalent medium.

The following procedures are applied to determine if repeated measurements are required.

- 1) Repeated measurement is not required when the original highest measured SAR is < 0.80 W/kg; steps 2) through 4) do not apply.
- 2) When the original highest measured SAR is  $\geq 0.80$  W/kg, repeat that measurement once.
- 3) Perform a second repeated measurement only if the ratio of largest to smallest SAR for the original and first repeated measurements is  $> 1.20$  or when the original or repeated measurement is  $\geq 1.45$  W/kg (~ 10% from the 1-g SAR limit).
- 4) Perform a third repeated measurement only if the original, first or second repeated measurement is  $\geq 1.5$  W/kg and the ratio of largest to smallest SAR for the original, first and second repeated measurements is  $> 1.20$ .

**Table 15.1: SAR Measurement Variability for Body Value (1g)**

Frequency		Configuration	Test Position	Original SAR (W/kg)	First Repeated SAR (W/kg)	The Ratio
MHz	Ch.					
2560	21350	QPSK_20MHz_1RB_50 offset High	Bottom	1.05	0.918	1.144
1908.75	1175	CDMA BC1 1xEV-DO-0	Bottom	1.2	1.27	1.058

**Note:** According to the KDB 865664 D01 repeated measurement is not required when the original highest measured SAR is < 0.8 W/kg.



## 16. Measurement Uncertainty

Measurement uncertainty for 750 MHz to 3 GHz averaged over 1 gram						
Uncertainty Component	Uncertainty	Prob.	Div.	$c_{i(1g)}$	Std. Unc. (1-g)	$v_i$ or $v_{eff}$
<b>Measurement System</b>						
Probe Calibration ( $k=1$ )	5.4	Normal	2	1	5.40	$\infty$
Probe Isotropy	4.70	Rectangular	$\sqrt{3}$	0.7	1.90	$\infty$
Modulation Response	2.40	Rectangular	$\sqrt{3}$	1	1.39	$\infty$
Hemispherical Isotropy	2.60	Rectangular	$\sqrt{3}$	0.7	1.05	$\infty$
Boundary Effect	1.00	Rectangular	$\sqrt{3}$	1	0.58	$\infty$
Linearity	4.70	Rectangular	$\sqrt{3}$	1	2.71	$\infty$
System Detection Limit	1.00	Rectangular	$\sqrt{3}$	1	0.58	$\infty$
Readout Electronics	0.30	Normal	1	1	0.30	$\infty$
Response Time	0.80	Rectangular	$\sqrt{3}$	1	0.46	$\infty$
Integration Time	2.60	Rectangular	$\sqrt{3}$	1	1.50	$\infty$
RF Ambient Noise	0.00	Rectangular	$\sqrt{3}$	1	0.00	$\infty$
RF Ambient Reflections	0.00	Rectangular	$\sqrt{3}$	1	0.00	$\infty$
Probe Positioner	0.40	Rectangular	$\sqrt{3}$	1	0.23	$\infty$
Probe Positioning	2.90	Rectangular	$\sqrt{3}$	1	1.67	$\infty$
Post-processing	1.00	Rectangular	$\sqrt{3}$	1	0.58	$\infty$
<b>Test sample Related</b>						
Test sample Positioning	1.2	Normal	1	1	1.2	5
Device Holder Uncertainty	3.2	Normal	1	1	3.2	71
Power drift	5	Rectangular	$\sqrt{3}$	1	2.89	$\infty$
Power Scaling	0	Rectangular	$\sqrt{3}$	1	0.00	$\infty$
<b>Phantom and Tissue Parameters</b>						
Phantom Uncertainty	4	Rectangular	$\sqrt{3}$	1	2.31	$\infty$
SAR correction	1.9	Rectangular	$\sqrt{3}$	1	1.10	$\infty$
Liquid Conductivity (meas)	4.19	Rectangular	1	0.78	3.27	$\infty$
Liquid Permittivity (meas)	4.4	Rectangular	1	0.26	1.14	$\infty$
Temp. unc. - Conductivity	0.18	Rectangular	$\sqrt{3}$	0.78	0.08	$\infty$
Temp. unc. - Permittivity	0.54	Rectangular	$\sqrt{3}$	0.23	0.07	$\infty$
<b>Combined Std. Uncertainty</b>		RSS			9.39	
<b>Expanded STD Uncertainty</b>		$k=2$			18.77%	

System check uncertainty for 750 MHz to 3 GHz averaged over 1 gram						
Uncertainty Component	Uncertainty	Prob.	Div.	$C_{i(1g)}$	Std. Unc. (1-g)	$V_i$ or $V_{eff}$
<b>Measurement System</b>						
Probe Calibration ( $k=1$ )	5.40	Normal	1	1	5.40	$\infty$
Probe Isotropy	4.70	Rectangular	$\sqrt{3}$	0.7	1.90	$\infty$
Modulation Response	2.40	Rectangular	$\sqrt{3}$	1	1.39	$\infty$
Hemispherical Isotropy	2.60	Rectangular	$\sqrt{3}$	0.7	1.05	$\infty$
Boundary Effect	1.00	Rectangular	$\sqrt{3}$	1	0.58	$\infty$
Linearity	4.70	Rectangular	$\sqrt{3}$	1	2.71	$\infty$
System Detection Limit	1.00	Rectangular	$\sqrt{3}$	1	0.58	$\infty$
Readout Electronics	0.30	Normal	1	1	0.30	$\infty$
Response Time	0.80	Rectangular	$\sqrt{3}$	1	0.46	$\infty$
Integration Time	2.60	Rectangular	$\sqrt{3}$	1	1.50	$\infty$
RF Ambient Noise	0.00	Rectangular	$\sqrt{3}$	1	0.00	$\infty$
RF Ambient Reflections	0.00	Rectangular	$\sqrt{3}$	1	0.00	$\infty$
Probe Positioner	0.40	Rectangular	$\sqrt{3}$	1	0.23	$\infty$
Probe Positioning	2.90	Rectangular	$\sqrt{3}$	1	1.67	$\infty$
Post-processing	1.00	Rectangular	$\sqrt{3}$	1	0.58	$\infty$
<b>Field source</b>						
Deviation of the experimental source from numerical source	5.5	Normal	1	1	5.5	$\infty$
Source to liquid distance	2	Rectangular	$\sqrt{3}$	1	1.15	$\infty$
Power drift	5	Rectangular	$\sqrt{3}$	1	2.89	$\infty$
<b>Phantom and Tissue Parameters</b>						
Phantom Uncertainty	4	Rectangular	$\sqrt{3}$	1	2.31	$\infty$
SAR correction	1.9	Rectangular	$\sqrt{3}$	1	1.10	$\infty$
Liquid Conductivity (meas)	4.19	Normal	1	0.78	3.27	$\infty$
Liquid Permittivity (meas)	4.4	Normal	1	0.26	1.14	$\infty$
Temp. unc. - Conductivity	0.18	Rectangular	$\sqrt{3}$	0.78	0.08	$\infty$
Temp. unc. - Permittivity	0.54	Rectangular	$\sqrt{3}$	0.23	0.07	$\infty$
<b>Combined Std. Uncertainty</b>		RSS			10.39	
<b>Expanded STD Uncertainty</b>		$k=2$			20.79%	

## 17. Main Test Instrument

**Table 17.1: List of Main Instruments**

Item	Instrument Name	Type	Serial Number	Manufacturer	Cal. Date	Cal. interval
1	Network analyzer	N5242A	MY51221755	Agilent	2018-12-17	1 year
2	Power meter	NRVD	102257	RS	2019-5-10	1 year
3	Power sensor	NRV-Z5	100241			
			100644			
4	Signal Generator	E4438C	MY49072044	Agilent	2019-5-10	1 Year
5	Amplifier	NTWPA-0086010 F	12023024	rflight	No Calibration Requested	
6	Coupler	778D	MY4825551	Agilent	2019-5-10	1 year
7	BTS	E5515C	MY50266468	Agilent	2018-12-17	1 year
		MT8820C	6201240338	Anritsu	2018-12-17	1 year
8	E-field Probe	ES3DV3	3252	SPEAG	2018-9-4	1 year
		EX3DV4	7401	SPEAG	2019-1-5	1 year
9	DAE	SPEAG DAE4	1244	SPEAG	2018-12-13	1 year
10	Dipole Validation Kit	SPEAG D750V3	1144	SPEAG	2018-10-26	3 year
		SPEAG D835V2	4d112	SPEAG	2018-10-25	3 year
		SPEAG D900V2	1d109	SPEAG	2018-10-29	3 year
		SPEAG D1750V2	1044	SPEAG	2018-10-31	3 year
		SPEAG D1900V2	5d151	SPEAG	2017-12-6	3 year
		SPEAG D2450V2	858	SPEAG	2018-10-26	3 year
		SPEAG D2600V2	1031	SPEAG	2018-11-1	3 year
		SPEAG D5GHzV2	1122	SPEAG	2018-3-30	3 year

## ANNEX A. Highest SAR GRAPH RESULTS

### Fig.1 GPRS850 4TS Phantom Mode Middle 10mm

Date/Time: 2019/7/29

Electronics: DAE4 Sn1244

Medium parameters used:  $f = 837 \text{ MHz}$ ;  $\sigma = 1.001 \text{ S/m}$ ;  $\epsilon_r = 56.695$ ;  $\rho = 1000 \text{ kg/m}^3$

Ambient Temperature:  $22.5 \text{ }^\circ\text{C}$       Liquid Temperature:  $22.5 \text{ }^\circ\text{C}$

Communication System: GSM 835MHz GPRS 4TS (0);      Frequency:  $836.6 \text{ MHz}$ ;

Duty Cycle: 1:2

Probe: ES3DV3 - SN3252ConvF(6.34, 6.34, 6.34); Calibrated: 9/4/2018

#### GPRS850 4TS Phantom Mode Middle 10mm/Area Scan (71x121x1):

Measurement grid:  $dx=10 \text{ mm}$ ,  $dy=10 \text{ mm}$

Maximum value of SAR (Measurement) =  $0.604 \text{ W/kg}$

#### GPRS850 4TS Phantom Mode Middle 10mm/Zoom Scan (7x7x7)/Cube 0:

Measurement grid:  $dx=5\text{mm}$ ,  $dy=5\text{mm}$ ,  $dz=5\text{mm}$

Reference Value =  $24.03 \text{ V/m}$ ; Power Drift =  $0.08 \text{ dB}$

Peak SAR (extrapolated) =  $0.687 \text{ W/kg}$

SAR(1 g) =  $0.577 \text{ W/kg}$ ; SAR(10 g) =  $0.461 \text{ W/kg}$

Maximum of SAR (measured) =  $0.598 \text{ W/kg}$

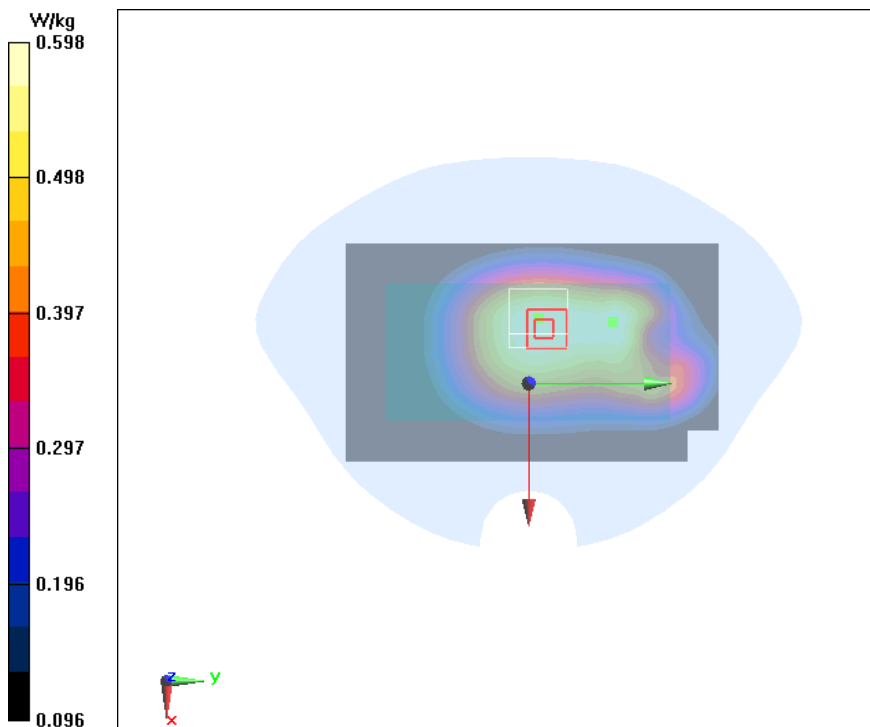

## Fig.2 GPRS850 4TS Ground Mode Middle 0mm

Date/Time: 2019/7/29

Electronics: DAE4 Sn1244

Medium parameters used:  $f = 837 \text{ MHz}$ ;  $\sigma = 1.001 \text{ S/m}$ ;  $\epsilon_r = 56.695$ ;  $\rho = 1000 \text{ kg/m}^3$

Ambient Temperature:  $22.5 \text{ }^\circ\text{C}$       Liquid Temperature:  $22.5 \text{ }^\circ\text{C}$

Communication System: GSM 835MHz GPRS 4TS (0);      Frequency:  $836.6 \text{ MHz}$ ;

Duty Cycle: 1:2

Probe: ES3DV3 - SN3252ConvF(6.34, 6.34, 6.34); Calibrated: 9/4/2018

### GPRS850 4TS Ground Mode Middle 0mm/Area Scan (71x121x1):

Measurement grid:  $dx=10 \text{ mm}$ ,  $dy=10 \text{ mm}$

Maximum value of SAR (Measurement) =  $3.49 \text{ W/kg}$

### GPRS850 4TS Ground Mode Middle 0mm/Zoom Scan (7x7x7)/Cube 0:

Measurement grid:  $dx=5\text{mm}$ ,  $dy=5\text{mm}$ ,  $dz=5\text{mm}$

Reference Value =  $16.44 \text{ V/m}$ ; Power Drift =  $-0.06 \text{ dB}$

Peak SAR (extrapolated) =  $5.97 \text{ W/kg}$

SAR(1 g) =  $3.23 \text{ W/kg}$ ; SAR(10 g) =  $1.76 \text{ W/kg}$

Maximum value of SAR (measured) =  $3.65 \text{ W/kg}$

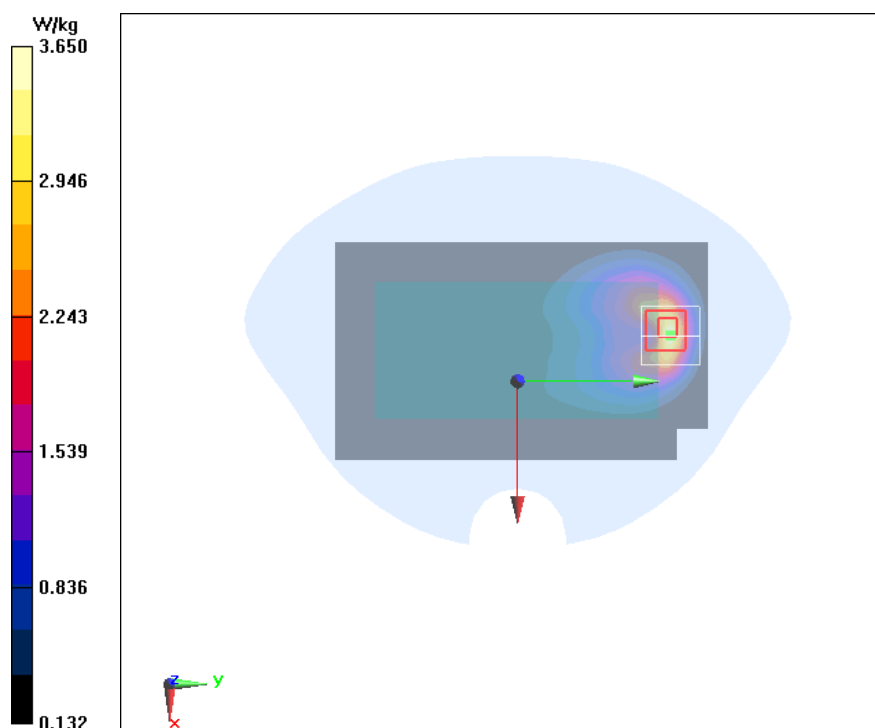

### Fig.3 GSM1900 4TS Bottom Mode High 10mm

Date/Time: 2019/7/31

Electronics: DAE4 Sn1244

Medium parameters used:  $f = 1910$  MHz;  $\sigma = 1.561$  S/m;  $\epsilon_r = 51.894$ ;  $\rho = 1000$  kg/m<sup>3</sup>

Ambient Temperature: 22.5 °C      Liquid Temperature: 22.5 °C

Communication System: GSM 1900MHz GPRS 4TS (0);      Frequency: 1909.8 MHz;

Duty Cycle: 1:2

Probe: ES3DV3 - SN3252ConvF(4.77, 4.77, 4.77); Calibrated: 9/4/2018

#### GSM1900 4TS Bottom Mode High 10mm /Area Scan (41x71x1):

Measurement grid: dx=10 mm, dy=10 mm

Maximum value of SAR (Measurement) = 0.651 W/kg

#### GSM1900 4TS Bottom Mode High 10mm /Zoom Scan (7x7x7)/Cube 0:

Measurement grid: dx=5mm, dy=5mm, dz=5mm

Reference Value = 5.308 V/m; Power Drift = 0.05 dB

Peak SAR (extrapolated) = 0.992 W/kg

SAR(1 g) = 0.612 W/kg; SAR(10 g) = 0.359 W/kg

Maximum value of SAR (measured) = 0.652 W/kg

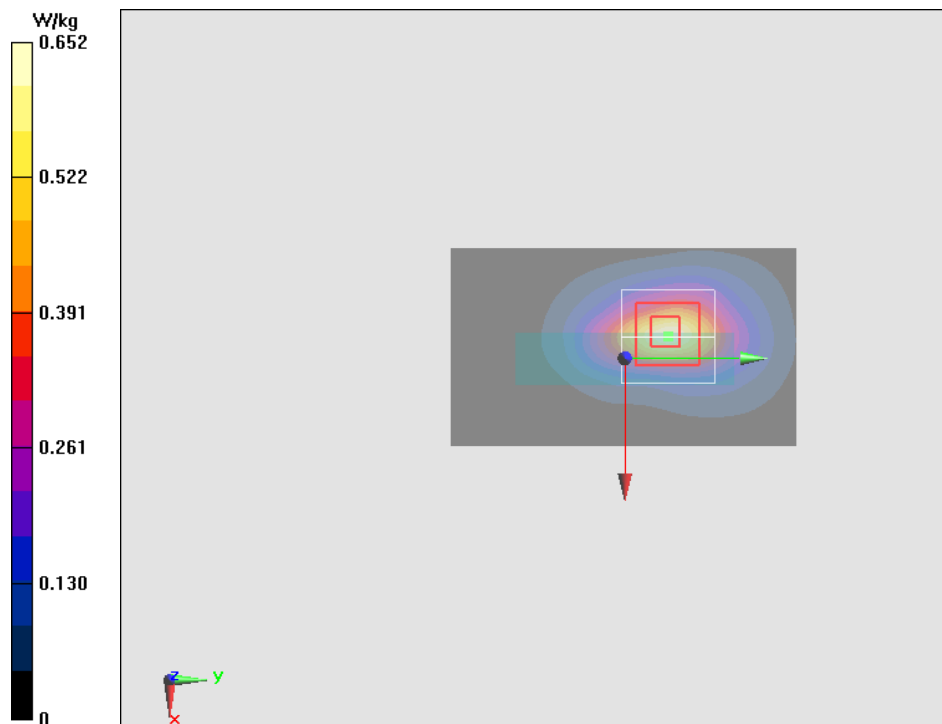

### Fig.4 GSM1900 4TS Ground Mode Middle 0mm

Date/Time: 2019/7/31

Electronics: DAE4 Sn1244

Medium parameters used:  $f = 1880 \text{ MHz}$ ;  $\sigma = 1.529 \text{ S/m}$ ;  $\epsilon_r = 51.996$ ;  $\rho = 1000 \text{ kg/m}^3$

Ambient Temperature:  $22.5 \text{ }^\circ\text{C}$       Liquid Temperature:  $22.5 \text{ }^\circ\text{C}$

Communication System: GSM 1900MHz GPRS 4TS (0);      Frequency: 1880 MHz;

Duty Cycle: 1:2

Probe: ES3DV3 - SN3252ConvF(4.77, 4.77, 4.77); Calibrated: 9/4/2018

#### GSM1900 4TS Ground Mode Middle 0mm/Area Scan (71x121x1):

Measurement grid:  $dx=10 \text{ mm}$ ,  $dy=10 \text{ mm}$

Maximum value of SAR (Measurement) =  $1.62 \text{ W/kg}$

#### GSM1900 4TS Ground Mode Middle 0mm/Zoom Scan (7x7x7)/Cube 0:

Measurement grid:  $dx=5\text{mm}$ ,  $dy=5\text{mm}$ ,  $dz=5\text{mm}$

Reference Value =  $8.800 \text{ V/m}$ ; Power Drift =  $0.05 \text{ dB}$

Peak SAR (extrapolated) =  $2.34 \text{ W/kg}$

SAR(1 g) =  $1.39 \text{ W/kg}$ ; SAR(10 g) =  $0.821 \text{ W/kg}$

Maximum value of SAR (measured) =  $1.51 \text{ W/kg}$

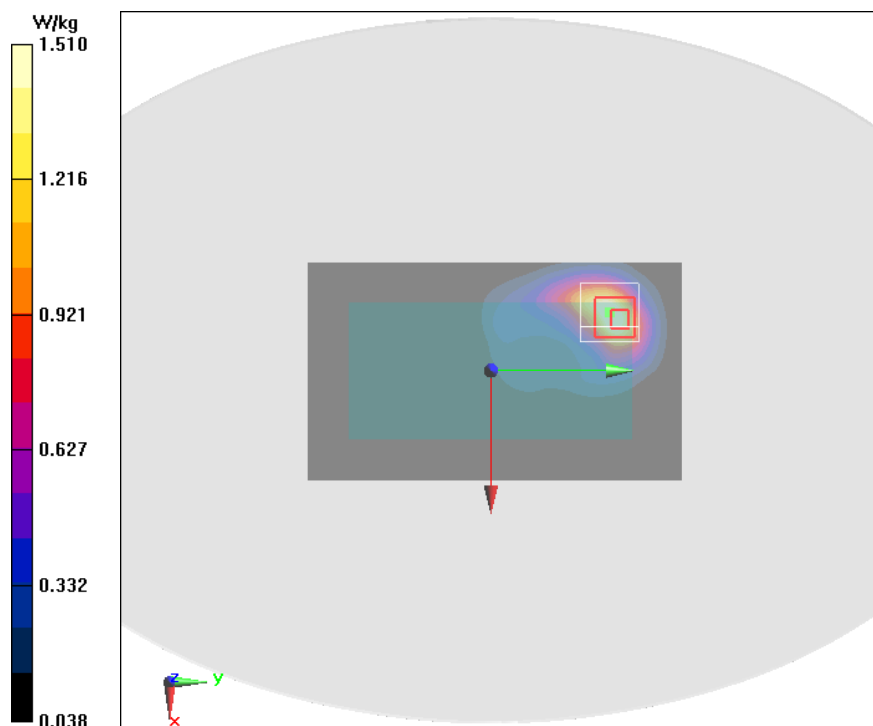

### Fig.5 WCDMA Band 2 Bottom Mode Middle

Date/Time: 2019/7/31

Electronics: DAE4 Sn1244

Medium parameters used:  $f = 1880 \text{ MHz}$ ;  $\sigma = 1.529 \text{ S/m}$ ;  $\epsilon_r = 51.996$ ;  $\rho = 1000 \text{ kg/m}^3$

Ambient Temperature:  $22.5 \text{ }^\circ\text{C}$       Liquid Temperature:  $22.5 \text{ }^\circ\text{C}$

Communication System: WCDMA Professional Band II; Frequency:  $1880 \text{ MHz}$ ;

Duty Cycle: 1:1

Probe: ES3DV3 - SN3252ConvF(4.77, 4.77, 4.77); Calibrated: 9/4/2018

#### WCDMA Band 2 Bottom Mode Middle/Area Scan (41x71x1):

Measurement grid:  $dx=10 \text{ mm}$ ,  $dy=10 \text{ mm}$

Maximum value of SAR (Measurement) =  $0.437 \text{ W/kg}$

#### WCDMA Band 2 Bottom Mode Middle/Zoom Scan (7x7x7)/Cube 0:

Measurement grid:  $dx=5\text{mm}$ ,  $dy=5\text{mm}$ ,  $dz=5\text{mm}$

Reference Value =  $5.574 \text{ V/m}$ ; Power Drift =  $-0.03 \text{ dB}$

Peak SAR (extrapolated) =  $0.671 \text{ W/kg}$

SAR(1 g) =  $0.420 \text{ W/kg}$ ; SAR(10 g) =  $0.249 \text{ W/kg}$

Maximum value of SAR (measured) =  $0.462 \text{ W/kg}$

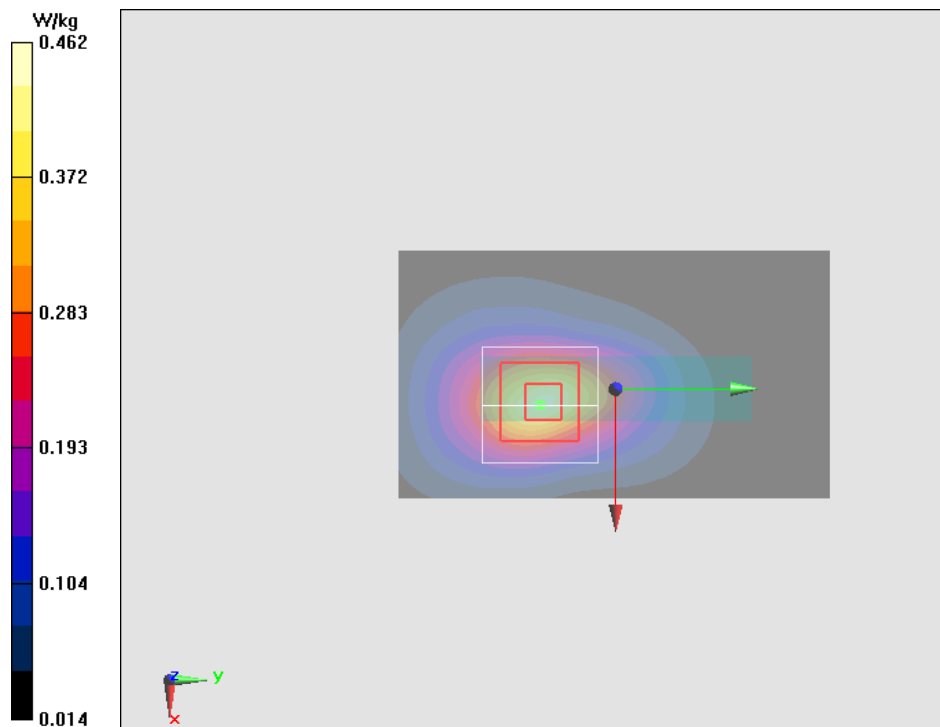



### Fig.6 WCDMA B2 Ground Mode Middle 0mm

Date/Time: 2019/7/31

Electronics: DAE4 Sn1244

Medium parameters used:  $f = 1880 \text{ MHz}$ ;  $\sigma = 1.529 \text{ S/m}$ ;  $\epsilon_r = 51.996$ ;  $\rho = 1000 \text{ kg/m}^3$

Ambient Temperature:  $22.5 \text{ }^\circ\text{C}$       Liquid Temperature:  $22.5 \text{ }^\circ\text{C}$

Communication System: WCDMA Professional Band II; Frequency:  $1880 \text{ MHz}$ ;

Duty Cycle: 1:1

Probe: ES3DV3 - SN3252ConvF(4.77, 4.77, 4.77); Calibrated: 9/4/2018

#### WCDMA B2 Ground Mode Middle 0mm/Area Scan (71x121x1):

Measurement grid:  $dx=10 \text{ mm}$ ,  $dy=10 \text{ mm}$

Maximum value of SAR (Measurement) =  $1.92 \text{ W/kg}$

#### WCDMA B2 Ground Mode Middle 0mm/Zoom Scan (7x7x7)/Cube 0:

Measurement grid:  $dx=5\text{mm}$ ,  $dy=5\text{mm}$ ,  $dz=5\text{mm}$

Reference Value =  $8.615 \text{ V/m}$ ; Power Drift =  $0.01 \text{ dB}$

Peak SAR (extrapolated) =  $2.68 \text{ W/kg}$

SAR(1 g) =  $1.57 \text{ W/kg}$ ; SAR(10 g) =  $0.926 \text{ W/kg}$

Maximum value of SAR (measured) =  $1.73 \text{ W/kg}$

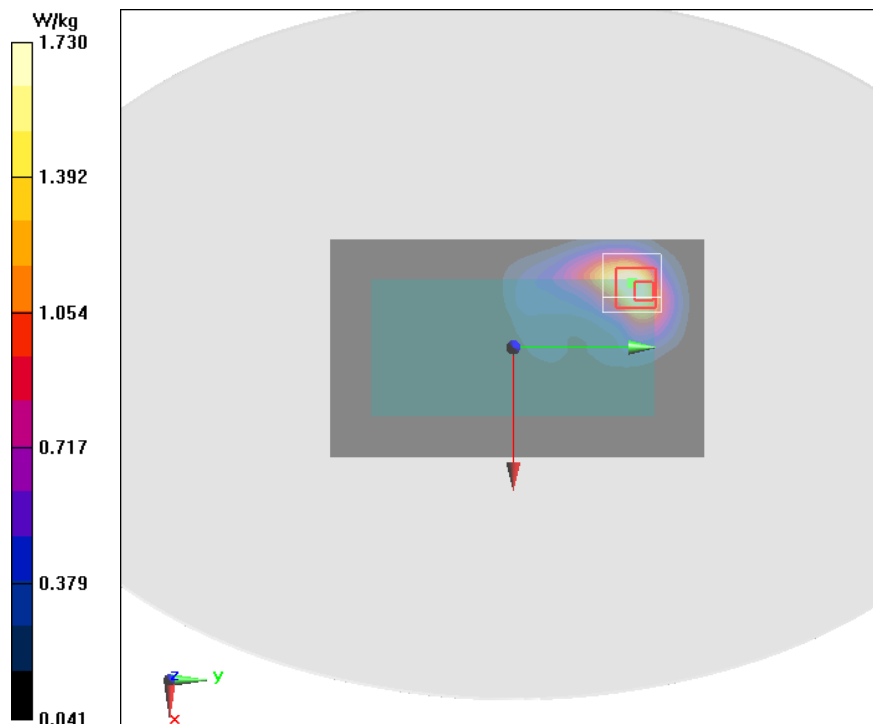

### Fig.7 WCDMA Band 4 Phantom Mode Middle 10mm

Date/Time: 2019/7/30

Electronics: DAE4 Sn1244

Medium parameters used:  $f = 1733 \text{ MHz}$ ;  $\sigma = 1.418 \text{ S/m}$ ;  $\epsilon_r = 55.195$ ;  $\rho = 1000 \text{ kg/m}^3$

Ambient Temperature:  $22.5 \text{ }^\circ\text{C}$       Liquid Temperature:  $22.5 \text{ }^\circ\text{C}$

Communication System: WCDMA Professional 1800MHz;    Frequency: 1732.6 MHz; Duty Cycle: 1:1

Probe: ES3DV3 - SN3252ConvF(4.99, 4.99, 4.99); Calibrated: 9/4/2018

#### WCDMA Band 4 Phantom Mode Middle 10mm/Area Scan (61x111x1):

Measurement grid:  $dx=10 \text{ mm}$ ,  $dy=10 \text{ mm}$

Maximum value of SAR (Measurement) = 0.486 W/kg

#### WCDMA Band 4 Phantom Mode Middle 10mm/Zoom Scan (7x7x7)/Cube 0:

Measurement grid:  $dx=5\text{mm}$ ,  $dy=5\text{mm}$ ,  $dz=5\text{mm}$

Reference Value = 9.435 V/m; Power Drift = 0.11 dB

Peak SAR (extrapolated) = 0.677 W/kg

SAR(1 g) = 0.438 W/kg; SAR(10 g) = 0.278 W/kg

Maximum value of SAR (measured) = 0.469 W/kg

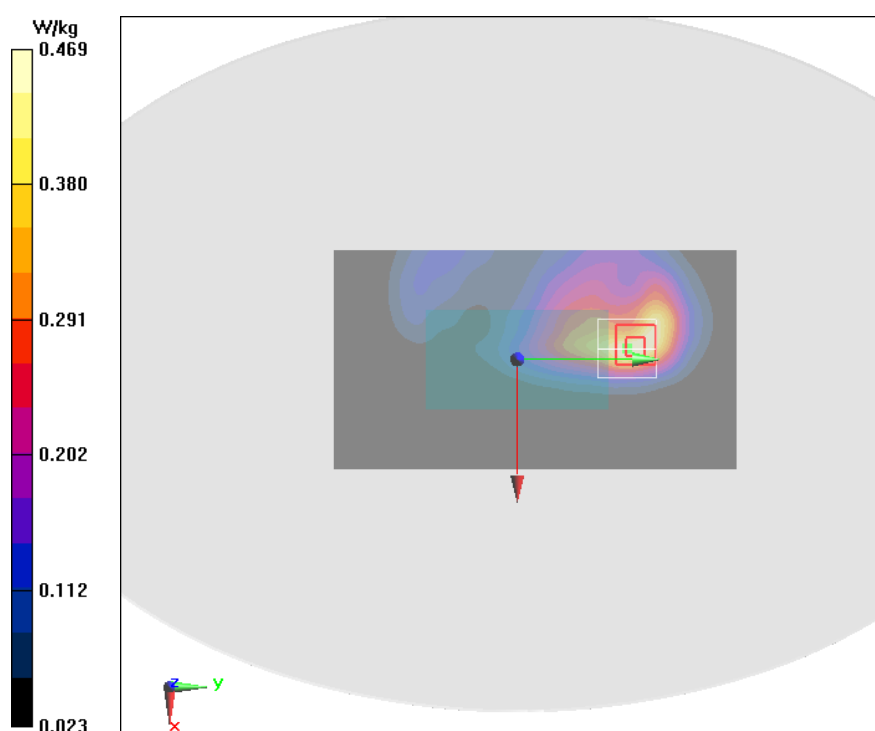

### Fig.8 WCDMA Band 4 Ground Mode Middle 0mm

Date/Time: 2019/7/30

Electronics: DAE4 Sn1244

Medium parameters used:  $f = 1733 \text{ MHz}$ ;  $\sigma = 1.418 \text{ S/m}$ ;  $\epsilon_r = 55.195$ ;  $\rho = 1000 \text{ kg/m}^3$

Ambient Temperature:  $22.5 \text{ }^\circ\text{C}$       Liquid Temperature:  $22.5 \text{ }^\circ\text{C}$

Communication System: WCDMA Professional 1800MHz;    Frequency: 1732.6 MHz; Duty Cycle: 1:1

Probe: ES3DV3 - SN3252ConvF(4.99, 4.99, 4.99); Calibrated: 9/4/2018

#### WCDMA Band 4 Ground Mode Middle 0mm/Area Scan (71x131x1):

Measurement grid:  $dx=10 \text{ mm}$ ,  $dy=10 \text{ mm}$

Maximum value of SAR (Measurement) =  $2.27 \text{ W/kg}$

#### WCDMA Band 4 Ground Mode Middle 0mm/Zoom Scan (7x7x7)/Cube 0:

Measurement grid:  $dx=5\text{mm}$ ,  $dy=5\text{mm}$ ,  $dz=5\text{mm}$

Reference Value =  $13.02 \text{ V/m}$ ; Power Drift =  $0.09 \text{ dB}$

Peak SAR (extrapolated) =  $3.18 \text{ W/kg}$

SAR(1 g) =  $1.92 \text{ W/kg}$ ; SAR(10 g) =  $1.12 \text{ W/kg}$

Maximum value of SAR (measured) =  $2.09 \text{ W/kg}$

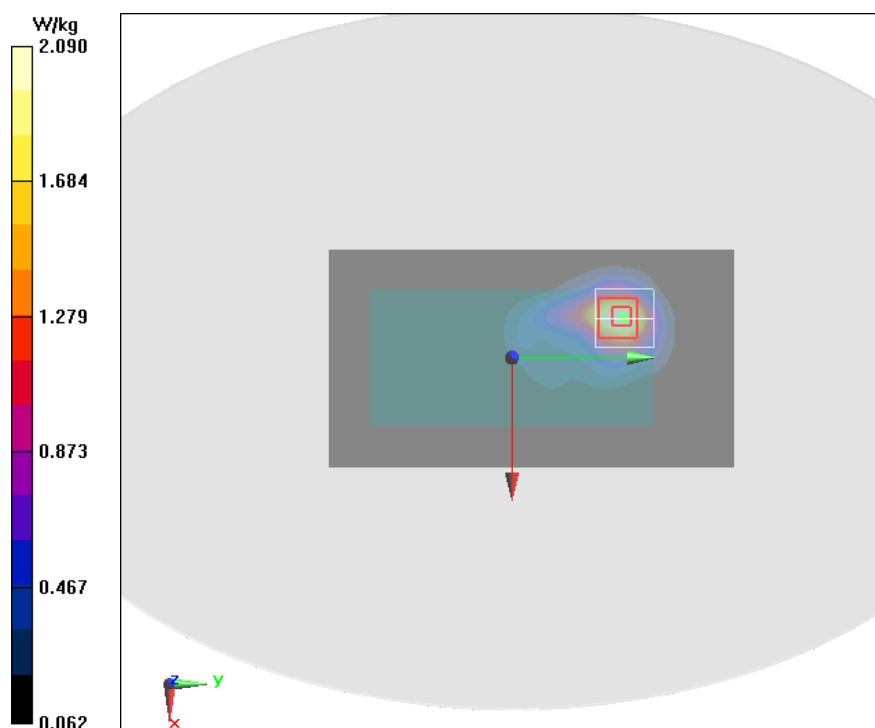

### Fig.9 WCDMA Band 5 Phantom Mode Middle 10mm

Date/Time: 2019/7/29

Electronics: DAE4 Sn1244

Medium parameters used:  $f = 837 \text{ MHz}$ ;  $\sigma = 1.001 \text{ S/m}$ ;  $\epsilon_r = 56.695$ ;  $\rho = 1000 \text{ kg/m}^3$

Ambient Temperature:  $22.5 \text{ }^\circ\text{C}$       Liquid Temperature:  $22.5 \text{ }^\circ\text{C}$

Communication System: WCDMA Professional 835MHz;      Frequency: 836.6 MHz;

Duty Cycle: 1:1

Probe: ES3DV3 - SN3252ConvF(6.34, 6.34, 6.34); Calibrated: 9/4/2018

#### WCDMA Band 5 Phantom Mode Middle 10mm/Area Scan (71x121x1):

Measurement grid:  $dx=10 \text{ mm}$ ,  $dy=10 \text{ mm}$

Maximum value of SAR (Measurement) =  $0.277 \text{ W/kg}$

#### WCDMA Band 5 Phantom Mode Middle 10mm/Zoom Scan (7x7x7)/Cube 0:

Measurement grid:  $dx=5\text{mm}$ ,  $dy=5\text{mm}$ ,  $dz=5\text{mm}$

Reference Value =  $16.49 \text{ V/m}$ ; Power Drift =  $0.04 \text{ dB}$

Peak SAR (extrapolated) =  $0.317 \text{ W/kg}$

SAR(1 g) =  $0.267 \text{ W/kg}$ ; SAR(10 g) =  $0.213 \text{ W/kg}$

Maximum value of SAR (measured) =  $0.277 \text{ W/kg}$

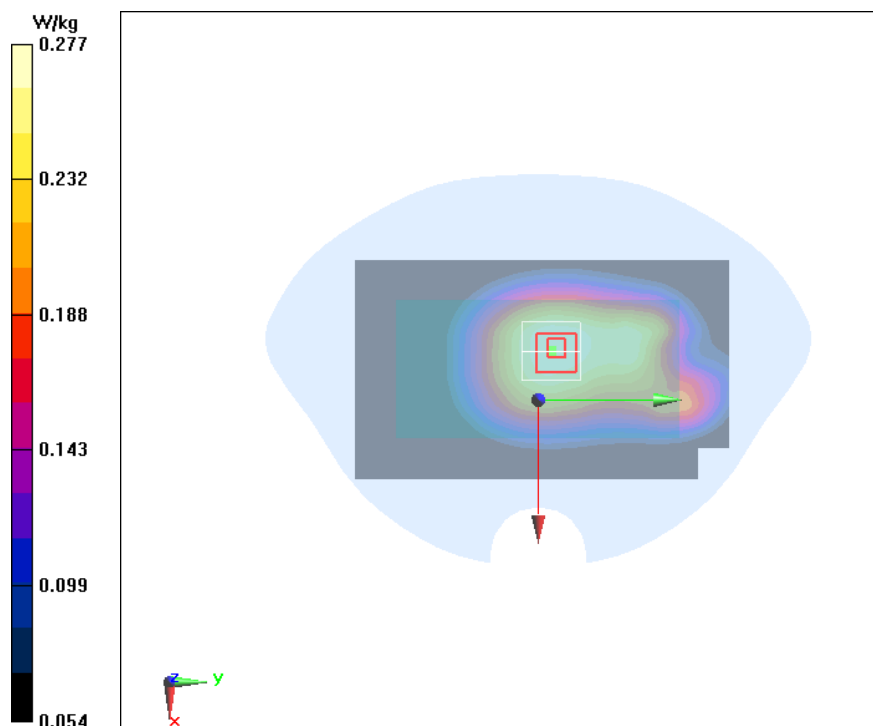

### Fig.10 WCDMA Band 5 Ground Mode Middle 0mm

Date/Time: 2019/7/29

Electronics: DAE4 Sn1244

Medium parameters used:  $f = 837 \text{ MHz}$ ;  $\sigma = 1.001 \text{ S/m}$ ;  $\epsilon_r = 56.695$ ;  $\rho = 1000 \text{ kg/m}^3$

Ambient Temperature:  $22.5 \text{ }^\circ\text{C}$       Liquid Temperature:  $22.5 \text{ }^\circ\text{C}$

Communication System: WCDMA Professional 835MHz;      Frequency: 836.6 MHz;

Duty Cycle: 1:1

Probe: ES3DV3 - SN3252ConvF(6.34, 6.34, 6.34); Calibrated: 9/4/2018

#### WCDMA Band 5 Ground Mode Middle 0mm/Area Scan (71x121x1):

Measurement grid:  $dx=10 \text{ mm}$ ,  $dy=10 \text{ mm}$

Maximum value of SAR (Measurement) = 1.34 W/kg

#### WCDMA Band 5 Ground Mode Middle 0mm/Zoom Scan (7x7x7)/Cube 0:

Measurement grid:  $dx=5\text{mm}$ ,  $dy=5\text{mm}$ ,  $dz=5\text{mm}$

Reference Value = 10.09 V/m; Power Drift = 0.03 dB

Peak SAR (extrapolated) = 2.33 W/kg

SAR(1 g) = 1.25 W/kg; SAR(10 g) = 0.675 W/kg

Maximum value of SAR (measured) = 1.42 W/kg

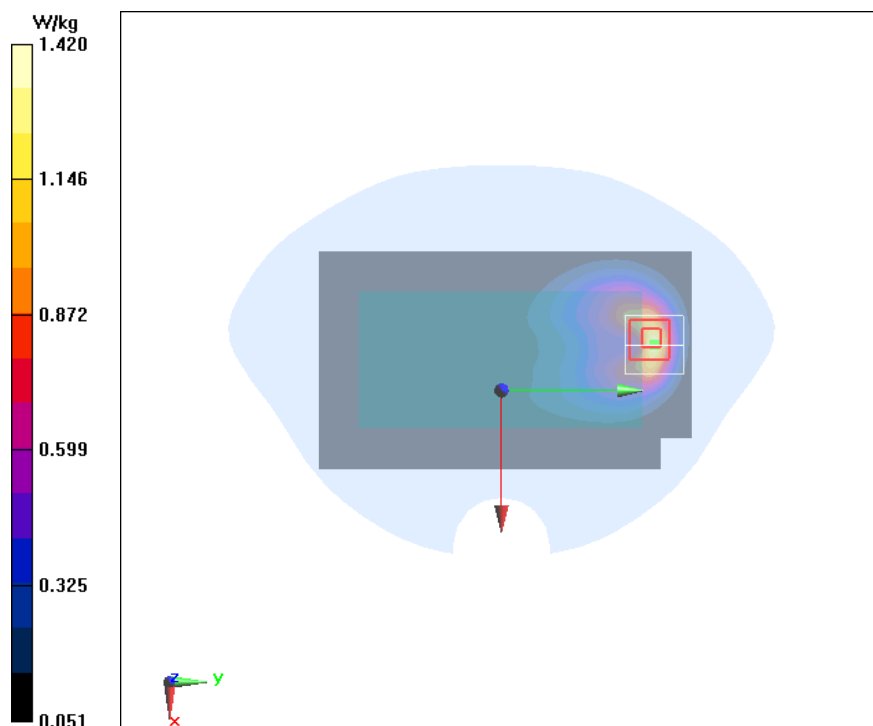

### Fig.11 LTE Band 4 20M 1RB 50 offset Phantom Mode Middle 10mm

Date/Time: 2019/7/29

Electronics: DAE4 Sn1244

Medium parameters used (interpolated):  $f = 1732.5$  MHz;  $\sigma = 1.421$  S/m;  $\epsilon_r = 55.126$ ;  
 $\rho = 1000$  kg/m<sup>3</sup>

Ambient Temperature: 22.5 °C      Liquid Temperature: 22.5 °C

Communication System: LTE Band 4 Professional 1800MHz;    Frequency: 1732.5 MHz; Duty Cycle: 1:1

Probe: ES3DV3 - SN3252ConvF(4.99, 4.99, 4.99); Calibrated: 9/4/2018

#### LTE Band 4 20M 1RB 50 offset Phantom Mode Middle 10mm /Area Scan (71x131x1):

Measurement grid: dx=10 mm, dy=10 mm

Maximum value of SAR (Measurement) = 0.532 W/kg

#### LTE Band 4 20M 1RB 50 offset Phantom Mode Middle 10mm/Zoom Scan (7x7x7)/Cube 0:

Measurement grid: dx=5mm, dy=5mm, dz=5mm

Reference Value = 7.693 V/m; Power Drift = -0.00 dB

Peak SAR (extrapolated) = 0.744 W/kg

SAR(1 g) = 0.485 W/kg; SAR(10 g) = 0.310 W/kg

Maximum value of SAR (measured) = 0.515 W/kg

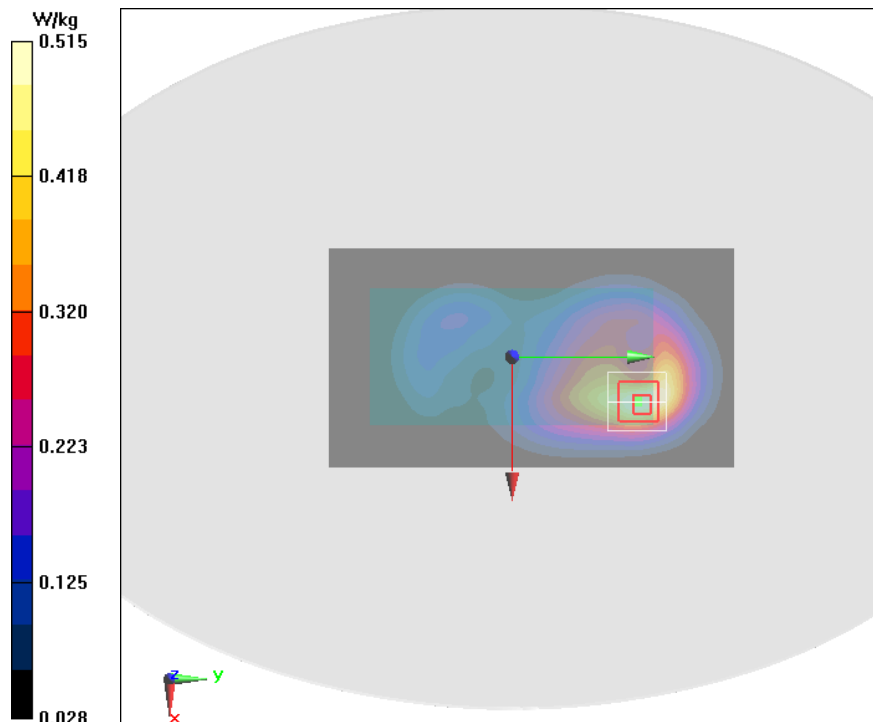

### Fig.12 LTE Band 4 20M 1RB 50 offset Ground Mode Middle 0mm

Date/Time: 2019/7/29

Electronics: DAE4 Sn1244

Medium parameters used (interpolated):  $f = 1732.5$  MHz;  $\sigma = 1.421$  S/m;  $\epsilon_r = 55.126$ ;  
 $\rho = 1000$  kg/m<sup>3</sup>

Ambient Temperature:22.5 °C      Liquid Temperature:22.5 °C

Communication System: LTE Band 4 Professional 1800MHz;    Frequency: 1732.5 MHz; Duty Cycle: 1:1

Probe: ES3DV3 - SN3252ConvF(4.99, 4.99, 4.99); Calibrated: 9/4/2018

#### LTE Band 4 20M 1RB 50 offset Ground Mode Middle 0mm/Area Scan (71x131x1):

Measurement grid: dx=10 mm, dy=10 mm

Maximum value of SAR (Measurement) = 2.28 W/kg

#### LTE Band 4 20M 1RB 50 offset Ground Mode Middle 0mm/Zoom Scan (7x7x7)/Cube 0:

Measurement grid: dx=5mm, dy=5mm, dz=5mm

Reference Value = 10.51 V/m; Power Drift = 0.01 dB

Peak SAR (extrapolated) = 3.05 W/kg

SAR(1 g) = 1.85 W/kg; SAR(10 g) = 1.08 W/kg

Maximum value of SAR (measured) = 2.03 W/kg

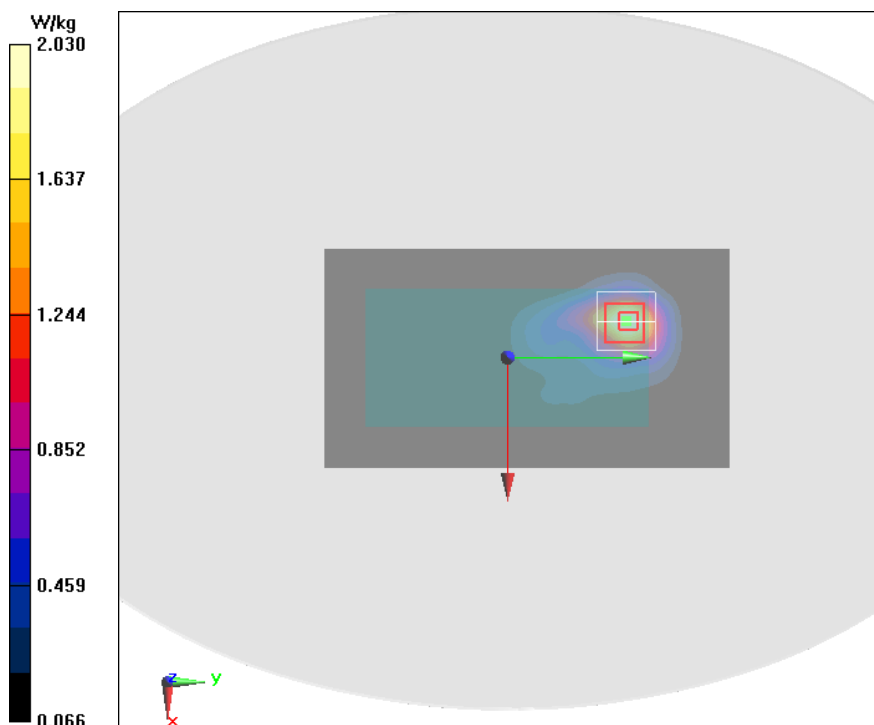

### Fig.13 LTE B5 10M 1RB25Offset Phantom Mode Middle 10mm

Date/Time: 2019/7/29

Electronics: DAE4 Sn1244

Medium parameters used (interpolated):  $f = 836.5 \text{ MHz}$ ;  $\sigma = 1 \text{ S/m}$ ;  $\epsilon_r = 56.699$ ;  $\rho = 1000 \text{ kg/m}^3$

Ambient Temperature:  $22.5 \text{ }^\circ\text{C}$       Liquid Temperature:  $22.5 \text{ }^\circ\text{C}$

Communication System: LTE Band 5 Professional 835MHz;    Frequency:  $836.5 \text{ MHz}$ ;

Duty Cycle: 1:1

Probe: ES3DV3 - SN3252ConvF(6.34, 6.34, 6.34); Calibrated: 9/4/2018

#### LTE B5 10M 1RB25Offset Phantom Mode Middle 10mm/Area Scan (71x121x1):

Measurement grid:  $dx=10 \text{ mm}$ ,  $dy=10 \text{ mm}$

Maximum value of SAR (Measurement) =  $0.261 \text{ W/kg}$

#### LTE B5 10M 1RB25Offset Phantom Mode Middle 10mm/Zoom Scan (7x7x7)/Cube 0:

Measurement grid:  $dx=5\text{mm}$ ,  $dy=5\text{mm}$ ,  $dz=5\text{mm}$

Reference Value =  $15.97 \text{ V/m}$ ; Power Drift =  $0.03 \text{ dB}$

Peak SAR (extrapolated) =  $0.297 \text{ W/kg}$

SAR(1 g) =  $0.250 \text{ W/kg}$ ; SAR(10 g) =  $0.199 \text{ W/kg}$

Maximum value of SAR (measured) =  $0.260 \text{ W/kg}$

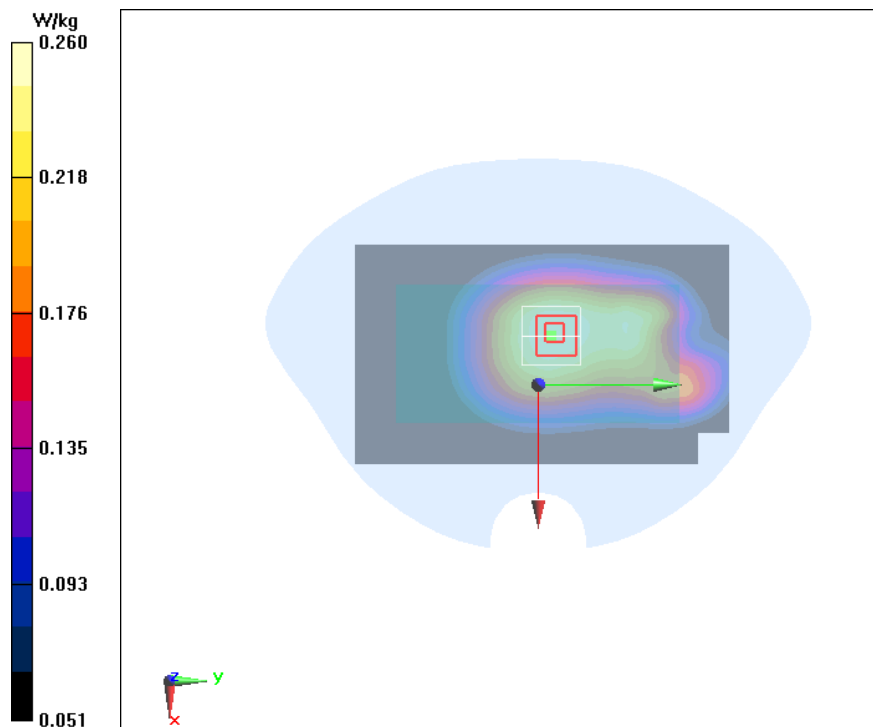



### Fig.14 LTE B5 10M 1RB25Offset Ground Mode Middle 0mm

Date/Time: 2019/7/29

Electronics: DAE4 Sn1244

Medium parameters used (interpolated):  $f = 836.5$  MHz;  $\sigma = 1$  S/m;  $\epsilon_r = 56.699$ ;  $\rho = 1000$  kg/m<sup>3</sup>

Ambient Temperature: 22.5 °C      Liquid Temperature: 22.5 °C

Communication System: LTE Band 5 Professional 835MHz;    Frequency: 836.5 MHz;

Duty Cycle: 1:1

Probe: ES3DV3 - SN3252ConvF(6.34, 6.34, 6.34); Calibrated: 9/4/2018

#### LTE B5 10M 1RB25Offset Ground Mode Middle 0mm/Area Scan (71x121x1):

Measurement grid: dx=10 mm, dy=10 mm

Maximum value of SAR (Measurement) = 1.19 W/kg

#### LTE B5 10M 1RB25Offset Ground Mode Middle 0mm/Zoom Scan (7x7x7)/Cube 0:

Measurement grid: dx=5mm, dy=5mm, dz=5mm

Reference Value = 10.51 V/m; Power Drift = -0.02 dB

Peak SAR (extrapolated) = 2.14 W/kg

SAR(1 g) = 1.13 W/kg; SAR(10 g) = 0.605 W/kg

Maximum value of SAR (measured) = 1.28 W/kg

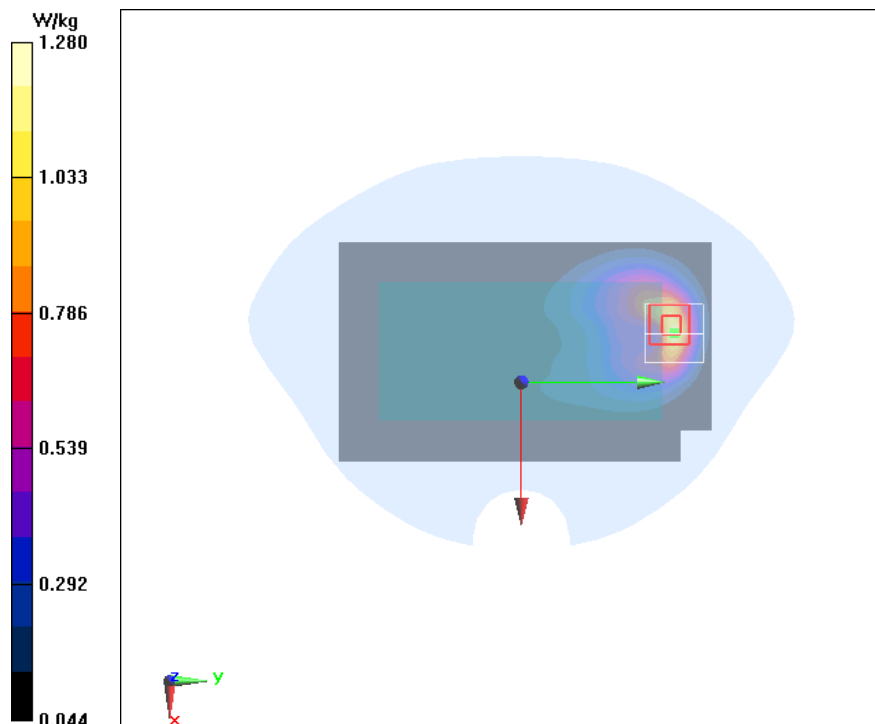

### Fig.15 LTE Band 7 20M 1RB 50 offset Bottom Mode Low 10mm

Date/Time: 2019/8/2

Electronics: DAE4 Sn1244

Medium parameters used:  $f = 2510$  MHz;  $\sigma = 1.977$  S/m;  $\epsilon_r = 52.081$ ;  $\rho = 1000$  kg/m<sup>3</sup>

Ambient Temperature: 22.5 °C      Liquid Temperature: 22.5 °C

Communication System: LTE Band 7 Professional 2500MHz;    Frequency: 2510 MHz; Duty Cycle: 1:1

Probe: ES3DV3 - SN3252ConvF(4.41, 4.41, 4.41); Calibrated: 9/4/2018

#### LTE Band 7 20M 1RB 50 offset Bottom Mode Low 10mm /Area Scan (41x71x1):

Measurement grid: dx=10 mm, dy=10 mm

Maximum value of SAR (Measurement) = 1.20 W/kg

#### LTE Band 7 20M 1RB 50 offset Bottom Mode Low 10mm /Zoom Scan

(7x7x7)/Cube 0:

Measurement grid: dx=5mm, dy=5mm, dz=5mm

Reference Value = 23.90 V/m; Power Drift = 0.09 dB

Peak SAR (extrapolated) = 2.01 W/kg

SAR(1 g) = 1.04 W/kg; SAR(10 g) = 0.508 W/kg

Maximum value of SAR (measured) = 1.16 W/kg

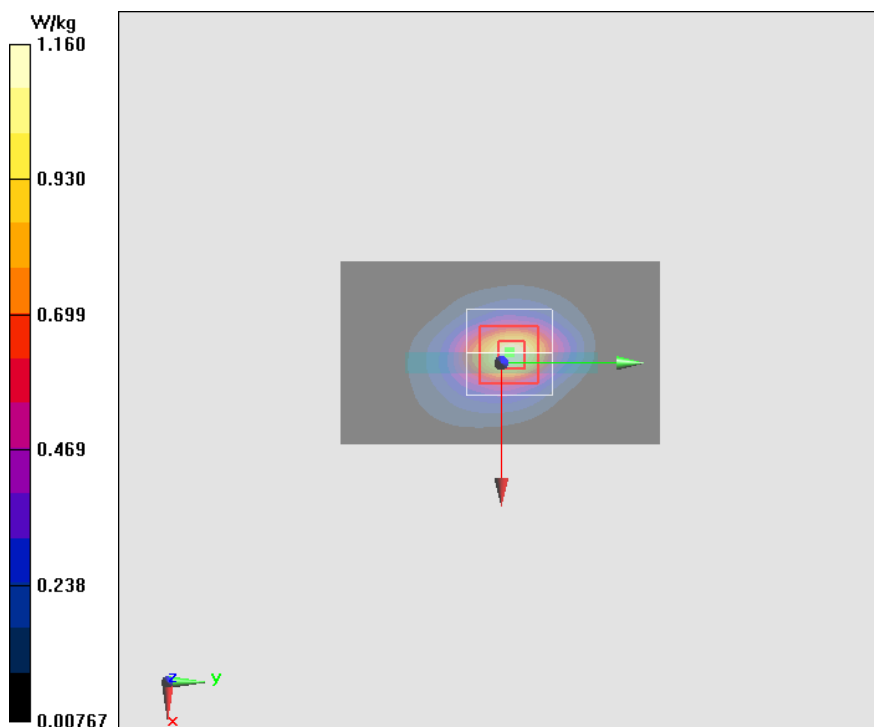

### Fig.16 LTE Band 7 20M 1RB 50 offset Ground Mode High 0mm

Date/Time: 2019/8/2

Electronics: DAE4 Sn1244

Medium parameters used:  $f = 2560$  MHz;  $\sigma = 2.041$  S/m;  $\epsilon_r = 51.89$ ;  $\rho = 1000$  kg/m<sup>3</sup>

Ambient Temperature: 22.5 °C      Liquid Temperature: 22.5 °C

Communication System: LTE Band 7 Professional 2600MHz;    Frequency: 2560 MHz; Duty Cycle: 1:1

Probe: ES3DV3 - SN3252ConvF(4.19, 4.19, 4.19); Calibrated: 9/4/2018

#### LTE Band 7 20M 1RB 50 offset Ground Mode High 0mm /Area Scan (71x121x1):

Measurement grid: dx=10 mm, dy=10 mm

Maximum value of SAR (Measurement) = 1.92 W/kg

#### LTE Band 7 20M 1RB 50 offset Ground Mode High 0mm /Zoom Scan (7x7x7)/Cube 0:

Measurement grid: dx=5mm, dy=5mm, dz=5mm

Reference Value = 3.053 V/m; Power Drift = 0.08 dB

Peak SAR (extrapolated) = 4.25 W/kg

SAR(1 g) = 1.94 W/kg; SAR(10 g) = 0.820 W/kg

Maximum value of SAR (measured) = 2.22 W/kg

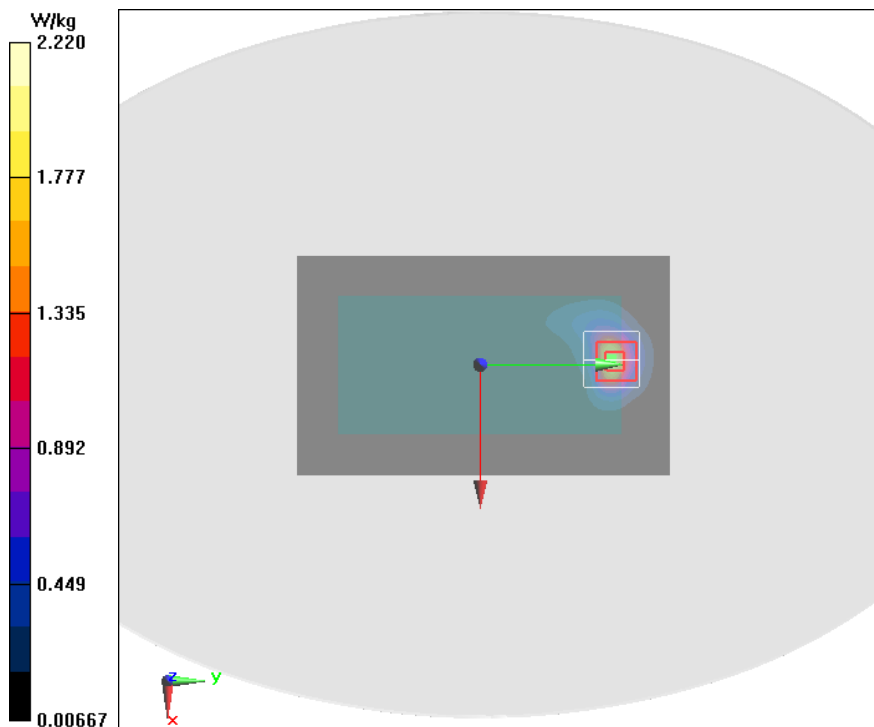

### Fig.17 LTE B12 10M 1RB25Offset Ground Mode Middle 10mm

Date/Time: 2019/7/28

Electronics: DAE4 Sn1244

Medium parameters used (interpolated):  $f = 707.5$  MHz;  $\sigma = 0.924$  S/m;  $\epsilon_r = 58.183$ ;  $\rho = 1000$  kg/m<sup>3</sup>

Ambient Temperature: 22.5 °C      Liquid Temperature: 22.5 °C

Communication System: LTE Band 12 Professional 835MHz;    Frequency: 707.5 MHz; Duty Cycle: 1:1

Probe: ES3DV3 - SN3252ConvF(6.53, 6.53, 6.53); Calibrated: 9/4/2018

#### LTE B12 10M 1RB25Offset Ground Mode Middle 10mm/Area Scan (71x121x1):

Measurement grid: dx=10 mm, dy=10 mm

Maximum value of SAR (Measurement) = 0.186 W/kg

#### LTE B12 10M 1RB25Offset Ground Mode Middle 10mm/Zoom Scan (7x7x7)/Cube 0:

Measurement grid: dx=5mm, dy=5mm, dz=5mm

Reference Value = 14.26 V/m; Power Drift = 0.07 dB

Peak SAR (extrapolated) = 0.217 W/kg

SAR(1 g) = 0.179 W/kg; SAR(10 g) = 0.144 W/kg

Maximum value of SAR (measured) = 0.186 W/kg

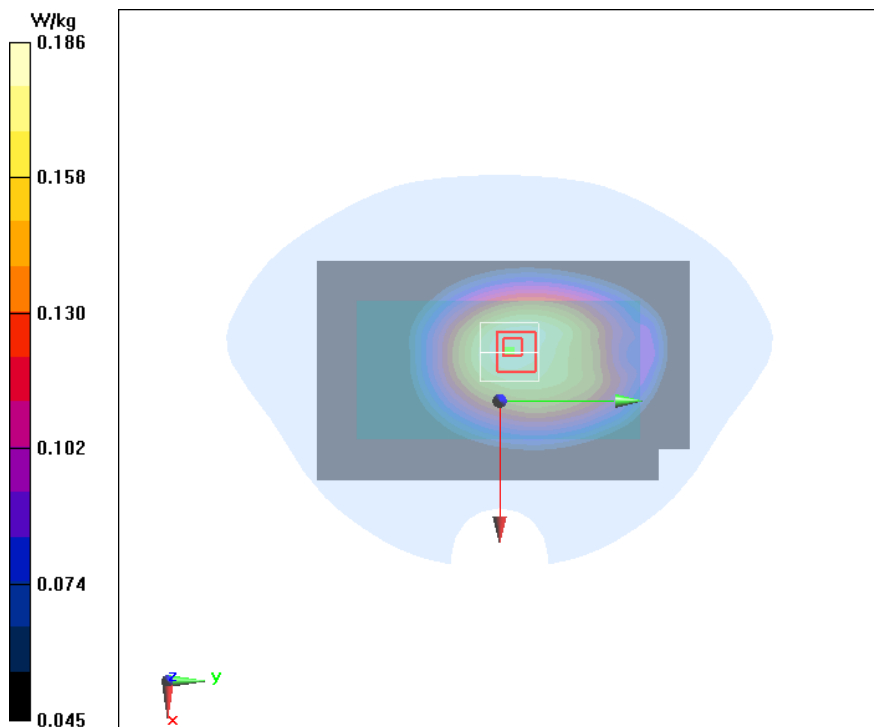

### Fig.18 LTE B12 10M 1RB25Offset Ground Mode Middle 0mm

Date/Time: 2019/7/28

Electronics: DAE4 Sn1244

Medium parameters used (interpolated):  $f = 707.5$  MHz;  $\sigma = 0.924$  S/m;  $\epsilon_r = 58.183$ ;  $\rho = 1000$  kg/m<sup>3</sup>

Ambient Temperature: 22.5 °C      Liquid Temperature: 22.5 °C

Communication System: LTE Band 12 Professional 835MHz;    Frequency: 707.5 MHz; Duty Cycle: 1:1

Probe: ES3DV3 - SN3252ConvF(6.53, 6.53, 6.53); Calibrated: 9/4/2018

#### LTE B12 10M 1RB25Offset Ground Mode Middle 0mm/Area Scan (71x121x1):

Measurement grid: dx=10 mm, dy=10 mm

Maximum value of SAR (Measurement) = 0.750 W/kg

#### LTE B12 10M 1RB25Offset Ground Mode Middle 0mm/Zoom Scan (7x7x7)/Cube 0:

Measurement grid: dx=5mm, dy=5mm, dz=5mm

Reference Value = 11.27 V/m; Power Drift = 0.02 dB

Peak SAR (extrapolated) = 1.51 W/kg

SAR(1 g) = 0.738 W/kg; SAR(10 g) = 0.400 W/kg

Maximum of SAR (measured) = 0.861 W/kg

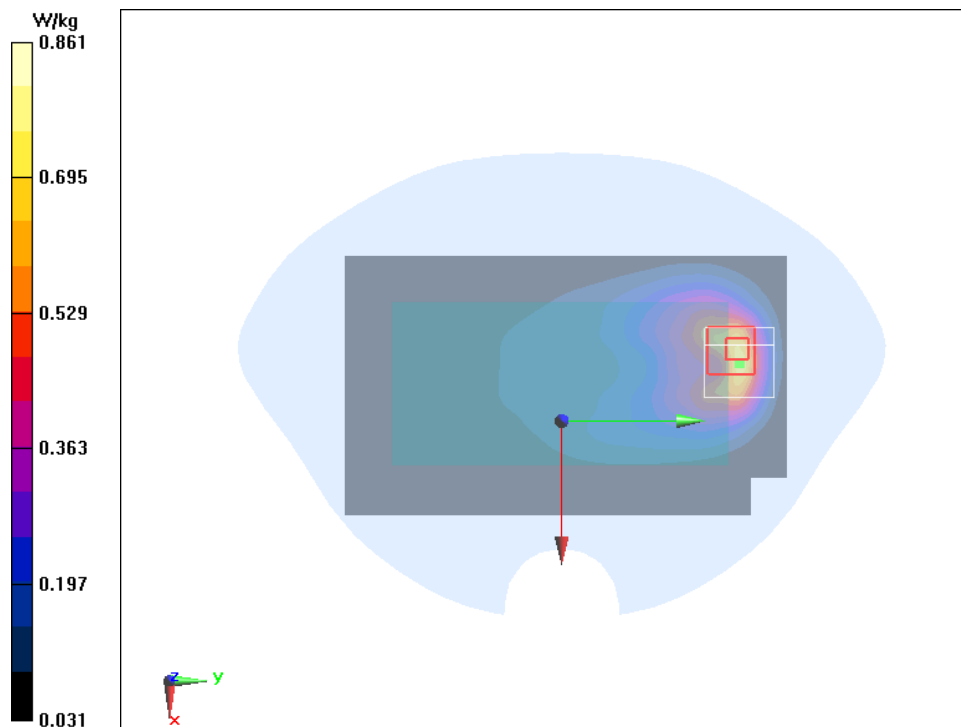

### Fig.19 LTE B13 10M 1RB25Offset Ground Mode Middle 10mm

Date/Time: 2019/7/28

Electronics: DAE4 Sn1244

Medium parameters used:  $f = 782 \text{ MHz}$ ;  $\sigma = 0.998 \text{ S/m}$ ;  $\epsilon_r = 57.316$ ;  $\rho = 1000 \text{ kg/m}^3$

Ambient Temperature:  $22.5 \text{ }^\circ\text{C}$       Liquid Temperature:  $22.5 \text{ }^\circ\text{C}$

Communication System: LTE Band 13 Professional 835MHz;      Frequency: 782 MHz;

Duty Cycle: 1:1

Probe: ES3DV3 - SN3252ConvF(6.53, 6.53, 6.53); Calibrated: 9/4/2018

#### LTE B13 10M 1RB25Offset Ground Mode Middle 10mm/Area Scan (71x121x1):

Measurement grid:  $dx=10 \text{ mm}$ ,  $dy=10 \text{ mm}$

Maximum value of SAR (Measurement) =  $0.194 \text{ W/kg}$

#### LTE B13 10M 1RB25Offset Ground Mode Middle 10mm/Zoom Scan

(7x7x7)/Cube 0:

Measurement grid:  $dx=5\text{mm}$ ,  $dy=5\text{mm}$ ,  $dz=5\text{mm}$

Reference Value =  $14.35 \text{ V/m}$ ; Power Drift =  $0.01 \text{ dB}$

Peak SAR (extrapolated) =  $0.221 \text{ W/kg}$

SAR(1 g) =  $0.184 \text{ W/kg}$ ; SAR(10 g) =  $0.147 \text{ W/kg}$

Maximum value of SAR (measured) =  $0.192 \text{ W/kg}$

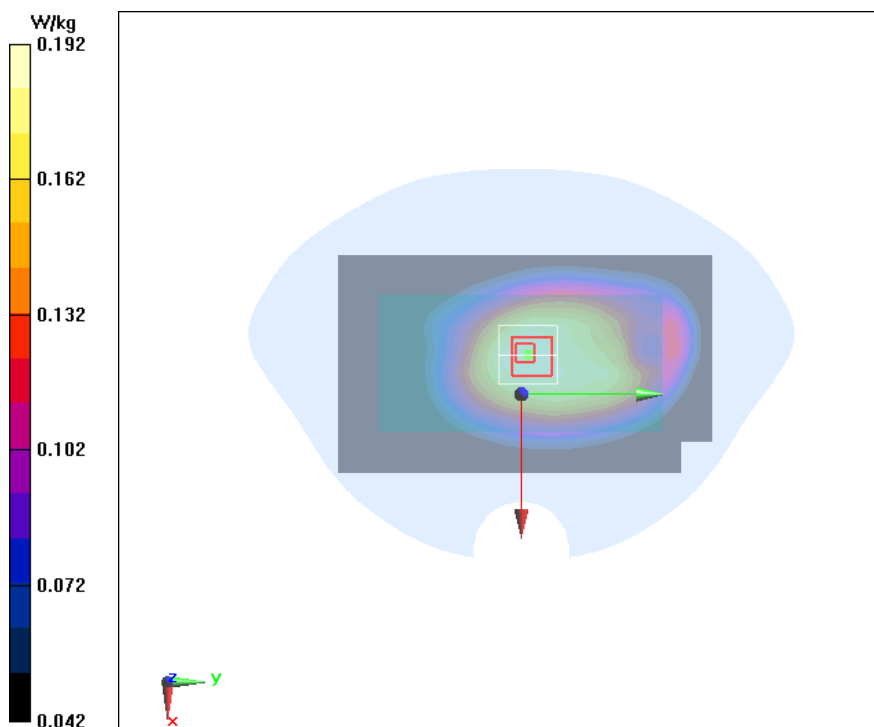

### Fig.20 LTE B13 10M 1RB25Offset Ground Mode Middle 0mm

Date/Time: 2019/7/28

Electronics: DAE4 Sn1244

Medium parameters used:  $f = 782 \text{ MHz}$ ;  $\sigma = 0.998 \text{ S/m}$ ;  $\epsilon_r = 57.316$ ;  $\rho = 1000 \text{ kg/m}^3$

Ambient Temperature:  $22.5 \text{ }^\circ\text{C}$       Liquid Temperature:  $22.5 \text{ }^\circ\text{C}$

Communication System: LTE Band 13 Professional 835MHz;    Frequency: 782 MHz;

Duty Cycle: 1:1

Probe: ES3DV3 - SN3252ConvF(6.53, 6.53, 6.53); Calibrated: 9/4/2018

#### LTE B13 10M 1RB25Offset Ground Mode Middle 0mm/Area Scan (71x121x1):

Measurement grid:  $dx=10 \text{ mm}$ ,  $dy=10 \text{ mm}$

Maximum value of SAR (Measurement) =  $0.889 \text{ W/kg}$

#### LTE B13 10M 1RB25Offset Ground Mode Middle 0mm/Zoom Scan

##### (7x7x7)/Cube 0:

Measurement grid:  $dx=5\text{mm}$ ,  $dy=5\text{mm}$ ,  $dz=5\text{mm}$

Reference Value =  $10.39 \text{ V/m}$ ; Power Drift =  $-0.05 \text{ dB}$

Peak SAR (extrapolated) =  $1.63 \text{ W/kg}$

SAR(1 g) =  $0.843 \text{ W/kg}$ ; SAR(10 g) =  $0.459 \text{ W/kg}$

Maximum value of SAR (measured) =  $0.936 \text{ W/kg}$

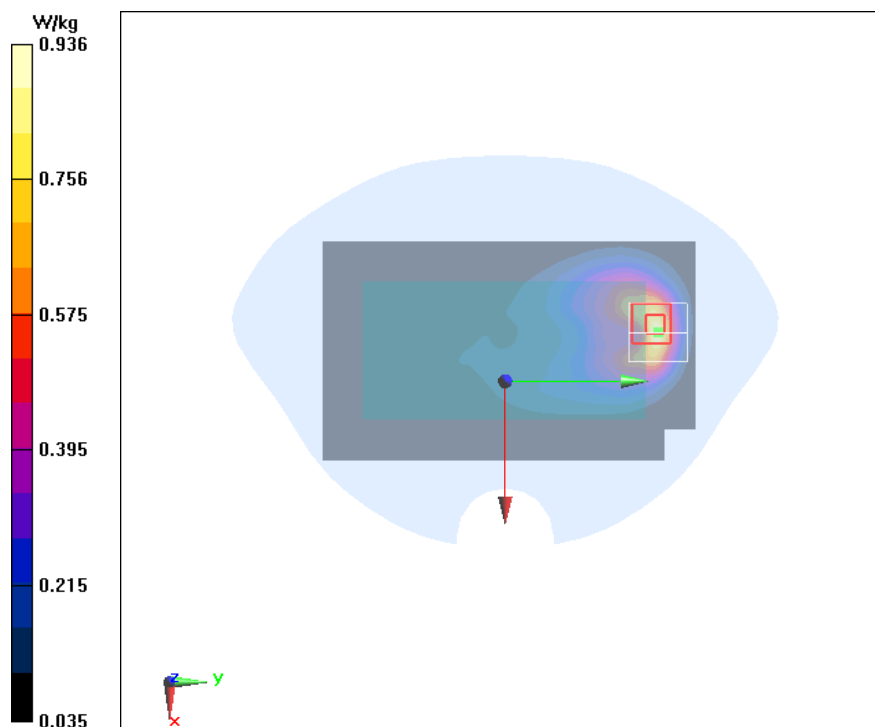

### Fig.21 LTE Band 25 20M 1RB 50 offset Bottom Mode Middle 10mm

Date/Time: 2019/7/31

Electronics: DAE4 Sn1244

Medium parameters used (interpolated):  $f = 1882.5$  MHz;  $\sigma = 1.531$  S/m;  $\epsilon_r = 51.988$ ;  
 $\rho = 1000$  kg/m<sup>3</sup>

Ambient Temperature: 22.5 °C      Liquid Temperature: 22.5 °C

Communication System: LTE Band 25 Professional 1900MHz;    Frequency: 1882.5 MHz; Duty Cycle: 1:1

Probe: ES3DV3 - SN3252ConvF(4.77, 4.77, 4.77); Calibrated: 9/4/2018

#### LTE Band 25 20M 1RB 50 offset Bottom Mode Middle 10mm/Area Scan (41x71x1):

Measurement grid: dx=10 mm, dy=10 mm

Maximum value of SAR (Measurement) = 0.570 W/kg

#### LTE Band 25 20M 1RB 50 offset Bottom Mode Middle 10mm/Zoom Scan (7x7x7)/Cube 0:

Measurement grid: dx=5mm, dy=5mm, dz=5mm

Reference Value = 5.637 V/m; Power Drift = 0.13 dB

Peak SAR (extrapolated) = 0.962 W/kg

SAR(1 g) = 0.595 W/kg; SAR(10 g) = 0.342 W/kg

Maximum value of SAR (measured) = 0.649 W/kg

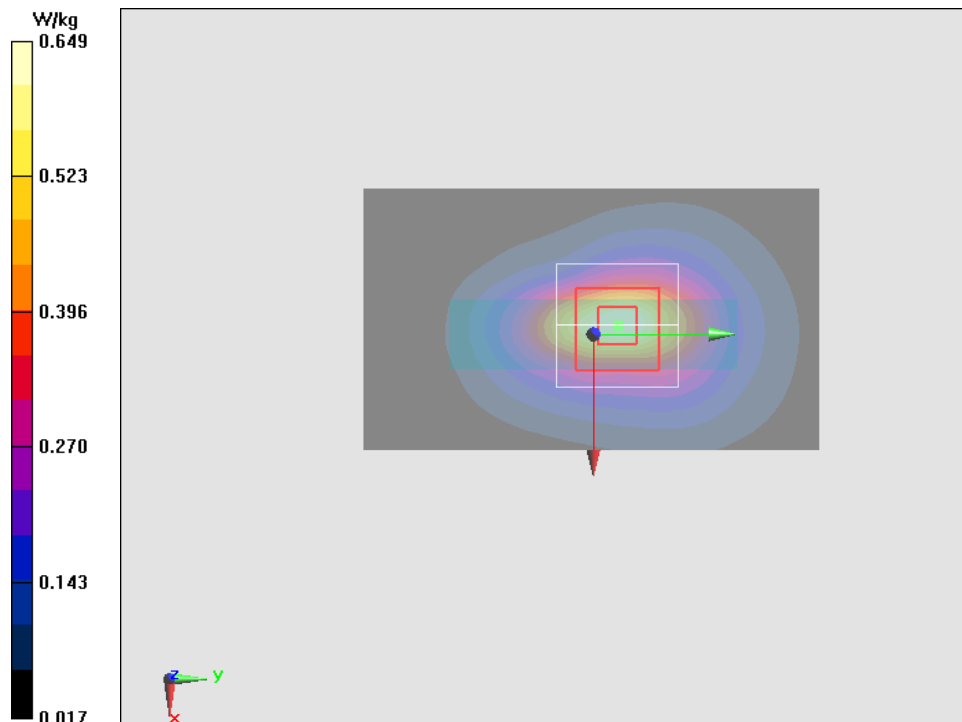



## Fig.22 LTE Band 25 20M 1RB 50 offset Phantom Mode Middle

### 0mm

Date/Time: 2019/7/31

Electronics: DAE4 Sn1244

Medium parameters used (interpolated):  $f = 1882.5$  MHz;  $\sigma = 1.531$  S/m;  $\epsilon_r = 51.988$ ;  $\rho = 1000$  kg/m<sup>3</sup>

Ambient Temperature: 22.5 °C      Liquid Temperature: 22.5 °C

Communication System: LTE Band 25 Professional 1900MHz;    Frequency: 1882.5 MHz; Duty Cycle: 1:1

Probe: ES3DV3 - SN3252ConvF(4.77, 4.77, 4.77); Calibrated: 9/4/2018

### LTE Band 25 20M 1RB 50 offset Phantom Mode Middle 0mm/Area Scan (71x121x1):

Measurement grid: dx=10 mm, dy=10 mm

Maximum value of SAR (Measurement) = 2.32 W/kg

### LTE Band 25 20M 1RB 50 offset Phantom Mode Middle 0mm/Zoom Scan (7x7x7)/Cube 0:

Measurement grid: dx=5mm, dy=5mm, dz=5mm

Reference Value = 4.435 V/m; Power Drift = 0.05 dB

Peak SAR (extrapolated) = 3.15 W/kg

SAR(1 g) = 1.69 W/kg; SAR(10 g) = 0.916 W/kg

Maximum value of SAR (measured) = 1.80 W/kg

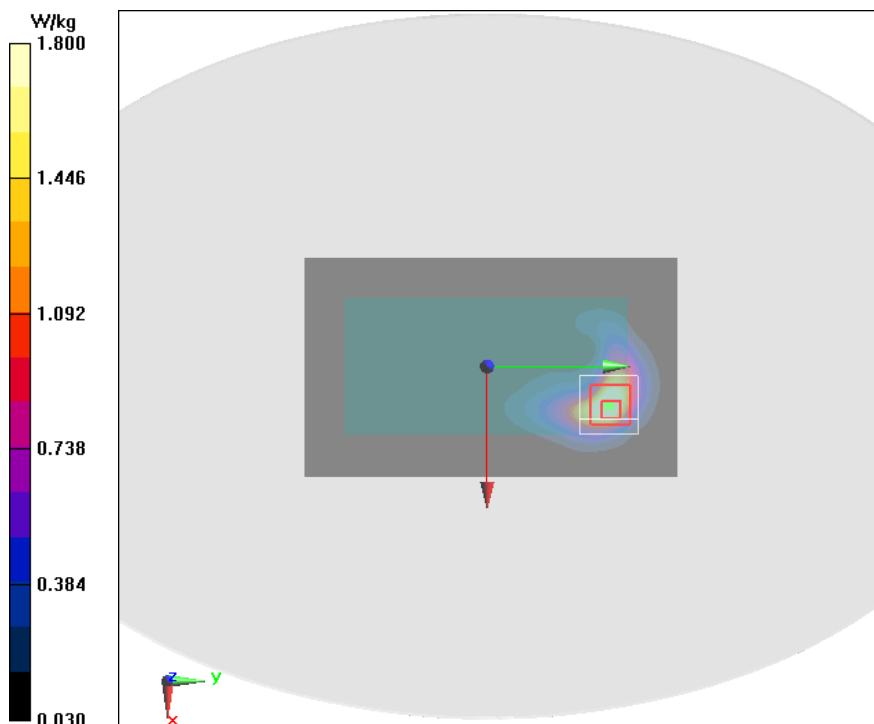

### Fig.23 LTE B26 15M 1RB38Offset Ground Mode Middle 10mm

Date/Time: 2019/7/29

Electronics: DAE4 Sn1244

Medium parameters used (interpolated):  $f = 841.5$  MHz;  $\sigma = 1.005$  S/m;  $\epsilon_r = 56.65$ ;  $\rho = 1000$  kg/m<sup>3</sup>

Ambient Temperature:22.5 °C      Liquid Temperature:22.5 °C

Communication System: LTE Band 26 Professional 835MHz;    Frequency: 841.5 MHz; Duty Cycle: 1:1

Probe: ES3DV3 - SN3252ConvF(6.34, 6.34, 6.34); Calibrated: 9/4/2018

#### LTE B26 15M 1RB38Offset Ground Mode Middle 10mm /Area Scan (71x121x1):

Measurement grid: dx=10 mm, dy=10 mm

Maximum value of SAR (Measurement) = 0.225 W/kg

#### LTE B26 15M 1RB38Offset Ground Mode Middle 10mm /Zoom Scan

##### (7x7x7)/Cube 0:

Measurement grid: dx=5mm, dy=5mm, dz=5mm

Reference Value = 15.08 V/m; Power Drift = 0.03 dB

Peak SAR (extrapolated) = 0.258 W/kg

SAR(1 g) = 0.215 W/kg; SAR(10 g) = 0.169 W/kg

Maximum value of SAR (measured) = 0.225 W/kg

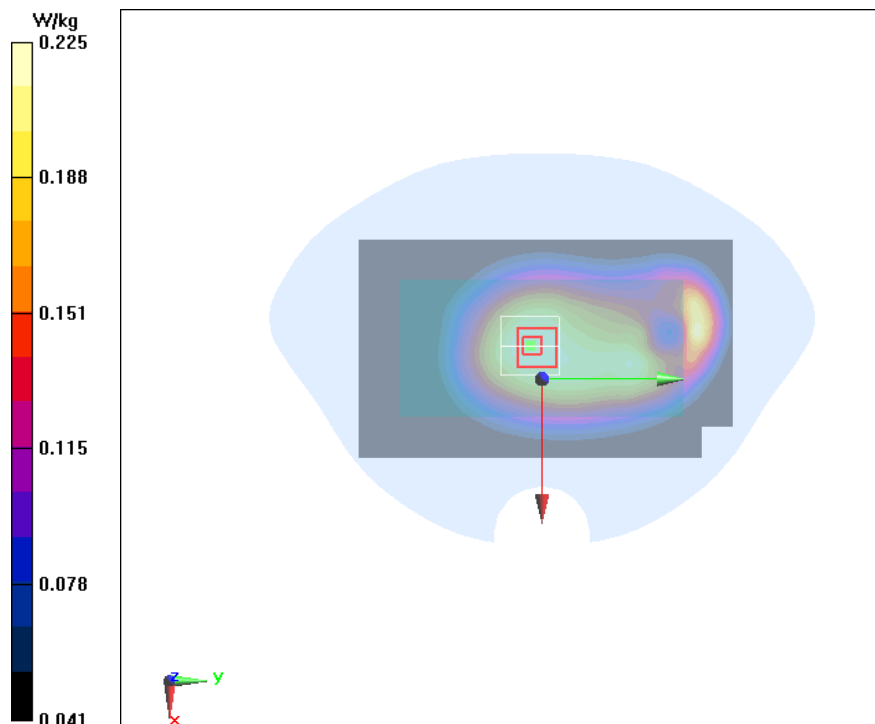

### Fig.24 LTE B26 15M 1RB38Offset Ground Mode Middle 0mm

Date/Time: 2019/7/29

Electronics: DAE4 Sn1244

Medium parameters used (interpolated):  $f = 841.5$  MHz;  $\sigma = 1.005$  S/m;  $\epsilon_r = 56.65$ ;  $\rho = 1000$  kg/m<sup>3</sup>

Ambient Temperature: 22.5 °C      Liquid Temperature: 22.5 °C

Communication System: LTE Band 26 Professional 835MHz;    Frequency: 841.5 MHz; Duty Cycle: 1:1

Probe: ES3DV3 - SN3252ConvF(6.34, 6.34, 6.34); Calibrated: 9/4/2018

#### LTE B26 15M 1RB38Offset Ground Mode Middle 0mm /Area Scan (71x121x1):

Measurement grid: dx=10 mm, dy=10 mm

Maximum value of SAR (Measurement) = 1.15 W/kg

#### LTE B26 15M 1RB38Offset Ground Mode Middle 0mm /Zoom Scan (7x7x7)/Cube 0:

Measurement grid: dx=5mm, dy=5mm, dz=5mm

Reference Value = 9.679 V/m; Power Drift = 0.01 dB

Peak SAR (extrapolated) = 2.05 W/kg

SAR(1 g) = 1.09 W/kg; SAR(10 g) = 0.583 W/kg

Maximum value of SAR (measured) = 1.24 W/kg

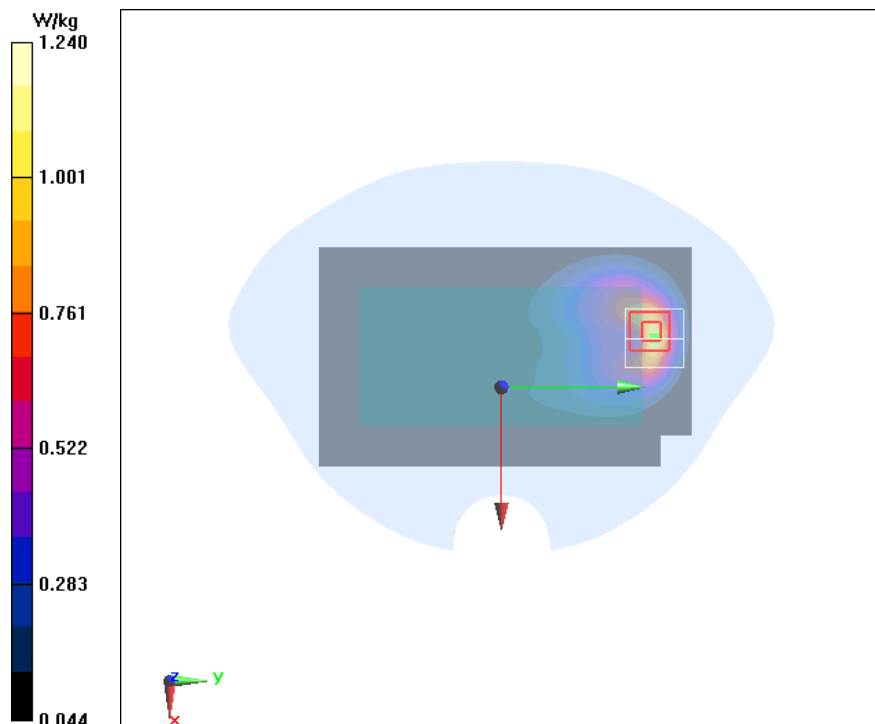

### Fig.25 CDMA BC0 1xEV-DO-0 Ground Mode Middle 10mm

Date/Time: 2019/7/29

Electronics: DAE4 Sn1244

Medium parameters used:  $f = 837 \text{ MHz}$ ;  $\sigma = 1.001 \text{ S/m}$ ;  $\epsilon_r = 56.695$ ;  $\rho = 1000 \text{ kg/m}^3$

Ambient Temperature:  $22.5 \text{ }^\circ\text{C}$       Liquid Temperature:  $22.5 \text{ }^\circ\text{C}$

Communication System: CDMA 835MHz 835MHz;    Frequency:  $836.52 \text{ MHz}$ ; Duty Cycle: 1:1

Probe: ES3DV3 - SN3252ConvF(6.34, 6.34, 6.34); Calibrated: 9/4/2018

#### CDMA BC0 1xEV-DO-0 Ground Mode Middle 10mm/Area Scan (71x121x1):

Measurement grid:  $dx=10 \text{ mm}$ ,  $dy=10 \text{ mm}$

Maximum value of SAR (Measurement) =  $0.373 \text{ W/kg}$

#### CDMA BC0 1xEV-DO-0 Ground Mode Middle 10mm/Zoom Scan (7x7x7)/Cube

**0:**

Measurement grid:  $dx=5\text{mm}$ ,  $dy=5\text{mm}$ ,  $dz=5\text{mm}$

Reference Value =  $19.36 \text{ V/m}$ ; Power Drift =  $0.08 \text{ dB}$

Peak SAR (extrapolated) =  $0.454 \text{ W/kg}$

SAR(1 g) =  $0.353 \text{ W/kg}$ ; SAR(10 g) =  $0.259 \text{ W/kg}$

Maximum value of SAR (measured) =  $0.375 \text{ W/kg}$

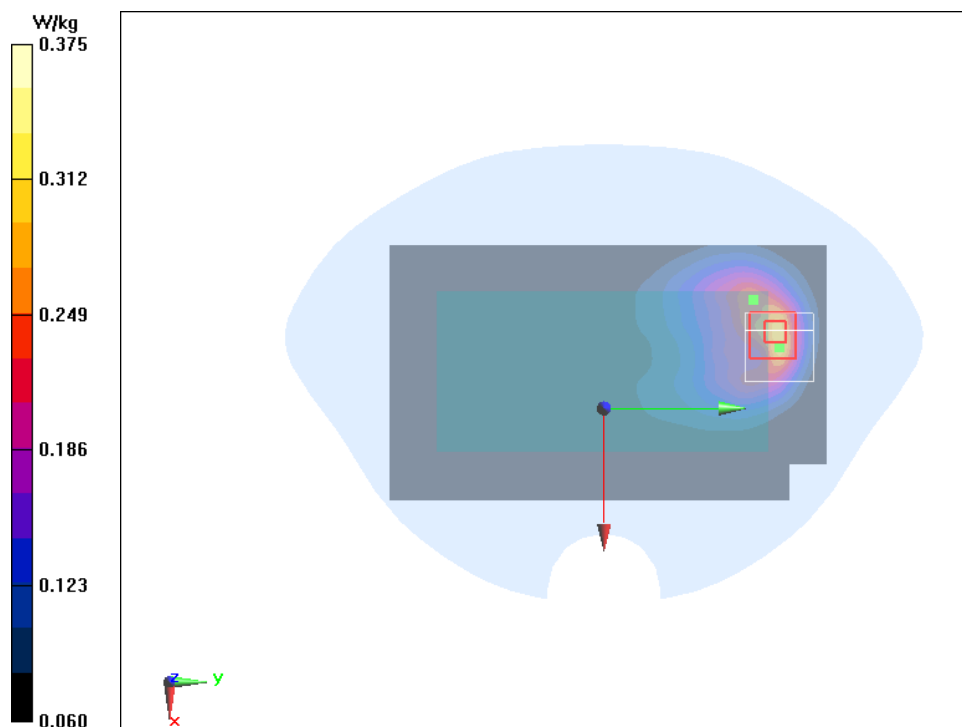

### Fig.26 CDMA BC0 1xEV-DO-0 Ground Mode Middle 0mm

Date/Time: 2019/7/29

Electronics: DAE4 Sn1244

Medium parameters used:  $f = 837 \text{ MHz}$ ;  $\sigma = 1.001 \text{ S/m}$ ;  $\epsilon_r = 56.695$ ;  $\rho = 1000 \text{ kg/m}^3$

Ambient Temperature:  $22.5 \text{ }^\circ\text{C}$       Liquid Temperature:  $22.5 \text{ }^\circ\text{C}$

Communication System: CDMA 835MHz 835MHz;      Frequency:  $836.52 \text{ MHz}$ ; Duty Cycle: 1:1

Probe: ES3DV3 - SN3252ConvF(6.34, 6.34, 6.34); Calibrated: 9/4/2018

#### CDMA BC0 1xEV-DO-0 Ground Mode Middle 0mm/Area Scan (71x121x1):

Measurement grid:  $dx=10 \text{ mm}$ ,  $dy=10 \text{ mm}$

Maximum value of SAR (Measurement) =  $1.59 \text{ W/kg}$

#### CDMA BC0 1xEV-DO-0 Ground Mode Middle 0mm/Zoom Scan (7x7x7)/Cube 0:

Measurement grid:  $dx=5\text{mm}$ ,  $dy=5\text{mm}$ ,  $dz=5\text{mm}$

Reference Value =  $11.99 \text{ V/m}$ ; Power Drift =  $0.02 \text{ dB}$

Peak SAR (extrapolated) =  $3.28 \text{ W/kg}$

SAR(1 g) =  $1.76 \text{ W/kg}$ ; SAR(10 g) =  $0.948 \text{ W/kg}$

Maximum of SAR (measured) =  $2.02 \text{ W/kg}$

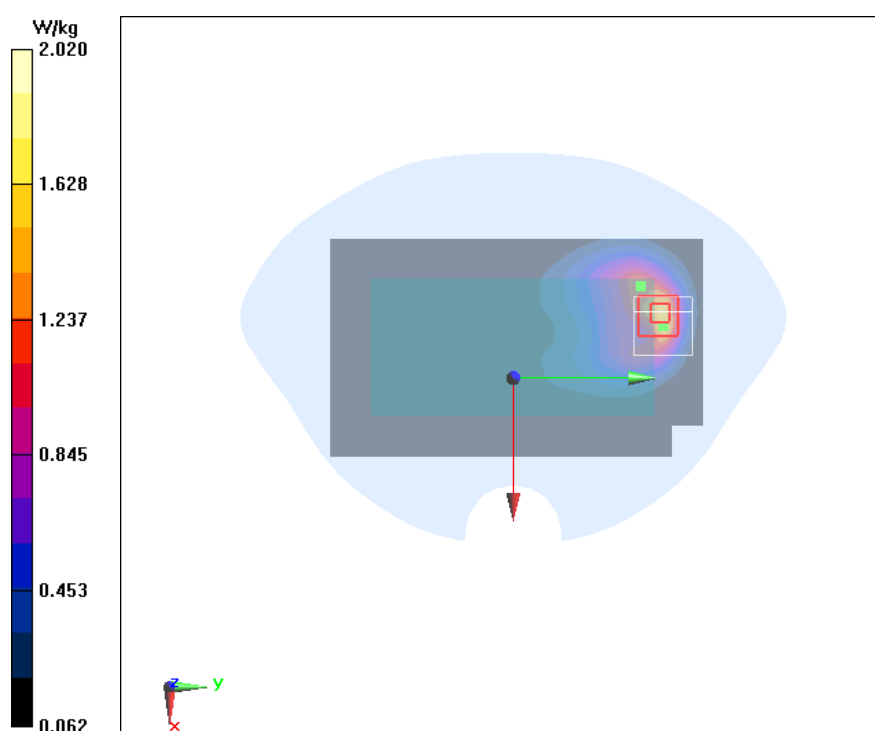

### Fig.27 CDMA BC1 1xEV-DO-0 Bottom Mode High 10mm

Date/Time: 2019/7/31

Electronics: DAE4 Sn1244

Medium parameters used:  $f = 1909$  MHz;  $\sigma = 1.56$  S/m;  $\epsilon_r = 51.897$ ;  $\rho = 1000$  kg/m<sup>3</sup>

Ambient Temperature: 22.5 °C      Liquid Temperature: 22.5 °C

Communication System: CDMA 1900MHz 1900MHz;      Frequency: 1908.75 MHz;

Duty Cycle: 1:1

Probe: ES3DV3 - SN3252ConvF(4.77, 4.77, 4.77); Calibrated: 9/4/2018

#### CDMA BC1 1xEV-DO-0 Bottom Mode High 10mm/Area Scan (41x61x1):

Measurement grid: dx=10 mm, dy=10 mm

Maximum value of SAR (Measurement) = 1.28 W/kg

#### CDMA BC1 1xEV-DO-0 Bottom Mode High 10mm/Zoom Scan (7x7x7)/Cube 0:

Measurement grid: dx=5mm, dy=5mm, dz=5mm

Reference Value = 22.84 V/m; Power Drift = -0.02 dB

Peak SAR (extrapolated) = 2.06 W/kg

SAR(1 g) = 1.27 W/kg; SAR(10 g) = 0.729 W/kg

Maximum value of SAR (measured) = 1.41 W/kg

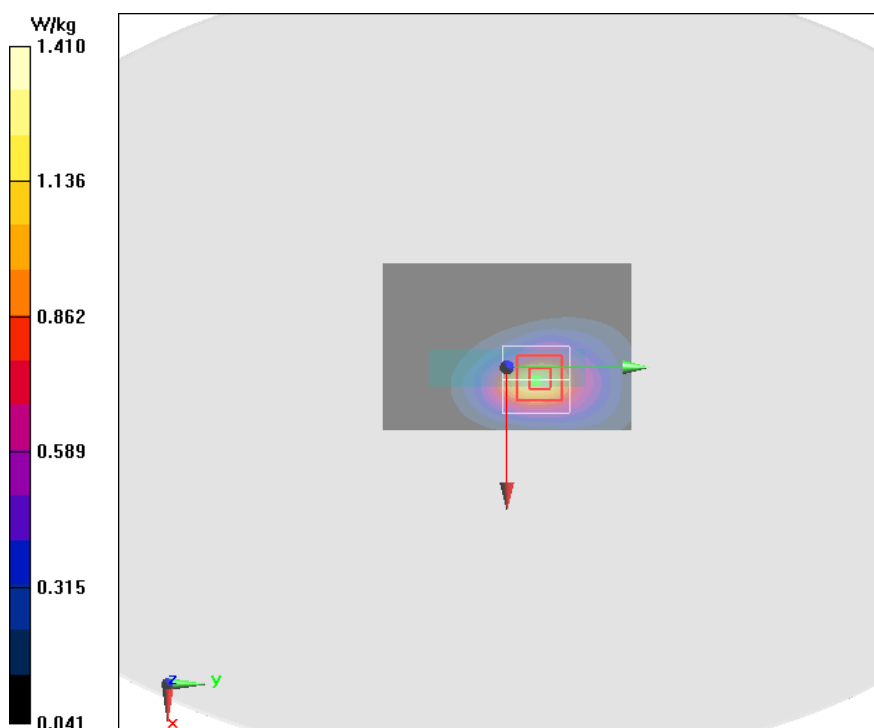

### Fig.28 CDMA BC1 1xEV-DO-0 Phantom Mode Middle 0mm

Date/Time: 2019/7/31

Electronics: DAE4 Sn1244

Medium parameters used:  $f = 1880 \text{ MHz}$ ;  $\sigma = 1.529 \text{ S/m}$ ;  $\epsilon_r = 51.996$ ;  $\rho = 1000 \text{ kg/m}^3$

Ambient Temperature:  $22.5 \text{ }^\circ\text{C}$       Liquid Temperature:  $22.5 \text{ }^\circ\text{C}$

Communication System: CDMA 1900MHz 1900MHz;      Frequency: 1880 MHz; Duty Cycle: 1:1

Probe: ES3DV3 - SN3252ConvF(4.77, 4.77, 4.77); Calibrated: 9/4/2018

#### CDMA BC1 1xEV-DO-0 Phantom Mode Middle 0mm/Area Scan (61x101x1):

Measurement grid:  $dx=10 \text{ mm}$ ,  $dy=10 \text{ mm}$

Maximum value of SAR (Measurement) =  $3.19 \text{ W/kg}$

#### CDMA BC1 1xEV-DO-0 Phantom Mode Middle 0mm/Zoom Scan (7x7x7)/Cube 0:

0:

Measurement grid:  $dx=5\text{mm}$ ,  $dy=5\text{mm}$ ,  $dz=5\text{mm}$

Reference Value =  $4.356 \text{ V/m}$ ; Power Drift =  $0.05 \text{ dB}$

Peak SAR (extrapolated) =  $5.57 \text{ W/kg}$

SAR(1 g) =  $3.11 \text{ W/kg}$ ; SAR(10 g) =  $1.7 \text{ W/kg}$

Maximum of SAR (measured) =  $3.36 \text{ W/kg}$

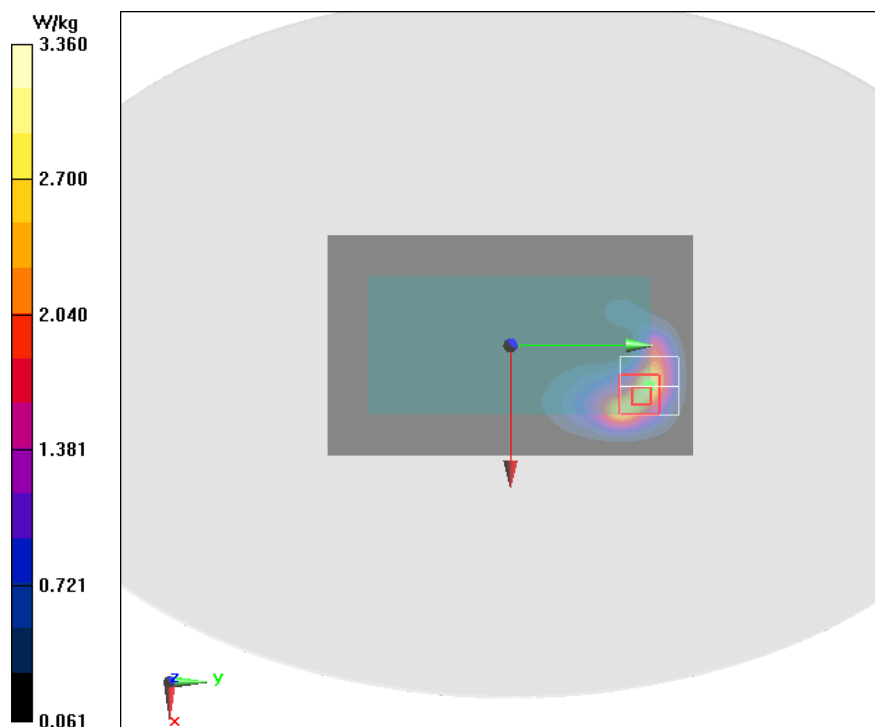

### Fig.29 wifi 802.11 b Right Mode Middle

Date/Time: 2019/8/1

Electronics: DAE4 Sn1244

Medium parameters used:  $f = 2437 \text{ MHz}$ ;  $\sigma = 1.916 \text{ S/m}$ ;  $\epsilon_r = 54.159$ ;  $\rho = 1000 \text{ kg/m}^3$

Ambient Temperature:  $22.5 \text{ }^\circ\text{C}$       Liquid Temperature:  $22.5 \text{ }^\circ\text{C}$

Communication System: Wifi 2450 2500MHz;    Frequency: 2437 MHz; Duty Cycle: 1:1

Probe: ES3DV3 - SN3252ConvF(4.41, 4.41, 4.41); Calibrated: 9/4/2018

#### wifi 802.11 b Right Mode Middle/Area Scan (41x101x1):

Measurement grid:  $dx=10 \text{ mm}$ ,  $dy=10 \text{ mm}$

Maximum value of SAR (Measurement) =  $0.209 \text{ W/kg}$

#### wifi 802.11 b Right Mode Middle/Zoom Scan (7x7x7)/Cube 0:

Measurement grid:  $dx=5\text{mm}$ ,  $dy=5\text{mm}$ ,  $dz=5\text{mm}$

Reference Value =  $2.377 \text{ V/m}$ ; Power Drift =  $0.01 \text{ dB}$

Peak SAR (extrapolated) =  $0.488 \text{ W/kg}$

SAR(1 g) =  $0.258 \text{ W/kg}$ ; SAR(10 g) =  $0.128 \text{ W/kg}$

Maximum value of SAR (measured) =  $0.293 \text{ W/kg}$

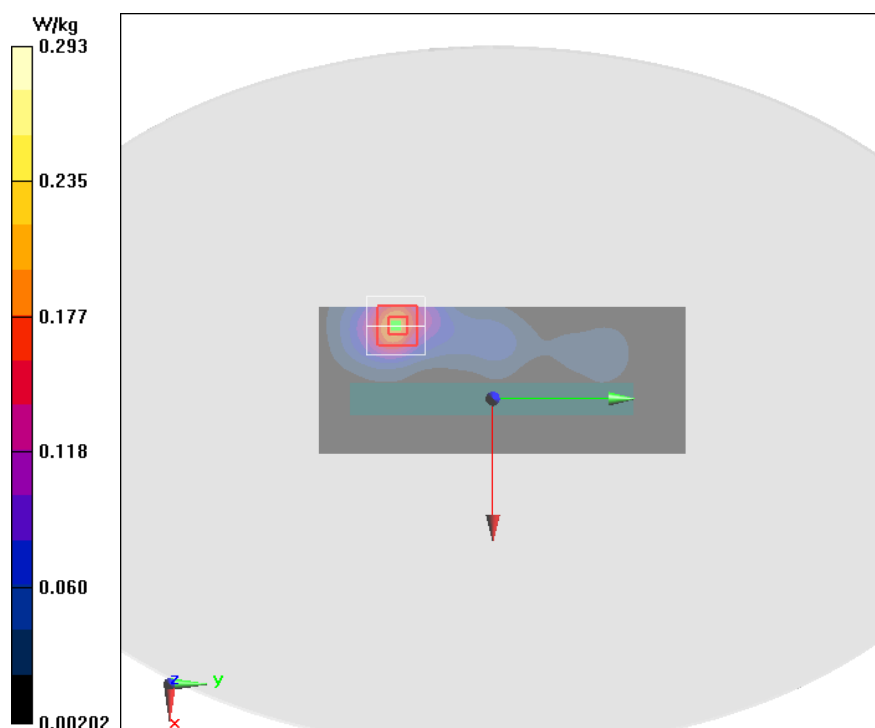



### Fig.30 wifi 2.4G Ground Mode High 0mm

Date/Time: 2019/8/1

Electronics: DAE4 Sn1244

Medium parameters used:  $f = 2462 \text{ MHz}$ ;  $\sigma = 1.946 \text{ S/m}$ ;  $\epsilon_r = 54.081$ ;  $\rho = 1000 \text{ kg/m}^3$

Ambient Temperature:  $22.5 \text{ }^\circ\text{C}$       Liquid Temperature:  $22.5 \text{ }^\circ\text{C}$

Communication System: Wifi 2450 2500MHz;    Frequency: 2462 MHz; Duty Cycle: 1:1

Probe: ES3DV3 - SN3252ConvF(4.41, 4.41, 4.41); Calibrated: 9/4/2018

#### wifi 2.4G Ground Mode High 0mm/Area Scan (71x121x1):

Measurement grid:  $dx=10 \text{ mm}$ ,  $dy=10 \text{ mm}$

Maximum value of SAR (Measurement) = 1.57 W/kg

#### wifi 2.4G Ground Mode High 0mm/Zoom Scan (7x7x7)/Cube 0:

Measurement grid:  $dx=5\text{mm}$ ,  $dy=5\text{mm}$ ,  $dz=5\text{mm}$

Reference Value = 8.594 V/m; Power Drift = 0.06 dB

Peak SAR (extrapolated) = 3.26 W/kg

SAR(1 g) = 1.41 W/kg; SAR(10 g) = 0.583 W/kg

Maximum value of SAR (measured) = 1.61 W/kg

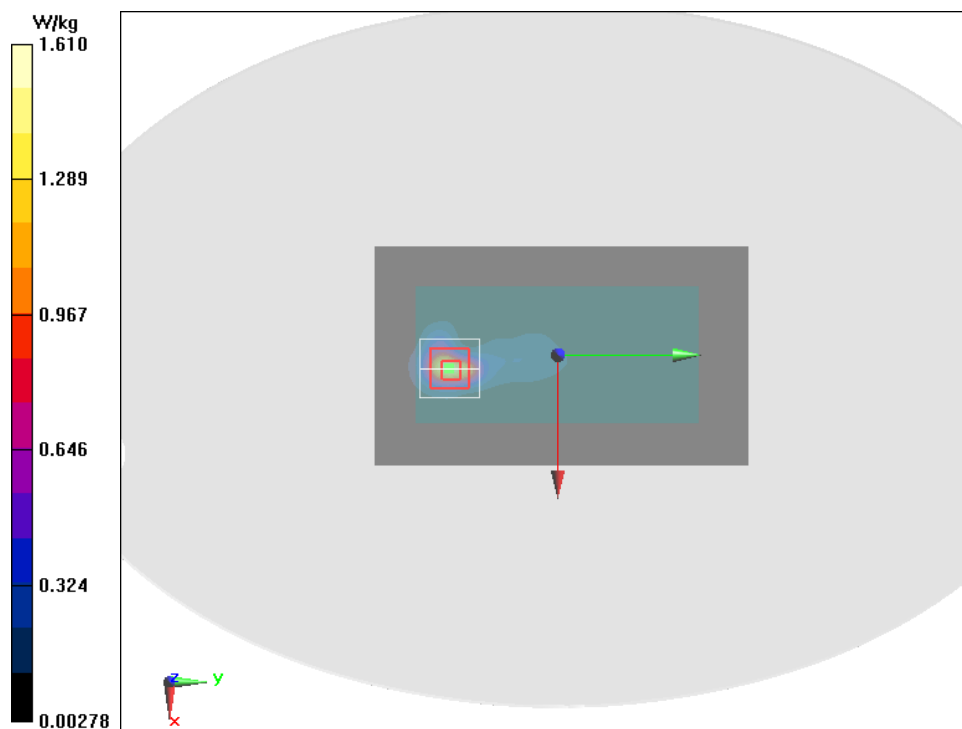

### Fig.31 wifi 5G Right Mode 10mm

Date/Time: 2019/8/3

Electronics: DAE4 Sn1244

Medium parameters used:  $f = 5775$  MHz;  $\sigma = 6.059$  S/m;  $\epsilon_r = 48.892$ ;  $\rho = 1000$  kg/m<sup>3</sup>

Ambient Temperature: 22.5 °C      Liquid Temperature: 22.5 °C

Communication System: 5GHz U-NII-3 5GHz;    Frequency: 5775 MHz; Duty Cycle: 1:1

Probe: EX3DV4 - SN7401ConvF(4.69, 4.69, 4.69); Calibrated: 1/15/2019

#### wifi 5G Right Mode 10mm/Area Scan (41x121x1):

Measurement grid: dx=10 mm, dy=10 mm

Maximum value of SAR (Measurement) = 0.249 W/kg

#### wifi 5G Right Mode 10mm/Zoom Scan (7x7x7)/Cube 0:

Measurement grid: dx=5mm, dy=5mm, dz=5mm

Reference Value = 2.880 V/m; Power Drift = 0.08 dB

Peak SAR (extrapolated) = 1.33 W/kg

SAR(1 g) = 0.329 W/kg; SAR(10 g) = 0.118 W/kg

Maximum value of SAR (measured) = 0.326 W/kg

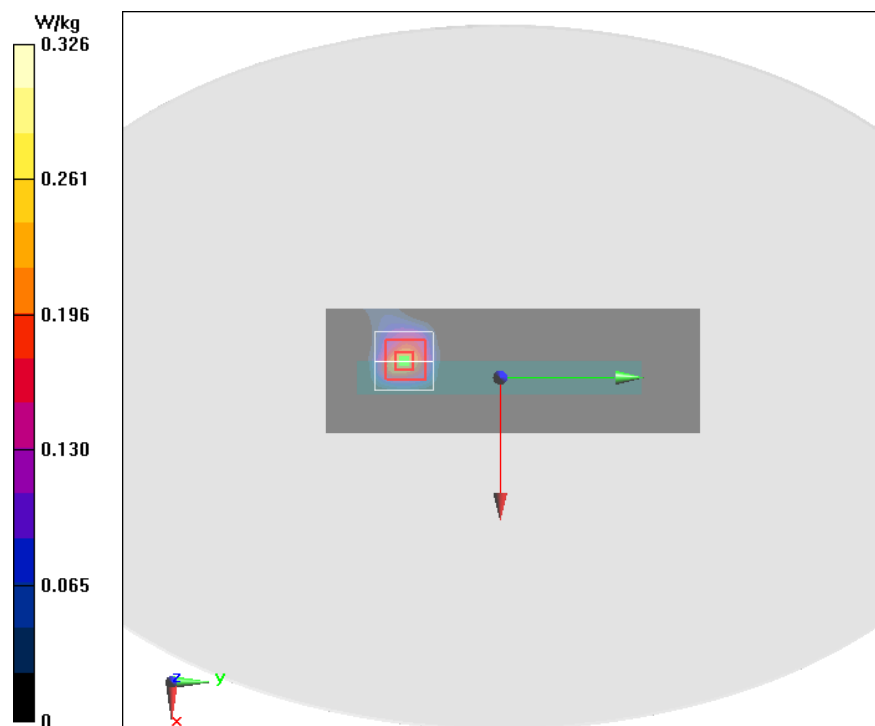

### Fig.32 wifi 5G Ground Mode 0mm

Date/Time: 2019/8/3

Electronics: DAE4 Sn1244

Medium parameters used:  $f = 5530 \text{ MHz}$ ;  $\sigma = 5.696 \text{ S/m}$ ;  $\epsilon_r = 49.431$ ;  $\rho = 1000 \text{ kg/m}^3$

Ambient Temperature:  $22.5 \text{ }^\circ\text{C}$       Liquid Temperature:  $22.5 \text{ }^\circ\text{C}$

Communication System: 5GHz U-NII-2C 5GHz;      Frequency:  $5530 \text{ MHz}$ ; Duty Cycle: 1:1

Probe: EX3DV4 - SN7401ConvF(4.66, 4.66, 4.66); Calibrated: 1/15/2019

#### wifi 5G Ground Mode 0mm /Area Scan (121x211x1):

Measurement grid:  $dx=10 \text{ mm}$ ,  $dy=10 \text{ mm}$

Maximum value of SAR (Measurement) =  $6.39 \text{ W/kg}$

#### wifi 5G Ground Mode 0mm /Zoom Scan (7x7x7)/Cube 0:

Measurement grid:  $dx=5\text{mm}$ ,  $dy=5\text{mm}$ ,  $dz=5\text{mm}$

Reference Value =  $0.9320 \text{ V/m}$ ; Power Drift =  $0.10 \text{ dB}$

Peak SAR (extrapolated) =  $13.0 \text{ W/kg}$

SAR(1 g) =  $2.37 \text{ W/kg}$ ; SAR(10 g) =  $0.484 \text{ W/kg}$

Maximum of SAR (measured) =  $7.41 \text{ W/kg}$

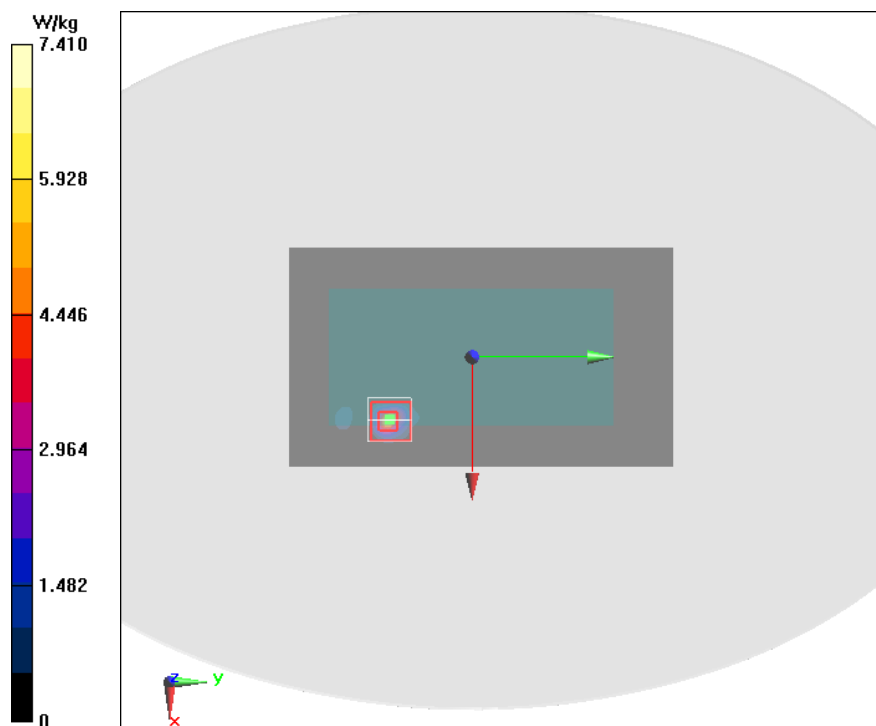

### Fig.33 WIFI 5G Left Cheek Middle

Date/Time: 2019/8/3

Electronics: DAE4 Sn1244

Medium parameters used:  $f = 5530 \text{ MHz}$ ;  $\sigma = 5.003 \text{ S/m}$ ;  $\epsilon_r = 36.538$ ;  $\rho = 1000 \text{ kg/m}^3$

Ambient Temperature:  $22.5 \text{ }^\circ\text{C}$       Liquid Temperature:  $22.5 \text{ }^\circ\text{C}$

Communication System: 5GHz U-NII-2C 5GHz;    Frequency:  $5530 \text{ MHz}$ ; Duty Cycle: 1:1

Probe: EX3DV4 - SN7401ConvF(5.2, 5.2, 5.2); Calibrated: 1/15/2019

#### WIFI 5G Left Cheek Middle/Area Scan (181x101x1):

Measurement grid:  $dx=10 \text{ mm}$ ,  $dy=10 \text{ mm}$

Maximum value of SAR (Measurement) =  $0.845 \text{ W/kg}$

#### WIFI 5G Left Cheek Middle/Zoom Scan (7x7x7)/Cube 0:

Measurement grid:  $dx=4\text{mm}$ ,  $dy=4\text{mm}$ ,  $dz=1.4\text{mm}$

Reference Value =  $1.313 \text{ V/m}$ ; Power Drift =  $0.08 \text{ dB}$

Peak SAR (extrapolated) =  $1.50 \text{ W/kg}$

SAR(1 g) =  $0.338 \text{ W/kg}$ ; SAR(10 g) =  $0.103 \text{ W/kg}$

Maximum of SAR (measured) =  $0.875 \text{ W/kg}$

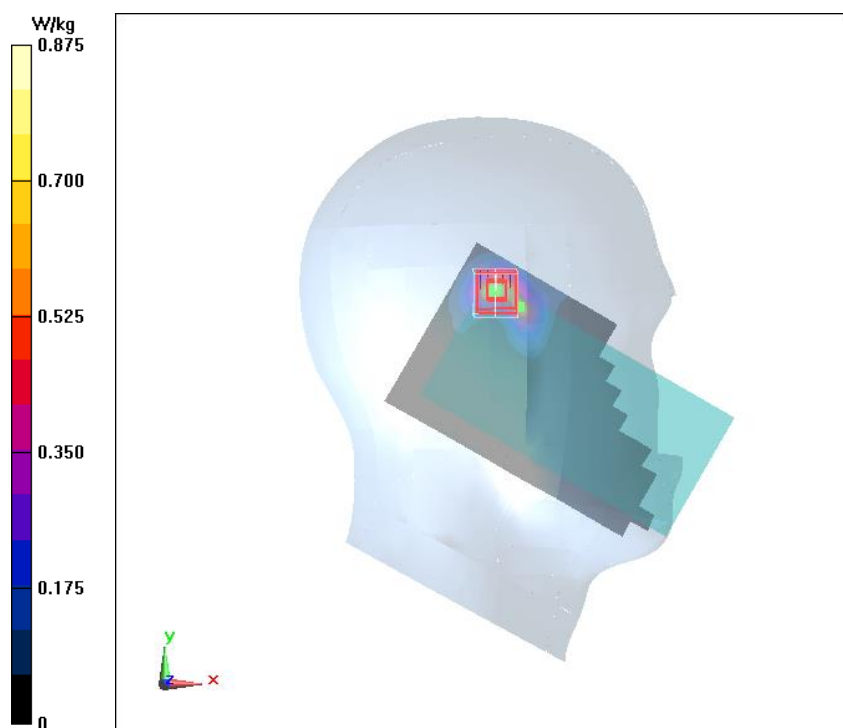

## ANNEX B. SYSTEM VALIDATION RESULTS

### Body 750MHz

Date/Time: 2019/7/28

Electronics: DAE4 Sn1244

Medium parameters used:  $f = 750 \text{ MHz}$ ;  $\sigma = 0.965 \text{ S/m}$ ;  $\epsilon_r = 57.696$ ;  $\rho = 1000 \text{ kg/m}^3$

Ambient Temperature:  $22.5 \text{ }^\circ\text{C}$       Liquid Temperature:  $22.5 \text{ }^\circ\text{C}$

Communication System: CW 835MHz;    Frequency: 750 MHz; Duty Cycle: 1:1

Probe: ES3DV3 - SN3252ConvF(6.53, 6.53, 6.53); Calibrated: 9/4/2018

#### System Validation/Area Scan (71x131x1):

Measurement grid:  $dx=10 \text{ mm}$ ,  $dy=10 \text{ mm}$

Maximum value of SAR (Measurement) =  $2.28 \text{ W/kg}$

#### System Validation/Zoom Scan (7x7x7) (7x7x7)/Cube 0:

Measurement grid:  $dx=5\text{mm}$ ,  $dy=5\text{mm}$ ,  $dz=5\text{mm}$

Reference Value =  $46.58 \text{ V/m}$ ; Power Drift =  $0.14 \text{ dB}$

Peak SAR (extrapolated) =  $3.05 \text{ W/kg}$

SAR(1 g) =  $2.11 \text{ W/kg}$ ; SAR(10 g) =  $1.42 \text{ W/kg}$

Maximum value of SAR (measured) =  $2.27 \text{ W/kg}$

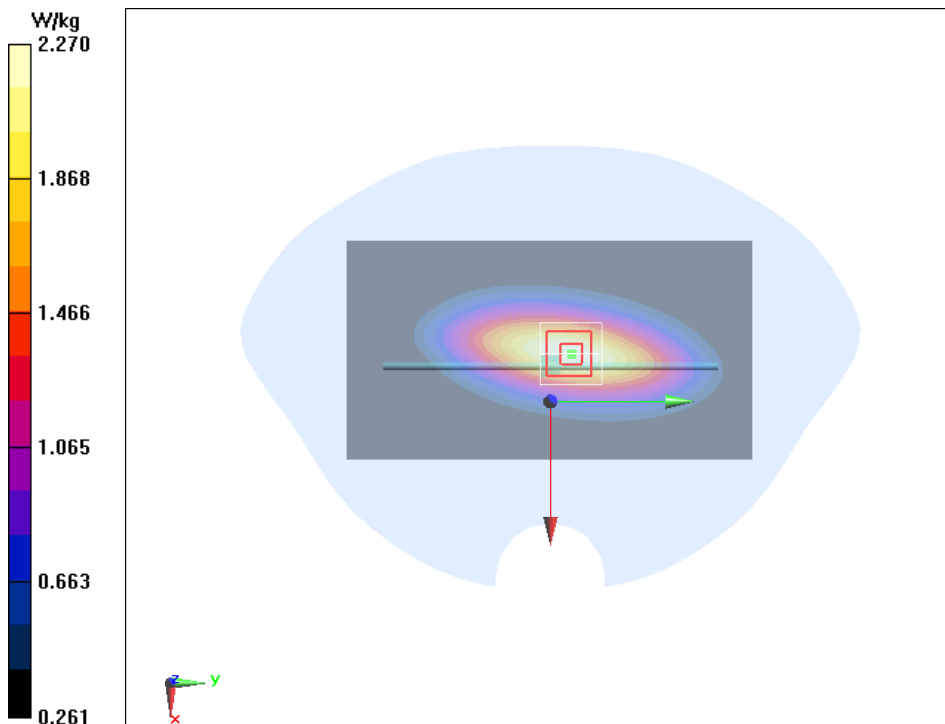

## Body 835MHz

Date/Time: 2019/7/29

Electronics: DAE4 Sn1244

Medium parameters used:  $f = 835 \text{ MHz}$ ;  $\sigma = 0.998 \text{ S/m}$ ;  $\epsilon_r = 56.715$ ;  $\rho = 1000 \text{ kg/m}^3$

Ambient Temperature:  $22.5 \text{ }^\circ\text{C}$       Liquid Temperature:  $22.5 \text{ }^\circ\text{C}$

Communication System: CW 835MHz;    Frequency: 835 MHz; Duty Cycle: 1:1

Probe: ES3DV3 - SN3252ConvF(6.34, 6.34, 6.34); Calibrated: 9/4/2018

### System Validation /Area Scan (61x131x1):

Measurement grid:  $dx=10 \text{ mm}$ ,  $dy=10 \text{ mm}$

Maximum value of SAR (Measurement) =  $2.72 \text{ W/kg}$

### System Validation /Zoom Scan (7x7x7)/Cube 0:

Measurement grid:  $dx=5\text{mm}$ ,  $dy=5\text{mm}$ ,  $dz=5\text{mm}$

Reference Value =  $51.46 \text{ V/m}$ ; Power Drift =  $0.04 \text{ dB}$

Peak SAR (extrapolated) =  $3.73 \text{ W/kg}$

SAR(1 g) =  $2.54 \text{ W/kg}$ ; SAR(10 g) =  $1.66 \text{ W/kg}$

Maximum value of SAR (measured) =  $2.74 \text{ W/kg}$

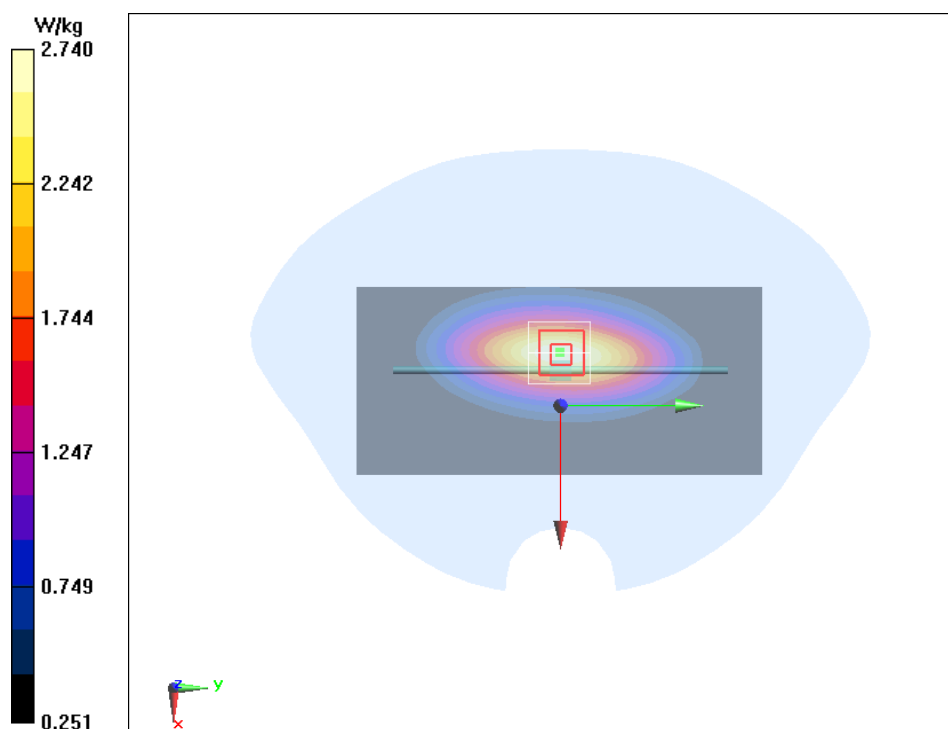

## Body 1750MHz

Date/Time: 2019/7/30

Electronics: DAE4 Sn1244

Medium parameters used:  $f = 1750 \text{ MHz}$ ;  $\sigma = 1.435 \text{ S/m}$ ;  $\epsilon_r = 55.141$ ;  $\rho = 1000 \text{ kg/m}^3$

Ambient Temperature:  $22.5 \text{ }^\circ\text{C}$       Liquid Temperature:  $22.5 \text{ }^\circ\text{C}$

Communication System: CW 1800MHz;    Frequency: 1750 MHz; Duty Cycle: 1:1

Probe: ES3DV3 - SN3252ConvF(4.99, 4.99, 4.99); Calibrated: 9/4/2018

### System check Validation/Area Scan (61x61x1):

Measurement grid:  $dx=10 \text{ mm}$ ,  $dy=10 \text{ mm}$

Maximum value of SAR (Measurement) =  $10.7 \text{ W/kg}$

### System check Validation/Zoom Scan (7x7x7) (7x7x7)/Cube 0:

Measurement grid:  $dx=5\text{mm}$ ,  $dy=5\text{mm}$ ,  $dz=5\text{mm}$

Reference Value =  $85.83 \text{ V/m}$ ; Power Drift =  $0.02 \text{ dB}$

Peak SAR (extrapolated) =  $16.1 \text{ W/kg}$

SAR(1 g) =  $9.15 \text{ W/kg}$ ; SAR(10 g) =  $4.98 \text{ W/kg}$

Maximum value of SAR (measured) =  $10.2 \text{ W/kg}$

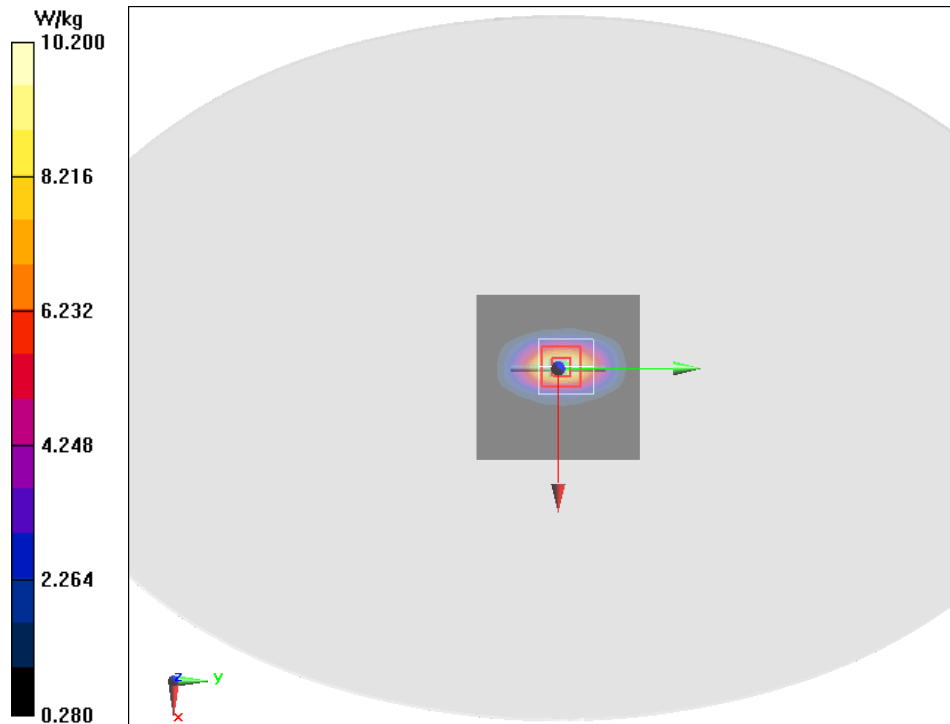

## Body 1900MHz

Date/Time: 2019/7/31

Electronics: DAE4 Sn1244

Medium parameters used:  $f = 1900 \text{ MHz}$ ;  $\sigma = 1.55 \text{ S/m}$ ;  $\epsilon_r = 51.929$ ;  $\rho = 1000 \text{ kg/m}^3$

Ambient Temperature:  $22.5 \text{ }^\circ\text{C}$       Liquid Temperature:  $22.5 \text{ }^\circ\text{C}$

Communication System: CW 1900MHz;    Frequency: 1900 MHz; Duty Cycle: 1:1

Probe: ES3DV3 - SN3252ConvF(4.77, 4.77, 4.77); Calibrated: 9/4/2018

### System check Validation /Area Scan (61x61x1):

Measurement grid:  $dx=10 \text{ mm}$ ,  $dy=10 \text{ mm}$

Maximum value of SAR (Measurement) =  $11.9 \text{ W/kg}$

### System check Validation /Zoom Scan (7x7x7) (7x7x7)/Cube 0:

Measurement grid:  $dx=5\text{mm}$ ,  $dy=5\text{mm}$ ,  $dz=5\text{mm}$

Reference Value =  $86.07 \text{ V/m}$ ; Power Drift =  $0.14 \text{ dB}$

Peak SAR (extrapolated) =  $19.3 \text{ W/kg}$

SAR(1 g) =  $10.4 \text{ W/kg}$ ; SAR(10 g) =  $5.41 \text{ W/kg}$

Maximum value of SAR (measured) =  $11.7 \text{ W/kg}$

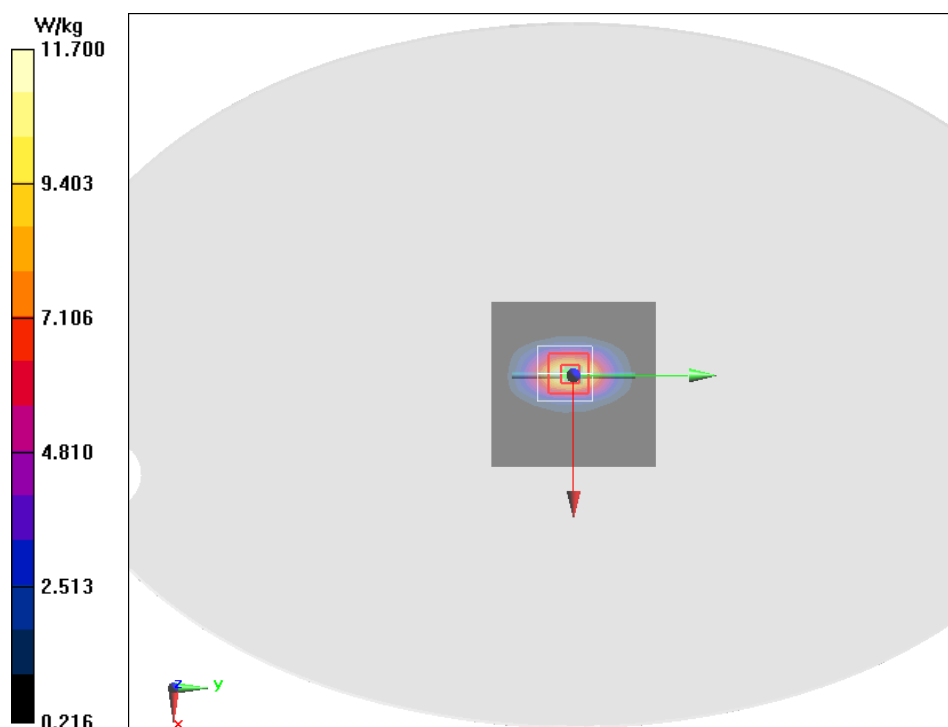



## Body 2450MHz

Date/Time: 2019/8/1

Electronics: DAE4 Sn1244

Medium parameters used:  $f = 2450 \text{ MHz}$ ;  $\sigma = 1.932 \text{ S/m}$ ;  $\epsilon_r = 54.12$ ;  $\rho = 1000 \text{ kg/m}^3$

Ambient Temperature:  $22.5 \text{ }^\circ\text{C}$       Liquid Temperature:  $22.5 \text{ }^\circ\text{C}$

Communication System: CW 2500MHz;    Frequency: 2450 MHz; Duty Cycle: 1:1

Probe: ES3DV3 - SN3252ConvF(4.41, 4.41, 4.41); Calibrated: 9/4/2018

### System Validation/Area Scan (91x71x1):

Measurement grid:  $dx=10 \text{ mm}$ ,  $dy=10 \text{ mm}$

Maximum value of SAR (Measurement) =  $15.8 \text{ W/kg}$

### System Validation/Zoom Scan (7x7x7) (7x7x7)/Cube 0:

Measurement grid:  $dx=5\text{mm}$ ,  $dy=5\text{mm}$ ,  $dz=5\text{mm}$

Reference Value =  $90.38 \text{ V/m}$ ; Power Drift =  $-0.08 \text{ dB}$

Peak SAR (extrapolated) =  $29.0 \text{ W/kg}$

SAR(1 g) =  $13.4 \text{ W/kg}$ ; SAR(10 g) =  $6.07 \text{ W/kg}$

Maximum value of SAR (measured) =  $15.1 \text{ W/kg}$

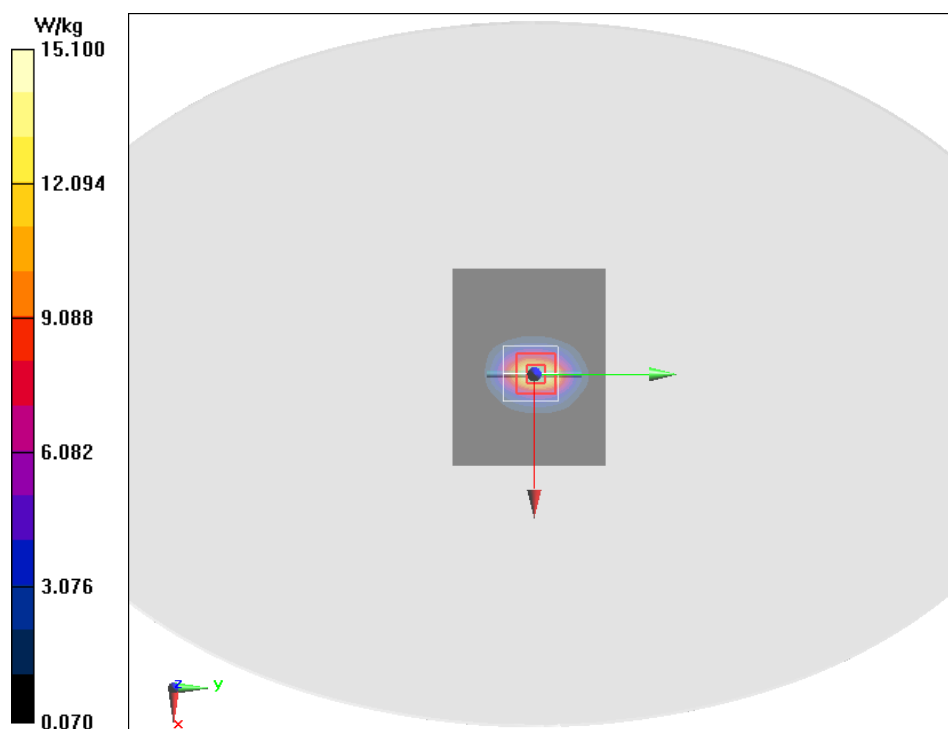

## Body 2600MHz

Date/Time: 2019/8/2

Electronics: DAE4 Sn1244

Medium parameters used:  $f = 2600 \text{ MHz}$ ;  $\sigma = 2.084 \text{ S/m}$ ;  $\epsilon_r = 51.75$ ;  $\rho = 1000 \text{ kg/m}^3$

Ambient Temperature:  $22.5 \text{ }^\circ\text{C}$       Liquid Temperature:  $22.5 \text{ }^\circ\text{C}$

Communication System: CW 2600MHz;    Frequency: 2600 MHz; Duty Cycle: 1:1

Probe: ES3DV3 - SN3252ConvF(4.19, 4.19, 4.19); Calibrated: 9/4/2018

### Body 2600MHz /Area Scan (101x101x1):

Measurement grid:  $dx=10 \text{ mm}$ ,  $dy=10 \text{ mm}$

Maximum value of SAR (Measurement) =  $16.1 \text{ W/kg}$

### Body 2600MHz /Zoom Scan (7x7x7)/Cube 0:

Measurement grid:  $dx=5\text{mm}$ ,  $dy=5\text{mm}$ ,  $dz=5\text{mm}$

Reference Value =  $85.68 \text{ V/m}$ ; Power Drift =  $0.04 \text{ dB}$

Peak SAR (extrapolated) =  $30.6 \text{ W/kg}$

SAR(1 g) =  $13.6 \text{ W/kg}$ ; SAR(10 g) =  $5.89 \text{ W/kg}$

Maximum value of SAR (measured) =  $15.7 \text{ W/kg}$

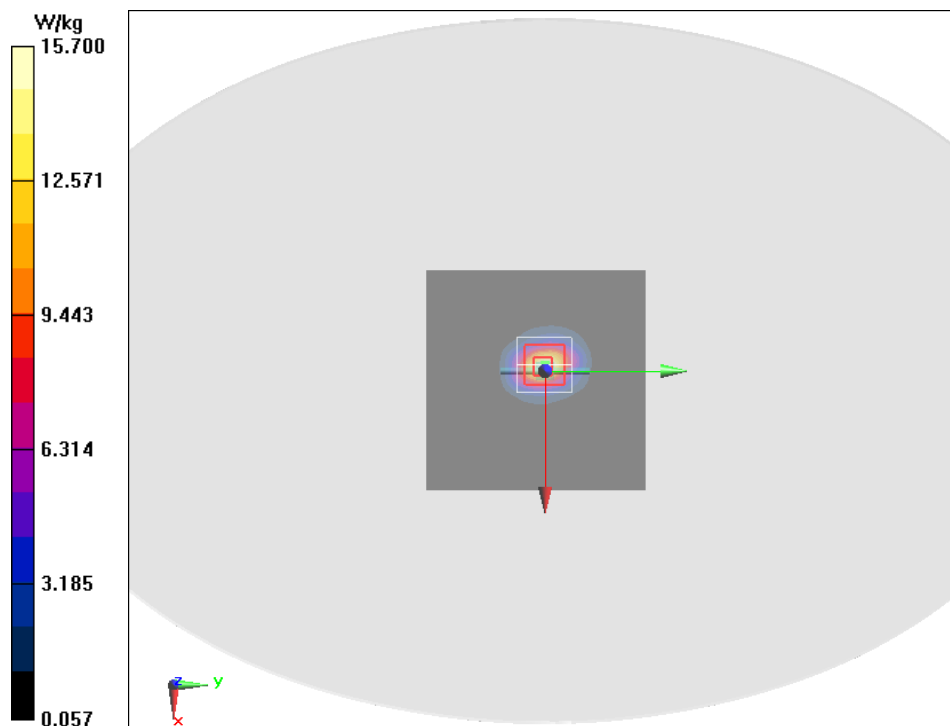

## Head 5500MHz

Date/Time: 2019/8/3

Electronics: DAE4 Sn1244

Medium parameters used:  $f = 5500 \text{ MHz}$ ;  $\sigma = 4.97 \text{ S/m}$ ;  $\epsilon_r = 36.592$ ;  $\rho = 1000 \text{ kg/m}^3$

Ambient Temperature:  $22.5 \text{ }^\circ\text{C}$       Liquid Temperature:  $22.5 \text{ }^\circ\text{C}$

Communication System: CW 5GHz;    Frequency: 5500 MHz; Duty Cycle: 1:1

Probe: EX3DV4 - SN7401ConvF(5.2, 5.2, 5.2); Calibrated: 1/15/2019

### System Validation 5500MHz/Area Scan (91x91x1):

Measurement grid:  $dx=10 \text{ mm}$ ,  $dy=10 \text{ mm}$

Maximum value of SAR (Measurement) =  $19.9 \text{ W/kg}$

### System Validation 5500MHz/Zoom Scan (4x4x1.4mm, graded), dist=1.4mm (7x7x7)/Cube 0:

Measurement grid:  $dx=4\text{mm}$ ,  $dy=4\text{mm}$ ,  $dz=1.4\text{mm}$

Reference Value =  $61.01 \text{ V/m}$ ; Power Drift =  $0.05 \text{ dB}$

Peak SAR (extrapolated) =  $36.5 \text{ W/kg}$

SAR(1 g) =  $7.71 \text{ W/kg}$ ; SAR(10 g) =  $2.15 \text{ W/kg}$

Maximum of SAR (measured) =  $20.7 \text{ W/kg}$

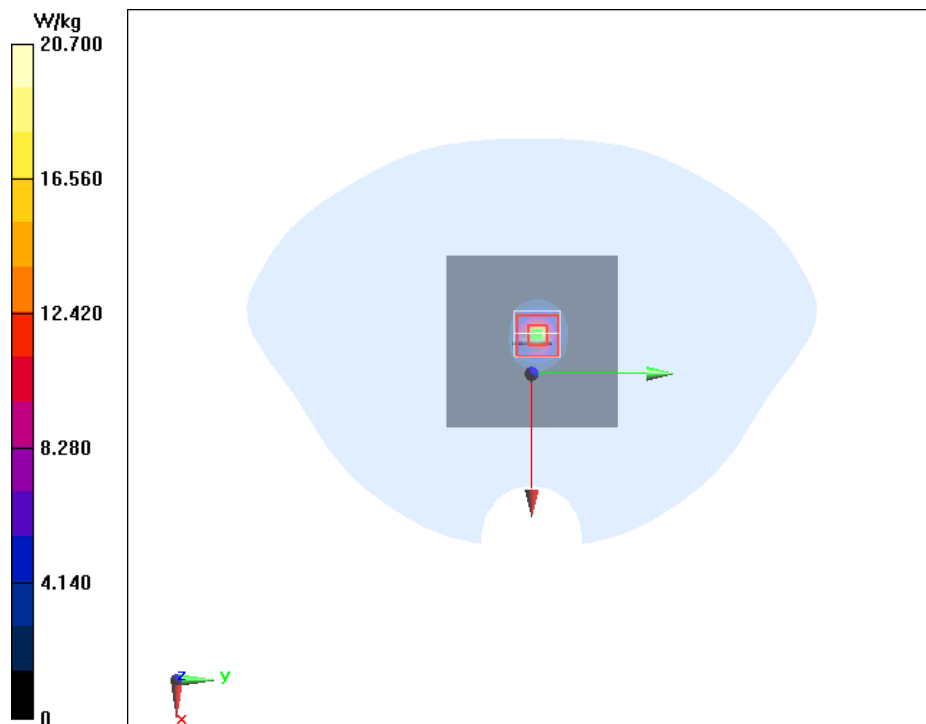

## Body 5500 MHz

Date/Time: 2019/8/3

Electronics: DAE4 Sn1244

Medium parameters used:  $f = 5500$  MHz;  $\sigma = 5.657$  S/m;  $\epsilon_r = 49.486$ ;  $\rho = 1000$  kg/m<sup>3</sup>

Ambient Temperature: 22.5 °C      Liquid Temperature: 22.5 °C

Communication System: CW 5GHz;    Frequency: 5500 MHz; Duty Cycle: 1:1

Probe: EX3DV4 - SN7401ConvF(4.66, 4.66, 4.66); Calibrated: 1/15/2019

### System Validation 5500 MHz/Area Scan (91x91x1):

Measurement grid: dx=10 mm, dy=10 mm

Maximum value of SAR (Measurement) = 19.0 W/kg

### System Validation 5500 MHz/Zoom Scan (4x4x1.4mm, graded), dist=1.4mm (7x7x7)/Cube 0:

Measurement grid: dx=4mm, dy=4mm, dz=1.4mm

Reference Value = 65.48 V/m; Power Drift = 0.01 dB

Peak SAR (extrapolated) = 34.7 W/kg

SAR(1 g) = 7.76 W/kg; SAR(10 g) = 2.15 W/kg

Maximum value of SAR (measured) = 20.7 W/kg

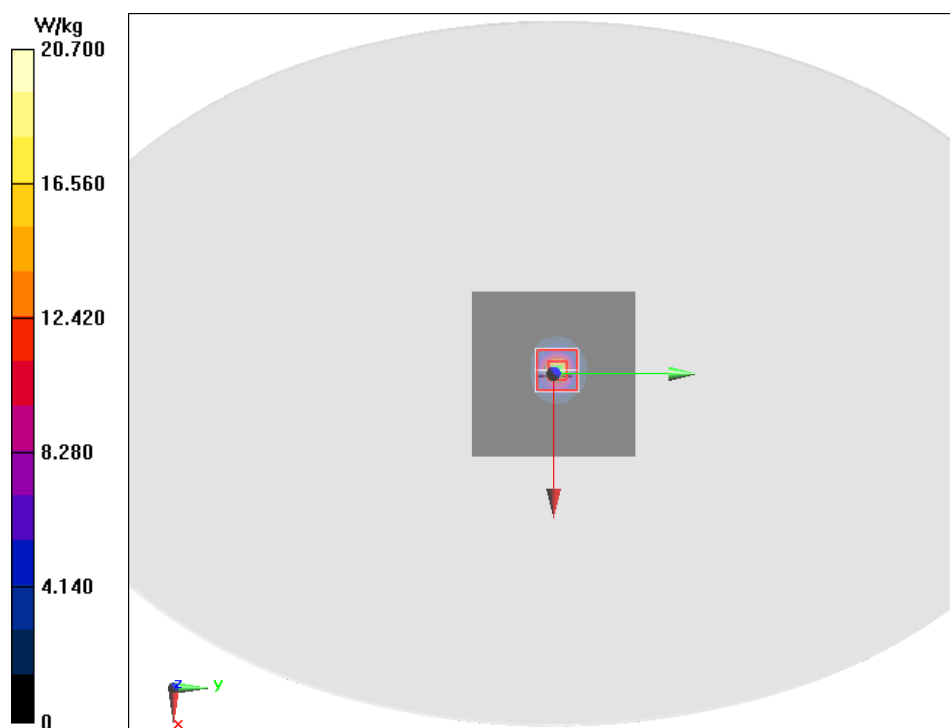

## Body 5800MHz

Date/Time: 2019/8/3

Electronics: DAE4 Sn1244

Medium parameters used:  $f = 5800 \text{ MHz}$ ;  $\sigma = 6.094 \text{ S/m}$ ;  $\epsilon_r = 48.844$ ;  $\rho = 1000 \text{ kg/m}^3$

Ambient Temperature:  $22.5 \text{ }^\circ\text{C}$       Liquid Temperature:  $22.5 \text{ }^\circ\text{C}$

Communication System: CW 5GHz;    Frequency: 5800 MHz; Duty Cycle: 1:1

Probe: EX3DV4 - SN7401ConvF(4.69, 4.69, 4.69); Calibrated: 1/15/2019

### System Validation /Area Scan (91x91x1):

Measurement grid:  $dx=10 \text{ mm}$ ,  $dy=10 \text{ mm}$

Maximum value of SAR (Measurement) =  $18.1 \text{ W/kg}$

### System Validation /Zoom Scan (4x4x1.4mm, graded), dist=1.4mm (7x7x7)/Cube 0:

Measurement grid:  $dx=4\text{mm}$ ,  $dy=4\text{mm}$ ,  $dz=1.4\text{mm}$

Reference Value =  $60.59 \text{ V/m}$ ; Power Drift =  $0.07 \text{ dB}$

Peak SAR (extrapolated) =  $35.3 \text{ W/kg}$

SAR(1 g) =  $7.26 \text{ W/kg}$ ; SAR(10 g) =  $2 \text{ W/kg}$

Maximum value of SAR (measured) =  $20.1 \text{ W/kg}$

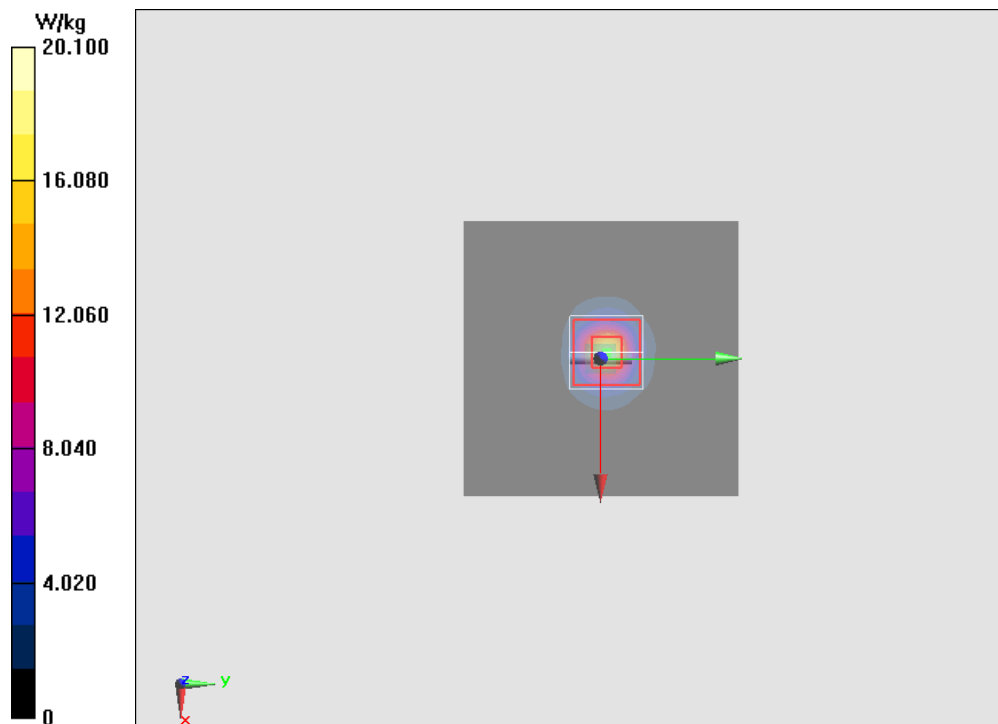

## ANNEX C. SAR Measurement Setup

### C.1. Measurement Set-up

The DASY5 system for performing compliance tests is illustrated above graphically. This system consists of the following items:

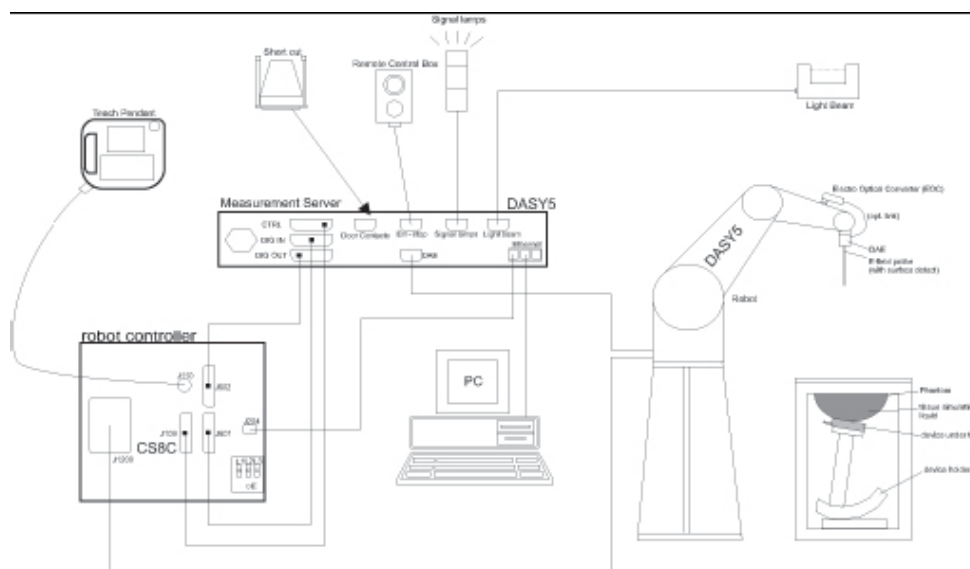

Picture C.1 SAR Lab Test Measurement Set-up

- A standard high precision 6-axis robot (Stäubli TX=RX family) with controller, teach pendant and software. An arm extension for accommodating the data acquisition electronics (DAE).
- An isotropic field probe optimized and calibrated for the targeted measurement.
- A data acquisition electronics (DAE) which performs the signal amplification, signal multiplexing, AD-conversion, offset measurements, mechanical surface detection, collision detection, etc. The unit is battery powered with standard or rechargeable batteries. The signal is optically transmitted to the EOC.
- The Electro-optical converter (EOC) performs the conversion from optical to electrical signals for the digital communication to the DAE. To use optical surface detection, a special version of the EOC is required. The EOC signal is transmitted to the measurement server.
- The function of the measurement server is to perform the time critical tasks such as signal filtering, control of the robot operation and fast movement interrupts.
- The Light Beam used is for probe alignment. This improves the (absolute) accuracy of the probe positioning.

- A computer running WinXP and the DASY5 software.
- Remote control and teach pendant as well as additional circuitry for robot safety such as
  - warning lamps, etc.
- The phantom, the device holder and other accessories according to the targeted measurement.

## C.2. DASY5 E-field Probe System

The SAR measurements were conducted with the dosimetric probe designed in the classical triangular configuration and optimized for dosimetric evaluation. The probe is constructed using the thick film technique; with printed resistive lines on ceramic substrates. The probe is equipped with an optical multifiber line ending at the front of the probe tip. It is connected to the EOC box on the robot arm and provides an automatic detection of the phantom surface. Half of the fibers are connected to a pulsed infrared transmitter, the other half to a synchronized receiver. As the probe approaches the surface, the reflection from the surface produces a coupling from the transmitting to the receiving fibers. This reflection increases first during the approach, reaches maximum and then decreases. If the probe is flatly touching the surface, the coupling is zero. The distance of the coupling maximum to the surface is independent of the surface reflectivity and largely independent of the surface to probe angle. The DASY5 software reads the reflection during a software approach and looks for the maximum using 2<sup>nd</sup> order curve fitting. The approach is stopped at reaching the maximum.

### Probe Specifications:

<b>Model:</b>	<b>ES3DV3,EX3DV4</b>
<b>Frequency</b>	<b>10MHz — 6GHz(EX3DV4)</b>
<b>Range:</b>	<b>10MHz — 4GHz(ES3DV3)</b>
<b>Calibration:</b>	<b>In head and body simulating tissue at Frequencies from 835 up to 5800MHz</b>
<b>Linearity:</b>	<b>± 0.2 dB(30 MHz to 4 GHz) for ES3DV3 ± 0.2 dB(30 MHz to 6 GHz) for EX3DV4</b>
<b>Dynamic Range:</b>	<b>10 mW/kg — 100W/kg</b>
<b>Probe Length:</b>	<b>330 mm</b>
<b>Probe Tip</b>	
<b>Length:</b>	<b>20 mm</b>
<b>Body Diameter:</b>	<b>12 mm</b>
<b>Tip Diameter:</b>	<b>2.5 mm (3.9 mm for ES3DV3)</b>
<b>Tip-Center:</b>	<b>1 mm (2.0mm for ES3DV3)</b>
<b>Application:</b>	<b>SAR Dosimetry Testing Compliance tests of mobile phones Dosimetry in strong gradient fields</b>



Picture7-2 Near-field Probe



Picture 7-3 E-field Probe

## C.3. E-field Probe Calibration

Each E-Probe/Probe Amplifier combination has unique calibration parameters. A TEM cell calibration procedure is conducted to determine the proper amplifier settings to enter in



the probe parameters. The amplifier settings are determined for a given frequency by subjecting the probe to a known E-field density (1 mW/cm<sup>2</sup>) using an RF Signal generator, TEM cell, and RF Power Meter.

The free space E-field from amplified probe outputs is determined in a test chamber. This calibration can be performed in a TEM cell if the frequency is below 1 GHz and in a waveguide or other methodologies above 1 GHz for free space. For the free space calibration, the probe is placed in the volumetric center of the cavity and at the proper orientation with the field. The probe is then rotated 360 degrees until the three channels show the maximum reading. The power density readings equate to 1 mW/cm<sup>2</sup>. E-field temperature correlation calibration is performed in a flat phantom filled with the appropriate simulated brain tissue. The E-field in the medium correlates with the temperature rise in the dielectric medium. For temperature correlation calibration a RF transparent thermistor-based temperature probe is used in conjunction with the E-field probe.

$$SAR = C \frac{\Delta T}{\Delta t}$$

Where:

$\Delta t$  = Exposure time (30 seconds),

C = Heat capacity of tissue (brain or muscle),

$\Delta T$  = Temperature increase due to RF exposure.

$$SAR = \frac{|E|^2 \cdot \sigma}{\rho}$$

Where:

$\sigma$  = Simulated tissue conductivity,

$\rho$  = Tissue density (kg/m<sup>3</sup>).

## **C.4. Other Test Equipment**

### **C.4.1. Data Acquisition Electronics(DAE)**

The data acquisition electronics consist of a highly sensitive electrometer-grade preamplifier with auto-zeroing, a channel and gain-switching multiplexer, a fast 16 bit AD-converter and a command decoder with a control logic unit. Transmission to the measurement server is accomplished through an optical downlink for data and status information, as well as an optical uplink for commands and the clock.

The mechanical probe mounting device includes two different sensor systems for frontal and sideways probe contacts. They are used for mechanical surface detection and probe collision detection.

The input impedance of the DAE is 200 MOhm; the inputs are symmetrical and floating. Common mode rejection is above 80 dB.



**PictureC.4: DAE**

### C.4.2. Robot

The SPEAG DASY system uses the high precision robots (DASY5: RX90L) type from Stäubli SA (France). For the 6-axis controller system, the robot controller version from Stäubli is used. The Stäubli robot series have many features that are important for our application:

- High precision (repeatability 0.02mm)
- High reliability (industrial design)
- Low maintenance costs (virtually maintenance free due to direct drive gears; no belt drives)
- Jerk-free straight movements (brushless synchron motors; no stepper motors)
- Low ELF interference (motor control fields shielded via the closed metallic construction shields)



**Picture C.5 DASY 5**

### C.4.3. Measurement Server

The Measurement server is based on a PC/104 CPU board with CPU (DASY5: 400 MHz, Intel Celeron), chipdisk (DASY5: 128MB), RAM (DASY5: 128MB). The necessary circuits for communication with the DAE electronic box, as well as the 16 bit AD converter system

for optical detection and digital I/O interface are contained on the DASY I/O board, which is directly connected to the PC/104 bus of the CPU board.

The measurement server performs all real-time data evaluation of field measurements and surface detection, controls robot movements and handles safety operation. The PC operating system cannot interfere with these time critical processes. All connections are supervised by a watchdog, and disconnection of any of the cables to the measurement server will automatically disarm the robot and disable all program-controlled robot movements. Furthermore, the measurement server is equipped with an expansion port which is reserved for future applications. Please note that this expansion port does not have a standardized pinout, and therefore only devices provided by SPEAG can be connected. Devices from any other supplier could seriously damage the measurement server.



**Picture C.6 Server for DASY 5**

#### **C.4.4. Device Holder for Phantom**

The SAR in the phantom is approximately inversely proportional to the square of the distance between the source and the liquid surface. For a source at 5mm distance, a positioning uncertainty of  $\pm 0.5\text{mm}$  would produce a SAR uncertainty of  $\pm 20\%$ . Accurate device positioning is therefore crucial for accurate and repeatable measurements. The positions in which the devices must be measured are defined by the standards.

The DASY device holder is designed to cope with the different positions given in the standard. It has two scales for device rotation (with respect to the body axis) and device inclination (with respect to the line between the ear reference points). The rotation centers for both scales is the ear reference point (ERP).

Thus the device needs no repositioning when changing the angles.

The DASY device holder is constructed of low-loss POM material having the following dielectric parameters: relative permittivity  $\epsilon = 3$  and loss tangent  $\delta = 0.02$ . The amount of dielectric material has been reduced in the closest vicinity of the device, since

measurements have suggested that the influence of the clamp on the test results could thus be lowered.

<Laptop Extension Kit>

The extension is lightweight and made of POM, acrylic glass and foam. It fits easily on the upper part of the Mounting Device in place of the phone positioner. The extension is fully compatible with the Twin-SAM and ELI phantoms.



**Picture C.7: Device Holder**

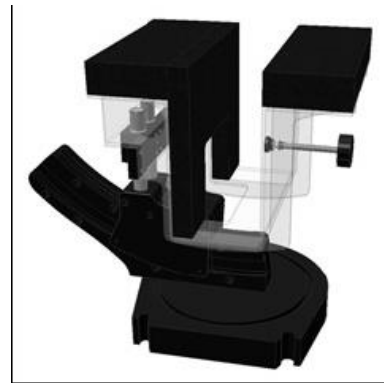

**Picture C.8: Laptop Extension Kit**

### C.4.5. Phantom

The SAM Twin Phantom V4.0 is constructed of a fiberglass shell integrated in a table. The shape of the shell is based on data from an anatomical study designed to represent the 90<sup>th</sup> percentile of the population. The phantom enables the dissymmetric evaluation of SAR for both left and right handed handset usage, as well as body-worn usage using the flat phantom region. Reference markings on the Phantom allow the complete setup of all predefined phantom positions and measurement grids by manually teaching three points in the robot. The shell phantom has a 2mm shell thickness (except the ear region where shell thickness increases to 6 mm).

Shell Thickness:  $2 \pm 0.2$  mm

Filling Volume: Approx. 25 liters

Dimensions: 810 x 1000 x 500 mm (H x L x W)

Available: Special



**Picture C.9: SAM Twin Phantom**

## ANNEX D. Position of the wireless device in relation to the phantom

### D.1. General considerations

This standard specifies two handset test positions against the head phantom – the “cheek” position and the “tilt” position.

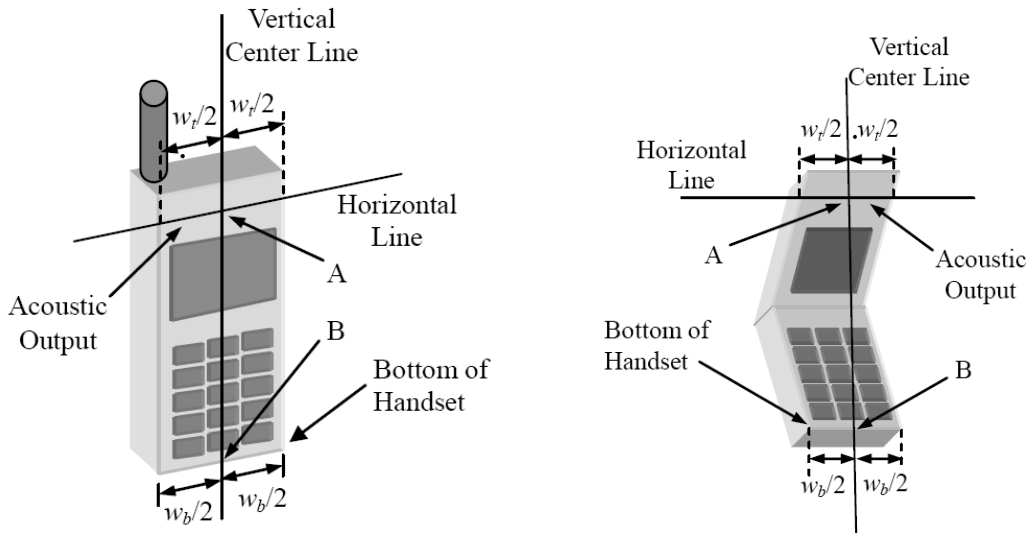

- $w_t$  Width of the handset at the level of the acoustic
- $w_b$  Width of the bottom of the handset
- A Midpoint of the width  $w_t$  of the handset at the level of the acoustic output
- B Midpoint of the width  $w_b$  of the bottom of the handset

Picture D.1-a Typical “fixed” case handset    Picture D.1-b Typical “clam-shell” case handset

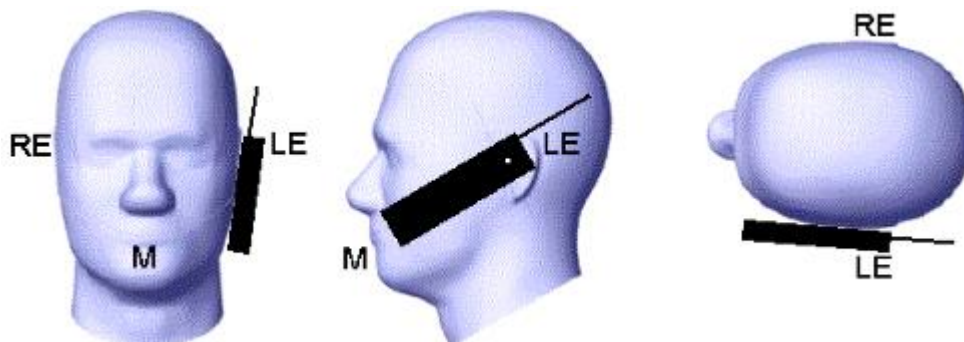

Picture D.2 Cheek position of the wireless device on the left side of SAM

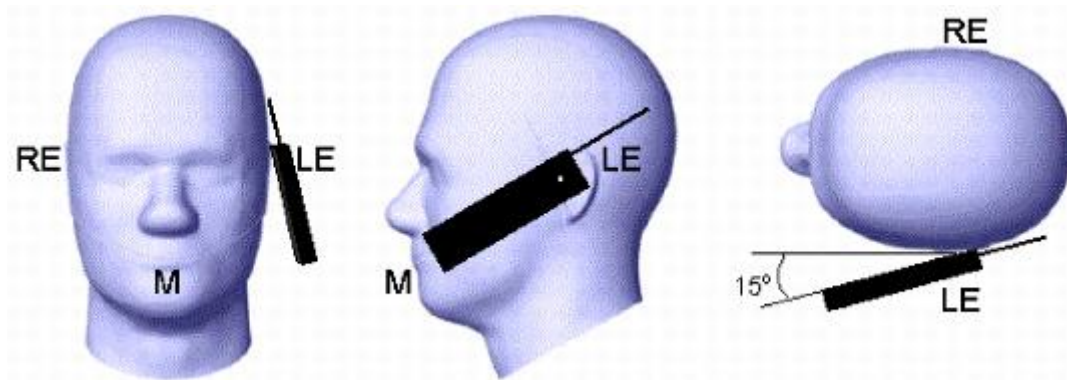

**Picture D.3 Tilt position of the wireless device on the left side of SAM**

### D.2. Body-worn device

A typical example of a body-worn device is a mobile phone, wireless enabled PDA or other battery operated wireless device with the ability to transmit while mounted on a person's body using a carry accessory approved by the wireless device manufacturer.

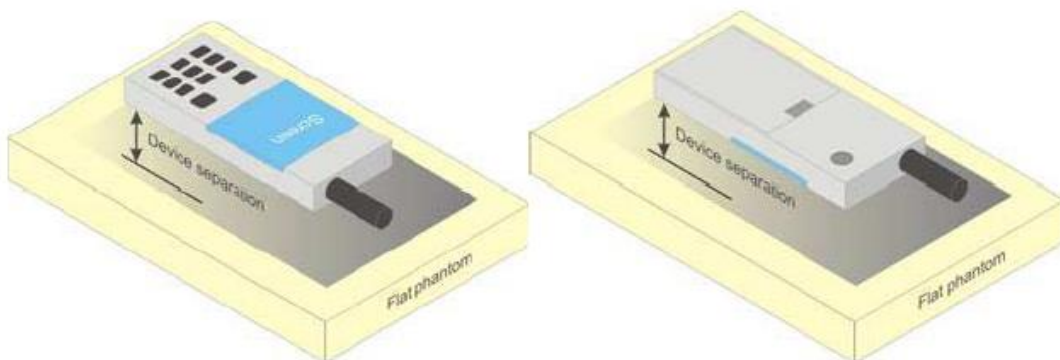

**Picture D.4 Test positions for body-worn devices**

### D.3. Desktop device

A typical example of a desktop device is a wireless enabled desktop computer placed on a table or desk when used.

The DUT shall be positioned at the distance and in the orientation to the phantom that corresponds to the intended use as specified by the manufacturer in the user instructions.

For devices that employ an external antenna with variable positions, tests shall be performed for all antenna positions specified. Picture 8.5 show positions for desktop device SAR tests. If the intended use is not specified, the device shall be tested directly against the flat phantom.



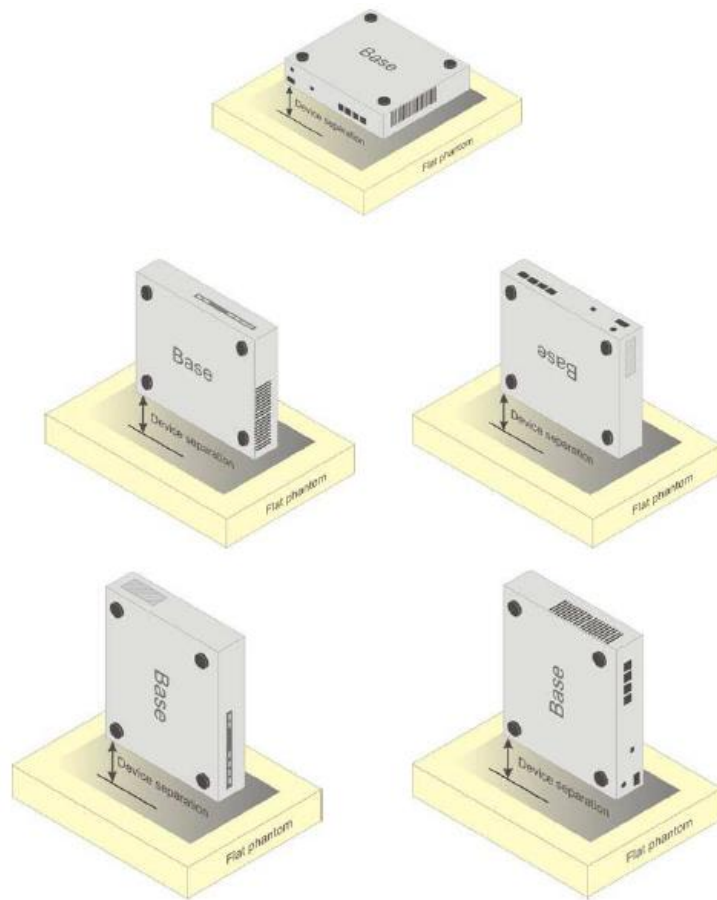

**Picture D.5 Test positions for desktop devices**

#### D.4. DUT Setup Photos



**Picture D.6 DSY5 system Set-up**

**Note:**

The photos of test sample and test positions show in additional document.

## ANNEX E. Equivalent Media Recipes

The liquid used for the frequency range of 800-3000 MHz consisted of water, sugar, salt, preventol, glycol monobutyl and Cellulose. The liquid has been previously proven to be suited for worst-case. The Table E.1 shows the detail solution. It's satisfying the latest tissue dielectric parameters requirements proposed by the IEEE 1528 and IEC 62209.

**Table E.1: Composition of the Tissue Equivalent Matter**

Frequency (MHz)	835 Head	835 Body	1900 Head	1900 Body	2450 Head	2450 Body
Ingredients (% by weight)						
Water	41.45	52.5	55.242	69.91	58.79	72.60
Sugar	56.0	45.0	\	\	\	\
Salt	1.45	1.4	0.306	0.13	0.06	0.18
Preventol	0.1	0.1	\	\	\	\
Cellulose	1.0	1.0	\	\	\	\
Glycol Monobutyl	\	\	44.452	29.96	41.15	27.22
Dielectric Parameters Target Value	$\epsilon=41.5$ $\sigma=0.90$	$\epsilon=55.2$ $\sigma=0.97$	$\epsilon=40.0$ $\sigma=1.40$	$\epsilon=53.3$ $\sigma=1.52$	$\epsilon=39.2$ $\sigma=1.80$	$\epsilon=52.7$ $\sigma=1.95$

## ANNEX F. System Validation

The SAR system must be validated against its performance specifications before it is deployed. When SAR probes, system components or software are changed, upgraded or recalibrated, these must be validated with the SAR system(s) that operates with such components.

**Table F.1: System Validation Part 1**

System No.	Probe SN.	Liquid name	Validation date	Frequency point	Permittivity $\epsilon$	Conductivity $\sigma$ (S/m)
1	3252	Body 750MHz	2019/7/28	750 MHz	57.696	0.915
2	3252	Body 835MHz	2019/7/29	835 MHz	56.715	0.998
3	3252	Body 1750MHz	2019/7/30	1800 MHz	54.985	1.488
4	3252	Body 1900MHz	2019/7/31	1900 MHz	51.929	1.550
5	3252	Body 2450MHz	2019/8/1	2450 MHz	54.120	1.932
6	3252	Body 2600MHz	2019/8/2	2600 MHz	51.750	2.084
7	7401	Body 5500MHz	2019/8/3	5500 MHz	49.486	5.657
8	7401	Body 5800MHz	2019/8/3	5800 MHz	48.844	6.090

**Table F.2: System Validation Part 2**

CW Validation	Sensitivity	PASS	PASS
	Probe linearity	PASS	PASS
	Probe Isotropy	PASS	PASS
Mod Validation	MOD.type	GMSK	GMSK
	MOD.type	OFDM	OFDM
	Duty factor	PASS	PASS
	PAR	PASS	PASS

## ANNEX G. Probe and DAE Calibration Certificate



Add: No.51 Xueyuan Road, Haidian District, Beijing, 100191, China  
 Tel: +86-10-62304633-2512 Fax: +86-10-62304633-2504  
 E-mail: cttl@chinattl.com [Http://www.chinattl.cn](http://www.chinattl.cn)



中国认可  
 国际互认  
 校准  
 CALIBRATION  
 CNAS L0570

 Client : **ECIT**

 Certificate No: **Z18-60529**

### CALIBRATION CERTIFICATE

Object: DAE4 - SN: 1244  
 Calibration Procedure(s): FF-Z11-002-01  
 Calibration Procedure for the Data Acquisition Electronics (DAEx)  
 Calibration date: December 03, 2018

This calibration Certificate documents the traceability to national standards, which realize the physical units of measurements(SI). The measurements and the uncertainties with confidence probability are given on the following pages and are part of the certificate.

All calibrations have been conducted in the closed laboratory facility: environment temperature(22±3)°C and humidity<70%.

Calibration Equipment used (M&TE critical for calibration)

Primary Standards	ID #	Cal Date(Calibrated by, Certificate No.)	Scheduled Calibration
Process Calibrator 753	1971018	20-Jun-18 (CTTL, No.J18X05034)	June-19

	Name	Function	Signature
Calibrated by:	Yu Zongying	SAR Test Engineer	
Reviewed by:	Lin Hao	SAR Test Engineer	
Approved by:	Qi Dianyuan	SAR Project Leader	

Issued: December 05, 2018

This calibration certificate shall not be reproduced except in full without written approval of the laboratory.



Add: No.51 Xueyuan Road, Haidian District, Beijing, 100191, China  
Tel: +86-10-62304633-2512 Fax: +86-10-62304633-2504  
E-mail: [ctl@chinatl.com](mailto:ctl@chinatl.com) [Http://www.chinatl.cn](http://www.chinatl.cn)

**Glossary:**

DAE data acquisition electronics  
Connector angle information used in DASY system to align probe sensor X to the robot coordinate system.

**Methods Applied and Interpretation of Parameters:**

- *DC Voltage Measurement:* Calibration Factor assessed for use in DASY system by comparison with a calibrated instrument traceable to national standards. The figure given corresponds to the full scale range of the voltmeter in the respective range.
- *Connector angle:* The angle of the connector is assessed measuring the angle mechanically by a tool inserted. Uncertainty is not required.
- The report provide only calibration results for DAE, it does not contain other performance test results.



Add: No.51 Xueyuan Road, Haidian District, Beijing, 100191, China  
Tel: +86-10-62304633-2512 Fax: +86-10-62304633-2504  
E-mail: cttl@chinattl.com Http://www.chinattl.cn

### DC Voltage Measurement

A/D - Converter Resolution nominal

High Range: 1LSB = 6.1 $\mu$ V, full range = -100...+300 mV

Low Range: 1LSB = 61nV, full range = -1.....+3mV

DASY measurement parameters: Auto Zero Time: 3 sec; Measuring time: 3 sec

Calibration Factors	X	Y	Z
High Range	403.818 $\pm$ 0.15% (k=2)	403.555 $\pm$ 0.15% (k=2)	404.470 $\pm$ 0.15% (k=2)
Low Range	3.95395 $\pm$ 0.7% (k=2)	3.97087 $\pm$ 0.7% (k=2)	3.97994 $\pm$ 0.7% (k=2)

### Connector Angle

Connector Angle to be used in DASY system	22.5° $\pm$ 1°
---	----------------



Client **ECIT** Certificate No: **Z18-60343**

CALIBRATION CERTIFICATE				
Object	ES3DV3 - SN:3252			
Calibration Procedure(s)	FF-Z11-004-01 Calibration Procedures for Dosimetric E-field Probes			
Calibration date:	September 04, 2018			
<p>This calibration Certificate documents the traceability to national standards, which realize the physical units of measurements(SI). The measurements and the uncertainties with confidence probability are given on the following pages and are part of the certificate.</p> <p>All calibrations have been conducted in the closed laboratory facility: environment temperature(22±3)°C and humidity&lt;70%.</p> <p>Calibration Equipment used (M&amp;TE critical for calibration)</p>				
Primary Standards	ID #	Cal Date(Calibrated by, Certificate No.)		Scheduled Calibration
Power Meter NRP2	101919	20-Jun-18 (CTTL, No.J18X05032)		Jun-19
Power sensor NRP-Z91	101547	20-Jun-18 (CTTL, No.J18X05032)		Jun-19
Power sensor NRP-Z91	101548	20-Jun-18 (CTTL, No.J18X05032)		Jun-19
Reference10dBAttenuator	18N50W-10dB	09-Feb-18(CTTL, No.J18X01133)		Feb-20
Reference20dBAttenuator	18N50W-20dB	09-Feb-18(CTTL, No.J18X01132)		Feb-20
Reference Probe EX3DV4	SN 3846	25-Jan-18(SPEAG,No.EX3-3846_Jan18)		Jan-19
DAE4	SN 777	15-Dec-17(SPEAG, No.DAE4-777_Dec17)		Dec -18
Secondary Standards	ID #	Cal Date(Calibrated by, Certificate No.)		Scheduled Calibration
SignalGeneratorMG3700A	6201052605	21-Jun-18 (CTTL, No.J18X05033)		Jun-19
Network Analyzer E5071C	MY46110673	14-Jan-18 (CTTL, No.J18X00561)		Jan -19
Calibrated by:	Name	Function	Signature	
	Yu Zongying	SAR Test Engineer		
Reviewed by:	Lin Hao	SAR Test Engineer		
Approved by:	Qi Dianyuan	SAR Project Leader		
Issued: September 06, 2018				
This calibration certificate shall not be reproduced except in full without written approval of the laboratory.				





Add: No.51 Xueyuan Road, Haidian District, Beijing, 100191, China  
 Tel: +86-10-62304633-2512 Fax: +86-10-62304633-2504  
 E-mail: cttl@chinattl.com [Http://www.chinattl.cn](http://www.chinattl.cn)

**Glossary:**

TSL	tissue simulating liquid
NORM <sub>x,y,z</sub>	sensitivity in free space
ConvF	sensitivity in TSL / NORM <sub>x,y,z</sub>
DCP	diode compression point
CF	crest factor (1/duty_cycle) of the RF signal
A,B,C,D	modulation dependent linearization parameters
Polarization $\Phi$	$\Phi$ rotation around probe axis
Polarization $\theta$	$\theta$ rotation around an axis that is in the plane normal to probe axis (at measurement center), i $\theta=0$ is normal to probe axis
Connector Angle	information used in DASY system to align probe sensor X to the robot coordinate system

**Calibration is Performed According to the Following Standards:**

- a) IEEE Std 1528-2013, "IEEE Recommended Practice for Determining the Peak Spatial-Averaged Specific Absorption Rate (SAR) in the Human Head from Wireless Communications Devices: Measurement Techniques", June 2013
- b) IEC 62209-1, "Measurement procedure for the assessment of Specific Absorption Rate (SAR) from hand-held and body-mounted devices used next to the ear (frequency range of 300 MHz to 6 GHz)", July 2016
- c) IEC 62209-2, "Procedure to determine the Specific Absorption Rate (SAR) for wireless communication devices used in close proximity to the human body (frequency range of 30 MHz to 6 GHz)", March 2010
- d) KDB 865664, "SAR Measurement Requirements for 100 MHz to 6 GHz"

**Methods Applied and Interpretation of Parameters:**

- NORM<sub>x,y,z</sub>: Assessed for E-field polarization  $\theta=0$  ( $f \leq 900\text{MHz}$  in TEM-cell;  $f > 1800\text{MHz}$ : waveguide). NORM<sub>x,y,z</sub> are only intermediate values, i.e., the uncertainties of NORM<sub>x,y,z</sub> does not effect the  $E^2$ -field uncertainty inside TSL (see below ConvF).
- NORM( $f$ )<sub>x,y,z</sub> = NORM<sub>x,y,z</sub> \* frequency\_response (see Frequency Response Chart). This linearization is implemented in DASY4 software versions later than 4.2. The uncertainty of the frequency response is included in the stated uncertainty of ConvF.
- DCP<sub>x,y,z</sub>: DCP are numerical linearization parameters assessed based on the data of power sweep (no uncertainty required). DCP does not depend on frequency nor media.
- PAR: PAR is the Peak to Average Ratio that is not calibrated but determined based on the signal characteristics.
- A<sub>x,y,z</sub>; B<sub>x,y,z</sub>; C<sub>x,y,z</sub>; VR<sub>x,y,z</sub>: A,B,C are numerical linearization parameters assessed based on the data of power sweep for specific modulation signal. The parameters do not depend on frequency nor media. VR is the maximum calibration range expressed in RMS voltage across the diode.
- ConvF and Boundary Effect Parameters: Assessed in flat phantom using E-field (or Temperature Transfer Standard for  $f \leq 800\text{MHz}$ ) and inside waveguide using analytical field distributions based on power measurements for  $f > 800\text{MHz}$ . The same setups are used for assessment of the parameters applied for boundary compensation (alpha, depth) of which typical uncertainty valued are given. These parameters are used in DASY4 software to improve probe accuracy close to the boundary. The sensitivity in TSL corresponds to NORM<sub>x,y,z</sub>\* ConvF whereby the uncertainty corresponds to that given for ConvF. A frequency dependent ConvF is used in DASY version 4.4 and higher which allows extending the validity from  $\pm 50\text{MHz}$  to  $\pm 100\text{MHz}$ .
- Spherical isotropy (3D deviation from isotropy): in a field of low gradients realized using a flat phantom exposed by a patch antenna.
- Sensor Offset: The sensor offset corresponds to the offset of virtual measurement center from the probe tip (on probe axis). No tolerance required.
- Connector Angle: The angle is assessed using the information gained by determining the NORM<sub>x</sub> (no uncertainty required).



Add: No.51 Xueyuan Road, Haidian District, Beijing, 100191, China  
Tel: +86-10-62304633-2512 Fax: +86-10-62304633-2504  
E-mail: [cttl@chinattl.com](mailto:cttl@chinattl.com) [Http://www.chinattl.cn](http://www.chinattl.cn)

# Probe ES3DV3

## SN: 3252

Calibrated: September 04, 2018

Calibrated for DASY/EASY Systems

(Note: non-compatible with DASY2 system!)



Add: No.51 Xueyuan Road, Haidian District, Beijing, 100191, China  
 Tel: +86-10-62304633-2512 Fax: +86-10-62304633-2504  
 E-mail: cttl@chinattl.com [Http://www.chinattl.cn](http://www.chinattl.cn)

## DASY/EASY – Parameters of Probe: ES3DV3 - SN: 3252

### Basic Calibration Parameters

	Sensor X	Sensor Y	Sensor Z	Unc (k=2)
Norm( $\mu\text{V}/(\text{V}/\text{m})^2$ ) <sup>A</sup>	1.29	1.35	1.33	$\pm 10.0\%$
DCP(mV) <sup>B</sup>	102.7	105.4	103.6	

### Modulation Calibration Parameters

UID	Communication System Name		A dB	B dB $\sqrt{\mu\text{V}}$	C	D dB	VR mV	Unc <sup>E</sup> (k=2)
0	CW	X	0.0	0.0	1.0	0.00	268.8	$\pm 2.5\%$
		Y	0.0	0.0	1.0		276.1	
		Z	0.0	0.0	1.0		278.3	

The reported uncertainty of measurement is stated as the standard uncertainty of Measurement multiplied by the coverage factor k=2, which for a normal distribution Corresponds to a coverage probability of approximately 95%.

<sup>A</sup> The uncertainties of Norm X, Y, Z do not affect the E<sup>2</sup>-field uncertainty inside TSL (see Page 5 and Page 6).

<sup>B</sup> Numerical linearization parameter: uncertainty not required.

<sup>E</sup> Uncertainty is determined using the max. deviation from linear response applying rectangular distribution and is expressed for the square of the field value.



Add: No.51 Xueyuan Road, Haidian District, Beijing, 100191, China  
 Tel: +86-10-62304633-2512 Fax: +86-10-62304633-2504  
 E-mail: cttl@chinattl.com [Http://www.chinattl.cn](http://www.chinattl.cn)

## DASY/EASY – Parameters of Probe: ES3DV3 - SN: 3252

### Calibration Parameter Determined in Head Tissue Simulating Media

f [MHz] <sup>C</sup>	Relative Permittivity <sup>F</sup>	Conductivity (S/m) <sup>F</sup>	ConvF X	ConvF Y	ConvF Z	Alpha <sup>G</sup>	Depth <sup>G</sup> (mm)	Unct. (k=2)
750	41.9	0.89	6.51	6.51	6.51	0.40	1.42	± 12.1%
835	41.5	0.90	6.36	6.36	6.36	0.40	1.56	± 12.1%
900	41.5	0.97	6.31	6.31	6.31	0.45	1.48	± 12.1%
1750	40.1	1.37	5.39	5.39	5.39	0.61	1.28	± 12.1%
1900	40.0	1.40	5.18	5.18	5.18	0.67	1.26	± 12.1%
2000	40.0	1.40	5.17	5.17	5.17	0.71	1.20	± 12.1%
2300	39.5	1.67	4.92	4.92	4.92	0.90	1.14	± 12.1%
2450	39.2	1.80	4.74	4.74	4.74	0.90	1.15	± 12.1%
2600	39.0	1.96	4.46	4.46	4.46	0.72	1.37	± 12.1%

<sup>C</sup> Frequency validity above 300 MHz of ±100MHz only applies for DASY v4.4 and higher (Page 2), else it is restricted to ±50MHz. The uncertainty is the RSS of ConvF uncertainty at calibration frequency and the uncertainty for the indicated frequency band. Frequency validity below 300 MHz is ± 10, 25, 40, 50 and 70 MHz for ConvF assessments at 30, 64, 128, 150 and 220 MHz respectively. Above 5 GHz frequency validity can be extended to ± 110 MHz.

<sup>F</sup> At frequency below 3 GHz, the validity of tissue parameters ( $\epsilon$  and  $\sigma$ ) can be relaxed to ±10% if liquid compensation formula is applied to measured SAR values. At frequencies above 3 GHz, the validity of tissue parameters ( $\epsilon$  and  $\sigma$ ) is restricted to ±5%. The uncertainty is the RSS of the ConvF uncertainty for indicated target tissue parameters.

<sup>G</sup> Alpha/Depth are determined during calibration. SPEAG warrants that the remaining deviation due to the boundary effect after compensation is always less than ± 1% for frequencies below 3 GHz and below ± 2% for the frequencies between 3-6 GHz at any distance larger than half the probe tip diameter from the boundary.



Add: No.51 Xueyuan Road, Haidian District, Beijing, 100191, China  
 Tel: +86-10-62304633-2512 Fax: +86-10-62304633-2504  
 E-mail: cttl@chinattl.com [Http://www.chinattl.cn](http://www.chinattl.cn)

## DASY/EASY – Parameters of Probe: ES3DV3 - SN: 3252

### Calibration Parameter Determined in Body Tissue Simulating Media

f [MHz] <sup>C</sup>	Relative Permittivity <sup>F</sup>	Conductivity (S/m) <sup>F</sup>	ConvF X	ConvF Y	ConvF Z	Alpha <sup>G</sup>	Depth <sup>G</sup> (mm)	Unct. (k=2)
750	55.5	0.96	6.53	6.53	6.53	0.40	1.50	±12.1%
835	55.2	0.97	6.34	6.34	6.34	0.42	1.58	±12.1%
900	55.0	1.05	6.29	6.29	6.29	0.47	1.51	±12.1%
1750	53.4	1.49	4.99	4.99	4.99	0.65	1.28	±12.1%
1900	53.3	1.52	4.77	4.77	4.77	0.75	1.23	±12.1%
2000	53.3	1.52	4.95	4.95	4.95	0.67	1.28	±12.1%
2300	52.9	1.81	4.63	4.63	4.63	0.90	1.15	±12.1%
2450	52.7	1.95	4.41	4.41	4.41	0.90	1.17	±12.1%
2600	52.5	2.16	4.19	4.19	4.19	0.90	1.15	±12.1%

<sup>C</sup> Frequency validity above 300 MHz of ±100MHz only applies for DASY v4.4 and higher (Page 2), else it is restricted to ±50MHz. The uncertainty is the RSS of ConvF uncertainty at calibration frequency and the uncertainty for the indicated frequency band. Frequency validity below 300 MHz is ± 10, 25, 40, 50 and 70 MHz for ConvF assessments at 30, 64, 128, 150 and 220 MHz respectively. Above 5 GHz frequency validity can be extended to ± 110 MHz.

<sup>F</sup> At frequency below 3 GHz, the validity of tissue parameters ( $\epsilon$  and  $\sigma$ ) can be relaxed to ±10% if liquid compensation formula is applied to measured SAR values. At frequencies above 3 GHz, the validity of tissue parameters ( $\epsilon$  and  $\sigma$ ) is restricted to ±5%. The uncertainty is the RSS of the ConvF uncertainty for indicated target tissue parameters.

<sup>G</sup> Alpha/Depth are determined during calibration. SPEAG warrants that the remaining deviation due to the boundary effect after compensation is always less than ± 1% for frequencies below 3 GHz and below ± 2% for the frequencies between 3-6 GHz at any distance larger than half the probe tip diameter from the boundary.



Add: No.51 Xueyuan Road, Haidian District, Beijing, 100191, China  
 Tel: +86-10-62304633-2512 Fax: +86-10-62304633-2504  
 E-mail: cttl@chinattl.com [Http://www.chinattl.cn](http://www.chinattl.cn)

### Frequency Response of E-Field (TEM-Cell: ifi110 EXX, Waveguide: R22)

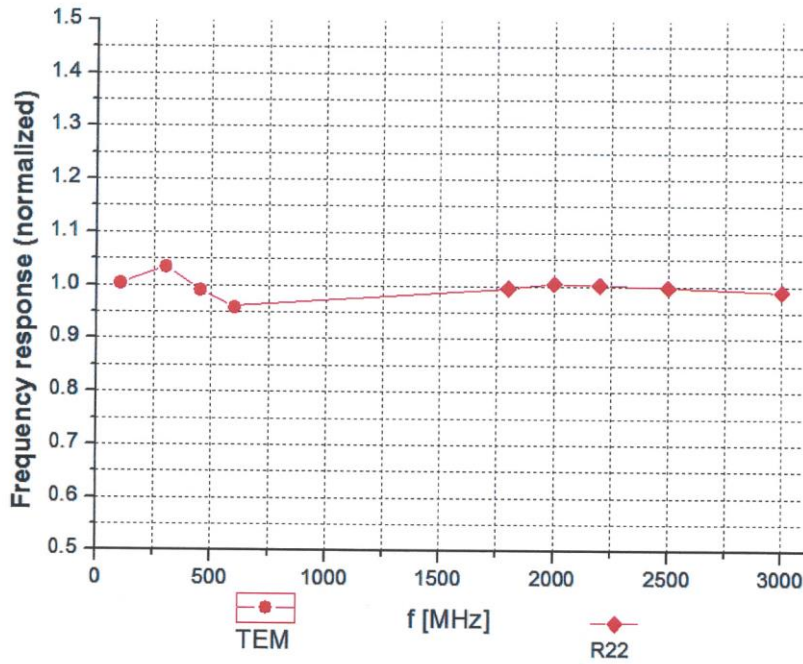

Uncertainty of Frequency Response of E-field:  $\pm 7.4\%$  (k=2)



Add: No.51 Xueyuan Road, Haidian District, Beijing, 100191, China  
Tel: +86-10-62304633-2512 Fax: +86-10-62304633-2504  
E-mail: cttl@chinattl.com [Http://www.chinattl.cn](http://www.chinattl.cn)

**Receiving Pattern ( $\Phi$ ),  $\theta=0^\circ$**

**f=600 MHz, TEM**

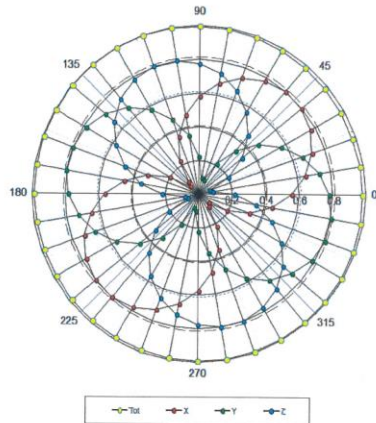

**f=1800 MHz, R22**

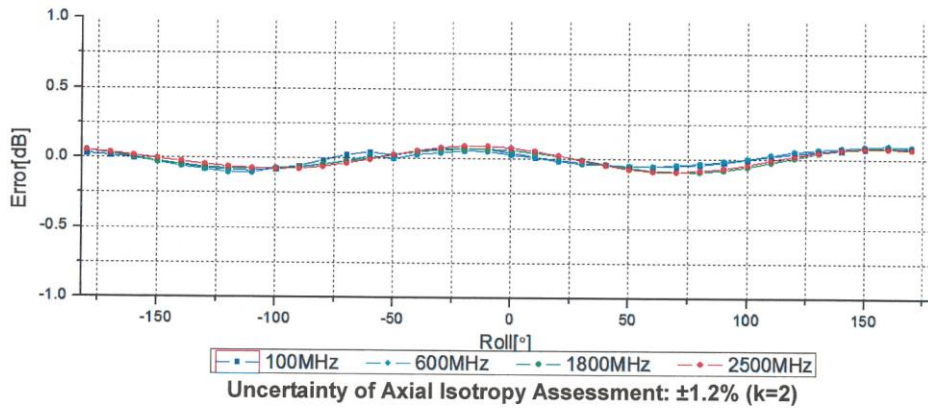
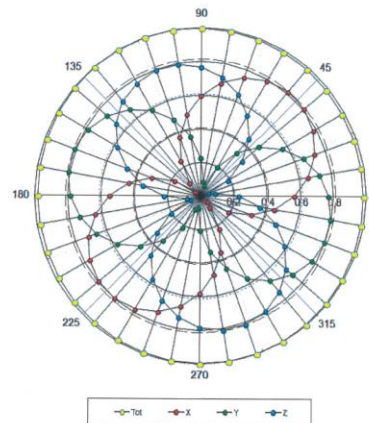



Add: No.51 Xueyuan Road, Haidian District, Beijing, 100191, China  
Tel: +86-10-62304633-2512 Fax: +86-10-62304633-2504  
E-mail: cttl@chinattl.com [Http://www.chinattl.cn](http://www.chinattl.cn)

**Dynamic Range f(SAR<sub>head</sub>)  
(TEM cell, f = 900 MHz)**

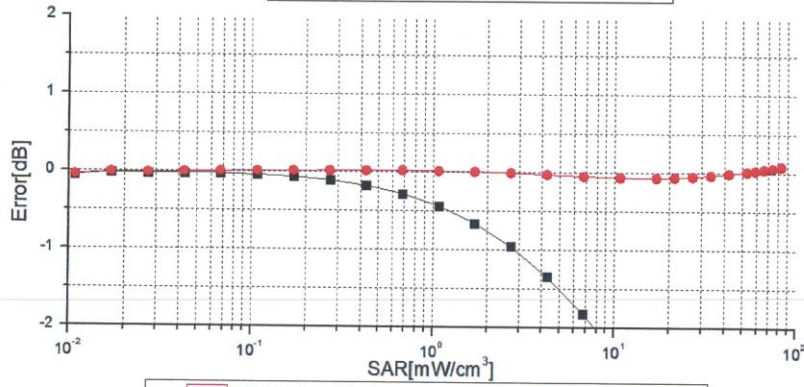
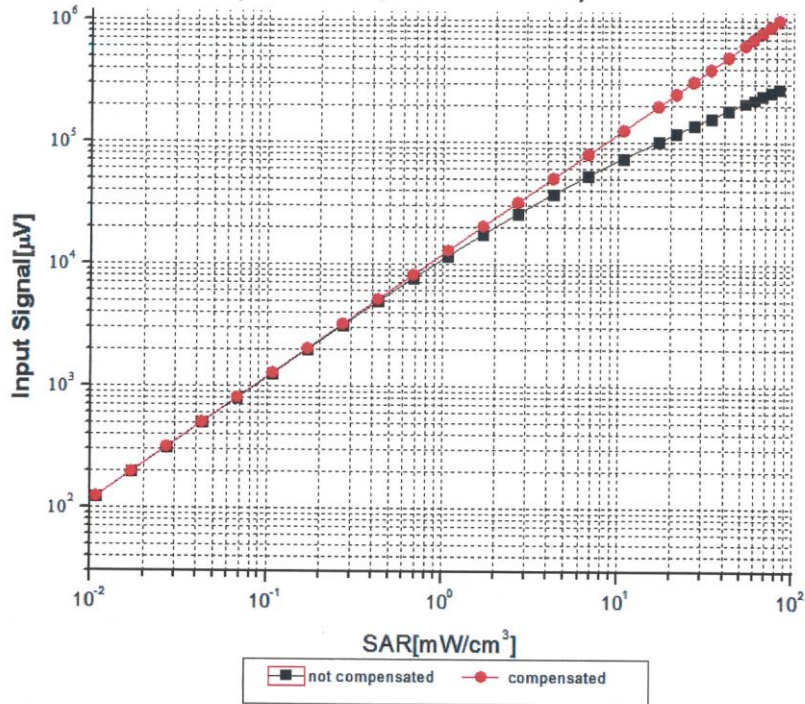

Uncertainty of Linearity Assessment: ±0.9% (k=2)





In Collaboration with  
 Add: No.51 Xueyuan Road, Haidian District, Beijing, 100191, China  
 Tel: +86-10-62304633-2512 Fax: +86-10-62304633-2504  
 E-mail: cttl@chinattl.com [Http://www.chinattl.cn](http://www.chinattl.cn)

## Conversion Factor Assessment

f=750 MHz, WGLS R9(H\_convF)

f=1750 MHz, WGLS R22(H\_convF)

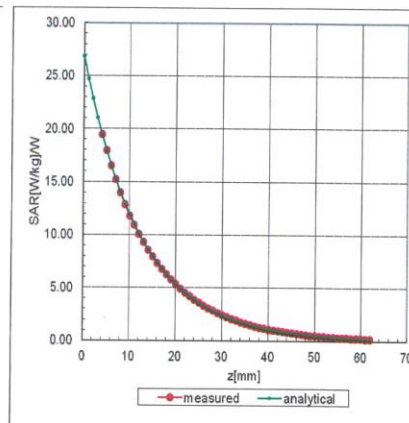
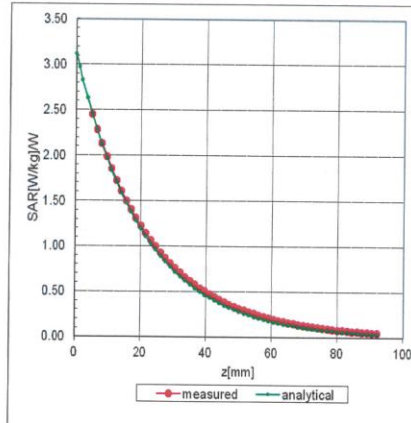

## Deviation from Isotropy in Liquid

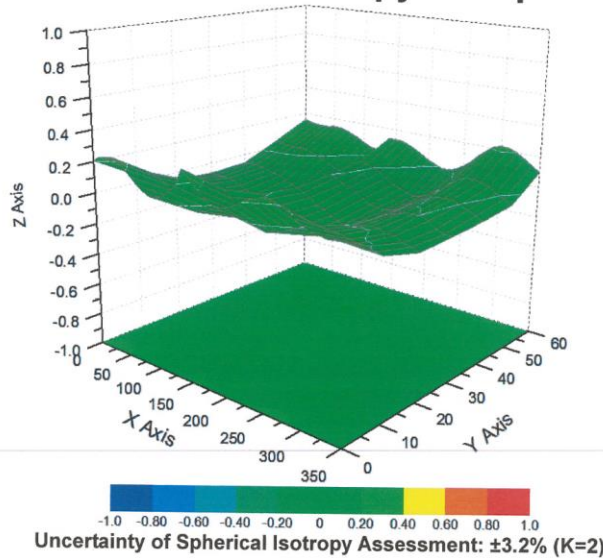



Add: No.51 Xueyuan Road, Haidian District, Beijing, 100191, China  
 Tel: +86-10-62304633-2512 Fax: +86-10-62304633-2504  
 E-mail: [cttl@chinattl.com](mailto:cttl@chinattl.com) [Http://www.chinattl.cn](http://www.chinattl.cn)

## DASY/EASY – Parameters of Probe: ES3DV3 - SN: 3252

### Other Probe Parameters

Sensor Arrangement	Triangular
Connector Angle (°)	131.6
Mechanical Surface Detection Mode	enabled
Optical Surface Detection Mode	disable
Probe Overall Length	337mm
Probe Body Diameter	10mm
Tip Length	10mm
Tip Diameter	4mm
Probe Tip to Sensor X Calibration Point	2mm
Probe Tip to Sensor Y Calibration Point	2mm
Probe Tip to Sensor Z Calibration Point	2mm
Recommended Measurement Distance from Surface	3mm