

IT1200 LABELS LIST

REV	DATE	DESCRIPTION	DESIGN	D'APP

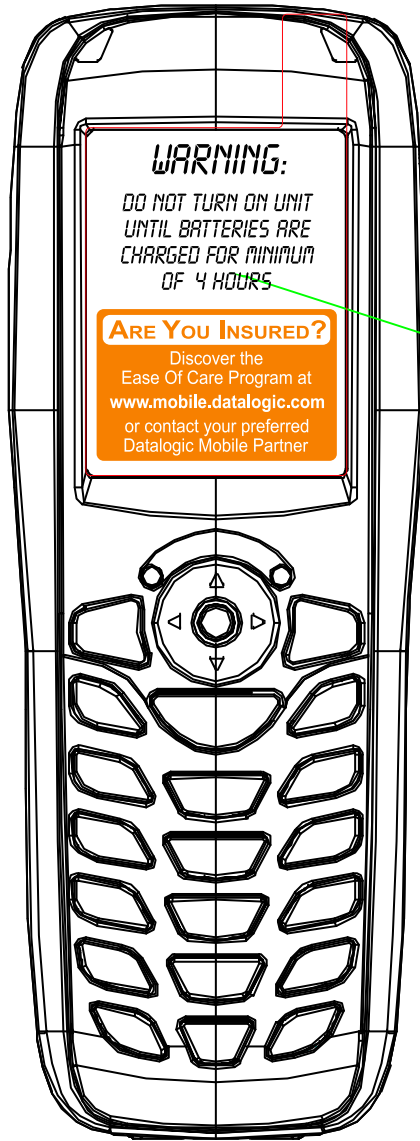

1 Display Protect film

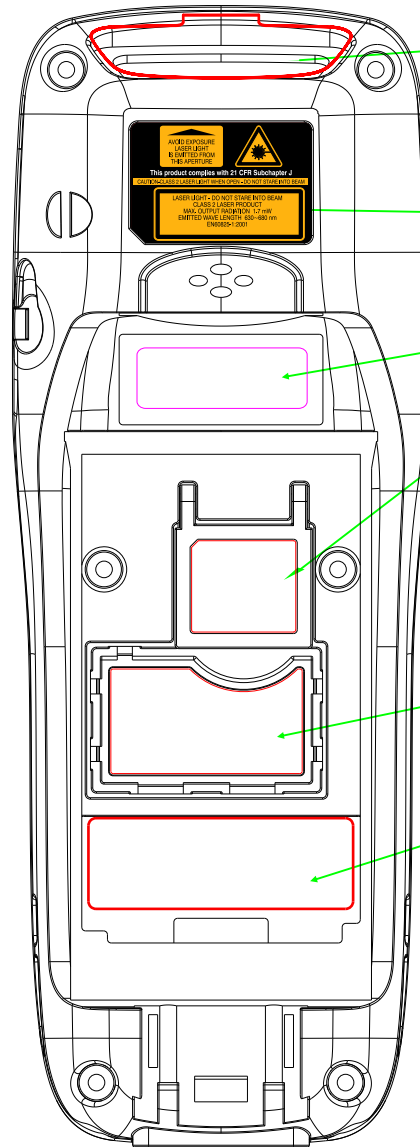

2 SCAN WINDOW 1D &2D FILM
34.3 x 15.5 mm



3 (1D or 2D) Laser Warning Label
24 x 16 mm

4 WinCE 5.0 label

5 FCC ID label
13.7 X 12.0 mm

6 certification label
25.3 X 13.8 mm

7 Model No. label
35 x 12 mm

 銀鐳科技股份有限公司				
:SCALE	:UNIT	:MODEL IT1200 Labels List		
:FINISH		:MATERIAL		
:DESIGN Vicki-lin		:TITLE		
:CHK		:N/P		
:D'APP		:N/P		
4A		SHEET	OF	REV

SIGN	
P	M

ITFM 5 FCC ID label (For P/N:944201038~40 用)

REV	DATE	DESCRIPTION	DESIGN	D'APP

1:1

2:1

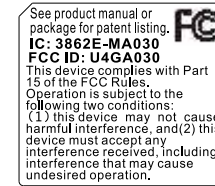

100% Size
Print Reference

SIGN	
P	M



:SCALE 1:1		:UNIT MM	:MODEL IT1200	
:FINISH			:MATERIAL Semi-bright Silver	
:DESIGN Vicki-lin			:TITLE FCC ID label (For P/N:944201038~40 用)	
:CHK			:D'APP	
:D'APP			:N/P 4G62-BB000201	
4A		SHEET 7 OF	:FILENAME	
			REV	

Tolerance : ± 0.3mm

ITFM 6 certification label For 944201038~41

REV	DATE	DESCRIPTION	DESIGN	D'APP

1:1

2:1

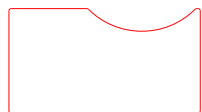

100% Size
Print Reference

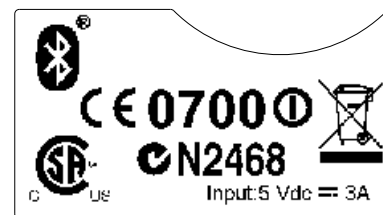

SIGN	
P	M

Bita 銀鑽科技股份有限公司

:SCALE 1:1	:UNIT MM	:MODEL IT1200
:FINISH	:MATERIAL Semi-bright Silver	
:DESIGN Vicki-lin	:TITLE certification label For 944201038~41	
:CHK	:D'APP	
:D'APP	:NVP 4G62-BB000301	
4A		SHEET 1 of 1
:FILENAME		REV

Tolerance : ± 0.3mm

ITFM 7 Model NO.label For (944201038)
802.11+BT+1D+CE5

REV	DATE	DESCRIPTION	DESIGN	D'APP

1:1

2:1

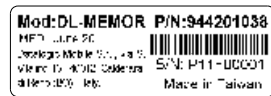
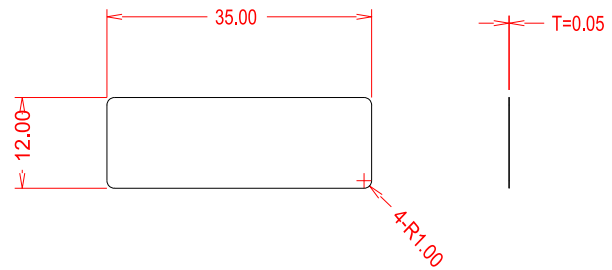

Mod:DL-MEMOR P/N:944201038
MFD : June 2011
Datalogic Mobile S.r.l, via S. Vitalino 13 - 40012, Calderara di Reno (BO) - Italy.



S/N: P11F00001
Made in Taiwan

100% Size
Print Reference

SIGN	
P	M

Note: *Serial Number composition: SYM#####
where :
S = Manufacturing Pole (2)
YY = Manufacturing Year
M = Manufacturing Month (A,B,C,...) (A=January,...,N=Dicember)
= 5 digit Progressive Serial number for Manufacturing Pole,
to be reseted at every month beginning
*Mod: is the product description
*Manufactured: is manufacturing date
*Last field is Manufacturer

Tolerance : ± 0.3mm

 銀鑽科技股份有限公司			
:SCALE	1:1	:UNIT	MM
:MODEL	IT1200		
:FINISH	Semi-bright Silver		
:DESIGN	Vicki-lin	:TITLE	Model NO.label For (944201038) 802.11+BT+1D+CE5
:CHK			
:D'APP	4G62-BB000401		
:A		SHEET 07	:FILENAME
			:REV

ITFM 7

Model NO.label For (944201039) 802.11+BT+2D+CE5

REV	DATE	DESCRIPTION	DESIGN	D'APP

1:1

2:1

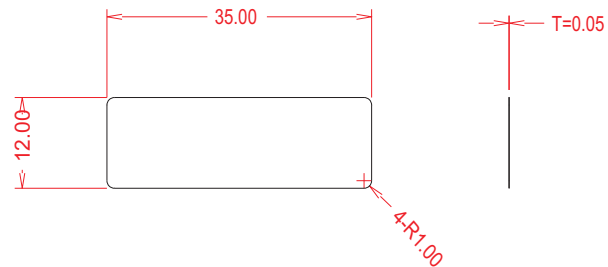

Mod:DL-MEMOR P/N:944201039
MFD : APR. 2011
Datalogic Mobile S.r.l, via S.
Vitalino 13 - 40012, Calderara
di Reno (BO) - Italy. S/N: P11D00001
Made in Taiwan

Mod:DL-MEMOR P/N:944201039
MFD : APR. 2011
Datalogic Mobile S.r.l, via S.
Vitalino 13 - 40012, Calderara
di Reno (BO) - Italy. S/N: P11D00001
Made in Taiwan

100% Size
Print Reference

Note: *Serial Number composition: SYM#####
where :
S = Manufacturing Pole (2)
YY = Manufacturing Year
M = Manufacturing Month (A,B,C,...) (A=January,...,N=Dicember)
= 5 digit Progressive Serial number for Manufacturing Pole,
to be reseted at every month beginning
*Mod: is the product description
*Manufactured: is manufacturing date
*Last field is Manufacturer

Tolerance : ± 0.3mm

SIGN	
P	M



:SCALE	1:1	:UNIT	MM	:MODEL	IT1200
:FINISH		:MATERIAL	Semi-bright Silver		
:DESIGN	Vicki-lin	:TITLE	Model NO.label For (944201039) 802.11+BT+2D+CE5		
:CHK		:D'APP	4G62-BB000401		
:D'APP		:NVP	4G62-BB000401		
4A		SHEET 1 of 1	:FILENAME		REV

ITFM 7 Model NO.label For (944201040)
802.11+BT+1D+WM6.1

REV	DATE	DESCRIPTION	DESIGN	D'APP

1:1

2:1

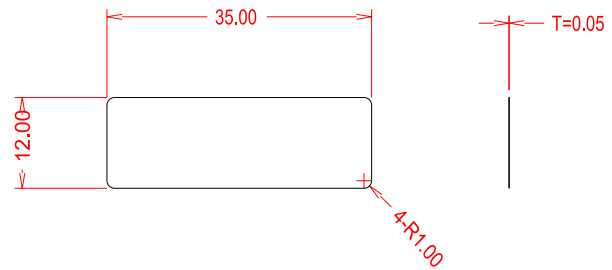

Mod:DL-MEMOR P/N:944201040
MFD: June 2011
Datalogic Mobile S.r.l. via S.
Vitalino 13 - 40012, Calderara
di Reno (BO) - Italy. Made in Taiwan



Mod:DL-MEMOR P/N:944201040
MFD: June 2011
Datalogic Mobile S.r.l. via S.
Vitalino 13 - 40012, Calderara
di Reno (BO) - Italy. Made in Taiwan

100% Size
Print Reference

SIGN	
P	M

Note: *Serial Number composition: SYM#####
where :
S = Manufacturing Pole (2)
YY = Manufacturing Year
M = Manufacturing Month (A,B,C,...) (A=January,...,N=Dicember)
= 5 digit Progressive Serial number for Manufacturing Pole,
to be resetted at every month beginning
*Mod: is the product description
*Manufactured: is manufacturing date
*Last field is Manufacturer

Tolerance : ± 0.3mm

 銀鐙科技股份有限公司					
:SCALE	1:1	:UNIT	MM	:MODEL	IT1200
:FINISH		:MATERIAL	Semi-bright Silver		
:DESIGN	Vicki-lin	:TITLE	Model NO.label For (944201040) 802.11+BT+1D+WM6.1		
:CHK					
:D'APP		:N/P	4G62-BB000401		
4A		SHEET 1 of 1	:FILENAME		REV

ITFM 7 Model NO.label For (944201041)
802.11+BT+2D+WM6.1

REV	DATE	DESCRIPTION	DESIGN	D'APP

1:1

2:1

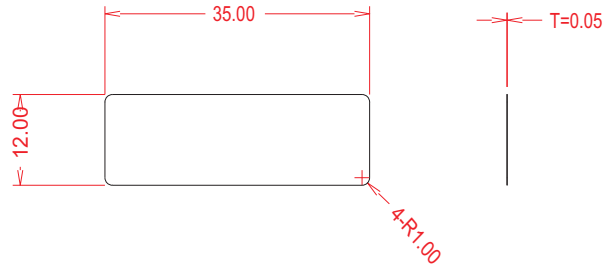

Mod:DL-MEMOR P/N:944201041
MFD : APR. 2009
Datalogic Mobile S.r.l, via S.
Vitalino 13 - 40012, Calderara S/N: P09D00001
di Reno (BO) - Italy. Made in Taiwan

Mod:DL-MEMOR P/N:944201041
MFD : APR. 2009
Datalogic Mobile S.r.l, via S.
Vitalino 13 - 40012, Calderara S/N: P09D00001
di Reno (BO) - Italy. Made in Taiwan

100% Size
Print Reference

SIGN	
P	M

Note: *Serial Number composition: SYM#####
where :
S = Manufacturing Pole (2)
YY = Manufacturing Year
M = Manufacturing Month (A,B,C,...) (A=January,...,N=Dicember)
= 5 digit Progressive Serial number for Manufacturing Pole,
to be resetted at every month beginning
*Mod: is the product description
*Manufactured: is manufacturing date
*Last field is Manufacturer

Tolerance : ± 0.3mm

銀鑽科技股份有限公司			
:SCALE	1:1	:UNIT	MM
:MODEL	IT1200		
:FINISH	Semi-bright Silver		
:DESIGN	Vicki-lin	:TITLE	Model NO.label For (944201041) 802.11+BT+2D+WM6.1
:CHK			
:D'APP	4G62-BB000401		
4A		SHEET 07	:FILENAME
			REV