

## Datalogic Memor™



[www.mobile.datalogic.com](http://www.mobile.datalogic.com)

World wide Sales Network  
available from: [www.mobile.datalogic.com/contacts](http://www.mobile.datalogic.com/contacts)

**Datalogic Mobile S.r.l.**  
Via S. Vitalino, 13  
40012 Lippo di Calderara di Reno  
Bologna - Italy  
Telephone: (+39) 051-3147011  
Fax: (+39) 051-3147561



822000882



Datalogic Mobile S.r.l.  
Via S. Vitalino 13  
40012 - Lippo di Calderara di Reno  
Bologna - Italy

Datalogic Memor™ - User's Manual

Software Version: 4.00

Ed.: 05/2009

**ALL RIGHTS RESERVED**

The Datalogic name and logo are registered trademarks of Datalogic S.p.A. in many countries.

The Memor name is a trademark of Datalogic Mobile S.r.l.

All other brand and product names mentioned herein are for identification purposes only and may be trademarks or registered trademarks of their respective owners.

Datalogic reserves the right to make modifications and improvements without prior notification.

Datalogic shall not be liable for technical or editorial errors or omissions contained herein, nor for incidental or consequential damages resulting from the use of this material.

© 2008-2009 Datalogic Mobile S.r.l. • All rights reserved. • Protected to the fullest extent under U.S. and international laws. • Copying, or altering of this document is prohibited without express written consent from Datalogic Mobile S.r.l.

# CONTENTS

---

	<b>REFERENCES.....</b>	<b>v</b>
	Conventions .....	v
	Reference Documentation .....	v
	Services and Support.....	v
	<b>SAFETY REGULATIONS .....</b>	<b>vi</b>
	General Safety Rules .....	vi
	Power Supply .....	vi
	Laser Safety .....	vii
	LED Class .....	xiii
	Radio Compliance .....	xiii
	FCC Compliance.....	xv
	SAR Compliance.....	xvi
	Patents .....	xvi
	WEEE Compliance.....	xvii
	China RoHS Pollution Control Logos .....	xix
	<b>GENERAL VIEW.....</b>	<b>xx</b>
<b>1</b>	<b>INTRODUCTION.....</b>	<b>1</b>
1.1	Datalogic Memor™ Description .....	1
1.2	Models Description.....	2
1.3	Package Contents .....	4
1.4	Inserting a Micro SD Card.....	5
1.5	Installing the SIM Card.....	7
1.5.1	Removing the SIM Card.....	9
1.6	Accessories.....	10
1.7	Operating System.....	10
<b>2</b>	<b>CONNECTIONS.....</b>	<b>11</b>
2.1	USB Connection.....	11
2.2	Connection to USB peripherals.....	13
2.3	RS232 Connection .....	15
2.4	WLAN Connection.....	16
2.5	WPAN Connection .....	18
2.6	WWAN Connection .....	19
2.7	Connection Cables.....	21
2.8	Wireless and Radio Frequencies Warnings .....	22
<b>3</b>	<b>USE AND FUNCTIONING .....</b>	<b>24</b>
3.1	Startup.....	24
3.1.1	Using the Stylus .....	26
3.1.2	Using the Joystick .....	27
3.2	Windows Mobile Welcome Wizard.....	28
3.3	Data Capture .....	29
3.3.1	Laser Data Capture.....	29
3.3.2	Imager Data Capture.....	30
3.4	Description of the Keys .....	32
3.4.1	Resetting the Memor™ .....	34

3.5	Status Indicators .....	37
3.5.1	LED Status .....	37
3.5.2	Taskbar .....	38
3.6	Data Capture Configuration.....	40
3.6.1	Configure.....	40
3.6.2	Capture.....	45
3.7	Control Panel .....	46
3.7.1	Buttons .....	47
3.7.2	Registry .....	48
3.7.3	Files Admin .....	49
3.7.4	Wireless Communications.....	51
3.7.5	Stylus Calibration .....	53
3.7.6	Volume Settings .....	56
3.8	Windows Connections.....	60
3.8.1	Microsoft® ActiveSync®.....	60
3.8.2	Bluetooth® Manager Device Setup.....	62
3.8.3	Windows Mobile Phone.....	71
3.8.4	FTP Server Setup.....	72
3.9	Backup Directory File Management .....	73
3.10	Firmware Update.....	73
<b>4</b>	<b>MAINTENANCE .....</b>	<b>74</b>
4.1	Charging the Battery Pack .....	74
4.2	Replacing the Battery Pack.....	76
4.3	Cleaning the Mobile Computer.....	80
<b>5</b>	<b>TECHNICAL FEATURES .....</b>	<b>81</b>
5.1	Technical Data .....	81
5.2	Reading Diagram .....	84
<b>6</b>	<b>TEST CODES .....</b>	<b>85</b>
	<b>GLOSSARY .....</b>	<b>89</b>
	<b>INDEX .....</b>	<b>91</b>

## REFERENCES

---

### CONVENTIONS

This manual uses the following conventions:

“User” refers to anyone using a Datalogic Memor™ mobile computer.

“Mobile computer” and “Datalogic Memor™” refer to Datalogic Memor™ mobile computer.

“You” refers to the System Administrator or Technical Support person using this manual to install, configure, operate, maintain or troubleshoot a Datalogic Memor™ mobile computer.

“Single Cradle” refers to the Datalogic Memor™ Single Cradle.

### REFERENCE DOCUMENTATION

For further information regarding Datalogic Memor™ refer to the SDK Help on-Line.

### SERVICES AND SUPPORT

Datalogic provides several services as well as technical support through its website.

Log on to [www.mobile.datalogic.com](http://www.mobile.datalogic.com) and click on the [links](#) indicated for further information including:

- **PRODUCTS**

Search through the links to arrive at your product page where you can download specific **Manuals** and **Software & Utilities**

- **SERVICES & SUPPORT**

- **Datalogic Services** Warranty Extensions and Maintenance Agreements

- **Authorised Repair Centres**

- **CONTACT US**

E-mail form and listing of Datalogic Subsidiaries

## SAFETY REGULATIONS

---



**NOTE**

*Read this manual carefully before performing any type of connection to the Datalogic Memor™ mobile computer. The user is responsible for any damages caused by incorrect use of the equipment or by inobservance of the indication supplied in this manual.*

### GENERAL SAFETY RULES

- Use only the components supplied by the manufacturer for the specific Datalogic Memor™ being used.
- Do not attempt to disassemble the Datalogic Memor™ mobile computer, as it does not contain parts that can be repaired by the user. Any tampering will invalidate the warranty.
- When replacing the battery pack or at the end of the operative life of the Datalogic Memor™ mobile computer, disposal must be performed in compliance with the laws in force.
- Before using the devices and the battery packs, read par. 4.2.
- Do not submerge the Datalogic Memor™ in liquid products.
- For further information, refer to this manual and to the Datalogic Mobile web site: [www.mobile.datalogic.com](http://www.mobile.datalogic.com).

### POWER SUPPLY

This device is intended to be connected to a UL Listed/CSA Certified computer which supplies power directly to the Datalogic Memor™ or else be supplied by a UL Listed/CSA Certified Power Unit marked "Class 2" or LPS power source rated 5 V, 3.0 A, which supplies power directly to the Datalogic Memor™ via the power connector of the cable.

The package includes three international plug adapters. The adapters must be plugged in the power supply before the power supply itself is plugged on the wall outlet.

## LASER SAFETY

The laser light is visible to the human eye and is emitted from the window indicated in the figure.

This information applies to both laser models and the Datalogic Memor™ Imager Aiming System.



I	D	F	E
La luce laser è visibile all'occhio umano e viene emessa dalla finestra indicata nella figura.	Die Laserstrahlung ist für das menschliche Auge sichtbar und wird am Strahlaustrittsfenster ausgesendet (siehe Bild).	Le rayon laser est visible à l'oeil nu et il est émis par la fenêtre désignée sur l'illustration dans la figure.	La luz láser es visible al ojo humano y es emitida por la ventana indicada en la figura.
LUCE LASER NON FISSARE IL FASCIO APPARECCHIO LASER DI CLASSE 2 MASSIMA POTENZA DI USCITA: 1.7mW LUNGHEZZA D'ONDA EMESSA: 650nm CONFORME A EN 60825-1 (2001)	LASERSTRAHLUNG NICHT IN DER STRAHL BLINKEN PRODUKT DER LASERKLASSE 2 MAXIMALE AUSGANGLEISTUNG: 1.7mW WELLENLÄNGE: 650nm ENTSPR. EN 60825-1 (2001)	RAYON LASER EVITER DE REGARDER LE RAYON APPAREIL LASER DE CLASSE 2 MAXIMUM PUISSANCE DE SORTIE: 1.7mW LONGUER D'ONDE EMISE: 650nm CONFORME A EN 60825-1 (2001)	RAYO LÁSER NO MIRAR FIJO EL RAYO APARATO LÁSER DE CLASE 2 MÁXIMA POTENCIA DE SALIDA: 1.7mW LONGITUD DE ONDA EMITIDA: 650nm CONFORME A EN 60825-1 (2001)



## ENGLISH

The following information is provided to comply with the rules imposed by international authorities and refers to the correct use of your mobile computer.

### STANDARD LASER SAFETY REGULATIONS

This product conforms to the applicable requirements of both CDRH 21 CFR 1040 Subchapter J and EN 60825-1:2001 at the date of manufacture.

For installation, use and maintenance, it is not necessary to open the device.



**CAUTION**

*Do not attempt to open or otherwise service any components in the optics cavity. Opening or servicing any part of the optics cavity by unauthorized personnel may violate laser safety regulations. The optics system is a factory only repair item.*



**CAUTION**

*Use of controls or adjustments or performance of procedures other than those specified herein may result in exposure to hazardous visible laser light.*

The product utilizes a low-power laser diode. Although staring directly at the laser beam momentarily causes no known biological damage, avoid staring at the beam as one would with any very strong light source, such as the sun. Avoid that the laser beam hits the eye of an observer, even through reflective surfaces such as mirrors, etc.



**CAUTION**

*Use of optical systems with the scanner will increase eye hazard. Optical instruments include binoculars, microscopes, eye glasses and magnifying glasses.*

## ITALIANO

Le seguenti informazioni vengono fornite dietro direttive delle autorità internazionali e si riferiscono all'uso corretto del terminale.

### NORMATIVE STANDARD PER LA SICUREZZA LASER

Questo prodotto risulta conforme alle normative vigenti sulla sicurezza laser alla data di produzione: CDRH 21 CFR 1040 sezione J e EN 60825-1:2001.

Non si rende mai necessario aprire l'apparecchio per motivi di installazione, utilizzo o manutenzione.



**ATTENZIONE**

*Non tentare di accedere allo scomparto contenente i componenti ottici o di farne la manutenzione.*

*L'apertura dello scomparto, o la manutenzione di qualsiasi parte ottica da parte di personale non autorizzato, potrebbe violare le norme della sicurezza. Il sistema ottico può essere riparato solamente alla fabbrica.*



**ATTENZIONE**

*L'utilizzo di procedure o regolazioni differenti da quelle descritte nella documentazione può provocare un'esposizione pericolosa a luce laser visibile.*

Il prodotto utilizza un diodo laser a bassa potenza. Sebbene non siano noti danni riportati dall'occhio umano in seguito ad una esposizione di breve durata, evitare di fissare il raggio laser così come si eviterebbe qualsiasi altra sorgente di luminosità intensa, ad esempio il sole. Evitare inoltre di dirigere il raggio laser negli occhi di un osservatore, anche attraverso superfici riflettenti come gli specchi.



**ATTENZIONE**

*L'uso di strumenti ottici assieme allo scanner può aumentare il pericolo di danno agli occhi. Tali strumenti ottici includono cannocchiali, microscopi, occhiali e lenti di ingrandimento.*

## DEUTSCH

Die folgenden Informationen stimmen mit den Sicherheitshinweisen überein, die von internationalen Behörden auferlegt wurden, und sie beziehen sich auf den korrekten Gebrauch vom Terminal.

### NORM FÜR DIE LASERSICHERHEIT

Dies Produkt entspricht am Tag der Herstellung den gültigen EN 60825-1:2001 und CDRH 21 CFR 1040 Subchapter J Normen für die Lasersicherheit.

Es ist nicht notwendig, das Gerät wegen Betrieb oder Installations-, und Wartungs-Arbeiten zu öffnen.



**ACHTUNG**

*Unter keinen Umständen darf versucht werden, die Komponenten im Optikhohlraum zu öffnen oder auf irgendwelche andere Weise zu warten. Das Öffnen bzw. Warten der Komponenten im Optikhohlraum durch unbefugtes Personal verstößt gegen die Laser-Sicherheitsbestimmungen. Das Optiksistem darf nur werkseitig repariert werden.*



**ACHTUNG**

*Jegliche Änderungen am Gerät sowie Vorgehensweisen, die nicht in dieser Betriebsanleitung beschrieben werden, können ein gefährliches Laserlicht verursachen.*

Der Produkt benutzt eine Laserdiode. Obwohl zur Zeit keine Augenschäden von kurzen Einstrahlungen bekannt sind, sollten Sie es vermeiden für längere Zeit in den Laserstrahl zu schauen, genauso wenig wie in starke Lichtquellen (z.B. die Sonne). Vermeiden Sie es, den Laserstrahl weder gegen die Augen eines Beobachters, noch gegen reflektierende Oberflächen zu richten.



**ACHTUNG**

*Die Verwendung von Optiksystemen mit diesem Scanner erhöht die Gefahr einer Augenbeschädigung. Zu optischen Instrumenten gehören unter anderem Ferngläser, Mikroskope, Brillen und Vergrößerungsgläser.*

#### FRANÇAIS

Les informations suivantes sont fournies selon les règles fixées par les autorités internationales et se réfèrent à une correcte utilisation du terminal.

#### NORMES DE SECURITE LASER

Ce produit est conforme aux normes de sécurité laser en vigueur à sa date de fabrication: CDRH 21 CFR 1040 sous-chapitre J et EN 60825-1:2001.

Il n'est pas nécessaire d'ouvrir l'appareil pour l'installation, l'utilisation ou l'entretien.



**ATTENTION**

*Ne pas essayer d'ouvrir ou de réparer les composants de la cavité optique. L'ouverture de la cavité optique ou la réparation de ses composants par une personne non qualifiée peut entraîner le nonrespect des règles de sécurité relatives au laser. Le système optique ne peut être réparé qu'en usine.*



**ATTENTION**

*L'utilisation de procédures ou réglages différents de ceux donnés ici peut entraîner une dangereuse exposition à lumière laser visible.*

Le produit utilise une diode laser. Aucun dommage aux yeux humains n'a été constaté à la suite d'une exposition au rayon laser. Eviter de regarder fixement le rayon, comme toute autre source lumineuse intense telle que le soleil. Eviter aussi de diriger le rayon vers les yeux d'un observateur, même à travers des surfaces réfléchissantes (miroirs, par exemple).



**ATTENTION**

*L'utilisation d'instruments optiques avec le scanneur augmente le danger pour les yeux. Les instruments optiques comprennent les jumelles, les microscopes, les lunettes et les verres grossissants.*

### ESPAÑOL

Las informaciones siguientes son presentadas en conformidad con las disposiciones de las autoridades internacionales y se refieren al uso correcto del terminal.

#### NORMATIVAS ESTÁNDAR PARA LA SEGURIDAD LÁSER

Este aparato resulta conforme a las normativas vigentes de seguridad láser a la fecha de producción: CDRH 21 CFR 1040 Sección J y EN 60825-1:2001.

No es necesario abrir el aparato para la instalación, la utilización o la manutención.



**ATENCIÓN**

*No intente abrir o de ninguna manera dar servicio a ninguno de los componentes del receptáculo óptico. Abrir o dar servicio a las piezas del receptáculo óptico por parte del personal no autorizado podría ser una violación a los reglamentos de seguridad. El sistema óptico se puede reparar en la fábrica solamente.*



**ATENCIÓN**

*La utilización de procedimientos o regulaciones diferentes de aquellas descritas en la documentación puede causar una exposición peligrosa a la luz láser visible.*

El aparato utiliza un diodo láser a baja potencia. No son notorios daños a los ojos humanos a consecuencia de una exposición de corta duración. Eviten de mirar fijo el rayo láser así como evitarían cualquiera otra fuente de luminosidad intensa, por ejemplo el sol. Además, eviten de dirigir el rayo láser hacia los ojos de un observador, también a través de superficies reflectantes como los espejos.



**ATENCIÓN**

*El uso de sistemas ópticos con el escáner aumentará el riesgo de daños oculares. Los instrumentos ópticos incluyen binoculares, microscopios, lentes y lupas.*

## LED CLASS

According to EN60825-1:2001, the Datalogic Memor™ 1D models which use the green spot LED are also CLASS 1 LED PRODUCTS.

APPARECCHIO LED CLASSE 1 IEC      PRODUIT LED DE CLASSE 1 IEC  
PRODUKT LED KLASSE 1 IEC      PRODUCTO LED DE CLASE 1 IEC

According to EN60825-1:2001, the Datalogic Memor™ 2D models which use the illuminator LED are also CLASS 1M LED PRODUCTS.

LED LIGHT      LUCE LED  
DO NOT VIEW DIRECTLY      NON OSSERVARE DIRETTAMENTE  
WITH OPTICAL INSTRUMENTS      CON STRUMENTI OTTICI  
CLASS 1M LED PRODUCT      APPARECCHIO LED DI CLASSE 1M

LAMPE LED      LUZ LED  
NE PAS OBSERVER DIRECTEMENT      NO OBSERVAR DIRECTAMENTE  
AVEC INSTRUMENTS OPTIQUES      CON INSTRUMENTOS ÓPTICOS.  
APPAREIL LED DE CLASSE 1M      PRODUCTO LED DE CLASE 1M

LED-LICHT.  
NICHT DIREKT MIT OPTISCHEN  
INSTRUMENTEN BETRACHTEN.  
GERÄTEKLASSE 1M.

## RADIO COMPLIANCE

In radio systems configured with mobile computers and access points, the frequencies to be used must be allowed by the spectrum authorities of the specific country in which the installation takes place. Be absolutely sure that the system frequencies are correctly set to be compliant with the spectrum requirements of the country.

The Radio modules used in this product automatically adapt to the frequencies set by the system and do not require any parameter settings.

The following shows the correspondence between the Datalogic Memor™ models and the Radio components:

- DL-Memor+802.11g+BT models: 802.11b/g and BT radio modules

**CE0678** 

- DL-Memor+EdgeE+BT models: GSM/GPRS/EDGE and BT radio modules

**CE0678**

## Information for the User

### ENGLISH

Contact the competent authority responsible for the management of radio frequency devices of your country to verify any possible restrictions or licenses required.

Refer to the web site <http://europa.eu.int/comm/enterprise/rte/spectr.htm> for further information.

### ITALIANO

Prendi contatto con l'autorità competente per la gestione degli apparati a radio frequenza del tuo paese, per verificare eventuali restrizioni o licenze. Ulteriori informazioni sono disponibili sul sito:

<http://europa.eu.int/comm/enterprise/rte/spectr.htm>.

### FRANÇAIS

Contactez l'autorité compétente en la gestion des appareils à radio fréquence de votre pays pour vérifier d'éventuelles restrictions ou licences. Pour tout renseignement vous pouvez vous adresser au site web:

<http://europa.eu.int/comm/enterprise/rte/spectr.htm>.

### DEUTSCH

Wenden Sie sich an die für Radiofrequenzgeräte zuständige Behörde Ihres Landes, um zu prüfen ob es Einschränkungen gibt, oder eine Lizenz erforderlich ist. Weitere Informationen finden Sie auf der Web Seite:

<http://europa.eu.int/comm/enterprise/rte/spectr.htm>.

### ESPAÑOL

Contacta la autoridad competente para la gestión de los dispositivos de radio frecuencia de tu país, para verificar cualesquiera restricciones o licencias posibles requerida. Además se puede encontrar mas información en el sitio Web:<http://europa.eu.int/comm/enterprise/rte/spectr.htm>.

## **FCC COMPLIANCE**

Modifications or changes to this equipment without the expressed written approval of Datalogic could void the authority to use the equipment.

This equipment has been tested and found to comply with the limits for a Class B digital device, pursuant to Part 15 of the FCC Rules. These limits are designed to provide reasonable protection against harmful interference in a residential installation. This equipment generates, uses and can radiate radio frequency energy and, if not installed and used in accordance with the instructions, may cause harmful interference to radio communications. However, there is no guarantee that interference will not occur in a particular installation.

If this equipment does cause harmful interference to radio or television reception, which can be determined by turning the equipment off and on, the user is encouraged to try to correct the interference by one or more of the following measures:

- Reorient or relocate the receiving antenna.
- Increase the separation between the equipment and receiver.
- Connect the equipment into an outlet on a circuit different from that to which the receiver is connected.
- Consult the dealer or an experienced radio/TV technician for help.

FCC ID:

U4G0030 for models:  
DL-Memor+802.11g+BT

## **SAR COMPLIANCE**

- This product has been tested and found to comply with the following standards:
- OET BULLETIN 65 SUPPLEMENT C: evaluating compliance with FCC guidelines for human exposure to radio frequency electromagnetic fields.
- EN 50360:2001: product standard to demonstrate the compliance of mobile phones with the basic restrictions related to human exposure to electromagnetic fields (300 MHz – 3 GHz).
- EN 62311:2008: assessment of electronic and electrical equipment related to human exposure restrictions for electromagnetic fields (0 Hz – 300 GHz).

## **PATENTS**

This product is covered by one or more of the following patents.

Design Pat.: AU 310182 S; CN 658612; HK 0601962.6; KR 30-0466667; JP 1325117; TW D118829; US D574,830 S.

US Pat.: 5,992,740; 6,808,114 B1; 6,997,385 B2; 7,387,246 B2.

European Pat.: 681,257 B1; 789,315 B1; 1,128,315 B1; 1,396,811 B1.

Additional patents pending.



## WEEE COMPLIANCE



### Informazione degli utenti ai sensi della Direttiva Europea 2002/96/EC

L'apparecchiatura che riporta il simbolo del bidone barrato deve essere smaltita, alla fine della sua vita utile, separatamente dai rifiuti urbani.

Smaltire l'apparecchiatura in conformità alla presente Direttiva consente di:

- evitare possibili conseguenze negative per l'ambiente e per la salute umana che potrebbero invece essere causati dall'errato smaltimento dello stesso;
- recuperare materiali di cui è composto al fine di ottenere un importante risparmio di energia e di risorse.

Per maggiori dettagli sulle modalità di smaltimento, contattare il Fornitore dal quale è stata acquistata l'apparecchiatura o consultare la sezione dedicata sul sito [www.mobile.datalogic.com](http://www.mobile.datalogic.com).

### Information for the user in accordance with the European Commission Directive 2002/96/EC

At the end of its useful life, the product marked with the crossed out wheeled wastebin must be disposed of separately from urban waste.

Disposing of the product according to this Directive:

- avoids potentially negative consequences to the environment and human health which otherwise could be caused by incorrect disposal
- enables the recovery of materials to obtain a significant savings of energy and resources.

For more detailed information about disposal, contact the supplier that provided you with the product in question or consult the dedicated section at the website [www.mobile.datalogic.com](http://www.mobile.datalogic.com).

### Information aux utilisateurs concernant la Directive Européenne 2002/96/EC

Au terme de sa vie utile, le produit qui porte le symbole d'un caisson à ordures barré ne doit pas être éliminé avec les déchets urbains.

Éliminer ce produit selon cette Directive permet de:

- éviter les retombées négatives pour l'environnement et la santé dérivant d'une élimination incorrecte
- récupérer les matériaux dans le but d'une économie importante en termes d'énergie et de ressources

Pour obtenir des informations complémentaires concernant l'élimination, veuillez contacter le fournisseur auprès duquel vous avez acheté le produit ou consulter la section consacrée au site Web [www.mobile.datalogic.com](http://www.mobile.datalogic.com).

### **Información para el usuario de acuerdo con la Directiva Europea 2002/96/CE**

Al final de su vida útil, el producto marcado con un símbolo de contenedor de basura móvil tachado no debe eliminarse junto a los desechos urbanos.

Eliminar este producto de acuerdo con la Directiva permite de:

- evitar posibles consecuencias negativas para el medio ambiente y la salud derivadas de una eliminación inadecuada
- recuperar los materiales obteniendo así un ahorro importante de energía y recursos

Para obtener una información más detallada sobre la eliminación, por favor, póngase en contacto con el proveedor donde lo compró o consultar la sección dedicada en el Web site [www.mobile.datalogic.com](http://www.mobile.datalogic.com).

### **Benutzerinformation bezüglich Richtlinie 2002/96/EC der europäischen Kommission**

Am Ende des Gerätelebenszyklus darf das Produkt nicht über den städtischen Hausmüll entsorgt werden. Eine entsprechende Mülltrennung ist erforderlich.

Beseitigung des Produkts entsprechend der Richtlinie:

- verhindert negative Auswirkungen für die Umwelt und die Gesundheit der Menschen
- ermöglicht die Wiederverwendung der Materialien und spart somit Energie und Ressourcen

Weitere Informationen zu dieser Richtlinie erhalten sie von ihrem Lieferanten über den sie das Produkt erworben haben, oder besuchen sie unsere Homepage unter [www.mobile.datalogic.com](http://www.mobile.datalogic.com).

## CHINA ROHS POLLUTION CONTROL LOGOS

Part name	Toxic or Hazardous Substances and Elements for DL-MEMOR					
	Pb	Hg	Cd	Cr6+	PBB	PBDE
Upper Case	O	O	O	O	O	O
Lower Case	O	O	O	O	O	O
Touch Panel	O	O	O	O	O	O
PCB Board	O	O	O	O	O	O
Laser Engine	X	O	O	O	O	O
Imager Engine	O	O	O	O	O	O
GSM Module (Note 1)	O	O	O	O	O	O
BT Module (Note 2)	O	O	O	O	O	O
802.11b/g Radio Module (Note 3)	O	O	O	O	O	O

O: Indicates that this is a toxic or hazardous substance contained in all of the homogenous materials for this part is below the limit requirement in SJ/T11363-2006.

X: Indicates that this is toxic or hazardous substance contained in at least one of the homogeneous materials used for this part is above the limit requirement in SJ/T11363-2006.

Note 1: It is only for 944201018 Model.

Note 2: It is only for 944201015, 944201019, 944201022, 944201018 Models.

Note 3: It is only for 944201015, 944201019, 944201022 Models.

Note 4: 99% of the parts of this product adopt the nonpoisonous and harmless environmental protection material to make, the part with poisonous harmful substance or the element is all unable to realize the substitution of the poisonous harmful thing or the element because the global technological development level is limited.

## GENERAL VIEW



- |                                       |                                  |
|---------------------------------------|----------------------------------|
| A) QVGA 64K Color Display             | G) Microphone                    |
| B) Good Read or User Programmable LED | H) Strap with Stylus Holder      |
| C) Charging Status LED                | I) Laser Safety Label            |
| D) Speaker                            | J) Rear Speaker                  |
| E) Scan Key                           | K) ON/OFF Power Key              |
| F) Keyboard                           | L) Product Label (under battery) |
|                                       | M) Battery Cover                 |



- N) Data Capture/Laser Output Window \*
- O) DC Charger Connector

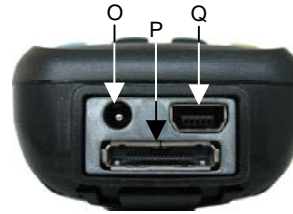

- P) Communication/Charger Connector (through cradle)
- Q) Mini USB Communication Connector (through cable)

\* Remove protective film cover before use

## 1 INTRODUCTION

---

### 1.1 DATALOGIC MEMOR™ DESCRIPTION

The newly updated Datalogic Memor™ mobile computer maximizes a compact and light weight form factor for ease of use and shirt pocket convenience without compromising durability. Feature introductions include the Microsoft Windows Mobile 6.1 operating system, an imaging bar code scanner, and a GSM radio with Edge. All three of these options combine to make the Memor a viable alternative for use in Field Force Automation applications. The Edge radio provides a broadband cellular connection for voice and data communication enabling real time transactions and on demand contact with field personnel. Already well accepted in Retail, Windows Mobile and 2D bar code reading capability expand the number of applications Memor tackles into the Pharmacy and emerging applications for produce traceability.

The computer architecture of the Memor starts with the industry leading XScale™ PXA310 microprocessor. Geared for smart phone computing requirements of real time information management and communication. Memory of 128 MB RAM / 256 MB Flash is sized for running multiple simultaneous applications, for managing large databases or the use of thick applications when off-line autonomy is required. The memory storage capacity can be increased through the user accessible Micro SD Card Slot.

The Memor computer architecture can be paired with one of two operating systems. Microsoft Windows CE 5.0 with Microsoft WordPad and Internet Explorer 6.0 minimizes the operating system size for faster uploads and more storage space. Microsoft Windows Mobile 6.1 reduces training requirements through common Windows' interfaces and tools including Outlook, Word Mobile, Excel Mobile, PowerPoint Mobile, One Note Mobile and Internet Explorer Mobile 6.0. An open source software development kit (SDK) aids in creating applications for both of these powerful Windows operating systems and alternative environments like Java Virtual Machine.

Whether communicating inside or outside the four walls, Memor provides voice and data wireless communication options to meet the business need. A GSM radio using Edge data compression provides a broadband cellular connection for real time data transactions in the field. A speaker and microphone equip the Memor to handle traditional phone calls. Inside the four walls, the Summit IEEE 802.11b/g radio's optimized transmit power and receiver sensitivity result in superior range with a tailored user interface for easy configuration and consistent management. Complimented by a CCX v4 security certification from Cisco, the Memor provides infrastructure compatibility focused on enterprise requirements for encrypted communication and seamless roaming. Client side applications leverage internet protocol connections for hands-free voice picking and push to talk communications. Bluetooth® Wireless Technology connects headsets, printers and other peripherals while eliminating cumbersome wires and costly replacement of broken or damaged cables.

Two scanner options optimize the Memor for the application needs. A laser scanner tackles intensive applications where speed and a wide depth of field

are essential. Datalogic's patented Green Spot good read feedback makes Memor's laser scanner intuitive while reducing errors. The 2D scan engine option leverages picture technology to capture a wide range of Linear, Stacked, and 2D codes while also providing the flexibility to capture a signatures or drivers license. Digital image decoding software reduces failed reads due to damaged and poor quality barcodes while enabling the user to scan from almost any orientation.

Durability ratings protect the computing investment against accidental drops and occasional exposure to liquids and dust. A touch color display provides an easy to read interface in a wide range of lighting conditions. The phone keyboard layout and four direction joystick increase associate efficiency. Push button battery lock provides an easy to locking mechanism for quick, no hassle battery exchanges. Rechargeable Lithium polymer batteries in two sizes customize capacity to the application. Charging cradles include a communication cradles for RS232 and USB. A powered vehicle dock and cigarette lighter adapter extend charging capabilities onto the road.

Powered by Wavelink® device maintenance and management tools makes the Memor a simple device to both deploy and maintain. Datalogic Firmware, Desktop and Configuration Utilities complete the package with unprecedented ability to customize device configuration to the use environment or process. Combined these tools streamline deployment and management activities while providing developer tools to further customize units for specific applications.

## 1.2 MODELS DESCRIPTION

The brand new Datalogic Memor™ is available in different models depending on the options it is equipped with. All options are listed below:

- communication options: 802.11b/g radio, Bluetooth®, GSM
- capture options: laser, imager
- compute options: O.S. version

For further details about the Datalogic Memor™ models refer to the web site: <http://www.mobile.datalogic.com>.

The currently available models are:

- 944201016 DL-Memor+Batch+1DGS+CE5 Datalogic Memor, Batch, 128MB RAM/256MB Flash, 23-key Numeric, Std Laser with Green Spot, CE 5.0
- 944201019 DL-Memor+802.11g+BT+1DGS+CE5 Datalogic Memor, 802.11b/g CCX V4, Bluetooth, 128MB RAM/256MB Flash, 23-key Numeric, Std Laser with Green Spot, CE 5.0
- 944201022 DL-Memor+802.11g+BT+2D+CE5 Datalogic Memor, 802.11b/g CCX V4, Bluetooth, 128MB RAM/256MB Flash, 23-key Numeric, Std 2D Imager, CE 5.0

- 944201015 DL-Memor+802.11g+BT+2D+WM6.1 Datalogic Memor, 802.11b/g CCX V4, Bluetooth, 128MB RAM/256MB Flash, 23-key Numeric, Std 2D Imager, WM 6.1
- 944201018 DL-Memor+EdgeE+BT+2D+WM6.1 Datalogic Memor, Edge Europe, Bluetooth, 128MB RAM/256MB Flash, 23-key Numeric, Std 2D Imager, WM 6.1

### 1.3 PACKAGE CONTENTS

The Datalogic Memor™ package contains:

- 1 Datalogic Memor™ mobile computer
- 1 AC/DC power supply
- 1 EU plug adapter
- 1 AUS. Plug Adapter
- 1 UK Plug Adapter
- 1 standard Mini USB cable
- 1 CD-ROM Datalogic SDK
- 1 CD-ROM Getting Started Disk only for Windows Mobile
- 1 extensible stylus
- 1 user's manual
- 1 rechargeable standard battery pack + cover
- 1 hand-strap with stylus holder
- 1 headset (GSM models only)
- 1 Windows Mobile/ CE End User License Agreement (depending on models)

Any other packages will contain the accessories necessary for the Datalogic Memor™ connection to the host computer and to the network: the cradle, one or more connection cables.

Remove all the components from their packaging; check their integrity and congruity with the packing documents.

**CAUTION**

*Keep the original packaging for use when sending products to the technical assistance center. Damage caused by improper packaging is not covered under the warranty.*

**NOTE**

*Rechargeable battery packs are not initially charged. Therefore the initial operation to perform is to charge them. See paragraph 4.1.*



## 1.4 INSERTING A MICRO SD CARD

Datalogic Memor™ provides the possibility to add a Micro SD memory storage card. To access the Micro SD card slot and insert the card, proceed as follows:

1. Turn off the Datalogic Memor™.
2. Press the latch release button and pull the latch down, as indicated in the figure below:



- a. Remove the cover and the battery pack, then open the Micro SD card slot by pulling up the locking plate:



- b. Shift the cardholder to the left and then pull it up; insert the Micro SD card with the written part upward.



- c. Lock the card into place by pushing the cardholder down and then shifting it to the right; pull the locking plate down.



6. Close the battery cover properly, by pressing the latch release button and pulling the latch down.

To remove the Micro SD card, follow the steps above to access the SD area, and remove it from its slot.

**CAUTION**

*Follow proper ESD precautions to avoid damaging the SD. Proper ESD precautions include, but are not limited to, working on an ESD mat and ensuring that the operator is properly grounded.*

*Do not force the card. If you feel resistance, remove the card, check the orientation, and reinsert it.*

*Do not use the Micro SD card slot for any other accessories.*

## 1.5 INSTALLING THE SIM CARD

To correctly insert the SIM Card, proceed as follows:

1. Turn off the Datalogic Memor™.
2. Press the latch release button and pull the latch down, as indicated in the figure below:



3. Remove the cover and the battery pack, then open the SIM card slot by pulling up the locking plate:



- Shift the cardholder to the left and then pull it up; insert the SIM Card with its contacts downward and its round corner at the bottom:



- Lock the card into place by pushing the cardholder down and then shifting it to the right.

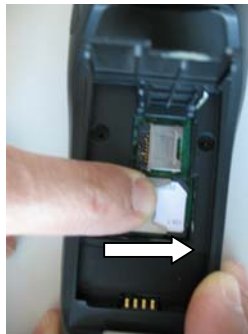

- Pull the locking plate down.
- Close the battery cover properly, by pressing the latch release button and pulling the latch down.

**CAUTION**

*Follow proper ESD precautions to avoid damaging the SIM card. Proper ESD precautions include, but are not limited to, working on an ESD mat and ensuring that the operator is properly grounded. Do not force the card. If you feel resistance, remove the card, check the orientation, and reinsert it. Do not use the SIM card slot for any other accessories.*

**NOTE**

*The SIM Card option is not available in 802.11b/g radio and batch models.*

### 1.5.1 Removing the SIM Card

To remove the SIM card, follow the steps above to access the SIM area, and remove it from its slot.

**NOTE**

*All the basic functionalities normally associated to the SIM card are managed by the terminal (GPRS connectivity, phone calls, SMS handling).*

*It is possible that not all the services connected to the SIM card can be used or can be managed by the terminal.*

## 1.6 ACCESSORIES

### ❑ Cradles

- 94A151111 Datalogic Memor™ Single Cradle
- 94A151121 Datalogic Memor™ Powered Vehicle Dock

### ❑ Batteries

- 94ACC1368 DL-MEMOR Standard Battery CVR2 (Li-Pol or Li-Ion battery pack 1000 mAh@3.7 V)
- 94ACC1367 DL-MEMOR Large Capacity Battery CVR2 (Li-Pol or Li-Ion battery pack 2000 mAh@3.7 V)

### ❑ Power Supply

- 94ACC1324 PG5-30P35 AC/DC Power Supply EU/USA Plug
- 94ACC1334 PG5-30P35 AUS. Plug Adapter (10pcs)
- 94ACC1335 PG5-30P35 UK Plug Adapter (10pcs)
- 94ACC1339 PG5-30P35 EU Plug Adapter (10pcs)

### ❑ Cables

- 94A051016 CAB-421 Mini USB Straight Cable
- 94A051022 WIN-NET Serial Cable (HRS ST40X-18S-CV)
- 94A051024 CAB USB Type Standard A (4 pin F) to Mini A (5 pin M)
- 94A051966 CAB Direct Cigarette Lighter Adapter

### ❑ Various

- 94ACC1328 Datalogic Memor™ Stylus Pens (10 pcs)
- 94ACC1365 Datalogic Memor™ Headset
- 94ACC1366 Datalogic Memor™ Softcase

**NOTE**

*Use only a Datalogic Mobile-approved power supply and cables. Use of an alternative power supply will invalidate any approval given to this device and may be dangerous.*

## 1.7 OPERATING SYSTEM

Datalogic Memor™ supports two different operating systems: Windows CE and Windows Mobile.

For further information regarding Windows Mobile refer to the website:  
<http://www.microsoft.com/windowsmobile>.

## 2 CONNECTIONS

### 2.1 USB CONNECTION

You can use any standard mini USB cable to directly connect the Datalogic Memor™ to a host computer to transfer data through the USB interface.

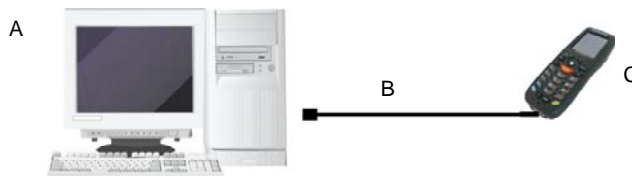

Key:

- |                            |                     |
|----------------------------|---------------------|
| A) Host Computer           | C) Datalogic Memor™ |
| B) Standard Mini USB cable |                     |



**NOTE**

*Connection through the cradle is compliant to 2.0 USB standard.*

The Single Cradle can be connected to the Host by any standard mini USB cable to transfer data through the USB interface.

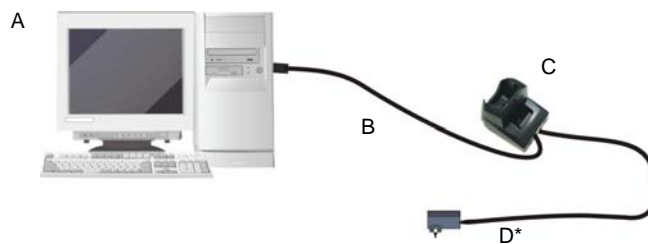

Key:

- |                            |  |
|----------------------------|--|
| A) Host Computer           | C) Single Cradle                                       |
| B) Standard Mini USB cable | D) *Power Supply (only necessary for battery charging) |

In this case the power supply is only necessary for battery charging. Insert the power supply plug into the power jack on the base of the cradle and attach the power supply to a power outlet.

**NOTE**

*Connection through the cradle is compliant to 1.1 USB standard.*

**NOTE**

*The actual data transfer speed can be appreciably lower than the maximum theoretical speed.*



**2.2 CONNECTION TO USB PERIPHERALS**

You can use a standard A (4 pin female) to mini A (5 pin male) USB cable to connect the Datalogic Memor™ to a keyboard or a memory. For all these devices maximum current withdrawal must be below 100mA.



Key:

A Keyboard with USB interface C 94A051024 (Standard A to Mini A USB cable)

B Datalogic Memor™





Key:

A USB hard drive/ external memory source C 94A051024 (Standard A to Mini A USB cable)

B Datalogic Memor™

 *Connect first the USB peripheral to the cable, and then the cable to the Datalogic Memor™.*  
NOTE

 *Datalogic Memor™ works with most of mentioned USB peripherals. In any case, we can't guarantee good operations with all devices available on market place.*  
NOTE

 *Connection through the cradle is compliant to 1.1 USB standard.*  
NOTE

**NOTE**

*The actual data transfer speed can be appreciably lower than the maximum theoretical speed.*

### 2.3 RS232 CONNECTION

You can use a cable to directly connect the Datalogic Memor™ to a host computer to transfer data through the RS232 interface.



Key:

- A) Host Computer
- B) 94A051022 WIN-NET (HRS ST40X-18S-CV)
- C) Datalogic Memor™

The Single Cradle can be connected to the Host by any standard 9-pin serial null-modem cable for RS232 communications.

Once the Host has been turned on, insert the Datalogic Memor™ mobile computer into the cradle.

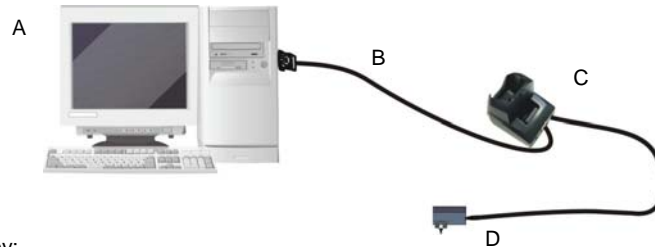

Key:

- A) Host Computer
- B) 94A051020 CAB-427 Null-Modem
- C) Single Cradle
- D) \*Power Supply (only necessary for battery charging)

In this case the power supply is only necessary for battery charging. Insert the power supply plug into the power jack on the base of the cradle and attach the power supply to a power outlet.



**CAUTION** *If the mobile computer supports Windows Mobile, before plugging the RS232 cable you have to check the 'COM1 Enable' option on the 'System, Configuration' window. (Start -> Programs -> System Configuration).*

## 2.4 WLAN CONNECTION

Datalogic Memor™ 802.11b/g radio models can communicate with the host using the on-board radio frequency component and an Access Point connected to the host computer.

For models using the 802.11g radio, you can find information about the applet for radio configuration: <http://www.summitdatacom.com/SCU.htm>.

To launch this utility you can tap the specific icon if it's visible on the taskbar or:

1. On Windows CE devices, you can open Connections folder or Control Panel from desktop and select the 'Summit Client Utility' icon.
2. On Windows Mobile devices, you can select the menu item: Start->Programs->Summit and tap the 'Summit Client Utility' icon.

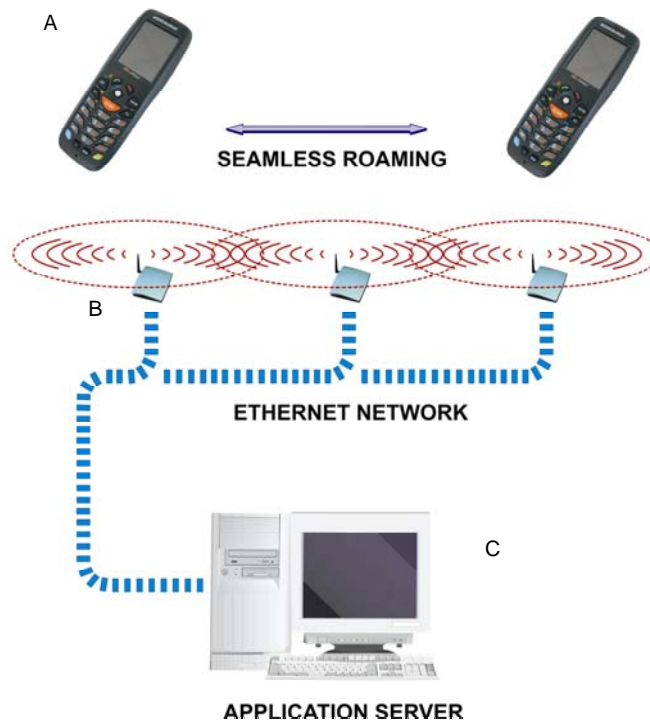

Key:

- A) Datalogic Memor™
- B) Access Point
- C) Host – Application Server

**NOTE**

*802.11g radio module is on by default, in order to avoid wasting energy, you can switch it off using the Wireless Communications applet.*

**NOTE**

*Suspending the terminal powers off the 802.11b/g radio and drops the radio connection. When the terminal resumes, depending on the radio power mode and security protocol selected, it may take up to 30 seconds for the 802.11b/g radio driver to re-associate the radio to the network.*

**NOTE**

*Area coverage and radio performance may vary, due to environmental conditions, access points types or interference caused by other devices (microwave ovens, radio transmitters, etc.)*

**NOTE**

*In case of heavy usage the Datalogic Memor™ could get warm, this is normal and does not mean a malfunction.*

## 2.5 WPAN CONNECTION

Datalogic Memor™ mobile computer models with Bluetooth® can communicate with other Bluetooth® enabled devices, such as a printer, within a range of 10 m, using the onboard Bluetooth® module.



Key:

- A) Datalogic Memor™
- B) Bluetooth® printer



**NOTE**

*In order to avoid wasting energy, the Bluetooth® module is off by default. If you need to have Bluetooth® working, the module must be powered on using the Wireless Communications applet (see par. 3.7.4), and perform the Discovery procedure (see par. 3.8.2).*



**NOTE**

*Suspending the terminal powers off the Bluetooth® radio and drops the piconet (Bluetooth® connection). When the terminal resumes, it takes approximately 10 seconds for the Bluetooth® radio driver to re-initialize the radio.*



**NOTE**

*Area coverage and Bluetooth® radio performance may vary, due to environmental conditions or interference caused by other devices (microwave ovens, radio transmitters, etc.), etc.*

## 2.6 WWAN CONNECTION

Datalogic Memor™ GSM models enhance your connectivity solutions giving you an opening to an international wireless infrastructure that is the global standard.

GSM (Global System for Mobile communications) is a digital mobile phone system based on TDMA; it utilizes the 850, 900, 1800 and 1900 MHz bands.

In order to use a WWAN Connection you have to install a SIM Card\* (see instructions on par. 1.5).

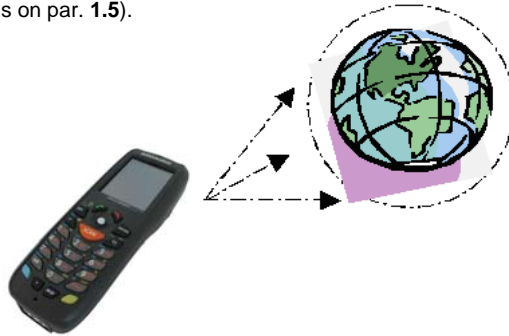

**NOTE**

*In order to avoid wasting energy, the GSM module is off by default. If you need to have GSM working, the module must be powered on using the Wireless Communications applet (see par. 3.7.4).*



**NOTE**

*Suspending the terminal powers off the GSM radio and drops the connection. When the terminal resumes, if the connection was managed by Microsoft Internet Explorer, it is automatically restored, otherwise, the radio connection must be manually re-initialized.*



**NOTE**

*The GSM voice capability of this mobile computer has to be addressed to occasional use, in well covered areas. If the coverage is poor, the voice quality can be highly affected.*



**NOTE**

*Calls can be made or received using the Datalogic Memor™ as a phone handset, by the Datalogic Memor™ headset or by a Bluetooth® headset.*

\* the SIM Card option is not available in 802.11g radio and batch models



*During a call, you can set the speaker volume by moving the joystick up and down.*

**NOTE**



*In case of heavy usage the Datalogic Memor™ could get warm, this is normal and does not mean a malfunction.*

**NOTE**



**2.7 CONNECTION CABLES**

- **RS232 Direct Connection:**  
**94A051022 WIN-NET SERIAL CAB (HRS ST40x-18S-CV)**

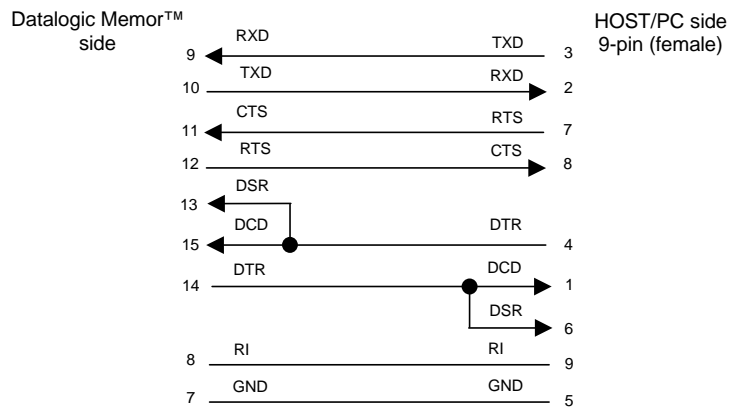

- **Power Supply Polarity:**

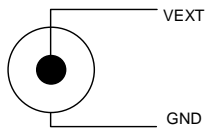

## 2.8 WIRELESS AND RADIO FREQUENCIES WARNINGS



**WARNING**

*Use only the supplied or an approved replacement antenna. Unauthorized antennas, modifications or attachments could damage the product and may violate laws and regulations.*



**WARNING**

*Most modern electronic equipment is shielded from RF signals. However, certain electronic equipment may not be shielded against the RF signals generated by Datalogic Memor™.*



**WARNING**

*Datalogic recommends persons with pacemakers or other medical devices to follow the same recommendations provided by Health Industry Manufacturers Associations for mobile phones.*

*Persons with pacemakers:*

- *Should ALWAYS keep this device more than twenty five (25) cm from their pacemaker and/or any other medical device;*
- *Should not carry this device in a breast pocket;*
- *Should keep the device at the opposite side of the pacemaker and/or any other medical device;*
- *Should turn this device OFF or move it immediately AWAY if there is any reason to suspect that interference is taking place.*
- *Should ALWAYS read pacemaker or any other medical device guides or should consult the manufacturer of the medical device to determine if it is adequately shielded from external RF energy.*

*In case of doubt concerning the use of wireless devices with an implanted medical device, contact your doctor.*



**WARNING**

*Turn this device OFF in health care facilities when any regulations posted in these areas instruct you to do so. Hospitals or health care facilities may use equipment that could be sensitive to external RF energy.*



**WARNING**

*RF signals may affect improperly installed or inadequately shielded electronic systems in motor vehicles. Check with the manufacturer or its representative regarding your vehicle. You should also consult the manufacturer of any equipment that has been added to your vehicle.*

**WARNING**

*An air bag inflates with great force. DO NOT place objects, including either installed or portable wireless equipment, in the area over the air bag or in the air bag deployment area. If vehicle's wireless equipment is improperly installed and the air bag inflates, serious injury could result.*

**WARNING**

*Turn off the device when in any area with a potentially explosive atmosphere. Observe restrictions and follow closely any laws, regulations, warnings and best practices on the use of radio equipment near fuel storage areas or distribution fuel areas, chemical plants or where some operation involves use of explosive materials.*

*Do not store or carry flammable liquids, explosive gases or materials with the device or its parts or accessories.*

*Areas with a potentially explosive atmosphere are often, but not always, clearly marked or showed.*

*Sparks in such areas could cause an explosion or fire, resulting in injury or even death.*

## 3 USE AND FUNCTIONING

---

The use of the Datalogic Memor™ depends on the application software loaded. However there are several parameters that can be set and utilities that can be used to perform some basic functions such as data capture, communications, file management, etc.

### 3.1 STARTUP

The Datalogic Memor™ turns on when the battery pack or the external supply is inserted.

After the battery pack is installed, use the [ON/OFF] key to turn the mobile computer on and off.

As soon as the mobile computer is on, the Windows CE 5.0/ Windows Mobile desktop configuration will appear on the screen. Wait a few seconds before starting any activity so that the mobile computer completes its startup procedure.



Windows CE Desktop

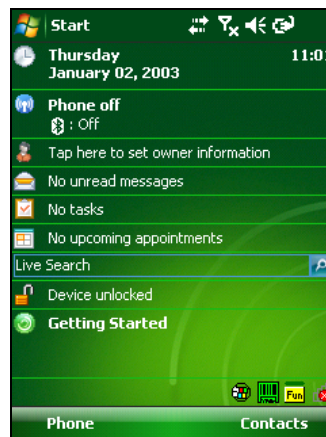

Windows MobileToday Screen

Use the stylus (par. 3.1.1) or joystick (par. 3.1.2) as suggested to select icons and options.

The mobile computer goes into power-off (low power with display and keyboard backlight off), when it is no longer used for more than a programmable timeout, which is defined in the POWER applet of the Control Panel. In this mode it can be awakened (resuming operation) by the [ON/OFF] key.



**NOTE**

*The mobile computer can also be awakened or turned off by the application program.*

### 3.1.1 Using the Stylus

The stylus selects items and enters information. The stylus functions like a mouse.

<b>Tap:</b>	Touch the screen once with the stylus to open items and select options (Windows Mobile only).
<b>Double Tap:</b>	Touch the screen twice with the stylus to open items and select options (Windows CE only).
<b>Drag:</b>	Hold the stylus on the screen and drag across the screen to select text and images. Drag in a list to select multiple items.
<b>Tap-and-hold:</b>	Tap and hold the stylus on an item to see a list of actions available for that item. On the pop-up menu that appears, tap the action you want to perform.

To recalibrate the touch screen use the Stylus Applet (see par. 3.7.5)



**CAUTION**

*Use only original Datalogic styluses supplied with the product itself.*

*In harsh applications, use of screen protectors should be taken into consideration, in order to extend the touch screen operating life.*

*To prevent damage to the screen, do not use sharp devices or any device other than the Datalogic Mobile-provided stylus.*

*Do not apply not necessary high pressures on the screen.*

*For applications where an intensive use of the touch screen is foreseen, please consider that touch screen components are subject to progressive wear.*

### 3.1.2 Using the Joystick

The joystick selects items and enters information. The joystick can work like the directional arrow keys of a PC keyboard or can function like a mouse and control the mouse pointer. It is possible to switch between the two functioning modes by pressing blue modifier + BKSP keys in sequence.

<b>Arrow Keys Mode (default):</b>	Move in the four directions: move forwards, backwards, upwards or downwards within text fields, scroll through a Menu list or browse among folder files.  Press down: selects the current function (like the Enter key).
<b>Mouse Mode:</b>	Move in the four directions: move the mouse pointer forwards, backwards, upwards or downwards.  Press down: like the left click of the mouse.



*During a phone call, you can set the speaker volume by moving the joystick up and down.*

**NOTE**

### 3.2 WINDOWS MOBILE WELCOME WIZARD

In Windows Mobile, at the very first Memor™ startup, following a clean boot or following a registry restore to default values, the mobile computer startup (see par. 3.1) is preceded by the Welcome Wizard.



**Welcome Wizard Screen**

The Welcome Wizard allows the user to calibrate the touch screen (see par. 3.7.5) and to configure an email account and a password to protect the terminal.

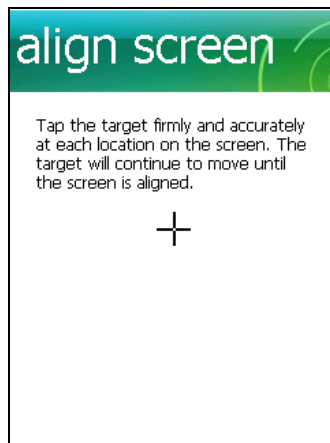

**Touch Screen Calibration Screen**



### 3.3 DATA CAPTURE

To capture data first of all select the barcode icon on the bottom-right side of the display and tap the 'Capture' menu item then proceed with the following directions.

To configure and enable data capture parameters refer to par. 3.6.

#### 3.3.1 Laser Data Capture

To scan barcodes, point the Datalogic Memor™ laser model onto the code from a distance within the reading range while pressing the SCAN key.

The lighted band emitted by the laser must completely intercept the barcode as shown in the figure below.

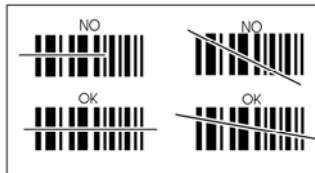
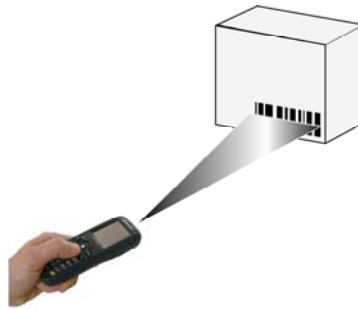

If the scan has taken place correctly:

- the Good Read LED gets constant Green for a configurable time;
- if enabled, the GoodReadSound emits an acoustic signal;
- if enabled, the GreenSpot projects a green spot onto the bar code image.



**NOTE**

*Remove the protective film cover over the Laser Output Window before use.*

### 3.3.2 Imager Data Capture

The Datalogic Memor™ Imager captures a picture of the entire bar code. The omni-directional scanning does not require that the operator orient the bar code to align with the scan pattern.

To read a 1D or 2D code, simply point the Datalogic Memor™ Imager model onto the code and press the SCAN Key.



The Datalogic Memor™ Imager uses an intelligent aiming system pattern, similar to those on cameras, indicating the field of view, which should be positioned over the code:

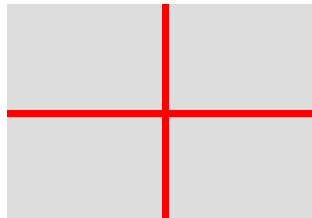

**Aiming System**

If the aiming system pattern is centered over the entire symbology as shown in the following figure, either wait for the timeout or release the Scan key to capture the image.

A red beam illuminates the code, which is captured and decoded. You will get a good read.

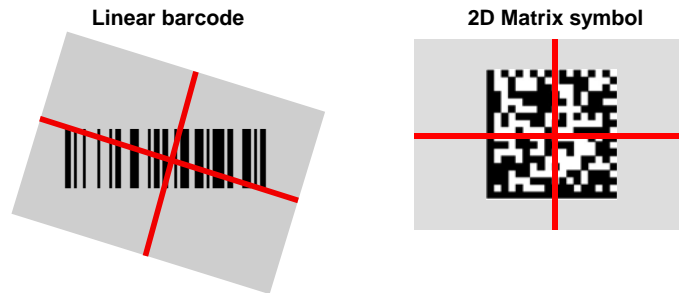

#### Relative Size and Location of Aiming System Pattern

The field of view changes its size as you move the reader closer or farther away from the code. The field of view indicated by the aiming system pattern will be smaller when the Datalogic Memor™ Imager is closer to the code and larger when it is farther from the code.

Symbologies with smaller bars or elements (mil size) should be read closer to the unit. Symbologies with larger bars or elements (mil size) should be read farther from the unit. (See par. 5.1 for further details).

If the scan has taken place correctly:







- the Good Read LED gets constant Green for a configurable time;
- if enabled, the GoodReadSound emits an acoustic signal.

### 3.4 DESCRIPTION OF THE KEYS





The Datalogic Memor™ provides a 23-key alphanumeric keyboard + ON/OFF key + joystick. The following image shows this keyboard.



## Main Keys Function

KEY	FUNCTION
	It starts barcode data capture.
	<p>The joystick lets you move forwards, backwards, upwards or downwards, scroll through a Menu list, browse among folder files or select functions if pressed down.</p> <p>It can work in two functioning modes: Arrow Keys Mode and Mouse Mode. It's possible to switch between them by pressing blue modifier + BKSP keys in sequence (see par. 3.1.2)</p>
	Yellow modifier: when pressed before a standard key, it enables the character or function printed in yellow above the key.
	Blue modifier: when pressed before a standard key, it enables the character or function printed in blue above the key.
	It powers the Datalogic Memor™ ON or OFF. It is placed on the upper left side of the terminal.
	The ALPHA key is used to alternate numeric and alphanumeric use of the 10 numeric keys.

## Special Function Icons

ICON	FUNCTION
	After a yellow modifier key press, it opens the Start menu.
	After a yellow modifier key press, it opens the file manager.
	After a yellow modifier key press, it switches ON/OFF the display backlight.
	After a blue modifier key press, it switches ON/OFF the keyboard backlight.
	After a blue modifier key press, it locks and unlocks the keyboard.

### 3.4.1 Resetting the Memor™

#### Windows CE

There are several reset methods for the Memor™.

A warm boot terminates an unresponsive application and clears the working RAM, but preserves both the file system and the registry.

A cold boot forces all applications to close and clears working RAM and files not resident on the persistent flash memory. Registry is restored from persistent memory if available or returned to factory default.

A Clean Boot restores the Memor™ to factory configuration: registry and file system return to factory default.

#### WARM BOOT

A warm boot closes all applications, clears the working RAM, but preserves the file system and registry. If an application "hangs" initiate a warm boot to terminate the application.

To perform a warm boot, press these keys simultaneously:



#### COLD BOOT

A cold boot is a complete reset of the Memor™ in which all applications are forcibly closed and RAM is completely cleared. Registry is restored from persistent memory if a saved copy is available (see 3.7.2) and RAM file system completely erased. You will lose any applications and data (registry too) which are not stored in persistent flash memory.

A cold boot is necessary when the Windows CE operating system locks up and the warm boot command does not work.

To perform a cold boot, press these keys simultaneously:



#### CLEAN BOOT

A clean boot is a cold boot that causes the device to be restored to factory configuration. The Memor™ will reset to its factory configuration, clear the working RAM and initialize the file system. You will lose any applications and data stored in persistent flash memory. At the next startup the system will ask to recalibrate the touch screen.

To perform a clean boot, follow these steps:

1. Perform a Cold Boot (see Cold Boot).
2. Quickly release all the keys when the screen goes black.
3. Within 1 second press and hold down the Esc and 0 keys until the left orange led starts blinking.
4. Release the Esc and 0 keys.

5. Enter 1 to proceed with the Clean Boot sequence. Enter 0 to cancel the Clean Boot and proceed with a Cold Boot.

	Warm Boot	Cold Boot	Clean Boot
<b>REGISTRY</b>	Preserved	Restored from flash (if available)	Factory default
<b>Flash Disk (Backup Folder)</b>	Preserved	Preserved	Clean disk
<b>RAM File System</b>	Preserved	Reinitialized (factory default)	Factory default



**CAUTION**

*Before performing a reset, it is recommended to:*

- *execute a system backup to keep your more important files and applications persistent. See par. 3.9;*
- *save the registry to non-volatile memory to guarantee the persistence of the Windows configuration. See par. 3.7.2.*

## Windows Mobile

There are several reset methods for the Memor.

A warm boot terminates an unresponsive application and clears the working RAM, but preserves the file system. Registry are restored from persistent memory if available or returned to factory default.

A cold boot forces all applications to close reinitializing completely the system. It clears the working RAM, but the file system is preserved. Registry is restored from persistent memory if available or returned to factory default.

A clean boot restores the Memor to a clean configuration: both the registry and the file system return to a clean status that conform to factory default, unless the user has installed an additional package.

### Warm Boot

A warm boot closes all applications and clears the working RAM, but preserves the file system. Registry are restored from persistent memory if a saved copy is available (see Registry Applet, par. 3.7.2) or returned to factory default. If an application hangs, initiate a warm boot to terminate the application.

To perform a warm boot, press and hold the following keys simultaneously:



### Cold Boot

A cold boot is a complete reset of the Memor in which all applications are forcibly closed and the RAM is completely cleared. Registry is restored from persistent memory if a saved copy is available (see Registry Applet, par. 3.7.2). Applications and data stored on file system are preserved. A cold boot is

necessary when the Windows Mobile operating system locks up and the warm boot command does not work.

To perform a cold boot, press and hold the following keys simultaneously:



### Clean Boot

A clean boot is a cold boot that causes the device to be restored to a clean configuration. The Memor will be reset to its factory configuration only if the user has not installed any additional package. Please note that you will lose any applications and data stored in persistent flash memory.

To perform a clean boot, follow these steps:

1. Perform a Cold Boot (see Cold Boot).
2. Quickly release all the keys when the screen goes black.
3. Within 1 second press and hold down the Esc and 0 keys until the left orange led starts blinking.
4. Release the Esc and 0 keys.
5. Enter 1 to proceed with the Clean Boot sequence. Enter 0 to cancel the Clean Boot and proceed with a Cold Boot.

	<b>Warm Boot</b>	<b>Cold Boot</b>	<b>Clean Boot</b>
<b>REGISTRY</b>	Restored from flash	Restored from flash	Clean configuration (no user config)
<b>File System</b>	Preserved	Preserved	Clean Installation (no user files)



### 3.5 STATUS INDICATORS











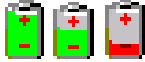

#### 3.5.1 LED Status

The Datalogic Memor™ provides three different LEDs signaling the mobile computer status.

LED	STATUS	
Good Read and General Purpose (left side)	Green	It is constant for a configurable time to signal that a successful read has occurred.
	Green/Red	It is also available to the application program.
Charging Status (right side)	Green constant	It is constant once the charging process has been completed.
	Red constant	It is constant while charging.

### 3.5.2 Taskbar

The Taskbar provides information about the time, the battery level, the keyboard function, and the decoding status.

ICONS	DESCRIPTION
<b>Time and Battery Icons</b>	
<b>10.50</b>	It displays the time.
	In Windows CE, they are representative of five different icons indicating the battery level. The icon is partially green when the power left is >20% and partially red colored when the power left is <20%.
	In Windows Mobile, it displays the system battery status.
	It indicates that the battery is charging (Windows CE).
	It indicates that the battery is charging (Windows Mobile).
<b>Keyboard Status Icons</b>	
	It indicates that the blue FUNC key has been pressed and is going to affect the next key press.
	It indicates that the yellow FUNC key has been pressed and is going to affect the next key press.
	It indicates that the ALPHA key has enabled the selection of the characters printed in orange.
	It indicates the NUMERIC key selection, the ALPHA key has not been pressed.
	It indicates that the ALPHA key has enabled the selection of the characters printed in orange and the Capslock is active.
	It indicates that the keyboard is locked.
<b>Decoding Status Icons</b>	
 	It indicates that the decoder is active (green), not active (grey).



Windows CE Taskbar



Windows Mobile Taskbars

### 3.6 DATA CAPTURE CONFIGURATION

From the Windows CE Taskbar, tap the "Decoding" icon to open a drop-down menu. Decoding can also be accessed from the Control Panel.

By selecting the *Info* item from this drop-down menu you can access information about the Scanner and the Software; the *Configure* item opens the configuration applet (Data Capture Configuration Window), while *Capture* accesses the data capture applet (Data Capture Window), which enables code reading.

The last menu item (*Wedge*) enables Wedge Emulation.

From the Windows Mobile Start menu, tap Settings -> System -> Decoding. The "Decoding" icon opens the configuration applet (Data Capture Configuration Window).

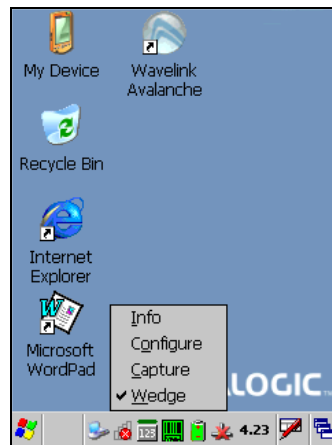

Windows CE



Windows Mobile

#### 3.6.1 Configure

The Configuration applet contains the barcode scanning configuration parameters in a directory tree structure. The available barcode parameters are divided into two groups: Reader Parameters and Scan Parameters.

The Reader Parameters depend on the type of scanner module installed on the mobile computer and allow barcode configuration (i.e. enable/disable Code 39, check digit control, etc.).

The Scan Parameters are common to all scanner modules and allow control of the scanning device (i.e. beeper control, LED control, laser timeout, etc.).

Each Data Capture screen window corresponds to a branch of the tree, and the name of the current branch is displayed at the bottom of each screen window.

File	Parameter	Window	Help
Parameter		Value	
	Reader Parame...	...	
	Scan Parameters	...	
Scanner Setup <Parameters>			

Data Capture Configuration Window

The screen format shows two columns where the left column indicates branches or parameters. Branches have three dots in the right column (...). You can navigate through the tree structure using the stylus or keyboard arrows directly on the item field or from the menu.

Parameters have their corresponding current values in the right column. You can edit parameter values using the stylus or keyboard arrows directly on the item field or from the menu. To change a value for example, select the line of the value to be changed, choose Edit from the Parameter Menu then choose a new value from the values listed in the box (see following figures).

File	Parameter	Window	Help
Paran	edit	Value	
..	root	..	
Sc	up	5000	
	GoodReadSound	Beep.wav	
	LedDuration	200	
	LedPulses	1	
	ContinuousMode	Disabled	
	KeyboardEmula...	no	
	SoftTrigger	Enabled	
	ScanAlwaysOn	Disabled	
	NotPrintableChar	Leave	
Scanner Setup <Scan Parameters>			

File	Parameter	Window	Help
Parameter		Value	
..	..	..	
	ScanTimeout	5000	
	G		
	L		
	L		
	C		
	K		
	S		
	S	[0...5]	
	NotPrintableChar	Leave	
Scanner Setup <Scan Parameters>			

Selecting Data Capture Setup Parameters

Alternatively using the stylus, you can tap once directly on the value on the right column; continue tapping until the desired value is reached.

To activate a new configuration select the File -> Save Menu to send the new configuration to the barcode decoding software and save the new configuration. This will save the configuration to non-volatile memory preventing loss at the next system reset.

## Reader Parameters

The barcode reading parameters and values are dependent upon the type of scanner module mounted in your mobile computer. For a detailed list of parameters and of their configuration procedures, please refer to the SDK Help file on the CD.

## Scan Parameters

The Scan Parameters are common to all scanner modules and allow control of the scanning device. The Scan parameters are described as follows:

**ScanTimeout:** the maximum time, in milliseconds, during which the scanner remains on without decoding any barcode.

**BeepType:** if set to dual tone, the good read beep is a sequence of high and low pitch sounds. If set to monotone, the beep is a single pitch sound.

**BeepDuration:** the time interval, in milliseconds, during which the beeper will sound when the scanner reads a code. To disable the beeper, set this value to 0.

**BeepFrequency:** determines the frequency in Hertz of the beeper.

**GoodReadSound:** is the beep sound emitted when the scanner reads a code.

**LedDuration:** the length of the good-read led pulse, in milliseconds.

**LedPulses:** the number of times the good-read led pulse is emitted when the scanner reads a code.

**ContinuousMode:** disables the effect of the ScanTimeout parameter.

**KeyboardEmulation:** if enabled all scanned data are transformed into keyboard events and can therefore be displayed and saved to a file as if input from the mobile computer keyboard.

**SoftTrigger:** when enabled, the laser can be turned on/off by the application software.

**ScanAlwaysOn:** enables the scanner for barcode reading independently from the application software.

**GreenSpotDuration:** determines the duration (measured in milliseconds) of the green spot feedback, which provides a "good read" green dot directly on the code, where the operator usually tends to be looking.

**NotPrintableChar:** if set to "Remove", all not printable characters included in the scanned data are deleted and the final barcode will include only printable characters.

**ScanButton:** enables/disables the scan button. If the scan button is disabled, the reader can be triggered under software control.

## Default Settings

The following tables contain the default values for the major barcode setup parameters, according to the type of scan engine mounted on the mobile computer. For a complete list of parameters and of their configuration procedures, please refer to the SDK Help file on the CD.

SCAN PARAMETERS	LASER MODELS	IMAGER MODELS
ScanTimeout	5000	Not available
BeepType	Dual tone	Not available
BeepDuration	20	Not available
BeepFrequency	2000	Not available
GoodReadSound	Beep	Beep.wav
LedDuration	200 ms	200 ms
LedPulses	1	1
ContinuousMode	Disabled	Disabled
KeyboardEmulation	Enabled	Enabled
SoftTrigger	Enabled	Enabled
ScanAlwaysOn	Disabled	Disabled
GreenSpotDuration	1000	Not available
NotPrintableChar	Leave	Leave
ScanButton	Enabled	Enabled

BARCODE SYMBOLOGY SPECIFIC READER PARAMETERS	LASER MODELS	IMAGER MODELS
UPC A	Enabled	*
UPC E	Enabled	
EAN 8	Enabled	
EAN 13	Enabled	
UPC/EAN/JAN	Not available	Enabled
Code 39	Enabled	Enabled
Code 39 Full ASCII	Disabled	Disabled
Code 32	Disabled	Not available
2/5: Interleaved	Enabled	Enabled
2/5: Industrial	Disabled	Not available
2/5: Matrix	Disabled	Not available
Code 128	Enabled	Enabled
EAN 128	Enabled	Disabled
Codabar	Disabled	Enabled

\* In the Imager models these codes may only be enabled or disabled as a group by the UPC/EAN/JAN family selection (see a few lines below).

BARCODE SYMBOLOGY SPECIFIC READER PARAMETERS	LASER MODELS	IMAGER MODELS
MSI	Disabled	Not available
Plessey	Disabled	Not available
Code 93	Disabled	Enabled
Code 11	Disabled	Not available
GS1 Databar	Disabled	Enabled
GS1 Databar Omnidirectional	Disabled	Not available
GS1 Databar General	Not available	Enabled
GS1 Databar Limited	Disabled	Enabled
GS1 Databar Expanded	Disabled	Enabled
PDF - 417	Not available	Enabled
Data Matrix	Not available	Enabled
QR	Not available	Enabled
POSTNET	Not available	Disabled*
PLANET	Not available	
Japan Post	Not available	
Australia Post	Not available	
KIX Code	Not available	
Royal Mail Code (RM4SCC)	Not available	

\* These codes may be enabled individually but are disabled as a group.



### 3.6.2 Capture

The Data Capture applet (Capture) enables code reading.

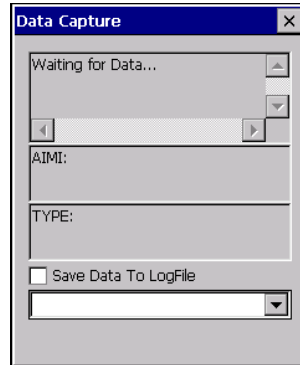

Data Capture Window

Data Capture can also be enabled through the Configuration applet by selecting File ->Scanner from the main menu, or by enabling the parameter Scan Always On in the Scan Parameters branch.

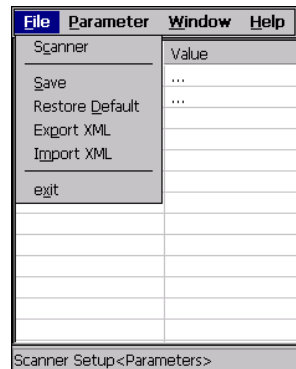

Enabling the Data Capture

### 3.7 CONTROL PANEL

From the Windows CE Desktop, double tap on the "My Device" icon and then double tap on the "Control Panel" icon to open the Windows CE control panel main window. The Control Panel can also be launched from Start ->Settings ->Control Panel.

APPLET programs are displayed as icons; one icon corresponds to each APPLETT.

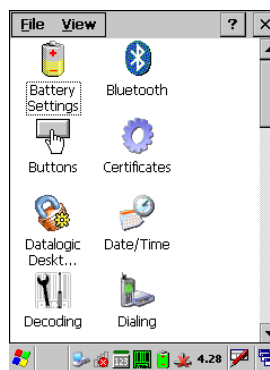

Windows CE Control Panel

From the Windows Mobile Start menu, tap Settings. A three tab dialog opens: Personal, System, Connections.

APPLET programs are displayed as icons; one icon corresponds to each APPLETT.

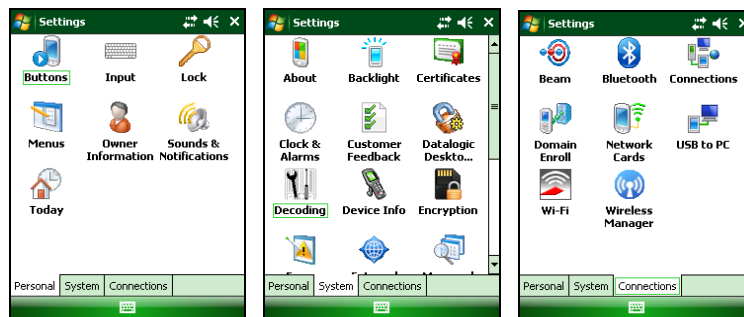

Windows Mobile Control Panel

### 3.7.1 Buttons

To configure the way up/down and the rest of keys control repeats, use the Up/Down Control applet (Start -> Settings -> Personal -> Buttons -> Up/Down Control).



Windows CE Buttons Icon



Buttons

Windows Mobile Buttons Icon

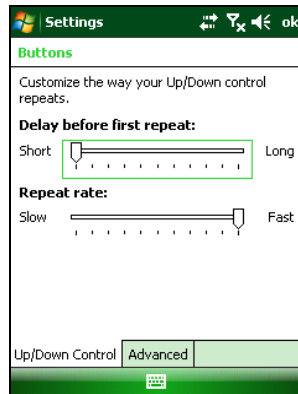

You can also select to wake up the terminal by the SCAN key.

To assign desired applications to be launched by one of the keys, refer to DFU Reference Guide.

### 3.7.2 Registry

The REGISTRY ADMIN applet provides management of Windows CE 5.0/Windows Mobile registry.

From the Windows CE control panel main window, , select the REGISTRY ADMIN applet by double tapping the Registry Admin icon.

From the Windows Mobile Start menu, tap Settings -> System ->Registry Admin. Select the REGISTRY ADMIN applet by tapping the Registry Admin icon.

The Registry Administration Main window appears. Two functions are available:

- Save Registry allows permanently saving the Windows configuration (example: custom configuration of screen desktop background color, or network adapter configuration) to non-volatile memory (SAVE button).
- Restore Default Registry allows restoring the initial factory default configuration (Restore Default button). After restoring the factory default configuration, you must perform a warm boot.

Saving the registry to non-volatile memory guarantees the persistence of the Windows configuration in case of battery pack replacement, cold boot or warm boot on Windows Mobile.

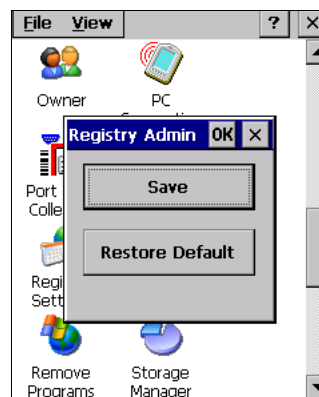

**Registry Administration Window**

### 3.7.3 Files Admin

The FILES ADMIN applet enables control of the permanence of files in the Windows CE System Folder.

Because Windows Mobile mounts the entire file system in persistent store (rather than using RAM), it provides both users and applications with a reliable storage platform even in the absence of battery power. The FILES ADMIN applet is therefore not necessary.

Two functions are available on the Files Admin Main window by means of two buttons:

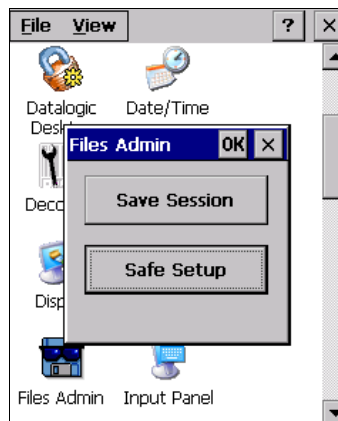

Files Admin Main Window

**Save Session:** with this button all files will be permanently saved in the \Windows directory in non-volatile memory. This function guarantees the steady maintenance of every file produced during the current working session - even of sub-directories and relevant files - with the exception of the files belonging to the FLASH image.

These current working session files will be backed-up in the \Backup\Windows directory.

At the next cold boot, the files previously saved in the \Backup\Windows directory will be restored to the Windows directory (see par. 3.9).

**Safe Setup:** with this button, the installation of software programs will be saved to non-volatile memory (Backup directory). Before doing this, it will be checked that the Backup directory has enough space to save the files. If the directory space is not enough, an error message will be shown and the program will exit the Safe Setup function.

Two activating procedures are available for Safe Setup:

- Select an installation file (for example, a .CAB cabinet file) from the Safe Setup mask.

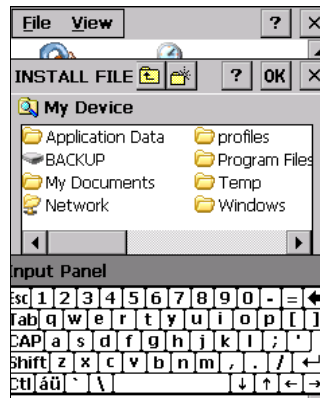

**Safe Setup First Mask**

Then select \Windows or a relevant sub-directory in the path box. Then, Safe Setup will recognize the new files and directories present in the \Windows directory, and will copy them to the \Backup\Windows directory. At the next cold boot, these files will be restored (see par. 3.9).

- Simply skip the first mask either by closing it or by pressing the ESC key. When it closes, a new mask will pop up: it will enable any type of installation (even remote ones like ActiveSync® installations). Make sure the installation directory is \Windows or one of its sub-directories. After installation, tap OK: Safe Setup will save the new files in the \Backup\Windows directory.

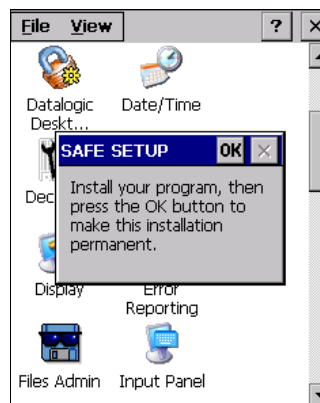

**Safe Setup Second Mask**

### 3.7.4 Wireless Communications

The WIRELESS COMMUNICATIONS applet provides management of the 802.11b/g radio, the Bluetooth® and GSM modules.



Windows CE Wireless Communications  
Icon



Windows Mobile Connectivity Icon

If the mobile computer supports Windows CE, select the WIRELESS COMMUNICATIONS applet by double tapping the Wireless Communications icon. The following window will appear:

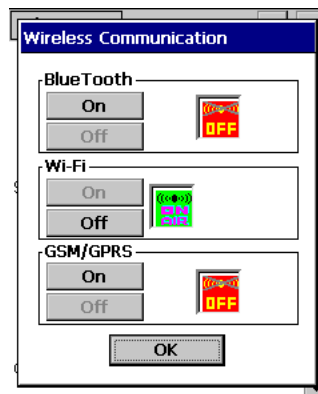

Wireless Communications Window

If the mobile computer supports Windows Mobile, the Wireless Manager application manages access to wireless connections.

The 'Wireless Manager' is a sort of 'Control Panel' for bluetooth and phone modules. From here it's possible to turn on or off bluetooth and phone radio stacks.

Open the Wireless Manager by tapping Start -> Settings -> Connections -> Wireless Manager, or by tapping the Connectivity icon located at the top of the screen. The following window will appear:



Windows Mobile Wireless Communications Window



### 3.7.5 Stylus Calibration

You might need to recalibrate the touch screen (i.e. when you attempt to select one item with the stylus, another item is erroneously selected).

To recalibrate the touch screen on Windows CE, complete the following steps:

1. Select **Start > Settings > Control Panel > Stylus** to open the **Stylus Properties** dialog as shown in Figure 1.
2. Adjust **Double-Tap** sensitivity if needed or desired.
3. Select the **Calibration** tab to open the **Calibration** application.

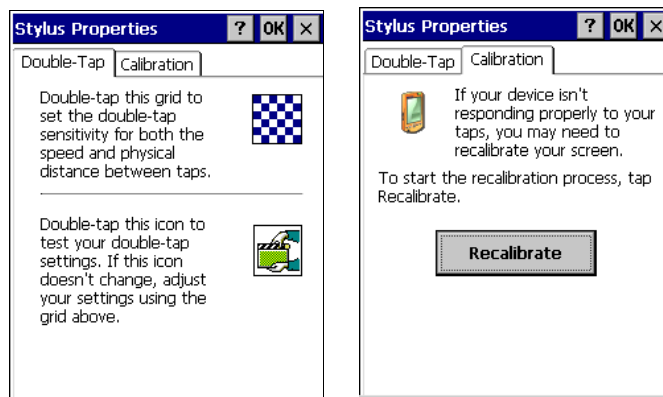

Figure 1

4. Tap **Recalibrate** to open the **Calibration** screen shown in Figure 2.
5. Carefully press and briefly hold stylus on the center of the target. Repeat as the target moves around the screen. Press the **<ESC>** key to cancel the stylus calibration.
6. Press the **<ENTER>** key or tap the screen to accept the new calibration settings. Press the **<ESC>** key to keep the old settings.
7. New calibration settings are persistently saved in registry.

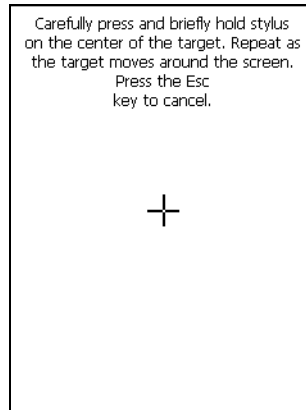

Figure 2

To recalibrate the touch screen on Windows Mobile, complete the following steps:

1. Select **Start > Settings > System > Screen** to open the **Screen Settings** dialog as shown in Figure 3.

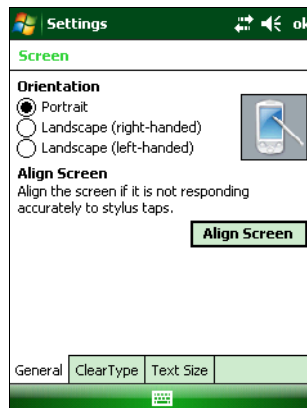

Figure 3

2. Tap **Align Screen** to open the **Calibration** screen shown in Figure 4.
3. Carefully press and briefly hold stylus on the center of the target. Repeat as the target moves around the screen. Press the **<ESC>** key at any time to cancel the stylus calibration.
4. By completing the calibration procedure you implicitly accept the new calibration settings.
5. New calibration settings are persistently saved in registry.

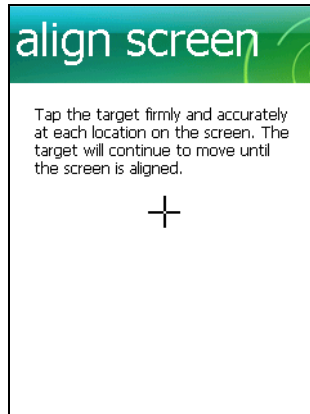

Figure 4

### Startup stylus calibration on Windows CE

When starting the terminal, a stylus calibration screen comes up if valid calibration settings are not available. This happens in the following circumstances:

1. At the first startup of the terminal.
2. After restoring registry default settings using the applet **Registry Admin** and performing a warm boot.
3. After a **Clean Boot**.
4. After a **Firmware Update** (see par. 3.10).

### Startup stylus calibration on Windows Mobile

When starting the terminal, a Welcome Wizard (with Stylus Calibration) comes up if valid calibration settings are not available. This happens in the following circumstances:

1. At the first startup of the terminal.
2. After restoring registry default settings using the applet **Registry Admin** and performing a boot.
3. After a **Clean Boot**.

### 3.7.6 Volume Settings

#### Windows CE

From the Windows CE control panel main window, select the Audio applet by double tapping the 'Audio' icon:

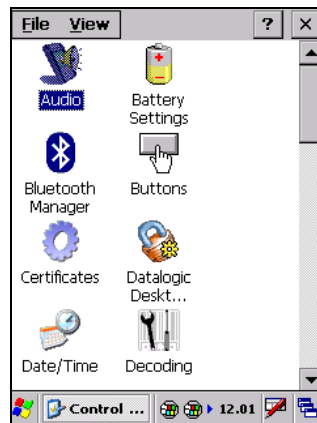

The Audio applet allows to set the recording volumes of the main microphone and of the headset microphone. Also, it allows to set the headset volume when the user is listening to an audio file.

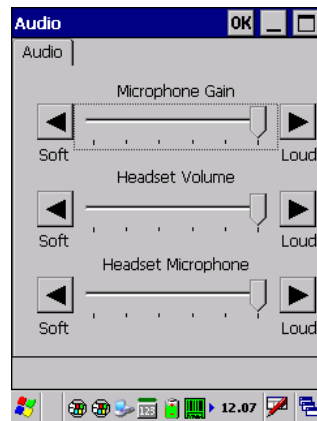

Audio Window

From the Windows CE control panel main window, select the Volume & Sounds applet by double tapping the Volume & Sounds icon:

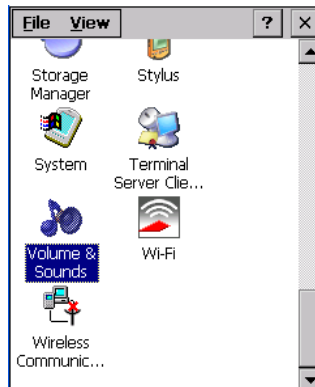

The Volume & Sounds applet allows to manage the audio features of the rear speaker and appears as follows:

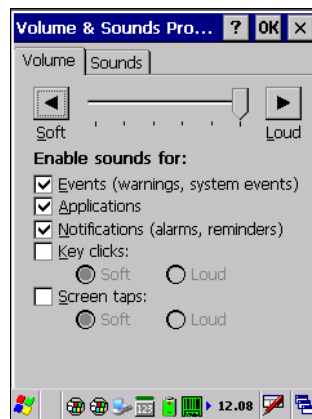

**Volume & Sounds Window**

## Windows Mobile

From the Windows Mobile Start Menu, select Settings > Connections tab and click the Audio icon:

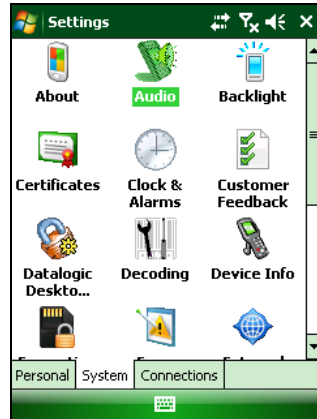

**Audio Window**

The Audio applet allows to set the recording volumes of the main microphone and of the headset microphone. Also, it allows to set the headset volume when the user is listening to an audio file.

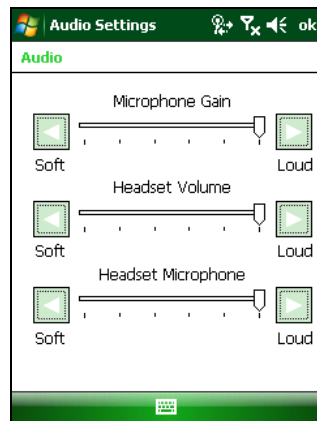

To set the speaker volume during a call, click the  icon on the right top of the Windows Mobile Start Menu. To set the front speaker or the headset speaker volume, use the right bar or move the joystick up and down. To set the rear speaker volume, use the left bar.

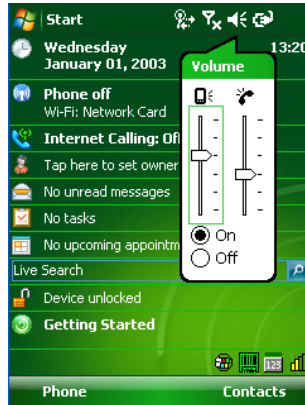

To set the Bluetooth® headset volume, tap Settings > Connections > Bluetooth Manager > Connections and select the headset. The following window will appear:

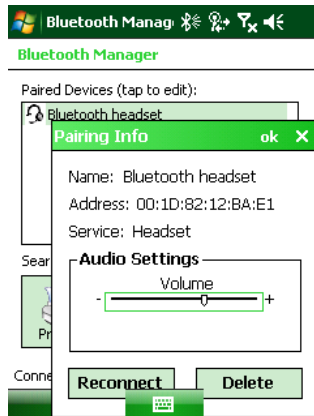

### 3.8 WINDOWS CONNECTIONS

To connect the Datalogic Memor™ to another device (i.e. Host PC) from Windows, several programs are available. These programs require specific electrical connections in order to function properly.

#### 3.8.1 Microsoft® ActiveSync®

Microsoft® ActiveSync® gives you the possibility to connect your desktop computer to your Datalogic Memor™ and synchronize the information on them. Synchronization compares the data on the Datalogic Memor™ with that on the desktop computer and updates both computers with the most recent information.

With ActiveSync®, it is possible to:

- Back up and restore Datalogic Memor™ data.
- Copy files between Datalogic Memor™ and desktop computer.
- Synchronize files by selecting a synchronization mode.

You can establish an ActiveSync® connection to your Datalogic Memor™ through the following electrical interfaces:

- **USB** either directly or through the Single Cradle
- **Bluetooth®** (see par. 3.8.2)

It is possible to constantly synchronize while connected to a desktop computer or, alternatively, synchronization can be performed only when the synchronize command is chosen. You can select which information types are synchronized and control how much data is synchronized.



**NOTE**

*By default, ActiveSync® does not automatically synchronize all types of information. Use ActiveSync® options to turn synchronization on and off for specific information types.*

For example:

Synchronize Microsoft Word and Microsoft Excel files between the Datalogic Memor™ and the desktop computer. The files will automatically be converted to the correct format.



**NOTE**

*In Windows Mobile before using the ActiveSync follow the directions described in par. 2.3*





**NOTE**

Visit the following Microsoft Web site for the latest in updates and technical information:

<http://www.microsoft.com/windowsmobile/activesync/default.aspx>

### ActiveSync® Remote



**NOTE**

Microsoft® ActiveSync® Remote is no longer supported in Windows CE. For backward compatibility you can download it from the Internet. We suggest enabling the FTP Server and connecting to an FTP Client. See par. 3.8.4.

### 3.8.2 Bluetooth® Manager Device Setup

#### Windows CE Bluetooth® Manager Device Setup

Before turning on Bluetooth®, ensure that the two devices are within close range and that both Bluetooth-enabled devices are discoverable.

1. Open the Bluetooth® control panel by tapping Start > Settings > Connections tab > Bluetooth Manager.
2. Tap Settings. The Settings tab allows you to enable or disable the Bluetooth radio and specify settings for Incoming Connections.
3. Select or clear the “Enable Bluetooth Radio” check box:

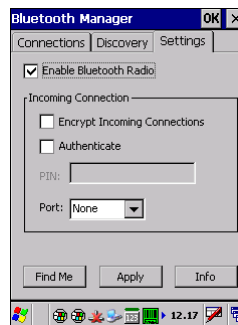

Tap Find Me if you want to make the Memor™ visible to other Bluetooth devices for 60 seconds, allowing them to set up a connection.

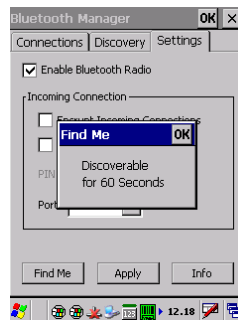

#### NOTE

*By default, Bluetooth® is turned off. If you turn it on, and then turn off your device, Bluetooth® also turns off. When you turn on your device again, Bluetooth® turns on automatically.*

To create a Bluetooth® partnership between your device and another device that has Bluetooth® capabilities, ensure that the two devices are turned on, discoverable, and within close range.

1. Open the Bluetooth® control panel by tapping Start > Settings > Connections tab > Bluetooth Manager.
1. Search for the type of Device(s) you want to connect to by tapping Printer, Serial or All. The Memor™ will search for Bluetooth® Devices within range.

**NOTE**

*If you attempt to set up a connection when the Bluetooth® Radio is disabled, you will receive a message reminding you that the radio is turned off, and asking you if you want to turn it on. Tap Yes if you need to enable the Bluetooth® Radio.*

3. Once searching is complete, Bluetooth® Device Profiles will be displayed in the Discovery tab. You can set up a connection to a device on the list, or clear it from the list by tapping the Clear button:

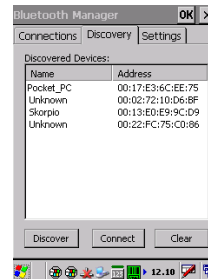
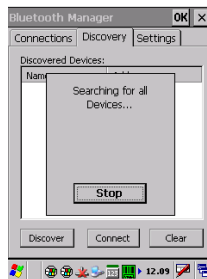

To set up a connection:

1. From the list of available devices, double tap the one you want to activate, or select and then tap Connect. The resulting dialog will display services that are available on the device:

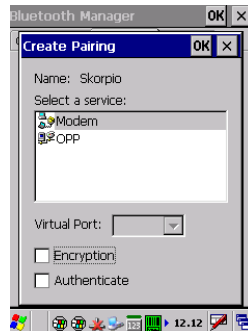

2. Select the service you want to connect to. The following table shows the icons that display for different types of service.

Icon	Service
	Dialup Networking
	Printer
	File Transfer Protocol (FTP) Object Exchange (OBEX)
	Object Push (OPP) Object Exchange (OBEX)
	ActiveSync
	Human Interface Device (HID) - Keyboard
	Serial

Virtual Port allows you to specify the incoming port, which is used to communicate serially with an incoming device just as if it were a physical COM port. This option is available only if you have selected a Printer or Serial service.

You can also select Encrypt or Authenticate from the Bluetooth® control panel to apply or modify those settings.

1. To require Authentication, tap the checkbox, then tap OK.
2. The Authentication Request dialog will then open, requesting that you enter a PIN. Use the Input Panel to type in the PIN.



3. Tap OK to complete.

The dialog will also appear when an Authentication request is received from another device.

Once you have set up a Pairing, you can view the settings by double-tapping its name from the Connections tab. The Pairing info dialog will display different options, depending on what type of device you have selected and what service you use.

- For a printer connection, tap the arrow to change the Virtual Port, or Delete to remove the device pairing.
- Tap Sync to initiate a Sync (available only if the service is an ActiveSync connection).

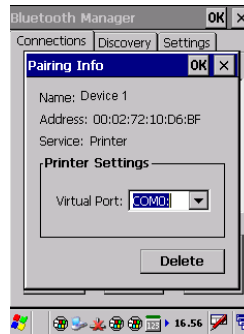

The icons displayed in the taskbar at the bottom of your Memor™'s screen will show you the state of the Bluetooth connection, as shown in the table below.

<b>Icon</b>	<b>Name</b>	<b>Description</b>
	Disabled Icon	Indicates that Bluetooth has been disabled.
	Unpaired Icon	Indicates that the Bluetooth radio is on but the device is currently not paired to another.
	Paired Icon	Indicates that the Bluetooth radio is on and the device is paired with at least another device.
	Discoverable	Indicates that the device is discoverable by other Bluetooth devices.

## Windows Mobile Bluetooth® Manager Device Setup



*The Bluetooth Device Properties icon will only be visible if Bluetooth hardware has been installed on the unit.*

### NOTE

Before turning on Bluetooth®, ensure that the two devices are within close range and that both Bluetooth-enabled devices are discoverable.

4. Tapping Start > Settings > Connections tab > Bluetooth Manager to open the Bluetooth® control panel.
5. Tap Settings. The Settings tab allows you to enable or disable the Bluetooth radio and specify settings for Incoming Connections.
6. Select or clear the “Enable Bluetooth Radio” check box:

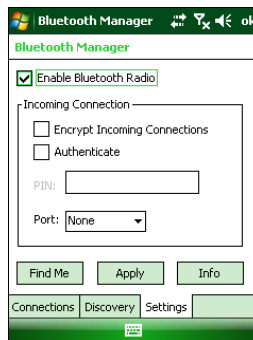

Tap Find Me if you want to make the Memor™ visible to other Bluetooth devices for 60 seconds, allowing them to set up a connection.

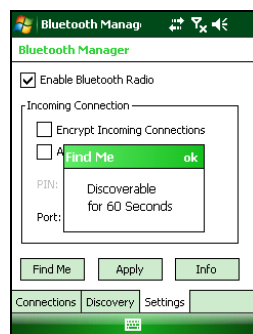

**NOTE**

*By default, Bluetooth® is turned off. If you turn it on, and then turn off your device, Bluetooth® also turns off. When you turn on your device again, Bluetooth® turns on automatically.*

To create a Bluetooth® partnership between your device and another device that has Bluetooth® capabilities, ensure that the two devices are turned on, discoverable, and within close range.

2. Open the Bluetooth® control panel by tapping Start > Settings > Connections tab > Bluetooth Manager.
1. Search for available Bluetooth® Devices by tapping the button for the type of device you want (Printer, Serial or All) or tap Discovery to skip this step. The Memor™ will search for Bluetooth® Devices within range.

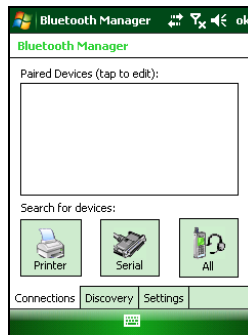
**NOTE**

*If you attempt to set up a connection when the Bluetooth® Radio is disabled, you will receive a message reminding you that the radio is turned off, and asking you if you want to turn it on. Tap Yes if you need to enable the Bluetooth® Radio.*

2. Once searching is complete, Bluetooth® Device Profiles will be displayed in the Discovery tab. You can set up a connection to a device on the list, or clear it from the list by tapping the Clear button:



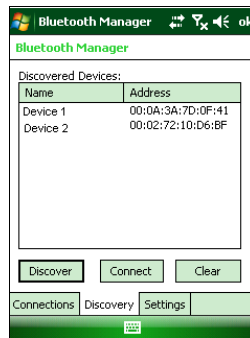





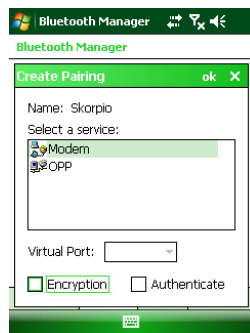

To set up a connection:

1. Double tap the device you want to activate, or select and then tap Connect. The resulting dialog will display services that are available on the device:



2. Select the service you want to connect to. The following table shows the icons that display for different types of service.

Icon	Service
	Dialup Networking
	Printer
	File Transfer Protocol (FTP) Object Exchange (OBEX)
	Object Push (OPP) Object Exchange (OBEX)
	ActiveSync
	Human Interface Device (HID) - Keyboard
	Serial

Virtual Port allows you to specify the incoming port, which is used to communicate serially with an incoming device just as if it were a physical COM port. This option is available only if you have selected a Printer or Serial service.

You can also select Encrypt or Authenticate from the Bluetooth® control panel to apply or modify those settings.

1. To require Authentication, tap the checkbox, then tap OK.

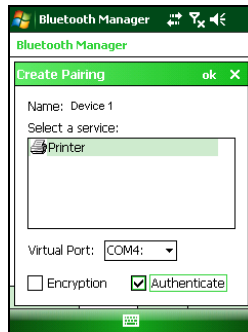

2. The Authentication Request dialog will then open, requesting that you enter a PIN. Use the Input Panel to type in the PIN.



3. Tap OK to complete.

The dialog will also appear when an Authentication request is received from another device.

Once you have set up a Pairing, you can view the settings by double-tapping its name from the Connections tab. Tap the arrow to change the Virtual Port, or Delete to remove the device pairing. Tap Sync to initiate a Sync (available only if the service is an ActiveSync connection).

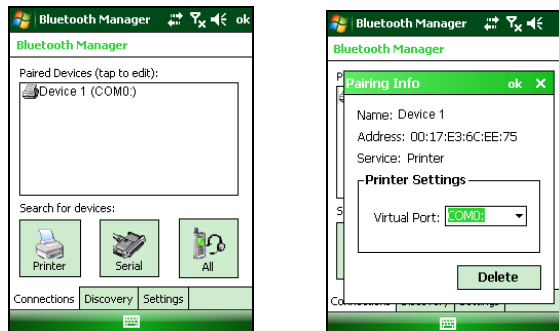

### 3.8.3 Windows Mobile Phone

For information on Windows Mobile Phone use and functioning, refer to the Windows Mobile web site: <http://www.microsoft.com/windowsmobile>.

### 3.8.4 FTP Server Setup

The Datalogic Memor™ Windows CE Operating System includes a sample File Transfer Protocol (FTP) server. FTP is used for copying files to and from remote computer systems over a network using TCP/IP. You can establish a connection to your Datalogic Memor™ using its FTP Server through the following interfaces:

**WLAN** using the 802.11b/g radio

Proceed as follows:

1. Create a registry file (extension .reg) to setup and enable FTP Server communication. A simple example file for anonymous logon is given below:

```
REGEDIT4

[HKEY_LOCAL_MACHINE\Comm\FTPD]
"DefaultDir"="\\"
"AllowAnonymousUpload"=dword:00000001
"UseAuthentication"=dword:00000000
"BaseDir"="\\"
"IsEnabled"=dword:00000001
"LogSize"=dword:00001000
"DebugOutputMask"=dword:00000017
"DebugOutputChannels"=dword:00000002
"IdleTimeout"=dword:0000012c
"AllowAnonymous"=dword:00000001
"AllowAnonymousVroots"=dword:00000001
```

2. Copy this file to the Datalogic Memor™ using ActiveSync®.
3. Launch the .reg file from the Datalogic Memor™.
4. Perform a warm boot on the Datalogic Memor™.
5. From the PC > Explorer address bar (or running an FTP Client from the PC), enter the Datalogic Memor™ IP address.



**NOTE**

*For more information on FTP Client/Server connections refer to the following web page:*

*<http://msdn2.microsoft.com/en-us/library/aa922316.aspx>*

### 3.9 BACKUP DIRECTORY FILE MANAGEMENT

All of the Windows CE 5.0 system files reside in RAM (volatile memory) except for the Backup directory, which resides in FLASH (non-volatile memory). Therefore the contents of the Backup directory are persistent even if the mobile computer is re-booted or the battery pack is changed.

You can save your more important files that you don't want to lose due to mobile computer re-boot, in the Backup directory or create a sub-directory within Backup.

Even though the Windows Directory resides in RAM, it often contains files or sub-directories created by the user or by installation programs that you don't want to lose at re-boot. To keep these files persistent it is necessary to copy them to the directory \Backup\Windows. This directory doesn't exist originally (only Backup exists), and therefore it must be created. At the next cold boot, before activating the shell, Windows CE 5.0 will copy the contents including all sub-directories of \Backup\Windows to \Windows.

Likewise, to maintain files that must be run at Windows CE 5.0 startup, (i.e. .exe, .lnk, .vb, .htm, etc.), it is necessary to copy them to the directory \Backup\Startup. This directory does not exist originally (only Backup exists), and therefore it must be created. The application programs will be run after any type of re-boot (both software and cold boot).

As an alternative to the Safe Setup function, it is possible to copy the .cab files to the directory \Backup\Cabfiles (the Cabfiles sub-directory doesn't exist originally and must therefore be created) and perform a mobile computer cold boot to have the application installed. Once these files are copied to the directory \Backup\Cabfiles, the application will be run after each re-boot.

From the second cold boot on, a message may be displayed such as "<application name> is already installed. Re-install?". This message blocks the boot process. Press the [Enter] key to continue the system initialization.

Even if the entire Windows Mobile file system reside in FLASH (non-volatile memory), the mechanism described above is supported also on Windows Mobile for backward compatibility.

### 3.10 FIRMWARE UPDATE

The Datalogic Memor<sup>TM</sup> is equipped with a tool that implements a firmware update service.

For further information, refer to DFU Reference Guide.

## 4 MAINTENANCE



**NOTE**

*Rechargeable backup batteries and battery packs are not initially charged. Therefore the initial operation to perform is to charge them. See below.*



**CAUTION**

*Annual replacement of rechargeable battery pack avoids possible risks or abnormalities and ensures maximum performance.*

### 4.1 CHARGING THE BATTERY PACK



**NOTE**

*The battery pack autonomy varies according to many factors, such as the frequency of barcode scanning, RF usage, battery life, storage, environmental conditions, etc.*

The battery icon on the Taskbar indicates when the battery pack is low.

It is possible to recharge the battery pack by connecting the power supply directly to the Datalogic Memor™.

Alternatively, it is also possible to recharge the battery pack by using a Single Cradle.

Moreover recharging is possible by USB Direct connection with the host computer, but with longer charging times and in this case it is advised to keep the mobile computer off.

During the charging process the LED positioned at the right side of the display is red constant. Once the charging process has been completed this LED is green constant (see par. 3.5).

If the battery pack is removed from the mobile computer, it can be recharged by inserting it into the rear slot of a Single Cradle.



**CAUTION**

*Do not use the Datalogic Memor™ until batteries are charged for minimum 4 hours.*

**NOTE**

*Even if the storage temperature range is wider, In order to achieve the longest battery life, store the terminal and the spare batteries between 20 to 30 °C (68 to 86 °F).*

*The Batteries must be charged at a temperature ranging from 0° to +40 °C (+32° to +104 °F).*

*For the GSM models the maximum recommended temperature is + 35° C. At higher values the charging may slow down.*

**NOTE**

*The battery level may not be displayed correctly for some minutes after the disconnection if the Datalogic Memor™ is disconnected from power supply before the charging cycle is completed.*

**NOTE**

*The Datalogic Memor™ could get warm during charging, this is normal and does not mean a malfunction.*

**NOTE**

*Use only a USB-IF compliant USB port as a charging source.*

## 4.2 REPLACING THE BATTERY PACK

To correctly replace the battery pack, proceed as follows.

1. Turn off the Datalogic Memor™.
2. Press the latch release button and pull the battery latch down as indicated in the figure below:



3. Remove the cover and the battery pack.



4. Install the new battery pack, first insert the bottom (contacts) side, then the upper side as indicated in the following figure:



5. Press the latch release button and pull the battery latch down to reinsert the cover.





**CAUTION**

*As the battery cover is lifted, the mobile computer automatically shuts off, in order to retain data during the pack substitution.*

**WARNING**

*Installing, charging and/or any other action should be done by authorized personnel and following this manual.*

*The battery pack may get hot, explode, ignite, and/or cause serious injury if exposed to abusive conditions.*

*If the battery pack is replaced with an improper type, there is risk of explosion.*

*Do not place the battery pack in or near a fire or heat; do not place the battery pack in direct sunlight, or use or store the battery pack inside unventilated areas in hot weather; do not place the battery pack in microwave ovens, dryer, high pressure containers, on induction cookware or similar device. Doing so may cause the battery pack to generate heat, explode or ignite. Using the battery pack in this manner may also result in a loss of performance and a shortened life expectancy.*

*Use only a Datalogic Mobile approved power supply. The use of an alternative power supply will void the product warranty, may cause product damage and may cause heat, explode or ignite.*

*The area in which the units are charged should be clear of debris and combustible materials or chemicals.*

*Do not use the battery pack of this terminal for power devices different from this mobile computer.*

*Immediately discontinue use of the battery pack if, while using, charging or storing the battery pack, the battery pack emits an unusual smell, feels hot, changes colour or shape, or appears abnormal in any other way.*

*Do not short-circuit the battery pack contacts connecting the positive terminal and negative terminal. This might happen, for example, when you carry a spare battery pack in your pocket or purse; accidental short-circuiting can occur when a metallic object such as a coin, clip, or pen causes direct connection of the contacts of the battery pack (these look like metal strips on the battery pack). Short-circuiting the terminals may damage the battery pack or the connecting object.*

*Do not apply voltages to the battery pack contacts.*

*Do not pierce the battery pack with nails, strike it with a hammer, step on it or otherwise subject it to strong impacts or shocks.*

**WARNING**

*Do not disassemble or modify (i.e. bend, crush or deform) the battery pack. The battery pack contains safety and protection devices, which, if damaged, may cause the battery pack to generate heat, explode or ignite.*

*In case of leakage of liquid from the battery, avoid contact with liquid the skin or eyes. If the contact occurs, immediately wash the affected area with water and consult a doctor.*

*Do not solder directly onto the battery pack.*

*Do not expose the battery pack to liquids.*

*Avoid any knocks or excessive vibrations. If the device or the battery is dropped, especially on a hard surface, you should take it to the nearest Authorised Repair Centre for inspection before continuing to use it.*

*Do not replace the battery pack when the device is turned on.*

*Do not remove or damage the battery pack's label.*

*Do not use the battery pack if it is damaged in any part.*

*Battery pack usage by children should be supervised.*

*Collect and recycle waste batteries separately from the device in comply with European Directive 2006/66/EC, 2002/95/EC, 2002/96/EC and subsequent modifications, US and China regulatory and others laws and regulations about environment.*

**NOTE**

*In order to guarantee an adequate operating autonomy, when replacing the battery pack the mobile computer checks the battery energy level. If the battery is not sufficiently charged, Datalogic Memor™ does not turn on (when pressing the ON/OFF key).*

*In this case, either substitute the battery pack with a charged one (sufficiently charged) or insert Datalogic Memor™ into a powered cradle or plug it into the direct power supply.*

**NOTE**

*To achieve the best battery life, turn off the radios not in use.*

### **4.3 CLEANING THE MOBILE COMPUTER**

Periodically clean the Datalogic Memor™ with a slightly dampened cloth.

## 5 TECHNICAL FEATURES

### 5.1 TECHNICAL DATA

#### Datalogic Memor™ Common Features

Electrical Features			
Power			
DC Supply		5 V ± 5%	
Battery Pack		1 cell Li-Pol or Li-Ion 1100 mAh@3.7 V (nominal) Alternatively 1 cell Li-Pol or Li-Ion 2000 mAh@3.7 V (nominal)	
Internal Backup Battery		Rechargeable Ni-MH 30 mAh (2 x 15 mAh cells)	
Communication Features		Windows CE COM Port	Windows Mobile COM Port
Bluetooth® Interface		COM5	COM5
Serial Interface	RS232	COM1	COM1
	USB 1.1	COM6	COM6
Wireless Features			
WLAN		IEEE 802.11b/g DSSS	
WPAN		Bluetooth® IEEE 802.15, Class 2, Version 2.0	
WWAN		GSM Quad-band (850, 900, 1800, 1900 MHz) Radio with accessible SIM card interface	
Environmental Features			
Working Temperature*		0° to +50 °C / 32 °F to +122 °F	
Storage Temperature		-20° to +70 °C / -4° to +158 °F	
Humidity**		10 to 80% non condensing for temperatures < 38 °C	
Protection		IP 54	
ESD Protection		4 KV contact discharge, 8 KV air discharge	
Drop Resistance***		1.2 m / 3 ft 9 in	

\* Battery must be charged at a temperature ranging from 0° to +40 °C. For the GSM models the maximum recommended temperature is +35°C. At higher values the charging may slow down

Close to the limits of the working temperature, some display and/or battery performance degradation may occur.

\*\* Multiple rapid humidity and/or temperature variations may cause condensing.

\*\*\* Multiple drops can permanently damage the device.

<b>Hardware Features</b>	
FLASH	256 MB
RAM	128 MB
Microprocessor	Marvell PXA 310 624 MHz
Audio	Rear Speaker for beeps and ringing tones Microphone and Front Speaker for phone calls Headset
LEDs	Two-color Good Read/Programmable Charging Status
Display	64K Color TFT LCD with 320 x 240 pixel resolution (QVGA), with LED backlight and touch screen, antiglare and antiscratch protection
Keyboard	23 Plastic Top - Backlit Keys + Joystick + lateral ON/OFF key
<b>Mechanical Features</b>	
Dimensions (LxWxH)	802.11b/g / Batch models: 15.2 x 5.5 x 4.0 cm / 5.9 x 2.2 x 1.6 in EDGE models: 16.5 x 5.5 x 4.0 cm / 6.5 x 2.2 x 1.6 in
Weight (depending on model)	220 g / 7.76 oz (incl. 1100 mAH battery) 250 g / 8.81 oz (incl. 2000 mAH battery)
<b>Programming Features</b>	
Operating system	Windows CE 5.0 Professional/ Windows Mobile 6.1 Professional
<b>Laser Models</b>	
Decoded barcodes 1D	UPC A, UPC E, EAN 8, EAN 13, Code 39, Code 39 Full ASCII, Code 32, Interleaved 2 of 5, Industrial 2 of 5, Matrix 2 of 5, Code 128, EAN 128, Codabar, MSI, Plessey, Code 93, Code 11, GS1 Databar
<b>Imager Models</b>	
Decoded barcodes 1D	UPC A, UPC E, EAN 8, EAN 13, UPC/EAN/JAN, Interleaved 2 of 5, Code 39, Code 39 Full ASCII, Codabar, Code 128, EAN 128, Code 93, GS1 Databar
Decoded barcodes 2D	PDF417, DataMatrix, QR, MacroPDF, RSS
Postal codes	POSTNET, PLANET, Japan Post, Australia Post, KIX Code, Royal Mail Code (RM4SCC)

**Datalogic Memor™ Optical Features**

	<b>Datalogic Memor™ 1D Models</b>
Maximum resolution	0.10 mm / 4 mils
Skew angle	± 50°
Pitch angle	± 65°
Scan rate - bidirectional	104 ± 12 scan/sec
Light source laser scanner	VLD, wavelength 630~680 nm
Safety class EN 60825-1:2001	Laser: Class 2 Led (Green Spot): Class 1
	<b>Datalogic Memor™ 2D Models</b>
Maximum resolution	0.13 mm / 5 mils
Scan rate	60 frames/sec
Aiming Laser	VLD, wavelength 645~665 nm
Safety class EN 60825-1:2001	Laser: Class 2 Led (Illuminator): Class 1M
Illumination System	LEDs 620~630 nm

## 5.2 READING DIAGRAM

### Datalogic Memor™ 1D

Typical Reading Diagram - Reading Zones (10° skew angle)

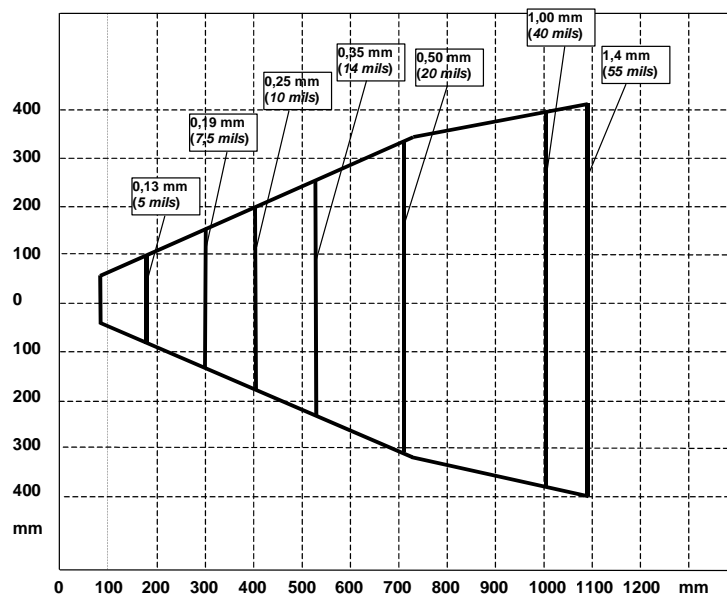



## 6 TEST CODES

---

### High Density Codes

0.25 mm (10 mils)

Code 39



17162

2/5 Interleaved



0123456784

Code 128



test

---

EAN 13



EAN 8



**Medium Density Codes**0.38 mm (15 mils)

Code 39



17162

Interleaved 2/5



0123456784

Code 128



test

EAN 13



8 012345 000012

EAN 8

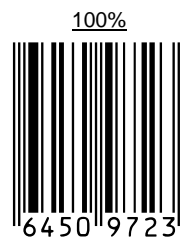

6450 9723

Low Density Codes

0.50 mm (20 mils)

Code 39



17162

Interleaved 2/5



0123456784

Code 128



test

EAN 13



8 012345 000012

EAN 8

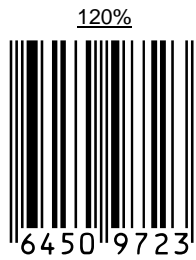

6450 9723

## 2D Codes

Datamatrix ECC200



Example

Inverse  
Datamatrix ECC200



Example

## **GLOSSARY**

---

### **Access Point**

A device that provides transparent access between Ethernet wired networks and IEEE 802.11 interoperable radio-equipped mobile units. Hand-held mobile computers, PDAs or other devices equipped with radio cards, communicate with wired networks using Access Points (AP). The mobile unit (mobile computer) may roam among the APs in the same subnet while maintaining a continuous, seamless connection to the wired network.

### **Barcode**

A pattern of variable-width bars and spaces which represents numeric or alphanumeric data in binary form. The general format of a barcode symbol consists of a leading margin, start character, data or message character, check character (if any), stop character, and trailing margin. Within this framework, each recognizable symbology uses its own unique format.

### **Baud Rate**

A measure for data transmission speed.

### **Bit**

Binary digit. One bit is the basic unit of binary information. Generally, eight consecutive bits compose one byte of data. The pattern of 0 and 1 values within the byte determines its meaning.

### **Bluetooth®**

A standard radio technology using a proprietary protocol. The onboard Bluetooth® module in the mobile computer is compatible with the 1.1 protocol.

### **Byte**

On an addressable boundary, eight adjacent binary digits (0 and 1) combined in a pattern to represent a specific character or numeric value. Bits are numbered from the right, 0 through 7, with bit 0 the low-order bit. One byte in memory can be used to store one ASCII character.

### **Decode**

To recognize a bar code symbology (e.g., Codabar, Code 128, Code 3 of 9, UPC/EAN, etc.) and analyze the content of the bar code scanned.

### **EEPROM**

Electrically Erasable Programmable Read-Only Memory. An on-board non-volatile memory chip.

### **Flash Disk**

Non-volatile memory for storing application and configuration files.

**GSM**

Global System for Mobile communication. It is a standard for digital cellular communications, currently used in the 900 MHz and 1800 MHz bands.

**Host**

A computer that serves other mobile computers in a network, providing services such as network control, database access, special programs, supervisory programs, or programming languages.

**Liquid Crystal Display (LCD)**

A display that uses liquid crystal sealed between two glass plates. The crystals are excited by precise electrical charges, causing them to reflect light outside according to their bias. They use little electricity and react relatively quickly. They require external light to reflect their information to the user.

**Light Emitting Diode (LED)**

A low power electronic light source commonly used as an indicator light. It uses less power than an incandescent light bulb but more than a Liquid Crystal Display (LCD).

**RAM**

Random Access Memory. Data in RAM can be accessed in random order, and quickly written and read.

**RF**

Radio Frequency.

**RTC**

Real Time Clock.

## INDEX

---

- A**
- Accessories; 10
  - ActiveSync® Remote; 61
- B**
- Backup Directory File Management; 73
  - Bluetooth® Manager Device Setup; 62
  - Buttons; 47
- C**
- Charging the Batteries; 74
  - China RoHS Pollution Control Logos; xix
  - Cleaning the Mobile Computer; 80
  - Connection Cables; 21
    - RS232 Direct Connection; 21
  - Connections; 11
    - Connection to USB peripherals; 13
  - Control Panel; 46
  - Conventions; v
- D**
- Data Capture; 29
    - Imager Data Capture; 30
    - Laser Data Capture; 29
  - Data Capture Configuration; 40
  - Datalogic Memor™ Description; 1
  - Default Settings; 43
  - Description of the Keys; 32
- F**
- FCC Compliance; xv
  - Files Admin; 49
  - Firmware Update for Windows CE; 73
  - FTP Server Setup; 72
- G**
- General View; xx
  - Glossary; 89
- L**
- Laser Safety; vii
  - LED Class; xiii
- M**
- Maintenance; 74
  - Micro SD Card Insertion; 5
  - Microsoft® ActiveSync®; 60
  - Models Description; 2
- O**
- Operating System; 10
- P**
- Package Contents; 4
  - Patents; xvi
- R**
- Radio Compliance; xiii
  - Reader Parameters; 42
  - Reading Diagram; 84
  - Reference Documentation; v
  - References; v
  - Registry; 48
  - Replacing the Batteries; 76
  - Resetting the Memor™; 34
  - RS232 Connection; 15
- S**
- Safe Setup; 49
  - Safety Regulations; vi
  - SAR Compliance; xvi
  - Save Session; 49
  - Scan Parameters; 42
  - Services and Support; v
  - SIM Card; 7
  - Special Function Icons; 33
  - Startup; 24
  - Status Indicators; 37
  - Stylus Calibration; 53
- T**
- Taskbar; 38
  - Technical Features; 81

Test Codes; 85

## **U**

USB Connection; 11  
Using the Joystick; 27  
Using the Stylus; 26

## **V**

Volume Settings; 56

## **W**

WEEE Compliance; xvii  
Windows Connections; 60  
Windows Mobile Bluetooth®  
Manager Device Setup; 67  
Windows Mobile Phone; 71  
Windows Mobile Welcome Wizard;  
28  
Wireless and Radio Frequencies  
Warnings; 22  
Wireless Communications; 51  
WLAN Connection; 16  
WPAN Connections; 18  
WWAN Connections; 19



Datalogic Mobile S.r.l.  
Via S. Vitalino, 13  
40012 - Lippo di Calderara  
Bologna - Italy



dichiara che  
declares that the  
déclare que le  
bescheinigt, daß das Gerät  
declare que el

**DL-MEMOR**

*modelli con funzionalità radio 802.11g+BT  
models with 802.11g+BT radio feature  
modèles avec 802.11g+BT radio intégrés  
modelle mit 802.11g+BT radio-funktionalität  
modelos con funcionalidad radio 802.11g+BT*

sono conformi alle Direttive del Consiglio Europeo sottoelencate:  
are in conformity with the requirements of the European Council Directives listed below  
sont conformes aux spécifications des Directives de l'Union Européenne ci-dessous:  
der nachstehend angeführten Direktiven des Europäischen Rats:  
cumple con los requisitos de las Directivas del Consejo Europeo, según la lista siguiente:

**2004/108/EC and 1999/5/EC R&TTE**

Questa dichiarazione è basata sulla conformità dei prodotti alle norme seguenti:  
This declaration is based upon compliance of the products to the following standards:  
Cette déclaration repose sur la conformité des produits aux normes suivantes:  
Diese Erklärung basiert darauf, daß das Produkt den folgenden Normen entspricht:  
Esta declaración se basa en el cumplimiento de los productos con la siguientes normas:

<b>ETSI EN 301 489-1 v1.8.1, APRIL 2008 :</b>	<i>ELECTROMAGNETIC COMPATIBILITY AND RADIO SPECTRUM MATTERS (ERM); ELECTROMAGNETIC COMPATIBILITY (EMC) STANDARD FOR RADIO EQUIPMENT AND SERVICES; PART 1: COMMON TECHNICAL REQUIREMENTS</i>
<b>ETSI EN 301 489-17 v1.3.2, APRIL 2008 :</b>	<i>ELECTROMAGNETIC COMPATIBILITY AND RADIO SPECTRUM MATTERS (ERM); ELECTROMAGNETIC COMPATIBILITY (EMC) STANDARD FOR RADIO EQUIPMENT; PART 17: SPECIFIC CONDITIONS FOR 2,4 GHZ WIDEBAND TRANSMISSION SYSTEMS, 5 GHZ HIGH PERFORMANCE WLAN EQUIPMENT AND 5,8 GHZ BROADBAND DATA TRANSMITTING SYSTEMS</i>
<b>ETSI EN 300 328 v1.7.1, OCTOBER 2006 :</b>	<i>ELECTROMAGNETIC COMPATIBILITY AND RADIO SPECTRUM MATTERS (ERM); WIDEBAND TRANSMISSION SYSTEMS; DATA TRANSMISSION EQUIPMENT OPERATING IN THE 2,4GHZ ISM BAND AND USING WIDE BAND MODULATION TECHNIQUES; HARMONIZED EN COVERING ESSENTIAL REQUIREMENTS UNDER ARTICLE 3.2 OF THE R&amp;TTE DIRECTIVE</i>
<b>EN 55022:2006 (CLASS B) + A1:2007 :</b>	<i>INFORMATION TECHNOLOGY EQUIPMENT RADIO DISTURBANCE CHARACTERISTICS LIMITS AND METHODS OF MEASUREMENTS</i>
<b>EN 55024:1998 + A1:2001 + A2:2003</b>	<i>INFORMATION TECHNOLOGY EQUIPMENT IMMUNITY CHARACTERISTICS LIMITS AND METHODS OF MEASUREMENT</i>
<b>EN 60950-1:2001 + A11:2004 :</b>	<i>INFORMATION TECHNOLOGY EQUIPMENT - SAFETY - PART 1 GENERAL REQUIREMENTS</i>

**EN 62311:2008 :**

*ASSESSMENT OF ELECTRONIC AND ELECTRICAL EQUIPMENT  
RELATED TO HUMAN EXPOSURE RESTRICTIONS FOR  
ELECTROMAGNETIC FIELDS (0 HZ - 300 GHz).*

Lippo di Calderara, May 19th 2009

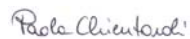

Paola Chientaroli  
Quality Assurance Manager

Datalogic Mobile S.r.l.  
Via S. Vitalino, 13  
40012 - Lippo di Calderara  
Bologna - Italy

CE0678 09

dichiara che  
declares that the  
déclare que le  
bescheinigt, daß das Gerät  
declare que el

**DL-MEMOR**

*modelli con funzionalità radio Edge+BT  
models with Edge+BT radio feature  
modèles avec Edge+BT radio intégrés  
modelle mit Edge+BT radio-funktionalität  
modelos con funcionalidad radio Edge+BT*

sono conformi alle Direttive del Consiglio Europeo sottoelencate:  
are in conformity with the requirements of the European Council Directives listed below  
sont conformes aux spécifications des Directives de l'Union Européenne ci-dessous:  
der nachstehend angeführten Direktiven des Europäischen Rats:  
cumple con los requisitos de las Directivas del Consejo Europeo, según la lista siguiente:

**2004/108/EC and 1999/5/EC R&TTE**

---

Questa dichiarazione è basata sulla conformità dei prodotti alle norme seguenti:  
This declaration is based upon compliance of the products to the following standards:  
Cette déclaration repose sur la conformité des produits aux normes suivantes:  
Diese Erklärung basiert darauf, daß das Produkt den folgenden Normen entspricht:  
Esta declaración se basa en el cumplimiento de los productos con la siguientes normas:

- ETSI EN 301 489-1 v1.8.1, APRIL 2008 :** *ELECTROMAGNETIC COMPATIBILITY AND RADIO SPECTRUM MATTERS (ERM); ELECTROMAGNETIC COMPATIBILITY (EMC) STANDARD FOR RADIO EQUIPMENT AND SERVICES; PART 1: COMMON TECHNICAL REQUIREMENTS*
- ETSI EN 301 489-7 v1.3.1, NOVEMBER 2005 :** *ELECTROMAGNETIC COMPATIBILITY AND RADIO SPECTRUM MATTERS (ERM); ELECTROMAGNETIC COMPATIBILITY (EMC) STANDARD FOR RADIO EQUIPMENT AND SERVICES; PART 7: SPECIFIC CONDITIONS FOR MOBILE AND PORTABLE RADIO AND ANCILLARY EQUIPMENT OF DIGITAL CELLULAR RADIO TELECOMMUNICATIONS SYSTEMS (GSM AND DCS)*
- ETSI EN 301 489-17 v1.3.2, APRIL 2008 :** *ELECTROMAGNETIC COMPATIBILITY AND RADIO SPECTRUM MATTERS (ERM); ELECTROMAGNETIC COMPATIBILITY (EMC) STANDARD FOR RADIO EQUIPMENT; PART 17: SPECIFIC CONDITIONS FOR 2,4 GHZ WIDEBAND TRANSMISSION SYSTEMS, 5 GHZ HIGH PERFORMANCE WLAN EQUIPMENT AND 5,8 GHZ BROADBAND DATA TRANSMITTING SYSTEMS*
- ETSI EN 300 328 v1.7.1, OCTOBER 2006 :** *ELECTROMAGNETIC COMPATIBILITY AND RADIO SPECTRUM MATTERS (ERM); WIDEBAND TRANSMISSION SYSTEMS; DATA TRANSMISSION EQUIPMENT OPERATING IN THE 2,4GHZ ISM BAND AND USING WIDE BAND MODULATION TECHNIQUES; HARMONIZED EN COVERING ESSENTIAL REQUIREMENTS UNDER ARTICLE 3.2 OF THE R&TTE DIRECTIVE*

<b>ETSI EN 301 511 v9.0.2, MARCH 2003 :</b>	<i>GLOBAL SYSTEM FOR MOBILE COMMUNICATIONS (GSM); HARMONIZED EN FOR MOBILE STATIONS IN THE GSM 900 AND GSM 1800 BANDS COVERING ESSENTIAL REQUIREMENTS UNDER ARTICLE 3.2 OF THE R&amp;TTE DIRECTIVE (1999/5/EC)</i>
<b>EN 55022:2006 (CLASS B) + A1:2007 :</b>	<i>INFORMATION TECHNOLOGY EQUIPMENT RADIO DISTURBANCE CHARACTERISTICS LIMITS AND METHODS OF MEASUREMENTS</i>
<b>EN 55024:1998 + A1:2001 + A2:2003</b>	<i>INFORMATION TECHNOLOGY EQUIPMENT IMMUNITY CHARACTERISTICS LIMITS AND METHODS OF MEASUREMENT</i>
<b>EN 60950-1:2001 + A11:2004 :</b>	<i>INFORMATION TECHNOLOGY EQUIPMENT - SAFETY - PART 1 : GENERAL REQUIREMENTS</i>
<b>EN 62311:2008 :</b>	<i>ASSESSMENT OF ELECTRONIC AND ELECTRICAL EQUIPMENT RELATED TO HUMAN EXPOSURE RESTRICTIONS FOR ELECTROMAGNETIC FIELDS (0 HZ - 300 GHZ).</i>
<b>EN 50360:2001 :</b>	<i>PRODUCT STANDARD TO DEMONSTRATE THE COMPLIANCE OF MOBILE PHONES WITH THE BASIC RESTRICTIONS RELATED TO HUMAN EXPOSURE TO ELECTROMAGNETIC FIELDS (300 MHZ - 3 GHZ).</i>

Lippo di Calderara, May 19th 2009



Paola Chientaroli  
Quality Assurance Manager