



Datalogic Mobile S.r.l.
Via S. Vitalino, 13
40012 - Lippo di Calderara di Reno
Bologna - Italy

Kyman™ - User's Manual

Ed.: 11/2007

ALL RIGHTS RESERVED

Datalogic reserves the right to make modifications and improvements without prior notification.

Datalogic shall not be liable for technical or editorial errors or omissions contained herein, nor for incidental or consequential damages resulting from the use of this material.

Product names mentioned herein are for identification purposes only and may be trademarks and or registered trademarks of their respective companies.

© Datalogic S.p.A. 2007

CONTENTS

	DATALOGIC END USER LICENSE AGREEMENT	V
	REFERENCES	VII
	Conventions	vii
	Reference Documentation	vii
	Services and Support.....	vii
	SAFETY REGULATIONS.....	VIII
	General Safety Rules.....	viii
	Bluetooth® Approval.....	viii
	Laser Safety.....	ix
	Radio Compliance.....	xiii
	FCC Compliance.....	xiii
	SAR Compliance.....	xv
	PATENTS	xv
	WEEE Compliance	xvi
	GENERAL VIEW	XVIII
1	INTRODUCTION	1
1.1	Kyman™ Description	1
1.2	Available Models.....	2
1.3	Package Contents.....	2
1.3.1	Using the Belt Clip	4
1.4	Handle Mounting.....	6
1.5	Installing the SIM/SD Card.....	7
1.5.1	Removing the SIM Card and SD-Card.....	9
1.6	Accessories.....	10
2	CONNECTIONS	12
2.1	Connection to the Host Computer.....	12
2.1.1	RS232/USB Direct Connection	12
2.1.2	WLAN Connection	13
2.1.3	WPAN Connections	15
2.1.4	WWAN Connections	16
2.2	Connection Cables.....	18
3	USE AND FUNCTIONING	20
3.1	Startup	20
3.2	Using the Stylus.....	21
3.3	Data Capture.....	22
3.3.1	Laser Data Capture.....	22
3.3.2	Imager Data Capture	23
3.3.3	RFID Data Capture	24

3.4	Description of the Keys	25
3.4.1	Alphanumeric Keyboard (53-key Model)	25
3.4.2	Numeric Keyboard (36-key Model)	28
3.5	Status Indicators	31
3.5.1	LED Status.....	31
3.5.2	Taskbar.....	32
3.6	Data Capture Configuration	33
3.6.1	Configure	33
3.6.2	Capture	39
3.7	Control Panel	40
3.7.1	Buttons.....	41
3.7.2	Registry.....	41
3.7.3	Files Admin	42
3.7.4	Wireless Communications.....	44
3.7.5	Ethernet Settings	45
3.7.6	Volume Settings.....	46
3.8	Windows Connections	50
3.8.1	Microsoft® ActiveSync®	50
3.8.2	Bluetooth® Manager Device Setup.....	52
3.8.3	FTP Server Setup	54
3.9	Backup Directory File Management	55
4	MAINTENANCE	56
4.1	Charging the Battery Pack	56
4.2	Replacing the Battery Pack.....	58
4.3	Cleaning the Mobile Computer.....	60
5	TECHNICAL FEATURES	61
5.1	Technical Data	61
5.2	Reading Diagrams	65
6	TEST CODES	66
	GLOSSARY.....	69
	INDEX.....	72

DATALOGIC END USER LICENSE AGREEMENT

BY DOWNLOADING OR INSTALLING THE SOFTWARE, OR BY USING DATALOGIC EQUIPMENT THAT INCLUDES THIS SOFTWARE, YOU ARE CONSENTING TO BE BOUND BY THIS AGREEMENT. IF YOU DO NOT AGREE TO ALL OF THE TERMS OF THIS AGREEMENT, THEN DO NOT DOWNLOAD, INSTALL, USE THE SOFTWARE NOR DATALOGIC EQUIPMENT.

The following terms and conditions govern your use of the Software except to the extent that a particular program (a) is the subject of a separate written agreement with Datalogic or (b) includes a separate "click-on" license agreement as part of the installation and/or download process. Should a conflict arise between the provisions of the foregoing documents, the order of precedence shall be (1) the written agreement, (2) the click-on agreement, and (3) this agreement ("Agreement").

1. License. Subject to the terms and conditions of and except as otherwise provided in this Agreement, Datalogic S.p.A. ("Datalogic") and its suppliers grant to Customer ("Customer") a nonexclusive and nontransferable license to use the specific program modules, feature set(s) or feature(s) in object code form only as well as associated media, printed materials and "online" or electronic documentation (the "Software") for which Customer has paid, if required, the license fees. The Software is licensed not sold. The license shall be subject to each of the following limitations:

- Unless otherwise expressly provided in the documentation, Customer shall use the Software solely as embedded in, for execution on, or (where the applicable documentation permits installation on non-Datalogic equipment) for communication with Datalogic equipment owned or leased by Customer;
- Customer's use of the Software shall be limited to use on a single hardware chassis, on a single central processing unit, as applicable, or use on such greater number of chassis or central processing units as Customer may have paid Datalogic the required license fee; and
- Customer's use of the Software shall also be limited, as applicable and set forth in Customer's purchase order or in Datalogic's product catalog, user documentation, or web site, to a maximum number of (a) seats (i.e. users with access to the installed Software), (b) concurrent users, sessions, ports, and/or issued and outstanding IP addresses, and/or (c) central processing unit cycles or instructions per second. Customer's use of the Software shall also be limited by any other restrictions set forth in Customer's purchase order or in Datalogic's product catalog, user documentation or web site for the Software.

2. General Limitations. Except as otherwise expressly provided under this Agreement, Customer shall have no right, and Customer specifically agrees not to (i) transfer, assign or sublicense its license rights to any other person, or use the Software on unauthorized or secondhand Datalogic equipment, and any such attempted transfer, assignment or sublicense shall be void; (ii) correct errors to or otherwise modify or adapt the Software or create derivative works based upon the Software, or to permit third parties to do the same; or (iii) decompile, decrypt, reverse engineer, disassemble or otherwise reduce the Software to human-readable form to gain access to trade secrets or confidential information in the Software. To the extent required by law, at Customer's request, Datalogic shall provide Customer with the interface information needed to achieve interoperability between the Software and another independently created program, upon payment of Datalogic's applicable fee. Customer shall observe strict obligations of confidentiality with respect to such information.

3. Upgrades and Additional Copies. For purposes of this Agreement, "Software" shall include (and the terms and conditions of this Agreement shall apply to) any upgrades, updates, bug fixes or modified versions (collectively, "Upgrades") or backup copies of the Software licensed or provided to Customer by Datalogic or an authorized distributor for which Customer has paid the applicable license fees. Notwithstanding any other provision of this Agreement: (1) customer has no license or right to use any such additional copies or upgrades unless customer, at the time of acquiring such copy or upgrade, already holds a valid license to the original Software and has paid the applicable fee for the upgrade, if required; (2) use of upgrades is limited to Datalogic equipment for which customer is the original end user, purchaser or lessee or who otherwise holds a valid license to use the Software which is being upgraded; and (3) use of additional copies is limited to backup purposes only.

4. Proprietary Notices. Customer agrees to maintain and reproduce all copyright and other proprietary notices on all copies, in any form, of the Software in the same form and manner that such copyright and other proprietary notices are included on the Software. Except as expressly authorized in this Agreement, Customer shall not make any copies or duplicates or any Software without the prior written permission of Datalogic. Customer may make such backup copies of the Software as may be necessary for Customer's lawful use, provided Customer affixes to such copies all copyright, confidentiality, and proprietary notices that appear on the original.

5. Protection of Information. Customer agrees that aspects of the Software and associated documentation, including the specific design and structure of individual programs, constitute trade secrets and/or copyrighted material of Datalogic. Customer shall not disclose, provide, or otherwise make available such trade secrets or copyrighted material in any form to any third party without the prior written consent of Datalogic. Customer shall implement reasonable security measures to protect such trade secrets and copyrighted material. Software and documentation shall remain solely property of Datalogic.

6. Limited Warranty. If Customer obtained the Software directly from Datalogic, then Datalogic warrants that during the Warranty Period (as defined below): (i) the media on which the Software is furnished will be free of defects in materials and workmanship under normal use; and (ii) the Software will substantially conform to its published specifications. The "Warranty Period" means a period beginning on the date of Customer's receipt of the Software and ending on the later of (a) ninety (90) days from the date of initial shipment of the Software by Datalogic, or (b) the end of the minimum period required by the law of the applicable jurisdiction. The limited warranties extend only to Customer as the original licensee. Customer's sole and exclusive remedy and the entire liability of Datalogic and its suppliers under these limited warranties will be, at Datalogic's sole option, repair or replacement of the Software if reported (or, upon request, returned) to Datalogic. Except as expressly granted in this Agreement, the Software is provided **AS IS** and with all faults. Datalogic does not warrant that the Software is error free or that Customer will be able to operate the Software without problems or interruptions. In addition, due to the continual development of new techniques for intruding upon and attacking networks, Datalogic does not warrant that the Software or any equipment, system or network on which the Software is used will be free of vulnerability to intrusion or attack. This warranty does not apply if the Software (a) is licensed for beta, evaluation, testing or demonstration purposes for which Datalogic does not receive a license fee, (b) has been altered, except by Datalogic, (c) has not been installed, operated, repaired, or maintained in accordance with instructions supplied by Datalogic, (d) has been subjected to abnormal physical or electrical stress, misuse, negligence, or accident, or (e) is used in ultra hazardous activities. If Customer obtained the Software from a Datalogic reseller, the terms of any warranty shall be as provided by such distributor, and Datalogic provides Customer no warranty with respect to such Software. The Software may contain support for programs written in Java. Java technology is not fault tolerant and is not designed, manufactured, or intended for use or resale as online control equipment in hazardous environments requiring fail-safe performance, such as in the operation of nuclear facilities, aircraft navigation or communication systems, air traffic control, direct life support machines, or weapons systems, in which the failure of Java technology could lead directly to death, personal injury, or severe physical or environmental damage. Microsoft Inc. has contractually obligated Datalogic to make this disclaimer.

7. Disclaimer of Warranties. Except as specified in this warranty, all expressed or implied conditions, representations, and warranties including, without limitation, any implied warranty or condition of merchantability, fitness for a particular purpose, non-infringement, satisfactory quality or arising from a course of dealing, usage, or trade practice, are hereby excluded to the extent allowed by applicable law. To the extent that an implied warranty cannot be excluded, such warranty is limited in duration to the warranty period.

8. Disclaimer of Liabilities. In no event will Datalogic or its suppliers be liable for any lost revenue, profit, or data, or for special, indirect, consequential, incidental, or punitive damages however caused and arising out of the use of or inability to use the Software even if Datalogic has been advised of the possibility of such damages. In no event shall Datalogic or its suppliers' liability to customer, whether in contract, tort (including negligence), or otherwise, exceed the price paid by customer. The foregoing limitations shall apply even if the above-stated warranty fails of its essential purpose.

9. Term and Termination. This Agreement is effective until terminated. Customer may terminate this Agreement at any time by destroying all copies of Software including any documentation. Customer's license rights under this Agreement will terminate immediately without notice from Datalogic if Customer fails to comply with any provision of this Agreement. Upon termination, Customer must destroy all copies of Software in its possession or control.

10. Customer Records. Customer grants to Datalogic and its independent accountants the right to examine Customer's books, records and accounts during Customer's normal business hours to verify compliance with this Agreement. In the event such audit discloses non-compliance with this Agreement, Customer shall promptly pay to Datalogic the appropriate license fees.

11. General Provisions. This Agreement shall be governed by and construed in accordance with the laws of Italy. All disputes arising out of or in connection with this Agreement will be subject to the exclusive jurisdiction of the competent Court of the place where Datalogic has its registered office. If any portion hereof is found to be void or unenforceable, the remaining provisions of this Agreement shall remain in full force and effect. Except as expressly provided herein, this Agreement constitutes the entire agreement between the parties with respect to the license of the Software and supercedes any conflicting or additional terms contained in the purchase order.



REFERENCES

CONVENTIONS

This manual uses the following conventions:

“User” refers to anyone using a Kyman™ mobile computer.

“Mobile computer” and “Kyman™” refer to Kyman™ mobile computer.

“You” refers to the System Administrator or Technical Support person using this manual to install, configure, operate, maintain or troubleshoot a Kyman™ mobile computer.

REFERENCE DOCUMENTATION

For further information regarding Kyman™ refer to the SDK Help on-Line.

SERVICES AND SUPPORT

Datalogic provides several services as well as technical support through its website. Log on to **www.mobile.datalogic.com** and click on the links indicated for further information including:

- **PRODUCTS**

Search through the links to arrive at your product page where you can download specific **Manuals** and **Software & Utilities**

- **SERVICES & SUPPORT**

- **Datalogic Services** Warranty Extensions and Maintenance Agreements

- **Authorised Repair Centres**

- **CONTACT US**

E-mail form and listing of Datalogic Subsidiaries

SAFETY REGULATIONS



NOTE

*Read this manual carefully before performing any type of connection to the Kyman™ mobile computer.
The user is responsible for any damages caused by incorrect use of the equipment or by inobservance of the indication supplied in this manual.*

GENERAL SAFETY RULES

- Use only the components supplied by the manufacturer for the specific Kyman™ being used.
- Do not attempt to disassemble the Kyman™ mobile computer, as it does not contain parts that can be repaired by the user. Any tampering will invalidate the warranty.
- When replacing the battery pack or at the end of the operative life of the Kyman™ mobile computer, disposal must be performed in compliance with the laws in force. See also par.4.2.
- Do not submerge the Kyman™ in liquid products.
- Avoid significant and rapid temperature variations, which can produce condensation inside the Kyman™ and reduce its performance.

BLUETOOTH® APPROVAL

This product is equipped with the following certified Bluetooth module:

Product Name: Datalogic CE BLUETOOTH SUBSYSTEM

Bluetooth ID: B03071

Product ID: DLBTCE-02

LASER SAFETY

The laser light is visible to the human eye and is emitted from the window indicated in the figure.
This information applies to both laser models and the Kyman™ Imager Aiming System.

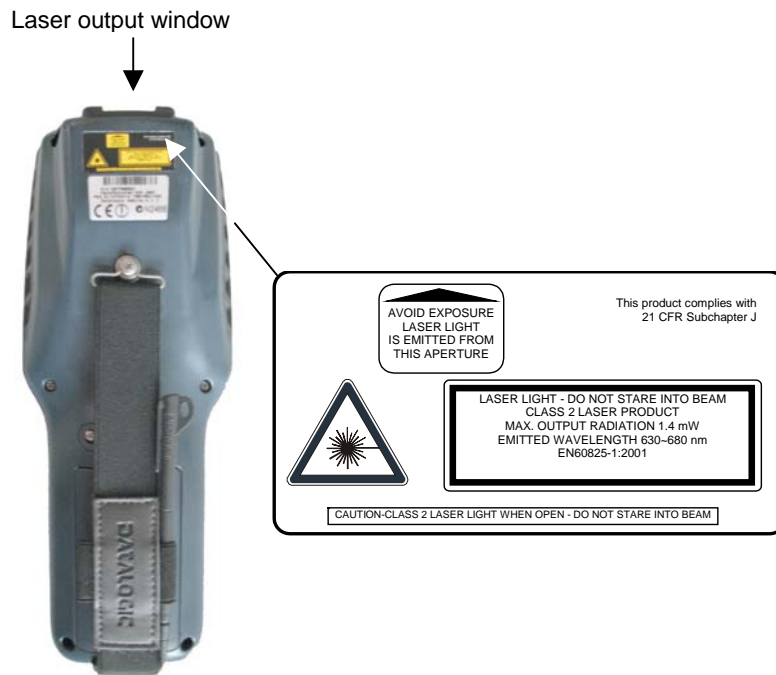

I	D	F	E
La luce laser è visibile all'occhio umano e viene emessa dalla finestra indicata nella figura.	Die Laserstrahlung ist für das menschliche Auge sichtbar und wird am Strahlaustrittsfenster ausgesendet (siehe Bild).	Le rayon laser est visible à l'oeil nu et il est émis par la fenêtre désignée sur l'illustration dans la figure.	La luz láser es visible al ojo humano y es emitida por la ventana indicada en la figura.
LUCE LASER NON FISSARE IL FASCIO APPARECCHIO LASER DI CLASSE 2 MINIMA POTENZA DI USCITA: LUNGHEZZA D'ONDA EMESSA: CONFORME A EN 60825-1 (2001)	LASERSTRAHLUNG NICHT IN DER STRAHL BLINKEN PRODUKT DER LASERKLASSE 2 MAXIMALE AUSGANGLEISTUNG: WELLENLÄNGE: ENTSPR. EN 60825-1 (2001)	RAYON LASER EVITER DE REGARDER LE RAYON APPAREIL LASER DE CLASSE 2 PUISSANCE DE SORTIE: LONGUER D'ONDE EMISE: CONFORME A EN 60825-1 (2001)	RAYO LÁSER NO MIRAR FIJO EL RAYO APARATO LÁSER DE CLASE 2 MÁXIMA POTENCIA DE SALIDA: LONGITUD DE ONDA EMITIDA: CONFORME A EN 60825-1 (2001)

ENGLISH

The following information is provided to comply with the rules imposed by international authorities and refers to the correct use of your mobile computer.

STANDARD LASER SAFETY REGULATIONS

This product conforms to the applicable requirements of both CDRH 21 CFR 1040 and EN 60825-1 at the date of manufacture.

For installation, use and maintenance, it is not necessary to open the device.

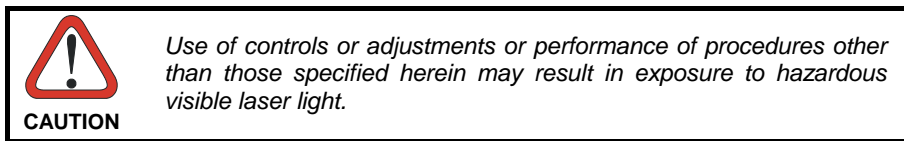

The product utilizes a low-power laser diode. Although staring directly at the laser beam momentarily causes no known biological damage, avoid staring at the beam as one would with any very strong light source, such as the sun. Avoid that the laser beam hits the eye of an observer, even through reflective surfaces such as mirrors, etc.

ITALIANO

Le seguenti informazioni vengono fornite dietro direttive delle autorità internazionali e si riferiscono all'uso corretto del terminale.

NORMATIVE STANDARD PER LA SICUREZZA LASER

Questo prodotto risulta conforme alle normative vigenti sulla sicurezza laser alla data di produzione: CDRH 21 CFR 1040 e EN 60825-1.

Non si rende mai necessario aprire l'apparecchio per motivi di installazione, utilizzo o manutenzione.

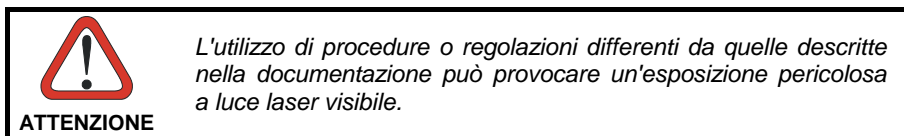

Il prodotto utilizza un diodo laser a bassa potenza. Sebbene non siano noti danni riportati dall'occhio umano in seguito ad una esposizione di breve durata, evitare di fissare il raggio laser così come si eviterebbe qualsiasi altra sorgente di luminosità intensa, ad esempio il sole. Evitare inoltre di dirigere il raggio laser negli occhi di un osservatore, anche attraverso superfici riflettenti come gli specchi.

DEUTSCH

Die folgenden Informationen stimmen mit den Sicherheitshinweisen überein, die von internationalen Behörden auferlegt wurden, und sie beziehen sich auf den korrekten Gebrauch vom Terminal.

NORM FÜR DIE LASERSICHERHEIT

Dies Produkt entspricht am Tag der Herstellung den gültigen EN 60825-1 und CDRH 21 CFR 1040 Normen für die Lasersicherheit.

Es ist nicht notwendig, das Gerät wegen Betrieb oder Installations-, und Wartungsarbeiten zu öffnen.

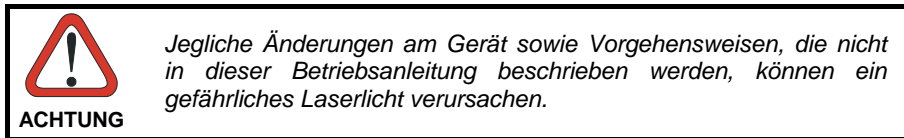

Der Produkt benutzt eine Laserdiode. Obwohl zur Zeit keine Augenschäden von kurzen Einstrahlungen bekannt sind, sollten Sie es vermeiden für längere Zeit in den Laserstrahl zu schauen, genauso wenig wie in starke Lichtquellen (z.B. die Sonne). Vermeiden Sie es, den Laserstrahl weder gegen die Augen eines Beobachters, noch gegen reflektierende Oberflächen zu richten.

FRANÇAIS

Les informations suivantes sont fournies selon les règles fixées par les autorités internationales et se réfèrent à une correcte utilisation du terminal.

NORMES DE SECURITE LASER

Ce produit est conforme aux normes de sécurité laser en vigueur à sa date de fabrication: CDRH 21 CFR 1040 et EN 60825-1.

Il n'est pas nécessaire d'ouvrir l'appareil pour l'installation, l'utilisation ou l'entretien.

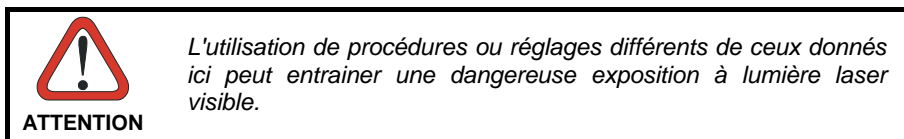

Le produit utilise une diode laser. Aucun dommage aux yeux humains n'a été constaté à la suite d'une exposition au rayon laser. Eviter de regarder fixement le rayon, comme toute autre source lumineuse intense telle que le soleil. Eviter aussi de diriger le rayon vers les yeux d'un observateur, même à travers des surfaces réfléchissantes (miroirs, par exemple).

ESPAÑOL

Las informaciones siguientes son presentadas en conformidad con las disposiciones de las autoridades internacionales y se refieren al uso correcto del terminal.

NORMATIVAS ESTÁNDAR PARA LA SEGURIDAD LÁSER

Este aparato resulta conforme a las normativas vigentes de seguridad láser a la fecha de producción: CDRH 21 CFR 1040 y EN 60825-1.

No es necesario abrir el aparato para la instalación, la utilización o la manutención.

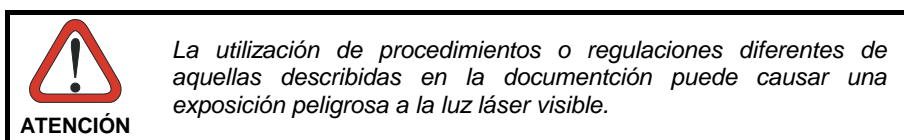

El aparato utiliza un diodo láser a baja potencia. No son notorios daños a los ojos humanos a consecuencia de una exposición de corta duración. Eviten de mirar fijo el rayo láser así como evitarían cualquiera otra fuente de luminosidad intensa, por ejemplo el sol. Además, eviten de dirigir el rayo láser hacia los ojos de un observador, también a través de superficies reflectantes como los espejos.

LED Illuminator

The use of an illuminator in the Kyman™ Imager models is a Class 1 LED product:

CLASS 1 LED PRODUCT

ILLUMINATORE LED CLASSE 1

AUSLEUCHTER LED KLASSE 1

ILLUMINATEUR A LED DE CLASSE 1

ILUMINADOR LED DE CLASE 1

RADIO COMPLIANCE

In radio systems configured with mobile computers and access points, the frequencies to be used must be allowed by the spectrum authorities of the specific country in which the installation takes place. Be absolutely sure that the system frequencies are correctly set to be compliant with the spectrum requirements of the country.

The Radio modules used in this product automatically adapt to the frequencies set by the system and do not require any parameter settings.

The following shows the correspondence between the Kyman™ models and the Radio modules:

- Kyman™ 7XX-XXX 802.11b/g (Wi-Fi) radio card
- Kyman™ X1X-XXX GSM/GPRS Tri-band (900,1800,1900 MHz) module
- Kyman™ X2X-XXX GSM/GPRS/EDGE Quad-band (800,900,1800,1900 MHz) module

FCC COMPLIANCE

Modifications or changes to this equipment without the expressed written approval of Datalogic could void the authority to use the equipment.

This device has been tested and found to comply with the limits for a CLASS A digital device, pursuant to Part 15 of the FCC Rules. These limits are designed to provide reasonable protection against harmful interference when the equipment is operated in a commercial environment. This equipment generates, uses, and can radiate radio frequency energy and, if not installed and used in accordance with the instruction manual, may cause harmful interference to radio communications. Operation of this equipment in a residential area is likely to cause harmful interference in which case the user will be required to correct the interference at his own expense.

FCC ID:
U4G0016

Information for the User

ENGLISH

Contact the competent authority responsible for the management of radio frequency devices of your country to verify any possible restrictions or licenses required. Refer to the web site <http://europa.eu.int/comm/enterprise/rte/spectr.htm> for further information.

ITALIANO

Contatta l'autorità competente per la gestione degli apparati a radio frequenza del tuo paese, per verificare eventuali restrizioni o licenze. Ulteriori informazioni sono disponibili sul sito:
<http://europa.eu.int/comm/enterprise/rte/spectr.htm>.

FRANÇAIS

Contactez l'autorité compétente en la gestion des appareils à radio fréquence de votre pays pour vérifier d'éventuelles restrictions ou licences. Pour tout renseignement vous pouvez vous adresser au site web:
<http://europa.eu.int/comm/enterprise/rte/spectr.htm>.

DEUTSCH

Wenden Sie sich an die für Radiofrequenzgeräte zuständige Behörde Ihres Landes, um zu prüfen ob es Einschränkungen gibt, oder eine Lizenz erforderlich ist. Weitere Informationen finden Sie auf der Web Seite:
<http://europa.eu.int/comm/enterprise/rte/spectr.htm>.

ESPAÑOL

Contacta la autoridad competente para la gestión de los dispositivos de radio frecuencia de tu país, para verificar cualesquiera restricciones o licencias posibles requerida. Además se puede encontrar mas información en el sitio web:
<http://europa.eu.int/comm/enterprise/rte/spectr.htm>.



SAR COMPLIANCE

This product has been tested and found to comply with the following standards:

- EN50360: product standard to demonstrate the compliance of mobile phones with the basic restrictions related to human exposure to electromagnetic fields (300 MHz – 3 GHz).
- EN50361: basic standard for the measurement of specific absorption rate related to human exposure to electromagnetic fields from mobile phones (300 MHz – 3 GHz).
- OET BULLETIN 65 SUPPLEMENT C: evaluating compliance with FCC guidelines for human exposure to radio frequency electromagnetic fields.
- Australian Radiation Protection And Nuclear Safety Agency (ARPANSA): radiation protection series publication No. 3: maximum exposure levels to radio frequency fields 3 KHz TO 300 GHz.

PATENTS

This product is covered by one or more of the following patents:

U.S. patents: 6,808,114B1; 6,997,385B2; 6,877,664B1

European patents: 681,257B1; 1,205,871B1

Additional patents pending.

WEEE COMPLIANCE



Informazione degli utenti ai sensi della Direttiva Europea 2002/96/EC

L'apparecchiatura che riporta il simbolo del bidone barrato deve essere smaltita, alla fine della sua vita utile, separatamente dai rifiuti urbani.

Smaltire l'apparecchiatura in conformità alla presente Direttiva consente di:

- evitare possibili conseguenze negative per l'ambiente e per la salute umana che potrebbero invece essere causati dall'errato smaltimento dello stesso;
- recuperare materiali di cui è composto al fine di ottenere un importante risparmio di energia e di risorse.

Per maggiori dettagli sulle modalità di smaltimento, contattare il Fornitore dal quale è stata acquistata l'apparecchiatura o consultare la sezione dedicata sul sito www.mobile.datalogic.com.

Information for the user in accordance with the European Commission Directive 2002/96/EC

At the end of its useful life, the product marked with the crossed out wheeled wastebin must be disposed of separately from urban waste.

Disposing of the product according to this Directive:

- avoids potentially negative consequences to the environment and human health which otherwise could be caused by incorrect disposal
- enables the recovery of materials to obtain a significant savings of energy and resources.

For more detailed information about disposal, contact the supplier that provided you with the product in question or consult the dedicated section at the website www.mobile.datalogic.com.

Information aux utilisateurs concernant la Directive Européenne 2002/96/EC

Au terme de sa vie utile, le produit qui porte le symbole d'un caisson à ordures barré ne doit pas être éliminé avec les déchets urbains.

Éliminer ce produit selon cette Directive permet de:

- éviter les retombées négatives pour l'environnement et la santé dérivant d'une élimination incorrecte
- récupérer les matériaux dans le but d'une économie importante en termes d'énergie et de ressources

Pour obtenir des informations complémentaires concernant l'élimination, veuillez contacter le fournisseur auprès duquel vous avez acheté le produit ou consulter la section consacrée au site Web www.mobile.datalogic.com.

Información para el usuario de acuerdo con la Directiva Europea 2002/96/CE

Al final de su vida útil, el producto marcado con un símbolo de contenedor de basura móvil tachado no debe eliminarse junto a los desechos urbanos.

Eliminar este producto de acuerdo con la Directiva permite de:

- evitar posibles consecuencias negativas para el medio ambiente y la salud derivadas de una eliminación inadecuada
- recuperar los materiales obteniendo así un ahorro importante de energía y recursos

Para obtener una información más detallada sobre la eliminación, por favor, póngase en contacto con el proveedor donde lo compró o consultar la sección dedicada en el Web site www.mobile.datalogic.com.

Benutzerinformation bezüglich Richtlinie 2002/96/EC der europäischen Kommission

Am Ende des Gerätelebenszyklus darf das Produkt nicht über den städtischen Hausmüll entsorgt werden. Eine entsprechende Mülltrennung ist erforderlich.

Beseitigung des Produkts entsprechend der Richtlinie:

- verhindert negative Auswirkungen für die Umwelt und die Gesundheit der Menschen
- ermöglicht die Wiederverwendung der Materialien und spart somit Energie und Ressourcen

Weitere Informationen zu dieser Richtlinie erhalten sie von ihrem Lieferanten über den sie das Produkt erworben haben, oder besuchen sie unsere Homepage unter www.mobile.datalogic.com.

GENERAL VIEW



- | | |
|--|---|
| A) Backlit display | G) Keyboard |
| B) User programmable LED | H) Microphone |
| C) Speaker | I) Laser safety label |
| D) Good read LED | J) Product label |
| E) Charging status and battery low warning LED | K) Adjustable elastic strap with stylus holders |
| F) Scan key | L) Battery pack |



- M) Trigger (Gun Version Only)
- N) Handle (Gun Version Only)



- O) Data capture/Laser Output window
- P) Communication/Charger/Headset connector

1 INTRODUCTION

1.1 KYMAN™ DESCRIPTION

The Datalogic Kyman™ rugged mobile computer is one of the key elements of Datalogic's mobile@work™ product family for logistic solutions.

Kyman™, thanks to the lightest weight of its category combined with one of the best ergonomics ever seen on the market, reduces the operators fatigue with no compromises in terms of reliability and robustness. Its sturdy outer casing with overmold protection has been designed to resist harsh environments, multiple drops, strong shocks, repetitive tumbles as well as sub-zero temperatures.

Available in both handheld and pistol-grip models, Kyman™ guarantees maximum flexibility thanks to the add-on handle. In fact, it is possible to insert or remove the handle by simply using a screwdriver, maintaining, at the same time, its industry standard performance for sealing and drop capabilities.

Kyman™ key features include fully integrated automatic data capture (1D bar code, 1D bar code & RFID HF-ISO tags, 1D & 2D bar codes & images), allowing codes to be read from near contact to several meters distance and simultaneous wireless communication capabilities (Bluetooth®, Wi-Fi, GSM/GPRS/EDGE).

Kyman™ system architecture is based on the “de-facto standard” combination of the fastest Intel X-Scale series processors coupled with the Windows CE 5.0 operating system and it is ready to satisfy the most demanding customer needs (i.e. allowing to expand its memory thanks to a Secure Digital standard slot).

Kyman™ provides 2 intuitive keyboard layouts, numeric/alphanumeric with backlight, able to fulfill 100% traditional text based applications (i.e. terminal emulation, through the DL-TCL-NET™ software client) as well as the most modern Web-based solutions (i.e. exploiting the Microsoft Internet Explorer through the DL Locked Web Browser™ application).

Kyman™ provides mobile professionals with the most relevant features needed to operate in demanding environments: reliability, ruggedness, drop resistance, long lasting batteries, flexible communication and efficient data capture.

1.2 AVAILABLE MODELS

The brand new Kyman™ is available in different models depending on the options it is equipped with. All options are listed below:

- data capture options: laser, imager, RfId, laser + RfId, laser extra-long range
- communication options: Wi-Fi 802.11b/g, GSM/GPRS, GSM/GPRS/EDGE, Bluetooth®
- data entry options: alphanumeric keyboard, numeric keyboard

For further details about the Kyman™ models refer to the web site: <http://www.datalogic.com>.

1.3 PACKAGE CONTENTS

The Kyman™ package contains:

- 1 Kyman™ mobile computer
- 1 CD-ROM Datalogic-NET SDK (Windows CE 5.0 SDK for Datalogic mobile computers)
- 1 styluses
- 1 user's manual
- 1 rechargeable battery pack
- 1 adjustable elastic strap with stylus holder (only handheld version)
- 1 belt clip (only handheld version)
- 1 belt clip pivot (only handheld version)
- 1 long strap (only gun version)
- 1 elastic strap for stylus
- 1 short strap for stylus (only gun version)

Other accessories, necessary for the Kyman™ connection to the host computer and to the network are sold separately: the cradle, power supply, and one or more connection cables.

Remove all the components from their packaging; check their integrity and congruity with the packing documents.

**CAUTION**

Keep the original packaging for use when sending products to the technical assistance center. Damage caused by improper packaging is not covered under the warranty.

**NOTE**

Rechargeable battery packs are not initially charged. Therefore the first operation to perform is to charge them. See paragraph 4.1.

1.3.1 Using the Belt Clip

To use the belt clip, proceed as follows:

1. Remove the elastic strap and unscrew the strap pivot.



2. Release the belt clip pivot by pressing the belt clip unlock button.

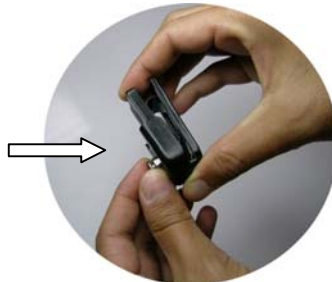

3. Screw the belt clip pivot on the terminal by using the fixing screw.



4. Insert the terminal in the belt clip by sliding the belt clip pivot into the belt clip until it clicks into place.



5. To release the terminal, press the belt clip unlock button.

1.4 HANDLE MOUNTING

- 1- Unscrew the A, B and C screws with a philips screwdriver and remove the cover of the handle connector socket.

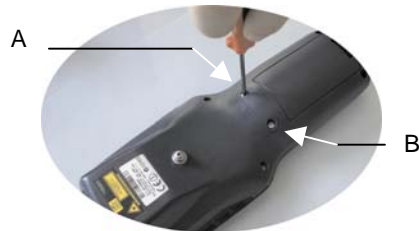

- 2- Insert the handle connector into the socket paying attention to the insertion key.



- 3- Fix the handle to the mobile computer body using the three screws included in the handle package.



1.5 INSTALLING THE SIM/SD CARD



To correctly insert the SIM/SD Card, proceed as follows:

- 4- Turn off the Kyman™ mobile computer.
- 5- Pull the battery latch down as indicated in the next figure and remove the battery pack.



- 6- Open the Sim/SD Card slot with a tweezer

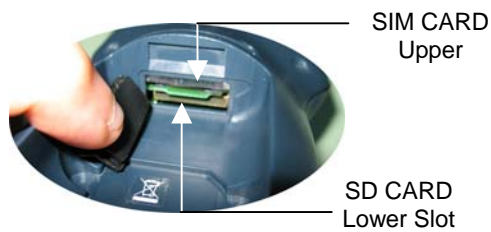

- 7- Insert the SIM CARD with the contacts downward and SD CARD with the contacts upward.



- 8- Push the cards into the slot using Datalogic Stylus until it clicks into place.

**CAUTION**

Follow proper ESD precautions to avoid damaging the SIM/SD. Proper ESD precautions include, but are not limited to, working on an ESD mat and ensuring that the operator is properly grounded.

Do not force the card. If you feel resistance, remove the card, check the orientation, and reinsert it.

Do not use the SIM/SD card slot for any other accessories.

1.5.1 Removing the SIM Card and SD-Card

To remove the SIM card and the SD-card, follow the steps above to access the SIM and SD-card area, and then follow the steps below:

- 9- To remove the SIM card and the SD card, just push them toward the inside, aided by the tip of the stylus, until they click; a spring system will return them out.

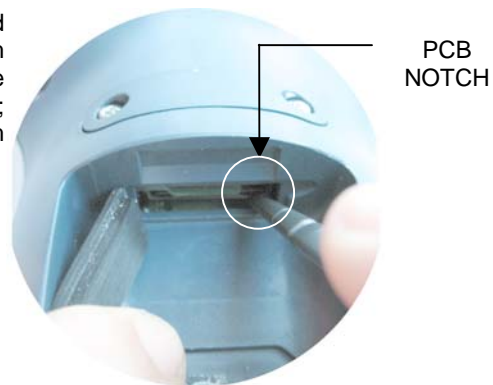
**NOTE**

All the basic functionalities normally associated to the SIM card are managed by the terminal (GPRS connectivity, phone calls, SMS handling).

It is possible that not all the services connected to the SIM card can be used or can be managed by the terminal.

1.6 ACCESSORIES

❑ Cradles

94A151101 Kyman™ Single Cradle Desk (includes slot for spare battery pack recharge; RS232 and USB communications)

94A151107 Kyman™ Vehicle Cradle

94A151115 Kyman™ Ethernet Desk Multi Cradle

❑ Charger

94A151102 Kyman™ Multi-Battery Pack Charger (4 slots)

❑ Batteries

94ACC1302 Kyman™ Standard Battery Pack (Li-Ion battery pack 2200 mAh@7.4 V)

❑ Power Supply

94ACC4595 FPS18 Power Supply without cord for Kyman™ Single Cradle Desk, for Kyman™ Multi-Battery Charger and for WIN-NET Serial/USB PWR Cables

94ACC1337 FPS19 W/O Power Cord, for Kyman™ Ethernet Desk Multi Cradle

94ACC1150 Power cord EU 3-pin

❑ Cables

94A051008 WIN-NET SERIAL CABLE (HRS 3500-16P-CV) cable for RS232 direct connection between the mobile computer and the PC

94A051009 WIN-NET USB CABLE (HRS 3500-16P-CV) cable for USB direct connection between the mobile computer and the PC

94A051014 WIN-NET SERIAL PWR CABLE (HRS 3500-16P-CV) cable for RS232 and power connections

94A051015 WIN-NET USB PWR CABLE (HRS 3500-16P-CV) cable for USB and power connections

94A051012 WIN-NET VEHICLE PWR CAB (HRS 3500-16P-CV) cable for car/truck cigarette lighter power adapter

❑ Various

94ACC1331 vo-CE® HEADSET

94ACC1332 vo-CE® HEADSET ADAPTER FOR Kyman™

94ACC1304 Kyman™ Belt Holster

94ACC1303 Kyman™ Functional Case

94ACC1301 Stylus Pen (20 pcs)

94ACC1300 JET™ & Kyman™ Backstrap Kit (1+1 pcs)

94ACC1336 Kyman™ Gun Handle



NOTE

Use only a Datalogic Mobile-approved power supply and cables. Use of an alternative power supply will invalidate any approval given to this device and may be dangerous.

2 CONNECTIONS

2.1 CONNECTION TO THE HOST COMPUTER

2.1.1 RS232/USB Direct Connection

You can use a cable to connect the Kyman™ to a host computer to transfer data.



Key:

- | | | | |
|---|---------------|---|--------------------------|
| A | Host computer | C | RS232 cable or USB cable |
| B | Kyman™ | | |

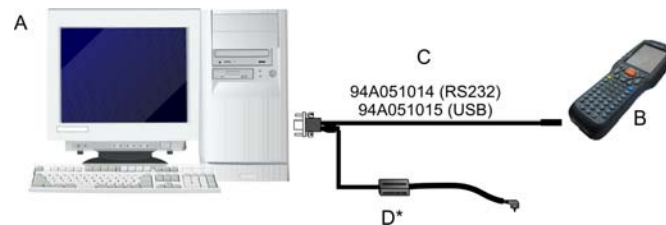

Key:

- | | | | |
|---|---------------|---|--------------------------|
| A | Host computer | C | RS232 cable or USB cable |
| B | Kyman™ | D | Power Supply* |

* Recommended Power Supply: FPS18 AC/DC Power Supply (94ACC4595).



CAUTION

USB communication may not be completely guaranteed while batteries are simultaneously in charge. Avoid the power supply connection when the USB link is active.

2.1.2 WLAN Connection

Kyman™ Wi-Fi 802.11b and Wi-Fi 802.11b/g¹ models can communicate with the host using the on-board radio frequency module and an Access Point connected to the host computer.

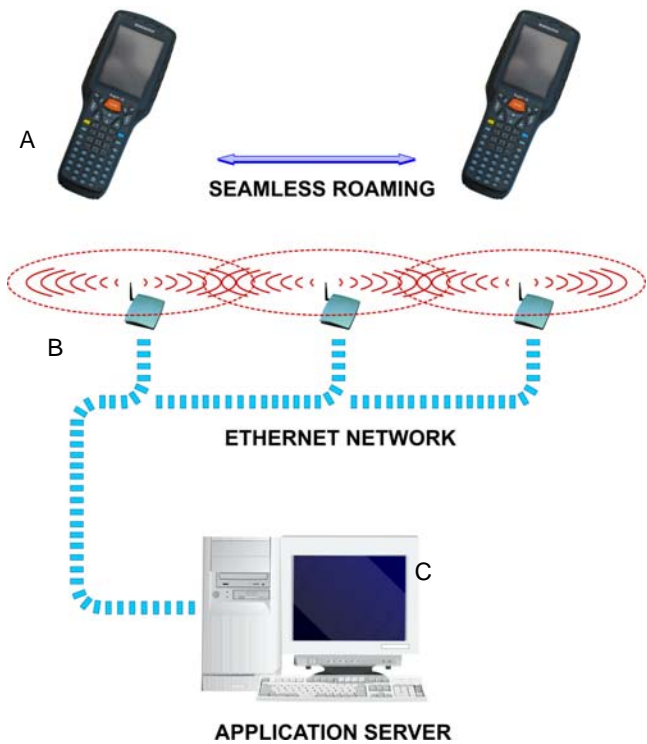

- Key:
- A) Kyman™
 - B) Access point
 - C) Host – Application Server

 **NOTE** *In order to avoid wasting energy, the Wi-Fi module is off by default. If you need to have the Wi-Fi module working, the module must be powered on using the Wireless Communications applet (see par. 3.7.4). To start configuring your WLAN connection, tap the Wi-Fi icon at the bottom of the screen.*

¹ Note: unless otherwise specified, the Wi-Fi term is used both for the 802.11b and the 802.11b/g cards.

**NOTE**

Suspending the terminal powers off the 802.11b/g radio and drops the radio connection. When the terminal resumes, depending on the radio power mode and security protocol selected, it takes approximately from 10 to 30 seconds for the 802.11b/g radio driver to re-associate the radio to the network.

**NOTE**

Area coverage and radio performance may vary, due to environmental conditions, access points types or interference caused by other devices (microwave ovens, radio transmitters, etc.)

2.1.3 WPAN Connections

Kyman™ mobile computers can communicate with a Bluetooth® device, such as a printer, within a range of 10 m, using the on-board Bluetooth® module.

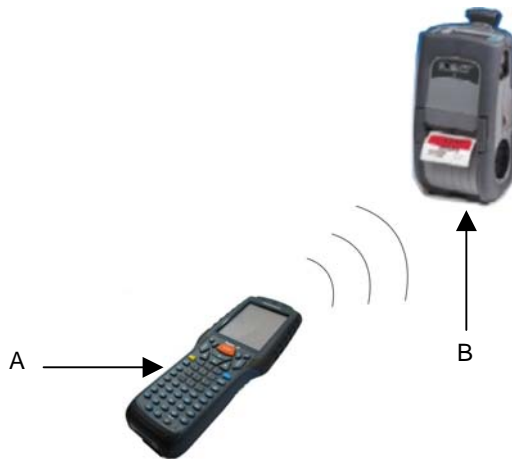

Key:

- A) Kyman™
- B) Bluetooth® printer

 **NOTE** *In order to avoid wasting energy, the Bluetooth® module is off by default. If you need to have Bluetooth® working, the module must be powered on using the Wireless Communications applet (see par. 3.7.4), and perform the Discovery procedure (see par. 3.8.2).*

 **NOTE** *Suspending the terminal powers off the Bluetooth radio and drops the piconet (Bluetooth connection). When the terminal resumes, it takes approximately 10 seconds for the Bluetooth radio driver to re-initialize the radio.*

 **NOTE** *Area coverage and Bluetooth radio performance may vary, due to environmental conditions or interference caused by other devices (microwave ovens, radio transmitters, etc.), etc.*

2.1.4 WWAN Connections

Kyman™ GSM/GPRS/EDGE models enhance your connectivity solutions giving you an opening to an international wireless infrastructure that is the standard in Europe and Asia.

GSM (Global System for Mobile communications), is a digital mobile phone system based on TDMA; it utilizes the 800, 900, 1800 and 1900 MHz bands.

GPRS supports IP (Internet Protocol) and allows accessing Internet and Intranet services, such as sending and receiving e-mail or Web browsing.

In order to use a WWAN Connection you have to install a SIM Card (see instructions on the following page).



NOTE

In order to avoid wasting energy, the GSM/GPRS module is off by default. If you need to have GSM/GPRS working, the module must be powered on using the Wireless Communications applet (see par. 3.7.4.)



NOTE

Suspending the terminal powers off the GSM/GPRS radio and drops the connection. When the terminal resumes, if the connection was managed by Microsoft Internet Explorer, it is automatically restored, otherwise, the radio connection must be manually re-initialized.



NOTE

The GSM voice capability of this mobile computer has to be addressed to occasional use, in well covered areas. If the coverage is poor, the voice quality can be highly affected. In case of vehicle cradle installations, a good habit is to install the external microphone to minimize the risk of noises and echoes. If the coverage is poor, in case of continuous communication, some degradation of the barcode reading capabilities can be experienced.



2.2 CONNECTION CABLES

The following cables are listed with their order number.

❑ **RS232 Direct Connection:**

94A051008 WIN-NET SERIAL CABLE (HRS 3500-16P-CV)

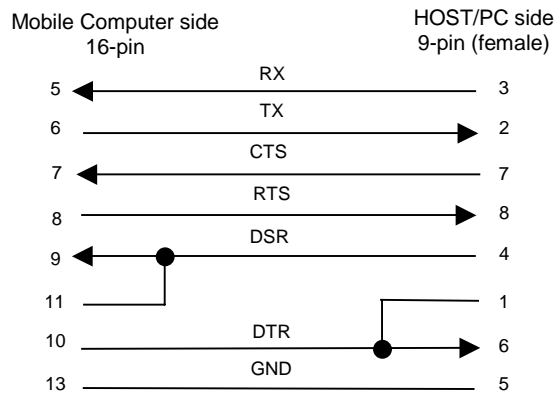

❑ **USB Direct Connection:**

94A051009 WIN-NET USB CABLE (HRS 3500-16P-CV)

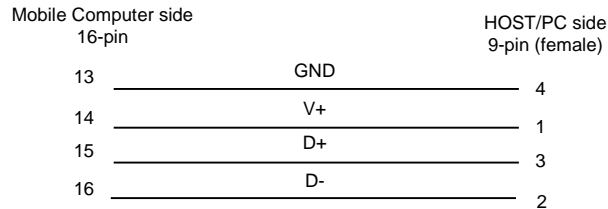

❑ **RS232 Direct Connection:**
94A051014 WIN-NET SERIAL PWR CABLE (HRS 3500-16P-CV)

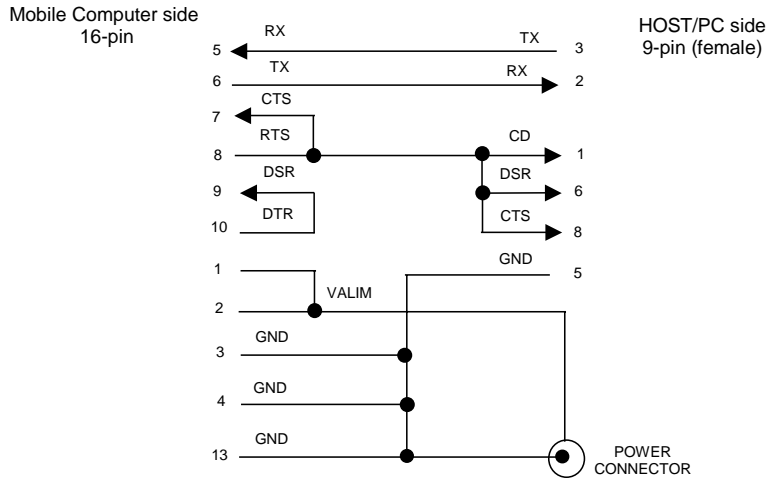

❑ **USB Direct Connection:**
94A051015 WIN-NET USB PWR CABLE (HRS 3500-16P-CV)

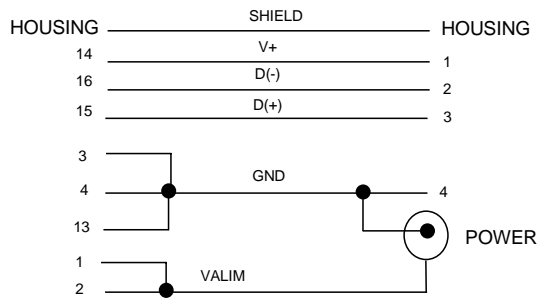

❑ **Power Supply Polarity:**

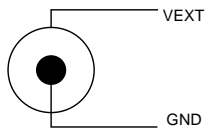

3 USE AND FUNCTIONING

The use of the Kyman™ depends on the application software loaded. However there are several parameters that can be set and utilities that can be used to perform some basic functions such as data capture, communications, file management, etc.

3.1 STARTUP

To turn on the Kyman™, please insert a charged battery or connect the external supply.

If the mobile computer was left without any power for more than a few days it will start the bootstrap procedure. The bootstrap can last a few minutes and, in the beginning of the procedure, the screen will be black, please be patient and wait a while.

Once the bootstrap is complete you will see the Windows CE desktop on the screen.

If instead the mobile computer was left without a power source for a smaller amount of time it will resume to the status it had before the power was removed. In this case you will need to use the ON/OFF key to turn on the mobile computer.



Use the stylus as suggested in paragraph 3.2 to select icons and options.

The mobile computer goes into power-off (low power with display and keyboard backlight off), when it is no longer used for more than a programmable timeout, which is defined in the POWER applet of the Control Panel. In this mode it can be awakened (resuming operation) pressing any key.

**NOTE**

The mobile computer can also be awakened or turned off by the application program.

3.2 USING THE STYLUS

The stylus selects items and enters information. The stylus functions like a mouse.

Tap:	Touch the screen once with the stylus to open items and select options.
Drag:	Hold the stylus on the screen and drag across the screen to select text and images. Drag in a list to select multiple items.
Tap-and-hold:	Tap and hold the stylus on an item to see a list of actions available for that item. On the pop-up menu that appears, tap the action you want to perform.

The stylus is factory aligned; however, it is possible to align the cursor on the screen with the tip of the stylus. Enter the STYLUS applet of the Control Panel and tap the center of each target that appears on the screen with the tip of the stylus.

**CAUTION**

Use only original Datalogic styluses supplied with the product itself.

In harsh applications, use of screen protectors should be taken into consideration, in order to extend the touch screen operating life.

To prevent damage to the screen, do not use sharp devices or any device other than the Datalogic Mobile-provided stylus.

Do not apply not necessary high pressures on the screen.

For applications where an intensive use of the touch screen is foreseen, please consider that touch screen components are subject to progressive wear.

3.3 DATA CAPTURE

To configure and enable data capture parameters refer to par. 3.6.

3.3.1 Laser Data Capture

To scan barcodes, point the Kyman™ laser model onto the code from a distance within the reading range while pressing the SCAN key. See the reading diagrams in par. 5.2 for the reading range of your model.

The lighted band emitted by the laser must completely intercept the barcode as shown in the figure below. If enabled, the emission of an acoustic signal will indicate that the scan has taken place correctly.

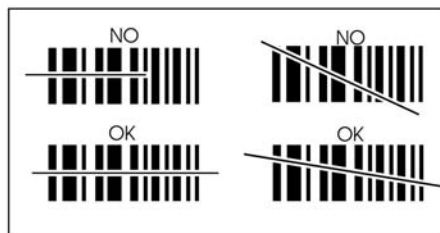
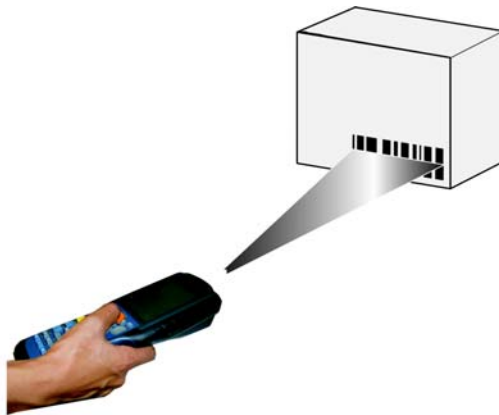

3.3.2 Imager Data Capture

To read a 1D or 2D code, simply point the Kyman™ Imager model onto the code from a distance within the reading range (See par. 5.1, section Kyman™ Imager Optical Features) and press the SCAN key.



The Kyman™ Imager uses an intelligent aiming system pattern similar to those on cameras, which indicates the field of view which should be positioned over the code:

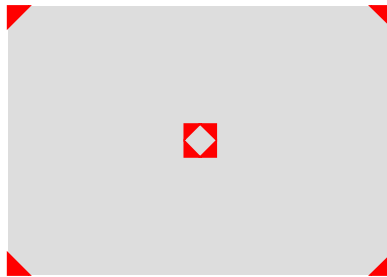

Aiming System

If the aiming system pattern is centered over the entire symbology as shown in the following figure, either wait for the timeout or release the Scan key to capture the image.

A red beam illuminates the code, which is captured and decoded. You will get a good read.

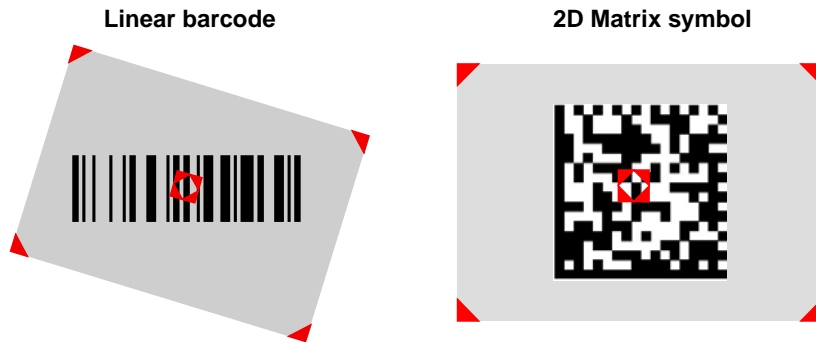

Relative Size and Location of Aiming System Pattern

The field of view changes its size as you move the reader closer or farther away from the code. The field of view indicated by the aiming system pattern will be smaller when the Kyman™ Imager is closer to the code and larger when it is farther from the code.

Symbologies with smaller bars or elements (mil size) should be read closer to the unit. Symbologies with larger bars or elements (mil size) should be read farther from the unit. (See par. 5.1 for further details).

3.3.3 RFID Data Capture

To read or write a tag, place the Kyman™ so that the RFID emission window is in front of and almost in contact with the tag, then press the SCAN key or the application defined key.



3.4 DESCRIPTION OF THE KEYS









The Kyman™ provides two different keyboards, an alphanumeric keyboard and a numeric keyboard, having a total of respectively 53 and 36 keys.

3.4.1 Alphanumeric Keyboard (53-key Model)





The following image shows the Alphanumeric keyboard.



Main Keys Function

KEY	FUNCTION
	It starts data capture.
	They let you move forwards, backwards, upwards or downwards within text fields, scroll through a Menu list or browse among folder files.
	After a yellow modifier key press, they let you scroll the pages up and down.
	After a blue modifier key press, the blue arrows allow moving forwards or backwards within the Internet Explorer browser pages.
	Yellow modifier: when pressed before a standard key, it enables the function printed in yellow above the key.
	Blue modifier: when pressed before a standard key, it enables the function printed in blue above the key.
	After a yellow modifier key press, subsequent key presses allow the selection of seldom used characters. The selected character is entered after a short timeout or if a different key is pressed.
	It powers the Kyman™ ON or OFF.
Home	After a blue modifier key press, it allows returning to the Home page.
Stop	After a blue modifier key press, it allows ending a page downloading.
Refresh	After a blue modifier key press, it performs a page refresh.

Special Function Icons

ICON	FUNCTION
	After a yellow modifier key press, it opens the Start menu.
	After a yellow modifier key press, it opens the file manager.
	After a yellow modifier key press, it switches ON/OFF the keyboard backlight.
	After a yellow modifier key press, it locks and unlocks the keyboard.

Hardware and Software Reset



By pressing these keys simultaneously, a system hardware reset is performed.



By pressing these keys simultaneously, a system software reset is performed.



CAUTION



Before performing a hardware or software reset, it is recommended to:

- *execute a system backup to keep persistent your more important files and applications. See par. 3.8.3;*
- *save the registry to non-volatile memory to guarantee the persistence of the Windows configuration. See par. 3.7.2.*

3.4.2 Numeric Keyboard (36-key Model)



Main Keys Function

KEY	FUNCTION
	It starts data capture.
	They let you move forwards, backwards, upwards or downwards within text fields, scroll through a Menu list or browse among folder files.

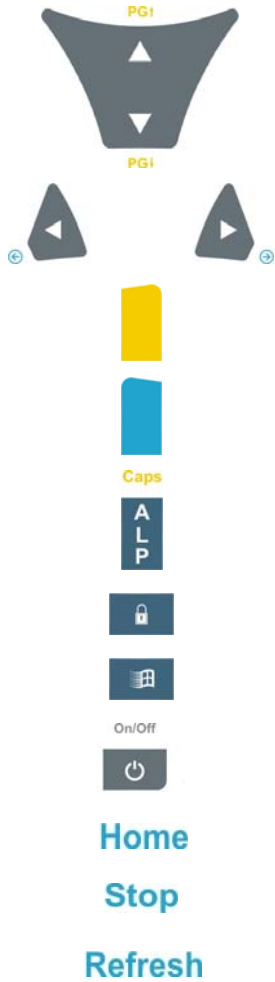

After a yellow modifier key press, they let you scroll the pages up and down.

After a blue modifier key press, the blue arrows allow moving forwards or backwards within the Internet Explorer browser pages.

Yellow modifier: when pressed before a standard key, it enables the function printed in yellow above the key.

Blue modifier: when pressed before a standard key, it enables the function printed in blue above the key.

When pressed, it toggles the alphanumeric/numeric modes.

It locks and unlocks the keyboard.

It opens the Start menu.

It powers the Kyman™ ON or OFF.

After a blue modifier key press, it allows returning to the Home page.

After a blue modifier key press, it allows ending a page downloading.

After a blue modifier key press, it performs a page refresh.



Once the Alpha mode has been entered, press the Alpha key again to exit this mode.

NOTE

Keys from 1 to 9 share the following behavior scheme:



- A. Function of the key when directly pressed
- B. Function of the key when in Alpha mode.
When in Alpha mode press the key until the desired letter is shown.
The letter is entered if you wait for a short timeout or if you press a different key.

Special Function Icons

ICON	FUNCTION
	It opens the file manager.
	It switches ON/OFF the keyboard backlight.

Hardware and Software Reset

	By pressing these keys simultaneously, a system hardware reset is performed.
	By pressing these keys simultaneously, a system software reset is performed.



CAUTION

Before performing a hardware or software reset, it is recommended to:

- *execute a system backup to keep persistent your more important files and applications. See par. 3.8.3;*
- *save the registry to non-volatile memory to guarantee the persistence of the Windows configuration. See par. 3.7.2.*

3.5 STATUS INDICATORS

3.5.1 LED Status







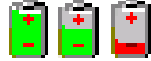

The Kyman™ provides three different LEDs signaling the mobile computer status.

LED	STATUS	
General Purpose (left-side)	Green/Red	This LED is available to the application program.
Charging Status and Battery Low Warning (right side)	Green constant	It is constant once the charging process has been completed.
	Red blinking	When the mobile computer is powered by the battery (not by the cradle nor by the cable), this LED blinks red to signal that the battery is running down.
	Red constant	It is constant while charging.
	Orange blinking	It blinks when a charging error has occurred, for example when a mobile computer without battery is connected to the external power or inserted into a powered cradle.
Good Read (middle)	Green	It is constant for a configurable time to signal that a successful read has occurred.

3.5.2 Taskbar

The Taskbar provides information about the time, the battery level, the keyboard function, and the decoding status.



ICONS	DESCRIPTION
Time and Battery Icons	
10.50	It displays the time.
	They are representative of five different icons indicating the battery level. The icon is partially green when the power left is >20% and partially red colored when the power left is <20%.
	It indicates that the battery is charging.
Keyboard Status Icons	
	It indicates that the blue FUNC key has been pressed and is going to affect the next key press.
	It indicates that the yellow FUNC key has been pressed and is going to affect the next key press.
	It indicates that the keyboard is in ALPHA mode.
	It indicates that the keyboard is in Normal mode.
	It indicates that the keyboard is in ALPHA mode and that the Capslock is active.
	It indicates that the keyboard is locked.
Decoding Status Icons	
	It indicates that the decoder is active (green), not active (grey).

3.6 DATA CAPTURE CONFIGURATION

From the Taskbar, tap the "Data Capture" icon to open a drop-down menu. Data Capture can also be accessed from the Control Panel.



By selecting the *Info* item from this drop-down menu you can access information about the Scanner and the Software; the *Configure* item opens the configuration applet (Data Capture Configuration Window), while *Capture* accesses the data capture applet (Data Capture Window), which enables code reading. The last menu item (*Wedge*) enables Wedge Emulation.

3.6.1 Configure

The Configuration applet contains the barcode scanning configuration parameters in a directory tree structure. The available barcode parameters are divided into two groups: Reader Parameters and Scan Parameters.

The Reader Parameters depend on the type of scanner module installed on the mobile computer and allow barcode configuration (i.e. enable/disable Code 39, check digit control, etc.).

The Scan Parameters are common to all scanner modules and allow control of the scanning device (i.e. beeper control, LED control, laser timeout, etc.).

Each Data Capture screen window corresponds to a branch of the tree, and the name of the current branch is displayed at the bottom of each screen window.

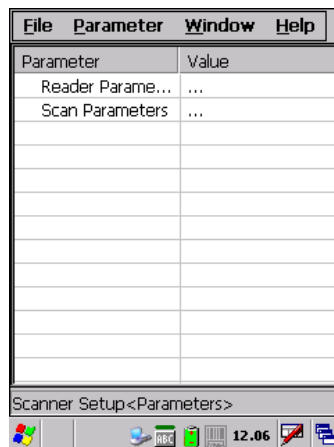

Data Capture Configuration Window

The screen format shows two columns where the left column indicates branches or parameters. Branches have three dots in the right column (...). You can navigate through the tree structure using the stylus or keyboard arrows directly on the item field or from the menu.

Parameters have their corresponding current values in the right column. You can edit parameter values using the stylus or keyboard arrows directly on the item field or from the menu. To change a value for example, select the line of the value to be changed, choose Edit from the Parameter Menu then choose a new value from the values listed in the box (see following figures).

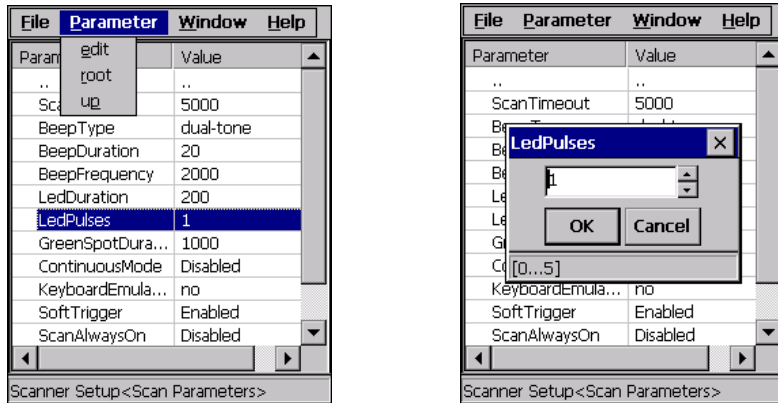

Selecting Data Capture Setup Parameters

Alternatively using the stylus, you can tap once directly on the value on the right column; continue tapping until the desired value is reached.

To activate a new configuration select the File ->Save Menu to send the new configuration to the barcode decoding software and save the new configuration. This will save the configuration to non-volatile memory preventing loss at the next system reset.

Reader Parameters

The barcode reading parameters and values are dependent upon the type of scanner module mounted in your mobile computer. For a detailed list of parameters and of their configuration procedures, please refer to the SDK Help file on the CD.

Scan Parameters

The Scan Parameters are common to all scanner modules and allow control of the scanning device. The Scan parameters are described as follows:

ScanTimeout: the maximum time, in milliseconds, during which the scanner remains on without decoding any barcode.

BeepType: if set to dual tone, the good read beep is a sequence of high and low pitch sounds. If set to monotone, the beep is a single pitch sound.

BeepDuration: the time interval, in milliseconds, during which the beeper will sound when the scanner reads a code. To disable the beeper, set this value to 0.

BeepFrequency: determines the frequency in Hertz of the beeper.

GoodReadSound: is the filename of a .wav file played when the scanner reads a code.

LedDuration: the length of the good-read led pulse, in milliseconds.

LedPulses: the number of times the good-read led pulse is emitted when the scanner reads a code.

GreenSpotDuration: the length of the green spot pulse, in milliseconds

ContinuousMode: disables the effect of the ScanTimeout parameter.

KeyboardEmulation: if enabled all scanned data are transformed into keyboard events and can therefore be displayed and saved to a file as if input from the PDA keyboard. If set to "Yes (Clipboard)", it copies the scanned data to the system clipboard.

SoftTrigger: when enabled, the laser can be turned on/off by the application software.

ScanAlwaysOn: enables the scanner for barcode reading independently from the application software. If set to "Disabled after read", it disables the reading after a reading attempt. In case the scan button is accidentally pressed, this selection prevents the driver from decoding new data while the application is still elaborating previous data.

NotPrintableChar: if set to “Remove”, all not printable characters included in the scanned data are deleted and the final barcode will include only printable characters.

ScanButton: enables/disables the scan button. If the scan button is disabled, the reader can be triggered under software control.

Default Settings

The following tables contain the default values for the major barcode setup parameters, according to the type of scan engine mounted on the mobile computer. For a complete list of parameters and of their configuration procedures, please refer to the SDK Help file on the CD.

SCAN PARAMETERS	Laser Models (XXX-1XX, XXX-4XX)	Imager Models (XXX-7XX)	Laser Extra Long Range Models (XXX-6XX)
ScanTimeout	5000	Not available	5000
BeepType	Dual tone	Dual tone	Dual tone
BeepDuration	20	20	20
BeepFrequency	2000	2000	2000
GoodReadSound	Beep.wav	Beep.wav	Beep.wav
LedDuration	200 mS	200 mS	200 mS
LedPulses	1	1	1
GreenSpot Duration	1000	1000	1000
ContinuousMode	Disabled	Disabled	Disabled
KeyboardEmulation	No	No	No
SoftTrigger	Enabled	Enabled	Enabled
ScanAlwaysOn	Disabled	Disabled	Disabled
NotPrintableChar	Leave	Leave	Leave
ScanButton	Enabled	Enabled	Enabled

BARCODE SYMBOLOGY SPECIFIC READER PARAMETERS	Laser Models (XXX-1XX, XXX-4XX)	Imager Models (XXX-7XX)	Laser Extra Long Range Models (XXX-6XX)
UPC A	Enabled	*	Enabled
UPC E	Enabled		Enabled
EAN 8	Enabled		Enabled
EAN 13	Enabled		Enabled
UPC E1			Disabled
EAN Bookland			Disabled
UPC/EAN/JAN		Enabled	
Code 39	Enabled	Enabled	Enabled
Code 39 Full ASCII	Disabled	Disabled	Disabled
Code 32	Disabled		Disabled
Code 39 Trioptic			Disabled
2/5: Interleaved	Enabled	Enabled	Enabled
2/5: Industrial	Disabled		Disabled
2/5: Matrix	Disabled		
Code 128	Enabled	Enabled	Enabled
EAN 128	Enabled	Disabled	Enabled
ISBT 128			Disabled
Codabar	Enabled	Enabled	Disabled
RSS		Disabled	

* In the Imager models these codes may only be enabled or disabled as a group by the UPC/EAN/JAN family selection (see a few lines below in the same table).

BARCODE SYMBOLOGY SPECIFIC READER PARAMETERS	Laser Models (XXX-1XX, XXX-4XX)	Imager Models (XXX-7XX)	Laser Extra Long Range Models (XXX-6XX)
MSI	Enabled		Disabled
Plessey	Disabled		
Code 93	Disabled	Enabled	Disabled
Code 11	Disabled		
PDF - 417		Enabled	
Data Matrix		Enabled	
QR		Enabled	
POSTNET		Disabled*	
PLANET			
Japan Post			
Australia Post			
KIX Code			
Royal Mail Code (RM4SCC)			

* These codes may be enabled individually but are disabled as a group.

3.6.2 Capture

The Data Capture applet (Capture) enables code reading.

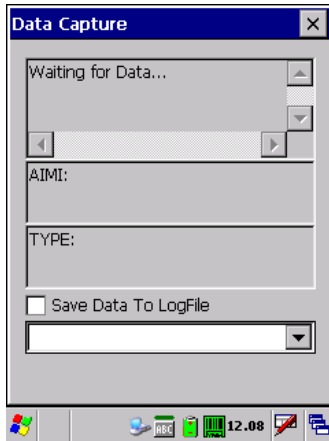

Data Capture Window

Data Capture can also be enabled through the Configuration applet by selecting File ->Scanner from the main menu, or by enabling the parameter Scan Always On in the Scan Parameters branch.

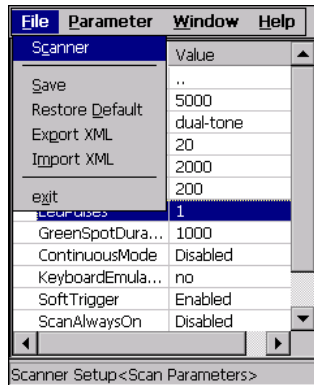

Enabling the Data Capture

3.7 CONTROL PANEL

From the Desktop, double tap on the "Control Panel" icon to open the Windows CE control panel main window. The Control Panel can also be launched from Start ->Settings ->Control Panel.

APPLET programs are displayed as icons; one icon corresponds to each APPLET.

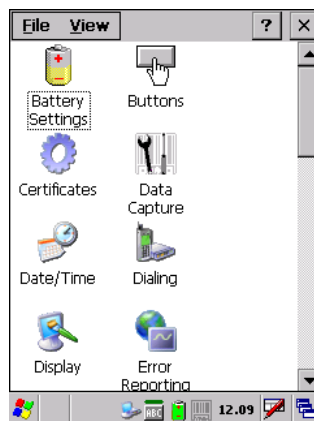

3.7.1 Buttons

The BUTTONS Applet allows assigning desired applications to be launched by one of the function keys (F1, F2, F3, F4).



3.7.2 Registry

The REGISTRY ADMIN applet provides management of Windows CE registry.

Select the REGISTRY ADMIN applet by double tapping the Registry Admin icon.

The Registry Administration Main window appears. Two functions are available:

- Save Registry allows permanently saving the Windows configuration (example: custom configuration of screen desktop background color, or network adapter configuration) to non-volatile memory (SAVE button).
- Restore Default Registry allows restoring the initial factory default configuration (Restore Default button). After restoring the factory default configuration, you must perform a software reset.

Saving the registry to non-volatile memory guarantees the persistence of the Windows configuration in case of battery pack replacement.

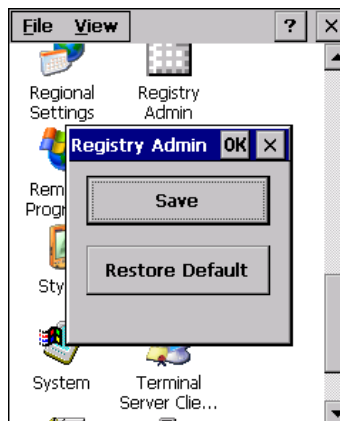

Registry Administration Window

3.7.3 Files Admin

The FILES ADMIN applet enables control of the permanence of files in the System Folder. Two functions are available on the Files Admin Main window by means of two buttons:

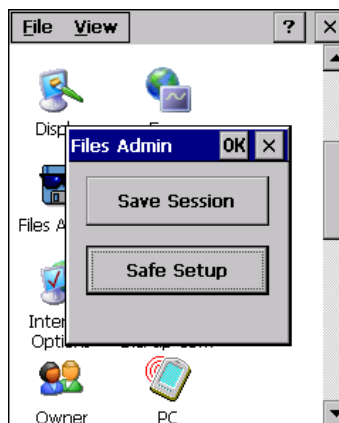

Files Admin Main Window

Save Session: with this button all files will be permanently saved in the \Windows directory in non-volatile memory. This function guarantees the steady maintenance of every file produced during the current working session - even of sub-directories and relevant files - with the exception of the files belonging to the FLASH image. These current working session files will be backed-up in the \Backup\Windows directory.

At the next hardware reset, the files previously saved in the \Backup\Windows directory will be restored to the Windows directory (see par. 3.8.3).

Safe Setup: with this button, the installation of software programs will be saved to non-volatile memory (Backup directory). Before doing this, it will be checked that the Backup directory has enough space to save the files. If the directory space is not enough, an error message will be shown and the program will exit the Safe Setup function.

Two activating procedures are available for Safe Setup:

- Select an installation file (for example, a .CAB cabinet file) from the Safe Setup mask.



Safe Setup First Mask

Then select \Windows or a relevant sub-directory in the path box. Then, Safe Setup will recognize the new files and directories present in the \Windows directory, and will copy them to the \Backup\Windows directory. At the next hardware reset, these files will be restored (see par. 3.8.3).

- Simply skip the first mask either by closing it or by pressing the ESC key. When it closes, a new mask will pop up: it will enable any type of installation (even remote ones like ActiveSync® installations). Make sure the installation directory is \Windows or one of its sub-directories. After installation, tap OK: Safe Setup will save the new files in the \Backup\Windows directory.



Safe Setup Second Mask

3.7.4 Wireless Communications

The WIRELESS COMMUNICATIONS applet provides management of the Wi-Fi Card and of the Bluetooth® and GSM/GPRS modules.



Select the WIRELESS COMMUNICATIONS applet by double tapping the Wireless Communications icon. The following window will appear:

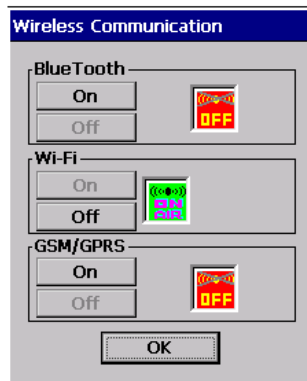

Wireless Communications Window



NOTE

In order to avoid wasting energy, all modules are off by default.

3.7.5 Ethernet Settings

Kyman™ can be connected to an Ethernet network by inserting it into the Datalogic Kyman™ Ethernet Multi Cradle.

When correctly inserted into the Ethernet Multi Cradle, the Ethernet driver installed on the mobile computer will automatically run, and using the DHCP service, will dynamically assign the IP Address.

The LAN icon will appear on the Taskbar indicating the LAN connection status.

By double tapping on the LAN icon in the Taskbar, the LANNDS1 applet allows visualizing the TCP/IP information. Other information such as the MAC Address is available by tapping the Details... button.

If it is necessary to set static TCP/IP parameters, you must open the LANNDS1 applet from the Network and Dial-up Connections applet in the Control Panel. This applet is only visible when the mobile computer is correctly inserted into the Ethernet Multi Cradle.

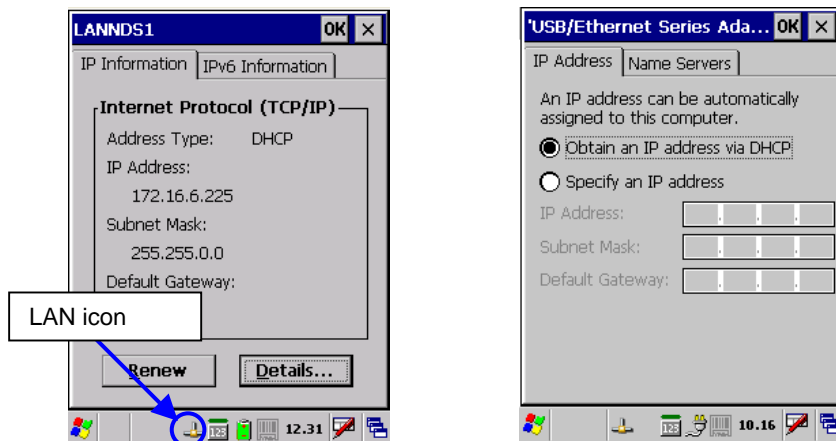

Ethernet LANNDS1 Communications Window

The IP Address belongs to Kyman™ while the MAC address is specific to each cradle slot.

Once you have established a valid ethernet connection you can use it in several ways:

- To configure the Internet Explorer for use with the ethernet line open Internet Explorer->view->Internet Options->Connection tab, check the "use LAN no autodial" then click on the OK button. If your network provides Internet Service and does not use a proxy server you can directly access

the Internet, otherwise set the internet proxy parameters according to your network settings.

- To access from the terminal the shared folders on a networked pc, open the explorer and enter the IP address (or name) of the pc in the address bar. You may be required to enter your network username and password. To access the terminal from a pc you can use an FTP connection. see par. 3.8.3 for details.

3.7.6 Volume Settings

The Volume Settings applet allows managing the audio features and appears as follows:

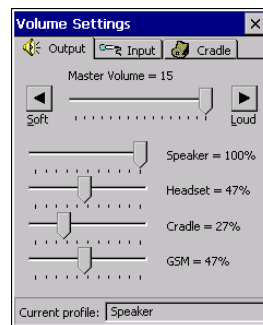

Volume Settings Window

The window is divided into three tabs:

- **Output** tab: allows setting the volume for each audio profile;
- **Input** tab: allows setting the microphone recording volume;
- **Cradle** tab: allows selecting the cradle type and managing the vehicle cradle headset functioning.

The Status bar always displays the current audio profile, which is activated automatically (by the device) or manually (by the user). Available profiles are:

- **Speaker**: it is the typical profile reproducing audio through the mobile computer speaker;
- **Cradle**: it is automatically activated as soon as the mobile computer is inserted into the vehicle cradle. Audio is reproduced by the vehicle cradle loudspeaker.
- **Headset**: it is automatically activated as soon as a headset is directly connected to the mobile computer. In case the device is inserted into the vehicle cradle and the headset is connected to the cradle, this profile must be manually activated

through the dedicated button (refer to “Cradle Tab” paragraph). When this profile is active, the speaker does not work;

- **GSM**: it is automatically activated each time a phone-call is started. It is not available when using the cradle loudspeaker (in this case Current Profile = Cradle).

Output Tab

It allows setting the volume for each audio profile:

The “Master Volume” slider allows setting the volume used by all audio profiles. In addition, it is possible to attenuate the volume for each single profile through the dedicated slider.

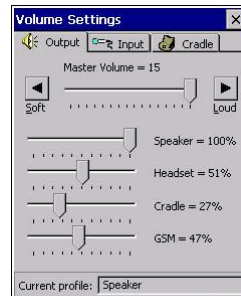

Input Tab

It allows setting the microphone recording volume:

The “Record Gain” slider allows setting the recording volume, while the “Enable Preamp” check box enables/disables the preamplifier (this option is not selectable when Current Profile = Cradle or GSM).



Cradle Tab

It allows selecting the cradle type and managing the vehicle cradle headset functioning:

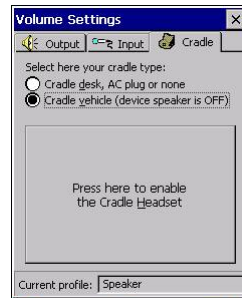
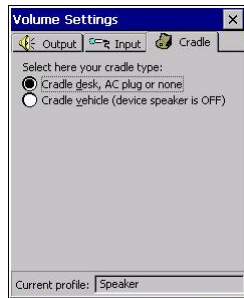

Two radio buttons allow selecting the type of cradle to be used.

Check the “Cradle desk, AC plug or none” radio button, if using a cradle different from the vehicle cradle or an AC adapter plug.

If using a vehicle cradle, check the related radio button.



NOTE

By inserting the mobile computer into the cradle when the “Cradle vehicle” radio button is checked, the mobile computer speaker is deactivated and audio will be reproduced through the vehicle cradle speaker or headset.

By selecting the “Cradle Vehicle” check box, a further button will appear allowing to enable the headset profile when using the vehicle cradle. If pressed, the button displays the headset icon in gray until the device is inserted into the vehicle cradle. Once inserted, the headset icon turns to green and the device activates the headset profile (refer to the following figures). Actually, the headset is ready to reproduce audio as soon as it is connected to the cradle jack:





WARNING

Do not use the vehicle cradle headset if the headset button is disabled, since it may cause hearing damage.

3.8 WINDOWS CONNECTIONS

To connect Kyman™ to another device (i.e. Host PC) from Windows, several programs are available in the "Connections" folder on the Kyman™ Desktop. These programs require specific electrical connections in order to function properly. From the Desktop, double tap on the "Connections" folder to open the following window:

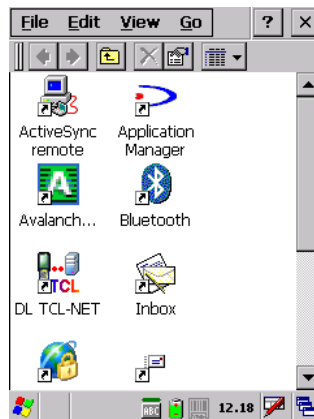

Windows Connections

3.8.1 Microsoft® ActiveSync®

Microsoft® ActiveSync® gives you the possibility to connect your desktop computer to your Kyman™ and synchronize the information on them. Synchronization compares the data on the Kyman™ with that on the desktop computer and updates both computers with the most recent information.

With ActiveSync®, it is possible to:

- Back up and restore Kyman™ data.
- Copy files between Kyman™ and desktop computer.
- Synchronize files by selecting a synchronization mode.

You can establish an ActiveSync® connection to your Kyman™ through the following electrical interfaces:

RS232 either directly or through the Kyman™ Single Cradle

USB either directly or through the Kyman™ Single Cradle

Bluetooth (see par. 3.8.2)

It is possible to constantly synchronize while connected to a desktop computer or, alternatively, synchronization can be performed only when the synchronize command is chosen. You can select which information types are synchronized and control how much data is synchronized.

**NOTE**

By default, ActiveSync® does not automatically synchronize all types of information. Use ActiveSync® options to turn synchronization on and off for specific information types.

For example:

Synchronize Microsoft Word and Microsoft Excel files between the Kyman™ and the desktop computer. The files will automatically be converted to the correct format.

**NOTE**

*Visit the following Microsoft Web site for the latest in updates, technical information, and samples:
<http://www.microsoft.com/windowsmobile/resources/downloads>*

ActiveSync® Remote

**NOTE**

Microsoft® ActiveSync® Remote is no longer supported in Windows CE. For backward compatibility you can download it from the internet. We suggest enabling the FTP Server and connecting to an FTP Client. See par. 3.8.3.

3.8.2 Bluetooth® Manager Device Setup

In order to enable a Bluetooth® device for communication with the Kyman™ you must perform the discovery procedure and enable the device as follows:

1. Place the Bluetooth® device within the range of the Kyman™ (10 meters).
2. From the “Connections” folder double tap on the “Bluetooth” applet to open the Bluetooth® Manager Device window:



3. Tap on the “Me” button to enter the related window; then, tap on the “ON” button to activate the Bluetooth® module. The module activation may be also performed by using the WIRELESS COMMUNICATION applet as described in par. 3.7.4.

By tapping on the “HW Details” and “SW Details” buttons, information about the mobile computer Bluetooth® hardware and software will be displayed, while the “Enable Encryption” button starts encryption of the Bluetooth® communication data. If tapping on the “Close” button the Bluetooth® Manager Device window will be closed.



- Tap on the “Discovery” button to enter the related window; then, tap on the “Scan” button to run the Discovery procedure.

Once the Discovery procedure has been completed, select the desired Bluetooth® device from the list. It is also possible to digit (12 hexadecimal digits) the Bluetooth® address of the desired device by tapping on the “Add” button. The “Clear” button deletes all discovered devices from the list.

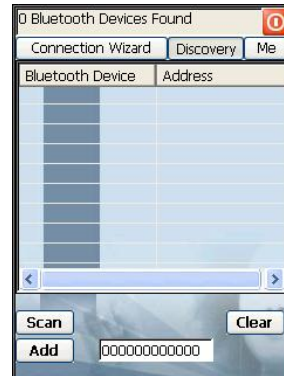

- Once the desired Bluetooth® device has been selected, tap on the “Connection Wizard” button to enter the related window where selecting the connection type to be used for communication with the Bluetooth® device.

The “Serial Port” button starts communication through the Bluetooth® serial port COM 5 (typically used for connection with GPS devices).
 The “Printer” button starts communication with a printer through the Bluetooth® serial port COM 5.
 The “Kbd Emulation” button allows connection with a barcode reader using the keyboard emulation.
 The “ActiveSync” button starts communication with a PC equipped with a Bluetooth® antenna and the related ActiveSync.



- Hide the Bluetooth® Manager Device window by tapping on the  icon available on each window or close it through the “Close” button available in the “Me” window (see step 3 of this procedure).

3.8.3 FTP Server Setup

The Kyman™ Operating System includes a sample File Transfer Protocol (FTP) server. FTP is used for copying files to and from remote computer systems over a network using TCP/IP. You can establish a connection to your Kyman™ using its FTP Server through the following interfaces:

WLAN using the WiFi radio

Proceed as follows:

1. Create a registry file (extension .reg) to setup and enable FTP Server communication. A simple example file for anonymous logon is given below:

```
REGEDIT4

[HKEY_LOCAL_MACHINE\Comm\FTPD]
"DefaultDir"="\\"
"AllowAnonymousUpload"=dword:00000001
"UseAuthentication"=dword:00000000
"BaseDir"="\\"
"IsEnabled"=dword:00000001
"LogSize"=dword:00001000
"DebugOutputMask"=dword:00000017
"DebugOutputChannels"=dword:00000002
"IdleTimeout"=dword:0000012c
"AllowAnonymous"=dword:00000001
"AllowAnonymousVroots"=dword:00000001
```

2. Copy this file to the Kyman™ using ActiveSync®.
3. Launch the .reg file from the Kyman™.
4. Perform a software reset on the Kyman™.
5. From the PC > Explorer address bar (or running an FTP Client from the PC), enter the Kyman™ IP address.



NOTE

For more information on FTP Client/Server connections refer to the following web page:

<http://msdn2.microsoft.com/en-us/library/ms901310.aspx>

3.9 BACKUP DIRECTORY FILE MANAGEMENT

All of the Windows CE system files reside in RAM (volatile memory) except for the Backup directory, which resides in FLASH (non-volatile memory). Therefore the contents of the Backup directory are persistent even if the mobile computer is re-booted or the battery pack is changed.

You can save your more important files that you don't want to lose due to mobile computer re-boot, in the Backup directory or create a sub-directory within Backup.

Even though the Windows Directory resides in RAM, it often contains files or sub-directories created by the user or by installation programs that you don't want to lose at re-boot. To keep these files persistent it is necessary to copy them to the directory \Backup\Windows. This directory doesn't exist originally (only Backup exists), and therefore it must be created. At the next hardware reset, before activating the shell, Windows CE will copy the contents including all sub-directories of \Backup\Windows to \Windows.

Likewise, to maintain files that must be run at Windows CE startup, (i.e. .exe, .lnk, .vb, .htm, etc.), it is necessary to copy them to the directory \Backup\Startup. This directory does not exist originally (only Backup exists), and therefore it must be created. The application programs will be run after any type of re-boot (both software and hardware reset).

As an alternative to the Safe Setup function, it is possible to copy the .cab files to the directory \Backup\Cabfiles (the Cabfiles sub-directory doesn't exist originally and must therefore be created) and perform a mobile computer cold boot to have the application installed. Once these files are copied to the directory \Backup\Cabfiles, the application will be run after each re-boot.

From the second cold boot on, a message may be displayed such as "<application name> is already installed. Re-install?". This message blocks the boot process. Press the [Enter] key to continue the system initialization.

4 MAINTENANCE



NOTE

Rechargeable battery packs are not initially charged. Therefore the first operation to perform is to charge them. See below.

4.1 CHARGING THE BATTERY PACK

The battery pack autonomy varies according to factors, such as the frequency of barcode scanning, RF usage, etc.

When the battery pack is low, the LED positioned at the right side of the display blinks orange.

It is possible to recharge the battery pack by using the FPS-18 AC/DC external power supply directly connected to the Kyman™, see par. 2.1.1.

Alternatively, it is also possible to recharge the battery pack by using the Kyman™ Single Cradle Desk or the Kyman™ Vehicle Cradle.

During the charging process the LED positioned at the right side of the display is red constant. Once the charging process has been completed this LED is green constant (see par. 3.5).

If the battery pack is removed from the mobile computer, it can be recharged by inserting it into the Kyman™ Multi-Battery Pack Charger.



NOTE

The battery pack autonomy varies according to many factors, such as the frequency of barcode scanning, RF usage, battery life, storage, environmental conditions, etc.



CAUTION

If the battery pack is new or has not been recharged for a long time, it is necessary to perform two or three charging and discharging cycles (complete use) before it can reach its maximum charge capability.

The maximum time required to recharge a completely run-down battery pack is about 3 hours if the mobile computer is idling.

**NOTE**

*Even if the storage temperature range is wider, In order to achieve the longest battery life, store the terminal and the spare batteries between 20 to 30 °C (68 to 86 °F).
The Batteries must be charged at a temperature ranging from 0° to +45 °C (+32° to +113 °F).*

4.2 REPLACING THE BATTERY PACK

To correctly replace the battery pack, proceed as follows.

1. Turn off the Kyman™.
2. Pull the battery latch down as indicated in the figure below.



3. Remove the battery pack.

Battery Contacts



4. To correctly insert the new battery pack, first insert the bottom and then the upper part of the battery pack into the slot as indicated in the following figure:



5. Press it back until the battery latch is automatically closed.

**WARNING**

Use only a Datalogic Mobile approved power supply. Use of an alternative power supply will void the product warranty and may cause product damage. Do not apply voltages to the batteries contacts.

Risk of explosion if the battery is replaced by an incorrect type.

Do not use the batteries of this terminal to power devices different from this mobile computer.

Do not place the battery in or near a fire or heat as they may explode.

Do not place the battery in direct sunlight, or use or store the battery inside unventilated areas in hot weather. Doing so may cause the battery to generate heat, explode or ignite. Using the battery in this manner may also result in a loss of performance and a shortened life expectancy.

Do not place the battery in microwave ovens, high pressure containers, or on induction cookware.

Immediately discontinue use of battery if, while using, charging or storing the battery, the battery emits an unusual smell, feels hot, changes colour or shape, or appears abnormal in any other way.

Do not short-circuit the battery contacts. Accidental short-circuiting can occur when a metallic object such as a coin, clip, or pen causes direct connection of the contacts of the battery (these look like metal strips on the battery).

Do not carry or store battery pack together with metal objects (this might happen, for example, when you carry a spare battery in your pocket or purse). Short-circuiting the terminals may damage the battery or the connecting object.

Do not pierce the battery pack with nails, strike it with a hammer, step on it or otherwise subject it to strong impacts or shocks.

Do not solder directly onto the battery pack.

Do not disassemble or modify the battery. The battery contains safety and protection devices, which, if damaged, may cause the battery to generate heat, explode or ignite.

Do not expose the battery pack to liquids.

**NOTE**

In order to guarantee an adequate operating autonomy, when replacing the battery pack the mobile computer checks the battery energy level. If the battery is not sufficiently charged, Kyman™ does not turn on (when pressing the ON button).

In this case, either substitute the battery pack with a charged one (sufficiently charged) or insert Kyman™ into a powered cradle or plug it into the direct power supply.

**NOTE**

To achieve the best battery life, turn off the radios not in use.

4.3 CLEANING THE MOBILE COMPUTER

Periodically clean the Kyman™ with a slightly dampened cloth.

Do not use alcohol, corrosive products or solvents.

5 TECHNICAL FEATURES

5.1 TECHNICAL DATA

Kyman™ Common Features

Electrical Features	
Power	
DC supply	14 V ± 5%
Battery pack	2 cell Li-Ion 2200 mAh@ 7.4 V (nominal)
Internal backup battery	Rechargeable Li-Ion 30 mAh
Communication Features	
Serial interface	RS232 USB 1.1
Windows CE COM Port	
	COM1 COM6
Wireless Features	
WLAN	IEEE 802.11g DSSS
WPAN	Bluetooth® IEEE 802.15, Class 2, Version 1.2
WWAN	GSM/GPRS Tri-band (900, 1800, 1900 MHz) Radio with accessible SIM card interface or GSM/GPRS7EDGE Quad-band (850, 900, 1800, 1900 MHz) Radio with accessible SIM card interface
Hardware Features	
FLASH	128 MB
RAM	128 MB
Microprocessor	Intel XScale PXA 270 520 MHz
Audio	Speaker, Microphone, Buzzer
LED	Two-color Programmable LED Charging Status (two-color LED) Good Read LED
Display	64K Color TFT LCD with 320 x 240 pixel resolution, with LED backlight and touch screen
Keyboard	53 or 36 Plastic Top Backlit Keys
Environmental Features	
Working temperature*	-20° to + 50 °C / -4° to +122 °F
Storage temperature	-20° to +70 °C / -4° to +158 °F
Humidity***	90% non condensing for temperatures<40°C
Protection	IP64
ESD protection**	4 KV contact discharge, 8 KV air discharge
Drop resistance****	1.8 m / 6 ft

Mechanical Features	
Dimensions (LxWxH)	NO HANDLE : 23.8 x 9.1 x 5.5 cm / 9.3 x 3.5 x 2.2 in WITH HANDLE: 23.8 x 9.1 x 16.2 cm / 9.3 x 3.5 x 6.3 in
Weight (depending on model)	NO HANDLE: 550 - 630 g / 19.3 - 22.1 oz (incl. battery) WITH HANDLE: 660 - 690 g / 23.1 - 24.2 oz (incl. battery)

- * Close to the limits of the working temperature, some display and/or battery performance degradation may occur.
- ** This device is designed and tested to withstand strong electrostatic discharges (ESD) and RF noise in order to work in harsh environments.
When used in wired connections to a host computer, the host device must also be designed to withstand ESD and RF noise in order for the whole system to resist disturbance.
- *** Multiple rapid humidity and/or temperature variations may cause condensing.
- **** Multiple drops can permanently damage the device.

Programming Features	
Operating system	Windows CE 5.0 Professional
Laser models	
Decoded barcodes 1D	UPCA A, UPC E, EAN 8; EAN 13, Code 39, Code 39 Full ASCII, Code 32, Interleaved 2 of 5, Industrial 2 of 5, Matrix 2 of 5, Code 128, EAN 128, Codabar, MSI, Plessey, Code 93, Code 11
RFID + Laser models	
Decoded barcodes 1D	UPC A, UPC E, UPC E1, EAN 8, EAN 13, EAN Bookland, Code 39, Code 39 Full ASCII, Code 32, Code 39 Trioptic, Interleaved 2 of 5, Industrial 2 of 5, Code 128, EAN 128, Codabar, MSI, Code 93
Decoded RFID Tags	EMS HMS Series, EMS LRP ISO15693 Series, Philips Mifare Classic 1k (read/write block only), Philips Mifare Classic 4k (read/write block only), Philips Mifare Ultralight, Philips I-Code SLI ISO15693, Texas Tag-It HF-I ISO15693, Infineon ISO15693
Imager models	
	UPC A, UPC E, EAN 8, EAN 13, UPC/EAN/JAN, Interleaved 2 of 5, Code 39, Code 39 Full ASCII, Codabar, Code 128, EAN 128, Code 93.
Decoded barcodes 2D	PDF417, DataMatrix, QR, MacroPDF, RSS.
Postal codes	POSTNET, PLANET, Japan Post, Australia Post, KIX Code, Royal Mail Code (RM4SCC)
Laser Extra Long Range Models	
Decoded barcodes 1D	UPC A, UPC E, UPC E1, EAN 8, EAN 13, Code 128, EAN 128, Code 39, Code 39 Full ASCII, Code 32, Code 93, Interleaved 2 of 5, discrete 2 of 5, Codabar, MSI, RSS

Kyman™ Laser Optical Features

Laser Optical Features		
	Kyman™ XXX-9XX Models	Kyman™ XXX-6XX Models
Maximum resolution	0.1 mm / 4 mils	0.2 mm / 7.5 mils
Skew angle	± 65°	± 60°
Pitch angle	± 50°	± 65°
Scan rate - horizontal	105 ± 12 scan/sec	40 ± 6 scan/sec
Depth of field	See reading diagrams on the next page	
Light Source	VLD, wavelength 630~680 nm	
Laser Safety	Class II EN 60825-1/CDRH	

Kyman™ Imager Optical Features (XXX-7XX models)

Imager Optical Features			
Max. resolution			
1D Codes	0.10 mm / 4 mils		
2D Codes	0.17 mm / 6.6 mils		
Skew angle	± 40 °		
Pitch angle	± 35 °		
Depth of field*			
1D (linear):	X-dimension mm (mils)	Symbol size cm (in)	DOF cm (in)
Code39	0.13 (5)	1.2 (0.47)	8.0 to 15.0 (3.15 to 5.90)
	0.50 (20)	3.2 (1.26)	8.0 to 33.0 (3.15 to 12.99)
EAN13	0.33 (13)	3.1 (1.22)	7.5 to 24.5 (2.95 to 9.65)
2D:	X-dimension mm (mils)	Symbol size cm (in)	DOF cm (in)
POSTNET	0.5 (20)	4.0 x 0.4 (1.57 x 0.16)	11.5 to 30.0 (4.53 to 11.81)
PDF417	0.13 (5)	1.1 x 0.9 (0.43 x 0.35)	8.5 to 15.5 (3.35 to 6.10)
	0.17 (6.6)	1.4 x 1.2 (0.55 x 0.47)	7.0 to 19.0 (2.76 to 7.48)
	0.25 (10)	2.2 x 1.8 (0.86 x 0.71)	4.5 to 24.0 (1.77 to 9.45)
QR	0.25 (10)	0.7 x 0.7 (0.28 x 0.28)	7.0 to 15.5 (2.76 to 6.10)
	0.38 (15)	1.1 x 1.1 (0.43 x 0.43)	4.5 to 21.0 (1.77 to 8.27)
DataMatrix	0.19 (7.5)	0.8 x 0.8 (0.31 x 0.31)	9.0 to 13.0 (3.54 to 5.12)
	0.25 (10)	0.8 x 0.8 (0.31 x 0.31)	7.5 to 16.5 (2.95 to 6.50)
	0.38 (15)	1.0 x 1.0 (0.39 x 0.39)	6.0 to 22.0 (2.36 to 8.66)
Sensor	640 x 480 pixel element, 2D CMOS array		
Illuminator	LED array		
Wavelength	630~670 nm		
LED Safety class	Class 1 to EN 60825-1		
Aiming System	Visible Laser Diode		
Wavelength	650 nm		
Laser Safety	Class 2 EN 60825-1; Class II CDRH		

* Reading distances are measured from the nose of the reader using the test codes. The reading performances may vary depending on the code printing quality.

5.2 READING DIAGRAMMS

Kyman™ Laser (XXX-9XX models)

Reading Zones (10° skew angle)

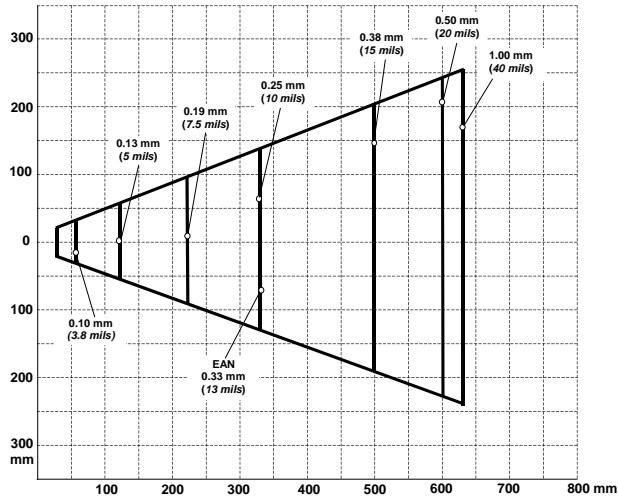

Kyman™ XLR (XXX-6XX models)

Reading Zones (10° skew angle)

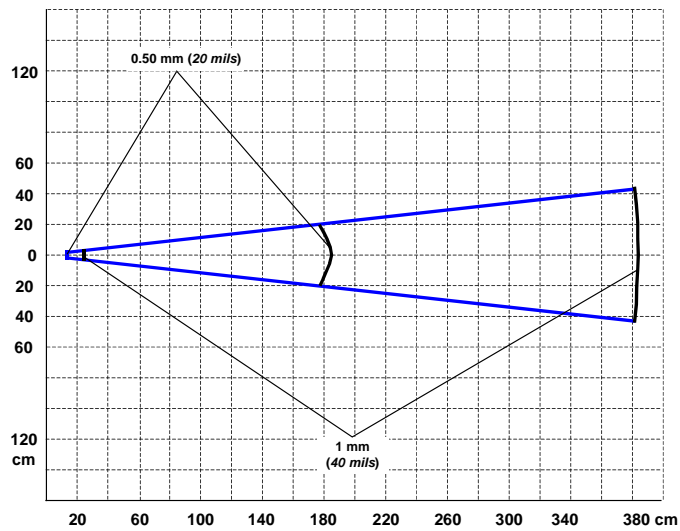

6 TEST CODES

High Density Codes

0.25 mm (10 mils)

Code 39



17162

2/5 Interleaved



0123456784

Code 128



test

EAN 13



8 012345 000012

EAN 8



6450 9723

Medium Density Codes

0.38 mm (15 mils)

Code 39



17162

Interleaved 2/5



0123456784

Code 128



test

EAN 13



8 012345 000012

EAN 8



6450 9723

Low Density Codes

0.50 mm (20 mils)

Code 39



17162

Interleaved 2/5



0123456784

Code 128



test

EAN 13

120%



8 012345 000012

EAN 8

120%



6450 9723

GLOSSARY

Access Point

A device that provides transparent access between Ethernet wired networks and IEEE 802.11 interoperable radio-equipped mobile units. Hand-held mobile computers, PDAs or other devices equipped with radio cards, communicate with wired networks using Access Points (AP). The mobile unit (mobile computer) may roam among the APs in the same subnet while maintaining a continuous, seamless connection to the wired network.

Barcode

A pattern of variable-width bars and spaces which represents numeric or alphanumeric data in binary form. The general format of a barcode symbol consists of a leading margin, start character, data or message character, check character (if any), stop character, and trailing margin. Within this framework, each recognizable symbology uses its own unique format.

Baud Rate

A measure for data transmission speed.

Bit

Binary digit. One bit is the basic unit of binary information. Generally, eight consecutive bits compose one byte of data. The pattern of 0 and 1 values within the byte determines its meaning.

Bluetooth®

A standard radio technology using a proprietary protocol. The onboard Bluetooth module in the mobile computer is compatible with the 1.1 protocol.

Byte

On an addressable boundary, eight adjacent binary digits (0 and 1) combined in a pattern to represent a specific character or numeric value. Bits are numbered from the right, 0 through 7, with bit 0 the low-order bit. One byte in memory can be used to store one ASCII character.

Decode

To recognize a bar code symbology (e.g., Codabar, Code 128, Code 3 of 9, UPC/EAN, etc.) and analyze the content of the bar code scanned.

EDGE

Enhanced Data rates for GSM Evolution, EDGE is a wireless packet-based communication service based on GSM. Its data transfer can reach a theoretical maximum of 473.6 Kbps.

EEPROM

Electrically Erasable Programmable Read-Only Memory. An on-board non-volatile memory chip.

Flash Disk

Non-volatile memory for storing application and configuration files.

GPRS

General Packet Radio Service. GPRS is a wireless packet-based communication service based on GSM. Its data transfer is rated between 56 Kbps to 114 Kbps. It makes very efficient use of available radio spectrum, and users pay only for the volume of data sent and received.

GSM

Global System for Mobile communication. It is a standard for digital cellular communications, currently used in the 900 MHz and 1800 MHz bands.

Host

A computer that serves other mobile computers in a network, providing services such as network control, database access, special programs, supervisory programs, or programming languages.

Liquid Crystal Display (LCD)

A display that uses liquid crystal sealed between two glass plates. The crystals are excited by precise electrical charges, causing them to reflect light outside according to their bias. They use little electricity and react relatively quickly. They require external light to reflect their information to the user.

Light Emitting Diode (LED)

A low power electronic light source commonly used as an indicator light. It uses less power than an incandescent light bulb but more than a Liquid Crystal Display (LCD).

RAM

Random Access Memory. Data in RAM can be accessed in random order, and quickly written and read.

RF

Radio Frequency

RFID (Radio frequency identification)

A technology that incorporates the use of electromagnetic or electrostatic coupling in the radio frequency (RF) portion of the electromagnetic spectrum to uniquely identify an object, animal, or person. RFID is coming into increasing use in industry as an alternative to the barcode identification.

INDEX

A

Accessories; 10
Alphanumeric Keyboard; 25
Available Models; 2

B

Backup Directory File Management;
55
Bluetooth® Approval; viii
Bluetooth® Manager Device Setup;
52
Buttons; 41

C

Charging the Batteries; 56
Cleaning the Mobile Computer; 60
Connection Cables; 18
 RS232 Direct Connection; 18
 RS232 Power Connection; 19
 USB Direct Connection; 18
 USB Power Connection; 19
Connections; 12
 RS232/USB Direct Connection; 12
 WLAN Connection; 13
 WPAN Connections; 15
 WWAN Connections; 16
Control Panel; 40
Conventions; vii

D

Data Capture; 22
 Imager Data Capture; 23
 Laser Data Capture; 22
 RFID Data Capture; 24
Data Capture Configuration; 33
Default Settings; 38
Description of the Keys; 25

E

End User License Agreement; v

F

Files Admin; 42
FTP Server Setup; 54

G

General View; xviii
Glossary; 69

K

Kyman-NET™ Description; 1

M

Maintenance; 56
Microsoft® ActiveSync®; 50

N

Numeric Keyboard; 28

P

Package Contents; 2

R

Reader Parameters; 36
Reading Diagrams; 65
Reference Documentation; vii
References; vii
Registry; 41
Replacing the Batteries; 58

S

Safe Setup; 42
Safety Regulations; viii

FCC Compliance; xiii
Laser Safety; ix
Radio Compliance; xiii
SAR Compliance; xv
WEEE Compliance; xvi
Save Session; 42
Scan Parameters; 36
Services and Support; vii
SIM Card; 7
Startup; 20
Status Indicators; 31

T

Technical Features; 61

Test Codes; 66

U

Using the Stylus; 21

V

Vocal Communication; 46

Volume Settings; 46

W

Wireless Communication; 44

DATALOGIC MOBILE S.r.l.
Via S. Vitalino, 13
40012 - Lippo di Calderara
Bologna - Italy



dichiara che
declares that the
déclare que le
bescheinigt, daß das Gerät
declare que el

Kyman™ XXX-XXX

e tutti i suoi modelli
and all its models
et tous ses modèles
und seine Modelle
y todos sus modelos

sono conformi alla Direttiva del Consiglio Europeo sottoelencata:
are in conformity with the requirements of the European Council Directive listed below:
sont conformes aux spécifications de la Directive de l'Union Européenne ci-dessous:
der nachstehenden angeführten Direktive des Europäischen Rats entsprechen:
cumple con los requisitos de la Directiva del Consejo Europeo, según la lista siguiente:

1999/5/EEC R&TTE

Questa dichiarazione è basata sulla conformità dei prodotti alle norme seguenti:
This declaration is based upon compliance of the products to the following standards:
Cette déclaration repose sur la conformité des produits aux normes suivantes:
Diese Erklärung basiert darauf, daß das Produkt den folgenden Normen entspricht:
Esta declaración se basa en el cumplimiento de los productos con las siguientes normas:

- ETSI EN 301 489-3 v1.4.1, August 2002:** ELECTROMAGNETIC COMPATIBILITY AND RADIO SPECTRUM MATTERS (ERM); ELECTROMAGNETIC COMPATIBILITY (EMC) STANDARD FOR RADIO EQUIPMENT AND SERVICES; PART 3: SPECIFIC CONDITIONS FOR SHORT-RANGE DEVICES (SRD) OPERATING ON FREQUENCIES BETWEEN 9 KHZ AND 40 GHZ
- ETSI EN 301 489-7 v1.2.1, August 2002:** ELECTROMAGNETIC COMPATIBILITY AND RADIO SPECTRUM MATTERS (ERM); ELECTROMAGNETIC COMPATIBILITY (EMC) CONDITIONS FOR MOBILE AND PORTABLE RADIO AND ANCILLARY EQUIPMENT OF DIGITAL CELLULAR RADIO TELECOMMUNICATIONS SYSTEMS (GSM AND DCS) OPERATING ON FREQUENCIES BETWEEN 9 KHZ AND 40 GHZ
- ETSI EN 301 489-17 v1.2.1, August 2002:** ELECTROMAGNETIC COMPATIBILITY AND RADIO SPECTRUM MATTERS (ERM); ELECTROMAGNETIC COMPATIBILITY (EMC) STANDARD FOR RADIO EQUIPMENT AND SERVICES; PART 17: SPECIFIC CONDITIONS FOR 2,4 GHZ WIDEBAND TRANSMISSION SYSTEMS AND 5 GHZ HIGH PERFORMANCE RLAN EQUIPMENT
- ETSI EN 301 511, March 2003:** GLOBAL SYSTEM FOR MOBILE COMMUNICATIONS (GSM); HARMONIZED EN FOR MOBILE STATIONS IN THE GSM 900 AND GSM 1800 BANDS COVERING ESSENTIAL REQUIREMENTS UNDER ARTICLE 3.2 OF THE R&TTE DIRECTIVE (1999/5/EC)

ETSI EN 300 328 v1.6.1, November 2004: ELECTROMAGNETIC COMPATIBILITY AND RADIO SPECTRUM MATTERS (ERM); WIDEBAND TRANSMISSION SYSTEMS; DATA TRANSMISSION EQUIPMENT OPERATING IN THE 2.4 GHz ISM BAND AND USING WIDE BAND MODULATION TECHNIQUES; HARMONIZED EN COVERING ESSENTIAL REQUIREMENTS UNDER ARTICLE 3.2 OF THE R&TTE DIRECTIVE

ETSI EN 300 330-2 v1.1.1, June 2001: ELECTROMAGNETIC COMPATIBILITY AND RADIO SPECTRUM MATTERS (ERM); SHORT RANGE DEVICES (SRD); RADIO EQUIPMENT IN THE FREQUENCY RANGE 9 KHZ TO 25 MHz AND INDUCTIVE LOOP SYSTEMS IN THE FREQUENCY RANGE 9 KHZ TO 30 MHz; PART 2: HARMONIZED EN UNDER ARTICLE 3.2 OF THE R&TTE DIRECTIVE

EN 60950-1, December 2001: INFORMATION TECHNOLOGY EQUIPMENT – SAFETY – PART 1: GENERAL REQUIREMENTS

EN 50360, November 2001: PRODUCT STANDARD TO DEMONSTRATE THE COMPLIANCE OF MOBILE PHONES WITH THE BASIC RESTRICTIONS RELATED TO HUMAN EXPOSURE TO ELECTROMAGNETIC FIELDS (300 MHz – 3 GHz)

Lippo di Calderara, 10/05/2007

Paola Chientaroli
Quality Assurance Manager