



TEST REPORT

Test Report No. : UL-RPT-RP12491864-116A V2.0

Manufacturer : DATALOGIC
Model No. : WLC4090
FCC ID : U4FWRLCHR
Test Standard(s) : FCC Parts 15.207 & 15.209

1. This test report shall not be reproduced in full or partial, without the written approval of UL VS LTD.
2. The results in this report apply only to the sample(s) tested.
3. The sample tested is in compliance with the above standard(s).
4. The test results in this report are traceable to the national or international standards.
5. Version 2.0 supersedes all previous versions.

Date of Issue: 03 April 2019

Checked by:

Ian Watch
Senior Test Engineer, Radio Laboratory

Issued by :

Sarah Williams
Senior Test Engineer, Radio Laboratory
UL VS LTD



This laboratory is accredited by UKAS. The tests reported herein have been performed in accordance with its terms of accreditation.

UL VS LTD

Pavilion A, Ashwood Park, Ashwood Way, Basingstoke, Hampshire, RG23 8BG, UK
Telephone: +44 (0)1256 312000
Facsimile: +44 (0)1256 312001

This page has been left intentionally blank.

Table of Contents

1. Customer Information.....	4
2. Summary of Testing.....	5
2.1. General Information	5
2.2. Summary of Test Results	5
2.3. Methods and Procedures	5
2.4. Deviations from the Test Specification	5
3. Equipment Under Test (EUT)	6
3.1. Identification of Equipment Under Test (EUT)	6
Description of EUT	6
3.2. Modifications Incorporated in the EUT	6
3.3. Additional Information Related to Testing	6
3.4. Support Equipment	7
4. Operation and Monitoring of the EUT during Testing	8
4.1. Operating Modes	8
4.2. Configuration and Peripherals	8
5. Measurements, Examinations and Derived Results	9
5.1. General Comments	9
5.2. Test Results	10
5.2.1. Transmitter AC Conducted Spurious Emissions	10
5.2.2. Transmitter Radiated Emissions	15
6. Measurement Uncertainty	24
7. Report Revision History	25
8. Appendix 1	26

1. Customer Information





Company Name:	DATALOGIC S.R.L.
Address:	VIA SAN VITALINO 13 40012 LIPPO DI CALDERARA DI RENO (BO) ITALY

2. Summary of Testing

2.1. General Information

Specification Reference:	47CFR15.207 & 47CFR15.209
Specification Title:	Code of Federal Regulations Volume 47 (Telecommunications): Part 15 Subpart C (Intentional Radiators) - Sections 15.207, 15.209 & 15.215
Site Registration:	621311
Location of Testing:	UL VS LTD, Unit 3 Horizon, Wade Road, Kingsland Business Park, Basingstoke, Hampshire, RG24 8AH, United Kingdom
Test Dates:	30 November 2018 to 15 March 2019

2.2. Summary of Test Results

FCC Reference (47CFR)	Measurement	Result
Part 15.207	Transmitter AC Conducted Emissions	
Part 15.209	Transmitter Radiated Emissions	
Key to Results		
 = Complied  = Did not comply		

2.3. Methods and Procedures

Reference:	ANSI C63.10-2013
Title:	American National Standard of Procedures for Compliance Testing of Unlicensed Wireless Devices
Reference:	FCC KDB 414788 D01 Radiated Test Site v01r01 July 12, 2018
Title:	Test Sites For Radiated Emission Measurements
Reference:	FCC KDB 174176 D01 Line Conducted FAQ v01r01 June 3, 2015
Title:	AC Power-Line Conducted Emissions Frequently Asked Questions

2.4. Deviations from the Test Specification

For the measurements contained within this test report, there were no deviations from, additions to, or exclusions from the test specification identified above.

3. Equipment Under Test (EUT)

3.1. Identification of Equipment Under Test (EUT)

Brand Name:	DATALOGIC
Model Name or Number:	WLC4090
Test Sample Serial Number:	Z18P01797
Hardware Version:	A
Software Version:	A
FCC ID:	U4FWRLCHR

Description of EUT

The Equipment Under Test (EUT) was a Wireless Power Transfer (WPT) base station that has a module (FCC ID: U4F0022) incorporated within it. The EUT incorporates a WPT module to wirelessly charge the battery within the GM4500. The EUT is marketed as a WPT system.

3.2. Modifications Incorporated in the EUT

No modifications were applied to the EUT during testing.

3.3. Additional Information Related to Testing

Tested Technology:	Wireless Power Transfer (Qi compatible)	
Base Station Power Supply Requirement:	Nominal	4.75 to 14 VDC. Powered from USB or AC to DC adaptor
Type of Unit:	Transceiver	
WPT Frequency	130.4 kHz	

3.4. Support Equipment

The following support equipment was used to exercise the EUT during testing:

Brand Name:	DATALOGIC
Model Name or Number:	GM4500
Test Sample Serial Number:	Z18P01410
Hardware Version:	A
Software Version:	A
FCC ID:	Contains FCC ID: U4F0022

Description:	AC to 12 VDC switched mode power supply
Brand Name:	Phihong
Model Name or Number:	PSAA18U-120
Serial Number:	182401521A1

Description:	Laptop PC
Brand Name:	Lenovo
Model Name or Number:	L480
Serial Number:	PF1EHZPL

Description:	USB type A to RJ45 cable, used to connect the laptop PC and base station. Quantity 1. Length 2 metres
Brand Name:	Not marked or stated
Model Name or Number:	Not marked or stated
Serial Number:	Not marked or stated

Description:	Laptop PC AC to DC adaptor
Brand Name:	Lenovo
Model Name or Number:	ADLX6565YCC3A
Serial Number:	8SSA10M13950C1SG8940349

4. Operation and Monitoring of the EUT during Testing

4.1. Operating Modes

The EUT was tested in the following operating mode:

- WPT – Charging mode.

4.2. Configuration and Peripherals

The EUT was tested in the following configuration(s):

- The EUT was configured prior to testing using instructions supplied by the customer named 'Datalogic bar codes to avoid object detection mode.pdf' dated 24th December 2018.
- WPT charging of the EUT's reader battery commenced when the reader was placed into the docking port of the base station.
- All testing was performed with a discharged battery and charge status monitored using the LED battery indicator on the base station.
- There are two model variants of the EUT but there is no difference within the WPT circuitry between the *Bluetooth* and SRD variants. WPT initial testing was performed on both variants and the SRD 910 MHz variant was deemed the worst case and used for all final measurements.
- Radiated measurements were performed with the reader was placed 2 mm above the base it produced worst case emissions and output power, therefore this alignment was used for all measurements.
- There are two ports on the base station. One is a power socket that is connected to a 12 VDC switched mode power supply, the other is an RJ45 socket used as a USB port. A USB to RJ45 cable is used to connect a PC to the base station RJ45 socket. This allows data communications between the base station and PC, it also provides 5 VDC secondary power supply to the base station if the 12 VDC primary power supply is not present.
- The base station can be powered from an external AC to 12 VDC switched mode power supply or USB (via USB to RJ45 cable) when connected to a PC. When both are connected, the EUT takes its power from the external power supply. Radiated measurements tests were performed with the EUT powered from the AC to 12 VDC switched mode power supply. A laptop PC was connected to the EUT base station USB port. USB cable so all ports were terminated. During tests in a semi-anechoic chamber, the laptop PC was placed under the chamber floor.
- Refer to Appendix 1 of this test report for details of radiated tests on an open field test site.
- Radiated emission measurements were initially performed with the WPT system place in all three orientations X, Y and Z to identify the worst case orientation. Final measurements were performed in the worst case orientations which are stated below:
 - Measurements < 30 MHz – In the Z orientation the base in its normal end-user position.
 - Measurements > 30 MHz – In the Y orientation with the base vertically positioned.

5. Measurements, Examinations and Derived Results

5.1. General Comments

Measurement uncertainties are evaluated in accordance with current best practice. Our reported expanded uncertainties are based on standard uncertainties, which are multiplied by an appropriate coverage factor to provide a statistical confidence level of approximately 95%. Please refer to Section 6 Measurement Uncertainty for details.

In accordance with UKAS requirements all the measurement equipment is on a calibration schedule. All equipment was within the calibration period on the date of testing.

5.2. Test Results

5.2.1. Transmitter AC Conducted Spurious Emissions

Test Summary:

Test Engineers:	Nick Tye & Mark Perry	Test Date:	15 March 2019
Test Sample Serial Numbers:	Reader: Z18P01410 / Base: Z18P01797		

FCC Reference:	Part 15.207
Test Method Used:	ANSI C63.10 Section 6.2 and notes below

Environmental Conditions:

Temperature (°C):	18
Relative Humidity (%):	43

Note(s):

1. The EUT Base was connected to the LISN via the Pihong AC to DC adaptor. The EUT Reader was placed in the EUT Base. A fully discharged battery was fitted to the EUT Reader. The LISN input was connected to a 120 VAC 60 Hz single phase supply. The laptop PC was connected to the EUT's USB port via the EUT USB type A to RJ45 cable and the laptop PC was used to place the EUT into WPT mode.
2. In accordance with FCC KDB 174176 Q4, tests were performed with a 240 VAC 60 Hz single phase supply as this was within the voltage range marked on the Pihong AC to DC adaptor.
3. A pulse limiter was fitted between the LISN and the test receiver.
4. Pre-scans were performed and markers placed on the highest live and neutral measured levels. Final measurements were performed on the marker frequencies and the results entered into the tables below.

Test setup:

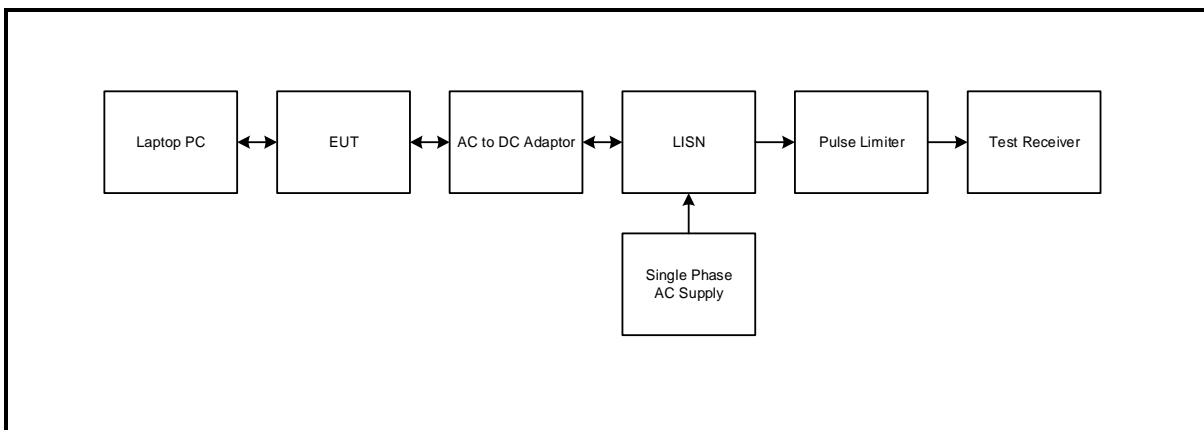

Transmitter AC Conducted Spurious Emissions (continued)**Results: Live / Quasi Peak / 120 VAC 60 Hz**

Frequency (MHz)	Line	Level (dB μ V)	Limit (dB μ V)	Margin (dB)	Result
0.150000	Live	61.7	66.0	4.3	Complied
0.172500	Live	57.4	64.8	7.4	Complied
0.478500	Live	42.5	56.4	13.9	Complied
1.653000	Live	37.9	56.0	18.1	Complied
4.263000	Live	42.4	56.0	13.6	Complied
9.492000	Live	44.8	60.0	15.2	Complied

Results: Live / Average / 120 VAC 60 Hz

Frequency (MHz)	Line	Level (dB μ V)	Limit (dB μ V)	Margin (dB)	Result
0.150000	Live	48.4	56.0	7.6	Complied
0.483000	Live	37.1	46.3	9.2	Complied
4.141500	Live	36.5	46.0	9.5	Complied
9.496500	Live	37.1	50.0	12.9	Complied
11.526000	Live	39.8	50.0	10.2	Complied
12.709500	Live	35.7	50.0	14.3	Complied

Results: Neutral / Quasi Peak / 120 VAC 60 Hz

Frequency (MHz)	Line	Level (dB μ V)	Limit (dB μ V)	Margin (dB)	Result
0.150000	Neutral	61.1	66.0	4.9	Complied
0.357000	Neutral	41.5	58.8	17.3	Complied
0.474000	Neutral	43.0	56.4	13.4	Complied
3.943500	Neutral	41.5	56.0	14.5	Complied
7.417500	Neutral	40.9	60.0	19.1	Complied
9.447000	Neutral	42.4	60.0	17.6	Complied

Results: Neutral / Average / 120 VAC 60 Hz

Frequency (MHz)	Line	Level (dB μ V)	Limit (dB μ V)	Margin (dB)	Result
0.150000	Neutral	48.8	56.0	7.2	Complied
0.483000	Neutral	39.6	46.3	6.7	Complied
4.173000	Neutral	37.4	46.0	8.6	Complied
9.451500	Neutral	39.2	50.0	10.8	Complied
10.126500	Neutral	39.0	50.0	11.0	Complied
12.507000	Neutral	40.4	50.0	9.6	Complied

Transmitter AC Conducted Spurious Emissions (continued)

Results: 120 VAC 60 Hz

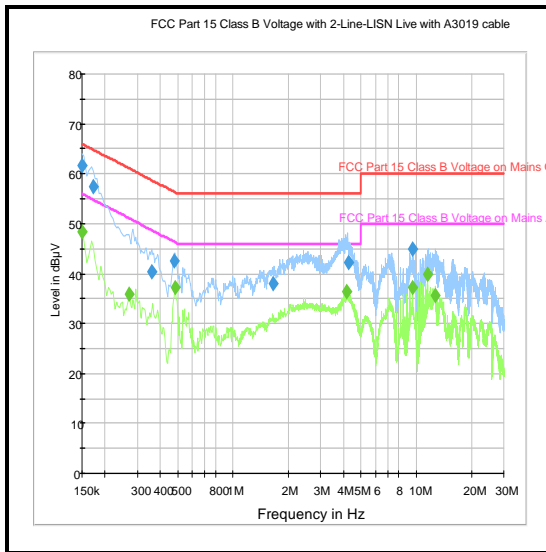

Live

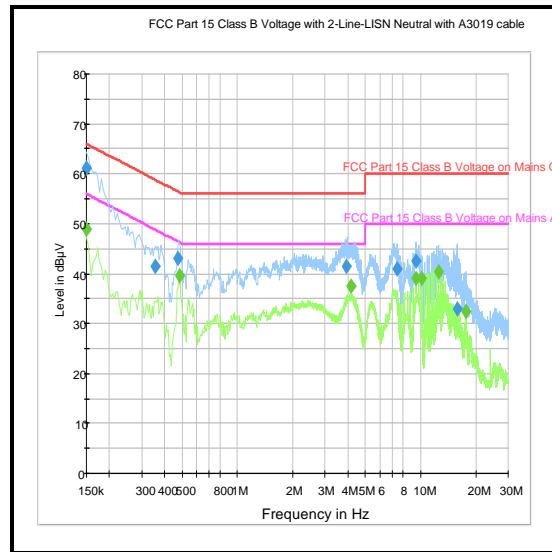

Neutral

Note: These plots are pre-scans and for indication purposes only. For final measurements, see accompanying tables.

Transmitter AC Conducted Spurious Emissions (continued)**Results: Live / Quasi Peak / 240 VAC 60 Hz**

Frequency (MHz)	Line	Level (dB μ V)	Limit (dB μ V)	Margin (dB)	Result
0.150000	Live	59.6	66.0	6.4	Complied
0.496500	Live	43.3	56.1	12.8	Complied
2.017500	Live	41.9	56.0	14.1	Complied
4.213500	Live	46.0	56.0	10.0	Complied
8.961000	Live	40.8	60.0	19.2	Complied
11.998500	Live	40.7	60.0	19.3	Complied

Results: Live / Average / 240 VAC 60 Hz

Frequency (MHz)	Line	Level (dB μ V)	Limit (dB μ V)	Margin (dB)	Result
0.163500	Live	47.0	55.3	8.3	Complied
0.501000	Live	37.8	46.0	8.2	Complied
2.409000	Live	34.9	46.0	11.1	Complied
4.245000	Live	38.4	46.0	7.6	Complied
9.609000	Live	37.8	50.0	12.2	Complied
11.980500	Live	35.7	50.0	14.3	Complied

Results: Neutral / Quasi Peak / 240 VAC 60 Hz

Frequency (MHz)	Line	Level (dB μ V)	Limit (dB μ V)	Margin (dB)	Result
0.150000	Neutral	59.6	66.0	6.4	Complied
0.501000	Neutral	43.4	56.0	12.6	Complied
1.567500	Neutral	39.7	56.0	16.3	Complied
3.844500	Neutral	41.6	56.0	14.4	Complied
4.258500	Neutral	41.2	56.0	14.8	Complied
9.411000	Neutral	40.7	60.0	19.3	Complied

Results: Neutral / Average / 240 VAC 60 Hz

Frequency (MHz)	Line	Level (dB μ V)	Limit (dB μ V)	Margin (dB)	Result
0.168000	Neutral	47.4	55.1	7.7	Complied
0.501000	Neutral	37.5	46.0	8.5	Complied
2.350500	Neutral	35.7	46.0	10.3	Complied
4.195500	Neutral	35.1	46.0	10.9	Complied
9.402000	Neutral	34.9	50.0	15.1	Complied
12.457500	Neutral	33.9	50.0	16.1	Complied

Transmitter AC Conducted Spurious Emissions (continued)

Results: 240 VAC 60 Hz

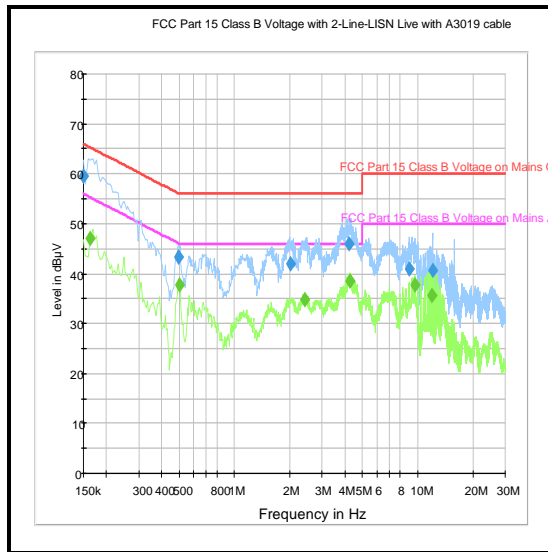

Live

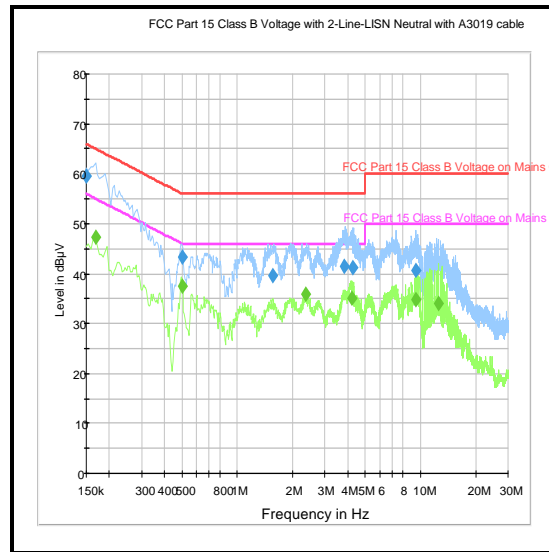

Neutral

Test Equipment Used:

Asset No.	Instrument	Manufacturer	Type No.	Serial No.	Date Calibration Due	Cal. Interval (Months)
M2037	Thermohygrometer	Testo	608-H1	45124925	27 Mar 2019	12
M1273	Test Receiver	Rohde & Schwarz	ESIB 26	100275	18 Dec 2019	12
A3019	Matched LISN Power Cable	UL VS LTD	Not stated	Not stated	23 Aug 2019	12
A649	LISN	Rohde & Schwarz	ESH3-Z5	825562/008	23 Aug 2019	12
A1830	Pulse Limiter	Rohde & Schwarz	ESH3-Z2	100668	06 Apr 2019	12

Test Measurement Software/Firmware Used:

Name	Version	Release Date
Rohde & Schwarz EMC32	6.30.0	2018

5.2.2. Transmitter Radiated Emissions**Test Summary:**

Test Engineers:	Andrew Edwards & Mark Perry	Test Dates:	10 December 2018, 12 December 2018 & 27 January 2019
Test Sample Serial Numbers:	Reader: Z18P01410 / Base: Z18P01797		

FCC Reference:	Part 15.209
Test Method Used:	ANSI C63.10 Sections 6.3, 6.4 and 6.5. FCC KDB 414788 and Notes below
Frequency Range:	9 kHz to 1000 MHz

Environmental Conditions:

Temperature (°C):	10 to 21
Relative Humidity (%):	41 to 70

Notes:

- Limits below 30 MHz are specified at a test distance of 30 metres, whilst below 0.49 MHz they are specified at a test distance of 300 metres. However, as specified by FCC Section 15.31 (f)(2), measurements may be performed at a closer distance and the measured level corrected to the specified measurement distance by using the square of an inverse linear distance extrapolation factor (40 dB/decade).
- In accordance with FCC KDB 414788, an attempt was made to perform measurements at the distances specified in Part 15.209(a) on an open field test site. It was not possible to determine the spurious emission values at the test distances specified below 30 MHz on an open field test site, therefore in accordance with 47CFR15.31(f), measurements were made at closer distances. Attempts were made to measure spurious emissions at 3, 30 and 300 metres on an open field test site on 10 December 2018. Unfortunately, spurious emissions from the EUT could not be seen above the ambient emissions present at the open field test site or the noise floor of the measurement system. Additional measurement were performed in a semi-anechoic chamber tests on 12 December 2018 and results are shown in this section. In addition, the open field test result plots for measurements between 9 kHz and 30 MHz are also shown. These measurement plots are identical to background scan plots of the open field test site. Background scans of the open field test site and further information are shown in Appendix 1 of this test report.
- The final measured value, for the given emission, in the table below incorporates the calibrated antenna factor and cable loss. Only the highest six spurious emissions in the range 30 MHz to 1 GHz were recorded in the table below. Markers were placed on the peaks of the pre-scan plot and final measurements were performed using a quasi-peak detector.
- Measurements above 30 MHz were performed on 27 January 2019 in a semi-anechoic chamber (UL VS LTD Asset Number K0001) at a distance of 3 metres. The EUT was placed at a height of 80 cm above the reference ground plane in the centre of the chamber turntable. Between 30 MHz and 1 GHz, maximum emission levels were determined by height searching the measurement antenna over the range 1 metre to 4 metres.
- The emission shown on the result plots at approximately 130.4 kHz is the EUT's WPT system emission. The peak level (worst case) at a measurement distance of 300 metres was greater than 20 dB below the applicable limit.
- Final measurement values include corrections for antenna factor and cable losses.
- All other emissions were greater than 20 dB below the applicable limit, below the noise floor of the measurement system or ambient.

Note(s) (continued):

8. Measurement plots in this section for tests between 9 kHz and 30 MHz on an open field test site have markers placed on the highest level ambient emissions. This is for information only.
9. A transducer factor was used on the test receiver during open field tests. This factor includes correction between the fixed gain of the magnetic loop antenna and the calibration values. It also includes the value of the RF cable used to connect the antenna to the spectrum analyser which was incorporated into the annual calibration of the magnetic loop antenna.
10. 150 kHz to 30 MHz pre-scan measurements were also performed in a semi-anechoic chamber at 3 metres. There were two emissions seen at 656 kHz and 912 kHz, as the limit is expressed at 30 metres these final performed measurement were reduced by an additional 40 dB/decade, therefore greater than 20 dB below the applicable limit.
11. Some of the result plots may show the incorrect UL job number. The correct job number for all plots is 12491864.

Transmitter Radiated Spurious Emissions (continued)

Test setup for radiated measurements:

Measurements on an open field test site

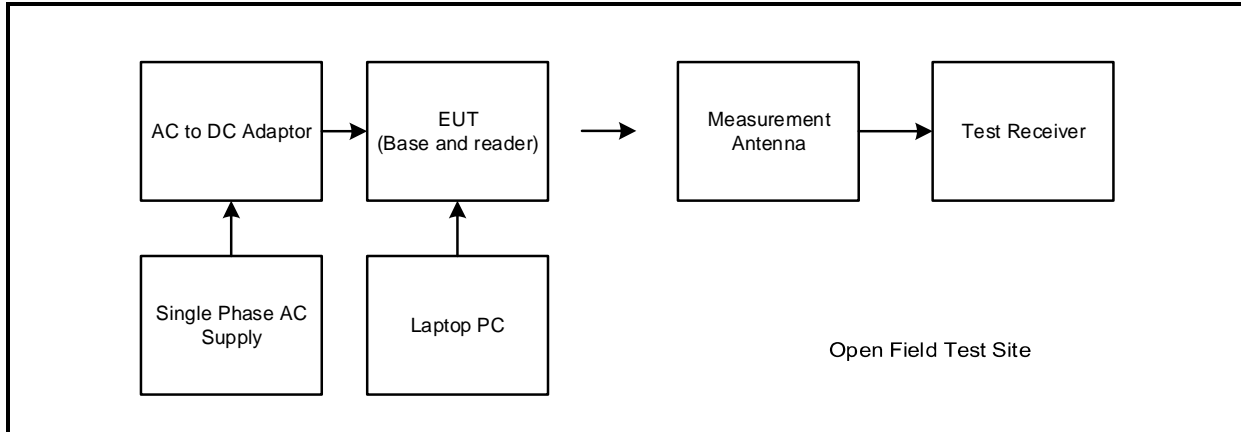

Measurements in a semi-anechoic chamber

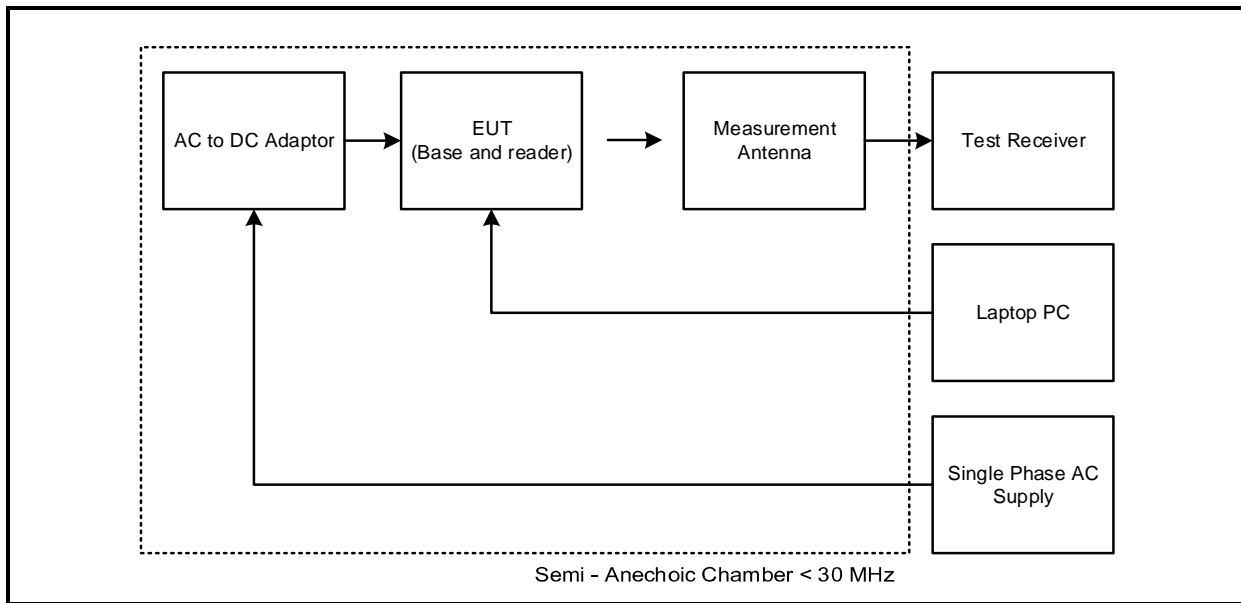

Transmitter Radiated Spurious Emissions (continued)

Test setup for radiated measurements:

Measurements in a semi-anechoic chamber

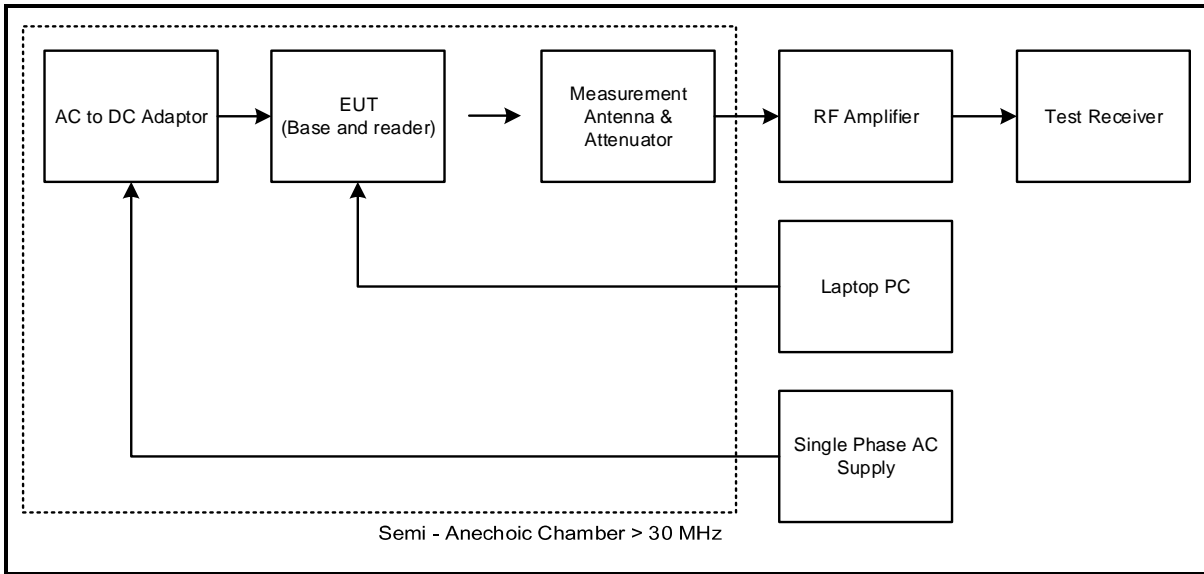

Transmitter Radiated Spurious Emissions (continued)**Results: Quasi Peak**

Frequency (MHz)	Antenna Polarity	Level (dB μ V/m)	Limit (dB μ V/m)	Margin (dB)	Result
57.214	Vertical	36.7	40.0	3.3	Complied
69.588	Vertical	24.3	40.0	15.7	Complied
76.020	Vertical	30.3	40.0	9.7	Complied
89.189	Vertical	30.8	43.5	12.7	Complied
497.986	Horizontal	38.9	46.0	7.1	Complied
534.898	Horizontal	31.3	46.0	14.7	Complied

Transmitter Radiated Spurious Emissions (continued)

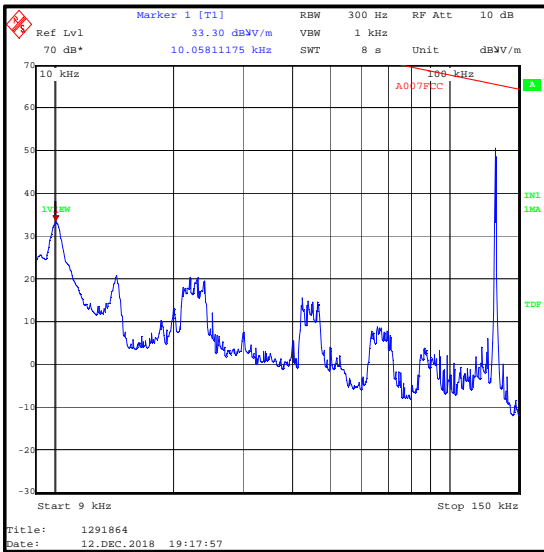

9 kHz to 150 kHz / peak detector / measured at 3 metres extrapolated to 30 metres / measured in a semi-anechoic chamber

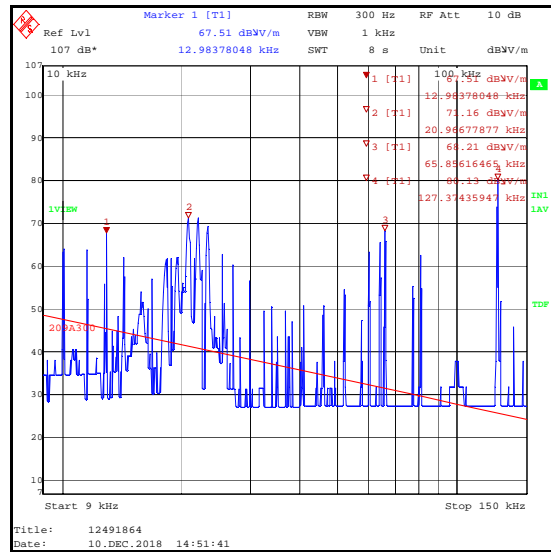

9 kHz to 150 kHz / average detector / EUT operating / measured at 3 metres on an open field test site

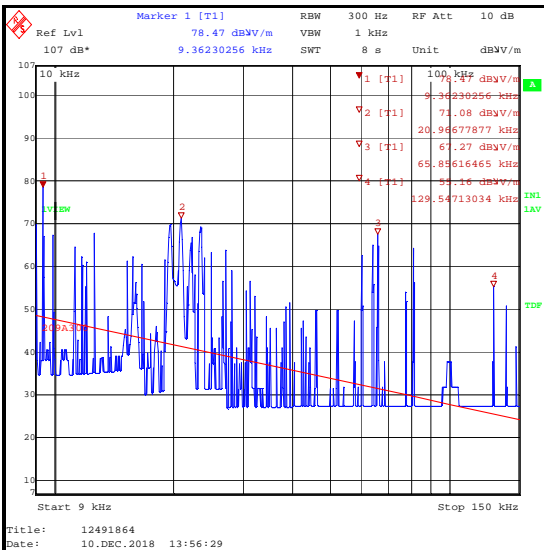

9 kHz to 150 kHz / average detector / EUT operating / measured at 30 metres on an open field test site

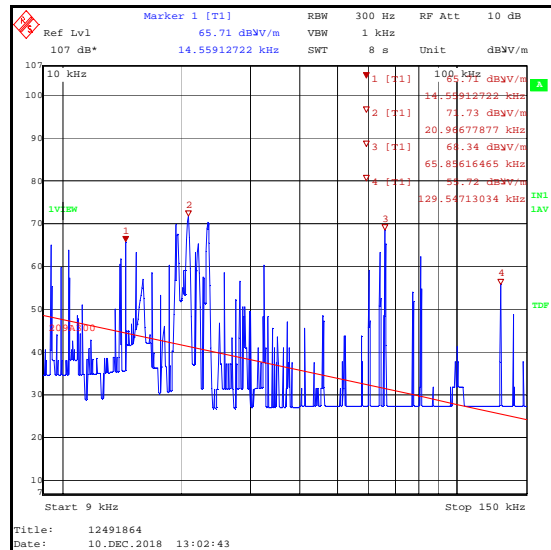

9 kHz to 150 kHz / average detector / EUT operating / measured at 300 metres on an open field test site

Transmitter Radiated Spurious Emissions (continued)

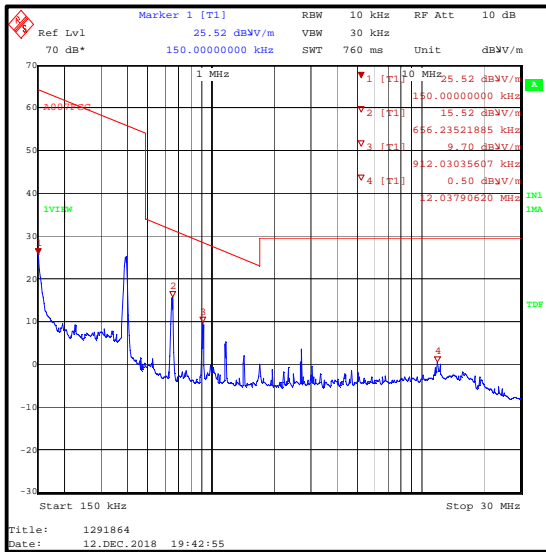

150 kHz to 30 MHz / peak detector (worst case) / EUT operating / measured at 3 metres / measured in a semi-anechoic chamber

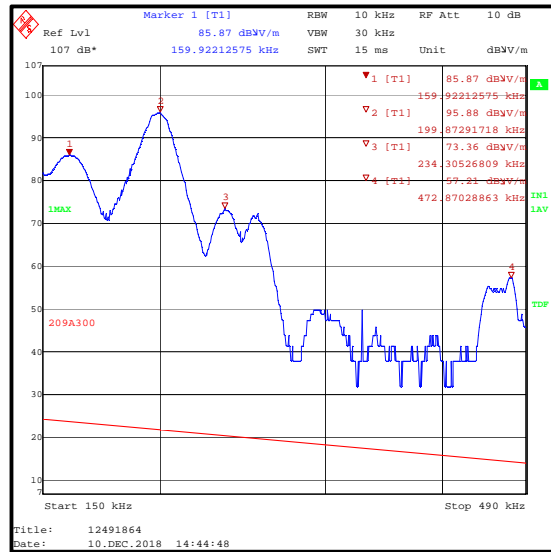

150 kHz to 490 kHz / average detector / EUT operating / measured at 3 metres on an open field test site



150 kHz to 490 kHz / average detector / EUT operating / measured at 30 metres on an open field test site



150 kHz to 490 kHz / average detector / EUT operating / measured at 300 metres on an open field test site

Transmitter Radiated Spurious Emissions (continued)

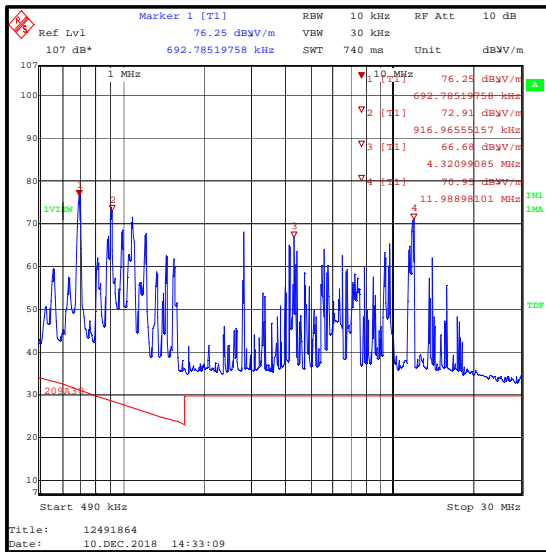

490 kHz to 30 MHz / peak detector / EUT operating / measured at 3 metres on an open field test site

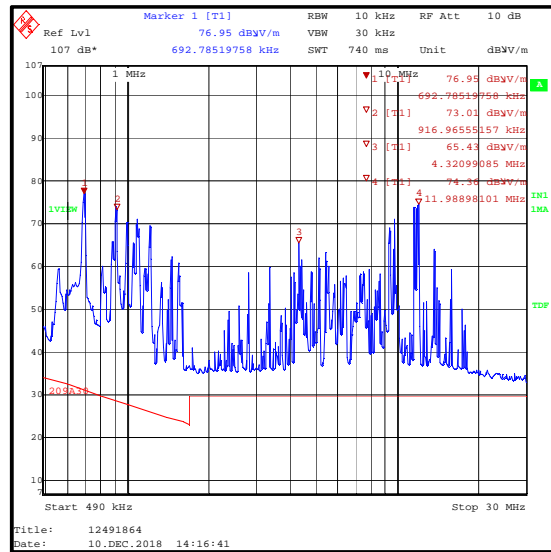

490 kHz to 30 MHz / peak detector / EUT operating / measured at 30 metres on an open field test site

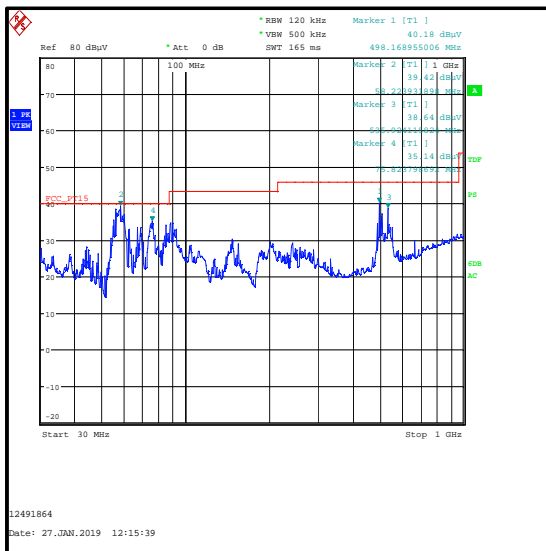

30 MHz to 1 GHz / peak detector (worst case) / measured at 3 metres in a semi-anechoic chamber

Note: The 30 MHz to 1 GHz plot is a pre-scan and for indication purposes only. For final measurements, see accompanying table.

Transmitter Radiated Spurious Emissions (continued)**Test Equipment Used:**

Asset No.	Instrument	Manufacturer	Type No.	Serial No.	Date Calibration Due	Cal. Interval (Months)
M2040	Thermohygrometer	Testo	608-H1	45124934	27 Mar 2019	12
M2043	Thermohygrometer	Testo	608-H1	45120017	27 Mar 2019	12
K0001	5m RSE Chamber	Rainford EMC	N/A	N/A	04 Oct 2019	12
M1124	Test Receiver	Rohde & Schwarz	ESIB26	100046	08 Aug 2019	12
A007	Magnetic Loop Antenna	Rohde & Schwarz	HFH2-Z2	880 458/020	14 Feb 2019	12
M2054	Precision Steel Rule 1 m / 39 in	RS	Not marked or stated	1218213/42	11 Sep 2019	12
A2686	Distance Measuring Wheel	Rolson Quality Tools	50799	Not marked or stated	Calibrated before use	-
A2955	Protractor	Not marked or stated	9781907550980	#1	Calibration not required	-
M2044	Test Receiver	Rohde & Schwarz	ESU26	100122	17 Apr 2019	12
A3154	Pre-Amplifier	Com-Power	PAM-103	18020012	14 Sep 2019	12
A553	Antenna	Chase	CBL6111A	1593	08 Oct 2019	12
A3112	Attenuator	AtlanTecRF	AN18-06	219706#2	08 Oct 2019	12

6. Measurement Uncertainty

No measurement or test can ever be perfect and the imperfections give rise to error of measurement in the results. Consequently the result of a measurement is only an approximation to the value of the measurand (the specific quantity subject to measurement) and is only complete when accompanied by a statement of the uncertainty of the approximation.

The expression of uncertainty of a measurement result allows realistic comparison of results with reference values and limits given in specifications and standards.

The uncertainty of the result may need to be taken into account when interpreting the measurement results.

The reported expanded uncertainties below are based on a standard uncertainty multiplied by an appropriate coverage factor such that a confidence level of approximately 95% is maintained. For the purposes of this document "approximately" is interpreted as meaning "effectively" or "for most practical purposes".

Measurement Type	Range	Confidence Level (%)	Calculated Uncertainty
AC Conducted Spurious Emissions	0.15 MHz to 30 MHz	95%	±2.40 dB
Radiated Spurious Emissions	9 kHz to 30 MHz	95%	±4.39 dB
Radiated Spurious Emissions	30 MHz to 1000 MHz	95%	±4.65 dB

The methods used to calculate the above uncertainties are in line with those recommended within the various measurement specifications. Where measurement specifications do not include guidelines for the evaluation of measurement uncertainty the published guidance of the appropriate accreditation body is followed.

7. Report Revision History

Version Number	Revision Details		
	Page No(s)	Clause	Details
1.0	-	-	Initial Version
2.0	1 & 6 6 8 26 to 30	-	At the request of the TCB: Changed model name and FCC ID Changed description of EUT Moved reader details to page 7 Section 4.2 added bullet 6 Removed EUT photos due to STC

8. Appendix 1

Test setup/arrangement of EUT during open field tests on 10 December 2018

Refer to test setup photos document

GPS coordinates

Mag loop location (lower marker on photo)
N51° 08.739' W001° 26.328'

30 metre test point (middle marker on photo)
N51° 08.755' W001° 26.325'

300 metre test point (upper marker on photo)
N51° 08.895' W001° 26.289'



Details of 3 metre and 30 metre open field test site used on 10 December 2018

Temperature: 10°C

Relative Humidity: 70%

Ground conditions: Dry

Refer to test setup photos document

Set up for 3 metre measurements

Refer to test setup photos document

Set up for 30 metre measurements

Measurements at 3 and 30 metres

The test site was free from underground metal objects.

The EUT (base station) was powered from 120 VAC 60 Hz via the AC to DC switched mode power supply. The input to the power supply was connected to a single phase supply from a portable generator. A power cable was run across the site to the EUT. An RCD was fitted to the power source. The generator was located 50 metres from the EUT and surrounded by radio absorbent material. For safety purposes, an RCD was fitted to the generator output. A laptop PC was connected to the EUT (base station) USB port via the USB type A to RJ45 cable.

The EUT was placed on a plastic table at a height of 0.8 metres above ground level. All associated cables and support equipment were arranged according to ANSI C63.10-2013 Section 6.12.

The test receiver used for measurements was located in a vehicle approximately 30 metres from the magnetic loop antenna. Power to the test equipment was from a single phase supply.

The test distance was from the centre of the mag loop antenna to the closest periphery of the EUT. This distance was maintained as the EUT was rotated.

Initially, The EUT was rotated through 360 degrees in 60 degree steps at both measurement distances. The mag loop antenna was rotated through 90 degrees in 30 degree steps at every position the EUT was moved to. The EUT and mag loop antenna were then rotated in small increments in order to maximise emission levels.

Details of 300 metre open field test site used on 10 December 2018

Temperature: 11°C

Relative Humidity: 64%

Ground conditions: Dry

Refer to test setup photos document

Set up for 300 metre measurements

Refer to test setup photos document

**Set up for 300 metre measurements
(mag loop end)**

Measurements at 300 metres

The test site was free from underground metal objects.

The EUT (base station) was powered from 120 VAC 60 Hz via the AC to DC switched mode power supply. The input to the power supply was connected to a single phase supply from a portable generator. A power cable was run across the site to the EUT. An RCD was fitted to the power source. The generator was located 50 metres from the EUT and surrounded by radio absorbent material. For safety purposes, an RCD was fitted to the generator output. A laptop PC was connected to the EUT (base station) USB port via the USB type A to RJ45 cable.

The EUT was placed on a plastic table at a height of 0.8 metres above ground level. All associated cables were arranged according to ANSI C63.10-2013 Section 6.12.

The test receiver used for measurements was located in a vehicle 30 metres from the magnetic loop antenna. Power to the test equipment was from a single phase supply.

The test distance was from the centre of the mag loop antenna to the closest periphery of the EUT. This distance was maintained as the EUT was rotated.

Initially, The EUT was rotated through 360 degrees in 60 degree steps at both measurement distances. The mag loop antenna was rotated through 90 degrees in 30 degree steps at every position the EUT was moved to. The EUT and mag loop antenna were then rotated in small increments in order to maximise emission levels.

Comparison of open field test site with semi-anechoic chamber measurements at 3 metres

Radiated measurements were performed at an open field test site and within a 5 metre semi-anechoic chamber.

For the signal source, a modified loop antenna was connected to a signal generator at the transmit side. A standard active magnetic loop antenna was connected to a spectrum analyser at the receive side. The signal generator was set to its maximum supported output power and the signal was transmitted to the spectrum analyser via the two antennas and associated RF cables.

A sweep in small frequency increments was performed from 9 kHz to 30 MHz. The sweep was repeatedly performed with both antennas rotated about the axis in various orientations. Received levels for all orientations were recorded and the maximum levels for the open field test site and the semi-anechoic chamber are shown on the graph below. Full data for both tests are archived on the UL VS LTD IT server and available for inspection on request.

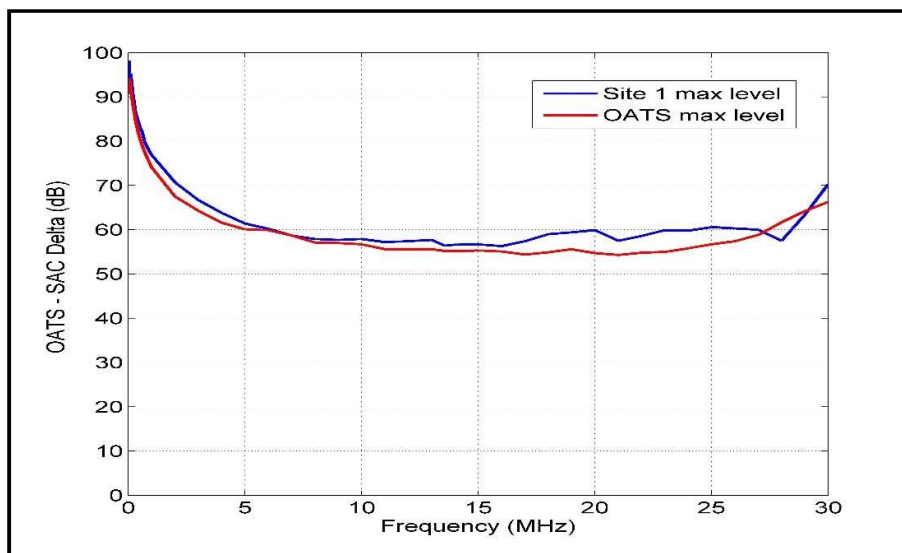

The conclusion was that the open field test site compares well with the semi-anechoic chamber at a measurement distance of 3 metres. If anything, the semi-anechoic chamber results are generally slightly higher. This means that if the measurement passes in the semi-anechoic chamber, it will pass with a higher margin on an open field test site.

The magnetic loop antenna used to perform these measurements is the same antenna or same type of antenna used during measurements contained in this test report.

Verification of open field test site and semi-anechoic chamber measurements at 3 metres prior to performing measurements

Two reference units are used for verification of the measurement system before testing commences. Both reference units are door entry systems modified by the manufacturer for test purposes only.

One reference unit transmits a continuous, unmodulated signal at a fixed frequency of 125 kHz when a 12 Volt power pack is connected. The output power is fixed and known to be stable.

The second transmits a continuous, modulated signal at a fixed frequency of 13.56 MHz when a 12 Volt power pack is connected. The output power is fixed and known to be stable.

Both frequencies are commonly used RFID frequencies.

A UL VS LTD internal verification document explains the procedure in detail. A brief description is given below.

The centre of the magnetic loop antenna is placed exactly 3 metres from the reference unit. The reference unit is placed on a plastic table at a height of 0.8 metres above floor level and the centre of the mag loop antenna is 1 metre above the floor level. The mag loop antenna and reference unit are oriented in certain positions to ensure repeatability.

Each reference unit is connected to a 12 Volt power pack and once transmitting, the maximum raw received level at each of the two frequencies is read on the spectrum analyser by using the marker peak function. The measured level has to be within certain levels as specified in the UL VS LTD internal test procedure. The plot of the verification measurement is archived on the UL VS LTD IT server. The peak level of each reference unit is recorded on a spreadsheet which is also archived on the UL VS LTD IT server.

The internal verification procedure and verification plots are available for inspection on request.

Radiated measurements below 30 MHz were performed in a semi-anechoic chamber at a distance of 3 metres.

Verification plots of the two reference units at a measurement distance of 3 metres are shown on the following page. Plots were taken on an open field test site (10 December 2018) and in a semi-anechoic chamber (12 December 2018).

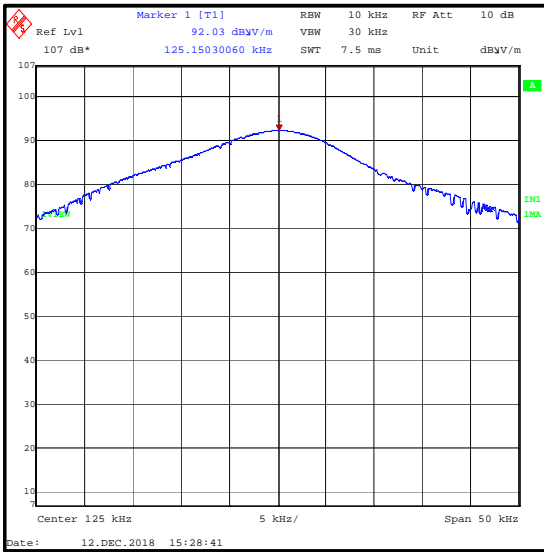

125 kHz reference unit signal at 3 metres in a semi-anechoic chamber on 12 December 2018

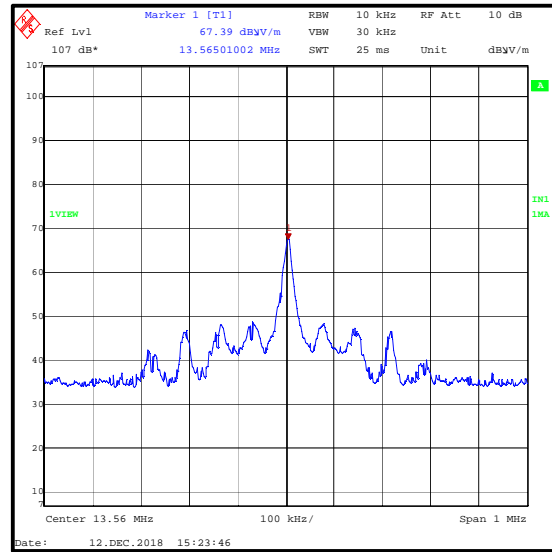

13.56 MHz reference unit signal at 3 metres in a semi-anechoic chamber on 12 December 2018

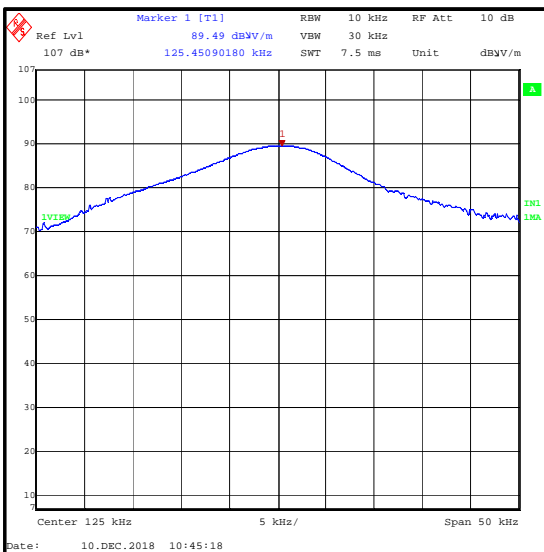

125 kHz reference unit signal at 3 metres on an open field test site on 10 December 2018

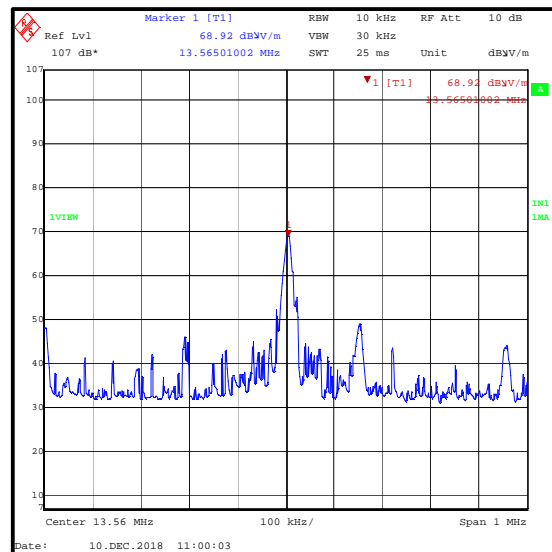

13.56 MHz reference unit signal at 3 metres on an open field test site on 10 December 2018

Note(s):

1. The above plots show comparable measurements of reference units on an open field test site and in a semi-anechoic chamber at spot frequencies.

Background scans of the open field test site

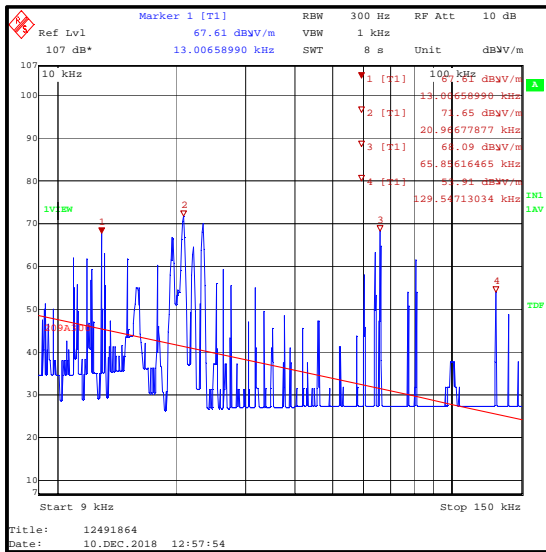

**Frequency range: 9 kHz to 150 kHz
Average detector / background scan**

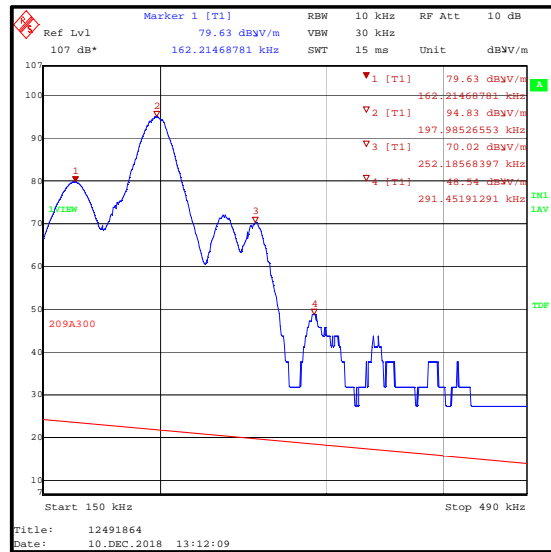

**Frequency range: 150 kHz to 490 kHz
Average detector / background scan**

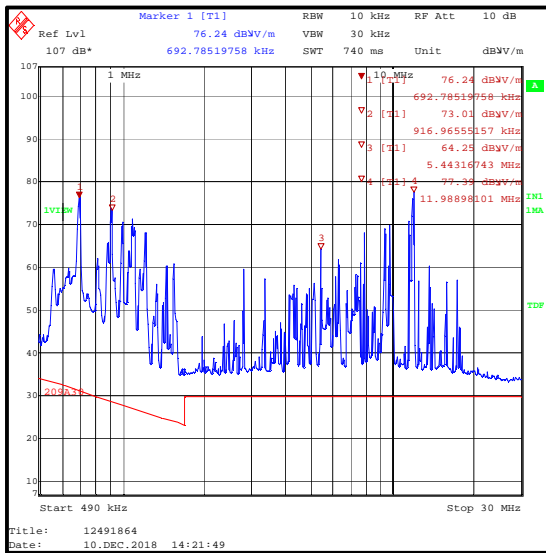

**Frequency range: 490 kHz to 30 MHz
Peak detector / background scan**

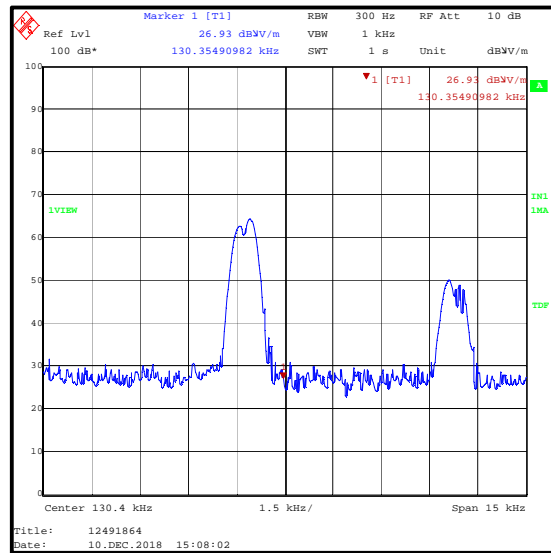

**Frequency range: 122.9 kHz to 137.9 kHz
/ background scan of the open field test site**

Note(s):

1. The above plots are background scans of the open field test site. The EUT and generator (when used) were turned off when the background scans were performed.

--- END OF REPORT ---