

# FCC CERTIFICATION TEST REPORT

## FOR

<b>Applicant</b>	:	ASSA ABLOY Inc.
<b>Address</b>	:	110 Sargent Drive New Haven CT 06511 USA
<b>Equipment under Test</b>	:	Digital Door Viewer
<b>Model No</b>	:	YRV740-WI
<b>FCC ID</b>	:	U4AYRV740WI
<b>Manufacturer</b>	:	ASSA ABLOY Inc.
<b>Address</b>	:	110 Sargent Drive New Haven CT 06511 USA

**Issued By: Dongguan Dongdian Testing Service Co., Ltd.**

**Add:** No. 17, Zongbu Road 2, Songshan Lake Sci&Tech, Industry Park, Dongguan City,  
Guangdong Province, China, 523808

**Tel:** +86-0769-22891499 [Http://www.dgddt.com](http://www.dgddt.com)

# REPORT

## TABLE OF CONTENTS

	Test report declares.....	4
1.	Summary of test results .....	4
2.	General test information.....	6
2.1.	Description of EUT .....	6
2.2.	Accessories of EUT.....	6
2.3.	Assistant equipment used for test.....	6
2.4.	Block diagram of EUT configuration for test .....	7
2.5.	Deviations of test standard .....	7
2.6.	Test environment conditions .....	7
2.7.	Test laboratory.....	7
2.8.	Measurement uncertainty .....	8
3.	Equipment used during test .....	9
4.	Emissions in restricted frequency bands .....	10
4.1.	Block diagram of test setup .....	10
4.2.	Limit .....	11
4.3.	Test Procedure.....	12
4.4.	Test result .....	13
5.	Band Edge Compliance.....	17
5.1.	Block diagram of test setup .....	17
5.2.	Limit .....	17
5.3.	Test Procedure.....	17
5.4.	Test result .....	17
6.	Power Line Conducted Emission .....	30
6.1.	Block diagram of test setup .....	30
6.2.	Power Line Conducted Emission Limits(Class B).....	30
6.3.	Test Procedure.....	30
6.4.	Test Result.....	31
7.	Test setup photograph .....	34
8.	Photos of the EUT .....	36

## TEST REPORT DECLARE

<b>Applicant</b>	:	ASSA ABLOY Inc.
<b>Address</b>	:	110 Sargent Drive New Haven CT 06511 USA
<b>Equipment under Test</b>	:	Digital Door Viewer
<b>Model No</b>	:	YRV740-WI
<b>FCC ID</b>	:	U4AYRV740WI
<b>Manufacturer</b>	:	ASSA ABLOY Inc.
<b>Address</b>	:	110 Sargent Drive New Haven CT 06511 USA

**Test Standard Used:** FCC Rules and Regulations Part 15 Subpart C: 2015

**Test procedure used:** ANSI C63.10:2013, ANSI C63.4:2014, KDB558074 D01 DTS Meas Guidance V03r02.

**We Declare:**

The equipment described above is tested by Dongguan Dongdian Testing Service Co., Ltd and in the configuration tested the equipment complied with the standards specified above. The test results are contained in this test report and Dongguan Dongdian Testing Service Co., Ltd is assumed of full responsibility for the accuracy and completeness of these tests.

**After test and evaluation, our opinion is that the equipment provided for test compliance with the requirement of the above FCC standards.**

<b>Report No:</b>	DDT-R16Q0719-1E1		
<b>Date of Test:</b>	July 21, 2016~July 27, 2016	<b>Date of Report:</b>	July 27, 2016

*Prepared By:*



*Leo Liu/Engineer*



*Kevin Kong/EMC Manager*

Note: This report applies to above tested sample only. This report shall not be reproduced in parts without written approval of Dongguan Dongdian Testing Service Co., Ltd.

## 1. Summary of test results

The EUT have been tested according to the applicable standards as referenced below.		
Description of Test Item	Standard	Results
Emissions in restricted frequency bands	FCC Part 15: 15.209 FCC Part 15: 15.247 ANSI C63.10: 2013 ANSI C63.4:2014 KDB558074	PASS
Band Edge Compliance	FCC Part 15: 15.209 FCC Part 15: 15.247 ANSI C63.10: 2013 ANSI C63.4:2014 KDB558074	PASS
Power Line Conducted Emission	FCC Part 15: 15.207 ANSI C63.10: 2013 ANSI C63.4:2014	PASS
Note: 'N/A' is an abbreviation for Not Applicable. This product can not be connected into public power supply.		

Remark: This report is the revision of the previous test report DDT-R15Q1221-1E1, the EUT use the same RF module and Antenna with DDT-R15Q1221-1E1 report's EUT, only peripheral circuit is different.

Based on engineering judgement, transmitter spurious emission, band edge compliance and power line conducted emission were retested.

## 2. General test information

### 2.1. Description of EUT

EUT* Name	: Digital Door Viewer
Model Number	: YRV740-WI
EUT function description	: Please reference user manual of this device
Power supply	: DC 1.5V from AA Battery*4 or DC 3.7V from Li-Po Battery*2 DC 5V from adapter input AC 120V/60Hz
Radio Technology	: IEEE802.11b/g/n
FCC Operation frequency	: IEEE 802.11b: 2412MHz—2462MHz IEEE 802.11g: 2412MHz—2462MHz IEEE 802.11n HT20: 2412MHz—2462MHz
Modulation	: IEEE 802.11b: DSSS(CCK,DQPSK,DBPSK) IEEE 802.11g: OFDM(64QAM, 16QAM, QPSK, BPSK) IEEE 802.11n HT20: OFDM (64QAM, 16QAM, QPSK,BPSK)
Antenna Type	: Integrated antenna, maximum PK gain: 2.0dBi
Date of Receipt	: July 21, 2016
Sample Type	: Series production

Note1: EUT is the ab.of equipment under test.

Channle information							
CH	Frequency	CH	Frequency	CH	Frequency	CH	Frequency
1	2412	5	2432	9	2452	/	/
2	2417	6	2437	10	2457	/	/
3	2422	7	2442	11	2462	/	/
4	2427	8	2447	/	/	/	/

### 2.2. Accessories of EUT

Description of Accessories	Manufacturer	Model number or Type	Output.
AC/AD ADAPTOR (Ktec)	Kuantech (Beihai) Co., Ltd.	KSAS0050500100VUU	5V/1.0A
SWITCHING ADAPTER (3E)	Dongguan City Gangqi Electronics Co., Ltd	GQ05-050100-AU	5V/1.0A

Note: After the preliminary scan, EUT powered from external power (Ktec) adapter will have highest emission, was selected and recorded in this report.

### 2.3. Assistant equipment used for test

Description of Assistant equipment	Manufacturer	Model number or Type	EMC Compliance	SN
Notebook	DELL	Latitude D610	FCC DOC	00045-534-136-300

## 2.4. Block diagram of EUT configuration for test



EUT was connected to control to a special test jig provided by manufacturer which has a USB connector to connect to Notebook, and the Notebook will run a special test software “WNC1000 Test tool” provided by manufacturer to control EUT work in Continuous TX mode (>98% duty cycle), and select test channel, wireless mode and data rate.

Tested mode, channel, and data rate information			
Mode	data rate (Mbps) (see Note)	Channel	Frequency (MHz)
IEEE 802.11b	11	Low :CH1	2412
	11	Middle: CH6	2437
	11	High: CH11	2462
IEEE 802.11g	6	Low :CH1	2412
	6	Middle: CH6	2437
	6	High: CH11	2462
IEEE 802.11n HT20	MCS 0	Low :CH1	2412
	MCS 0	Middle: CH6	2437
	MCS 0	High: CH11	2462

Note: According exploratory test, EUT will have maximum output power in those data rate, so those data rate were used for all test.

## 2.5. Deviations of test standard

No Deviation

## 2.6. Test environment conditions

During the measurement the environmental conditions were within the listed ranges:

Temperature range:	21-25°C
Humidity range:	40-75%
Pressure range:	86-106kPa

## 2.7. Test laboratory

Dongguan Dongdian Testing Service Co., Ltd

Add: No. 17, Zongbu Road 2, Songshan Lake Sci&Tech, Industry Park, Dongguan City, Guangdong Province, China, 523808 Tel: +86-0769-22891499 <http://www.dgddt.com>

FCC Registration Number: 270092 Industry Canada site registration number: 10288A-1

## 2.8. Measurement uncertainty

Test Item	Uncertainty
Bandwidth	±1.1%
Peak Output Power(Conducted)( Spectrum analyzer)	0.86dB(10 MHz ≤ f < 3.6GHz);
	1.38dB(3.6GHz ≤ f < 8GHz)
Peak Output Power(Conducted)(Power Sensor)	0.74dB
Dwell Time	±0.6%
Conducted spurious emissions	0.86dB(10 MHz ≤ f < 3.6GHz);
	1.40dB(3.6GHz ≤ f < 8GHz)
	1.66dB(8GHz ≤ f < 22GHz)
Uncertainty for radio frequency (RBW<20KHz)	3×10-8
Temperature	±0.4℃
Humidity	±2%
Uncertainty for Radiation Emission test (30MHz-1GHz)	±3.14 dB (Antenna Polarize: V)
	±3.16 dB (Antenna Polarize: H)
Uncertainty for Radiation Emission test (1GHz-18GHz)	±4.14dB(1-6GHz)
	±4.46dB (6GHz-18Gz)
Uncertainty for Power line conduction emission test	2.44dB (150KHz-30MHz)
Note: This uncertainty represents an expanded uncertainty expressed at approximately the 95% confidence level using a coverage factor of k=2.	

### 3. Equipment used during test

Equipment	Manufacturer	Model No.	Serial No.	Last Cal.	Cal. Interval
<b>RF Connected Test</b>					
Spectrum analyzer	R&S	FSU26	1166.1660.26	2015/10/24	1Year
Vertor Signal Generator	R&S	SMBV100A	1407.6004K02	2015/10/24	1Year
RF Signal Generator	R&S	SMR20	1104.0002.20	2015/10/24	1Year
Power Sensor	Agilent	U2021XA	MY55150010	2016/04/18	1Year
Power Sensor	Agilent	U2021XA	MY55150011	2016/04/19	1Year
DC Power Source	MATRIS	MPS-3005L-3	D813058W	2015/10/24	1Year
Attenuator	Mini-Circuits	BW-S10W2	101109	2015/08/18	1Year
RF Cable	Micable	C10-01-01-1	100309	2015/08/18	1Year
Test Software	JS Tonscend	JS1120-2	Ver.2.5	N/A	N/A
USB Data acquisition	Agilent	U2531A	TW55043503	N/A	N/A
Auto control Unit	JS Tonscend	JS0806-2	158060010	N/A	N/A
<b>Radiated Emission Test</b>					
EMI Test Receiver	R&S	ESU8	100316	2015/10/24	1Year
Spectrum analyzer	R&S	FSU26	1166.1660.26	2015/10/24	1Year
Trilog Broadband Antenna	Schwarzbeck	VULB9163	9163-462	2016/05/30	1 Year
Active Loop antenna	Schwarzbeck	FMZB-1519	1519-038	2015/10/24	1 Year
Double Ridged Horn Antenna	R&S	HF907	100276	2015/10/31	1 Year
Pre-amplifier	A.H.	PAM-0118	360	2015/08/18	1 Year
RF Cable	HUBSER	CP-X2	W11.03	2015/10/24	1Year
RF Cable	HUBSER	CP-X1	W12.02	2015/10/24	1 Year
MI Cable	HUBSER	C10-01-01-1M	1091629	2015/10/24	1 Year
Test software	Audix	E3	V 6.11111b	/	/
<b>Power Line Conducted Emissions Test</b>					
Test Receiver	R&S	ESU8	100316	2015/10/24	1 Year
LISN 1	R&S	ENV216	101109	2015/10/24	1 Year
LISN 2	R&S	ESH2-Z5	100309	2015/10/24	1 Year
Pulse Limiter	R&S	ESH3-Z2	101242	2015/10/24	1 Year
CE Cable 1	HUBSER	ESU8/RF2	W10.01	2015/10/24	1 Year
Test software	Audix	E3	V 6.11111b	/	/



### 4. Emissions in restricted frequency bands

#### 4.1. Block diagram of test setup

In 3m Anechoic Chamber Test Setup Diagram for 9KHz-30MHz

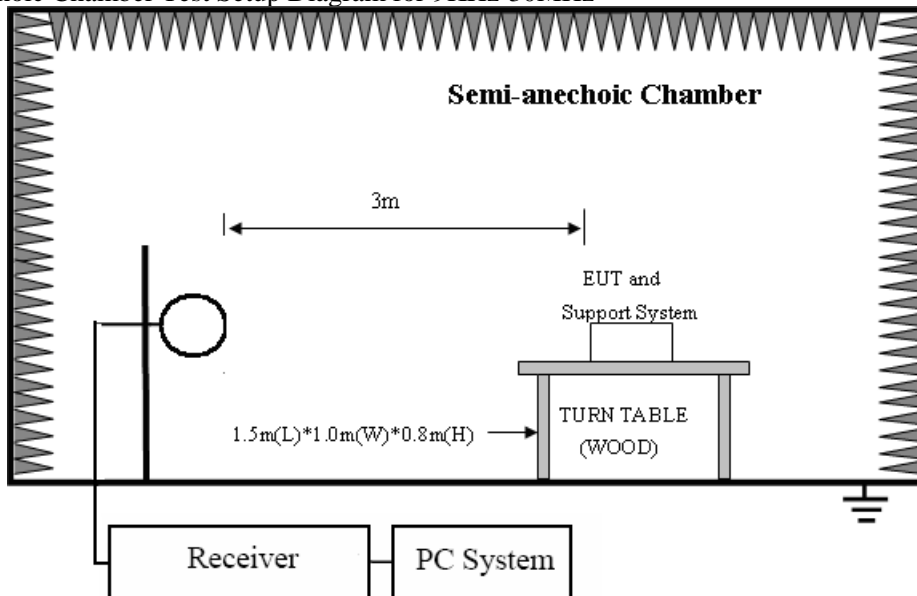

In 3m Anechoic Chamber Test Setup Diagram for 30MHz-1GHz

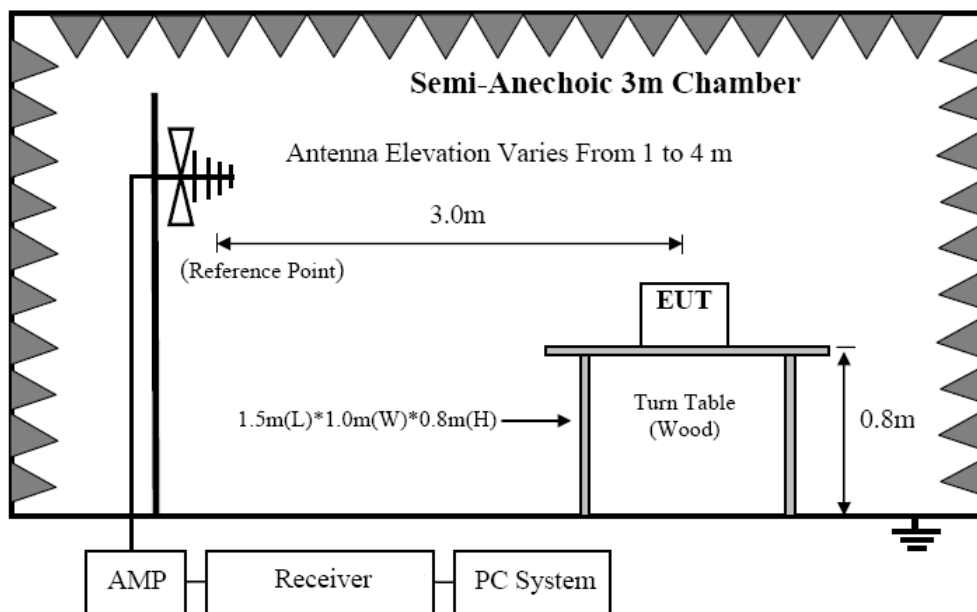

In 3m Anechoic Chamber Test Setup Diagram for frequency above 1GHz

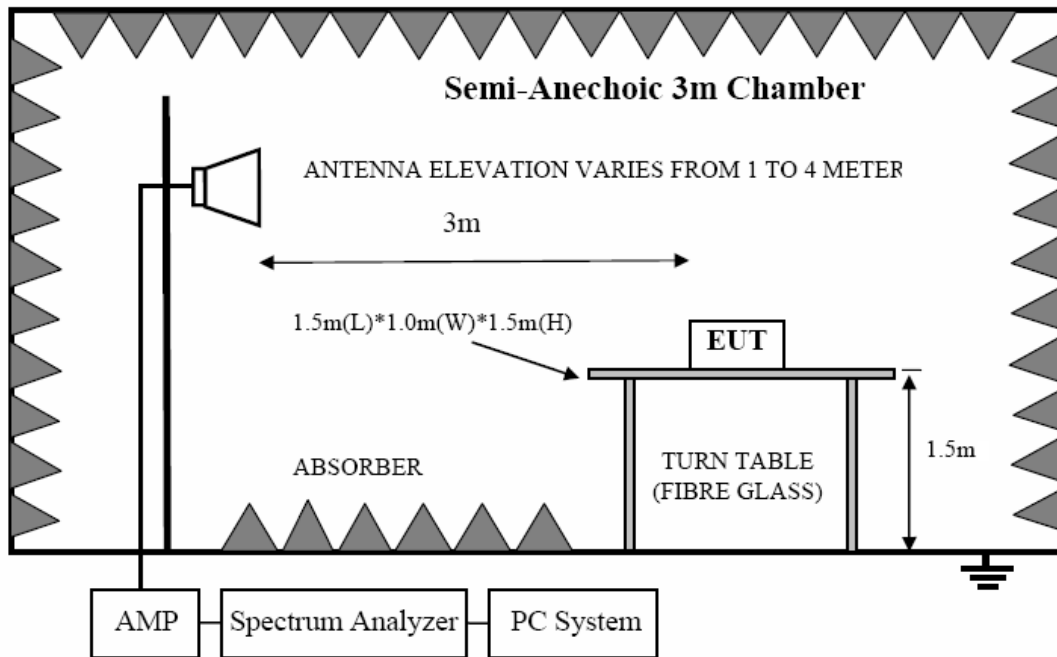

Note: For harmonic emissions test a appropriate high pass filter was inserted in the input port of AMP.

## 4.2. Limit

### 4.2.1 FCC 15.205 Restricted frequency band

MHz	MHz	MHz	GHz
0.090 - 0.110	16.42 - 16.423	399.9 - 410	4.5 - 5.15
<sup>1</sup> 0.495 - 0.505	16.69475 - 16.69525	608 - 614	5.35 - 5.46
2.1735 - 2.1905	16.80425 - 16.80475	960 - 1240	7.25 - 7.75
4.125 - 4.128	25.5 - 25.67	1300 - 1427	8.025 - 8.5
4.17725 - 4.17775	37.5 - 38.25	1435 - 1626.5	9.0 - 9.2
4.20725 - 4.20775	73 - 74.6	1645.5 - 1646.5	9.3 - 9.5
6.215 - 6.218	74.8 - 75.2	1660 - 1710	10.6 - 12.7
6.26775 - 6.26825	108 - 121.94	1718.8 - 1722.2	13.25 - 13.4
6.31175 - 6.31225	123 - 138	2200 - 2300	14.47 - 14.5
8.291 - 8.294	149.9 - 150.05	2310 - 2390	15.35 - 16.2
8.362 - 8.366	156.52475 - 156.52525	2483.5 - 2500	17.7 - 21.4
8.37625 - 8.38675	156.7 - 156.9	2690 - 2900	22.01 - 23.12
8.41425 - 8.41475	162.0125 - 167.17	3260 - 3267	23.6 - 24.0
12.29 - 12.293	167.72 - 173.2	3332 - 3339	31.2 - 31.8
12.51975 - 12.52025	240 - 285	3345.8 - 3358	36.43 - 36.5
12.57675 - 12.57725	322 - 335.4	3600 - 4400	( <sup>2</sup> )

### 4.2.2 FCC 15.209 Limit.

FREQUENCY MHz	DISTANCE Meters	FIELD STRENGTHS LIMIT	
		μV/m	dB(μV)/m
0.009 ~ 0.490	300	2400/F(KHz)	67.6-20log(F)
0.490 ~ 1.705	30	24000/F(KHz)	87.6-20log(F)
1.705 ~ 30.0	30	30	29.54
30 ~ 88	3	100	40.0
88 ~ 216	3	150	43.5

216 ~ 960	3	200	46.0
960 ~ 1000	3	500	54.0
Above 1000	3	74.0 dB( $\mu$ V)/m (Peak) 54.0 dB( $\mu$ V)/m (Average)	

Note: (1)The emission limits shown in the above table are based on measurements employing a CISPR QP detector except for the frequency bands 9-90KHz, 110-490KHz and above 1000MHz.Radiated emissions limits in these three bands are based on measurements employing an average detector.

(2) At frequencies below 30MHz, measurement may be performed at a distance closer then that specified, and the limit at closer measurement distance can be extrapolated by below formula:

$$\text{Limit}_{3m}(\text{dBuV/m}) = \text{Limit}_{30m}(\text{dBuV/m}) + 40\text{Log}(30m/3m)$$

#### 4.2.3 Limit for this EUT

All the emissions appearing within 15.205 restricted frequency bands shall not exceed the limits shown in 15.209, all the other emissions shall be at least 20dB below the fundamental emissions, or comply with 15.209 limits.

### 4.3. Test Procedure

(1) EUT height should be 0.8m for below 1GHz at a semi - anechoic chamber while EUT height should be 1.5m for above 1GHz at full chamber or semi - anechoic chamber ground with absorbers.

(2) The antenna used as below table.

Test frequency range	Test antenna used	Measuring distance
9KHz-30MHz	Active Loop antenna	3 m
30MHz-1GHz	Trilog Broadband Antenna	3 m
1GHz-18GHz	Double Ridged Horn Antenna(1GHz-18GHz)	3 m
18GHz-40GHz	Horn Antenna(18GHz-40GHz)	1 m

According ANSI C63.10:2013 clause 6.4.4.2 and 6.5.3, for measurements below 30 MHz, the loop antenna was positioned with its plane vertical from the EUT and rotated about its vertical axis for maximum response at each azimuth position around the EUT. And the loop antenna also be positioned with its plane horizontal at the specified distance from the EUT. The center of the loop is 1 m above the ground. for measurement above 30MHz, the Trilog Broadband Antenna or Horn Antenna was located 3m from EUT, Measurements were made with the antenna positioned in both the horizontal and vertical planes of Polarization, and the measurement antenna was varied from 1 m to 4 m. in height above the reference ground plane to obtain the maximum signal strength.

(3) Below pre-scan procedure was first performed in order to find prominent frequency spectrum radiated emissions from 9KHz to 25GHz:

(a) Scanning the peak frequency spectrum with the antenna specified in step (3), and the EUT was rotated 360 degree, the antenna height was varied from 1m to 4m(Except loop antenna, it's fixed 1m above

ground.)

- (b) Change work frequency or channel of device if practicable.
- (c) Change modulation type of device if practicable.
- (d) Change power supply range from 85% to 115% of the rated supply voltage
- (e) Rotated EUT though three orthogonal axes to determine the attitude of EUT arrangement produces highest emissions.

Spectrum frequency from 9KHz to 25GHz (tenth harmonic of fundamental frequency) was investigated, and no any obvious emission were detected from 18GHz to 25GHz, so below final test was performed with frequency range from 9KHz to 18GHz.

- (4) For final emissions measurements at each frequency of interest, the EUT was rotated and the antenna height was varied between 1m and 4m in order to maximize the emission. Measurements in both horizontal and vertical polarities were made and the data was recorded. In order to find the maximum emission, the relative positions of equipments and all of the interface cables were changed according to ANSI C63.10 2013 on Radiated Emission test.
- (5) The emissions from 9KHz to 1GHz were measured based on CISPR QP detector except for the frequency bands 9-90KHz, 110-490KHz, for emissions from 9KHz-90KHz,110KHz-490KHz and above 1GHz were measured based on average detector, for emissions above 1GHz, peak emissions also be measured and need comply with Peak limit.
- (6) The emissions from 9KHz to 1GHz, QP or average values were measured with EMI receiver with below RBW

Frequency band	RBW
9KHz-150KHz	200Hz
150KHz-30MHz	9KHz
30MHz-1GHz	120KHz

- (7) For emissions above 1GHz, both Peak and Average level were measured with Spectrum Analyzer, and the RBW is set at 1MHz, VBW is set at 3MHz for Peak measure; RMS detector RBW 1MHz VBW 3MHz for Average measure(according ANSI C63.10:2013 clause 4.2.3.2.3 procedure for average measure).

#### 4.4. Test result

##### **PASS. (See below detailed test result)**

All the emissions except fundamental emission from 9KHz to 25GHz were comply with 15.209 limit.

Note1: According exploratory test no any obvious emission were detected from 9KHz to 30MHz and 18GHz to 25GHz, so the final test was performed with frequency range from 30MHz to 18GHz and recorded in below.

Note2: For emissions below 1GHz, according exploratory explorer test, when change Tx mode and channel, have no distinct influence on emissions level, so for emissions below 1GHz, the final test was only performed with EUT working in 11b, Tx CH6 mode.

**Radiated Emission test (below 1GHz)**

**TR-4-E-009 Radiated Emission Test Result**

<b>Test Site</b>	: DDT 3m Chamber	<b>D:\2016 Report Data\16Q0719-1\RF.EM6</b>
<b>Test Date</b>	: 2016-07-23	<b>Tested By</b> : Toby
<b>EUT</b>	: Digital Door Viewer	<b>Model Number</b> : YRV740-WI
<b>Power Supply</b>	: AC 120V/60Hz	<b>Test Mode</b> : TX Mode
<b>Condition</b>	: Temp:24.5'C,Humi:55%, Press:100.1kPa	<b>Antenna/Distance</b> : 2015 VULB9163/3m/VERTICAL
<b>Memo</b>	:	

Data: 1

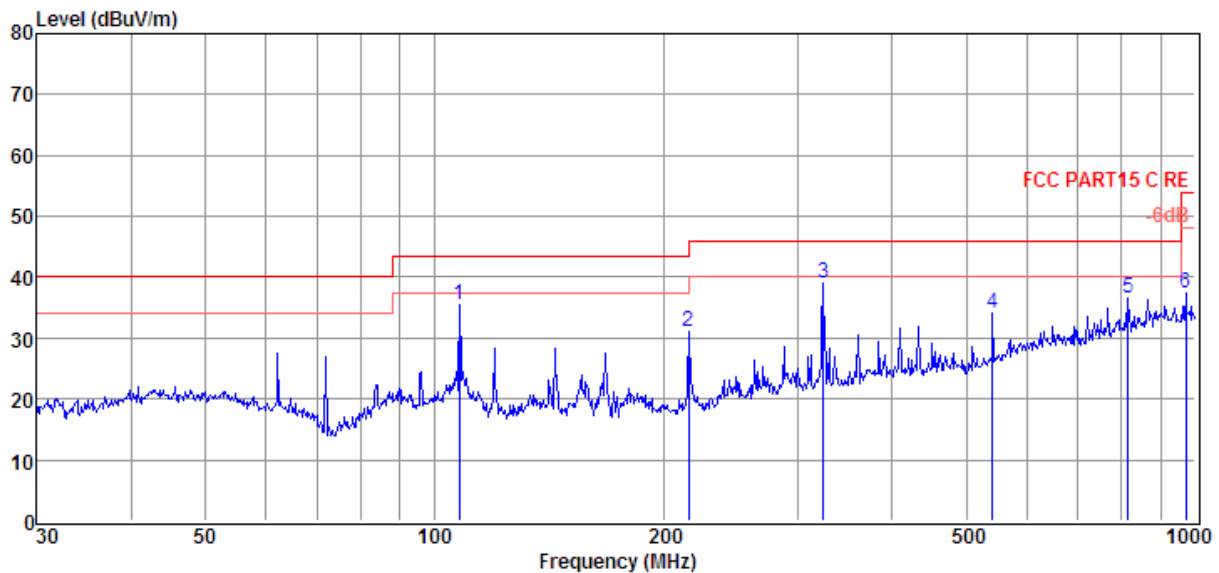

Item (Mark)	Freq (MHz)	Read Level (dBμV)	Antenna Factor (dB/m)	Cable Loss (dB)	Result Level (dBμV/m)	Limit Line (dBμV/m)	Over Limit (dB)	Detector	Polarization
1	107.89	24.31	11.25	0.00	35.56	43.50	-7.94	QP	VERTICAL
2	216.02	20.13	11.06	0.00	31.19	46.00	-14.81	QP	VERTICAL
3	324.46	25.32	13.79	0.00	39.11	46.00	-6.89	QP	VERTICAL
4	541.37	15.87	18.21	0.00	34.08	46.00	-11.92	QP	VERTICAL
5	815.97	15.15	21.32	0.00	36.47	46.00	-9.53	QP	VERTICAL
6	972.34	14.45	22.88	0.00	37.33	54.00	-16.67	QP	VERTICAL

- Note: 1. Result Level = Read Level + Antenna Factor + Cable loss.  
 2. If Peak Result complies with QP limit, QP Result is deemed to comply with QP limit.  
 3. Test setup: RBW: 120 kHz, VBW: 300 kHz, Sweep time: auto.

## TR-4-E-009 Radiated Emission Test Result

<b>Test Site</b>	: DDT 3m Chamber	D:\2016 Report Data\16Q0719-1\RF.EM6
<b>Test Date</b>	: 2016-07-23	<b>Tested By</b> : Toby
<b>EUT</b>	: Digital Door Viewer	<b>Model Number</b> : YRV740-WI
<b>Power Supply</b>	: AC 120V/60Hz	<b>Test Mode</b> : TX Mode
<b>Condition</b>	: Temp:24.5°C,Humi:55%, Press:100.1kPa	<b>Antenna/Distance</b> : 2015 VULB9163/3m/HORIZONTAL
<b>Memo</b>	:	

Data: 2

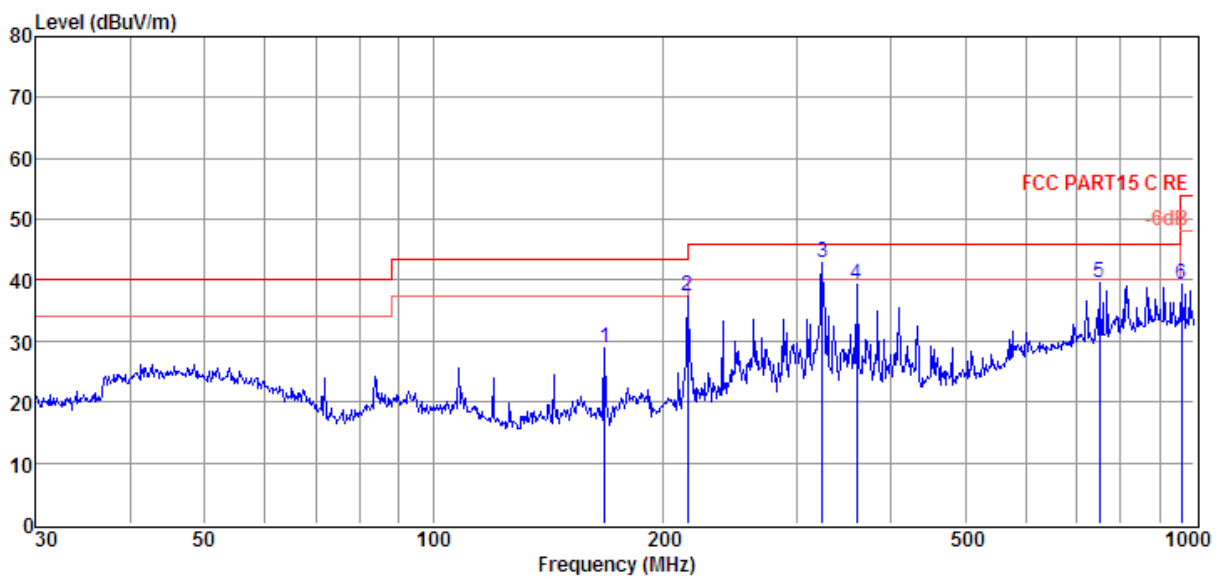

Item (Mark)	Freq (MHz)	Read Level (dBμV)	Antenna Factor (dB/m)	Cable Loss dB	Result Level (dBμV/m)	Limit Line (dBμV/m)	Over Limit (dB)	Detector	Polarization
1	167.82	20.58	8.31	0.00	28.89	43.50	-14.61	QP	HORIZONTAL
2	216.02	26.20	11.06	0.00	37.26	46.00	-8.74	QP	HORIZONTAL
3	324.46	28.99	13.79	0.00	42.78	46.00	-3.22	QP	HORIZONTAL
4	360.45	24.41	15.01	0.00	39.42	46.00	-6.58	QP	HORIZONTAL
5	750.11	19.67	19.91	0.00	39.58	46.00	-6.42	QP	HORIZONTAL
6	962.16	16.33	23.06	0.00	39.39	54.00	-14.61	QP	HORIZONTAL

Note: 1. Result Level = Read Level + Antenna Factor + Cable loss.  
 2. If Peak Result complies with QP limit, QP Result is deemed to comply with QP limit.  
 3. Test setup: RBW: 120 kHz, VBW: 300 kHz, Sweep time: auto.

**Radiated Emission test (above 1GHz)**

Freq (MHz)	Read level (dB $\mu$ V)	Antenna Factor (dB/m)	PRM Factor (dB)	Cable Loss (dB)	Result Level (dB $\mu$ V/m)	Limit (dB $\mu$ V/m)	Margin (dB)	Detector type	Polarization
<b>11b CH1</b>									
4824.00	36.00	35.42	29.32	8.09	50.19	54.00	-3.81	Average	HORIZONTAL
4824.00	48.65	35.42	29.32	8.09	62.84	74.00	-11.16	Peak	HORIZONTAL
7236.00	30.01	37.24	30.52	9.95	46.68	54.00	-7.32	Average	HORIZONTAL
7237.00	46.27	37.24	30.52	9.95	62.94	74.00	-11.06	Peak	HORIZONTAL
4824.00	35.66	35.42	29.32	8.09	49.85	54.00	-4.15	Average	VERTICAL
4824.00	50.26	35.42	29.32	8.09	64.45	74.00	-9.55	Peak	VERTICAL
7236.00	30.55	37.24	30.52	9.95	47.22	54.00	-6.78	Average	VERTICAL
7236.00	44.26	37.24	30.52	9.95	60.93	74.00	-13.07	Peak	VERTICAL
<b>11b CH6</b>									
4874.00	35.25	35.51	29.33	8.14	49.57	54.00	-4.43	Average	HORIZONTAL
4874.00	53.02	35.51	29.33	8.14	67.34	74.00	-6.66	Peak	HORIZONTAL
7311.00	29.58	37.29	30.57	9.97	46.27	54.00	-7.73	Average	HORIZONTAL
7311.00	45.15	37.29	30.57	9.97	61.84	74.00	-12.16	Peak	HORIZONTAL
4874.00	35.35	35.51	29.33	8.14	49.67	54.00	-4.33	Average	VERTICAL
4874.00	48.25	35.51	29.33	8.14	62.57	74.00	-11.43	Peak	VERTICAL
7311.00	29.87	37.29	30.57	9.97	46.56	54.00	-7.44	Average	VERTICAL
7311.00	46.68	37.29	30.57	9.97	63.37	74.00	-10.63	Peak	VERTICAL
<b>11b CH11</b>									
4924.00	35.26	35.59	29.34	8.16	49.67	54.00	-4.33	Average	HORIZONTAL
4924.00	50.14	35.59	29.34	8.16	64.55	74.00	-9.45	Peak	HORIZONTAL
7386.00	30.06	37.34	30.65	10.01	46.76	54.00	-7.24	Average	HORIZONTAL
7386.00	44.25	37.34	30.65	10.01	60.95	74.00	-13.05	Peak	HORIZONTAL
4924.00	30.28	35.59	29.34	8.16	44.69	54.00	-9.31	Average	VERTICAL
4924.00	41.21	35.59	29.34	8.16	55.62	74.00	-18.38	Peak	VERTICAL
7384.00	32.47	37.34	30.65	10.01	49.17	54.00	-4.83	Average	VERTICAL
7384.00	45.15	37.34	30.65	10.01	61.85	74.00	-12.15	Peak	VERTICAL

Note: 1.30MHz~18GHz: (Scan with 11b, 11g and 11n HT20, the worst case is 11b Mode)

2. Result Level = Read Level + Antenna Factor + Cable loss - PRM Factor.

3. Test setup: RBW: 1 MHz, VBW: 3 MHz, Sweep time: auto.

## 5. Band Edge Compliance

### 5.1. Block diagram of test setup

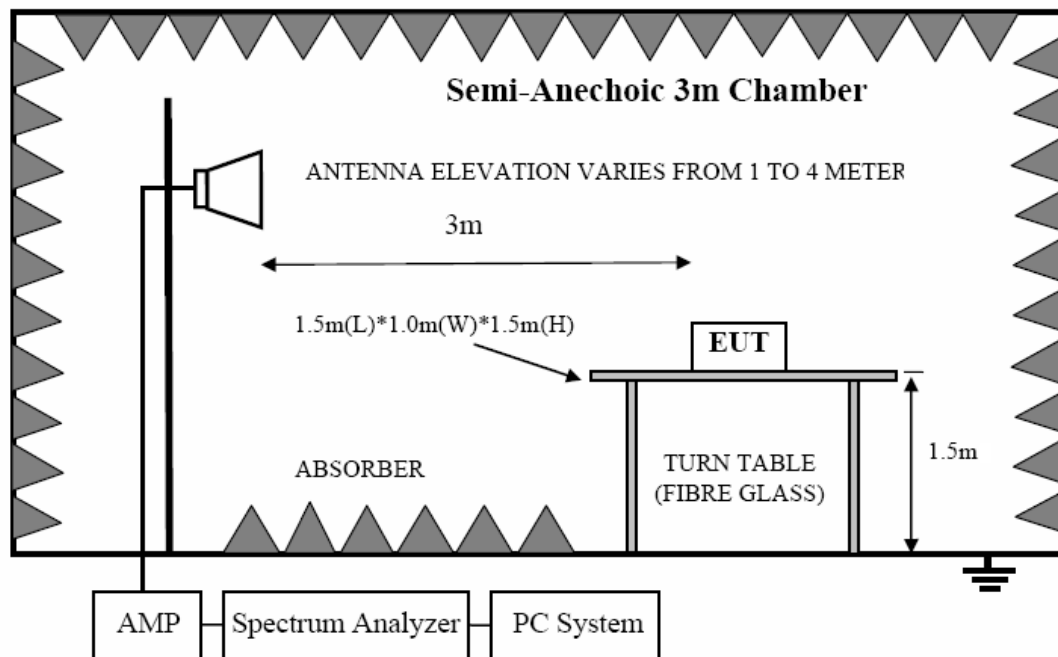

### 5.2. Limit

All restricted frequency bands shall not exceed the limits shown in 15.209, all the other emissions outside operation frequency band 2400MHz to 2483.5MHz shall be at least 20dB below the fundamental emissions, or comply with RSS-Gen Issue 3 clause 7.2.5 (Same as FCC 15.209) limits.

### 5.3. Test Procedure

Same with clause 4.3 except change investigated frequency range from 2100MHz to 2450MHz and 2450MHz to 2500MHz.

Remark: All restriction band have been tested, and only the worse case is shown in report.

### 5.4. Test result

**PASS. (See below detailed test result)**



# TR-4-E-009 Radiated Emission Test Result

**Test Site** : DDT 3m Chamber **D:\2016 Report Data\16Q0719-1\RE2.EM6**  
**Test Date** : 2016-07-23 **Tested By** : Toby  
**EUT** : Digital Door Viewer **Model Number** : YRV740-WI  
**Power Supply** : AC 120V/60HZ **Test Mode** : 11b CH1  
**Condition** : Temp:24.5°C,Humi:55%,  
 Press:100.1kPa **Antenna/Distance** : 2015 HF907/3m/HORIZONTAL  
**Memo** :

Data: 1

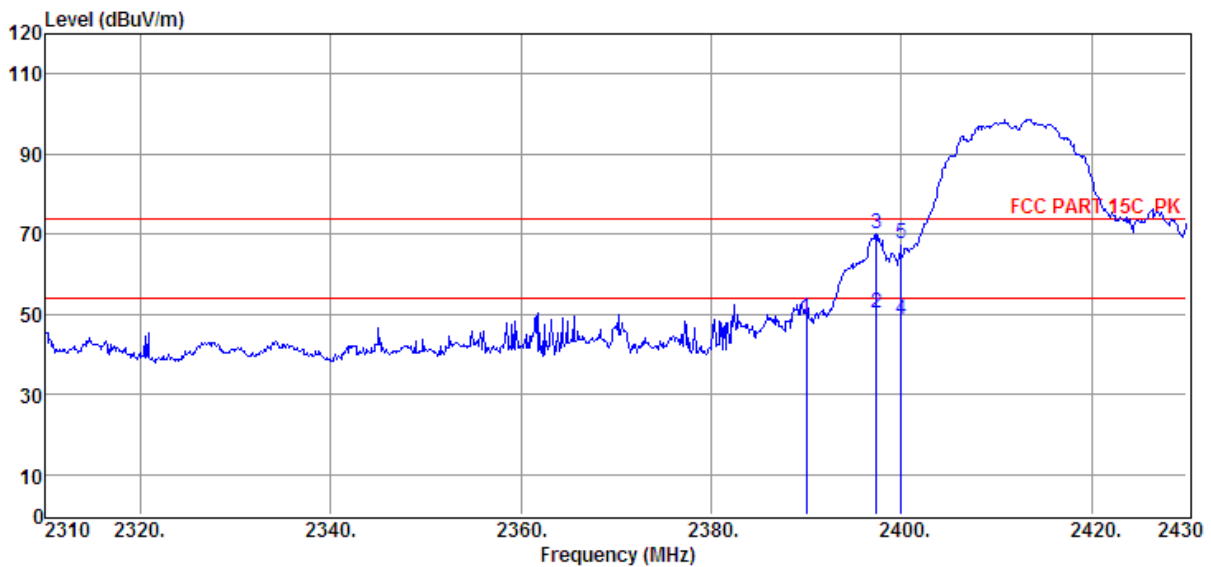

Item (Mark)	Freq (MHz)	Read Level (dBμV)	Antenna Factor (dB/m)	PRM Factor (dB)	Cable Loss (dB)	Result Level (dBμV/m)	Limit Line (dBμV/m)	Over Limit (dB)	Detector	Polarization
1	2390.00	43.45	29.99	29.41	5.17	49.20	74.00	-24.80	Peak	HORIZONTAL
2	2397.36	44.58	29.99	29.44	5.17	50.30	54.00	-3.70	Average	HORIZONTAL
3	2397.36	64.21	29.99	29.44	5.17	69.93	74.00	-4.07	Peak	HORIZONTAL
4	2400.00	42.90	29.99	29.44	5.17	48.62	54.00	-5.38	Average	HORIZONTAL
5	2400.00	61.89	29.99	29.44	5.17	67.61	74.00	-6.39	Peak	HORIZONTAL

- Note: 1. Result Level = Read Level + Antenna Factor + Cable loss - PRM Factor.  
 2. If Peak Result complies with AV limit, AV Result is deemed to comply with AV limit.  
 3. Test setup: RBW: 1 MHz, VBW: 3 MHz, Sweep time: auto.

## TR-4-E-009 Radiated Emission Test Result

<b>Test Site</b>	: DDT 3m Chamber	<b>D:\2016 Report Data\16Q0719-1\RE2.EM6</b>
<b>Test Date</b>	: 2016-07-23	<b>Tested By</b> : Toby
<b>EUT</b>	: Digital Door Viewer	<b>Model Number</b> : YRV740-WI
<b>Power Supply</b>	: AC 120V/60Hz	<b>Test Mode</b> : 11b CH1
<b>Condition</b>	: Temp:24.5°C,Humi:55%, Press:100.1kPa	<b>Antenna/Distance</b> : 2015 HF907/3m/HORIZONTAL
<b>Memo</b>	:	

Data: 2

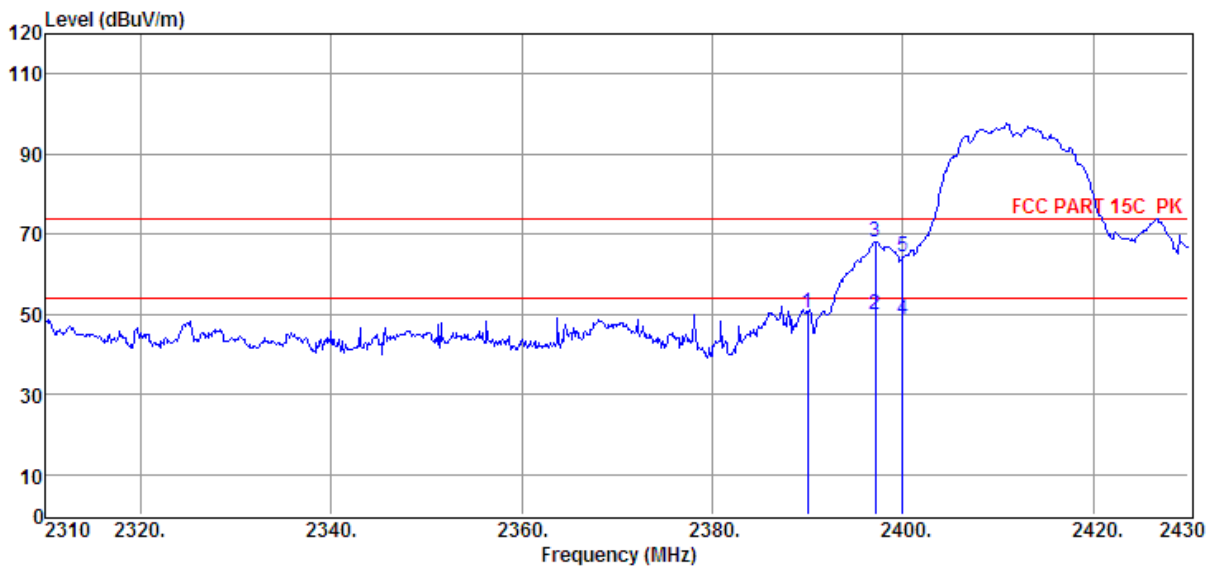

Item (Mark)	Freq (MHz)	Read Level (dBμV)	Antenna Factor (dB/m)	PRM Factor dB	Cable Loss dB	Result Level (dBμV/m)	Limit Line (dBμV/m)	Over Limit (dB)	Detector	Polarization
1	2390.04	44.59	29.99	29.41	5.17	50.34	74.00	-23.66	Peak	VERTICAL
2	2397.12	44.25	29.99	29.42	5.17	49.99	54.00	-4.01	Average	VERTICAL
3	2397.12	62.15	29.99	29.42	5.17	67.89	74.00	-6.11	Peak	VERTICAL
4	2400.00	42.90	29.99	29.44	5.17	48.62	54.00	-5.38	Average	VERTICAL
5	2400.00	58.54	29.99	29.44	5.17	64.26	74.00	-9.74	Peak	VERTICAL

- Note: 1. Result Level = Read Level + Antenna Factor + Cable loss - PRM Factor.  
 2. If Peak Result complies with AV limit, AV Result is deemed to comply with AV limit.  
 3. Test setup: RBW: 1 MHz, VBW: 3 MHz, Sweep time: auto.

## TR-4-E-009 Radiated Emission Test Result

<b>Test Site</b>	: DDT 3m Chamber	D:\2016 Report Data\16Q0719-1\RE2.EM6
<b>Test Date</b>	: 2016-07-23	<b>Tested By</b> : Toby
<b>EUT</b>	: Digital Door Viewer	<b>Model Number</b> : YRV740-WI
<b>Power Supply</b>	: AC 120V/60Hz	<b>Test Mode</b> : 11b CH11
<b>Condition</b>	: Temp:24.5°C,Humi:55%, Press:100.1kPa	<b>Antenna/Distance</b> : 2015 HF907/3m/HORIZONTAL
<b>Memo</b>	:	

Data: 3

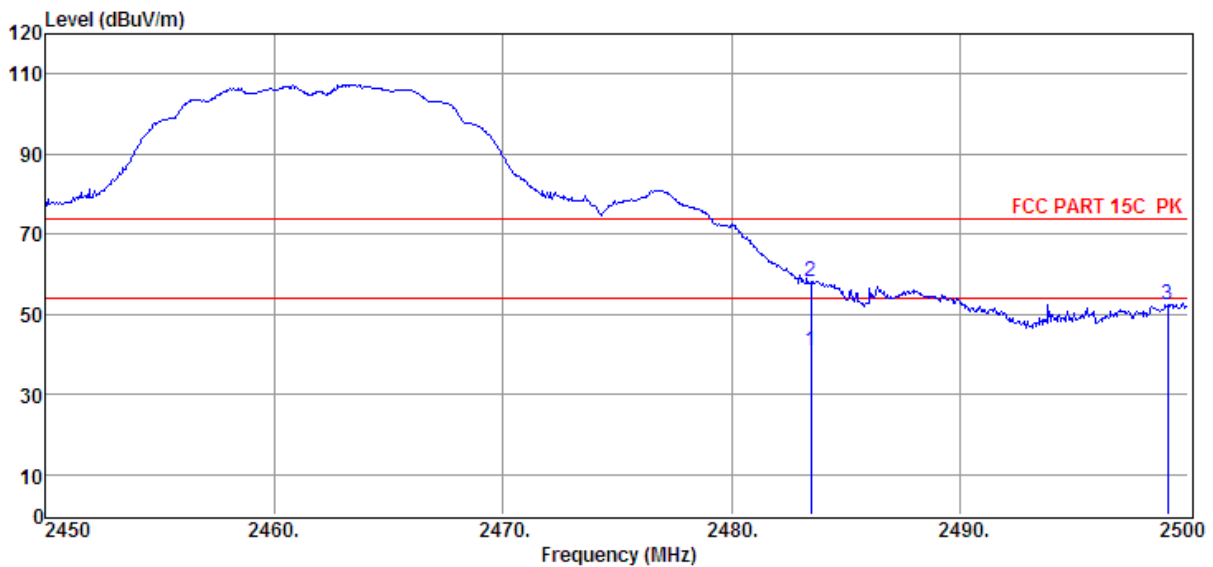

Item (Mark)	Freq (MHz)	Read Level (dBμV)	Antenna Factor (dB/m)	PRM Factor dB	Cable Loss dB	Result Level (dBμV/m)	Limit Line (dBμV/m)	Over Limit (dB)	Detector	Polarization
1	2483.50	35.02	30.25	29.71	5.31	40.87	54.00	-13.13	Average	HORIZONTAL
2	2483.50	52.13	30.25	29.71	5.31	57.98	74.00	-16.02	Peak	HORIZONTAL
3	2499.10	46.63	30.30	29.75	5.38	52.56	74.00	-21.44	Peak	HORIZONTAL

- Note: 1. Result Level = Read Level + Antenna Factor + Cable loss - PRM Factor.  
 2. If Peak Result complies with AV limit, AV Result is deemed to comply with AV limit.  
 3. Test setup: RBW: 1 MHz, VBW: 3 MHz, Sweep time: auto.

## TR-4-E-009 Radiated Emission Test Result

<b>Test Site</b>	: DDT 3m Chamber	D:\2016 Report Data\16Q0719-1\RE2.EM6
<b>Test Date</b>	: 2016-07-23	<b>Tested By</b> : Toby
<b>EUT</b>	: Digital Door Viewer	<b>Model Number</b> : YRV740-WI
<b>Power Supply</b>	: AC 120V/60Hz	<b>Test Mode</b> : 11b CH11
<b>Condition</b>	: Temp:24.5°C,Humi:55%, Press:100.1kPa	<b>Antenna/Distance</b> : 2015 HF907/3m/HORIZONTAL
<b>Memo</b>	:	

Data: 4

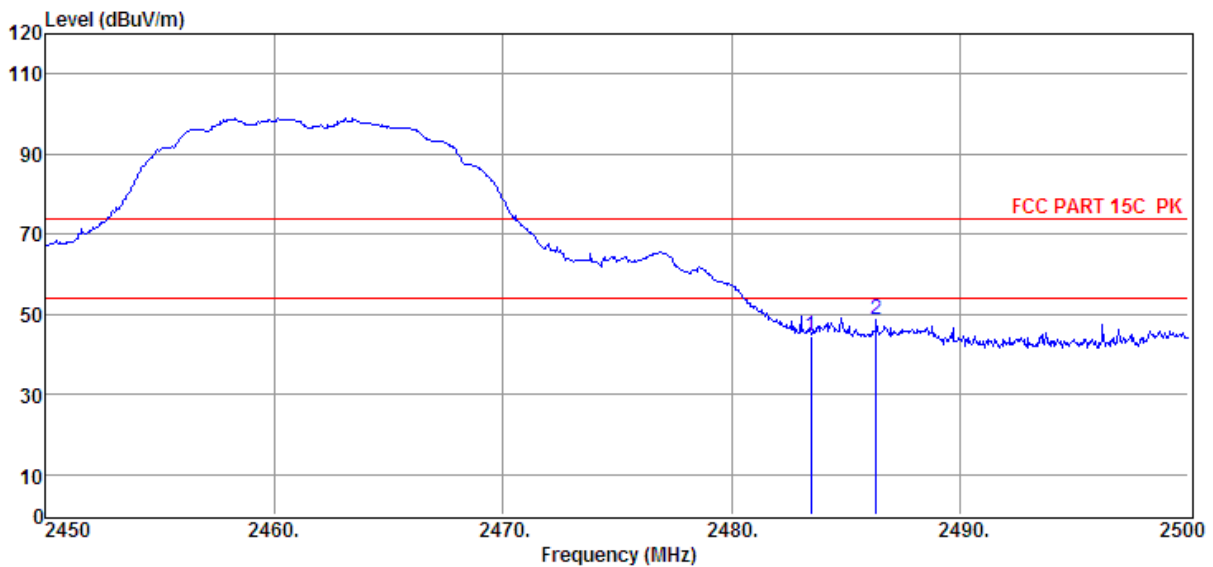

Item (Mark)	Freq (MHz)	Read Level (dBμV)	Antenna Factor (dB/m)	PRM Factor dB	Cable Loss dB	Result Level (dBμV/m)	Limit Line (dBμV/m)	Over Limit (dB)	Detector	Polarization
1	2483.50	38.58	30.25	29.71	5.31	44.43	74.00	-29.57	Peak	VERTICAL
2	2486.35	42.78	30.25	29.71	5.31	48.63	74.00	-25.37	Peak	VERTICAL

- Note: 1. Result Level = Read Level + Antenna Factor + Cable loss - PRM Factor.  
 2. If Peak Result complies with AV limit, AV Result is deemed to comply with AV limit.  
 3. Test setup: RBW: 1 MHz, VBW: 3 MHz, Sweep time: auto.

## TR-4-E-009 Radiated Emission Test Result

<b>Test Site</b>	: DDT 3m Chamber	<b>D:\2016 Report Data\16Q0719-1\RE2.EM6</b>
<b>Test Date</b>	: 2016-07-23	<b>Tested By</b> : Toby
<b>EUT</b>	: Digital Door Viewer	<b>Model Number</b> : YRV740-WI
<b>Power Supply</b>	: AC 120V/60Hz	<b>Test Mode</b> : 11g CH1
<b>Condition</b>	: Temp:24.5°C,Humi:55%, Press:100.1kPa	<b>Antenna/Distance</b> : 2015 HF907/3m/HORIZONTAL
<b>Memo</b>	:	

Data: 5

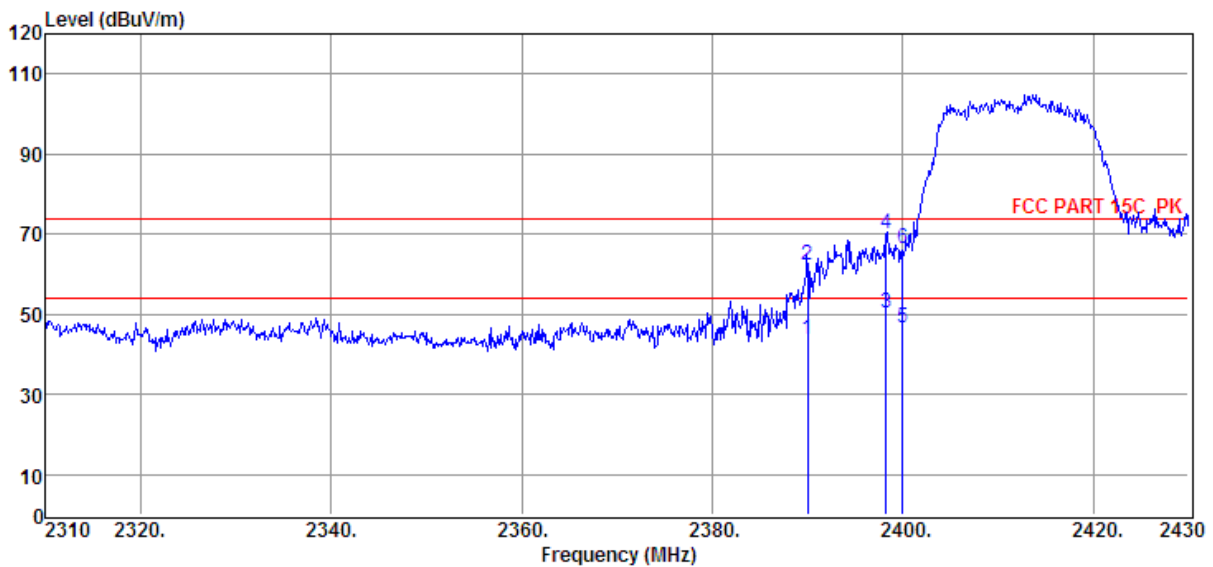

Item (Mark)	Freq (MHz)	Read Level (dBμV)	Antenna Factor (dB/m)	PRM Factor dB	Cable Loss dB	Result Level (dBμV/m)	Limit Line (dBμV/m)	Over Limit (dB)	Detector	Polarization
1	2390.00	38.00	29.99	29.41	5.17	43.75	54.00	-10.25	Average	VERTICAL
2	2390.00	56.57	29.99	29.41	5.17	62.32	74.00	-11.68	Peak	VERTICAL
3	2398.25	44.78	29.99	29.44	5.17	50.50	54.00	-3.50	Average	VERTICAL
4	2398.26	64.26	29.99	29.44	5.17	69.98	74.00	-4.02	Peak	VERTICAL
5	2400.00	41.00	29.99	29.44	5.17	46.72	54.00	-7.28	Average	VERTICAL
6	2400.00	60.86	29.99	29.44	5.17	66.58	74.00	-7.42	Peak	VERTICAL

- Note: 1. Result Level = Read Level + Antenna Factor + Cable loss - PRM Factor.  
 2. If Peak Result complies with AV limit, AV Result is deemed to comply with AV limit.  
 3. Test setup: RBW: 1 MHz, VBW: 3 MHz, Sweep time: auto.

# TR-4-E-009 Radiated Emission Test Result

**Test Site** : DDT 3m Chamber **D:\2016 Report Data\16Q0719-1\RE2.EM6**  
**Test Date** : 2016-07-23 **Tested By** : Toby  
**EUT** : Digital Door Viewer **Model Number** : YRV740-WI  
**Power Supply** : AC 120V/60Hz **Test Mode** : 11g CH1  
**Condition** : Temp:24.5°C,Humi:55%,  
 Press:100.1kPa **Antenna/Distance** : 2015 HF907/3m/HORIZONTAL  
**Memo** :

Data: 6

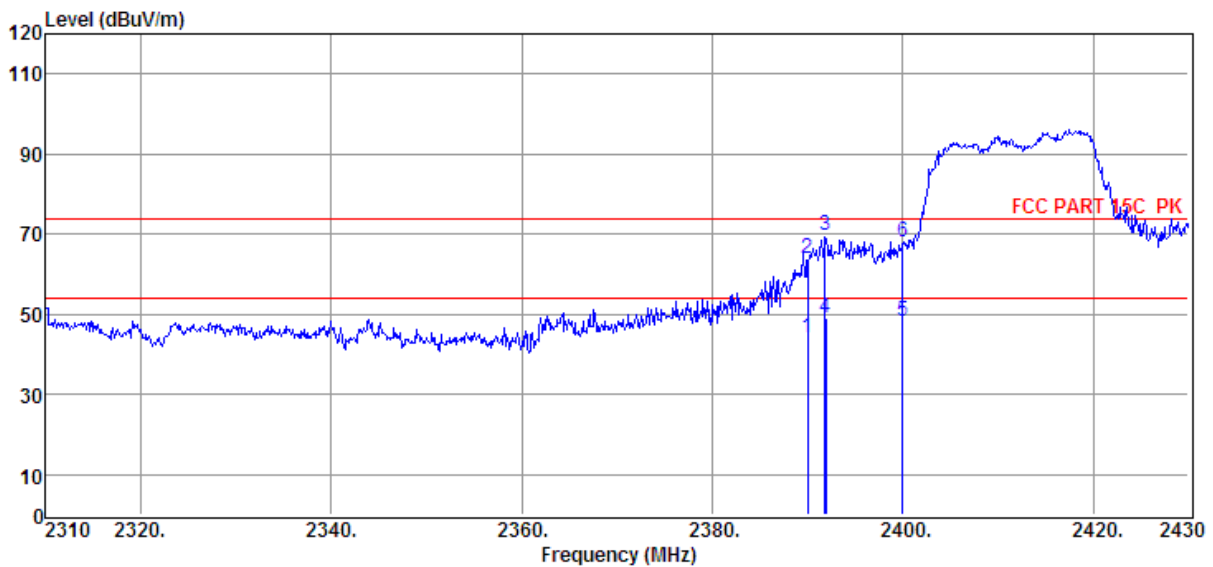

Item (Mark)	Freq (MHz)	Read Level (dBμV)	Antenna Factor (dB/m)	PRM Factor dB	Cable Loss dB	Result Level (dBμV/m)	Limit Line (dBμV/m)	Over Limit (dB)	Detector	Polarization
1	2390.00	38.26	29.99	29.41	5.17	44.01	54.00	-9.99	Average	HORIZONTAL
2	2390.00	58.35	29.99	29.41	5.17	64.10	74.00	-9.90	Peak	HORIZONTAL
3	2391.84	63.96	29.99	29.42	5.17	69.70	74.00	-4.30	Peak	HORIZONTAL
4	2391.96	43.20	29.99	29.42	5.17	48.94	54.00	-5.06	Average	HORIZONTAL
5	2400.00	42.40	29.99	29.44	5.17	48.12	54.00	-5.88	Average	HORIZONTAL
6	2400.00	62.25	29.99	29.44	5.17	67.97	74.00	-6.03	Peak	HORIZONTAL

- Note: 1. Result Level = Read Level + Antenna Factor + Cable loss - PRM Factor.  
 2. If Peak Result complies with AV limit, AV Result is deemed to comply with AV limit.  
 3. Test setup: RBW: 1 MHz, VBW: 3 MHz, Sweep time: auto.

# TR-4-E-009 Radiated Emission Test Result

**Test Site** : DDT 3m Chamber **D:\2016 Report Data\16Q0719-1\RE2.EM6**  
**Test Date** : 2016-07-23 **Tested By** : Toby  
**EUT** : Digital Door Viewer **Model Number** : YRV740-WI  
**Power Supply** : AC 120V/60Hz **Test Mode** : 11g CH11  
**Condition** : Temp:24.5°C,Humi:55%,  
 Press:100.1kPa **Antenna/Distance** : 2015 HF907/3m/HORIZONTAL  
**Memo** :

Data: 7

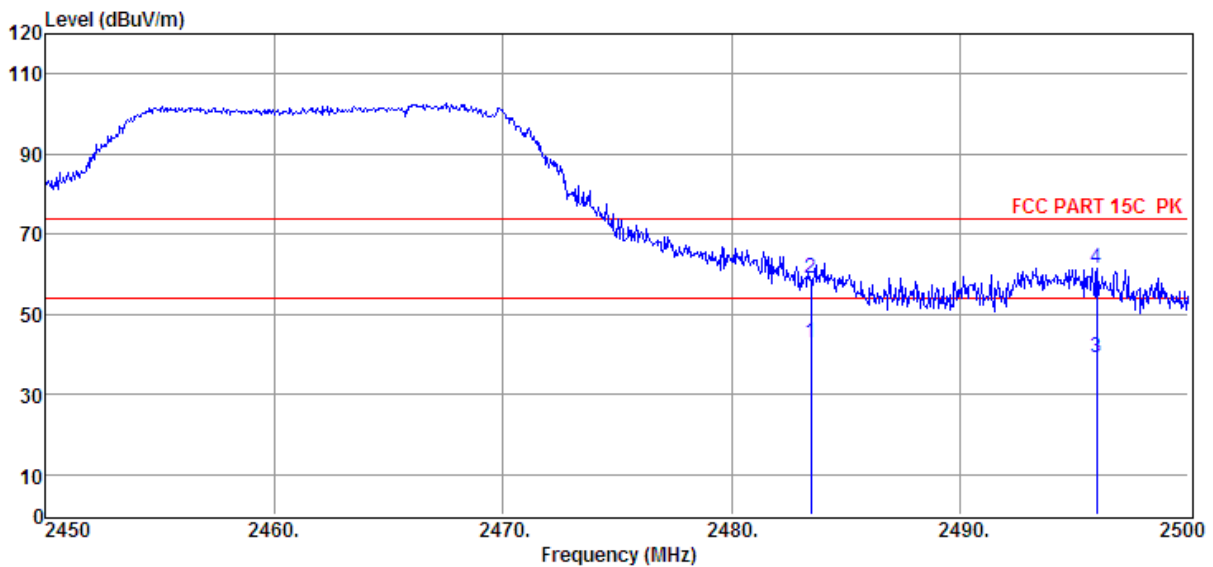

Item (Mark)	Freq (MHz)	Read Level (dBμV)	Antenna Factor (dB/m)	PRM Factor (dB)	Cable Loss (dB)	Result Level (dBμV/m)	Limit Line (dBμV/m)	Over Limit (dB)	Detector	Polarization
1	2483.50	37.10	30.25	29.71	5.31	42.95	54.00	-11.05	Average	HORIZONTAL
2	2483.50	53.02	30.25	29.71	5.31	58.87	74.00	-15.13	Peak	HORIZONTAL
3	2496.00	33.29	30.30	29.73	5.38	39.24	54.00	-14.76	Average	HORIZONTAL
4	2496.00	55.66	30.30	29.73	5.38	61.61	74.00	-12.39	Peak	HORIZONTAL

Note: 1. Result Level = Read Level + Antenna Factor + Cable loss - PRM Factor.  
 2. If Peak Result complies with AV limit, AV Result is deemed to comply with AV limit.  
 3. Test setup: RBW: 1 MHz, VBW: 3 MHz, Sweep time: auto.

## TR-4-E-009 Radiated Emission Test Result

<b>Test Site</b>	: DDT 3m Chamber	D:\2016 Report Data\16Q0719-1\RE2.EM6
<b>Test Date</b>	: 2016-07-23	<b>Tested By</b> : Toby
<b>EUT</b>	: Digital Door Viewer	<b>Model Number</b> : YRV740-WI
<b>Power Supply</b>	: AC 120V/60Hz	<b>Test Mode</b> : 11g CH11
<b>Condition</b>	: Temp:24.5°C,Humi:55%, Press:100.1kPa	<b>Antenna/Distance</b> : 2015 HF907/3m/HORIZONTAL
<b>Memo</b>	:	

Data: 8

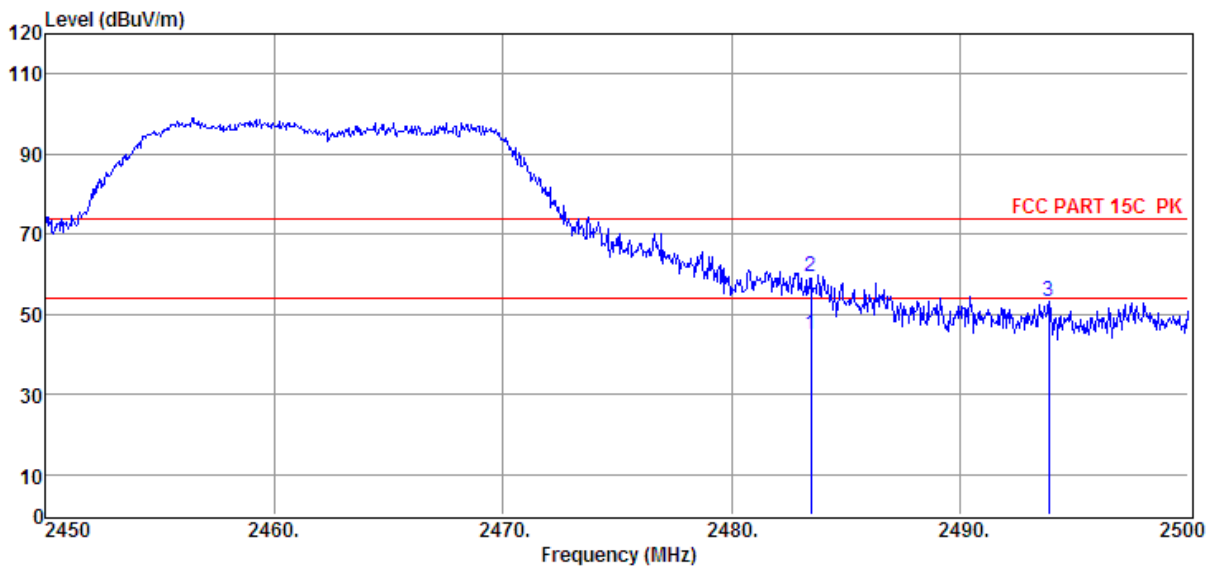

Item (Mark)	Freq (MHz)	Read Level (dBμV)	Antenna Factor (dB/m)	PRM Factor dB	Cable Loss dB	Result Level (dBμV/m)	Limit Line (dBμV/m)	Over Limit (dB)	Detector	Polarization
1	2483.50	39.09	30.25	29.71	5.31	44.94	54.00	-9.06	Average	VERTICAL
2	2483.50	53.36	30.25	29.71	5.31	59.21	74.00	-14.79	Peak	VERTICAL
3	2493.90	47.42	30.30	29.73	5.31	53.30	74.00	-20.70	Peak	VERTICAL

- Note: 1. Result Level = Read Level + Antenna Factor + Cable loss - PRM Factor.  
 2. If Peak Result complies with AV limit, AV Result is deemed to comply with AV limit.  
 3. Test setup: RBW: 1 MHz, VBW: 3 MHz, Sweep time: auto.



## TR-4-E-009 Radiated Emission Test Result

<b>Test Site</b> : DDT 3m Chamber	D:\2016 Report Data\16Q0719-1\RE2.EM6
<b>Test Date</b> : 2016-07-23	<b>Tested By</b> : Toby
<b>EUT</b> : Digital Door Viewer	<b>Model Number</b> : YRV740-WI
<b>Power Supply</b> : AC 120V/60Hz	<b>Test Mode</b> : 11n HT20 CH1
<b>Condition</b> : Temp:24.5°C,Humi:55%, Press:100.1kPa	<b>Antenna/Distance</b> : 2015 HF907/3m/HORIZONTAL
<b>Memo</b> :	

Data: 9

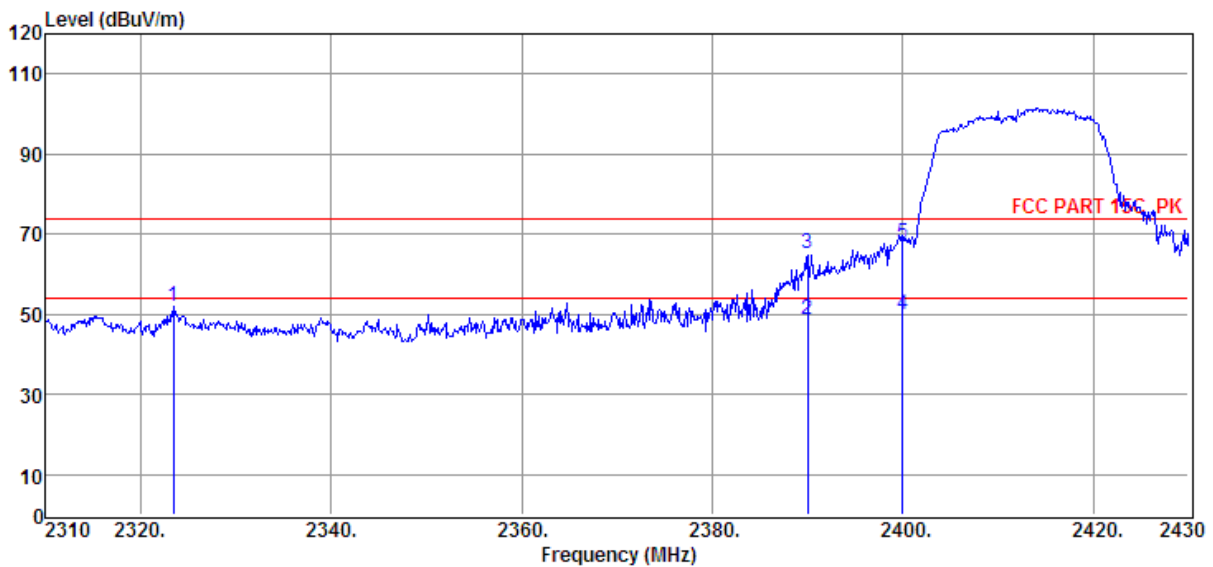

Item (Mark)	Freq (MHz)	Read Level (dBμV)	Antenna Factor (dB/m)	PRM Factor dB	Cable Loss dB	Result Level (dBμV/m)	Limit Line (dBμV/m)	Over Limit (dB)	Detector	Polarization
1	2323.44	46.39	29.78	29.30	5.06	51.93	74.00	-22.07	Peak	HORIZONTAL
2	2390.00	43.00	29.99	29.41	5.17	48.75	54.00	-5.25	Average	HORIZONTAL
3	2390.00	59.25	29.99	29.41	5.17	65.00	74.00	-9.00	Peak	HORIZONTAL
4	2400.00	44.20	29.99	29.44	5.17	49.92	54.00	-4.08	Average	HORIZONTAL
5	2400.00	62.00	29.99	29.44	5.17	67.72	74.00	-6.28	Peak	HORIZONTAL

Note: 1. Result Level = Read Level + Antenna Factor + Cable loss - PRM Factor.  
 2. If Peak Result complies with AV limit, AV Result is deemed to comply with AV limit.  
 3. Test setup: RBW: 1 MHz, VBW: 3 MHz, Sweep time: auto.

## TR-4-E-009 Radiated Emission Test Result

<b>Test Site</b>	: DDT 3m Chamber	<b>D:\2016 Report Data\16Q0719-1\RE2.EM6</b>
<b>Test Date</b>	: 2016-07-23	<b>Tested By</b> : Toby
<b>EUT</b>	: Digital Door Viewer	<b>Model Number</b> : YRV740-WI
<b>Power Supply</b>	: AC 120V/60Hz	<b>Test Mode</b> : 11n HT20 CH1
<b>Condition</b>	: Temp:24.5°C,Humi:55%, Press:100.1kPa	<b>Antenna/Distance</b> : 2015 HF907/3m/HORIZONTAL
<b>Memo</b>	:	

Data: 10

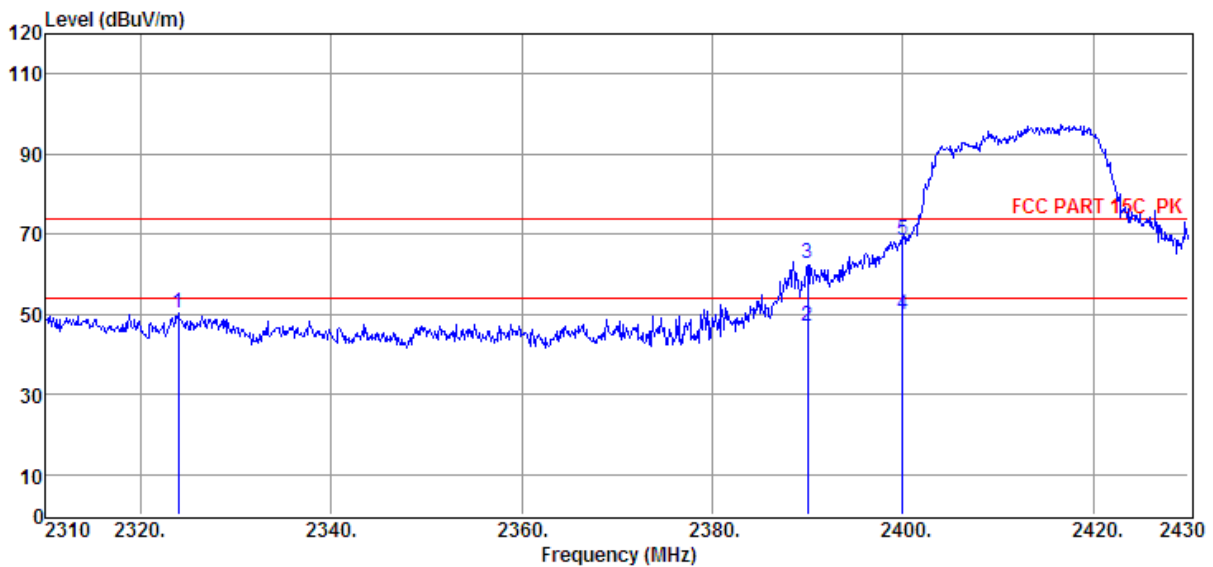

Item (Mark)	Freq (MHz)	Read Level (dBμV)	Antenna Factor (dB/m)	PRM Factor dB	Cable Loss dB	Result Level (dBμV/m)	Limit Line (dBμV/m)	Over Limit (dB)	Detector	Polarization
1	2323.92	44.63	29.78	29.30	5.06	50.17	74.00	-23.83	Peak	VERTICAL
2	2390.00	41.25	29.99	29.41	5.17	47.00	54.00	-7.00	Average	VERTICAL
3	2390.00	56.76	29.99	29.41	5.17	62.51	74.00	-11.49	Peak	VERTICAL
4	2400.00	44.00	29.99	29.44	5.17	49.72	54.00	-4.28	Average	VERTICAL
5	2400.00	62.59	29.99	29.44	5.17	68.31	74.00	-5.69	Peak	VERTICAL

Note: 1. Result Level = Read Level + Antenna Factor + Cable loss - PRM Factor.  
 2. If Peak Result complies with AV limit, AV Result is deemed to comply with AV limit.  
 3. Test setup: RBW: 1 MHz, VBW: 3 MHz, Sweep time: auto.

# TR-4-E-009 Radiated Emission Test Result

**Test Site** : DDT 3m Chamber D:\2016 Report Data\16Q0719-1\RE2.EM6  
**Test Date** : 2016-07-23 **Tested By** : Toby  
**EUT** : Digital Door Viewer **Model Number** : YRV740-WI  
**Power Supply** : AC 120V/60Hz **Test Mode** : 11n HT20 CH1  
**Condition** : Temp:24.5°C,Humi:55%,  
 Press:100.1kPa **Antenna/Distance** : 2015 HF907/3m/HORIZONTAL  
**Memo** :

Data: 11

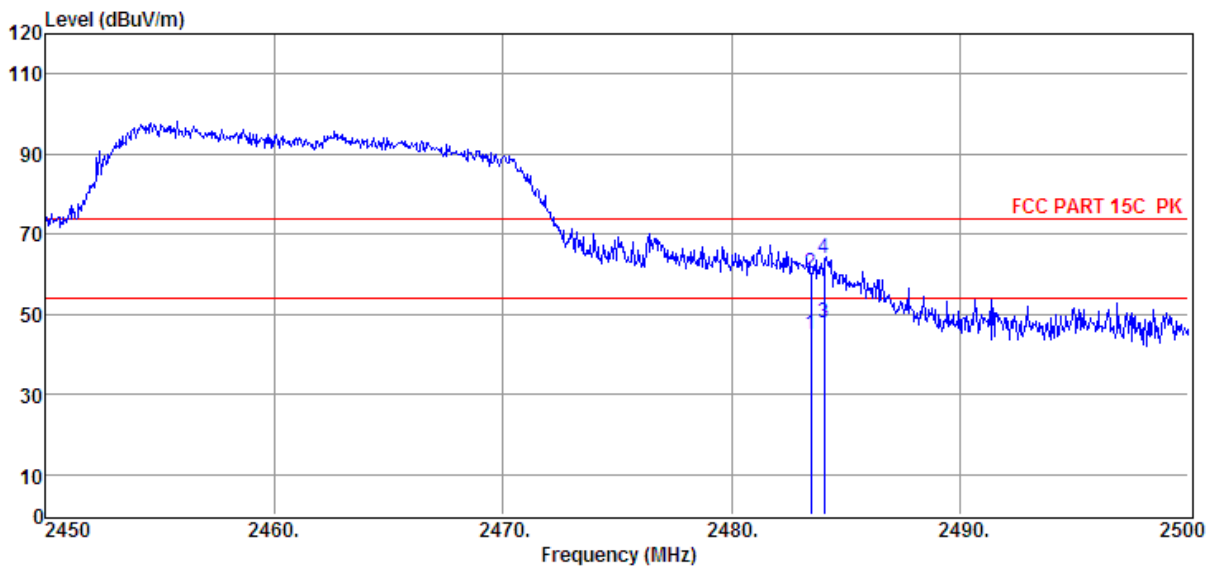

Item (Mark)	Freq (MHz)	Read Level (dBμV)	Antenna Factor (dB/m)	PRM Factor (dB)	Cable Loss (dB)	Result Level (dBμV/m)	Limit Line (dBμV/m)	Over Limit (dB)	Detector	Polarization
1	2483.50	39.20	30.25	29.71	5.31	45.05	54.00	-8.95	Average	VERTICAL
2	2483.50	54.25	30.25	29.71	5.31	60.10	74.00	-13.90	Peak	VERTICAL
3	2484.05	42.18	30.25	29.71	5.31	48.03	54.00	-5.97	Average	VERTICAL
4	2484.05	58.00	30.25	29.71	5.31	63.85	74.00	-10.15	Peak	VERTICAL

- Note: 1. Result Level = Read Level + Antenna Factor + Cable loss - PRM Factor.  
 2. If Peak Result complies with AV limit, AV Result is deemed to comply with AV limit.  
 3. Test setup: RBW: 1 MHz, VBW: 3 MHz, Sweep time: auto.

## TR-4-E-009 Radiated Emission Test Result

<b>Test Site</b>	: DDT 3m Chamber	D:\2016 Report Data\16Q0719-1\RE2.EM6
<b>Test Date</b>	: 2016-07-23	<b>Tested By</b> : Toby
<b>EUT</b>	: Digital Door Viewer	<b>Model Number</b> : YRV740-WI
<b>Power Supply</b>	: AC 120V/60Hz	<b>Test Mode</b> : 11n HT20 CH1
<b>Condition</b>	: Temp:24.5°C,Humi:55%, Press:100.1kPa	<b>Antenna/Distance</b> : 2015 HF907/3m/HORIZONTAL
<b>Memo</b>	:	

Data: 12

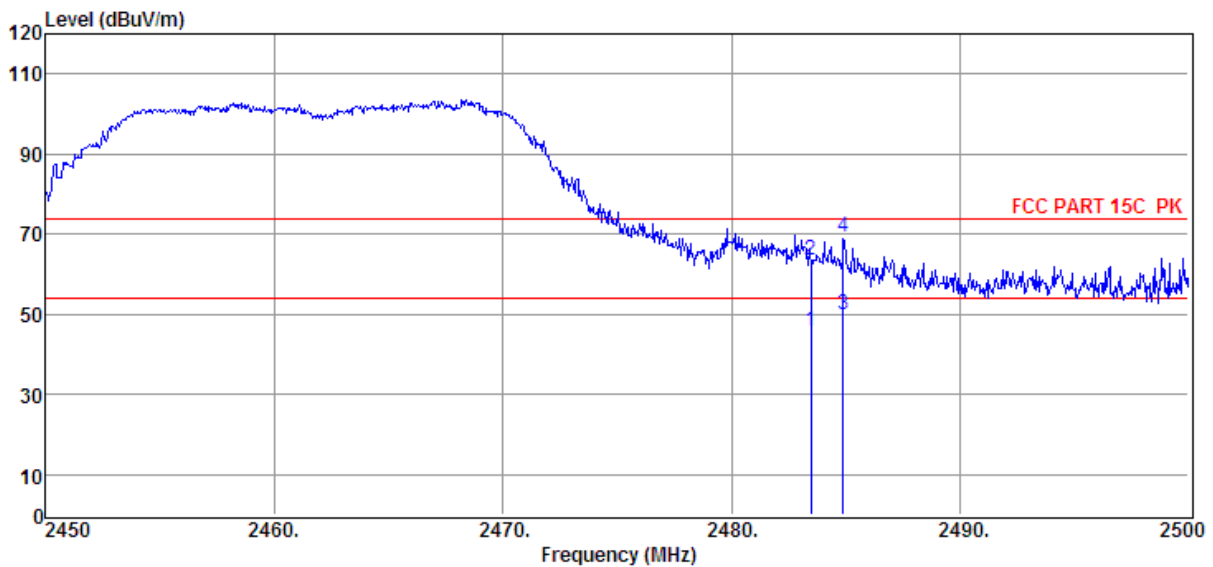

Item (Mark)	Freq (MHz)	Read Level (dBμV)	Antenna Factor (dB/m)	PRM Factor dB	Cable Loss dB	Result Level (dBμV/m)	Limit Line (dBμV/m)	Over Limit (dB)	Detector	Polarization
1	2483.50	39.98	30.25	29.71	5.31	45.83	54.00	-8.17	Average	HORIZONTAL
2	2483.50	57.58	30.25	29.71	5.31	63.43	74.00	-10.57	Peak	HORIZONTAL
3	2484.90	43.95	30.25	29.71	5.31	49.80	54.00	-4.20	Average	HORIZONTAL
4	2484.90	63.57	30.25	29.71	5.31	69.42	74.00	-4.58	Peak	HORIZONTAL

Note: 1. Result Level = Read Level + Antenna Factor + Cable loss - PRM Factor.  
 2. If Peak Result complies with AV limit, AV Result is deemed to comply with AV limit.  
 3. Test setup: RBW: 1 MHz, VBW: 3 MHz, Sweep time: auto.

## 6. Power Line Conducted Emission

### 6.1. Block diagram of test setup

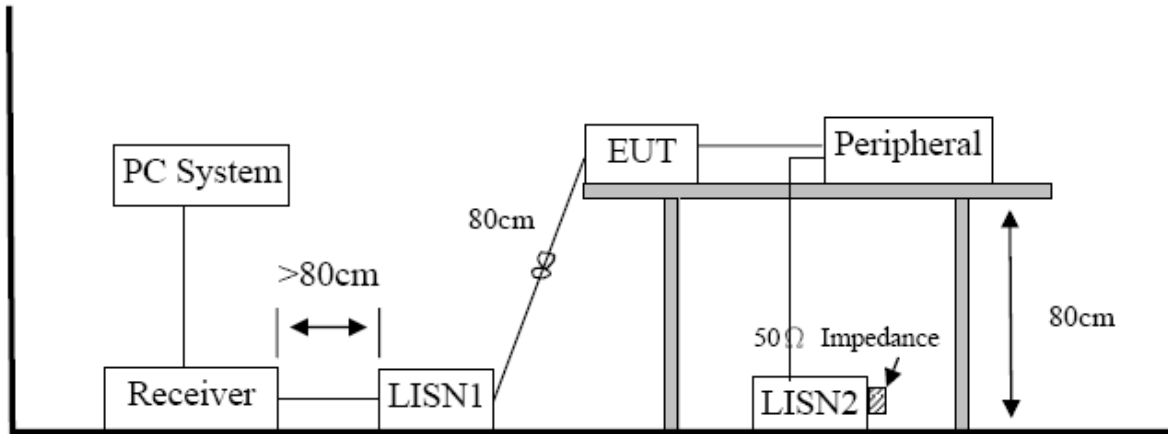

### 6.2. Power Line Conducted Emission Limits(Class B)

Frequency	Quasi-Peak Level dB( $\mu$ V)	Average Level dB( $\mu$ V)
150kHz ~ 500kHz	66 ~ 56*	56 ~ 46*
500kHz ~ 5MHz	56	46
5MHz ~ 30MHz	60	50

Note 1: \* Decreasing linearly with logarithm of frequency.

Note 2: The lower limit shall apply at the transition frequencies.

### 6.3. Test Procedure

The EUT and Support equipment, if needed, were put placed on a non-metallic table, 80cm above the ground plane.

Configuration EUT to simulate typical usage as described in clause 2.4 and test equipment as described in clause 10.2 of this report.

All I/O cables were positioned to simulate typical actual usage as per ANSI C63.4.

All support equipment power received from a second LISN.

Emissions were measured on each current carrying line of the EUT using an EMI Test Receiver connected to the LISN powering the EUT.

The Receiver scanned from 150 kHz to 30MHz for emissions in each of the test modes.

During the above scans, the emissions were maximized by cable manipulation.

The test mode(s) described in clause 2.4 were scanned during the preliminary test.

After the preliminary scan, we found the test mode producing the highest emission level.

The EUT configuration and worse cable configuration of the above highest emission levels were recorded for reference of the final test.

EUT and support equipment were set up on the test bench as per the configuration with highest emission level in the preliminary test.

A scan was taken on both power lines, Neutral and Line, recording at least the six highest emissions.

Emission frequency and amplitude were recorded into a computer in which correction factors were used to calculate the emission level and compare reading to the applicable limit.

The test data of the worst-case condition(s) was recorded.

The bandwidth of test receiver is set at 9 KHz.

#### **6.4. Test Result**

**PASS. (See below detailed test result)**

Note1: All emissions not reported below are too low against the prescribed limits.

Note2: “-----” means Peak detection; “-----” mans Average detection

# TR-4-E-010 Conducted Emission Test Result

<b>Test Site</b>	: DDT 1# Shield Room	<b>E:\2016 report data\16Q0719-1\CE.EM6</b>
<b>Test Date</b>	: 2016-07-22	<b>Tested By</b> : Toby
<b>EUT</b>	: Digital Door Viewer	<b>Model Number</b> : YRV740-WI
<b>Power Supply</b>	: AC 120V/60Hz	<b>Test Mode</b> : Tx mode
<b>Condition</b>	: Temp:24.5°C,Humi:55%, Press:100.1kPa	<b>LISN</b> : 2015 ENV216/LINE

Data: 6

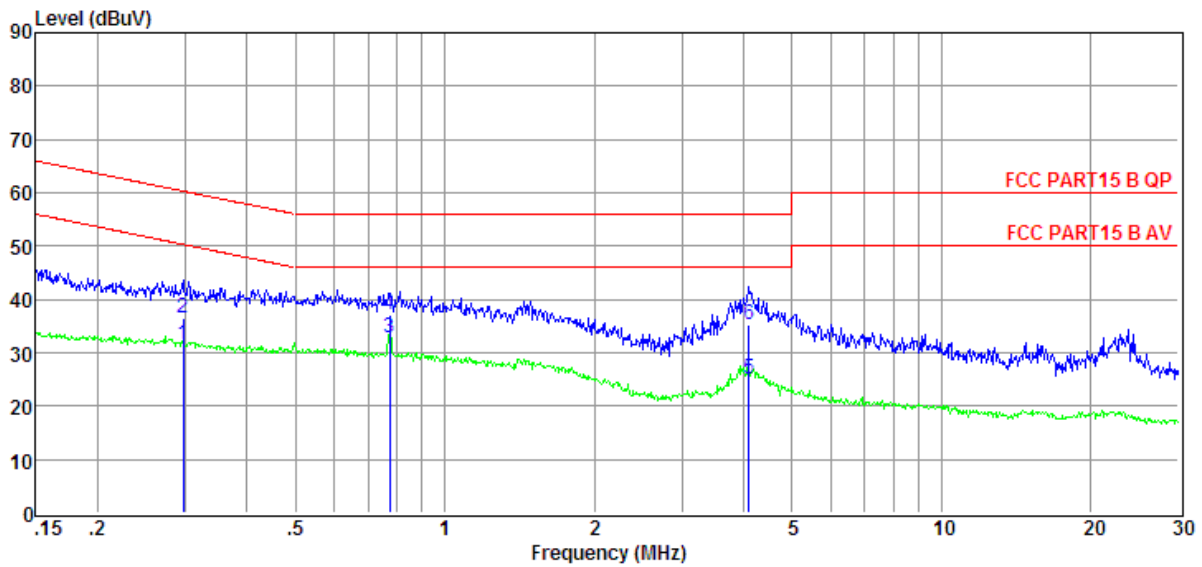

Item	Freq	Read Level	LISN Factor	Cable Loss	Pulse Limiter Factor	Result Level	Limit Line	Over Limit	Detector	Phase
(Mark)	(MHz)	(dBμV)	(dB)	(dB)	(dB)	(dBμV)	(dBμV)	(dB)		
1	0.30	12.08	9.61	0.02	9.86	31.57	50.32	-18.75	Average	LINE
2	0.30	16.93	9.61	0.02	9.86	36.42	60.32	-23.90	QP	LINE
3	0.78	13.39	9.61	0.03	9.86	32.89	46.00	-13.11	Average	LINE
4	0.78	17.71	9.61	0.03	9.86	37.21	56.00	-18.79	QP	LINE
5	4.09	5.61	9.65	0.06	9.88	25.20	46.00	-20.80	Average	LINE
6	4.09	15.70	9.65	0.06	9.88	35.29	56.00	-20.71	QP	LINE

- Note: 1. Result Level = Read Level + LISN Factor + Pulse Limiter Factor + Cable loss.  
 2. If QP Result complies with AV limit, AV Result is deemed to comply with AV limit.  
 3. Test setup: RBW: 200 Hz (9 kHz—150 kHz), 9 kHz (150 kHz—30 MHz).  
 4. Step size: 80Hz (0.009MHz-0.15MHz), 4 kHz (0.15MHz-30MHz), Scan time: auto.

## TR-4-E-010 Conducted Emission Test Result

<b>Test Site</b>	: DDT 1# Shield Room	E:\2016 report data\16Q0719-1\CE.EM6
<b>Test Date</b>	: 2016-07-22	<b>Tested By</b> : Toby
<b>EUT</b>	: Digital Door Viewer	<b>Model Number</b> : YRV740-WI
<b>Power Supply</b>	: AC 120V/60Hz	<b>Test Mode</b> : Tx mode
<b>Condition</b>	: Temp:24.5°C,Humi:55%, Press:100.1kPa	<b>LISN</b> : 2015 ENV216/NEUTRAL

Data: 8

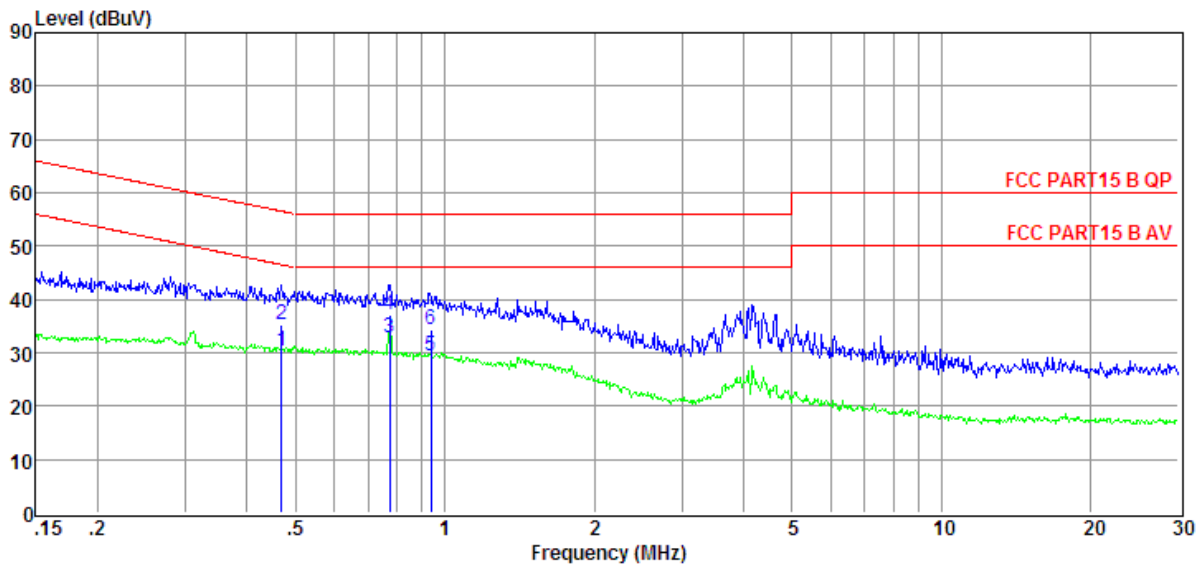

Item	Freq	Read Level	LISN Factor	Cable Loss	Pulse Limiter Factor	Result Level	Limit Line	Over Limit	Detector	Phase
(Mark)	(MHz)	(dBμV)	(dB)	(dB)	(dB)	(dBμV)	(dBμV)	(dB)		
1	0.47	10.74	9.61	0.02	9.86	30.23	46.54	-16.31	Average	NEUTRAL
2	0.47	15.67	9.61	0.02	9.86	35.16	56.54	-21.38	QP	NEUTRAL
3	0.78	13.17	9.61	0.03	9.86	32.67	46.00	-13.33	Average	NEUTRAL
4	0.78	17.74	9.61	0.03	9.86	37.24	56.00	-18.76	QP	NEUTRAL
5	0.94	9.82	9.61	0.03	9.86	29.32	46.00	-16.68	Average	NEUTRAL
6	0.94	14.73	9.61	0.03	9.86	34.23	56.00	-21.77	QP	NEUTRAL

- Note: 1. Result Level = Read Level + LISN Factor + Pulse Limiter Factor + Cable loss.  
 2. If QP Result complies with AV limit, AV Result is deemed to comply with AV limit.  
 3. Test setup: RBW: 200 Hz (9 kHz—150 kHz), 9 kHz (150 kHz—30 MHz).  
 4. Step size: 80Hz (0.009MHz-0.15MHz), 4 kHz (0.15MHz-30MHz), Scan time: auto.



7. Test setup photograph





**8. Photos of the EUT**











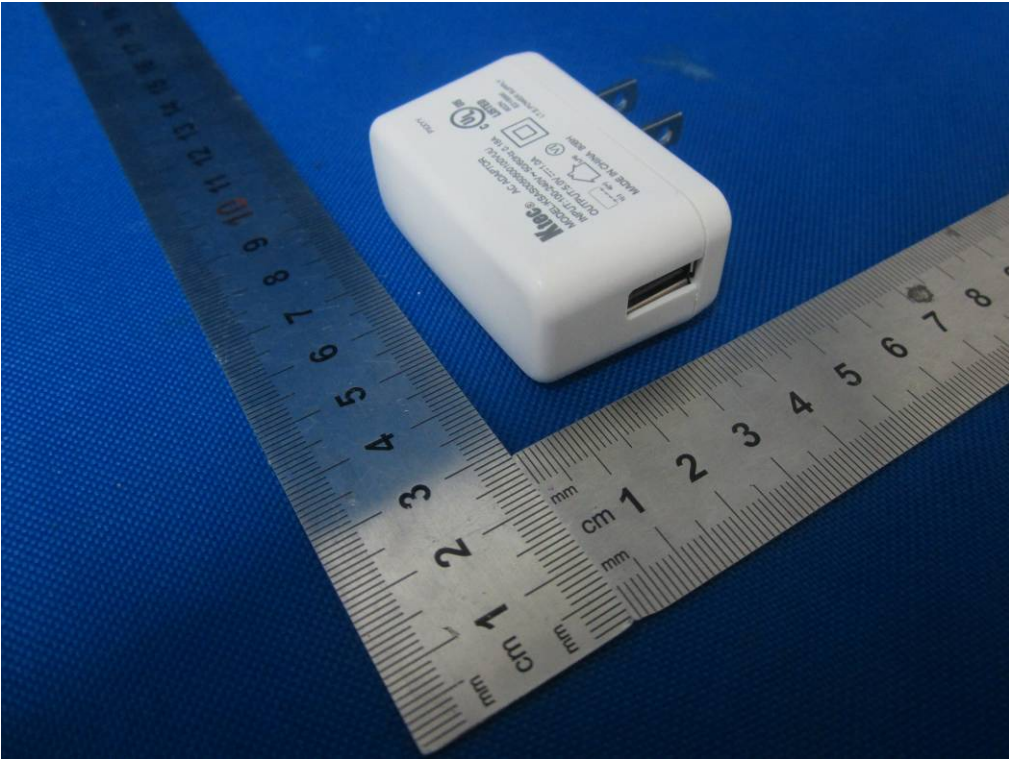
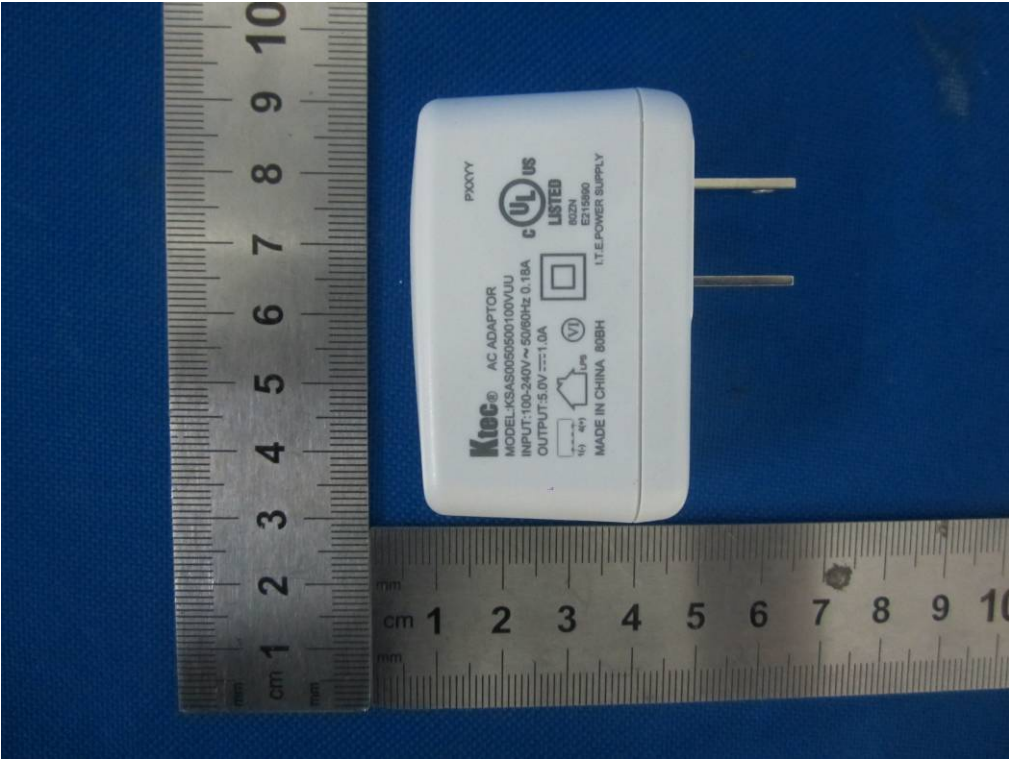

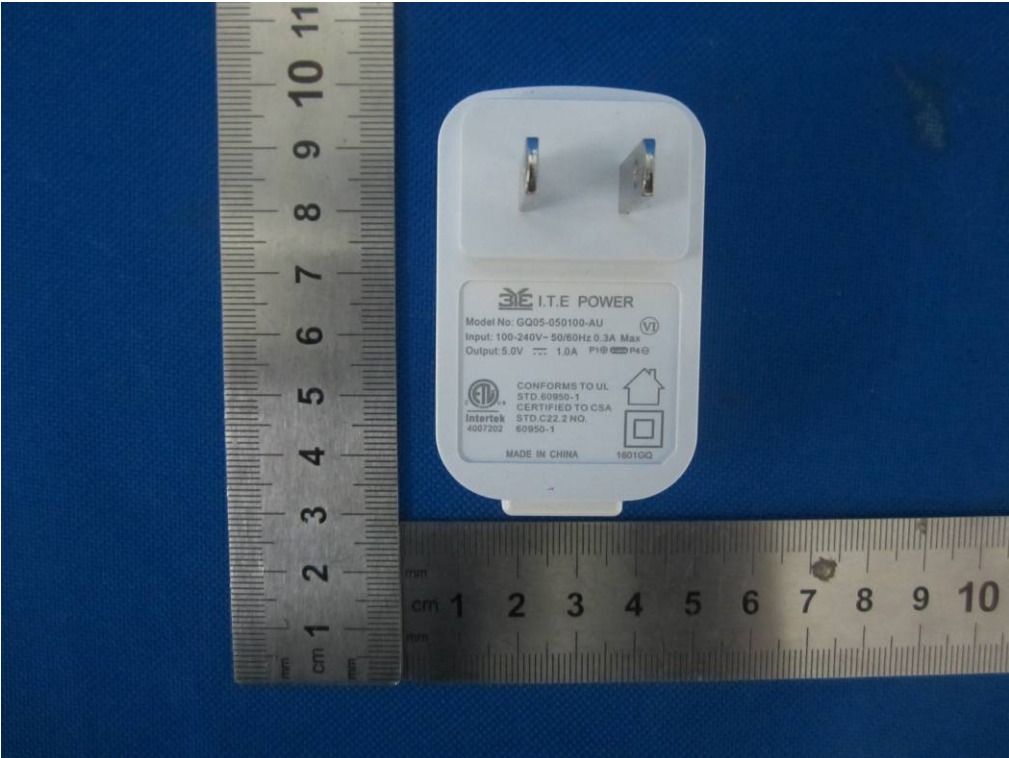



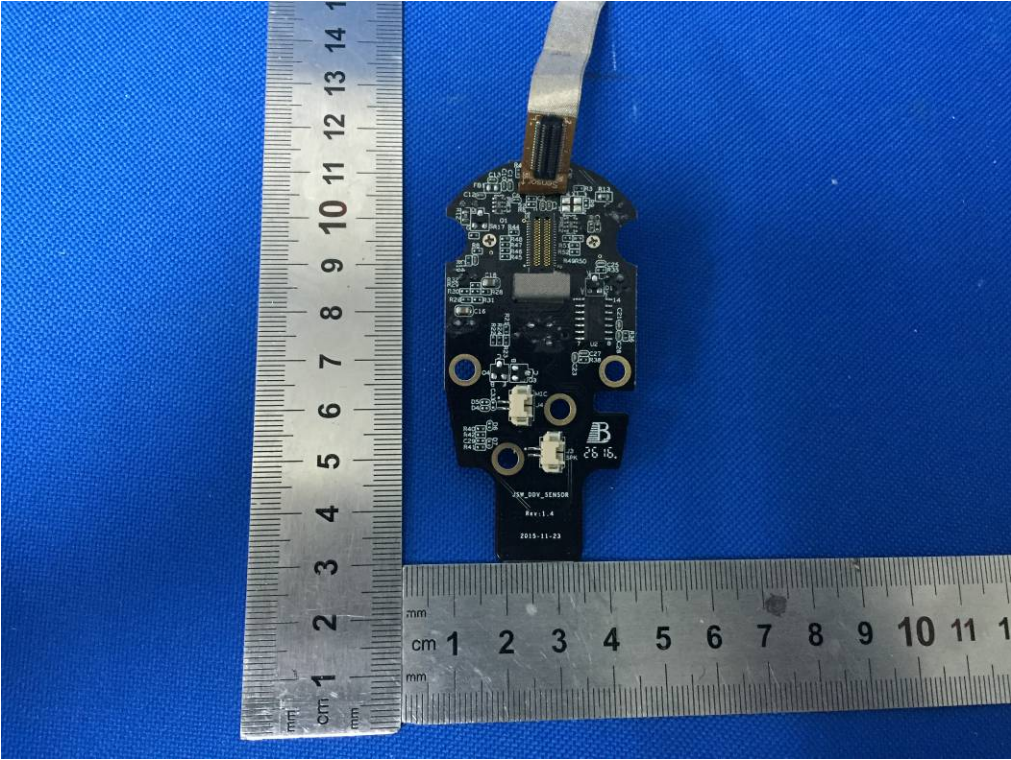
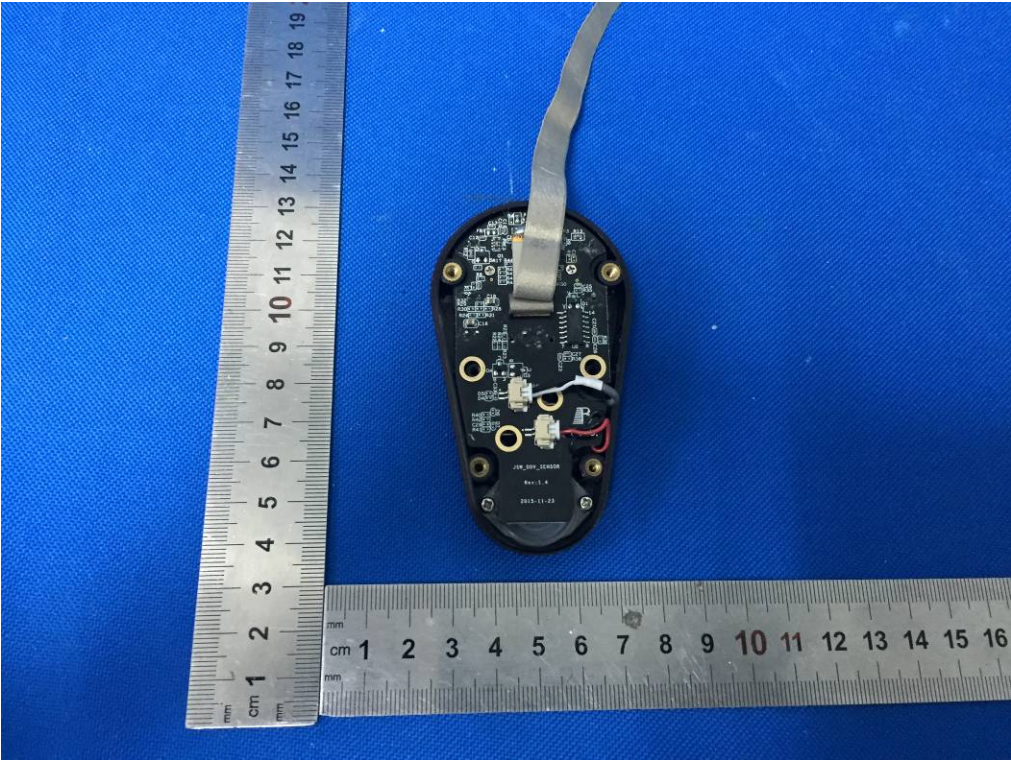



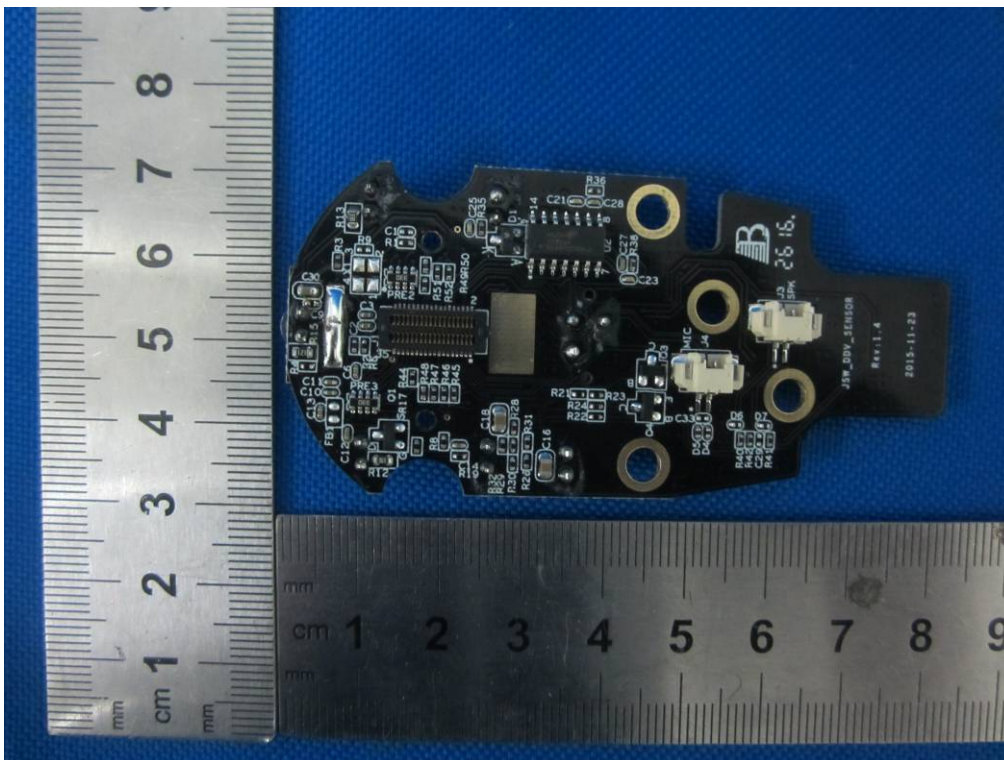
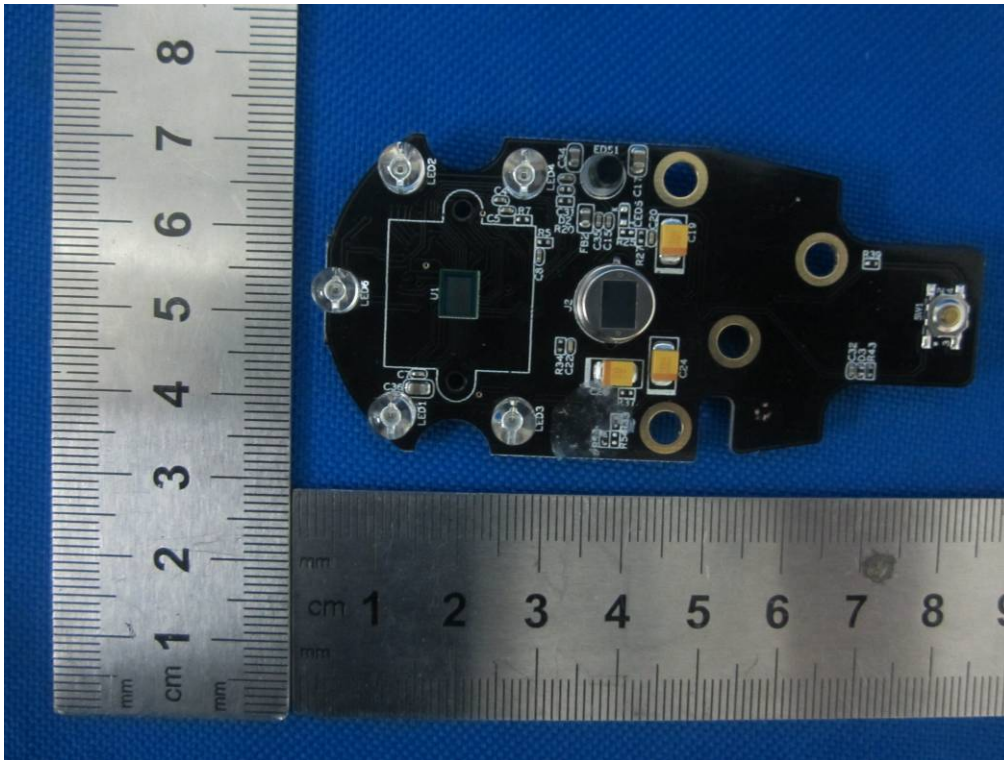

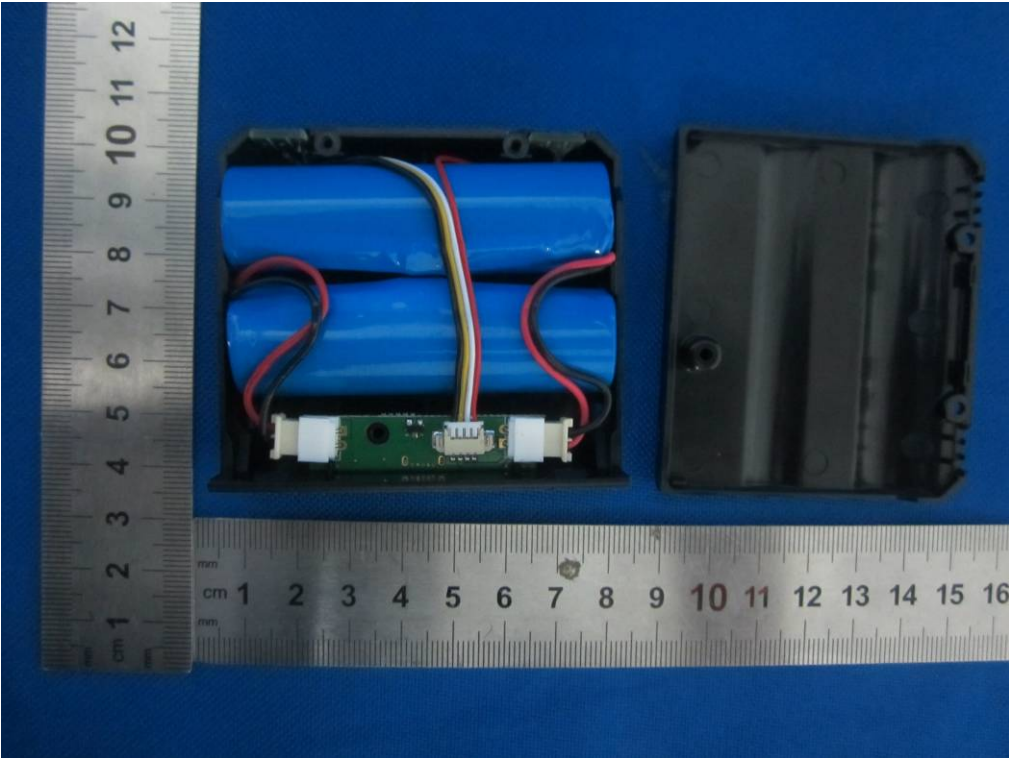



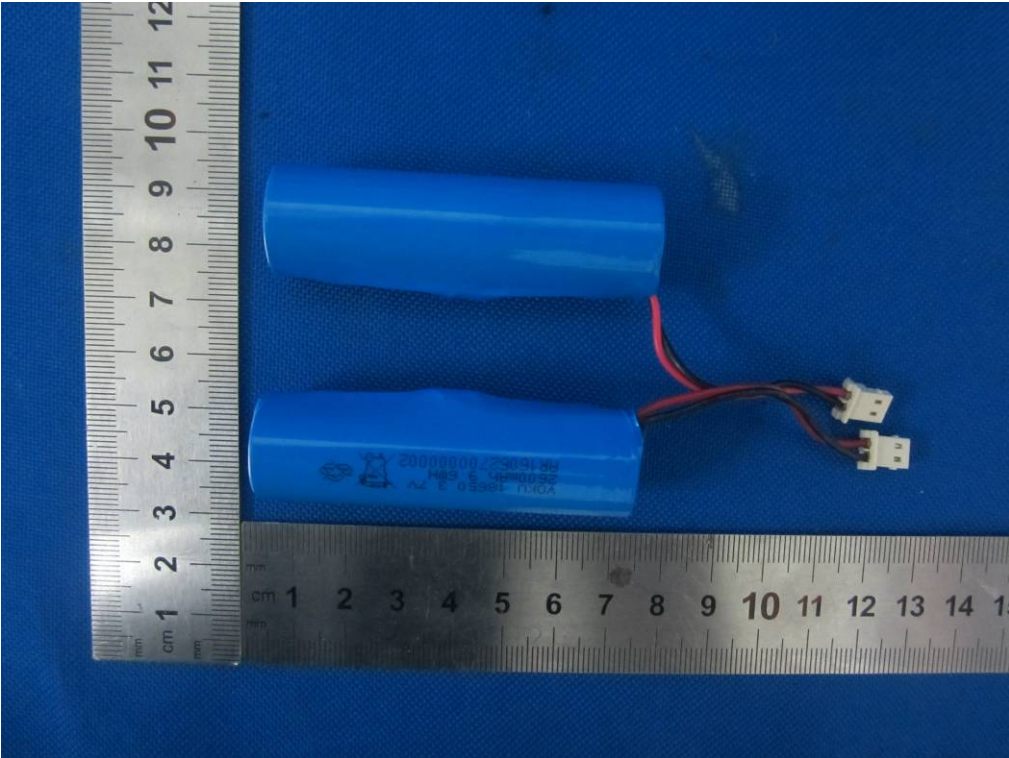

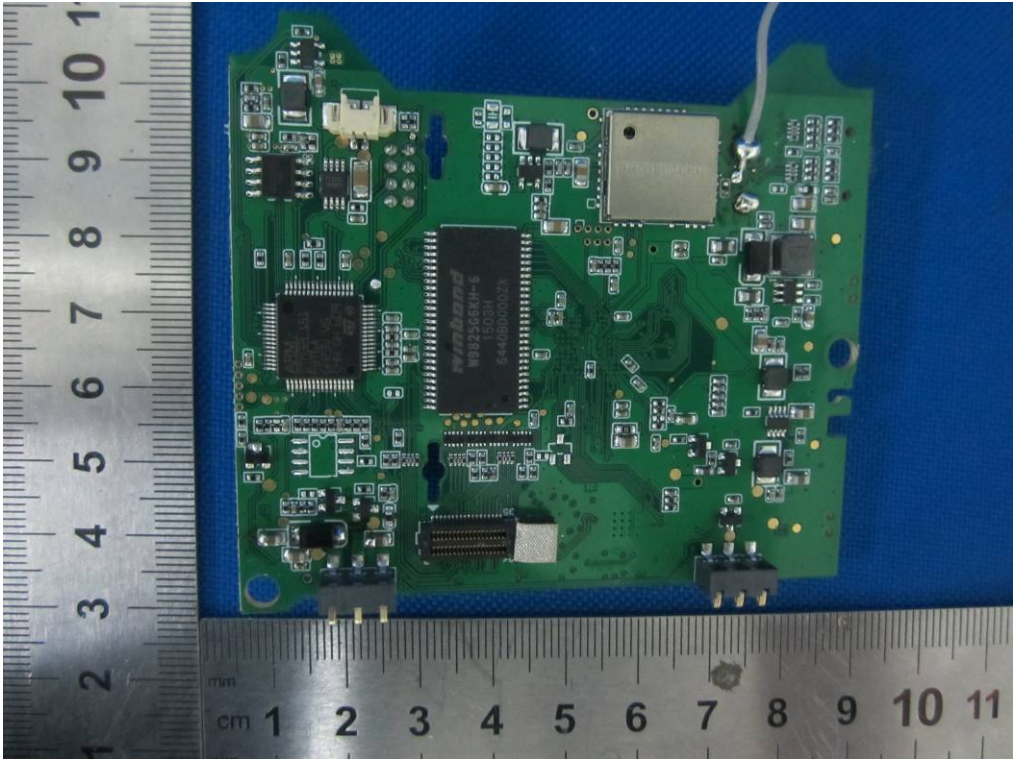
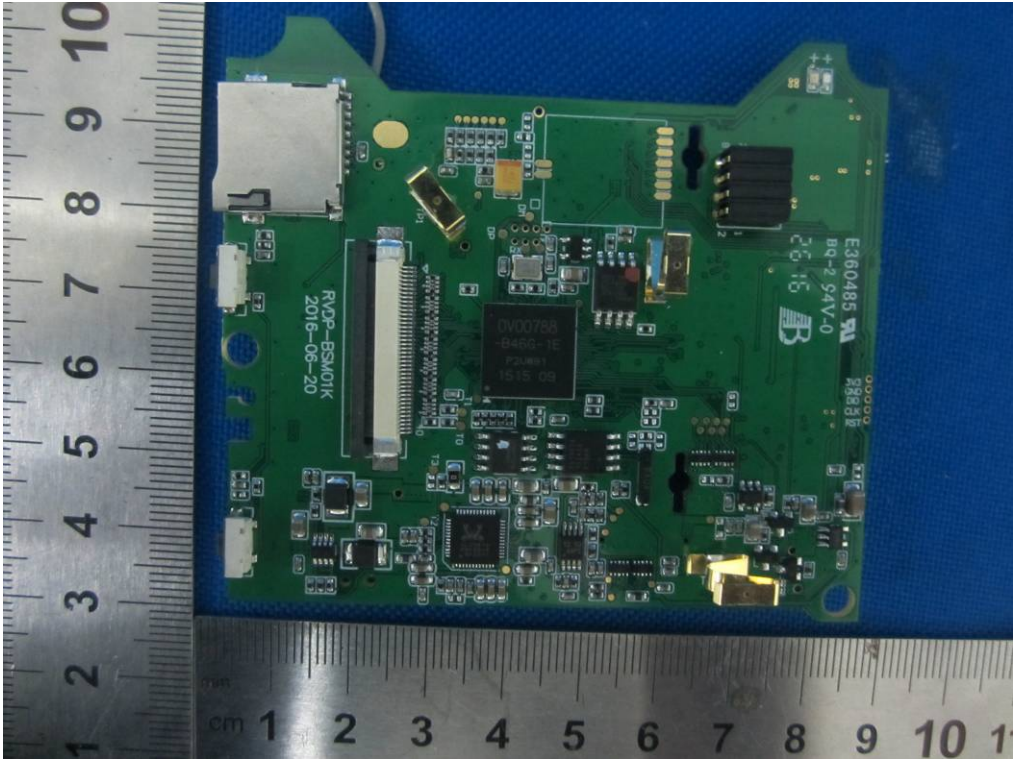



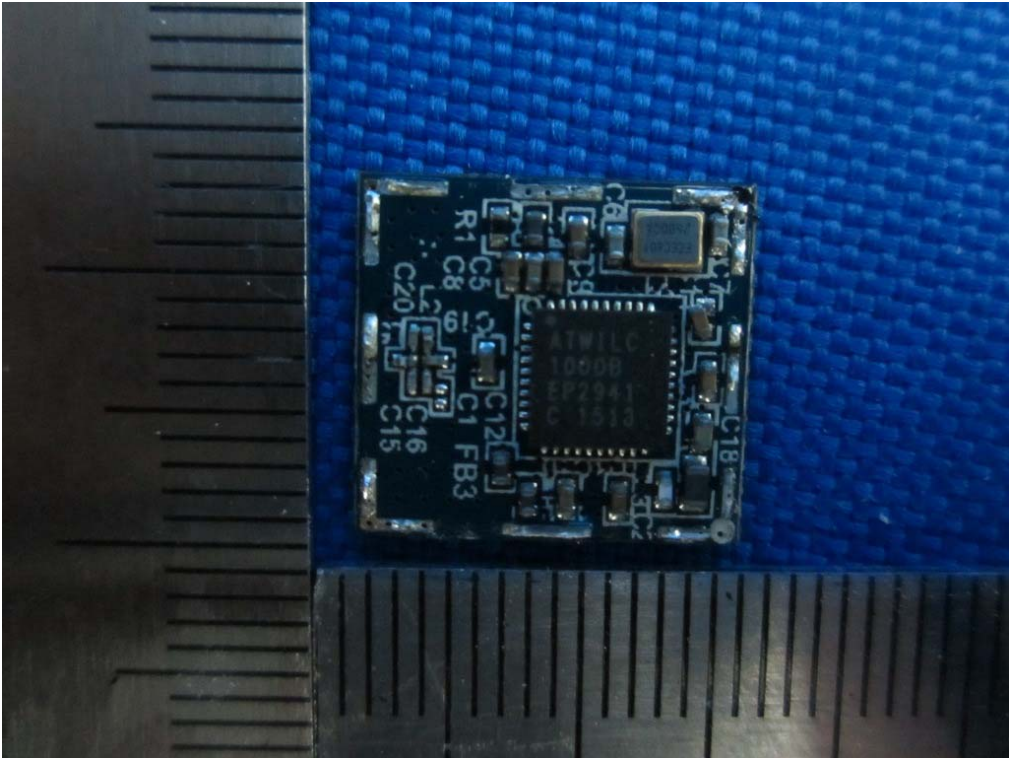
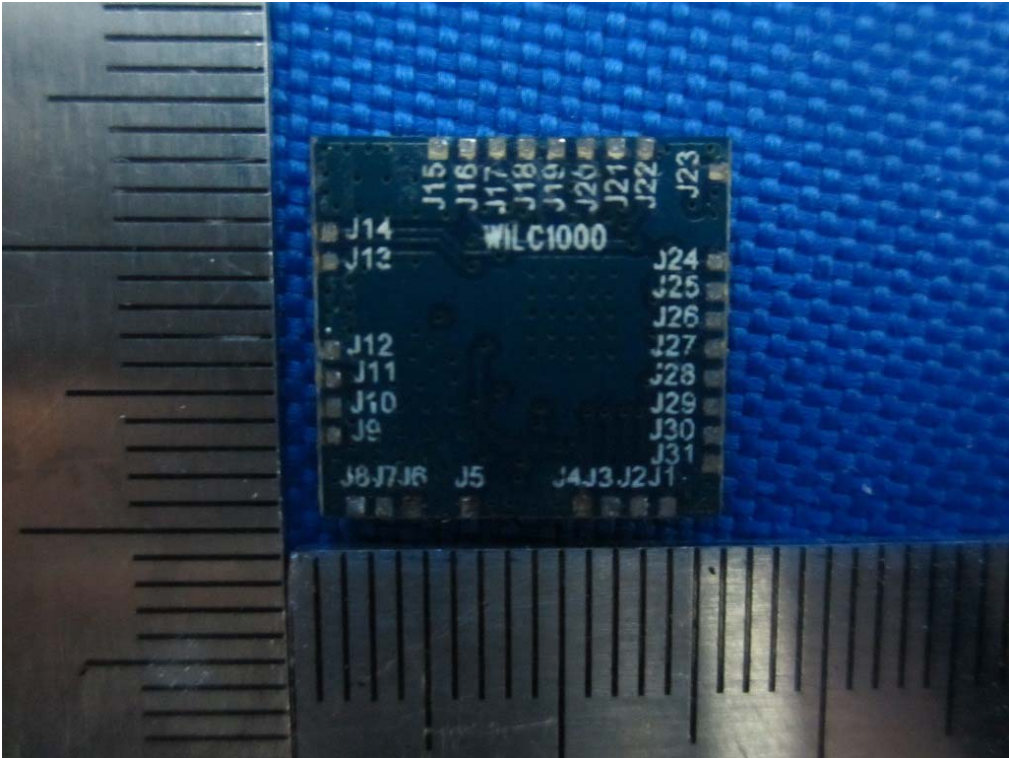

END OF REPORT