



Excellence in Compliance Testing

Certification Exhibit

**FCC ID: U4A-YRHZPZW0
IC: 6982A-YRHZPZW0**

**FCC Rule Part: 15.249
IC Radio Standards Specification: RSS-210**

ACS Project Number: 12-0002

Manufacturer: Assa Abloy Inc.
Models: YRD220-ZW, YRD210-ZW, YRT210-ZW, YRT220-ZW

Manual – YRD220-ZW



Yale Real Living™ Touchscreen Deadbolt Installation and Programming Instructions



NOTE TO INSTALLER

FAILURE TO FOLLOW THESE INSTRUCTIONS
COULD RESULT IN DAMAGE TO THE PRODUCT
AND VOID THE FACTORY WARRANTY

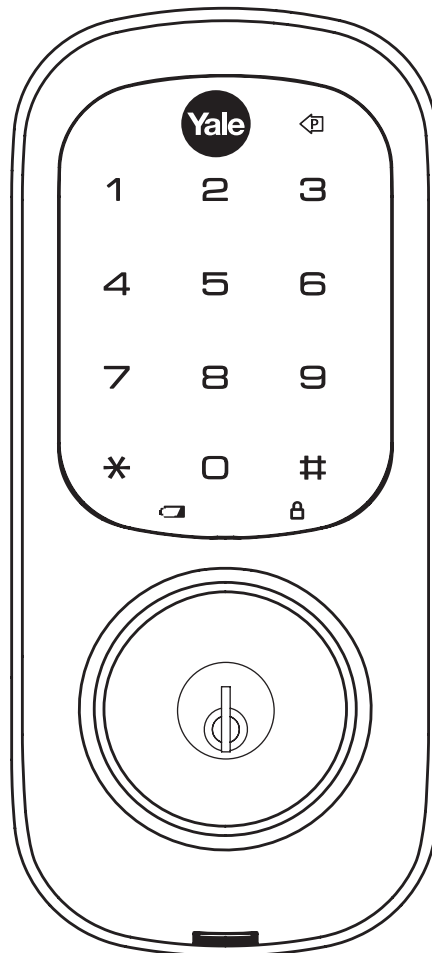

For Technical Assistance call Yale at 1-800-810-WIRE (9473)

This document is available on our website in printed Spanish and French. Go to www.yalerealliving.com.
Click "Product Information & Documentation" and then "Installation Instructions".

Este documento está disponible en español en nuestra página de internet. Vaya a www.yalerealliving.com.
Presione "Información del Producto y Documentación" y luego "Instrucciones de Instalación".

Ce document est disponible sur notre site Web dans le français imprimé. Allez à www.yalerealliving.com.
Cliquez sur le " ; Information sur le produit et Documentation" et puis "Installation Instructions".

TABLE OF CONTENTS

Warnings	2
Reset Lock to Factory Default	3
Introduction	4
Installation	
Components and Tools.....	5
Prepare Lock for Installation.....	6
Install Lock.....	7-8
Programming	
Programming Features-Menu Keys-Definitions	9-10
Operation.....	11-13
Miscellaneous Information	
Hardware Troubleshooting.....	14
Programming Troubleshooting	15
Installing the Network Module.....	16
Replace/Install Cylinder.....	17
Sample Pin Code Management Sheets	18-19

WARNINGS

Warning: Changes or modifications to this device not expressly approved by Yale Security, Inc. could void the user's authority to operate the equipment.

IMPORTANT: The accuracy of the door preparation is critical for the proper functioning and security of this product. Misalignment can cause performance degradation and a lessening of security.

Finish Care: This lockset is designed to provide the highest standard of product quality and performance. Care should be taken to ensure a long-lasting finish. When cleaning is required use a soft, damp cloth. Using lacquer thinner, caustic soaps, abrasive cleaners or polishes could damage the coating and result in tarnishing.

FCC:

FCC ID: U4A-YRHCPZW0 (Z-Wave); U4A-YRHCPZB0 (Zigbee)

Model(s): YRD220-ZW, YRD220-ZB

This equipment has been tested and found to comply with the limits for a Class B digital device, pursuant to Part 15 of the FCC Rules. These limits are designed to provide reasonable protection against harmful interference in a residential installation. This equipment generates, uses, and can radiate radio frequency energy and, if not installed and used in accordance with the instructions, may cause harmful interference to radio communications. However, there is no guarantee that interference will not occur in a particular installation. If this equipment does cause harmful Interference to radio or television reception, which can be determined by turning the equipment off and on, the user is encouraged to try to correct the interference by one or more of the following measures:

- Reorient or relocate the receiving antenna.
- Increase the separation between the equipment and receiver.
- Connect the equipment into an outlet on a circuit different from that to which the receiver is connected.
- Consult the dealer or an experienced radio/TV technician for help.



To Ensure Proper Lock Handing and for an explanation of how to determine your lock handing, please read this important note.

IMPORTANT: Do not install batteries until the lock is completely installed on door. For your convenience, the Yale Real Living lock will automatically determine whether it will function as a right or left-handed lock. (The "hand" or "handing" of the lock, is determined by the side of the entry door that the hinges are on when standing outside the door)

NOTE: The bolt must be in a retracted (unlocked) position when installing the lockset and before batteries are installed.

When the batteries are properly inserted for the first time, the lock will attempt to determine its handing - whether the lock is installed on the door or not. If the lock is not completely installed on the door, it could hand itself incorrectly.

Should this occur, the lock must be installed on the door and then reset to its factory defaults, allowing the lock to "hand" itself correctly.

To reset the lock to factory default, see the following:

Reset Lock to Factory Default

The following procedure clears the automatic handing of the lock and returns the lock to programming default - deleting all user codes and setting the Master PIN code* back to the default ("12345678").

1. Remove the batteries and then remove the inside escutcheon to access the reset button.
 2. The reset button (see image at right) is located above the PCB cable connector.
 3. Hold down the reset button for a minimum of 3 seconds and then reinstall the batteries; once the batteries are properly installed, release the reset button.
 4. Reassemble the lock by reversing the same steps on page 6.
- All features should now be returned to factory default.

*The default Master PIN code **must be changed** prior to programming of the lock.

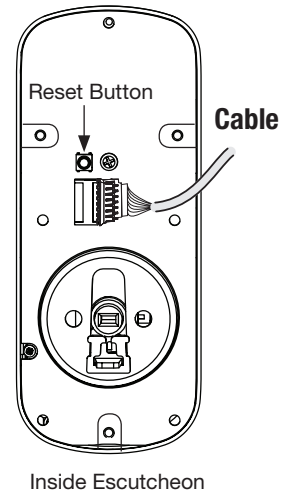

Industry Canada:

Canadian ID: 6982A-YRHCPZW0 (Z-Wave); 6982A-YRHCPZB0 (Zigbee)
Model(s): YRD220-ZW, YRD220-ZB

This Class B digital apparatus meets all requirements of the Canadian Interference Causing Equipment Regulations. Operation is subject to the following two conditions: (1) this device may not cause harmful interference, and (2) this device must accept any interference received, including interference that may cause undesired operation.

Cet appareillage numérique de la classe B répond à toutes les exigences de l'interférence canadienne causant des règlements d'équipement. L'opération est sujette aux deux conditions suivantes: (1) ce dispositif peut ne pas causer l'interférence nocive, et (2) ce dispositif doit accepter n'importe quelle interférence reçue, y compris l'interférence qui peut causer l'opération peu désirée.

For the U4A-YRHCPZB0 and 6982A-YRHCPZB0, the following statement applies:

“This equipment complies with FCC/IC radiation exposure limits set forth for an uncontrolled environment. This equipment should be installed and operated with minimum distance 20cm between the radiator and your body. This transmitter must not be co-located or operating in conjunction with any other antenna or transmitter.”

Section 7.1.2 of RSS-GEN Under Industry Canada regulations, this radio transmitter may only operate using an antenna of a type and maximum (or lesser) gain approved for the transmitter by Industry Canada. To reduce potential radio interference to other users, the antenna type and its gain should be so chosen that the equivalent isotropically radiated power (e.i.r.p.) is not more than that necessary for successful communication.

En vertu des règlements d'Industrie Canada, cet émetteur radio ne peut fonctionner avec une antenne d'un type et un maximum (ou moins) approuvés pour gagner de l'émetteur par Industrie Canada. Pour réduire le risque d'interférence aux autres utilisateurs, le type d'antenne et son gain doivent être choisies de façon que la puissance isotrope rayonnée équivalente (PIRE) ne dépasse pas ce qui est nécessaire pour une communication réussie.

Section 7.1.3 of RSS-GEN This Device complies with Industry Canada License-exempt RSS standard(s). Operation is subject to the following two conditions: 1) this device may not cause interference, and 2) this device must accept any interference, including interference that may cause undesired operation of the device.

Cet appareil est conforme avec Industrie Canada RSS standard exemptes de licence(s). Son fonctionnement est soumis aux deux conditions suivantes: 1) ce dispositif ne peut causer des interférences, et 2) cet appareil doit accepter toute interférence, y compris les interférences qui peuvent causer un mauvais fonctionnement du dispositif.

INTRODUCTION

The Yale Real Living™ Stand-alone Touchscreen Deadbolt Lock combines a robust lockset with a contemporary electronic aesthetic.

Users benefit from an interactive touchscreen that makes day-to-day access effortless, as well as offering voice-guided programming for simple updates to user information in the event of staffing changes or security breaches. Yale Real Living™ is engineered for quick and easy installation and fits in place of a standard deadbolt lock door prep (ANSI/BHMA A156.115).

If this is an RF-enabled network lock, it needs to be located within 50 - 100 feet of another network controller. That distance is influenced by objects between the lock and the controller and may be expanded depending on proximity to other RF network devices. Also, if the lock is connected to a network controller, it is recommended that it is programmed through the centralized user interface (PC or hand-held device) to ensure communication between the lock and the controller unit.

INSTALLATION

COMPONENTS AND TOOLS

Included in the box . . .

- | | | |
|--|--|---|
| <input type="checkbox"/> Quick Start Guide | <input type="checkbox"/> Inside Escutcheon | <input type="checkbox"/> Bolt |
| <input type="checkbox"/> Installation Instructions | <input type="checkbox"/> Inside Mounting Plate | <input type="checkbox"/> Strike Plate |
| <input type="checkbox"/> Door Marker | <input type="checkbox"/> Battery Cover | <input type="checkbox"/> Screw Pack (see below) |
| <input type="checkbox"/> Outside Escutcheon | <input type="checkbox"/> 4 AA Alkaline Batteries | <input type="checkbox"/> Keys |

Parts Illustrations

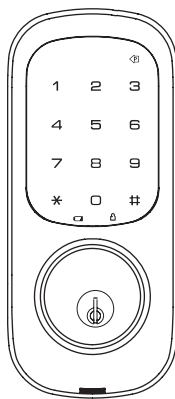

Outside Escutcheon

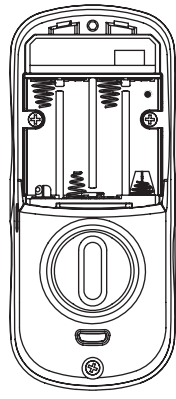

Inside Escutcheon

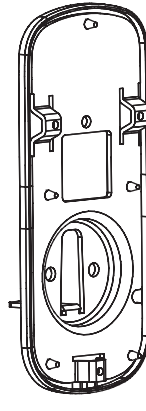

Inside Mounting Plate

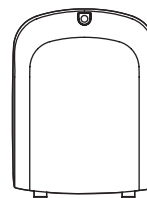

Battery Cover

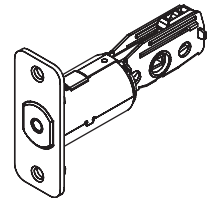

Bolt

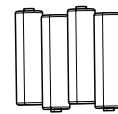

4 AA Alkaline Batteries



Strike Plate

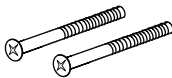

(2) Through bolts



(3) Inside Escutcheon Mounting screws

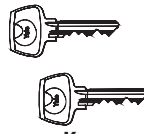

Keys

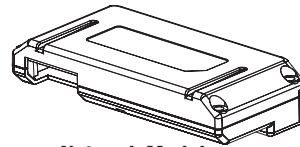

Network Module (Optional)



(4) Bolt & Strike Plate Mounting Screws

Tools Needed

Door Prep

- 2-1/8" (54mm) hole saw
- 1" (26mm) boring bit
- 7/64" (2.5mm) drill bit
- Chisel & hammer

Lock Installation

- #2 Phillips screwdriver

PREPARE LOCK FOR INSTALLATION

Unpack the Lock

The lock is packed representative of how it will install on the door.

Before installing the lock on the door:

A. Inside escutcheon

1. Loosen the screw (Phillips #2) holding the battery cover. (The screw remains attached to battery cover)
2. Slide the battery cover up and out (note the two tabs at bottom of battery cover).
3. Remove the inside mounting plate (with gasket) from the back (door side) of the inside escutcheon.

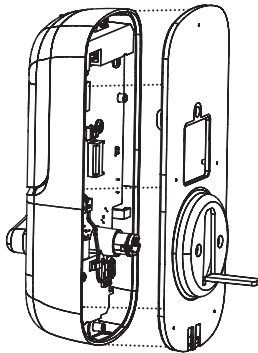
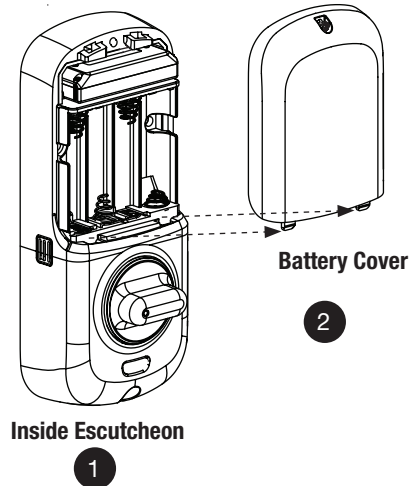

Inside Escutcheon & Mounting Plate (with gasket)

3

- a. Ensure that gasket on inside mounting plate is properly fitted. Note the positioning of the gasket's five rubber nubs (Figure 3A).

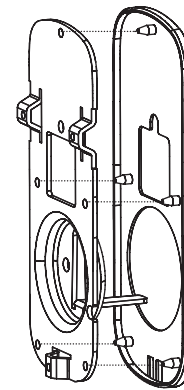

Figure 3A

B. Bolt

Note: Bolt ships with backset in 2-3/8" position. If required, press small black button on underside of bolt and pull to extend to 2-3/4" backset position.

Image (Fig. 3B) shows proper orientation when installing the bolt.

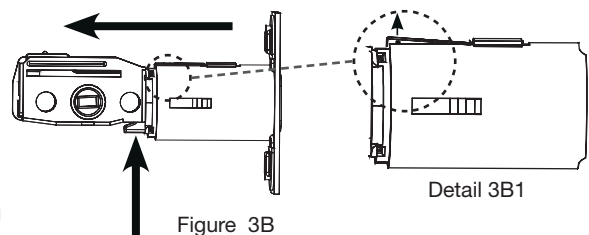

Figure 3B

- C. The outside escutcheon (with gasket) remains assembled.



6

INSTALL LOCK

1. Install bolt in door.

NOTE: The bolt must be in a retracted (unlocked) position when installing the lockset.

Attach with two (2) M4 x 25.4mm [8-32 x 1"] screws supplied.

2. Install strike on the door frame, making sure to allow for the bolt to be centered in the strike.

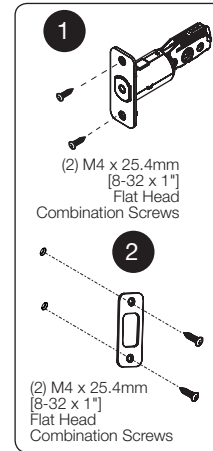

3. Install outside escutcheon.

As you position the outside escutcheon, route the cable through 2-1/8" diameter hole (Figure 3A).



NOTE: Cable goes under bolt (Fig. 3B).

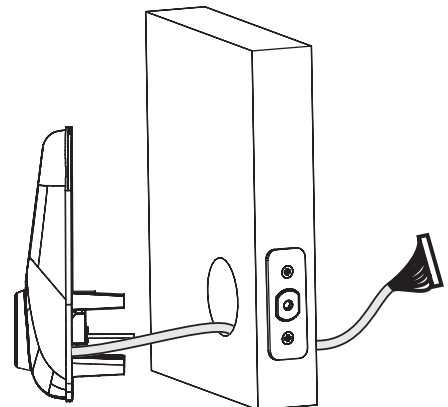

Figure 3A

4. Holding the outside escutcheon flush to the door, position the inside mounting plate by first routing the cable and connector through the mounting plate's 1/2" hole (Fig. 4A) and then inserting the mounting plate "tongue" into the bottom slot of the outside escutcheon (Fig. 4B).

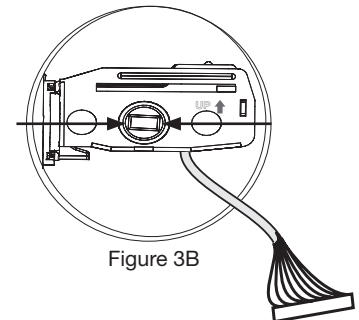

Figure 3B

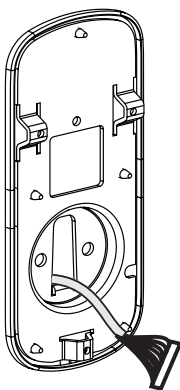

Figure 4A

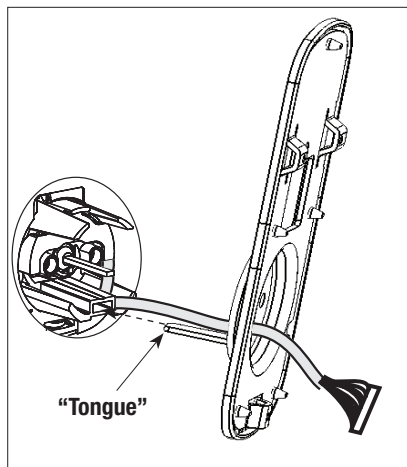

Figure 4B

- Secure both assemblies using (2) M6 x 59.5mm pan head machine screws, making sure that outside escutcheon is vertically aligned.

Tighten securely with a #2 Phillips screwdriver. Do not over-tighten.

- Attach cable assembly to the inside escutcheon printed circuit board (PCB) by lining up notches on top of cable connector to slots on PCB connector (Fig. 6B). Press connector in firmly using thumbs until completely seated (proper position indicated by arrows on PCB as in Figures 6A and 6B).

CAUTION:

Use care when assembling to ensure that the cable lies against the back recessed area of the inside escutcheon (Fig. 6A).

Position and bend cable, using the harness clip as shown in Fig. 6A to prevent binding when installing the escutcheon over the mounting plate.

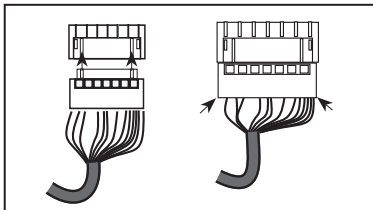

Figure 6B

- Install inside escutcheon on inside mounting plate. Note in Fig. 7A the horizontal orientation of the tail piece as you insert the inside escutcheon (thumb turn should be vertical).

NOTE: The bolt must be in a retracted (unlocked) position prior to installing the batteries.

- Install and secure using (3) M4 x 8mm [8-32 x 5/16"] pan head screws through the inside escutcheon into the mounting plate.

IMPORTANT: Before installing the batteries, test the **mechanical** operation of the lock by using both thumb turn and the key. The movement of the bolt should be smooth and unobstructed. If operation is not smooth, review the previous steps to ensure proper installation.

- Insert four (4) AA alkaline batteries. The lock responds, **“Welcome to Yale Real Living™”**. When activating the lock for the first time, the lock will adjust for proper handing.

Note: Refer to programming instructions prior to completion of step 10.

- Install battery cover and tighten Phillips head screw.

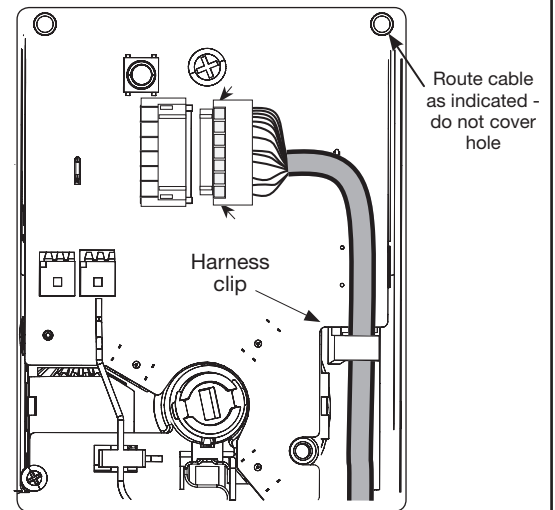
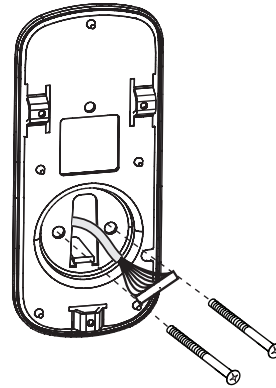

Figure 6A

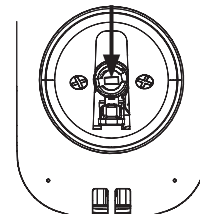
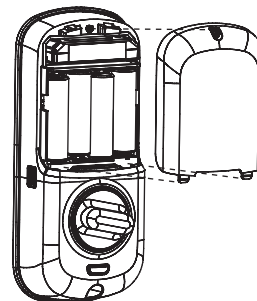
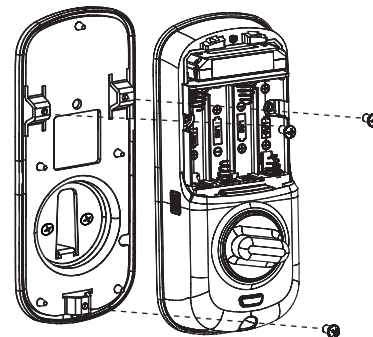

Figure 7A



PROGRAMMING

Programming Features-Menus-Keys-Definitions 9-10
 Operation 11-13

PROGRAMMING FEATURES - MENU KEYS - DEFINITIONS

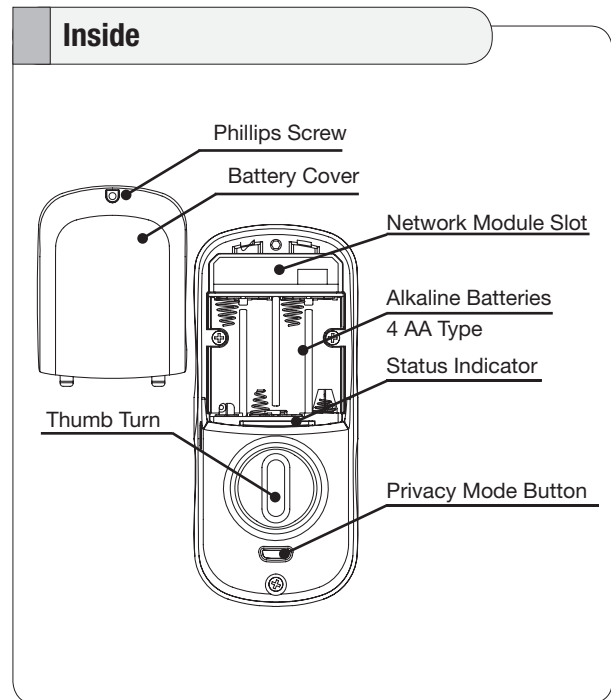
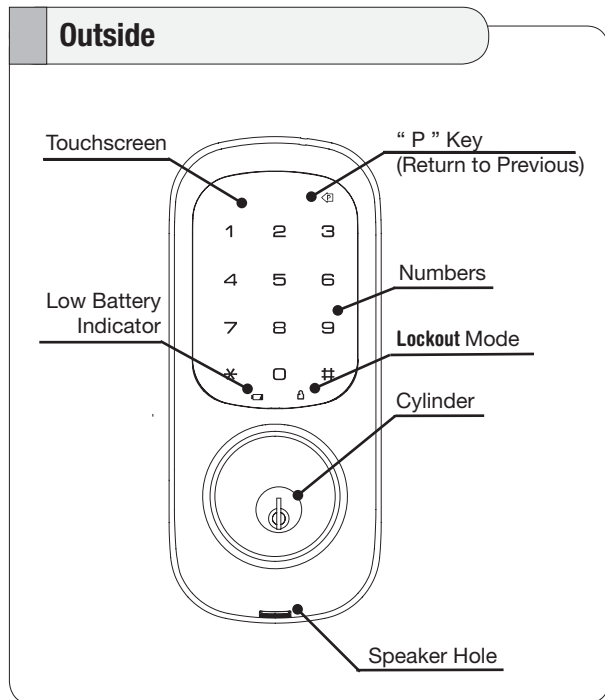

Menu Keys and Icons Used in This Guide

	Touch the screen with back of hand or fingers to begin and end actions.		Repeat operation using settings indicated. Enter Value 1 -10 (times or seconds).
	Press the indicated number.		Enter M aster PIN code* (4-8 digits in length). Factory default: 12345678.
	Press the Star key on the touchscreen to Enter or Accept entry.		Enter U ser PIN code. Can be 4-8 digits in length.
	Press the Pound key on the touchscreen to enter Menu mode.		U ser Number (1-25); R F Network-Controlled (1-250).
	Press this key to return to the previous step or menu setting.		

*The default Master PIN code **must be changed** prior to programming of the lock.

Status Indicators

1 Low Battery Warning

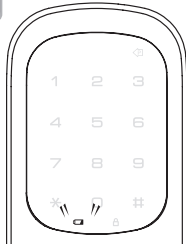

2 Lock-out Mode

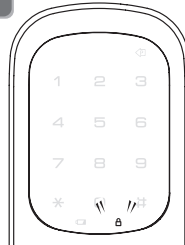

3 Return to previous step

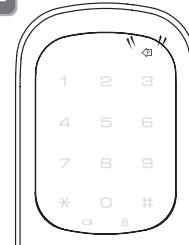

Definitions

Lockout Mode: This feature is enabled by the Master PIN code. When enabled, it restricts all user PIN code access. When the unit is in Lockout Mode, the red locked padlock will appear on the screen when attempting to enter a PIN code.

Low Battery: When battery power is low, the **low battery icon** will begin blinking. If battery power is completely lost, use the key override.

Master PIN code: The Master PIN code is used for programming and for feature settings. **NOTE: The default Master Pin Code must be changed prior to any further programming of the lock.** The Master PIN code will also operate the lock.

Privacy Mode : This button located under the thumb turn on the inside escutcheon, activates/deactivates the voice response and keypad and is indicated by a **blue LED** flash every ten (10) seconds. It is also overridden by mechanically operating the thumb turn or key.

Auto Re-lock: After successful PIN code entry and the unit unlocks, it will automatically re-lock after a default of thirty (30) seconds. Re-lock time is adjustable from five (5) to thirty (30) seconds.

OneTouch Re-Lock: When the bolt is retracted, activating the keypad will extend the bolt (during Auto Re-Lock duration or when Auto Re-Lock is disabled).

Shutdown Time: The unit will shutdown for a default of sixty (60) seconds and not allow operation after the wrong code entry limit has been met. When the unit is in Shutdown, the red **locked padlock icon** will flash every ten (10) seconds.

Silent Mode: Enabling Silent mode shuts off the code confirmation tone playback for use in quiet areas. Silent mode is selected in the Volume feature (4) of Menu Mode. There are three levels (High/Low/Silent).

Status LED: Located on inside escutcheon.

User PIN code: The User PIN code operates the lock. Maximum number of user PIN codes is 250 with Network Module; without Network Module, maximum is 25 user PIN codes.

Wrong Code Entry Limit: After a specified number of unsuccessful attempts at entering a valid PIN code the unit will shut down and not allow operation. Wrong code entry limit is adjustable from three (3) to ten (10) times through feature settings (up to 5 times with no RF network enabled - default is 5; 10 with RF network enabled).

Factory Defaults

Settings	Factory Defaults
Master Code	12345678
Auto Re-lock	Enabled
Volume	High
Auto Re-lock Time	*30 Seconds
Wrong Code Entry Limit	*5 Times
Shutdown Time	*60 Seconds
Language	ENGLISH

*Adjustable only when using Network Module

OPERATION



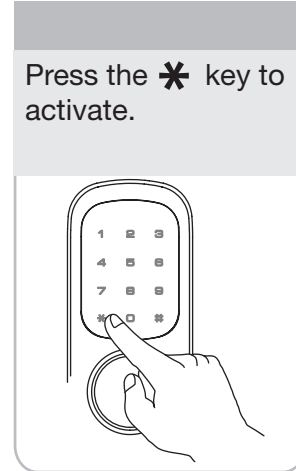
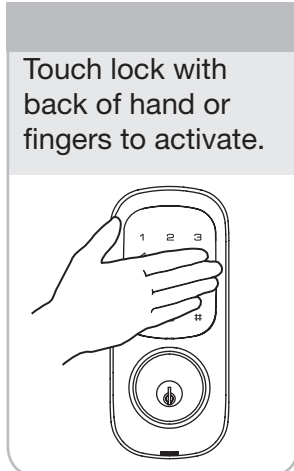

Lock Activation

The touchscreen can be activated in several ways:



Lock Operation

Change Default Master Code Before Programming*

1. Touch the screen with the back of your hand or fingers to activate .
2. Enter the 8-digit default Master PIN code (12345678) followed by the  key.
Lock Response: "Menu mode, enter number, press the .
3. Enter "1" followed by the .
4. Enter new 4-8 digit Master PIN code followed by the .

*This step is required prior to programming of the lock.

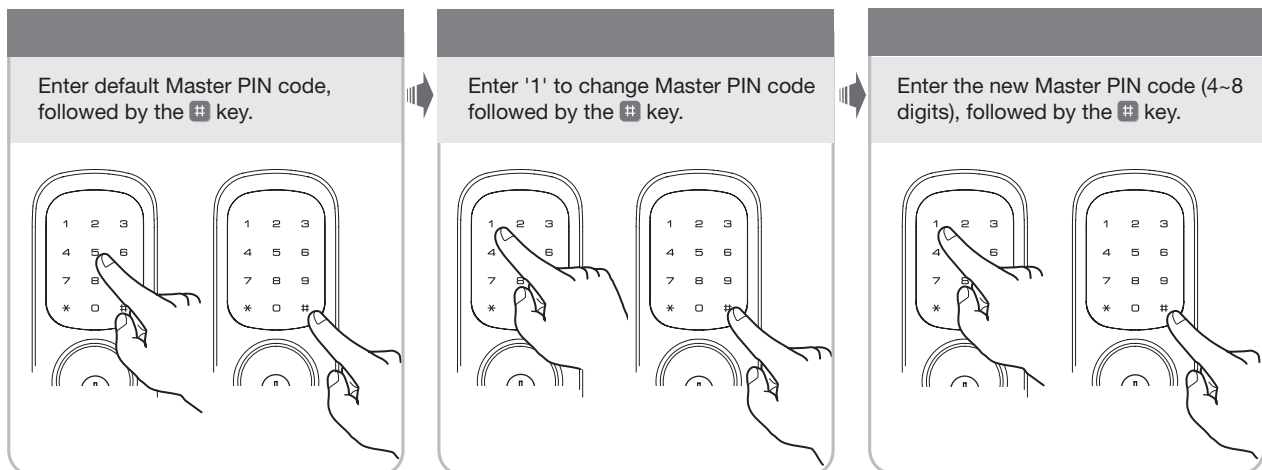









PIN code structure

Maximum number of user codes is 250 with Network Module; without Network Module, maximum is 25 user codes

Set Up User PIN Codes

User PIN Codes can only be programmed through the Master PIN Code*.

1. Touch the screen with the back of your hand or fingers to activate .
2. Enter the 4-8 digit Master PIN code followed by the  key.
Lock Response: “Menu mode, enter number, press the  key to continue.”
3. Enter “2” followed by the  key.
4. Enter “1” followed by the  key.
5. Enter the User Number to be registered (1-25) followed by the  key.
6. Enter a 4-8 digit PIN code for the User number followed by the  key.
7. **To continue adding users** press the  key.
8. Press the  key to complete the process and conclude the programming session.

Note: When registering User codes, the code must be entered within 20 seconds or time expires, Lock Response: “Time expired”, no codes are registered and the process must be re-started.

*Master PIN code must be changed from the default before User codes can be added.



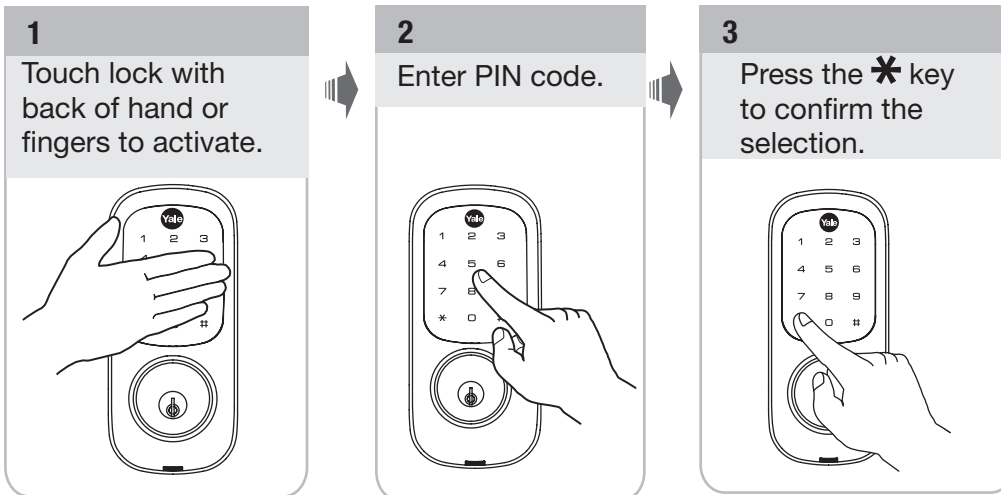

Open Door with PIN Code



Privacy Mode vs. Lockout Mode

- Lockout is a Menu feature (6) that restricts Pin code access (except Master).
- Privacy mode is set by pressing and holding the button (found below thumb turn) for a duration of four beeps. This deactivates the keypad and sound, and because it is set from the inside, provides a secure and silent lock for the convenience of the occupant(s).

Feature Programming Through Menu Mode Using Master PIN code*

1. Touch the screen with the back of your hand or fingers to activate .
2. Enter the 4-8 digit Master PIN code* followed by the  key.
Lock Response: "Menu mode, enter number, press the  key to continue."
3. Enter digit corresponding to the function to be performed followed by the  key.
Follow the voice commands.

Note: If the lock is connected to a network controller, it is recommended that it is programmed through the centralized user interface (PC or hand-held device) to ensure communication between the lock and the controller unit.

*The default Master PIN code must be changed prior to programming of the lock.

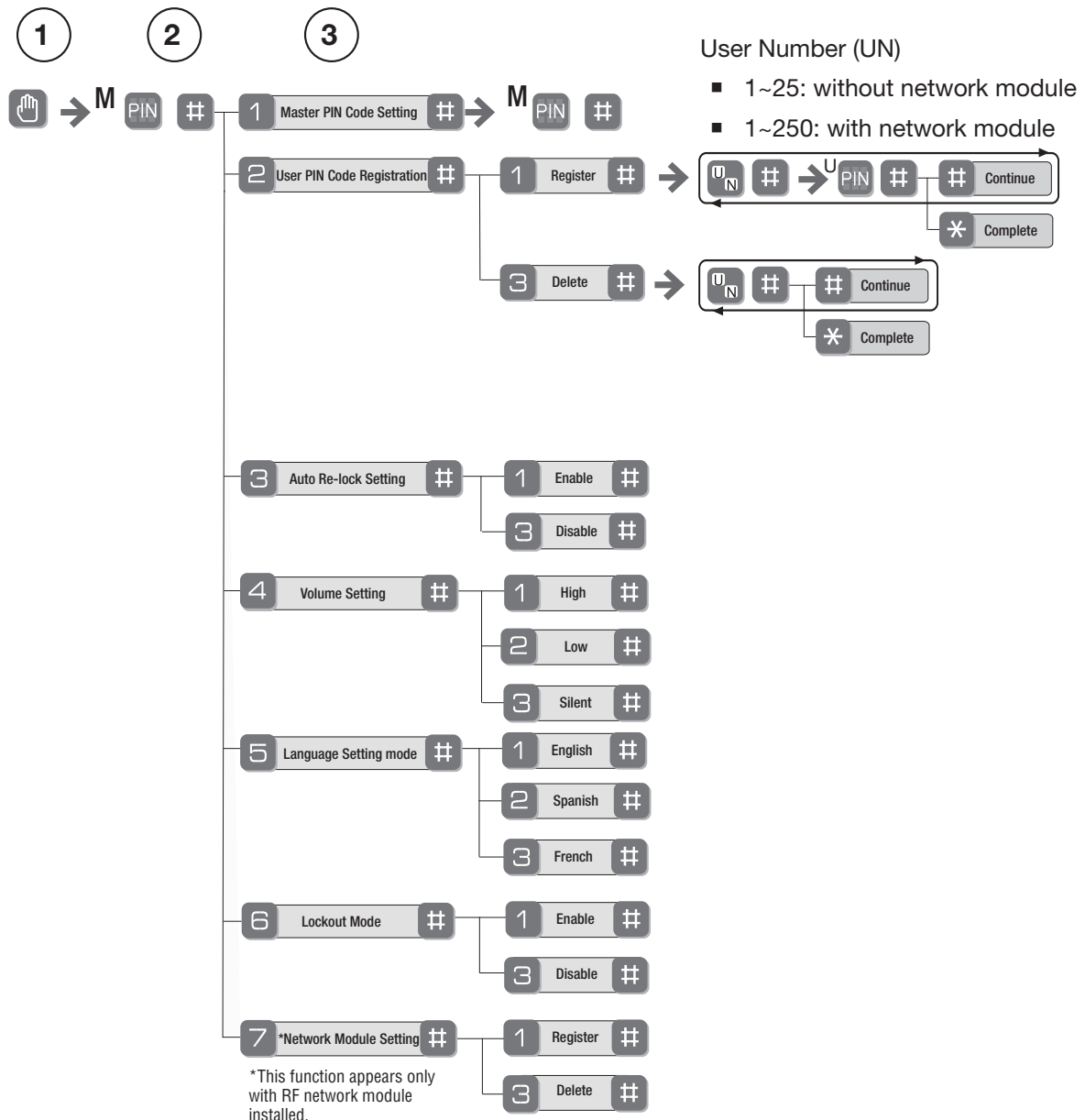

CAUTION: When joining a network your controller may or may not be aware of any previously saved user codes stored in the lock. It is recommended that all user codes be deleted from the lock prior to joining a network.

MISCELLANEOUS

Hardware Troubleshooting.....	14
Programming Troubleshooting	15
Installing the Network Module	16
Replace/Install Cylinder	17
Sample Pin Code Management Sheets	18-19

TROUBLESHOOTING

Hardware Troubleshooting

Cycle the lock in both the locked and the unlocked positions. If problems are found:

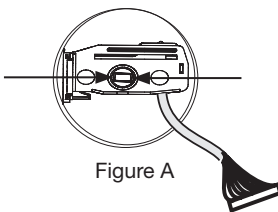
Symptom	Suggested Action
Door is binding	<ul style="list-style-type: none"> a. Check that door and frame are properly aligned and door is free swinging. b. Check hinges: They should not be loose or have excessive wear on knuckles.
Bolt will not deadlock	<ul style="list-style-type: none"> a. Check for sufficient clearance of the bolt within the strike-side jamb. Correct this by increasing the depth of the pocket for the bolt. b. Check for misalignment of bolt and/or strike which may be preventing bolt from properly entering the strike. With the door open, extend and retract the bolt; if it is smooth, check the strike alignment.
Bolt does not extend or retract smoothly	<ul style="list-style-type: none"> a. Bolt and strike are misaligned, see above. b. Check the backset of door relative to adjustments already made to bolt. c. Verify proper door preparation and re-bore holes that are too small or misaligned. d. Verify keypad cable/connector is routed under the bolt (see Fig. A). e. Verify bolt is installed with correct side up (Fig. A). <div style="text-align: center;">  <p>Figure A</p> </div>

Programming Troubleshooting

Symptom	Suggested Action
Lock does not respond – door is open and accessible.	<p>The touchscreen will become active when pressed with the back of hand or fingers in at least 3 areas simultaneously.</p> <p>Use a larger area of the hand or fingers and verify contact with at least 3 areas.</p> <p>If touchscreen numbers are visible, check to see if they respond when pressed.</p> <p>Check batteries are installed and oriented correctly in the battery case.</p> <p>Check batteries are in good condition; replace batteries* if discharged.</p> <p>Check to see if touchscreen cable is fully connected and not pinched.</p>
Lock does not respond – door is locked and inaccessible.	<p>Lock may be in Privacy mode (set from inside room). Mechanical key will grant access.</p> <p>Batteries may be completely discharged.</p> <p>Use mechanical key to gain entry and replace batteries*.</p>
The unit is on for a while, and then shows no reaction. Lights dim.	<p>The batteries do not have enough power. Replace the batteries*.</p>
Unit chimes to indicate code acceptance, but the door will not open.	<p>Check to see if there is an existing lock device on the door.</p> <p>Check the door gaps for any foreign objects between door and frame.</p> <p>Check that the cable is firmly connected to the PCB.</p>
Unit operates to allow access, but will not automatically re-lock.	<p>Check to see if Passage Mode** is enabled (Network module units only).</p> <p>If the Passage Mode icon on the touchscreen and the status indicator on the interior escutcheon flicker for several seconds, it is set at Passage Mode.</p> <p>Disable Passage Mode to lock the door.</p> <p>If low battery indicator is lit, replace batteries*.</p>
PIN codes will not register.	<p>PIN codes must consist of 4 to 8 digits to register.</p> <p>The same PIN code cannot be used for multiple users.</p> <p>Registration/management of PIN codes is set by the authority of Master Code.</p> <p>The default Master PIN code (12345678) must be changed prior to adding any users.</p> <p>Contact the Master user.</p> <p>User codes must be entered within 20 seconds (while the touchscreen is active) or the process will have to be restarted.</p> <p>The star * (*) or pound # (#) can not be used as part of the PIN code.</p>
Upon entering a PIN code and pressing the star (*) key, the unit displays an “invalid code” error or the lock times out without responding.	<p>Lockout Mode is enabled.</p> <p>Only the Master Code can enable Lockout Mode.</p> <p>Contact the Master user.</p>
Upon entering a PIN code and pressing the (*) key, the red padlock icon appears and there are different tones.	<p>Check to see if lock is set** at Lockout Mode.</p> <p>Setting/managing Lockout Mode is done through Master Code only. Contact the Master user.</p>
The unit operates, but it makes no sound.	<p>Check to see if Silent Mode is enabled (pages 8, 11).</p>
The unit responds “Low Battery”	<p>This is the voice alarm alerting that it is time to replace the batteries. Replace all four (4) batteries with new AA Alkaline batteries*.</p>
Upon entering a PIN code and pressing the star (*) key, the unit responds “Wrong number of digits.”	<p>The digits entered were incorrect or incomplete. Re-enter the correct code.</p>

* When batteries are replaced, Network Module locks have a real time clock that will be set through the User Interface; it is recommended to verify correct date and time particularly those locks operating under Daylight Saving Time (DST).

** Network module units only

Installing the Network Module

IMPORTANT: The batteries must be removed prior to removing and/or inserting the network module:

- Remove batteries
- Remove and/or insert network module
- Reinstall batteries

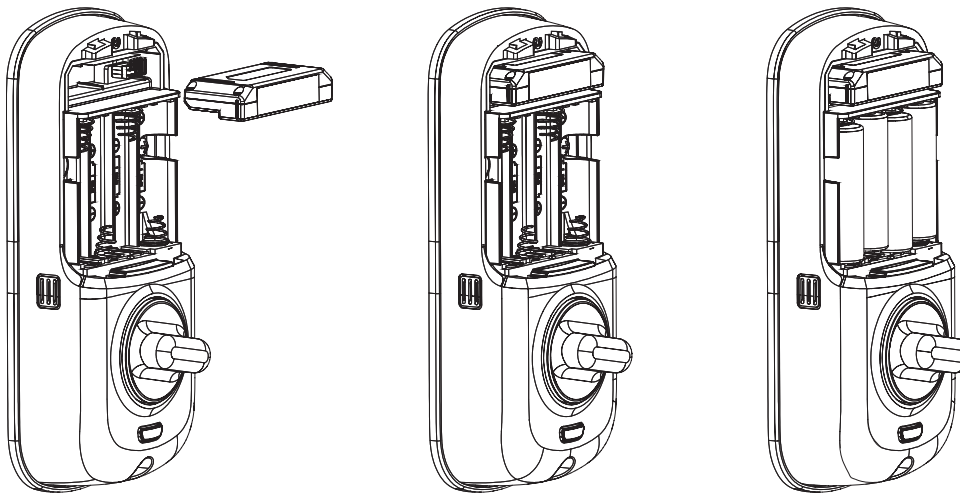

Use feature programming step 7 (page 13) for enrollment of the Network Module.

How to Replace or Install Cylinder

1. Remove cylinder:
 - A. Remove outside escutcheon from door.
 - B. Remove rubber gasket.
 - C. Insert small flathead screw driver under spring; (gently) lift spring.
 - D. **Note:** notch on top of cylinder engages spring
 - E. Remove cylinder by pulling (outward) towards outside of door.

Before installing cylinder, please be sure tailpiece is correct length (see below).

2. Install new cylinder:
 - A. Reverse previous steps for removing cylinder.

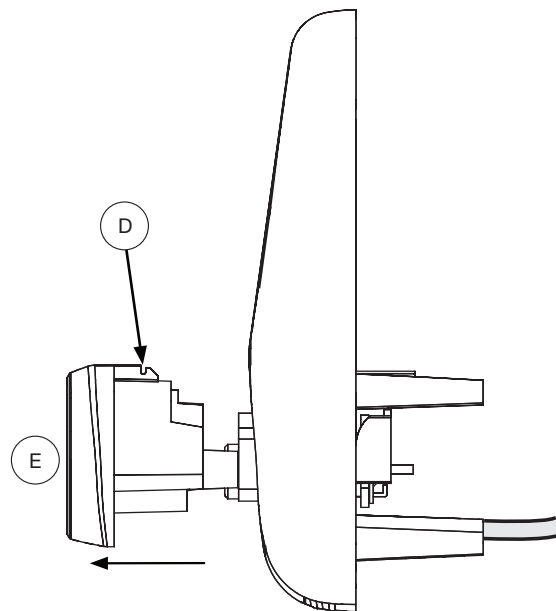
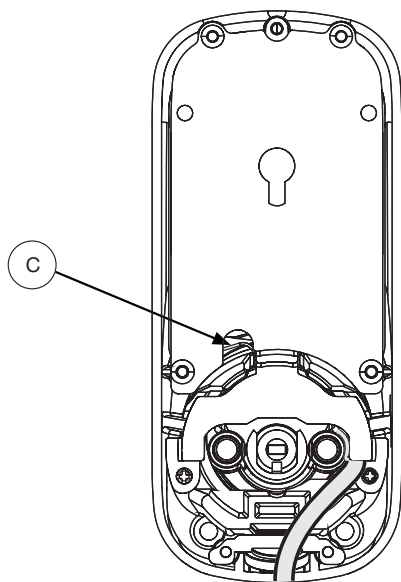
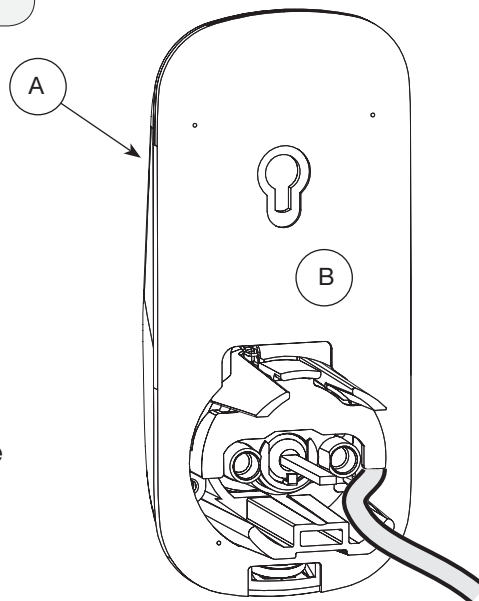

Cylinder tailpiece information:

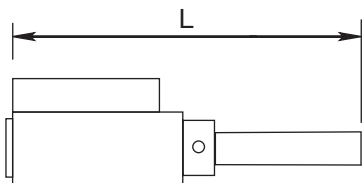

1-3/8" to 2" thick doors, **L** = 3-1/2" (88.8mm)
 2" to 2-1/4" thick doors, **L** = 3-3/4" (95.3mm)

**Requires addition of Thin Door Kit.*

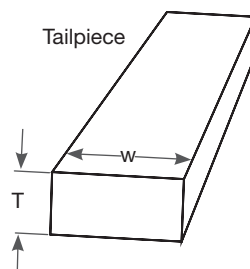

T = .098" (2.5mm)
W = .2" (5.2mm)

PIN CODE MANAGEMENT SAMPLE SHEETS

PIN Code Management (No Network Module - Up to 25 Users)

Location:		Door Number:		User	User Name	User #	PIN Code
User Type	User Name	User #	PIN Code				
Master				User 13			
User 01				User 14			
User 02				User 15			
User 03				User 16			
User 04				User 17			
User 05				User 18			
User 06				User 19			
User 07				User 20			
User 08				User 21			
User 09				User 22			
User 10				User 23			
User 11				User 24			
User 12				User 25			

ONLINE LITERATURE AND TEMPLATES

For the latest information on Yale products visit our website at www.yalelocks.com. Click on the “Literature” button to find the most up-to-date catalogs, parts manuals, templates, specifications and installation instructions.

Yale Locks & Hardware

100 Yale Avenue, Lenoir City, TN 37771 • Product Support Tel 800.810.WIRE (9473) • www.yalelocks.com

Yale Locks & Hardware is a division of Yale Security Inc., an ASSA ABLOY Group company.

Yale® is a registered trademark of Yale Security Inc., an ASSA ABLOY Group company. All rights reserved. Yale Real Living™ is a trademark of Copyright © 2011, Yale Security Inc., an ASSA ABLOY Group company. All rights reserved. Reproduction in whole or in part without express written permission of Yale Security Inc., an ASSA ABLOY Group company is prohibited.

YALE, with its unique global reach and range of products, is the world’s favorite lock — the preferred solution for securing your home, family and personal belongings.

ASSA ABLOY is the global leader in door opening solutions, dedicated to satisfying end-user needs for security, safety and convenience.