

Rev 1.0 ENG
All rights reserved
© 2023BLUECOM Co.,Ltd.



Please read the Important Safety Information for the proper use of this product. After reading, store this User Manual in a place easily accessible to all users.

Images may differ in appearance from the actual product. Content is subject to change without prior notice.

Bluetooth® is a registered trademark of Bluetooth SIG, Inc. worldwide.

1 Power

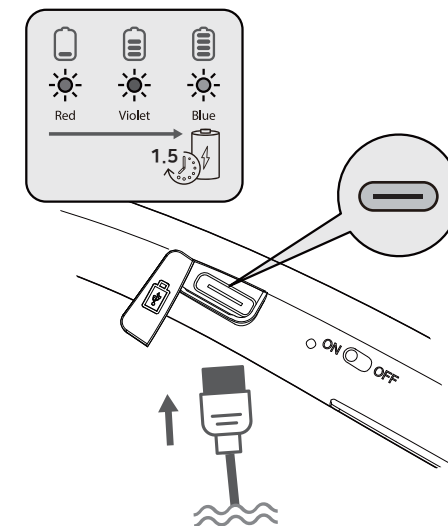
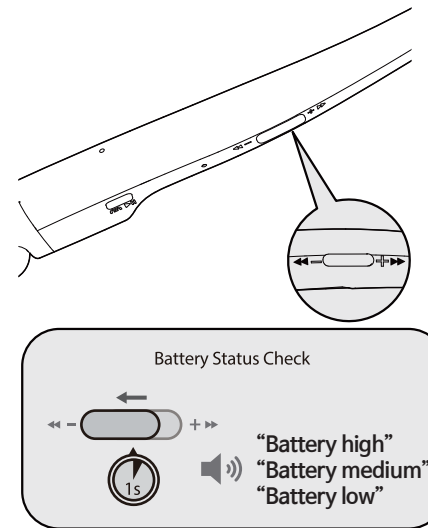
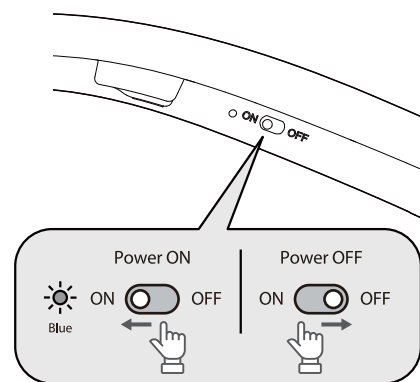
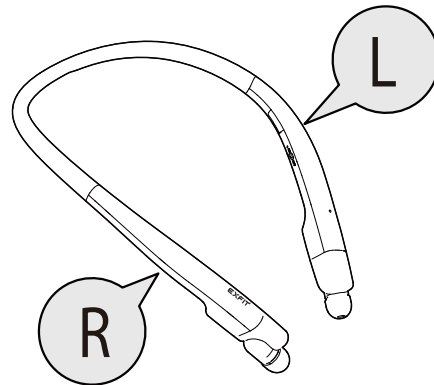
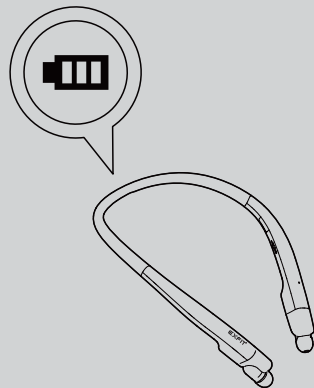

2 Connection

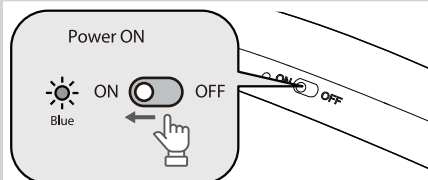
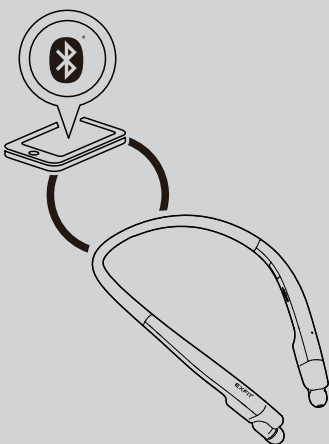

* If connecting for the first time, the headset will enter pairing mode automatically after it is powered on.

* After initial pairing, the headset will automatically reconnect to the previously connected device when turned on.

Manual Pairing Mode

* To connect to other device, press and hold the Call Key and slide the Power Key to the ON position to turn it on. Voice prompt: "Ready to pair" will initiate Pairing mode.

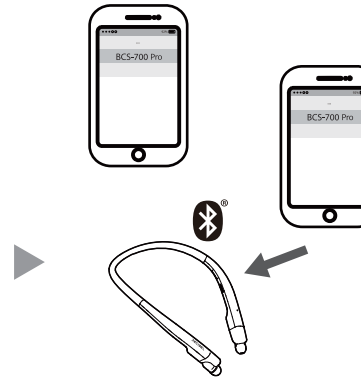
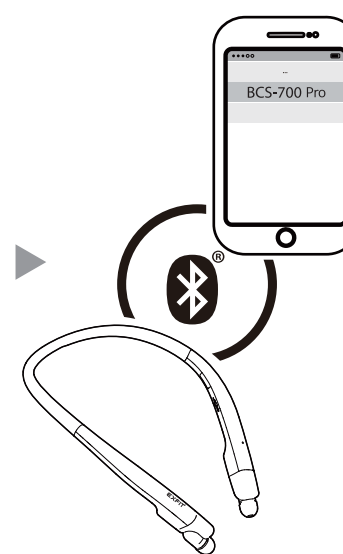
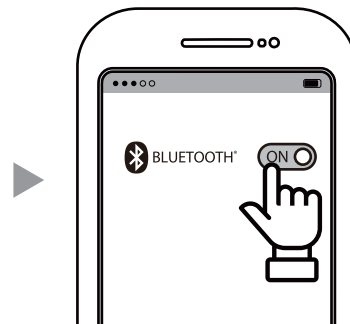
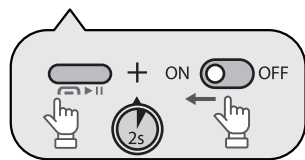

Multi-Point
While BCS-700 Pro is in connection with a device (Primary device), manually try to connect to another paired device (Secondary device).

3 Music

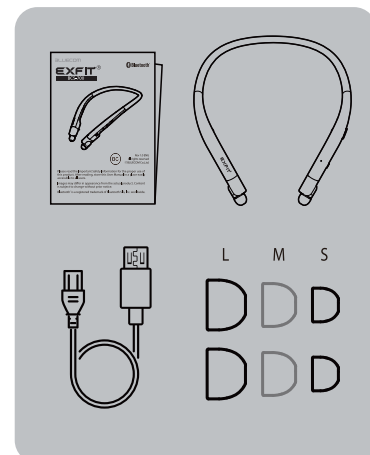
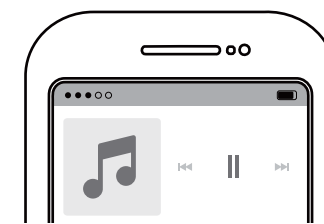
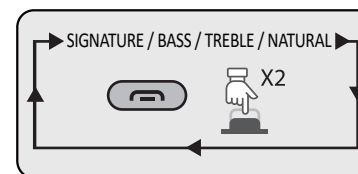
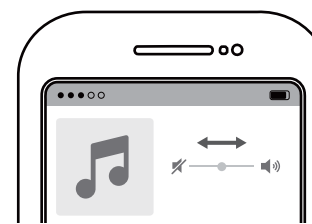
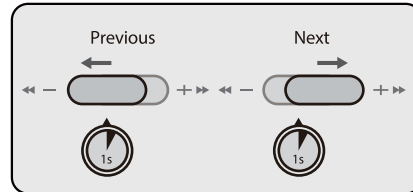
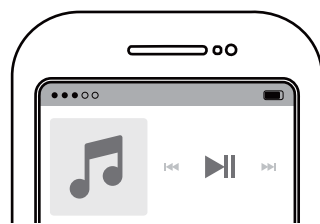
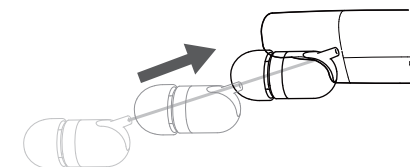
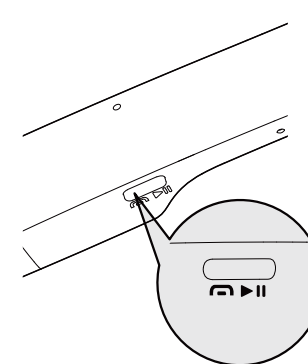
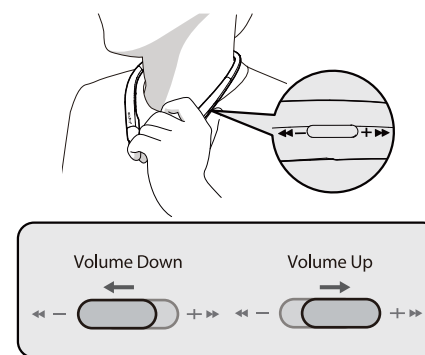
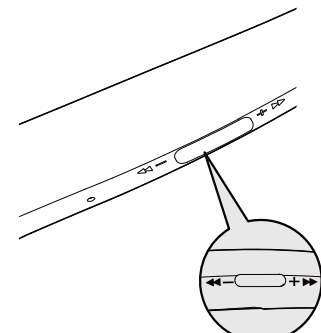
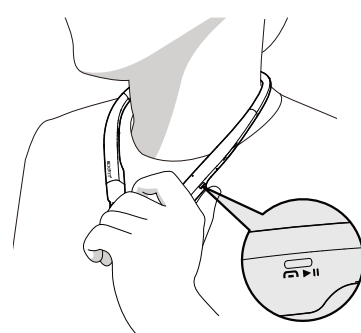
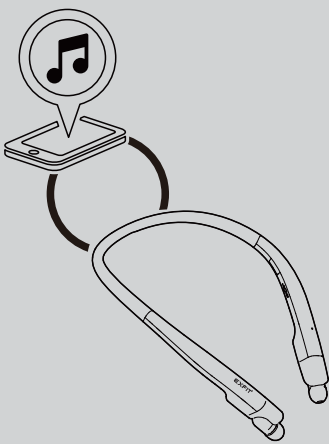

CAUTION

Make sure authentic components are used. Using a non-authentic component may damage the product and thus void the warranty. Actual product design may differ from images shown in manual.



4 Call

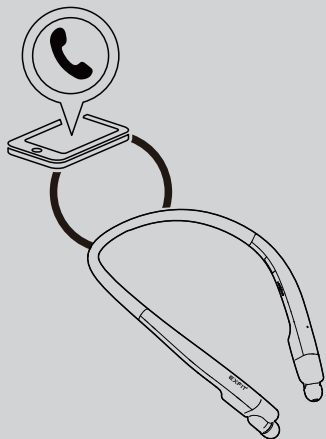

On the phone

Call end

Accept **Decline**

Incoming call

Long press for 2 seconds

Incoming call

Accept

Pull out one side

Decline /Call end

Retract back both sides

Call Swap

Long press for 2 seconds

On the phone

Audio Transfer

Long press for 2 seconds

On the phone

Mic Mute

Mic Mute/Un-mute mode

Long press for 2 seconds

Mic Mute/Un-mute mode

Long press for 2 seconds

Voice Recognition (or Voice Dialing)

Ready

Apple Siri Google Assistant

What time is it now? It's 10 o'clock.

* Voice Recognition function through Bluetooth® headset may only be used if your handset device supports the function. Please consult with your handset device manufacturer for compatibility.

5 Setting

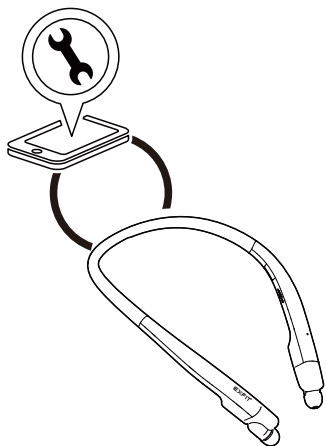

Game Mode

Depending on the connection conditions, the game mode may not function properly.

Vibrate ON / Vibrate OFF

Ambient Mode ON/OFF

Ambient mode ON

Ambient mode OFF

* Ambient mode (Audio Transparency) captures the environment sound when using the headset.

* Adjust the volume of the ambient sound with the volume jog key at standby status.

* **IMPORTANT SAFETY INSTRUCTIONS**
Do NOT rely on the Ambient mode to hear surrounding sounds which may present a danger to yourself or others (for example, while riding a bicycle or walking in or near traffic, a construction site or railroad tracks).

Auto Answer ON/OFF

L M S

M

SPECIFICATION

Bluetooth® Specification	Ver 5.2
Profiles	HSP/HFP/A2DP/AVRCP
Battery	130mAh Li-Polymer
Audio	HD Voice
RCV	Dynamic 8mm Receiver
Play Time	23hours
Rated Input Voltage	DC 5V 400mA
Noise Reduction	Dual MEMS MICs, Noise Reduction / Echo Cancellation
Water Resistant	Water / Sweat Resistant
FCC ID	U3WBCS700PRO

Duration of use may vary depending on the connected mobile device, features being used, settings, signal strength, operating temperature, frequency band, and other methods of use.

This device was tested in compliance with FCC RF Exposure limit. (0 mm distance from human head/body (limit 1.6 W/kg @ 1g SAR) and extremity (limit 4.0 W/kg @ 10g SAR)).

IMPORTANT SAFETY INSTRUCTIONS

- CAUTION**
- Do not disassemble, adjust, or repair the product arbitrarily.
 - Do not place the product near excessive heat or flammable material.
 - Do not arbitrarily replace the battery, as it may explode.
 - The product may be damaged if an incompatible recharger is used.
 - Make sure that an infant or child does not swallow a magnet or a small component of the product.
 - Make sure that foreign objects do not enter the charger's connectors (charging port and power plug).
 - Failure to do so may result in fire or electric shock.
 - For your safety, do not wear the product while it is being charged.
 - If you have a medical device implanted, contact your doctor before using this device.
 - Do not pull the earphone cable with excessive force.
 - For your safety, do not remove the battery incorporated in the product.
 - The lithium-ion polymer battery is a hazardous component which can cause injury.
 - Battery replacement by an unqualified professional can cause damage to your device.
 - If the product is exposed to excessive sweat, clean the product.
 - Keep the earphone gel tip clean.
 - Do not bend or twist the headset excessively.

WARNING

- Do not drop the product from a high place.
- Make sure there is no water, alcohol, or benzene in contact with the product.
- Do not store the product in a wet or dusty place.
- Do not place heavy objects on the product.
- It is not waterproof and should not be submerged in water. (Product is sweat and water resistant)
- The headset contains magnets in its earbuds. The American Heart Association (US) and the Medicines and Healthcare Products Regulatory Agency (UK) both warn that magnets can affect the operation of implanted pacemakers, cardioverters, defibrillators, insulin pumps or other electro medical devices (collectively, "Medical Device") within the range of 15 cm (6 inches). If you are a user of any of these Medical Devices, DO NOT USE THE HEADSET UNLESS YOU HAVE CONSULTED WITH YOUR PHYSICIAN.
- Do not store your headset near magnetic fields. Magnetic stripe cards, including credit cards, phone cards, passbooks, and boarding passes, may be damaged by magnetic fields.
- Avoiding hearing damage
Permanent hearing loss may occur if you use your headset at a high volume. Set the volume to a safe level. Over time you can become accustomed to a higher volume that may sound normal but can be damaging to your hearing. If you experience ringing in your ears or muffled speech, stop listening and have your hearing checked. The louder the volume, the less time that is required before your hearing could be affected.



- Using headsets safely
Use of headsets to listen to music while operating a vehicle is not recommended and is illegal in some areas. Be careful and attentive while driving. Stop using this device if you find it disruptive or distracting while operating any type of vehicle or performing any other activity that requires your full attention.

REGULATORY INFORMATION

FCC NOTICE TO USERS:
This device complies with part 15 of the FCC Rules. This equipment is subject to the following two conditions:
(1) This device may not cause harmful interference, and
(2) This device must accept any interference received, including interference that may cause undesired operation.

Changes or modifications not expressly approved by the manufacturer (or party responsible) for compliance could void the user's authority to operate the equipment.

FCC Part 15.105 statement
This equipment has been tested and found to comply with the limits for a Class B digital device, pursuant to Part 15 of the FCC Rules. These limits are designed to provide reasonable protection against harmful interference in a residential installation. This equipment generates, uses and can radiate radio frequency energy and, if not installed and used in accordance with the instructions, may cause harmful interference to radio communications. However, there is no guarantee that interference will not occur in a particular installation. If this equipment does cause harmful interference to radio or television reception, which can be determined by turning the equipment off and on, the user is encouraged to try to correct the interference by one or more of the following measures:
- Reorient or relocate the receiving antenna.
- Increase the separation between the equipment and receiver.
- Connect the equipment into an outlet on a circuit different from that to which the receiver is connected.
- Consult the dealer or an experienced radio/TV technician for help.

IMPORTANT NOTE:

To comply with the FCC RF exposure compliance requirements, no change to the antenna or the device is permitted. Any change to the antenna or the device could result in the device exceeding the RF exposure requirements and void the user's authority to operate the device.

ADDITIONAL INFORMATION

Bluetooth® connection precautions
- To avoid problems when connecting your headset to another device, place the devices close to each other.
- Ensure that your headset and the other Bluetooth® device are within the Bluetooth® connection range (10 m). The distance may vary depending on the environment the devices are used in.
- Ensure that there are no obstacles between the headset and a connected device, including human bodies, walls, corners, or fences etc.
- If equipment using 2.4GHz frequency nearby, it may cause interference.

Potentially explosive atmosphere
Turn off your electronic device when in any area with a potentially explosive atmosphere. Although this is uncommon, your electronic device could generate sparks. Sparks in such areas could cause an explosion or fire resulting in bodily injury or even death. Areas with a potentially explosive atmosphere are often but not always clearly marked.

Emergency calls

This Bluetooth® headset and the electronic device connected to the headset, operate using radio signals and mobile and landline networks, as well as user-programmed functions, which cannot guarantee connection under all conditions. Therefore you should never rely solely upon any electronic device for essential communications (e.g., medical emergencies). Remember, in order to make or receive calls, the headset and the electronic device connected to the headset must be switched on and in a service area with adequate mobile signal strength. Emergency calls may not be possible on all mobile phone networks or when certain network services and/or phone features are in use. Check with your local service provider.

Battery information

- A rechargeable battery has a long service life if treated properly.
A new battery or one that has not been used for a long period of time could have reduced capacity the first few times it is used. Do not expose the battery to extreme temperatures, never above +50°C (+122°F) or below -10°C (+14°F). For maximum battery capacity, use the battery at room temperature. If the battery is used in low temperatures, the battery capacity will be reduced. The battery can only be charged in temperatures between +10°C (+50°F) and +45°C (+113°F).
- The battery is consumable and the useful charge will get shorter over time.

Standard Limited Warranty

Bluecom declares product warranty as described in the user manual. This warranty period starts from the date of purchase. If the purchase date has not been identified, warranty period will be counted three months after the date of manufacture.

Subject and Warranty Period

- 1, Main unit, USB cable warranty period 1 year from date of purchase
- 2, Packing box, user manual, etc., are not guaranteed to be replaced

What is not covered under warranty?

This Limited Warranty is conditioned upon proper use of the Product. This Limited Warranty does not cover: (a) defects or damage resulting from accident, misuse, abnormal use, abnormal conditions, improper storage, exposure to liquid, moisture, dampness, sand or dirt, neglect, or unusual physical, electrical or electromechanical stress; (b) scratches, dents and cosmetic damage, unless caused by BLUECOM; (c) defects or damage resulting from excessive force; (d) equipment that has the serial number or the QR code removed, defaced, damaged, altered or made illegible; (e) ordinary wear and tear; (f) defects or damage resulting from the use of Product in conjunction or connection with accessories, products, or ancillary/peripheral equipment not furnished or approved by BLUECOM; (g) defects or damage resulting from improper testing, operation, maintenance, installation, service, or adjustment not furnished or approved by BLUECOM, including but not limited to installation of unauthorized software and unauthorized root access, both of which shall void this limited warranty; (h) defects or damage resulting from external causes such as collision with an object, fire, flooding, dirt, windstorm, lightning,

earthquake, exposure to weather conditions, theft, blown fuse, or improper use of any electrical source; (i) defects or damage resulting from cellular signal reception or transmission, or viruses or other software problems introduced into the Product; or (j) Product used or purchased outside the United States. This Limited Warranty covers batteries only if battery capacity falls below 80% of rated capacity or the battery leaks, and this Limited Warranty does not cover any battery if the battery has been charged by a battery charger not specified or approved by BLUECOM for charging the battery.

How to obtain Warranty Service

To obtain service under this Limited Warranty, you must return the Product to BLUECOM's designated location in an adequate container for shipping, accompanied by the sales receipt or comparable proof of sale showing the original date of purchase by the first consumer purchaser, the serial number of the Product and the seller's name and address. To obtain assistance on where to deliver the Product, please E-mail BLUECOM support desk at support@bluec.co.kr. If BLUECOM determines that any Product is not covered by this Limited Warranty, you must pay all parts, shipping, and labor charges for the repair or return of such Product.

Bluecom Co., Ltd.
116, Venture-ro, Yeonsu-gu, Incheon,
22013, Republic of Korea
255 West Victoria Street,
Compton, CA 90220
support@bluec.co.kr