



A D T

FCC TEST REPORT (15.407)

REPORT NO.: RF980504L06-1

MODEL NO.: ZF7762

RECEIVED: May 04, 2009

TESTED: Jul. 07 ~ Jul. 27, 2009

ISSUED: Aug. 03, 2009

Applicant's Company	Senao Networks, Inc.
Applicant Address	3F, No. 529, Chung Cheng Rd., Hsintien, Taipei, Taiwan
FCC ID	U2M-ZF7762
Manufacturer's Company	Senao Networks, Inc.
Manufacturer Address	3F, No. 529, Chung Cheng Rd., Hsintien, Taipei, Taiwan

ISSUED BY: Bureau Veritas Consumer Products Services (H.K.) Ltd., Taoyuan Branch

LAB ADDRESS: No. 47, 14th Ling, Chia Pau Tsuen, Lin Kou Hsiang, Taipei Hsien 244, Taiwan, R.O.C.

TEST LOCATION: No. 19, Hwa Ya 2nd Rd, Wen Hwa Tsuen, Kwei Shan Hsiang, Taoyuan Hsien 333, Taiwan, R.O.C.

This test report consists of 214 pages in total. It may be duplicated completely for legal use with the approval of the applicant. It should not be reproduced except in full, without the written approval of our laboratory. The client should not use it to claim product endorsement by TAF or any government agencies. The test results in the report only apply to the tested sample.





TABLE OF CONTENTS

1.	CERTIFICATION.....	4
2.	SUMMARY OF TEST RESULTS	5
2.1	MEASUREMENT UNCERTAINTY	5
3.	GENERAL INFORMATION.....	6
3.1	GENERAL DESCRIPTION OF EUT	6
3.2	DESCRIPTION OF TEST MODES.....	8
3.2.1	CONFIGURATION OF SYSTEM UNDER TEST	9
3.2.2	TEST MODE APPLICABILITY AND TESTED CHANNEL DETAIL.....	11
3.3	GENERAL DESCRIPTION OF APPLIED STANDARDS	13
3.4	DESCRIPTION OF SUPPORT UNITS	14
4.	TEST TYPES AND RESULTS	15
4.1	RADIATED EMISSION MEASUREMENT	15
4.1.1	LIMITS OF RADIATED EMISSION MEASUREMENT.....	15
4.1.2	LIMITS OF UNWANTED EMISSION OUT OF THE RESTRICTED BANDS.....	15
4.1.3	TEST INSTRUMENTS	16
4.1.4	TEST PROCEDURES	17
4.1.5	DEVIATION FROM TEST STANDARD	17
4.1.6	TEST SETUP	18
4.1.7	EUT OPERATING CONDITION	18
4.1.8	TEST RESULTS	19
4.2	CONDUCTED EMISSION MEASUREMENT	39
4.2.1	LIMITS OF CONDUCTED EMISSION MEASUREMENT.....	39
4.2.2	TEST INSTRUMENTS	39
4.2.3	TEST PROCEDURES	40
4.2.4	DEVIATION FROM TEST STANDARD	40
4.2.5	TEST SETUP	41
4.2.6	EUT OPERATING CONDITIONS.....	41
4.2.7	TEST RESULTS	42
4.3	MAXIMUM CONDUCTED OUTPUT POWER MEASUREMENT	54
4.3.1	LIMITS OF MAXIMUM CONDUCTED OUTPUT POWER MEASUREMENT	54
4.3.2	TEST INSTRUMENTS	54
4.3.3	TEST PROCEDURES	55
4.3.4	DEVIATION FROM TEST STANDARD	55
4.3.5	TEST SETUP	55
4.3.6	EUT OPERATING CONDITIONS.....	55
4.3.7	TEST RESULTS	56
4.4	PEAK POWER EXCURSION MEASUREMENT	106
4.4.1	LIMITS OF PEAK POWER EXCURSION MEASUREMENT.....	106
4.4.2	TEST INSTRUMENTS	106
4.4.3	TEST PROCEDURE	106
4.4.4	DEVIATION FROM TEST STANDARD	107
4.4.5	TEST SETUP	107
4.4.6	EUT OPERATING CONDITIONS.....	107
4.4.7	TEST RESULTS	108
4.5	PEAK POWER SPECTRAL DENSITY MEASUREMENT	154
4.5.1	LIMITS OF PEAK POWER SPECTRAL DENSITY MEASUREMENT.....	154
4.5.2	TEST INSTRUMENTS	154
4.5.3	TEST PROCEDURES	154
4.5.4	DEVIATION FROM TEST STANDARD	155
4.5.5	TEST SETUP	155



A D T

4.5.6	EUT OPERATING CONDITIONS	155
4.5.7	TEST RESULTS	156
4.6	FREQUENCY STABILITY	181
4.6.1	LIMITS OF FREQUENCY STABILITY MEASUREMENT	181
4.6.2	TEST INSTRUMENTS	181
4.6.3	TEST PROCEDURE	181
4.6.4	DEVIATION FROM TEST STANDARD	182
4.6.5	TEST SETUP	182
4.6.6	EUT OPERATING CONDITION	182
4.6.7	TEST RESULTS	183
4.7	BAND EDGES MEASUREMENT	185
4.7.1	TEST INSTRUMENTS	185
4.7.2	TEST PROCEDURE	185
4.7.3	EUT OPERATING CONDITION	186
4.7.4	TEST RESULTS	186
4.8	ANTENNA REQUIREMENT	211
4.8.1	STANDARD APPLICABLE	211
4.8.2	ANTENNA CONNECTED CONSTRUCTION	211
5.	PHOTOGRAPHS OF THE TEST CONFIGURATION	212
6.	INFORMATION ON THE TESTING LABORATORIES	213
7.	APPENDIX A - MODIFICATIONS RECORDERS FOR ENGINEERING CHANGES TO THE EUT BY THE LAB	214



A D T

1. CERTIFICATION

PRODUCT: Zone Flex 7762 AccessPoint
MODEL NO.: ZF7762
BRAND: Ruckus
APPLICANT: Senao Networks Inc.
TEST SAMPLE: R&D SAMPLE
TESTED: Jul. 07 ~ Jul. 27, 2009
STANDARDS: **FCC Part 15, Subpart E (Section 15.407)**
ANSI C63.4-2003

The above equipment (Model: ZF7762) has been tested by **Bureau Veritas Consumer Products Services (H.K.) Ltd., Taoyuan Branch**, and found compliance with the requirement of the above standards. The test record, data evaluation & Equipment Under Test (EUT) configurations represented herein are true and accurate accounts of the measurements of the sample's EMC characteristics under the conditions specified in this report.

PREPARED BY : Peggy Chen , **DATE:** Aug. 03, 2009
Peggy Chen / Specialist

TECHNICAL ACCEPTANCE : Long Chen , **DATE:** Aug. 03, 2009
Responsible for RF Long Chen / Senior Engineer

APPROVED BY : Gary Chang , **DATE:** Aug. 03, 2009
Gary Chang / Assistant Manager



2. SUMMARY OF TEST RESULTS

The EUT has been tested according to the following specifications:

APPLIED STANDARD: FCC PART 15, SUBPART E (SECTION 15.407)			
STANDARD SECTION	TEST TYPE AND LIMIT	RESULT	REMARK
15.407(b)(5)	AC Power Conducted Emission	PASS	Meet the requirement of limit. Minimum passing margin is -0.03dB at 0.931MHz.
15.407(b)(1/2/3) (b)(5)	Electric Field Strength Spurious Emissions, 30MHz ~ 40000MHz	PASS	Meet the requirement of limit. Minimum passing margin is -0.62dB at 10360.00MHz.
15.407(a)(1/2/3)	Peak Transmit Power	PASS	Meet the requirement of limit.
15.407(a)(6)	Peak Power Excursion	PASS	Meet the requirement of limit.
15.407(a)(1/2/3)	Peak Power Spectral Density	PASS	Meet the requirement of limit.
15.407(g)	Frequency Stability	PASS	Meet the requirement of limit.

2.1 MEASUREMENT UNCERTAINTY

Where relevant, the following measurement uncertainty levels have been estimated for tests performed on the EUT as specified in CISPR 16-4-2:

MEASUREMENT	FREQUENCY	UNCERTAINTY
Conducted emissions	150kHz~30MHz	2.44 dB
Radiated emissions	30MHz ~ 200MHz	3.34 dB
	200MHz ~1000MHz	3.35 dB
	1GHz ~ 18GHz	2.26 dB
	18GHz ~ 40GHz	1.94 dB

This uncertainty represents an expanded uncertainty expressed at approximately the 95% confidence level using a coverage factor of $k = 2$.



A D T

3. GENERAL INFORMATION

3.1 GENERAL DESCRIPTION OF EUT

EUT	Zone Flex 7762 AccessPoint
MODEL NO.	ZF7762
FCC ID	U2M-ZF7762
POWER SUPPLY	12Vdc from DC power supply 48Vdc from POE
MODULATION TYPE	CCK, DQPSK, DBPSK for DSSS 64QAM, 16QAM, QPSK, BPSK for OFDM
MODULATION TECHNOLOGY	DSSS, OFDM
TRANSFER RATE	802.11a: 54.0/ 48.0/ 36.0/ 24.0/ 18.0/ 12.0/ 9.0/ 6.0Mbps Draft 802.11n: up to 270.0Mbps
FREQUENCY RANGE	5180 ~ 5240MHz
NUMBER OF CHANNEL	4 for 802.11a, draft 802.11n (20MHz) 2 for draft 802.11n (40MHz)
OUTPUT POWER	38.766mW
ANTENNA TYPE	Internal: Proprietary omni antenna with 3dBi gain External: Directional Panel antenna with 14dBi gain (Option)
DATA CABLE	NA
I/O PORTS	Refer to user's manual
ACCESSORY DEVICES	PoE, adapter(for PoE use)

NOTE:

- The EUT was operated with following PoE:

MODEL:	NPE-5818at
---------------	------------

The adapter of PoE:

BRAND:	Ruckus
MODEL:	GS60A48
INPUT:	100-240Vac, 50-60Hz, 1.4A
OUTPUT:	48Vdc, 1.25A
POWER LINE:	1.8m non-shielded cable with one core



A D T

2. The EUT is a Zone Flex 7762 AccessPoint. The functions of EUT listed as below:

	TEST STANDARD	REFERENCE REPORT
WLAN 802.11b/g, draft 802.11n	FCC Part 15, Subpart C (Section 15.247)	RF980504L06
WLAN 802.11a, draft 802.11n (5745~5825 MHz)		
WLAN 802.11a, draft 802.11n (5180~ 5240MHz)	FCC Part 15, Subpart E (Section 15.407)	RF980504L06-1

3. The frequency bands used in this EUT are listed as follows:

Frequency Band (MHz)	2412~2462	5180~5240	5745~5825
802.11b	√		
802.11g	√		
802.11a		√	√
Draft 802.11n (20MHz)	√	√	√
Draft 802.11n (40MHz)	√	√	√

4. The EUT incorporates a MIMO function. Physically, the EUT provides three completed transmitters and three receivers or two completed transmitters and two receivers.

MODULATION MODE	TX FUNCTION	
	INTERNAL ANTENNA (For 2.4G & 5.0GHz band)	EXTERNAL ANTENNA (For 5.0GHz band only)
802.11b	3TX	-
802.11g	3TX	-
802.11a	3TX	2TX
Draft 802.11n (20MHz)	3TX	2TX
Draft 802.11n (40MHz)	3TX	2TX

5. The internal and external works separately. In firmware, when external antenna plug in, the major transmission would program from external antenna. Two antennas will not transmit simultaneously. It was controlled by firmware.

6. The above EUT information was declared by manufacturer and for more detailed features description, please refer to the manufacturer's specifications or user's manual.

3.2 DESCRIPTION OF TEST MODES

Operated in 5180 ~ 5240MHz

4 channels are provided for 802.11a, draft 802.11n (20MHz):

CHANNEL	FREQUENCY
36	5180 MHz
40	5200 MHz
44	5220 MHz
48	5240 MHz

2 channels are provided for draft 802.11n (40MHz):

CHANNEL	FREQUENCY
38	5190MHz
46	5230MHz

3.2.1 CONFIGURATION OF SYSTEM UNDER TEST

TEST MODE A, C

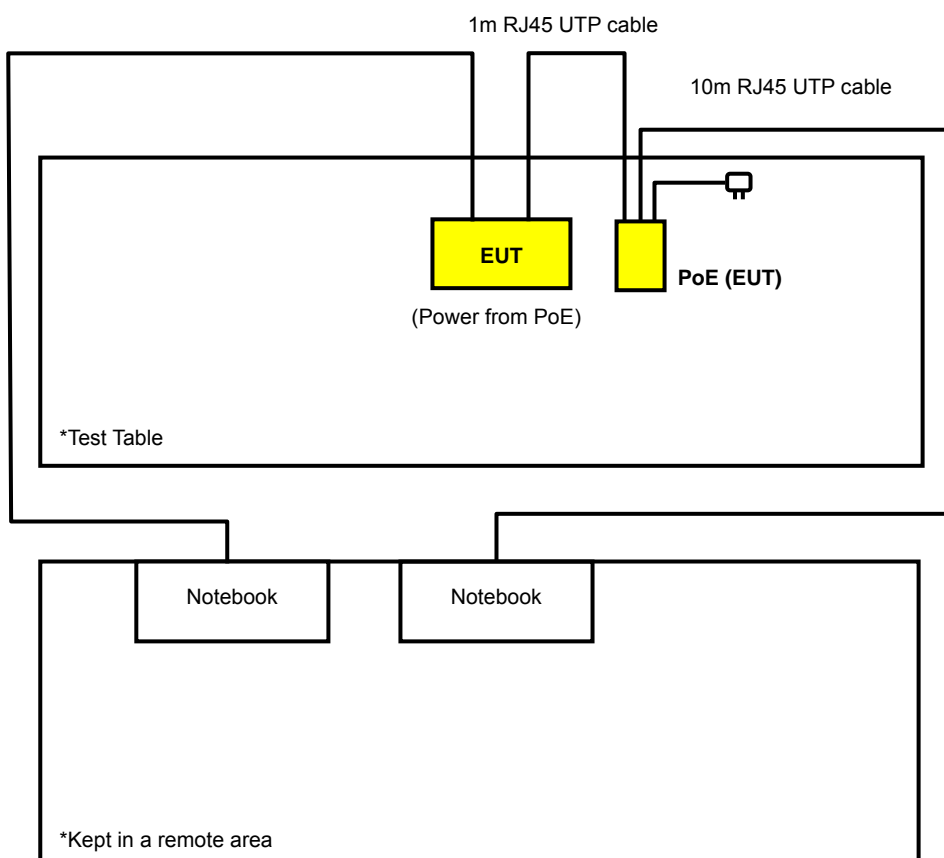

TEST MODE B, D

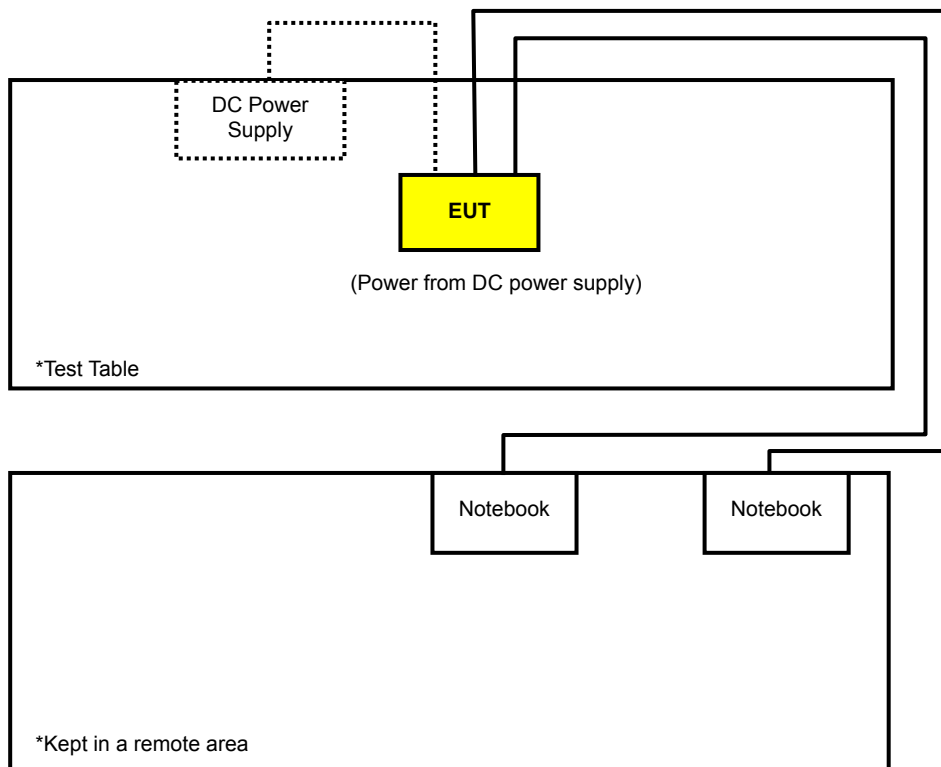



3.2.2 TEST MODE APPLICABILITY AND TESTED CHANNEL DETAIL

EUT CONFIGURE MODE	APPLICABLE TO				DESCRIPTION	
	RE≥1G	RE<1G	PLC	APCM	Antenna	Power Source
A	√	√	√	√	Internal	Power from PoE
B	-	√	√	-		Power from DC power supply
C	√	√	√	√	External	Power from PoE
D	-	√	√	-		Power from DC power supply

Where **RE≥1G**: Radiated Emission above 1GHz **RE<1G**: Radiated Emission below 1GHz
PLC: Power Line Conducted Emission **APCM**: Antenna Port Conducted Measurement

NOTE: "-" means no effect.

RADIATED EMISSION TEST (ABOVE 1GHz):

- Pre-Scan has been conducted to determine the worst-case mode from all possible combinations between available modulations, data rates, XYZ axis and antenna ports (if EUT with antenna diversity architecture).
- Following channel(s) was (were) selected for the final test as listed below.

EUT CONFIGURE MODE	MODE	AVAILABLE CHANNEL	TESTED CHANNEL	MODULATION TECHNOLOGY	MODULATION TYPE	DATA RATE (Mbps)	AXIS
A & C	802.11a	36 to 48	36, 40, 48	OFDM	BPSK	6.0	Z
A & C	Draft 802.11n (20MHz)	36 to 48	36, 40, 48	OFDM	BPSK	6.5	Z
A & C	Draft 802.11n (40MHz)	38 to 46	38, 46	OFDM	BPSK	13.5	Z

RADIATED EMISSION TEST (BELOW 1GHz):

- Pre-Scan has been conducted to determine the worst-case mode from all possible combinations between available modulations, data rates, XYZ axis and antenna ports (if EUT with antenna diversity architecture).
- Following channel(s) was (were) selected for the final test as listed below.

EUT CONFIGURE MODE	MODE	AVAILABLE CHANNEL	TESTED CHANNEL	MODULATION TECHNOLOGY	MODULATION TYPE	DATA RATE (Mbps)	AXIS
A & B	Draft 802.11n (40MHz)	38 to 46	40	OFDM	BPSK	13.5	Z
C & D	Draft 802.11n (40MHz)	38 to 46	40	OFDM	BPSK	13.5	Z

POWER LINE CONDUCTED EMISSION TEST:

- Pre-Scan has been conducted to determine the worst-case mode from all possible combinations between available modulations, data rates and antenna ports (if EUT with antenna diversity architecture).
- Following channel(s) was (were) selected for the final test as listed below.

EUT CONFIGURE MODE	MODE	AVAILABLE CHANNEL	TESTED CHANNEL	MODULATION TECHNOLOGY	MODULATION TYPE	DATA RATE (Mbps)
A & B	Draft 802.11n (40MHz)	38 to 46	40	OFDM	BPSK	13.5
C & D	Draft 802.11n (40MHz)	38 to 46	40	OFDM	BPSK	13.5

BANDEDGE MEASUREMENT:

- Pre-Scan has been conducted to determine the worst-case mode from all possible combinations between available modulations, data rates, XYZ axis and antenna ports (if EUT with antenna diversity architecture).
- Following channel(s) was (were) selected for the final test as listed below.

EUT CONFIGURE MODE	MODE	AVAILABLE CHANNEL	TESTED CHANNEL	MODULATION TECHNOLOGY	MODULATION TYPE	DATA RATE (Mbps)	AXIS
A & C	802.11a	36 to 48	36,48	OFDM	BPSK	6.0	Z
A & C	Draft 802.11n (20MHz)	36 to 48	36, 48	OFDM	BPSK	6.5	Z
A & C	Draft 802.11n (40MHz)	38 to 46	38, 46	OFDM	BPSK	13.5	Z

ANTENNA PORT CONDUCTED MEASUREMENT:

- Pre-Scan has been conducted to determine the worst-case mode from all possible combinations between available modulations, data rates and antenna ports (if EUT with antenna diversity architecture).
- Following channel(s) was (were) selected for the final test as listed below.

EUT CONFIGURE MODE	MODE	AVAILABLE CHANNEL	TESTED CHANNEL	MODULATION TECHNOLOGY	MODULATION TYPE	DATA RATE (Mbps)
A & C	802.11a	36 to 64	36, 40, 48	OFDM	BPSK	6.0
A & C	Draft 802.11n (20MHz)	36 to 64	36, 40, 48	OFDM	BPSK	6.5
A & C	Draft 802.11n (40MHz)	38 to 62	38, 46	OFDM	BPSK	13.5

3.3 GENERAL DESCRIPTION OF APPLIED STANDARDS

The EUT is a RF Product. According to the specifications of the manufacturer, it must comply with the requirements of the following standards:

FCC Part 15, Subpart E (15.407)

ANSI C63.4-2003

All test items have been performed and recorded as per the above standards.

NOTE: The EUT is also considered as a kind of computer peripheral, because the connection to computer is necessary for typical use. It has been verified to comply with the requirements of FCC Part 15, Subpart B, Class B (DoC). The test report has been issued separately.

3.4 DESCRIPTION OF SUPPORT UNITS

The EUT has been tested as an independent unit together with other necessary accessories or support units. The following support units or accessories were used to form a representative test configuration during the tests.

NO.	PRODUCT	BRAND	MODEL NO.	SERIAL NO.	FCC ID
1	DC POWER SUPPLY	Topward	TF-6306A	727263	NA
2	NOTEBOOK COMPUTER	DELL	PP05L	12130898320	E2K24CLNS
3	NOTEBOOK COMPUTER	DELL	PP05L	9954115984	E2K24CLNS

NO.	SIGNAL CABLE DESCRIPTION OF THE ABOVE SUPPORT UNITS
1	NA
2	10m RJ45 cable
3	10m RJ45 cable

NOTE 1: All power cords of the above support units are non shielded (1.8m).

NOTE 2: Item 2, 3 acted as communication partners to transfer data.

4. TEST TYPES AND RESULTS

4.1 RADIATED EMISSION MEASUREMENT

4.1.1 LIMITS OF RADIATED EMISSION MEASUREMENT

Emissions radiated outside of the specified bands, shall be according to the general radiated limits in 15.209 as following:

FREQUENCIES (MHz)	FIELD STRENGTH (microvolts/meter)	MEASUREMENT DISTANCE (meters)
0.009 ~ 0.490	2400/F(kHz)	300
0.490 ~ 1.705	24000/F(kHz)	30
1.705 ~ 30.0	30	30
30 ~ 88	100	3
88 ~ 216	150	3
216 ~ 960	200	3
Above 960	500	3

NOTE:

1. The lower limit shall apply at the transition frequencies.
2. Emission level (dBuV/m) = 20 log Emission level (uV/m).
3. As shown in 15.35(b), for frequencies above 1000MHz, the field strength limits are based on average detector, however, the peak field strength of any emission shall not exceed the maximum permitted average limits, specified above by more than 20dB under any condition of modulation.

4.1.2 LIMITS OF UNWANTED EMISSION OUT OF THE RESTRICTED BANDS

FREQUENCIES (MHz)	EIRP LIMIT (dBm)	EQUIVALENT FIELD STRENGTH AT 3m (dBµV/m) *NOTE
	PK	PK
5150 ~ 5350	-27	68.3
5470 ~ 5725	-27	68.3

NOTE:

The following formula is used to convert the equipment isotropic radiated power (eirp) to field strength:

$$E = \frac{1000000\sqrt{30P}}{3} \mu\text{V/m, where P is the eirp (Watts).}$$



A D T

4.1.3 TEST INSTRUMENTS

DESCRIPTION & MANUFACTURER	MODEL NO.	SERIAL NO.	DATE OF CALIBRATION	DUE DATE OF CALIBRATION
Test Receiver ROHDE & SCHWARZ	ESI7	100033	Jul. 06, 2009	Jul. 05, 2010
Spectrum Analyzer ROHDE & SCHWARZ	FSP40	100076	May. 26, 2009	May. 25, 2010
BILOG Antenna SCHWARZBECK	VULB9168	9168-160	Apr. 27, 2009	Apr. 26, 2010
HORN Antenna SCHWARZBECK	9120D	9120D-209	Jul. 01, 2009	Jun. 30, 2010
HORN Antenna SCHWARZBECK	BBHA 9170	BBHA9170243	Dec. 25, 2008	Dec. 24, 2009
Preamplifier Agilent	8447D	2944A10633	Nov. 03, 2008	Nov. 02, 2009
Preamplifier Agilent	8449B	3008A01964	Oct. 23, 2008	Oct. 22, 2009
RF signal cable HUBER+SUHNNER	SUCOFLEX 104	238141/4	May 13, 2009	May 12, 2010
RF signal cable HUBER+SUHNNER	SUCOFLEX 104	12738/6	May 13, 2009	May 12, 2010
Software ADT.	ADT_Radiated_ V7.6.15.9.2	NA	NA	NA
Antenna Tower inn-co GmbH	MA 4000	013303	NA	NA
Antenna Tower Controller inn-co GmbH	CO2000	017303	NA	NA
Turn Table ADT.	TT100.	TT93021703	NA	NA
Turn Table Controller ADT.	SC100.	SC93021703	NA	NA
26GHz ~ 40GHz Amplifier	EM26400	07026401	Aug. 27, 2008	Aug. 26, 2009

- NOTE:**
1. The calibration interval of the above test instruments is 12 months and the calibrations are traceable to NML/ROC and NIST/USA.
 2. The test was performed in HwaYa Chamber 3.
 3. The horn antenna and HP preamplifier (model: 8449B) are used only for the measurement of emission frequency above 1GHz if tested.
 4. The FCC Site Registration No. is 988962.
 5. The IC Site Registration No. is IC 7450F-3.

4.1.4 TEST PROCEDURES

- a. The EUT was placed on the top of a rotating table 0.8 meters above the ground at a 3 meter semi-anechoic chamber. The table was rotated 360 degrees to determine the position of the highest radiation.
- b. The EUT was set 3 meters away from the interference-receiving antenna, which was mounted on the top of a variable-height antenna tower.
- c. The antenna is a broadband antenna, and its height is varied from one meter to four meters above the ground to determine the maximum value of the field strength. Both horizontal and vertical polarizations of the antenna are set to make the measurement.
- d. For each suspected emission, the EUT was arranged to its worst case and then the antenna was tuned to heights from 1 meter to 4 meters and the rotatable table was turned from 0 degrees to 360 degrees to find the maximum reading.
- e. The test-receiver system was set to Peak Detect Function and Specified Bandwidth with Maximum Hold Mode.
- f. If the emission level of the EUT in peak mode was 10dB lower than the limit specified, then testing could be stopped and the peak values of the EUT would be reported. Otherwise the emissions that did not have 10dB margin would be re-tested one by one using peak, quasi-peak or average method as specified and then reported in a data sheet.

NOTE:

1. The resolution bandwidth and video bandwidth of test receiver/spectrum analyzer is 120kHz for Peak detection (PK) and Quasi-peak detection (QP) at frequency below 1GHz.
2. The resolution bandwidth of test receiver/spectrum analyzer is 1MHz and video bandwidth is 3MHz for Peak detection at frequency above 1GHz.
3. The resolution bandwidth of test receiver/spectrum analyzer is 1MHz and the video bandwidth is 10Hz for Average detection (AV) at frequency above 1GHz.
4. All modes of operation were investigated and the worst-case emissions are reported.

4.1.5 DEVIATION FROM TEST STANDARD

No deviation

4.1.6 TEST SETUP

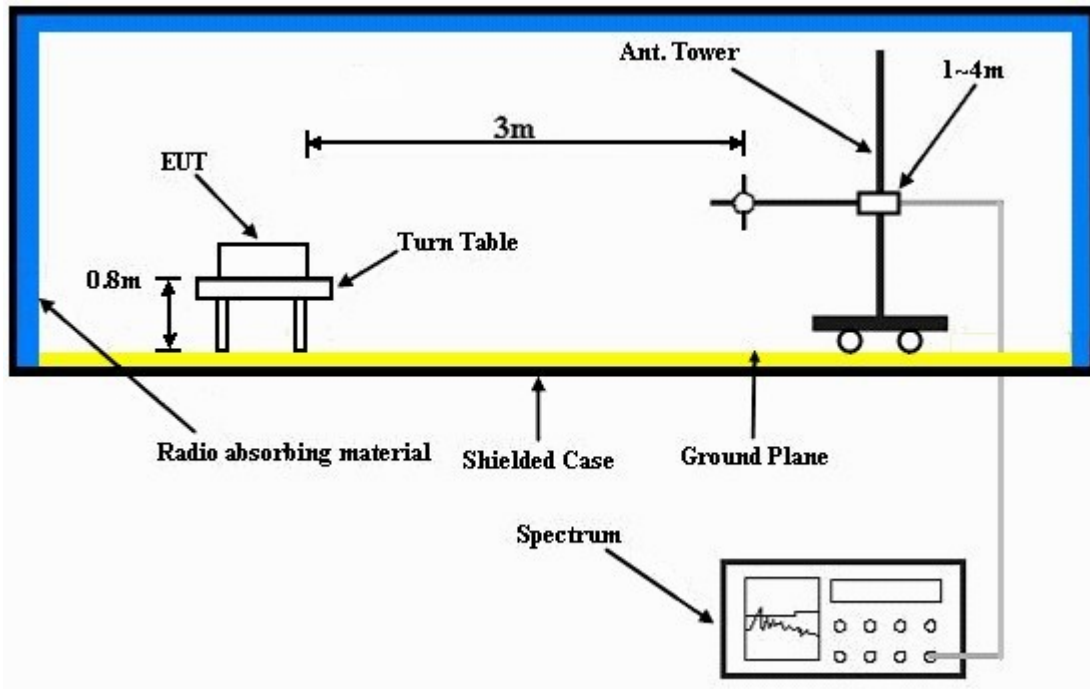

For the actual test configuration, please refer to the attached file (Test Setup Photo).

4.1.7 EUT OPERATING CONDITION

- a. Placed the EUT on the testing table.
- b. Prepared two notebook systems to act as communication partners and placed them outside of testing area.
- c. The communication partners run a test program (provided by manufacturer) to enable EUT under transmission condition continuously at specific channel frequency via RJ45 cables.
- d. The communication partners sent data to EUT by command "PING".

4.1.8 TEST RESULTS

802.11a OFDM MODULATION

EUT TEST CONDITION		MEASUREMENT DETAIL	
CHANNEL	Channel 36	FREQUENCY RANGE	1 ~ 40GHz
INPUT POWER (SYSTEM)	120Vac, 60 Hz	DETECTOR FUNCTION	Peak (PK) Average (AV)
ENVIRONMENTAL CONDITIONS	24deg. C, 64%RH 1002 hPa	TESTED BY	Brad Wu
TEST MODE	A		

ANTENNA POLARITY & TEST DISTANCE: HORIZONTAL AT 3 M								
NO.	FREQ. (MHz)	EMISSION LEVEL (dBuV/m)	LIMIT (dBuV/m)	MARGIN (dB)	ANTENNA HEIGHT (m)	TABLE ANGLE (Degree)	RAW VALUE (dBuV)	CORRECTION FACTOR (dB/m)
1	5150.00	65.42 PK	74.00	-8.58	1.00 H	178	28.38	37.04
2	5150.00	48.36 AV	54.00	-5.64	1.00 H	178	11.32	37.04
3	*5180.00	107.85 PK			1.00 H	178	70.78	37.07
4	*5180.00	97.21 AV			1.00 H	178	60.14	37.07
5	#10360.00	66.82 PK	68.30	-1.48	1.04 H	219	19.56	47.26
ANTENNA POLARITY & TEST DISTANCE: VERTICAL AT 3 M								
NO.	FREQ. (MHz)	EMISSION LEVEL (dBuV/m)	LIMIT (dBuV/m)	MARGIN (dB)	ANTENNA HEIGHT (m)	TABLE ANGLE (Degree)	RAW VALUE (dBuV)	CORRECTION FACTOR (dB/m)
1	5150.00	63.12 PK	74.00	-10.88	1.02 V	96	26.08	37.04
2	5150.00	46.03 AV	54.00	-7.97	1.02 V	96	8.99	37.04
3	*5180.00	106.36 PK			1.02 V	96	69.29	37.07
4	*5180.00	95.74 AV			1.02 V	96	58.67	37.07
5	#10360.00	67.68 PK	68.30	-0.62	1.31 V	15	20.42	47.26

REMARKS: 1. Emission level (dBuV/m) = Raw Value (dBuV) + Correction Factor (dB/m).

2. Correction Factor (dB/m) = Antenna Factor (dB/m) + Cable Factor (dB).

3. The other emission levels were very low against the limit.

4. Margin value = Emission level – Limit value.

5. “ * “: Fundamental frequency.

6. “#“: The radiated frequency is out the restricted band.



A D T

EUT TEST CONDITION		MEASUREMENT DETAIL	
CHANNEL	Channel 40	FREQUENCY RANGE	1 ~ 40GHz
INPUT POWER (SYSTEM)	120Vac, 60 Hz	DETECTOR FUNCTION	Peak (PK) Average (AV)
ENVIRONMENTAL CONDITIONS	24deg. C, 64%RH 1002 hPa	TESTED BY	Brad Wu
TEST MODE	A		

ANTENNA POLARITY & TEST DISTANCE: HORIZONTAL AT 3 M								
NO.	FREQ. (MHz)	EMISSION LEVEL (dBuV/m)	LIMIT (dBuV/m)	MARGIN (dB)	ANTENNA HEIGHT (m)	TABLE ANGLE (Degree)	RAW VALUE (dBuV)	CORRECTION FACTOR (dB/m)
1	*5200.00	107.76 PK			1.01 H	179	70.67	37.09
2	*5200.00	97.04 AV			1.01 H	179	59.95	37.09
3	#10400.00	66.95 PK	68.30	-1.35	1.01 H	235	19.48	47.47
ANTENNA POLARITY & TEST DISTANCE: VERTICAL AT 3 M								
NO.	FREQ. (MHz)	EMISSION LEVEL (dBuV/m)	LIMIT (dBuV/m)	MARGIN (dB)	ANTENNA HEIGHT (m)	TABLE ANGLE (Degree)	RAW VALUE (dBuV)	CORRECTION FACTOR (dB/m)
1	*5200.00	106.21 PK			1.03 V	95	69.12	37.09
2	*5200.00	95.64 AV			1.03 V	95	58.55	37.09
3	#10400.00	67.51 PK	68.30	-0.79	1.30 V	24	20.04	47.47

- REMARKS:**
1. Emission level (dBuV/m) = Raw Value (dBuV) + Correction Factor (dB/m).
 2. Correction Factor (dB/m) = Antenna Factor (dB/m) + Cable Factor (dB).
 3. The other emission levels were very low against the limit.
 4. Margin value = Emission level – Limit value.
 5. “ * “: Fundamental frequency.
 6. “#”:The radiated frequency is out the restricted band.



A D T

EUT TEST CONDITION		MEASUREMENT DETAIL	
CHANNEL	Channel 48	FREQUENCY RANGE	1 ~ 40GHz
INPUT POWER (SYSTEM)	120Vac, 60 Hz	DETECTOR FUNCTION	Peak (PK) Average (AV)
ENVIRONMENTAL CONDITIONS	24deg. C, 64%RH 1002 hPa	TESTED BY	Brad Wu
TEST MODE	A		

ANTENNA POLARITY & TEST DISTANCE: HORIZONTAL AT 3 M								
NO.	FREQ. (MHz)	EMISSION LEVEL (dBuV/m)	LIMIT (dBuV/m)	MARGIN (dB)	ANTENNA HEIGHT (m)	TABLE ANGLE (Degree)	RAW VALUE (dBuV)	CORRECTION FACTOR (dB/m)
1	*5240.00	107.65 PK			1.02 H	183	70.45	37.20
2	*5240.00	96.92 AV			1.02 H	183	59.72	37.20
3	5350.00	51.46 PK	74.00	-22.54	1.02 H	183	14.06	37.40
4	5350.00	38.49 AV	54.00	-15.51	1.02 H	183	1.09	37.40
5	#10480.00	66.58 PK	68.30	-1.72	1.06 H	223	18.92	47.66
ANTENNA POLARITY & TEST DISTANCE: VERTICAL AT 3 M								
NO.	FREQ. (MHz)	EMISSION LEVEL (dBuV/m)	LIMIT (dBuV/m)	MARGIN (dB)	ANTENNA HEIGHT (m)	TABLE ANGLE (Degree)	RAW VALUE (dBuV)	CORRECTION FACTOR (dB/m)
1	*5240.00	106.13 PK			1.04 V	96	68.93	37.20
2	*5240.00	95.58 AV			1.04 V	96	58.38	37.20
3	5350.00	50.25 PK	74.00	-23.75	1.04 V	96	12.85	37.40
4	5350.00	36.84 AV	54.00	-17.16	1.04 V	96	-0.56	37.40
5	#10480.00	67.42 PK	68.30	-0.88	1.09 V	26	19.76	47.66

- REMARKS:**
1. Emission level (dBuV/m) = Raw Value (dBuV) + Correction Factor (dB/m).
 2. Correction Factor (dB/m) = Antenna Factor (dB/m) + Cable Factor (dB).
 3. The other emission levels were very low against the limit.
 4. Margin value = Emission level – Limit value.
 5. “ * “: Fundamental frequency.
 6. “#“: The radiated frequency is out the restricted band.



A D T

EUT TEST CONDITION		MEASUREMENT DETAIL	
CHANNEL	Channel 36	FREQUENCY RANGE	1 ~ 40GHz
INPUT POWER (SYSTEM)	120Vac, 60 Hz	DETECTOR FUNCTION	Peak (PK) Average (AV)
ENVIRONMENTAL CONDITIONS	24deg. C, 64%RH 1002 hPa	TESTED BY	Brad Wu
TEST MODE	C		

ANTENNA POLARITY & TEST DISTANCE: HORIZONTAL AT 3 M								
NO.	FREQ. (MHz)	EMISSION LEVEL (dBuV/m)	LIMIT (dBuV/m)	MARGIN (dB)	ANTENNA HEIGHT (m)	TABLE ANGLE (Degree)	RAW VALUE (dBuV)	CORRECTION FACTOR (dB/m)
1	5150.00	52.15 PK	74.00	-21.85	1.05 H	214	15.11	37.04
2	5150.00	35.04 AV	54.00	-18.96	1.05 H	214	-2.00	37.04
3	*5180.00	90.53 PK			1.05 H	214	53.46	37.07
4	*5180.00	79.92 AV			1.05 H	214	42.85	37.07
5	#10360.00	66.53 PK	68.30	-1.77	1.14 H	235	19.27	47.26
ANTENNA POLARITY & TEST DISTANCE: VERTICAL AT 3 M								
NO.	FREQ. (MHz)	EMISSION LEVEL (dBuV/m)	LIMIT (dBuV/m)	MARGIN (dB)	ANTENNA HEIGHT (m)	TABLE ANGLE (Degree)	RAW VALUE (dBuV)	CORRECTION FACTOR (dB/m)
1	5150.00	65.21 PK	74.00	-8.79	1.02 V	179	28.17	37.04
2	5150.00	48.13 AV	54.00	-5.87	1.02 V	179	11.09	37.04
3	*5180.00	107.68 PK			1.02 V	179	70.61	37.07
4	*5180.00	97.04 AV			1.02 V	179	59.97	37.07
5	#10360.00	67.45 PK	68.30	-0.85	1.03 V	224	20.19	47.26

- REMARKS:**
1. Emission level (dBuV/m) = Raw Value (dBuV) + Correction Factor (dB/m).
 2. Correction Factor (dB/m) = Antenna Factor (dB/m) + Cable Factor (dB).
 3. The other emission levels were very low against the limit.
 4. Margin value = Emission level – Limit value.
 5. “ * “: Fundamental frequency.
 6. “#”:The radiated frequency is out the restricted band.



A D T

EUT TEST CONDITION		MEASUREMENT DETAIL	
CHANNEL	Channel 40	FREQUENCY RANGE	1 ~ 40GHz
INPUT POWER (SYSTEM)	120Vac, 60 Hz	DETECTOR FUNCTION	Peak (PK) Average (AV)
ENVIRONMENTAL CONDITIONS	24deg. C, 64%RH 1002 hPa	TESTED BY	Brad Wu
TEST MODE	C		

ANTENNA POLARITY & TEST DISTANCE: HORIZONTAL AT 3 M								
NO.	FREQ. (MHz)	EMISSION LEVEL (dBuV/m)	LIMIT (dBuV/m)	MARGIN (dB)	ANTENNA HEIGHT (m)	TABLE ANGLE (Degree)	RAW VALUE (dBuV)	CORRECTION FACTOR (dB/m)
1	*5200.00	90.41 PK			1.06 H	209	53.32	37.09
2	*5200.00	79.83 AV			1.06 H	209	42.74	37.09
3	#10400.00	66.69 PK	68.30	-1.61	1.06 H	199	19.22	47.47
ANTENNA POLARITY & TEST DISTANCE: VERTICAL AT 3 M								
NO.	FREQ. (MHz)	EMISSION LEVEL (dBuV/m)	LIMIT (dBuV/m)	MARGIN (dB)	ANTENNA HEIGHT (m)	TABLE ANGLE (Degree)	RAW VALUE (dBuV)	CORRECTION FACTOR (dB/m)
1	*5200.00	107.53 PK			1.03 V	182	70.44	37.09
2	*5200.00	96.86 AV			1.03 V	182	59.77	37.09
3	#10400.00	67.34 PK	68.30	-0.96	1.05 V	201	19.87	47.47

- REMARKS:**
1. Emission level (dBuV/m) = Raw Value (dBuV) + Correction Factor (dB/m).
 2. Correction Factor (dB/m) = Antenna Factor (dB/m) + Cable Factor (dB).
 3. The other emission levels were very low against the limit.
 4. Margin value = Emission level – Limit value.
 5. “ * “: Fundamental frequency.
 6. “#”:The radiated frequency is out the restricted band.



A D T

EUT TEST CONDITION		MEASUREMENT DETAIL	
CHANNEL	Channel 48	FREQUENCY RANGE	1 ~ 40GHz
INPUT POWER (SYSTEM)	120Vac, 60 Hz	DETECTOR FUNCTION	Peak (PK) Average (AV)
ENVIRONMENTAL CONDITIONS	24deg. C, 64%RH 1002 hPa	TESTED BY	Brad Wu
TEST MODE	C		

ANTENNA POLARITY & TEST DISTANCE: HORIZONTAL AT 3 M								
NO.	FREQ. (MHz)	EMISSION LEVEL (dBuV/m)	LIMIT (dBuV/m)	MARGIN (dB)	ANTENNA HEIGHT (m)	TABLE ANGLE (Degree)	RAW VALUE (dBuV)	CORRECTION FACTOR (dB/m)
1	*5240.00	107.53 PK			1.04 H	186	70.33	37.20
2	*5240.00	96.81 AV			1.04 H	186	59.61	37.20
3	5350.00	51.35 PK	74.00	-22.65	1.04 H	186	13.95	37.40
4	5350.00	38.32 AV	54.00	-15.68	1.04 H	186	0.92	37.40
5	#10480.00	66.35 PK	68.30	-1.95	1.09 H	217	18.69	47.66
ANTENNA POLARITY & TEST DISTANCE: VERTICAL AT 3 M								
NO.	FREQ. (MHz)	EMISSION LEVEL (dBuV/m)	LIMIT (dBuV/m)	MARGIN (dB)	ANTENNA HEIGHT (m)	TABLE ANGLE (Degree)	RAW VALUE (dBuV)	CORRECTION FACTOR (dB/m)
1	*5240.00	106.02 PK			1.05 V	101	68.82	37.20
2	*5240.00	95.43 AV			1.05 V	101	58.23	37.20
3	5350.00	50.12 PK	74.00	-23.88	1.05 V	101	12.72	37.40
4	5350.00	36.69 AV	54.00	-17.31	1.05 V	101	-0.71	37.40
5	#10480.00	67.21 PK	68.30	-1.09	1.12 V	35	19.55	47.66

- REMARKS:**
1. Emission level (dBuV/m) = Raw Value (dBuV) + Correction Factor (dB/m).
 2. Correction Factor (dB/m) = Antenna Factor (dB/m) + Cable Factor (dB).
 3. The other emission levels were very low against the limit.
 4. Margin value = Emission level – Limit value.
 5. “ * “: Fundamental frequency.
 6. “#“: The radiated frequency is out the restricted band.



A D T

DRAFT 802.11n (20MHz) OFDM MODULATION

EUT TEST CONDITION		MEASUREMENT DETAIL	
CHANNEL	Channel 36	FREQUENCY RANGE	1 ~ 40GHz
INPUT POWER (SYSTEM)	120Vac, 60 Hz	DETECTOR FUNCTION	Peak (PK) Average (AV)
ENVIRONMENTAL CONDITIONS	24deg. C, 64%RH 1002 hPa	TESTED BY	Brad Wu
TEST MODE	A		

ANTENNA POLARITY & TEST DISTANCE: HORIZONTAL AT 3 M								
NO.	FREQ. (MHz)	EMISSION LEVEL (dBuV/m)	LIMIT (dBuV/m)	MARGIN (dB)	ANTENNA HEIGHT (m)	TABLE ANGLE (Degree)	RAW VALUE (dBuV)	CORRECTION FACTOR (dB/m)
1	5150.00	65.31 PK	74.00	-8.69	1.01 H	182	28.27	37.04
2	5150.00	48.25 AV	54.00	-5.75	1.01 H	182	11.21	37.04
3	*5180.00	107.63 PK			1.01 H	182	70.56	37.07
4	*5180.00	97.02 AV			1.01 H	182	59.95	37.07
5	#10360.00	66.65 PK	68.30	-1.65	1.10 H	234	19.39	47.26
ANTENNA POLARITY & TEST DISTANCE: VERTICAL AT 3 M								
NO.	FREQ. (MHz)	EMISSION LEVEL (dBuV/m)	LIMIT (dBuV/m)	MARGIN (dB)	ANTENNA HEIGHT (m)	TABLE ANGLE (Degree)	RAW VALUE (dBuV)	CORRECTION FACTOR (dB/m)
1	5150.00	63.02 PK	74.00	-10.98	1.03 V	99	25.98	37.04
2	5150.00	45.95 AV	54.00	-8.05	1.03 V	99	8.91	37.04
3	*5180.00	106.25 PK			1.03 V	99	69.18	37.07
4	*5180.00	95.63 AV			1.03 V	99	58.56	37.07
5	#10360.00	67.53 PK	68.30	-0.77	1.28 V	27	20.27	47.26

- REMARKS:**
1. Emission level (dBuV/m) = Raw Value (dBuV) + Correction Factor (dB/m).
 2. Correction Factor (dB/m) = Antenna Factor (dB/m) + Cable Factor (dB).
 3. The other emission levels were very low against the limit.
 4. Margin value = Emission level – Limit value.
 5. “ * “: Fundamental frequency.
 6. "#":The radiated frequency is out the restricted band.



A D T

EUT TEST CONDITION		MEASUREMENT DETAIL	
CHANNEL	Channel 40	FREQUENCY RANGE	1 ~ 40GHz
INPUT POWER (SYSTEM)	120Vac, 60 Hz	DETECTOR FUNCTION	Peak (PK) Average (AV)
ENVIRONMENTAL CONDITIONS	24deg. C, 64%RH 1002 hPa	TESTED BY	Brad Wu
TEST MODE	A		

ANTENNA POLARITY & TEST DISTANCE: HORIZONTAL AT 3 M								
NO.	FREQ. (MHz)	EMISSION LEVEL (dBuV/m)	LIMIT (dBuV/m)	MARGIN (dB)	ANTENNA HEIGHT (m)	TABLE ANGLE (Degree)	RAW VALUE (dBuV)	CORRECTION FACTOR (dB/m)
1	*5200.00	107.62 PK			1.02 H	183	70.53	37.09
2	*5200.00	96.91 AV			1.02 H	183	59.82	37.09
3	#10400.00	67.13 PK	68.30	-1.17	1.02 H	199	19.66	47.47
ANTENNA POLARITY & TEST DISTANCE: VERTICAL AT 3 M								
NO.	FREQ. (MHz)	EMISSION LEVEL (dBuV/m)	LIMIT (dBuV/m)	MARGIN (dB)	ANTENNA HEIGHT (m)	TABLE ANGLE (Degree)	RAW VALUE (dBuV)	CORRECTION FACTOR (dB/m)
1	*5200.00	106.03 PK			1.05 V	98	68.94	37.09
2	*5200.00	95.46 AV			1.05 V	98	58.37	37.09
3	#10400.00	67.36 PK	68.30	-0.94	1.26 V	38	19.89	47.47

- REMARKS:**
1. Emission level (dBuV/m) = Raw Value (dBuV) + Correction Factor (dB/m).
 2. Correction Factor (dB/m) = Antenna Factor (dB/m) + Cable Factor (dB).
 3. The other emission levels were very low against the limit.
 4. Margin value = Emission level – Limit value.
 5. “ * “: Fundamental frequency.
 6. “#”:The radiated frequency is out the restricted band.



A D T

EUT TEST CONDITION		MEASUREMENT DETAIL	
CHANNEL	Channel 48	FREQUENCY RANGE	1 ~ 40GHz
INPUT POWER (SYSTEM)	120Vac, 60 Hz	DETECTOR FUNCTION	Peak (PK) Average (AV)
ENVIRONMENTAL CONDITIONS	24deg. C, 64%RH 1002 hPa	TESTED BY	Brad Wu
TEST MODE	A		

ANTENNA POLARITY & TEST DISTANCE: HORIZONTAL AT 3 M								
NO.	FREQ. (MHz)	EMISSION LEVEL (dBuV/m)	LIMIT (dBuV/m)	MARGIN (dB)	ANTENNA HEIGHT (m)	TABLE ANGLE (Degree)	RAW VALUE (dBuV)	CORRECTION FACTOR (dB/m)
1	*5240.00	107.53 PK			1.04 H	186	70.33	37.20
2	*5240.00	96.81 AV			1.04 H	186	59.61	37.20
3	5350.00	51.35 PK	74.00	-22.65	1.04 H	186	13.95	37.40
4	5350.00	38.32 AV	54.00	-15.68	1.04 H	186	0.92	37.40
5	#10480.00	66.35 PK	68.30	-1.95	1.09 H	217	18.69	47.66
ANTENNA POLARITY & TEST DISTANCE: VERTICAL AT 3 M								
NO.	FREQ. (MHz)	EMISSION LEVEL (dBuV/m)	LIMIT (dBuV/m)	MARGIN (dB)	ANTENNA HEIGHT (m)	TABLE ANGLE (Degree)	RAW VALUE (dBuV)	CORRECTION FACTOR (dB/m)
1	*5240.00	106.02 PK			1.05 V	101	68.82	37.20
2	*5240.00	95.43 AV			1.05 V	101	58.23	37.20
3	5350.00	50.12 PK	74.00	-23.88	1.05 V	101	12.72	37.40
4	5350.00	36.69 AV	54.00	-17.31	1.05 V	101	-0.71	37.40
5	#10480.00	67.21 PK	68.30	-1.09	1.12 V	35	19.55	47.66

- REMARKS:**
1. Emission level (dBuV/m) = Raw Value (dBuV) + Correction Factor (dB/m).
 2. Correction Factor (dB/m) = Antenna Factor (dB/m) + Cable Factor (dB).
 3. The other emission levels were very low against the limit.
 4. Margin value = Emission level – Limit value.
 5. “ * “: Fundamental frequency.
 6. “#“: The radiated frequency is out the restricted band.



A D T

EUT TEST CONDITION		MEASUREMENT DETAIL	
CHANNEL	Channel 36	FREQUENCY RANGE	1 ~ 40GHz
INPUT POWER (SYSTEM)	120Vac, 60 Hz	DETECTOR FUNCTION	Peak (PK) Average (AV)
ENVIRONMENTAL CONDITIONS	24deg. C, 64%RH 1002 hPa	TESTED BY	Brad Wu
TEST MODE	C		

ANTENNA POLARITY & TEST DISTANCE: HORIZONTAL AT 3 M								
NO.	FREQ. (MHz)	EMISSION LEVEL (dBuV/m)	LIMIT (dBuV/m)	MARGIN (dB)	ANTENNA HEIGHT (m)	TABLE ANGLE (Degree)	RAW VALUE (dBuV)	CORRECTION FACTOR (dB/m)
1	5150.00	52.03 PK	74.00	-21.97	1.04 H	216	14.99	37.04
2	5150.00	34.92 AV	54.00	-19.08	1.04 H	216	-2.12	37.04
3	*5180.00	90.42 PK			1.04 H	216	53.35	37.07
4	*5180.00	79.81 AV			1.04 H	216	42.74	37.07
5	#10360.00	66.44 PK	68.30	-1.86	1.13 H	229	19.18	47.26
ANTENNA POLARITY & TEST DISTANCE: VERTICAL AT 3 M								
NO.	FREQ. (MHz)	EMISSION LEVEL (dBuV/m)	LIMIT (dBuV/m)	MARGIN (dB)	ANTENNA HEIGHT (m)	TABLE ANGLE (Degree)	RAW VALUE (dBuV)	CORRECTION FACTOR (dB/m)
1	5150.00	65.03 PK	74.00	-8.97	1.05 V	186	27.99	37.04
2	5150.00	47.92 AV	54.00	-6.08	1.05 V	186	10.88	37.04
3	*5180.00	107.51 PK			1.05 V	186	70.44	37.07
4	*5180.00	96.87 AV			1.05 V	186	59.80	37.07
5	#10360.00	67.26 PK	68.30	-1.04	1.09 V	235	20.00	47.26

- REMARKS:**
1. Emission level (dBuV/m) = Raw Value (dBuV) + Correction Factor (dB/m).
 2. Correction Factor (dB/m) = Antenna Factor (dB/m) + Cable Factor (dB).
 3. The other emission levels were very low against the limit.
 4. Margin value = Emission level – Limit value.
 5. “ * “: Fundamental frequency.
 6. “#”: The radiated frequency is out the restricted band.



A D T

EUT TEST CONDITION		MEASUREMENT DETAIL	
CHANNEL	Channel 40	FREQUENCY RANGE	1 ~ 40GHz
INPUT POWER (SYSTEM)	120Vac, 60 Hz	DETECTOR FUNCTION	Peak (PK) Average (AV)
ENVIRONMENTAL CONDITIONS	24deg. C, 64%RH 1002 hPa	TESTED BY	Brad Wu
TEST MODE	C		

ANTENNA POLARITY & TEST DISTANCE: HORIZONTAL AT 3 M								
NO.	FREQ. (MHz)	EMISSION LEVEL (dBuV/m)	LIMIT (dBuV/m)	MARGIN (dB)	ANTENNA HEIGHT (m)	TABLE ANGLE (Degree)	RAW VALUE (dBuV)	CORRECTION FACTOR (dB/m)
1	*5200.00	90.29 PK			1.08 H	213	53.20	37.09
2	*5200.00	79.71 AV			1.08 H	213	42.62	37.09
3	#10400.00	66.52 PK	68.30	-1.78	1.09 H	183	19.05	47.47
ANTENNA POLARITY & TEST DISTANCE: VERTICAL AT 3 M								
NO.	FREQ. (MHz)	EMISSION LEVEL (dBuV/m)	LIMIT (dBuV/m)	MARGIN (dB)	ANTENNA HEIGHT (m)	TABLE ANGLE (Degree)	RAW VALUE (dBuV)	CORRECTION FACTOR (dB/m)
1	*5200.00	107.41 PK			1.05 V	193	70.32	37.09
2	*5200.00	96.72 AV			1.05 V	193	59.63	37.09
3	#10400.00	67.16 PK	68.30	-1.14	1.02 V	195	19.69	47.47

- REMARKS:**
1. Emission level (dBuV/m) = Raw Value (dBuV) + Correction Factor (dB/m).
 2. Correction Factor (dB/m) = Antenna Factor (dB/m) + Cable Factor (dB).
 3. The other emission levels were very low against the limit.
 4. Margin value = Emission level – Limit value.
 5. “ * “: Fundamental frequency.
 6. “#”:The radiated frequency is out the restricted band.



A D T

EUT TEST CONDITION		MEASUREMENT DETAIL	
CHANNEL	Channel 48	FREQUENCY RANGE	1 ~ 40GHz
INPUT POWER (SYSTEM)	120Vac, 60 Hz	DETECTOR FUNCTION	Peak (PK) Average (AV)
ENVIRONMENTAL CONDITIONS	24deg. C, 64%RH 1002 hPa	TESTED BY	Brad Wu
TEST MODE	C		

ANTENNA POLARITY & TEST DISTANCE: HORIZONTAL AT 3 M								
NO.	FREQ. (MHz)	EMISSION LEVEL (dBuV/m)	LIMIT (dBuV/m)	MARGIN (dB)	ANTENNA HEIGHT (m)	TABLE ANGLE (Degree)	RAW VALUE (dBuV)	CORRECTION FACTOR (dB/m)
1	*5240.00	90.34 PK			1.01 H	217	53.14	37.20
2	*5240.00	79.68 AV			1.01 H	217	42.48	37.20
3	5350.00	49.12 PK	74.00	-24.88	1.01 H	217	11.72	37.40
4	5350.00	36.02 AV	54.00	-17.98	1.01 H	217	-1.38	37.40
5	#10480.00	67.13 PK	68.30	-1.17	1.10 H	194	19.47	47.66
ANTENNA POLARITY & TEST DISTANCE: VERTICAL AT 3 M								
NO.	FREQ. (MHz)	EMISSION LEVEL (dBuV/m)	LIMIT (dBuV/m)	MARGIN (dB)	ANTENNA HEIGHT (m)	TABLE ANGLE (Degree)	RAW VALUE (dBuV)	CORRECTION FACTOR (dB/m)
1	*5240.00	107.41 PK			1.08 V	194	70.21	37.20
2	*5240.00	96.70 AV			1.08 V	194	59.50	37.20
3	5350.00	51.22 PK	74.00	-22.78	1.08 V	194	13.82	37.40
4	5350.00	38.14 AV	54.00	-15.86	1.08 V	194	0.74	37.40
5	#10480.00	67.25 PK	68.30	-1.05	1.13 V	194	19.59	47.66

- REMARKS:**
1. Emission level (dBuV/m) = Raw Value (dBuV) + Correction Factor (dB/m).
 2. Correction Factor (dB/m) = Antenna Factor (dB/m) + Cable Factor (dB).
 3. The other emission levels were very low against the limit.
 4. Margin value = Emission level – Limit value.
 5. “ * “: Fundamental frequency.
 6. “#“: The radiated frequency is out the restricted band.



A D T

DRAFT 802.11n (40MHz) OFDM MODULATION

EUT TEST CONDITION		MEASUREMENT DETAIL	
CHANNEL	Channel 38	FREQUENCY RANGE	1 ~ 40GHz
INPUT POWER (SYSTEM)	120Vac, 60 Hz	DETECTOR FUNCTION	Peak (PK) Average (AV)
ENVIRONMENTAL CONDITIONS	24deg. C, 64%RH 1002 hPa	TESTED BY	Brad Wu
TEST MODE	A		

ANTENNA POLARITY & TEST DISTANCE: HORIZONTAL AT 3 M								
NO.	FREQ. (MHz)	EMISSION LEVEL (dBuV/m)	LIMIT (dBuV/m)	MARGIN (dB)	ANTENNA HEIGHT (m)	TABLE ANGLE (Degree)	RAW VALUE (dBuV)	CORRECTION FACTOR (dB/m)
1	5150.00	66.54 PK	74.00	-7.46	1.01 H	182	29.51	37.04
2	5150.00	49.45 AV	54.00	-4.55	1.01 H	182	12.41	37.04
3	*5190.00	104.69 PK			1.01 H	182	67.61	37.08
4	*5190.00	94.12 AV			1.01 H	182	57.04	37.08
5	#10380.00	66.51 PK	68.30	-1.79	1.02 H	223	19.15	47.36
ANTENNA POLARITY & TEST DISTANCE: VERTICAL AT 3 M								
NO.	FREQ. (MHz)	EMISSION LEVEL (dBuV/m)	LIMIT (dBuV/m)	MARGIN (dB)	ANTENNA HEIGHT (m)	TABLE ANGLE (Degree)	RAW VALUE (dBuV)	CORRECTION FACTOR (dB/m)
1	5150.00	62.03 PK	74.00	-11.97	1.05 V	106	24.99	37.04
2	5150.00	45.12 AV	54.00	-8.88	1.05 V	106	8.08	37.04
3	*5190.00	103.25 PK			1.05 V	106	66.17	37.08
4	*5190.00	92.61 AV			1.05 V	106	55.53	37.08
5	#10380.00	67.12 PK	68.30	-1.18	1.07 V	31	19.76	47.36

- REMARKS:**
1. Emission level (dBuV/m) = Raw Value (dBuV) + Correction Factor (dB/m).
 2. Correction Factor (dB/m) = Antenna Factor (dB/m) + Cable Factor (dB).
 3. The other emission levels were very low against the limit.
 4. Margin value = Emission level – Limit value.
 5. “ * “: Fundamental frequency.
 6. “#“: The radiated frequency is out the restricted band.



A D T

EUT TEST CONDITION		MEASUREMENT DETAIL	
CHANNEL	Channel 46	FREQUENCY RANGE	1 ~ 40GHz
INPUT POWER (SYSTEM)	120Vac, 60 Hz	DETECTOR FUNCTION	Peak (PK) Average (AV)
ENVIRONMENTAL CONDITIONS	24deg. C, 64%RH 1002 hPa	TESTED BY	Brad Wu
TEST MODE	A		

ANTENNA POLARITY & TEST DISTANCE: HORIZONTAL AT 3 M								
NO.	FREQ. (MHz)	EMISSION LEVEL (dBuV/m)	LIMIT (dBuV/m)	MARGIN (dB)	ANTENNA HEIGHT (m)	TABLE ANGLE (Degree)	RAW VALUE (dBuV)	CORRECTION FACTOR (dB/m)
1	*5230.00	104.52 PK			1.04 H	185	67.35	37.17
2	*5230.00	94.03 AV			1.04 H	185	56.86	37.17
3	5350.00	51.85 PK	74.00	-22.15	1.04 H	185	14.45	37.40
4	5350.00	38.62 AV	54.00	-15.38	1.04 H	185	1.22	37.40
5	#10460.00	66.13 PK	68.30	-2.17	1.05 H	249	18.52	47.61
ANTENNA POLARITY & TEST DISTANCE: VERTICAL AT 3 M								
NO.	FREQ. (MHz)	EMISSION LEVEL (dBuV/m)	LIMIT (dBuV/m)	MARGIN (dB)	ANTENNA HEIGHT (m)	TABLE ANGLE (Degree)	RAW VALUE (dBuV)	CORRECTION FACTOR (dB/m)
1	*5230.00	103.11 PK			1.06 V	109	65.94	37.17
2	*5230.00	92.48 AV			1.06 V	109	55.31	37.17
3	5350.00	50.46 PK	74.00	-23.54	1.06 V	109	13.06	37.40
4	5350.00	36.98 AV	54.00	-17.02	1.06 V	109	-0.42	37.40
5	#10460.00	66.87 PK	68.30	-1.43	1.01 V	235	19.26	47.61

- REMARKS:**
1. Emission level (dBuV/m) = Raw Value (dBuV) + Correction Factor (dB/m).
 2. Correction Factor (dB/m) = Antenna Factor (dB/m) + Cable Factor (dB).
 3. The other emission levels were very low against the limit.
 4. Margin value = Emission level – Limit value.
 5. “ * “: Fundamental frequency.
 6. “#“: The radiated frequency is out the restricted band.



A D T

EUT TEST CONDITION		MEASUREMENT DETAIL	
CHANNEL	Channel 38	FREQUENCY RANGE	1 ~ 40GHz
INPUT POWER (SYSTEM)	120Vac, 60 Hz	DETECTOR FUNCTION	Peak (PK) Average (AV)
ENVIRONMENTAL CONDITIONS	24deg. C, 64%RH 1002 hPa	TESTED BY	Brad Wu
TEST MODE	C		

ANTENNA POLARITY & TEST DISTANCE: HORIZONTAL AT 3 M								
NO.	FREQ. (MHz)	EMISSION LEVEL (dBuV/m)	LIMIT (dBuV/m)	MARGIN (dB)	ANTENNA HEIGHT (m)	TABLE ANGLE (Degree)	RAW VALUE (dBuV)	CORRECTION FACTOR (dB/m)
1	5150.00	50.26 PK	74.00	-23.74	1.07 H	216	13.22	37.04
2	5150.00	33.18 AV	54.00	-20.82	1.07 H	216	-3.86	37.04
3	*5190.00	87.42 PK			1.07 H	216	50.34	37.08
4	*5190.00	76.75 AV			1.07 H	216	39.67	37.08
5	#10380.00	66.34 PK	68.30	-1.96	1.08 H	179	18.98	47.36
ANTENNA POLARITY & TEST DISTANCE: VERTICAL AT 3 M								
NO.	FREQ. (MHz)	EMISSION LEVEL (dBuV/m)	LIMIT (dBuV/m)	MARGIN (dB)	ANTENNA HEIGHT (m)	TABLE ANGLE (Degree)	RAW VALUE (dBuV)	CORRECTION FACTOR (dB/m)
1	5150.00	66.42 PK	74.00	-7.58	1.02 V	186	29.38	37.04
2	5150.00	49.34 AV	54.00	-4.66	1.02 V	186	12.30	37.04
3	*5190.00	104.54 PK			1.02 V	186	67.46	37.08
4	*5190.00	94.03 AV			1.02 V	186	56.95	37.08
5	#10380.00	67.03 PK	68.30	-1.27	1.06 V	24	19.67	47.36

- REMARKS:**
1. Emission level (dBuV/m) = Raw Value (dBuV) + Correction Factor (dB/m).
 2. Correction Factor (dB/m) = Antenna Factor (dB/m) + Cable Factor (dB).
 3. The other emission levels were very low against the limit.
 4. Margin value = Emission level – Limit value.
 5. “ * “: Fundamental frequency.
 6. “#”:The radiated frequency is out the restricted band.



A D T

EUT TEST CONDITION		MEASUREMENT DETAIL	
CHANNEL	Channel 46	FREQUENCY RANGE	1 ~ 40GHz
INPUT POWER (SYSTEM)	120Vac, 60 Hz	DETECTOR FUNCTION	Peak (PK) Average (AV)
ENVIRONMENTAL CONDITIONS	24deg. C, 64%RH 1002 hPa	TESTED BY	Brad Wu
TEST MODE	C		

ANTENNA POLARITY & TEST DISTANCE: HORIZONTAL AT 3 M								
NO.	FREQ. (MHz)	EMISSION LEVEL (dBuV/m)	LIMIT (dBuV/m)	MARGIN (dB)	ANTENNA HEIGHT (m)	TABLE ANGLE (Degree)	RAW VALUE (dBuV)	CORRECTION FACTOR (dB/m)
1	*5230.00	87.31 PK			1.09 H	217	50.14	37.17
2	*5230.00	76.62 AV			1.09 H	217	39.45	37.17
3	5350.00	50.36 PK	74.00	-23.64	1.09 H	217	12.96	37.40
4	5350.00	37.22 AV	54.00	-16.78	1.09 H	217	-0.18	37.40
5	#10460.00	66.15 PK	68.30	-2.15	1.05 H	193	18.54	47.61
ANTENNA POLARITY & TEST DISTANCE: VERTICAL AT 3 M								
NO.	FREQ. (MHz)	EMISSION LEVEL (dBuV/m)	LIMIT (dBuV/m)	MARGIN (dB)	ANTENNA HEIGHT (m)	TABLE ANGLE (Degree)	RAW VALUE (dBuV)	CORRECTION FACTOR (dB/m)
1	*5230.00	104.46 PK			1.03 V	189	67.29	37.17
2	*5230.00	93.91 AV			1.03 V	189	56.74	37.17
3	5350.00	52.46 PK	74.00	-21.54	1.03 V	189	15.06	37.40
4	5350.00	39.45 AV	54.00	-14.55	1.03 V	189	2.05	37.40
5	#10460.00	66.84 PK	68.30	-1.46	1.03 V	211	19.23	47.61

- REMARKS:**
1. Emission level (dBuV/m) = Raw Value (dBuV) + Correction Factor (dB/m).
 2. Correction Factor (dB/m) = Antenna Factor (dB/m) + Cable Factor (dB).
 3. The other emission levels were very low against the limit.
 4. Margin value = Emission level – Limit value.
 5. “ * “: Fundamental frequency.
 6. “#“: The radiated frequency is out the restricted band.



A D T

BELOW 1GHz WORST-CASE DATA : DRAFT 802.11n (40MHz) OFDM MODULATION

EUT TEST CONDITION		MEASUREMENT DETAIL	
CHANNEL	Channel 46	FREQUENCY RANGE	Below 1000MHz
INPUT POWER (SYSTEM)	120Vac, 60 Hz	DETECTOR FUNCTION	Quasi-Peak
ENVIRONMENTAL CONDITIONS	24deg. C, 64%RH 1000 hPa	TESTED BY	Brad Wu
TEST MODE	A		

ANTENNA POLARITY & TEST DISTANCE: HORIZONTAL AT 3 M								
NO.	FREQ. (MHz)	EMISSION LEVEL (dBuV/m)	LIMIT (dBuV/m)	MARGIN (dB)	ANTENNA HEIGHT (m)	TABLE ANGLE (Degree)	RAW VALUE (dBuV)	CORRECTION FACTOR (dB/m)
1	68.79	35.62 QP	40.00	-4.38	2.00 H	223	22.40	13.22
2	249.60	43.95 QP	46.00	-2.05	1.25 H	178	30.15	13.80
3	375.98	35.18 QP	46.00	-10.82	1.00 H	265	18.14	17.04
4	681.24	38.97 QP	46.00	-7.03	1.00 H	136	14.40	24.57
5	751.23	39.52 QP	46.00	-6.48	1.00 H	223	14.01	25.51
6	852.33	36.90 QP	46.00	-9.10	1.25 H	214	9.92	26.97
ANTENNA POLARITY & TEST DISTANCE: VERTICAL AT 3 M								
NO.	FREQ. (MHz)	EMISSION LEVEL (dBuV/m)	LIMIT (dBuV/m)	MARGIN (dB)	ANTENNA HEIGHT (m)	TABLE ANGLE (Degree)	RAW VALUE (dBuV)	CORRECTION FACTOR (dB/m)
1	33.79	37.81 QP	40.00	-2.19	1.00 V	10	24.02	13.79
2	70.73	37.27 QP	40.00	-2.73	1.00 V	100	24.39	12.88
3	249.60	38.46 QP	46.00	-7.54	1.25 V	193	24.65	13.80
4	500.42	38.23 QP	46.00	-7.77	1.00 V	160	17.80	20.44
5	751.23	40.78 QP	46.00	-5.22	1.00 V	190	15.27	25.51
6	867.89	36.57 QP	46.00	-9.43	1.00 V	250	9.29	27.28

- REMARKS:**
1. Emission level (dBuV/m) = Raw Value (dBuV) + Correction Factor (dB/m).
 2. Correction Factor (dB/m) = Antenna Factor (dB/m) + Cable Factor (dB).
 3. The other emission levels were very low against the limit.
 4. Margin value = Emission level – Limit value.



A D T

DRAFT 802.11n (40MHz) OFDM MODULATION

EUT TEST CONDITION		MEASUREMENT DETAIL	
CHANNEL	Channel 46	FREQUENCY RANGE	Below 1000MHz
INPUT POWER (SYSTEM)	120Vac, 60 Hz	DETECTOR FUNCTION	Quasi-Peak
ENVIRONMENTAL CONDITIONS	25deg. C, 65%RH 1000 hPa	TESTED BY	Brad Wu
TEST MODE	B		

ANTENNA POLARITY & TEST DISTANCE: HORIZONTAL AT 3 M								
NO.	FREQ. (MHz)	EMISSION LEVEL (dBuV/m)	LIMIT (dBuV/m)	MARGIN (dB)	ANTENNA HEIGHT (m)	TABLE ANGLE (Degree)	RAW VALUE (dBuV)	CORRECTION FACTOR (dB/m)
1	249.60	43.34 QP	46.00	-2.66	1.00 H	94	29.54	13.80
2	346.82	38.19 QP	46.00	-7.81	1.00 H	349	22.38	15.80
3	599.58	37.40 QP	46.00	-8.60	1.25 H	76	15.01	22.39
4	681.24	40.09 QP	46.00	-5.91	1.00 H	43	15.52	24.57
5	751.23	41.07 QP	46.00	-4.93	1.00 H	10	15.56	25.51
6	865.94	40.93 QP	46.00	-5.07	1.50 H	13	13.69	27.24

ANTENNA POLARITY & TEST DISTANCE: VERTICAL AT 3 M								
NO.	FREQ. (MHz)	EMISSION LEVEL (dBuV/m)	LIMIT (dBuV/m)	MARGIN (dB)	ANTENNA HEIGHT (m)	TABLE ANGLE (Degree)	RAW VALUE (dBuV)	CORRECTION FACTOR (dB/m)
1	43.51	36.02 QP	40.00	-3.98	1.25 V	271	21.51	14.51
2	86.28	33.96 QP	40.00	-6.04	1.25 V	310	26.01	7.95
3	265.16	39.36 QP	46.00	-6.64	1.00 V	283	25.57	13.79
4	729.84	38.57 QP	46.00	-7.43	1.00 V	349	13.26	25.31
5	867.89	41.21 QP	46.00	-4.79	1.00 V	268	13.93	27.28
6	930.11	39.26 QP	46.00	-6.74	1.00 V	10	10.96	28.30

- REMARKS:**
1. Emission level (dBuV/m) = Raw Value (dBuV) + Correction Factor (dB/m).
 2. Correction Factor (dB/m) = Antenna Factor (dB/m) + Cable Factor (dB).
 3. The other emission levels were very low against the limit.
 4. Margin value = Emission level – Limit value.



A D T

DRAFT 802.11n (40MHz) OFDM MODULATION

EUT TEST CONDITION		MEASUREMENT DETAIL	
CHANNEL	Channel 46	FREQUENCY RANGE	Below 1000MHz
INPUT POWER (SYSTEM)	120Vac, 60 Hz	DETECTOR FUNCTION	Quasi-Peak
ENVIRONMENTAL CONDITIONS	25deg. C, 65%RH 1000 hPa	TESTED BY	Brad Wu
TEST MODE	C		

ANTENNA POLARITY & TEST DISTANCE: HORIZONTAL AT 3 M								
NO.	FREQ. (MHz)	EMISSION LEVEL (dBuV/m)	LIMIT (dBuV/m)	MARGIN (dB)	ANTENNA HEIGHT (m)	TABLE ANGLE (Degree)	RAW VALUE (dBuV)	CORRECTION FACTOR (dB/m)
1	113.50	33.94 QP	43.50	-9.56	1.50 H	244	22.53	11.41
2	249.60	40.74 QP	46.00	-5.26	1.00 H	67	26.94	13.80
3	500.42	36.20 QP	46.00	-9.80	1.50 H	121	15.77	20.44
4	681.24	39.46 QP	46.00	-6.54	1.00 H	289	14.89	24.57
5	751.23	36.34 QP	46.00	-9.66	1.00 H	220	10.83	25.51
6	867.89	38.89 QP	46.00	-7.11	1.25 H	223	11.61	27.28

ANTENNA POLARITY & TEST DISTANCE: VERTICAL AT 3 M								
NO.	FREQ. (MHz)	EMISSION LEVEL (dBuV/m)	LIMIT (dBuV/m)	MARGIN (dB)	ANTENNA HEIGHT (m)	TABLE ANGLE (Degree)	RAW VALUE (dBuV)	CORRECTION FACTOR (dB/m)
1	74.20	38.61 QP	40.00	-1.39	1.24 V	198	27.54	11.07
2	113.50	39.14 QP	43.50	-4.36	1.00 V	169	27.73	11.41
3	249.60	38.44 QP	46.00	-7.56	1.50 V	121	24.64	13.80
4	500.42	40.19 QP	46.00	-5.81	1.00 V	178	19.75	20.44
5	729.84	40.68 QP	46.00	-5.32	1.00 V	172	15.37	25.31
6	867.89	39.48 QP	46.00	-6.52	1.50 V	166	12.20	27.28

- REMARKS:**
1. Emission level (dBuV/m) = Raw Value (dBuV) + Correction Factor (dB/m).
 2. Correction Factor (dB/m) = Antenna Factor (dB/m) + Cable Factor (dB).
 3. The other emission levels were very low against the limit.
 4. Margin value = Emission level – Limit value.



A D T

DRAFT 802.11n (40MHz) OFDM MODULATION

EUT TEST CONDITION		MEASUREMENT DETAIL	
CHANNEL	Channel 46	FREQUENCY RANGE	Below 1000MHz
INPUT POWER (SYSTEM)	120Vac, 60 Hz	DETECTOR FUNCTION	Quasi-Peak
ENVIRONMENTAL CONDITIONS	25deg. C, 65%RH 1000 hPa	TESTED BY	Brad Wu
TEST MODE	D		

ANTENNA POLARITY & TEST DISTANCE: HORIZONTAL AT 3 M								
NO.	FREQ. (MHz)	EMISSION LEVEL (dBuV/m)	LIMIT (dBuV/m)	MARGIN (dB)	ANTENNA HEIGHT (m)	TABLE ANGLE (Degree)	RAW VALUE (dBuV)	CORRECTION FACTOR (dB/m)
1	152.39	36.14 QP	43.50	-7.36	1.50 H	103	22.05	14.10
2	249.60	32.22 QP	46.00	-13.78	1.50 H	184	18.42	13.80
3	519.86	34.39 QP	46.00	-11.61	1.50 H	256	13.54	20.84
4	681.24	38.86 QP	46.00	-7.14	1.00 H	79	14.29	24.57
5	751.23	39.00 QP	46.00	-7.00	1.50 H	175	13.49	25.51
6	902.89	38.27 QP	46.00	-7.73	1.00 H	88	10.33	27.94
ANTENNA POLARITY & TEST DISTANCE: VERTICAL AT 3 M								
NO.	FREQ. (MHz)	EMISSION LEVEL (dBuV/m)	LIMIT (dBuV/m)	MARGIN (dB)	ANTENNA HEIGHT (m)	TABLE ANGLE (Degree)	RAW VALUE (dBuV)	CORRECTION FACTOR (dB/m)
1	43.51	38.41 QP	40.00	-1.59	1.50 V	283	23.90	14.51
2	68.79	36.83 QP	40.00	-3.17	1.00 V	199	23.61	13.22
3	500.42	34.56 QP	46.00	-11.44	1.00 V	157	14.12	20.44
4	599.58	35.93 QP	46.00	-10.07	1.00 V	166	13.54	22.39
5	731.79	40.60 QP	46.00	-5.40	1.00 V	172	15.27	25.33
6	867.89	39.73 QP	46.00	-6.27	1.00 V	175	12.46	27.28

- REMARKS:**
1. Emission level (dBuV/m) = Raw Value (dBuV) + Correction Factor (dB/m).
 2. Correction Factor (dB/m) = Antenna Factor (dB/m) + Cable Factor (dB).
 3. The other emission levels were very low against the limit.
 4. Margin value = Emission level – Limit value.

4.2 CONDUCTED EMISSION MEASUREMENT

4.2.1 LIMITS OF CONDUCTED EMISSION MEASUREMENT

FREQUENCY OF EMISSION (MHz)	CONDUCTED LIMIT (dB μ V)	
	Quasi-peak	Average
0.15 ~ 0.5	66 to 56	56 to 46
0.5 ~ 5	56	46
5 ~ 30	60	50

- NOTE:** 1. The lower limit shall apply at the transition frequencies.
 2. The limit decreases in line with the logarithm of the frequency in the range of 0.15 to 0.50MHz.
 3. All emanations from a class A/B digital device or system, including any network of conductors and apparatus connected thereto, shall not exceed the level of field strengths specified above.

4.2.2 TEST INSTRUMENTS

DESCRIPTION & MANUFACTURER	MODEL NO.	SERIAL NO.	DATE OF CALIBRATION	DUE DATE OF CALIBRATION
Test Receiver ROHDE & SCHWARZ	ESCS30	100288	Sep. 22, 2008	Sep. 21, 2009
RF signal cable Woken	5D-FB	Cable-HYCO2-01	Dec. 31, 2008	Dec. 30, 2009
LISN ROHDE & SCHWARZ	ESH2-Z5	100100	Dec. 29, 2008	Dec. 28, 2009
LISN ROHDE & SCHWARZ	ESH3-Z5	100311	Jul. 29, 2008	Jul. 28, 2009
Software ADT	ADT_Cond_ V7.3.7	NA	NA	NA

- NOTE:** 1. The calibration interval of the above test instruments is 12 months and the calibrations are traceable to NML/ROC and NIST/USA.
 2. The test was performed in HwaYa Shielded Room 2.
 3. The VCCI Site Registration No. is C-2047.

4.2.3 TEST PROCEDURES

- a. The EUT was placed 0.4 meters from the conducting wall of the shielded room with EUT being connected to the power mains through a line impedance stabilization network (LISN). Other support units were connected to the power mains through another LISN. The two LISNs provide 50 ohm/ 50uH of coupling impedance for the measuring instrument.
- b. Both lines of the power mains connected to the EUT were checked for maximum conducted interference.
- c. The frequency range from 150kHz to 30MHz was searched. Emission levels under (Limit - 20dB) was not recorded.

4.2.4 DEVIATION FROM TEST STANDARD

No deviation

4.2.5 TEST SETUP

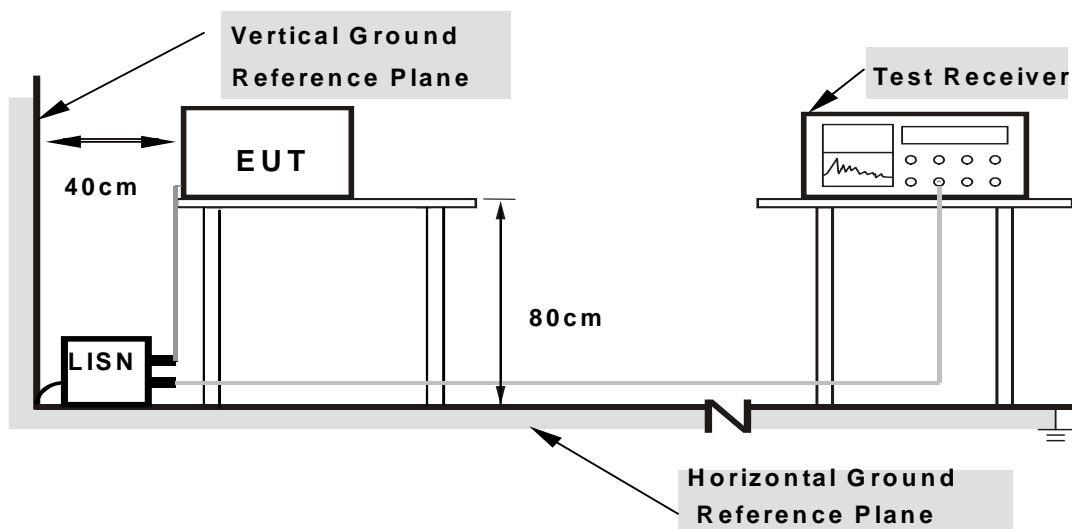

Note: 1.Support units were connected to second LISN.

2.Both of LISNs (AMN) are 80 cm from EUT and at least 80 from other units and other metal planes

For the actual test configuration, please refer to the attached file (Test Setup Photo).

4.2.6 EUT OPERATING CONDITIONS

Same as 4.1.6.



A D T

4.2.7 TEST RESULTS

CONDUCTED WORST-CASE DATA : DRAFT 802.11n (40MHz) OFDM MODULATION

EUT TEST CONDITION		MEASUREMENT DETAIL	
CHANNEL	Channel 46	PHASE	Line 1
MODULATION TYPE	BPSK	INPUT POWER (SYSTEM)	120Vac, 60Hz
TRANSFER RATE	13.5Mbps	6dB BANDWIDTH	9kHz
ENVIRONMENTAL CONDITIONS	25deg. C, 77%RH, 982hPa	TESTED BY	Scott Yang
TEST MODE	A		

No	Freq. [MHz]	Corr. Factor (dB)	Reading Value		Emission Level		Limit		Margin	
			[dB (uV)]		[dB (uV)]		[dB (uV)]		(dB)	
			Q.P.	AV.	Q.P.	AV.	Q.P.	AV.	Q.P.	AV.
1	0.279	0.13	50.72	-	50.85	-	60.85	50.85	-9.99	-
2	0.326	0.14	57.36	45.55	57.50	45.69	59.56	49.56	-2.06	-3.87
3	0.416	0.14	55.57	44.55	55.71	44.69	57.54	47.54	-1.82	-2.84
4	0.444	0.14	52.94	38.12	53.08	38.26	56.98	46.98	-3.90	-8.72
5	0.541	0.15	55.15	40.25	55.30	40.40	56.00	46.00	-0.70	-5.60
6	0.627	0.15	53.49	40.92	53.64	41.07	56.00	46.00	-2.36	-4.93
7	0.740	0.16	54.39	38.21	54.55	38.37	56.00	46.00	-1.45	-7.63
8	0.931	0.17	55.35	39.29	55.52	39.46	56.00	46.00	-0.48	-6.54
9	1.090	0.17	54.04	38.27	54.21	38.44	56.00	46.00	-1.79	-7.56
10	1.418	0.18	54.26	36.89	54.44	37.07	56.00	46.00	-1.56	-8.93
11	1.711	0.18	52.81	37.86	52.99	38.04	56.00	46.00	-3.01	-7.96
12	2.227	0.20	49.57	36.38	49.77	36.58	56.00	46.00	-6.23	-9.42
13	2.621	0.22	48.35	34.07	48.57	34.29	56.00	46.00	-7.43	-11.71
14	3.297	0.25	43.66	-	43.91	-	56.00	46.00	-12.09	-
15	3.680	0.27	42.16	-	42.43	-	56.00	46.00	-13.57	-

- REMARKS:**
1. Q.P. and AV. are abbreviations of quasi-peak and average individually.
 2. "-": The Quasi-peak reading value also meets average limit and measurement with the average detector is unnecessary.
 3. The emission levels of other frequencies were very low against the limit.
 4. Margin value = Emission level - Limit value
 5. Correction factor = Insertion loss + Cable loss
 6. Emission Level = Correction Factor + Reading Value.



A D T

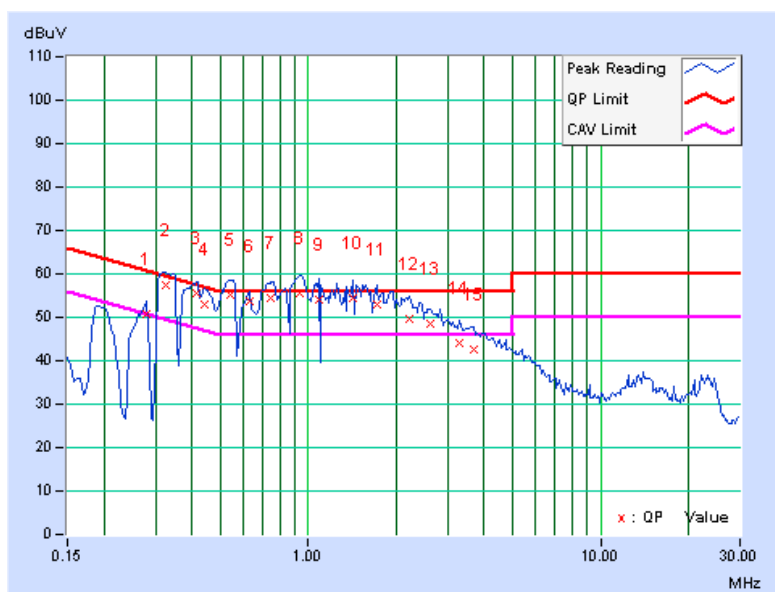



A D T

EUT TEST CONDITION		MEASUREMENT DETAIL	
CHANNEL	Channel 46	PHASE	Line 2
MODULATION TYPE	BPSK	INPUT POWER (SYSTEM)	120Vac, 60Hz
TRANSFER RATE	13.5Mbps	6dB BANDWIDTH	9kHz
ENVIRONMENTAL CONDITIONS	25deg. C, 77%RH, 982hPa	TESTED BY	Scott Yang
TEST MODE	A		

No	Freq. [MHz]	Corr. Factor (dB)	Reading Value		Emission Level		Limit		Margin	
			[dB (uV)]		[dB (uV)]		[dB (uV)]		(dB)	
			Q.P.	AV.	Q.P.	AV.	Q.P.	AV.	Q.P.	AV.
1	0.279	0.14	50.46	-	50.60	-	60.85	50.85	-10.25	-
2	0.338	0.14	56.37	45.84	56.51	45.98	59.26	49.26	-2.75	-3.28
3	0.416	0.15	55.02	44.13	55.17	44.28	57.54	47.54	-2.36	-3.25
4	0.439	0.15	52.96	37.47	53.11	37.62	57.08	47.08	-3.97	-9.46
5	0.548	0.15	54.75	41.04	54.90	41.19	56.00	46.00	-1.10	-4.81
6	0.724	0.16	53.78	36.36	53.94	36.52	56.00	46.00	-2.06	-9.48
7	0.939	0.17	55.74	39.41	55.91	39.58	56.00	46.00	-0.09	-6.42
8	1.051	0.17	54.31	37.62	54.48	37.79	56.00	46.00	-1.52	-8.21
9	1.227	0.18	54.06	36.21	54.24	36.39	56.00	46.00	-1.76	-9.61
10	1.406	0.18	53.61	34.82	53.79	35.00	56.00	46.00	-2.21	-11.00
11	1.738	0.19	52.63	38.45	52.82	38.64	56.00	46.00	-3.18	-7.36
12	2.090	0.20	50.09	35.68	50.29	35.88	56.00	46.00	-5.71	-10.12
13	2.344	0.22	48.98	34.41	49.20	34.63	56.00	46.00	-6.80	-11.37
14	2.660	0.23	46.24	31.64	46.47	31.87	56.00	46.00	-9.53	-14.13
15	3.730	0.29	41.34	-	41.63	-	56.00	46.00	-14.37	-

- REMARKS:**
1. Q.P. and AV. are abbreviations of quasi-peak and average individually.
 2. "-": The Quasi-peak reading value also meets average limit and measurement with the average detector is unnecessary.
 3. The emission levels of other frequencies were very low against the limit.
 4. Margin value = Emission level - Limit value
 5. Correction factor = Insertion loss + Cable loss
 6. Emission Level = Correction Factor + Reading Value.



A D T

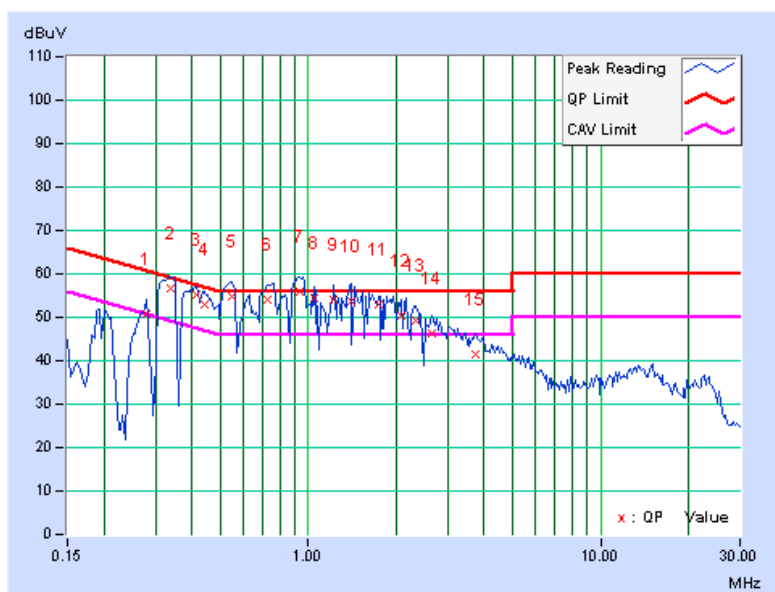



DRAFT 802.11n (40MHz) OFDM MODULATION

EUT TEST CONDITION		MEASUREMENT DETAIL	
CHANNEL	Channel 46	PHASE	Line 1
MODULATION TYPE	BPSK	INPUT POWER (SYSTEM)	120Vac, 60Hz
TRANSFER RATE	13.5Mbps	6dB BANDWIDTH	9kHz
ENVIRONMENTAL CONDITIONS	25deg. C, 77%RH, 982hPa	TESTED BY	Scott Yang
TEST MODE	B		

No	Freq. [MHz]	Corr. Factor (dB)	Reading Value		Emission Level		Limit		Margin	
			[dB (uV)]		[dB (uV)]		[dB (uV)]		(dB)	
			Q.P.	AV.	Q.P.	AV.	Q.P.	AV.	Q.P.	AV.
1	0.150	0.13	48.39	-	48.52	-	66.00	56.00	-17.48	-
2	0.158	0.13	46.96	-	47.09	-	65.58	55.58	-18.49	-
3	0.275	0.13	40.15	-	40.28	-	60.97	50.97	-20.68	-
4	0.404	0.14	40.70	-	40.84	-	57.77	47.77	-16.93	-
5	0.427	0.14	40.78	-	40.92	-	57.30	47.30	-16.38	-
6	0.463	0.14	39.47	-	39.61	-	56.65	46.65	-17.03	-

- REMARKS:**
1. Q.P. and AV. are abbreviations of quasi-peak and average individually.
 2. "-": The Quasi-peak reading value also meets average limit and measurement with the average detector is unnecessary.
 3. The emission levels of other frequencies were very low against the limit.
 4. Margin value = Emission level - Limit value
 5. Correction factor = Insertion loss + Cable loss
 6. Emission Level = Correction Factor + Reading Value.

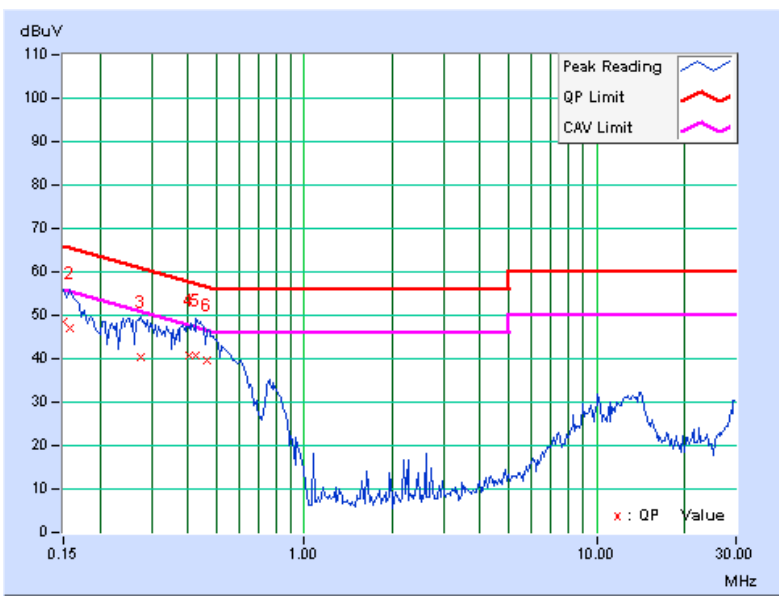



A D T

EUT TEST CONDITION		MEASUREMENT DETAIL	
CHANNEL	Channel 46	PHASE	Line 2
MODULATION TYPE	BPSK	INPUT POWER (SYSTEM)	120Vac, 60Hz
TRANSFER RATE	13.5Mbps	6dB BANDWIDTH	9kHz
ENVIRONMENTAL CONDITIONS	25deg. C, 77%RH, 982hPa	TESTED BY	Scott Yang
TEST MODE	B		

No	Freq. [MHz]	Corr. Factor (dB)	Reading Value		Emission Level		Limit		Margin	
			[dB (uV)]		[dB (uV)]		[dB (uV)]		(dB)	
			Q.P.	AV.	Q.P.	AV.	Q.P.	AV.	Q.P.	AV.
1	0.150	0.13	49.05	-	49.18	-	66.00	56.00	-16.82	-
2	0.158	0.13	47.57	-	47.70	-	65.58	55.58	-17.88	-
3	0.166	0.13	46.12	-	46.25	-	65.18	55.18	-18.93	-
4	0.177	0.13	44.33	-	44.46	-	64.61	54.61	-20.15	-
5	0.330	0.14	38.72	-	38.86	-	59.46	49.46	-20.60	-
6	0.420	0.15	39.81	-	39.96	-	57.46	47.46	-17.50	-
7	0.463	0.15	38.42	-	38.57	-	56.65	46.65	-18.08	-

- REMARKS:**
1. Q.P. and AV. are abbreviations of quasi-peak and average individually.
 2. "-": The Quasi-peak reading value also meets average limit and measurement with the average detector is unnecessary.
 3. The emission levels of other frequencies were very low against the limit.
 4. Margin value = Emission level - Limit value
 5. Correction factor = Insertion loss + Cable loss
 6. Emission Level = Correction Factor + Reading Value.

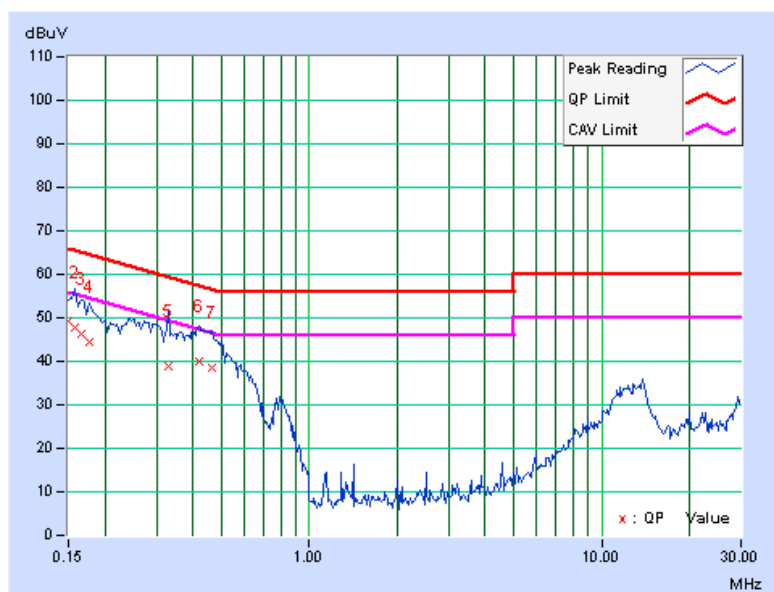

**DRAFT 802.11n (40MHz) OFDM MODULATION**

EUT TEST CONDITION		MEASUREMENT DETAIL	
CHANNEL	Channel 46	PHASE	Line 1
MODULATION TYPE	BPSK	INPUT POWER (SYSTEM)	120Vac, 60Hz
TRANSFER RATE	13.5Mbps	6dB BANDWIDTH	9kHz
ENVIRONMENTAL CONDITIONS	25deg. C, 77%RH, 982hPa	TESTED BY	Scott Yang
TEST MODE	C		

No	Freq. [MHz]	Corr. Factor (dB)	Reading Value		Emission Level		Limit		Margin	
			[dB (uV)]		[dB (uV)]		[dB (uV)]		(dB)	
			Q.P.	AV.	Q.P.	AV.	Q.P.	AV.	Q.P.	AV.
1	0.196	0.13	52.84	-	52.97	-	63.80	53.80	-10.83	-
2	0.275	0.13	52.95	44.27	53.08	44.40	60.97	50.97	-7.88	-6.56
3	0.348	0.14	58.04	45.49	58.18	45.63	59.01	49.01	-0.83	-3.38
4	0.373	0.14	58.18	42.44	58.32	42.58	58.44	48.44	-0.12	-5.86
5	0.482	0.14	54.27	42.41	54.41	42.55	56.30	46.30	-1.89	-3.75
6	0.556	0.15	52.57	39.59	52.72	39.74	56.00	46.00	-3.28	-6.26
7	0.679	0.15	53.68	37.44	53.83	37.59	56.00	46.00	-2.17	-8.41
8	0.763	0.16	52.64	36.02	52.80	36.18	56.00	46.00	-3.20	-9.82
9	0.896	0.16	54.79	40.33	54.95	40.49	56.00	46.00	-1.05	-5.51
10	1.070	0.17	54.46	39.06	54.63	39.23	56.00	46.00	-1.37	-6.77
11	1.313	0.18	53.40	39.07	53.58	39.25	56.00	46.00	-2.42	-6.75
12	1.508	0.18	50.68	36.69	50.86	36.87	56.00	46.00	-5.14	-9.13
13	2.000	0.19	49.16	35.80	49.35	35.99	56.00	46.00	-6.65	-10.01
14	2.363	0.21	47.41	34.73	47.62	34.94	56.00	46.00	-8.38	-11.06
15	2.781	0.23	45.12	-	45.35	-	56.00	46.00	-10.65	-

- REMARKS:**
1. Q.P. and AV. are abbreviations of quasi-peak and average individually.
 2. "-": The Quasi-peak reading value also meets average limit and measurement with the average detector is unnecessary.
 3. The emission levels of other frequencies were very low against the limit.
 4. Margin value = Emission level - Limit value
 5. Correction factor = Insertion loss + Cable loss
 6. Emission Level = Correction Factor + Reading Value.



A D T

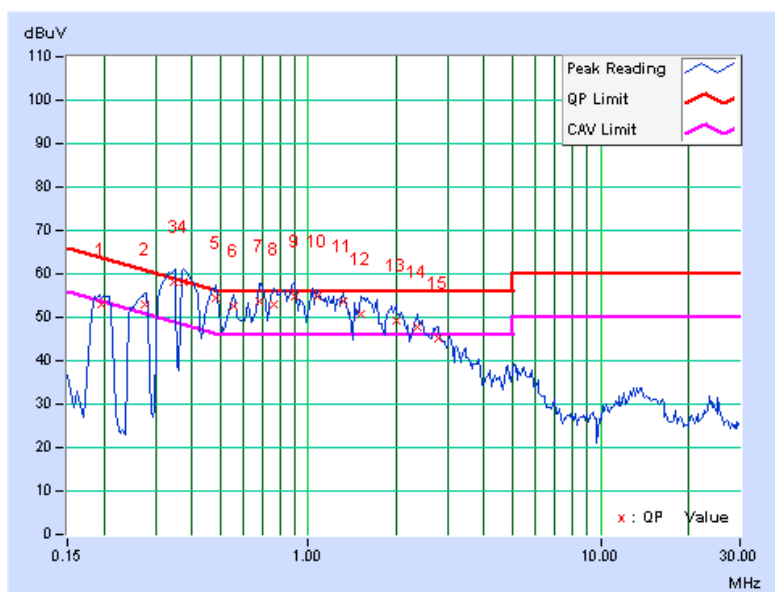



A D T

EUT TEST CONDITION		MEASUREMENT DETAIL	
CHANNEL	Channel 46	PHASE	Line 2
MODULATION TYPE	BPSK	INPUT POWER (SYSTEM)	120Vac, 60Hz
TRANSFER RATE	13.5Mbps	6dB BANDWIDTH	9kHz
ENVIRONMENTAL CONDITIONS	25deg. C, 77%RH, 982hPa	TESTED BY	Scott Yang
TEST MODE	C		

No	Freq. [MHz]	Corr. Factor (dB)	Reading Value		Emission Level		Limit		Margin	
			[dB (uV)]		[dB (uV)]		[dB (uV)]		(dB)	
			Q.P.	AV.	Q.P.	AV.	Q.P.	AV.	Q.P.	AV.
1	0.197	0.13	51.50	-	51.63	-	63.74	53.74	-12.11	-
2	0.275	0.14	51.87	42.84	52.01	42.98	60.97	50.97	-8.96	-7.99
3	0.340	0.14	57.12	47.16	57.26	47.30	59.20	49.20	-1.94	-1.90
4	0.373	0.15	57.32	41.45	57.47	41.60	58.44	48.44	-0.97	-6.84
5	0.478	0.15	52.90	40.15	53.05	40.30	56.37	46.37	-3.32	-6.07
6	0.556	0.16	51.37	38.19	51.53	38.35	56.00	46.00	-4.47	-7.65
7	0.685	0.16	52.90	38.88	53.06	39.04	56.00	46.00	-2.94	-6.96
8	0.814	0.16	51.48	37.69	51.64	37.85	56.00	46.00	-4.36	-8.15
9	0.904	0.17	54.07	37.59	54.24	37.76	56.00	46.00	-1.76	-8.24
10	1.059	0.17	54.71	39.36	54.88	39.53	56.00	46.00	-1.12	-6.47
11	1.316	0.18	52.79	38.65	52.97	38.83	56.00	46.00	-3.03	-7.17
12	1.574	0.19	50.37	36.18	50.56	36.37	56.00	46.00	-5.44	-9.63
13	1.930	0.20	47.67	34.39	47.87	34.59	56.00	46.00	-8.13	-11.41
14	2.359	0.22	45.83	33.49	46.05	33.71	56.00	46.00	-9.95	-12.29
15	2.777	0.24	43.25	-	43.49	-	56.00	46.00	-12.51	-

- REMARKS:**
1. Q.P. and AV. are abbreviations of quasi-peak and average individually.
 2. "-": The Quasi-peak reading value also meets average limit and measurement with the average detector is unnecessary.
 3. The emission levels of other frequencies were very low against the limit.
 4. Margin value = Emission level - Limit value
 5. Correction factor = Insertion loss + Cable loss
 6. Emission Level = Correction Factor + Reading Value.



A D T

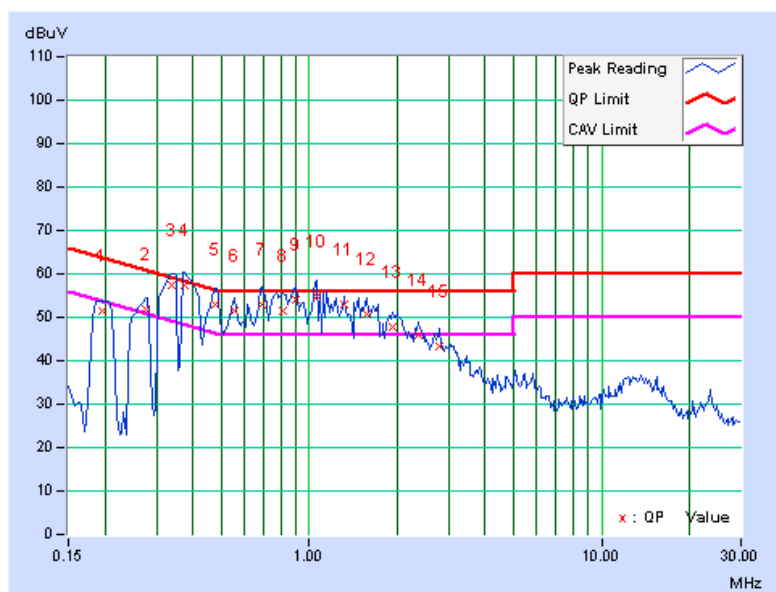



DRAFT 802.11n (40MHz) OFDM MODULATION

EUT TEST CONDITION		MEASUREMENT DETAIL	
CHANNEL	Channel 46	PHASE	Line 1
MODULATION TYPE	BPSK	INPUT POWER (SYSTEM)	120Vac, 60Hz
TRANSFER RATE	13.5Mbps	6dB BANDWIDTH	9kHz
ENVIRONMENTAL CONDITIONS	25deg. C, 77%RH, 982hPa	TESTED BY	Scott Yang
TEST MODE	D		

No	Freq. [MHz]	Corr. Factor (dB)	Reading Value [dB (uV)]		Emission Level [dB (uV)]		Limit [dB (uV)]		Margin (dB)	
			Q.P.	AV.	Q.P.	AV.	Q.P.	AV.	Q.P.	AV.
			1	0.150	0.13	48.31	-	48.44	-	66.00
2	0.170	0.13	45.23	-	45.36	-	64.98	54.98	-19.62	-
3	0.267	0.13	40.30	-	40.43	-	61.20	51.20	-20.77	-
4	0.384	0.14	39.75	-	39.89	-	58.18	48.18	-18.30	-
5	0.439	0.14	40.44	-	40.58	-	57.08	47.08	-16.50	-
6	13.188	0.51	30.95	-	31.46	-	60.00	50.00	-28.54	-

- REMARKS:**
1. Q.P. and AV. are abbreviations of quasi-peak and average individually.
 2. "-": The Quasi-peak reading value also meets average limit and measurement with the average detector is unnecessary.
 3. The emission levels of other frequencies were very low against the limit.
 4. Margin value = Emission level - Limit value
 5. Correction factor = Insertion loss + Cable loss
 6. Emission Level = Correction Factor + Reading Value.

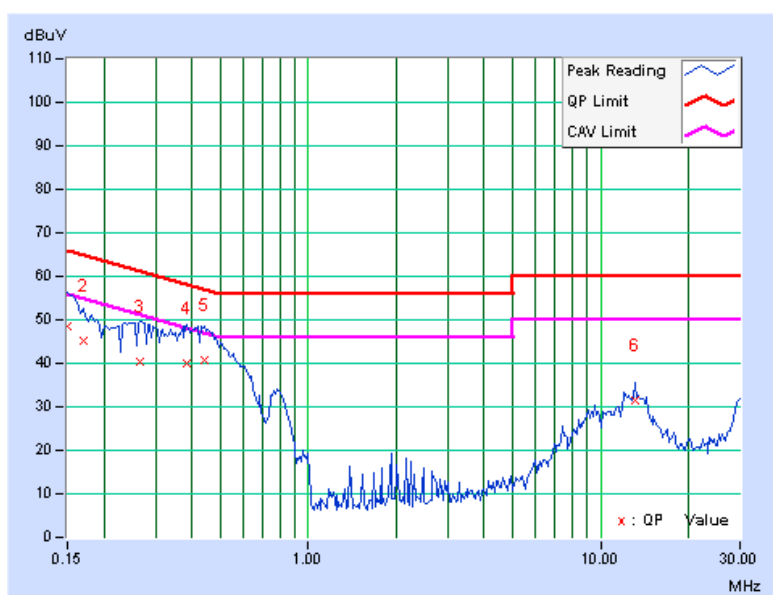



A D T

EUT TEST CONDITION		MEASUREMENT DETAIL	
CHANNEL	Channel 46	PHASE	Line 2
MODULATION TYPE	BPSK	INPUT POWER (SYSTEM)	120Vac, 60Hz
TRANSFER RATE	13.5Mbps	6dB BANDWIDTH	9kHz
ENVIRONMENTAL CONDITIONS	25deg. C, 77%RH, 982hPa	TESTED BY	Scott Yang
TEST MODE	D		

No	Freq. [MHz]	Corr. Factor (dB)	Reading Value		Emission Level		Limit		Margin	
			[dB (uV)]		[dB (uV)]		[dB (uV)]		(dB)	
			Q.P.	AV.	Q.P.	AV.	Q.P.	AV.	Q.P.	AV.
1	0.150	0.13	48.77	-	48.90	-	66.00	56.00	-17.10	-
2	0.158	0.13	47.12	-	47.25	-	65.58	55.58	-18.33	-
3	0.181	0.13	43.45	-	43.58	-	64.43	54.43	-20.85	-
4	0.271	0.14	39.89	-	40.03	-	61.08	51.08	-21.06	-
5	0.416	0.15	39.65	-	39.80	-	57.54	47.54	-17.73	-
6	0.439	0.15	39.39	-	39.54	-	57.08	47.08	-17.54	-
7	12.961	0.60	33.22	-	33.82	-	60.00	50.00	-26.18	-

- REMARKS:**
1. Q.P. and AV. are abbreviations of quasi-peak and average individually.
 2. "-": The Quasi-peak reading value also meets average limit and measurement with the average detector is unnecessary.
 3. The emission levels of other frequencies were very low against the limit.
 4. Margin value = Emission level - Limit value
 5. Correction factor = Insertion loss + Cable loss
 6. Emission Level = Correction Factor + Reading Value.

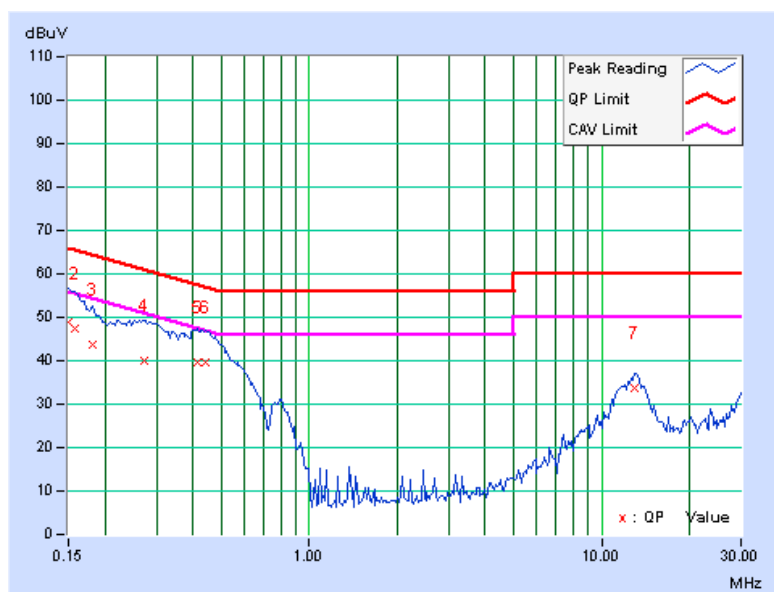



4.3 MAXIMUM CONDUCTED OUTPUT POWER MEASUREMENT

4.3.1 LIMITS OF MAXIMUM CONDUCTED OUTPUT POWER MEASUREMENT

FREQUENCY BAND	LIMIT
5.150 ~ 5.250GHz	The lesser of 50mW (17dBm) or 4dBm + 10logB

NOTE: Where B is the 26dB emission bandwidth in MHz.

4.3.2 TEST INSTRUMENTS

DESCRIPTION & MANUFACTURER	MODEL NO.	SERIAL NO.	DATE OF CALIBRATION	DUE DATE OF CALIBRATION
Spectrum Analyzer Agilent	E4446A	MY44360128	Dec. 12, 2008	Dec.11. 2009

NOTE: The calibration interval of the above test instruments is 12 months and the calibrations are traceable to NML/ROC and NIST/USA.

4.3.3 TEST PROCEDURES

- a. The transmitter output was connected to the spectrum analyzer.
- b. Set span to encompass the entire emission bandwidth of the signal.
- c. Set RBW to 1MHz, VBW to 3MHz.
- d. Using the spectrum analyzer's channel power measurement function to measure the output power.

NOTE: The test is performed in accordance with FCC Public Notice: APPENDIX A Guidelines for Assessing Unlicensed National Information Infrastructure (U-NII) Devices – Part 15, Subpart E, August 2002.

The transmitter output operates continuously therefore Method # 1 is used.

4.3.4 DEVIATION FROM TEST STANDARD

No deviation

4.3.5 TEST SETUP

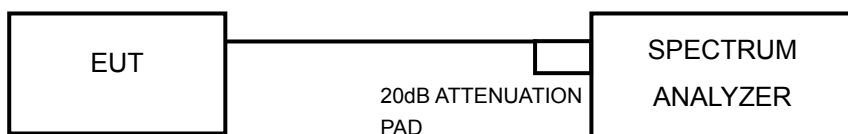

4.3.6 EUT OPERATING CONDITIONS

The software provided by client to enable the EUT under transmission condition continuously at specific channel frequencies individually.



A D T

4.3.7 TEST RESULTS

POWER OUTPUT: 802.11a OFDM MODULATION

MODULATION TYPE	BPSK	TRANSFER RATE	6.0Mbps
INPUT POWER (SYSTEM)	120Vac, 60Hz	ENVIRONMENTAL CONDITIONS	25deg.C, 65%RH, 991hPa
TESTED BY	Brad Wu	TEST MODE	A

CHAN.	CHAN. FREQ. (MHz)	POWER OUTPUT (dBm)			TOTAL POWER (mW)	TOTAL POWER (dBm)	POWER LIMIT (dBm)	PASS / FAIL
		CHAIN 0	CHAIN 1	CHAIN 2				
36	5180	11.06	11.07	11.01	38.176	15.82	17	PASS
40	5200	11.06	11.05	11.07	38.293	15.83	17	PASS
48	5240	11.11	11.03	11.10	38.471	15.85	17	PASS

CHAIN 0 CH 36

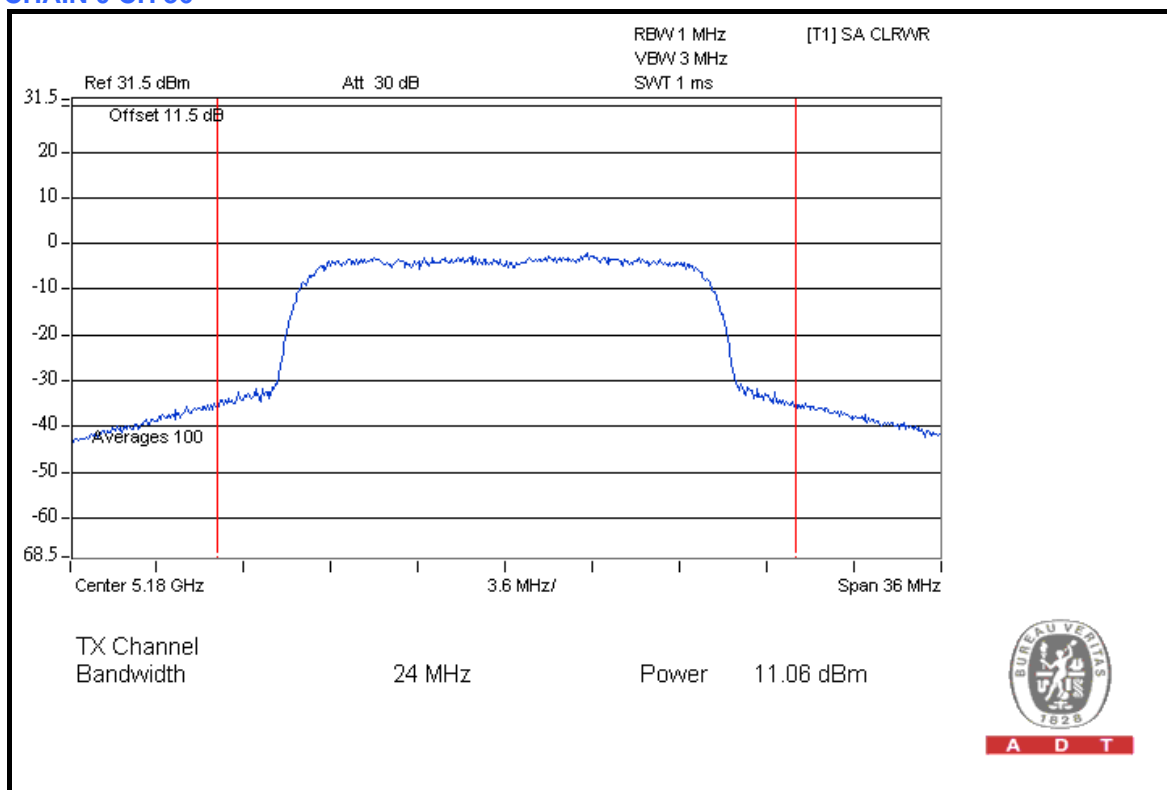

A D T



A D T

CH 40

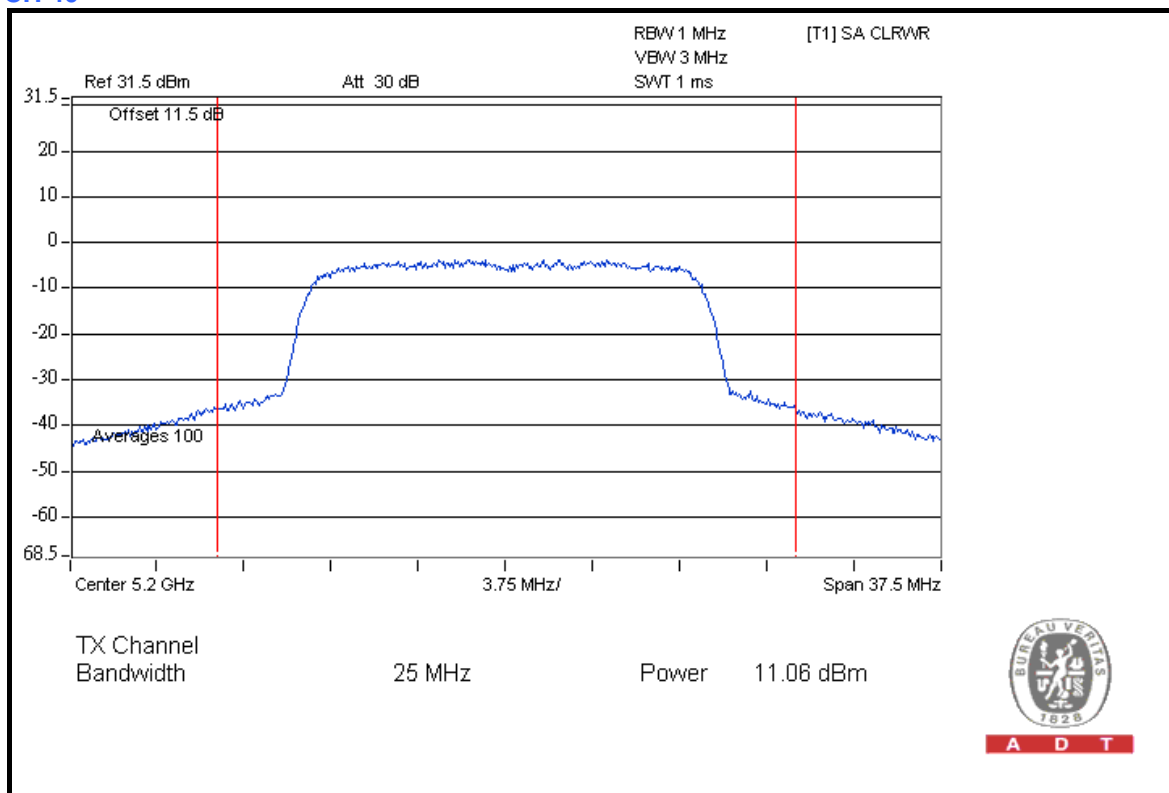

A D T

CH 48

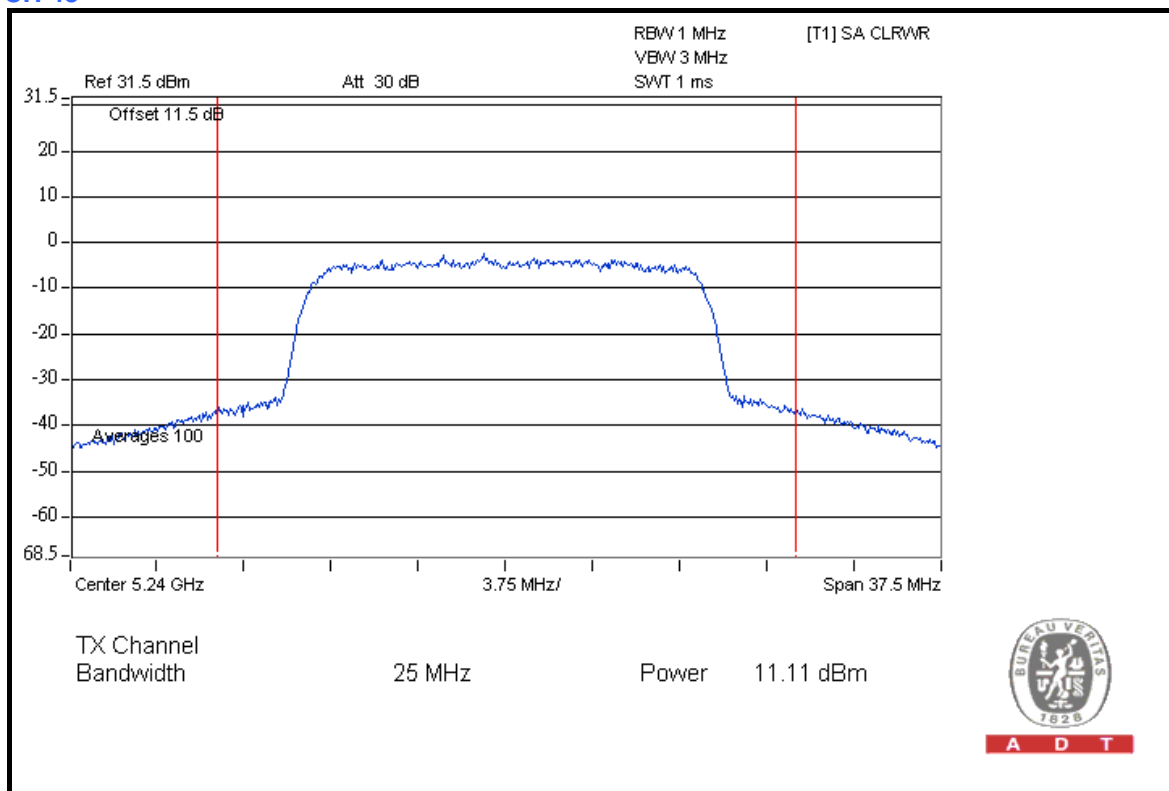

A D T



A D T

CHAIN 1 CH 36

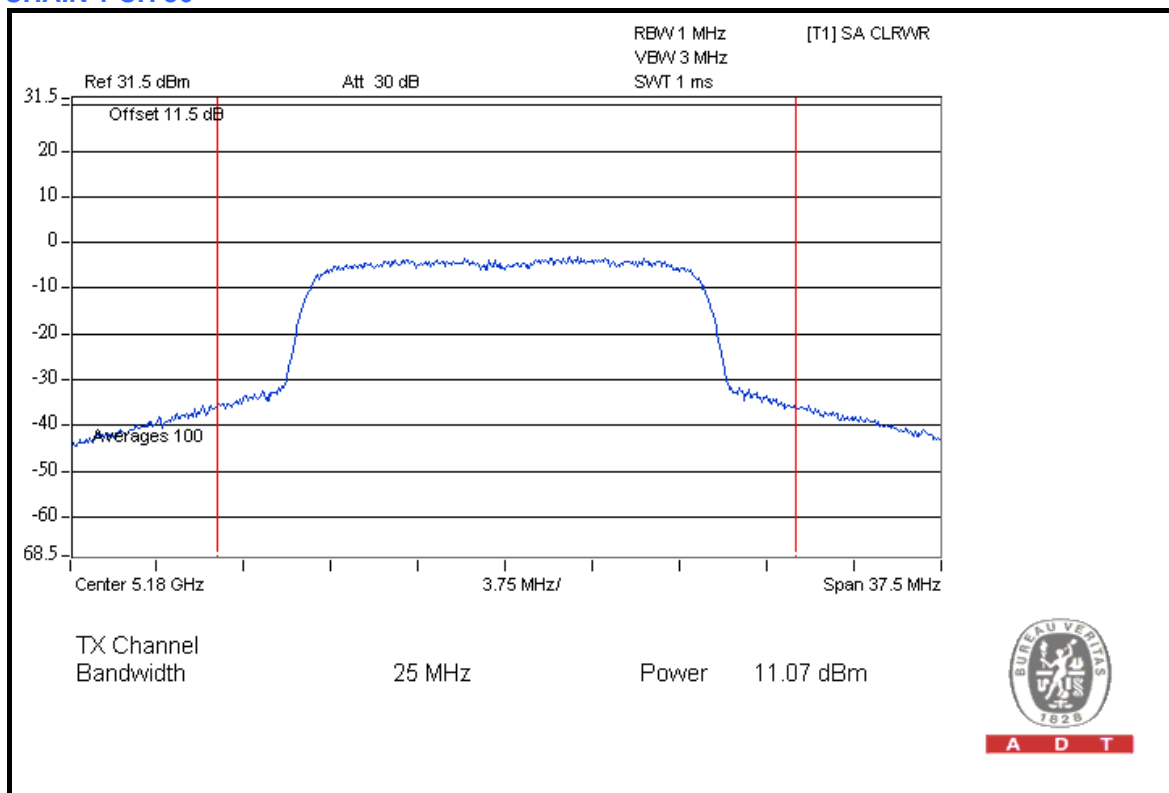

A D T

CH 40

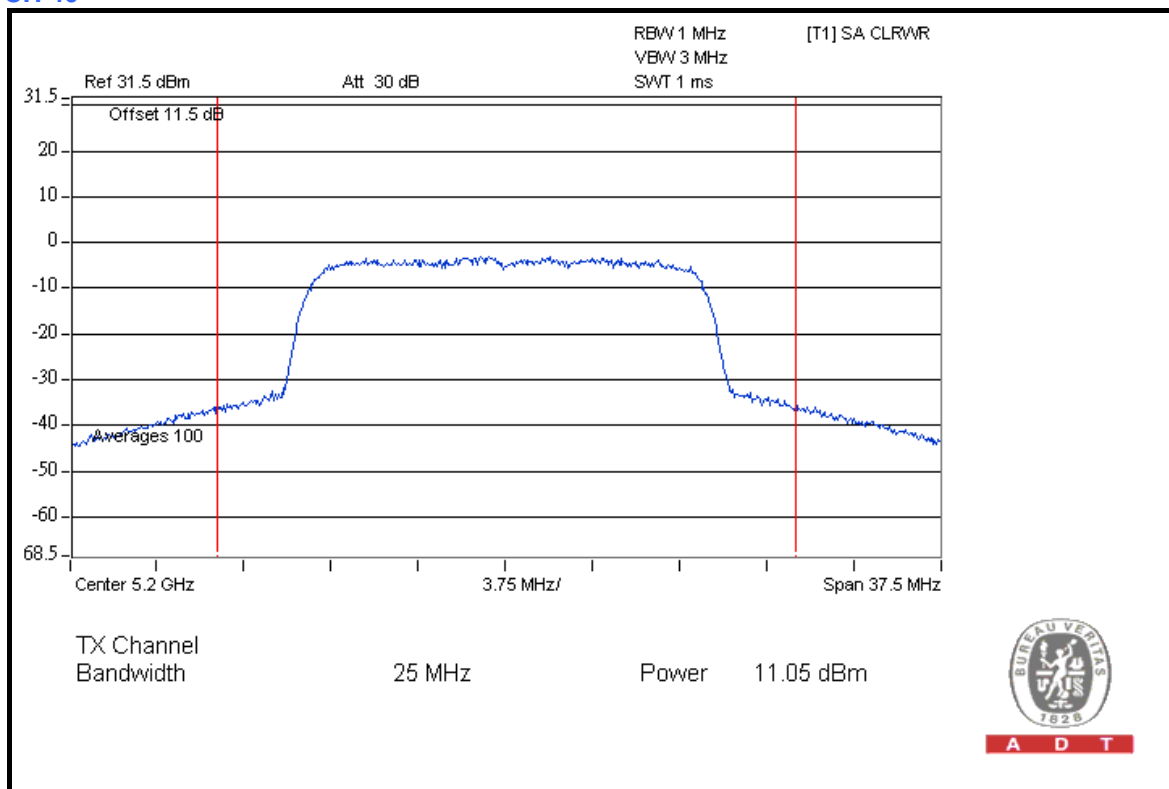

A D T



A D T

CH 48

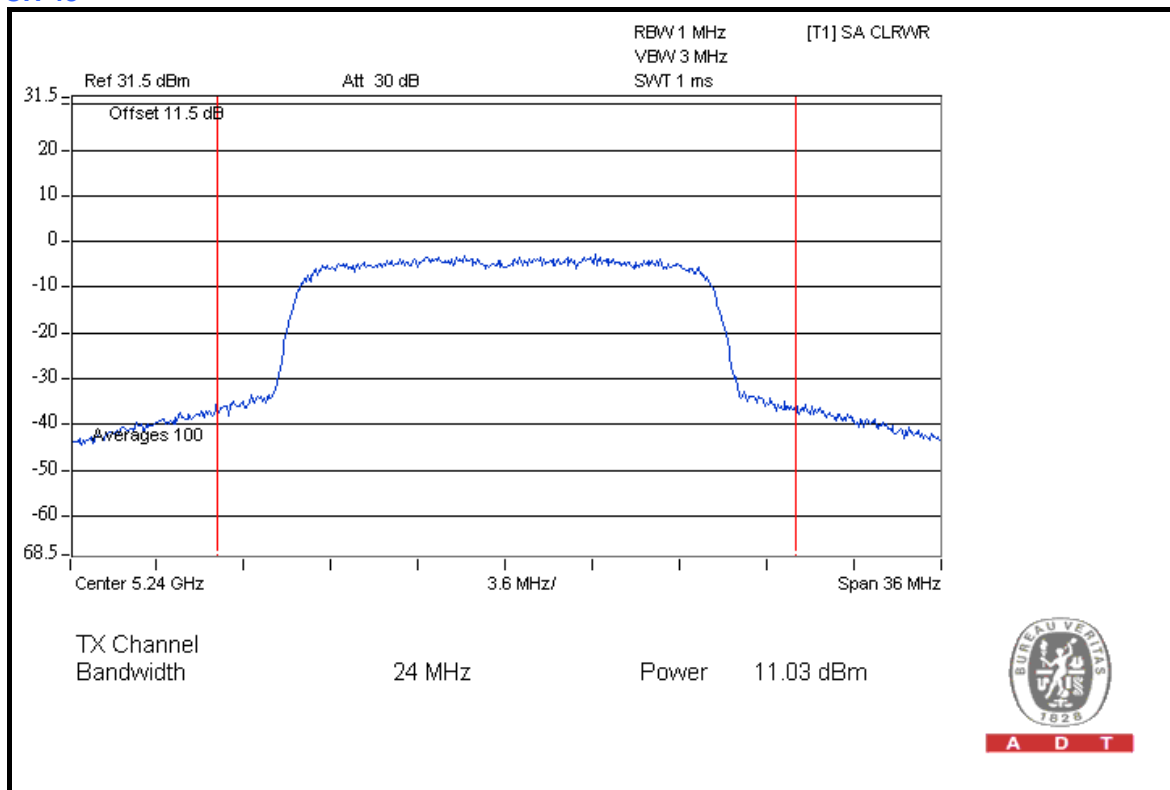

A D T

CHAIN 2 CH 36

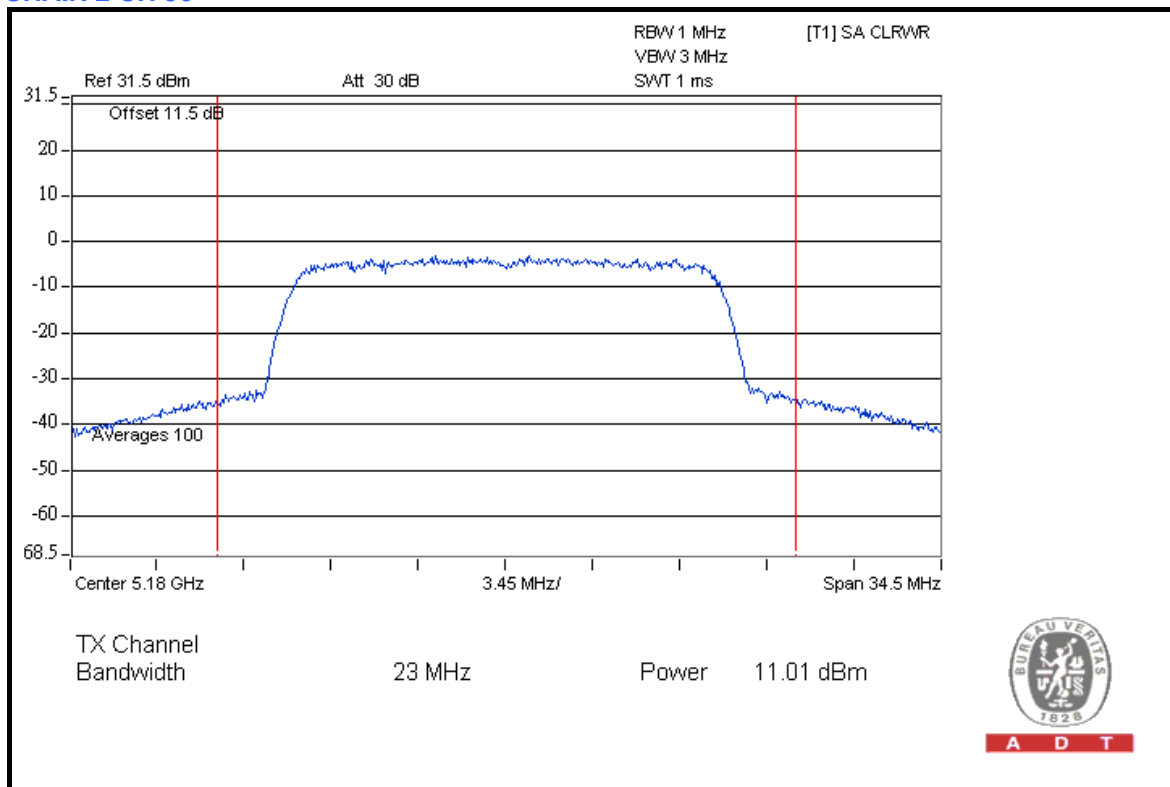

A D T



A D T

CH 40

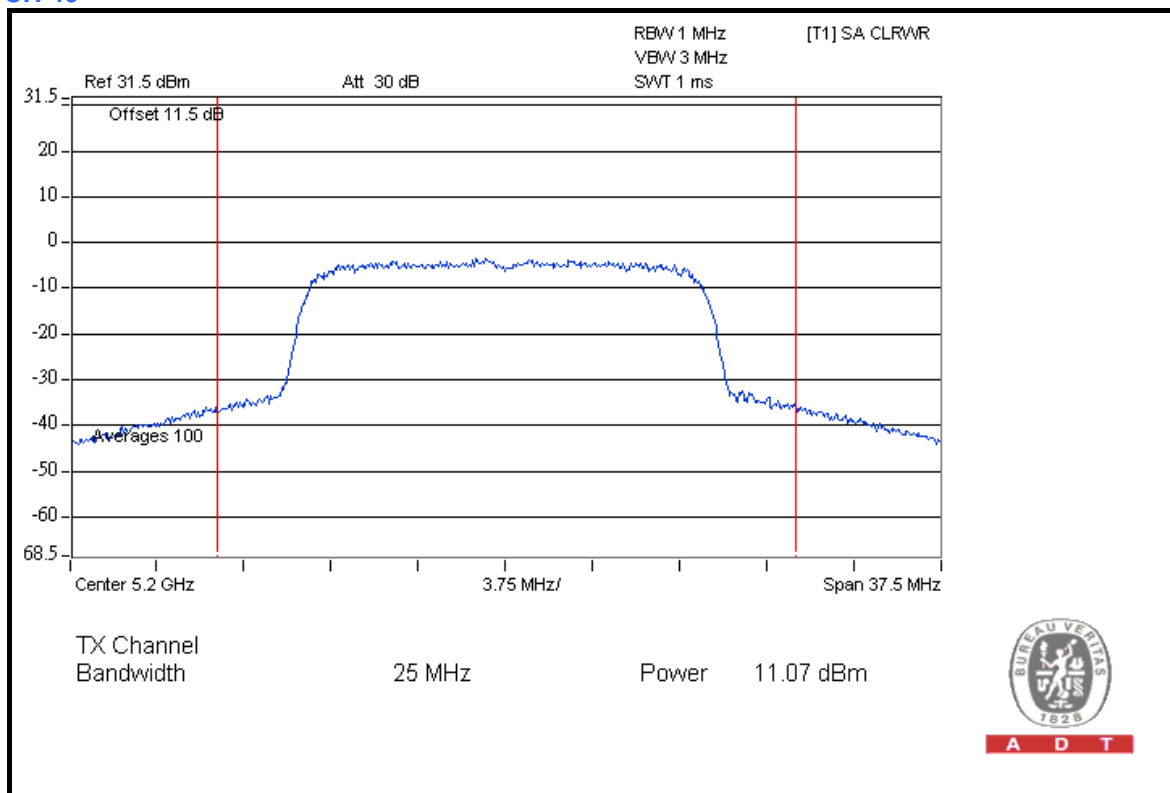

A D T

CH 48

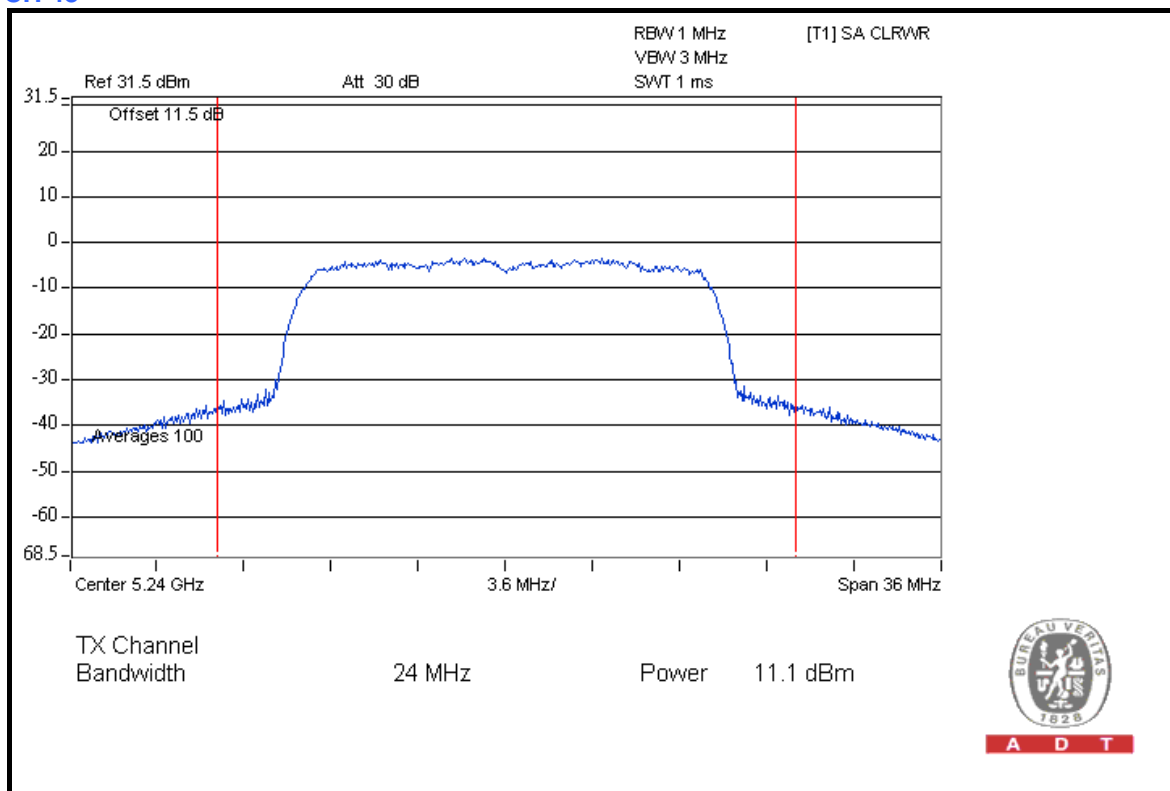

A D T



A D T

802.11a OFDM MODULATION

MODULATION TYPE	BPSK	TRANSFER RATE	6.0Mbps
INPUT POWER (SYSTEM)	120Vac, 60Hz	ENVIRONMENTAL CONDITIONS	25deg.C, 65%RH, 991hPa
TESTED BY	Brad Wu	TEST MODE	C

CHAN.	CHAN. FREQ. (MHz)	POWER OUTPUT (dBm)		TOTAL POWER (mW)	TOTAL POWER (dBm)	POWER LIMIT (dBm)	PASS / FAIL
		CHAIN 0	CHAIN 1				
36	5180	2.11	2.03	3.221	5.08	9	PASS
40	5200	2.10	2.08	3.236	5.10	9	PASS
48	5240	2.14	2.04	3.236	5.10	9	PASS

NOTE: According to 15.407 (a) (1) (2), the maximum antenna gain 14dBi is higher than 6dBi, so the limit of output power shall be reduced by 8 dB.



A D T

CHAIN 0 CH 36

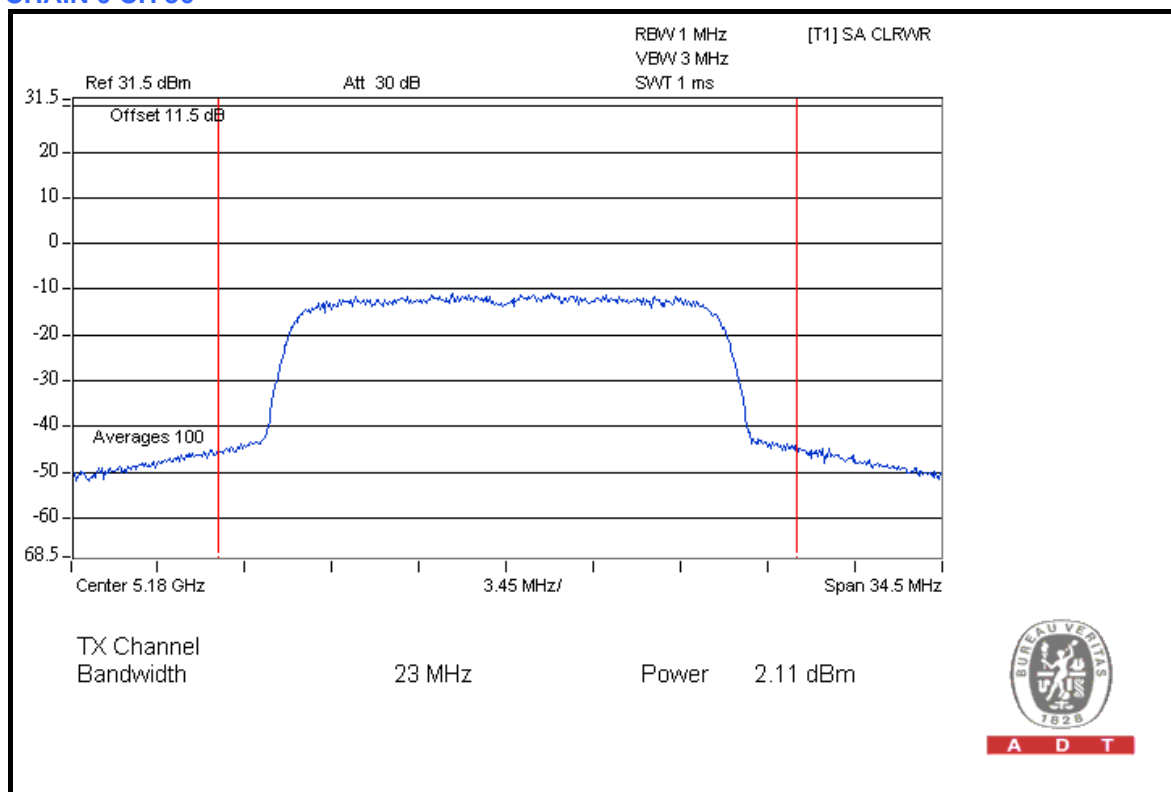

CH 40

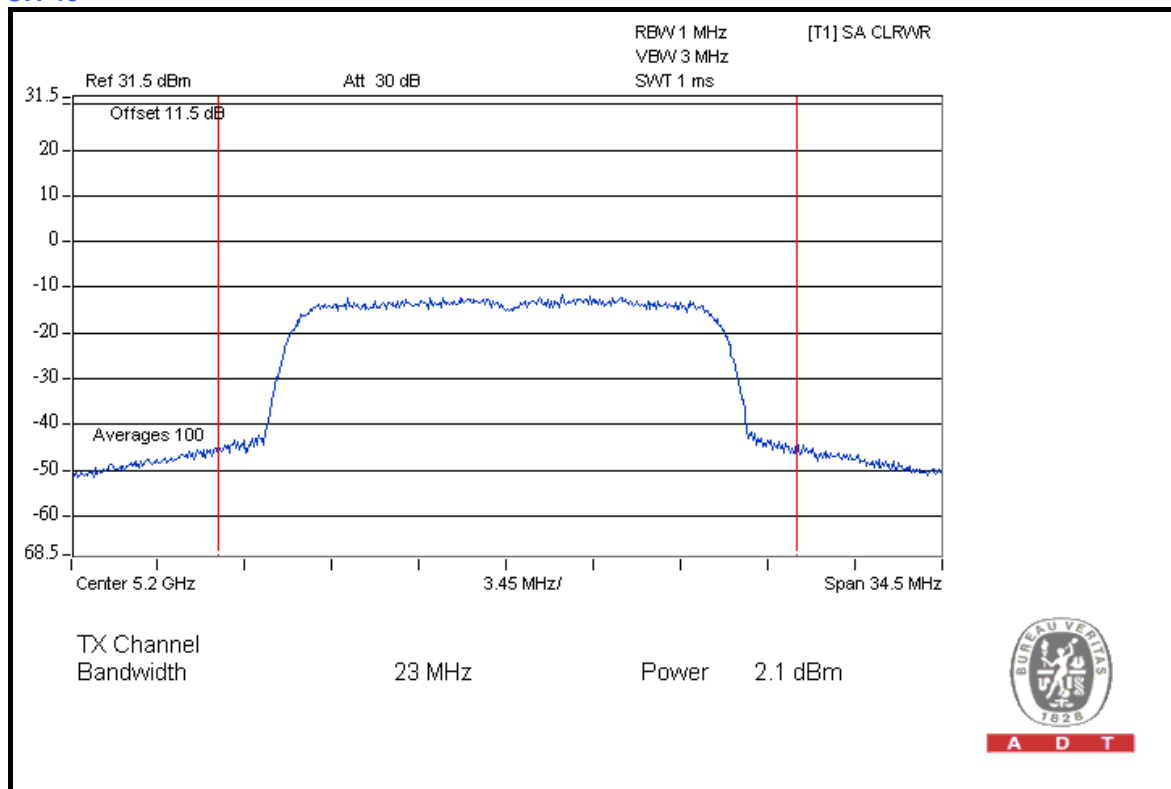



A D T

CH 48

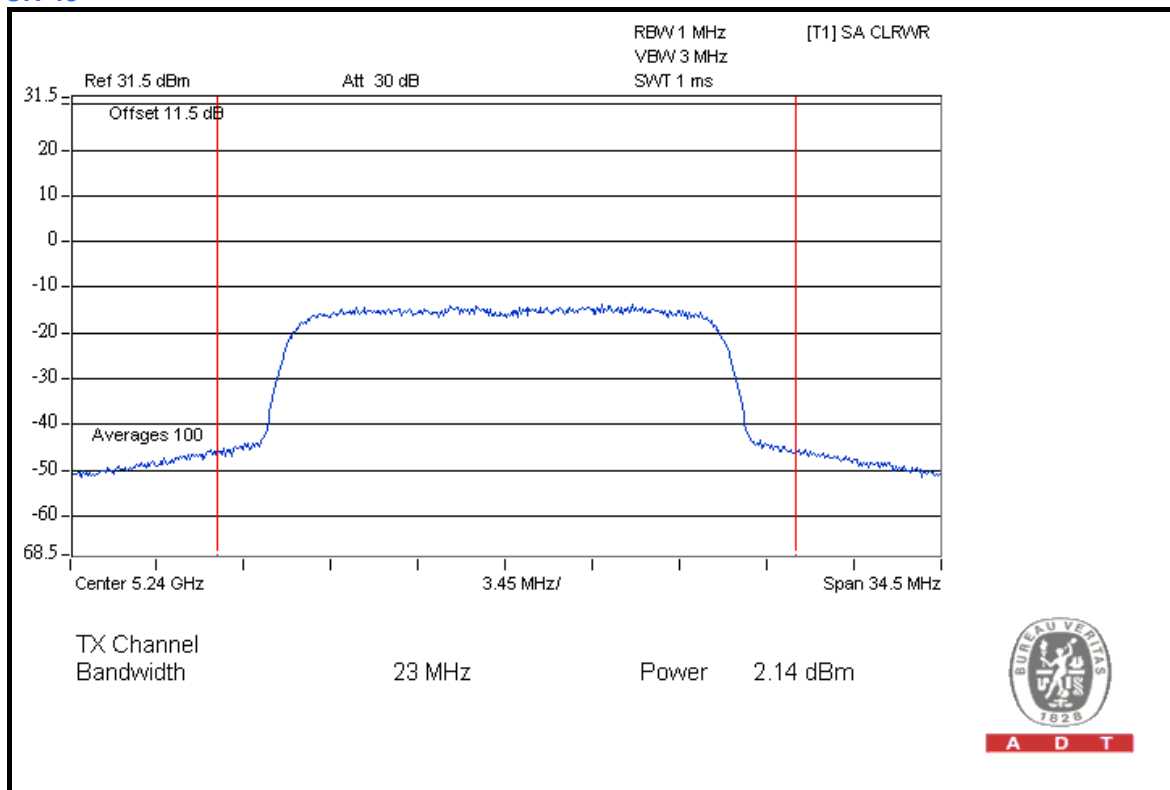

A D T

CHAIN 1 CH 36

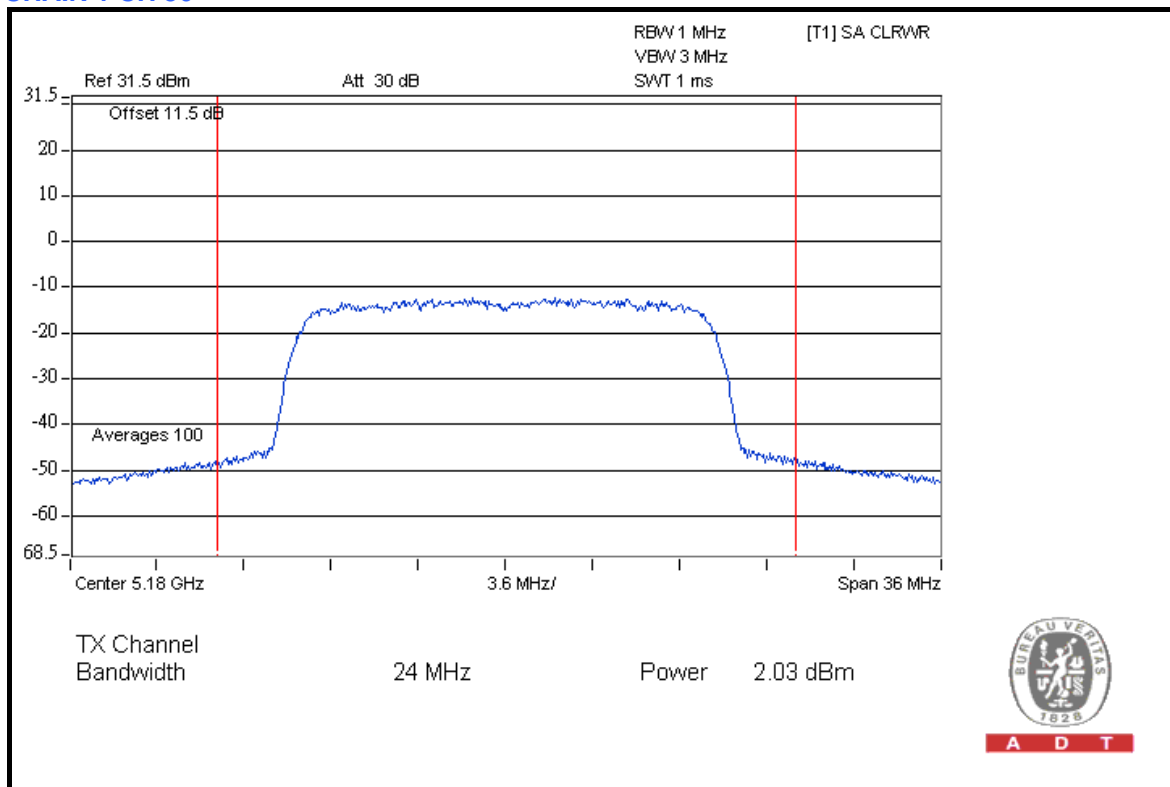

A D T



A D T

CH 40

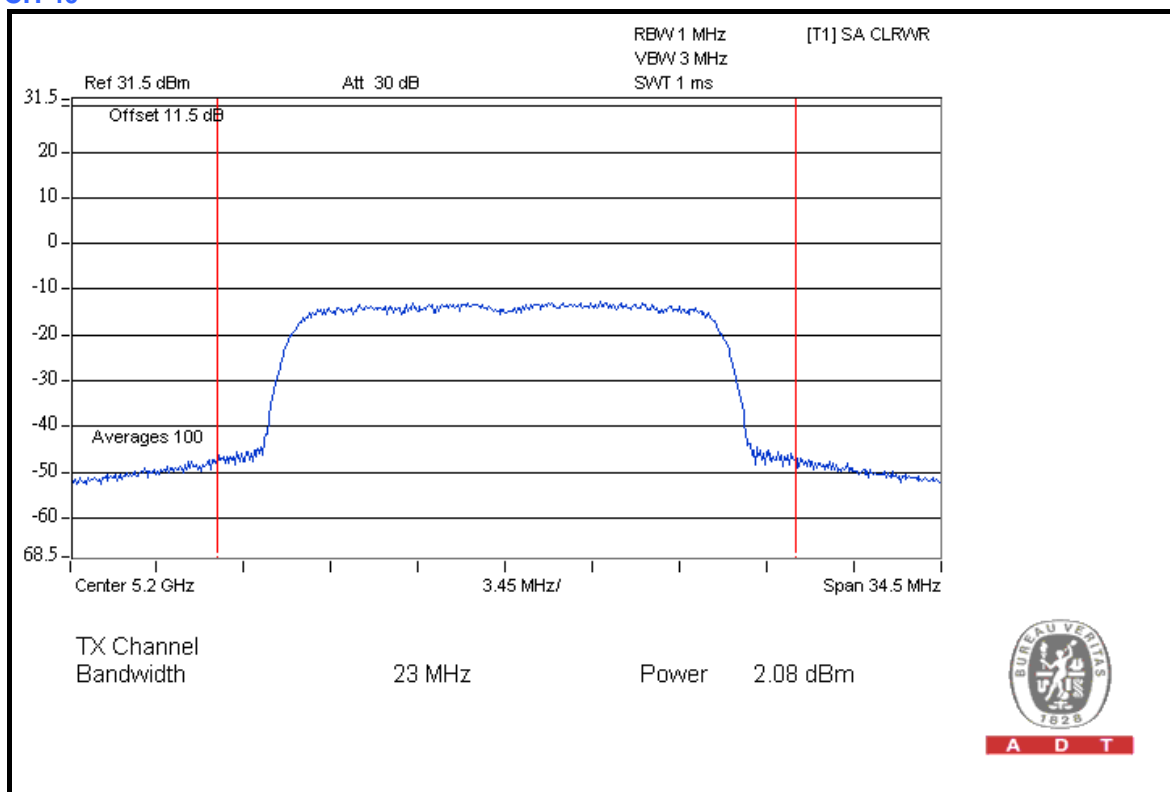

A D T

CH 48

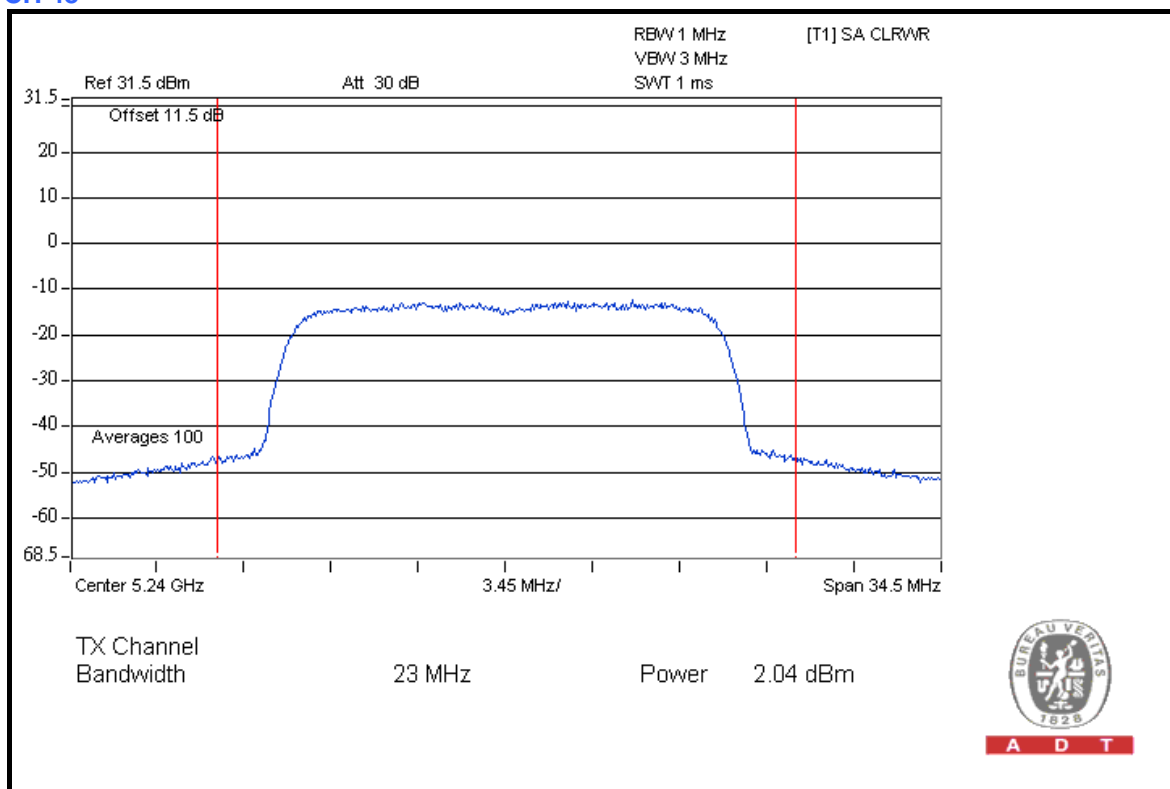

A D T



A D T

DRAFT 802.11n (20MHz) OFDM MODULATION

MODULATION TYPE	BPSK	TRANSFER RATE	6.5Mbps
INPUT POWER (SYSTEM)	120Vac, 60Hz	ENVIRONMENTAL CONDITIONS	25deg.C, 65%RH, 991hPa
TESTED BY	Brad Wu	TEST MODE	A

CHAN.	CHAN. FREQ. (MHz)	POWER OUTPUT (dBm)			TOTAL POWER (mW)	TOTAL POWER (dBm)	POWER LIMIT (dBm)	PASS / FAIL
		CHAIN 0	CHAIN 1	CHAIN 2				
36	5180	11.12	11.14	11.05	38.679	15.87	17	PASS
40	5200	11.04	11.07	11.04	38.205	15.82	17	PASS
48	5240	11.02	11.02	11.06	38.059	15.80	17	PASS

CHAIN 0 CH 36

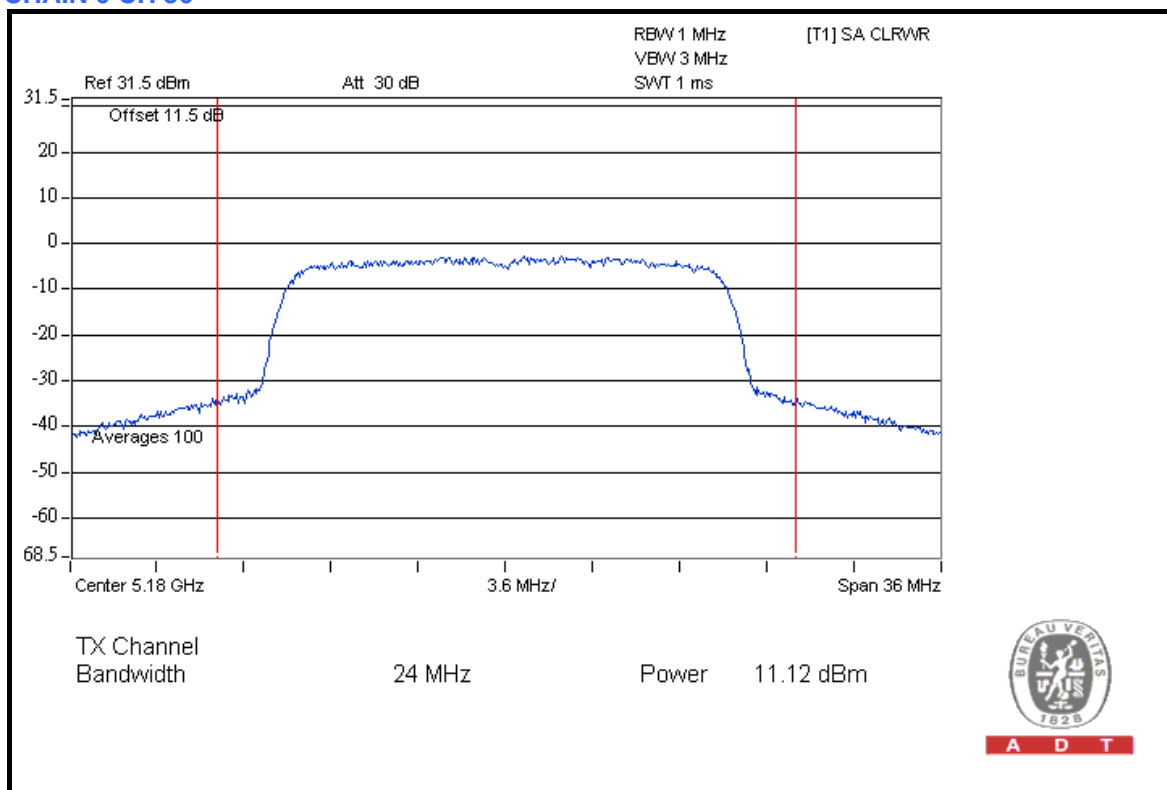

A D T



A D T

CH 40

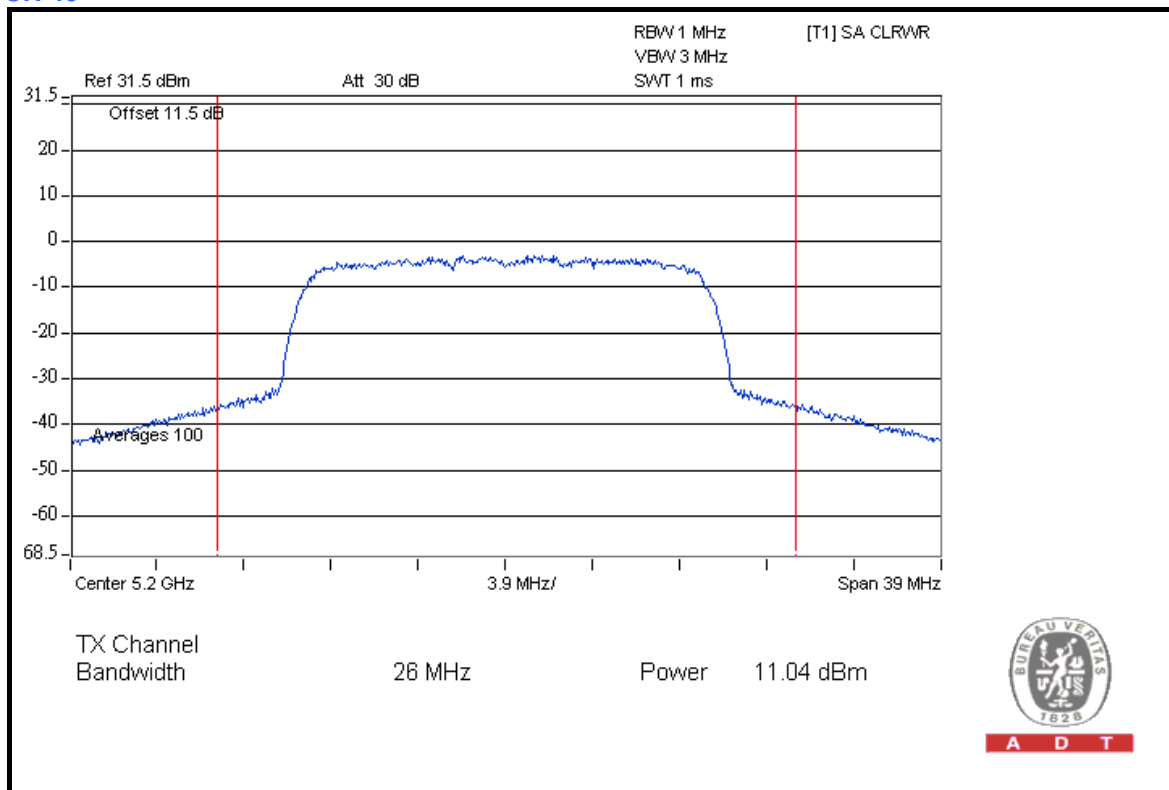

A D T

CH 48

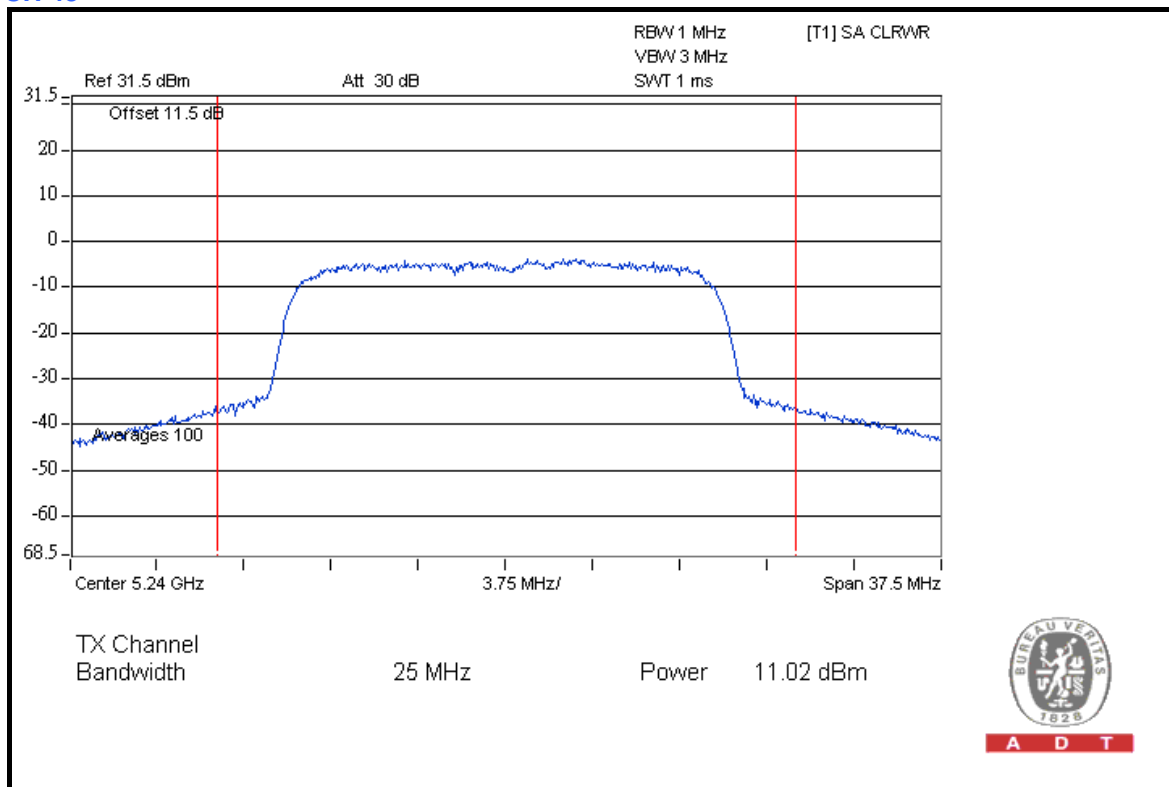

A D T



A D T

CHAIN 1 CH 36

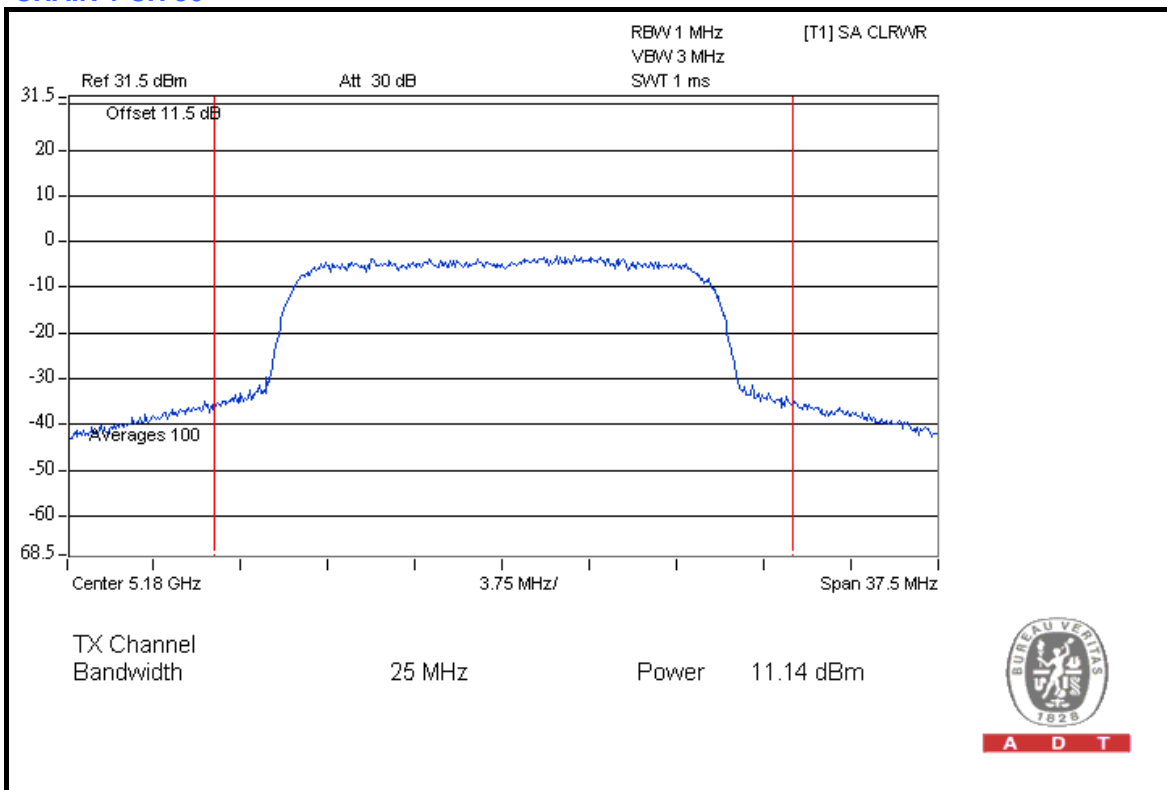

A D T

CH 40

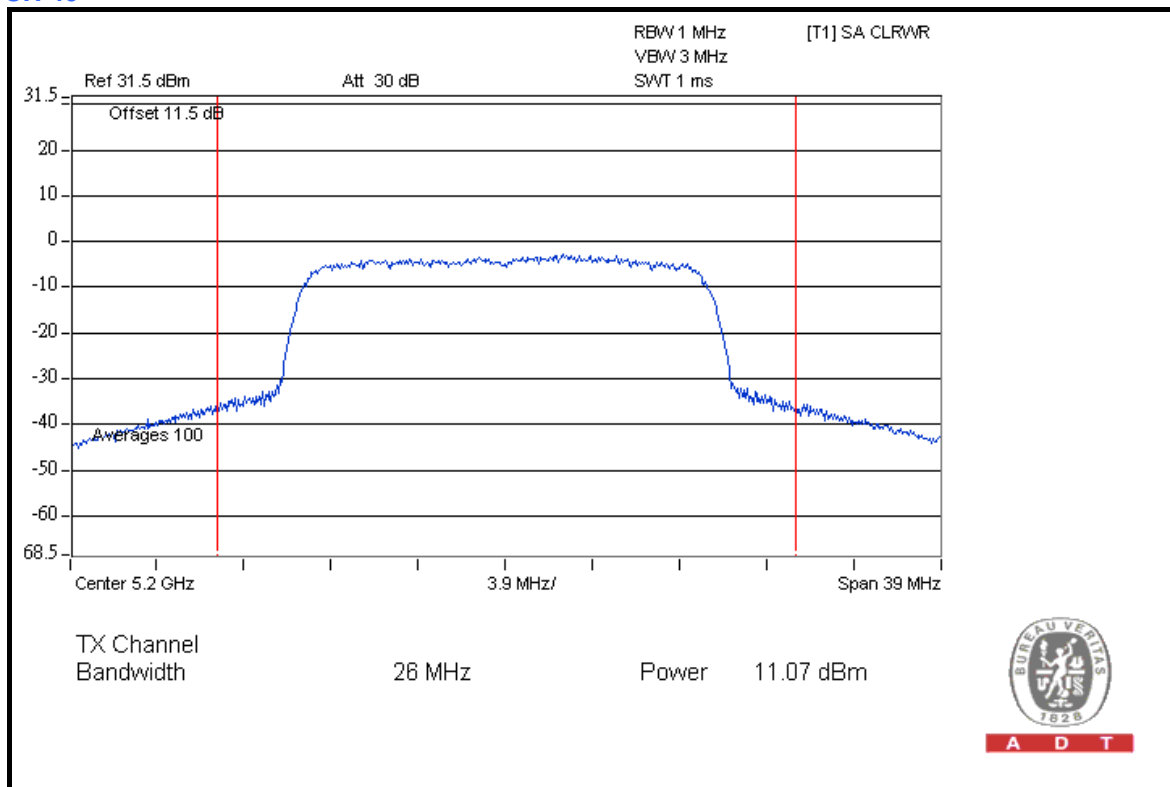

A D T



A D T

CH 48

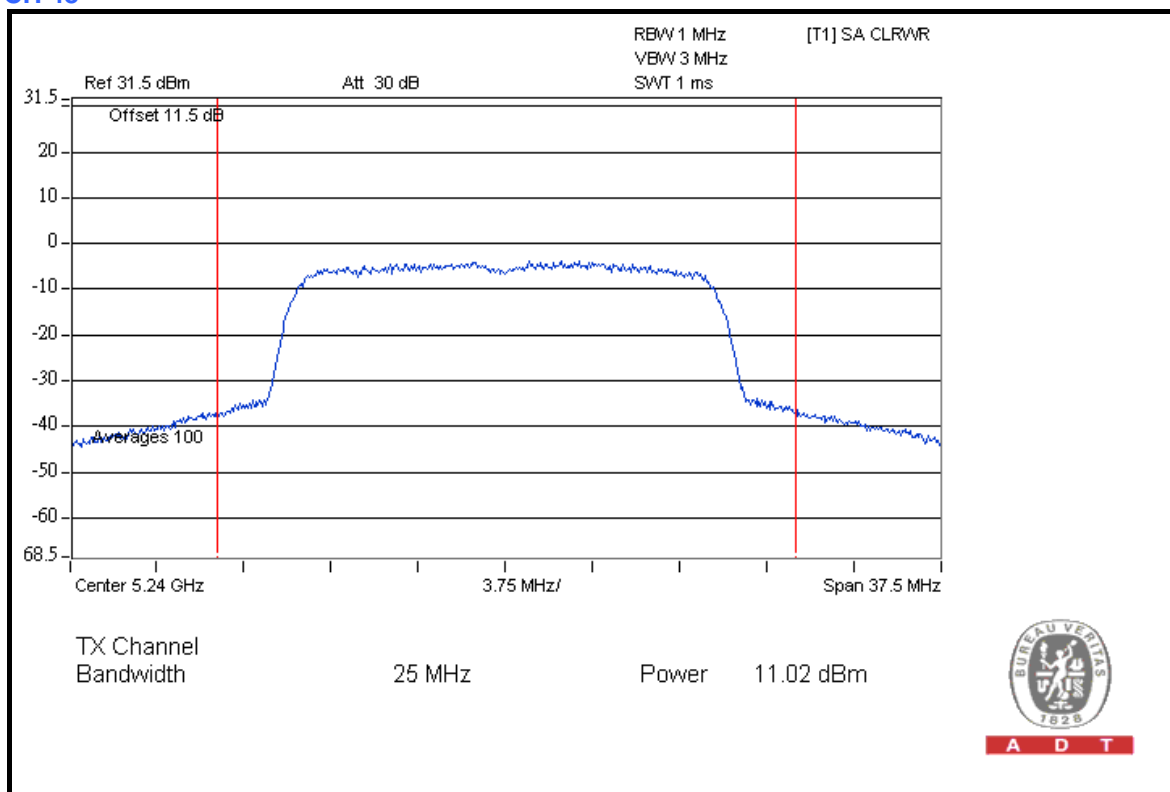

CHAIN 2 CH 36

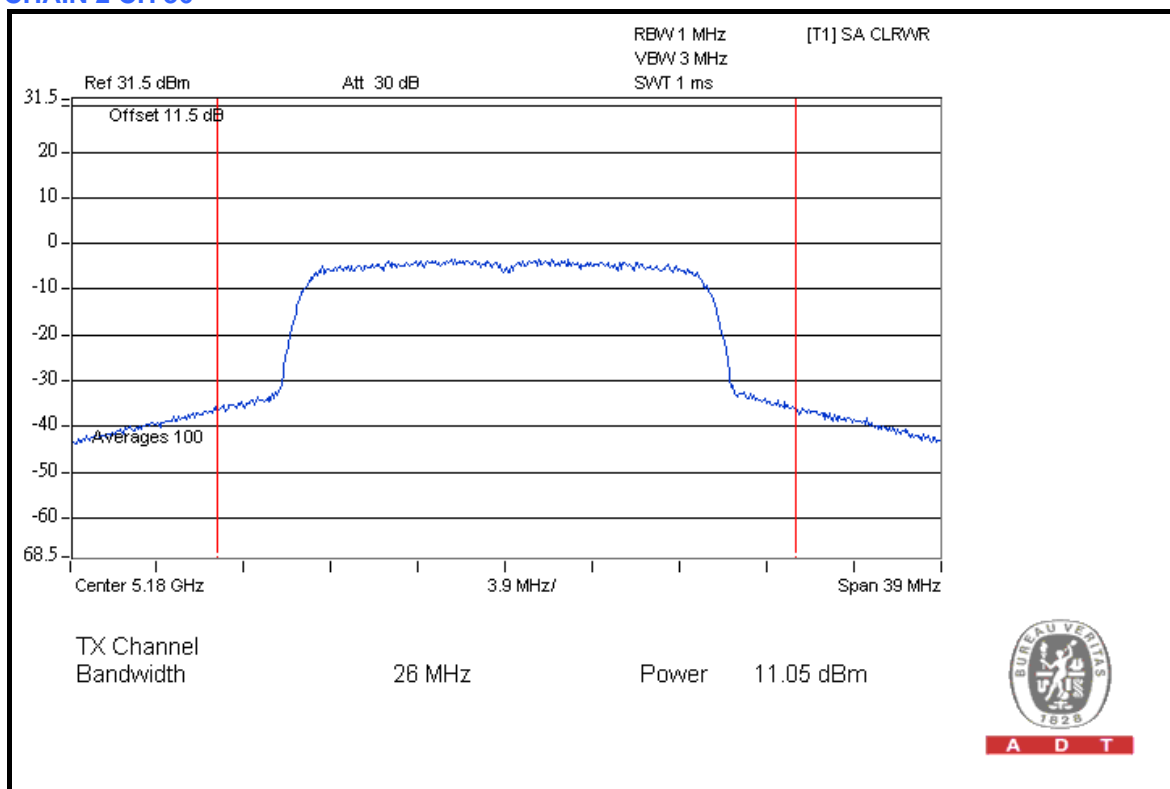



A D T

CH 40

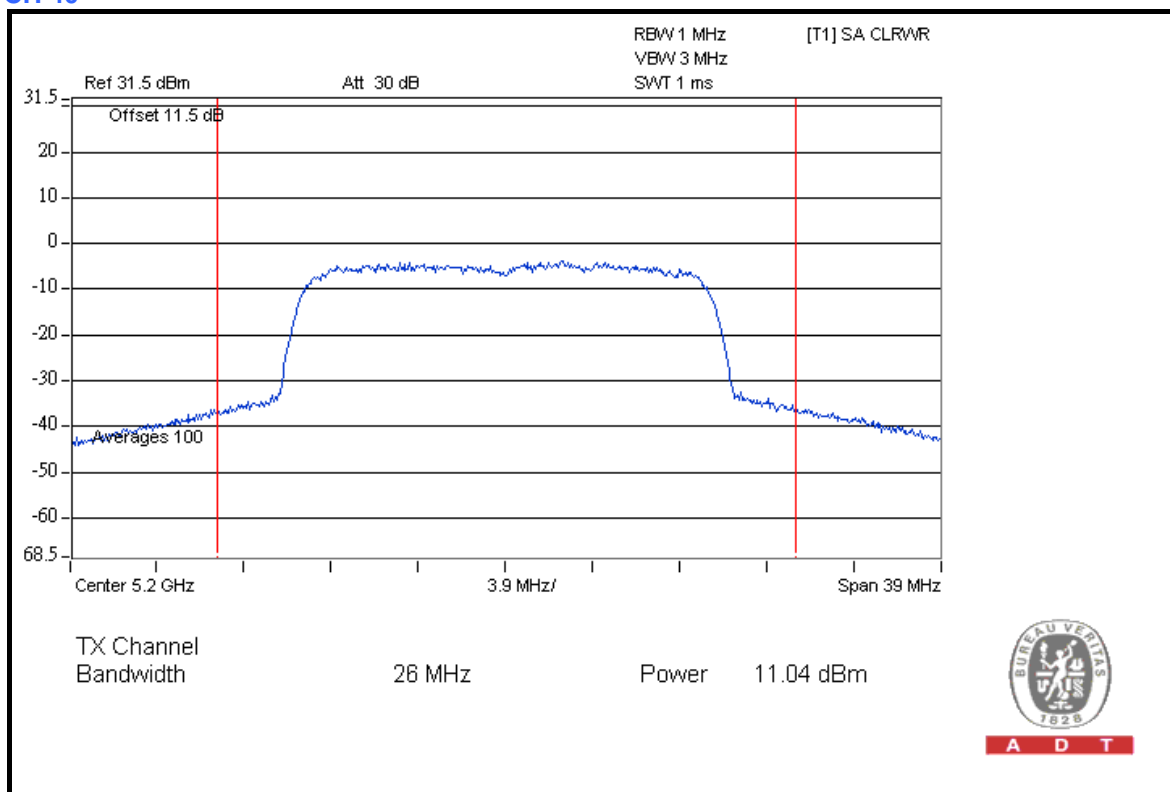

CH 48

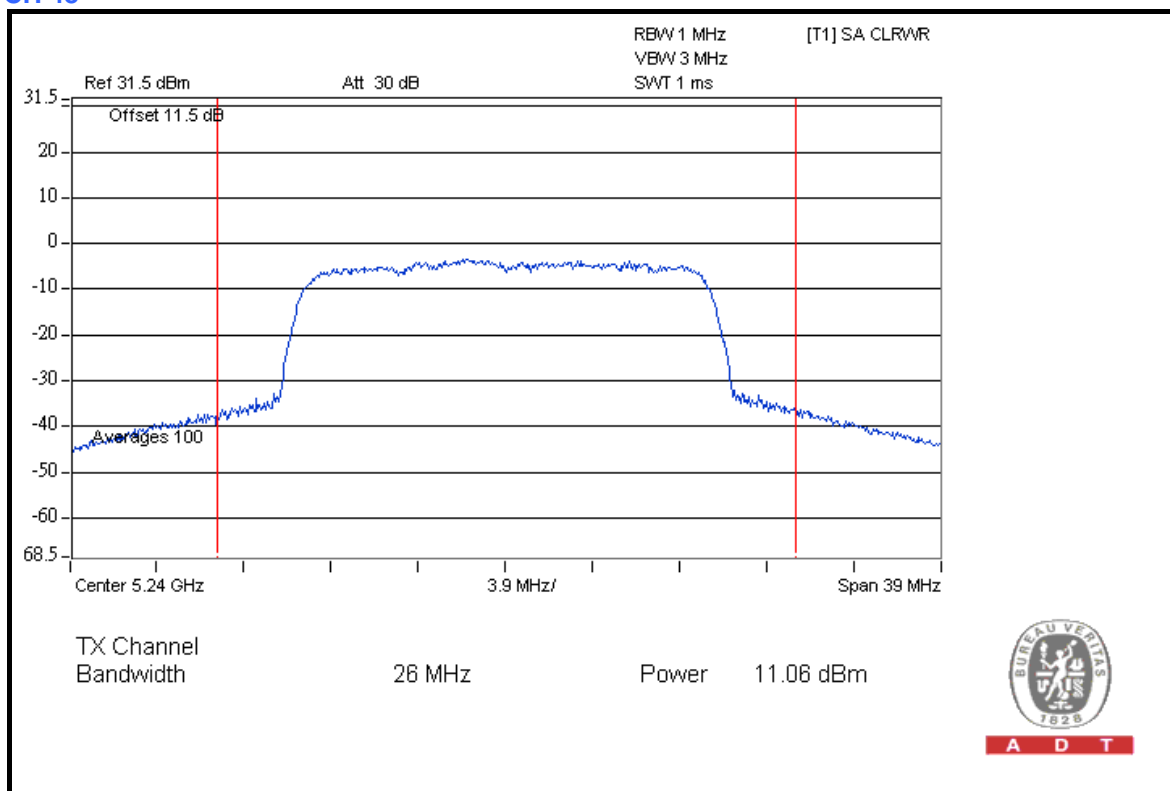



A D T

DRAFT 802.11n (20MHz) OFDM MODULATION

MODULATION TYPE	BPSK	TRANSFER RATE	6.5Mbps
INPUT POWER (SYSTEM)	120Vac, 60Hz	ENVIRONMENTAL CONDITIONS	25deg.C, 65%RH, 991hPa
TESTED BY	Brad Wu	TEST MODE	C

CHAN.	CHAN. FREQ. (MHz)	POWER OUTPUT (dBm)		TOTAL POWER (mW)	TOTAL POWER (dBm)	POWER LIMIT (dBm)	PASS / FAIL
		CHAIN 0	CHAIN 1				
36	5180	2.06	2.15	3.248	5.12	9	PASS
40	5200	2.08	2.05	3.218	5.08	9	PASS
48	5240	2.11	2.10	3.247	5.12	9	PASS

NOTE: According to 15.407 (a) (1) (2), the maximum antenna gain 14dBi is higher than 6dBi, so the limit of output power shall be reduced by 8 dB.



A D T

CHAIN 0 CH 36

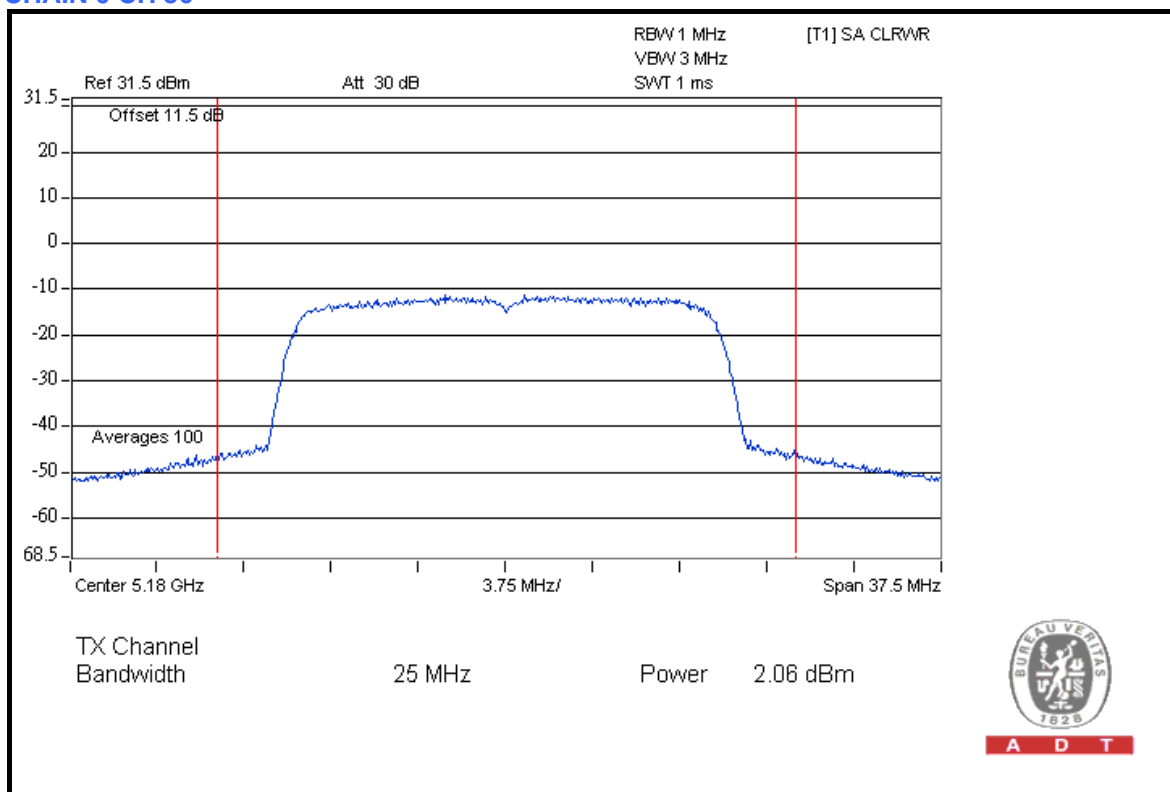

A D T

CH 40

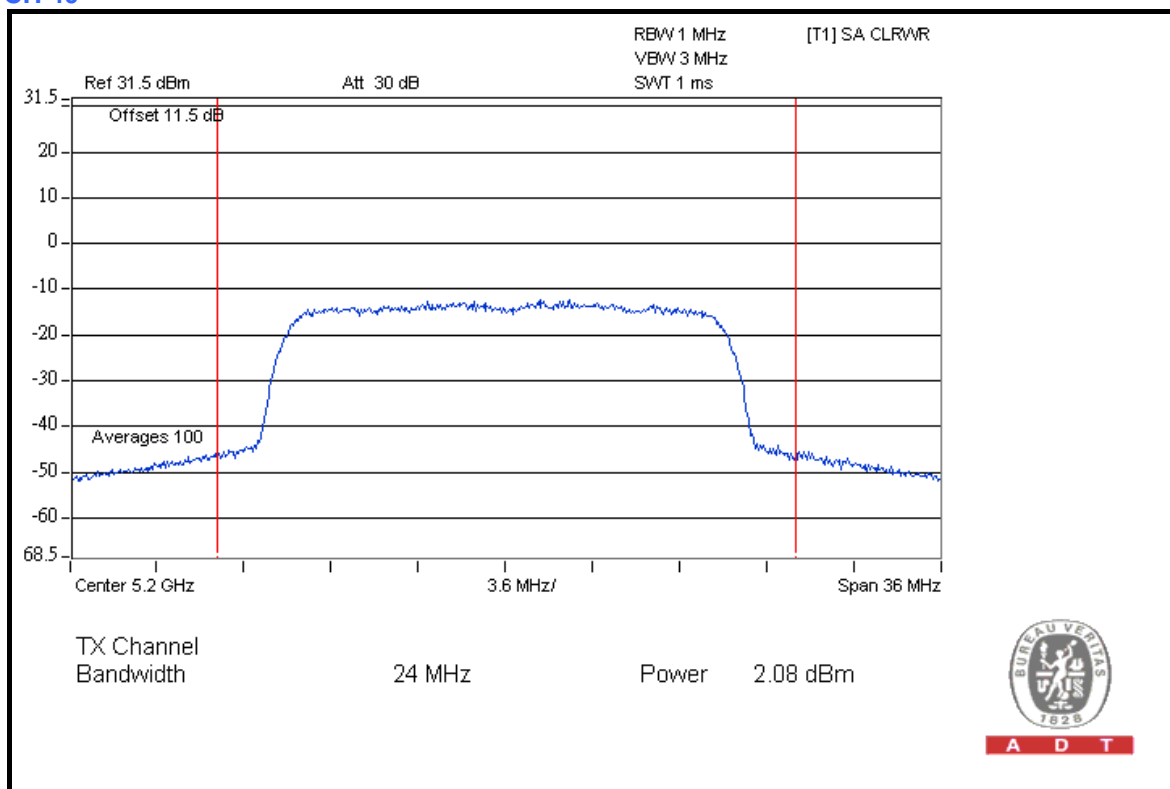

A D T



A D T

CH 48

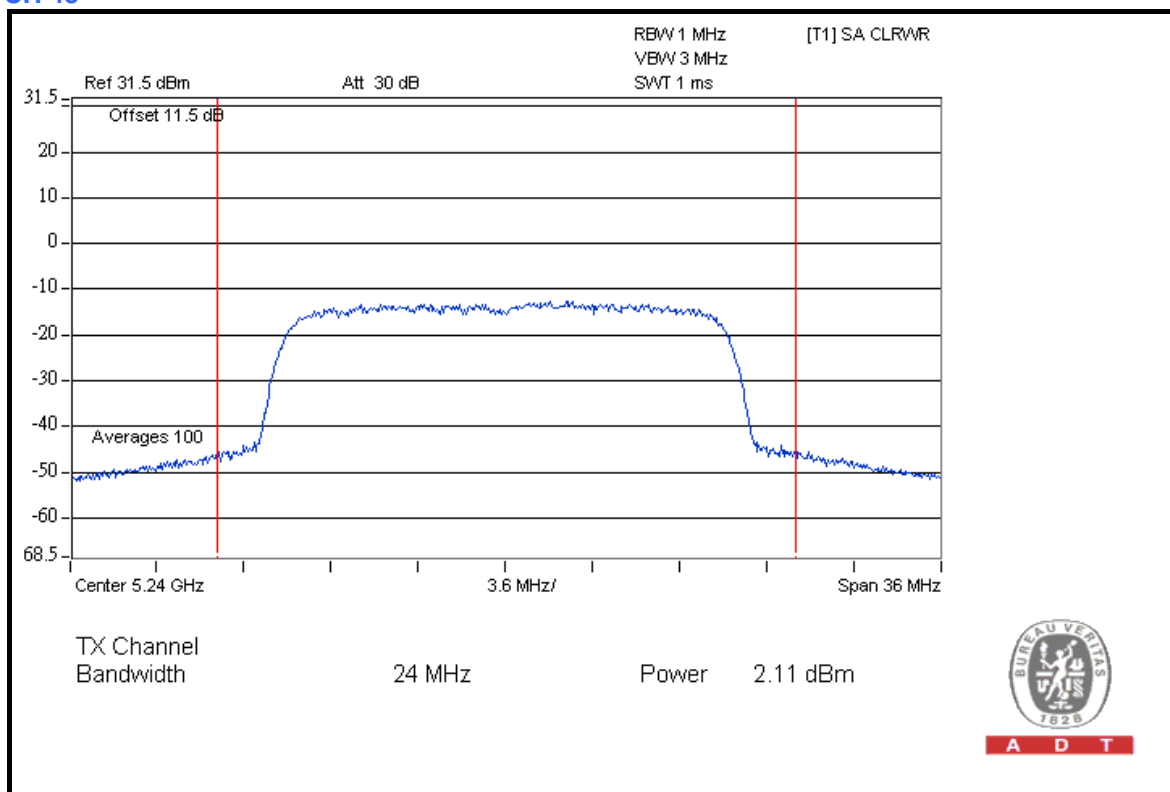

CHAIN 1 CH 36

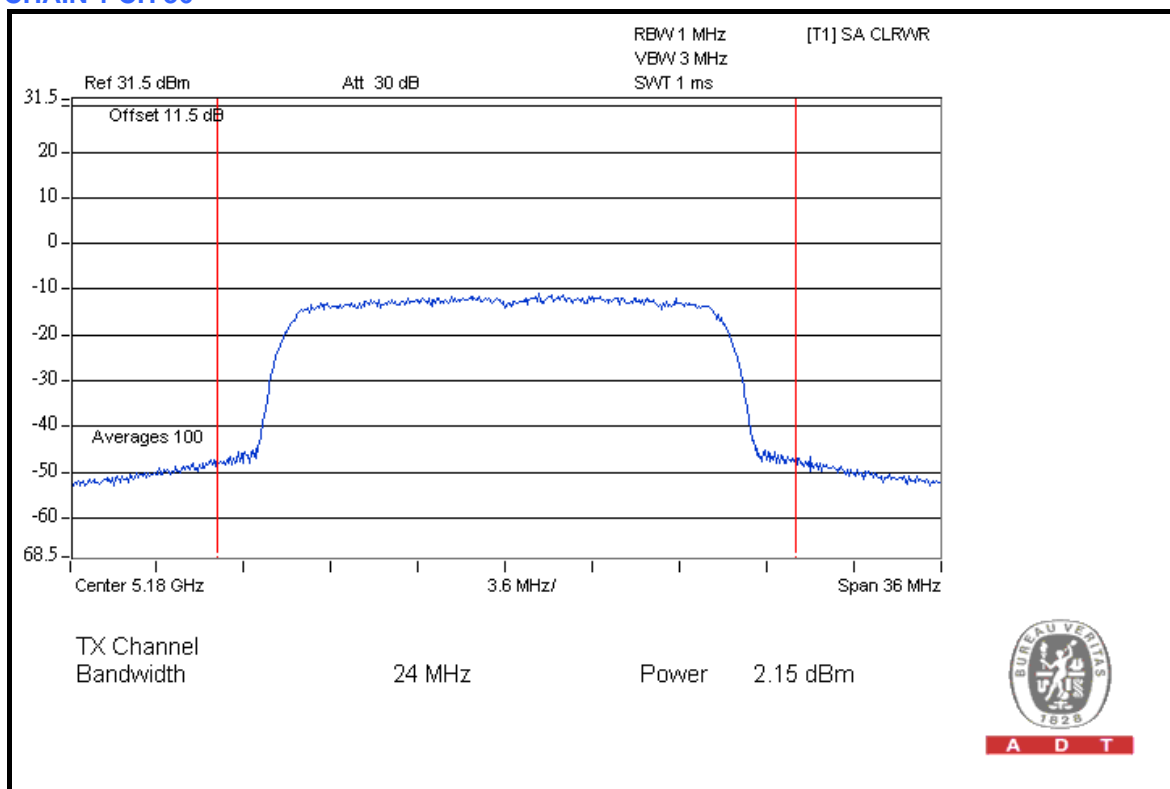



A D T

CH 40

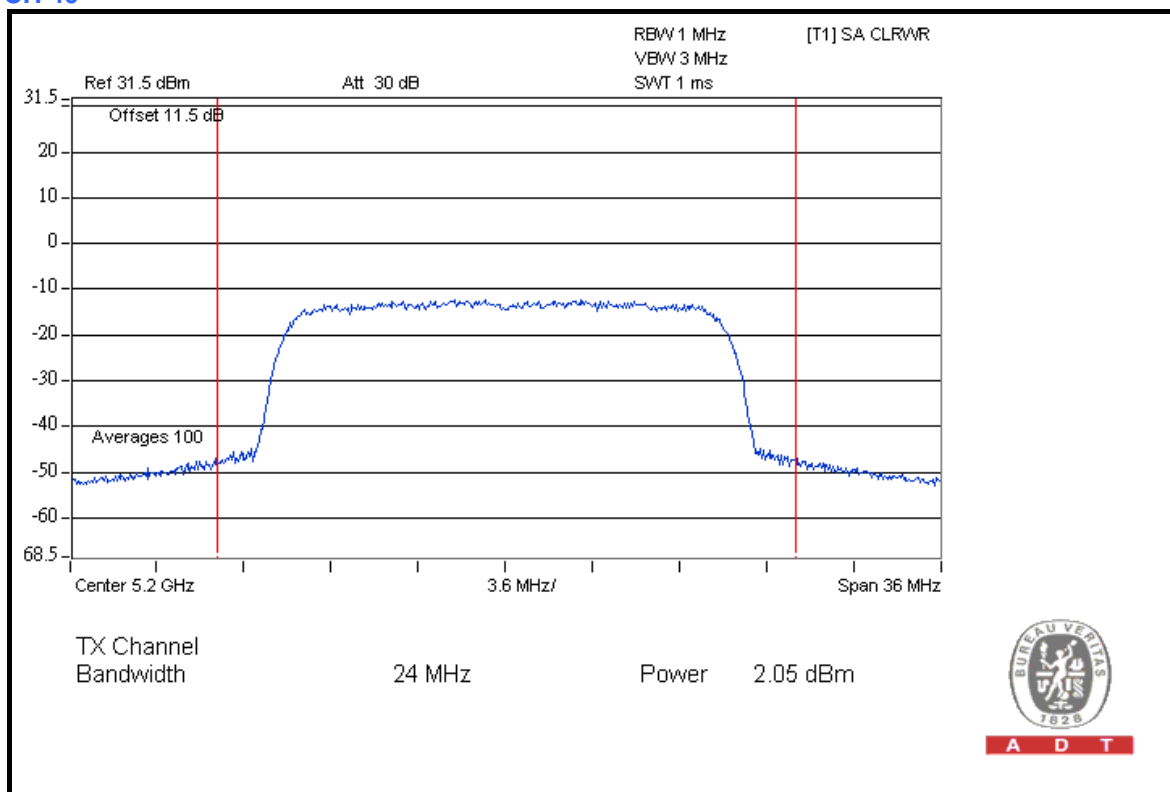

CH 48

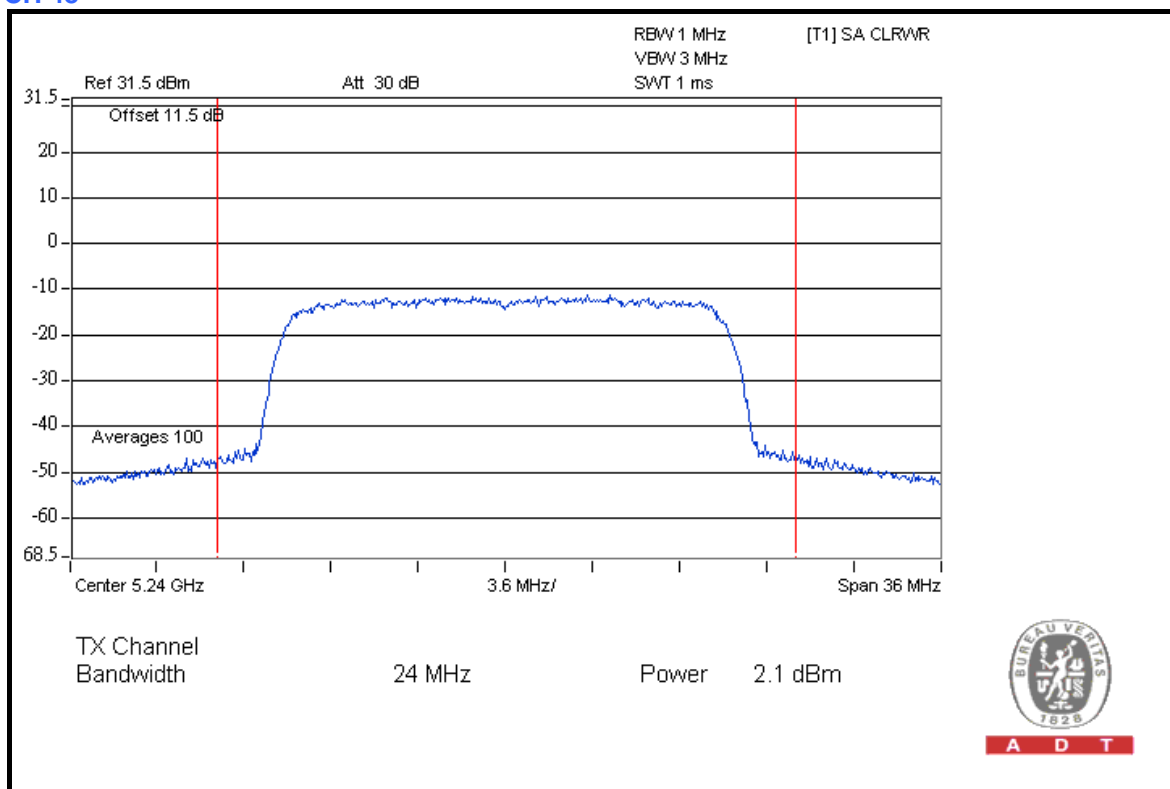



A D T

DRAFT 802.11n (40MHz) OFDM MODULATION

MODULATION TYPE	BPSK	TRANSFER RATE	13.5Mbps
INPUT POWER (SYSTEM)	120Vac, 60Hz	ENVIRONMENTAL CONDITIONS	25deg.C, 65%RH, 991hPa
TESTED BY	Brad Wu	TEST MODE	A

CHAN.	CHAN. FREQ. (MHz)	POWER OUTPUT (dBm)			TOTAL POWER (mW)	TOTAL POWER (dBm)	POWER LIMIT (dBm)	PASS / FAIL
		CHAIN 0	CHAIN 1	CHAIN 2				
38	5190	11.09	11.10	11.11	38.648	15.87	17	PASS
46	5230	11.10	11.13	11.11	38.766	15.88	17	PASS



A D T

CHAIN 0 CH 38

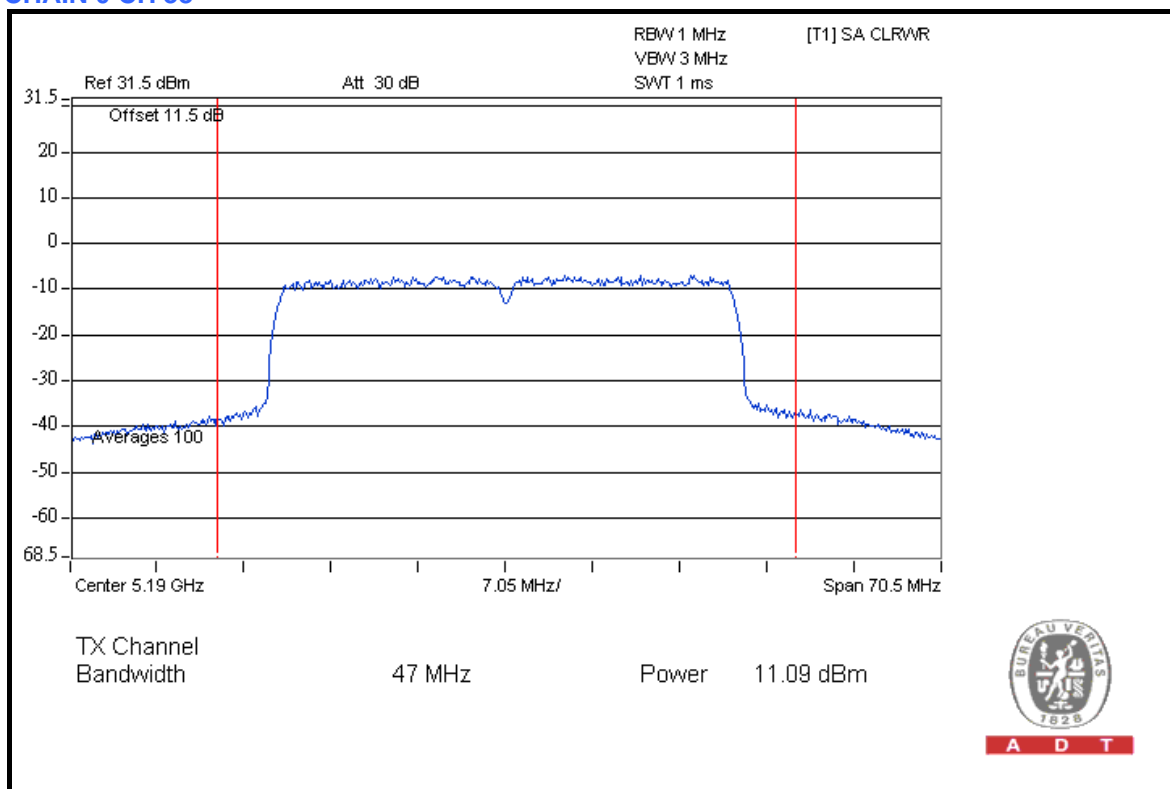

CH 46

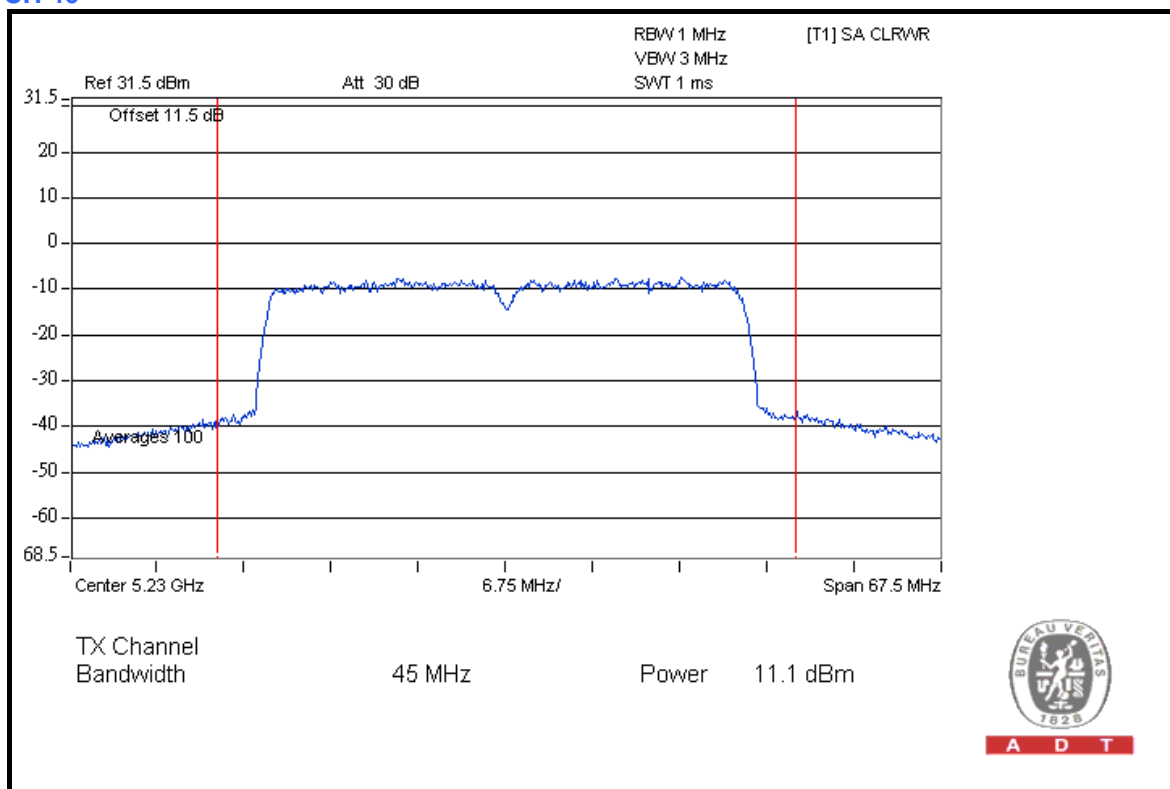



A D T

CHAIN 1 CH 38

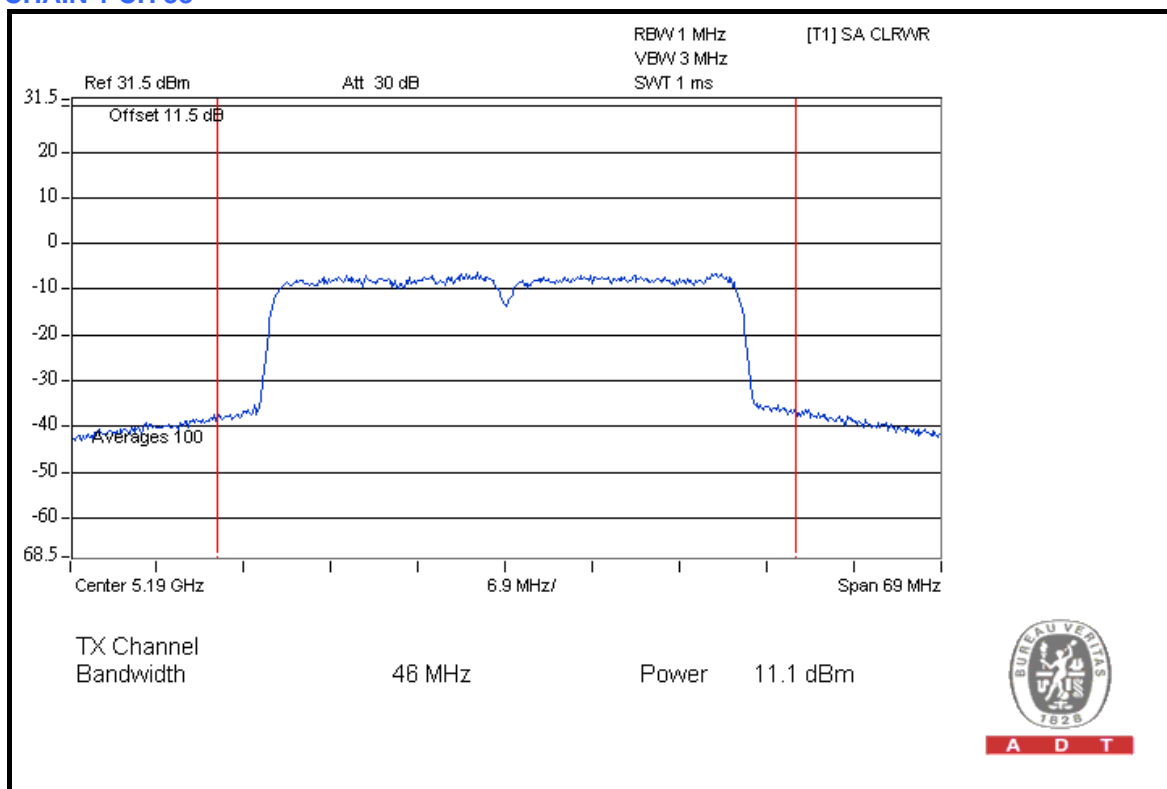

CH 46

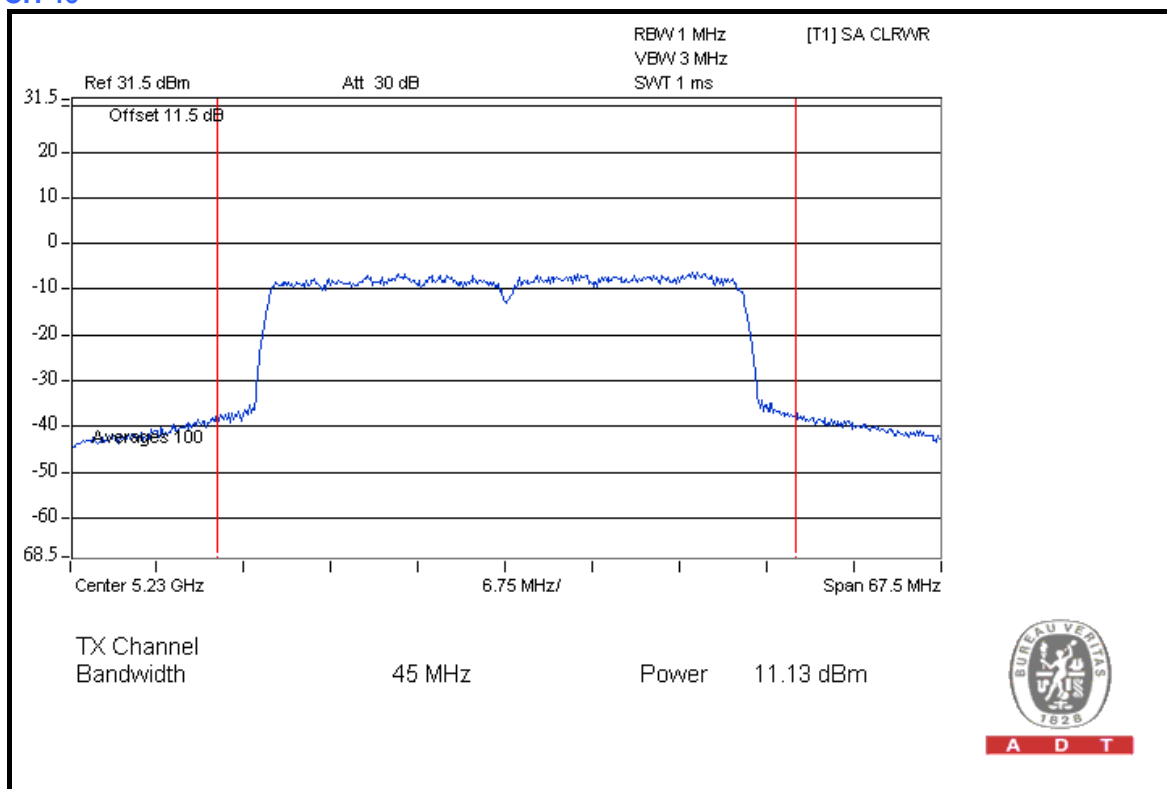



A D T

CHAIN 2 CH 38

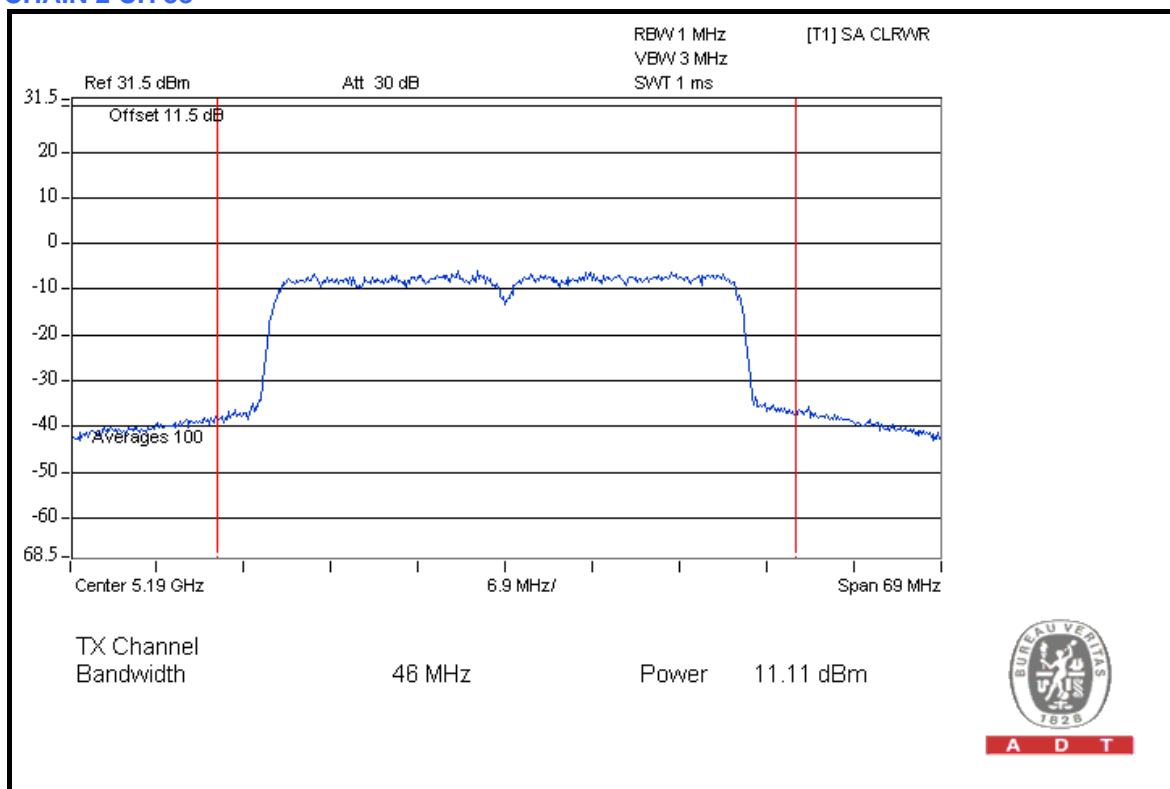

CH 46

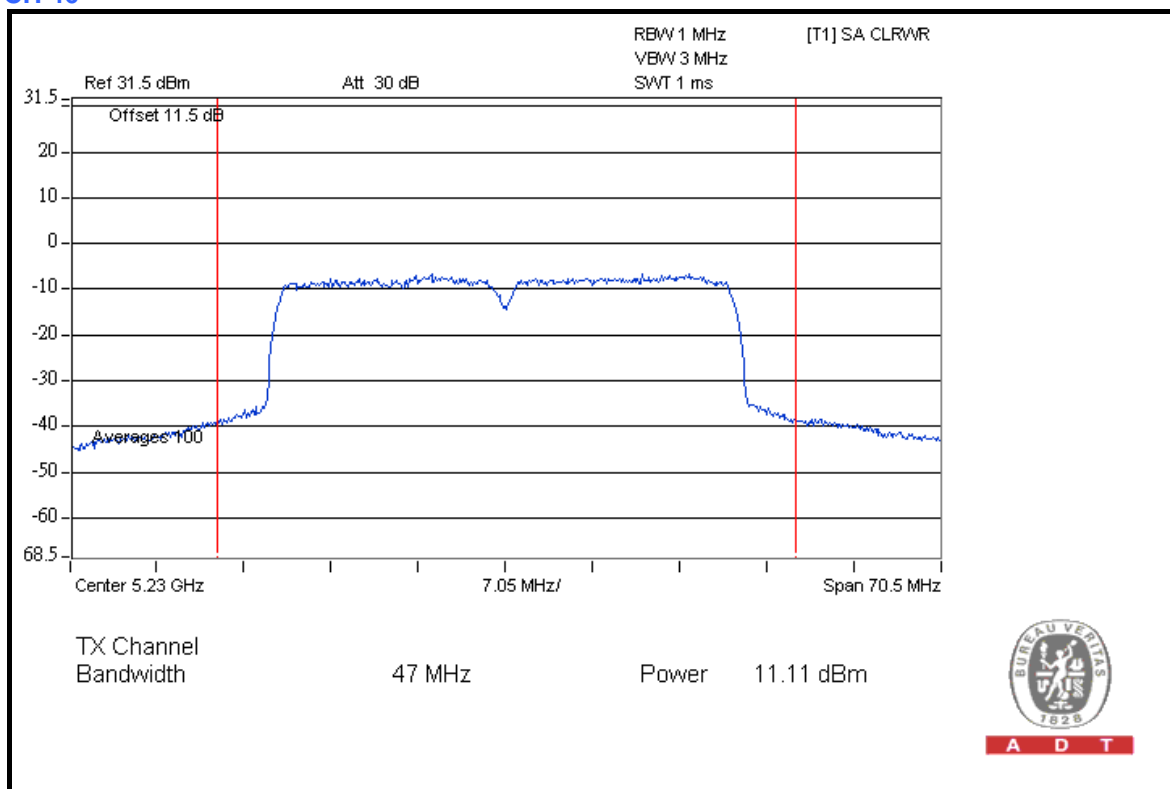



A D T

DRAFT 802.11n (40MHz) OFDM MODULATION

MODULATION TYPE	BPSK	TRANSFER RATE	13.5Mbps
INPUT POWER (SYSTEM)	120Vac, 60Hz	ENVIRONMENTAL CONDITIONS	25deg.C, 65%RH, 991hPa
TESTED BY	Brad Wu	TEST MODE	C

CHAN.	CHAN. FREQ. (MHz)	POWER OUTPUT (dBm)		TOTAL POWER (mW)	TOTAL POWER (dBm)	POWER LIMIT (dBm)	PASS / FAIL
		CHAIN 0	CHAIN 1				
38	5190	2.04	2.08	3.214	5.07	9	PASS
46	5230	2.14	2.10	3.259	5.13	9	PASS

NOTE: According to 15.407 (a) (1) (2), the maximum antenna gain 14dBi is higher than 6dBi, so the limit of output power shall be reduced by 8 dB.



A D T

CHAIN 0 CH 38

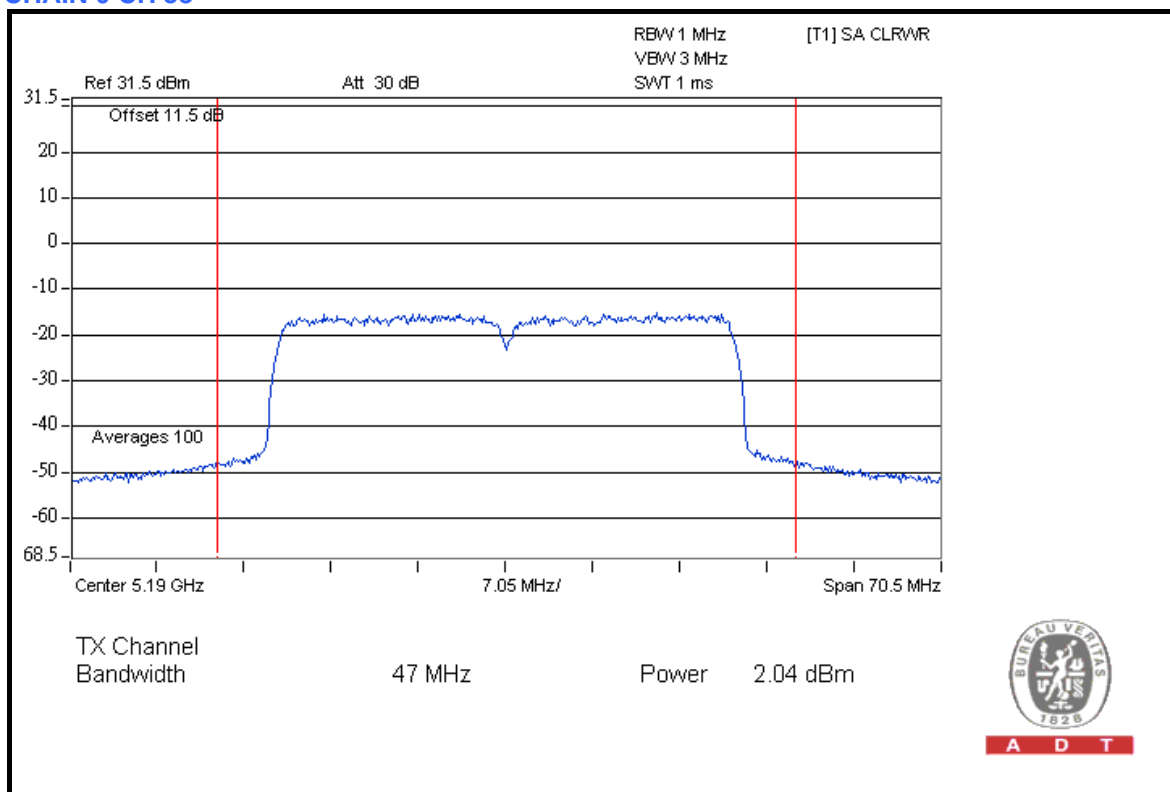

CH 46

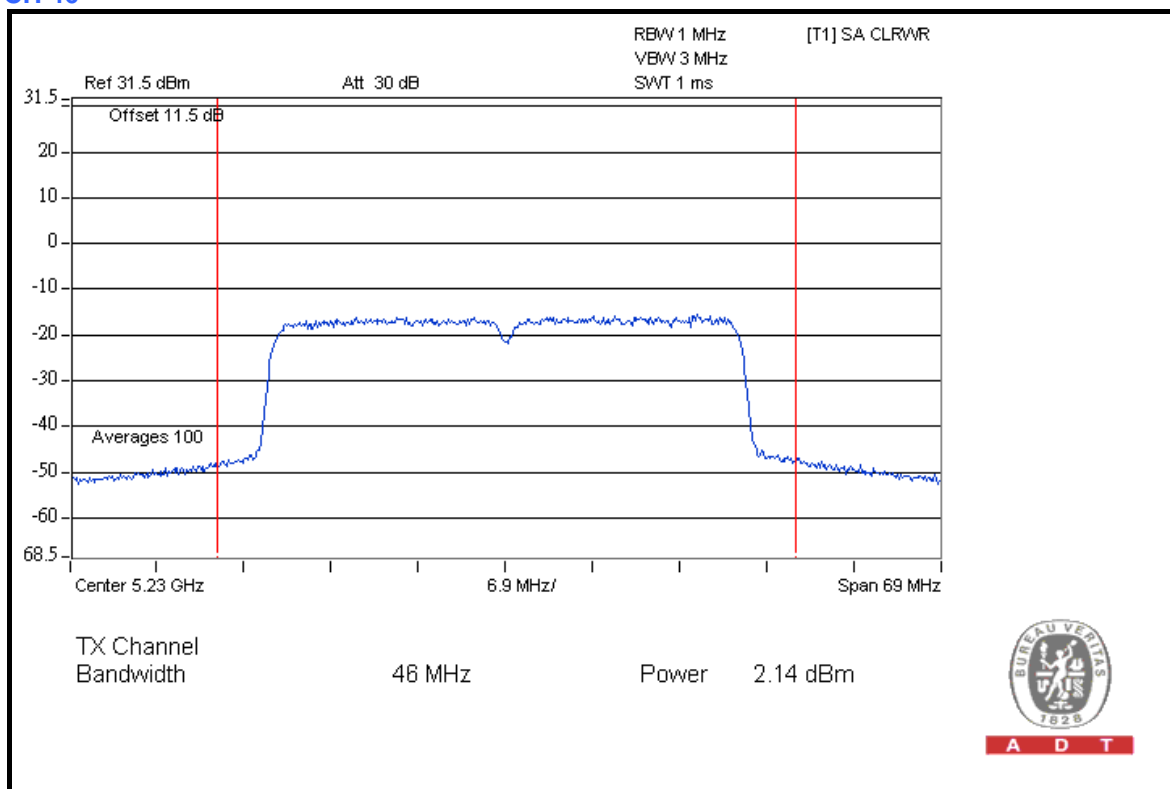



A D T

CHAIN 1 CH 38

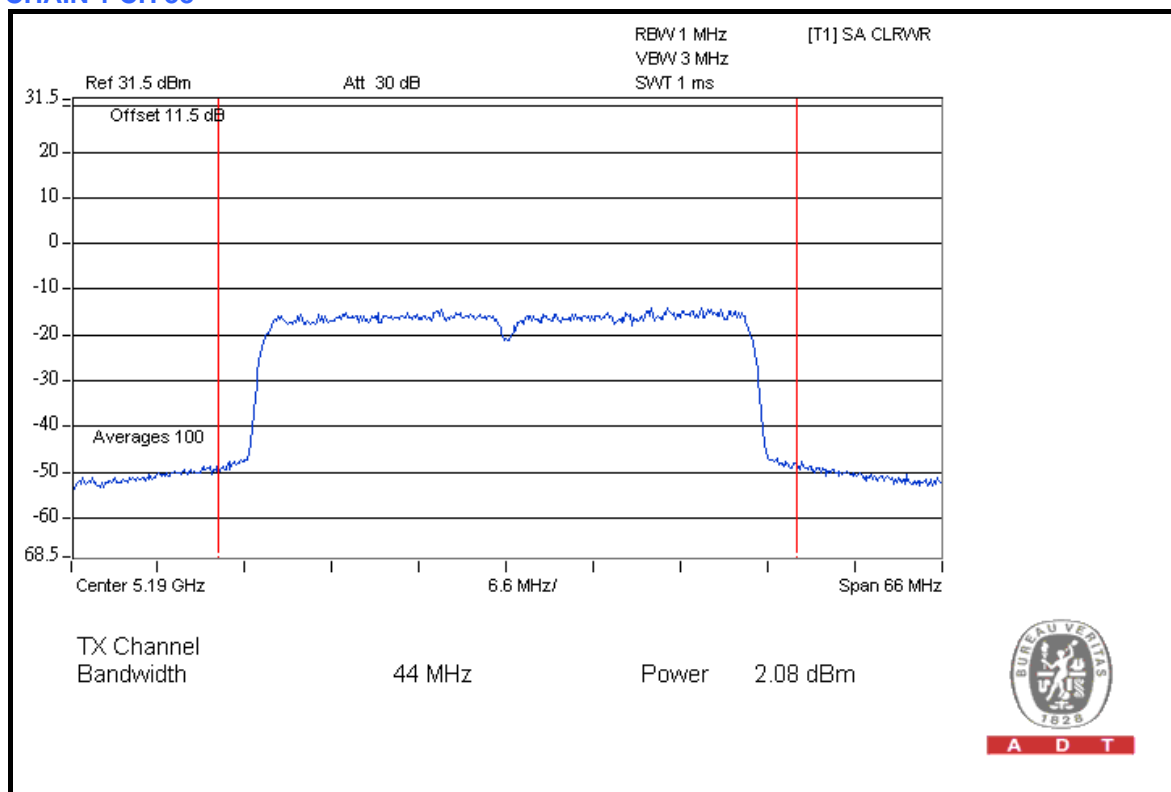

A D T

CH 46

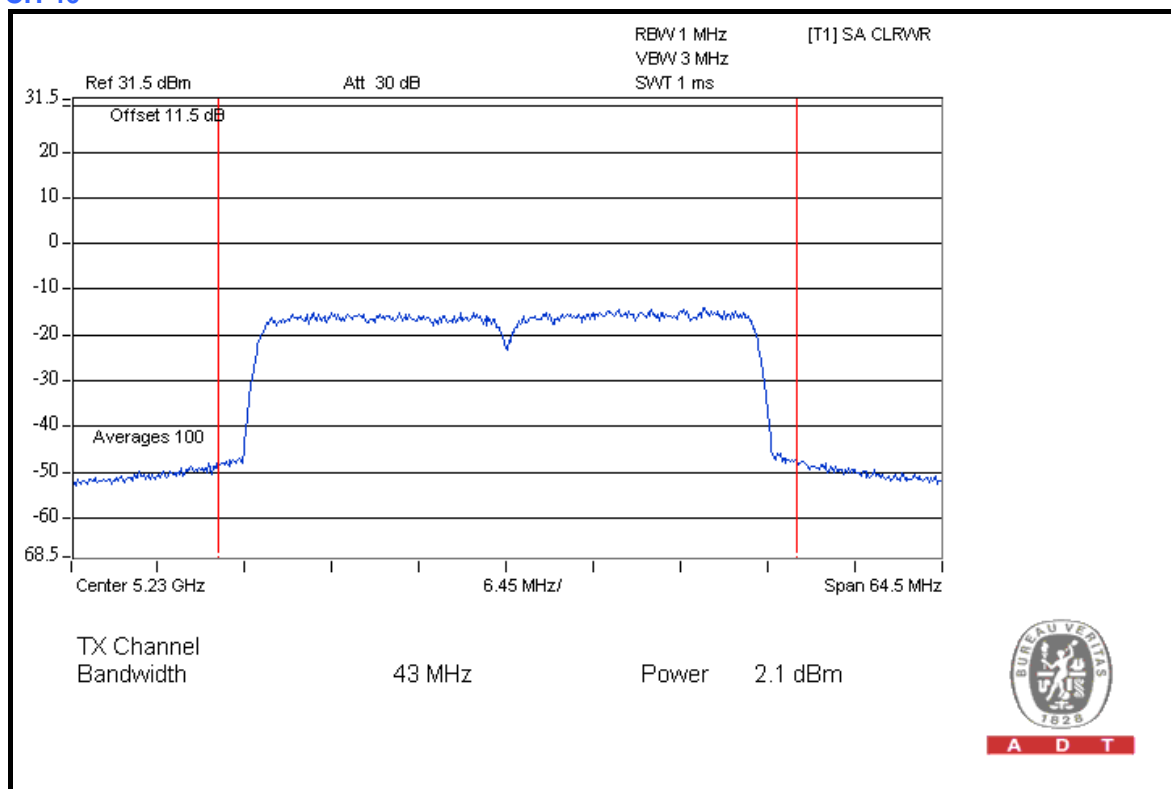

A D T



A D T

26dB OCCUPIED BANDWIDTH: 802.11a OFDM MODULATION

MODULATION TYPE	BPSK	TRANSFER RATE	6.0Mbps
INPUT POWER	120Vac, 60Hz	ENVIRONMENTAL CONDITIONS	25 deg.C, 65 %RH, 1021hPa
TESTED BY	Brad Wu	TEST MODE	A

CHANNEL	CHANNEL FREQUENCY (MHz)	26dBc OCCUPIED BANDWIDTH (MHz)			PASS / FAIL
		CHAIN 0	CHAIN 1	CHAIN 2	
36	5180	23.64	24.16	22.79	PASS
40	5200	24.53	24.37	24.12	PASS
48	5240	24.09	23.52	23.62	PASS

CHAIN 0 CH 36

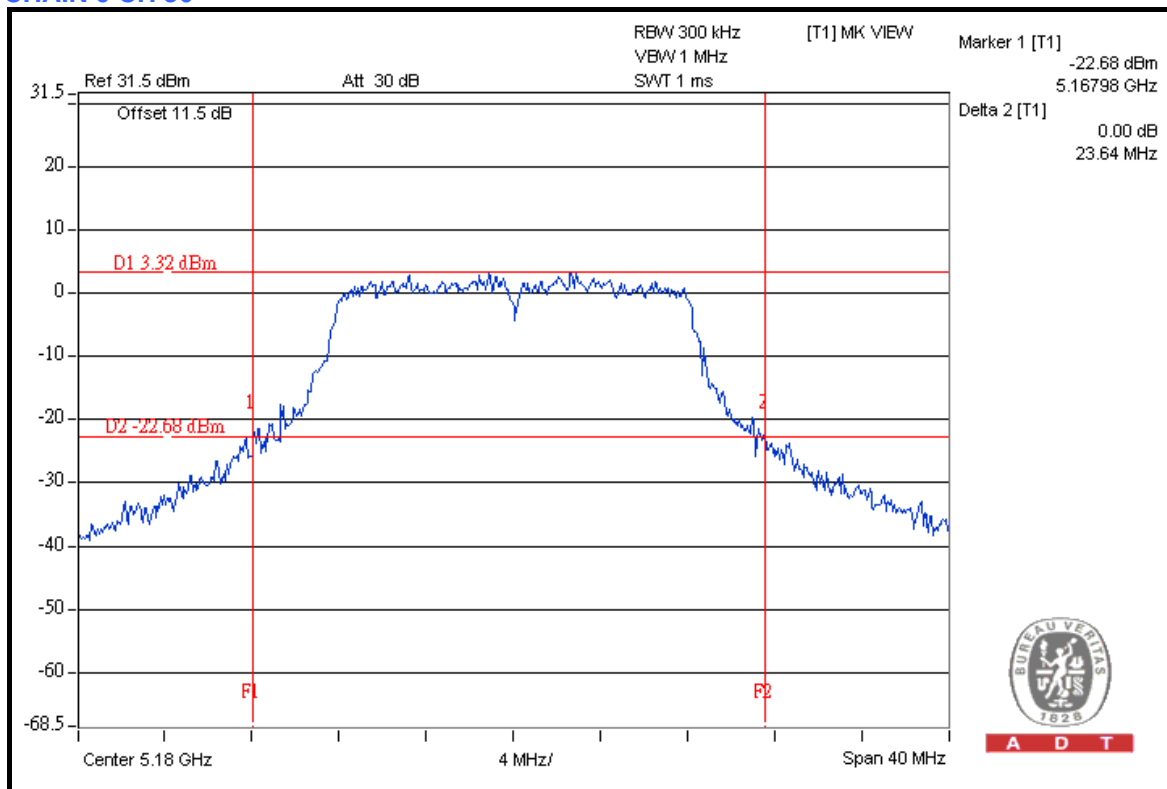



A D T

CH 40

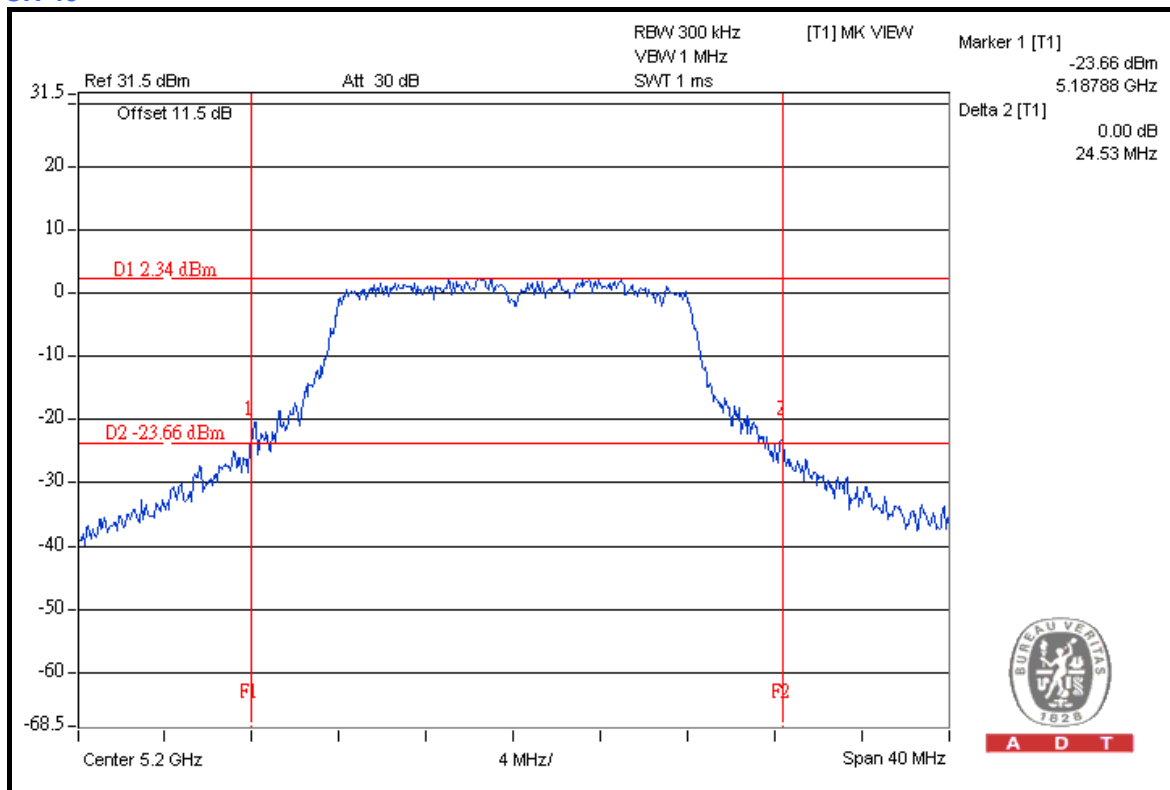

CH 48

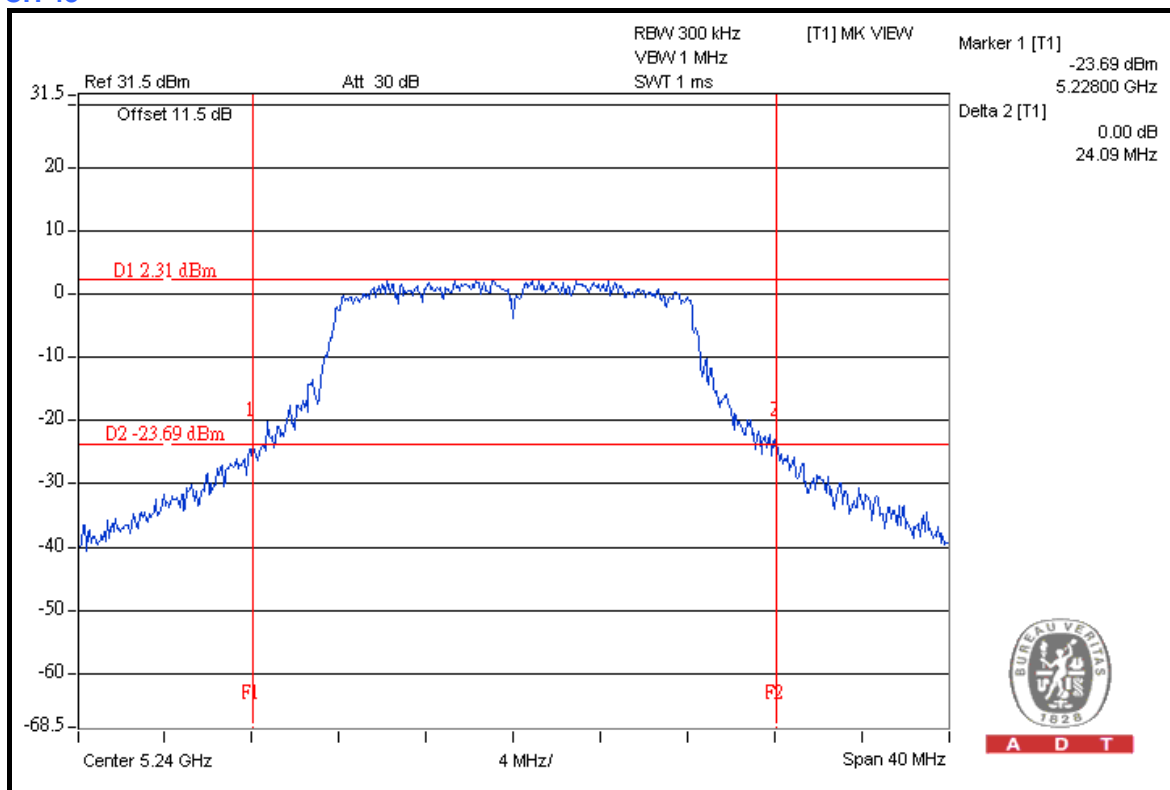



A D T

CHAIN 1 CH 36

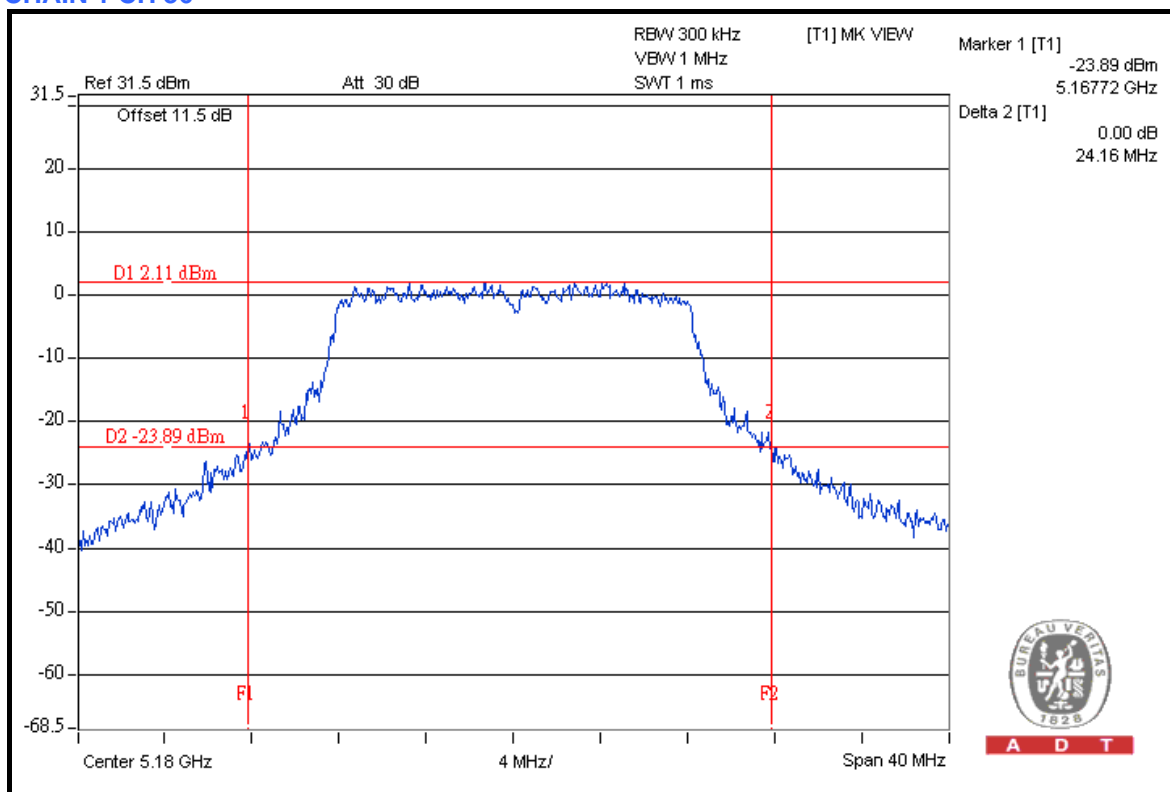

CH 40

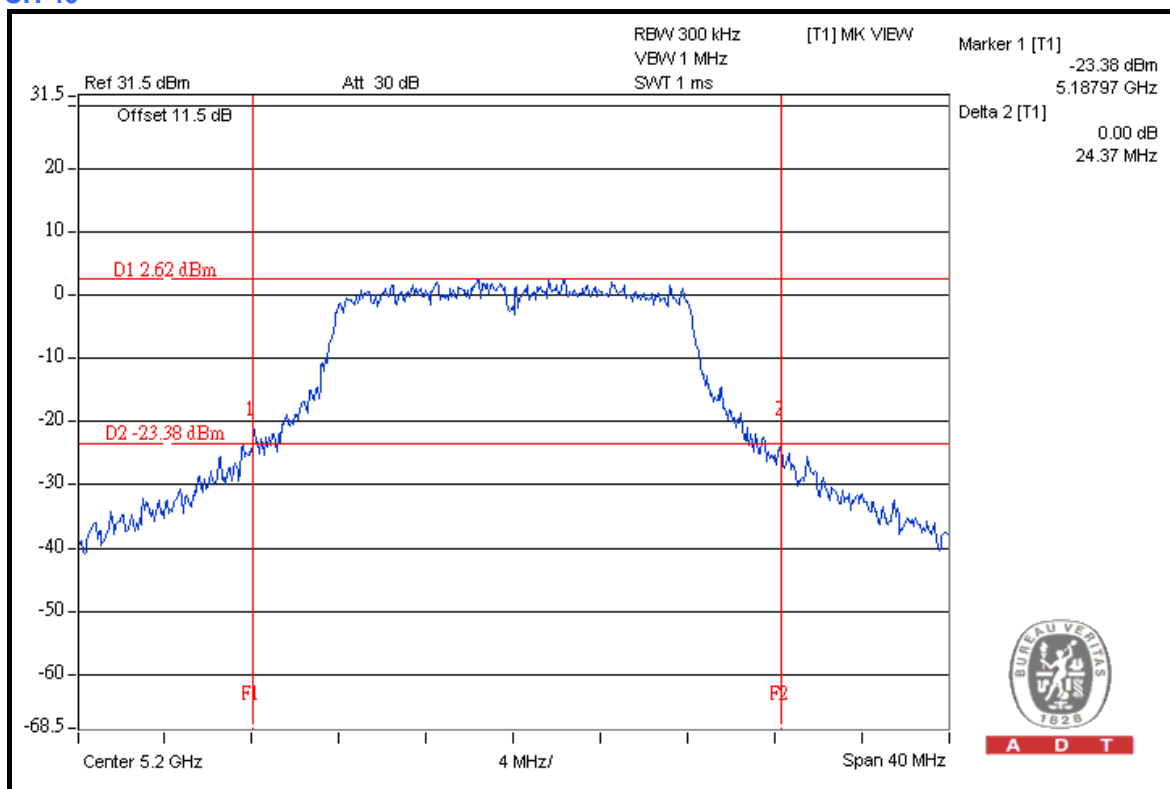



A D T

CH 48

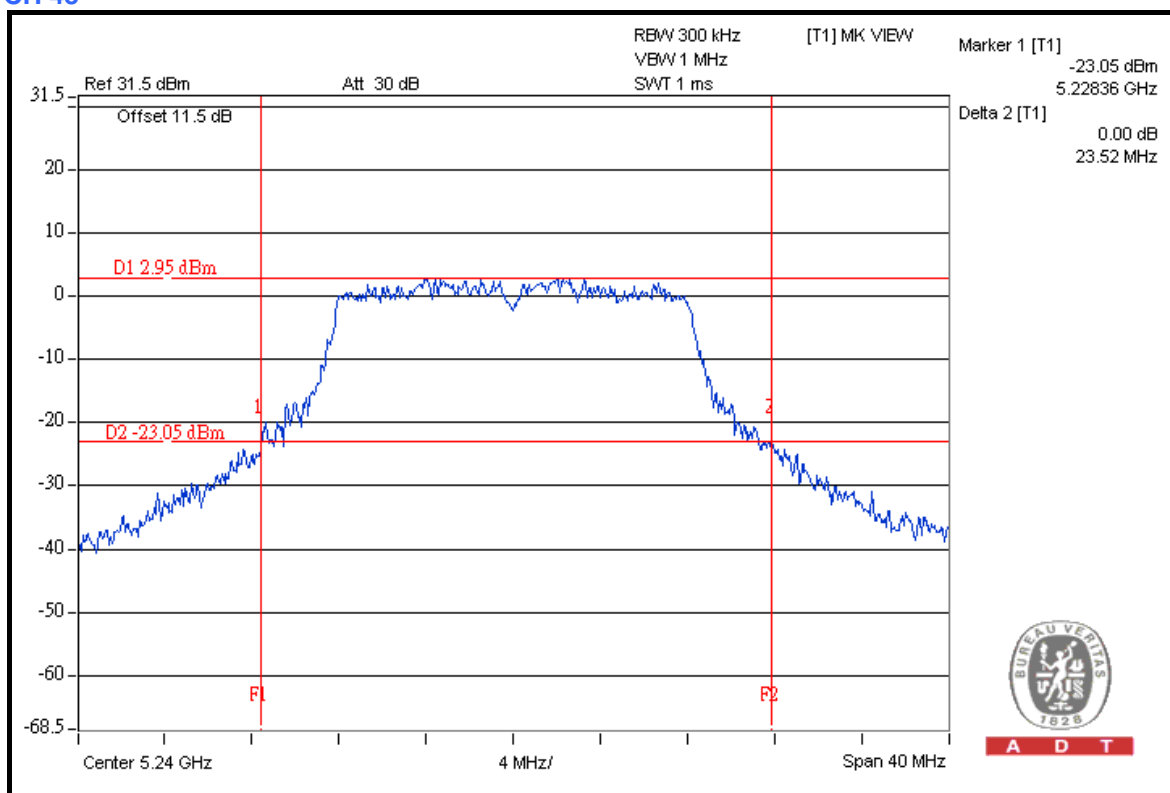

CHAIN 2 CH 36

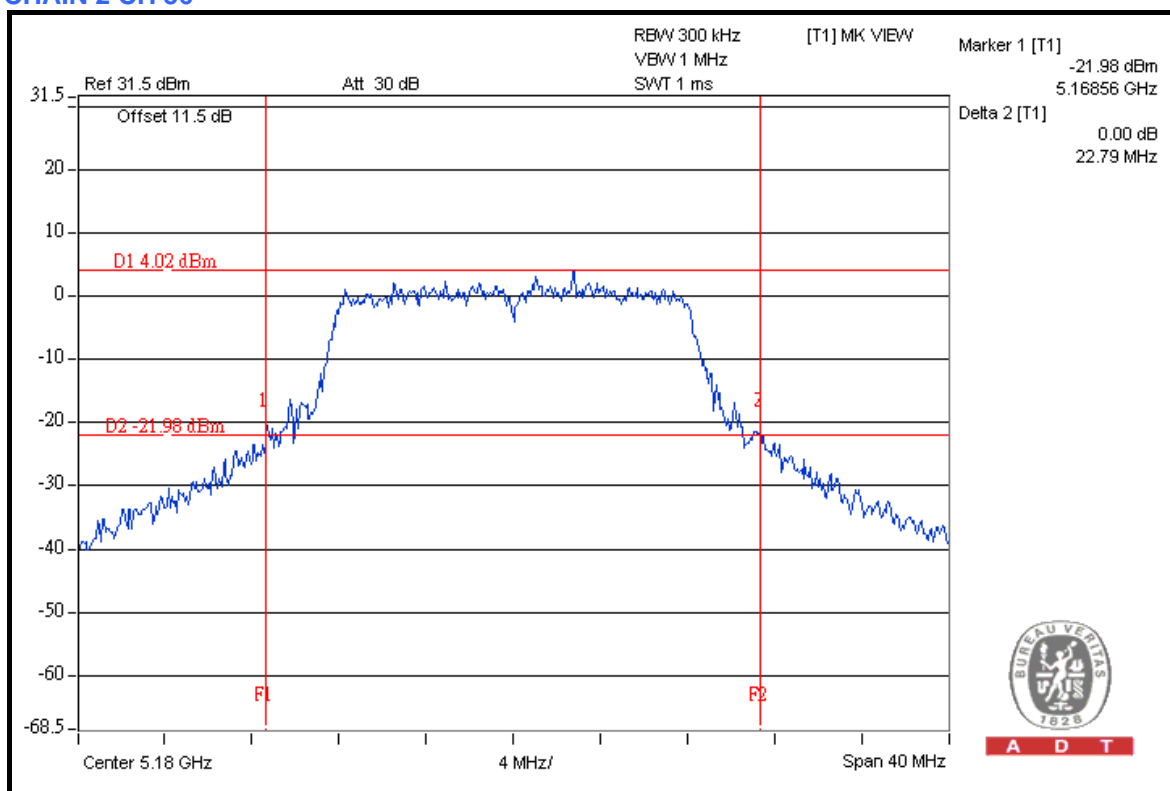



A D T

CH 40

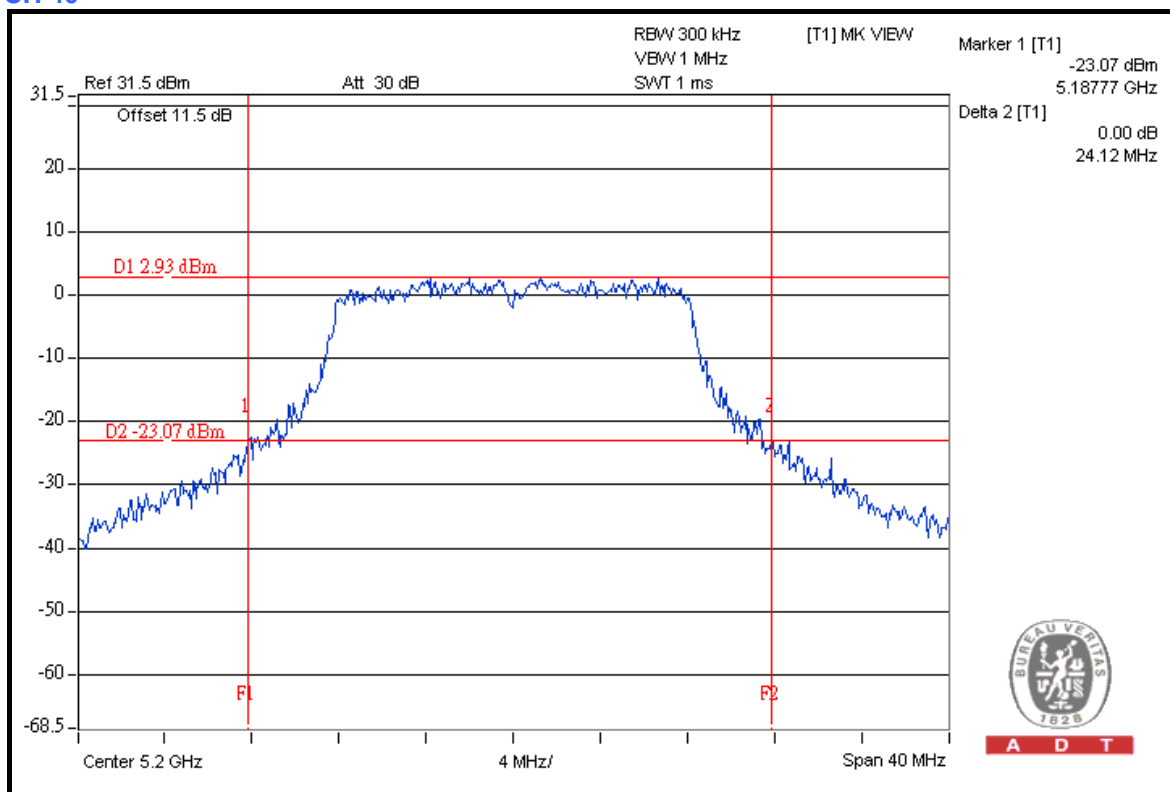

CH 48

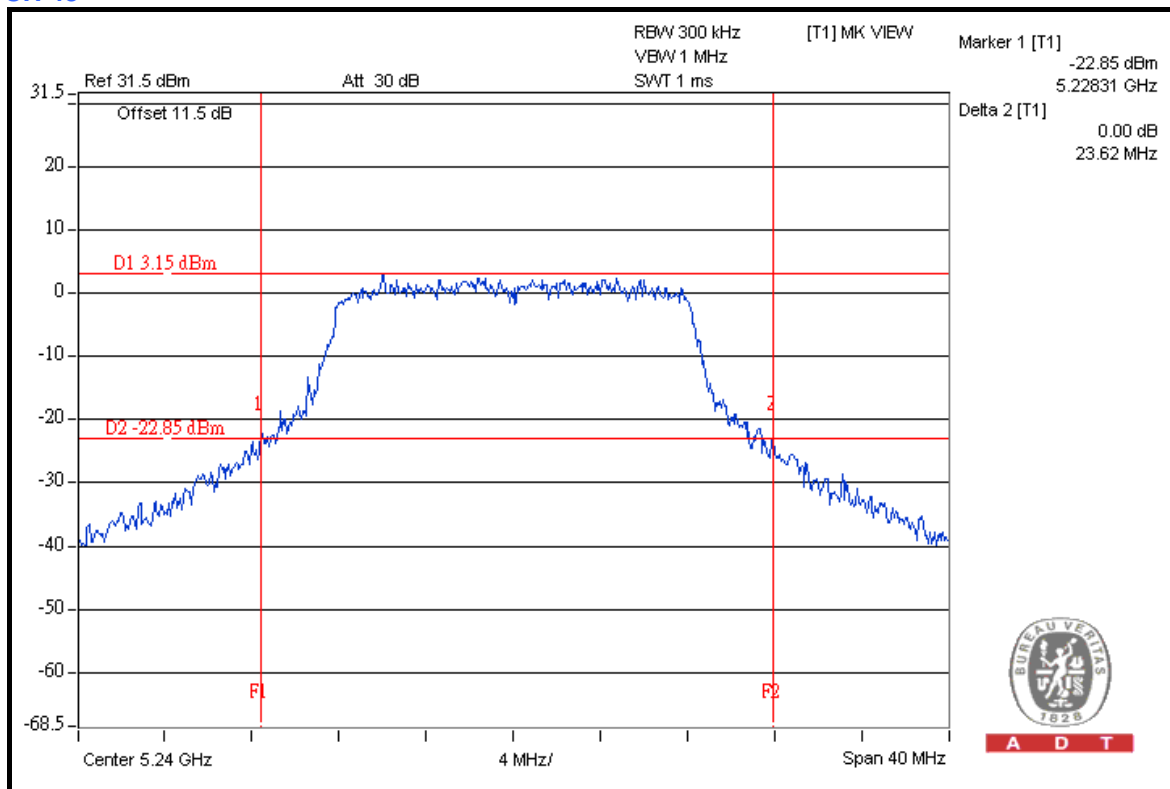



A D T

802.11a OFDM MODULATION

MODULATION TYPE	BPSK	TRANSFER RATE	6.0Mbps
INPUT POWER	120Vac, 60Hz	ENVIRONMENTAL CONDITIONS	25 deg.C, 65 %RH, 1021hPa
TESTED BY	Brad Wu	TEST MODE	C

CHANNEL	CHANNEL FREQUENCY (MHz)	26dBc OCCUPIED BANDWIDTH (MHz)		PASS / FAIL
		CHAIN 0	CHAIN 1	
36	5180	22.81	23.13	PASS
40	5200	22.38	22.20	PASS
48	5240	22.38	22.76	PASS



A D T

CHAIN 0 CH 36

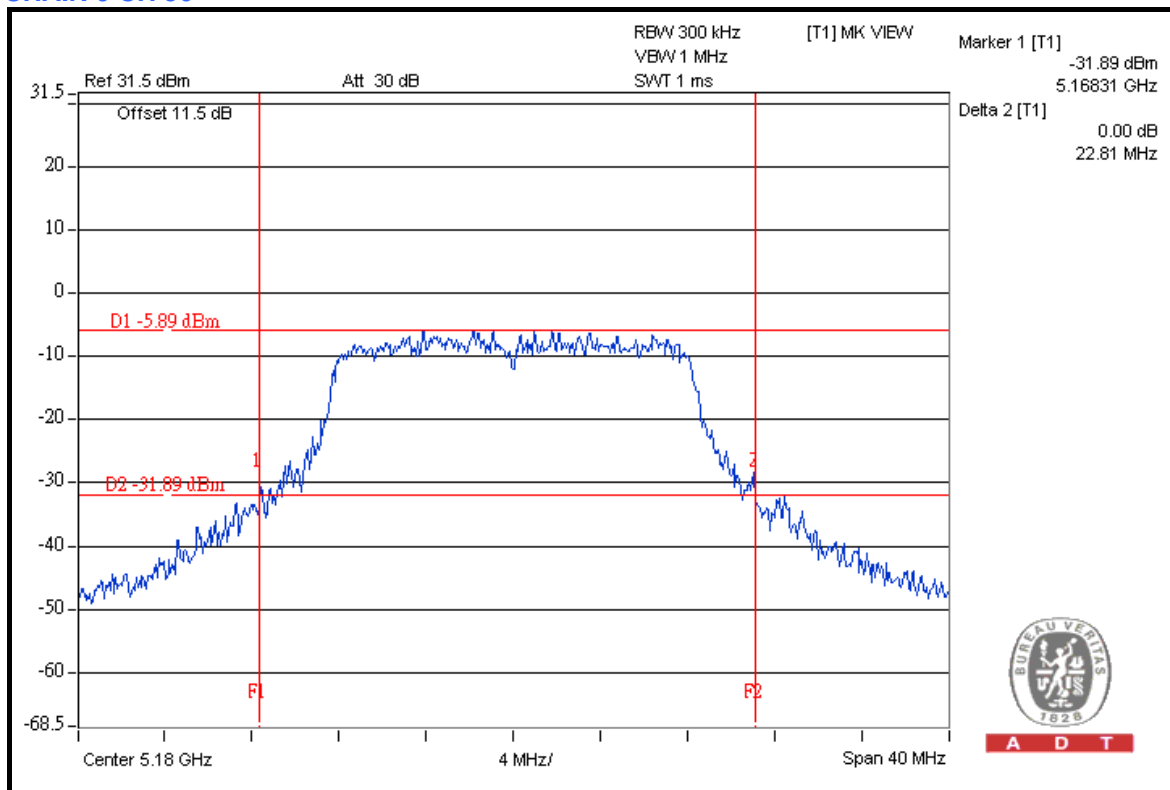

CH 40

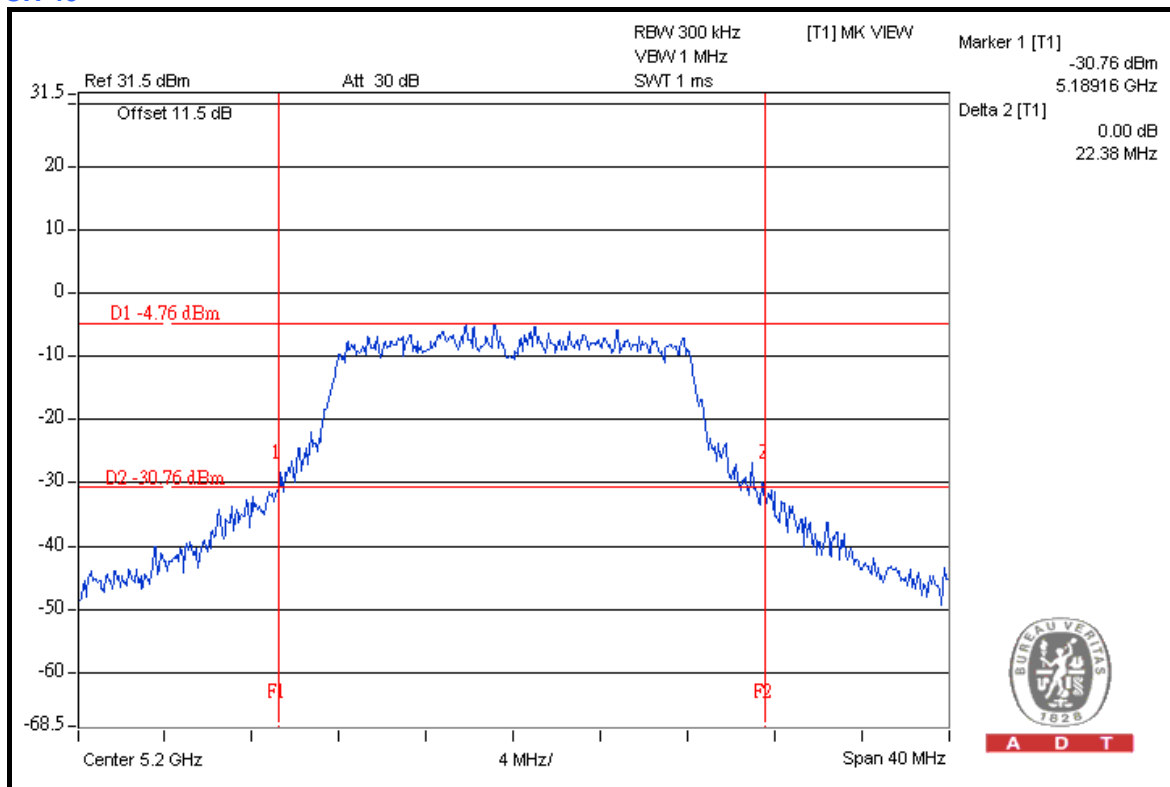



A D T

CH 48

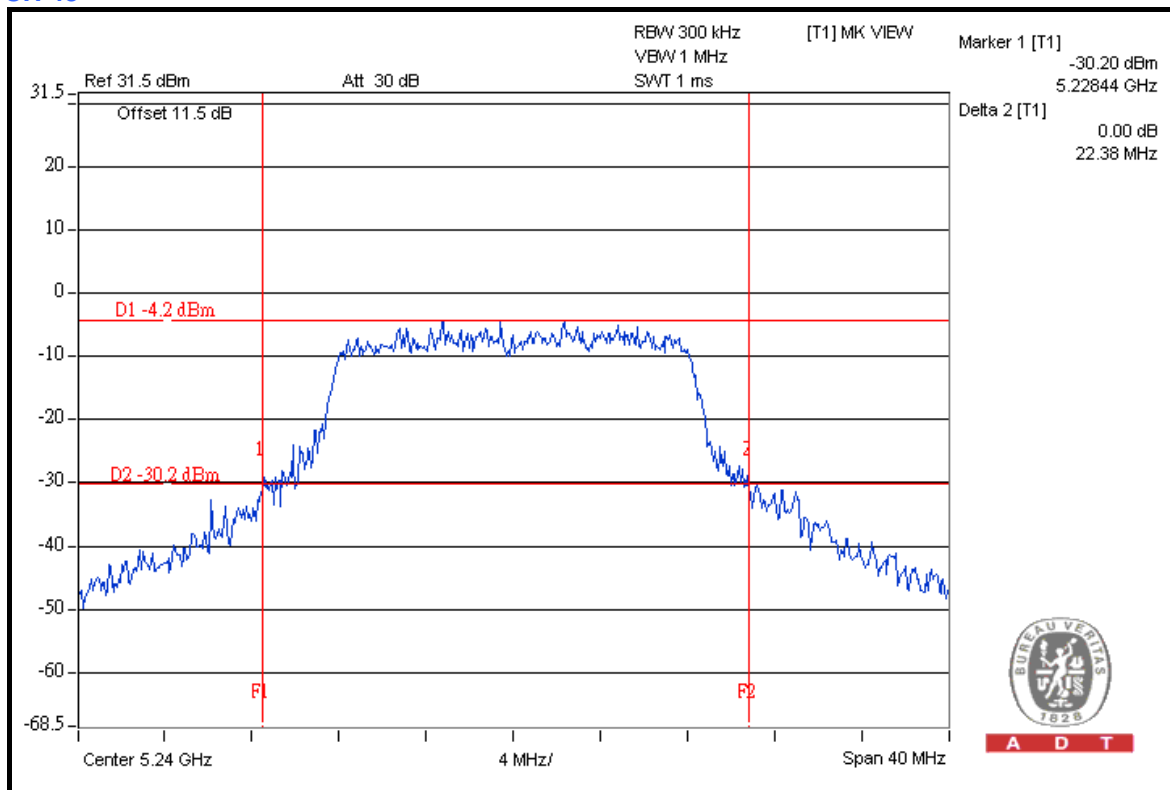

CHAIN 1 CH 36

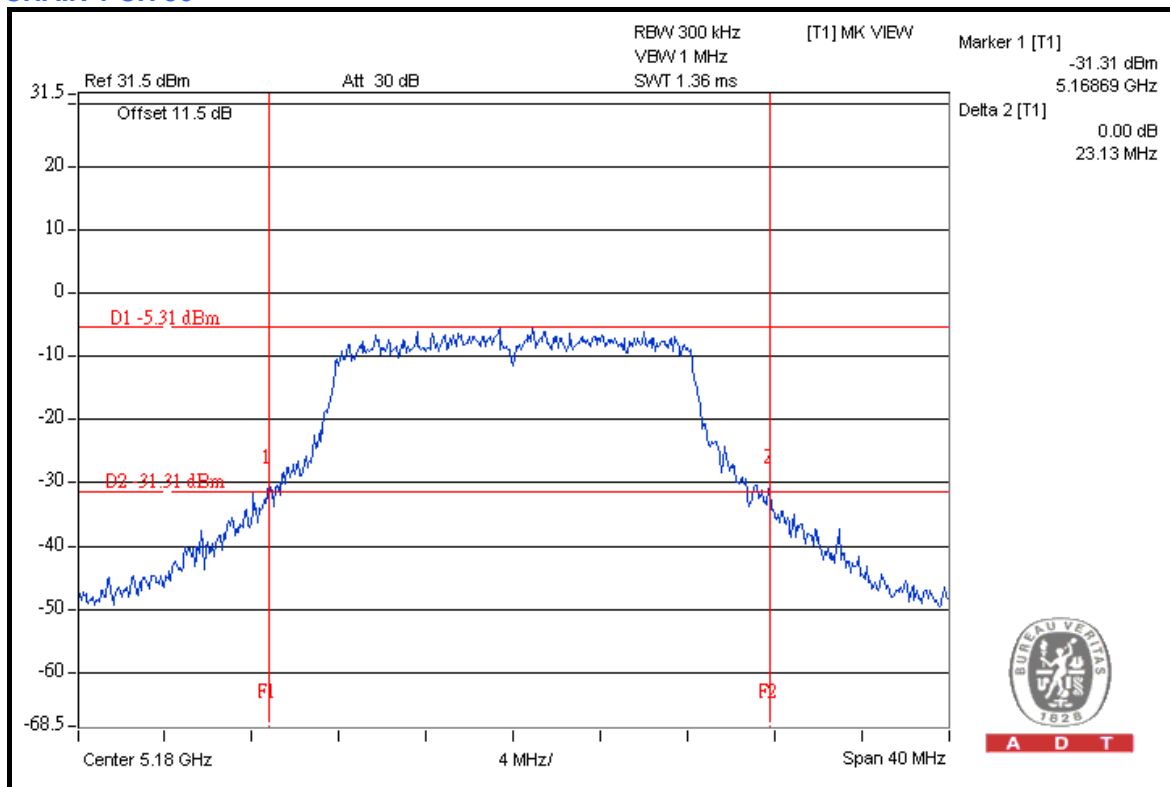



A D T

CH 40

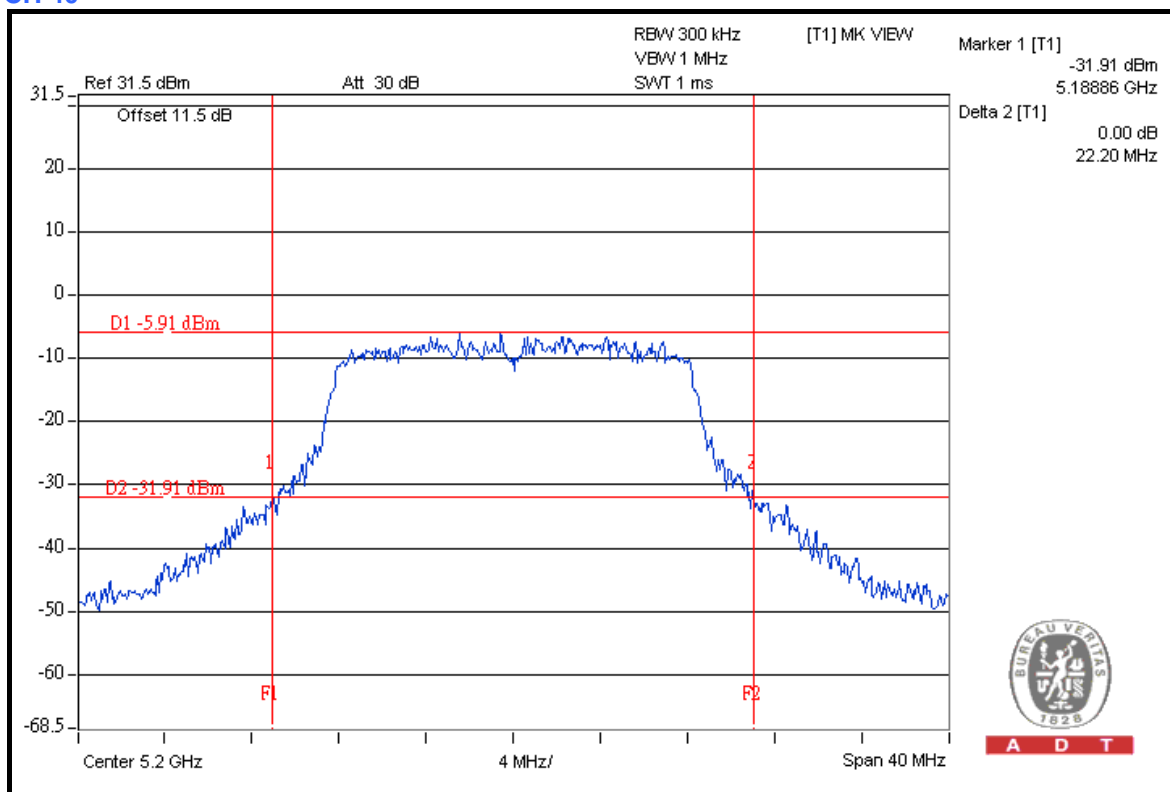

A D T

CH 48

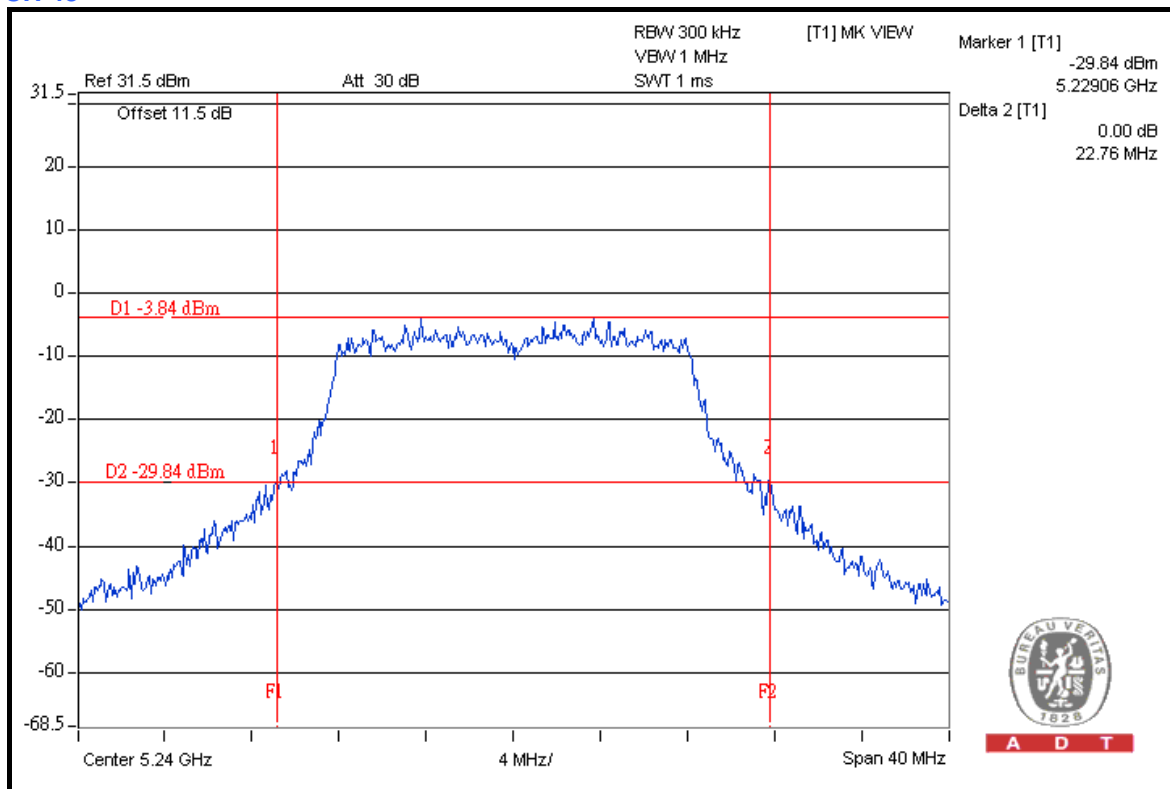

A D T



A D T

DRAFT 802.11n (20MHz) OFDM MODULATION

MODULATION TYPE	BPSK	TRANSFER RATE	6.5Mbps
INPUT POWER	120Vac, 60Hz	ENVIRONMENTAL CONDITIONS	25 deg.C, 65 %RH, 1021hPa
TESTED BY	Brad Wu	TEST MODE	A

CHANNEL	CHANNEL FREQUENCY (MHz)	26dBc OCCUPIED BANDWIDTH (MHz)			PASS / FAIL
		CHAIN 0	CHAIN 1	CHAIN 2	
36	5180	23.75	24.12	25.17	PASS
40	5200	25.27	25.49	25.40	PASS
48	5240	24.88	24.09	25.04	PASS

CHAIN 0 CH 36

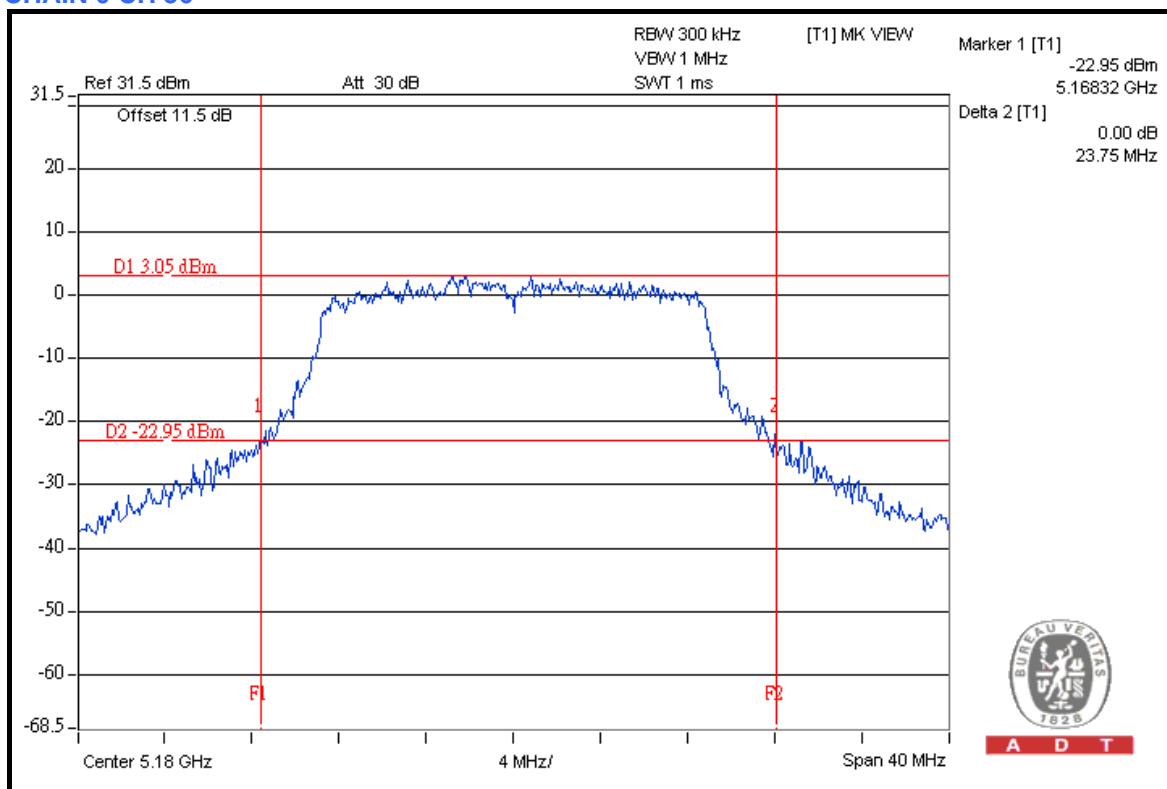



A D T

CH 40

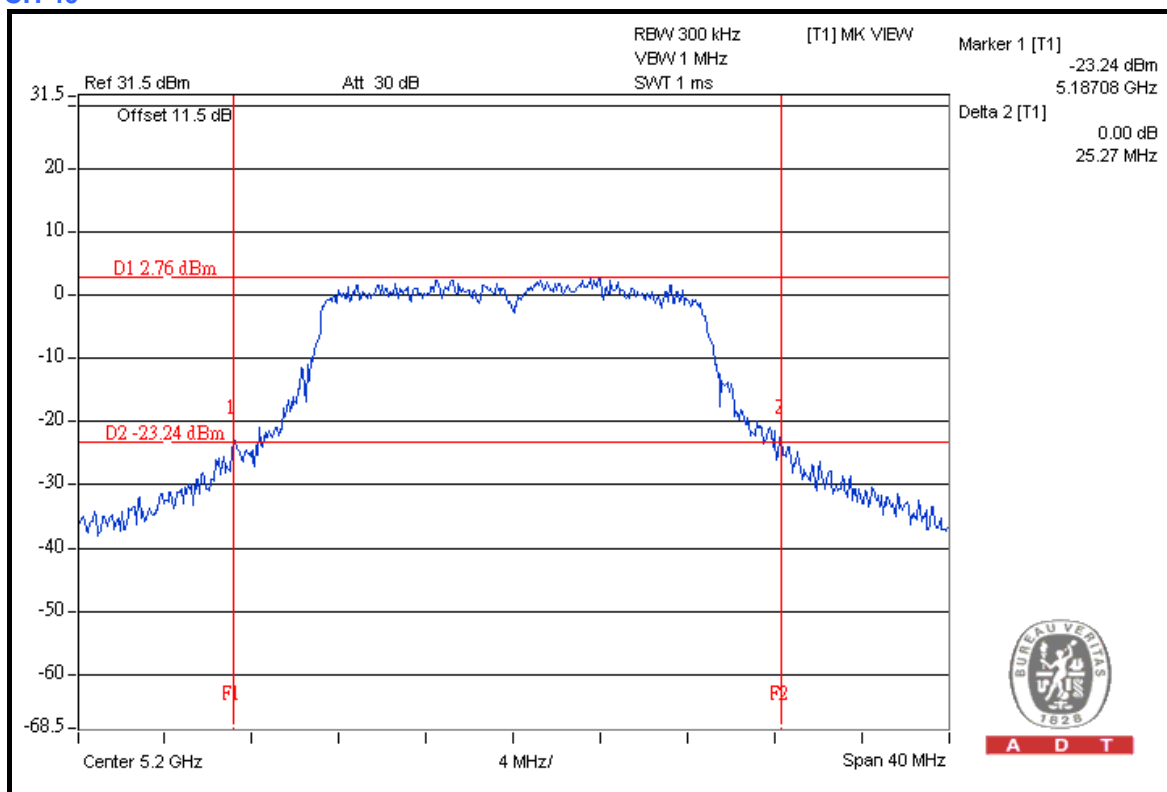

A D T

CH 48

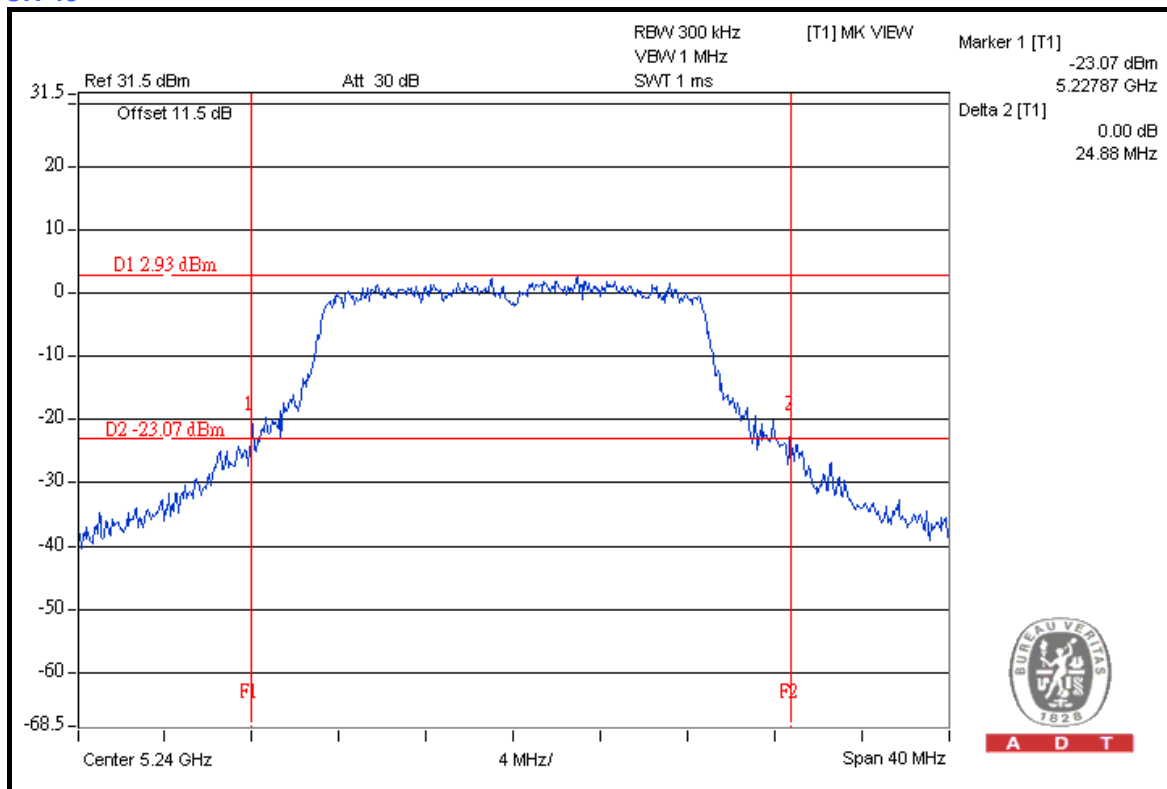

A D T



A D T

CHAIN 1 CH 36

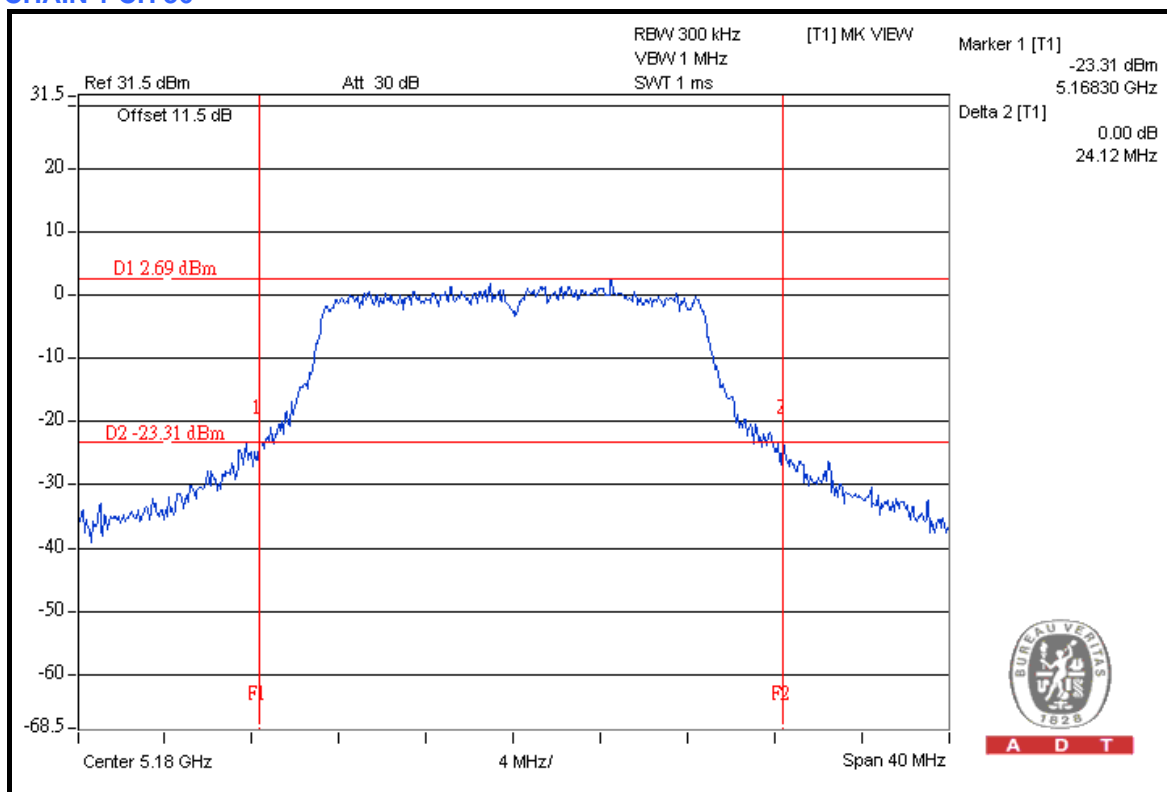

CH 40

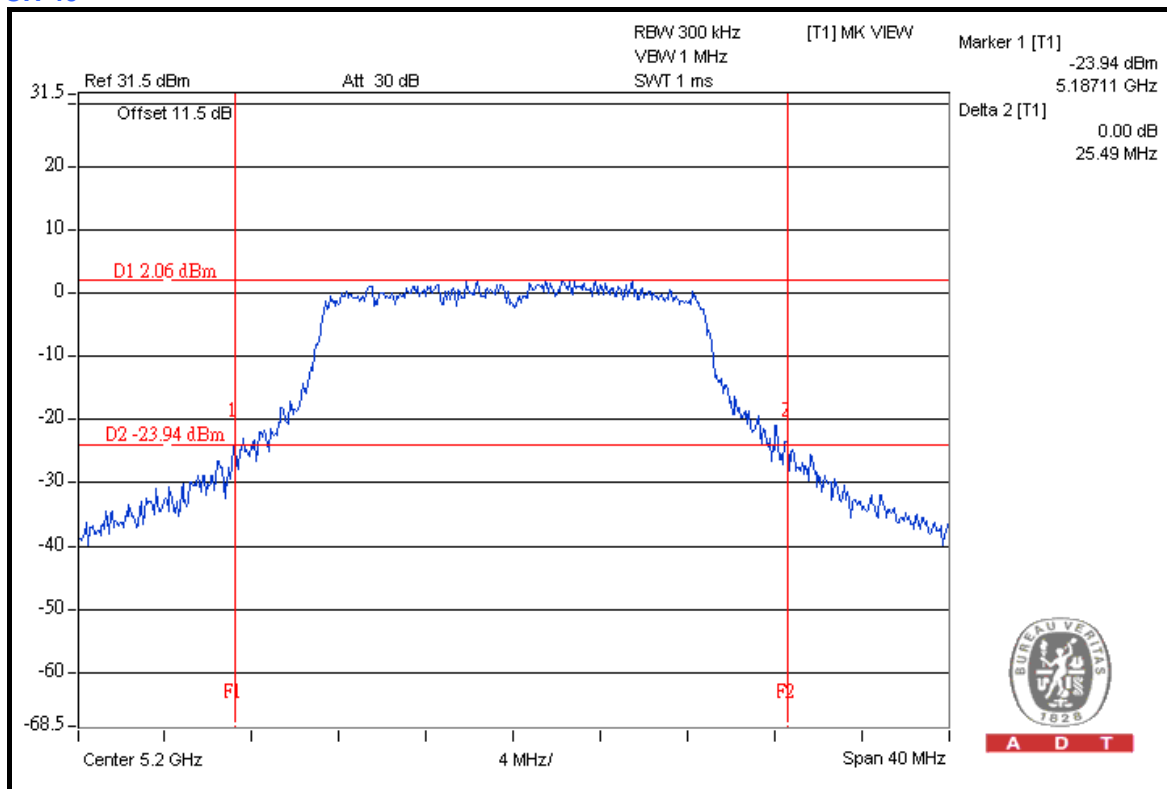



A D T

CH 48

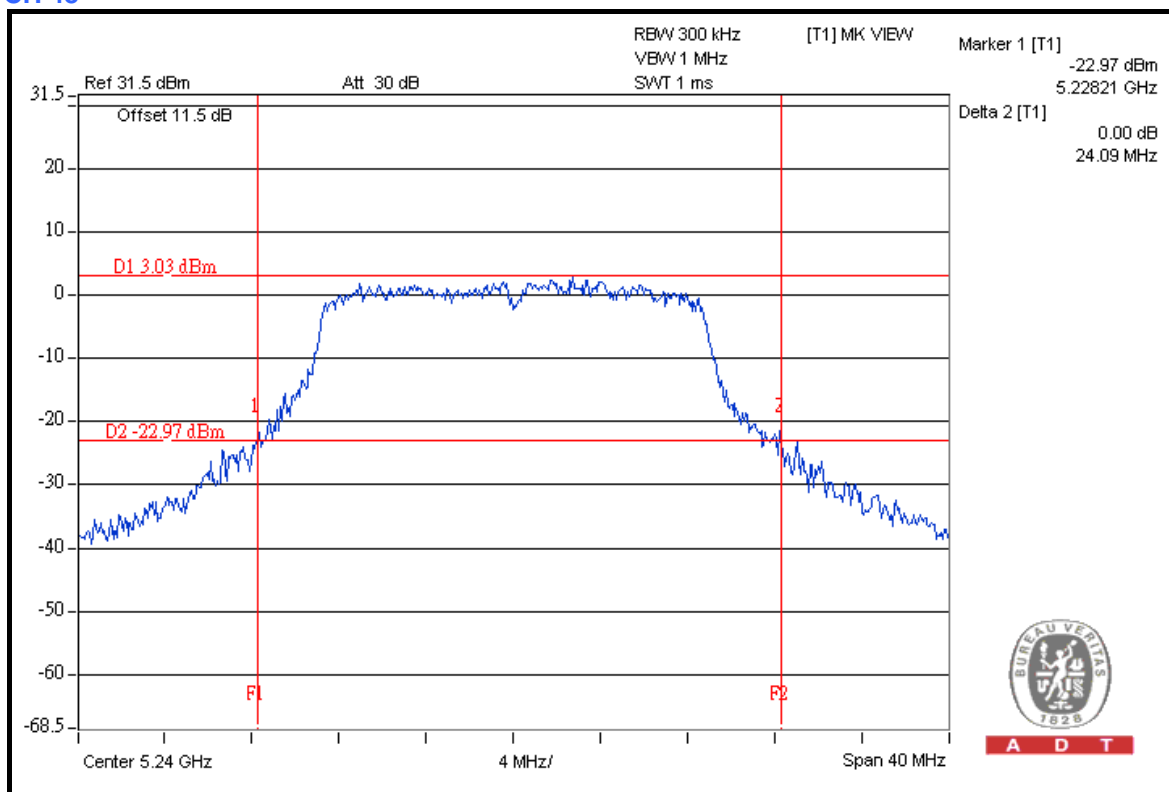

A D T

CHAIN 2 CH 36

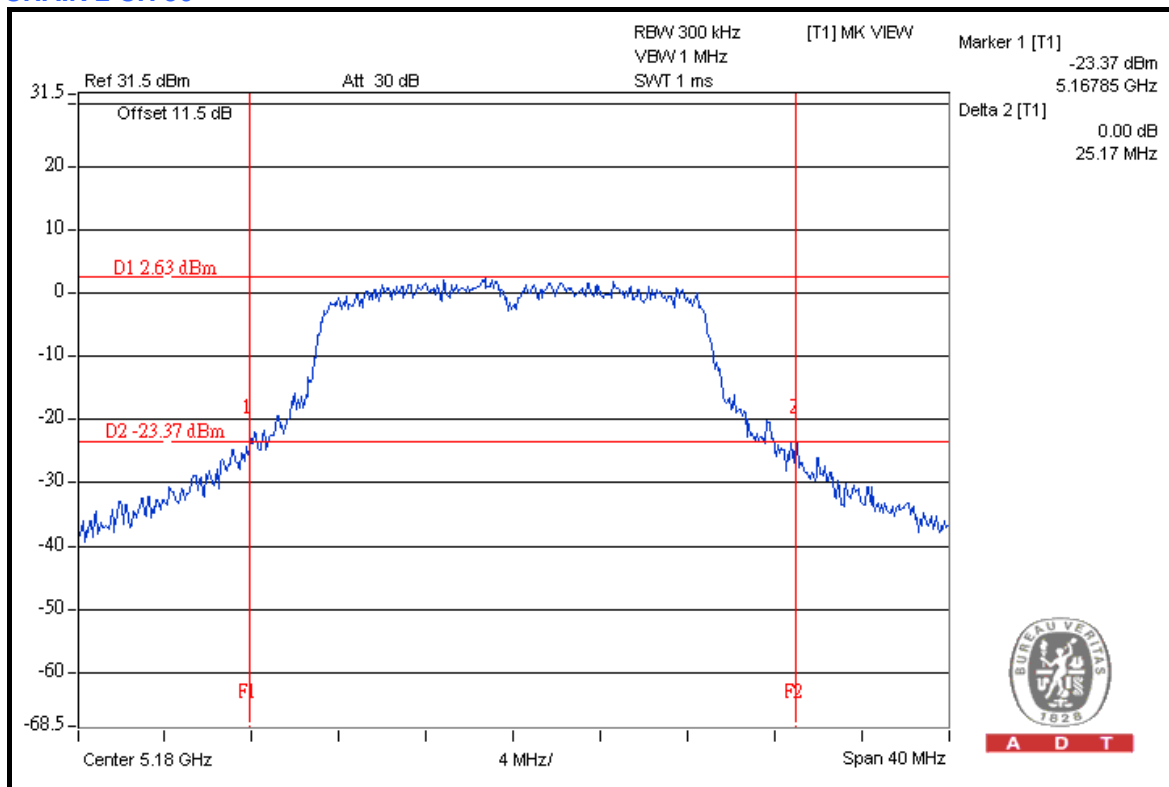

A D T



A D T

CH 40

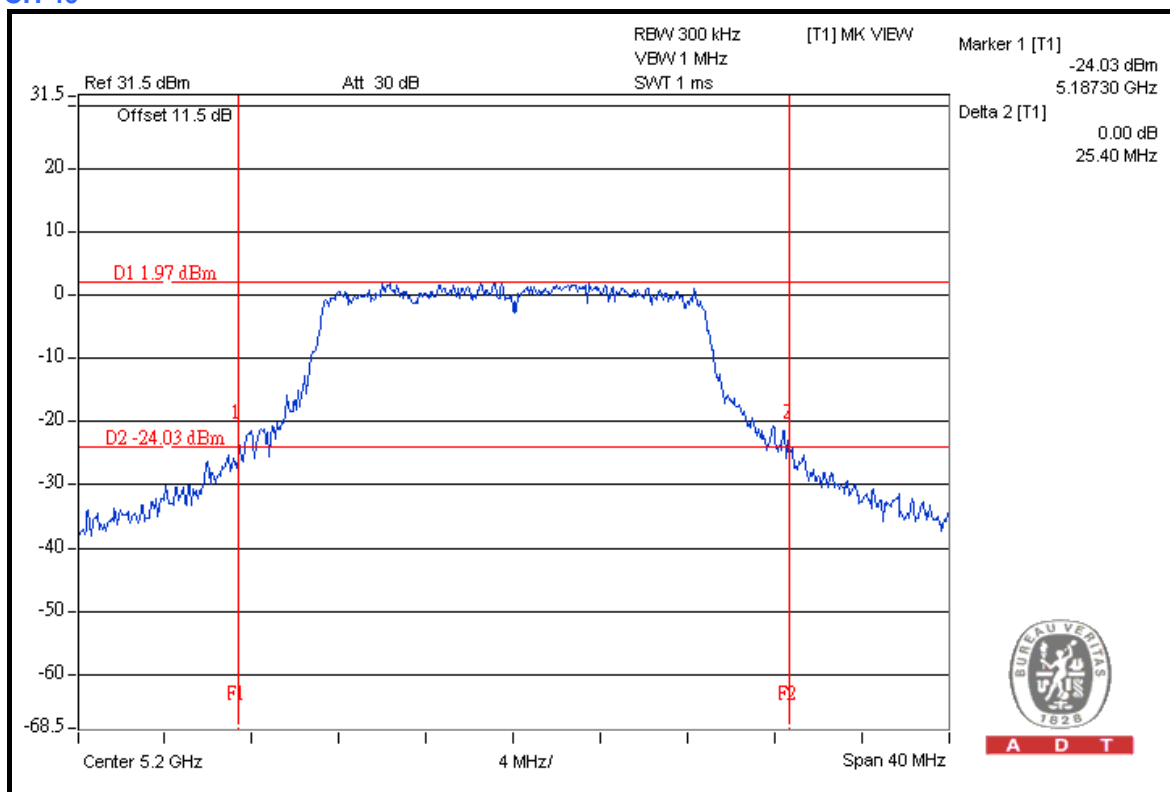

CH 48

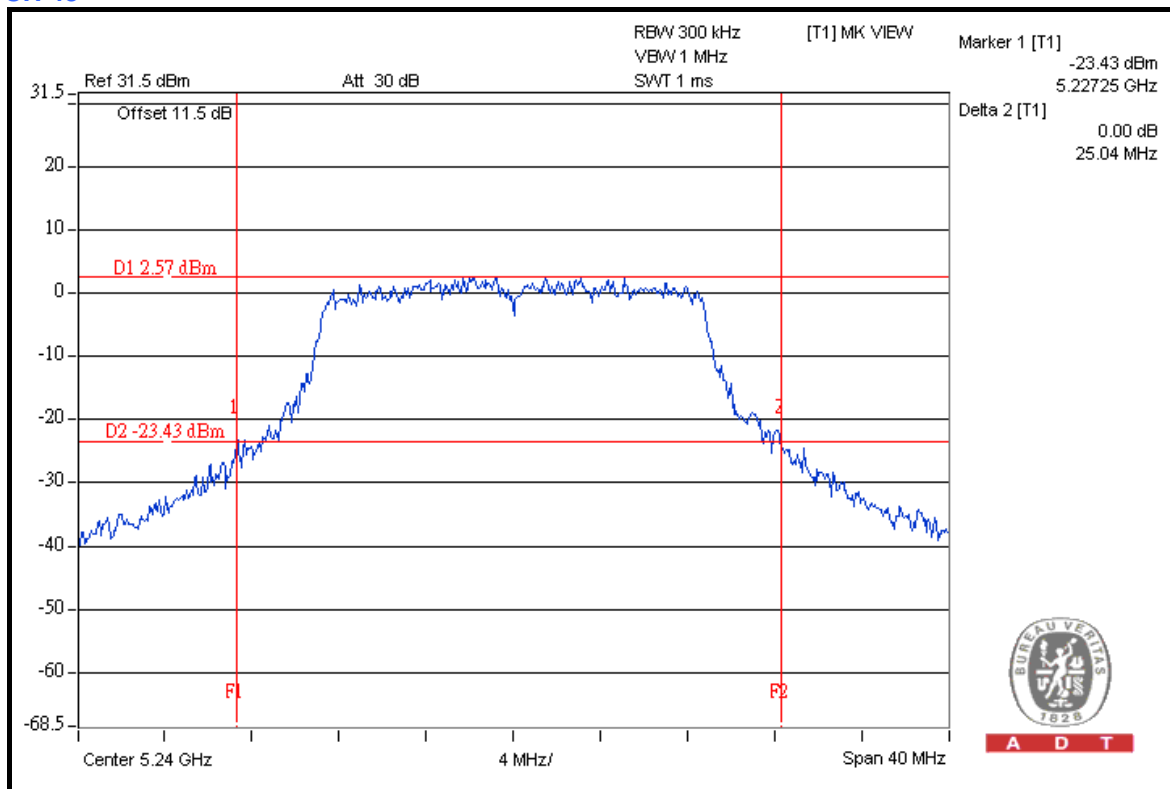



A D T

DRAFT 802.11n (20MHz) OFDM MODULATION

MODULATION TYPE	BPSK	TRANSFER RATE	6.5Mbps
INPUT POWER	120Vac, 60Hz	ENVIRONMENTAL CONDITIONS	25 deg.C, 65 %RH, 1021hPa
TESTED BY	Brad Wu	TEST MODE	C

CHANNEL	CHANNEL FREQUENCY (MHz)	26dBc OCCUPIED BANDWIDTH (MHz)		PASS / FAIL
		CHAIN 0	CHAIN 1	
36	5180	24.04	23.78	PASS
40	5200	23.78	23.84	PASS
48	5240	23.82	23.17	PASS



A D T

CHAIN 0 CH 36

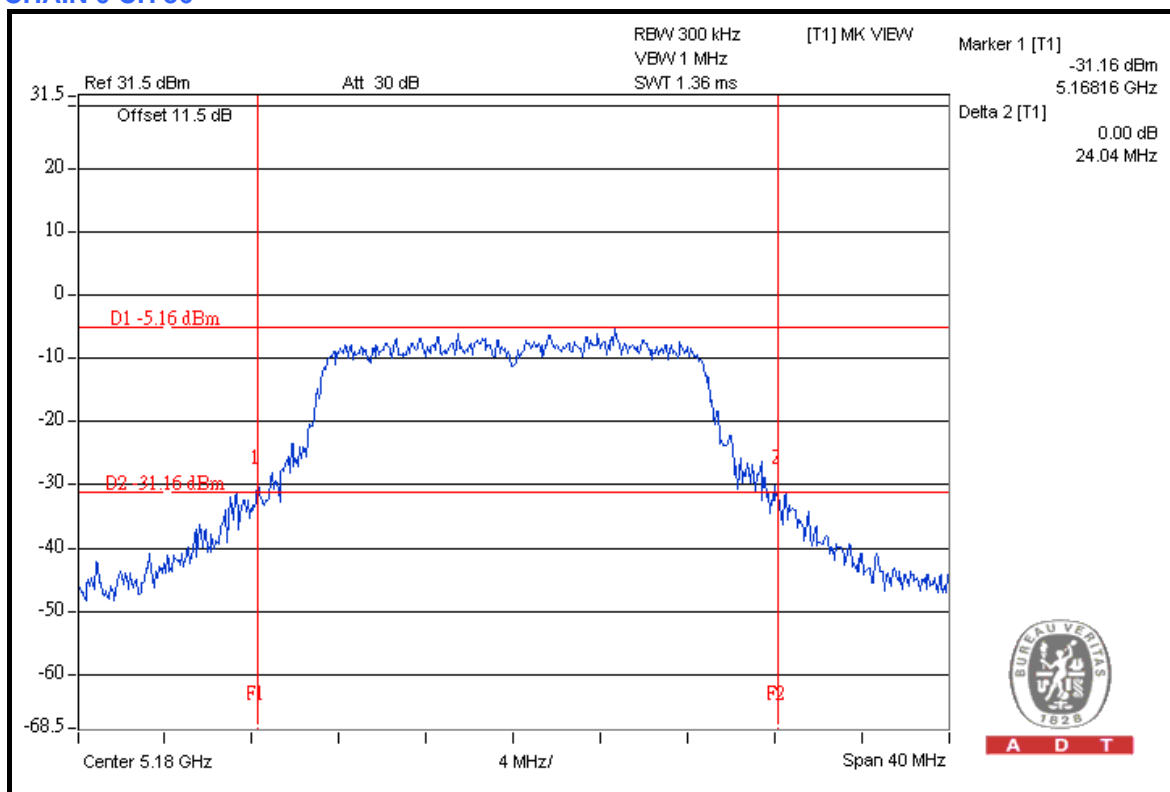

CH 40

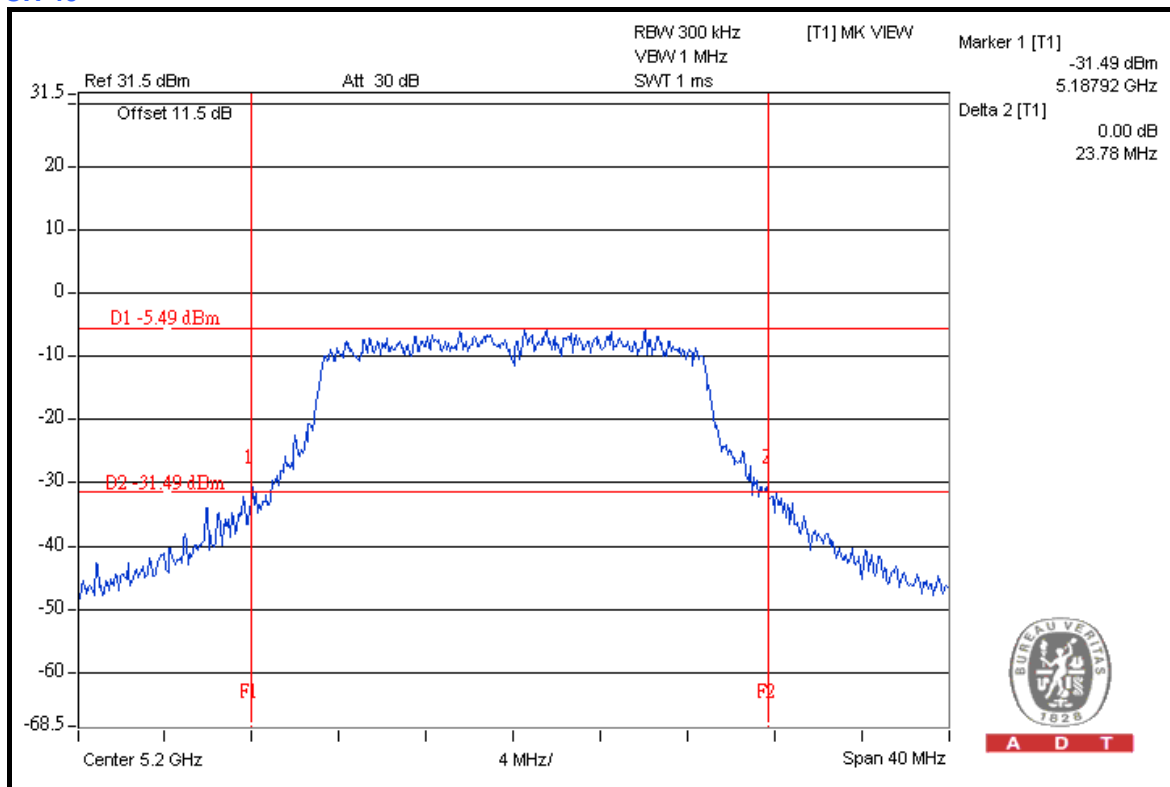



A D T

CH 48

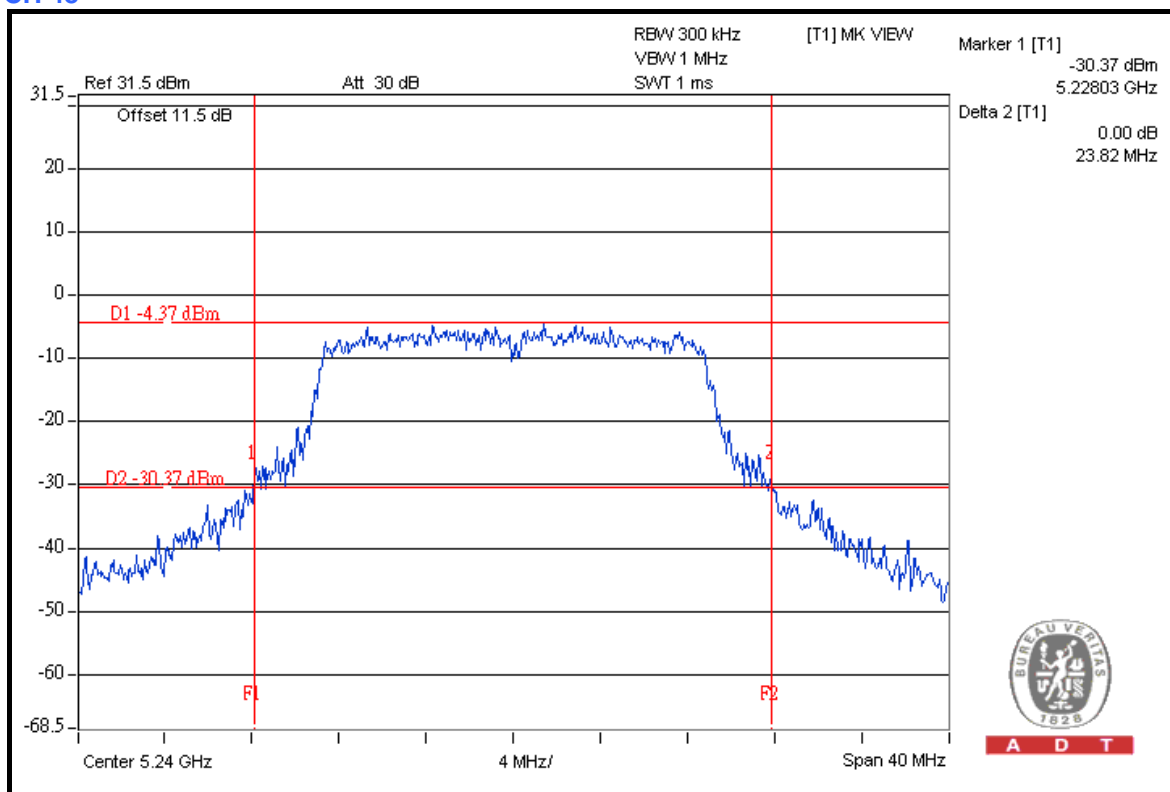

CHAIN 1 CH 36

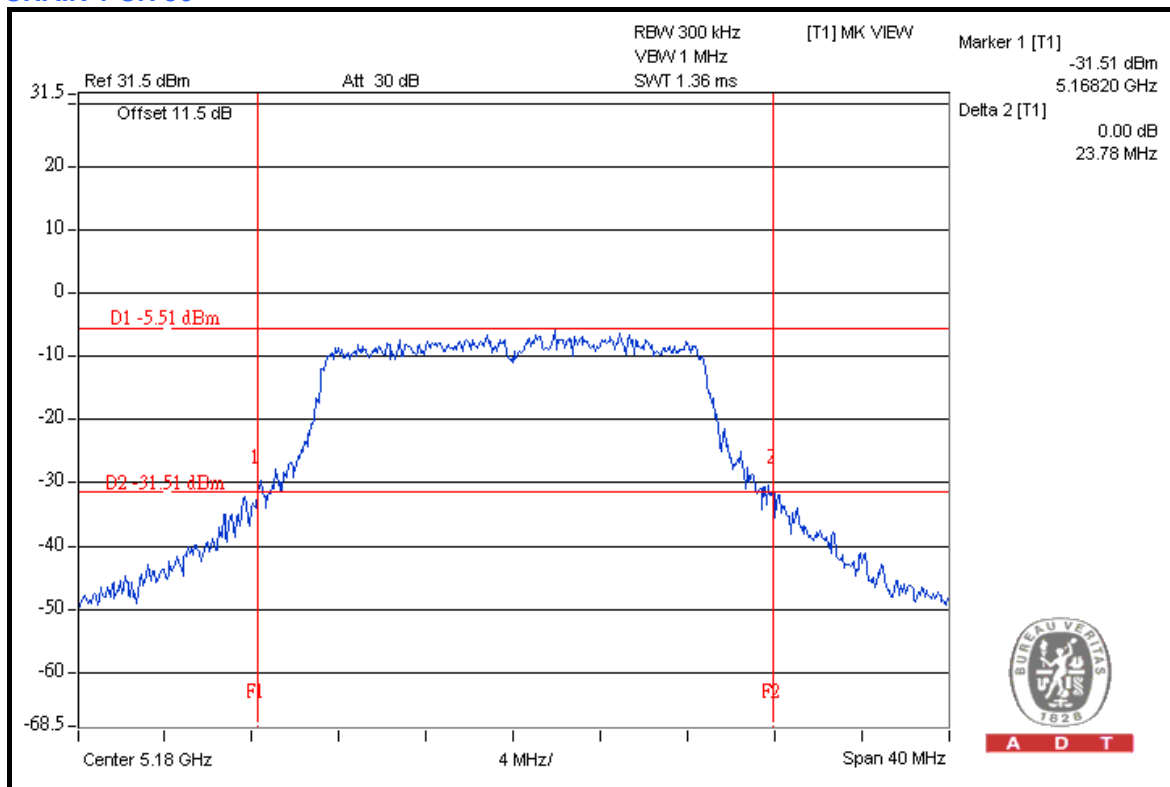



A D T

CH 40

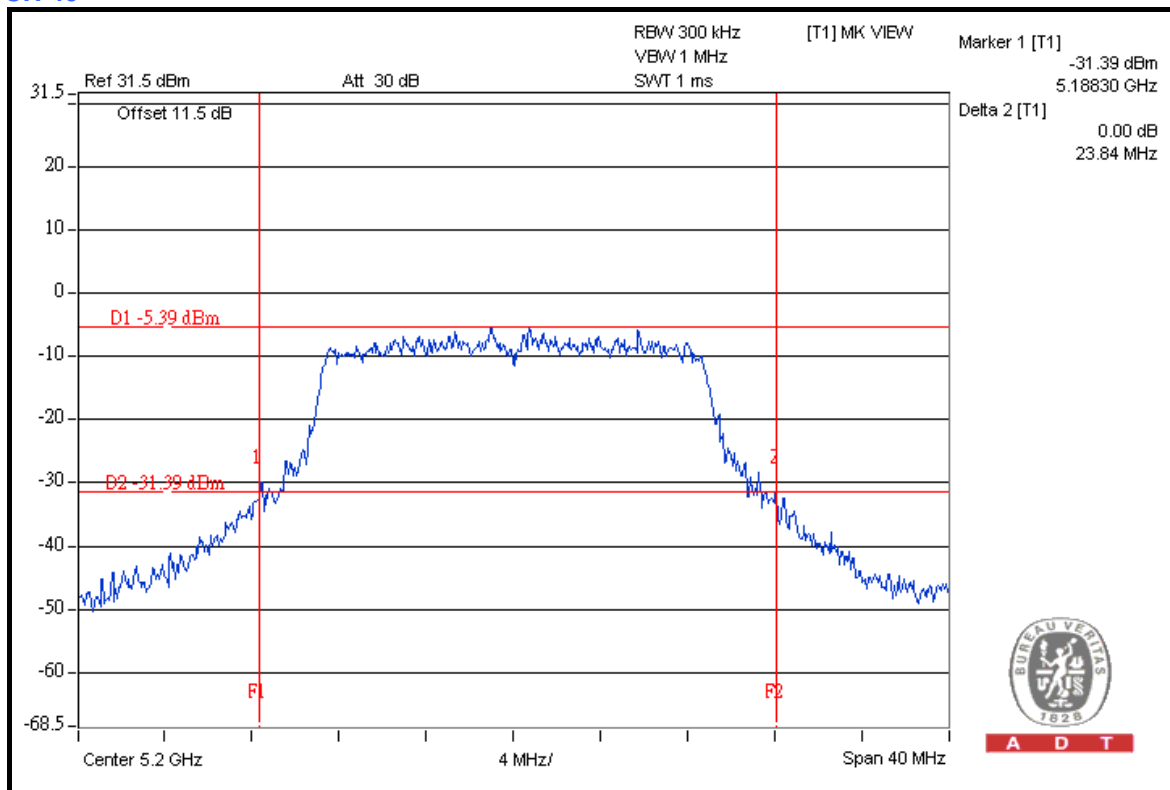

CH 48

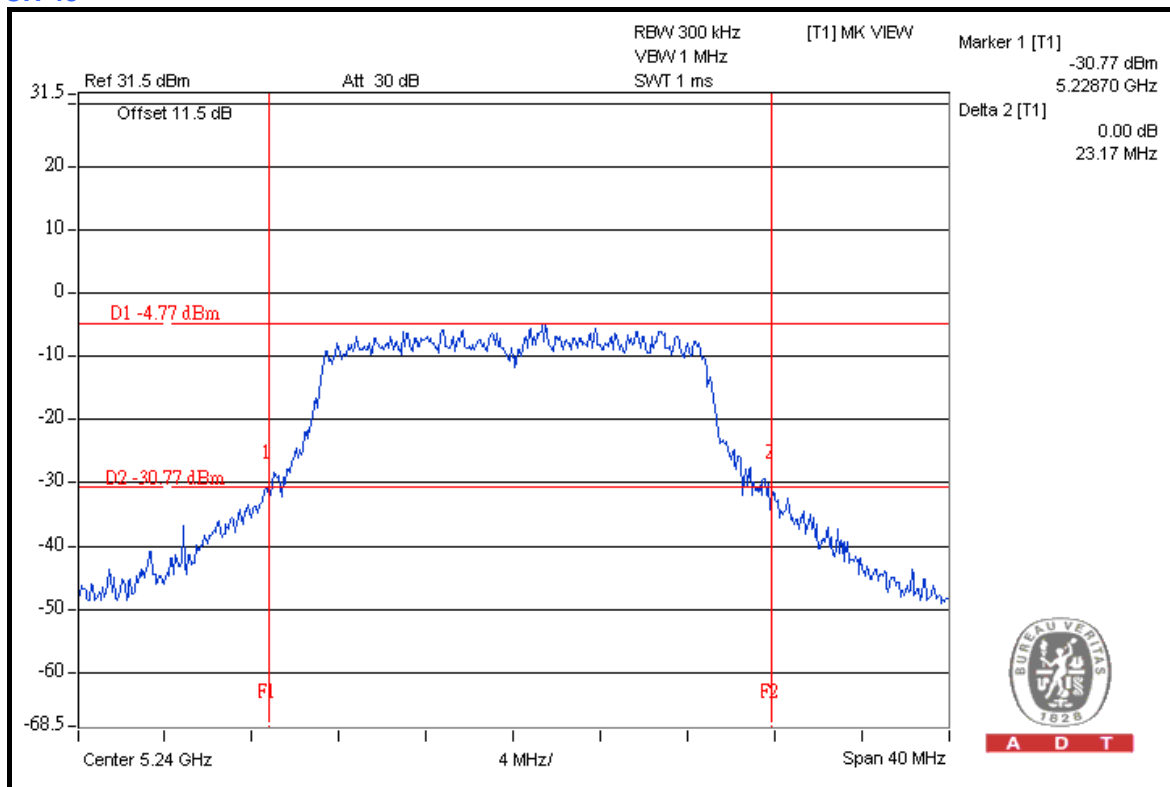



A D T

DRAFT 802.11n (40MHz) OFDM MODULATION

MODULATION TYPE	BPSK	TRANSFER RATE	13.5Mbps
INPUT POWER	120Vac, 60Hz	ENVIRONMENTAL CONDITIONS	25 deg.C, 65 %RH, 1021hPa
TESTED BY	Brad Wu	TEST MODE	A

CHANNEL	CHANNEL FREQUENCY (MHz)	26dBc OCCUPIED BANDWIDTH (MHz)			PASS / FAIL
		CHAIN 0	CHAIN 1	CHAIN 2	
38	5190	46.35	45.64	45.48	PASS
46	5230	44.29	44.77	46.00	PASS



A D T

CHAIN 0 CH 38

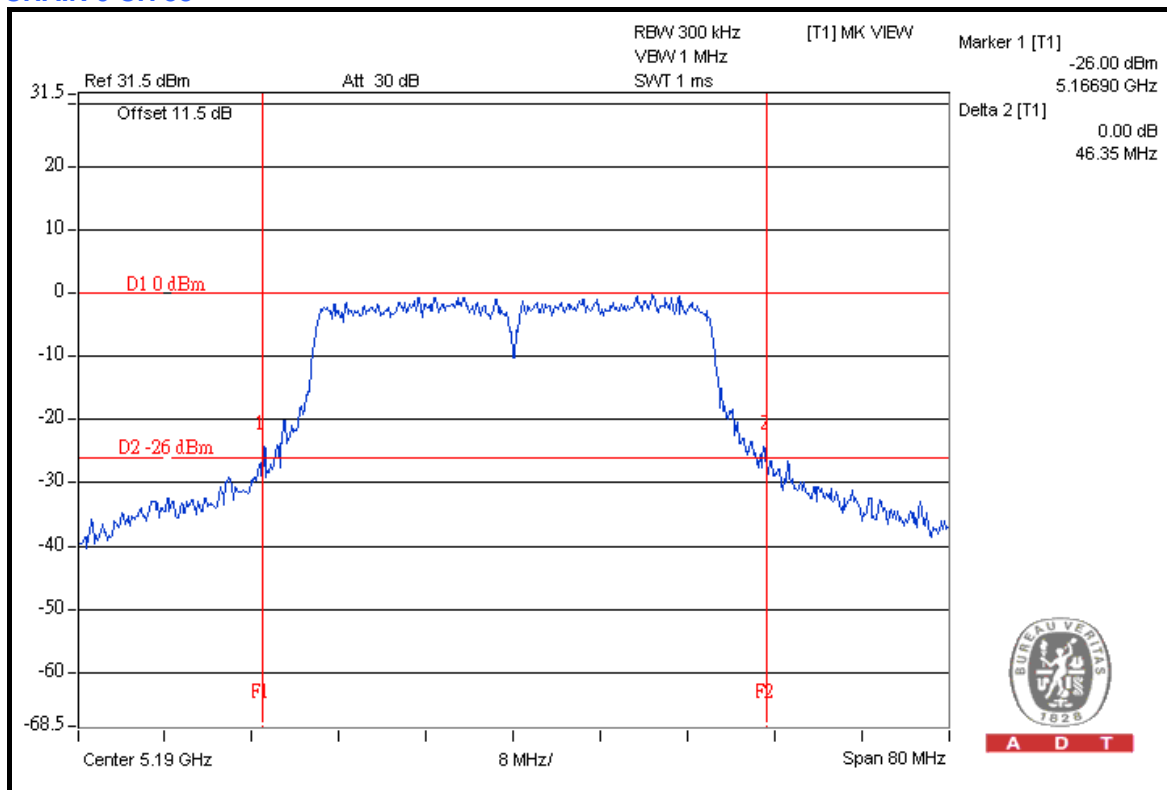

A D T

CH 46

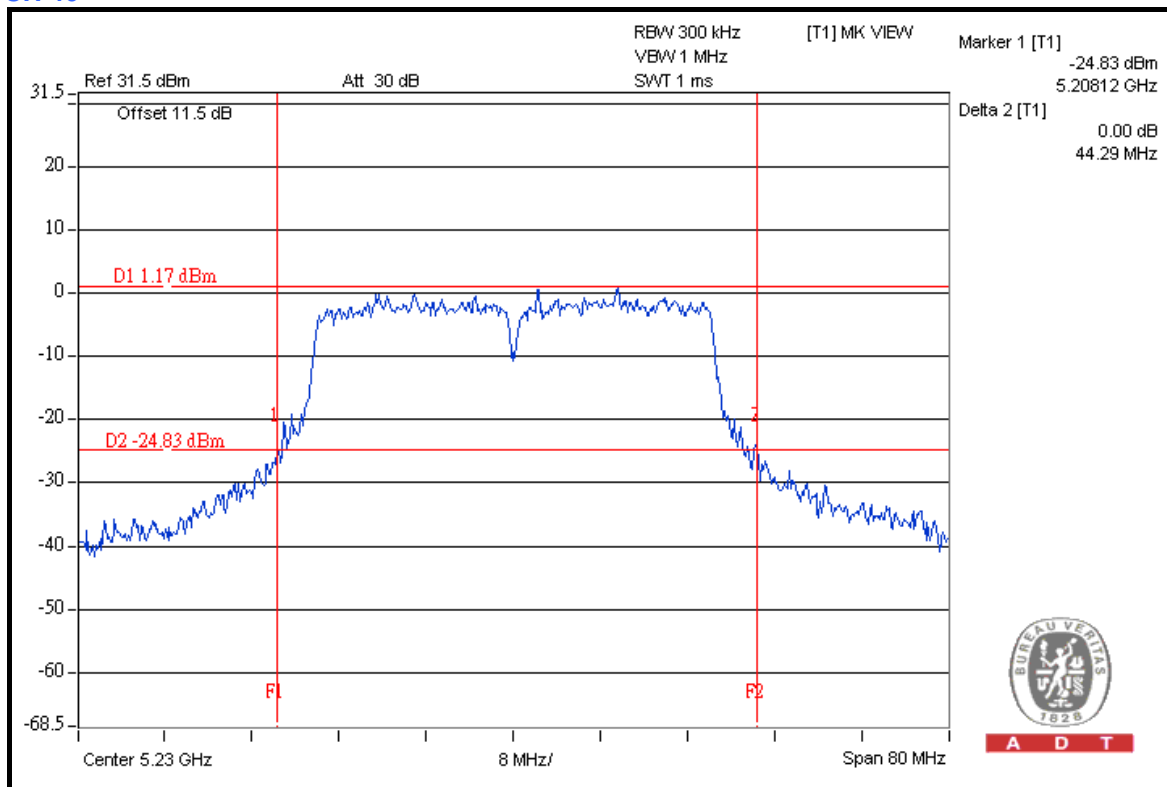

A D T



A D T

CHAIN 1 CH 38

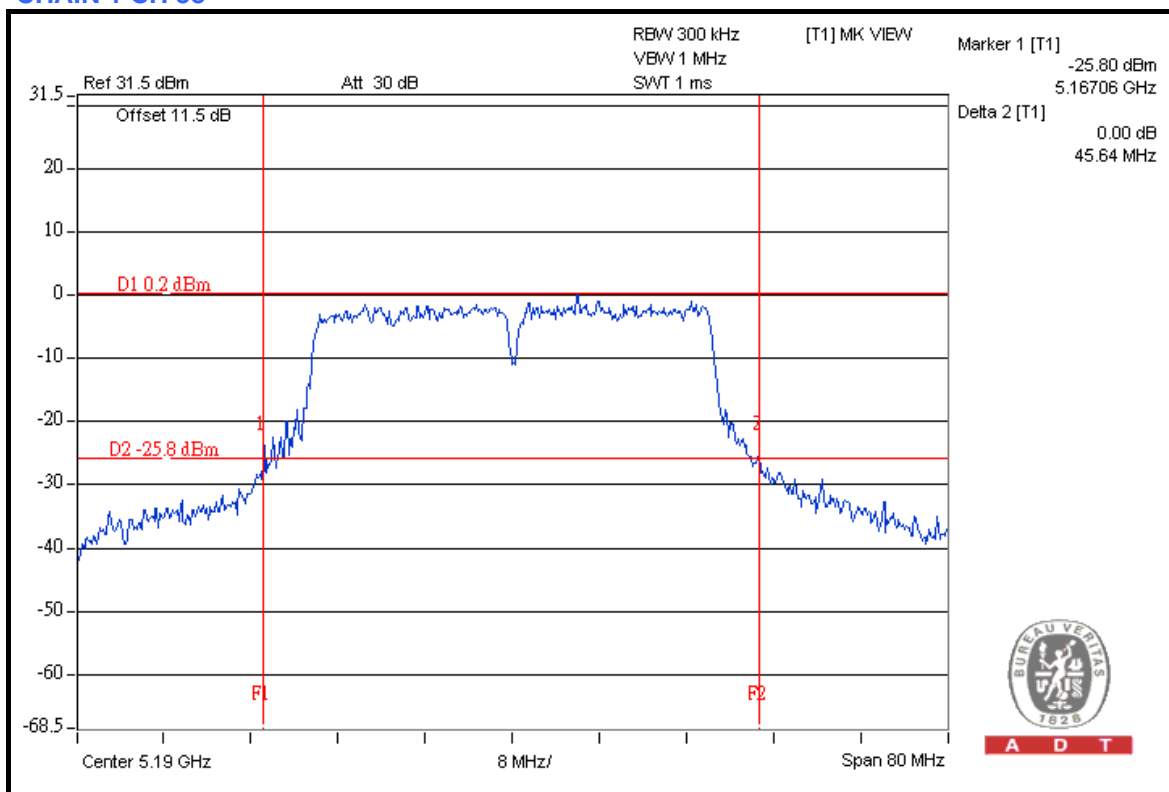

A D T

CH 46

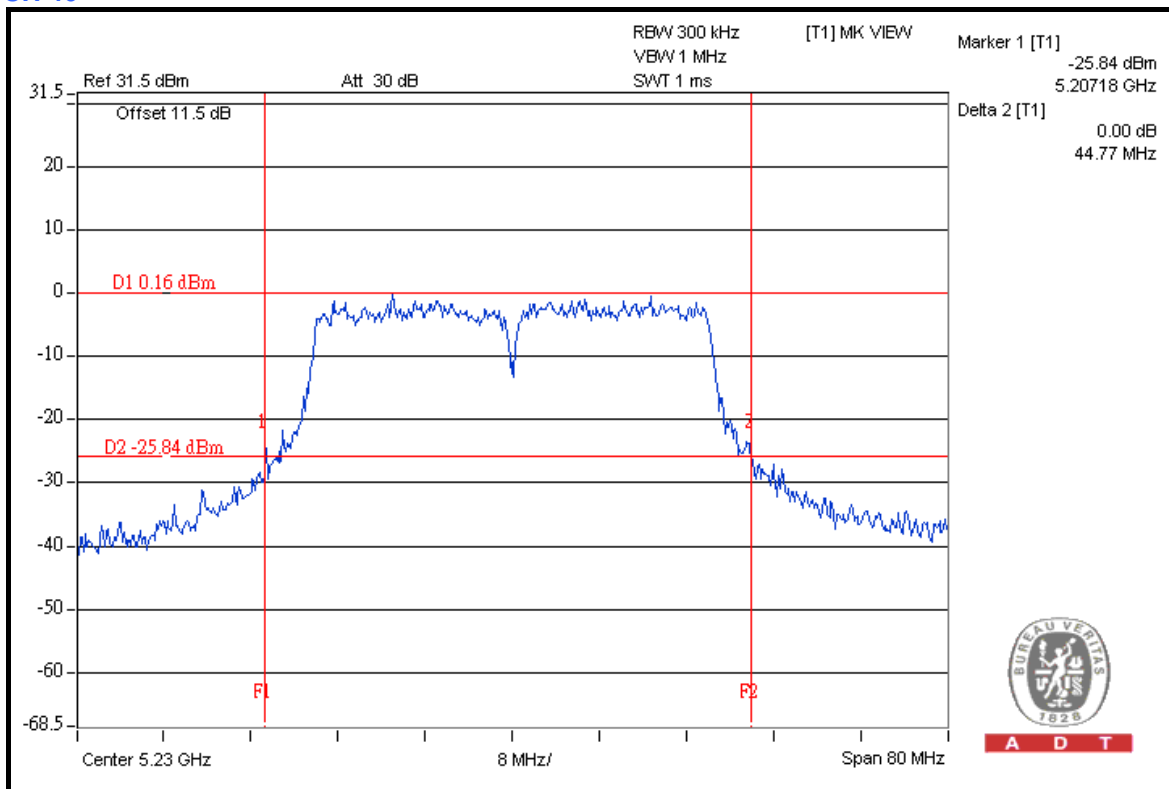

A D T



A D T

CHAIN 2 CH 38

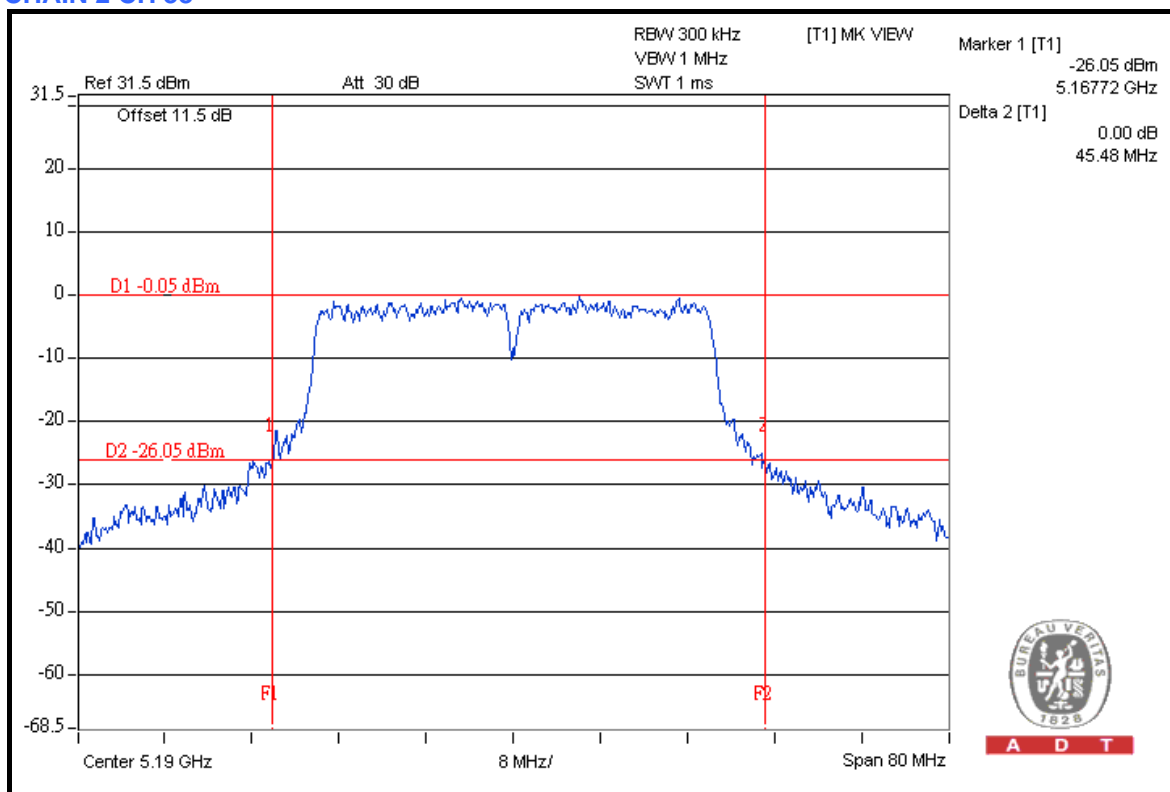

CH 46

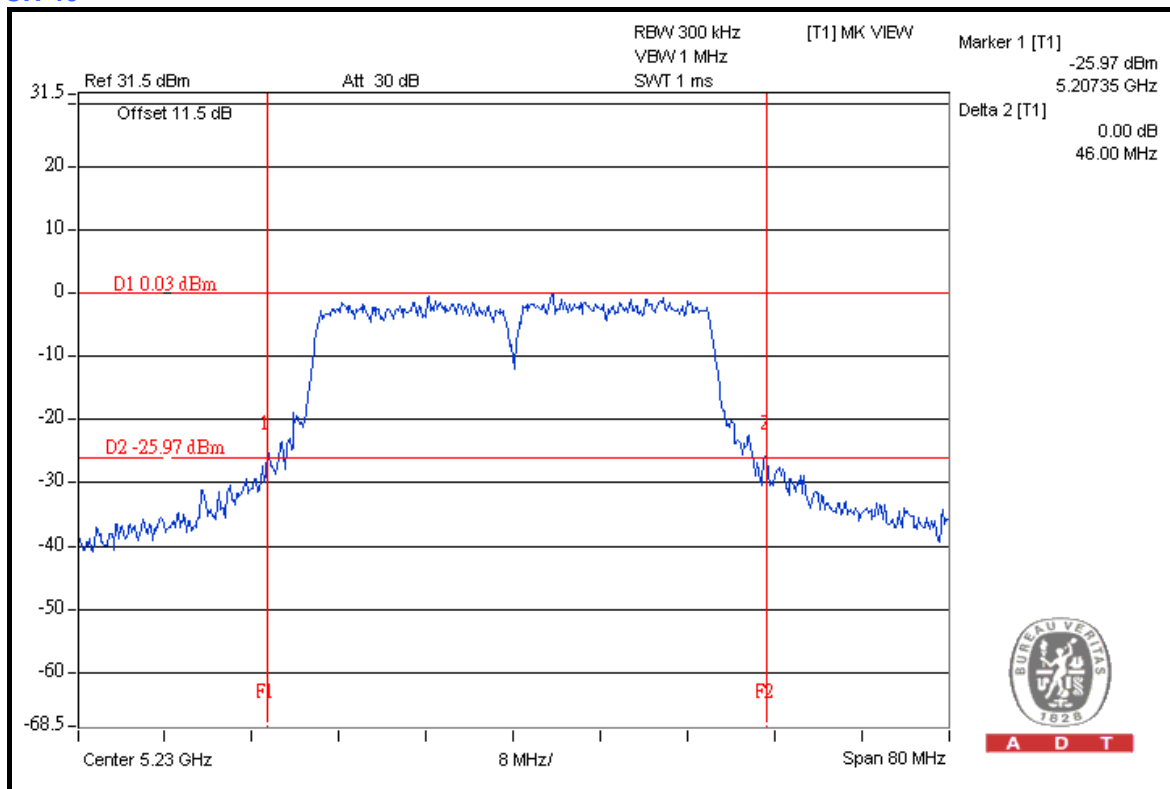



A D T

DRAFT 802.11n (40MHz) OFDM MODULATION

MODULATION TYPE	BPSK	TRANSFER RATE	13.5Mbps
INPUT POWER	120Vac, 60Hz	ENVIRONMENTAL CONDITIONS	25 deg.C, 65 %RH, 1021hPa
TESTED BY	Brad Wu	TEST MODE	C

CHANNEL	CHANNEL FREQUENCY (MHz)	26dBc OCCUPIED BANDWIDTH (MHz)		PASS / FAIL
		CHAIN 0	CHAIN 1	
38	5190	46.41	43.75	PASS
46	5230	45.61	42.96	PASS



A D T

CHAIN 0 CH 38

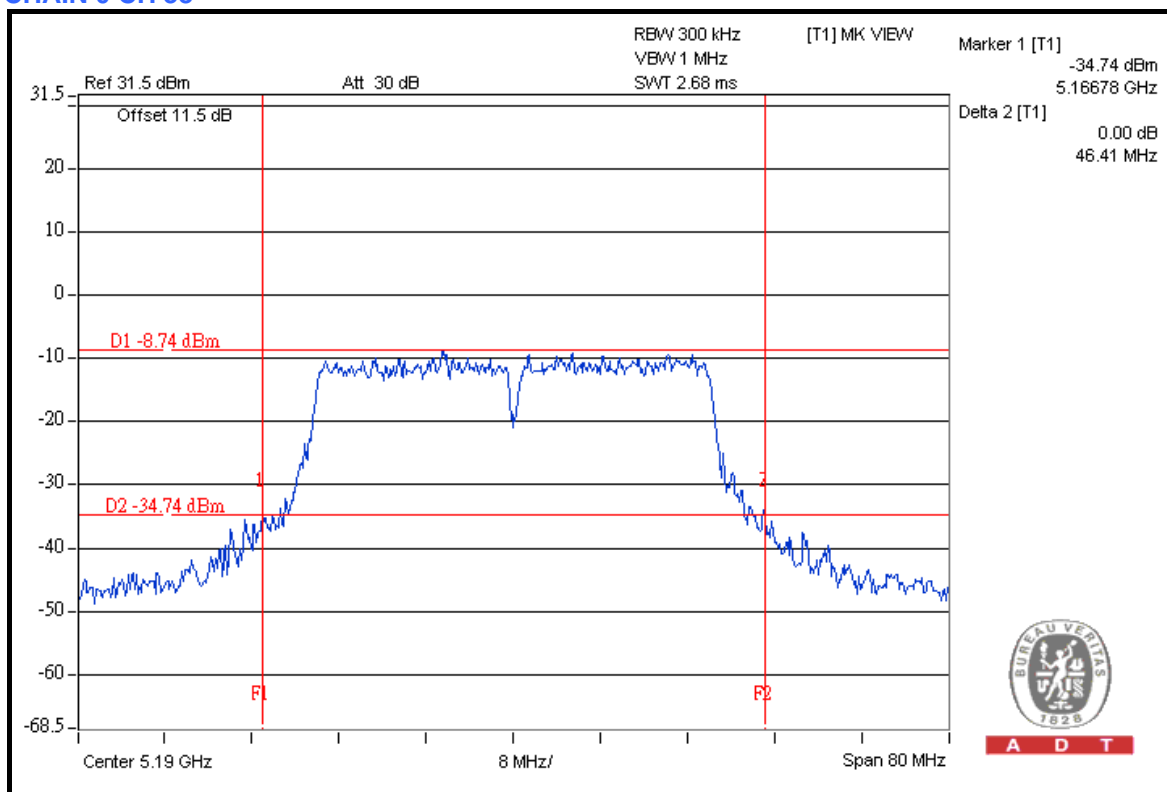

CH 46

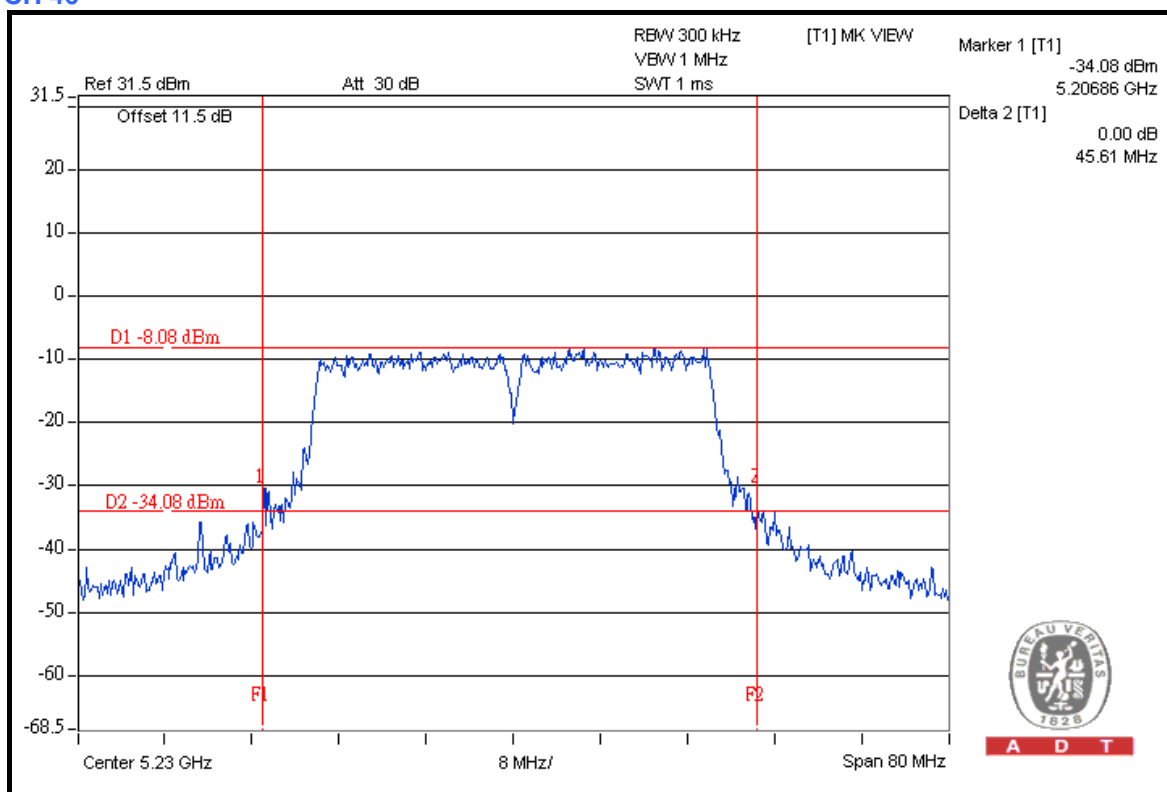



A D T

CHAIN 1 CH 38

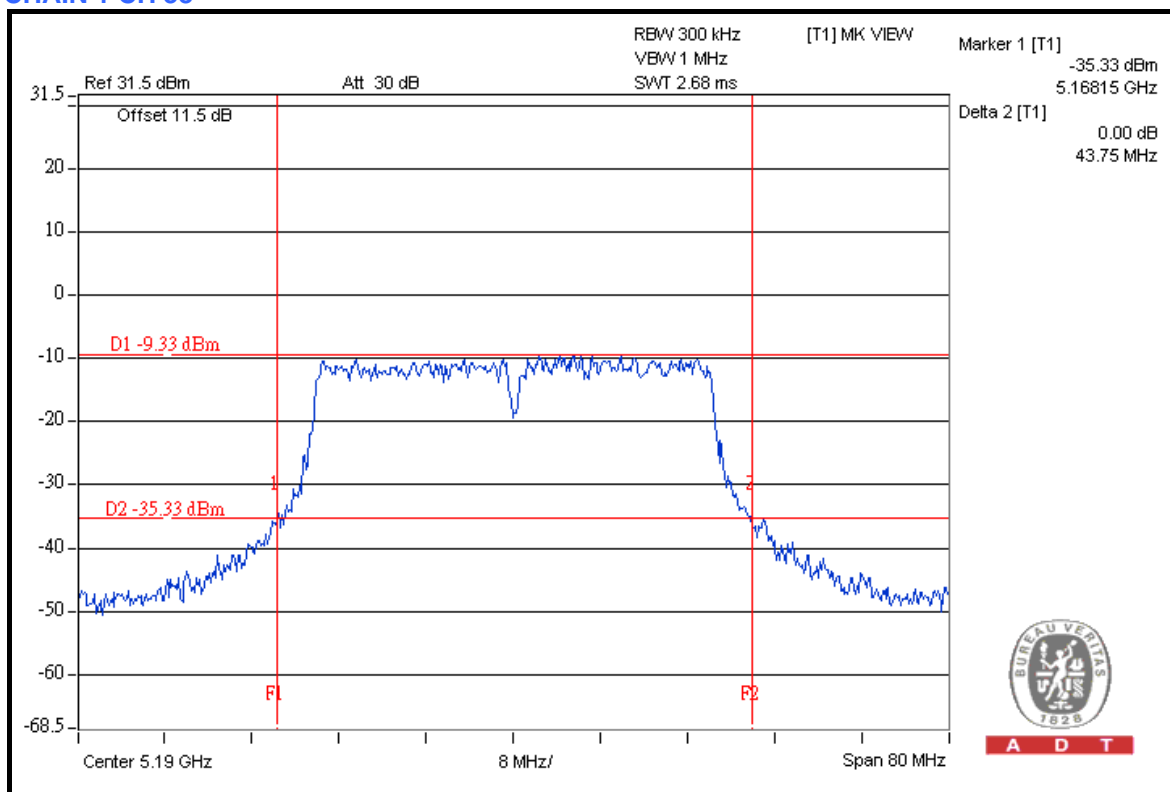

CH 46

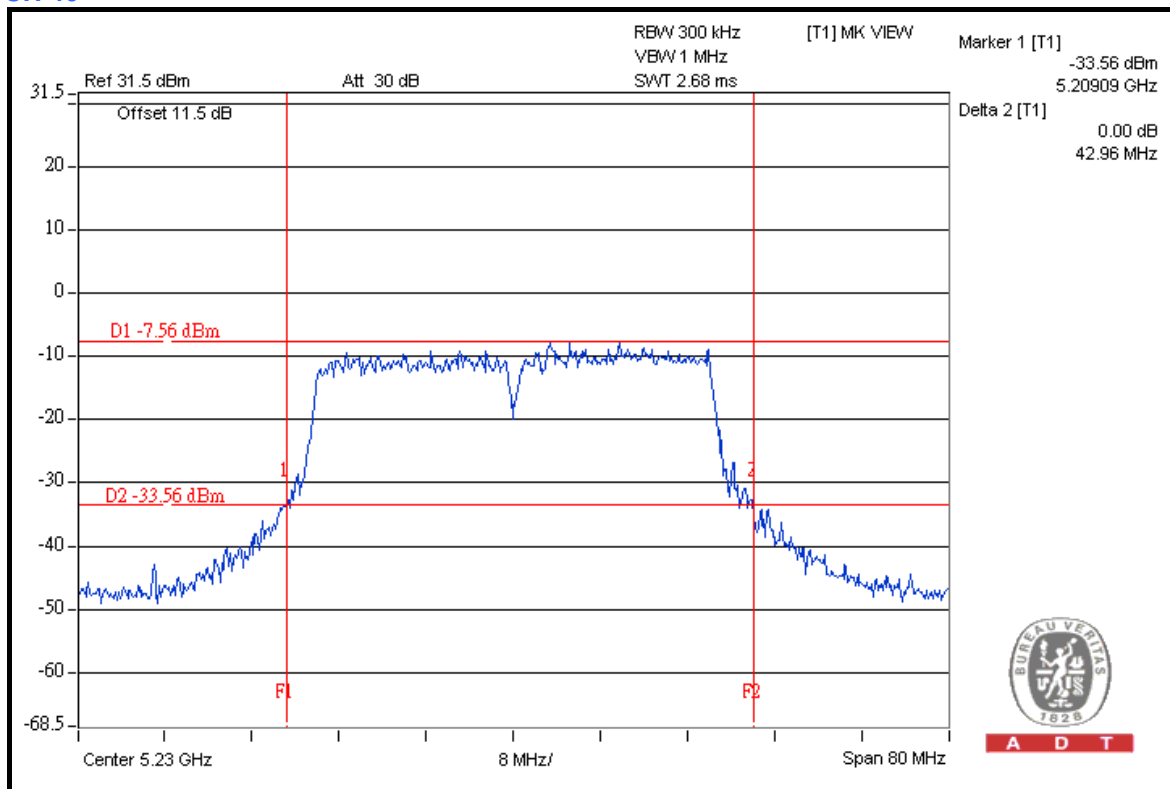



4.4 PEAK POWER EXCURSION MEASUREMENT

4.4.1 LIMITS OF PEAK POWER EXCURSION MEASUREMENT

FREQUENCY BAND	LIMIT
5.150 ~ 5.250GHz	13dB

4.4.2 TEST INSTRUMENTS

DESCRIPTION & MANUFACTURER	MODEL NO.	SERIAL NO.	DATE OF CALIBRATION	DUE DATE OF CALIBRATION
R&S SPECTRUM ANALYZER	FSP40	100041	May 13, 2009	May 12, 2010

NOTE: The calibration interval of the above test instruments is 12 months and the calibrations are traceable to NML/ROC and NIST/USA.

4.4.3 TEST PROCEDURE

- a. The transmitter output was connected to the spectrum analyzer.
- b. Set the spectrum bandwidth span to view the entire spectrum.
- c. Using peak detector and Max-hold function for Trace 1 (RB = 1MHz, VB = 3MHz) and 2 (RB = 1MHz, VB = 300 kHz).
- d. The differences between Trace1 and Trace 2 in any 1MHz band at f1 to f2 range were recorded and showed to another trace.

4.4.4 DEVIATION FROM TEST STANDARD

No deviation

4.4.5 TEST SETUP

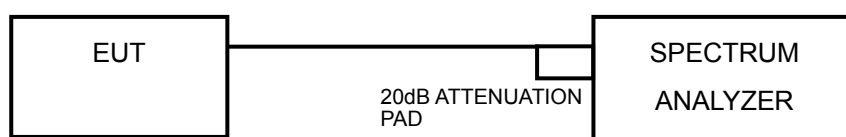

4.4.6 EUT OPERATING CONDITIONS

The software provided by client to enable the EUT under transmission condition continuously at specific channel frequencies individually.



A D T

4.4.7 TEST RESULTS

802.11a OFDM MODULATION

MODULATION TYPE	BPSK	TRANSFER RATE	6.0Mbps
INPUT POWER (SYSTEM)	120Vac, 60Hz	ENVIRONMENTAL CONDITIONS	25deg.C, 65%RH, 991hPa
TESTED BY	Brad Wu	TEST MODE	A

CHANNEL	CHANNEL FREQUENCY (MHz)	PEAK POWER EXCURSION (dB)			PEAK to AVERAGE EXCURSION LIMIT (dB)	PASS/FAIL
		CHAIN 0	CHAIN 1	CHAIN2		
36	5180	9.03	9.38	9.09	13	PASS
40	5200	9.50	8.48	9.61	13	PASS
48	5240	8.56	9.05	9.71	13	PASS



A D T

CHAIN 0 CH 36

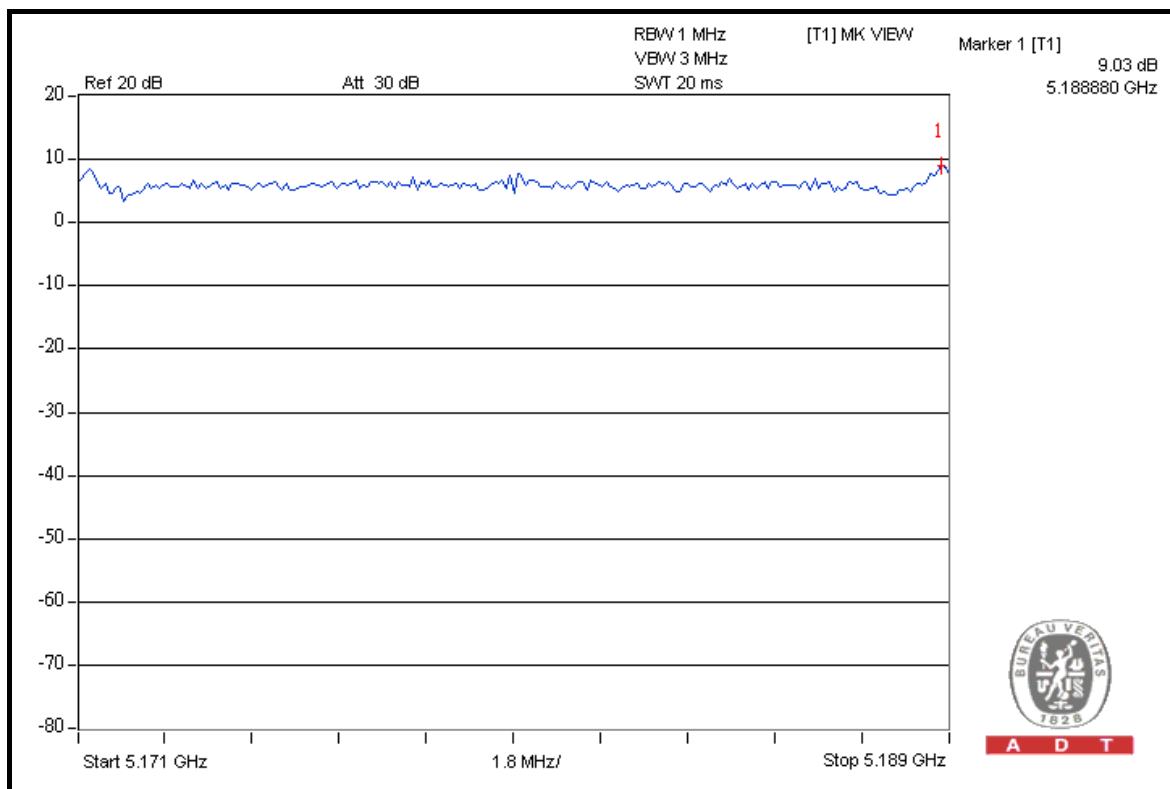
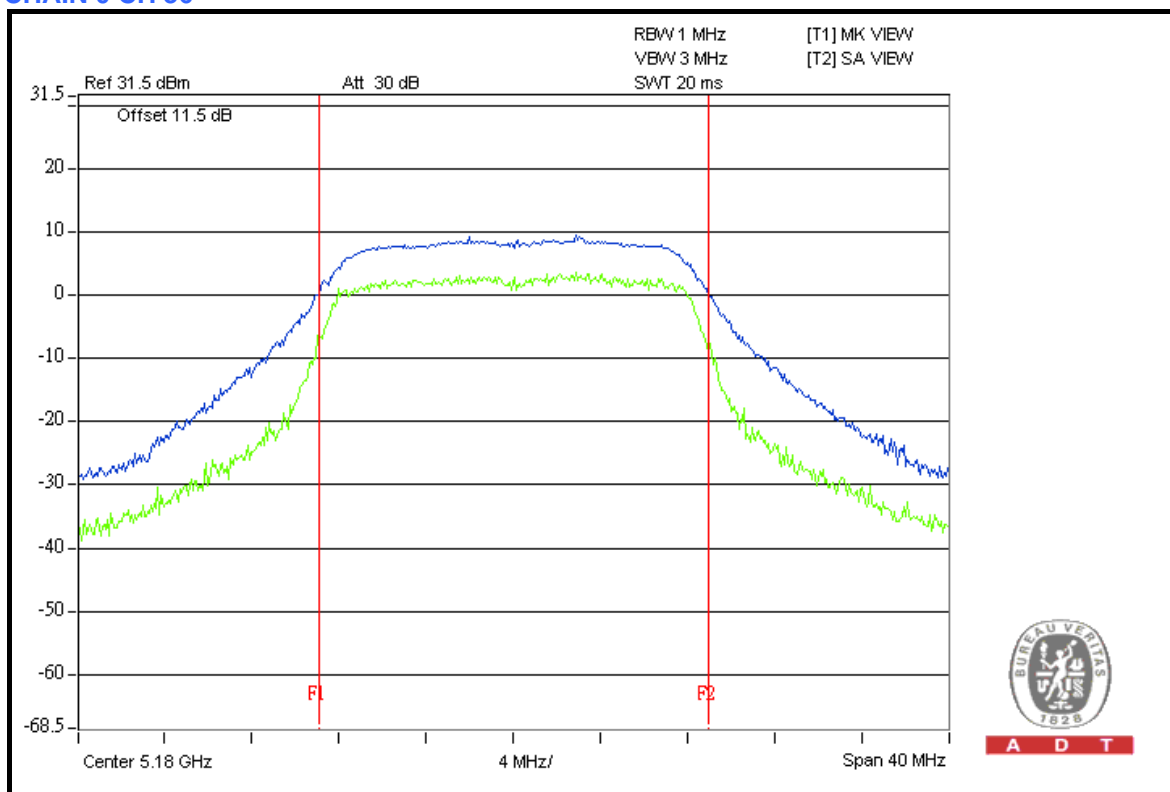



A D T

CH 40

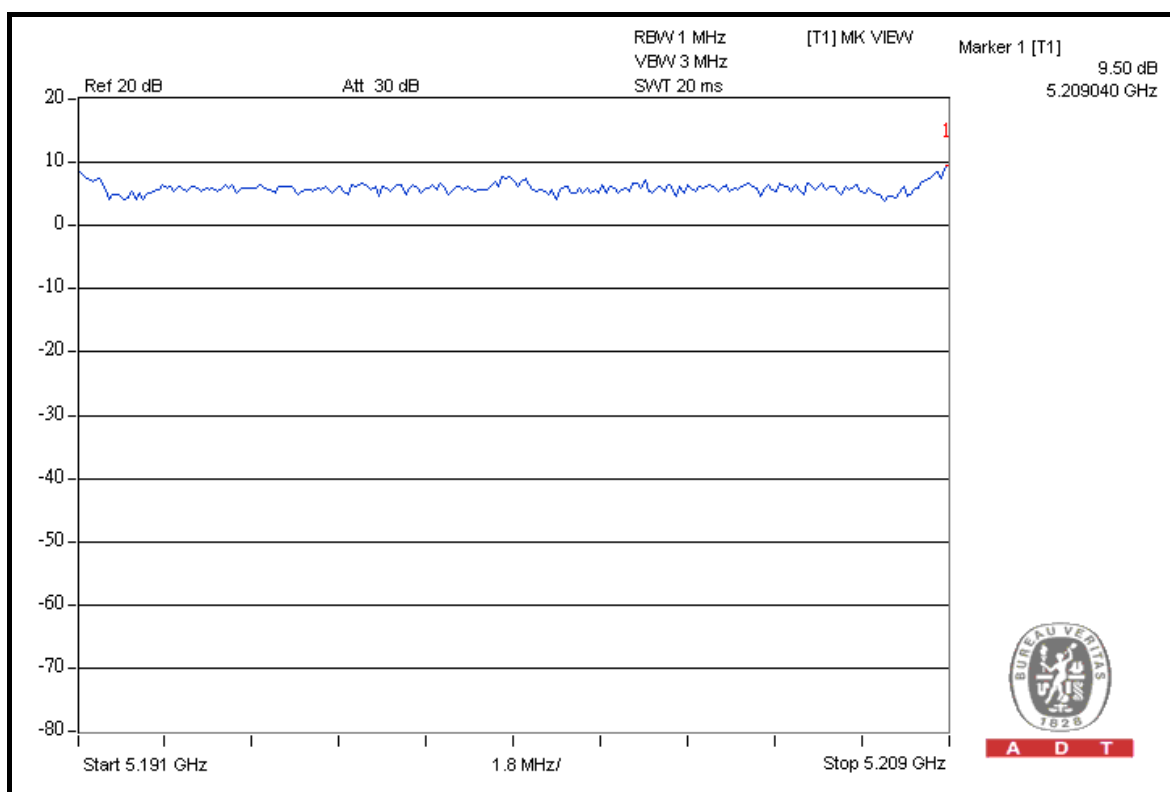
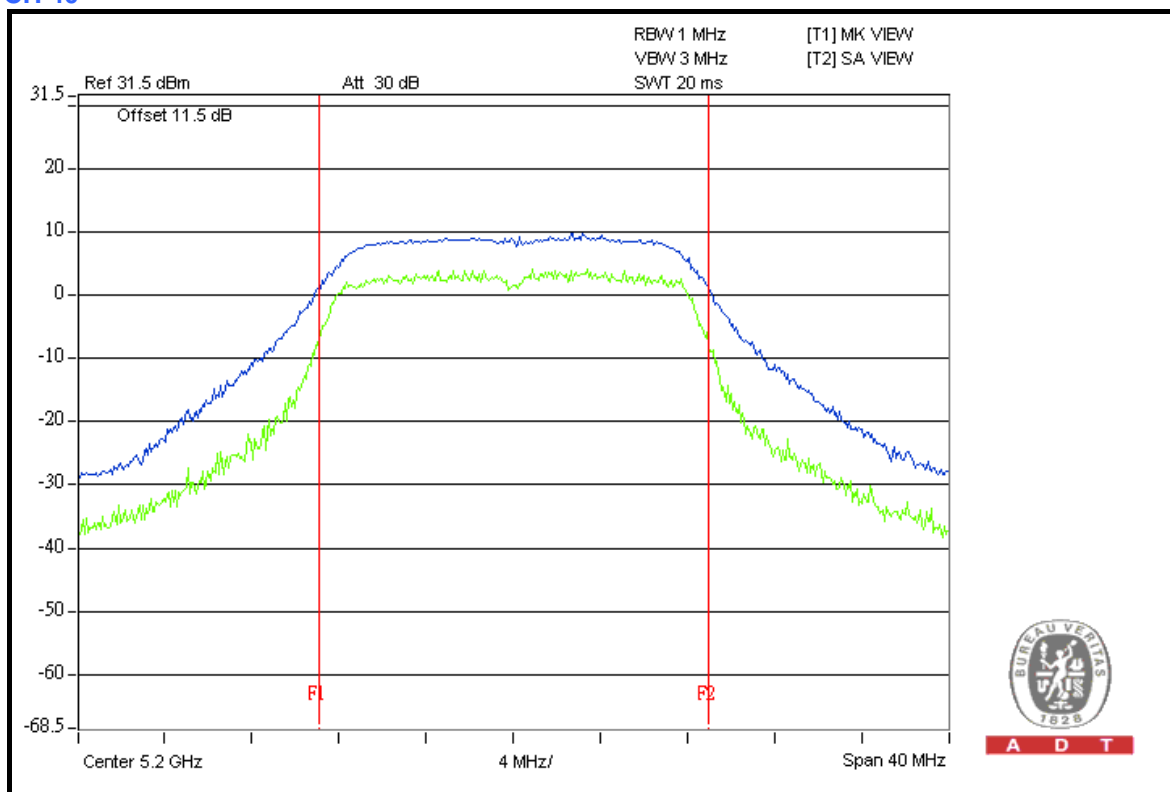



A D T

CH 48

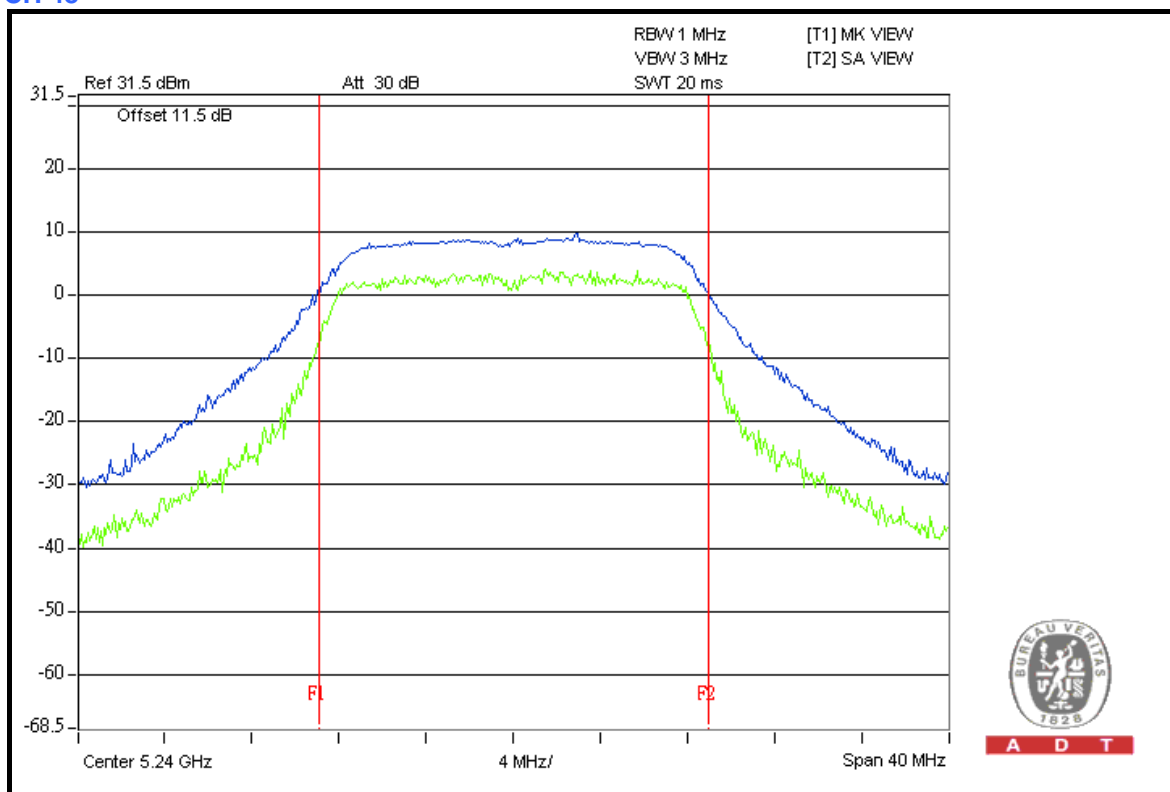

A D T

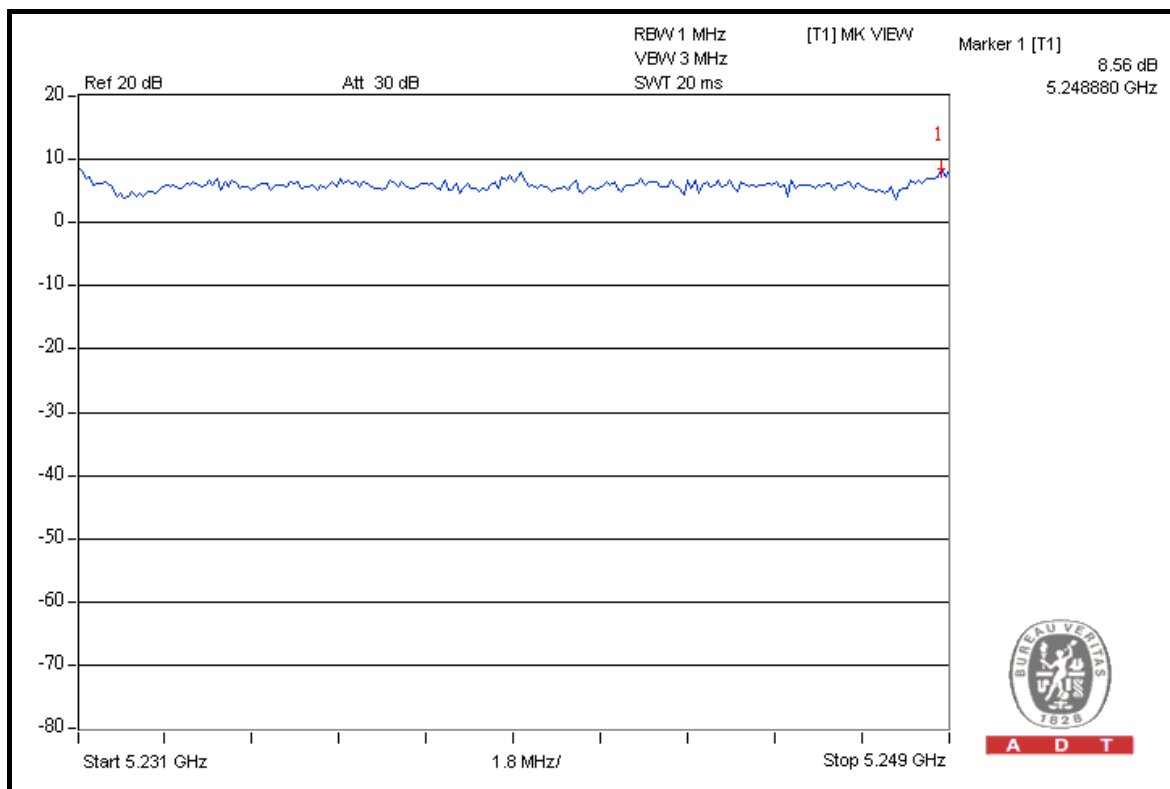

A D T



A D T

CHAIN 1 CH 36

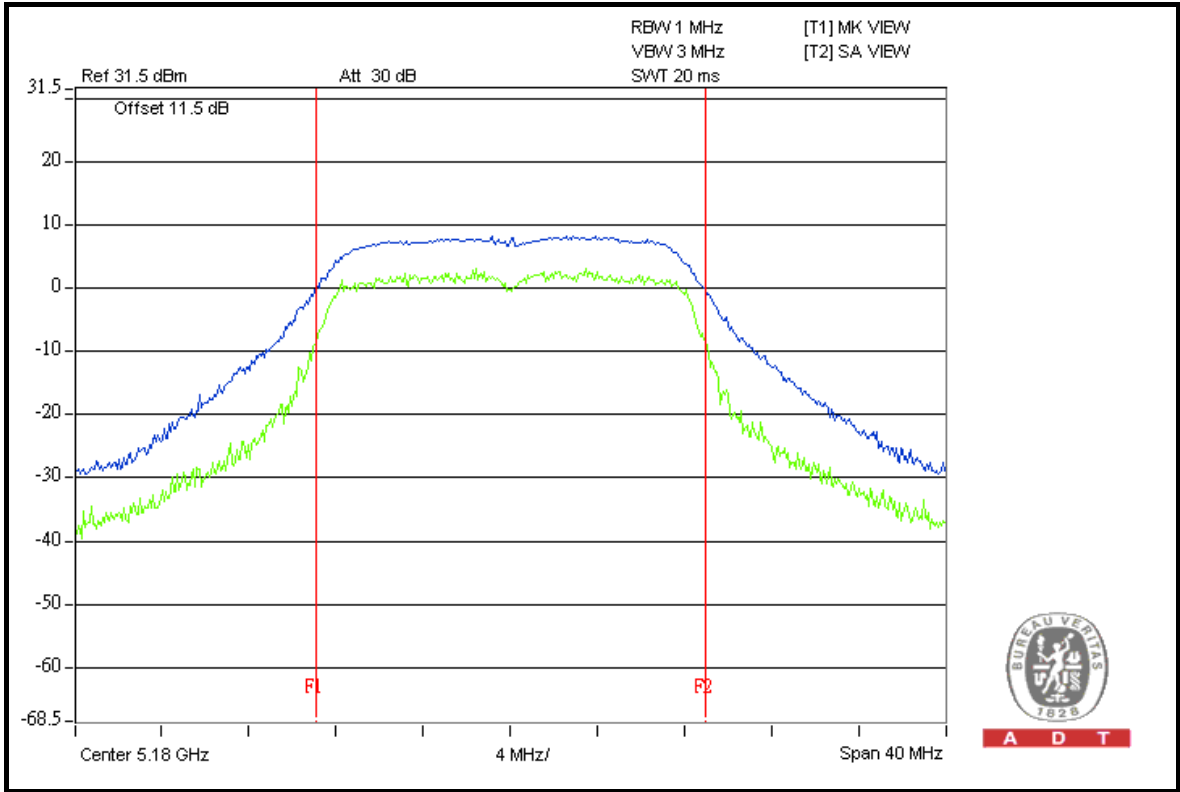

A D T

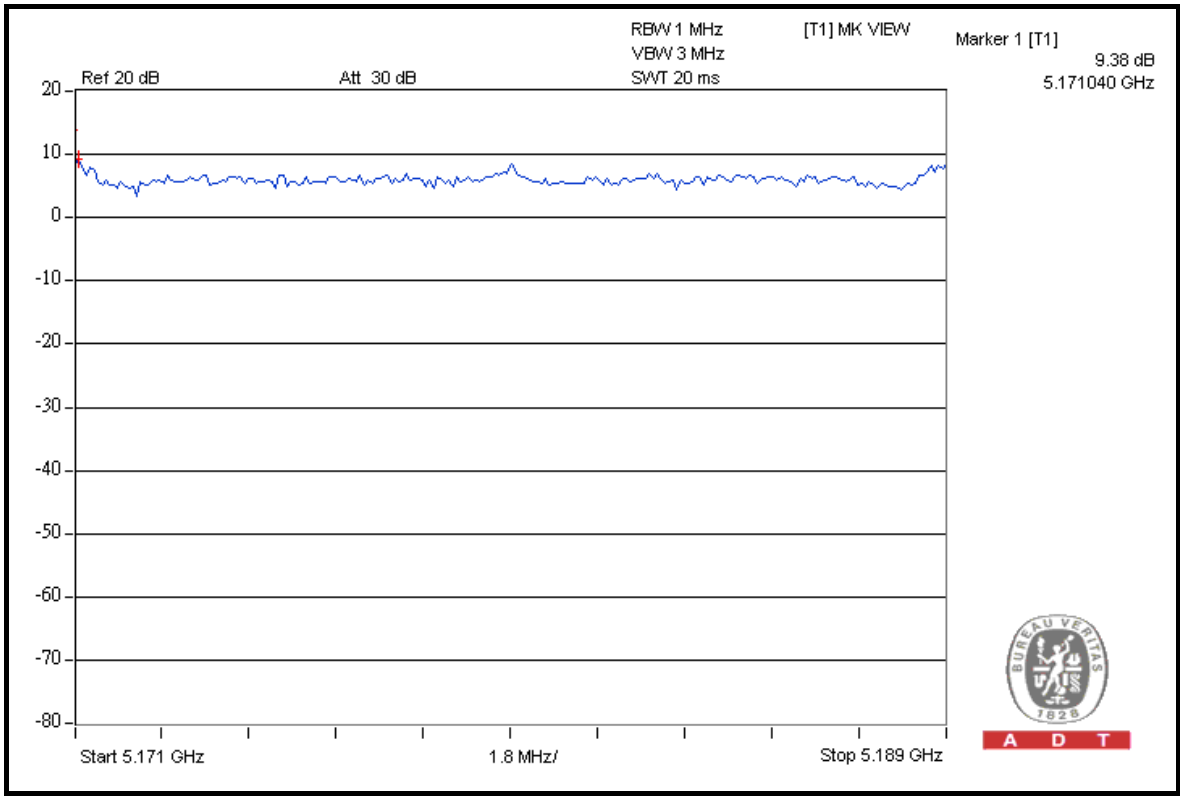

A D T



A D T

CH 40

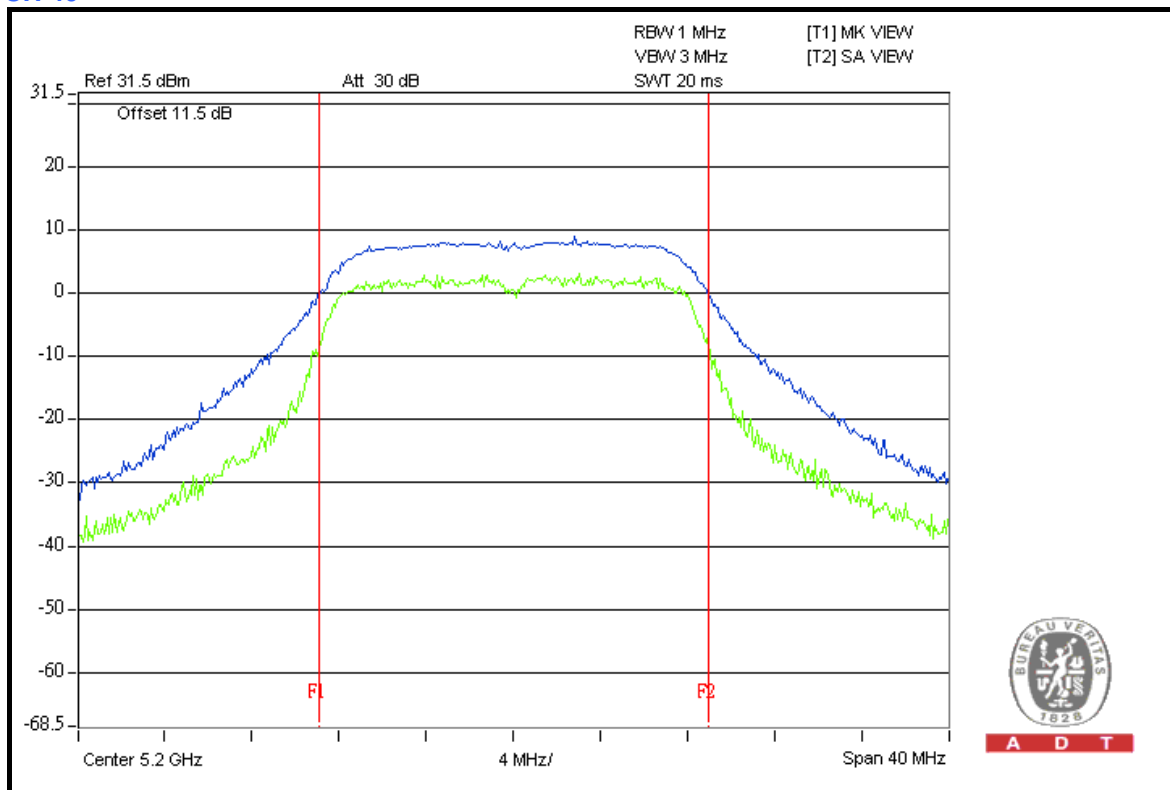

A D T

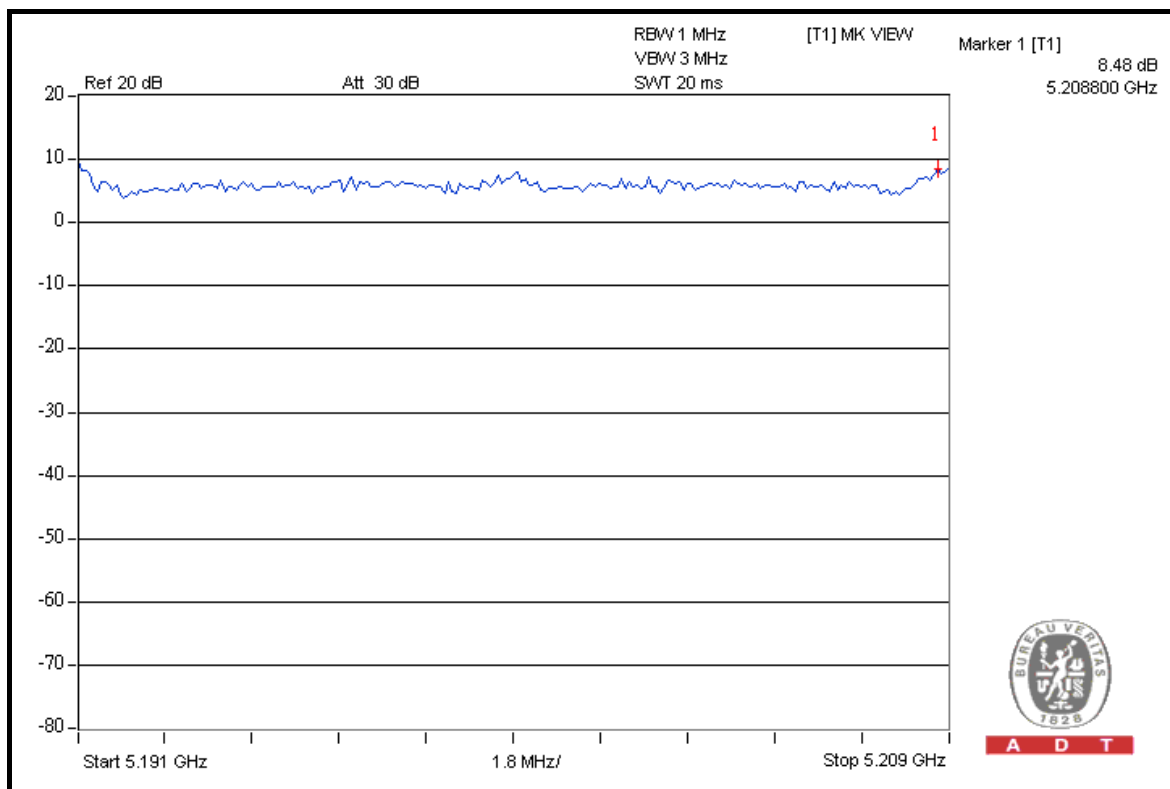

A D T



A D T

CH 48

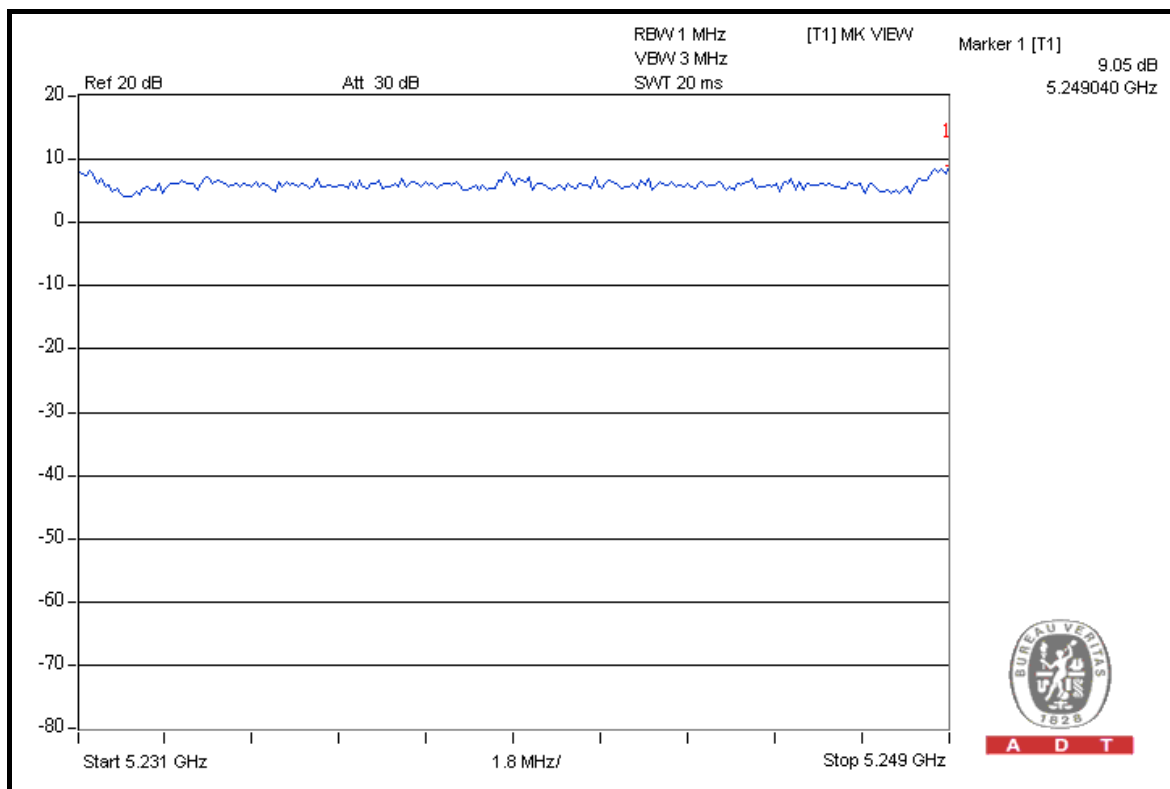
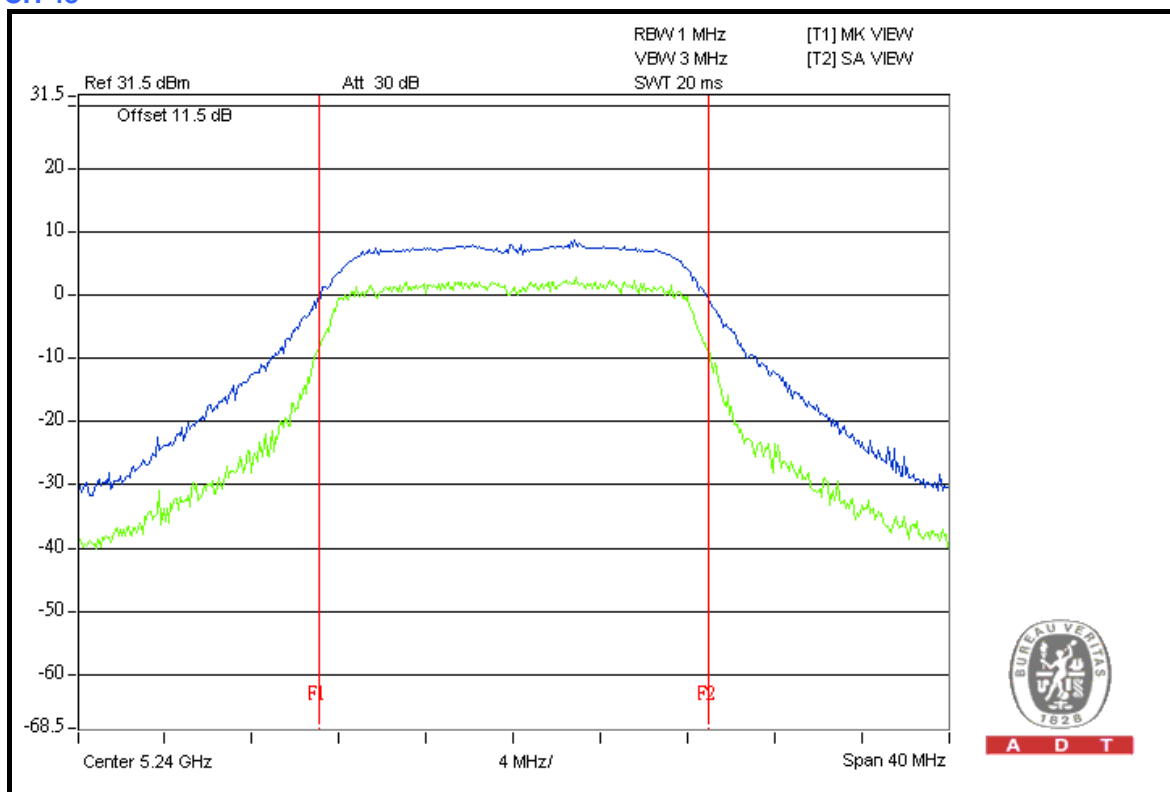



A D T

CHAIN 2 CH 36

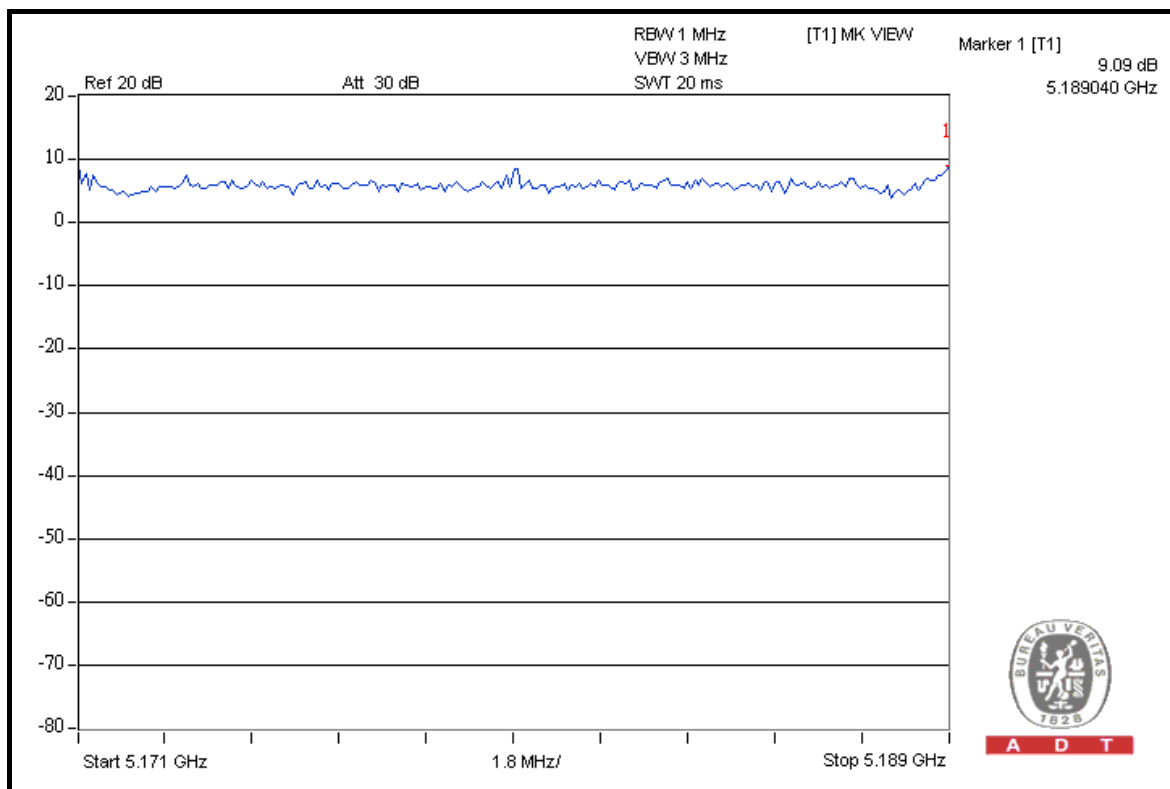
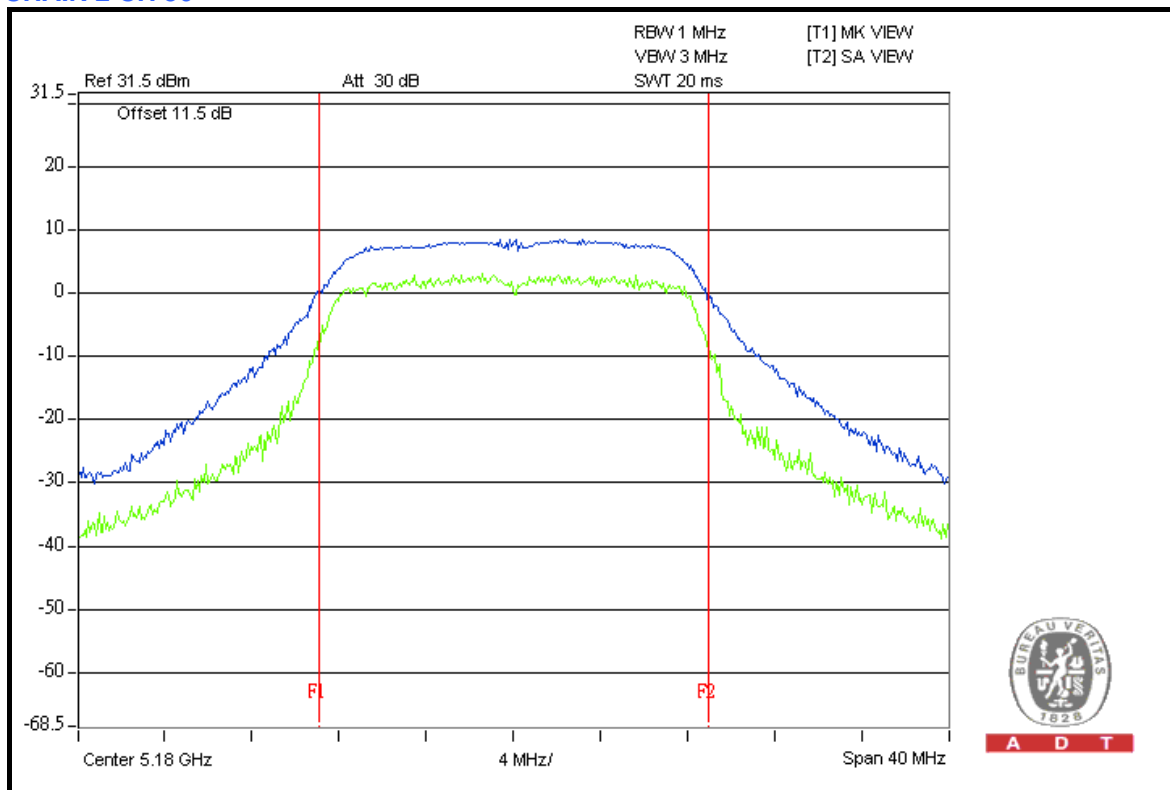



A D T

CH 40

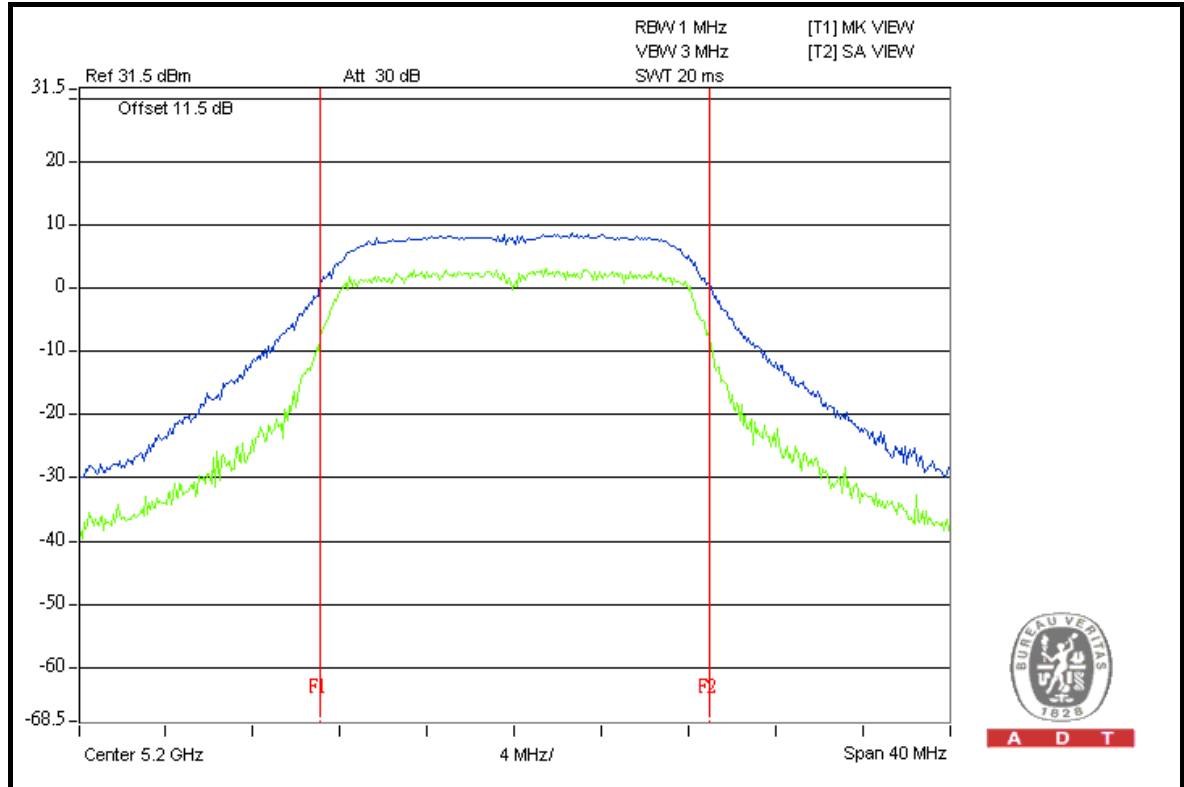

A D T

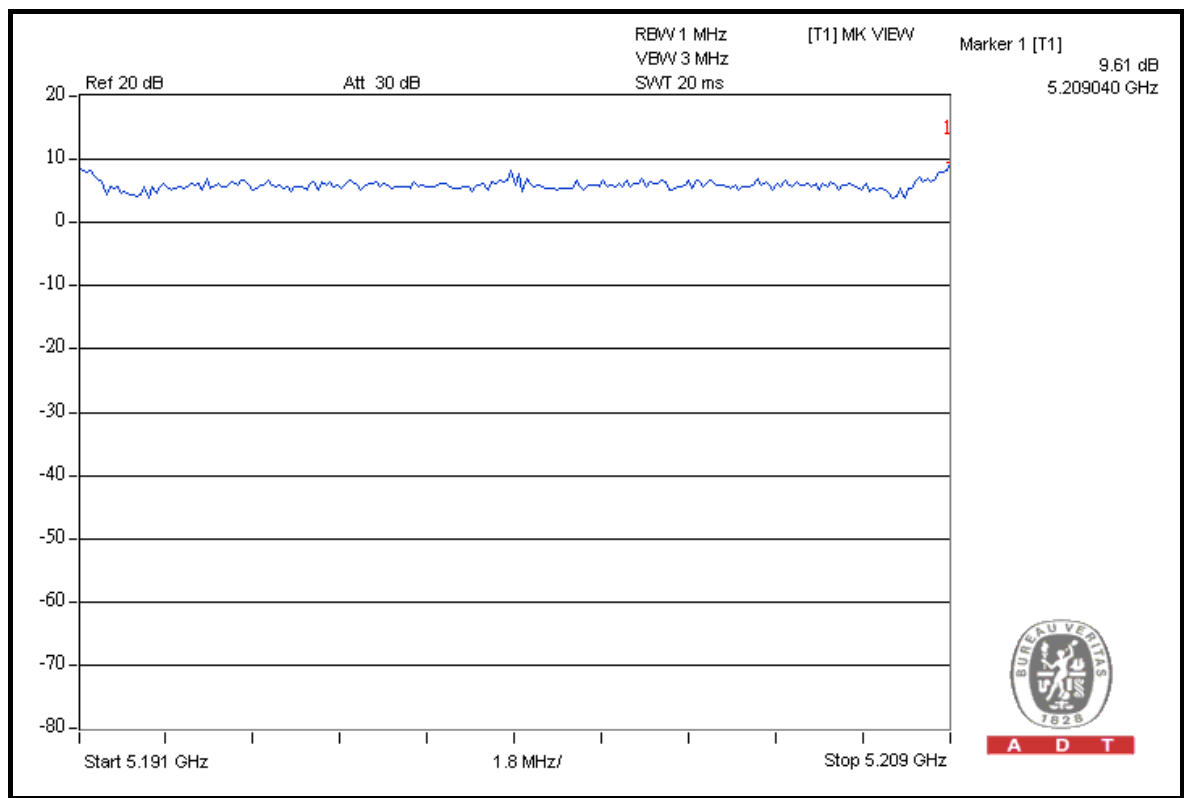

A D T



A D T

CH 48

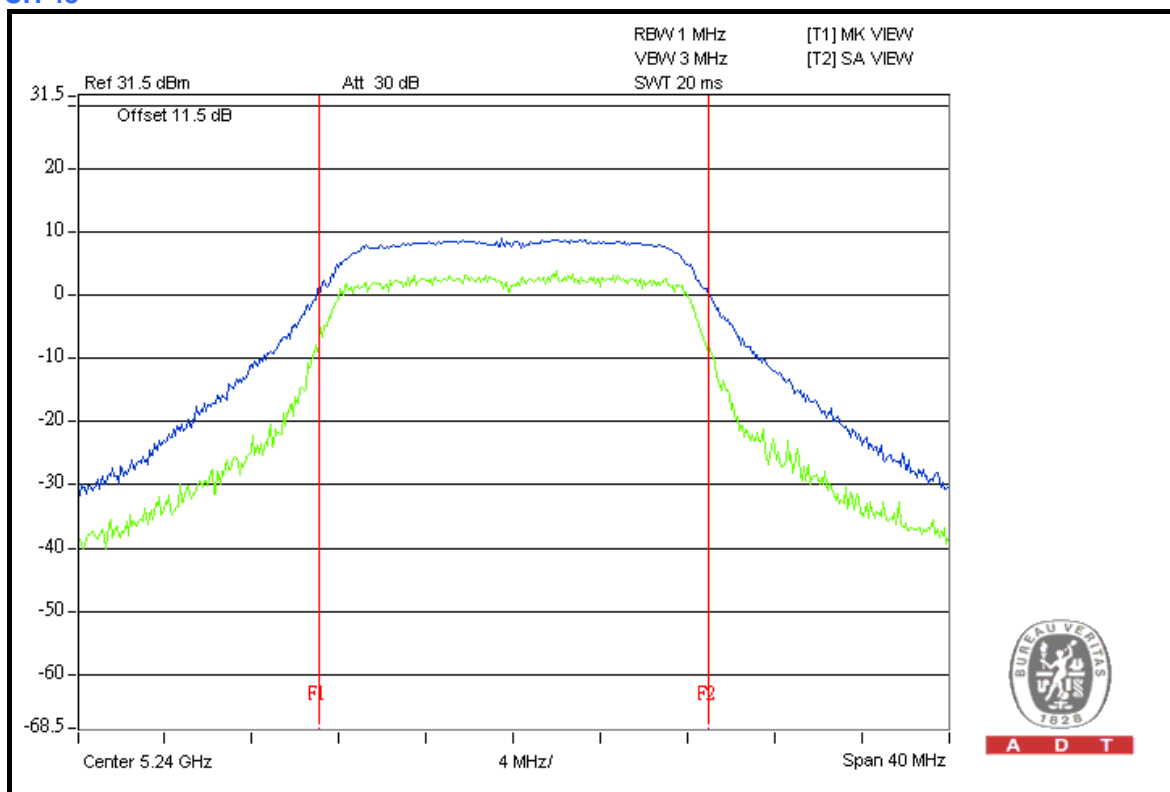

A D T

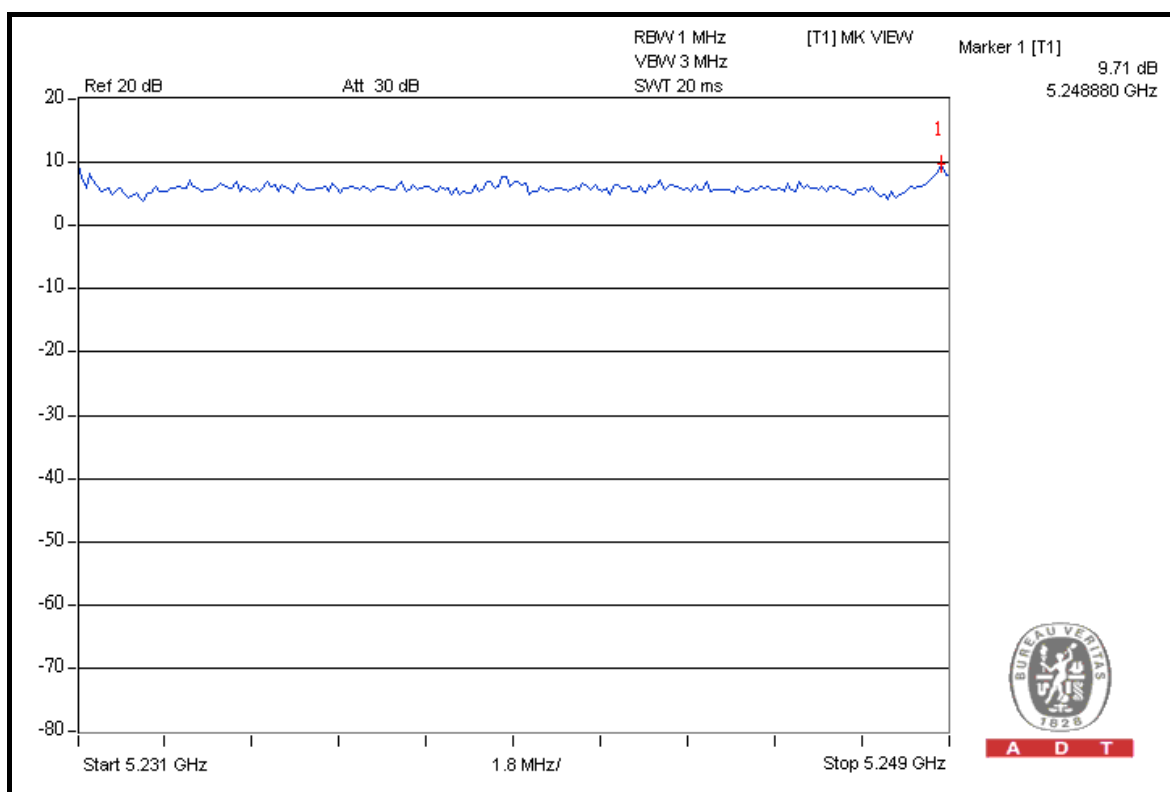

A D T



A D T

802.11a OFDM MODULATION

MODULATION TYPE	BPSK	TRANSFER RATE	6.0Mbps
INPUT POWER (SYSTEM)	120Vac, 60Hz	ENVIRONMENTAL CONDITIONS	25deg.C, 65%RH, 991hPa
TESTED BY	Brad Wu	TEST MODE	C

CHANNEL	CHANNEL FREQUENCY (MHz)	PEAK POWER EXCURSION (dB)		PEAK TO AVERAGE EXCURSION LIMIT (dB)	PASS/FAIL
		CHAIN 0	CHAIN 1		
36	5180	10.38	9.07	13	PASS
40	5200	10.81	9.12	13	PASS
48	5240	9.40	9.38	13	PASS



A D T

CHAIN 0 CH 36

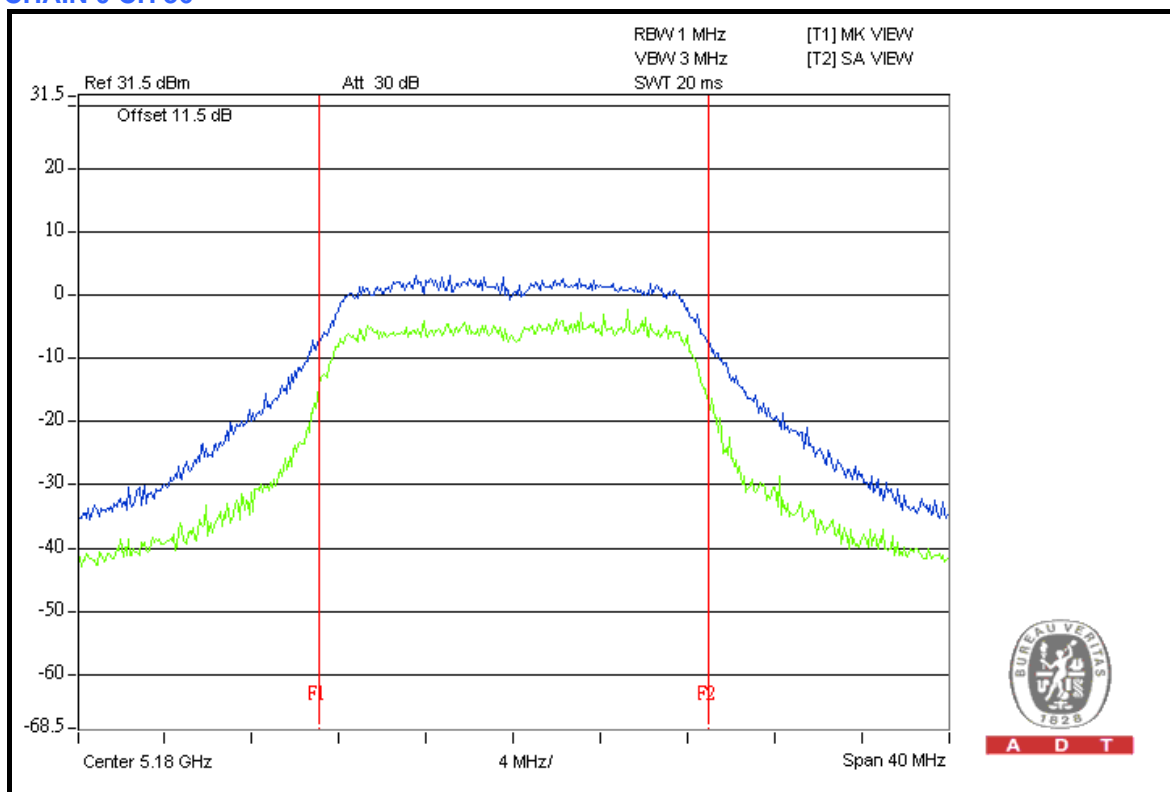

A D T

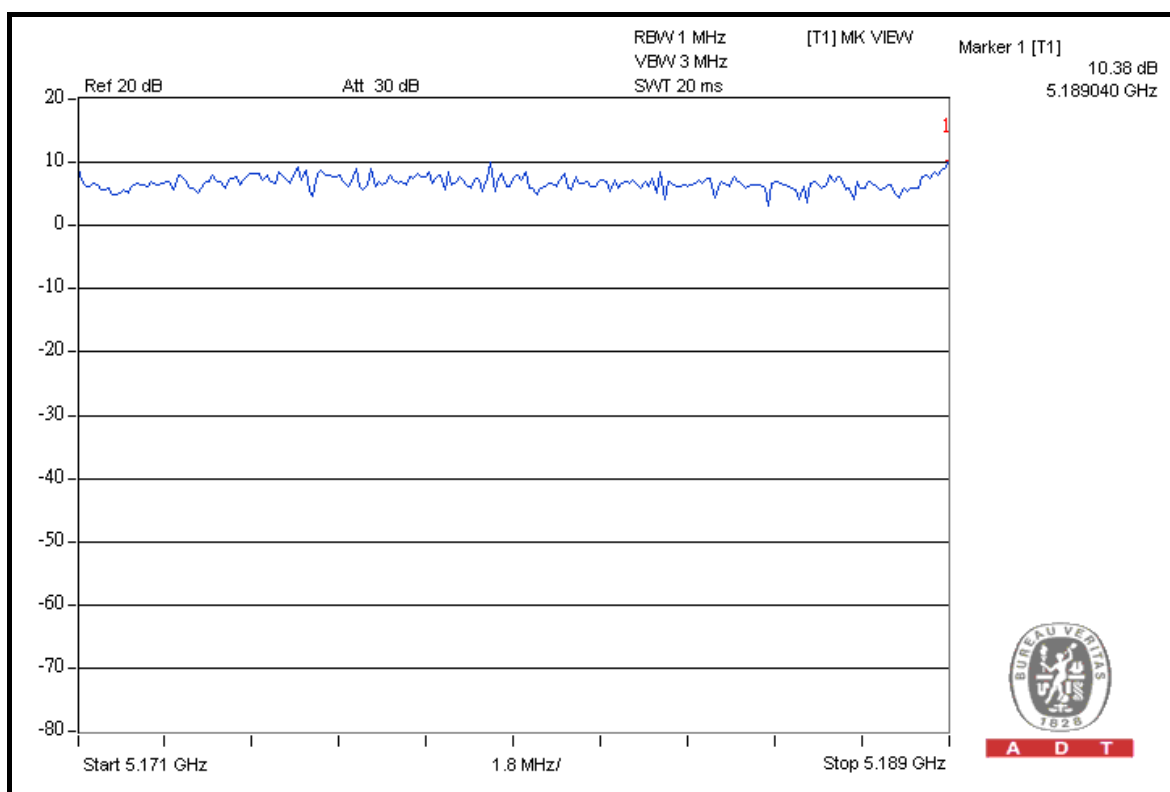

A D T



A D T

CH 40

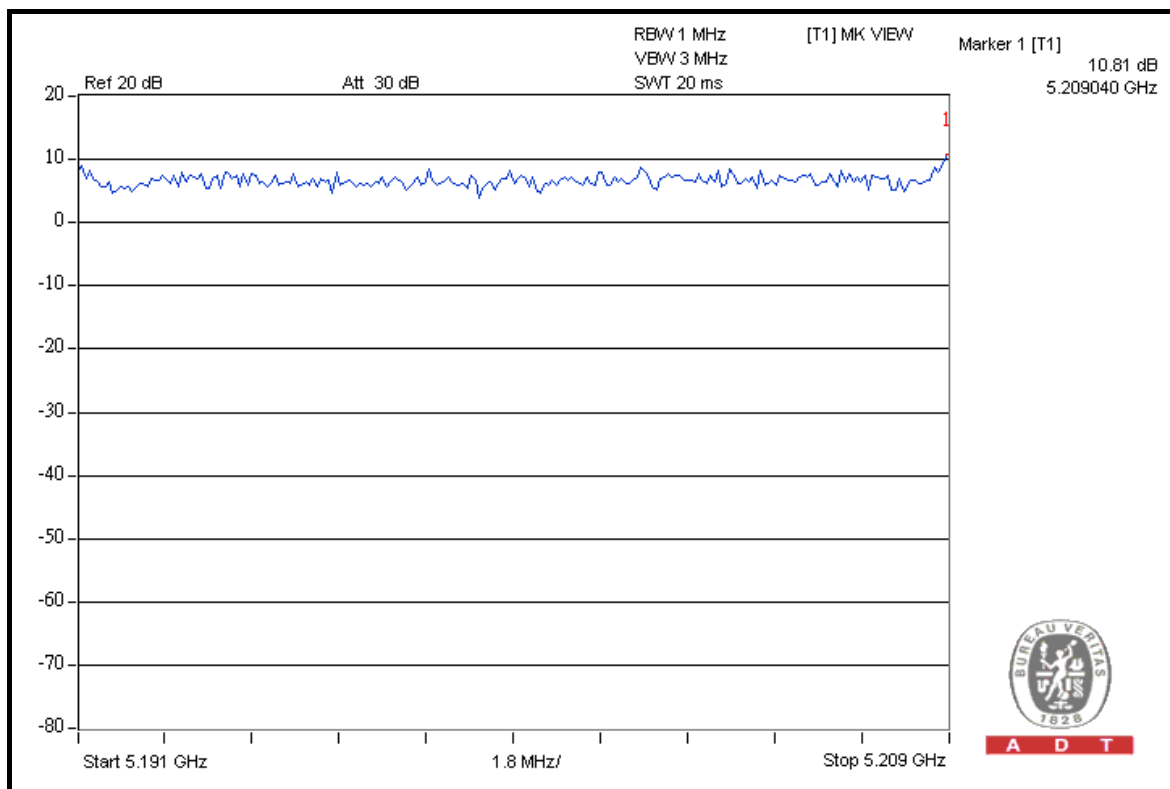
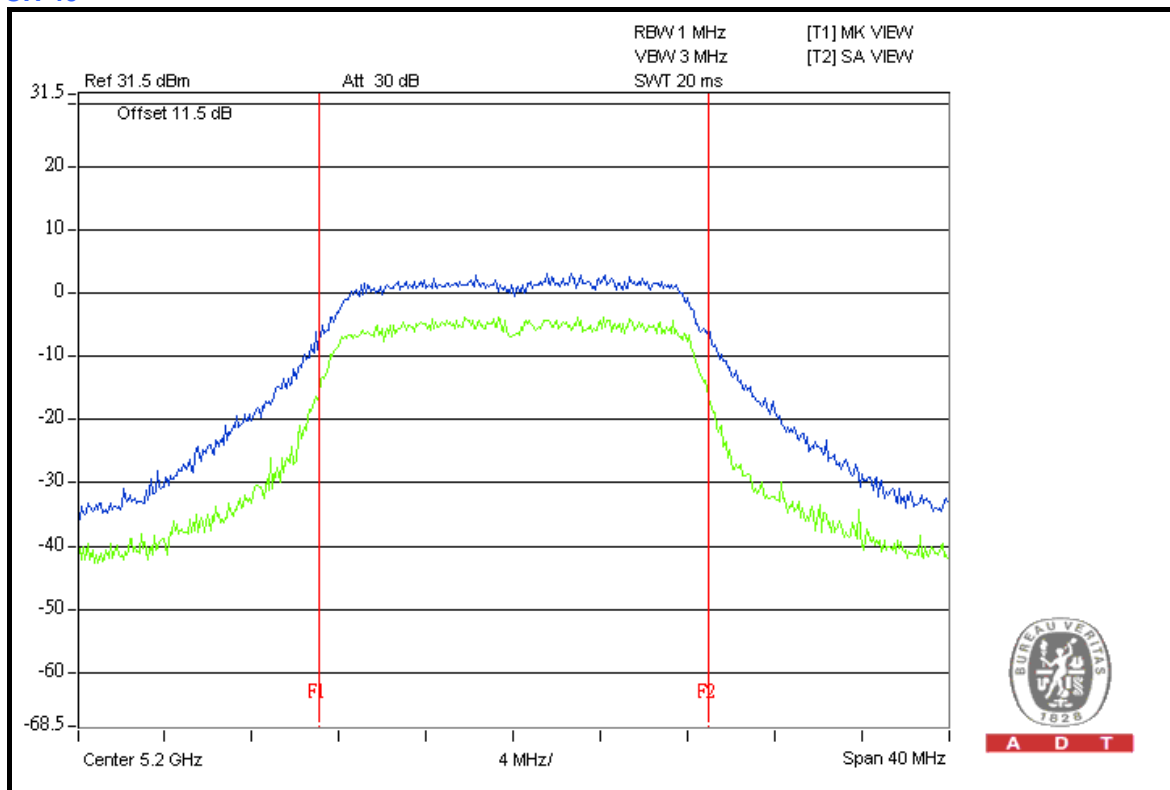



A D T

CH 48

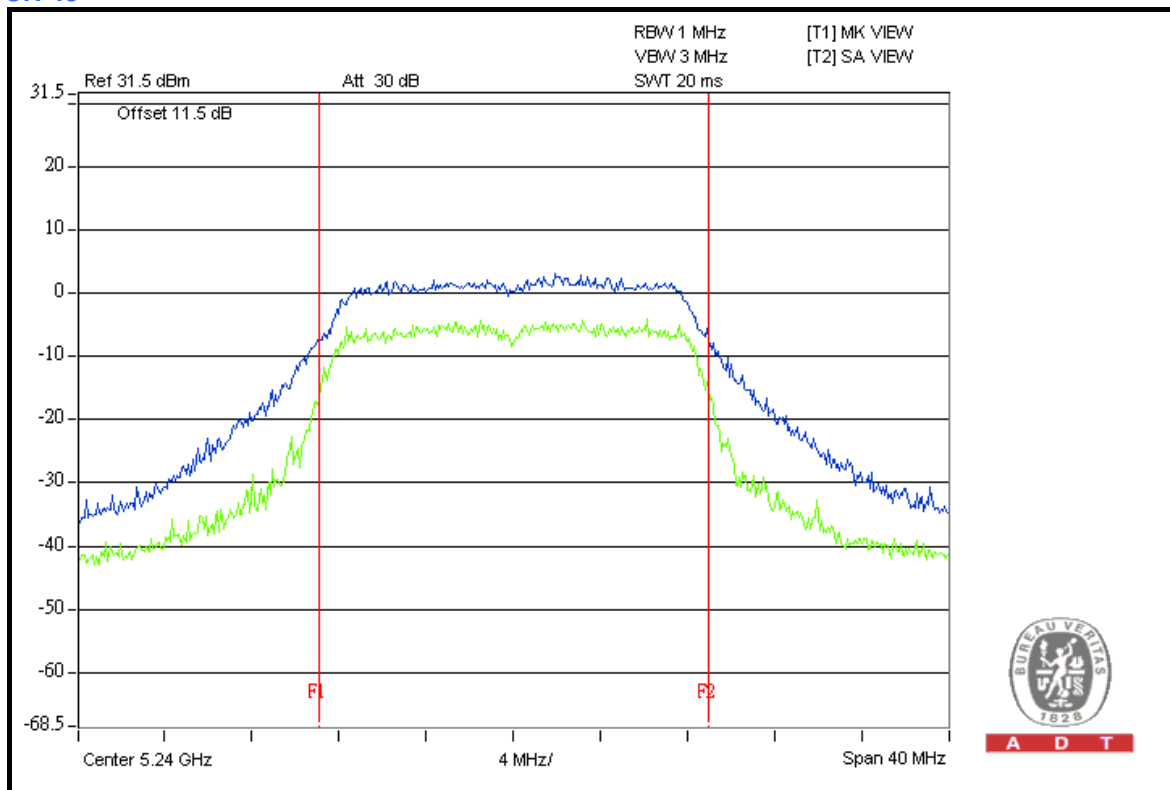

A D T

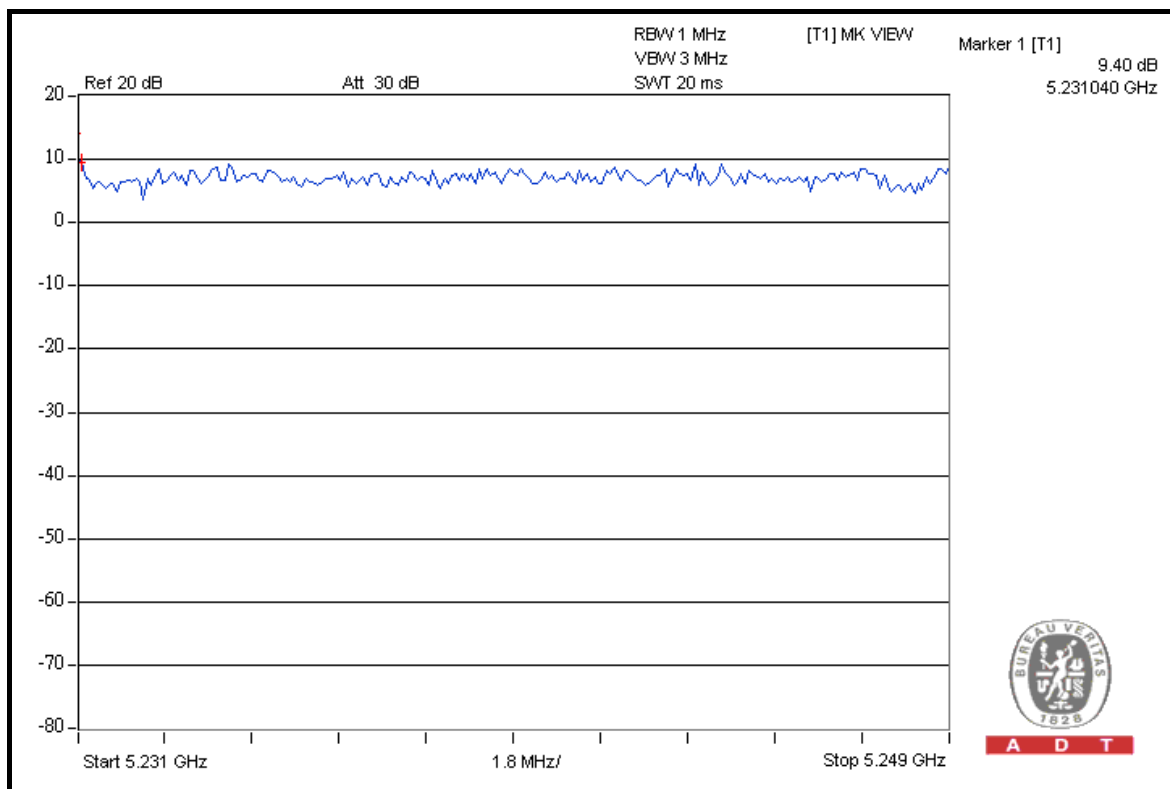

A D T



A D T

CHAIN 1 CH 36

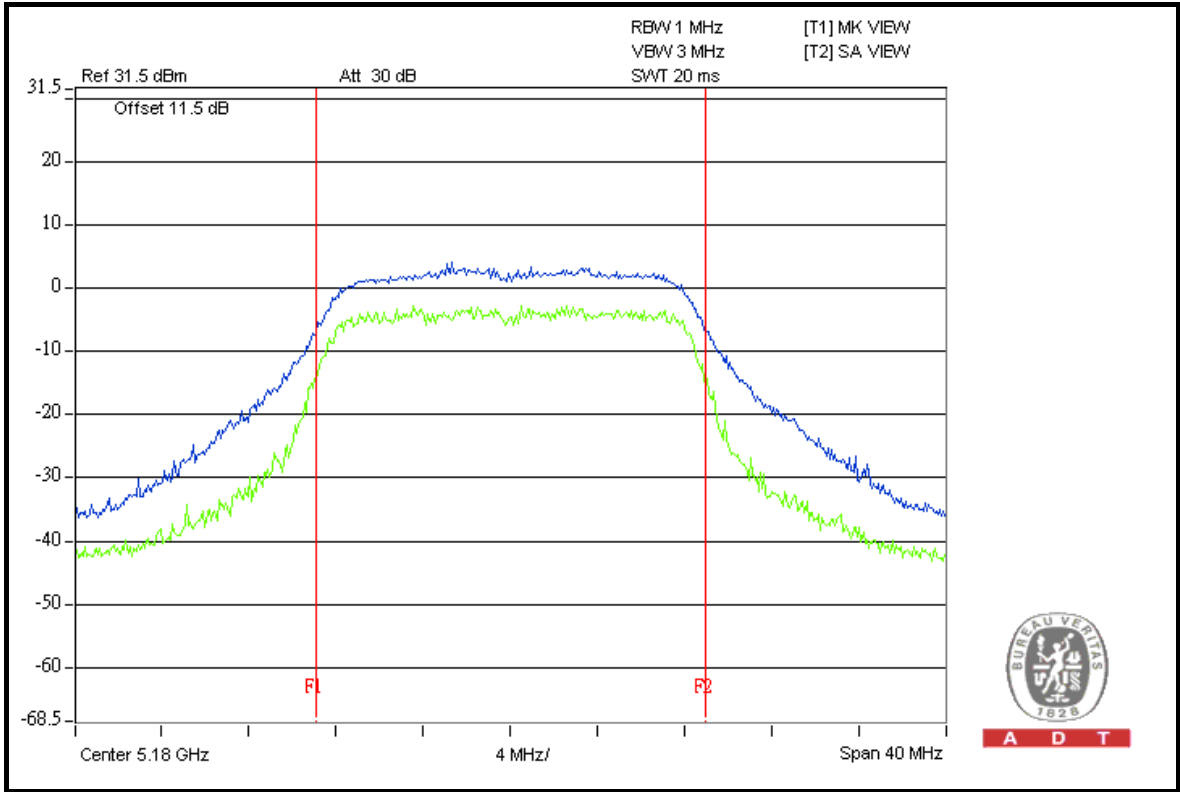

A D T

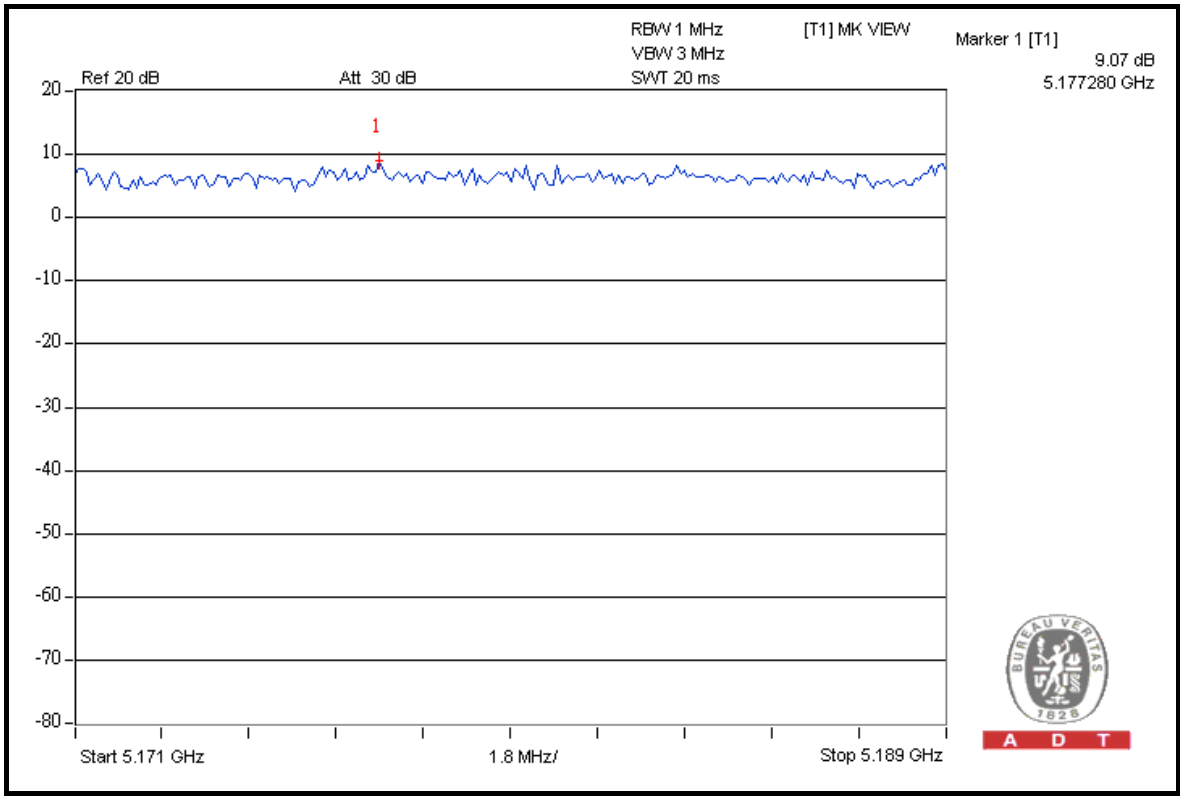

A D T



A D T

CH 40

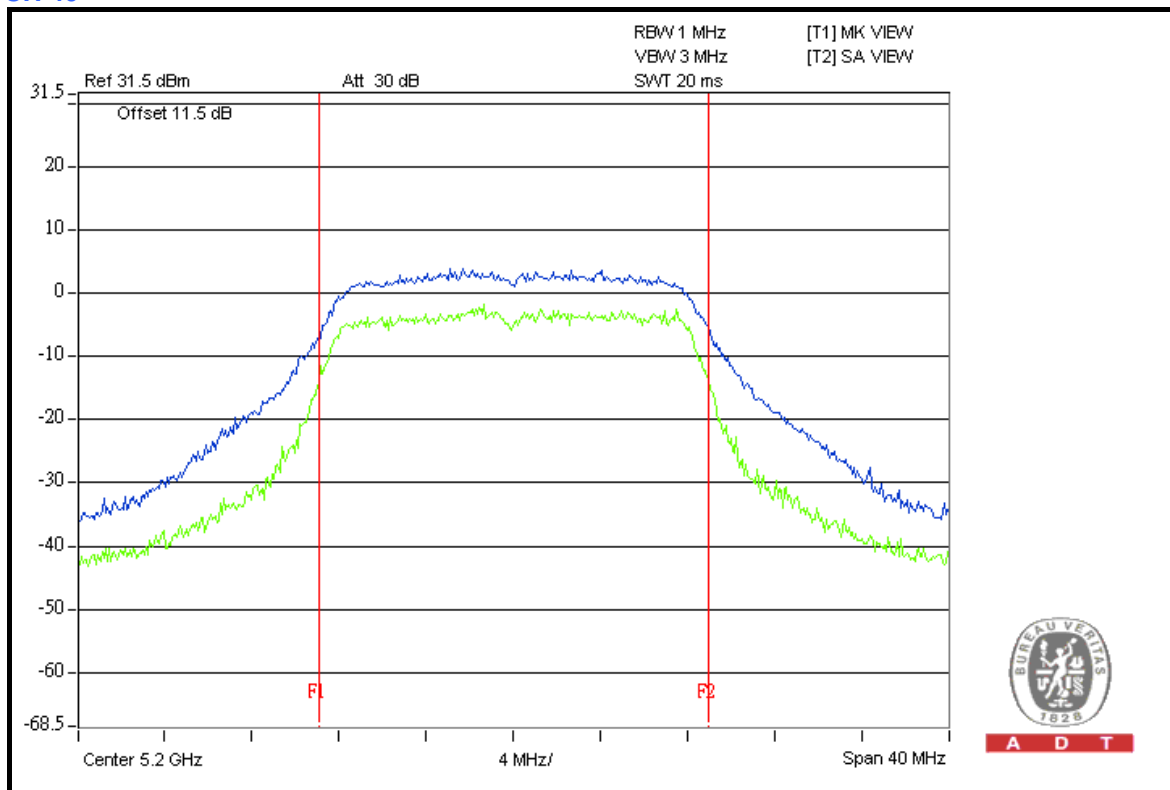

A D T

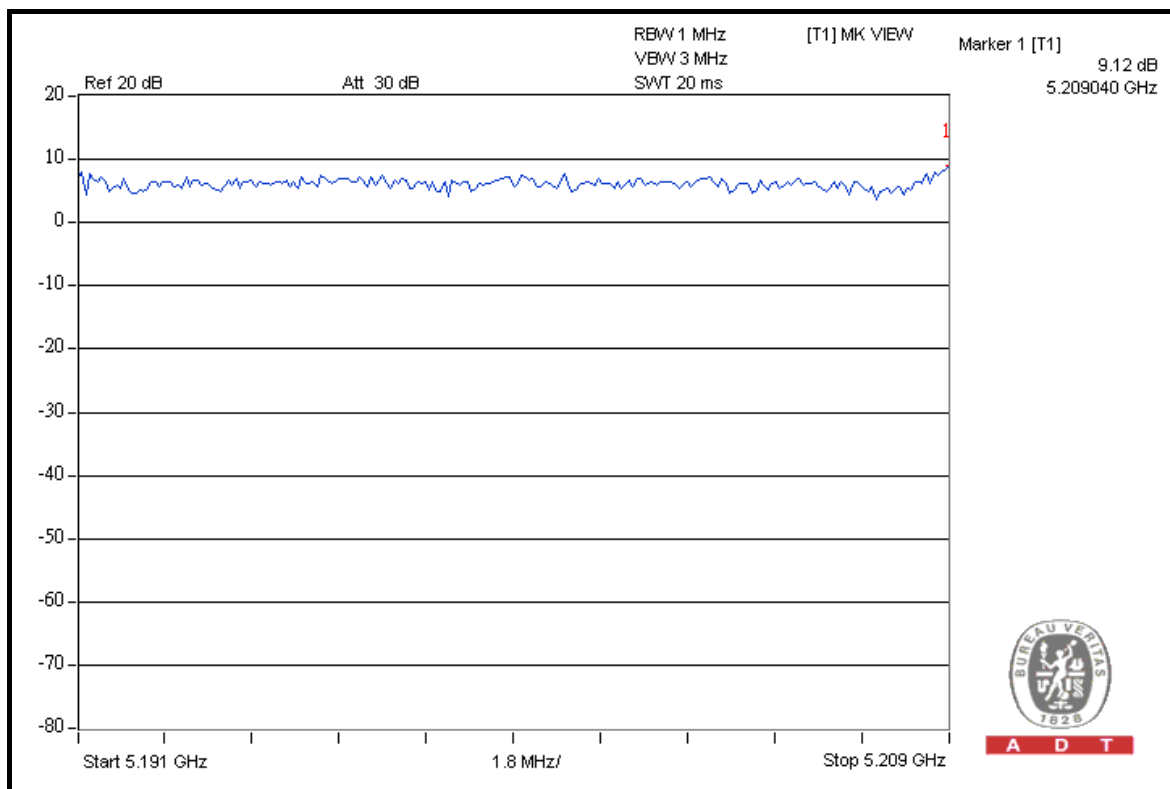

A D T



A D T

CH 48

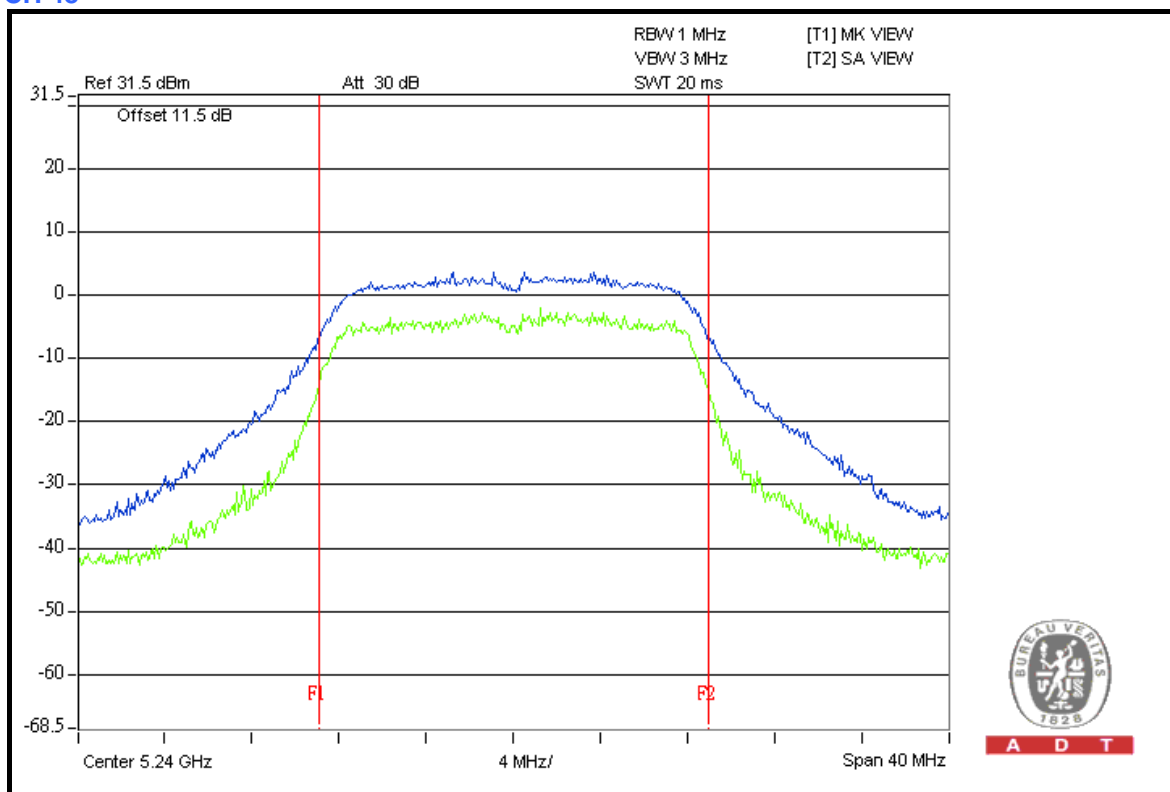

A D T

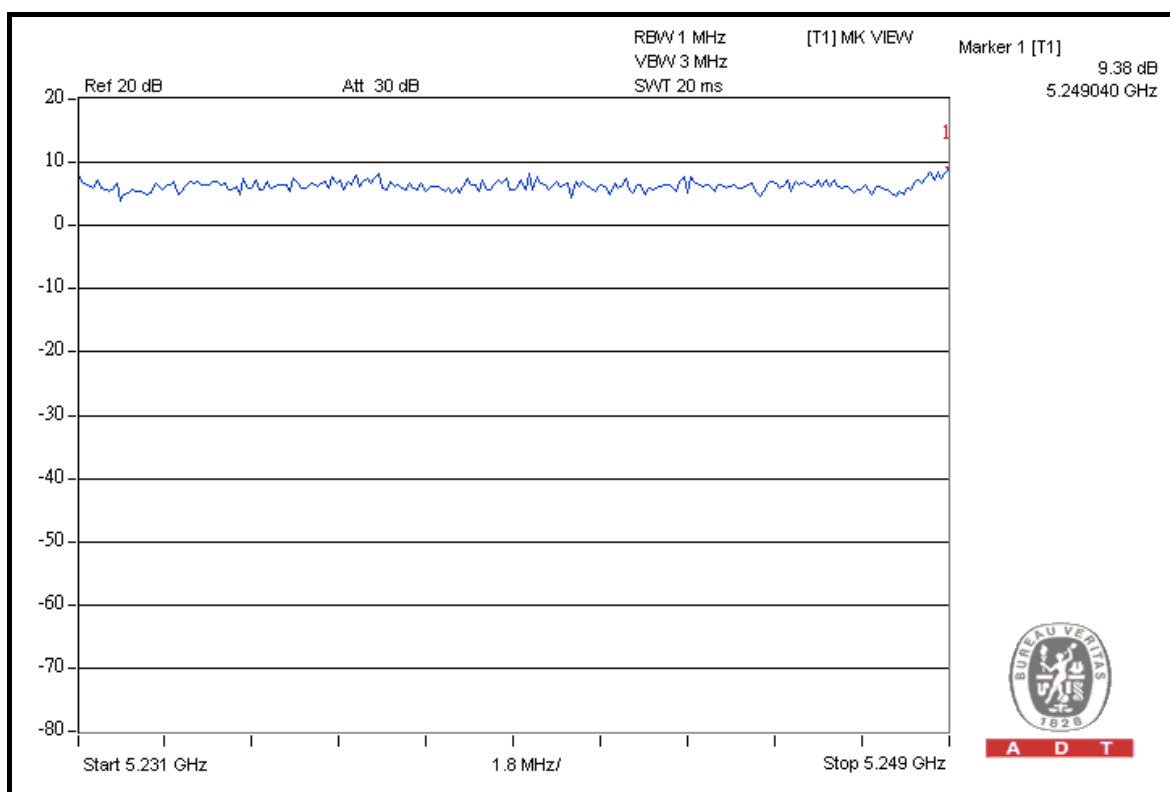

A D T



A D T

DRAFT 802.11n (20MHz) OFDM MODULATION

MODULATION TYPE	BPSK	TRANSFER RATE	6.5Mbps
INPUT POWER (SYSTEM)	120Vac, 60Hz	ENVIRONMENTAL CONDITIONS	25deg.C, 65%RH, 991hPa
TESTED BY	Brad Wu	TEST MODE	A

CHANNEL	CHANNEL FREQUENCY (MHz)	PEAK POWER EXCURSION (dB)			PEAK TO AVERAGE EXCURSION LIMIT (dB)	PASS/FAIL
		CHAIN 0	CHAIN 1	CHAIN2		
36	5180	7.83	8.27	8.57	13	PASS
40	5200	8.22	9.11	8.64	13	PASS
48	5240	8.08	7.61	7.44	13	PASS



A D T

CHAIN 0 CH 36

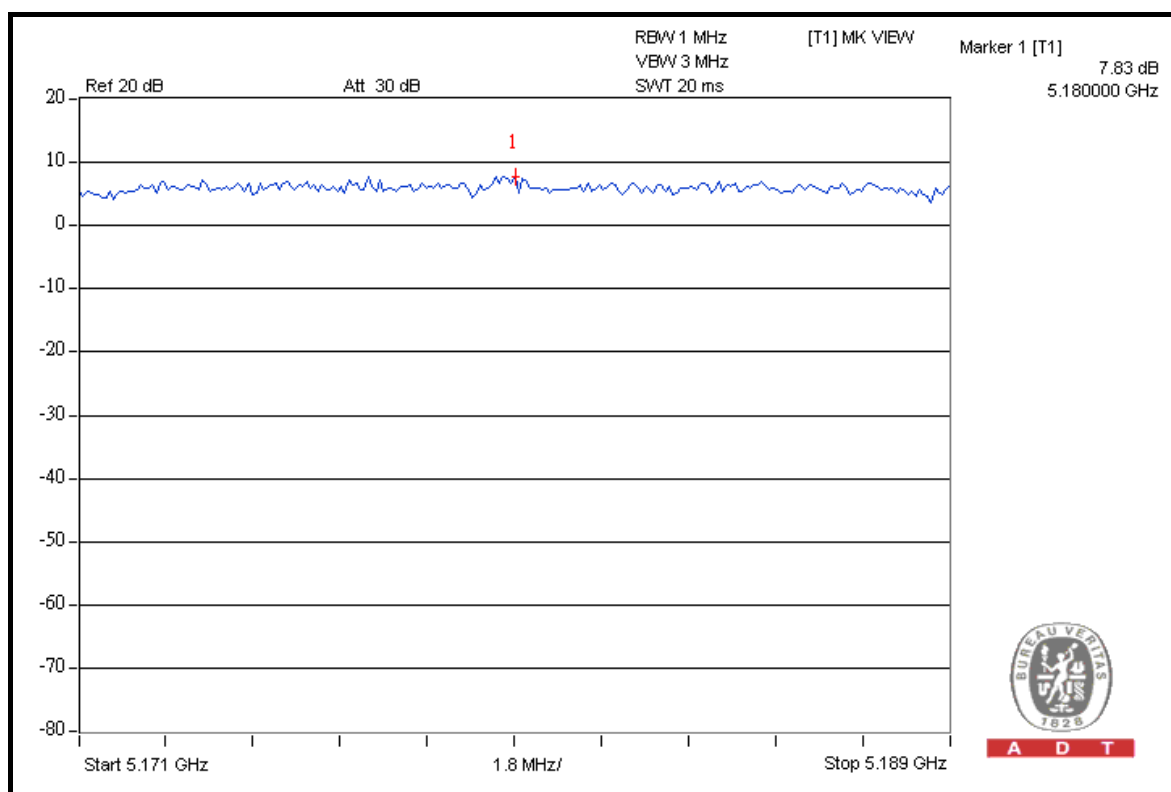
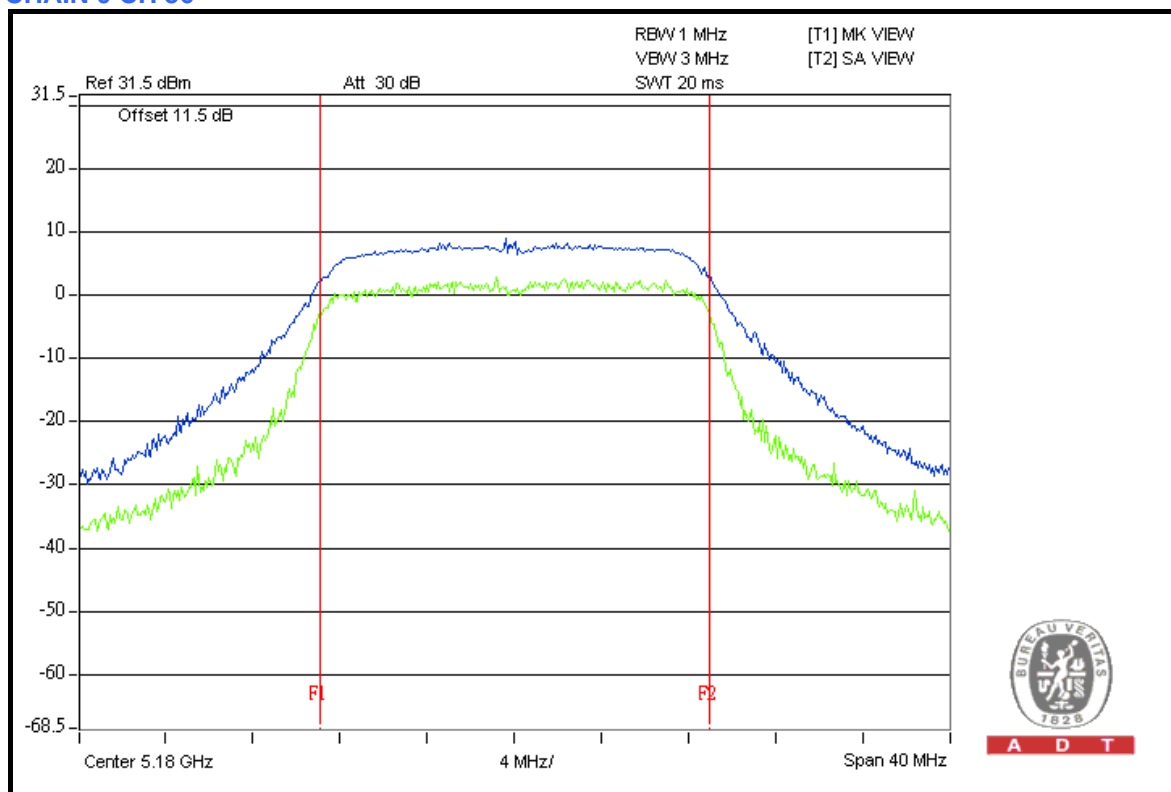



A D T

CH 40

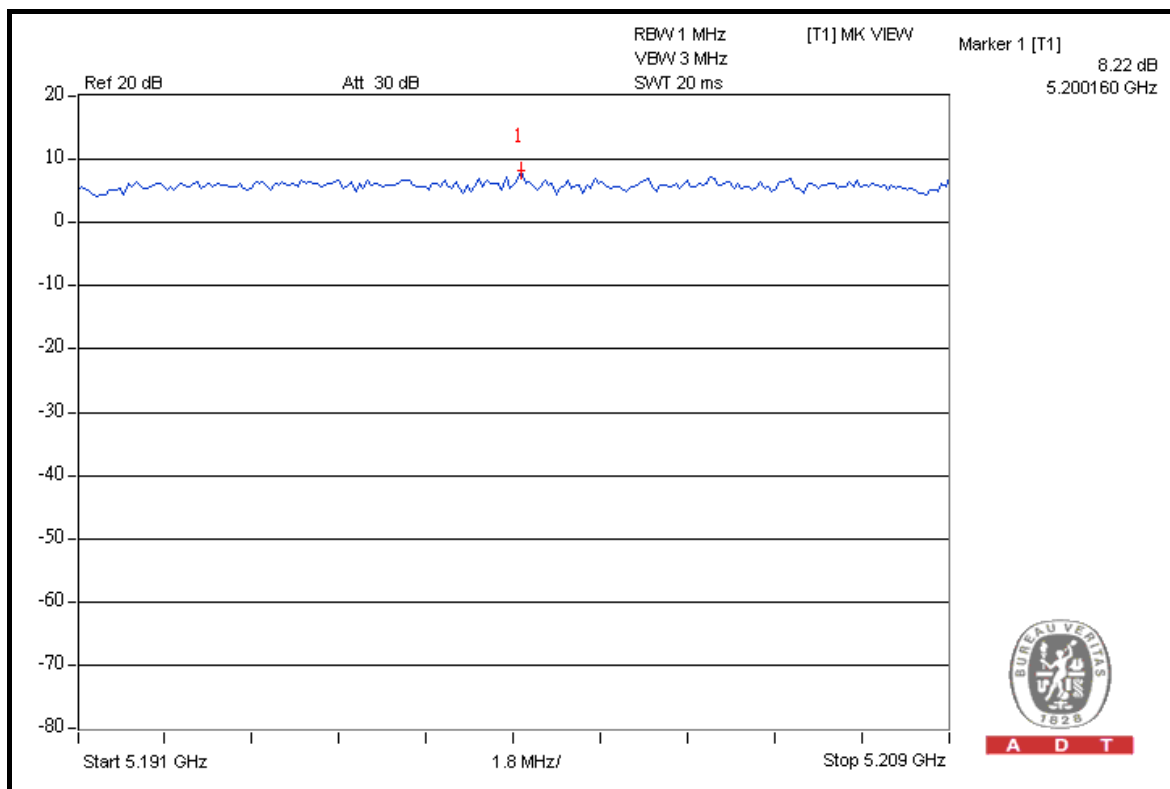
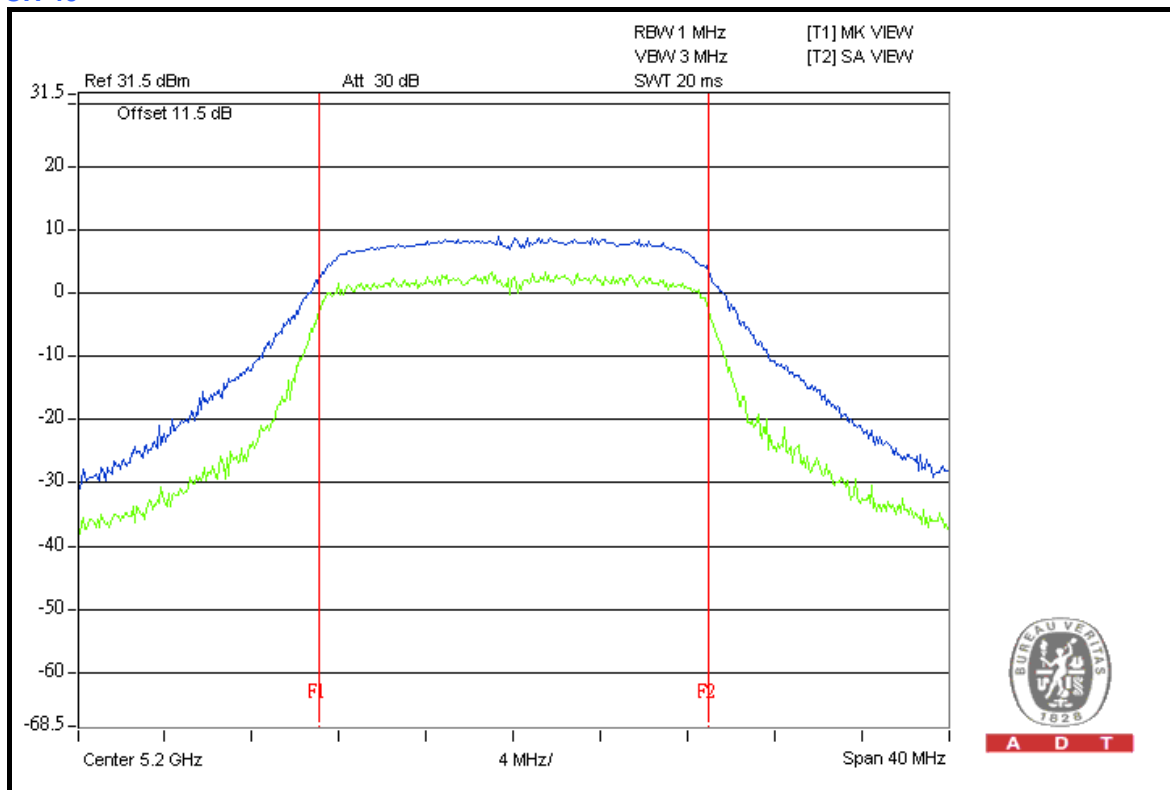



A D T

CH 48

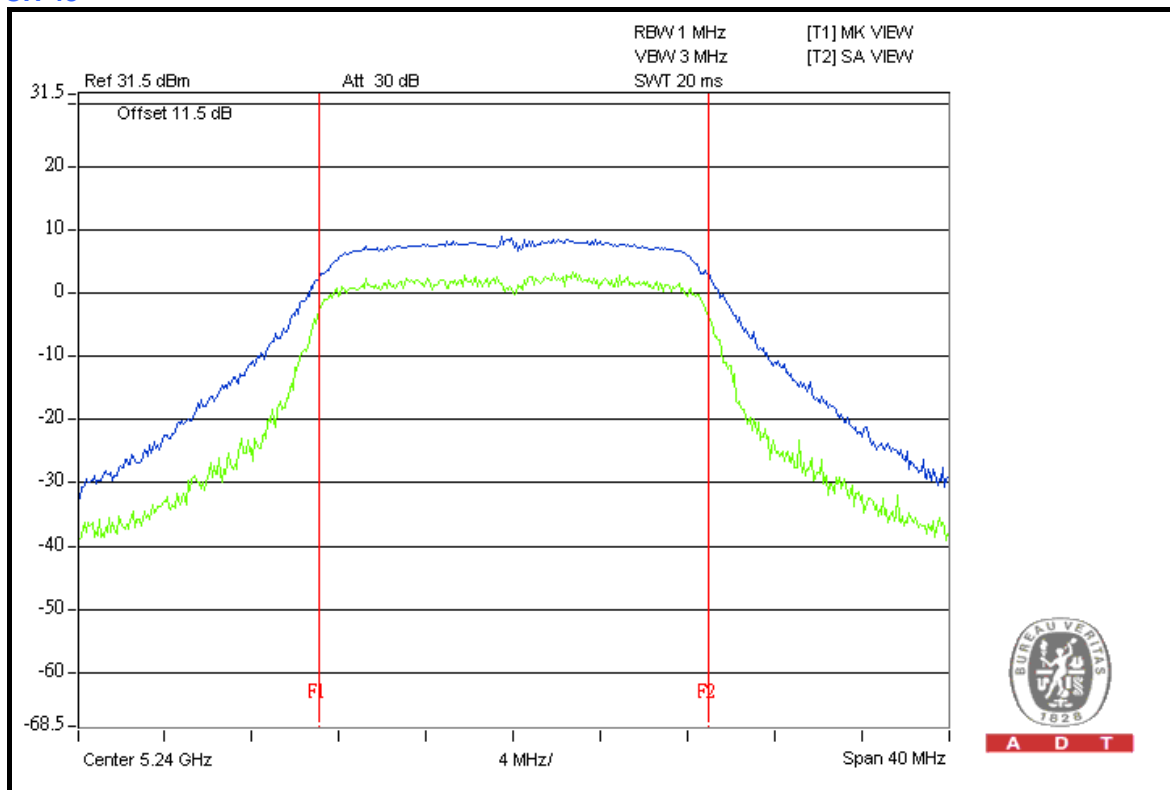

A D T

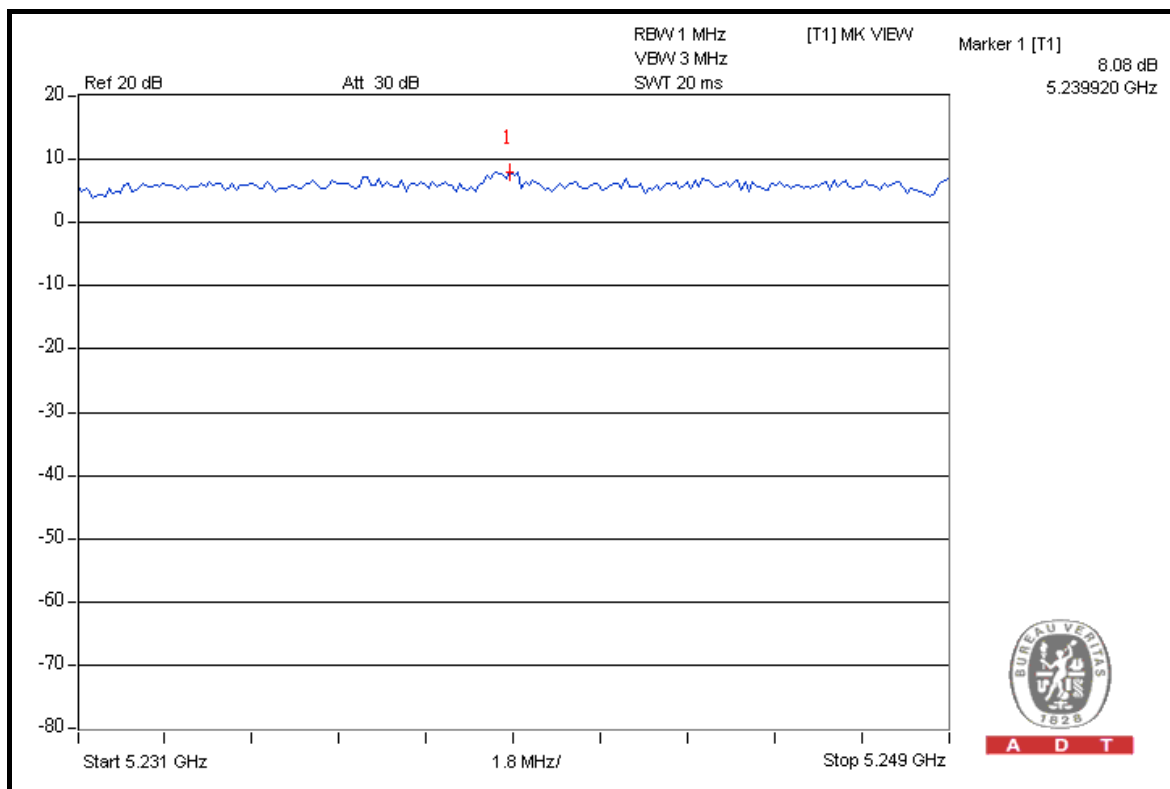

A D T



A D T

CHAIN 1 CH 36

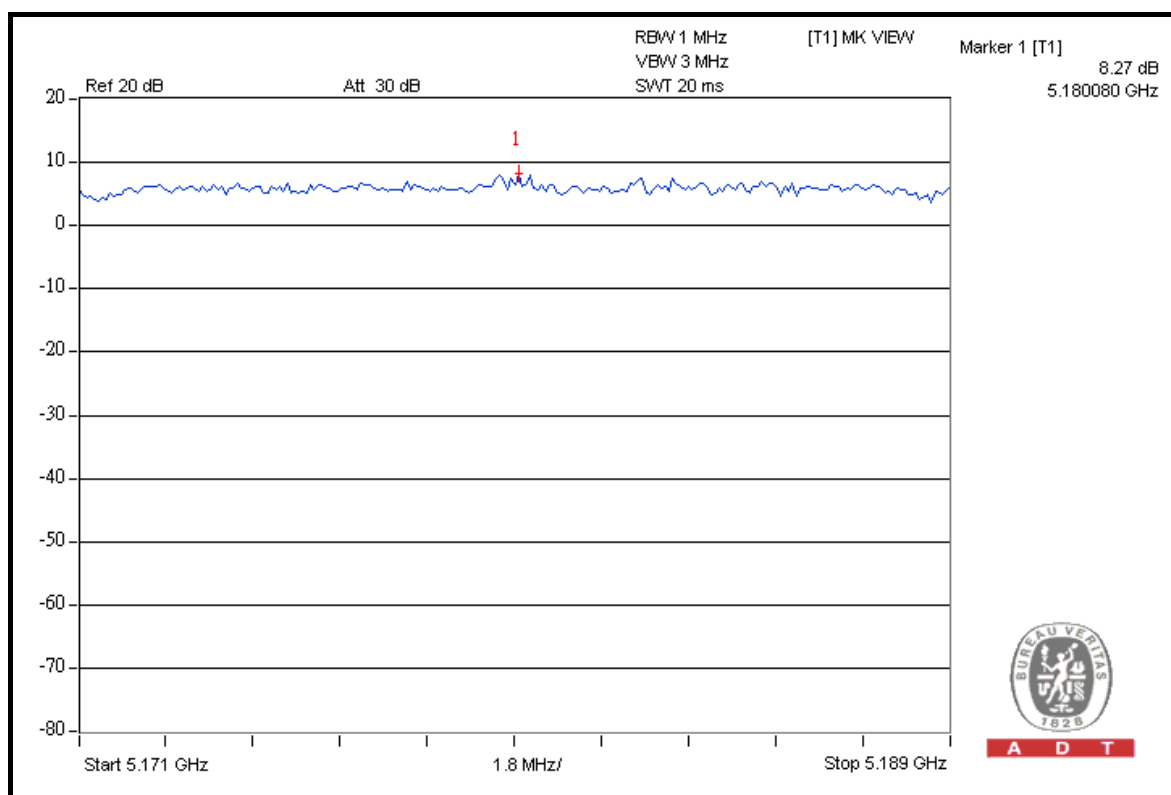
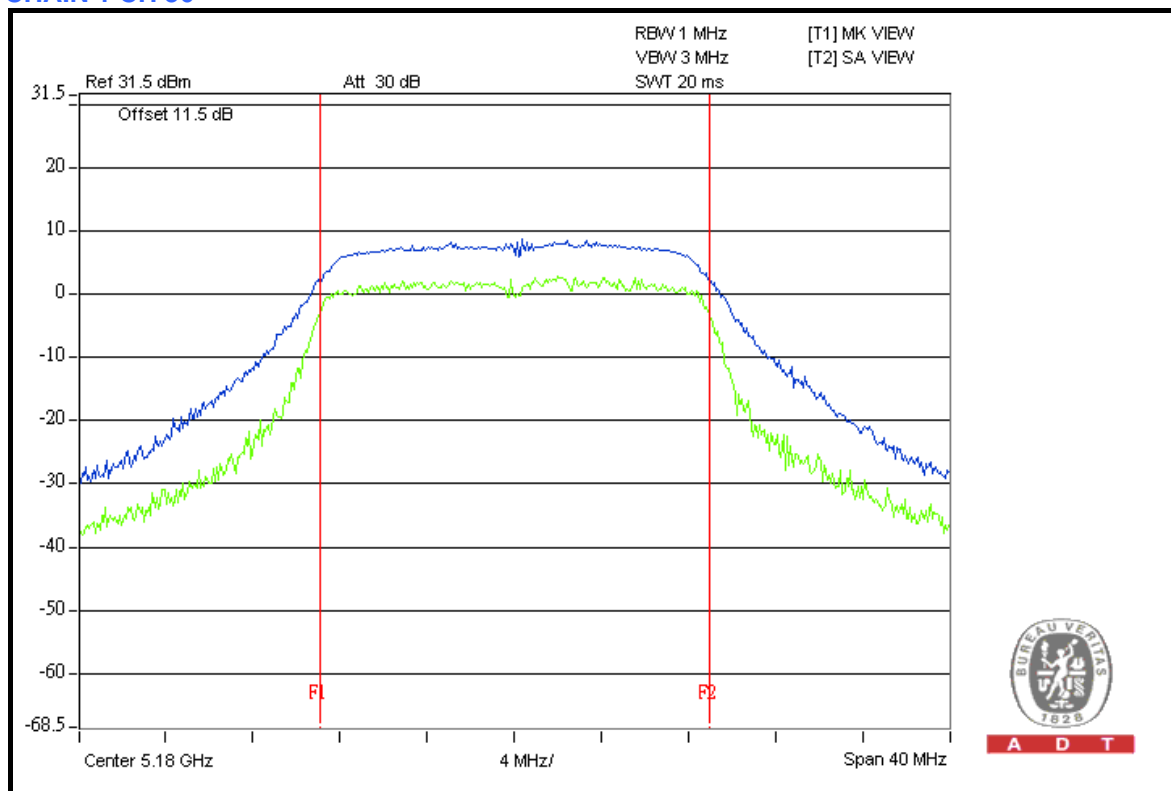



A D T

CH 40

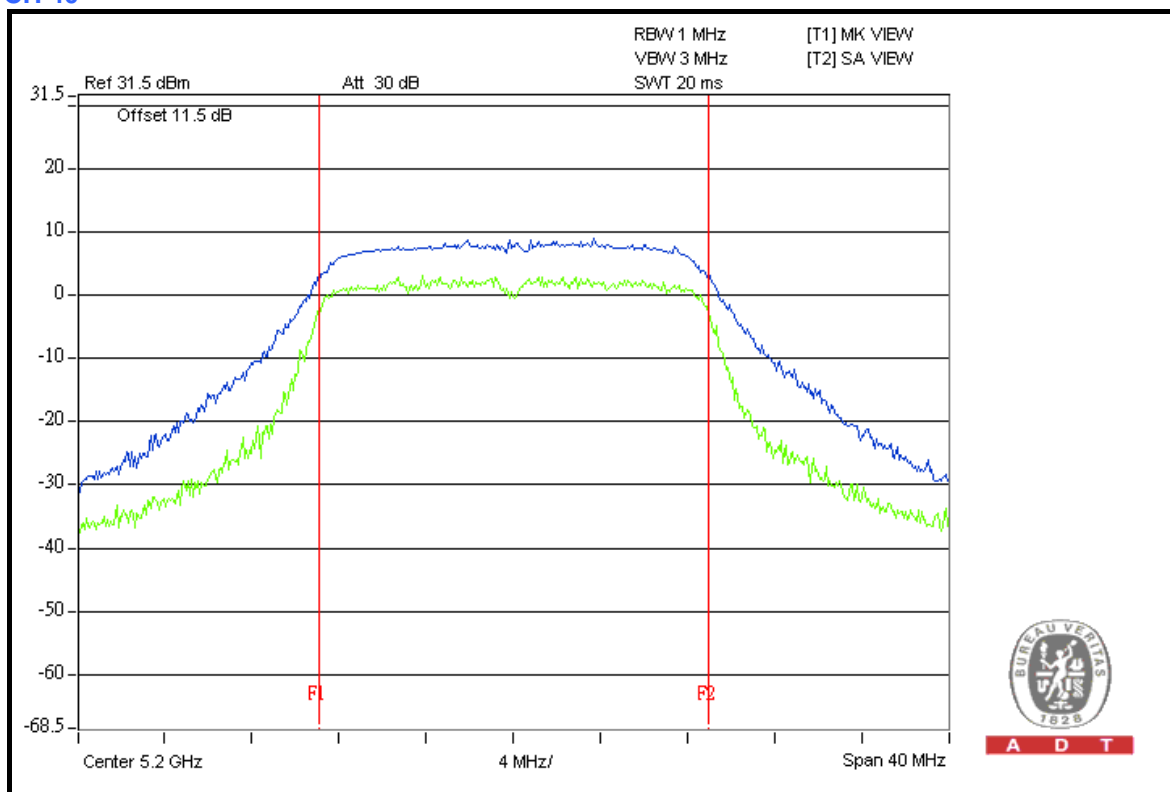

A D T

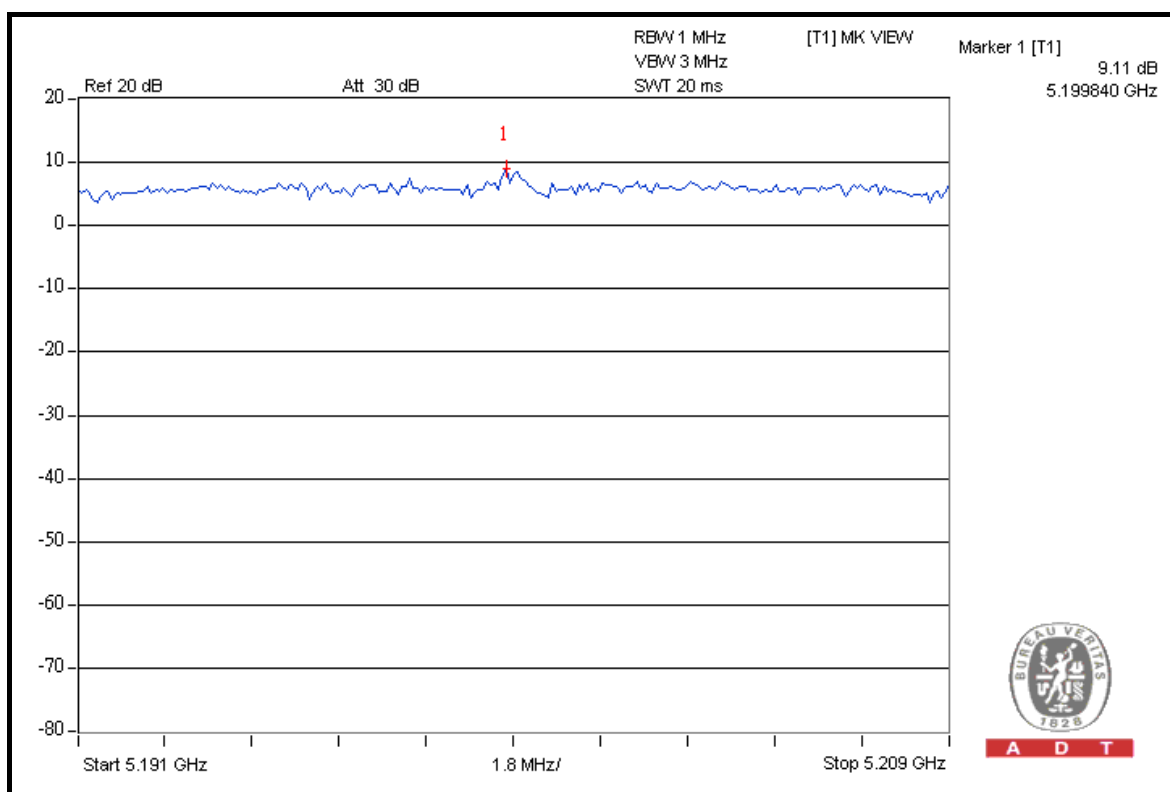

A D T



A D T

CH 48

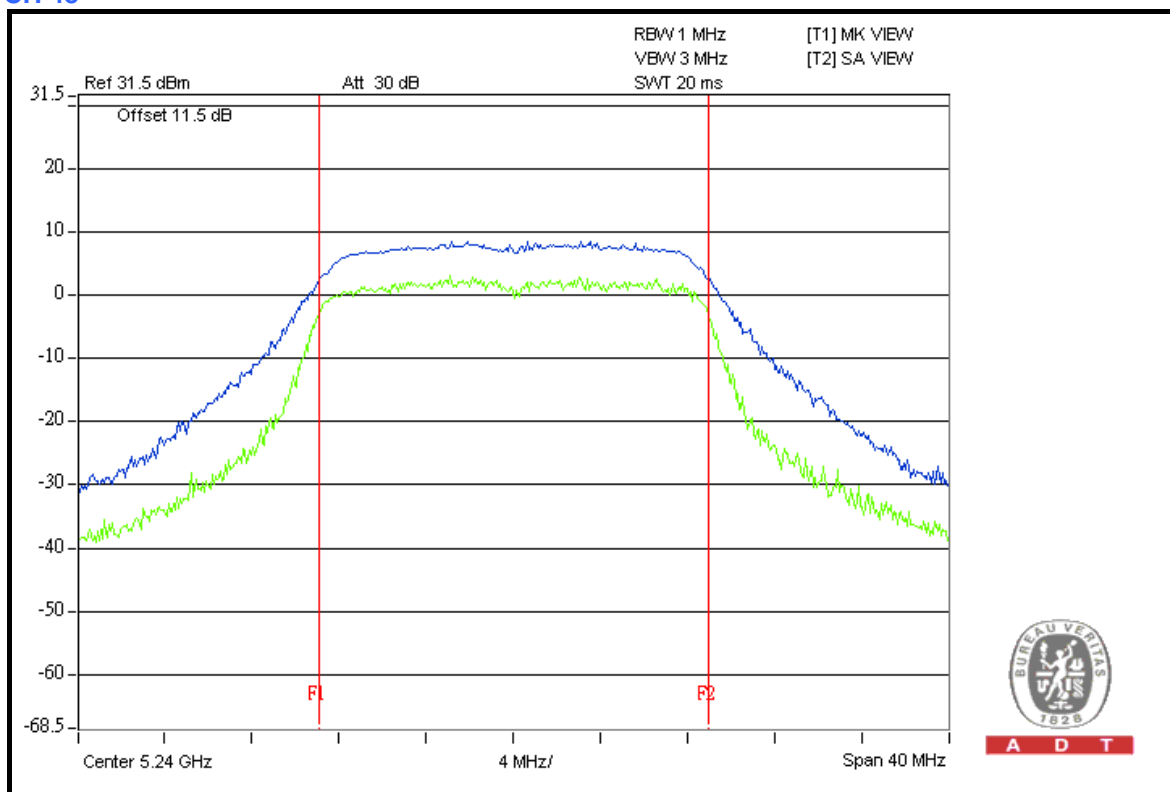

A D T

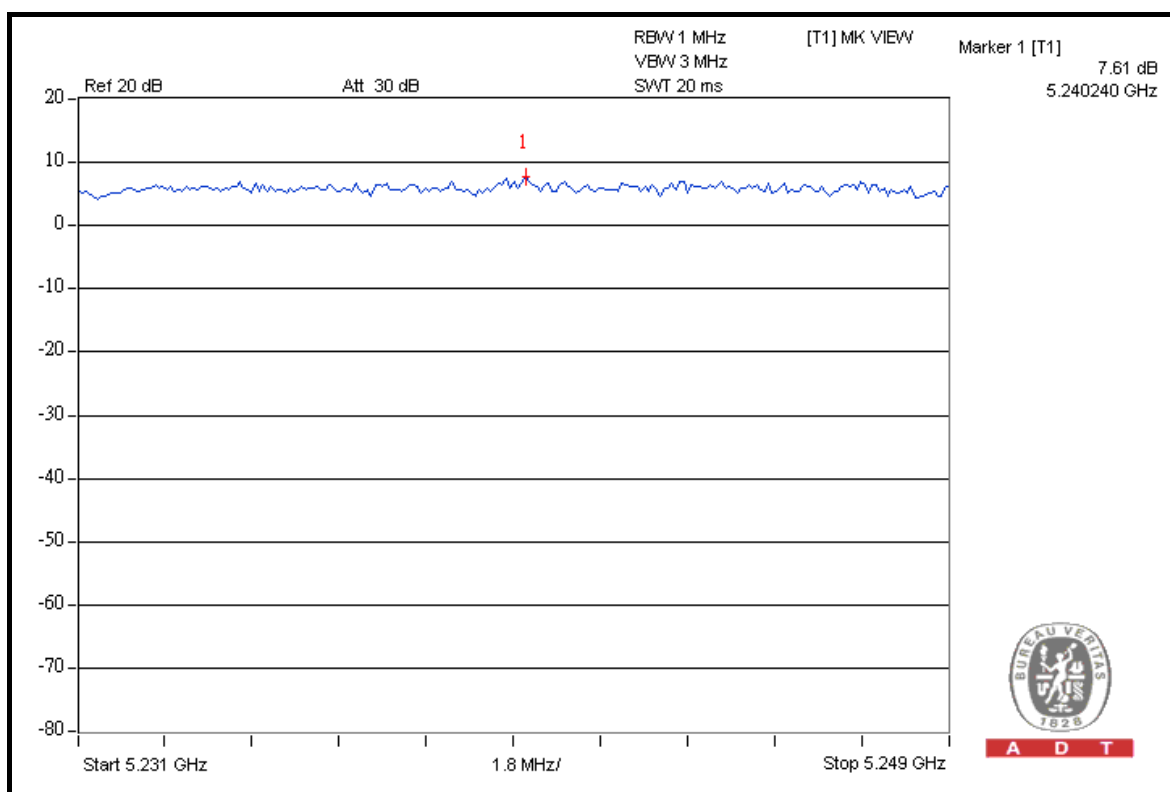

A D T



A D T

CHAIN 2 CH 36

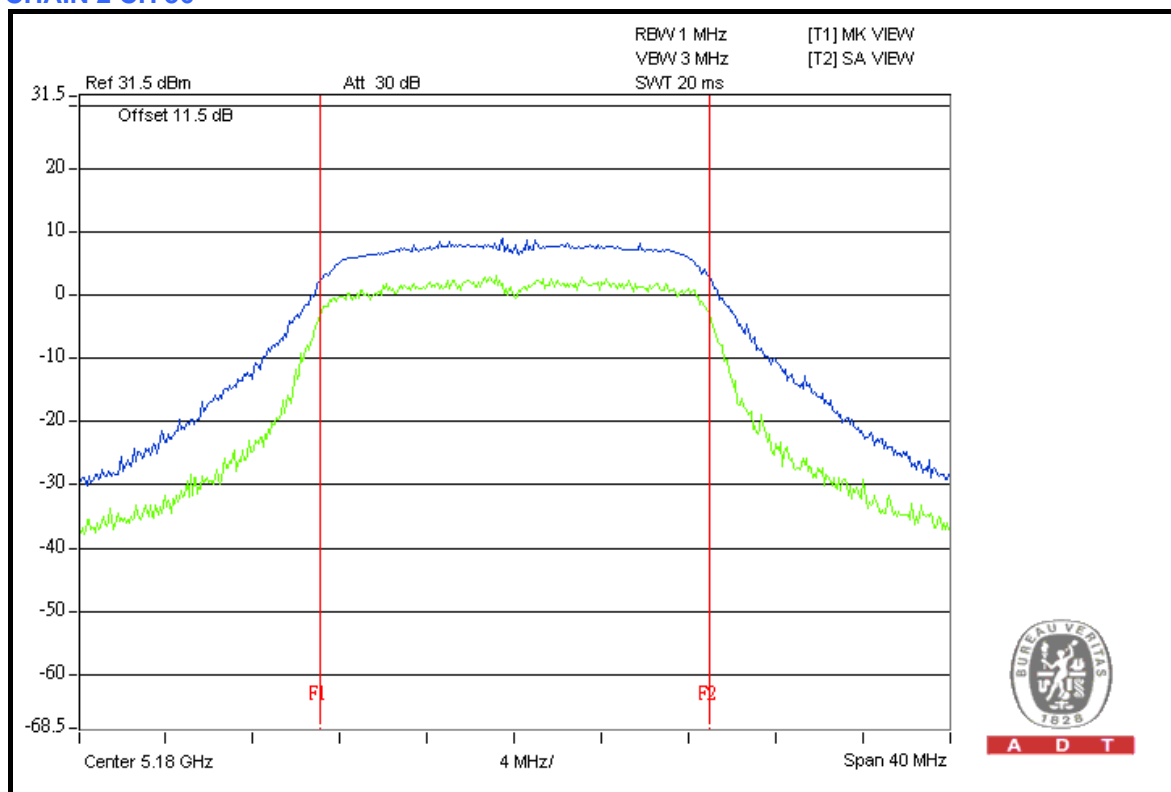

A D T

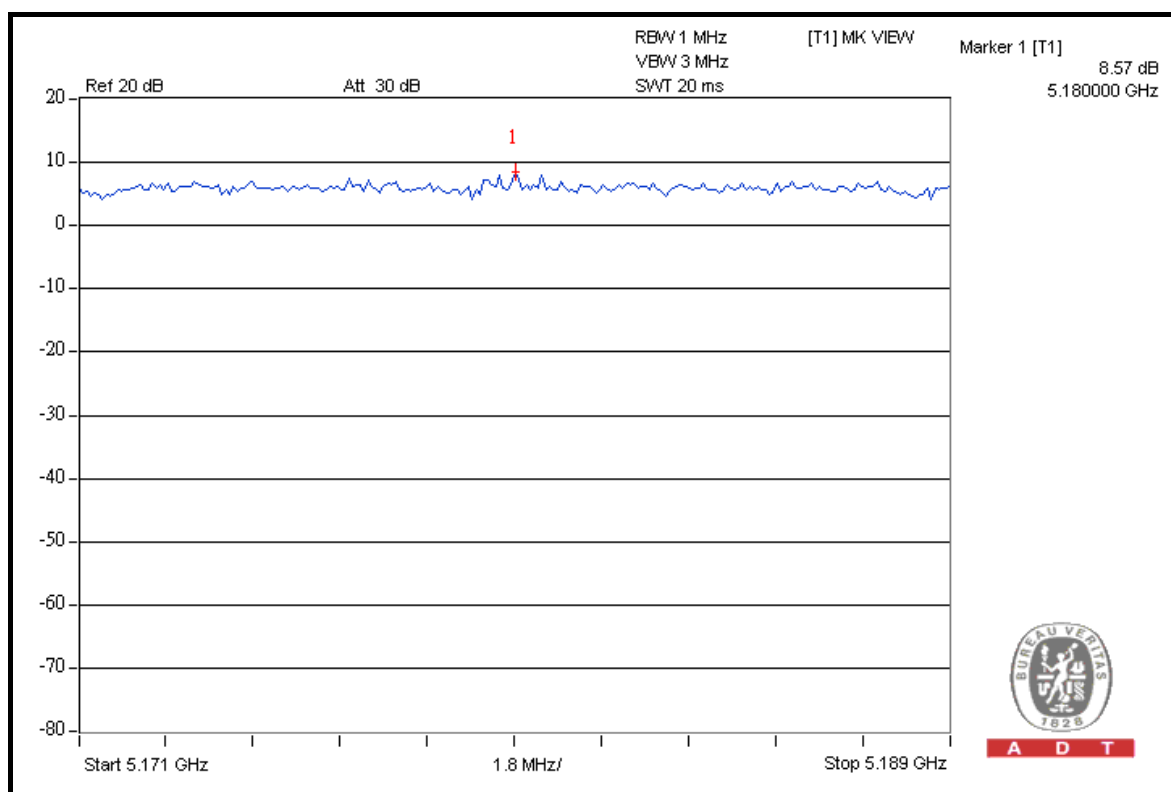

A D T



A D T

CH 40

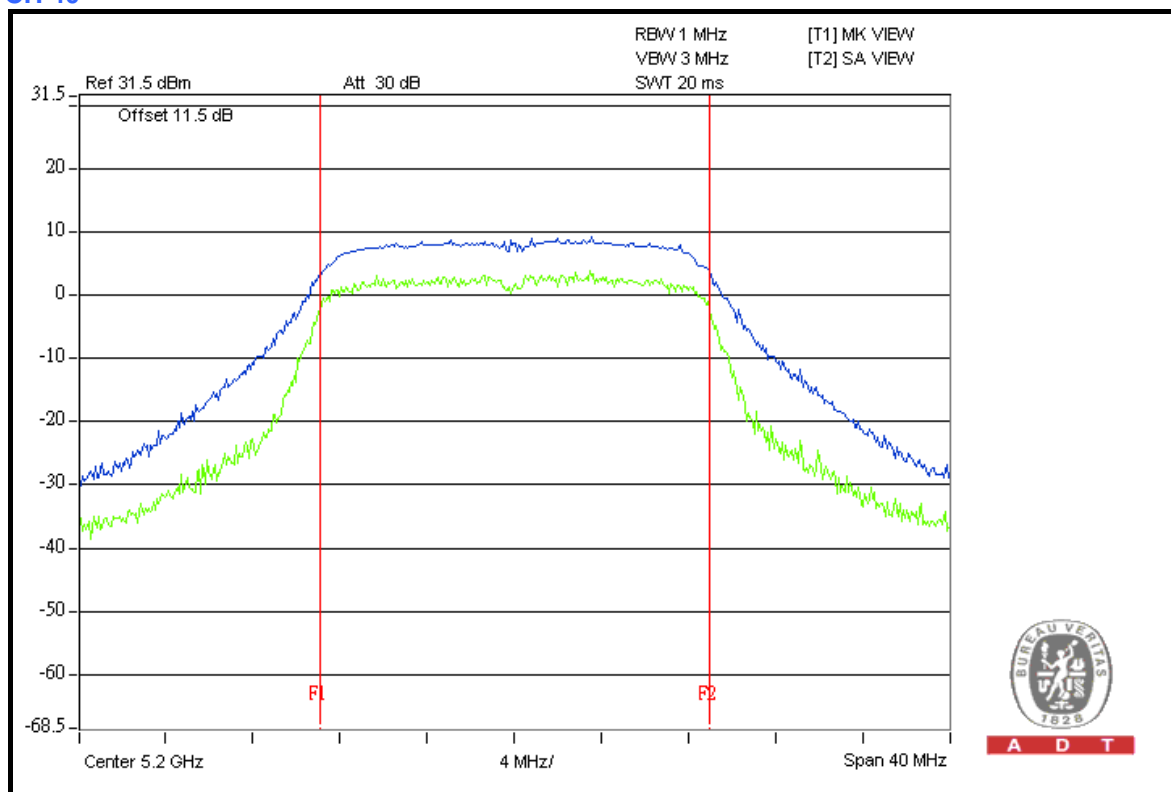

A D T

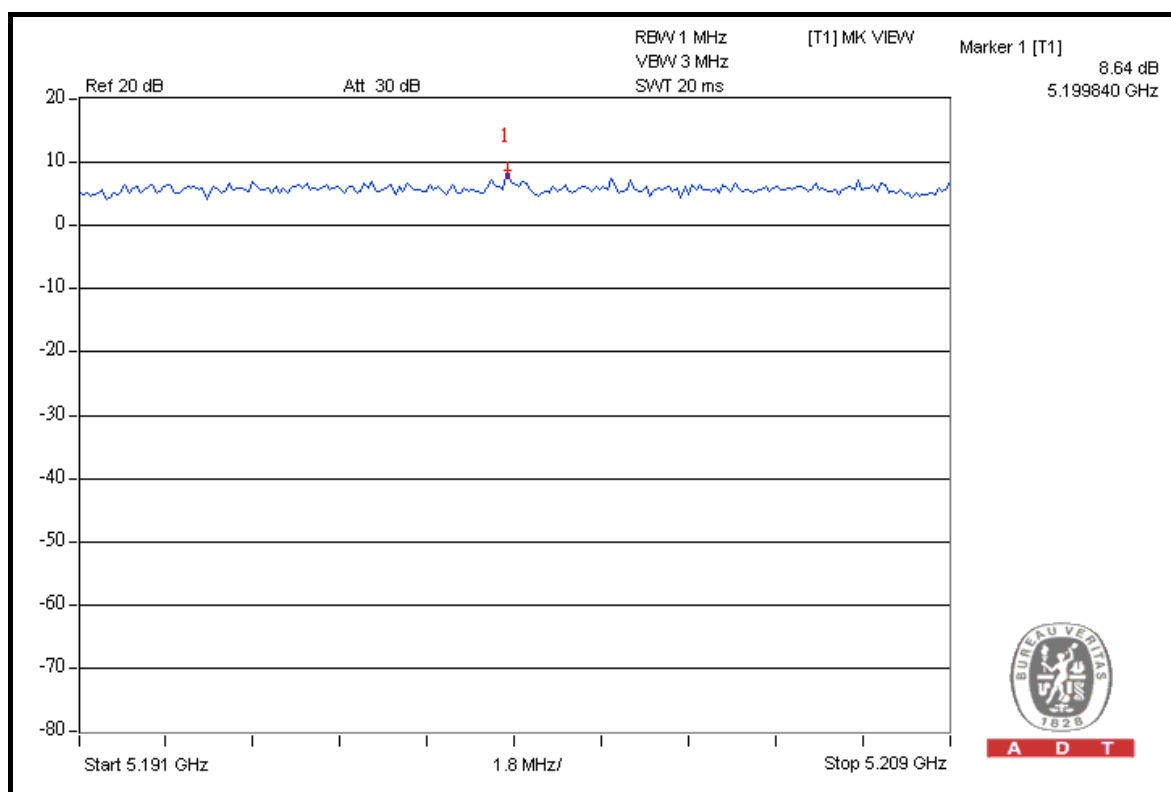

A D T



A D T

CH 48

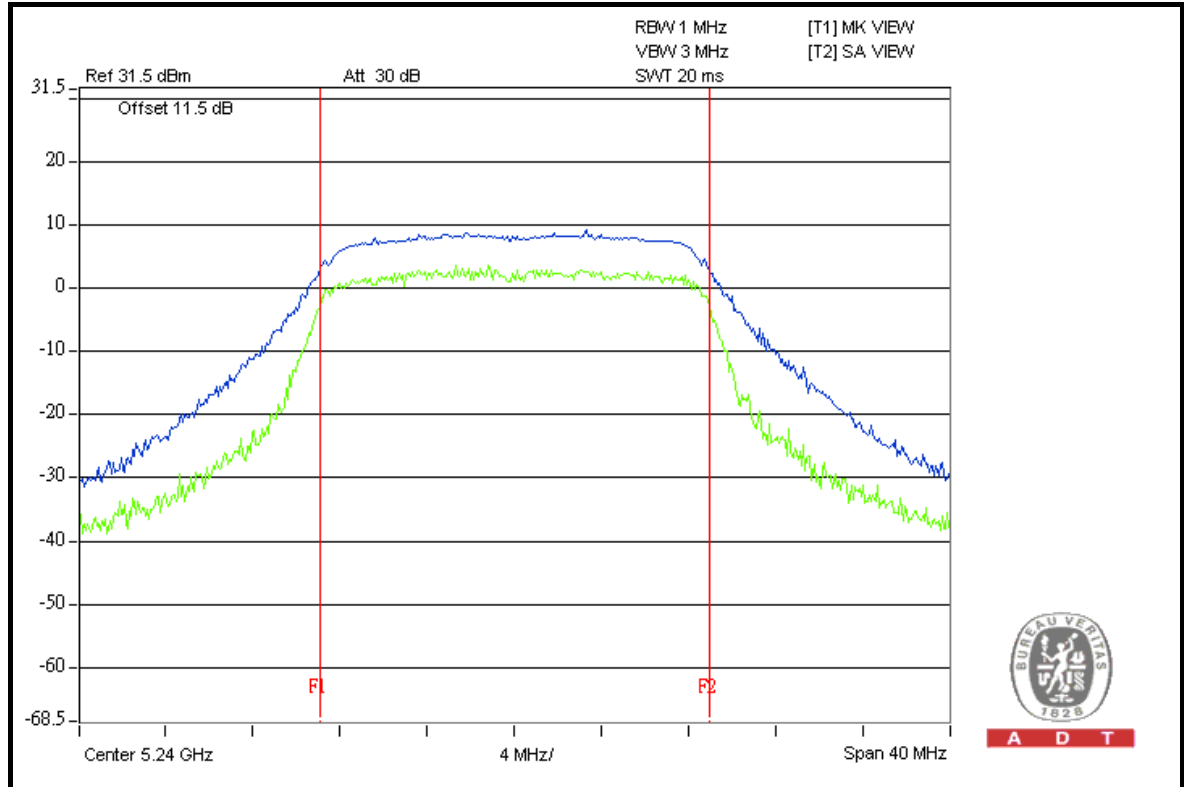

A D T

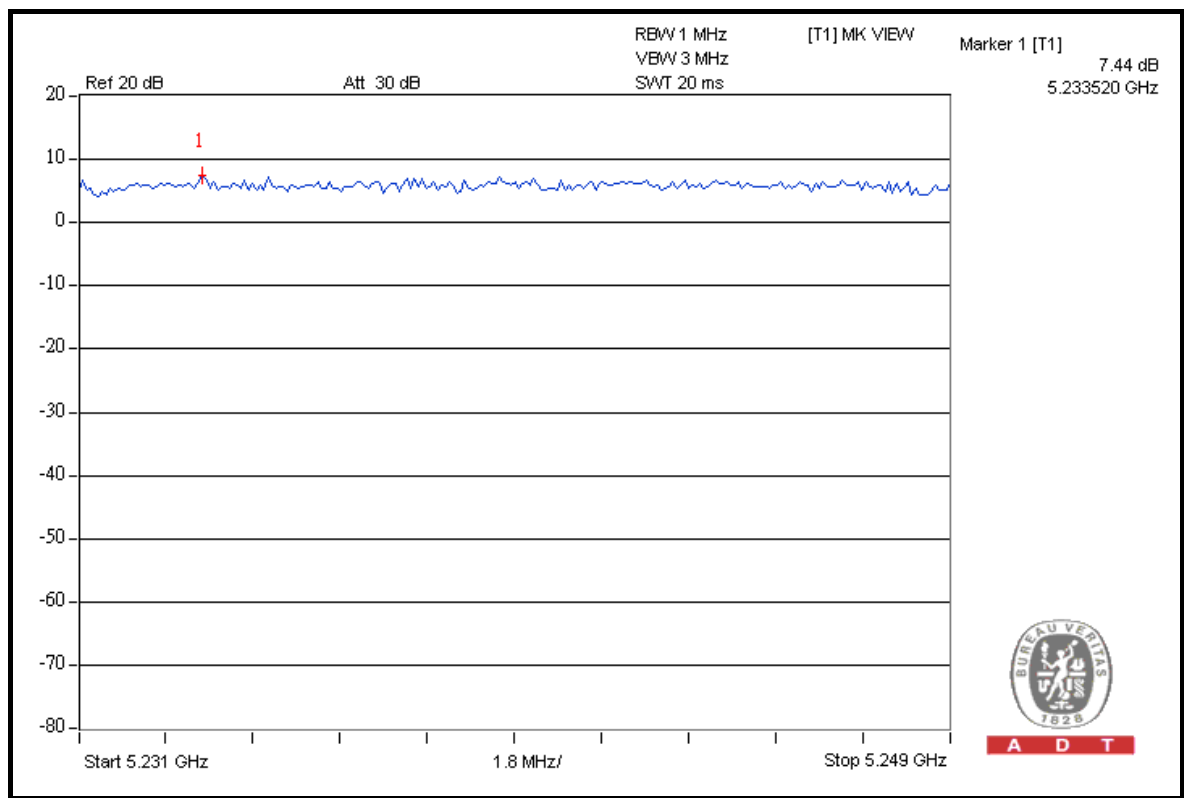

A D T



A D T

DRAFT 802.11n (20MHz) OFDM MODULATION

MODULATION TYPE	BPSK	TRANSFER RATE	6.5Mbps
INPUT POWER (SYSTEM)	120Vac, 60Hz	ENVIRONMENTAL CONDITIONS	25deg.C, 65%RH, 991hPa
TESTED BY	Brad Wu	TEST MODE	C

CHANNEL	CHANNEL FREQUENCY (MHz)	PEAK POWER EXCURSION (dB)		PEAK TO AVERAGE EXCURSION LIMIT (dB)	PASS/FAIL
		CHAIN 0	CHAIN 1		
36	5180	9.28	7.65	13	PASS
40	5200	9.07	8.09	13	PASS
48	5240	8.88	8.30	13	PASS



A D T

CHAIN 0 CH 36

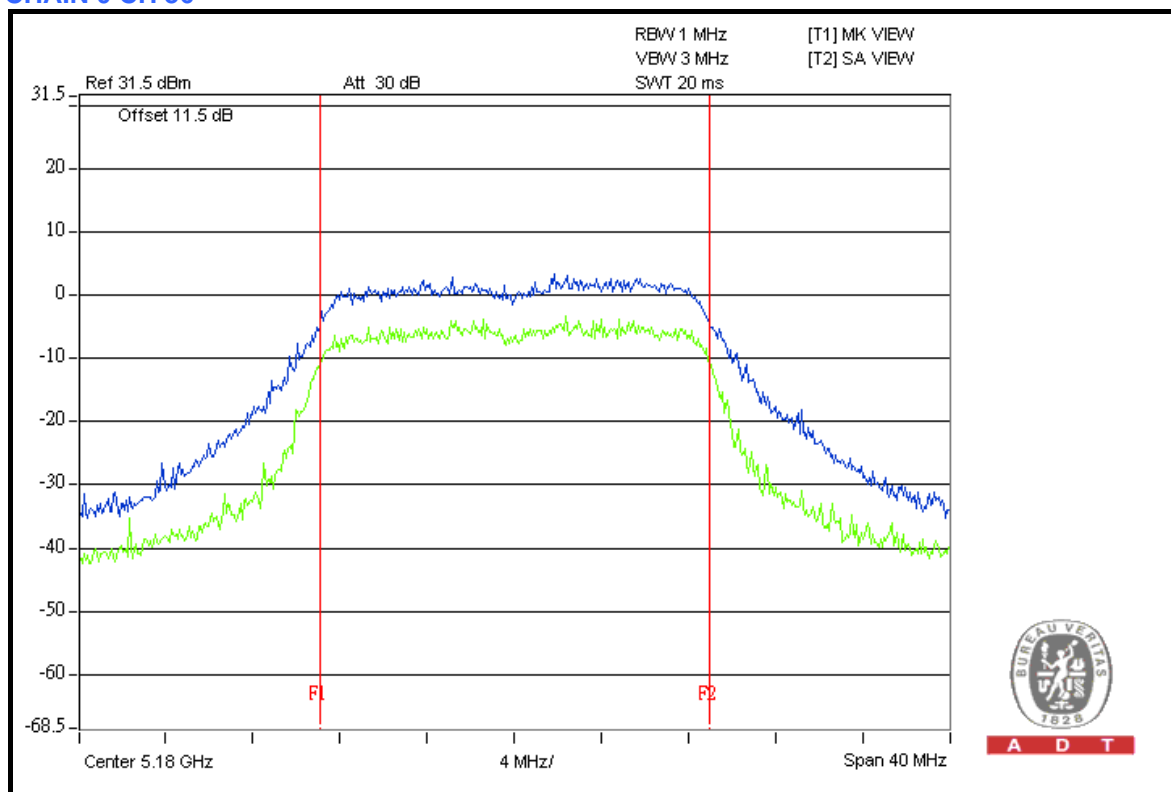

A D T

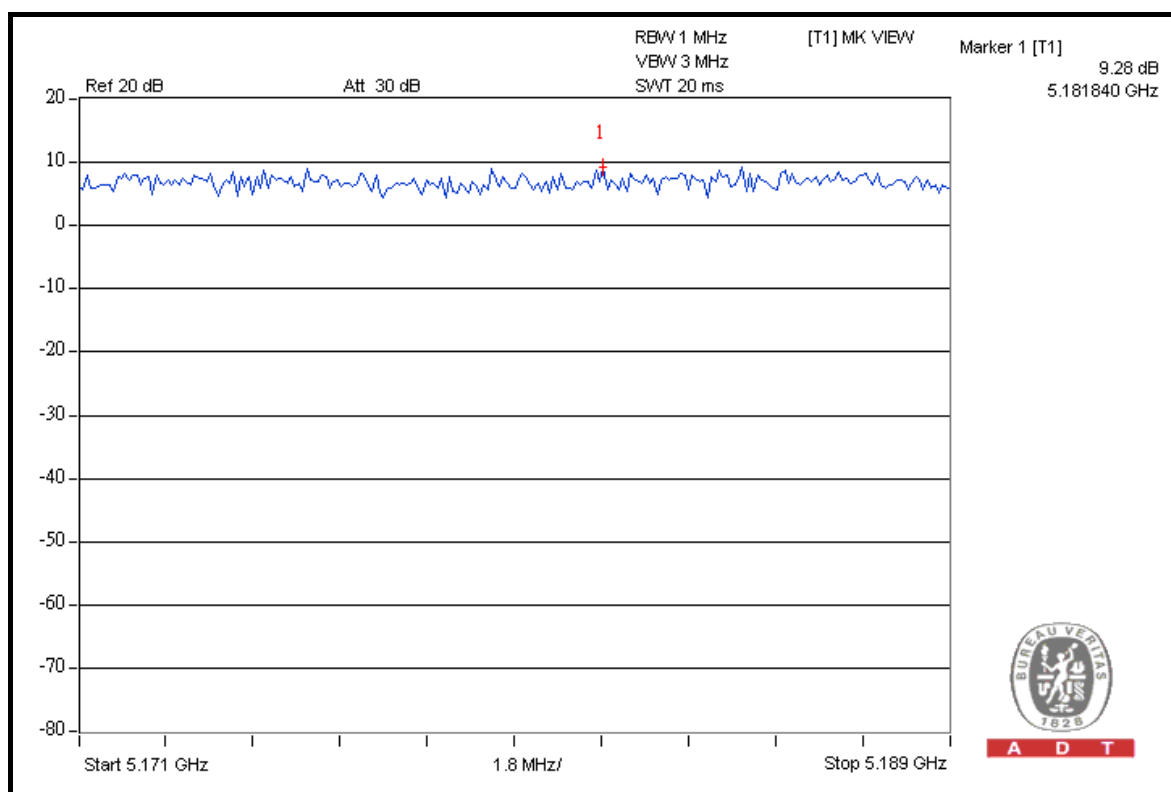

A D T



A D T

CH 40

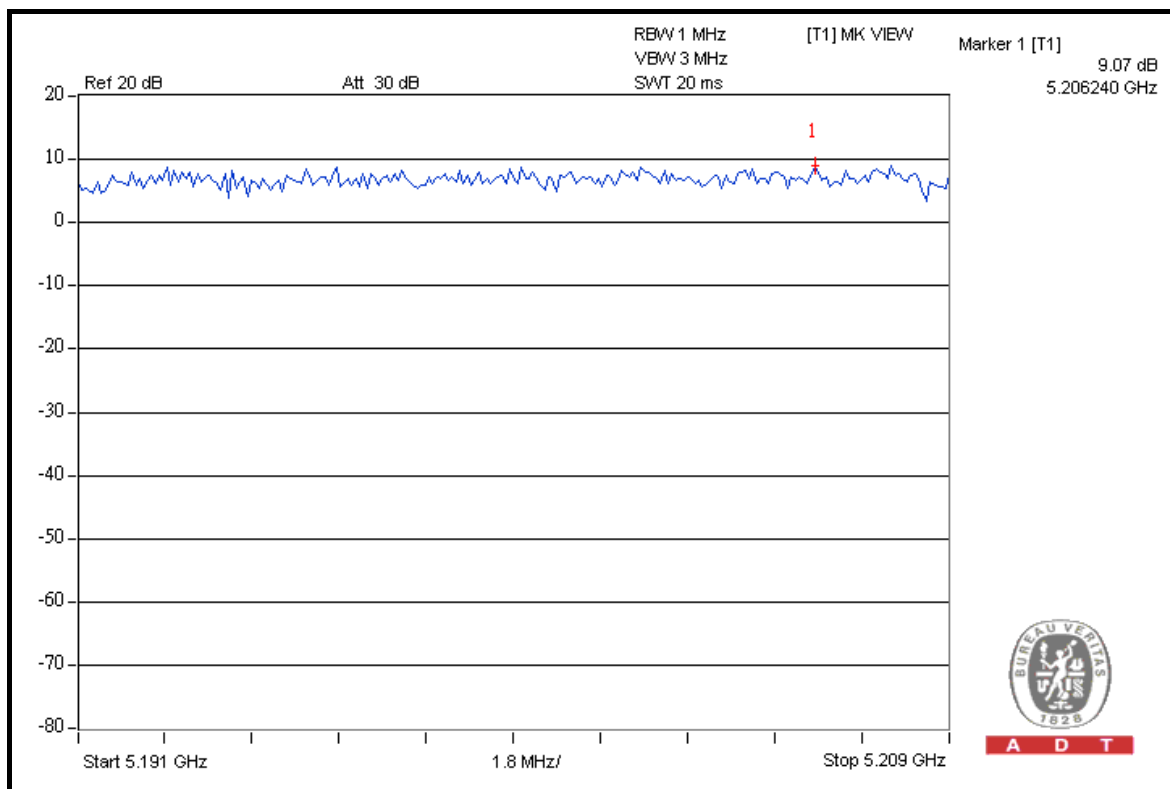
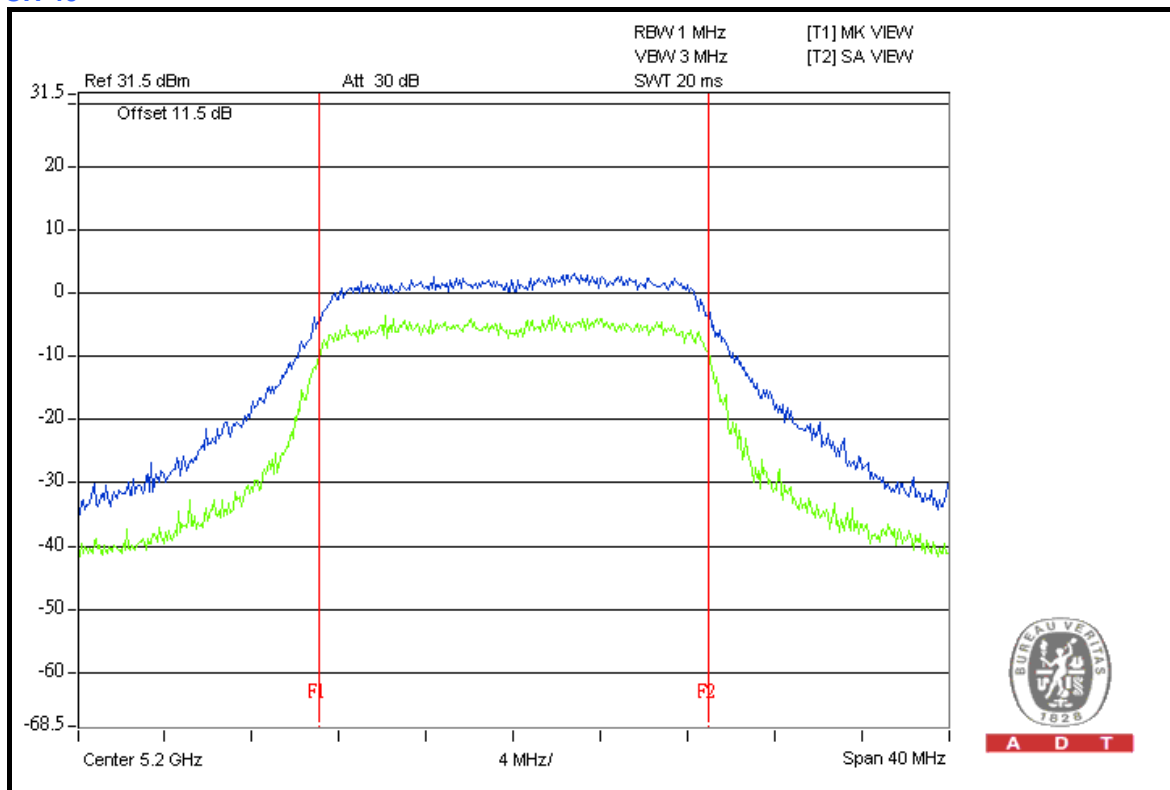



A D T

CH 48

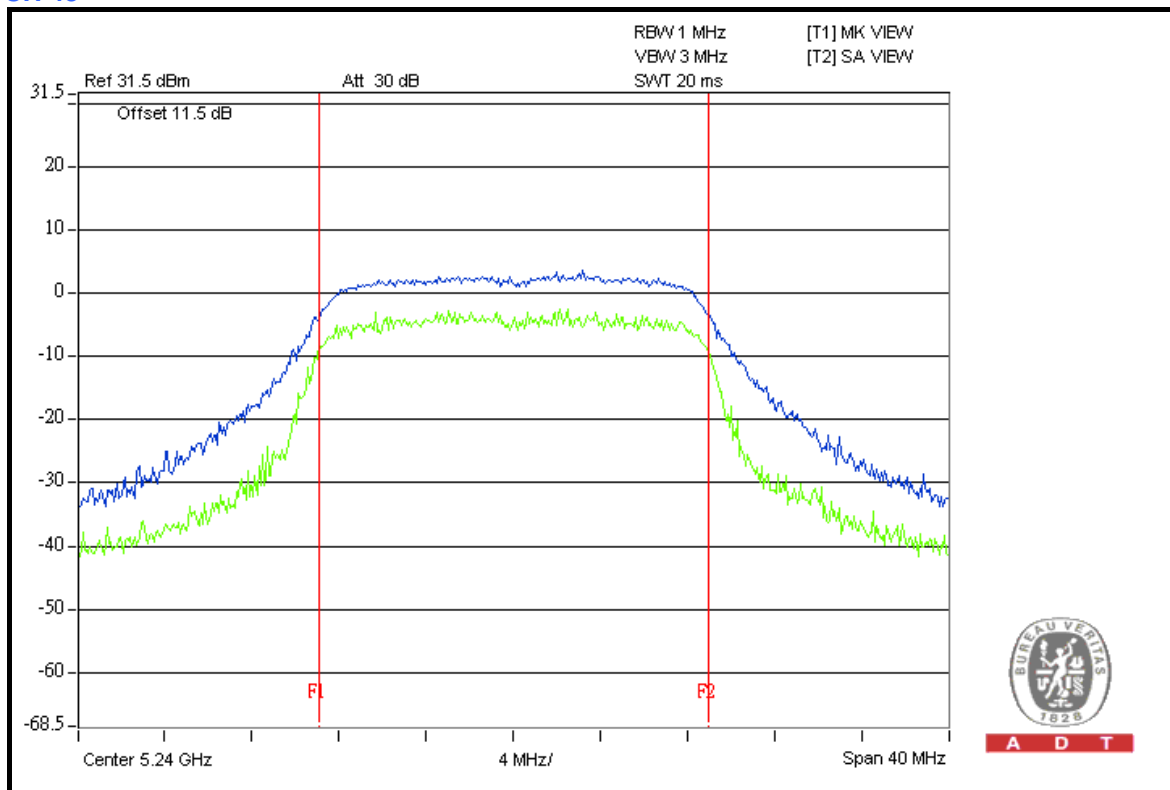

A D T

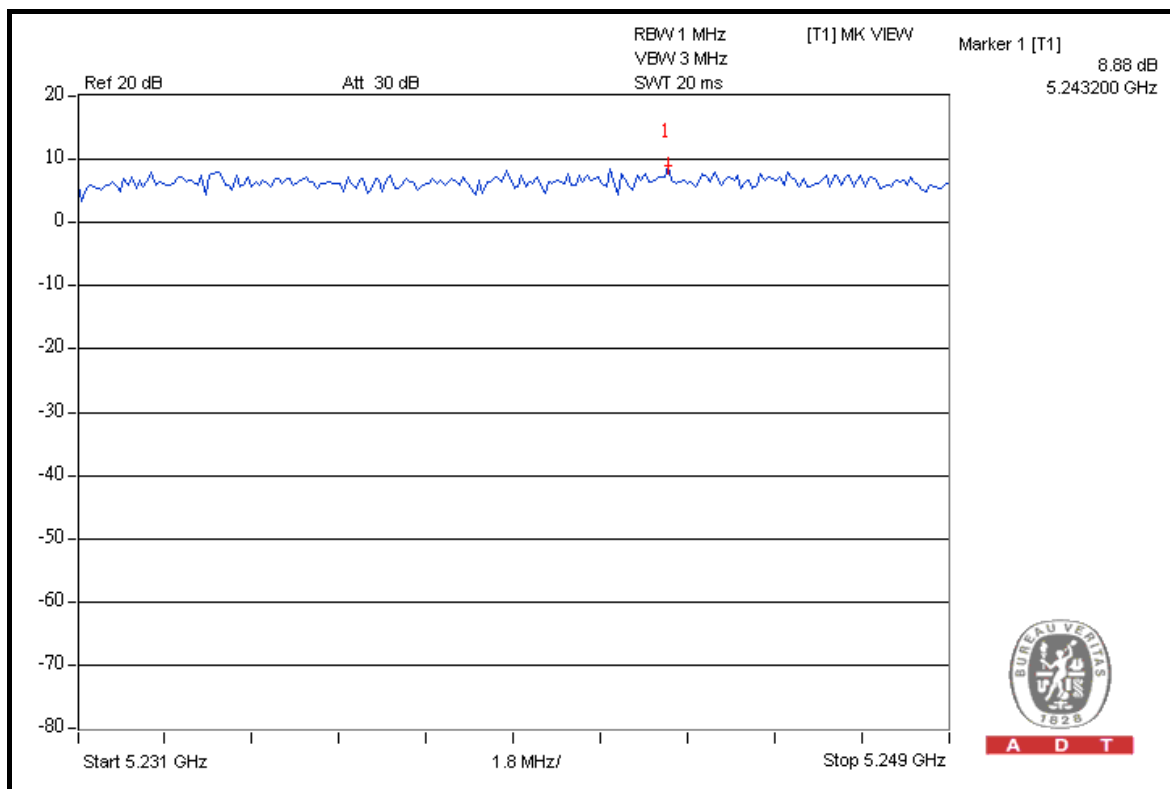

A D T



A D T

CHAIN 1 CH 36

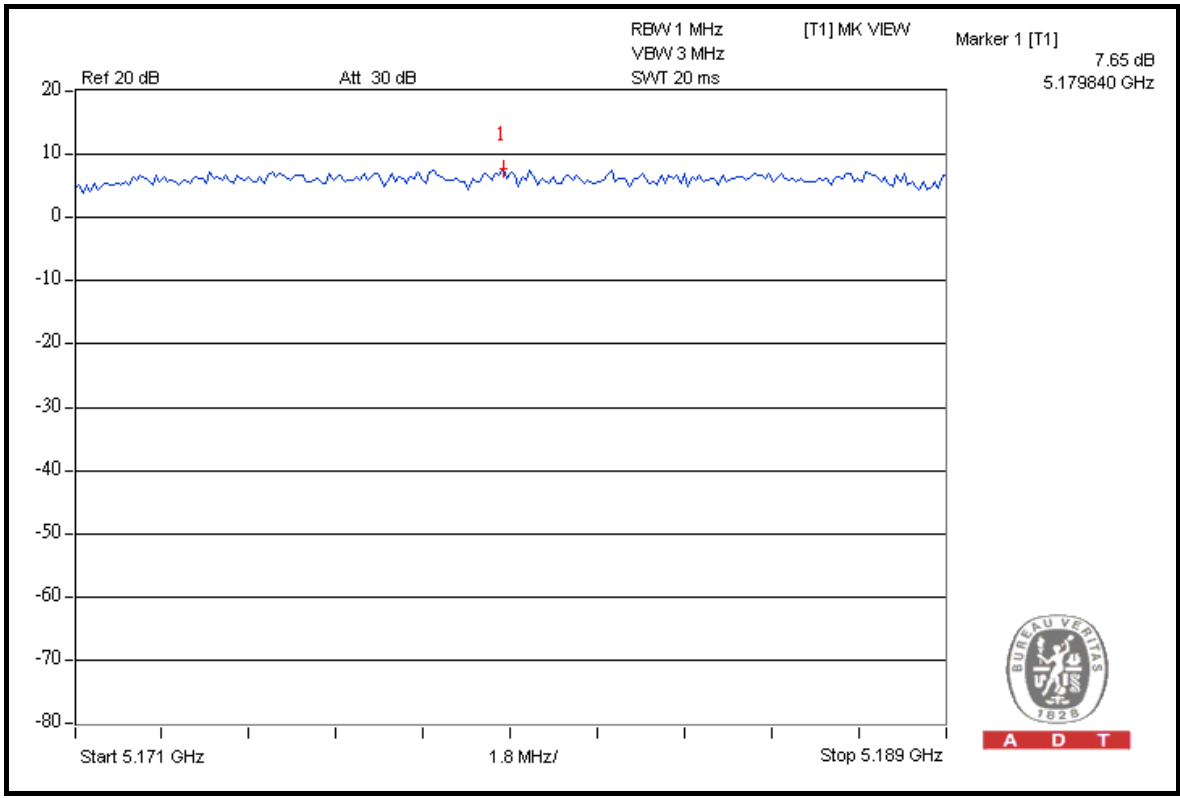
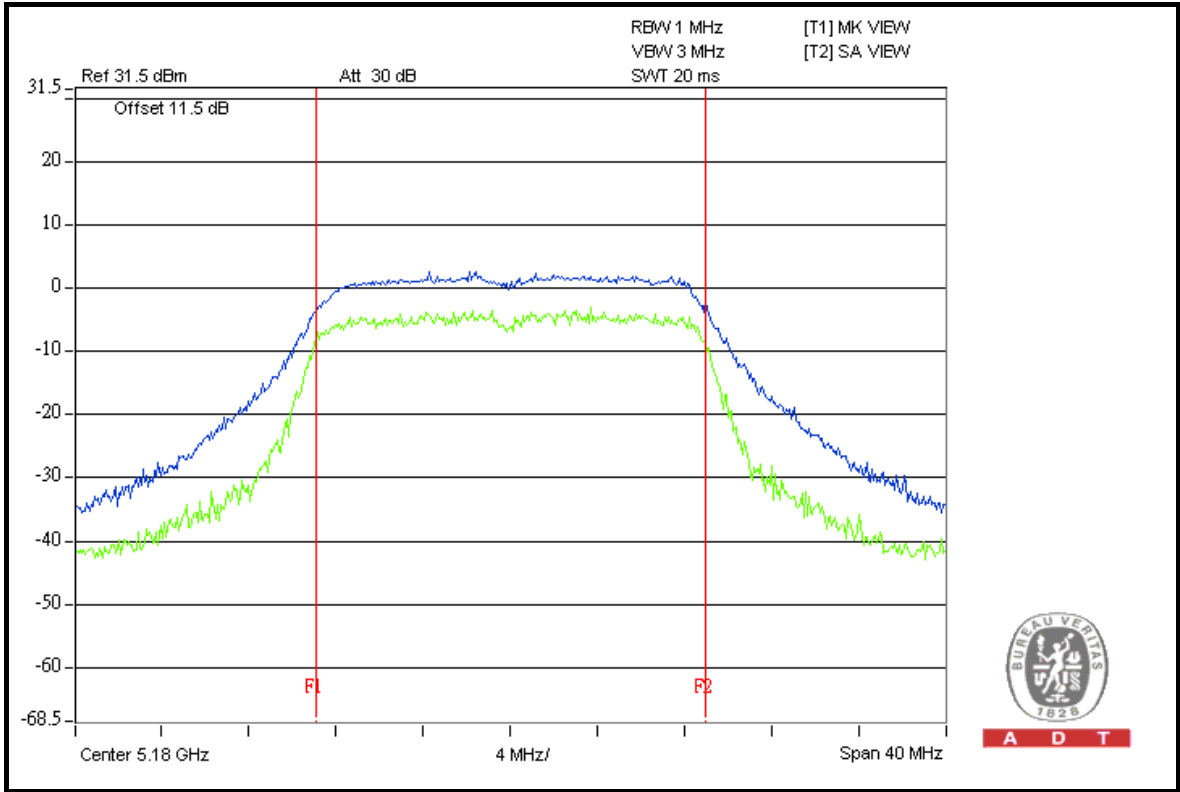



A D T

CH 40

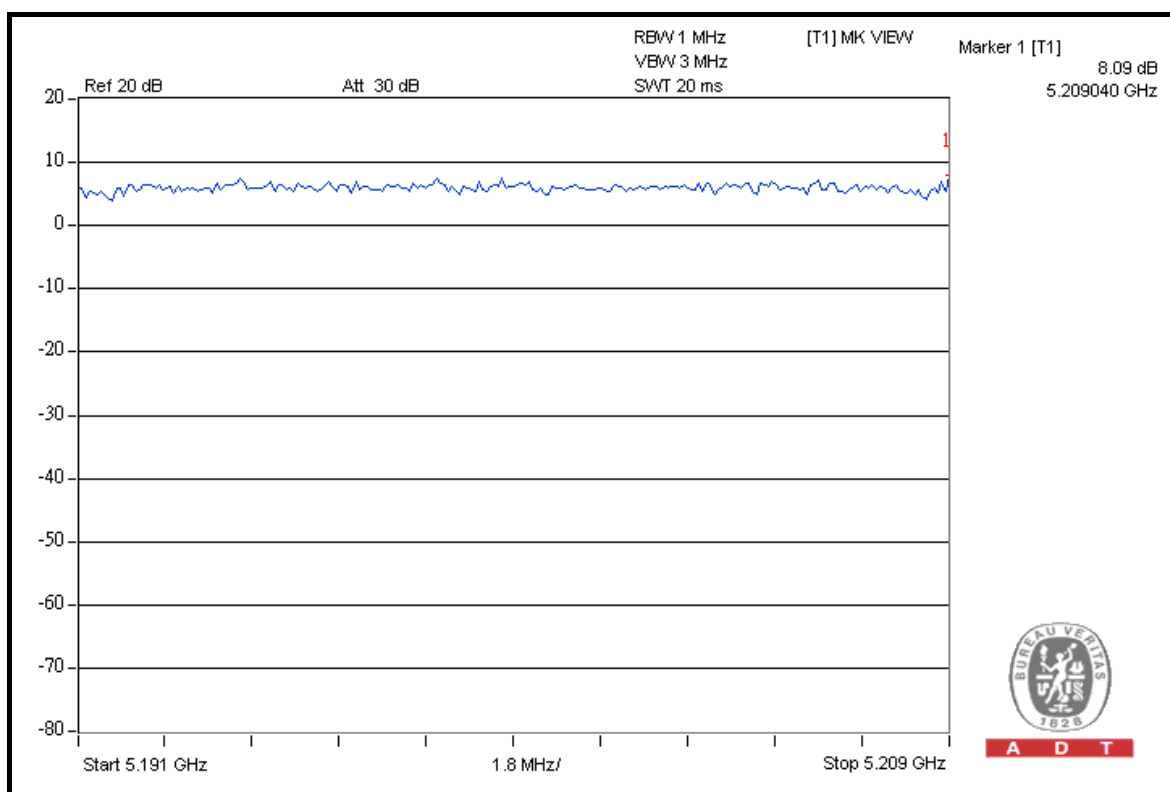
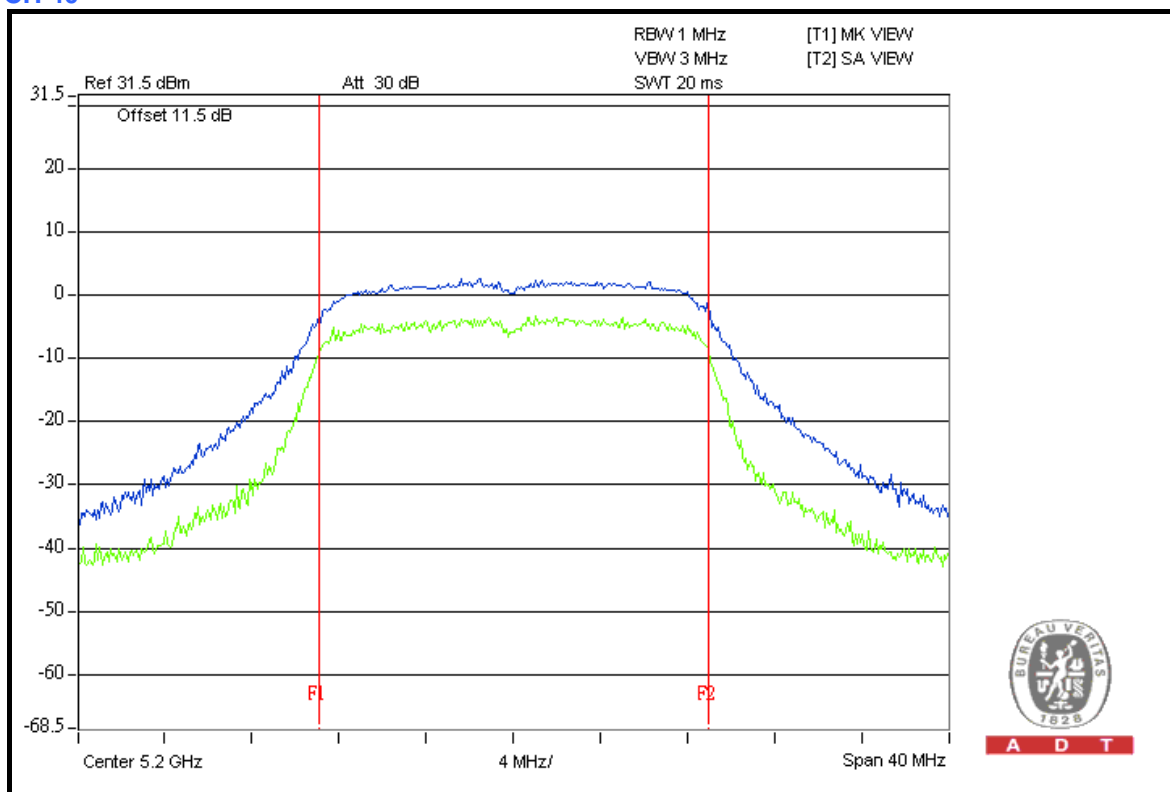



A D T

CH 48

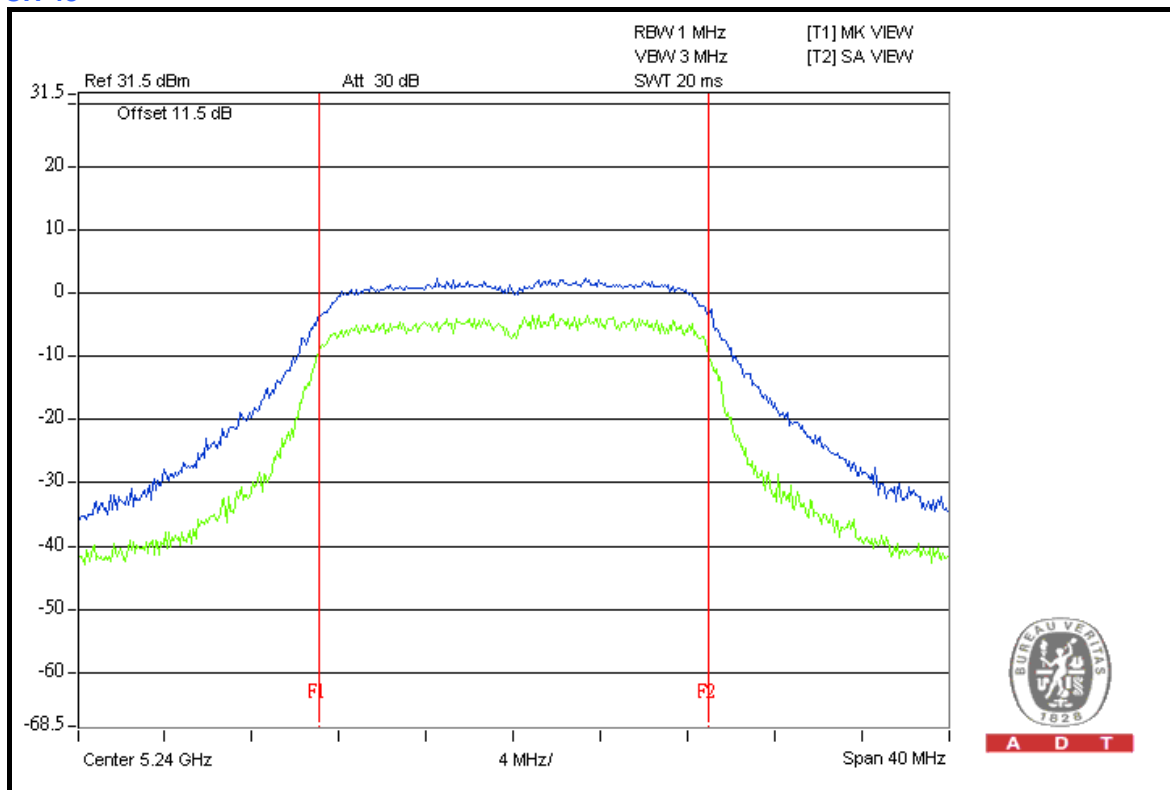

A D T

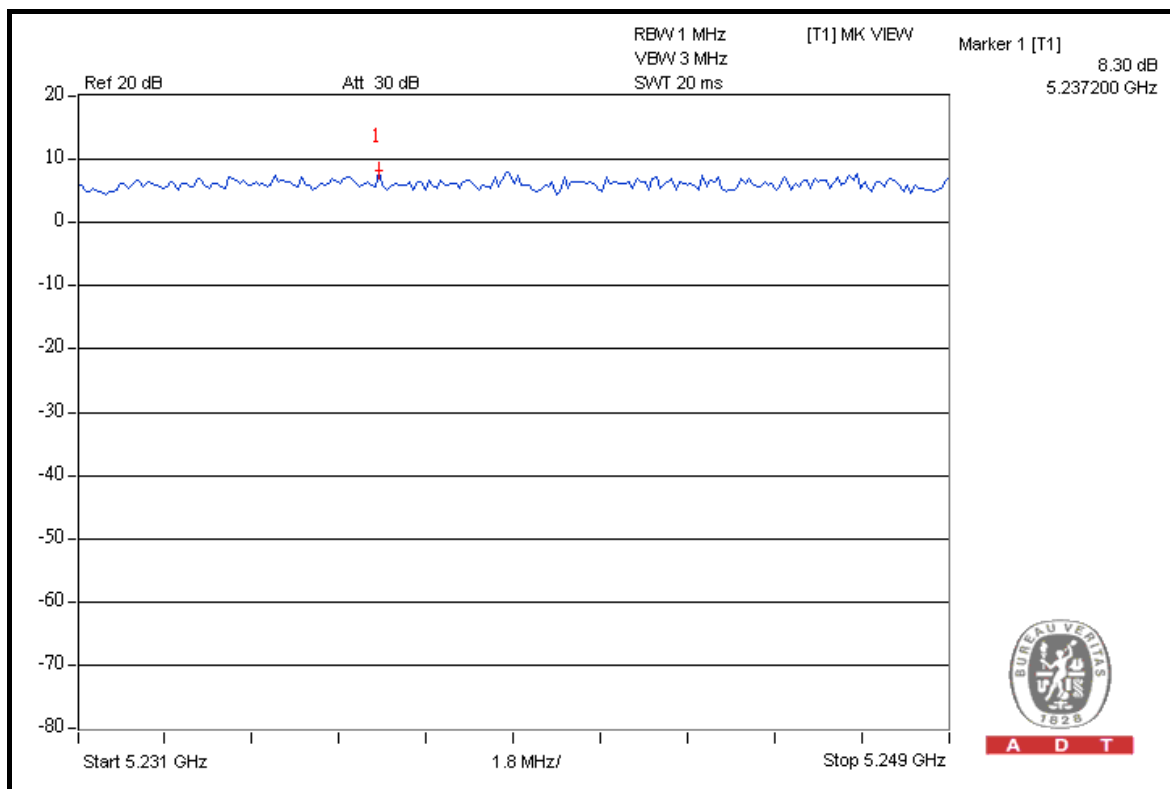

A D T



A D T

DRAFT 802.11n (40MHz) OFDM MODULATION

MODULATION TYPE	BPSK	TRANSFER RATE	13.5Mbps
INPUT POWER (SYSTEM)	120Vac, 60Hz	ENVIRONMENTAL CONDITIONS	25deg.C, 65%RH, 991hPa
TESTED BY	Brad Wu	TEST MODE	A

CHANNEL	CHANNEL FREQUENCY (MHz)	PEAK POWER EXCURSION (dB)			PEAK to AVERAGE EXCURSION LIMIT (dB)	PASS/FAIL
		CHAIN 0	CHAIN 1	CHAIN2		
38	5190	9.53	9.19	8.35	13	PASS
46	5230	8.32	9.03	9.60	13	PASS



A D T

CHAIN 0 CH 38

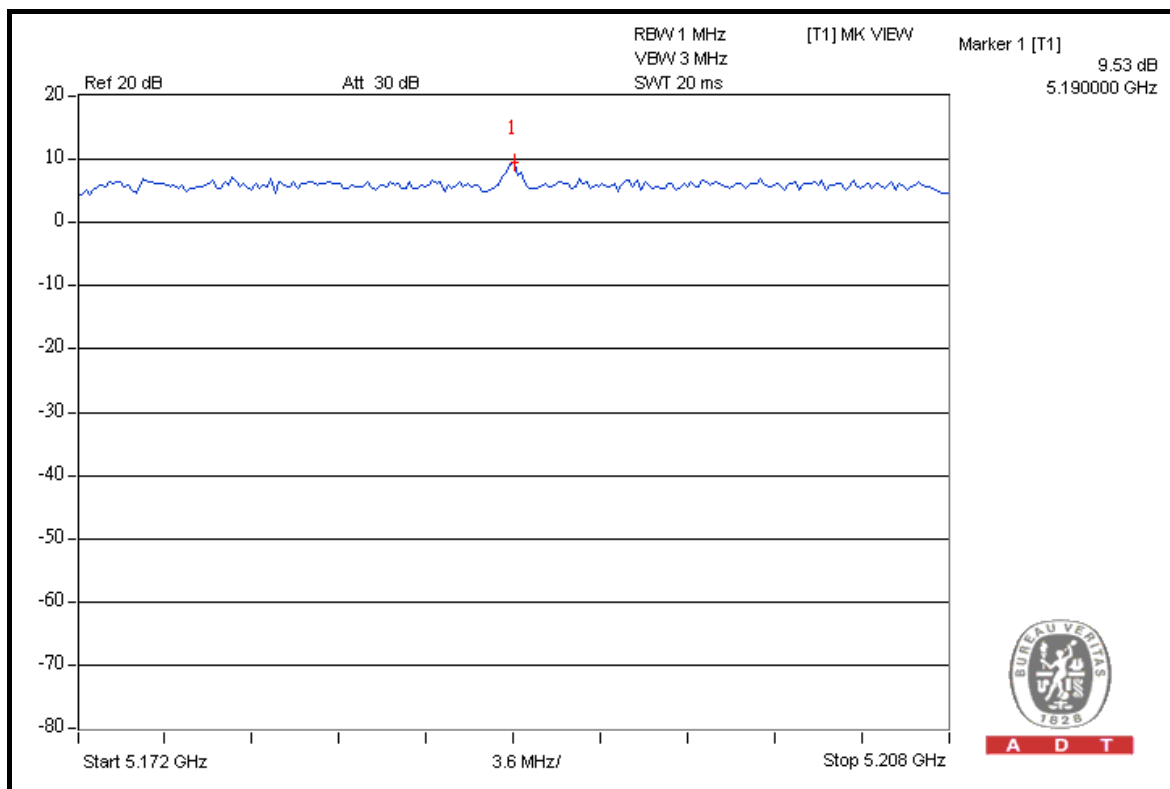
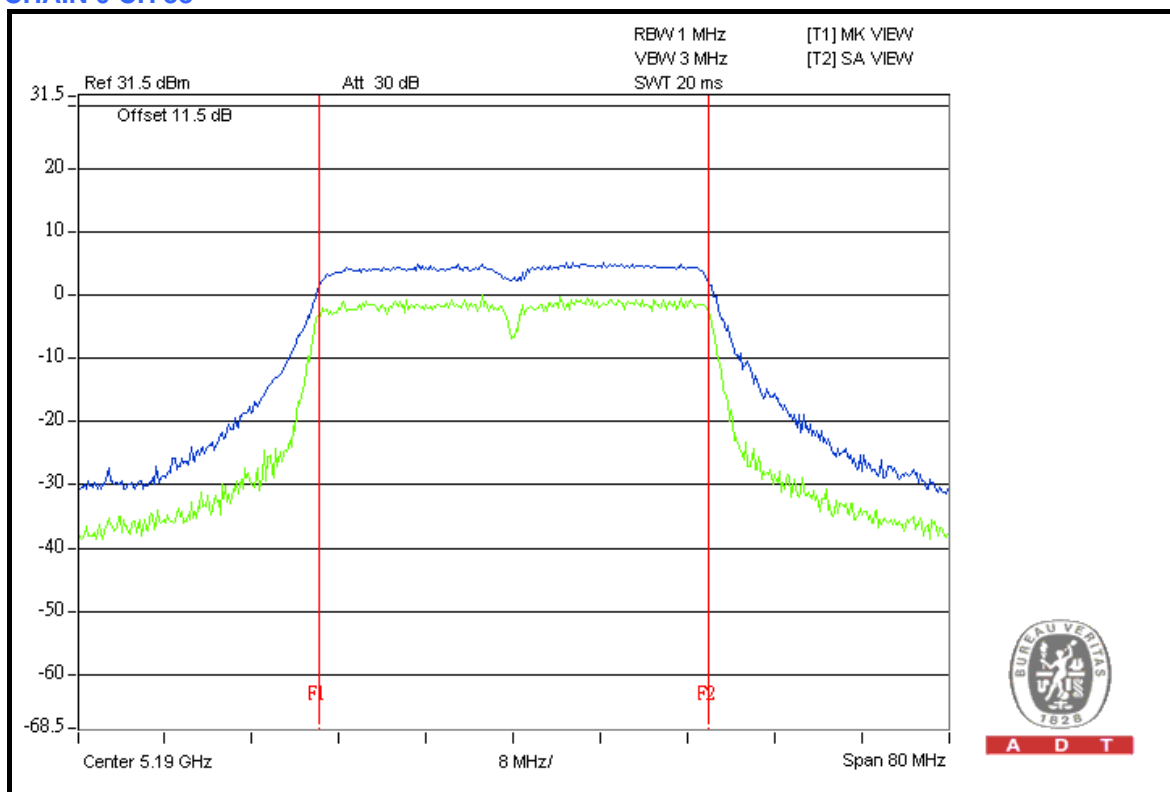



A D T

CH 46

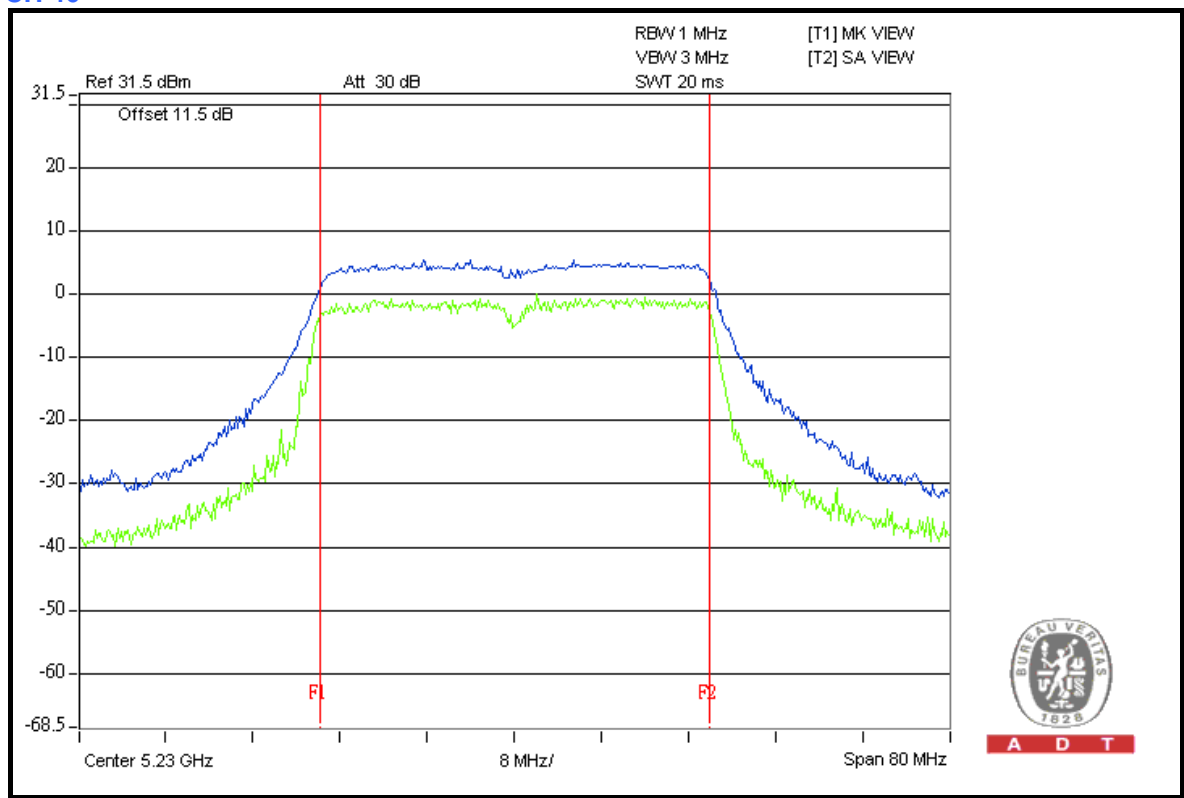

A D T

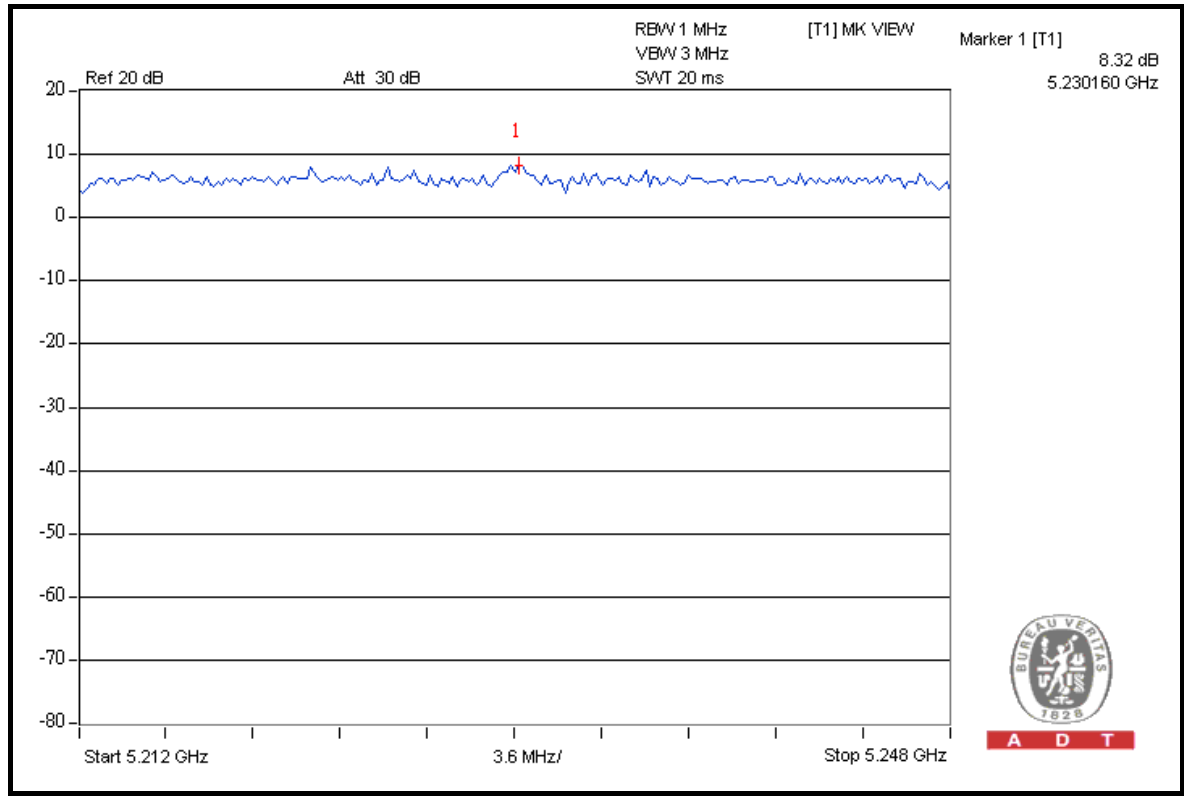

A D T



A D T

CHAIN 1 CH 38

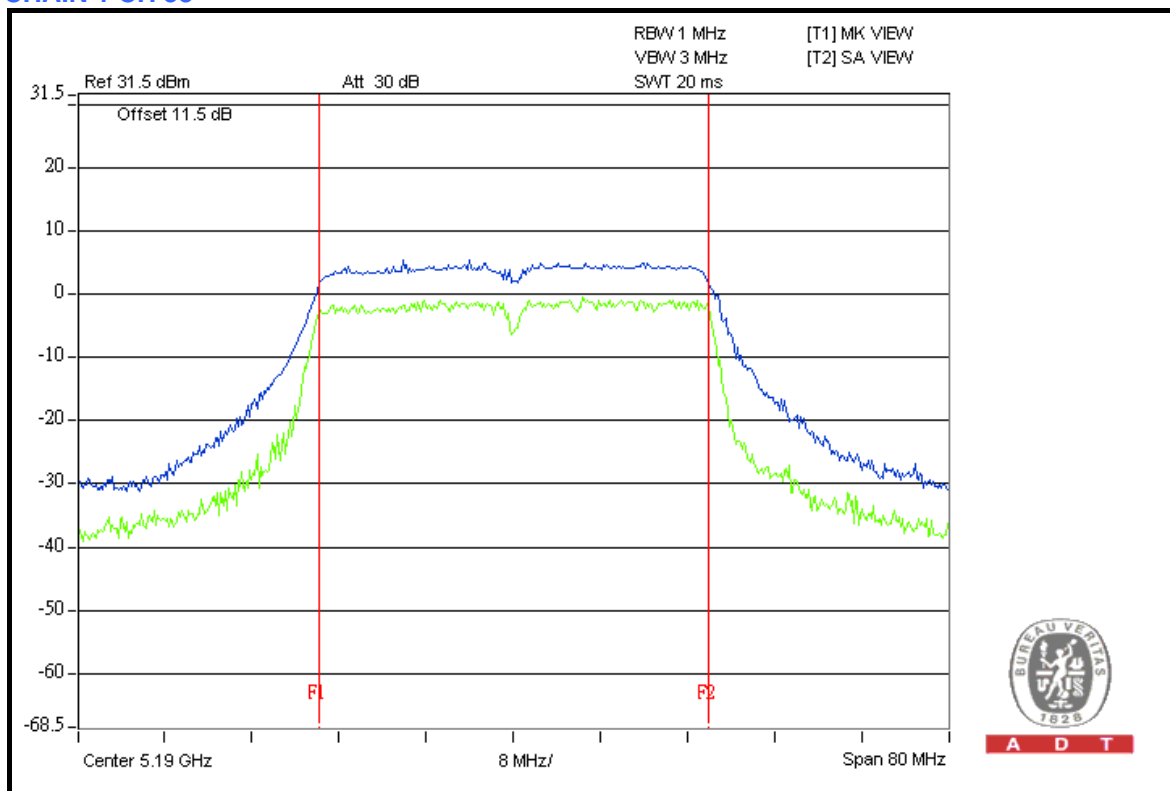

A D T

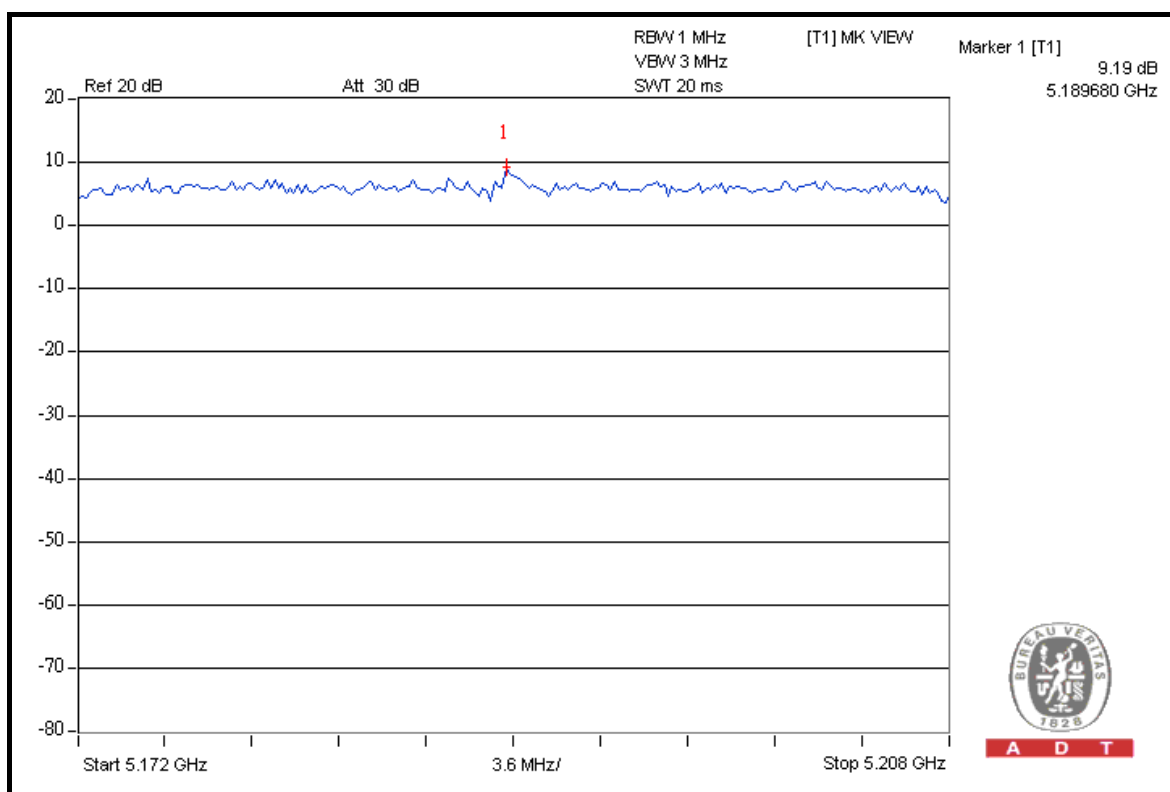

A D T



A D T

CH 46

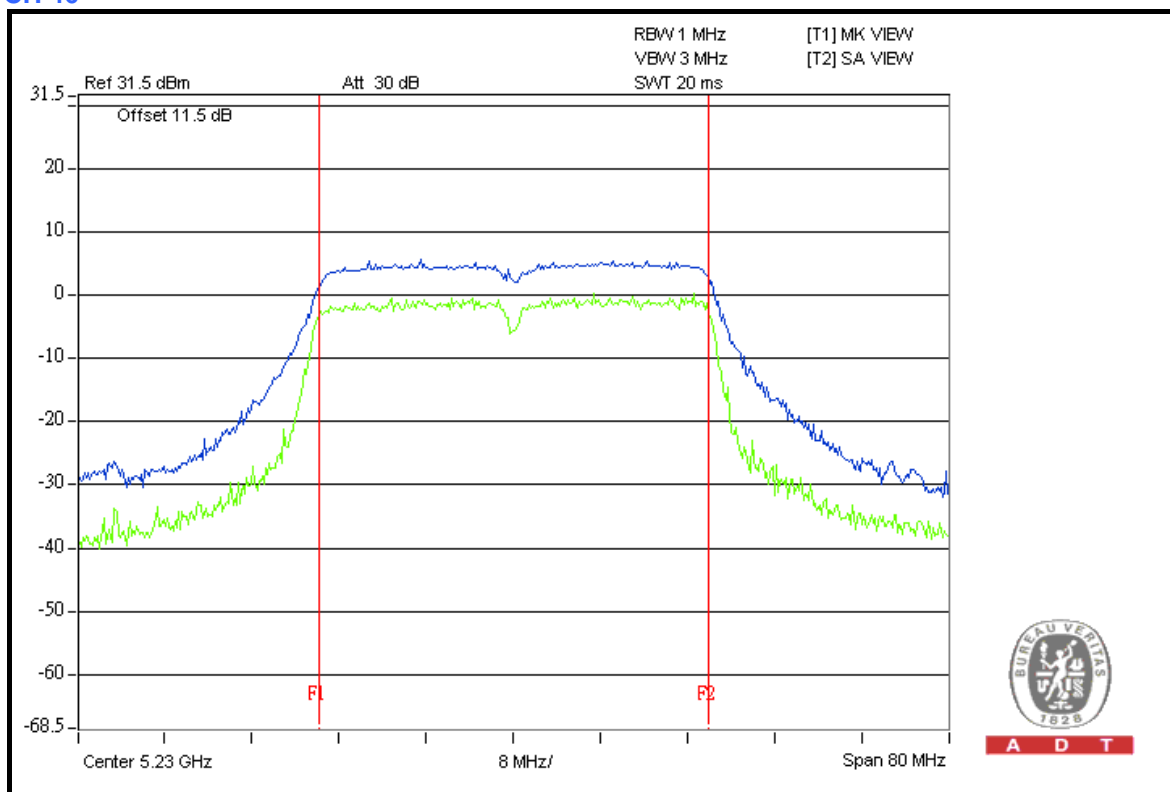

A D T

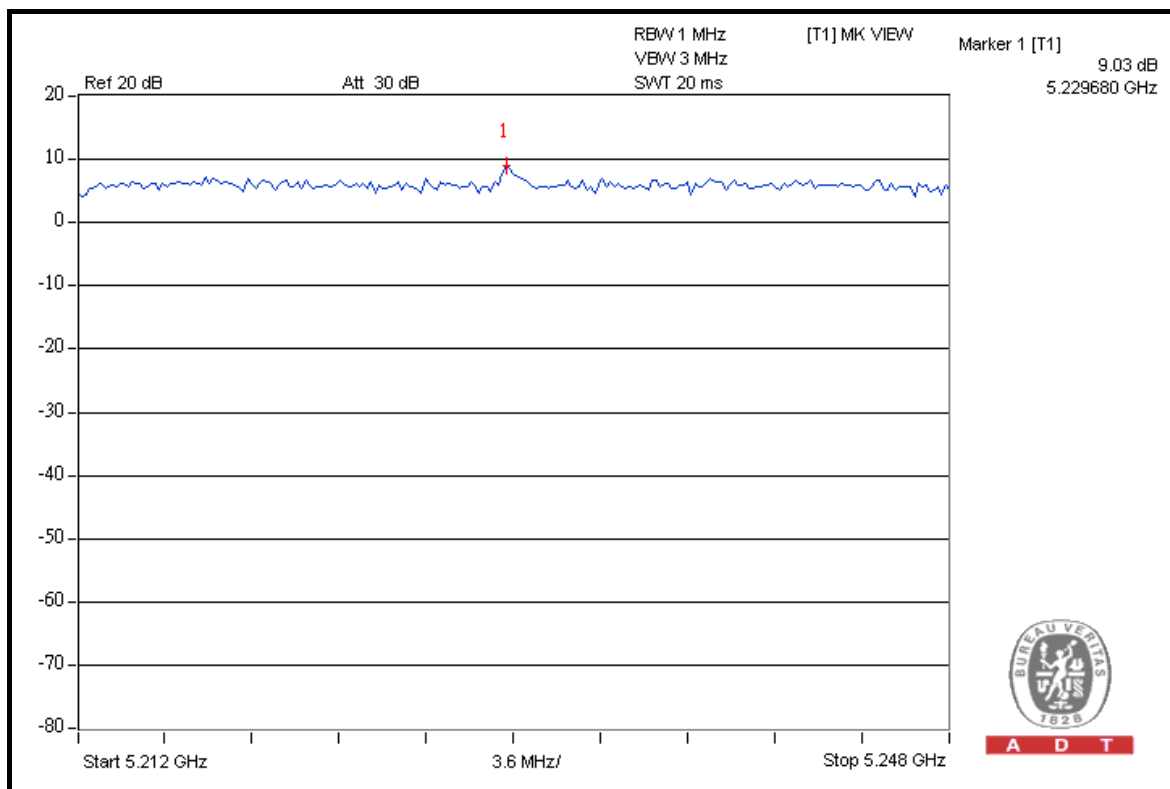

A D T



A D T

CHAIN 2 CH 38

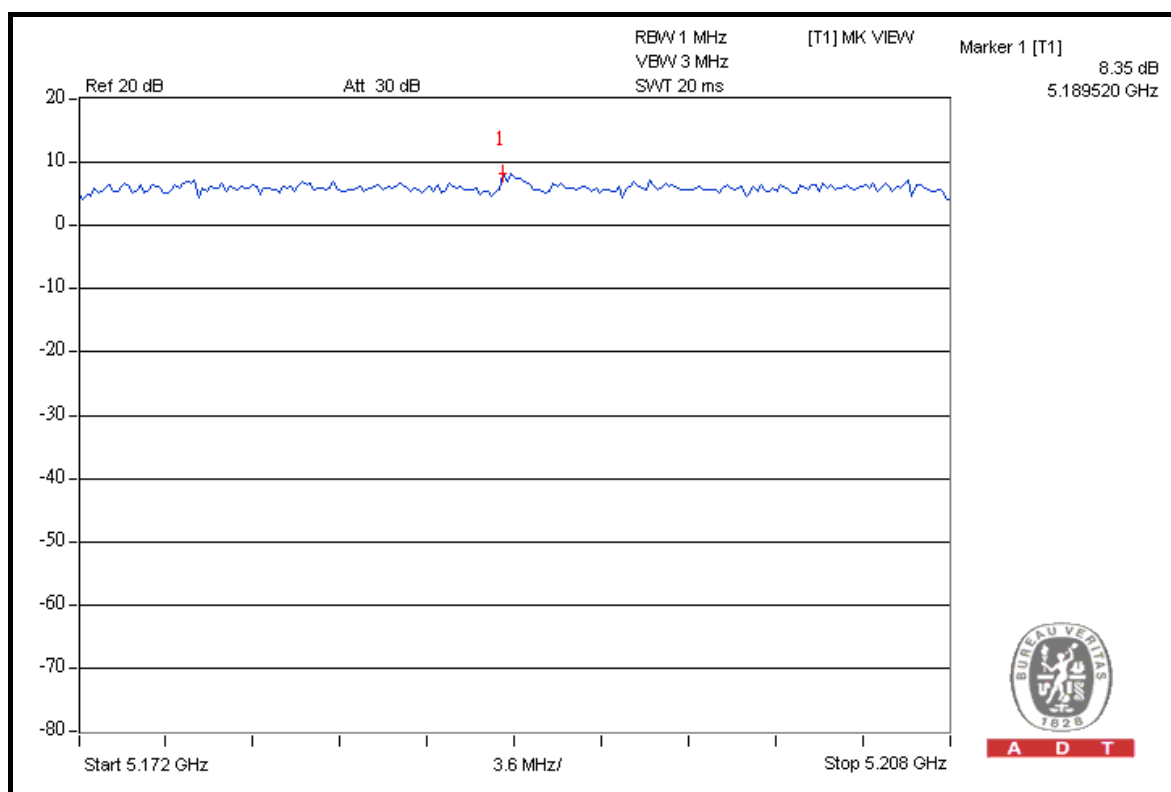
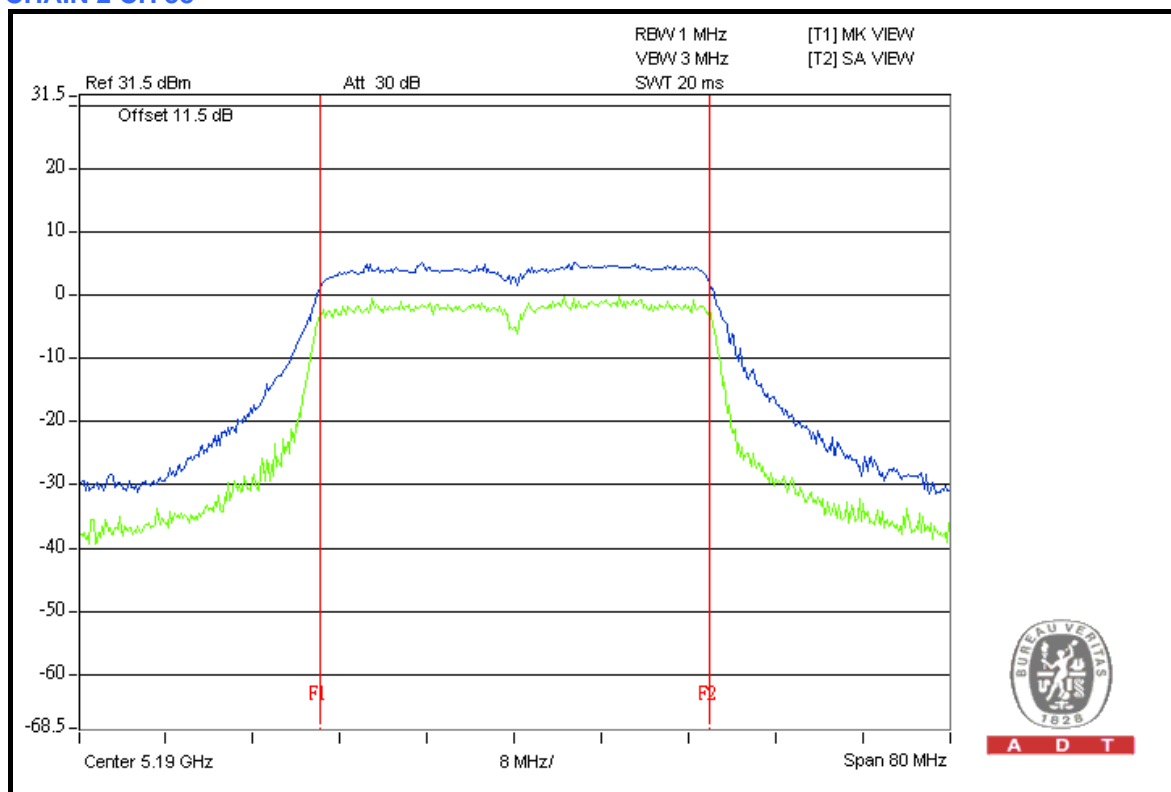



A D T

CH 46

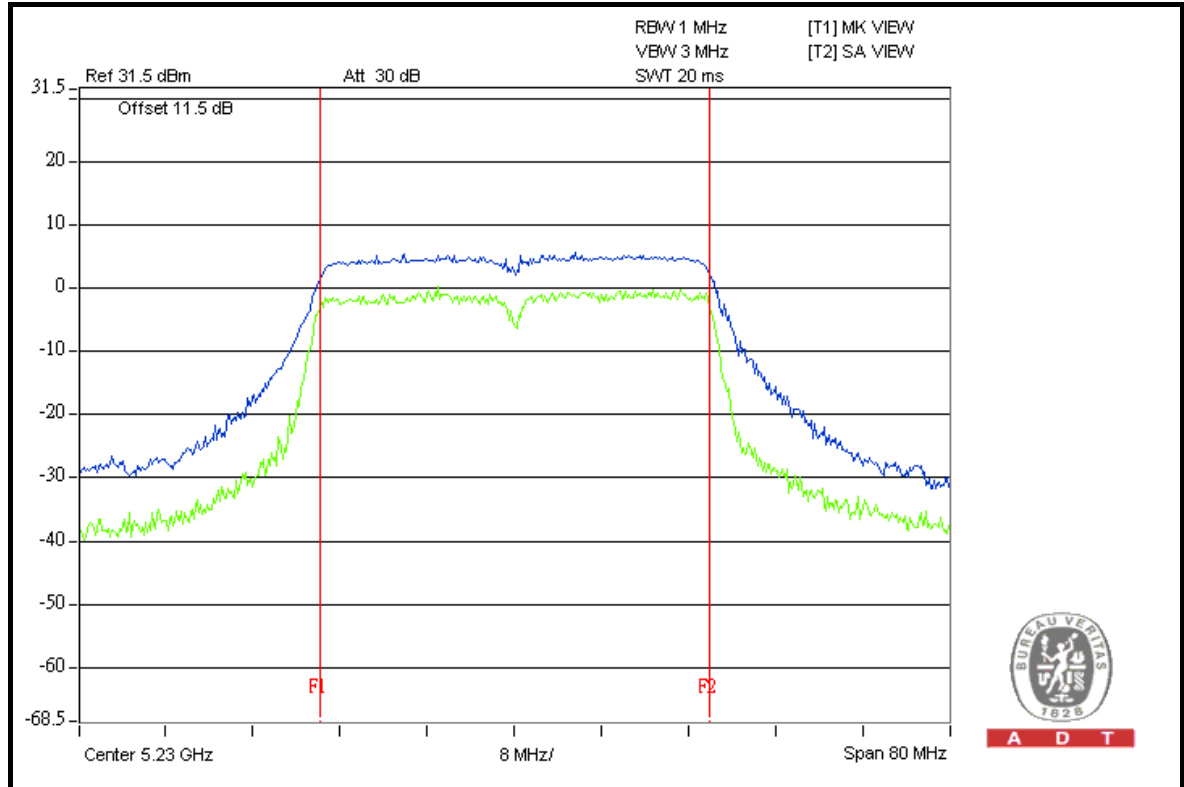

A D T

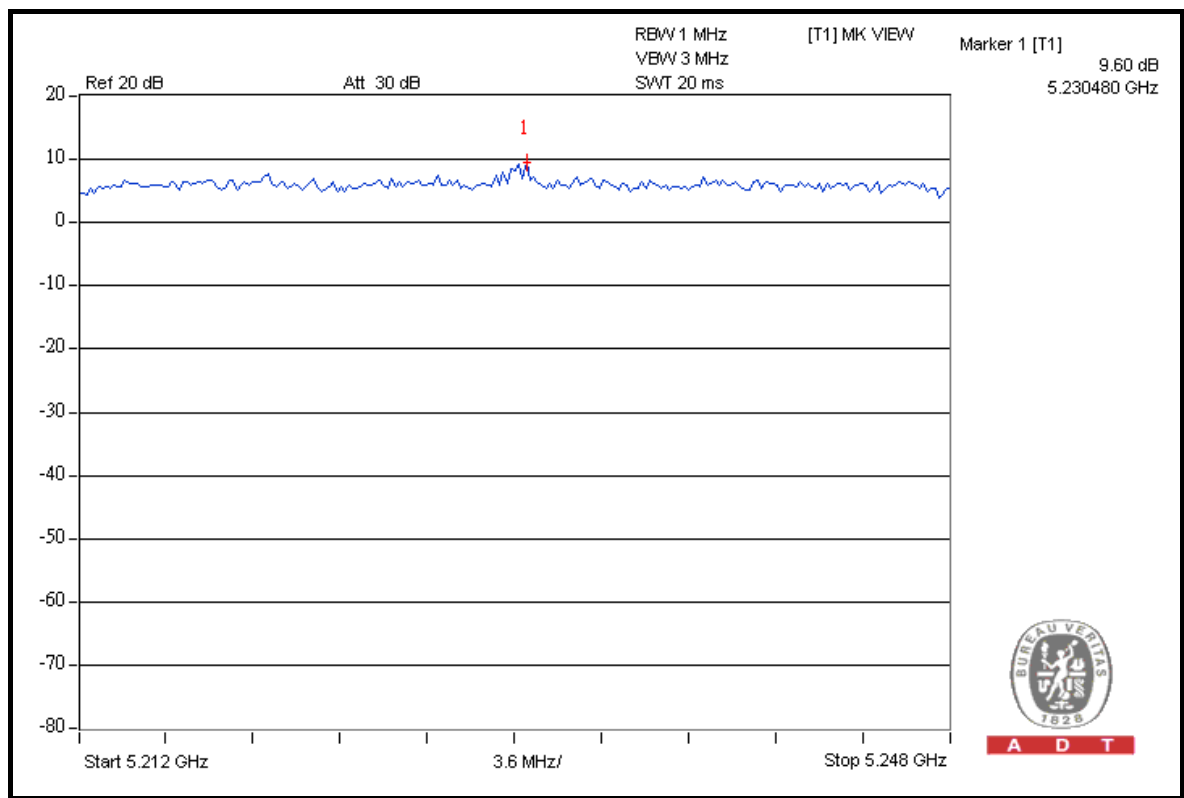

A D T



A D T

DRAFT 802.11n (40MHz) OFDM MODULATION

MODULATION TYPE	BPSK	TRANSFER RATE	13.5Mbps
INPUT POWER (SYSTEM)	120Vac, 60Hz	ENVIRONMENTAL CONDITIONS	25deg.C, 65%RH, 991hPa
TESTED BY	Brad Wu	TEST MODE	C

CHANNEL	CHANNEL FREQUENCY (MHz)	PEAK POWER EXCURSION (dB)		PEAK TO AVERAGE EXCURSION LIMIT (dB)	PASS/FAIL
		CHAIN 0	CHAIN 1		
38	5190	9.56	9.06	13	PASS
46	5230	8.91	10.26	13	PASS



A D T

CHAIN 0 CH 38

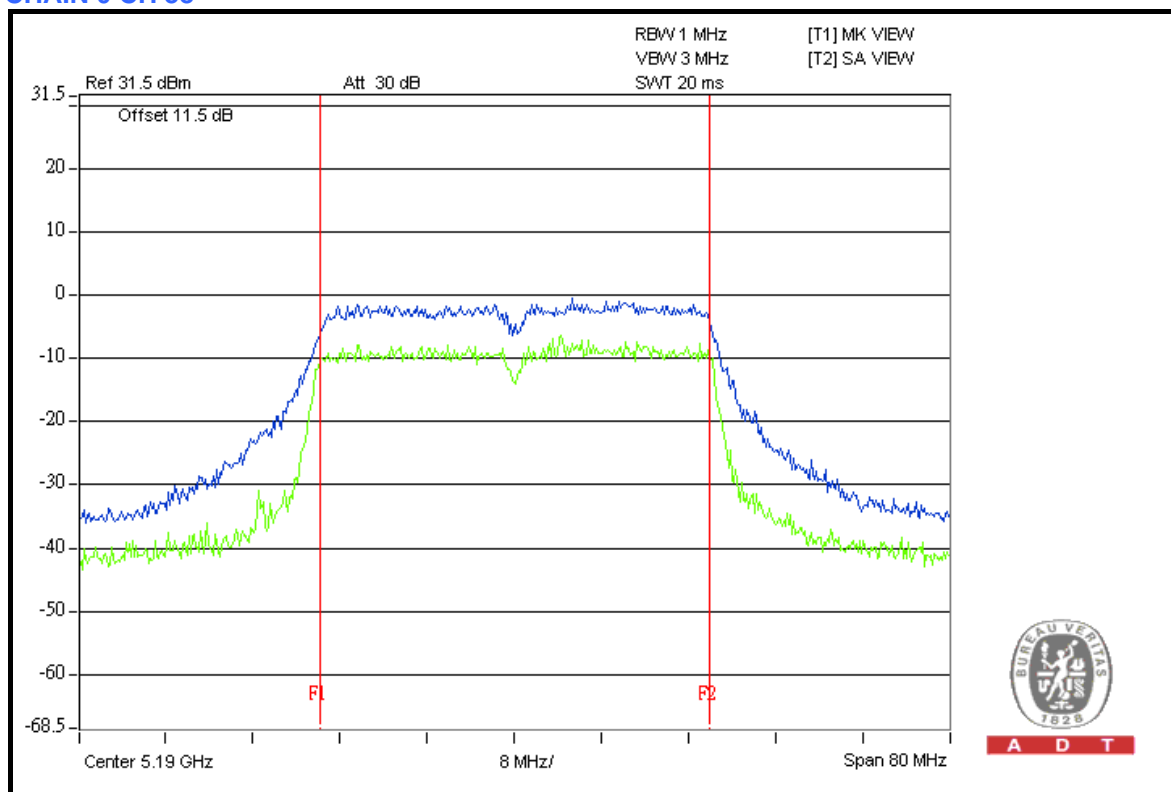

A D T

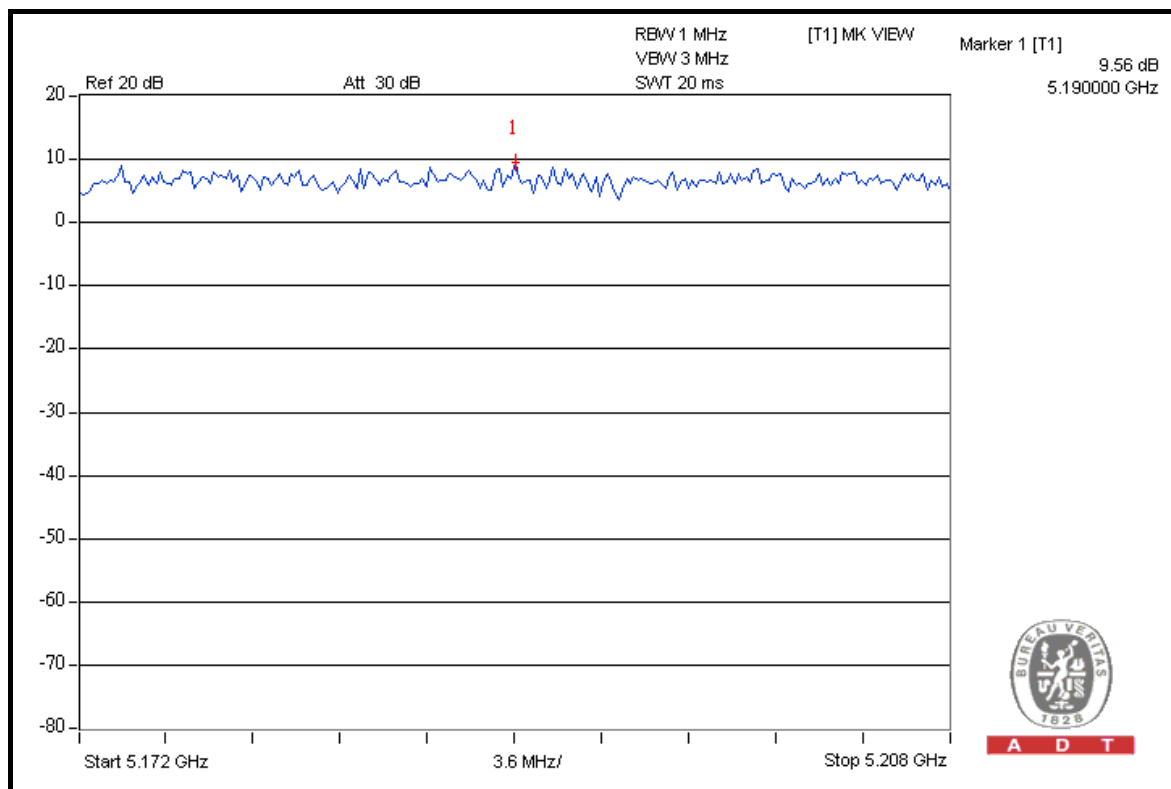

A D T



A D T

CH 46

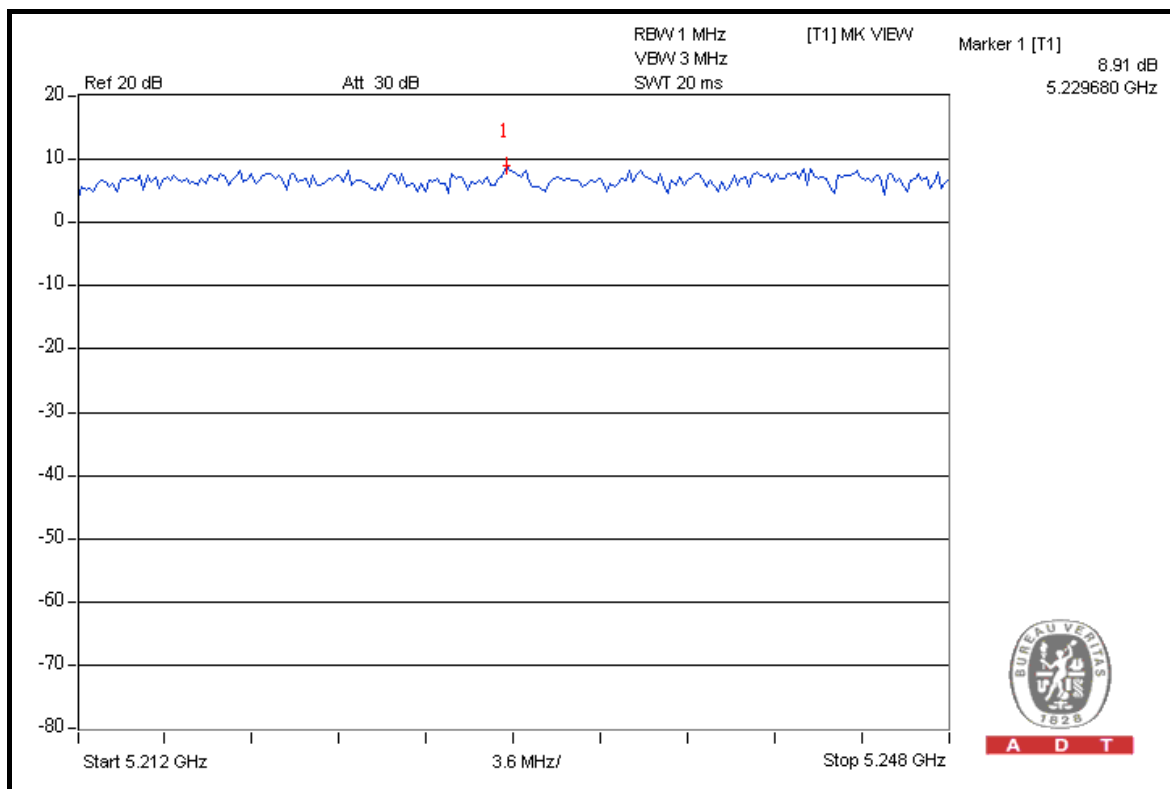
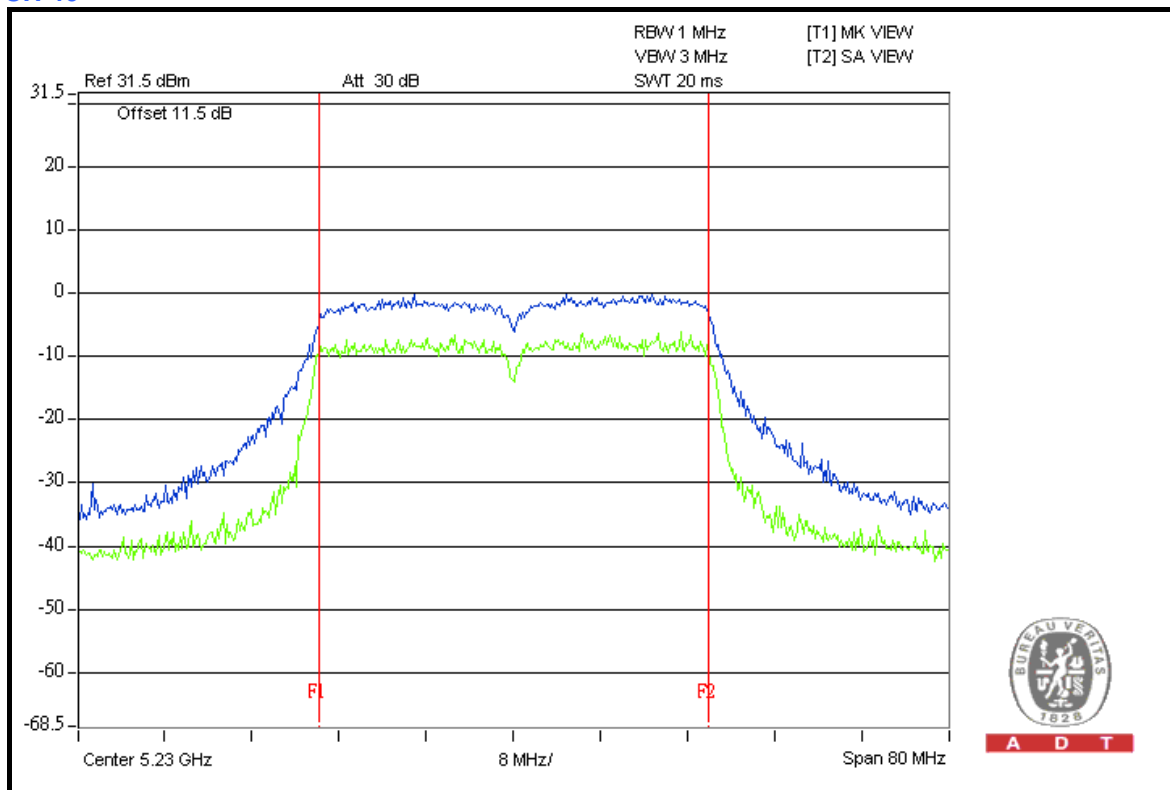



A D T

CHAIN 1 CH 38

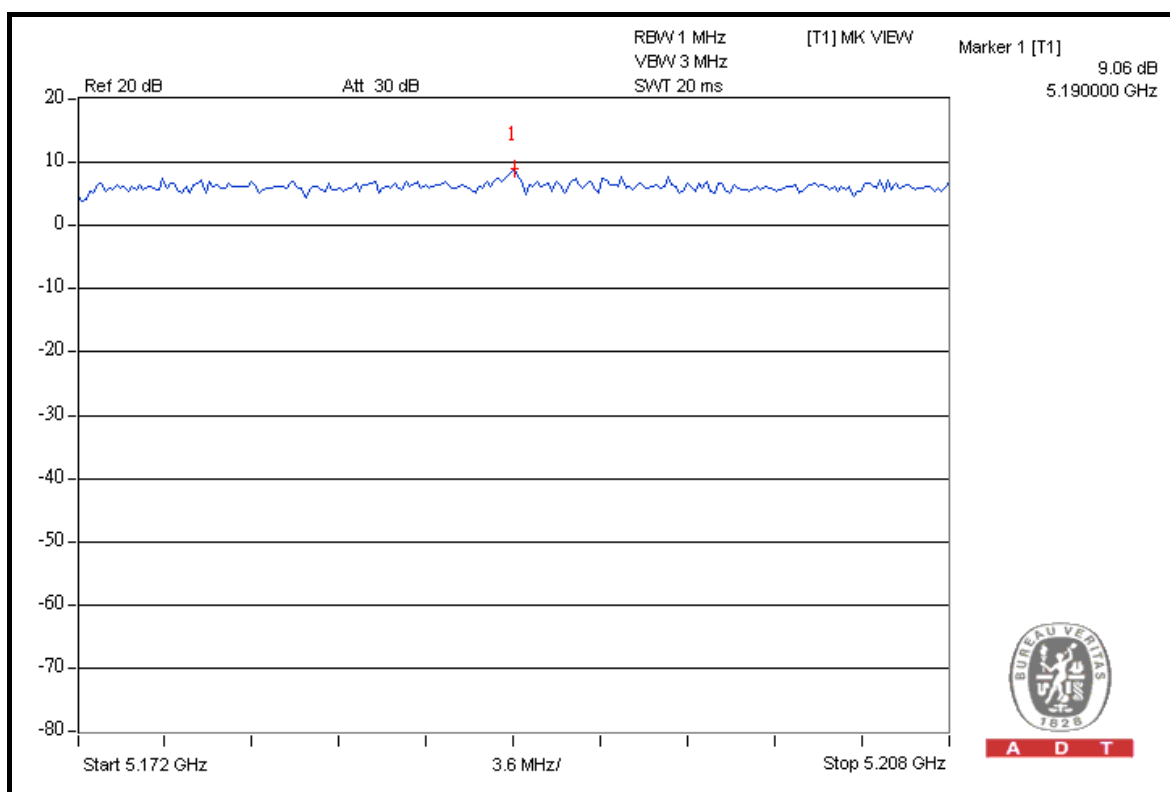
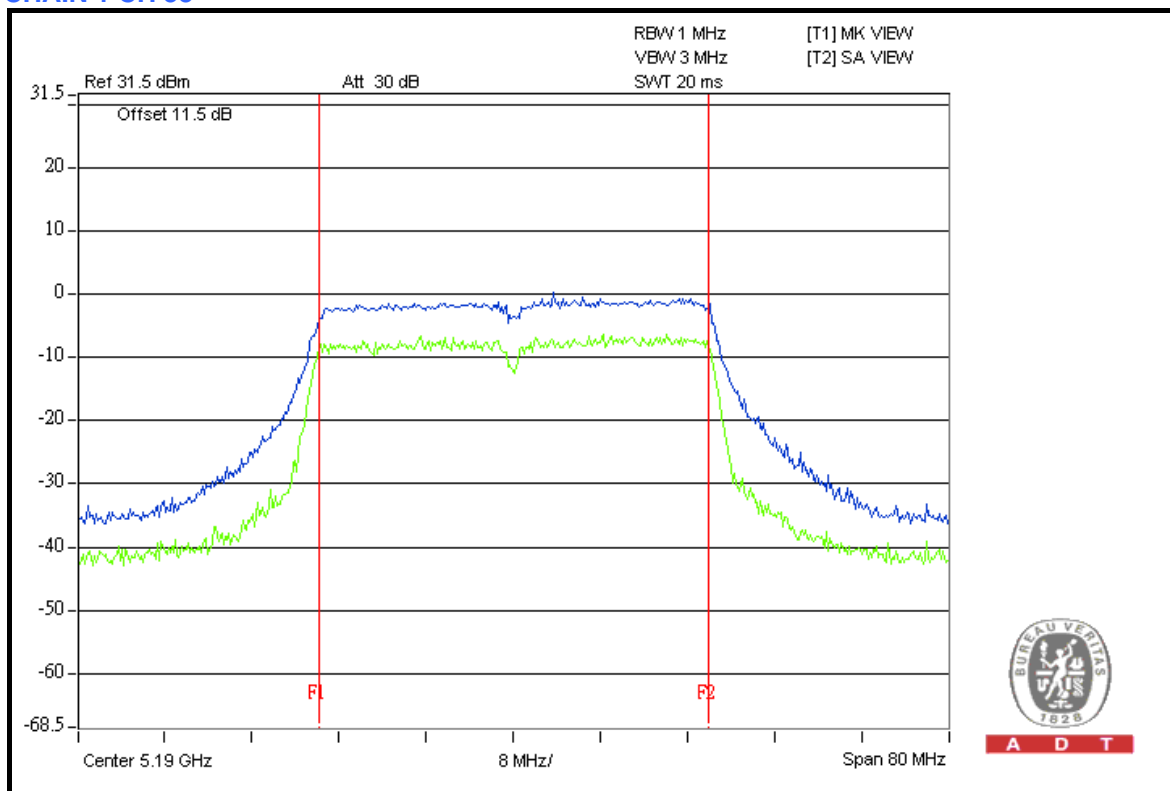



A D T

CH 46

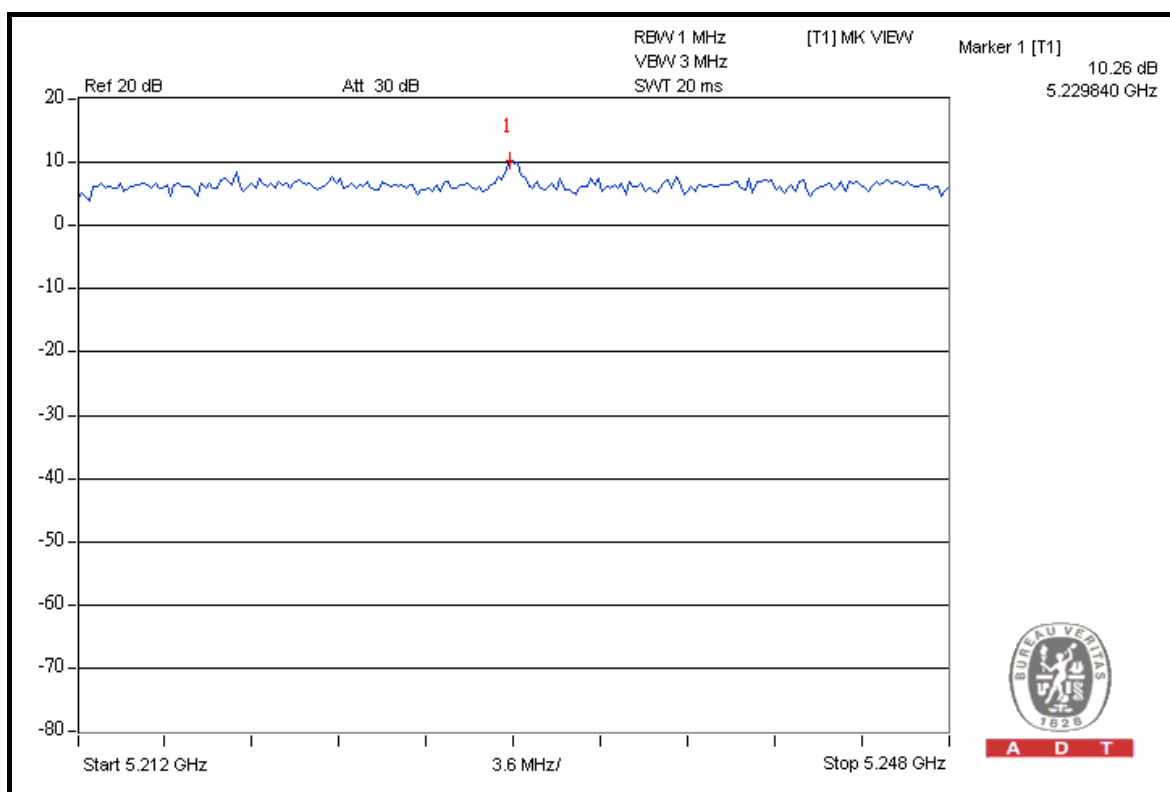
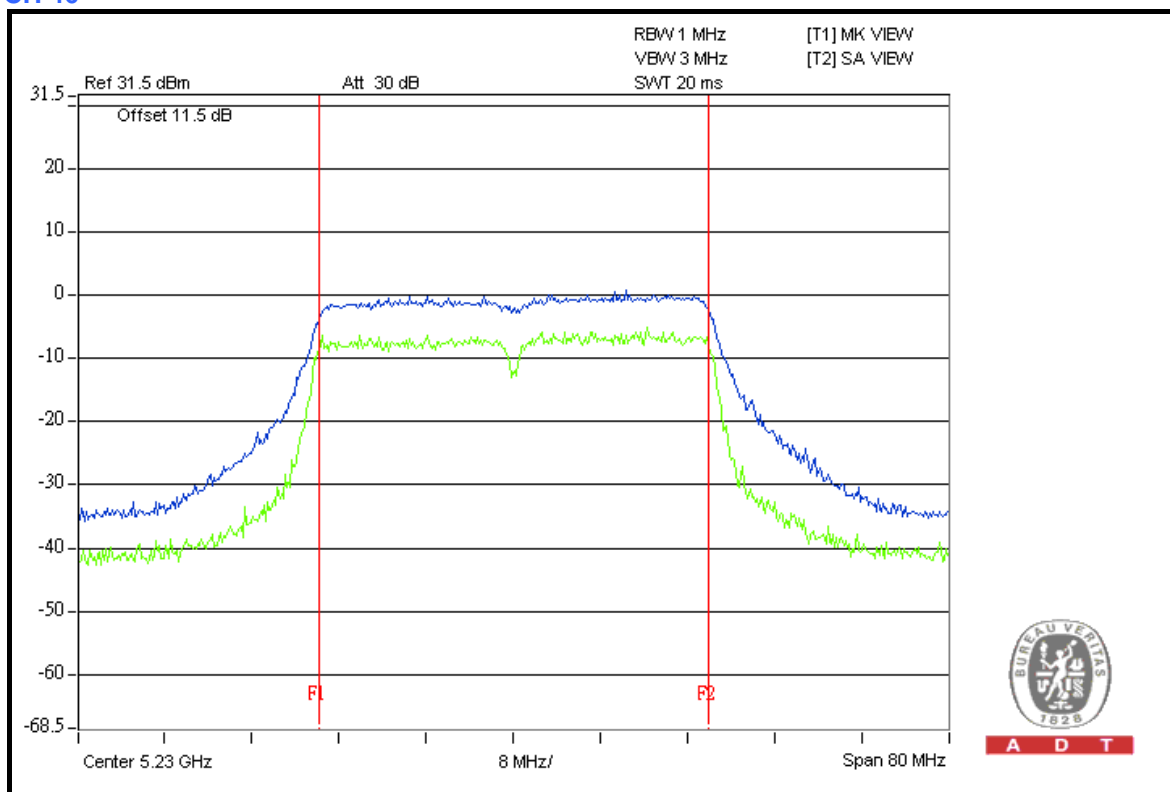



4.5 PEAK POWER SPECTRAL DENSITY MEASUREMENT

4.5.1 LIMITS OF PEAK POWER SPECTRAL DENSITY MEASUREMENT

FREQUENCY BAND	LIMIT
5.150 ~ 5.250GHz	4dBm

4.5.2 TEST INSTRUMENTS

DESCRIPTION & MANUFACTURER	MODEL NO.	SERIAL NO.	DATE OF CALIBRATION	DUE DATE OF CALIBRATION
R&S SPECTRUM ANALYZER	FSP40	100041	May 13, 2009	May 12, 2010

NOTE: The calibration interval of the above test instruments is 12 months and the calibrations are traceable to NML/ROC and NIST/USA.

4.5.3 TEST PROCEDURES

- a. The transmitter output was connected to the spectrum analyzer.
- b. Set RBW = 1MHz, VBW = 3MHz. The PPSD is the highest level found across the emission in any 1MHz band.

4.5.4 DEVIATION FROM TEST STANDARD

No deviation

4.5.5 TEST SETUP

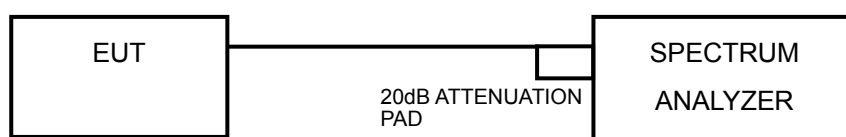

4.5.6 EUT OPERATING CONDITIONS

Same as 4.4.6



A D T

4.5.7 TEST RESULTS

802.11a OFDM MODULATION

MODULATION TYPE	BPSK	TRANSFER RATE	6.0Mbps
INPUT POWER (SYSTEM)	120Vac, 60Hz	ENVIRONMENTAL CONDITIONS	25deg.C, 65%RH, 991hPa
TESTED BY	Brad Wu	TEST MODE	A

CHAN.	CHAN. FREQ. (MHz)	RF POWER LEVEL IN 1MHz BW (dBm)			TOTAL POWER DENSITY (mW)	TOTAL POWER DENSITY (dBm)	MAX. LIMIT (dBm)	PASS / FAIL
		CHAIN 0	CHAIN 1	CHAIN 2				
36	5180	-2.04	-2.24	-2.12	1.836	2.64	4	PASS
40	5200	-2.09	-2.21	-2.31	1.807	2.57	4	PASS
48	5240	-2.16	-2.19	-2.10	1.829	2.62	4	PASS

CHAIN 0 CH 36

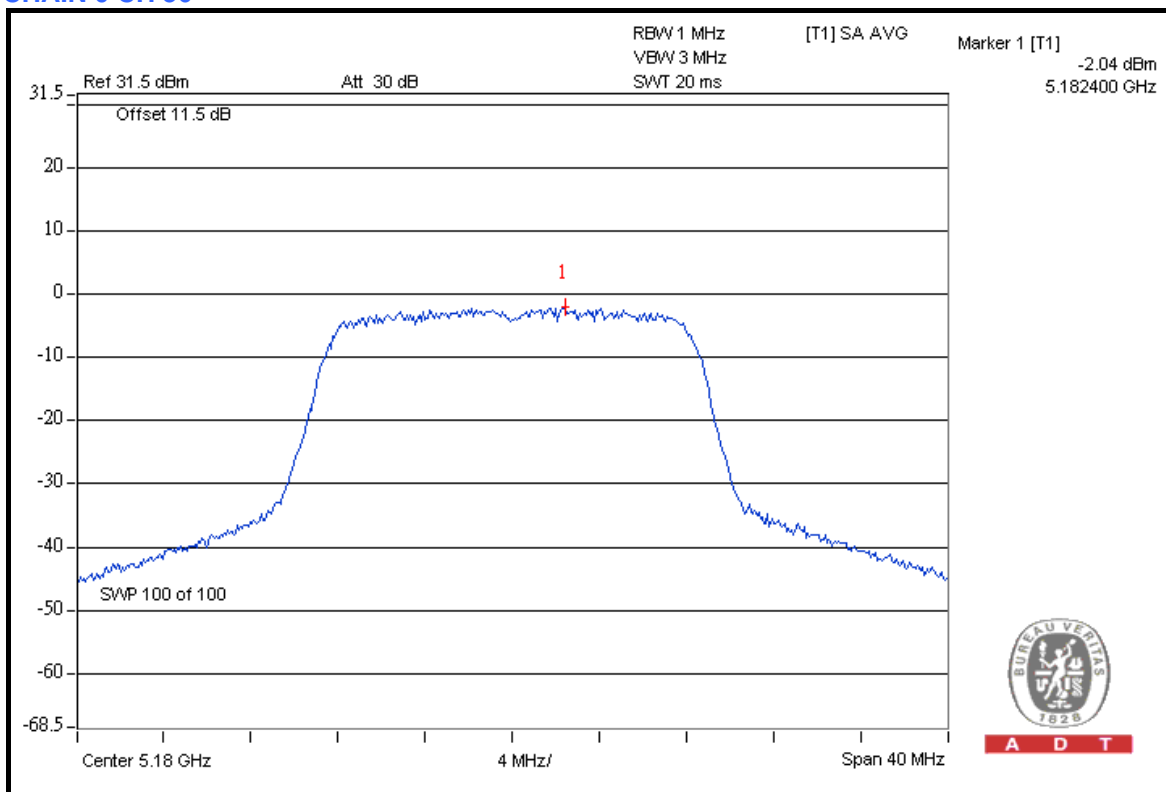

A D T



A D T

CH 40

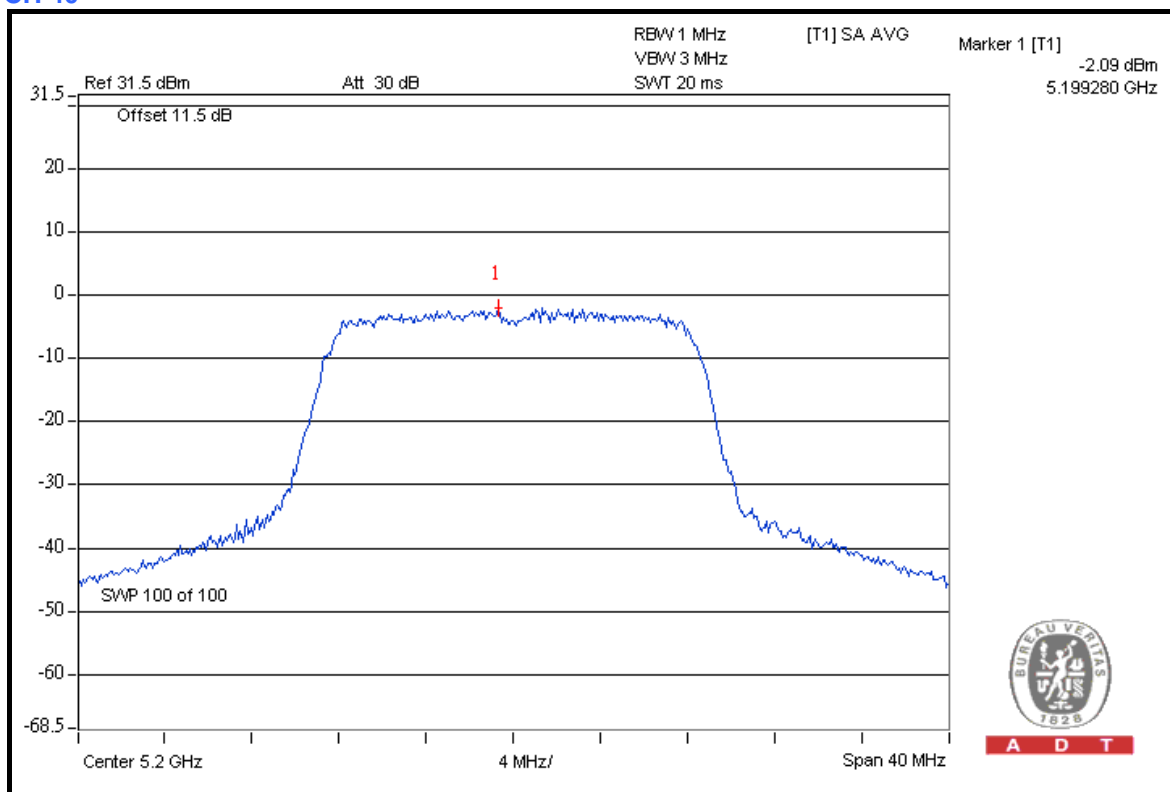

CH 48

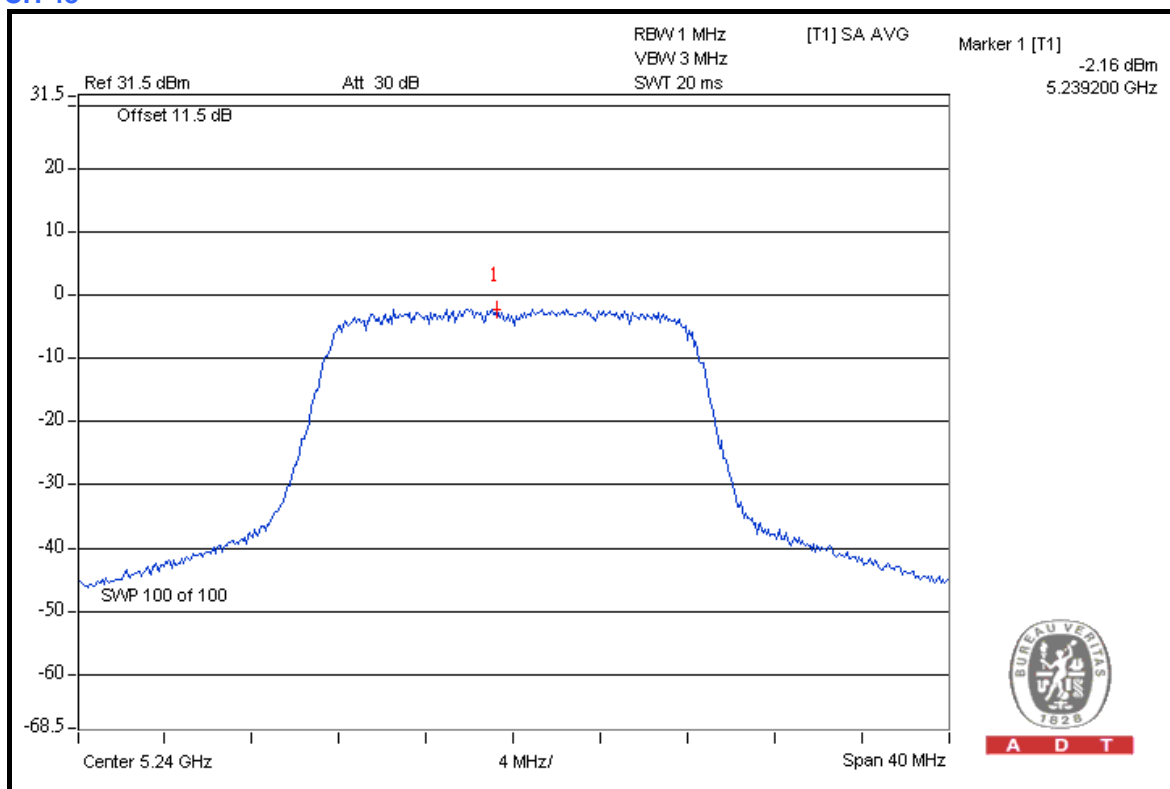



A D T

CHAIN 1 CH 36

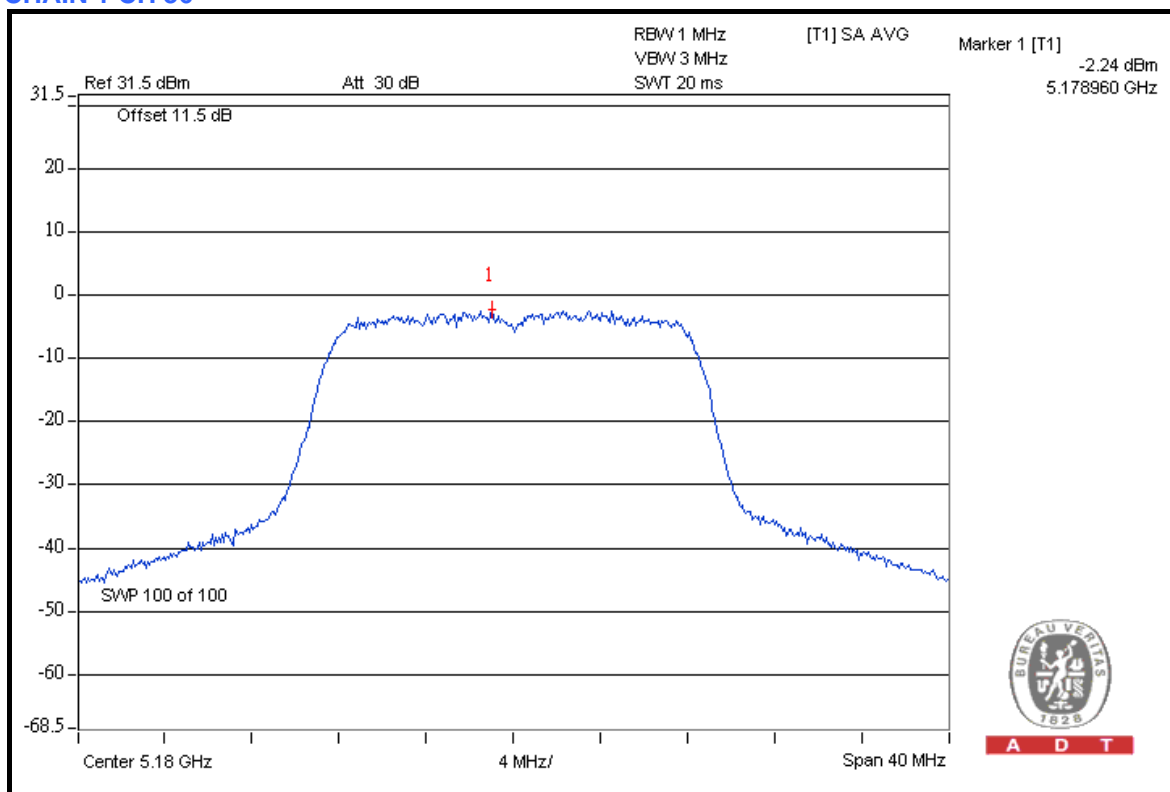

CH 40

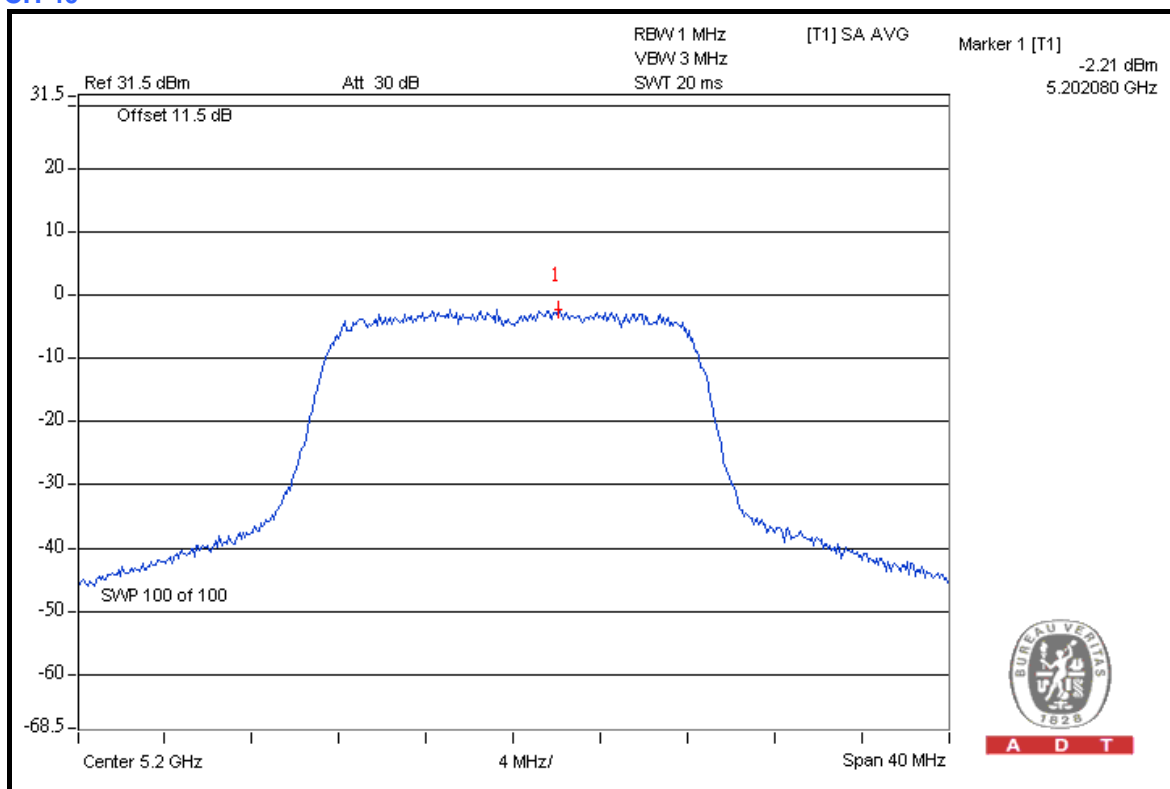



A D T

CH 48

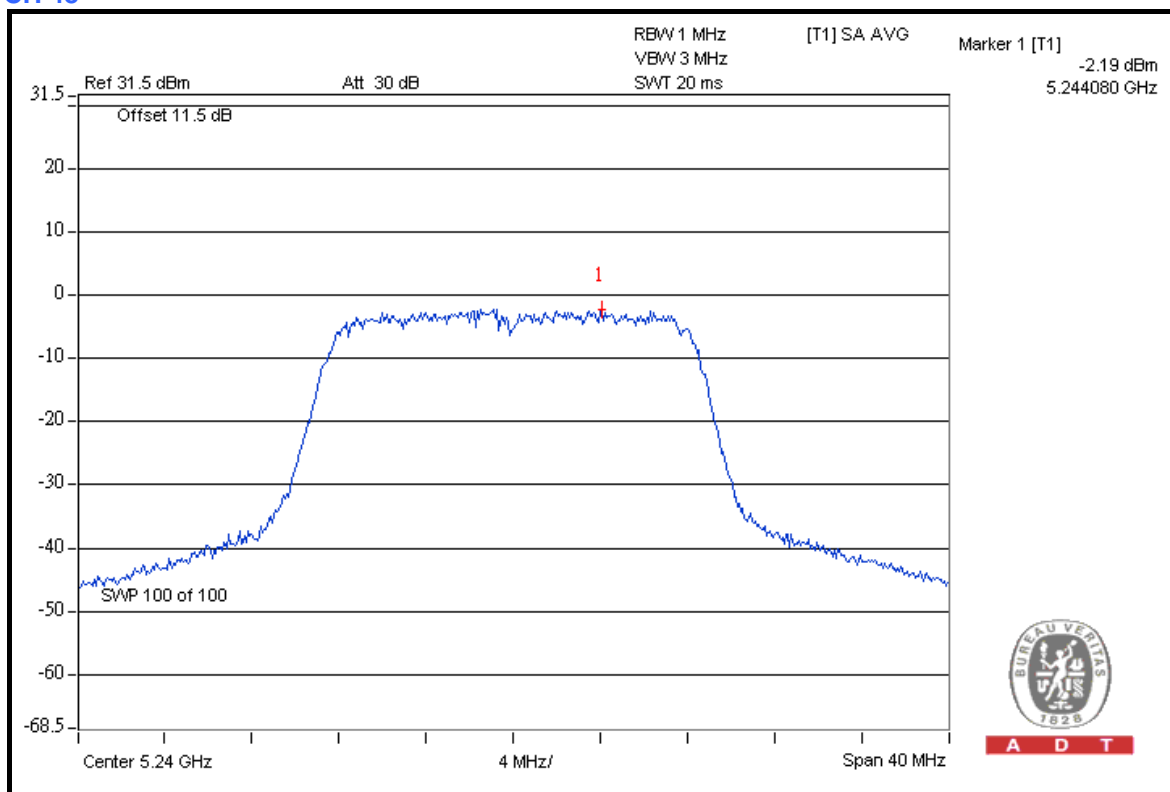

CHAIN 2 CH 36

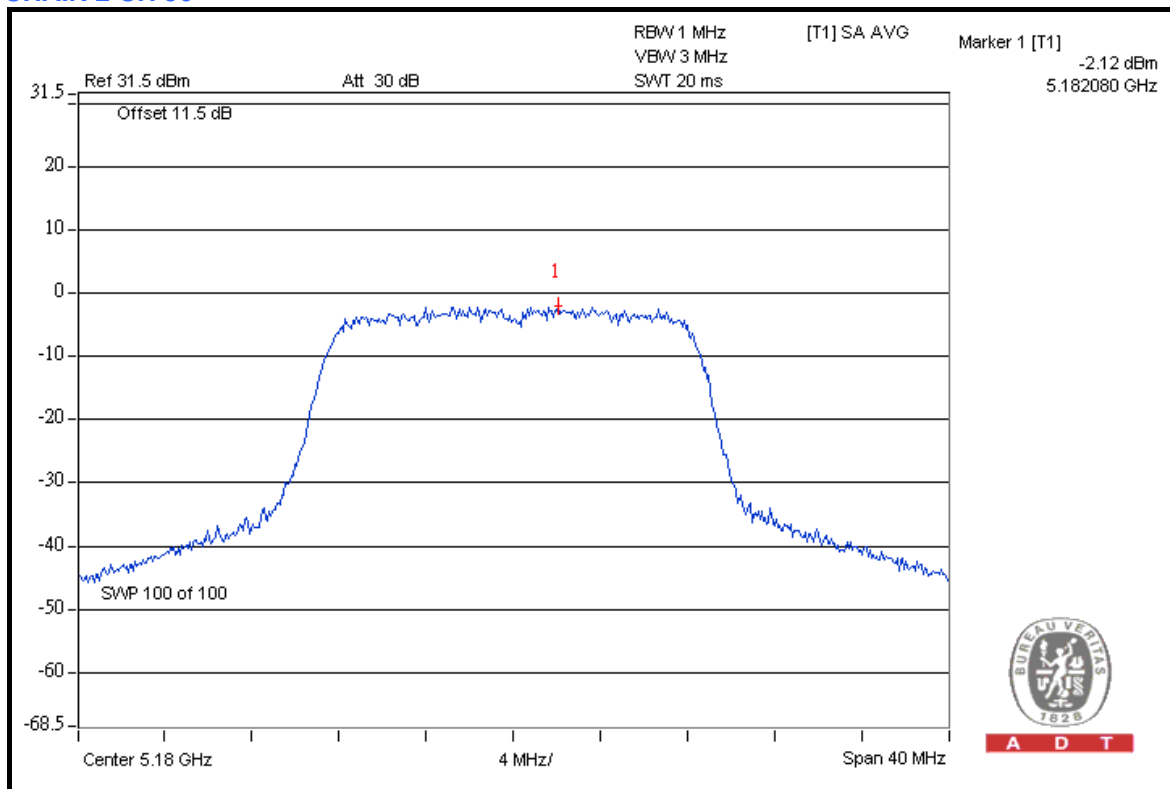



A D T

CH 40

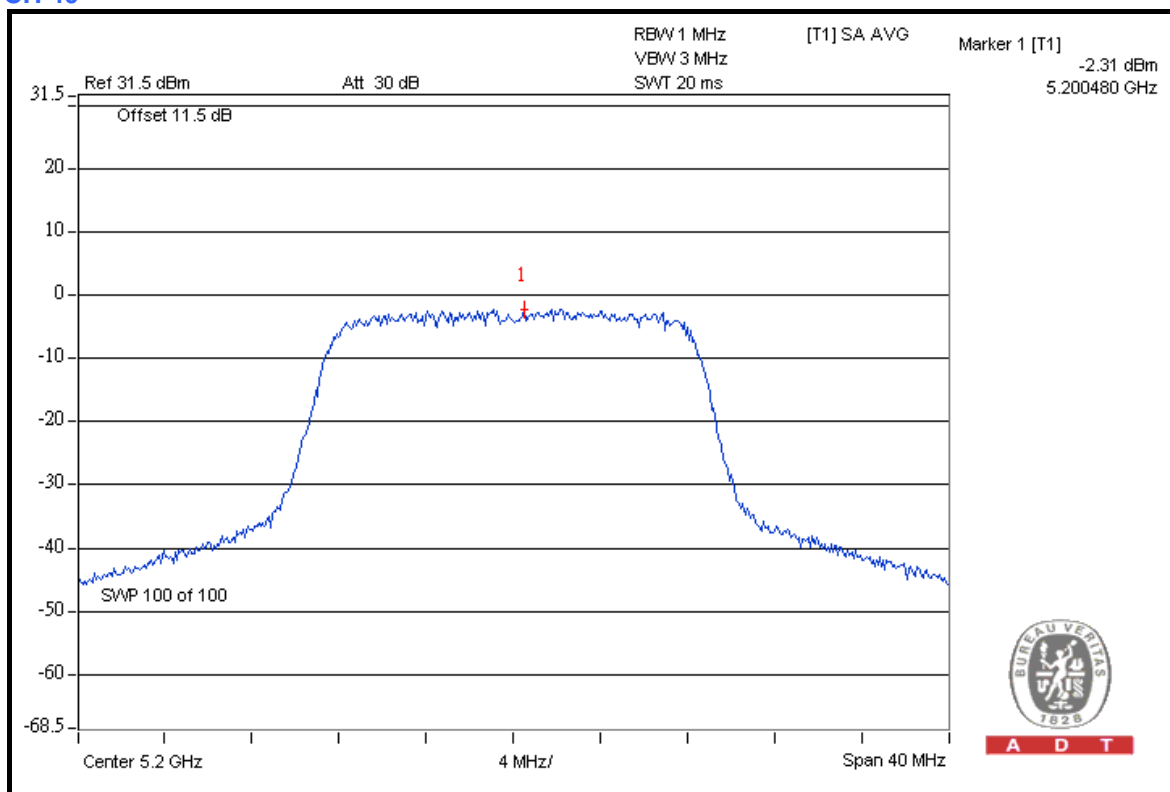

CH 48

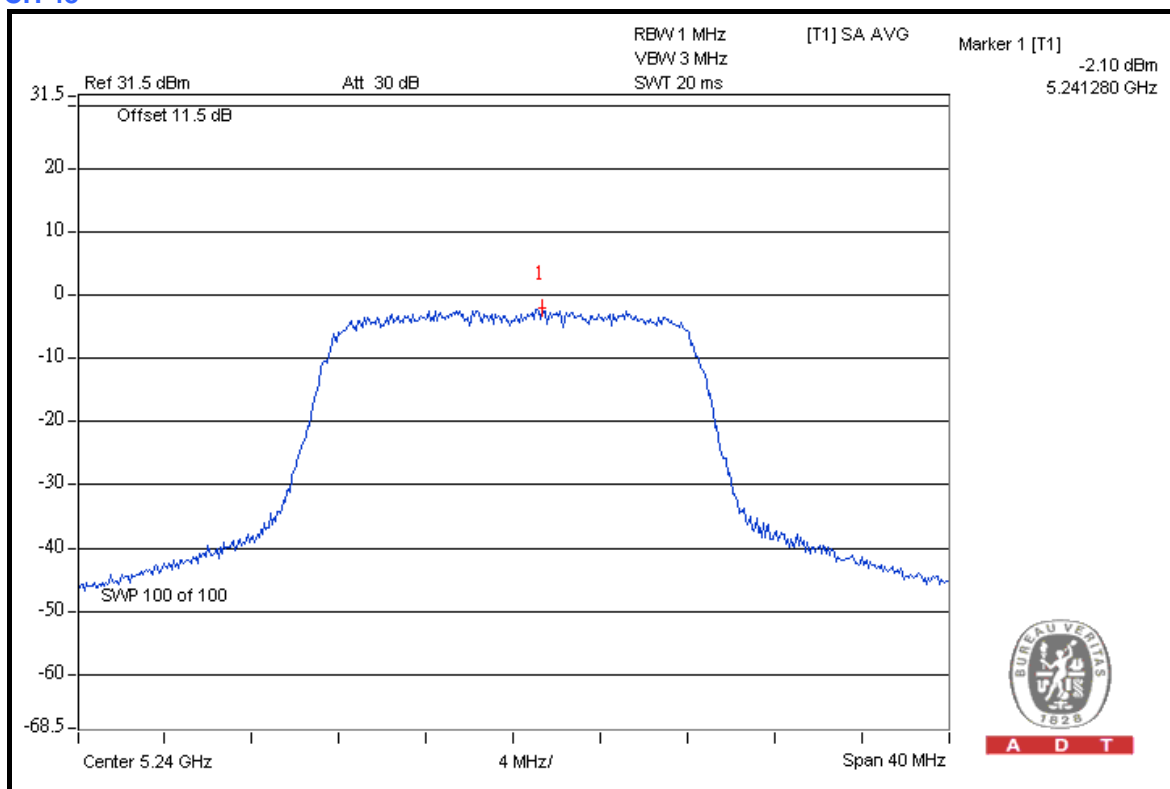



A D T

802.11a OFDM MODULATION

MODULATION TYPE	BPSK	TRANSFER RATE	6.0Mbps
INPUT POWER (SYSTEM)	120Vac, 60Hz	ENVIRONMENTAL CONDITIONS	25deg.C, 65%RH, 991hPa
TESTED BY	Brad Wu	TEST MODE	C

CHAN.	CHAN. FREQ. (MHz)	RF POWER LEVEL IN 1MHz BW (dBm)		TOTAL POWER DENSITY (mW)	TOTAL POWER DENSITY (dBm)	MAX. LIMIT (dBm)	PASS / FAIL
		CHAIN 0	CHAIN 1				
36	5180	-9.36	-8.82	0.247	-6.07	-4	PASS
40	5200	-9.31	-8.80	0.249	-6.04	-4	PASS
48	5240	-9.49	-8.62	0.250	-6.02	-4	PASS

NOTE: According to 15.407 (a) (1) (2), the maximum antenna gain 14dBi is higher than 6dBi, so the limit of peak power spectral density shall be reduced by 8 dB.



A D T

CHAIN 0 CH 36

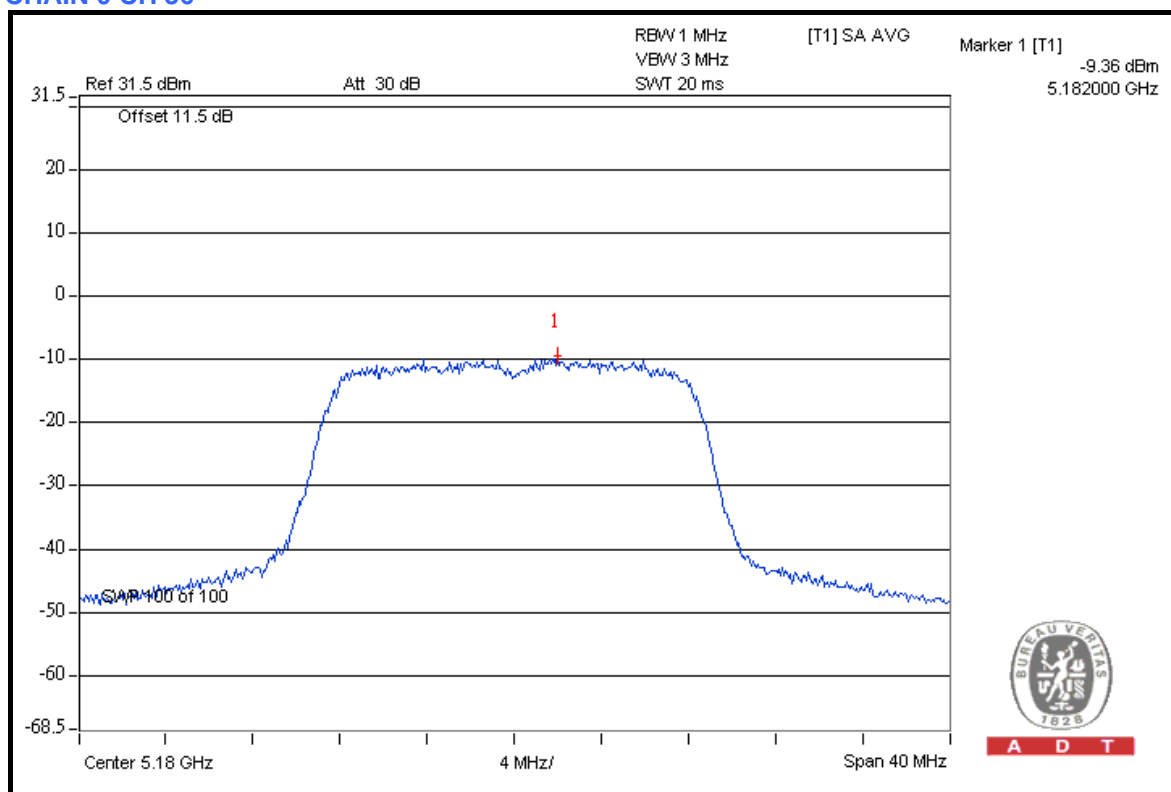

A D T

CH 40

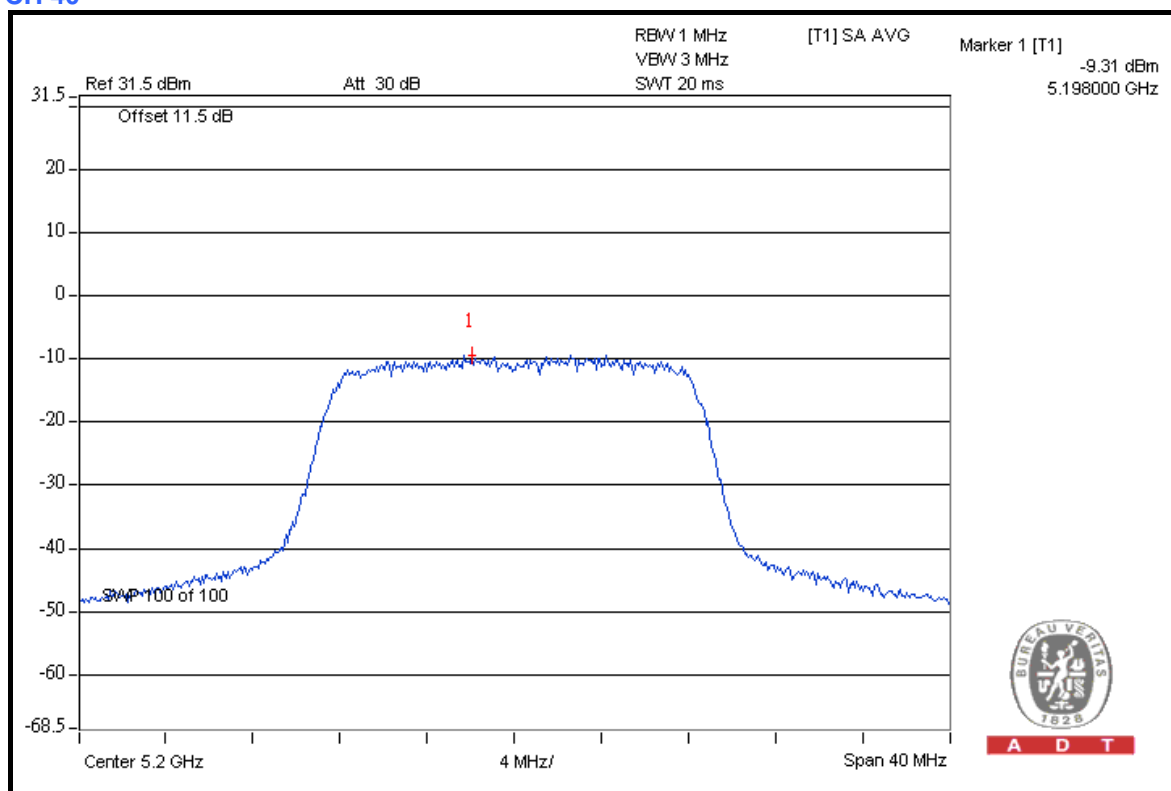

A D T



A D T

CH 48

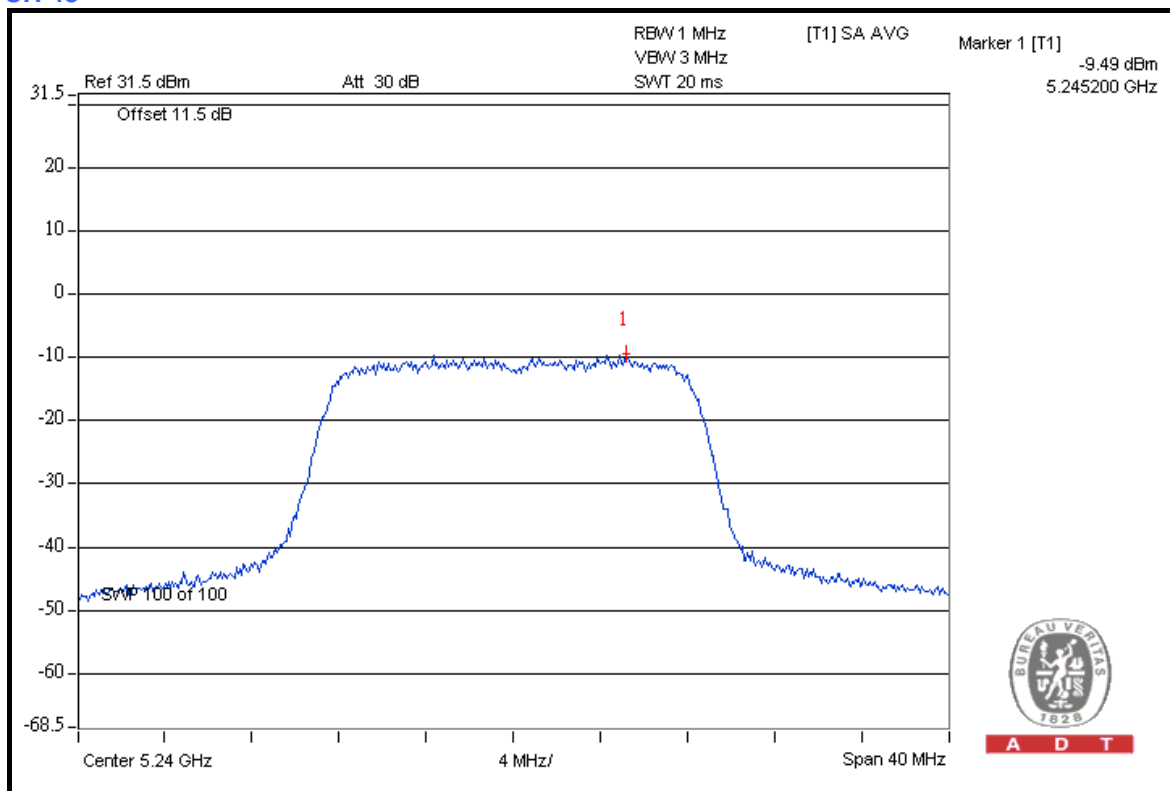

A D T

CHAIN 1 CH 36

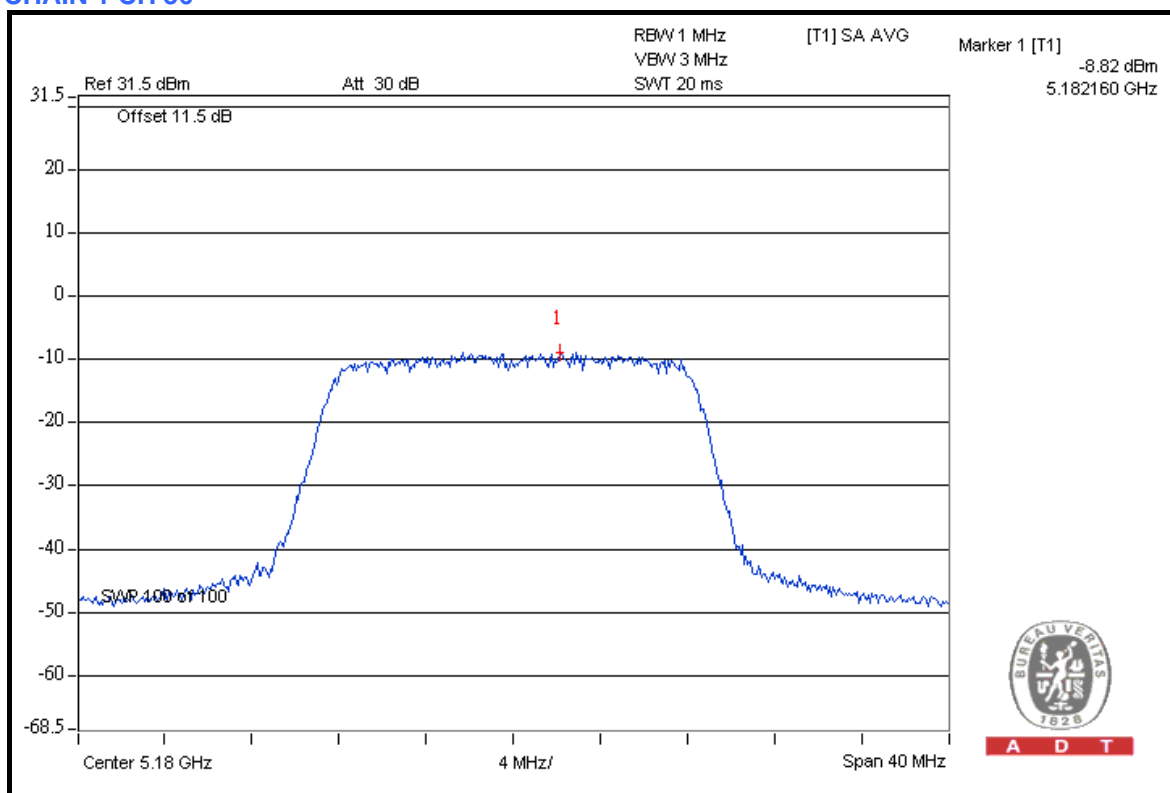

A D T



A D T

CH 40

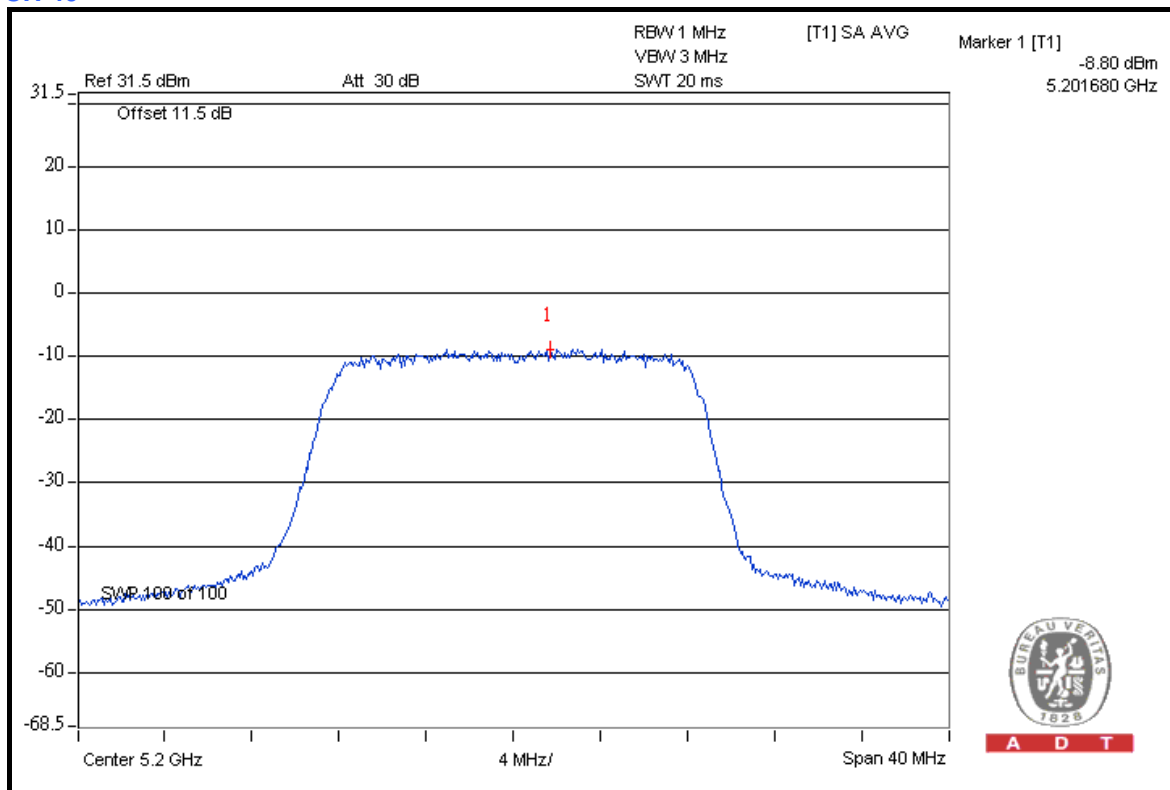

CH 48

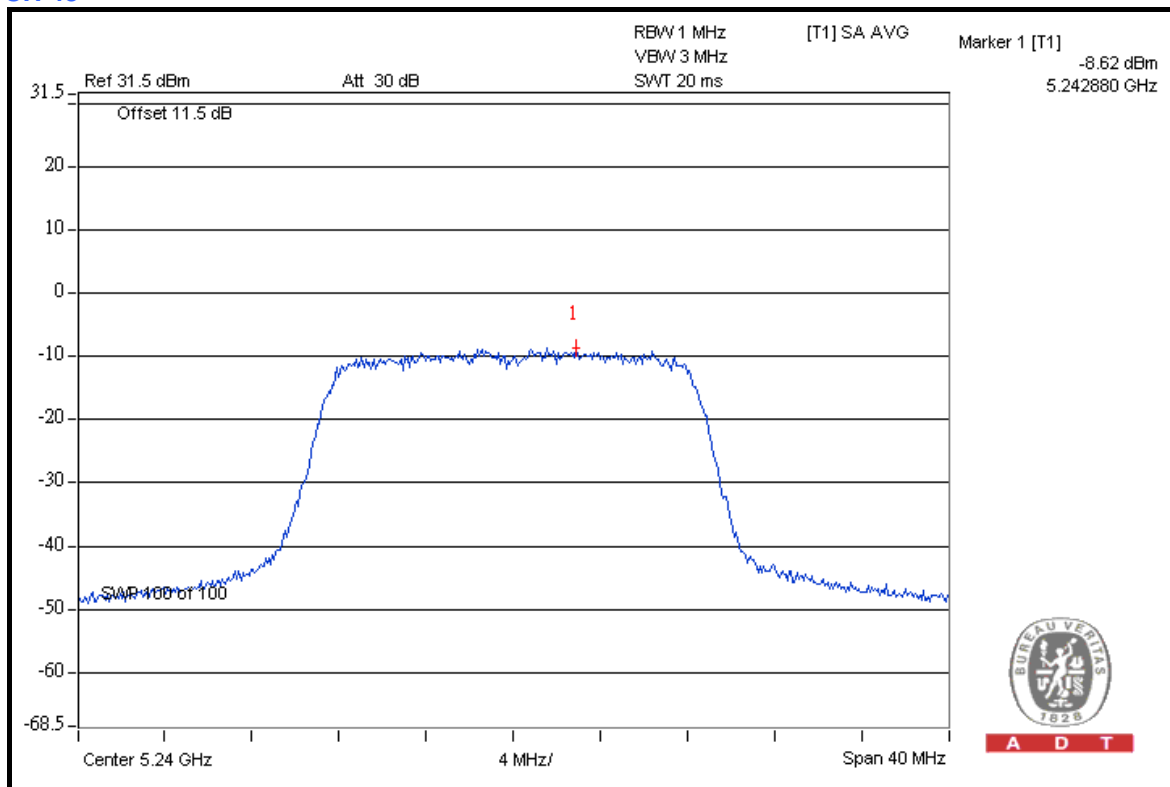



A D T

DRAFT 802.11n (20MHz) OFDM MODULATION

MODULATION TYPE	BPSK	TRANSFER RATE	6.5Mbps
INPUT POWER (SYSTEM)	120Vac, 60Hz	ENVIRONMENTAL CONDITIONS	25deg.C, 65%RH, 991hPa
TESTED BY	Brad Wu	TEST MODE	A

CHAN.	CHAN. FREQ. (MHz)	RF POWER LEVEL IN 1MHz BW (dBm)			TOTAL POWER DENSITY (mW)	TOTAL POWER DENSITY (dBm)	MAX. LIMIT (dBm)	PASS / FAIL
		CHAIN 0	CHAIN 1	CHAIN 2				
36	5180	-2.33	-2.33	-2.31	1.757	2.45	4	PASS
40	5200	-2.12	-2.17	-2.15	1.830	2.62	4	PASS
48	5240	-2.11	-2.29	-2.17	1.812	2.58	4	PASS

CHAIN 0 CH 36

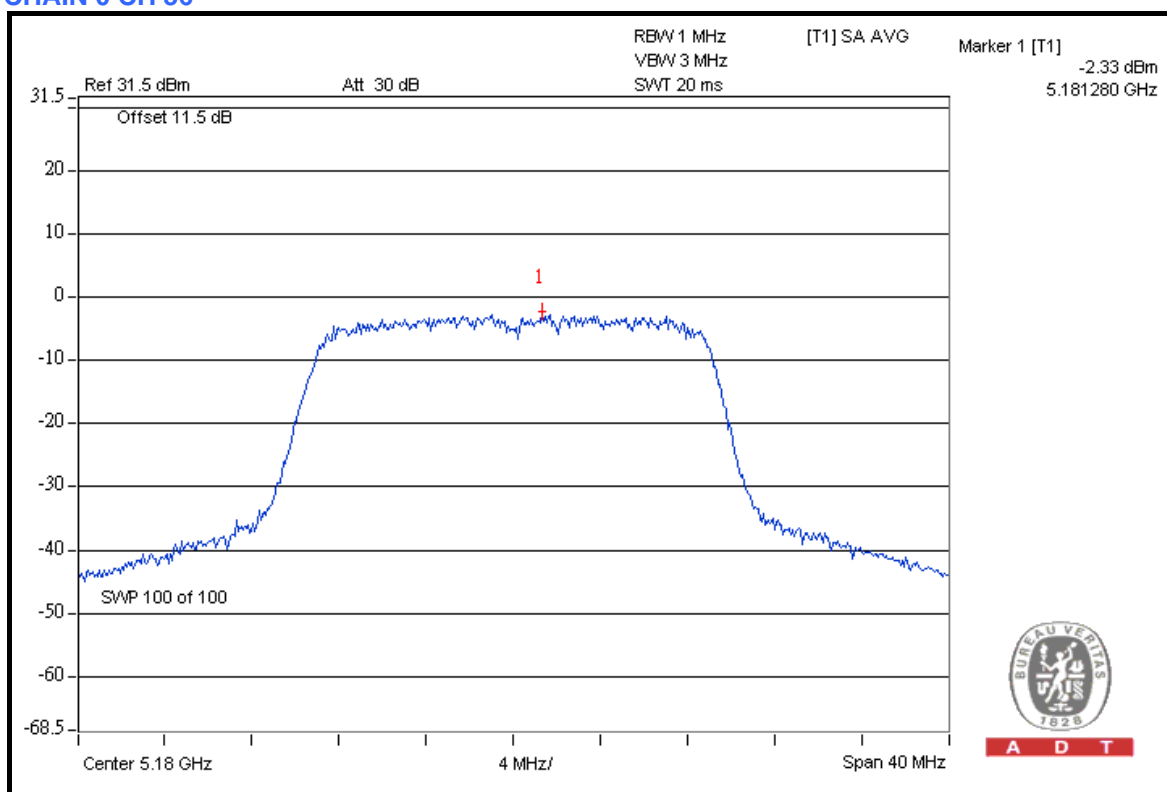

A D T



A D T

CH 40

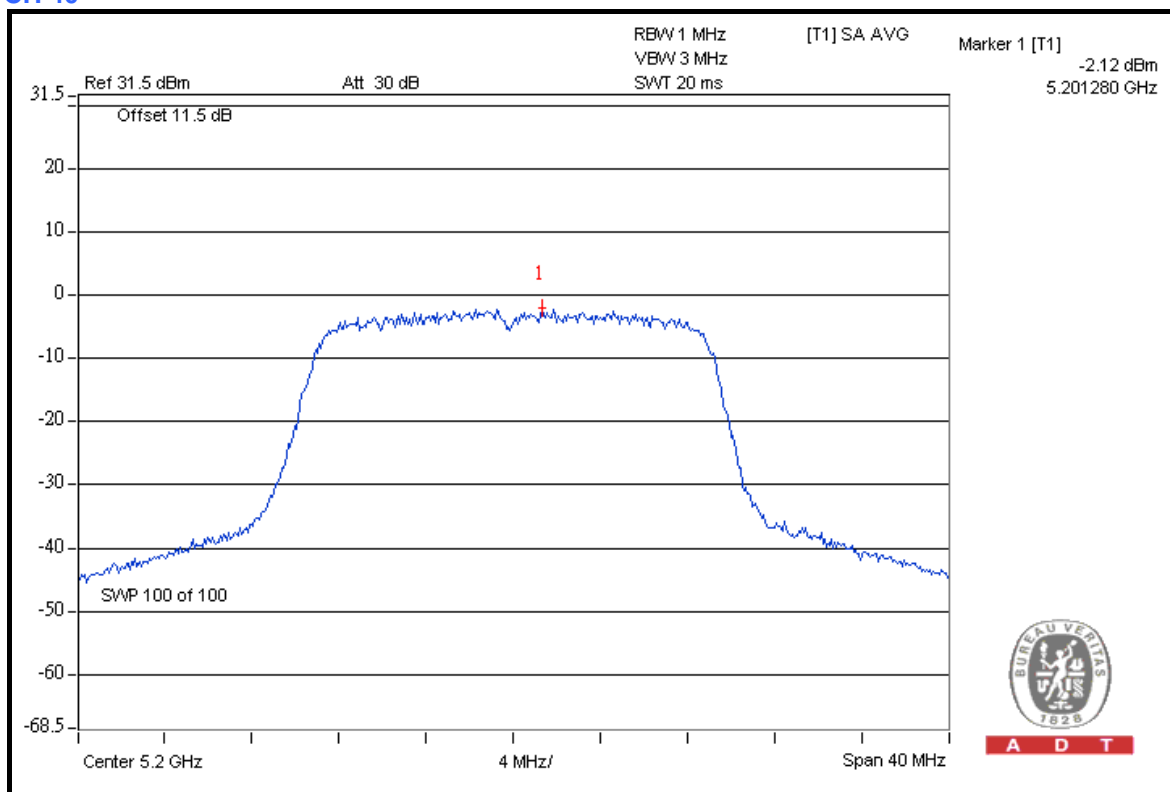

CH 48

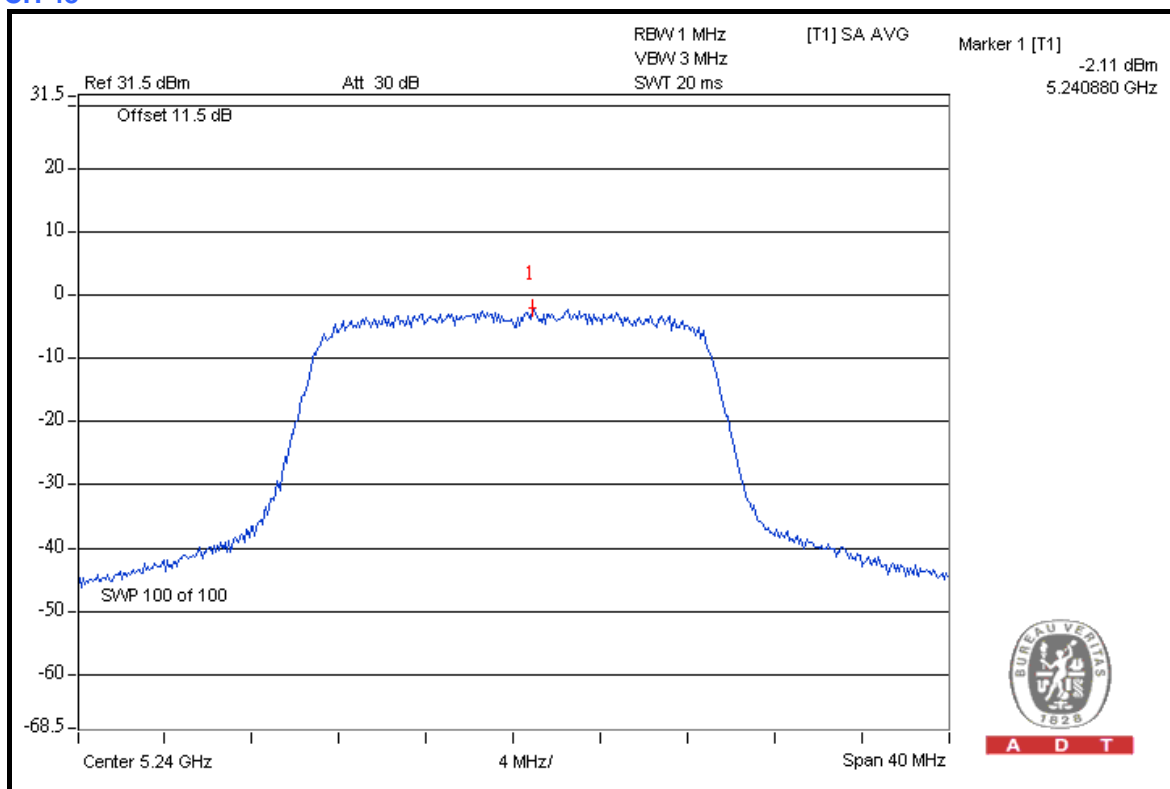



A D T

CHAIN 1 CH 36

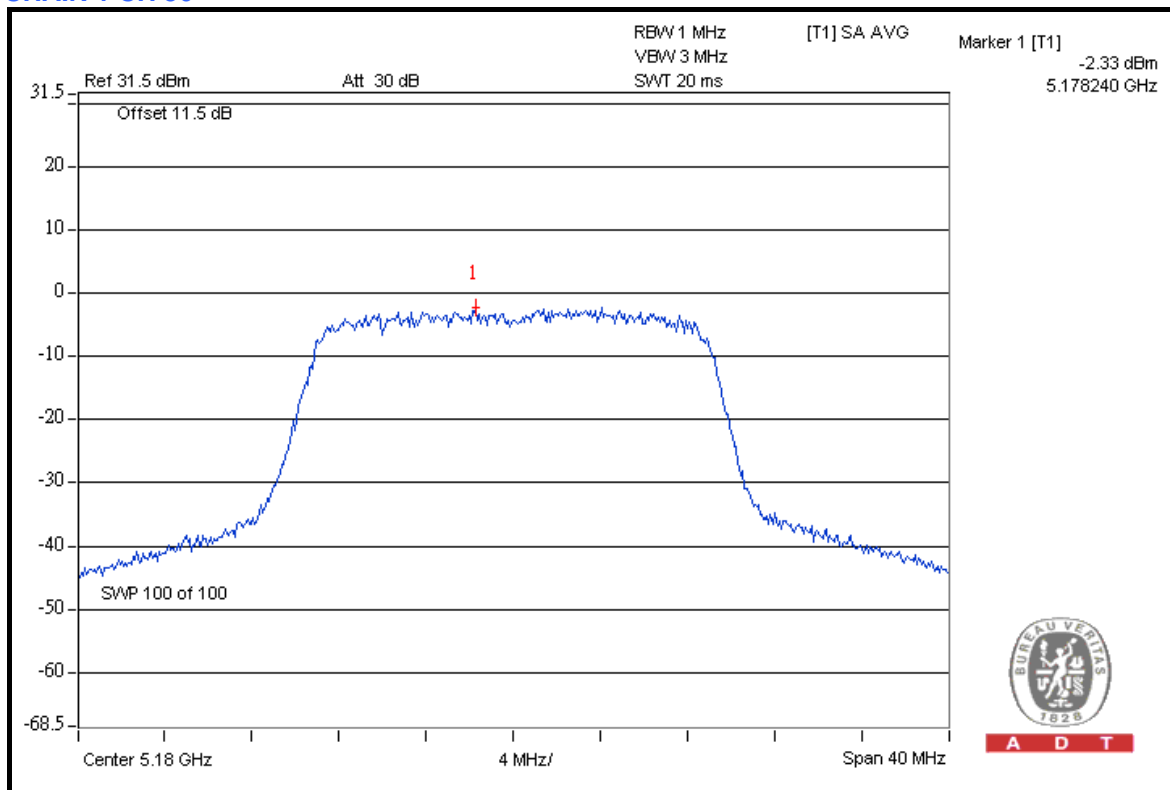

CH 40

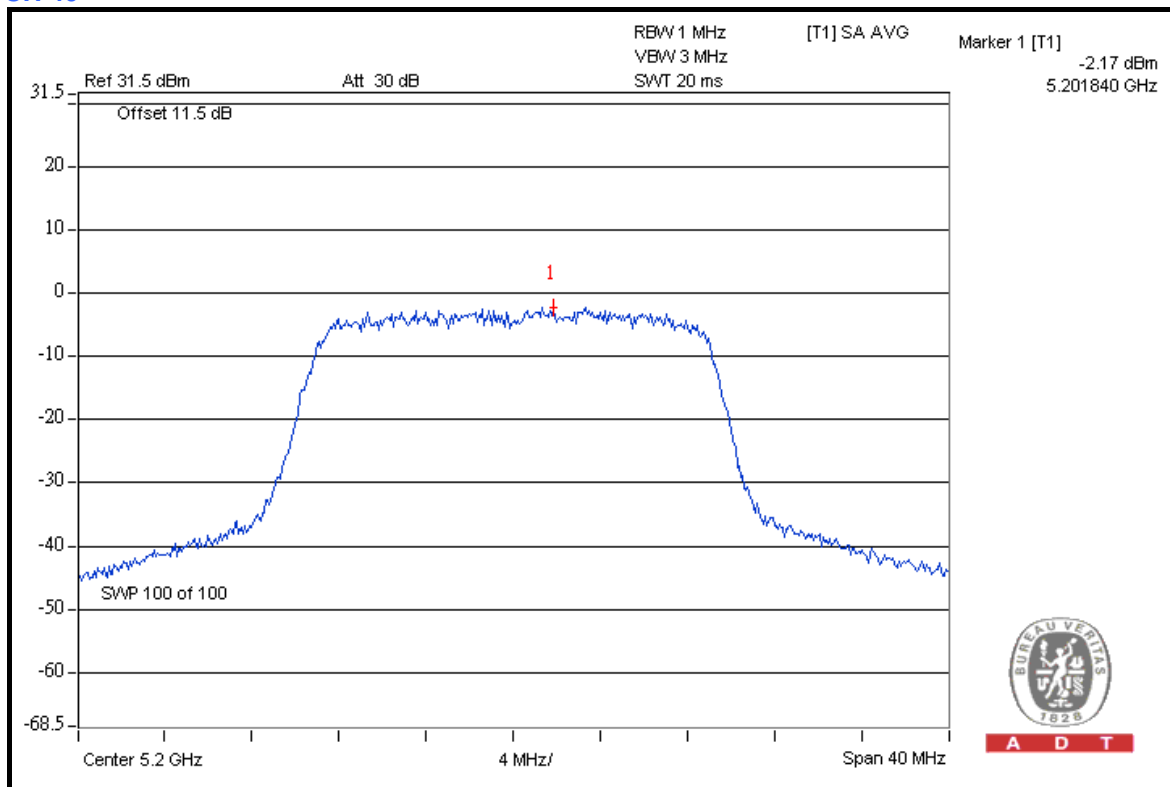



A D T

CH 48

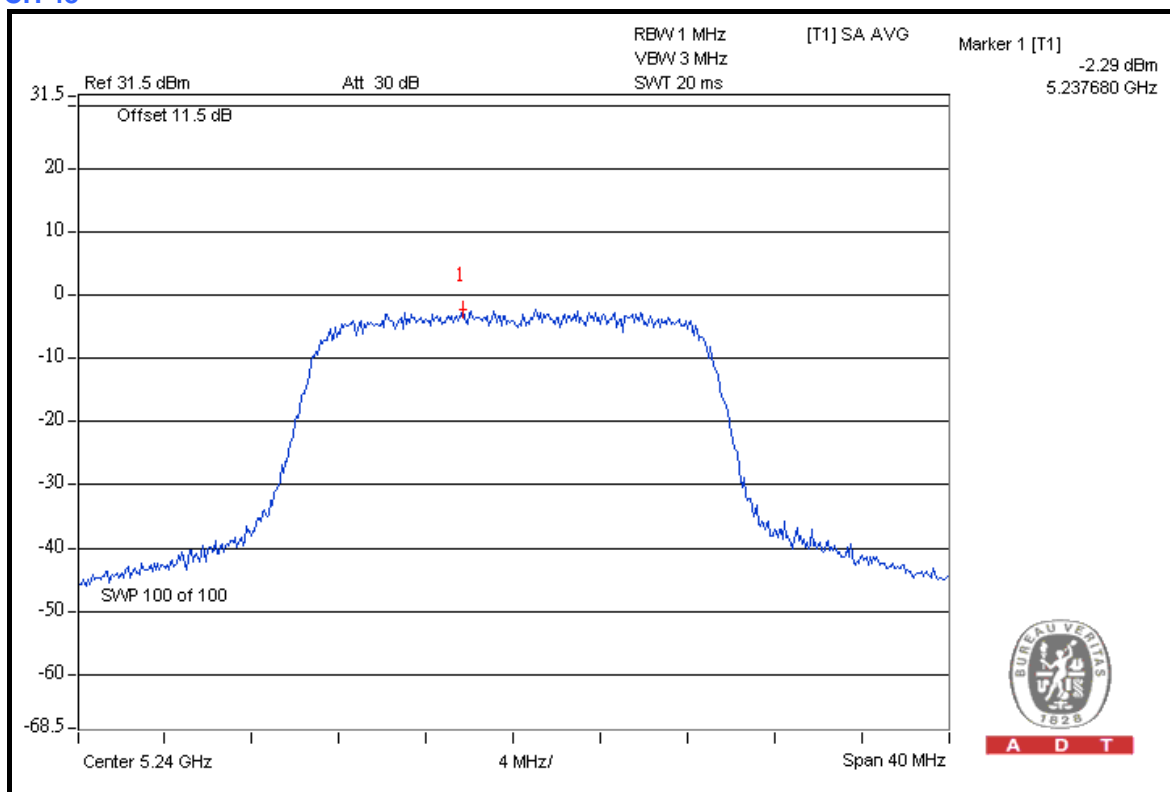

CHAIN 2 CH 36

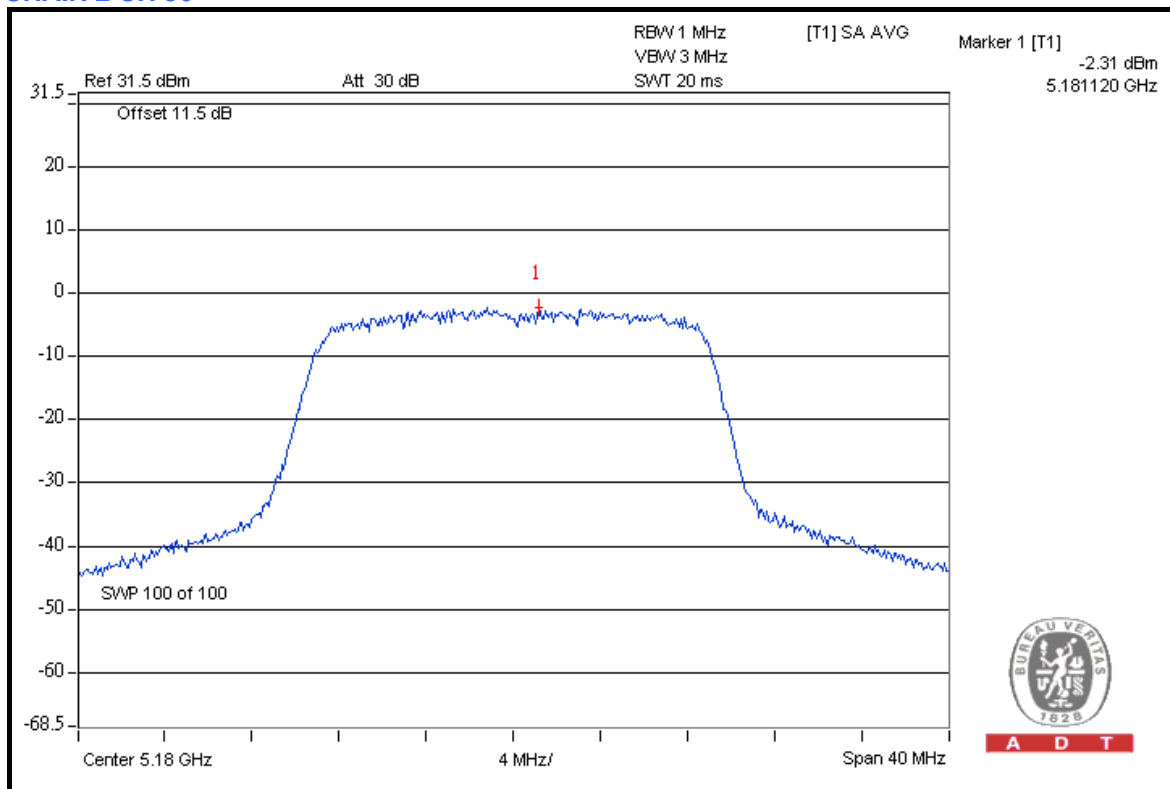



A D T

CH 40

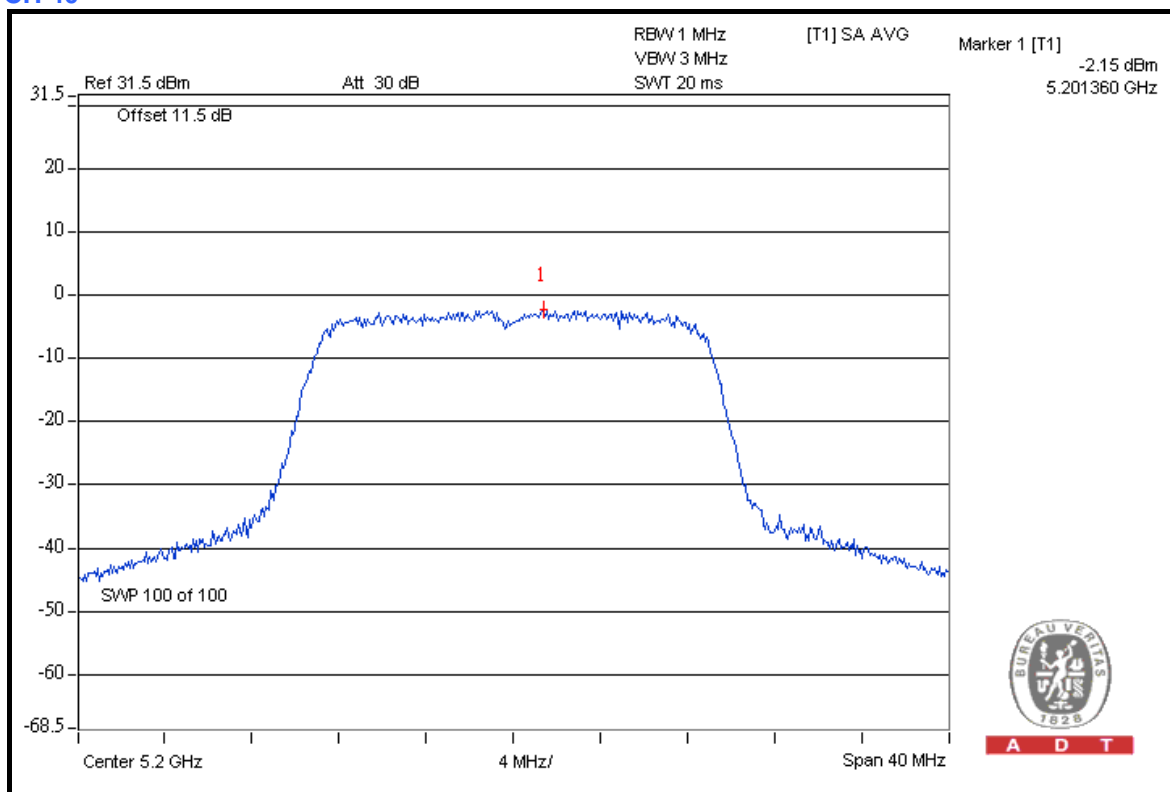

CH 48

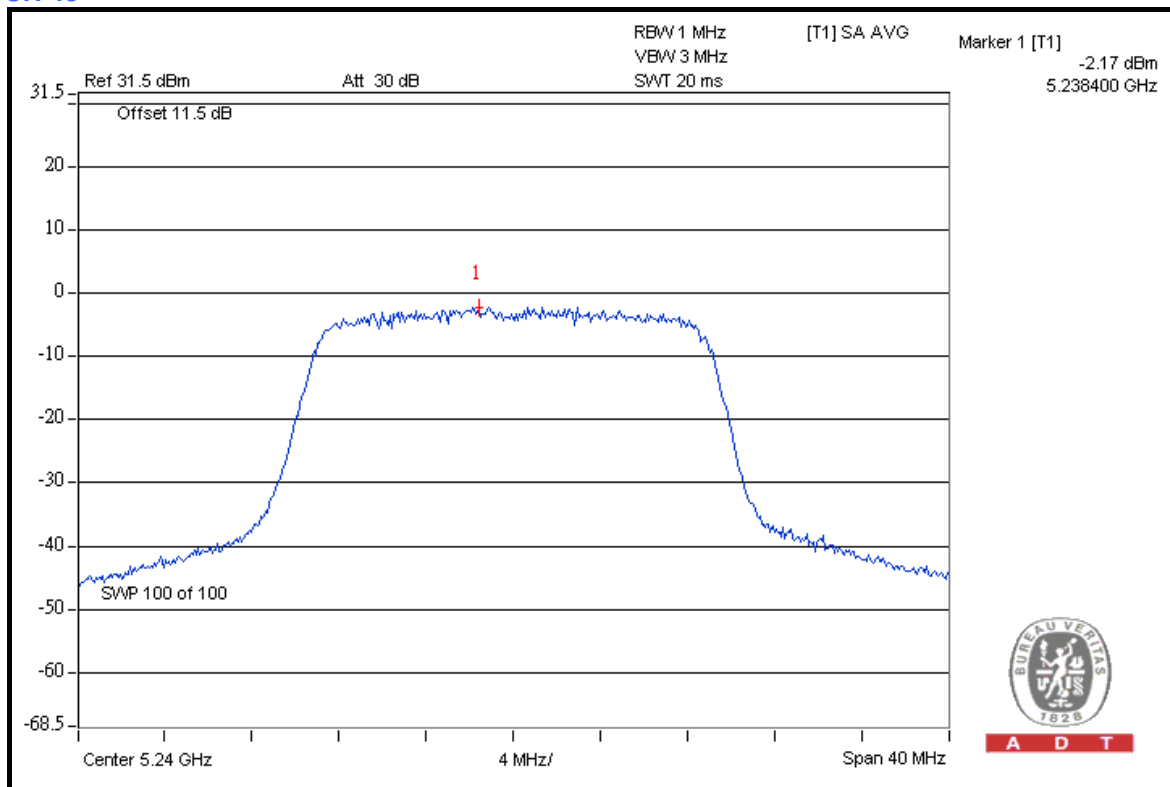



A D T

DRAFT 802.11n (20MHz) OFDM MODULATION

MODULATION TYPE	BPSK	TRANSFER RATE	6.5Mbps
INPUT POWER (SYSTEM)	120Vac, 60Hz	ENVIRONMENTAL CONDITIONS	25deg.C, 65%RH, 991hPa
TESTED BY	Brad Wu	TEST MODE	C

CHAN.	CHAN. FREQ. (MHz)	RF POWER LEVEL IN 1MHz BW (dBm)		TOTAL POWER DENSITY (mW)	TOTAL POWER DENSITY (dBm)	MAX. LIMIT (dBm)	PASS / FAIL
		CHAIN 0	CHAIN 1				
36	5180	-10.38	-9.06	0.216	-6.66	-4	PASS
40	5200	-10.33	-8.92	0.221	-6.56	-4	PASS
48	5240	-10.32	-9.04	0.218	-6.62	-4	PASS

NOTE: According to 15.407 (a) (1) (2), the maximum antenna gain 14dBi is higher than 6dBi, so the limit of peak power spectral density shall be reduced by 8 dB.



A D T

CHAIN 0 CH 36

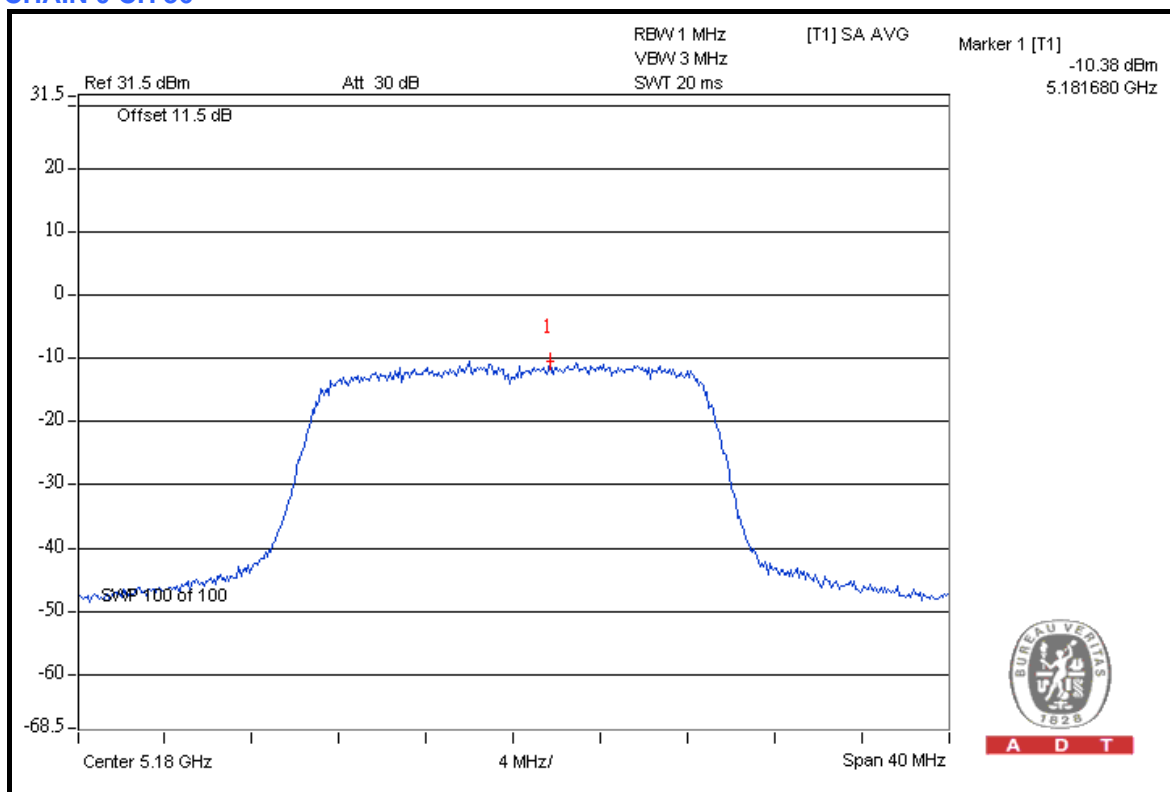

CH 40

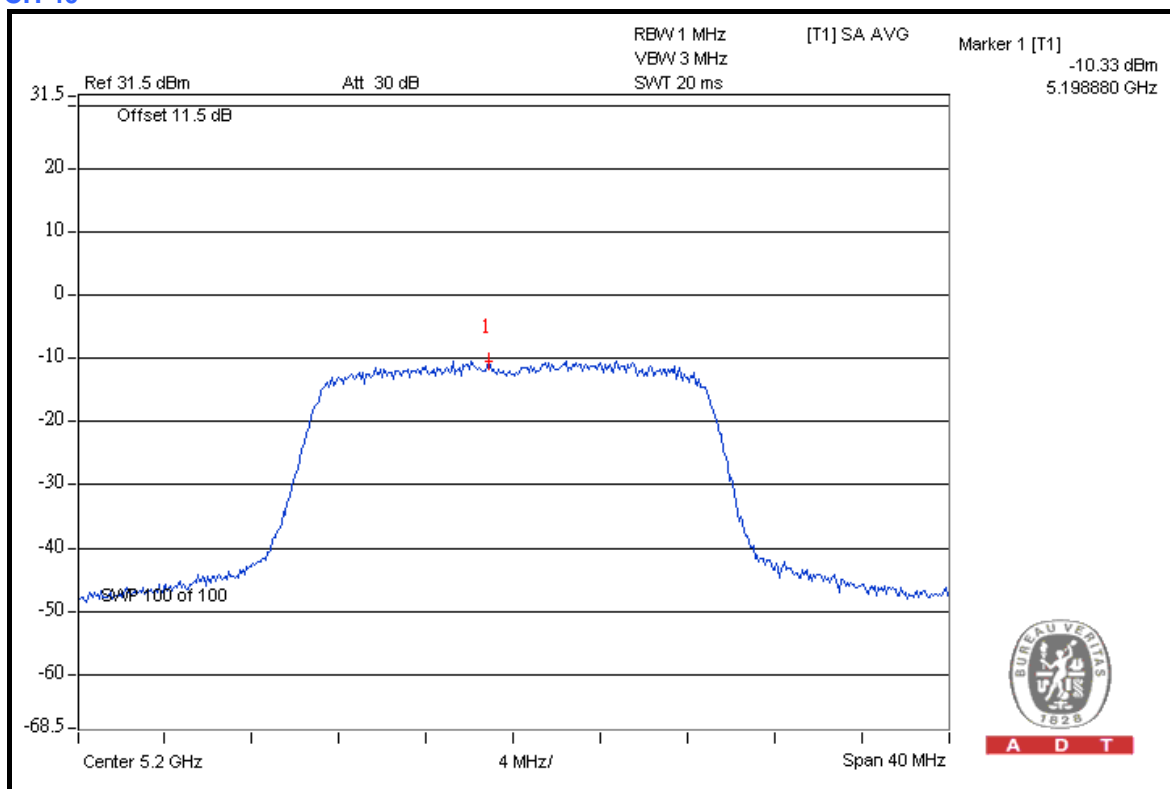



A D T

CH 48

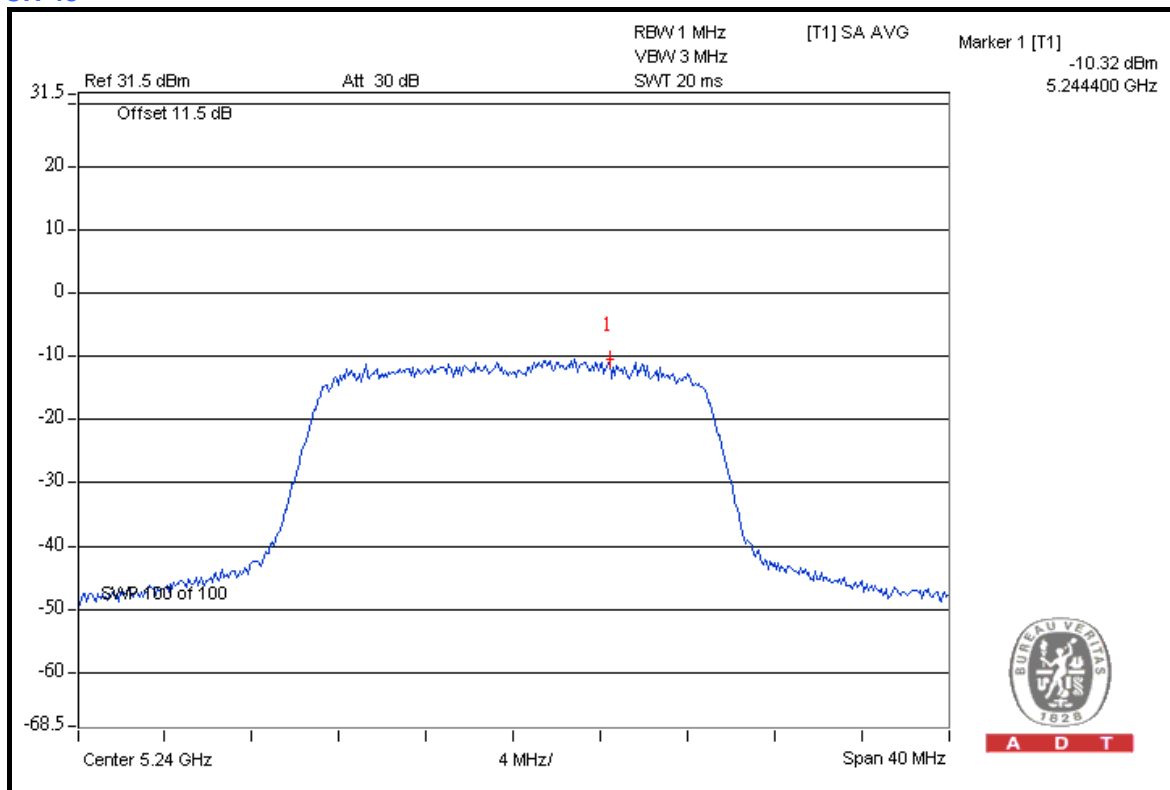

CHAIN 1 CH 36

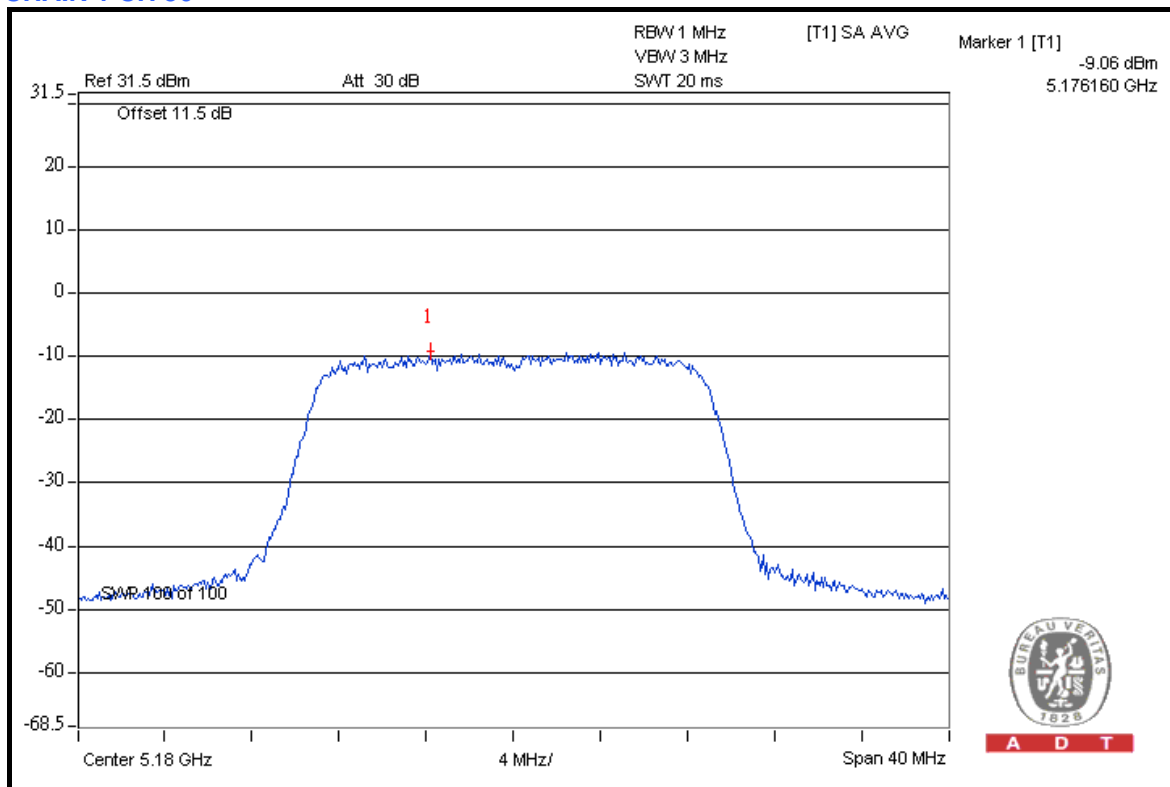



A D T

CH 40

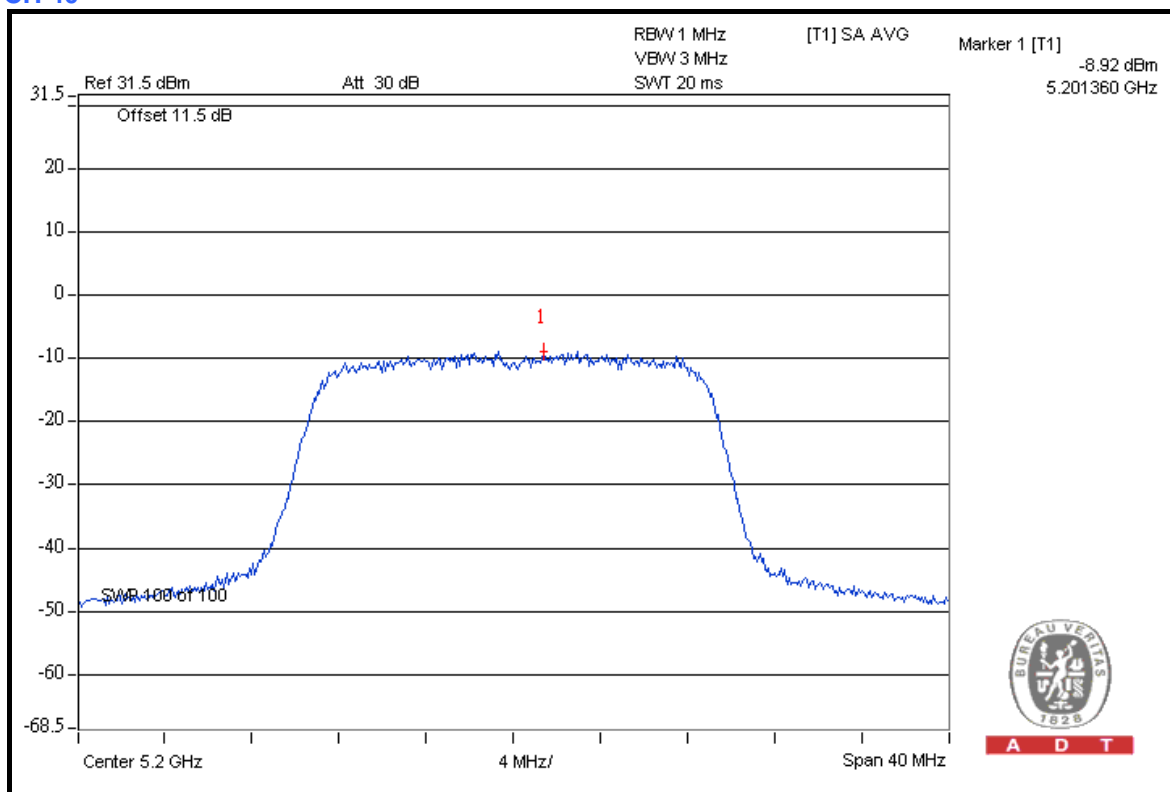

CH 48

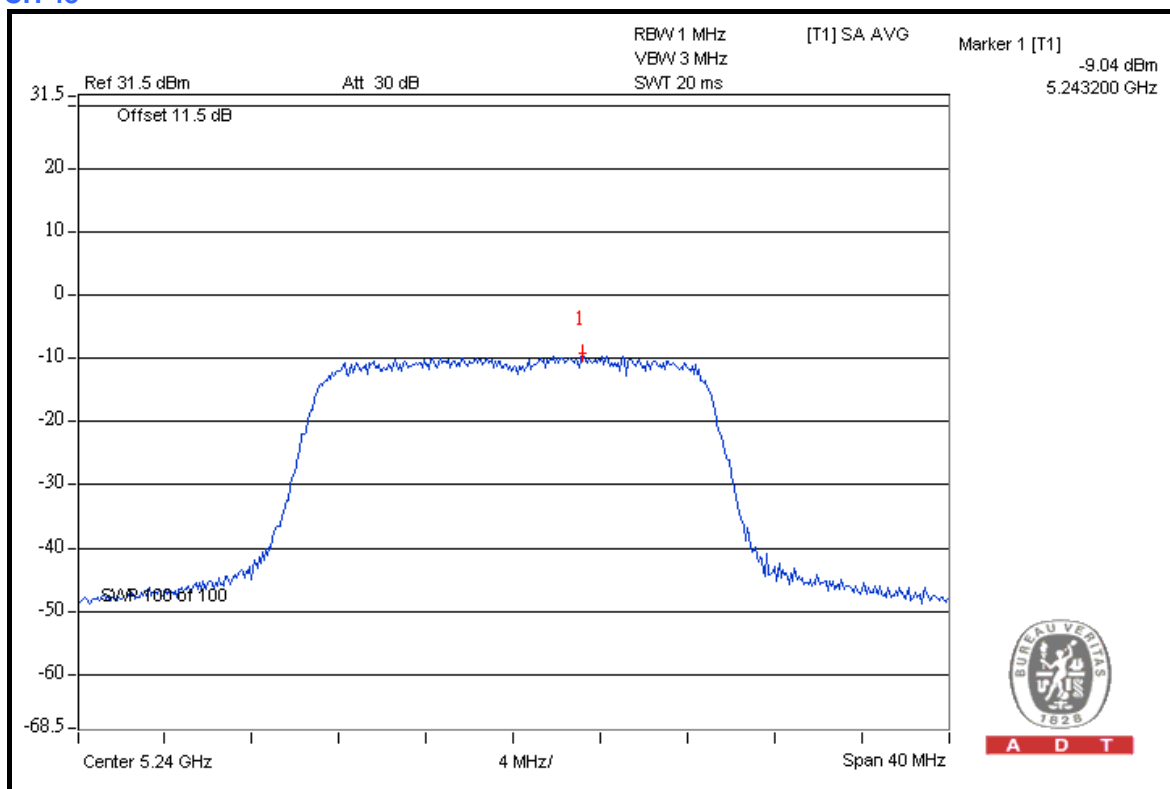



A D T

DRAFT 802.11n (40MHz) OFDM MODULATION

MODULATION TYPE	BPSK	TRANSFER RATE	13.5Mbps
INPUT POWER (SYSTEM)	120Vac, 60Hz	ENVIRONMENTAL CONDITIONS	25deg.C, 65%RH, 991hPa
TESTED BY	Brad Wu	TEST MODE	A

CHAN.	CHAN. FREQ. (MHz)	RF POWER LEVEL IN 1MHz BW (dBm)			TOTAL POWER DENSITY (mW)	TOTAL POWER DENSITY (dBm)	MAX. LIMIT (dBm)	PASS / FAIL
		CHAIN 0	CHAIN 1	CHAIN 2				
38	5190	-5.44	-5.72	-5.51	0.835	-0.78	4	PASS
46	5230	-5.23	-5.55	-5.36	0.870	-0.60	4	PASS



A D T

CHAIN 0 CH 38

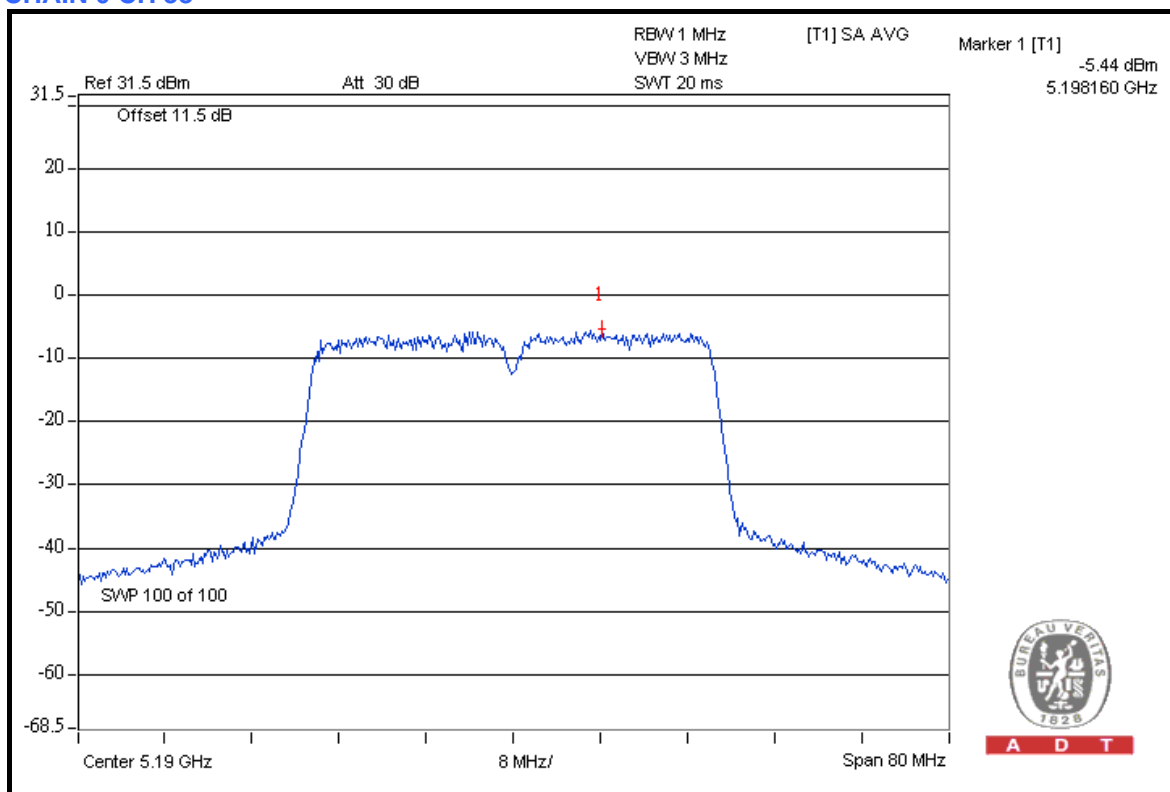

A D T

CH 46

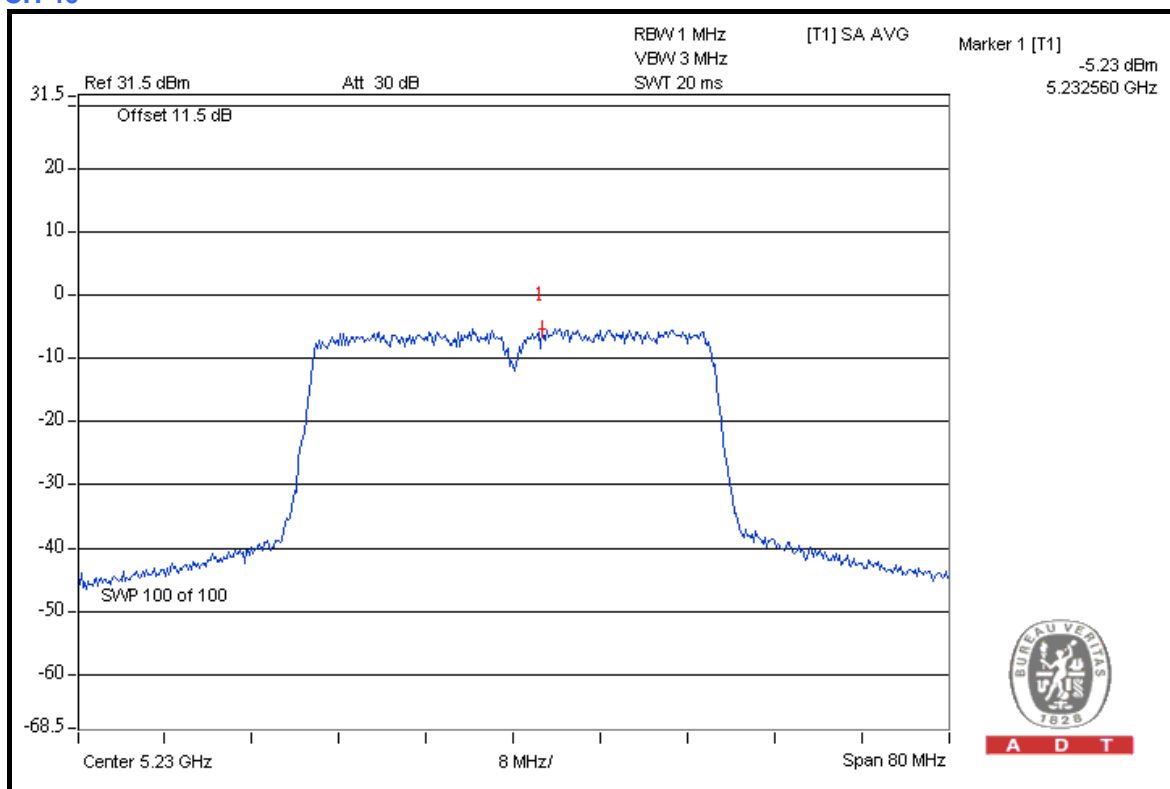

A D T



A D T

CHAIN 1 CH 38

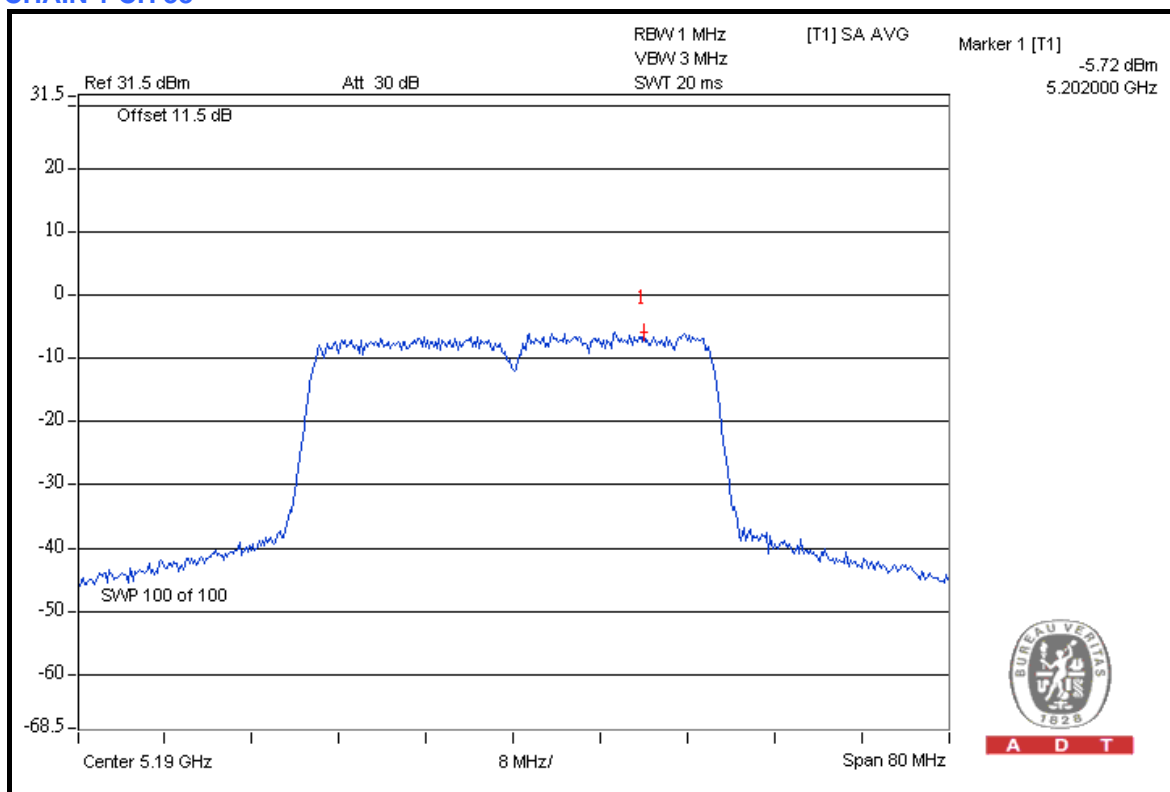

CH 46

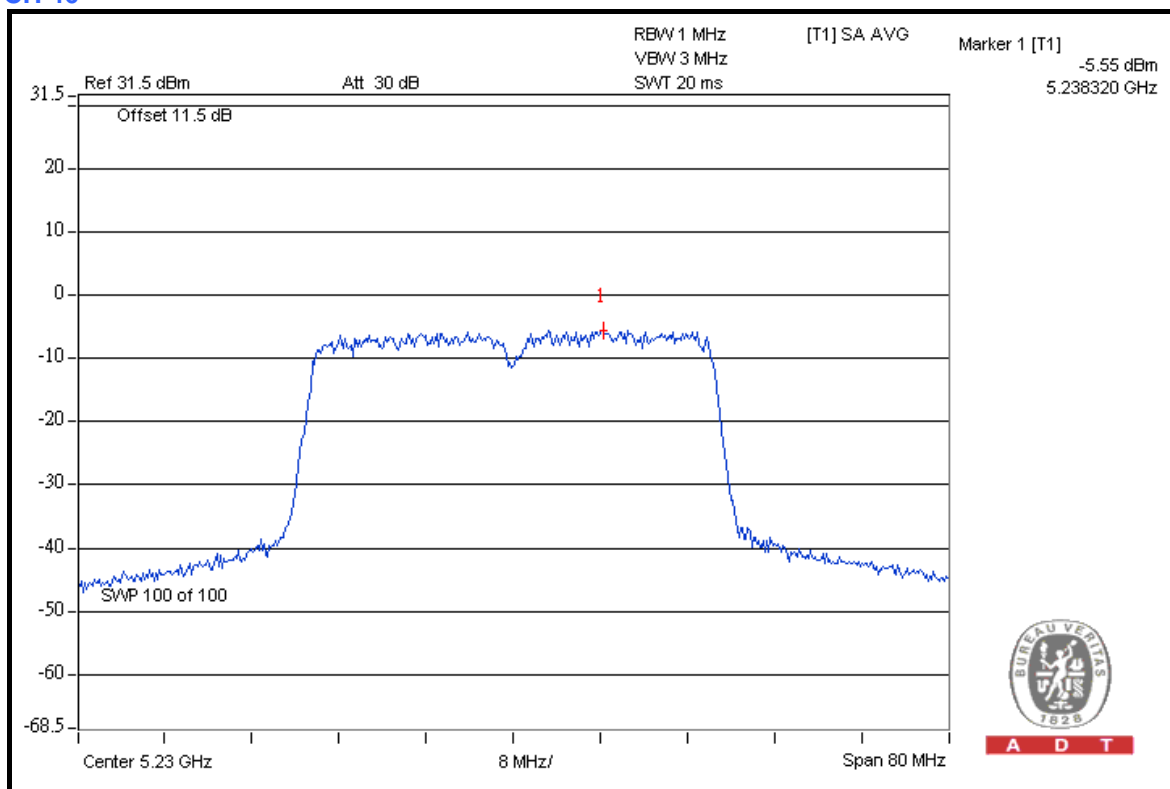



A D T

CHAIN 2 CH 38

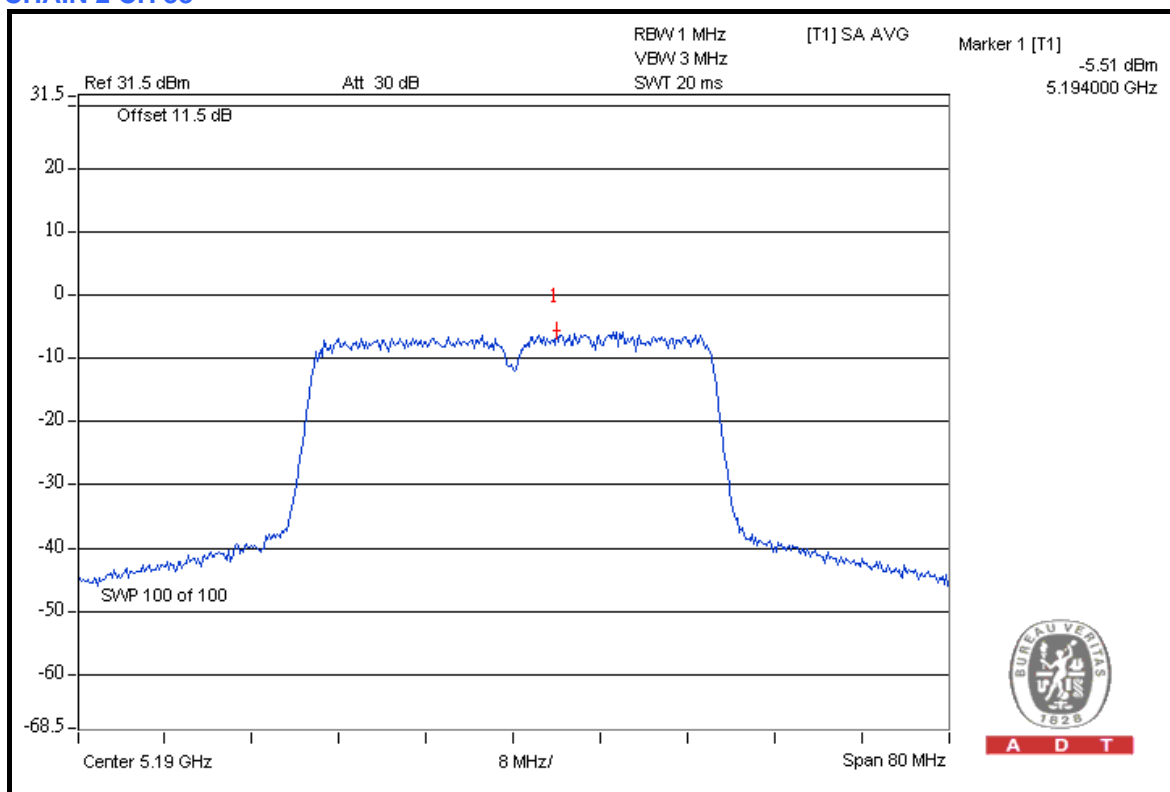

CH 46

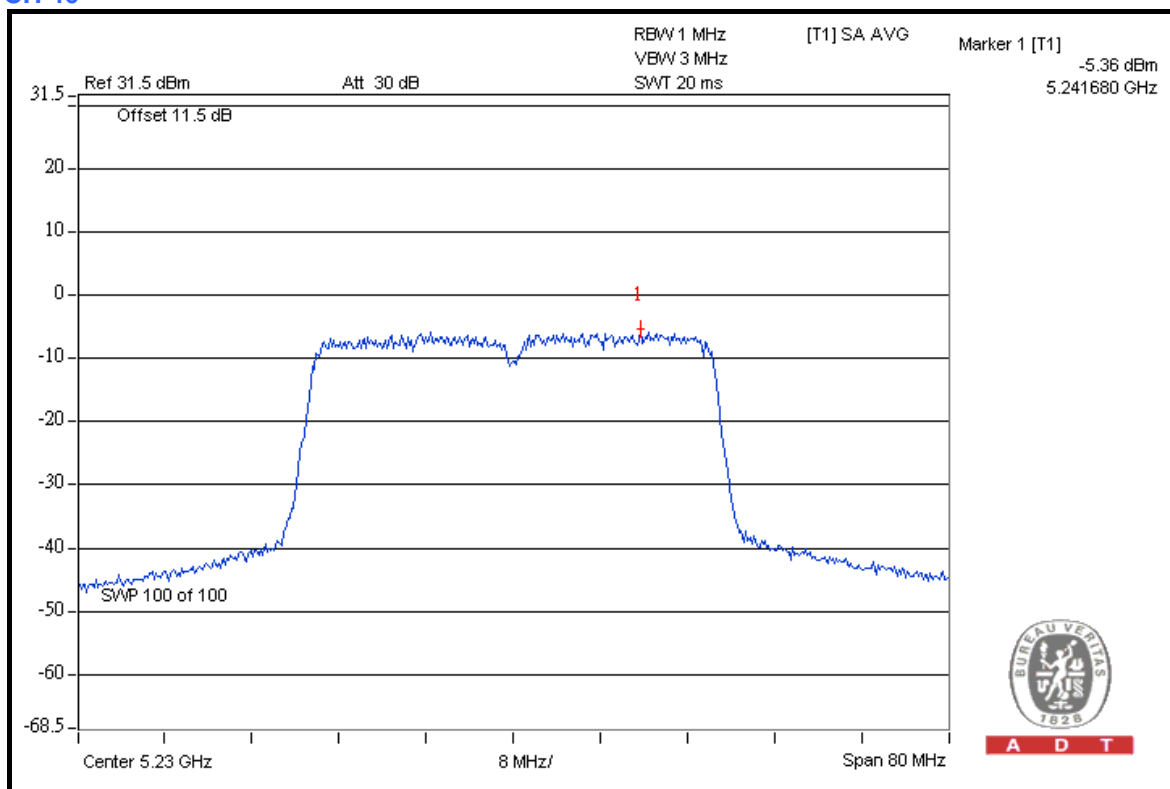



A D T

DRAFT 802.11n (40MHz) OFDM MODULATION

MODULATION TYPE	BPSK	TRANSFER RATE	13.5Mbps
INPUT POWER (SYSTEM)	120Vac, 60Hz	ENVIRONMENTAL CONDITIONS	25deg.C, 65%RH, 991hPa
TESTED BY	Brad Wu	TEST MODE	C

CHAN.	CHAN. FREQ. (MHz)	RF POWER LEVEL IN 1MHz BW (dBm)		TOTAL POWER DENSITY (mW)	TOTAL POWER DENSITY (dBm)	MAX. LIMIT (dBm)	PASS / FAIL
		CHAIN 0	CHAIN 1				
38	5190	-14.14	-12.21	0.099	-10.04	-4	PASS
46	5230	-14.05	-11.97	0.103	-9.87	-4	PASS

NOTE: According to 15.407 (a) (1) (2), the maximum antenna gain 14dBi is higher than 6dBi, so the limit of peak power spectral density shall be reduced by 8 dB.



A D T

CHAIN 0 CH 38

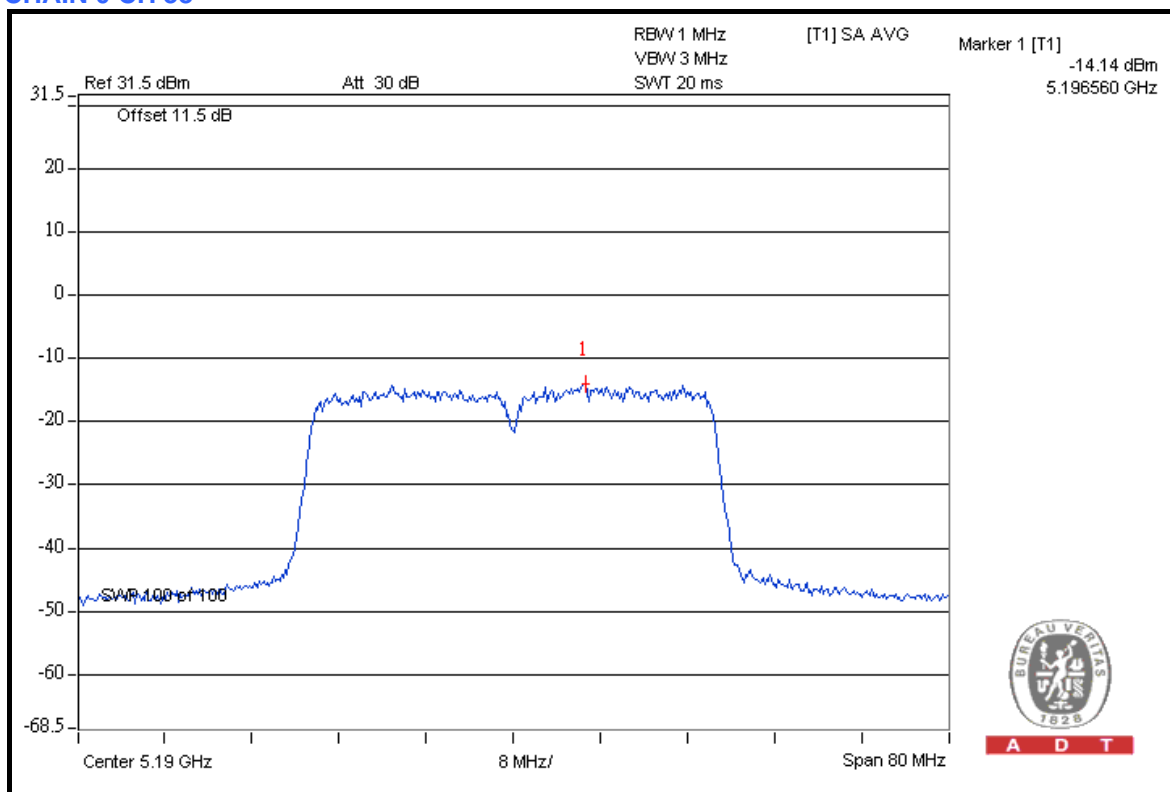

A D T

CH 46

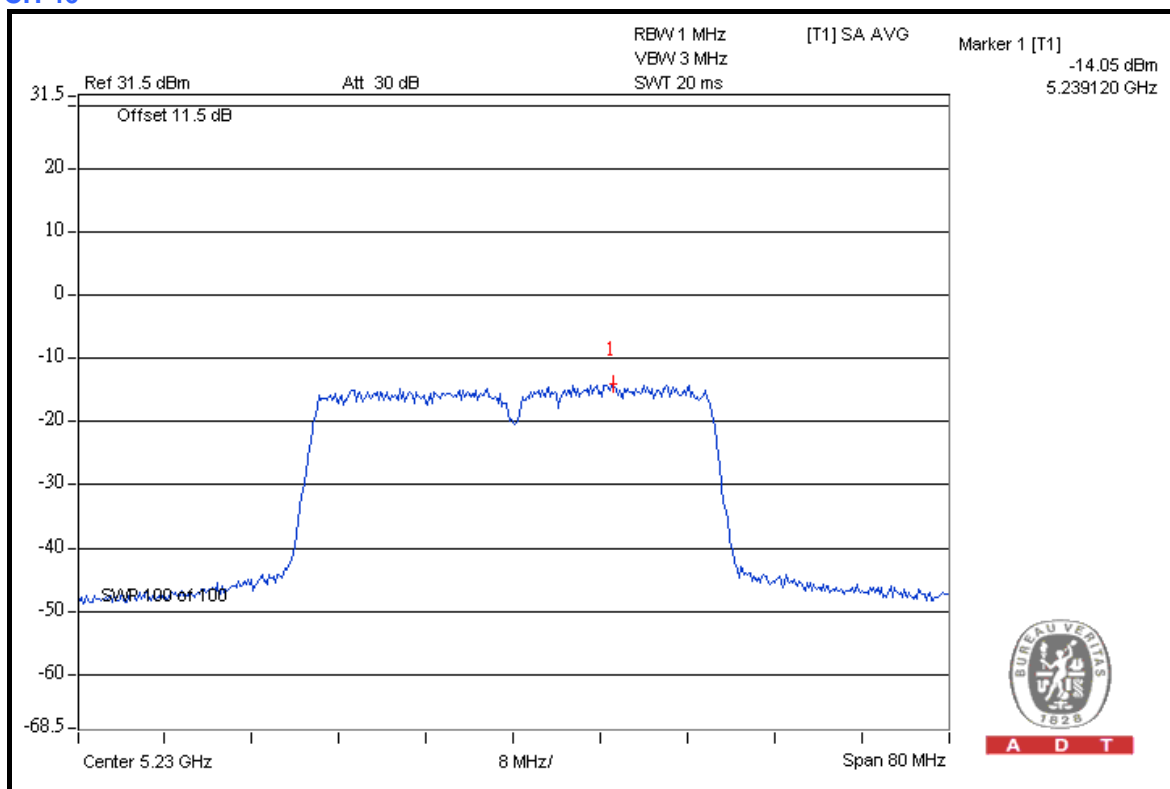

A D T



A D T

CHAIN 1 CH 38

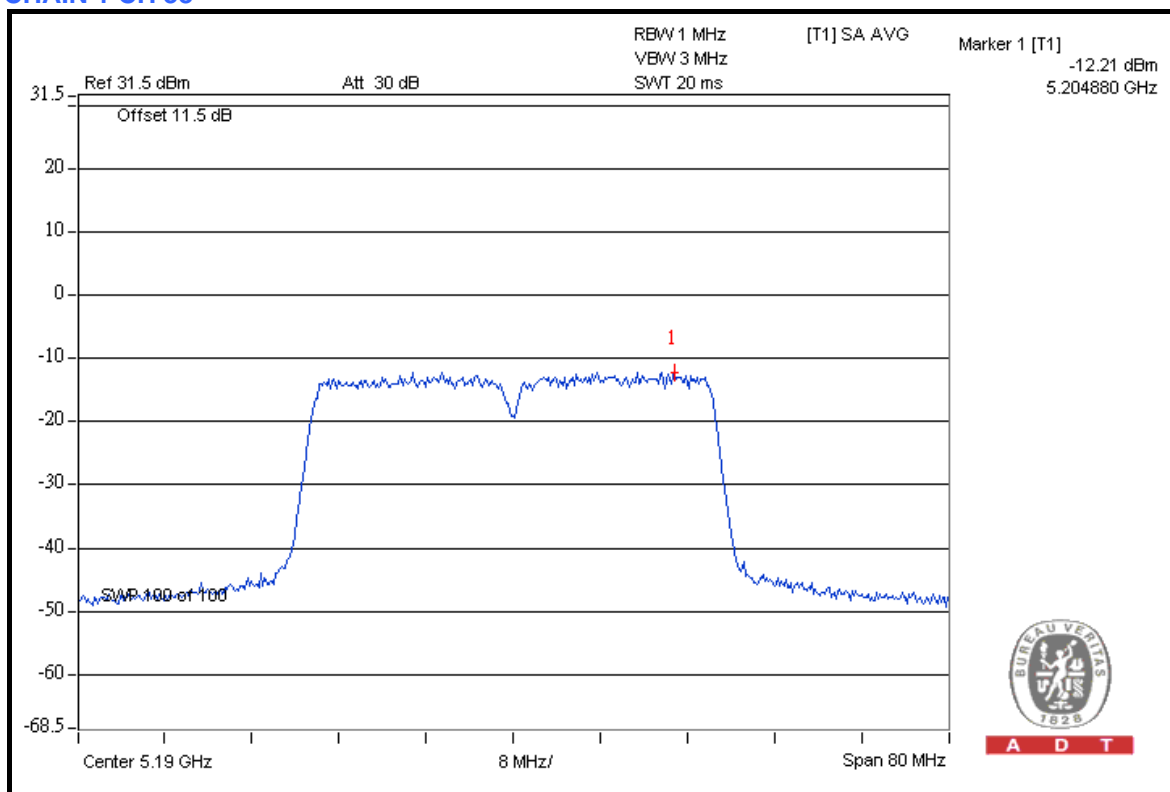

CH 46

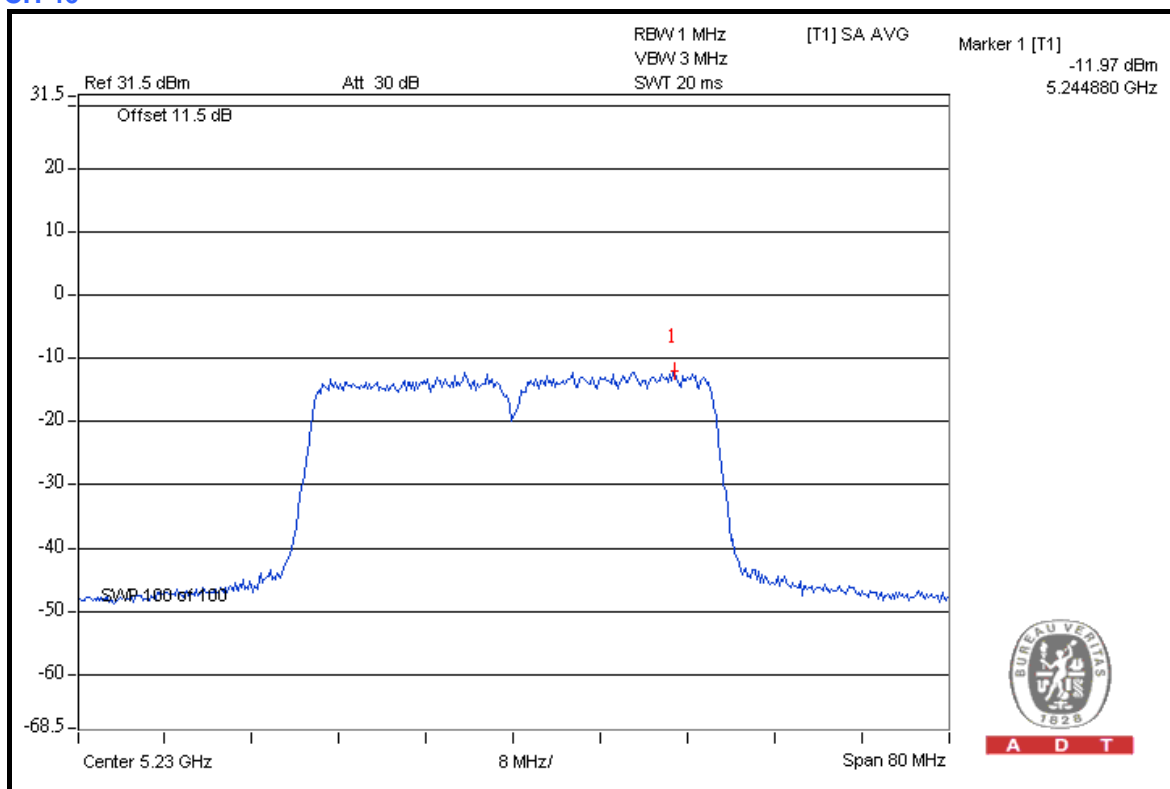

4.6 FREQUENCY STABILITY

4.6.1 LIMITS OF FREQUENCY STABILITY MEASUREMENT

The frequency tolerance of the carrier signal shall be maintained within the band of the operating frequency over a temperature variation of -30 degrees to 50 degrees C at normal supply voltage, and for a variation in the primary supply voltage from 85% to 115% of the rated supply voltage at a temperature of 20 degrees C.

4.6.2 TEST INSTRUMENTS

DESCRIPTION & MANUFACTURER	MODEL NO.	SERIAL NO.	DATE OF CALIBRATION	DUE DATE OF CALIBRATION
R&S SPECTRUM ANALYZER	FSP40	100041	May 13, 2009	May 12, 2010
WIT STANDARD TEMPERATURE AND HUMIDITY CHAMBER	TH-4S-C	W981030	Jun. 24, 2009	Jun. 23, 2010

NOTE: The calibration interval of the above test instruments is 12 months and the calibrations are traceable to NML/ROC and NIST/USA.

4.6.3 TEST PROCEDURE

- a. The EUT was placed inside the environmental test chamber and powered by nominal DC voltage.
- b. Turn the EUT on and couple its output to a spectrum analyzer.
- c. Turn the EUT off and set the chamber to the highest temperature specified.
- d. Allow sufficient time (approximately 30 min) for the temperature of the chamber to stabilize, turn the EUT on and measure the operating frequency after 2, 5, and 10 minutes.
- e. Repeat step b and c with the temperature chamber set to the lowest temperature.
- f. The test chamber was allowed to stabilize at $+20$ degree C for a minimum of 30 minutes. The supply voltage was then adjusted on the EUT from 85% to 115% and the frequency record.

4.6.4 DEVIATION FROM TEST STANDARD

No deviation

4.6.5 TEST SETUP

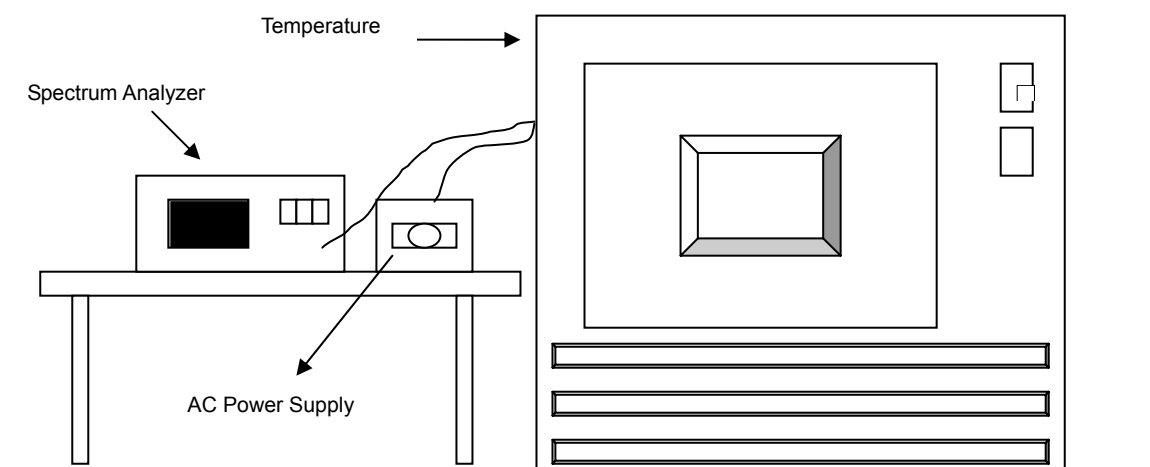

4.6.6 EUT OPERATING CONDITION

Same as Item 4.1.7



A D T

4.6.7 TEST RESULTS

FREQUENCY STABILITY VERSUS TEMP.									
OPERATING FREQUENCY: 5200MHz									
TEMP. (°C)	POWER SUPPLY (Vac)	0 MINUTE		2 MINUTE		5 MINUTE		10 MINUTE	
		Measured Frequency (MHz)	Frequency Drift (ppm)	Measured Frequency (MHz)	Frequency Drift (ppm)	Measured Frequency (MHz)	Frequency Drift (ppm)	Measured Frequency (MHz)	Frequency Drift (ppm)
50	110.0	5199.996743	-0.626	5199.997188	-0.541	5199.997038	-0.570	5199.996780	-0.619
40	110.0	5199.996514	-0.670	5199.996825	-0.611	5199.996890	-0.598	5199.996269	-0.717
30	110.0	5199.997120	-0.554	5199.997028	-0.572	5199.997393	-0.501	5199.997296	-0.520
20	110.0	5199.997390	-0.502	5199.997398	-0.500	5199.997229	-0.533	5199.997780	-0.427
10	110.0	5199.997544	-0.472	5199.997547	-0.472	5199.997679	-0.446	5199.997395	-0.501
0	110.0	5199.997871	-0.409	5199.998188	-0.348	5199.997904	-0.403	5199.998194	-0.347
-10	110.0	5199.996262	-0.719	5199.996245	-0.722	5199.996421	-0.688	5199.996342	-0.703
-20	110.0	5199.997406	-0.499	5199.997573	-0.467	5199.997440	-0.492	5199.997827	-0.418
-30	110.0	5199.996815	-0.612	5199.997260	-0.527	5199.996850	-0.606	5199.996602	-0.653

FREQUENCY STABILITY VERSUS VOLTAGE									
OPERATING FREQUENCY: 5200MHz									
TEMP. (°C)	POWER SUPPLY (Vac)	0 MINUTE		2 MINUTE		5 MINUTE		10 MINUTE	
		Measured Frequency (MHz)	Frequency Drift (ppm)	Measured Frequency (MHz)	Frequency Drift (ppm)	Measured Frequency (MHz)	Frequency Drift (ppm)	Measured Frequency (MHz)	Frequency Drift (ppm)
20	93.5	5199.997725	-0.437	5199.998190	-0.348	5199.998322	-0.323	5199.998205	-0.345
	110.0	5199.997871	-0.409	5199.998188	-0.348	5199.997904	-0.403	5199.998194	-0.347
	126.5	5199.998281	-0.331	5199.997555	-0.470	5199.997723	-0.438	5199.998003	-0.384



A D T

FREQUENCY STABILITY VERSUS TEMP.									
OPERATING FREQUENCY: 5200MHz									
TEMP. (°C)	POWER SUPPLY (Vac)	0 MINUTE		2 MINUTE		5 MINUTE		10 MINUTE	
		Measured Frequency (MHz)	Frequency Drift (ppm)	Measured Frequency (MHz)	Frequency Drift (ppm)	Measured Frequency (MHz)	Frequency Drift (ppm)	Measured Frequency (MHz)	Frequency Drift (ppm)
50	12.0	5199.996824	-0.611	5199.997250	-0.529	5199.996832	-0.609	5199.996986	-0.580
40	12.0	5199.996792	-0.617	5199.996727	-0.629	5199.996871	-0.602	5199.996575	-0.659
30	12.0	5199.996736	-0.628	5199.996972	-0.582	5199.996788	-0.618	5199.996558	-0.662
20	12.0	5199.997168	-0.545	5199.997432	-0.494	5199.997312	-0.517	5199.997385	-0.503
10	12.0	5199.997166	-0.545	5199.997430	-0.494	5199.996995	-0.578	5199.997593	-0.463
0	12.0	5199.997462	-0.488	5199.997291	-0.521	5199.997817	-0.420	5199.997774	-0.428
-10	12.0	5199.996228	-0.725	5199.996114	-0.747	5199.996398	-0.693	5199.996431	-0.686
-20	12.0	5199.997421	-0.496	5199.997353	-0.509	5199.997463	-0.488	5199.997697	-0.443
-30	12.0	5199.996676	-0.639	5199.996570	-0.660	5199.996991	-0.579	5199.996682	-0.638

FREQUENCY STABILITY VERSUS VOLTAGE									
OPERATING FREQUENCY: 5200MHz									
TEMP. (°C)	POWER SUPPLY (Vac)	0 MINUTE		2 MINUTE		5 MINUTE		10 MINUTE	
		Measured Frequency (MHz)	Frequency Drift (ppm)	Measured Frequency (MHz)	Frequency Drift (ppm)	Measured Frequency (MHz)	Frequency Drift (ppm)	Measured Frequency (MHz)	Frequency Drift (ppm)
20	10.2	5199.997557	-0.470	5199.997416	-0.497	5199.997304	-0.518	5199.997125	-0.553
	12.0	5199.997462	-0.488	5199.997291	-0.521	5199.997817	-0.420	5199.997774	-0.428
	13.8	5199.997983	-0.388	5199.997490	-0.483	5199.997845	-0.414	5199.997896	-0.405

4.7 BAND EDGES MEASUREMENT

4.7.1 TEST INSTRUMENTS

DESCRIPTION & MANUFACTURER	MODEL NO.	SERIAL NO.	DATE OF CALIBRATION	DUE DATE OF CALIBRATION
Test Receiver ROHDE & SCHWARZ	ESI7	100033	Jul. 06, 2009	Jul. 05, 2010
Spectrum Analyzer ROHDE & SCHWARZ	FSP40	100076	May. 26, 2009	May. 25, 2010
BILOG Antenna SCHWARZBECK	VULB9168	9168-160	Apr. 27, 2009	Apr. 26, 2010
HORN Antenna SCHWARZBECK	9120D	9120D-209	Jul. 01, 2009	Jun. 30, 2010
HORN Antenna SCHWARZBECK	BBHA 9170	BBHA9170243	Dec. 25, 2008	Dec. 24, 2009
Preamplifier Agilent	8447D	2944A10633	Nov. 03, 2008	Nov. 02, 2009
Preamplifier Agilent	8449B	3008A01964	Oct. 23, 2008	Oct. 22, 2009
RF signal cable HUBER+SUHNNER	SUCOFLEX 104	238141/4	May 13, 2009	May 12, 2010
RF signal cable HUBER+SUHNNER	SUCOFLEX 104	12738/6	May 13, 2009	May 12, 2010
Software ADT.	ADT_Radiated_ V7.6.15.9.2	NA	NA	NA
Antenna Tower inn-co GmbH	MA 4000	013303	NA	NA
Antenna Tower Controller inn-co GmbH	CO2000	017303	NA	NA
Turn Table ADT.	TT100.	TT93021703	NA	NA
Turn Table Controller ADT.	SC100.	SC93021703	NA	NA
26GHz ~ 40GHz Amplifier	EM26400	07026401	Aug. 27, 2008	Aug. 26, 2009

NOTE: The calibration interval of the above test instruments is 12 months and the calibrations are traceable to NML/ROC and NIST/USA.

4.7.2 TEST PROCEDURE

The transmitter output was connected to the spectrum analyzer via a low lose cable. Set both RBW and VBW of spectrum analyzer to 1MHz and 3MHz with suitable frequency span including 100MHz bandwidth from band edge. The band edges was measured and recorded.

4.7.3 EUT OPERATING CONDITION

The software provided by client to enable the EUT under transmission condition continuously at specific channel frequencies individually.

4.7.4 TEST RESULTS

For signals in the restricted bands above and below the 5.18 to 5.32GHz and 5.50 to 5.70GHz allocated band a measurement was made of the amplitude of the spurious emissions with respect to the intentional signals. The relative amplitude, in dBc, was applied to the average and peak field strength of the intentional signal made on the OATS to calculate the field strength of the unintentional signals.

The spectrum plots (Peak RBW = 1MHz, VBW = 3MHz) are attached on the following pages.

FOR 5180-5240MHz BAND: 802.11a OFDM MODULATION

TEST MODE A

Channel 36 (5180MHz)

The band edge emission plot on the next page shows 49.80dBc between carrier maximum power and local maximum emission in restrict band. The emission of carrier strength list in the test result of channel 36 is 107.85dBuV/m (Peak), so the maximum field strength in restrict band is $107.85 - 49.80 = 58.05$ dBuV/m which is under 74dBuV/m limit.

The band edge emission plot on the next page shows 51.87dBc between carrier maximum power and local maximum emission in restrict band. The emission of carrier strength list in the test result of channel 36 is 97.21dBuV/m (Average), so the maximum field strength in restrict band is $97.21 - 51.87 = 45.34$ dBuV/m which is under 54dBuV/m limit.

Channel 48 (5240MHz)

The band edge emission plot on the next second page shows 48.52dBc between carrier maximum power and local maximum emission in restrict band. The emission of carrier strength list in the test result of channel 48 is 107.65dBuV/m (Peak), so the maximum field strength in restrict band is $107.65 - 48.52 = 59.13$ dBuV/m which is under 74dBuV/m limit.

The band edge emission plot on the next third page shows 50.47dBc between carrier maximum power and local maximum emission in restrict band. The emission of carrier strength list in the test result of channel 48 is 96.92dBuV/m (Average), so the maximum field strength in restrict band is $96.92 - 50.47 = 46.45$ dBuV/m which is under 54dBuV/m limit.



A D T

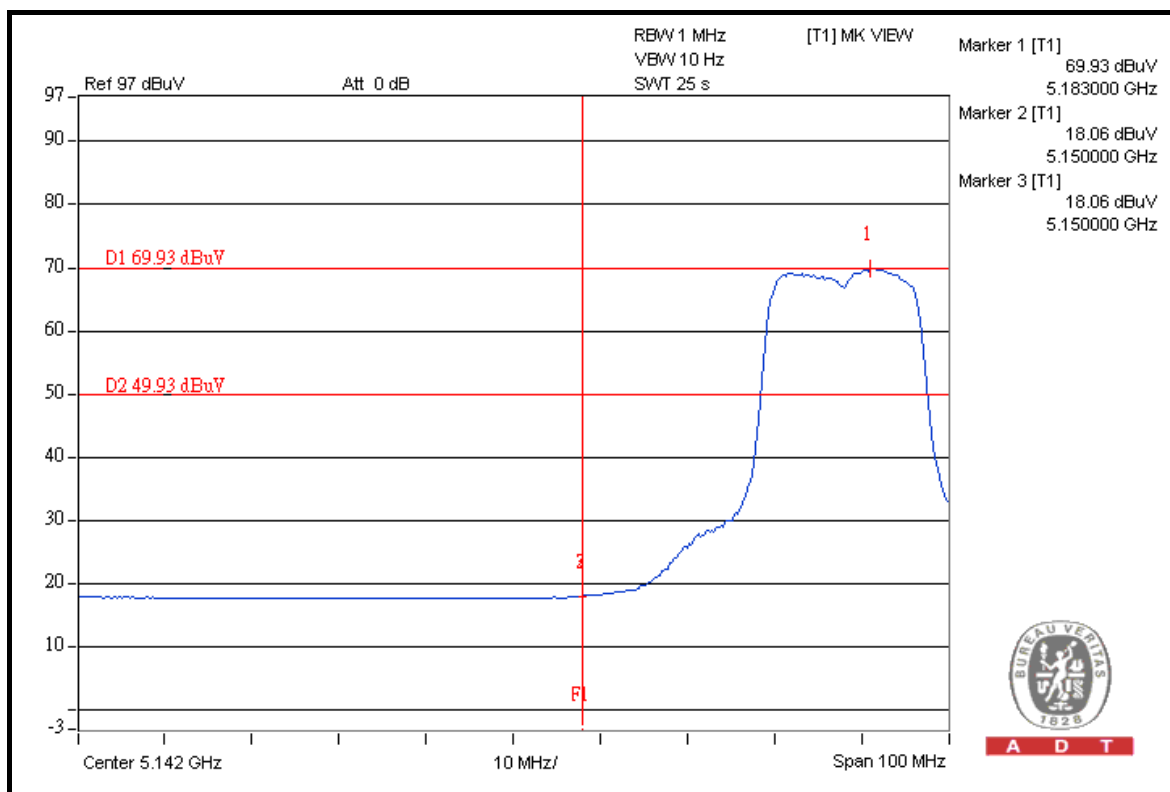
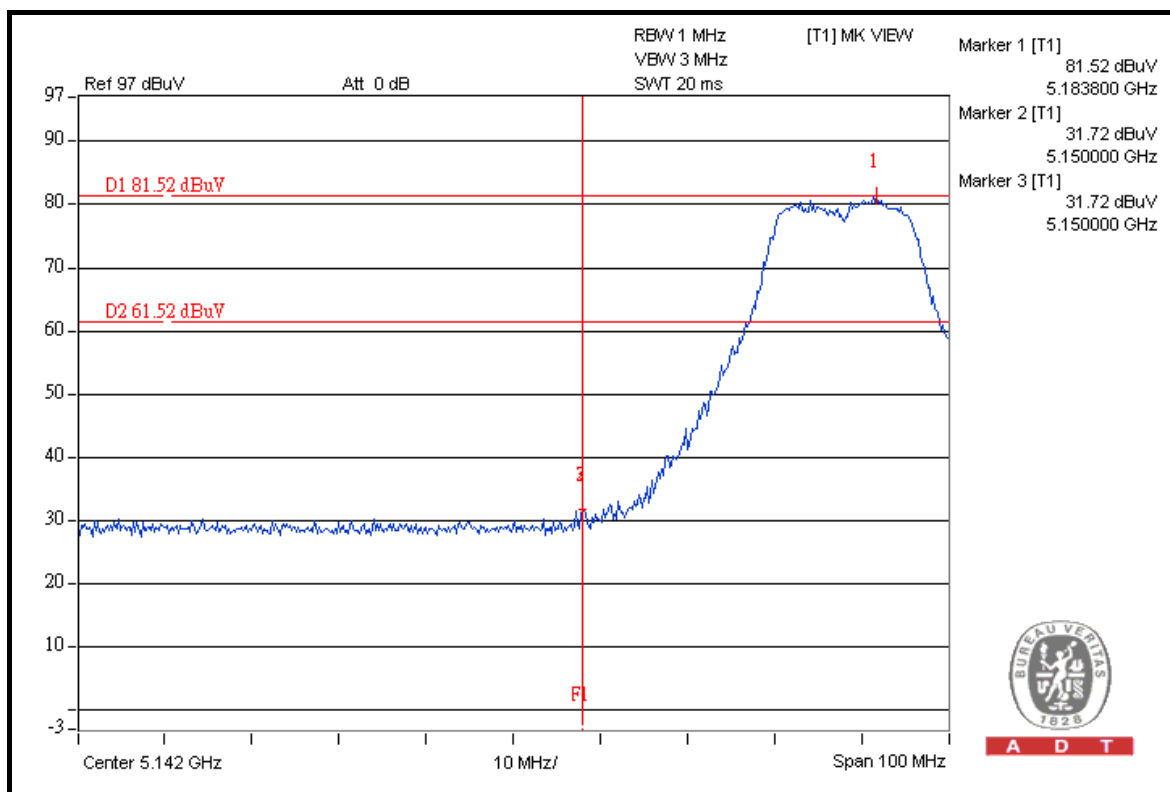



A D T

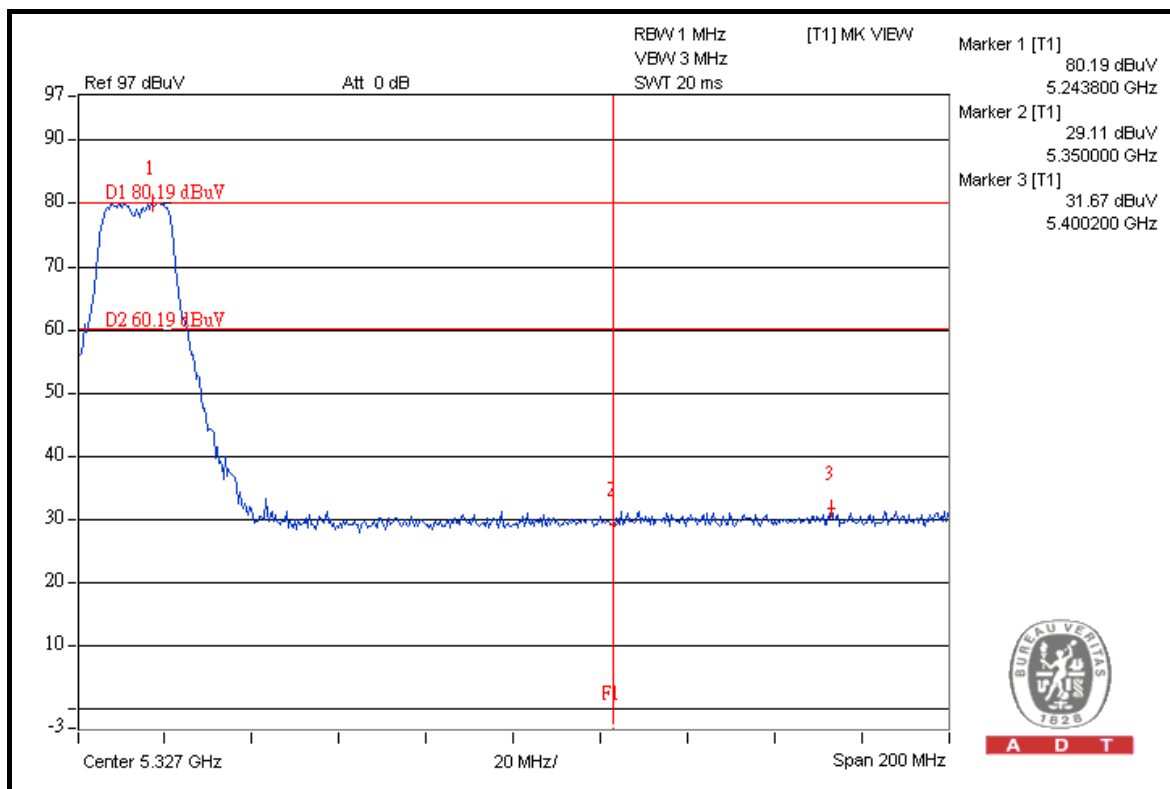
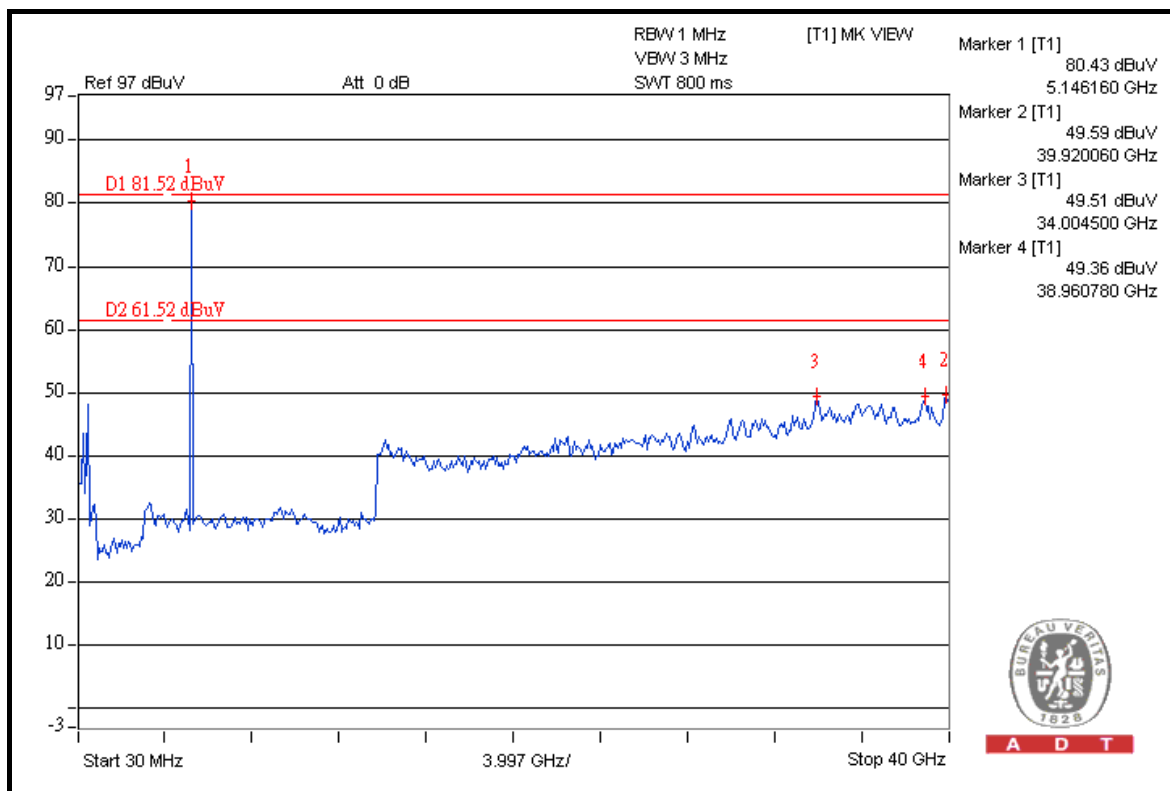



A D T

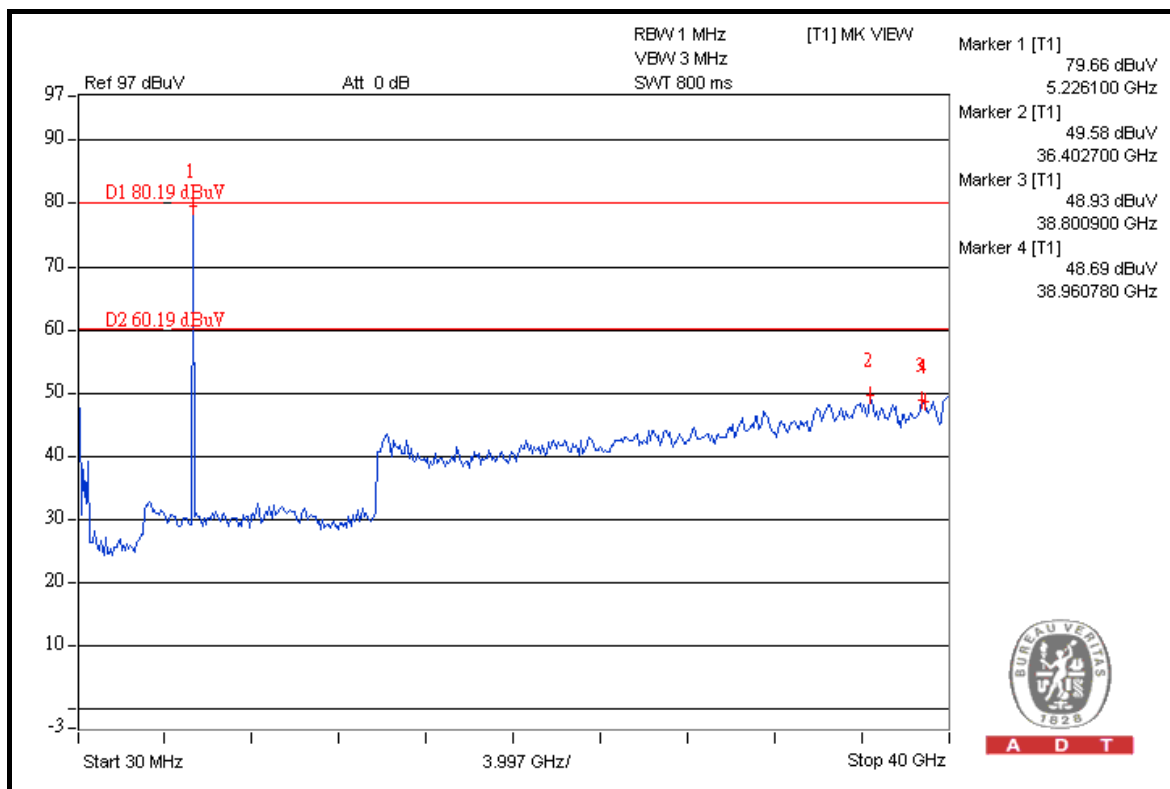
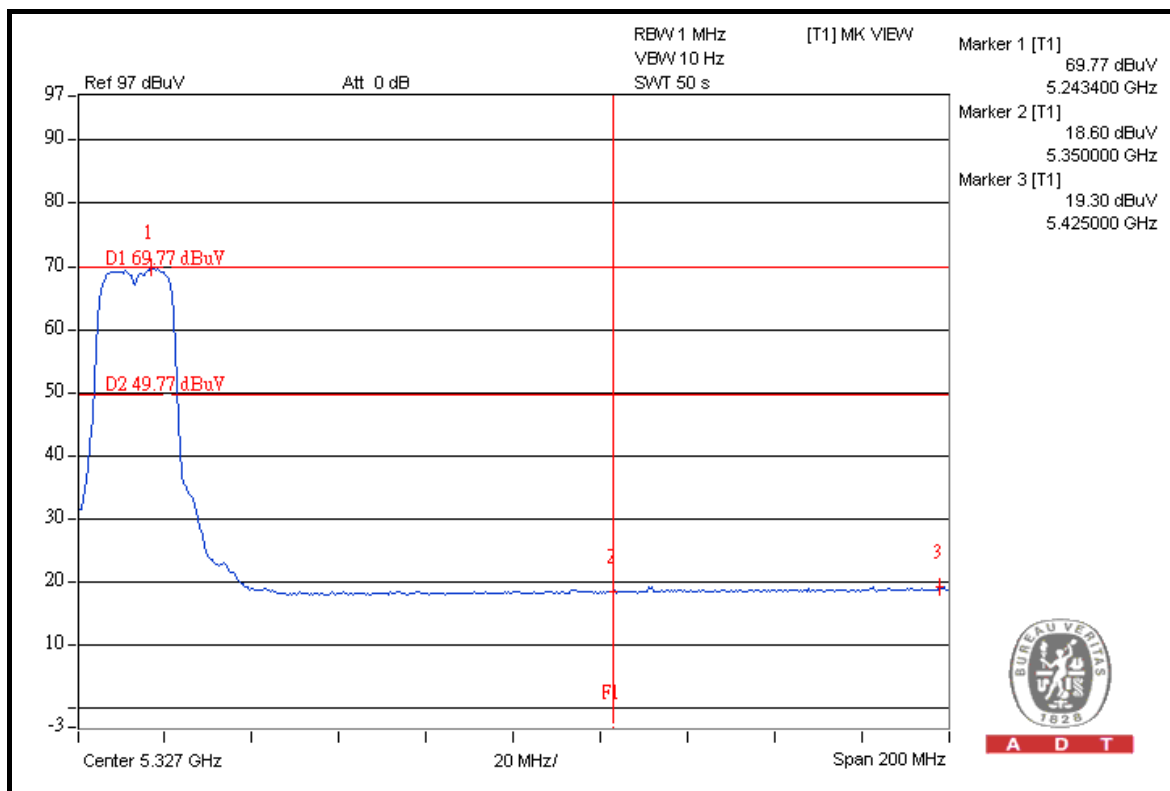

TEST MODE C

Channel 36 (5180MHz)

The band edge emission plot on the next page shows 48.46dBc between carrier maximum power and local maximum emission in restrict band. The emission of carrier strength list in the test result of channel 36 is 107.68dBuV/m (Peak), so the maximum field strength in restrict band is $107.68 - 48.46 = 59.22\text{dBuV/m}$ which is under 74dBuV/m limit.

The band edge emission plot on the next page shows 52.14dBc between carrier maximum power and local maximum emission in restrict band. The emission of carrier strength list in the test result of channel 36 is 97.04dBuV/m (Average), so the maximum field strength in restrict band is $97.04 - 52.14 = 44.90\text{dBuV/m}$ which is under 54dBuV/m limit.

Channel 48 (5240MHz)

The band edge emission plot on the next second page shows 47.12dBc between carrier maximum power and local maximum emission in restrict band. The emission of carrier strength list in the test result of channel 48 is 107.53dBuV/m (Peak), so the maximum field strength in restrict band is $107.53 - 47.12 = 60.41\text{dBuV/m}$ which is under 74dBuV/m limit.

The band edge emission plot on the next third page shows 49.69dBc between carrier maximum power and local maximum emission in restrict band. The emission of carrier strength list in the test result of channel 48 is 96.81dBuV/m (Average), so the maximum field strength in restrict band is $96.81 - 49.69 = 47.12\text{dBuV/m}$ which is under 54dBuV/m limit.



A D T

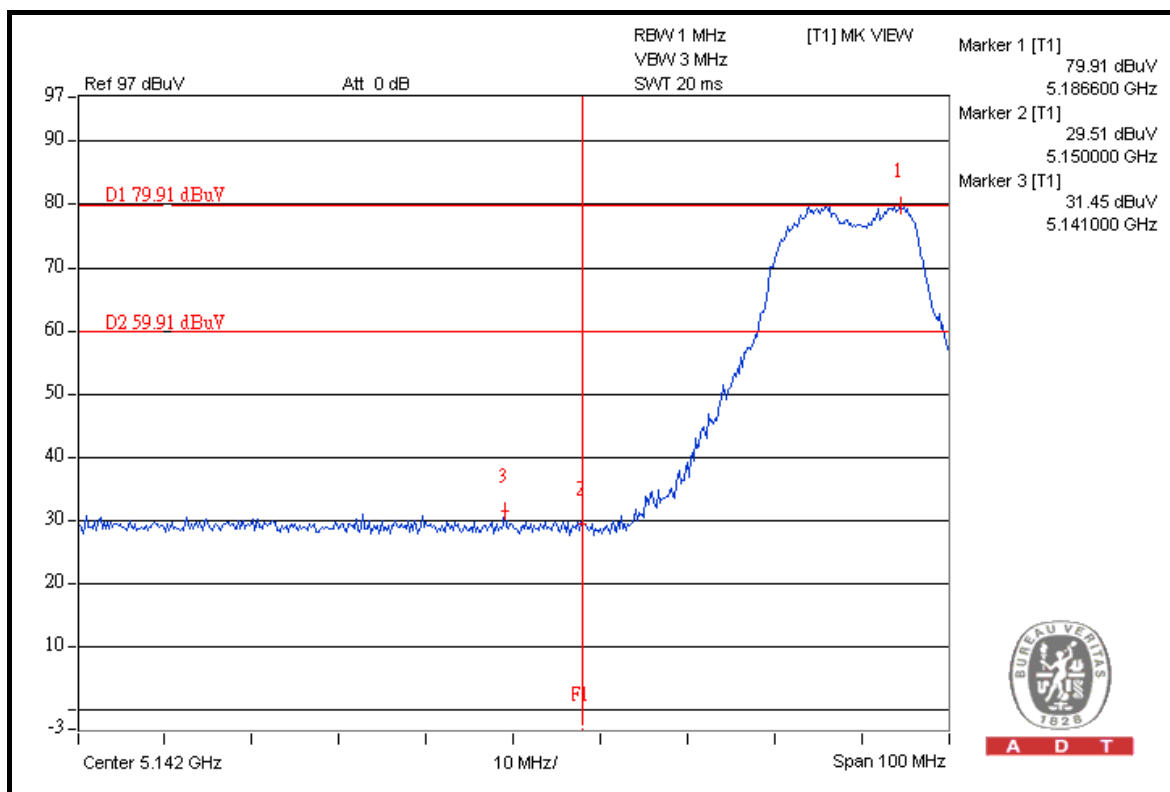

A D T

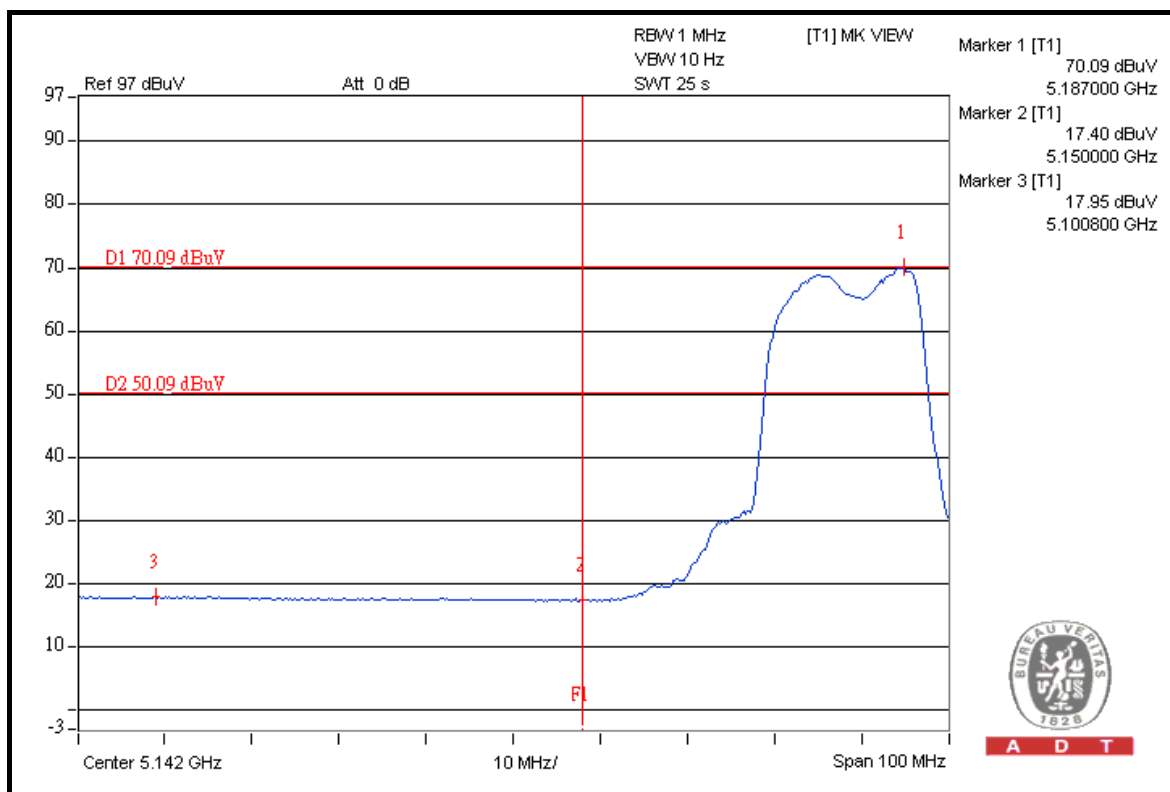

A D T



A D T

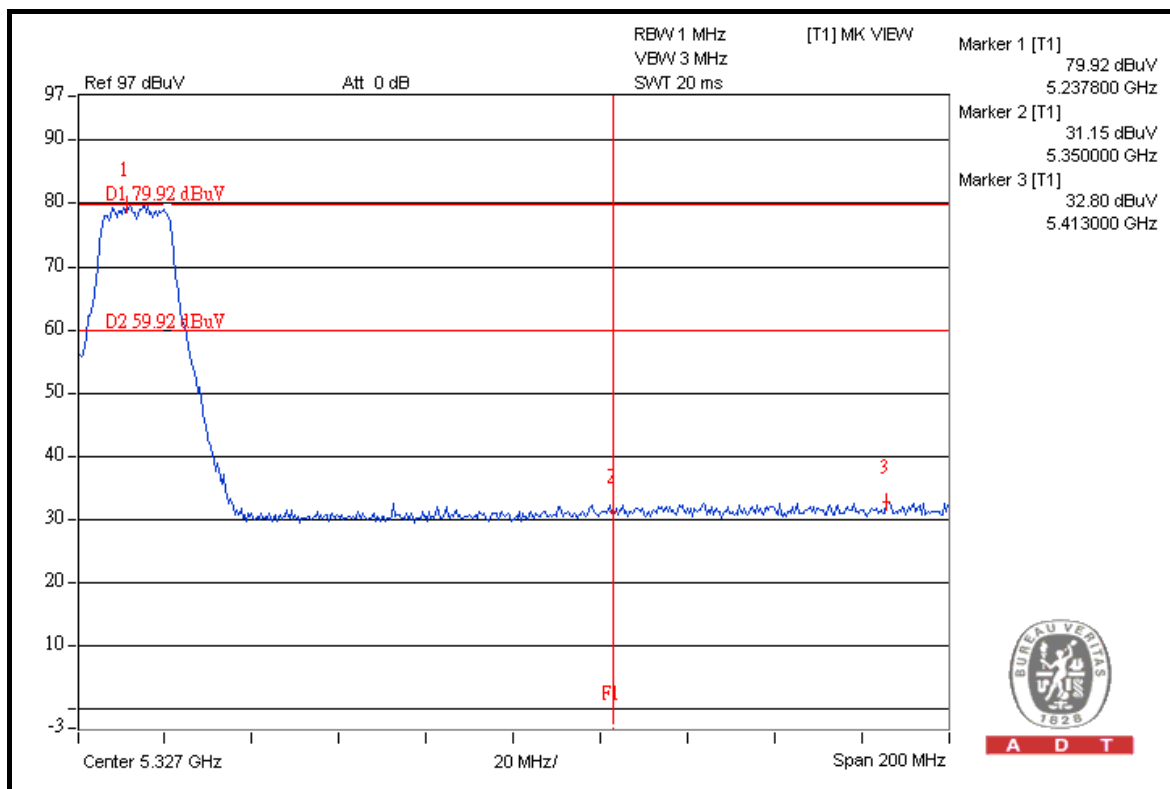
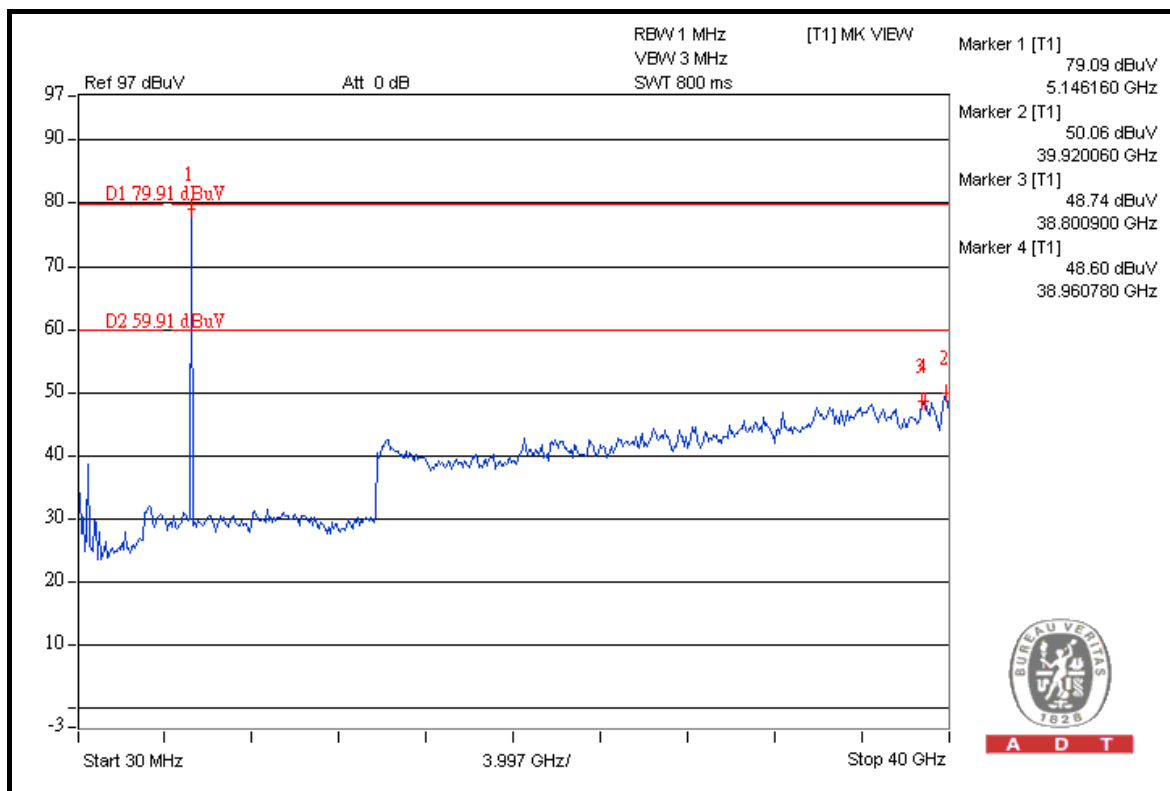



A D T

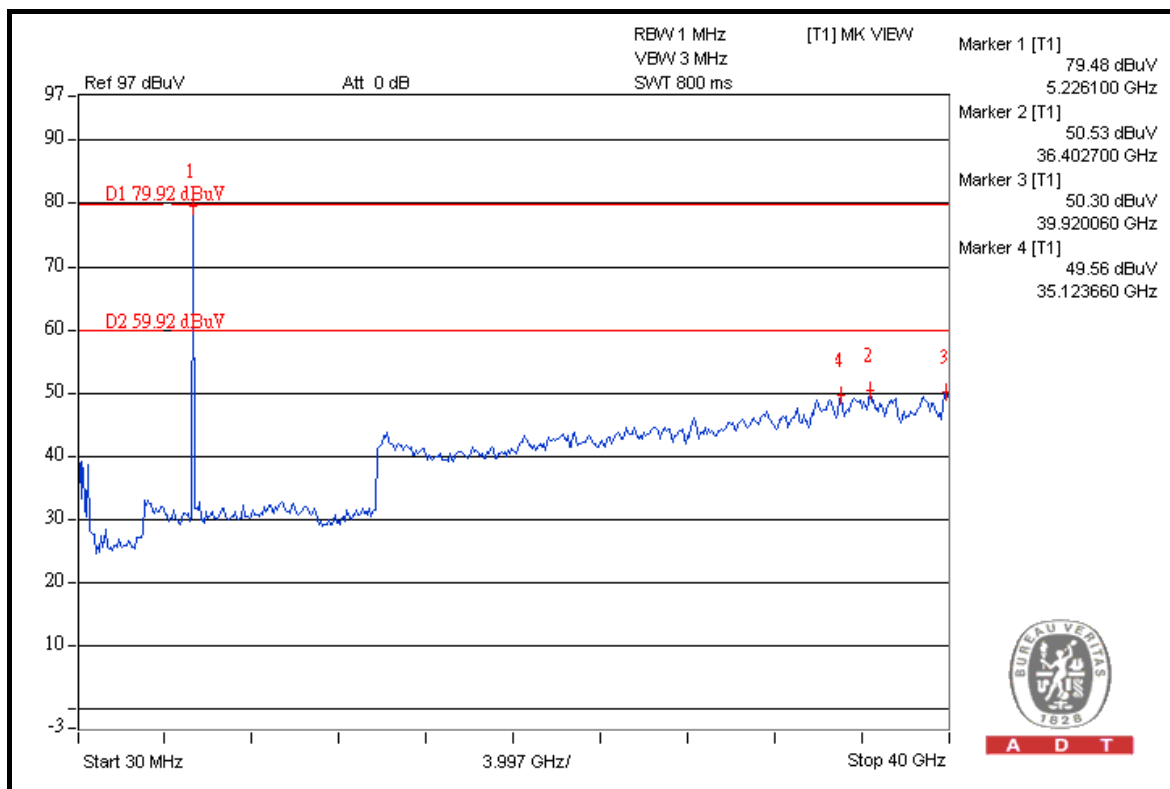
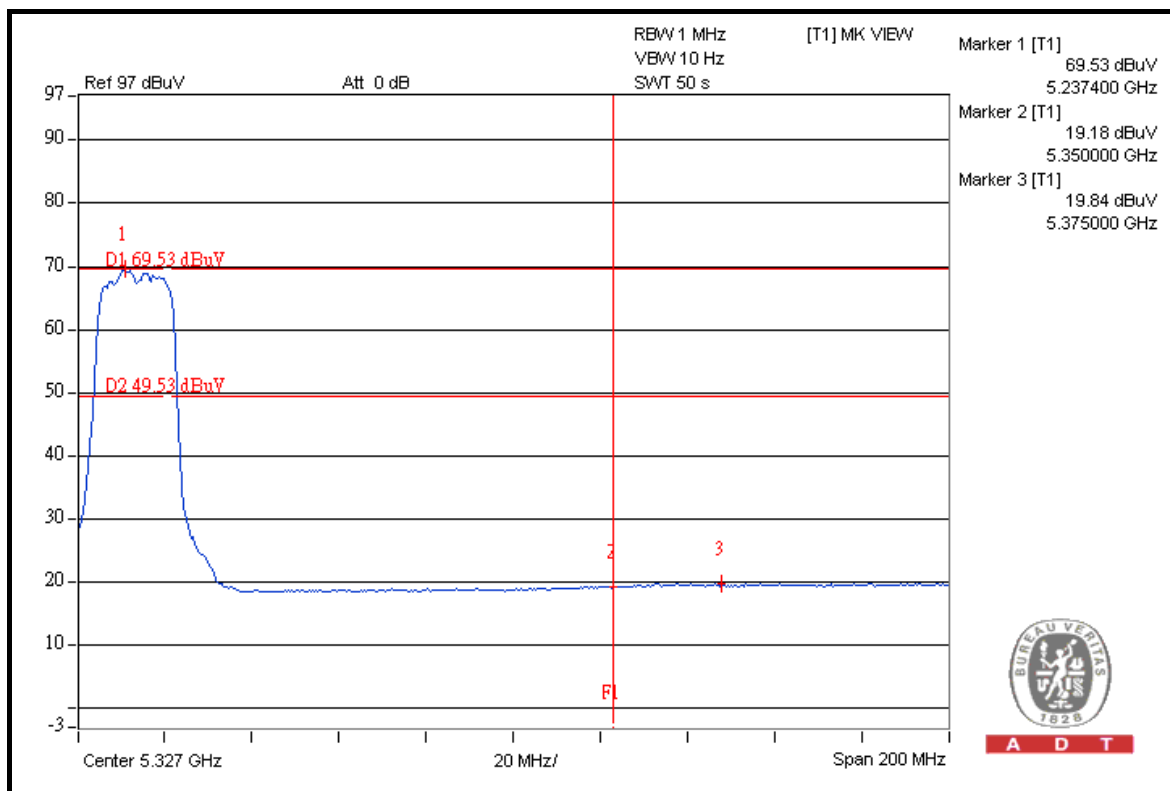



A D T

DRAFT 802.11n (20MHz) OFDM MODULATION

TEST MODE A

Channel 36 (5180MHz)

The band edge emission plot on the next page shows 49.36dBc between carrier maximum power and local maximum emission in restrict band. The emission of carrier strength list in the test result of channel 36 is 107.63dBuV/m (Peak), so the maximum field strength in restrict band is $107.63 - 49.36 = 58.27$ dBuV/m which is under 74dBuV/m limit.

The band edge emission plot on the next page shows 51.60dBc between carrier maximum power and local maximum emission in restrict band. The emission of carrier strength list in the test result of channel 36 is 97.02dBuV/m (Average), so the maximum field strength in restrict band is $97.02 - 51.60 = 45.42$ dBuV/m which is under 54dBuV/m limit.

Channel 48 (5240MHz)

The band edge emission plot on the next second page shows 47.32dBc between carrier maximum power and local maximum emission in restrict band. The emission of carrier strength list in the test result of channel 48 is 107.53dBuV/m (Peak), so the maximum field strength in restrict band is $107.53 - 47.32 = 60.21$ dBuV/m which is under 74dBuV/m limit.

The band edge emission plot on the next third page shows 49.86dBc between carrier maximum power and local maximum emission in restrict band. The emission of carrier strength list in the test result of channel 48 is 96.81dBuV/m (Average), so the maximum field strength in restrict band is $96.81 - 49.86 = 46.95$ dBuV/m which is under 54dBuV/m limit.



A D T

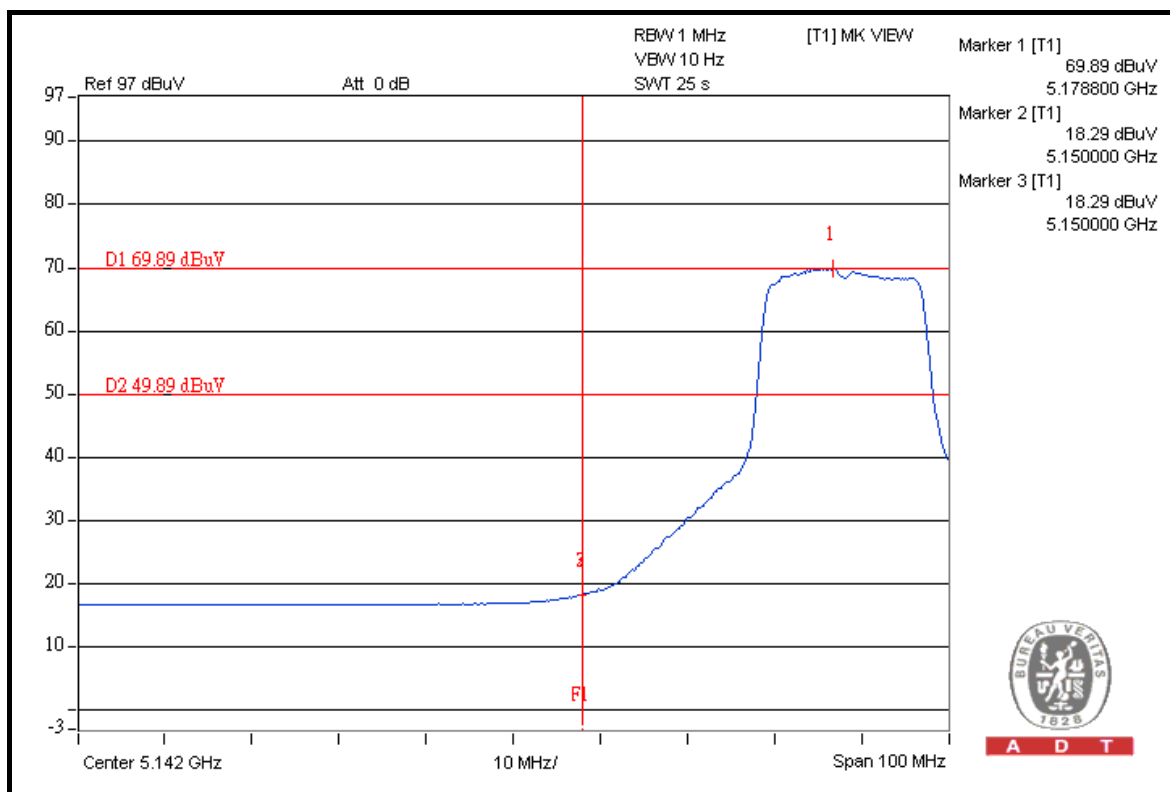
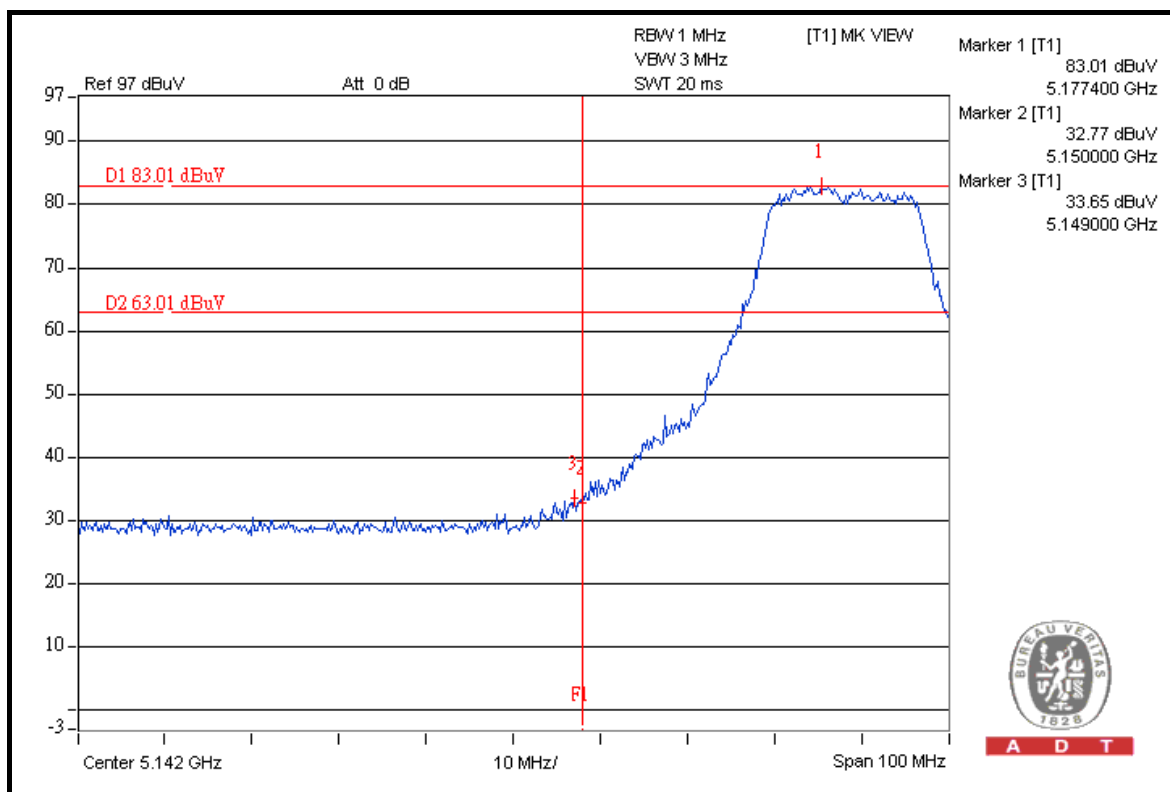



A D T

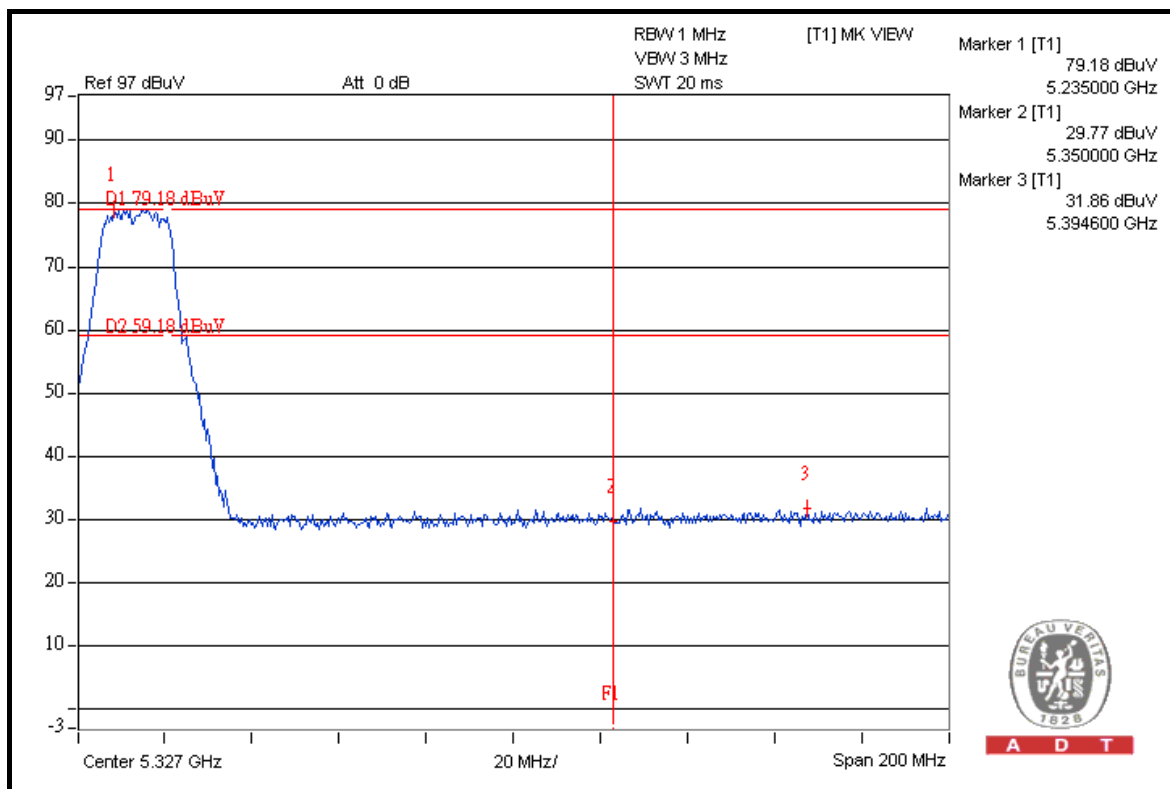
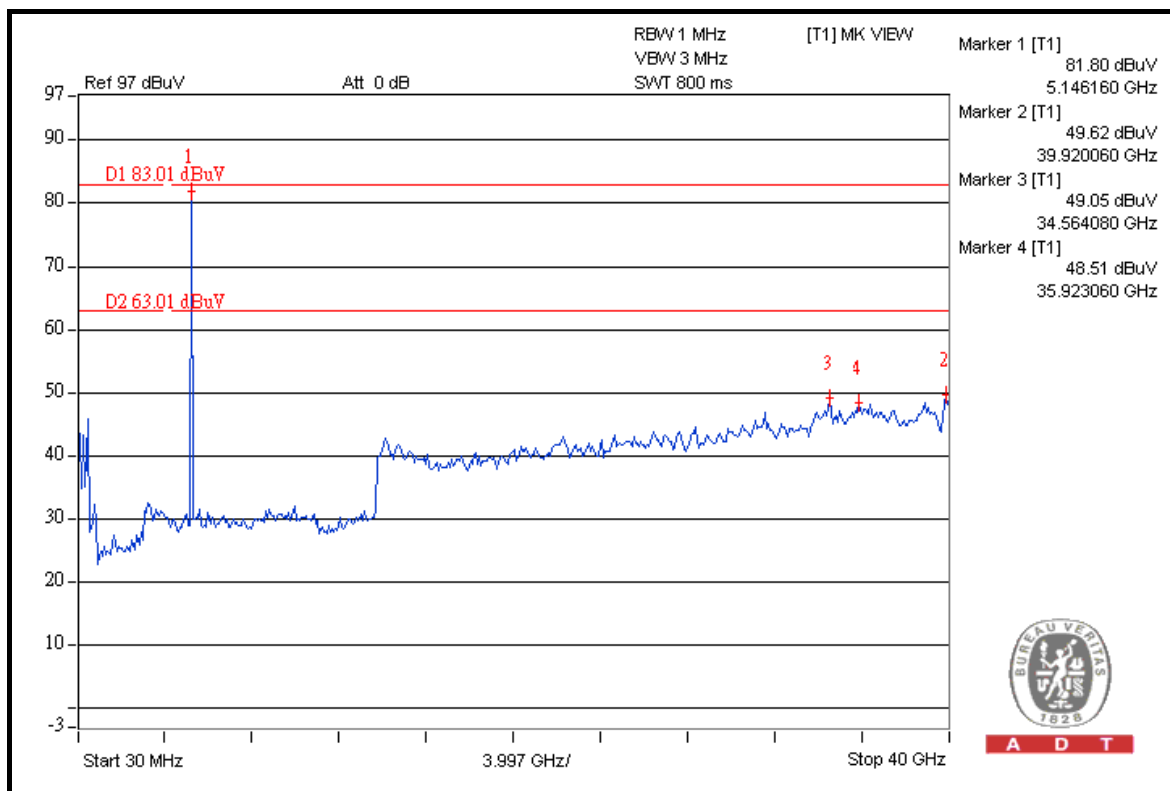



A D T

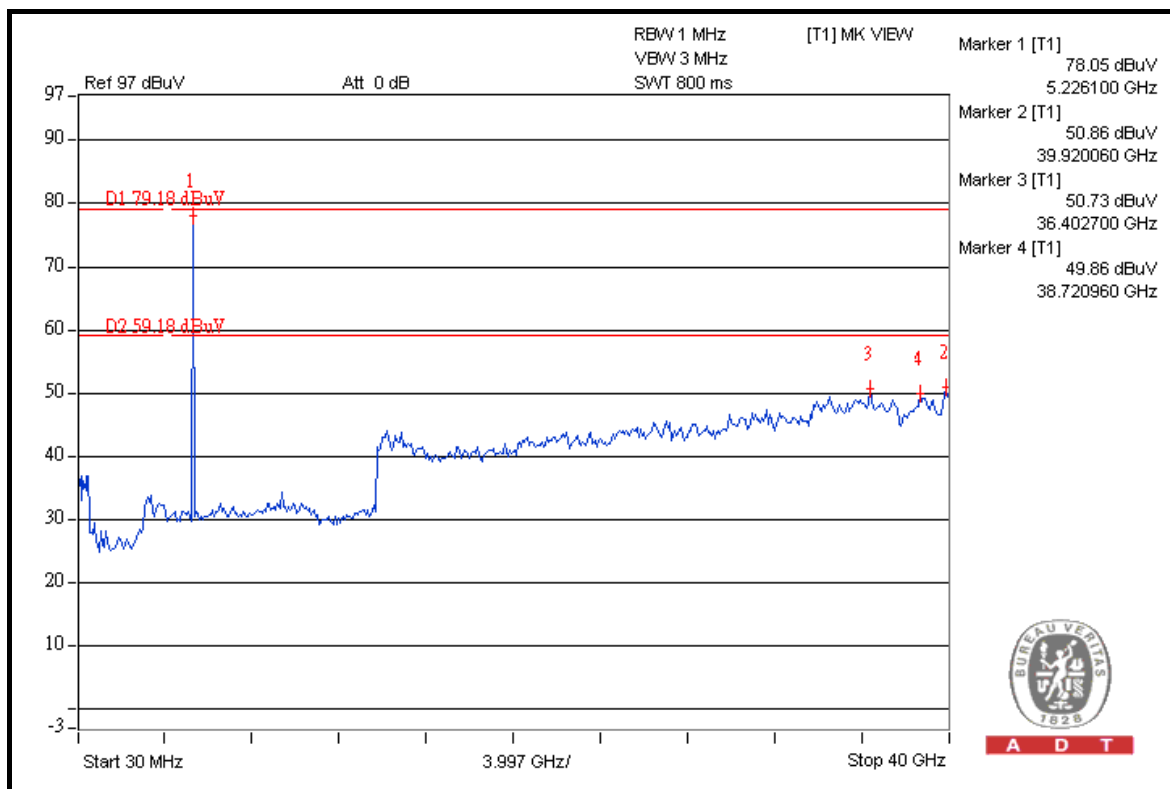
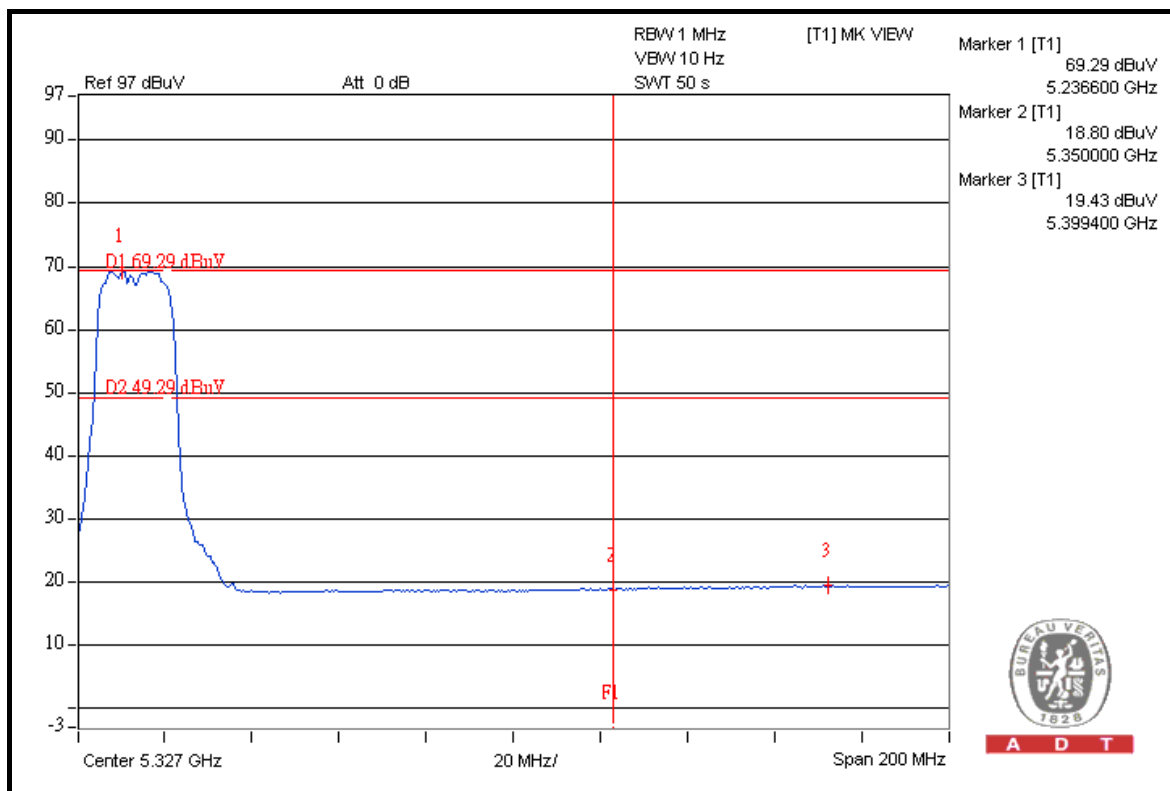

TEST MODE C

Channel 36 (5180MHz)

The band edge emission plot on the next page shows 48.80dBc between carrier maximum power and local maximum emission in restrict band. The emission of carrier strength list in the test result of channel 36 is 107.51dBuV/m (Peak), so the maximum field strength in restrict band is $107.51 - 48.80 = 58.71$ dBuV/m which is under 74dBuV/m limit.

The band edge emission plot on the next page shows 50.94dBc between carrier maximum power and local maximum emission in restrict band. The emission of carrier strength list in the test result of channel 36 is 96.87dBuV/m (Average), so the maximum field strength in restrict band is $96.87 - 50.94 = 45.93$ dBuV/m which is under 54dBuV/m limit.

Channel 48 (5240MHz)

The band edge emission plot on the next second page shows 45.72dBc between carrier maximum power and local maximum emission in restrict band. The emission of carrier strength list in the test result of channel 64 is 107.41dBuV/m (Peak), so the maximum field strength in restrict band is $107.41 - 45.72 = 61.69$ dBuV/m which is under 74dBuV/m limit.

The band edge emission plot on the next third page shows 49.83dBc between carrier maximum power and local maximum emission in restrict band. The emission of carrier strength list in the test result of channel 48 is 96.70dBuV/m (Average), so the maximum field strength in restrict band is $96.70 - 49.83 = 46.87$ dBuV/m which is under 54dBuV/m limit.



A D T

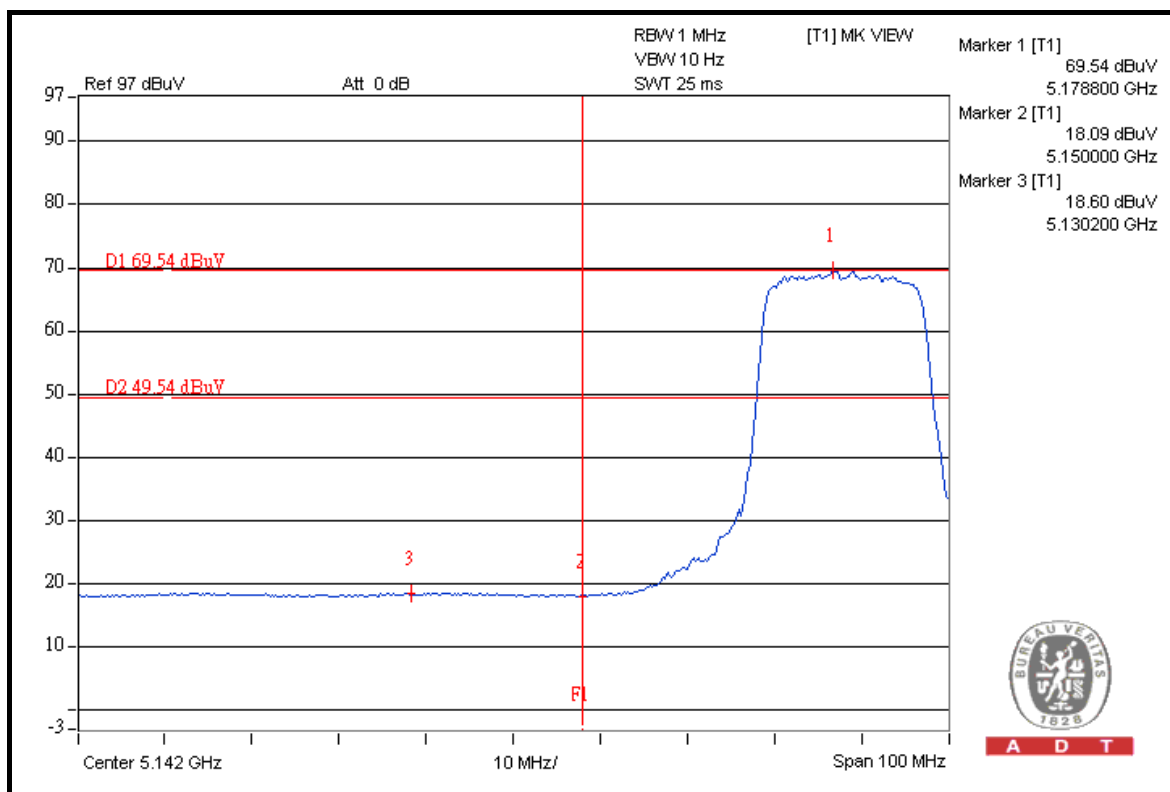
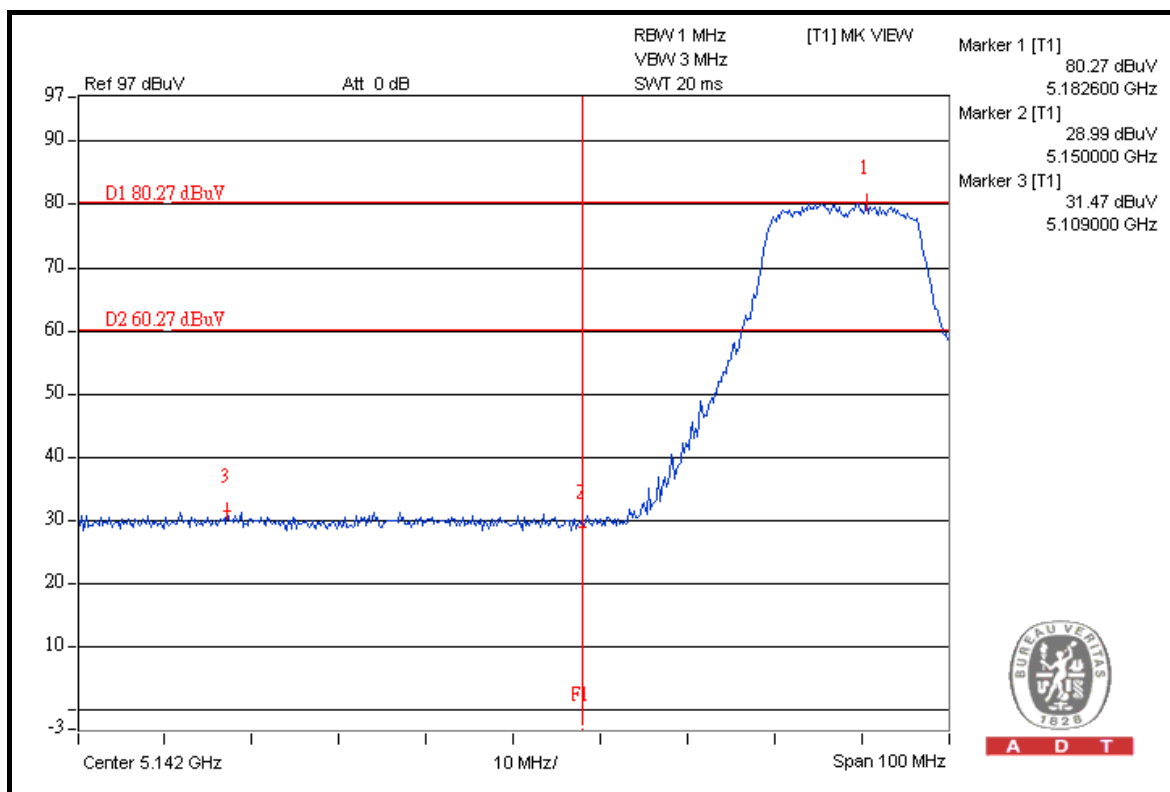



A D T

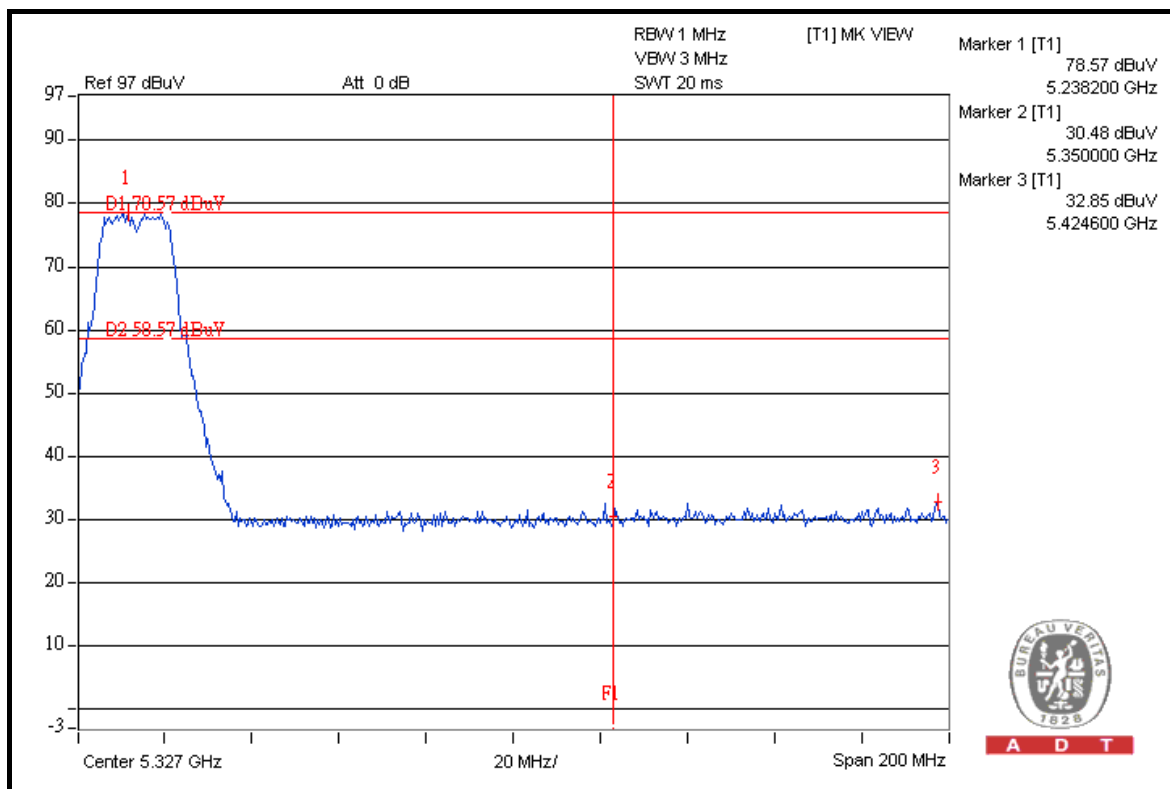
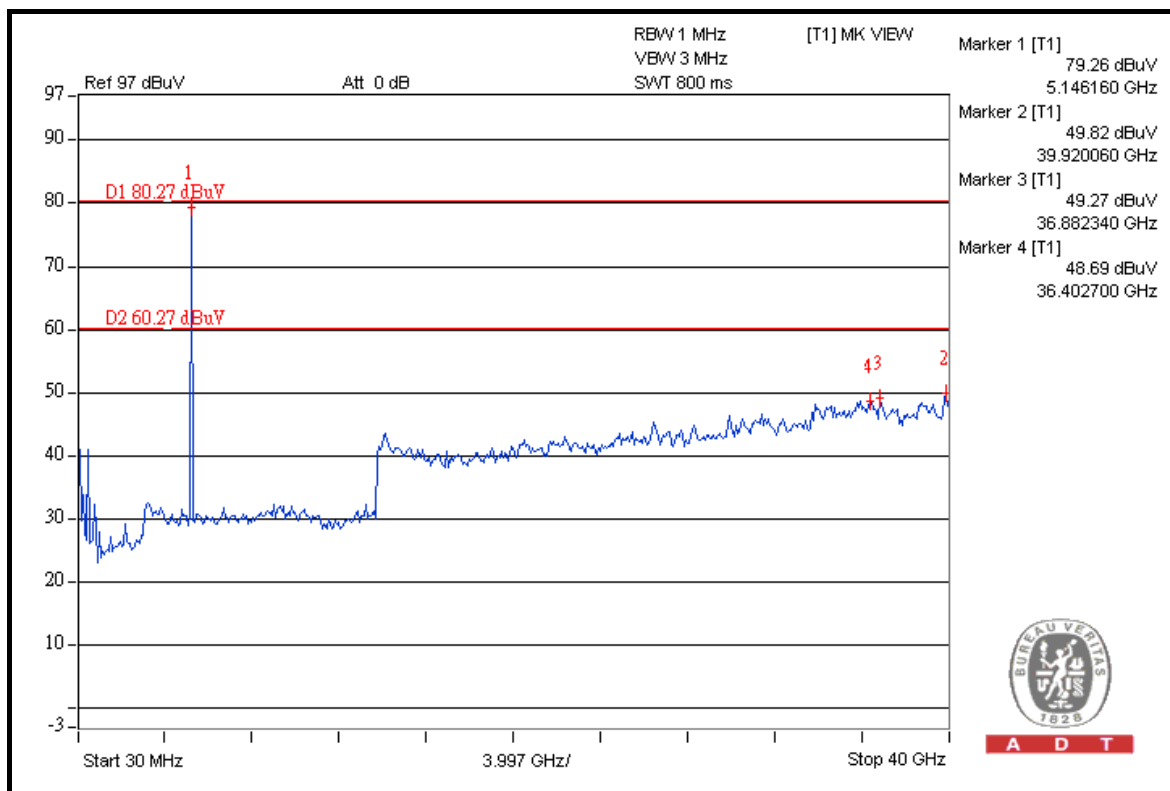



A D T

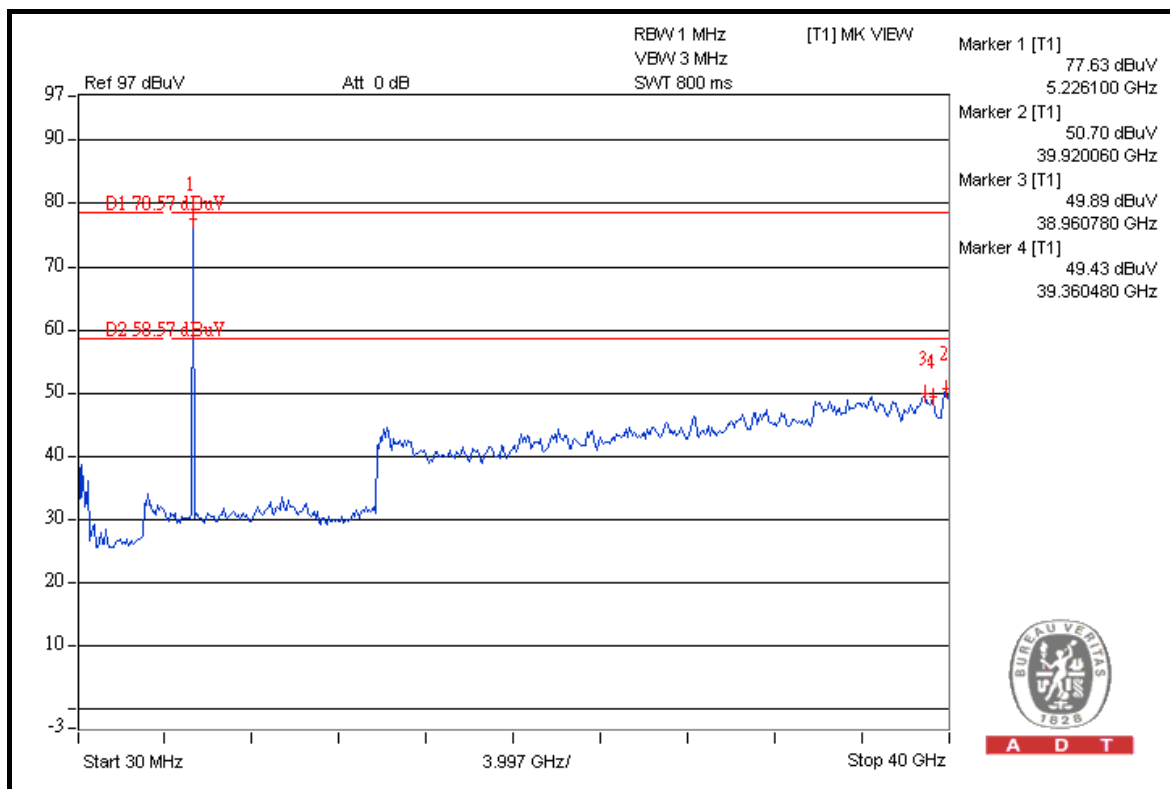
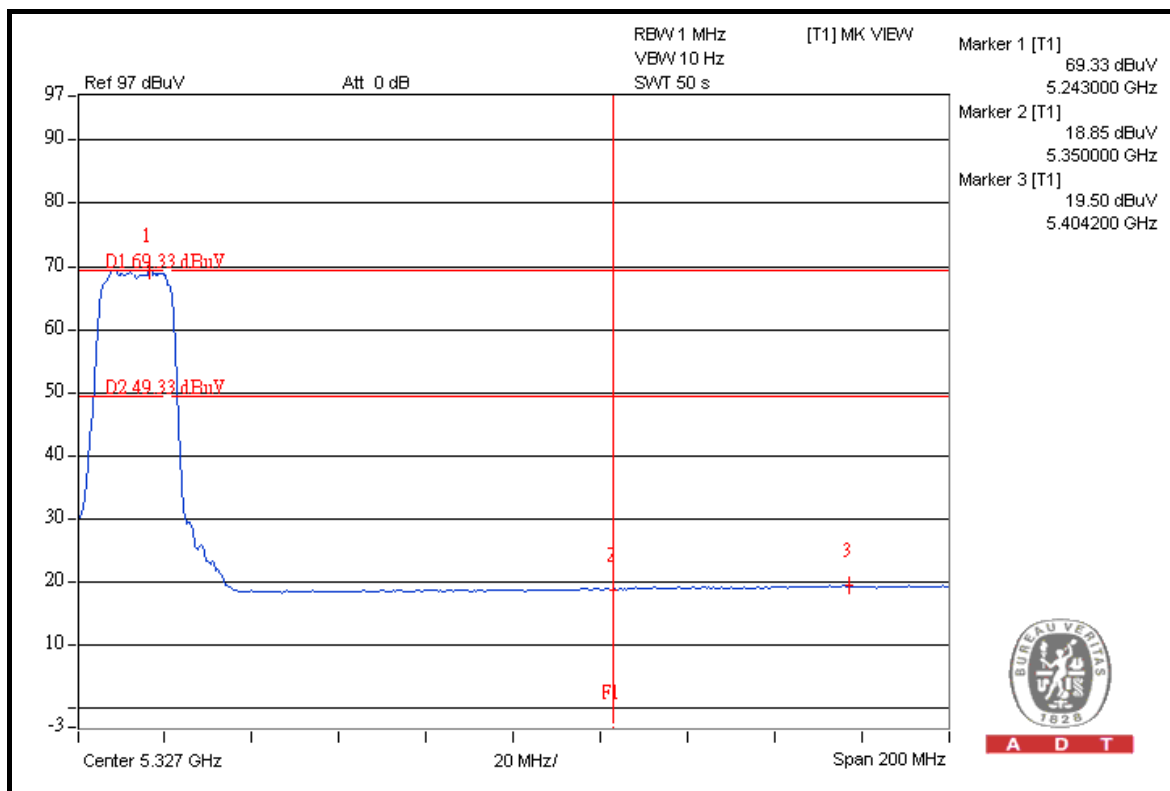



DRAFT 802.11n (40MHz) OFDM MODULATION

TEST MODE A

Channel 38 (5190MHz)

The band edge emission plot on the next page shows 35.87dBc between carrier maximum power and local maximum emission in restrict band. The emission of carrier strength list in the test result of channel 38 is 104.69dBuV/m (Peak), so the maximum field strength in restrict band is $104.69 - 35.87 = 68.82$ dBuV/m which is under 74dBuV/m limit.

The band edge emission plot on the next page shows 43.85dBc between carrier maximum power and local maximum emission in restrict band. The emission of carrier strength list in the test result of channel 38 is 94.12dBuV/m (Average), so the maximum field strength in restrict band is $94.12 - 43.85 = 50.27$ dBuV/m which is under 54dBuV/m limit.

Channel 46 (5230MHz)

The band edge emission plot on the next second page shows 44.00dBc between carrier maximum power and local maximum emission in restrict band. The emission of carrier strength list in the test result of channel 46 is 104.52dBuV/m (Peak), so the maximum field strength in restrict band is $104.52 - 44.00 = 60.52$ dBuV/m which is under 74dBuV/m limit.

The band edge emission plot on the next third page shows 44.94dBc between carrier maximum power and local maximum emission in restrict band. The emission of carrier strength list in the test result of channel 46 is 94.03dBuV/m (Average), so the maximum field strength in restrict band is $94.03 - 44.94 = 49.09$ dBuV/m which is under 54dBuV/m limit.



A D T

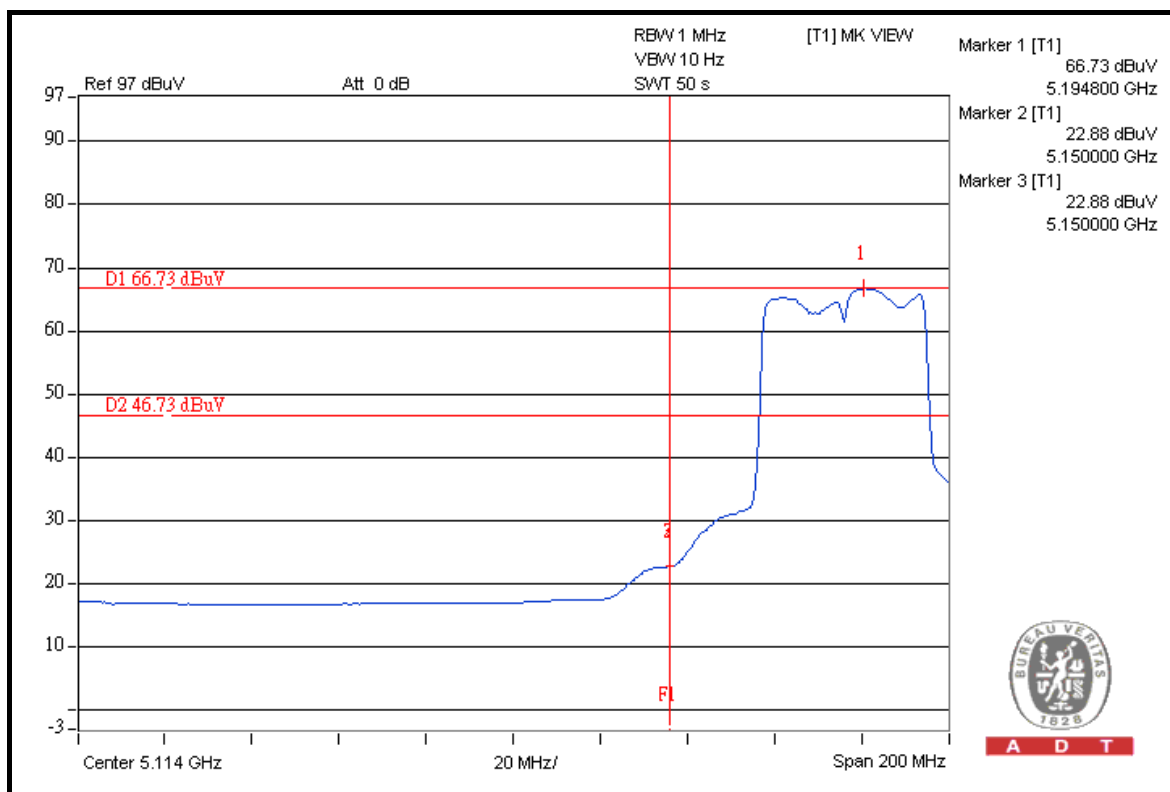
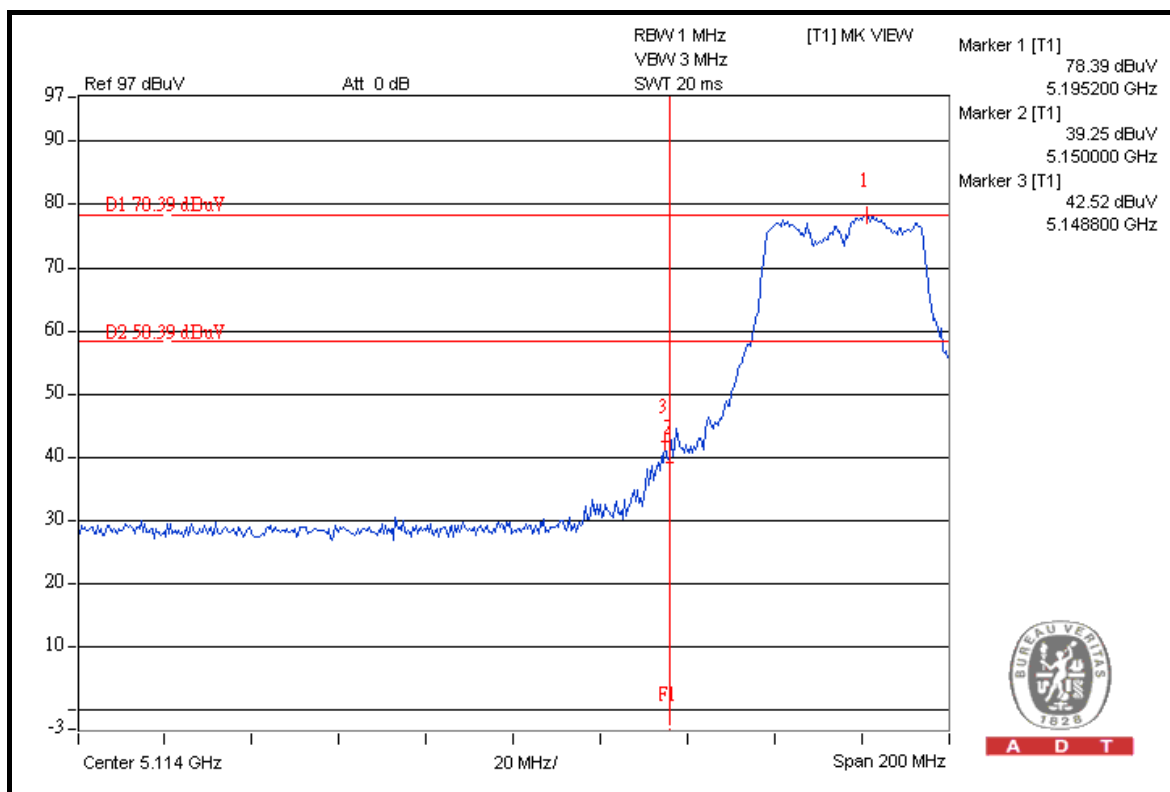



A D T

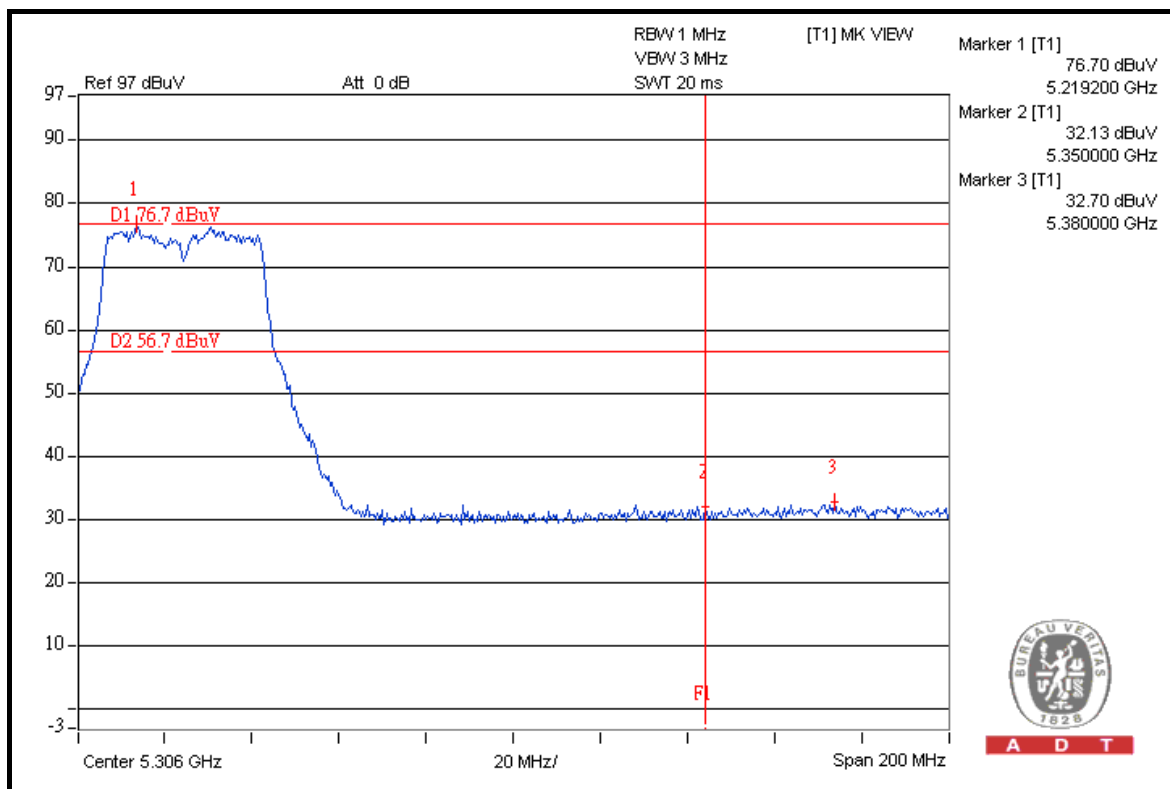
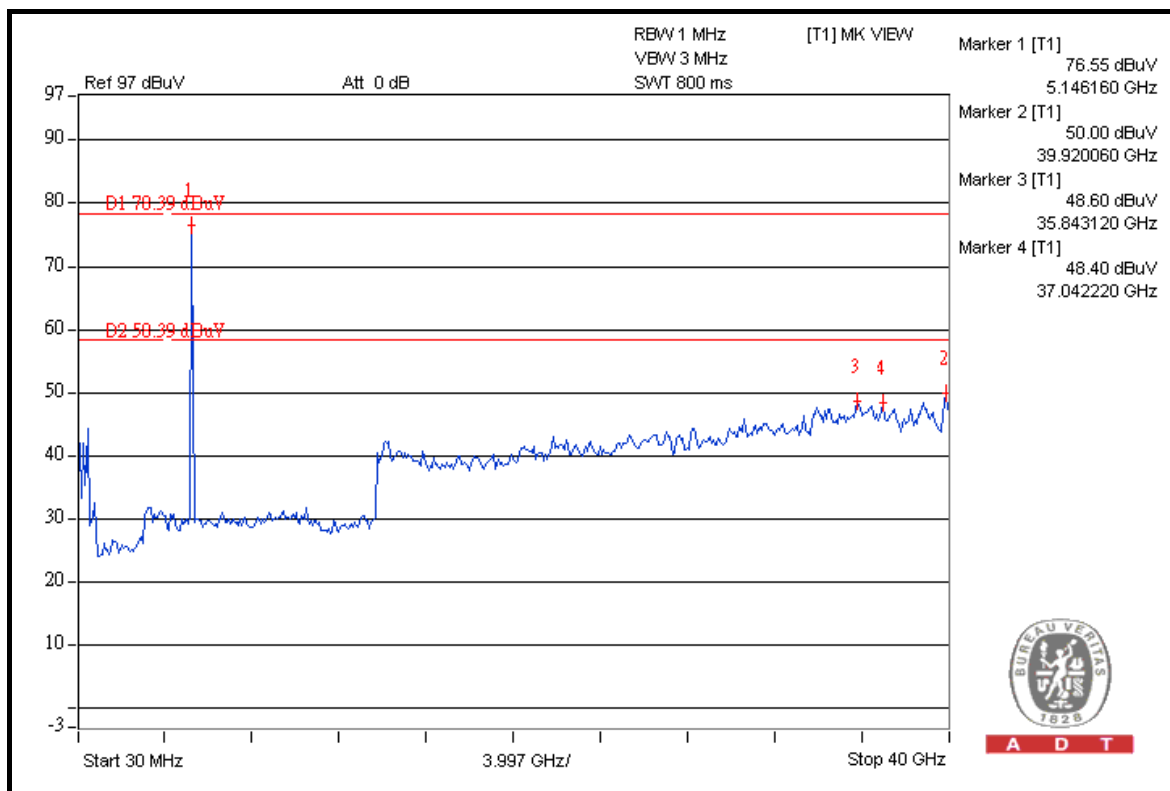



A D T

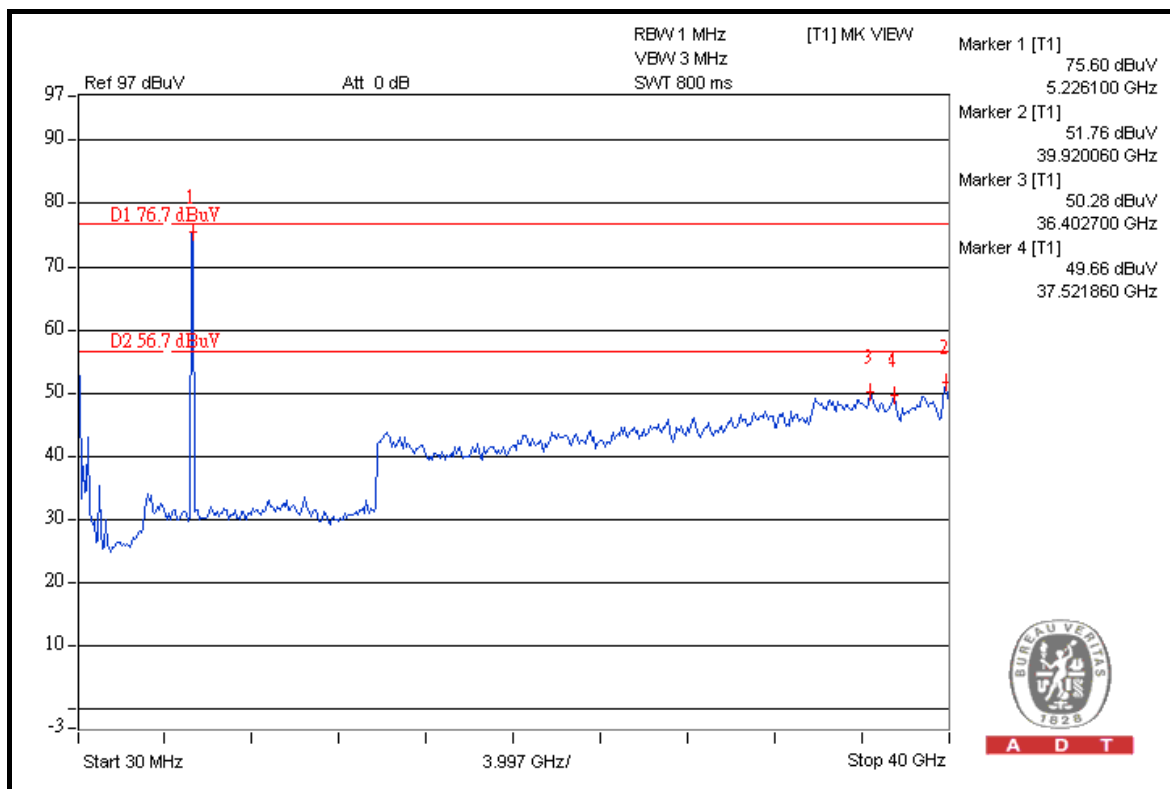
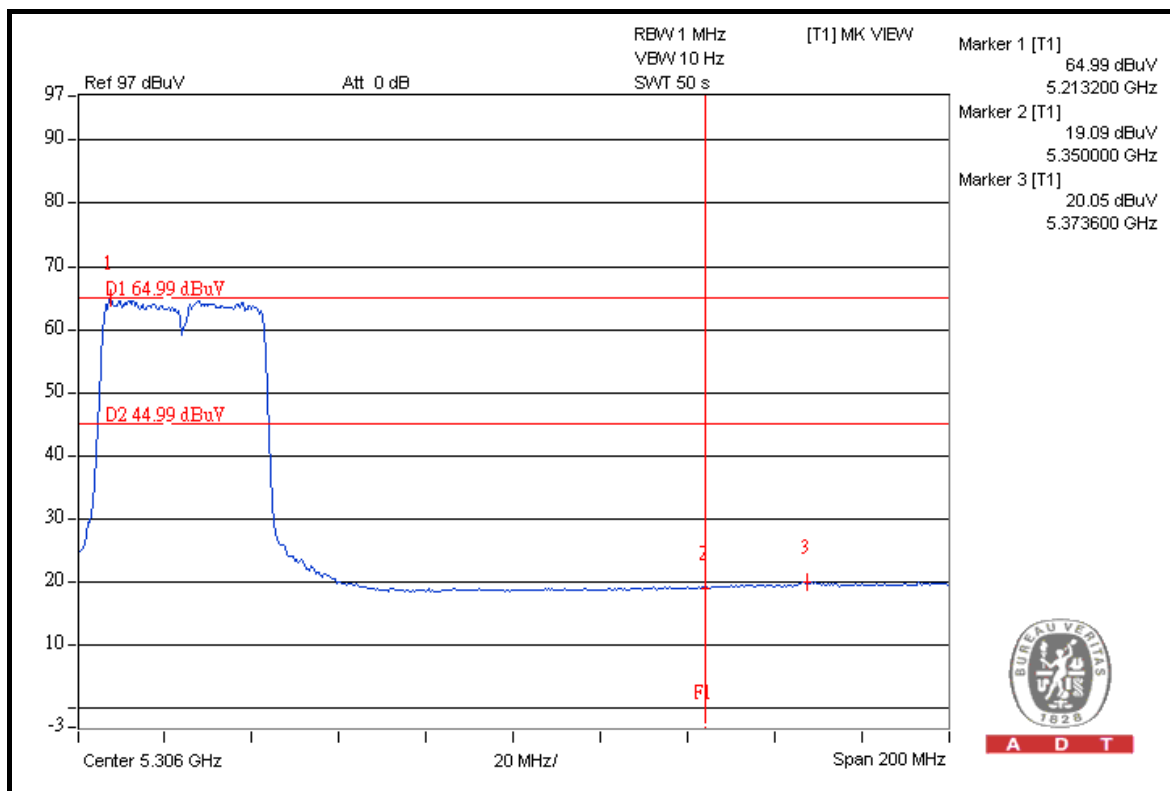

TEST MODE C

Channel 38 (5190MHz)

The band edge emission plot on the next page shows 44.60dBc between carrier maximum power and local maximum emission in restrict band. The emission of carrier strength list in the test result of channel 38 is 104.54dBuV/m (Peak), so the maximum field strength in restrict band is $104.54 - 44.60 = 59.94$ dBuV/m which is under 74dBuV/m limit.

The band edge emission plot on the next page shows 45.94dBc between carrier maximum power and local maximum emission in restrict band. The emission of carrier strength list in the test result of channel 38 is 94.03dBuV/m (Average), so the maximum field strength in restrict band is $94.03 - 45.94 = 48.09$ dBuV/m which is under 54dBuV/m limit.

Channel 46 (5230MHz)

The band edge emission plot on the next second page shows 44.26dBc between carrier maximum power and local maximum emission in restrict band. The emission of carrier strength list in the test result of channel 46 is 104.46dBuV/m (Peak), so the maximum field strength in restrict band is $104.46 - 44.26 = 60.20$ dBuV/m which is under 74dBuV/m limit.

The band edge emission plot on the next third page shows 46.18dBc between carrier maximum power and local maximum emission in restrict band. The emission of carrier strength list in the test result of channel 46 is 93.91dBuV/m (Average), so the maximum field strength in restrict band is $93.91 - 46.18 = 47.73$ dBuV/m which is under 54dBuV/m limit.



A D T

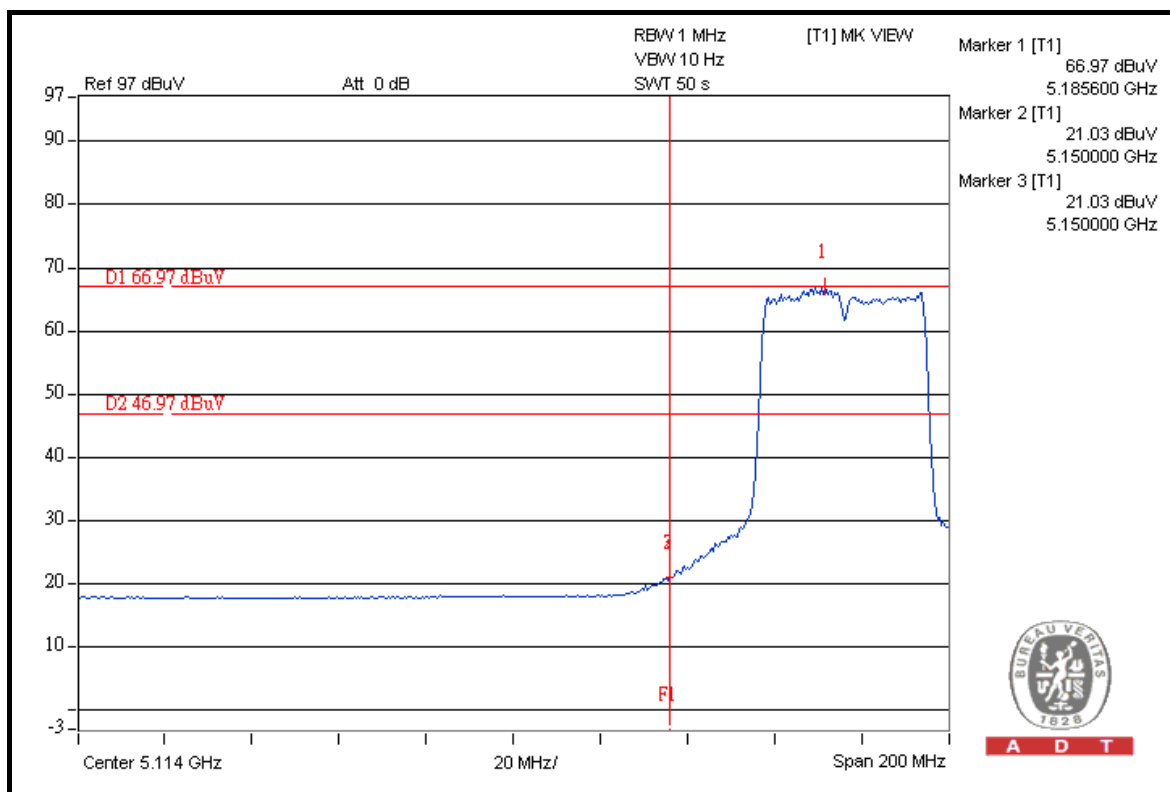
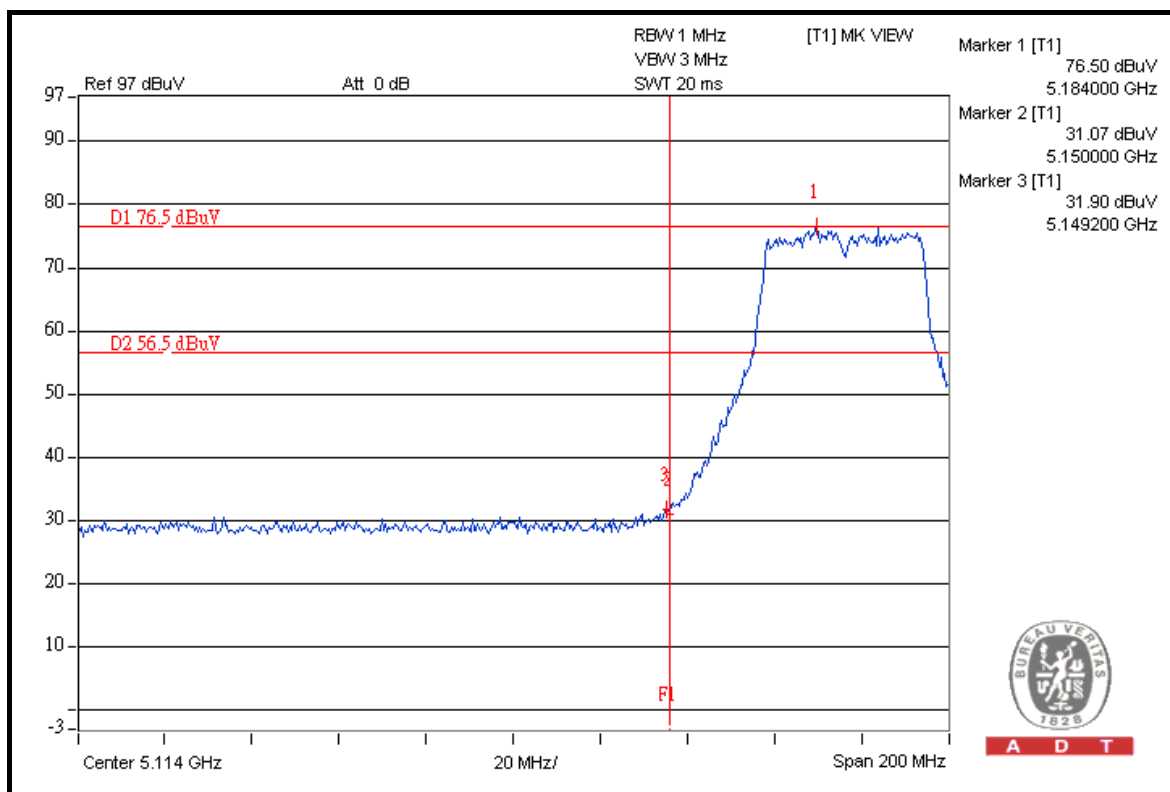



A D T

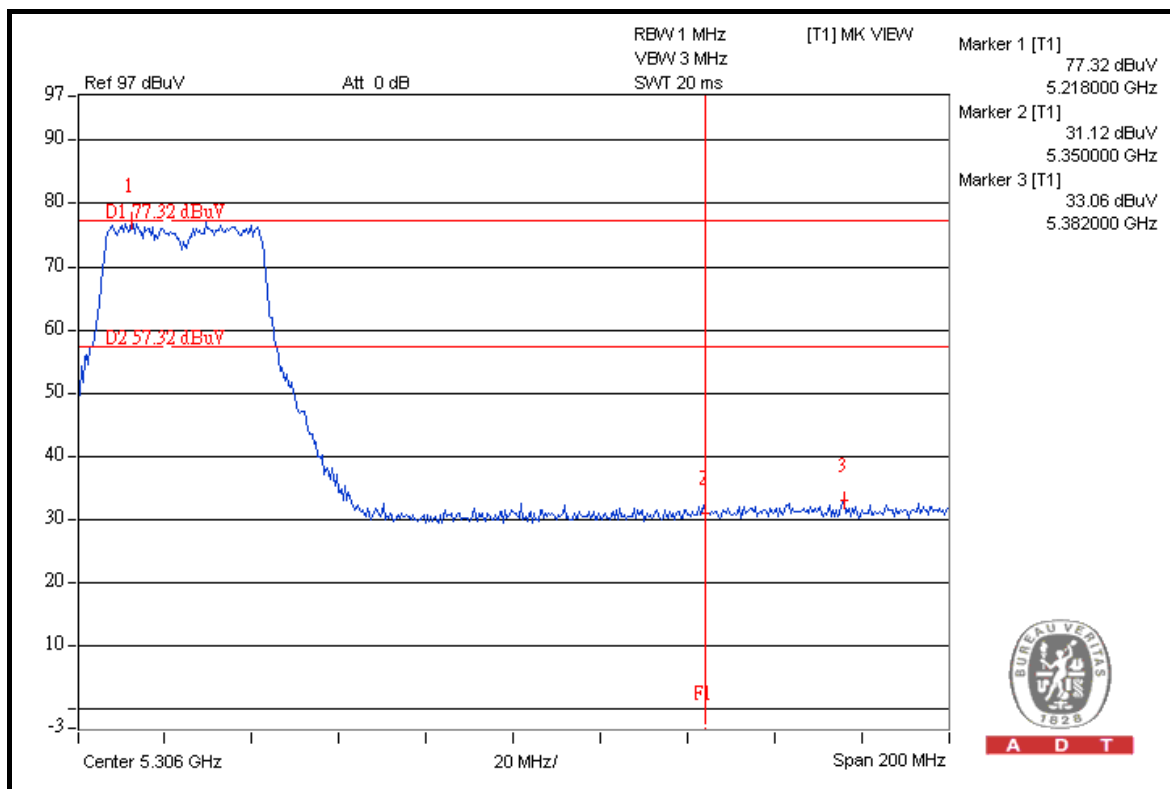
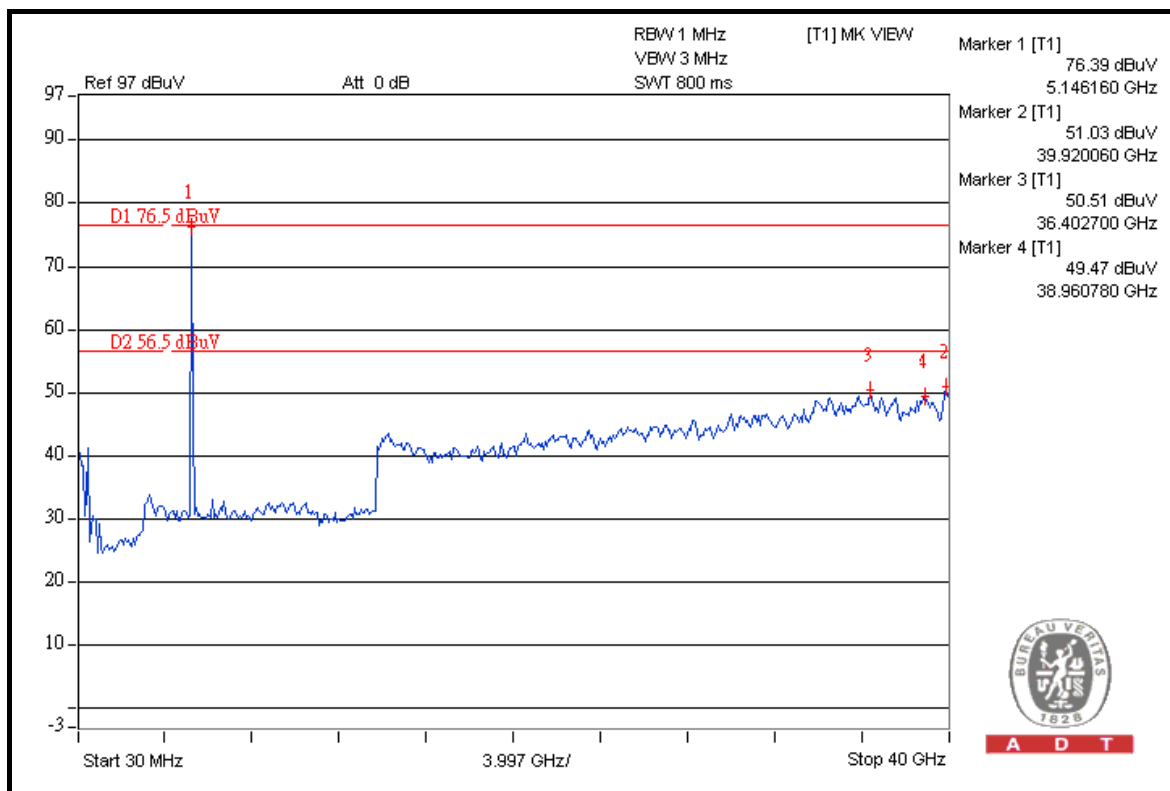



A D T

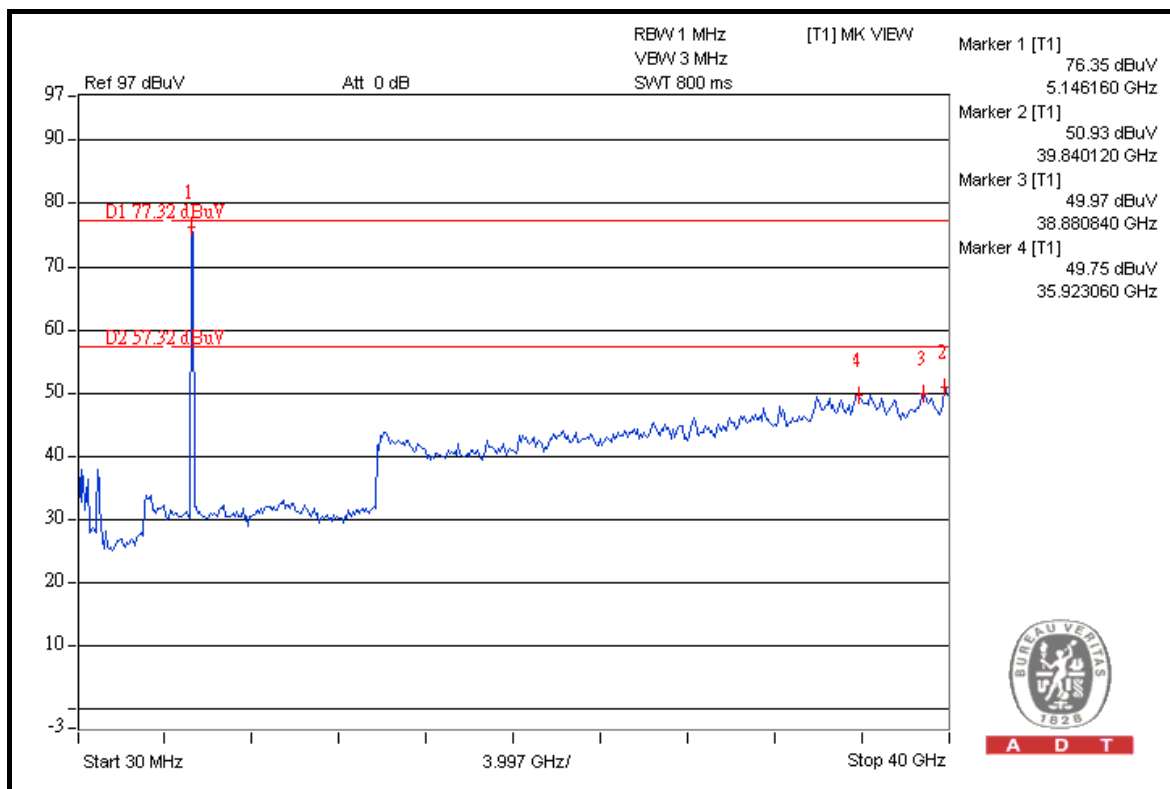
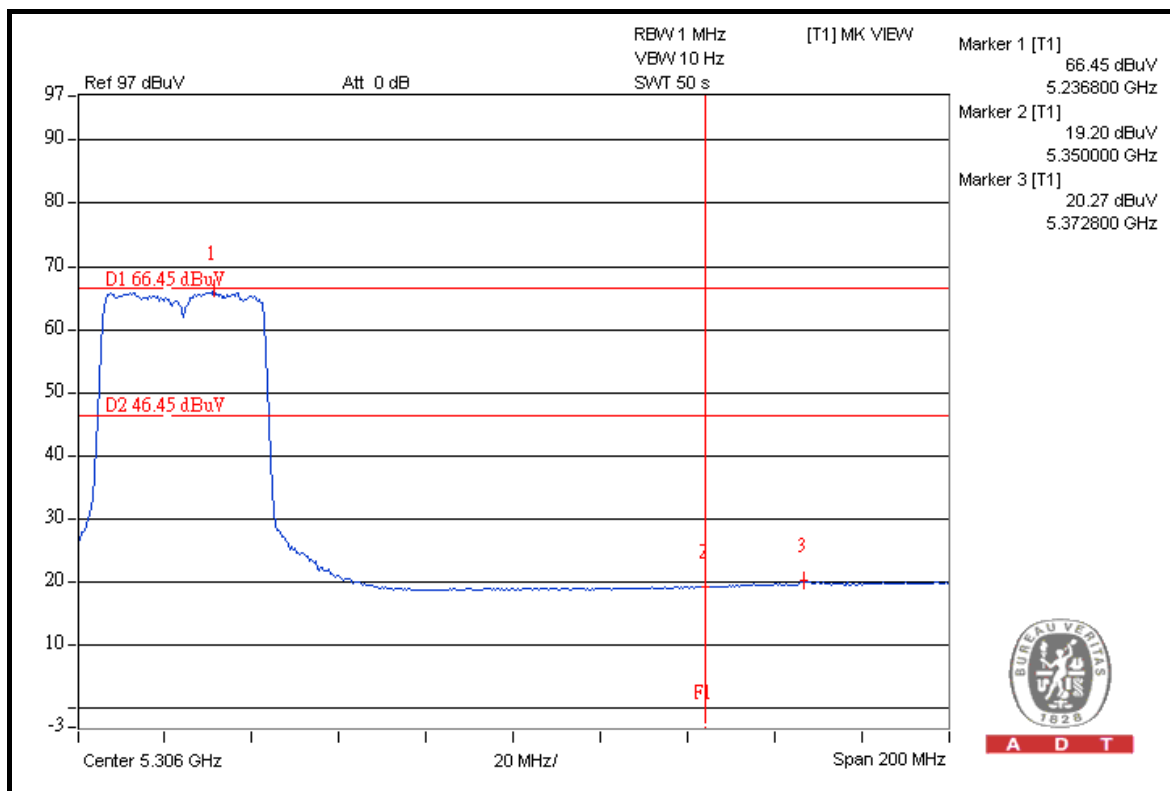

4.8 ANTENNA REQUIREMENT

4.8.1 STANDARD APPLICABLE

For intentional device, according to FCC 47 CFR Section 15.203, an intentional radiator shall be designed to ensure that no antenna other than that furnished by the responsible party shall be used with the device.

And according to FCC 47 CFR Section 15.407(a), if transmitting antennas of directional gain greater than 6dBi are used, the power shall be reduced by the amount in dB that the directional gain of the antenna exceeds 6dBi.

4.8.2 ANTENNA CONNECTED CONSTRUCTION

The antennas used in this product are internal: proprietary omni antenna without connector and external: directional panel antenna with female N-Type connector. The maximum gain of the antenna is 14dBi.



5. PHOTOGRAPHS OF THE TEST CONFIGURATION

Please refer to the attached file (Test Setup Photo).



6. INFORMATION ON THE TESTING LABORATORIES

We, Bureau Veritas Consumer Products Services (H.K.) Ltd., Taoyuan Branch, were founded in 1988 to provide our best service in EMC, Radio, Telecom and Safety consultation. Our laboratories are accredited and approved by the following approval agencies according to ISO/IEC 17025.

USA	FCC, NVLAP
Germany	TUV Rheinland
Japan	VCCI
Norway	NEMKO
Canada	INDUSTRY CANADA , CSA
R.O.C.	TAF, BSMI, NCC
Netherlands	Telefication
Singapore	GOST-ASIA(MOU)
Russia	CERTIS(MOU)

Copies of accreditation certificates of our laboratories obtained from approval agencies can be downloaded from our web site: www.adt.com.tw/index.5/phtml. If you have any comments, please feel free to contact us at the following:

Linko EMC/RF Lab:
Tel: 886-2-26052180
Fax: 886-2-26051924

Hsin Chu EMC/RF Lab:
Tel: 886-3-5935343
Fax: 886-3-5935342

Hwa Ya EMC/RF/Safety Telecom Lab:
Tel: 886-3-3183232
Fax: 886-3-3185050

Web Site: www.adt.com.tw

The address and road map of all our labs can be found in our web site also.

7. APPENDIX A - MODIFICATIONS RECORDERS FOR ENGINEERING CHANGES TO THE EUT BY THE LAB

No any modifications are made to the EUT by the lab during the test.

---END---