



A D T

FCC TEST REPORT (15.247)

REPORT NO.: RF980504L06

MODEL NO.: ZF7762

RECEIVED: May 04, 2009

TESTED: Jul. 07 ~ Jul. 27, 2009

ISSUED: Aug. 03, 2009

Applicant's Company	Senao Networks, Inc.
Applicant Address	3F, No. 529, Chung Cheng Rd., Hsintien, Taipei, Taiwan
FCC ID	U2M-ZF7762
Manufacturer's Company	Senao Networks, Inc.
Manufacturer Address	3F, No. 529, Chung Cheng Rd., Hsintien, Taipei, Taiwan

ISSUED BY: Bureau Veritas Consumer Products Services (H.K.) Ltd., Taoyuan Branch

LAB ADDRESS: No. 47, 14th Ling, Chia Pau Tsuen, Lin Kou Hsiang, Taipei Hsien 244, Taiwan, R.O.C.

TEST LOCATION: No. 19, Hwa Ya 2nd Rd, Wen Hwa Tsuen, Kwei Shan Hsiang, Taoyuan Hsien 333, Taiwan, R.O.C.

This test report consists of 298 pages in total. It may be duplicated completely for legal use with the approval of the applicant. It should not be reproduced except in full, without the written approval of our laboratory. The client should not use it to claim product endorsement by TAF or any government agencies. The test results in the report only apply to the tested sample.





TABLE OF CONTENTS

1.	CERTIFICATION.....	5
2.	SUMMARY OF TEST RESULTS	6
2.1	MEASUREMENT UNCERTAINTY	6
3.	GENERAL INFORMATION.....	7
3.1	GENERAL DESCRIPTION OF EUT	7
3.2	DESCRIPTION OF TEST MODES.....	9
3.2.1	CONFIGURATION OF SYSTEM UNDER TEST	10
3.2.2	TEST MODE APPLICABILITY AND TESTED CHANNEL DETAIL	12
3.3	GENERAL DESCRIPTION OF APPLIED STANDARDS	16
3.4	DESCRIPTION OF SUPPORT UNITS	16
4.	TEST TYPES AND RESULTS (FOR 2.4GHz BAND).....	17
4.1	RADIATED EMISSION MEASUREMENT	17
4.1.1	LIMITS OF RADIATED EMISSION MEASUREMENT.....	17
4.1.2	TEST INSTRUMENTS	18
4.1.3	TEST PROCEDURES	19
4.1.4	DEVIATION FROM TEST STANDARD	19
4.1.5	TEST SETUP	20
4.1.6	EUT OPERATING CONDITIONS	20
4.1.7	TEST RESULTS	21
4.2	CONDUCTED EMISSION MEASUREMENT	35
4.2.1	LIMITS OF CONDUCTED EMISSION MEASUREMENT.....	35
4.2.2	TEST INSTRUMENTS	35
4.2.3	TEST PROCEDURES	36
4.2.4	DEVIATION FROM TEST STANDARD	36
4.2.5	TEST SETUP	37
4.2.6	EUT OPERATING CONDITIONS	37
4.2.7	TEST RESULTS	38
4.3	6dB BANDWIDTH MEASUREMENT	44
4.3.1	LIMITS OF 6dB BANDWIDTH MEASUREMENT	44
4.3.2	TEST INSTRUMENTS	44
4.3.3	TEST PROCEDURE	44
4.3.4	DEVIATION FROM TEST STANDARD	44
4.3.5	TEST SETUP	45
4.3.6	EUT OPERATING CONDITIONS	45
4.3.7	TEST RESULTS	46
4.4	MAXIMUM PEAK OUTPUT POWER	66
4.4.1	LIMITS OF MAXIMUM PEAK OUTPUT POWER MEASUREMENT	66
4.4.2	INSTRUMENTS.....	66
4.4.3	TEST PROCEDURES	66
4.4.4	DEVIATION FROM TEST STANDARD	67
4.4.5	TEST SETUP	67
4.4.6	EUT OPERATING CONDITIONS	67
4.4.7	TEST RESULTS	68
4.5	POWER SPECTRAL DENSITY MEASUREMENT.....	88
4.5.1	LIMITS OF POWER SPECTRAL DENSITY MEASUREMENT	88
4.5.2	TEST INSTRUMENTS	88
4.5.3	TEST PROCEDURE	88
4.5.4	DEVIATION FROM TEST STANDARD	89
4.5.5	TEST SETUP	89



4.5.6	EUT OPERATING CONDITION	89
4.5.7	TEST RESULTS	90
4.6	BAND EDGES MEASUREMENT	110
4.6.1	LIMITS OF BAND EDGES MEASUREMENT	110
4.6.2	TEST INSTRUMENTS	110
4.6.3	TEST PROCEDURE	111
4.6.4	DEVIATION FROM TEST STANDARD	111
4.6.5	EUT OPERATING CONDITION	111
4.6.6	TEST RESULTS	112
4.7	ANTENNA REQUIREMENT	128
4.7.1	STANDARD APPLICABLE	128
4.7.2	ANTENNA CONNECTED CONSTRUCTION	128
5.	TEST TYPES AND RESULTS (FOR 5.0GHz BAND)	129
5.1	RADIATED EMISSION MEASUREMENT	129
5.1.1	LIMITS OF RADIATED EMISSION MEASUREMENT	129
5.1.2	TEST INSTRUMENTS	130
5.1.3	TEST PROCEDURES	131
5.1.4	DEVIATION FROM TEST STANDARD	131
5.1.5	TEST SETUP	132
5.1.6	EUT OPERATING CONDITIONS	132
5.1.7	TEST RESULTS	133
5.2	CONDUCTED EMISSION MEASUREMENT	153
5.2.1	LIMITS OF CONDUCTED EMISSION MEASUREMENT	153
5.2.2	TEST INSTRUMENTS	153
5.2.3	TEST PROCEDURES	154
5.2.4	DEVIATION FROM TEST STANDARD	154
5.2.5	TEST SETUP	155
5.2.6	EUT OPERATING CONDITIONS	155
5.2.7	TEST RESULTS	156
5.3	6dB BANDWIDTH MEASUREMENT	168
5.3.1	LIMITS OF 6dB BANDWIDTH MEASUREMENT	168
5.3.2	TEST INSTRUMENTS	168
5.3.3	TEST PROCEDURE	168
5.3.4	DEVIATION FROM TEST STANDARD	169
5.3.5	TEST SETUP	169
5.3.6	EUT OPERATING CONDITIONS	169
5.3.7	TEST RESULTS	170
5.4	MAXIMUM PEAK OUTPUT POWER	195
5.4.1	LIMITS OF MAXIMUM PEAK OUTPUT POWER MEASUREMENT	195
5.4.2	INSTRUMENTS	195
5.4.3	TEST PROCEDURES	195
5.4.4	DEVIATION FROM TEST STANDARD	196
5.4.5	TEST SETUP	196
5.4.6	EUT OPERATING CONDITIONS	196
5.4.7	TEST RESULTS	197
5.5	POWER SPECTRAL DENSITY MEASUREMENT	247
5.5.1	LIMITS OF POWER SPECTRAL DENSITY MEASUREMENT	247
5.5.2	TEST INSTRUMENTS	247
5.5.3	TEST PROCEDURE	247
5.5.4	DEVIATION FROM TEST STANDARD	248
5.5.5	TEST SETUP	248
5.5.6	EUT OPERATING CONDITION	248



A D T

5.5.7	TEST RESULTS	249
5.6	BAND EDGES MEASUREMENT	274
5.6.1	LIMITS OF BAND EDGES MEASUREMENT	274
5.6.2	TEST INSTRUMENTS	274
5.6.3	TEST PROCEDURE	275
5.6.4	DEVIATION FROM TEST STANDARD	276
5.6.5	EUT OPERATING CONDITION	276
5.6.6	TEST RESULTS	276
5.7	ANTENNA REQUIREMENT	295
5.7.1	STANDARD APPLICABLE	295
5.7.2	ANTENNA CONNECTED CONSTRUCTION	295
6.	PHOTOGRAPHS OF THE TEST CONFIGURATION	296
7.	INFORMATION ON THE TESTING LABORATORIES	297
8.	APPENDIX A - MODIFICATIONS RECORDERS FOR ENGINEERING CHANGES TO THE EUT BY THE LAB	298



A D T

1. CERTIFICATION

PRODUCT: Zone Flex 7762 AccessPoint

MODEL NO.: ZF7762

BRAND: Ruckus

APPLICANT: Senao Networks Inc.

TEST SAMPLE: R&D SAMPLE

TESTED: Jul. 07 ~ Jul. 27, 2009

STANDARDS: FCC Part 15, Subpart C (Section 15.247)
ANSI C63.4-2003

The above equipment (Model: ZF7762) has been tested by **Bureau Veritas Consumer Products Services (H.K.) Ltd., Taoyuan Branch**, and found compliance with the requirement of the above standards. The test record, data evaluation & Equipment Under Test (EUT) configurations represented herein are true and accurate accounts of the measurements of the sample's EMC characteristics under the conditions specified in this report.

PREPARED BY : Peggy Chen , **DATE** : Aug. 03, 2009
Peggy Chen / Specialist

TECHNICAL ACCEPTANCE : Long Chen , **DATE** : Aug. 03, 2009
Responsible for RF Long Chen / Senior Engineer

APPROVED BY : Gary Chang , **DATE** : Aug. 03, 2009
Gary Chang / Assistant Manager



A D T

2. SUMMARY OF TEST RESULTS

The EUT has been tested according to the following specifications:

APPLIED STANDARD: FCC PART 15, SUBPART C (SECTION 15.247)			
STANDARD SECTION	TEST TYPE AND LIMIT	RESULT	REMARK
15.207	AC Power Conducted Emission	PASS	Meet the requirement of limit. Minimum passing margin is -0.22dB at 0.345MHz.
15.247(a)(2)	Spectrum Bandwidth of a Direct Sequence Spread Spectrum System Limit: min. 500kHz	PASS	Meet the requirement of limit.
15.247(b)	Maximum Peak Output Power Limit: max. 30dBm	PASS	Meet the requirement of limit.
15.247(d)	Radiated Emissions Limit: Table 15.209	PASS	Meet the requirement of limit. Minimum passing margin is -0.27dB at 5725.00MHz.
15.247(e)	Power Spectral Density Limit: max. 8dBm	PASS	Meet the requirement of limit.
15.247(d)	Band Edge Measurement Limit: 20dB less than the peak value of fundamental frequency	PASS	Meet the requirement of limit.

2.1 MEASUREMENT UNCERTAINTY

Where relevant, the following measurement uncertainty levels have been estimated for tests performed on the EUT as specified in CISPR 16-4-2:

MEASUREMENT	FREQUENCY	UNCERTAINTY
Conducted emissions	150kHz~30MHz	2.44 dB
Radiated emissions	30MHz ~ 200MHz	3.34 dB
	200MHz ~1000MHz	3.35 dB
	1GHz ~ 18GHz	2.26 dB
	18GHz ~ 40GHz	1.94 dB

This uncertainty represents an expanded uncertainty expressed at approximately the 95% confidence level using a coverage factor of $k = 2$.



3. GENERAL INFORMATION

3.1 GENERAL DESCRIPTION OF EUT

PRODUCT	Zone Flex 7762 AccessPoint
MODEL NO.	ZF7762
FCC ID	U2M-ZF7762
POWER SUPPLY	12Vdc from DC power supply 48Vdc from POE
MODULATION TYPE	CCK, DQPSK, DBPSK for DSSS 64QAM, 16QAM, QPSK, BPSK for OFDM
MODULATION TECHNOLOGY	DSSS, OFDM
TRANSFER RATE	802.11b:11.0/ 5.5/ 2.0/ 1.0Mbps 802.11g: 54.0/ 48.0/ 36.0/ 24.0/ 18.0/ 12.0/ 9.0/ 6.0Mbps 802.11a: 54.0/ 48.0/ 36.0/ 24.0/ 18.0/ 12.0/ 9.0/ 6.0Mbps Draft 802.11n: up to 270.0Mbps
OPERATING FREQUENCY	2.4GHz: 2412~ 2462MHz 5.0GHz: 5745 ~ 5825MHz
NUMBER OF CHANNEL	2.4GHz: 11 for 802.11b, 802.11g, draft 802.11n (20MHz) 7 for draft 802.11n (40MHz) 5.0GHz: 5 for 802.11a & draft 802.11n (20MHz) 2 for draft 802.11n (40MHz)
OUTPUT POWER	2.4GHz: 605.979mW 5.0GHz: 243.294mW
ANTENNA TYPE	2.4GHz: Internal: Proprietary omni antenna with 3dBi gain 5.0GHz: Internal: Proprietary omni antenna with 3dBi gain External: Directional Panel antenna with 14dBi gain (Option)
I/O PORTS	Refer to user's manual
DATA CABLE	NA
ACCESSORY DEVICES	PoE, adapter(for PoE use)

NOTE:

- The EUT was operated with following PoE:

MODEL:	NPE-5818at
---------------	------------

The adapter of PoE:

BRAND:	Ruckus
MODEL:	GS60A48
INPUT:	100-240Vac, 50-60Hz, 1.4A
OUTPUT:	48Vdc, 1.25A
POWER LINE:	1.8m non-shielded cable with one core

2. The EUT is a Zone Flex 7762 AccessPoint. The functions of EUT listed as below:

	TEST STANDARD	REFERENCE REPORT
WLAN 802.11b/g, draft 802.11n	FCC Part 15, Subpart C (Section 15.247)	RF980504L06
WLAN 802.11a, draft 802.11n (5745~5825 MHz)		
WLAN 802.11a, draft 802.11n (5180~ 5240MHz)	FCC Part 15, Subpart E (Section 15.407)	RF980504L06-1

3. The frequency bands used in this EUT are listed as follows:

Frequency Band (MHz)	2412~2462	5180~5240	5745~5825
802.11b	√		
802.11g	√		
802.11a		√	√
Draft 802.11n (20MHz)	√	√	√
Draft 802.11n (40MHz)	√	√	√

4. The EUT incorporates a MIMO function. Physically, the EUT provides three completed transmitters and three receivers or two completed transmitters and two receivers.

MODULATION MODE	TX FUNCTION	
	INTERNAL ANTENNA (For 2.4G & 5.0GHz band)	EXTERNAL ANTENNA (For 5.0GHz band only)
802.11b	3TX	-
802.11g	3TX	-
802.11a	3TX	2TX
Draft 802.11n (20MHz)	3TX	2TX
Draft 802.11n (40MHz)	3TX	2TX

5. The internal and external works separately. In firmware, when external antenna plug in, the major transmission would program from external antenna. Two antennas will not transmit simultaneously. It was controlled by firmware.

6. The above EUT information was declared by manufacturer and for more detailed features description, please refer to the manufacturer's specifications or user's manual.



3.2 DESCRIPTION OF TEST MODES

FOR 2.4GHz:

11 channels are provided for 802.11b, 802.11g and draft 802.11n (20MHz):

CHANNEL	FREQUENCY	CHANNEL	FREQUENCY
1	2412MHz	7	2442MHz
2	2417MHz	8	2447MHz
3	2422MHz	9	2452MHz
4	2427MHz	10	2457MHz
5	2432MHz	11	2462MHz
6	2437MHz		

7 channels are provided for draft 802.11n (40MHz):

CHANNEL	FREQUENCY	CHANNEL	FREQUENCY
1	2422MHz	5	2442MHz
2	2427MHz	6	2447MHz
3	2432MHz	7	2452MHz
4	2437MHz		

FOR 5.0GHz (5745 ~ 5825MHz):

5 channels are provided for 802.11a, draft 802.11n (20MHz):

CHANNEL	FREQUENCY	CHANNEL	FREQUENCY
149	5745MHz	161	5805MHz
153	5765MHz	165	5825MHz
157	5785MHz		

2 channels are provided for draft 802.11n (40MHz):

CHANNEL	FREQUENCY	CHANNEL	FREQUENCY
151	5755MHz	159	5795MHz

3.2.1 CONFIGURATION OF SYSTEM UNDER TEST

TEST MODE A, C

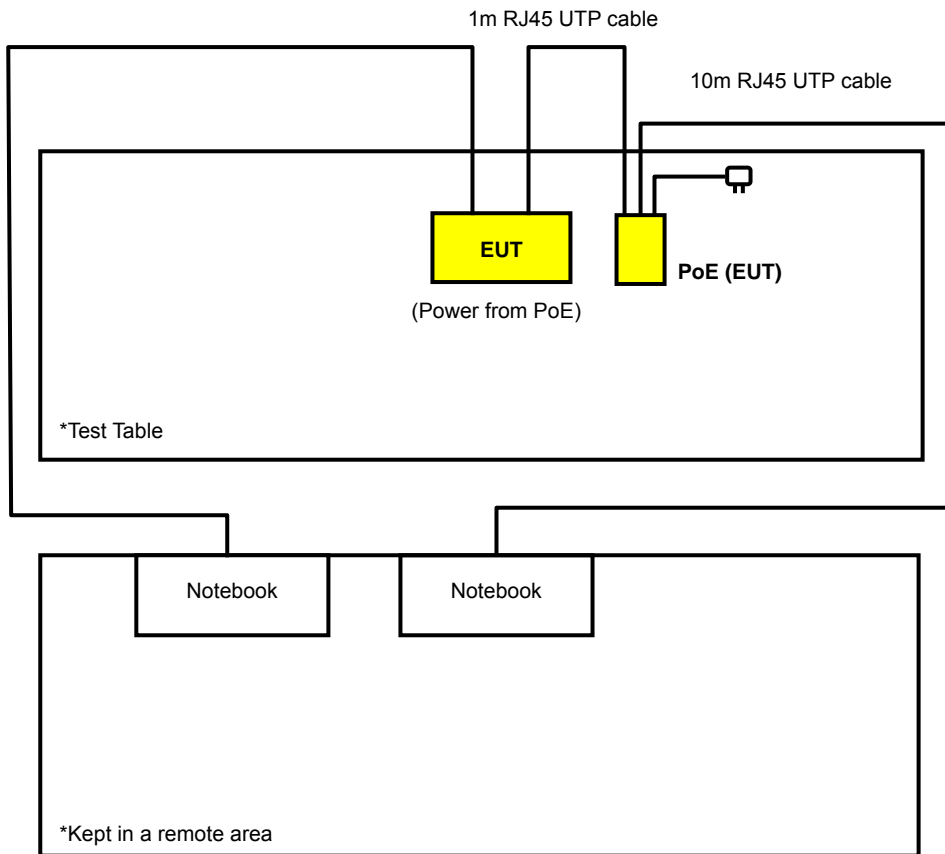



TEST MODE B, D

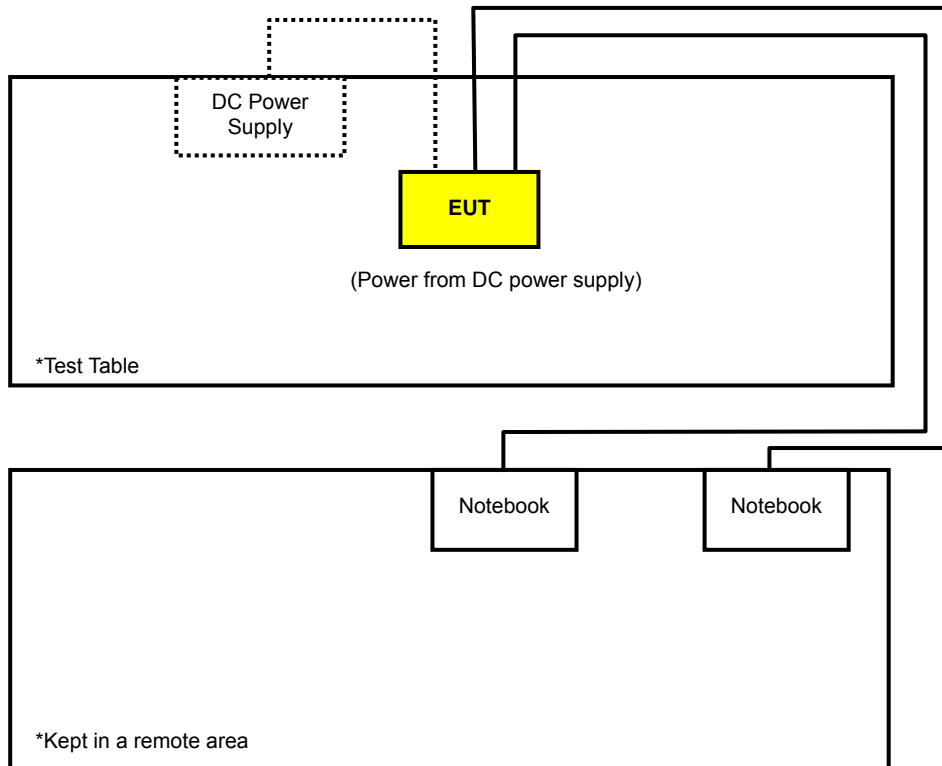



A D T

3.2.2 TEST MODE APPLICABILITY AND TESTED CHANNEL DETAIL

FOR 2.412 ~ 2.462GHz:

EUT CONFIGURE MODE	APPLICABLE TO				DESCRIPTION
	RE \geq 1G	RE<1G	PLC	APCM	
A	√	√	√	√	Power from POE
B	-	√	√	-	Power from DC power supply

Where **RE \geq 1G**: Radiated Emission above 1GHz

RE<1G: Radiated Emission below 1GHz

PLC: Power Line Conducted Emission

APCM: Antenna Port Conducted Measurement

NOTE: "-" means no effect.

RADIATED EMISSION TEST (ABOVE 1GHz):

- Pre-Scan has been conducted to determine the worst-case mode from all possible combinations between available modulations, data rates, XYZ axis and antenna ports (if EUT with antenna diversity architecture).
- Following channel(s) was (were) selected for the final test as listed below.

EUT CONFIGURE MODE	MODE	AVAILABLE CHANNEL	TESTED CHANNEL	MODULATION TECHNOLOGY	MODULATION TYPE	DATA RATE (Mbps)	AXIS
A	802.11b	1 to 11	1, 6, 11	DSSS	DBPSK	1.0	Z
A	802.11g	1 to 11	1, 6, 11	OFDM	BPSK	6.0	Z
A	Draft 802.11n (20MHz)	1 to 11	1, 6, 11	OFDM	BPSK	6.5	Z
A	Draft 802.11n (40MHz)	1 to 7	1, 4, 7	OFDM	BPSK	13.5	Z

RADIATED EMISSION TEST (BELOW 1GHz):

- Pre-Scan has been conducted to determine the worst-case mode from all possible combinations between available modulations, data rates, XYZ axis and antenna ports (if EUT with antenna diversity architecture).
- Following channel(s) was (were) selected for the final test as listed below.

EUT CONFIGURE MODE	MODE	AVAILABLE CHANNEL	TESTED CHANNEL	MODULATION TECHNOLOGY	MODULATION TYPE	DATA RATE (Mbps)	AXIS
A	802.11b	1 to 11	11	DSSS	DBPSK	1.0	Z
B	802.11b	1 to 11	11	DSSS	DBPSK	1.0	Z



POWER LINE CONDUCTED EMISSION TEST:

- Pre-Scan has been conducted to determine the worst-case mode from all possible combinations between available modulations, data rates and antenna ports (if EUT with antenna diversity architecture).
- Following channel(s) was (were) selected for the final test as listed below.

EUT CONFIGURE MODE	MODE	AVAILABLE CHANNEL	TESTED CHANNEL	MODULATION TECHNOLOGY	MODULATION TYPE	DATA RATE (Mbps)
A	802.11b	1 to 11	11	DSSS	DBPSK	1.0
B	802.11b	1 to 11	11	DSSS	DBPSK	1.0

BANDEDGE MEASUREMENT:

- Pre-Scan has been conducted to determine the worst-case mode from all possible combinations between available modulations, data rates and antenna ports (if EUT with antenna diversity architecture).
- Following channel(s) was (were) selected for the final test as listed below.

EUT CONFIGURE MODE	MODE	AVAILABLE CHANNEL	TESTED CHANNEL	MODULATION TECHNOLOGY	MODULATION TYPE	DATA RATE (Mbps)
A	802.11b	1 to 11	1, 11	DSSS	DBPSK	1.0
A	802.11g	1 to 11	1, 11	OFDM	BPSK	6.0
A	Draft 802.11n (20MHz)	1 to 11	1, 11	OFDM	BPSK	6.5
A	Draft 802.11n (40MHz)	1 to 7	1, 7	OFDM	BPSK	13.5

ANTENNA PORT CONDUCTED MEASUREMENT:

- Pre-Scan has been conducted to determine the worst-case mode from all possible combinations between available modulations, data rates and antenna ports (if EUT with antenna diversity architecture).
- Following channel(s) was (were) selected for the final test as listed below.

EUT CONFIGURE MODE	MODE	AVAILABLE CHANNEL	TESTED CHANNEL	MODULATION TECHNOLOGY	MODULATION TYPE	DATA RATE (Mbps)
A	802.11b	1 to 11	1, 6, 11	DSSS	DBPSK	1.0
A	802.11g	1 to 11	1, 6, 11	OFDM	BPSK	6.0
A	Draft 802.11n (20MHz)	1 to 11	1, 6, 11	OFDM	BPSK	6.5
A	Draft 802.11n (40MHz)	1 to 7	1, 4, 7	OFDM	BPSK	13.5



A D T

FOR 5.745 ~ 5.825GHz:

EUT CONFIGURE MODE	APPLICABLE TO				DESCRIPTION	
	RE≥1G	RE<1G	PLC	APCM	Antenna	Power Source
A	√	√	√	√	Internal	Power from PoE
B	-	√	√	-		Power from DC power supply
C	√	√	√	√	External	Power from PoE
D	-	√	√	-		Power from DC power supply

Where **RE≥1G**: Radiated Emission above 1GHz **RE<1G**: Radiated Emission below 1GHz
PLC: Power Line Conducted Emission **APCM**: Antenna Port Conducted Measurement

NOTE: "-" means no effect.

RADIATED EMISSION TEST (ABOVE 1GHz):

- Pre-Scan has been conducted to determine the worst-case mode from all possible combinations between available modulations, data rates, XYZ axis and antenna ports (if EUT with antenna diversity architecture).
- Following channel(s) was (were) selected for the final test as listed below.

EUT CONFIGURE MODE	MODE	AVAILABLE CHANNEL	TESTED CHANNEL	MODULATION TECHNOLOGY	MODULATION TYPE	DATA RATE (Mbps)	AXIS
A	802.11a	149 to 165	149, 157, 165	OFDM	BPSK	6.0	Z
C	802.11a	149 to 165	149, 157, 165	OFDM	BPSK	6.0	Z
A	Draft 802.11n (20MHz)	149 to 165	149, 157, 165	OFDM	BPSK	6.5	Z
C	Draft 802.11n (20MHz)	149 to 165	149, 157, 165	OFDM	BPSK	6.5	Z
A	Draft 802.11n (40MHz)	151 to 159	151, 159	OFDM	BPSK	13.5	Z
C	Draft 802.11n (40MHz)	151 to 159	151, 159	OFDM	BPSK	13.5	Z

RADIATED EMISSION TEST (BELOW 1GHz):

- Pre-Scan has been conducted to determine the worst-case mode from all possible combinations between available modulations, data rates, XYZ axis and antenna ports (if EUT with antenna diversity architecture).
- Following channel(s) was (were) selected for the final test as listed below.

EUT CONFIGURE MODE	MODE	AVAILABLE CHANNEL	TESTED CHANNEL	MODULATION TECHNOLOGY	MODULATION TYPE	DATA RATE (Mbps)	AXIS
A	802.11a	149 to 165	157	OFDM	BPSK	6.0	Z
B	802.11a	149 to 165	157	OFDM	BPSK	6.0	Z
C	Draft 802.11n (20MHz)	149 to 165	149	OFDM	BPSK	6.5	Z
D	Draft 802.11n (20MHz)	149 to 165	149	OFDM	BPSK	6.5	Z



POWER LINE CONDUCTED EMISSION TEST:

- Pre-Scan has been conducted to determine the worst-case mode from all possible combinations between available modulations, data rates and antenna ports (if EUT with antenna diversity architecture).
- Following channel(s) was (were) selected for the final test as listed below.

EUT CONFIGURE MODE	MODE	AVAILABLE CHANNEL	TESTED CHANNEL	MODULATION TECHNOLOGY	MODULATION TYPE	DATA RATE (Mbps)
A	802.11a	149 to 165	157	OFDM	BPSK	6.0
B	802.11a	149 to 165	157	OFDM	BPSK	6.0
C	Draft 802.11n (20MHz)	149 to 165	149	OFDM	BPSK	6.5
D	Draft 802.11n (20MHz)	149 to 165	149	OFDM	BPSK	6.5

BANDEDGE MEASUREMENT:

- Pre-Scan has been conducted to determine the worst-case mode from all possible combinations between available modulations, data rates and antenna ports (if EUT with antenna diversity architecture).
- Following channel(s) was (were) selected for the final test as listed below.

EUT CONFIGURE MODE	MODE	AVAILABLE CHANNEL	TESTED CHANNEL	MODULATION TECHNOLOGY	MODULATION TYPE	DATA RATE (Mbps)
A & C	802.11a	149 to 165	149, 165	OFDM	BPSK	6.0
A & C	Draft 802.11n (20MHz)	149 to 165	149, 165	OFDM	BPSK	6.5
A & C	Draft 802.11n (40MHz)	151 to 159	151, 159	OFDM	BPSK	13.5

ANTENNA PORT CONDUCTED MEASUREMENT:

- Pre-Scan has been conducted to determine the worst-case mode from all possible combinations between available modulations, data rates and antenna ports (if EUT with antenna diversity architecture).
- Following channel(s) was (were) selected for the final test as listed below.

EUT CONFIGURE MODE	MODE	AVAILABLE CHANNEL	TESTED CHANNEL	MODULATION TECHNOLOGY	MODULATION TYPE	DATA RATE (Mbps)
A & C	802.11a	149 to 165	149, 157, 165	OFDM	BPSK	6.0
A & C	Draft 802.11n (20MHz)	149 to 165	149, 157, 165	OFDM	BPSK	6.5
A & C	Draft 802.11n (40MHz)	151 to 159	151, 159	OFDM	BPSK	13.5



3.3 GENERAL DESCRIPTION OF APPLIED STANDARDS

The EUT is a RF Product. According to the specifications of the manufacturer, it must comply with the requirements of the following standards:

FCC Part 15, Subpart C (15.247)

ANSI C63.4-2003

All test items have been performed and recorded as per the above standards.

NOTE: The EUT is also considered as a kind of computer peripheral, because the connection to computer is necessary for typical use. It has been verified to comply with the requirements of FCC Part 15, Subpart B, Class B (DoC). The test report has been issued separately.

3.4 DESCRIPTION OF SUPPORT UNITS

The EUT has been tested as an independent unit together with other necessary accessories or support units. The following support units or accessories were used to form a representative test configuration during the tests.

NO.	PRODUCT	BRAND	MODEL NO.	SERIAL NO.	FCC ID
1	DC POWER SUPPLY	Topward	TF-6306A	727263	NA
2	NOTEBOOK COMPUTER	DELL	PP05L	12130898320	E2K24CLNS
3	NOTEBOOK COMPUTER	DELL	PP05L	9954115984	E2K24CLNS

NO.	SIGNAL CABLE DESCRIPTION OF THE ABOVE SUPPORT UNITS
1	NA
2	10m RJ45 cable
3	10m RJ45 cable

NOTE 1: All power cords of the above support units are non shielded (1.8m).

NOTE 2: Item 2, 3 acted as communication partners to transfer data.



4. TEST TYPES AND RESULTS (FOR 2.4GHz BAND)

4.1 RADIATED EMISSION MEASUREMENT

4.1.1 LIMITS OF RADIATED EMISSION MEASUREMENT

Emissions radiated outside of the specified bands, shall be according to the general radiated limits in 15.209 as following:

FREQUENCIES (MHz)	FIELD STRENGTH (microvolts/meter)	MEASUREMENT DISTANCE (meters)
0.009 ~ 0.490	2400/F(kHz)	300
0.490 ~ 1.705	24000/F(kHz)	30
1.705 ~ 30.0	30	30
30 ~ 88	100	3
88 ~ 216	150	3
216 ~ 960	200	3
Above 960	500	3

NOTE:

1. The lower limit shall apply at the transition frequencies.
2. Emission level (dBuV/m) = 20 log Emission level (uV/m).
3. As shown in 15.35(b), for frequencies above 1000MHz, the field strength limits are based on average detector, however, the peak field strength of any emission shall not exceed the maximum permitted average limits, specified above by more than 20dB under any condition of modulation.



A D T

4.1.2 TEST INSTRUMENTS

DESCRIPTION & MANUFACTURER	MODEL NO.	SERIAL NO.	DATE OF CALIBRATION	DUE DATE OF CALIBRATION
Test Receiver ROHDE & SCHWARZ	ESI7	100033	Jul. 06, 2009	Jul. 05, 2010
Spectrum Analyzer ROHDE & SCHWARZ	FSP40	100076	May. 26, 2009	May. 25, 2010
BILOG Antenna SCHWARZBECK	VULB9168	9168-160	Apr. 27, 2009	Apr. 26, 2010
HORN Antenna SCHWARZBECK	9120D	9120D-209	Jul. 01, 2009	Jun. 30, 2010
HORN Antenna SCHWARZBECK	BBHA 9170	BBHA9170243	Dec. 25, 2008	Dec. 24, 2009
Preamplifier Agilent	8447D	2944A10633	Nov. 03, 2008	Nov. 02, 2009
Preamplifier Agilent	8449B	3008A01964	Oct. 23, 2008	Oct. 22, 2009
RF signal cable HUBER+SUHNNER	SUCOFLEX 104	238141/4	May 13, 2009	May 12, 2010
RF signal cable HUBER+SUHNNER	SUCOFLEX 104	12738/6	May 13, 2009	May 12, 2010
Software ADT.	ADT_Radiated_ V7.6.15.9.2	NA	NA	NA
Antenna Tower inn-co GmbH	MA 4000	013303	NA	NA
Antenna Tower Controller inn-co GmbH	CO2000	017303	NA	NA
Turn Table ADT.	TT100.	TT93021703	NA	NA
Turn Table Controller ADT.	SC100.	SC93021703	NA	NA

- NOTE:** 1. The calibration interval of the above test instruments is 12 months and the calibrations are traceable to NML/ROC and NIST/USA.
2. The test was performed in HwaYa Chamber 3.
3. The horn antenna and HP preamplifier (model: 8449B) are used only for the measurement of emission frequency above 1GHz if tested.
4. The FCC Site Registration No. is 988962.
5. The IC Site Registration No. is IC 7450F-3.



A D T

4.1.3 TEST PROCEDURES

- a. The EUT was placed on the top of a rotating table 0.8 meters above the ground at a 3 meters semi-anechoic chamber. The table was rotated 360 degrees to determine the position of the highest radiation.
- b. The EUT was set 3 meters away from the interference-receiving antenna, which was mounted on the top of a variable-height antenna tower.
- c. The antenna is a broadband antenna, and its height is varied from one meter to four meters above the ground to determine the maximum value of the field strength. Both horizontal and vertical polarizations of the antenna are set to make the measurement.
- d. For each suspected emission, the EUT was arranged to its worst case and then the antenna was tuned to heights from 1 meter to 4 meters and the rotatable table was turned from 0 degrees to 360 degrees to find the maximum reading.
- e. The test-receiver system was set to Peak Detect Function and Specified Bandwidth with Maximum Hold Mode.
- f. If the emission level of the EUT in peak mode was lower than the limit specified, then testing could be stopped and the peak values of the EUT would be reported. Otherwise the emissions would be re-tested one by one using peak, quasi-peak or average method as specified and then reported in a data sheet.

NOTE:

1. The resolution bandwidth and video bandwidth of test receiver/spectrum analyzer is 120kHz for Quasi-peak detection at frequency below 1GHz.
2. The resolution bandwidth of test receiver/spectrum analyzer is 1MHz and video bandwidth is 3MHz for Peak detection at frequency above 1GHz.
3. The resolution bandwidth of test receiver/spectrum analyzer is 1MHz and the video bandwidth is 10Hz for Average detection (AV) at frequency above 1GHz.
4. All modes of operation were investigated and the worst-case emissions are reported.

4.1.4 DEVIATION FROM TEST STANDARD

No deviation.

4.1.5 TEST SETUP

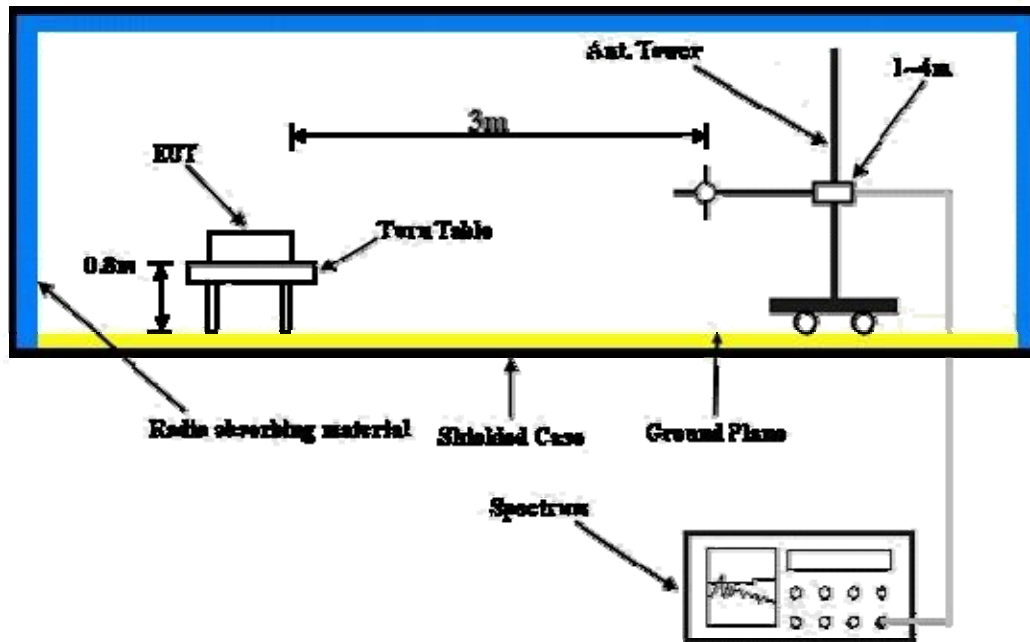

For the actual test configuration, please refer to the attached file (Test Setup Photo).

4.1.6 EUT OPERATING CONDITIONS

- a. Placed the EUT on the testing table.
- b. Prepared two notebook systems to act as communication partners and placed them outside of testing area.
- c. The communication partners run a test program (provided by manufacturer) to enable EUT under transmission condition continuously at specific channel frequency via RJ45 cables.
- d. The communication partners sent data to EUT by command "PING".



A D T

4.1.7 TEST RESULTS

802.11b DSSS MODULATION

EUT TEST CONDITION		MEASUREMENT DETAIL	
CHANNEL	Channel 1	FREQUENCY RANGE	1 ~ 25GHz
INPUT POWER (SYSTEM)	120Vac, 60 Hz	DETECTOR FUNCTION	Peak (PK) Average (AV)
ENVIRONMENTAL CONDITIONS	24deg. C, 64%RH 1002 hPa	TESTED BY	Brad Wu

ANTENNA POLARITY & TEST DISTANCE: HORIZONTAL AT 3 M								
NO.	FREQ. (MHz)	EMISSION LEVEL (dBuV/m)	LIMIT (dBuV/m)	MARGIN (dB)	ANTENNA HEIGHT (m)	TABLE ANGLE (Degree)	RAW VALUE (dBuV)	CORRECTION FACTOR (dB/m)
1	2386.00	61.87 PK	74.00	-12.13	1.10 H	251	31.23	30.64
2	2386.00	52.89 AV	54.00	-1.11	1.10 H	251	22.25	30.64
3	*2412.00	118.81 PK			1.10 H	251	88.08	30.73
4	*2412.00	114.11 AV			1.10 H	251	83.38	30.73
5	4824.00	54.94 PK	74.00	-19.06	1.10 H	107	18.52	36.42
6	4824.00	51.31 AV	54.00	-2.69	1.10 H	107	14.89	36.42
ANTENNA POLARITY & TEST DISTANCE: VERTICAL AT 3 M								
NO.	FREQ. (MHz)	EMISSION LEVEL (dBuV/m)	LIMIT (dBuV/m)	MARGIN (dB)	ANTENNA HEIGHT (m)	TABLE ANGLE (Degree)	RAW VALUE (dBuV)	CORRECTION FACTOR (dB/m)
1	2386.00	60.19 PK	74.00	-13.81	1.18 V	209	29.55	30.64
2	2386.00	49.70 AV	54.00	-4.30	1.18 V	209	19.06	30.64
3	*2412.00	114.06 PK			1.19 V	220	83.33	30.73
4	*2412.00	109.53 AV			1.19 V	220	78.80	30.73
5	4824.00	56.35 PK	74.00	-17.65	1.12 V	141	19.93	36.42
6	4824.00	53.40 AV	54.00	-0.60	1.12 V	141	16.98	36.42

- REMARKS:**
1. Emission level (dBuV/m) = Raw Value (dBuV) + Correction Factor (dB/m).
 2. Correction Factor (dB/m) = Antenna Factor (dB/m) + Cable Factor (dB).
 3. The other emission levels were very low against the limit.
 4. Margin value = Emission level – Limit value.
 5. “ * ”: Fundamental frequency.



A D T

EUT TEST CONDITION		MEASUREMENT DETAIL	
CHANNEL	Channel 6	FREQUENCY RANGE	1 ~ 25GHz
INPUT POWER (SYSTEM)	120Vac, 60 Hz	DETECTOR FUNCTION	Peak (PK) Average (AV)
ENVIRONMENTAL CONDITIONS	24deg. C, 64%RH 1002 hPa	TESTED BY	Brad Wu

ANTENNA POLARITY & TEST DISTANCE: HORIZONTAL AT 3 M								
NO.	FREQ. (MHz)	EMISSION LEVEL (dBuV/m)	LIMIT (dBuV/m)	MARGIN (dB)	ANTENNA HEIGHT (m)	TABLE ANGLE (Degree)	RAW VALUE (dBuV)	CORRECTION FACTOR (dB/m)
1	*2437.00	118.25 PK			1.09 H	253	87.44	30.81
2	*2437.00	113.58 AV			1.09 H	253	82.77	30.81
3	4874.00	55.68 PK	74.00	-18.32	1.04 H	215	19.21	36.47
4	4874.00	51.57 AV	54.00	-2.43	1.04 H	215	15.10	36.47
ANTENNA POLARITY & TEST DISTANCE: VERTICAL AT 3 M								
NO.	FREQ. (MHz)	EMISSION LEVEL (dBuV/m)	LIMIT (dBuV/m)	MARGIN (dB)	ANTENNA HEIGHT (m)	TABLE ANGLE (Degree)	RAW VALUE (dBuV)	CORRECTION FACTOR (dB/m)
1	*2437.00	113.52 PK			1.20 V	224	82.71	30.81
2	*2437.00	109.04 AV			1.20 V	224	78.23	30.81
3	4874.00	53.36 PK	74.00	-20.64	1.07 V	251	16.89	36.47
4	4874.00	48.06 AV	54.00	-5.94	1.07 V	251	11.59	36.47

- REMARKS:**
1. Emission level (dBuV/m) = Raw Value (dBuV) + Correction Factor (dB/m).
 2. Correction Factor (dB/m) = Antenna Factor (dB/m) + Cable Factor (dB).
 3. The other emission levels were very low against the limit.
 4. Margin value = Emission level – Limit value.
 5. “ * “: Fundamental frequency.



A D T

EUT TEST CONDITION		MEASUREMENT DETAIL	
CHANNEL	Channel 11	FREQUENCY RANGE	1 ~ 25GHz
INPUT POWER (SYSTEM)	120Vac, 60 Hz	DETECTOR FUNCTION	Peak (PK) Average (AV)
ENVIRONMENTAL CONDITIONS	24deg. C, 64%RH 1002 hPa	TESTED BY	Brad Wu

ANTENNA POLARITY & TEST DISTANCE: HORIZONTAL AT 3 M								
NO.	FREQ. (MHz)	EMISSION LEVEL (dBuV/m)	LIMIT (dBuV/m)	MARGIN (dB)	ANTENNA HEIGHT (m)	TABLE ANGLE (Degree)	RAW VALUE (dBuV)	CORRECTION FACTOR (dB/m)
1	*2462.00	118.02 PK			1.04 H	242	87.13	30.89
2	*2462.00	113.43 AV			1.04 H	242	82.54	30.89
3	2488.00	60.95 PK	74.00	-13.05	1.04 H	242	29.98	30.97
4	2488.00	51.84 AV	54.00	-2.16	1.04 H	242	20.87	30.97
5	4924.00	56.52 PK	74.00	-17.48	1.06 H	110	19.94	36.58
6	4924.00	53.38 AV	54.00	-0.62	1.06 H	110	16.80	36.58
ANTENNA POLARITY & TEST DISTANCE: VERTICAL AT 3 M								
NO.	FREQ. (MHz)	EMISSION LEVEL (dBuV/m)	LIMIT (dBuV/m)	MARGIN (dB)	ANTENNA HEIGHT (m)	TABLE ANGLE (Degree)	RAW VALUE (dBuV)	CORRECTION FACTOR (dB/m)
1	*2462.00	113.21 PK			1.44 V	213	82.32	30.89
2	*2462.00	108.76 AV			1.44 V	213	77.87	30.89
3	2483.50	59.36 PK	74.00	-14.64	1.44 V	213	28.40	30.96
4	2483.50	49.25 AV	54.00	-4.75	1.44 V	213	18.29	30.96
5	4924.00	52.98 PK	74.00	-21.02	1.00 V	264	16.40	36.58
6	4924.00	48.60 AV	54.00	-5.40	1.00 V	264	12.02	36.58

- REMARKS:**
1. Emission level (dBuV/m) = Raw Value (dBuV) + Correction Factor (dB/m).
 2. Correction Factor (dB/m) = Antenna Factor (dB/m) + Cable Factor (dB).
 3. The other emission levels were very low against the limit.
 4. Margin value = Emission level – Limit value.
 5. “ * “: Fundamental frequency.



A D T

802.11g OFDM MODULATION

EUT TEST CONDITION		MEASUREMENT DETAIL	
CHANNEL	Channel 1	FREQUENCY RANGE	1 ~ 25GHz
INPUT POWER (SYSTEM)	120Vac, 60 Hz	DETECTOR FUNCTION	Peak (PK) Average (AV)
ENVIRONMENTAL CONDITIONS	24deg. C, 64%RH 1002 hPa	TESTED BY	Brad Wu

ANTENNA POLARITY & TEST DISTANCE: HORIZONTAL AT 3 M								
NO.	FREQ. (MHz)	EMISSION LEVEL (dBuV/m)	LIMIT (dBuV/m)	MARGIN (dB)	ANTENNA HEIGHT (m)	TABLE ANGLE (Degree)	RAW VALUE (dBuV)	CORRECTION FACTOR (dB/m)
1	2390.00	70.08 PK	74.00	-3.92	1.32 H	250	39.43	30.65
2	2390.00	53.65 AV	54.00	-0.35	1.32 H	250	23.00	30.65
3	*2412.00	120.15 PK			1.32 H	250	89.42	30.73
4	*2412.00	109.72 AV			1.32 H	250	78.99	30.73
5	4824.00	54.71 PK	74.00	-19.29	1.05 H	216	18.29	36.42
6	4824.00	40.47 AV	54.00	-13.53	1.05 H	216	4.05	36.42
ANTENNA POLARITY & TEST DISTANCE: VERTICAL AT 3 M								
NO.	FREQ. (MHz)	EMISSION LEVEL (dBuV/m)	LIMIT (dBuV/m)	MARGIN (dB)	ANTENNA HEIGHT (m)	TABLE ANGLE (Degree)	RAW VALUE (dBuV)	CORRECTION FACTOR (dB/m)
1	2390.00	68.20 PK	74.00	-5.80	1.20 V	212	37.55	30.65
2	2390.00	50.67 AV	54.00	-3.33	1.20 V	212	20.02	30.65
3	*2412.00	115.13 PK			1.20 V	212	84.40	30.73
4	*2412.00	105.08 AV			1.20 V	212	74.35	30.73
5	4824.00	55.24 PK	74.00	-18.76	1.13 V	212	18.82	36.42
6	4824.00	41.34 AV	54.00	-12.66	1.13 V	212	4.92	36.42

- REMARKS:**
1. Emission level (dBuV/m) = Raw Value (dBuV) + Correction Factor (dB/m).
 2. Correction Factor (dB/m) = Antenna Factor (dB/m) + Cable Factor (dB).
 3. The other emission levels were very low against the limit.
 4. Margin value = Emission level – Limit value.
 5. “ * “: Fundamental frequency.



A D T

EUT TEST CONDITION		MEASUREMENT DETAIL	
CHANNEL	Channel 6	FREQUENCY RANGE	1 ~ 25GHz
INPUT POWER (SYSTEM)	120Vac, 60 Hz	DETECTOR FUNCTION	Peak (PK) Average (AV)
ENVIRONMENTAL CONDITIONS	24deg. C, 64%RH 1002 hPa	TESTED BY	Brad Wu

ANTENNA POLARITY & TEST DISTANCE: HORIZONTAL AT 3 M								
NO.	FREQ. (MHz)	EMISSION LEVEL (dBuV/m)	LIMIT (dBuV/m)	MARGIN (dB)	ANTENNA HEIGHT (m)	TABLE ANGLE (Degree)	RAW VALUE (dBuV)	CORRECTION FACTOR (dB/m)
1	*2437.00	120.36 PK			1.30 H	256	89.55	30.81
2	*2437.00	109.95 AV			1.30 H	256	79.14	30.81
3	4874.00	54.56 PK	74.00	-19.44	1.08 H	106	18.09	36.47
4	4874.00	40.93 AV	54.00	-13.07	1.08 H	106	4.46	36.47
ANTENNA POLARITY & TEST DISTANCE: VERTICAL AT 3 M								
NO.	FREQ. (MHz)	EMISSION LEVEL (dBuV/m)	LIMIT (dBuV/m)	MARGIN (dB)	ANTENNA HEIGHT (m)	TABLE ANGLE (Degree)	RAW VALUE (dBuV)	CORRECTION FACTOR (dB/m)
1	*2437.00	115.39 PK			1.23 V	214	84.58	30.81
2	*2437.00	105.22 AV			1.23 V	214	74.41	30.81
3	4874.00	56.68 PK	74.00	-17.32	1.11 V	211	20.21	36.47
4	4874.00	42.31 AV	54.00	-11.69	1.11 V	211	5.84	36.47

- REMARKS:**
1. Emission level (dBuV/m) = Raw Value (dBuV) + Correction Factor (dB/m).
 2. Correction Factor (dB/m) = Antenna Factor (dB/m) + Cable Factor (dB).
 3. The other emission levels were very low against the limit.
 4. Margin value = Emission level – Limit value.
 5. “ * “: Fundamental frequency.



A D T

EUT TEST CONDITION		MEASUREMENT DETAIL	
CHANNEL	Channel 11	FREQUENCY RANGE	1 ~ 25GHz
INPUT POWER (SYSTEM)	120Vac, 60 Hz	DETECTOR FUNCTION	Peak (PK) Average (AV)
ENVIRONMENTAL CONDITIONS	24deg. C, 64%RH 1002 hPa	TESTED BY	Brad Wu

ANTENNA POLARITY & TEST DISTANCE: HORIZONTAL AT 3 M								
NO.	FREQ. (MHz)	EMISSION LEVEL (dBuV/m)	LIMIT (dBuV/m)	MARGIN (dB)	ANTENNA HEIGHT (m)	TABLE ANGLE (Degree)	RAW VALUE (dBuV)	CORRECTION FACTOR (dB/m)
1	*2462.00	119.62 PK			1.29 H	248	88.73	30.89
2	*2462.00	109.01 AV			1.29 H	248	78.12	30.89
3	2483.50	62.49 PK	74.00	-11.51	1.29 H	248	31.53	30.96
4	2483.50	51.01 AV	54.00	-2.99	1.29 H	248	20.05	30.96
5	4924.00	57.36 PK	74.00	-16.64	1.13 H	99	20.78	36.58
6	4924.00	42.66 AV	54.00	-11.34	1.13 H	99	6.08	36.58
ANTENNA POLARITY & TEST DISTANCE: VERTICAL AT 3 M								
NO.	FREQ. (MHz)	EMISSION LEVEL (dBuV/m)	LIMIT (dBuV/m)	MARGIN (dB)	ANTENNA HEIGHT (m)	TABLE ANGLE (Degree)	RAW VALUE (dBuV)	CORRECTION FACTOR (dB/m)
1	*2462.00	115.17 PK			1.19 V	209	84.28	30.89
2	*2462.00	104.77 AV			1.19 V	209	73.88	30.89
3	2483.50	59.64 PK	74.00	-14.36	1.19 V	209	28.68	30.96
4	2483.50	46.62 AV	54.00	-7.38	1.19 V	209	15.66	30.96
5	4924.00	59.30 PK	74.00	-14.70	1.11 V	221	22.72	36.58
6	4924.00	44.14 AV	54.00	-9.86	1.11 V	221	7.56	36.58

- REMARKS:**
1. Emission level (dBuV/m) = Raw Value (dBuV) + Correction Factor (dB/m).
 2. Correction Factor (dB/m) = Antenna Factor (dB/m) + Cable Factor (dB).
 3. The other emission levels were very low against the limit.
 4. Margin value = Emission level – Limit value.
 5. “ * “: Fundamental frequency.



A D T

DRAFT 802.11n (20MHz) OFDM MODULATION

EUT TEST CONDITION		MEASUREMENT DETAIL	
CHANNEL	Channel 1	FREQUENCY RANGE	1 ~ 25GHz
INPUT POWER (SYSTEM)	120Vac, 60 Hz	DETECTOR FUNCTION	Peak (PK) Average (AV)
ENVIRONMENTAL CONDITIONS	24deg. C, 64%RH 1002 hPa	TESTED BY	Brad Wu

ANTENNA POLARITY & TEST DISTANCE: HORIZONTAL AT 3 M								
NO.	FREQ. (MHz)	EMISSION LEVEL (dBuV/m)	LIMIT (dBuV/m)	MARGIN (dB)	ANTENNA HEIGHT (m)	TABLE ANGLE (Degree)	RAW VALUE (dBuV)	CORRECTION FACTOR (dB/m)
1	2390.00	69.82 PK	74.00	-4.18	1.31 H	252	39.17	30.65
2	2390.00	53.41 AV	54.00	-0.59	1.31 H	252	22.76	30.65
3	*2412.00	119.86 PK			1.31 H	252	89.13	30.73
4	*2412.00	109.51 AV			1.31 H	252	78.78	30.73
5	4824.00	54.62 PK	74.00	-19.38	1.11 H	194	18.20	36.42
6	4824.00	40.34 AV	54.00	-13.66	1.11 H	194	3.92	36.42
ANTENNA POLARITY & TEST DISTANCE: VERTICAL AT 3 M								
NO.	FREQ. (MHz)	EMISSION LEVEL (dBuV/m)	LIMIT (dBuV/m)	MARGIN (dB)	ANTENNA HEIGHT (m)	TABLE ANGLE (Degree)	RAW VALUE (dBuV)	CORRECTION FACTOR (dB/m)
1	2390.00	68.02 PK	74.00	-5.98	1.18 V	216	37.37	30.65
2	2390.00	50.51 AV	54.00	-3.49	1.18 V	216	19.86	30.65
3	*2412.00	114.84 PK			1.18 V	216	84.11	30.73
4	*2412.00	104.81 AV			1.18 V	216	74.08	30.73
5	4824.00	55.01 PK	74.00	-18.99	1.19 V	228	18.59	36.42
6	4824.00	41.15 AV	54.00	-12.85	1.19 V	228	4.73	36.42

- REMARKS:**
1. Emission level (dBuV/m) = Raw Value (dBuV) + Correction Factor (dB/m).
 2. Correction Factor (dB/m) = Antenna Factor (dB/m) + Cable Factor (dB).
 3. The other emission levels were very low against the limit.
 4. Margin value = Emission level – Limit value.
 5. “ * ”: Fundamental frequency.



A D T

EUT TEST CONDITION		MEASUREMENT DETAIL	
CHANNEL	Channel 6	FREQUENCY RANGE	1 ~ 25GHz
INPUT POWER (SYSTEM)	120Vac, 60 Hz	DETECTOR FUNCTION	Peak (PK) Average (AV)
ENVIRONMENTAL CONDITIONS	24deg. C, 64%RH 1002 hPa	TESTED BY	Brad Wu

ANTENNA POLARITY & TEST DISTANCE: HORIZONTAL AT 3 M								
NO.	FREQ. (MHz)	EMISSION LEVEL (dBuV/m)	LIMIT (dBuV/m)	MARGIN (dB)	ANTENNA HEIGHT (m)	TABLE ANGLE (Degree)	RAW VALUE (dBuV)	CORRECTION FACTOR (dB/m)
1	*2437.00	120.04 PK			1.31 H	259	89.23	30.81
2	*2437.00	109.61 AV			1.31 H	259	78.80	30.81
3	4874.00	54.43 PK	74.00	-19.57	1.10 H	109	17.96	36.47
4	4874.00	40.82 AV	54.00	-13.18	1.10 H	109	4.35	36.47
ANTENNA POLARITY & TEST DISTANCE: VERTICAL AT 3 M								
NO.	FREQ. (MHz)	EMISSION LEVEL (dBuV/m)	LIMIT (dBuV/m)	MARGIN (dB)	ANTENNA HEIGHT (m)	TABLE ANGLE (Degree)	RAW VALUE (dBuV)	CORRECTION FACTOR (dB/m)
1	*2437.00	115.13 PK			1.21 V	216	84.32	30.81
2	*2437.00	105.04 AV			1.21 V	216	74.23	30.81
3	4874.00	56.43 PK	74.00	-17.57	1.16 V	239	19.96	36.47
4	4874.00	42.05 AV	54.00	-11.95	1.16 V	239	5.58	36.47

- REMARKS:**
1. Emission level (dBuV/m) = Raw Value (dBuV) + Correction Factor (dB/m).
 2. Correction Factor (dB/m) = Antenna Factor (dB/m) + Cable Factor (dB).
 3. The other emission levels were very low against the limit.
 4. Margin value = Emission level – Limit value.
 5. “ * “: Fundamental frequency.



A D T

EUT TEST CONDITION		MEASUREMENT DETAIL	
CHANNEL	Channel 11	FREQUENCY RANGE	1 ~ 25GHz
INPUT POWER (SYSTEM)	120Vac, 60 Hz	DETECTOR FUNCTION	Peak (PK) Average (AV)
ENVIRONMENTAL CONDITIONS	24deg. C, 64%RH 1002 hPa	TESTED BY	Brad Wu

ANTENNA POLARITY & TEST DISTANCE: HORIZONTAL AT 3 M								
NO.	FREQ. (MHz)	EMISSION LEVEL (dBuV/m)	LIMIT (dBuV/m)	MARGIN (dB)	ANTENNA HEIGHT (m)	TABLE ANGLE (Degree)	RAW VALUE (dBuV)	CORRECTION FACTOR (dB/m)
1	*2462.00	119.45 PK			1.28 H	246	88.56	30.89
2	*2462.00	108.81 AV			1.28 H	246	77.92	30.89
3	2483.50	62.38 PK	74.00	-11.62	1.28 H	246	31.42	30.96
4	2483.50	50.94 AV	54.00	-3.06	1.28 H	246	19.98	30.96
5	4924.00	57.48 PK	74.00	-16.52	1.16 H	108	20.90	36.58
6	4924.00	42.81 AV	54.00	-11.19	1.16 H	108	6.23	36.58
ANTENNA POLARITY & TEST DISTANCE: VERTICAL AT 3 M								
NO.	FREQ. (MHz)	EMISSION LEVEL (dBuV/m)	LIMIT (dBuV/m)	MARGIN (dB)	ANTENNA HEIGHT (m)	TABLE ANGLE (Degree)	RAW VALUE (dBuV)	CORRECTION FACTOR (dB/m)
1	*2462.00	114.94 PK			1.18 V	212	84.05	30.89
2	*2462.00	104.56 AV			1.18 V	212	73.67	30.89
3	2483.50	59.58 PK	74.00	-14.42	1.18 V	212	28.62	30.96
4	2483.50	46.51 AV	54.00	-7.49	1.18 V	212	15.55	30.96
5	4924.00	59.68 PK	74.00	-14.32	1.09 V	216	23.10	36.58
6	4924.00	44.52 AV	54.00	-9.48	1.09 V	216	7.94	36.58

- REMARKS:**
1. Emission level (dBuV/m) = Raw Value (dBuV) + Correction Factor (dB/m).
 2. Correction Factor (dB/m) = Antenna Factor (dB/m) + Cable Factor (dB).
 3. The other emission levels were very low against the limit.
 4. Margin value = Emission level – Limit value.
 5. “ * “: Fundamental frequency.



A D T

DRAFT 802.11n (40MHz) OFDM MODULATION

EUT TEST CONDITION		MEASUREMENT DETAIL	
CHANNEL	Channel 1	FREQUENCY RANGE	1 ~ 25GHz
INPUT POWER (SYSTEM)	120Vac, 60 Hz	DETECTOR FUNCTION	Peak (PK) Average (AV)
ENVIRONMENTAL CONDITIONS	24deg. C, 64%RH 1002 hPa	TESTED BY	Brad Wu

ANTENNA POLARITY & TEST DISTANCE: HORIZONTAL AT 3 M								
NO.	FREQ. (MHz)	EMISSION LEVEL (dBuV/m)	LIMIT (dBuV/m)	MARGIN (dB)	ANTENNA HEIGHT (m)	TABLE ANGLE (Degree)	RAW VALUE (dBuV)	CORRECTION FACTOR (dB/m)
1	2390.00	70.64 PK	74.00	-3.36	1.30 H	259	39.99	30.65
2	2390.00	53.62 AV	54.00	-0.38	1.30 H	259	22.97	30.65
3	*2422.00	117.29 PK			1.30 H	259	86.53	30.76
4	*2422.00	106.94 AV			1.30 H	259	76.18	30.76
5	4844.00	50.63 PK	74.00	-23.37	1.00 H	108	14.19	36.44
6	4844.00	38.07 AV	54.00	-15.93	1.00 H	108	1.63	36.44
ANTENNA POLARITY & TEST DISTANCE: VERTICAL AT 3 M								
NO.	FREQ. (MHz)	EMISSION LEVEL (dBuV/m)	LIMIT (dBuV/m)	MARGIN (dB)	ANTENNA HEIGHT (m)	TABLE ANGLE (Degree)	RAW VALUE (dBuV)	CORRECTION FACTOR (dB/m)
1	2390.00	68.46 PK	74.00	-5.54	1.19 V	218	37.81	30.65
2	2390.00	50.92 AV	54.00	-3.08	1.19 V	218	20.27	30.65
3	*2422.00	112.31 PK			1.19 V	218	81.55	30.76
4	*2422.00	102.25 AV			1.19 V	218	71.49	30.76
5	4844.00	53.81 PK	74.00	-20.19	1.11 V	211	17.37	36.44
6	4844.00	40.79 AV	54.00	-13.21	1.11 V	211	4.35	36.44

- REMARKS:**
1. Emission level (dBuV/m) = Raw Value (dBuV) + Correction Factor (dB/m).
 2. Correction Factor (dB/m) = Antenna Factor (dB/m) + Cable Factor (dB).
 3. The other emission levels were very low against the limit.
 4. Margin value = Emission level – Limit value.
 5. “ * “: Fundamental frequency.



A D T

EUT TEST CONDITION		MEASUREMENT DETAIL	
CHANNEL	Channel 4	FREQUENCY RANGE	1 ~ 25GHz
INPUT POWER (SYSTEM)	120Vac, 60 Hz	DETECTOR FUNCTION	Peak (PK) Average (AV)
ENVIRONMENTAL CONDITIONS	24deg. C, 64%RH 1002 hPa	TESTED BY	Brad Wu

ANTENNA POLARITY & TEST DISTANCE: HORIZONTAL AT 3 M								
NO.	FREQ. (MHz)	EMISSION LEVEL (dBuV/m)	LIMIT (dBuV/m)	MARGIN (dB)	ANTENNA HEIGHT (m)	TABLE ANGLE (Degree)	RAW VALUE (dBuV)	CORRECTION FACTOR (dB/m)
1	*2437.00	117.36 PK			1.32 H	256	86.55	30.81
2	*2437.00	107.11 AV			1.32 H	256	76.30	30.81
3	4874.00	54.11 PK	74.00	-19.89	1.06 H	124	17.64	36.47
4	4874.00	40.56 AV	54.00	-13.44	1.06 H	124	4.09	36.47
ANTENNA POLARITY & TEST DISTANCE: VERTICAL AT 3 M								
NO.	FREQ. (MHz)	EMISSION LEVEL (dBuV/m)	LIMIT (dBuV/m)	MARGIN (dB)	ANTENNA HEIGHT (m)	TABLE ANGLE (Degree)	RAW VALUE (dBuV)	CORRECTION FACTOR (dB/m)
1	*2437.00	112.55 PK			1.20 V	215	81.74	30.81
2	*2437.00	102.46 AV			1.20 V	215	71.65	30.81
3	4874.00	56.32 PK	74.00	-17.68	1.10 V	214	19.85	36.47
4	4874.00	42.76 AV	54.00	-11.24	1.10 V	214	6.29	36.47

- REMARKS:**
1. Emission level (dBuV/m) = Raw Value (dBuV) + Correction Factor (dB/m).
 2. Correction Factor (dB/m) = Antenna Factor (dB/m) + Cable Factor (dB).
 3. The other emission levels were very low against the limit.
 4. Margin value = Emission level – Limit value.
 5. “ * “: Fundamental frequency.



A D T

EUT TEST CONDITION		MEASUREMENT DETAIL	
CHANNEL	Channel 7	FREQUENCY RANGE	1 ~ 25GHz
INPUT POWER (SYSTEM)	120Vac, 60 Hz	DETECTOR FUNCTION	Peak (PK) Average (AV)
ENVIRONMENTAL CONDITIONS	24deg. C, 64%RH 1002 hPa	TESTED BY	Brad Wu

ANTENNA POLARITY & TEST DISTANCE: HORIZONTAL AT 3 M								
NO.	FREQ. (MHz)	EMISSION LEVEL (dBuV/m)	LIMIT (dBuV/m)	MARGIN (dB)	ANTENNA HEIGHT (m)	TABLE ANGLE (Degree)	RAW VALUE (dBuV)	CORRECTION FACTOR (dB/m)
1	*2452.00	117.04 PK			1.29 H	246	86.18	30.86
2	*2452.00	106.62 AV			1.29 H	246	75.76	30.86
3	2483.50	66.42 PK	74.00	-7.58	1.29 H	246	35.46	30.96
4	2483.50	53.46 AV	54.00	-0.54	1.29 H	246	22.50	30.96
5	4904.00	54.55 PK	74.00	-19.45	1.05 H	107	18.04	36.51
6	4904.00	41.31 AV	54.00	-12.69	1.05 H	107	4.80	36.51
ANTENNA POLARITY & TEST DISTANCE: VERTICAL AT 3 M								
NO.	FREQ. (MHz)	EMISSION LEVEL (dBuV/m)	LIMIT (dBuV/m)	MARGIN (dB)	ANTENNA HEIGHT (m)	TABLE ANGLE (Degree)	RAW VALUE (dBuV)	CORRECTION FACTOR (dB/m)
1	*2452.00	112.32 PK			1.21 V	218	81.46	30.86
2	*2452.00	102.24 AV			1.21 V	218	71.38	30.86
3	2483.50	61.85 PK	74.00	-12.15	1.21 V	218	30.89	30.96
4	2483.50	48.62 AV	54.00	-5.38	1.21 V	218	17.66	30.96
5	4904.00	56.55 PK	74.00	-17.45	1.10 V	216	20.04	36.51
6	4904.00	42.81 AV	54.00	-11.19	1.10 V	216	6.30	36.51

- REMARKS:**
1. Emission level (dBuV/m) = Raw Value (dBuV) + Correction Factor (dB/m).
 2. Correction Factor (dB/m) = Antenna Factor (dB/m) + Cable Factor (dB).
 3. The other emission levels were very low against the limit.
 4. Margin value = Emission level – Limit value.
 5. “ * “: Fundamental frequency.



A D T

BELOW 1GHz WORST-CASE DATA : 802.11b DSSS MODULATION

EUT TEST CONDITION		MEASUREMENT DETAIL	
CHANNEL	Channel 11	FREQUENCY RANGE	Below 1000MHz
INPUT POWER (SYSTEM)	120Vac, 60 Hz	DETECTOR FUNCTION	Quasi-Peak
ENVIRONMENTAL CONDITIONS	24deg. C, 64%RH 1000 hPa	TESTED BY	Brad Wu
TEST MODE	A		

ANTENNA POLARITY & TEST DISTANCE: HORIZONTAL AT 3 M								
NO.	FREQ. (MHz)	EMISSION LEVEL (dBuV/m)	LIMIT (dBuV/m)	MARGIN (dB)	ANTENNA HEIGHT (m)	TABLE ANGLE (Degree)	RAW VALUE (dBuV)	CORRECTION FACTOR (dB/m)
1	72.67	36.16 QP	40.00	-3.84	1.00 H	229	24.29	11.87
2	249.60	44.05 QP	46.00	-1.95	1.00 H	100	30.24	13.80
3	375.98	34.36 QP	46.00	-11.64	1.00 H	277	17.32	17.04
4	681.24	37.99 QP	46.00	-8.01	1.00 H	136	13.42	24.57
5	751.23	39.57 QP	46.00	-6.43	1.00 H	232	14.06	25.51
6	801.78	35.72 QP	46.00	-10.28	1.00 H	196	9.67	26.05
ANTENNA POLARITY & TEST DISTANCE: VERTICAL AT 3 M								
NO.	FREQ. (MHz)	EMISSION LEVEL (dBuV/m)	LIMIT (dBuV/m)	MARGIN (dB)	ANTENNA HEIGHT (m)	TABLE ANGLE (Degree)	RAW VALUE (dBuV)	CORRECTION FACTOR (dB/m)
1	34.62	36.61 QP	40.00	-3.39	1.26 V	140	22.52	14.09
2	70.82	36.58 QP	40.00	-3.42	1.00 V	189	23.74	12.84
3	249.60	38.19 QP	46.00	-7.81	1.50 V	172	24.39	13.80
4	401.26	38.01 QP	46.00	-7.99	1.00 V	10	19.93	18.08
5	500.42	38.83 QP	46.00	-7.17	1.00 V	160	18.40	20.44
6	751.23	42.01 QP	46.00	-3.99	1.00 V	199	16.50	25.51

- REMARKS:**
1. Emission level (dBuV/m) = Raw Value (dBuV) + Correction Factor (dB/m).
 2. Correction Factor (dB/m) = Antenna Factor (dB/m) + Cable Factor (dB).
 3. The other emission levels were very low against the limit.
 4. Margin value = Emission level – Limit value.



A D T

EUT TEST CONDITION		MEASUREMENT DETAIL	
CHANNEL	Channel 11	FREQUENCY RANGE	Below 1000MHz
INPUT POWER (SYSTEM)	120Vac, 60 Hz	DETECTOR FUNCTION	Quasi-Peak
ENVIRONMENTAL CONDITIONS	24deg. C, 64%RH 1000 hPa	TESTED BY	Mark Liao
TEST MODE	B		

ANTENNA POLARITY & TEST DISTANCE: HORIZONTAL AT 3 M								
NO.	FREQ. (MHz)	EMISSION LEVEL (dBuV/m)	LIMIT (dBuV/m)	MARGIN (dB)	ANTENNA HEIGHT (m)	TABLE ANGLE (Degree)	RAW VALUE (dBuV)	CORRECTION FACTOR (dB/m)
1	86.28	30.55 QP	40.00	-9.45	1.50 H	64	22.60	7.95
2	250.00	44.97 QP	46.00	-1.03	1.09 H	236	31.14	13.83
3	360.43	30.89 QP	46.00	-15.11	1.00 H	229	14.50	16.38
4	500.42	33.84 QP	46.00	-12.16	1.50 H	238	13.40	20.44
5	681.24	38.03 QP	46.00	-7.97	1.00 H	55	13.46	24.57
6	751.23	38.44 QP	46.00	-7.56	1.25 H	220	12.93	25.51
ANTENNA POLARITY & TEST DISTANCE: VERTICAL AT 3 M								
NO.	FREQ. (MHz)	EMISSION LEVEL (dBuV/m)	LIMIT (dBuV/m)	MARGIN (dB)	ANTENNA HEIGHT (m)	TABLE ANGLE (Degree)	RAW VALUE (dBuV)	CORRECTION FACTOR (dB/m)
1	51.29	37.21 QP	40.00	-2.79	1.00 V	10	24.05	13.16
2	92.12	33.61 QP	43.50	-9.89	1.50 V	148	24.93	8.68
3	249.60	42.01 QP	46.00	-3.99	1.00 V	295	28.20	13.80
4	500.42	30.56 QP	46.00	-15.44	1.00 V	196	10.13	20.44
5	681.24	34.64 QP	46.00	-11.36	1.00 V	220	10.07	24.57
6	751.23	37.61 QP	46.00	-8.39	1.00 V	286	12.10	25.51

- REMARKS:**
1. Emission level (dBuV/m) = Raw Value (dBuV) + Correction Factor (dB/m).
 2. Correction Factor (dB/m) = Antenna Factor (dB/m) + Cable Factor (dB).
 3. The other emission levels were very low against the limit.
 4. Margin value = Emission level – Limit value.



ADT

4.2 CONDUCTED EMISSION MEASUREMENT

4.2.1 LIMITS OF CONDUCTED EMISSION MEASUREMENT

FREQUENCY OF EMISSION (MHz)	CONDUCTED LIMIT (dB μ V)	
	Quasi-peak	Average
0.15 ~ 0.5	66 to 56	56 to 46
0.5 ~ 5	56	46
5 ~ 30	60	50

- NOTE:** 1. The lower limit shall apply at the transition frequencies.
2. The limit decreases in line with the logarithm of the frequency in the range of 0.15 to 0.50MHz.
3. All emanations from a class A/B digital device or system, including any network of conductors and apparatus connected thereto, shall not exceed the level of field strengths specified above.

4.2.2 TEST INSTRUMENTS

DESCRIPTION & MANUFACTURER	MODEL NO.	SERIAL NO.	DATE OF CALIBRATION	DUE DATE OF CALIBRATION
Test Receiver ROHDE & SCHWARZ	ESCS30	100288	Sep. 22, 2008	Sep. 21, 2009
RF signal cable Woken	5D-FB	Cable-HYCO2-01	Dec. 31, 2008	Dec. 30, 2009
LISN ROHDE & SCHWARZ	ESH2-Z5	100100	Dec. 29, 2008	Dec. 28, 2009
LISN ROHDE & SCHWARZ	ESH3-Z5	100311	Jul. 29, 2008	Jul. 28, 2009
Software ADT	ADT_Cond_ V7.3.7	NA	NA	NA

- NOTE:** 1. The calibration interval of the above test instruments is 12 months and the calibrations are traceable to NML/ROC and NIST/USA.
2. The test was performed in HwaYa Shielded Room 2.
3. The VCCI Site Registration No. is C-2047.



A D T

4.2.3 TEST PROCEDURES

- a. The EUT was placed 0.4 meters from the conducting wall of the shielded room with EUT being connected to the power mains through a line impedance stabilization network (LISN). Other support units were connected to the power mains through another LISN. The two LISNs provide 50 ohm/ 50uH of coupling impedance for the measuring instrument.
- b. Both lines of the power mains connected to the EUT were checked for maximum conducted interference.
- c. The frequency range from 150kHz to 30MHz was searched. Emission levels under (Limit - 20dB) was not recorded.

NOTE: All modes of operation were investigated and the worst-case emissions are reported.

4.2.4 DEVIATION FROM TEST STANDARD

No deviation.

4.2.5 TEST SETUP

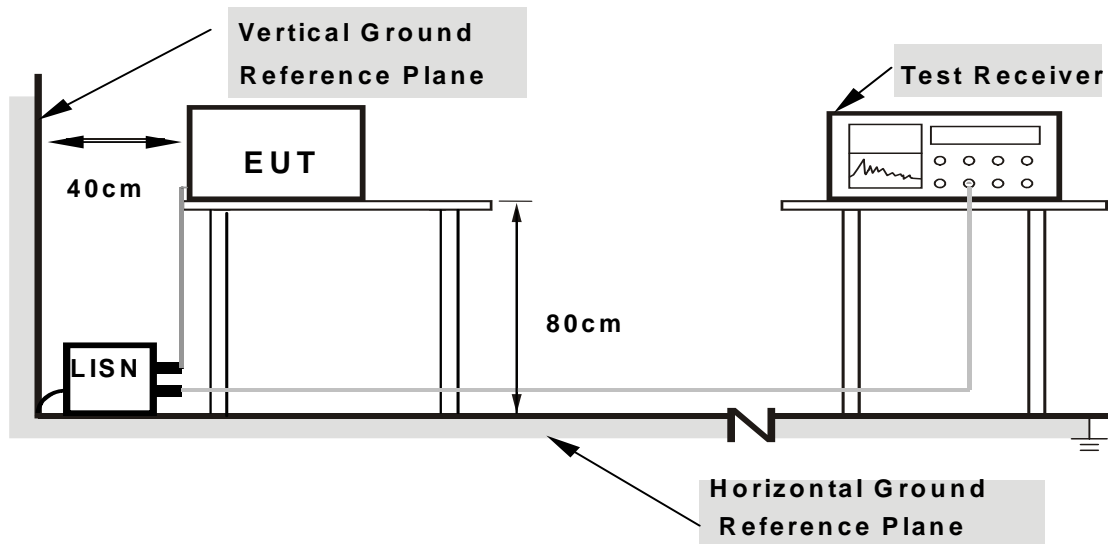

- Note:**
1. Support units were connected to second LISN.
 2. Both of LISNs (AMN) are 80 cm from EUT and at least 80 from other units and other metal planes

For the actual test configuration, please refer to the attached file (Test Setup Photo).

4.2.6 EUT OPERATING CONDITIONS

Same as 4.1.6.



4.2.7 TEST RESULTS

CONDUCTED WORST-CASE DATA : 802.11b DSSS MODULATION

EUT TEST CONDITION		MEASUREMENT DETAIL	
CHANNEL	Channel 11	PHASE	Line 1
MODULATION TYPE	DBPSK	INPUT POWER	120Vac, 60Hz
TRANSFER RATE	1.0Mbps	6dB BANDWIDTH	9kHz
ENVIRONMENTAL CONDITIONS	25deg. C, 77%RH, 1021hPa	TEST MODE	A
TESTED BY	Scott Yang		

No	Freq. [MHz]	Corr. Factor (dB)	Reading Value		Emission Level		Limit		Margin	
			[dB (uV)]		[dB (uV)]		[dB (uV)]		(dB)	
			Q.P.	AV.	Q.P.	AV.	Q.P.	AV.	Q.P.	AV.
1	0.209	0.13	47.85	-	47.98	-	63.26	53.26	-15.28	-
2	0.279	0.13	49.21	-	49.34	-	60.85	50.85	-11.50	-
3	0.338	0.14	56.31	45.60	56.45	45.74	59.26	49.26	-2.82	-3.53
4	0.416	0.14	54.69	42.91	54.83	43.05	57.54	47.54	-2.70	-4.48
5	0.416	0.14	54.75	42.93	54.89	43.07	57.54	47.54	-2.64	-4.46
6	0.435	0.14	52.41	36.30	52.55	36.44	57.15	47.15	-4.60	-10.71
7	0.552	0.15	54.42	41.45	54.57	41.60	56.00	46.00	-1.43	-4.40
8	0.759	0.16	54.00	41.17	54.16	41.33	56.00	46.00	-1.84	-4.67
9	0.943	0.17	54.89	39.33	55.06	39.50	56.00	46.00	-0.94	-6.50
10	1.086	0.17	53.54	37.21	53.71	37.38	56.00	46.00	-2.29	-8.62
11	1.254	0.18	54.55	39.55	54.73	39.73	56.00	46.00	-1.27	-6.27
12	1.414	0.18	53.51	36.35	53.69	36.53	56.00	46.00	-2.31	-9.47
13	1.453	0.18	53.29	38.97	53.47	39.15	56.00	46.00	-2.53	-6.85
14	1.551	0.18	51.64	34.62	51.82	34.80	56.00	46.00	-4.18	-11.20
15	1.711	0.18	52.31	36.99	52.49	37.17	56.00	46.00	-3.51	-8.83
16	2.129	0.20	50.66	35.90	50.86	36.10	56.00	46.00	-5.14	-9.90
17	2.637	0.22	48.27	33.74	48.49	33.96	56.00	46.00	-7.51	-12.04
18	3.063	0.24	45.10	-	45.34	-	56.00	46.00	-10.66	-
19	3.344	0.25	44.31	-	44.56	-	56.00	46.00	-11.44	-

- REMARKS:**
1. Q.P. and AV. are abbreviations of quasi-peak and average individually.
 2. "-": The Quasi-peak reading value also meets average limit and measurement with the average detector is unnecessary.
 3. The emission levels of other frequencies were very low against the limit.
 4. Margin value = Emission level - Limit value
 5. Correction factor = Insertion loss + Cable loss
 6. Emission Level = Correction Factor + Reading Value.

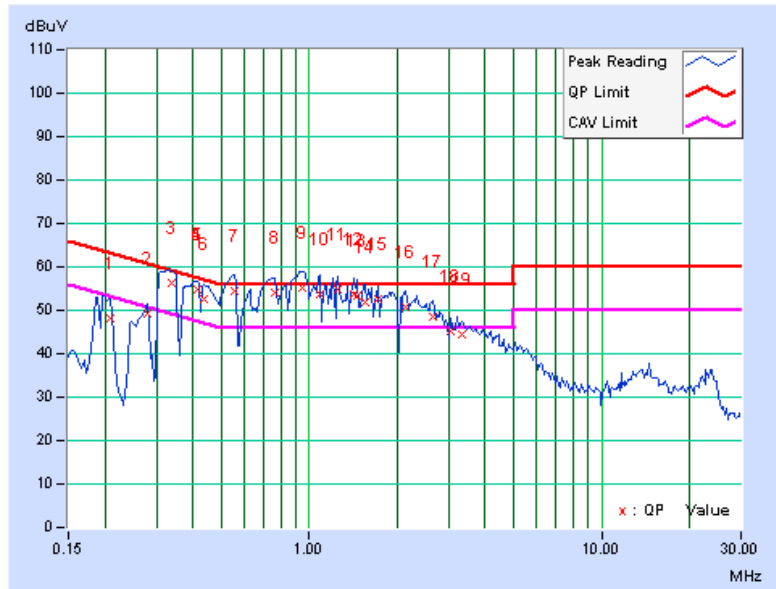



A D T

EUT TEST CONDITION		MEASUREMENT DETAIL	
CHANNEL	Channel 11	PHASE	Line 2
MODULATION TYPE	DBPSK	INPUT POWER	120Vac, 60Hz
TRANSFER RATE	1.0Mbps	6dB BANDWIDTH	9kHz
ENVIRONMENTAL CONDITIONS	25deg. C, 77%RH, 1021hPa	TEST MODE	A
TESTED BY	Scott Yang		

No	Freq. [MHz]	Corr. Factor (dB)	Reading Value		Emission Level		Limit		Margin	
			[dB (uV)]		[dB (uV)]		[dB (uV)]		(dB)	
			Q.P.	AV.	Q.P.	AV.	Q.P.	AV.	Q.P.	AV.
1	0.206	0.13	47.53	-	47.66	-	63.36	53.36	-15.70	-
2	0.275	0.14	48.47	-	48.61	-	60.97	50.97	-12.36	-
3	0.338	0.14	55.79	45.14	55.93	45.28	59.26	49.26	-3.33	-3.98
4	0.416	0.15	54.35	42.79	54.50	42.94	57.54	47.54	-3.03	-4.59
5	0.439	0.15	51.80	36.62	51.95	36.77	57.08	47.08	-5.13	-10.31
6	0.541	0.15	53.83	38.81	53.98	38.96	56.00	46.00	-2.02	-7.04
7	0.627	0.16	52.07	38.81	52.23	38.97	56.00	46.00	-3.77	-7.03
8	0.732	0.16	52.89	35.66	53.05	35.82	56.00	46.00	-2.95	-10.18
9	0.822	0.16	51.58	36.08	51.74	36.24	56.00	46.00	-4.26	-9.76
10	0.939	0.17	54.36	38.81	54.53	38.98	56.00	46.00	-1.47	-7.02
11	1.059	0.17	52.96	36.17	53.13	36.34	56.00	46.00	-2.87	-9.66
12	1.219	0.18	53.22	35.44	53.40	35.62	56.00	46.00	-2.60	-10.38
13	1.398	0.18	52.92	34.87	53.10	35.05	56.00	46.00	-2.90	-10.95
14	1.551	0.19	51.22	33.95	51.41	34.14	56.00	46.00	-4.59	-11.86
15	1.742	0.19	52.77	37.76	52.96	37.95	56.00	46.00	-3.04	-8.05
16	1.938	0.20	51.01	36.66	51.21	36.86	56.00	46.00	-4.79	-9.14
17	2.359	0.22	47.78	35.02	48.00	35.24	56.00	46.00	-8.00	-10.76
18	2.617	0.23	46.98	32.28	47.21	32.51	56.00	46.00	-8.79	-13.49
19	2.805	0.24	45.21	-	45.45	-	56.00	46.00	-10.55	-
20	3.316	0.27	42.57	-	42.84	-	56.00	46.00	-13.16	-

- REMARKS:**
1. Q.P. and AV. are abbreviations of quasi-peak and average individually.
 2. "-": The Quasi-peak reading value also meets average limit and measurement with the average detector is unnecessary.
 3. The emission levels of other frequencies were very low against the limit.
 4. Margin value = Emission level - Limit value
 5. Correction factor = Insertion loss + Cable loss
 6. Emission Level = Correction Factor + Reading Value.



A D T

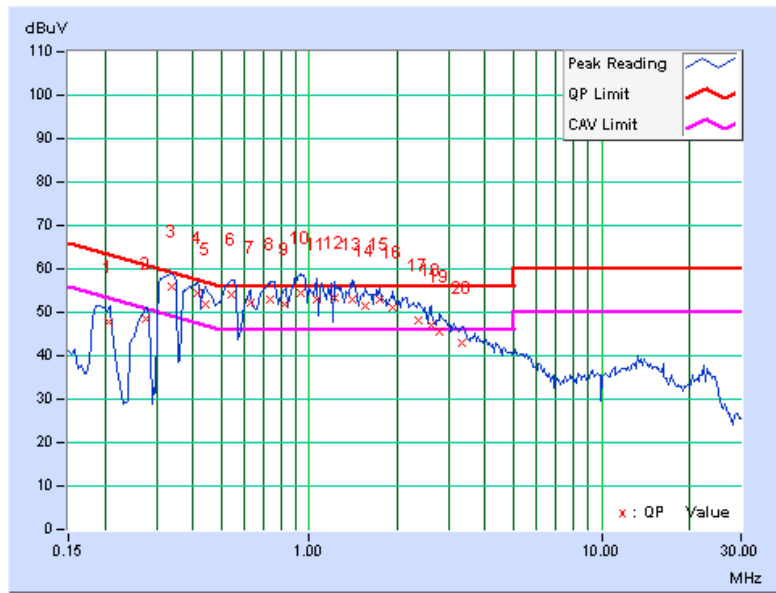



A D T

EUT TEST CONDITION		MEASUREMENT DETAIL	
CHANNEL	Channel 11	PHASE	Line 1
MODULATION TYPE	DBPSK	INPUT POWER	120Vac, 60Hz
TRANSFER RATE	1.0Mbps	6dB BANDWIDTH	9kHz
ENVIRONMENTAL CONDITIONS	25deg. C, 77%RH, 1021hPa	TEST MODE	B
TESTED BY	Scott Yang		

No	Freq. [MHz]	Corr. Factor (dB)	Reading Value		Emission Level		Limit		Margin	
			[dB (uV)]		[dB (uV)]		[dB (uV)]		(dB)	
			Q.P.	AV.	Q.P.	AV.	Q.P.	AV.	Q.P.	AV.
1	0.150	0.13	48.33	-	48.46	-	66.00	56.00	-17.54	-
2	0.170	0.13	44.87	-	45.00	-	64.98	54.98	-19.98	-
3	0.291	0.13	40.17	-	40.30	-	60.51	50.51	-20.20	-
4	0.416	0.14	40.49	-	40.63	-	57.54	47.54	-16.90	-
5	0.447	0.14	40.32	-	40.46	-	56.93	46.93	-16.47	-
6	13.641	0.52	29.69	-	30.21	-	60.00	50.00	-29.79	-

- REMARKS:**
1. Q.P. and AV. are abbreviations of quasi-peak and average individually.
 2. "-": The Quasi-peak reading value also meets average limit and measurement with the average detector is unnecessary.
 3. The emission levels of other frequencies were very low against the limit.
 4. Margin value = Emission level - Limit value
 5. Correction factor = Insertion loss + Cable loss
 6. Emission Level = Correction Factor + Reading Value.

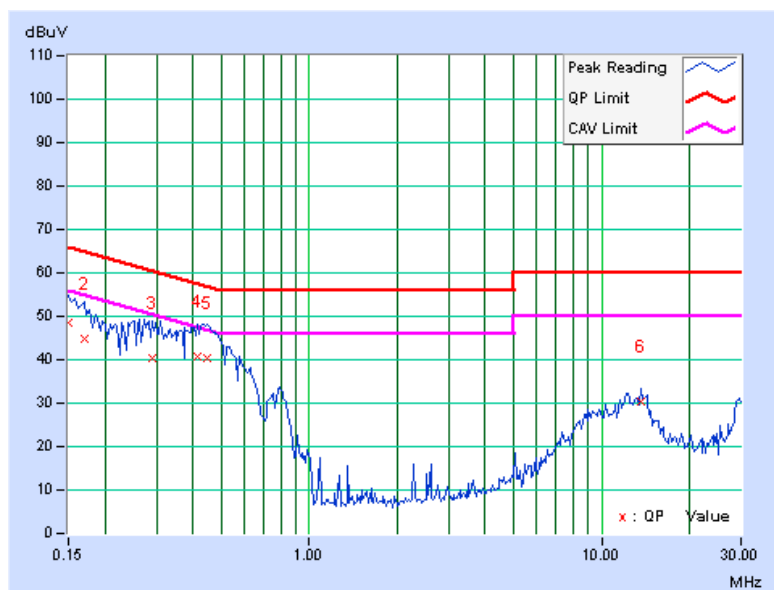

EUT TEST CONDITION		MEASUREMENT DETAIL	
CHANNEL	Channel 11	PHASE	Line 2
MODULATION TYPE	DBPSK	INPUT POWER	120Vac, 60Hz
TRANSFER RATE	1.0Mbps	6dB BANDWIDTH	9kHz
ENVIRONMENTAL CONDITIONS	25deg. C, 77%RH, 1021hPa	TEST MODE	B
TESTED BY	Scott Yang		

No	Freq. [MHz]	Corr. Factor (dB)	Reading Value		Emission Level		Limit		Margin	
			[dB (uV)]		[dB (uV)]		[dB (uV)]		(dB)	
			Q.P.	AV.	Q.P.	AV.	Q.P.	AV.	Q.P.	AV.
1	0.150	0.13	48.85	-	48.98	-	66.00	56.00	-17.02	-
2	0.162	0.13	46.64	-	46.77	-	65.38	55.38	-18.61	-
3	0.236	0.13	39.54	-	39.67	-	62.24	52.24	-22.56	-
4	0.420	0.15	39.84	-	39.99	-	57.46	47.46	-17.47	-
5	0.451	0.15	38.77	-	38.92	-	56.86	46.86	-17.94	-
6	13.059	0.60	30.09	-	30.69	-	60.00	50.00	-29.31	-

- REMARKS:**
1. Q.P. and AV. are abbreviations of quasi-peak and average individually.
 2. "-": The Quasi-peak reading value also meets average limit and measurement with the average detector is unnecessary.
 3. The emission levels of other frequencies were very low against the limit.
 4. Margin value = Emission level - Limit value
 5. Correction factor = Insertion loss + Cable loss
 6. Emission Level = Correction Factor + Reading Value.

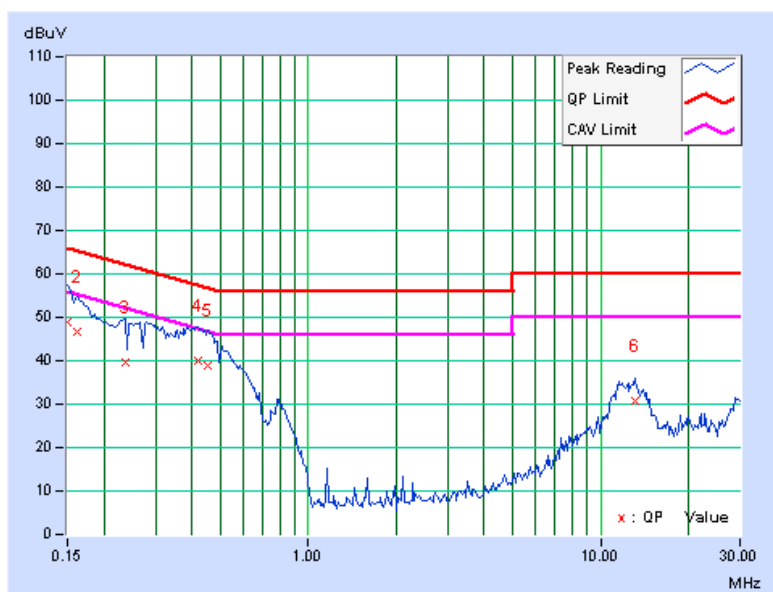



A D T

4.3 6dB BANDWIDTH MEASUREMENT

4.3.1 LIMITS OF 6dB BANDWIDTH MEASUREMENT

The minimum of 6dB Bandwidth Measurement is 0.5 MHz.

4.3.2 TEST INSTRUMENTS

DESCRIPTION & MANUFACTURER	MODEL NO.	SERIAL NO.	DATE OF CALIBRATION	DUE DATE OF CALIBRATION
R&S SPECTRUM ANALYZER	FSP40	100041	May 13, 2009	May 12, 2010

NOTE: The calibration interval of the above test instruments is 12 months and the calibrations are traceable to NML/ROC and NIST/USA.

4.3.3 TEST PROCEDURE

The transmitter output was connected to the spectrum analyzer through an attenuator. The bandwidth of the fundamental frequency was measured by spectrum analyzer with 100kHz RBW and 300kHz VBW. The 6dB bandwidth is defined as the total spectrum the power of which is higher than peak power minus 6dB.

4.3.4 DEVIATION FROM TEST STANDARD

No deviation.

4.3.5 TEST SETUP



4.3.6 EUT OPERATING CONDITIONS

The software provided by client to enable the EUT under transmission condition continuously at lowest, middle and highest channel frequencies individually.



A D T

4.3.7 TEST RESULTS

802.11b DSSS MODULATION

MODULATION TYPE	DBPSK	TRANSFER RATE	1.0Mbps
INPUT POWER	120Vac, 60Hz	ENVIRONMENTAL CONDITIONS	25deg.C, 65%RH, 1021hPa
TESTED BY	Brad		

CHANNEL	CHANNEL FREQUENCY (MHz)	6dB BANDWIDTH (MHz)			MINIMUM LIMIT (MHz)	PASS / FAIL
		CHAIN 0	CHAIN 1	CHAIN 2		
1	2412	10.13	11.13	11.12	0.5	PASS
6	2437	10.13	10.13	11.14	0.5	PASS
11	2462	12.08	12.11	12.58	0.5	PASS

FOR CHAIN 0: CH 1

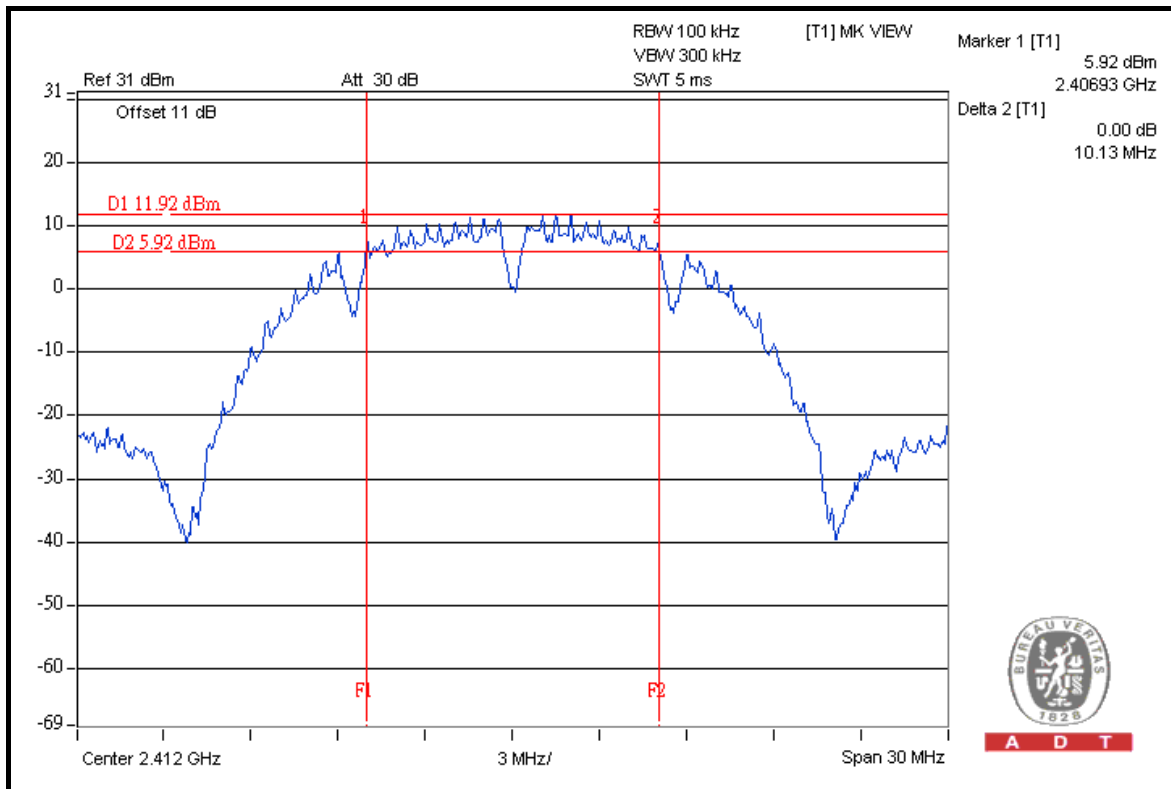



A D T

CH 6

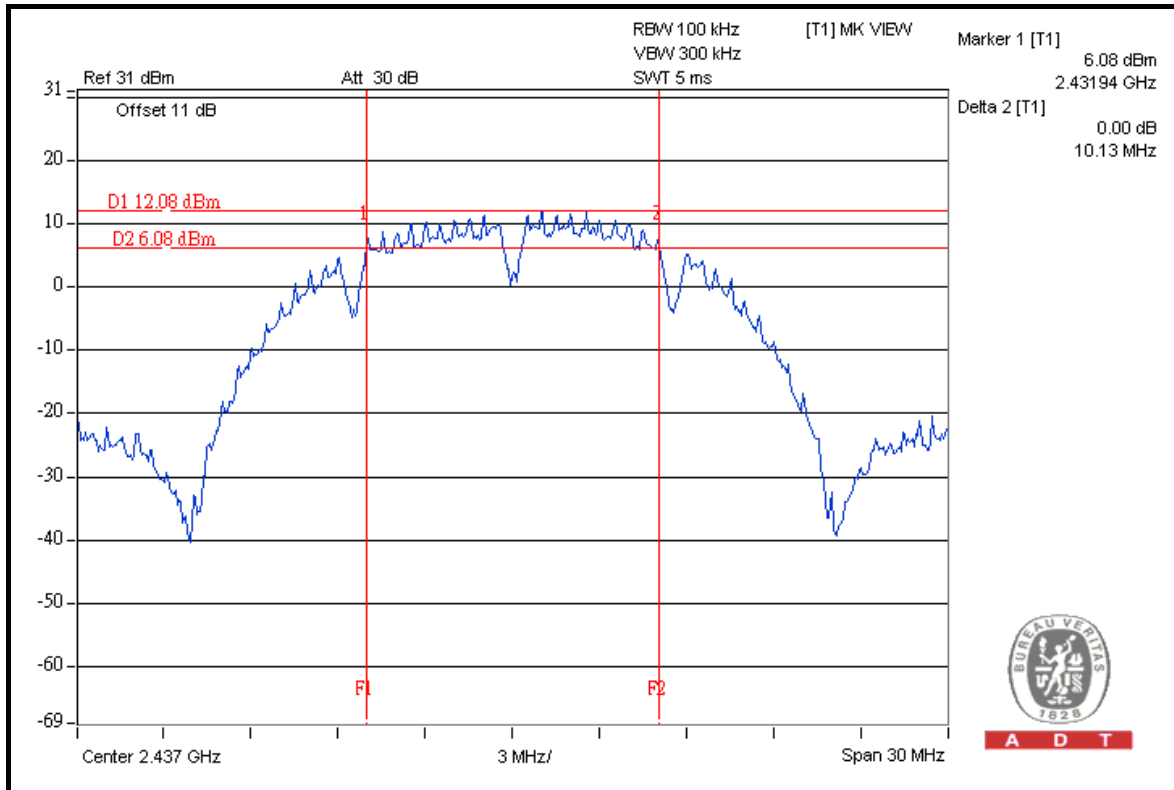

CH 11

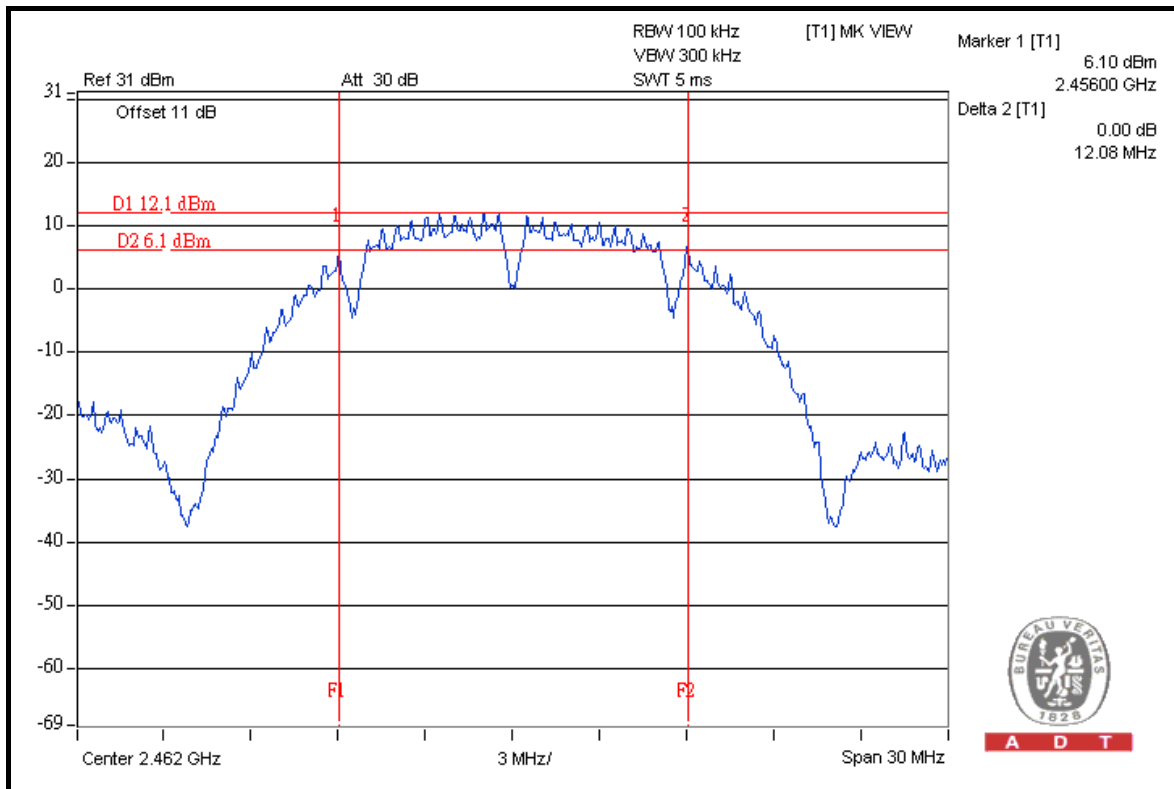



A D T

FOR CHAIN 1: CH 1

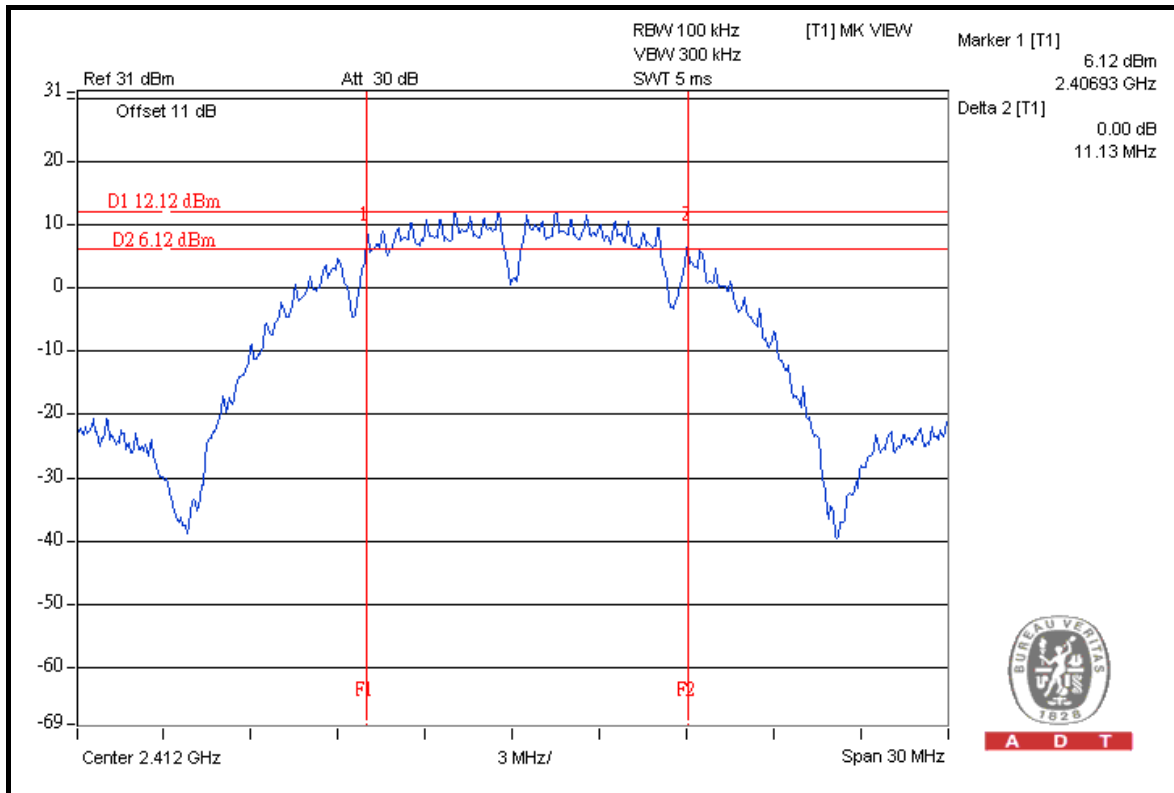

CH 6

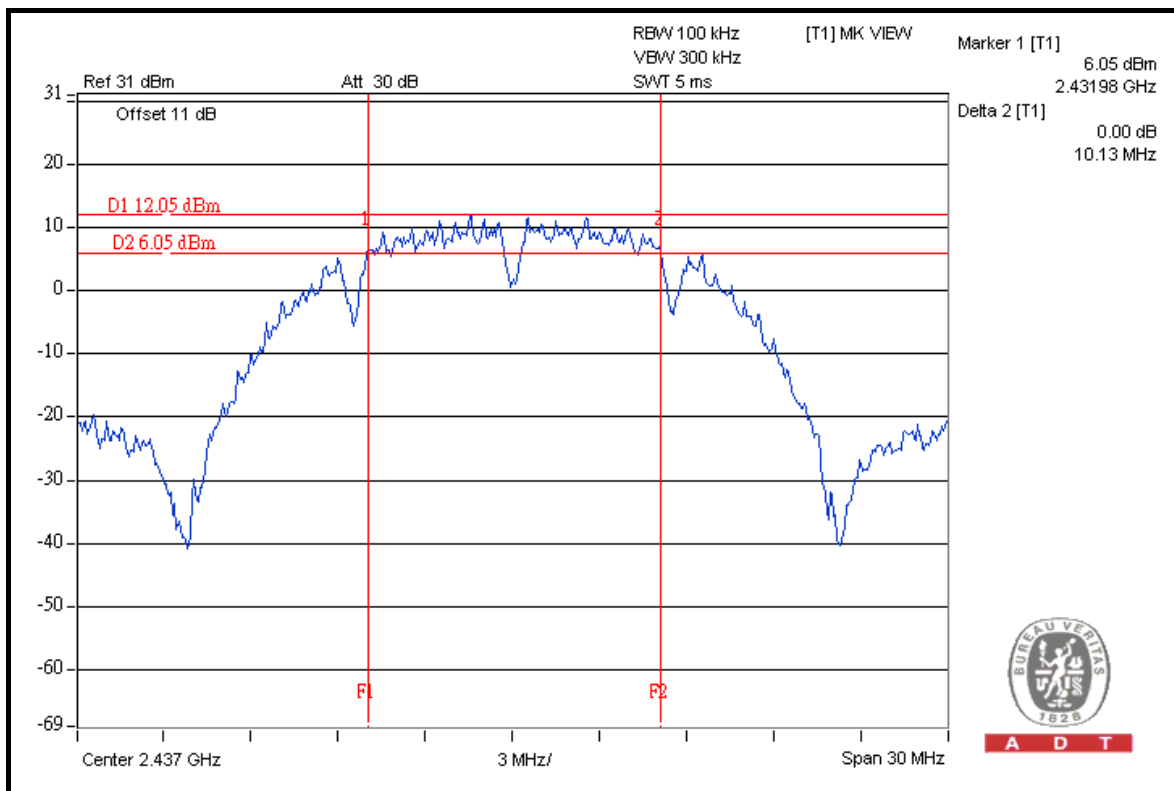



A D T

CH 11

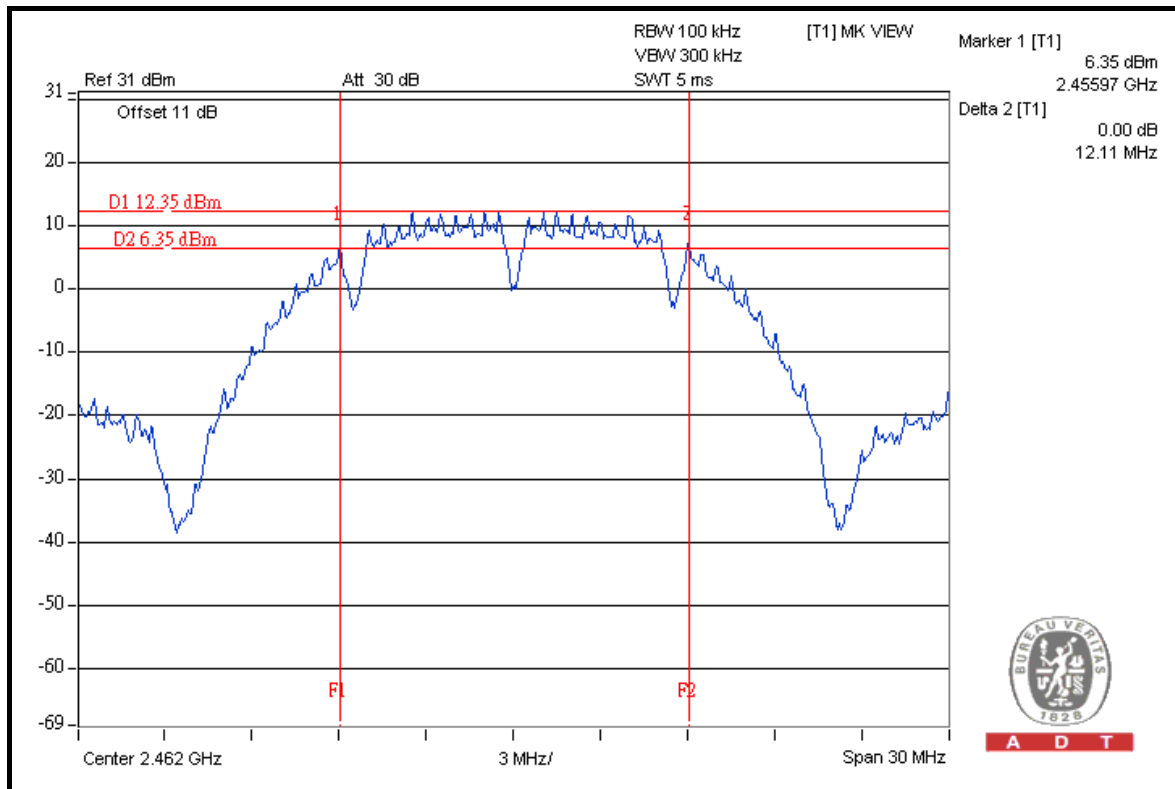

FOR CHAIN 2: CH 1

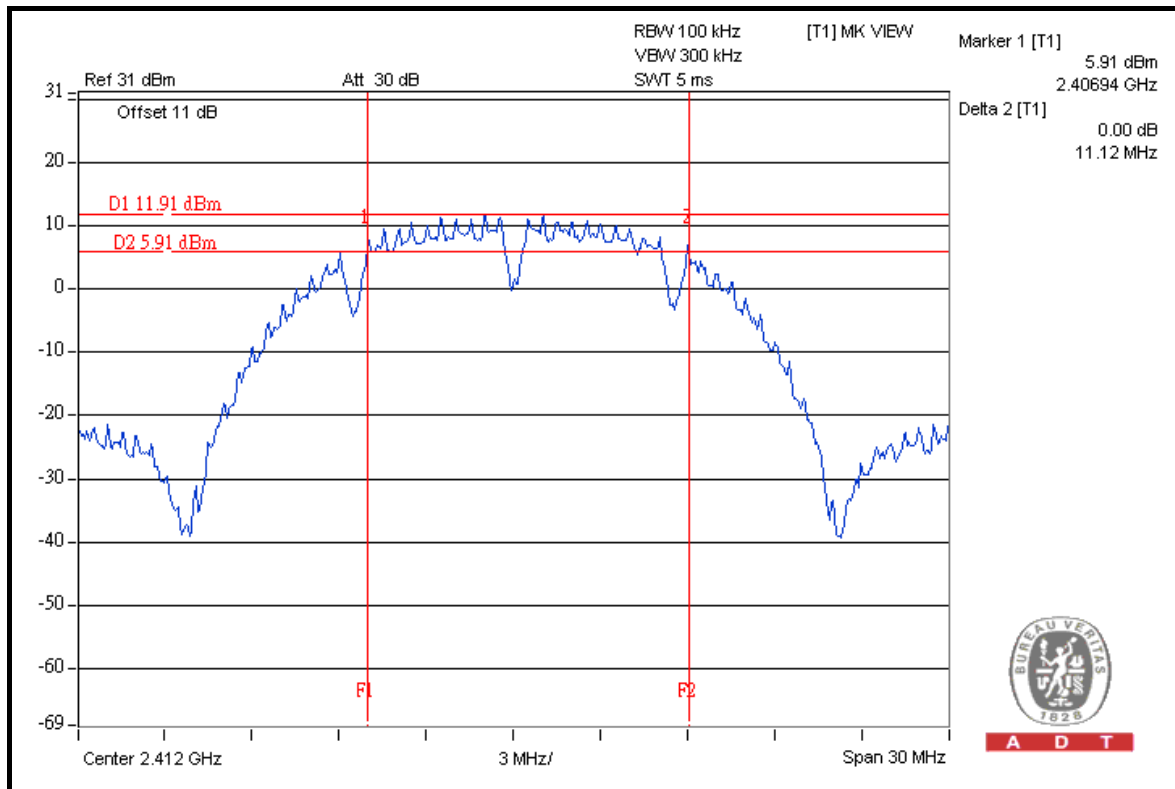



A D T

CH 6

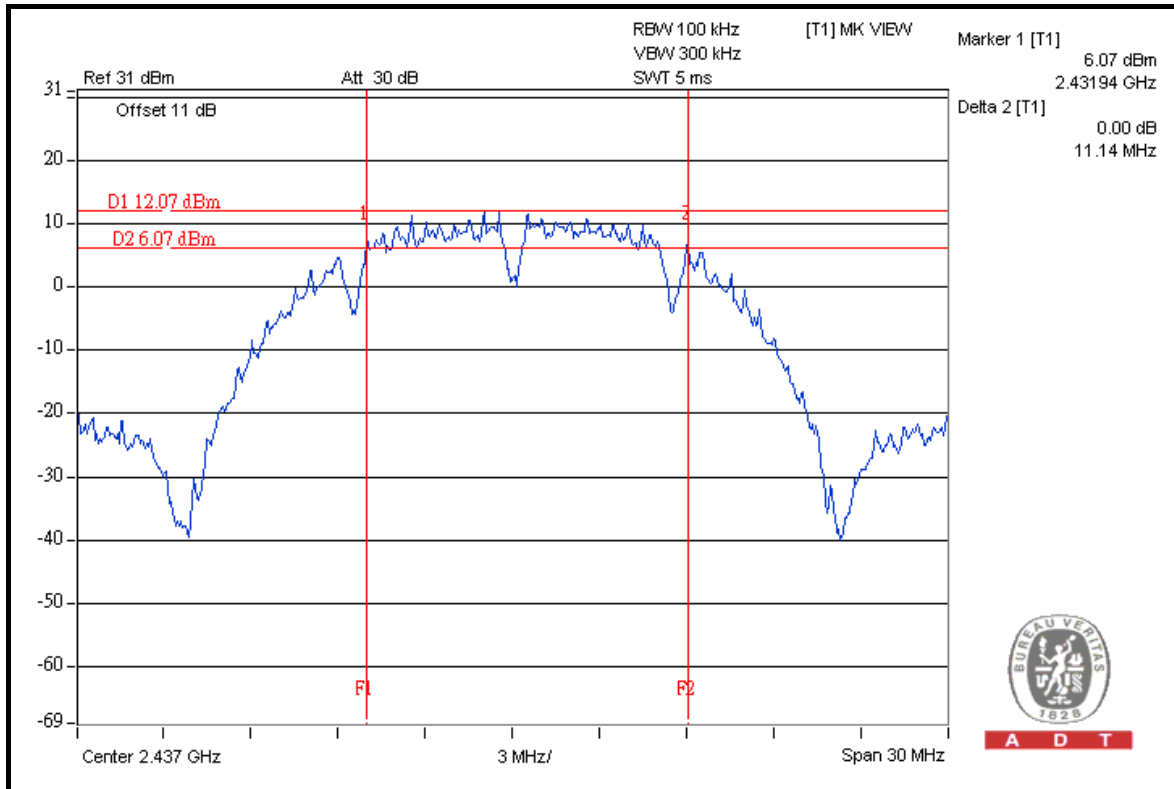

CH 11

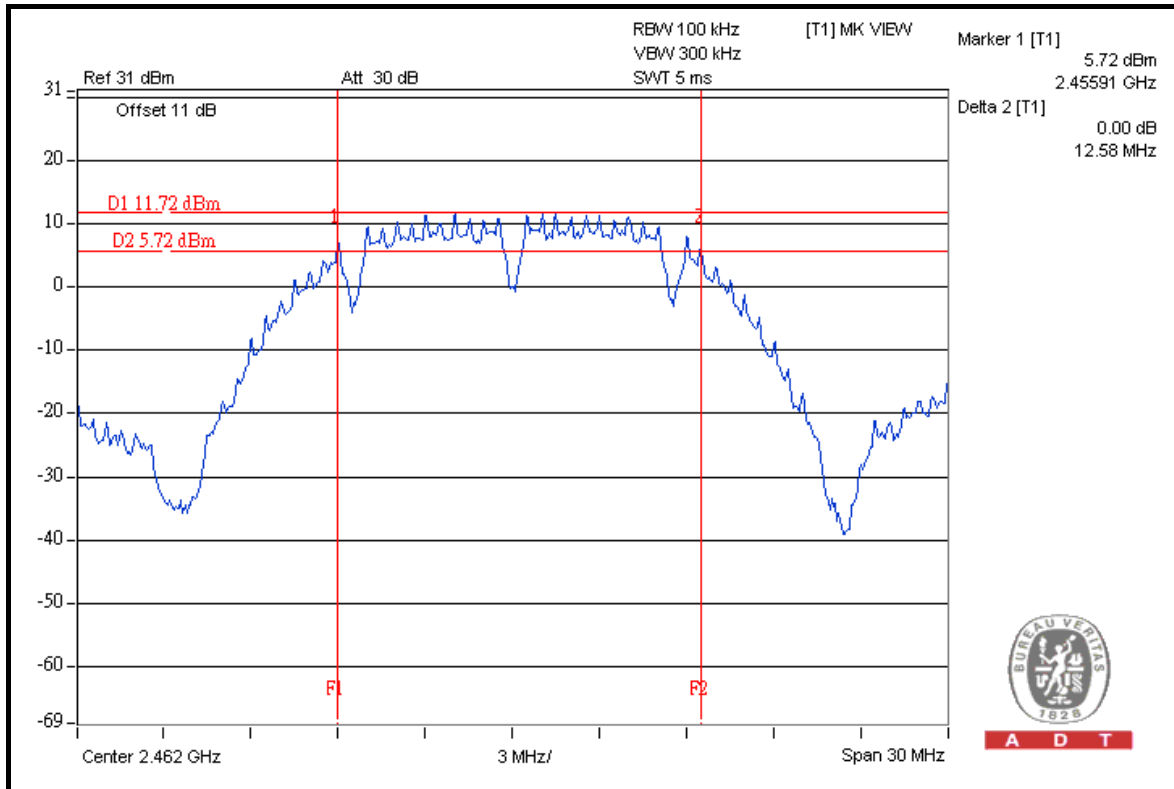



A D T

802.11g OFDM MODULATION

MODULATION TYPE	BPSK	TRANSFER RATE	6.0Mbps
INPUT POWER	120Vac, 60Hz	ENVIRONMENTAL CONDITIONS	25deg.C, 65%RH, 1021hPa
TESTED BY	Brad Wu		

CHANNEL	CHANNEL FREQUENCY (MHz)	6dB BANDWIDTH (MHz)			MINIMUM LIMIT (MHz)	PASS / FAIL
		CHAIN 0	CHAIN 1	CHAIN 2		
1	2412	16.35	16.35	16.39	0.5	PASS
6	2437	16.37	16.36	16.37	0.5	PASS
11	2462	16.37	16.40	16.37	0.5	PASS

FOR CHAIN 0: CH 1

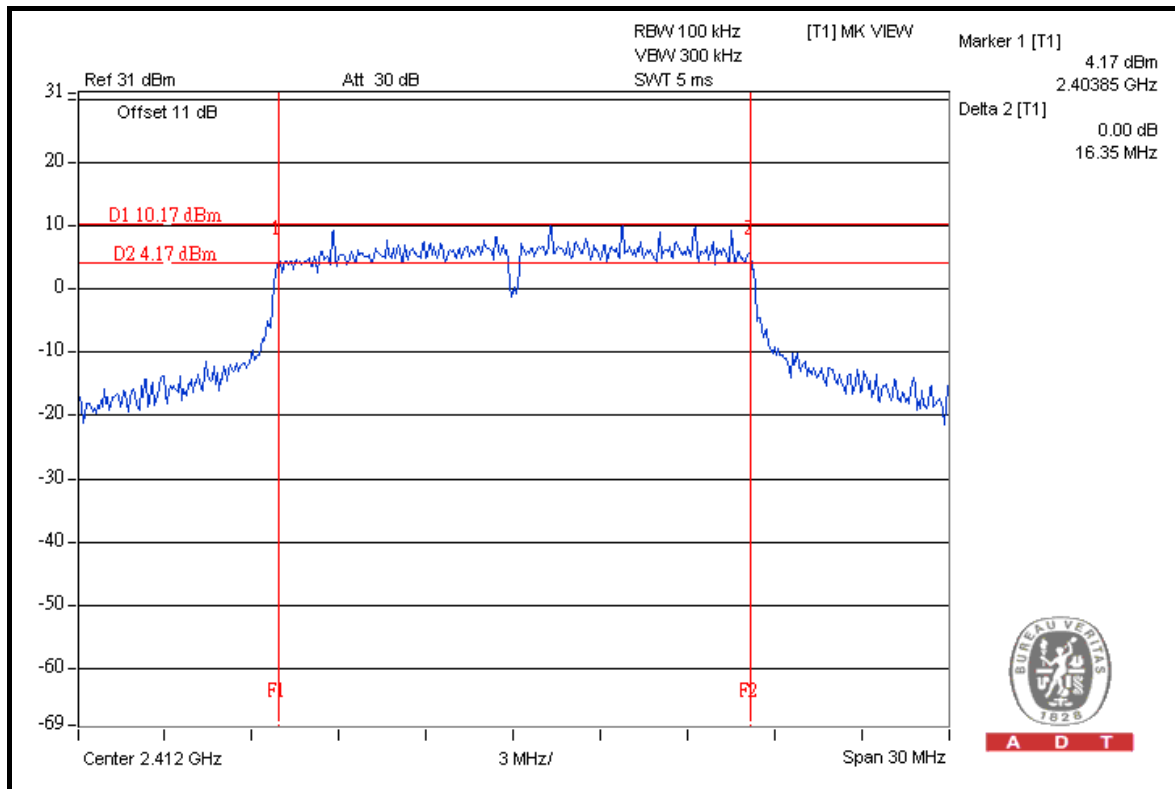



A D T

CH 6

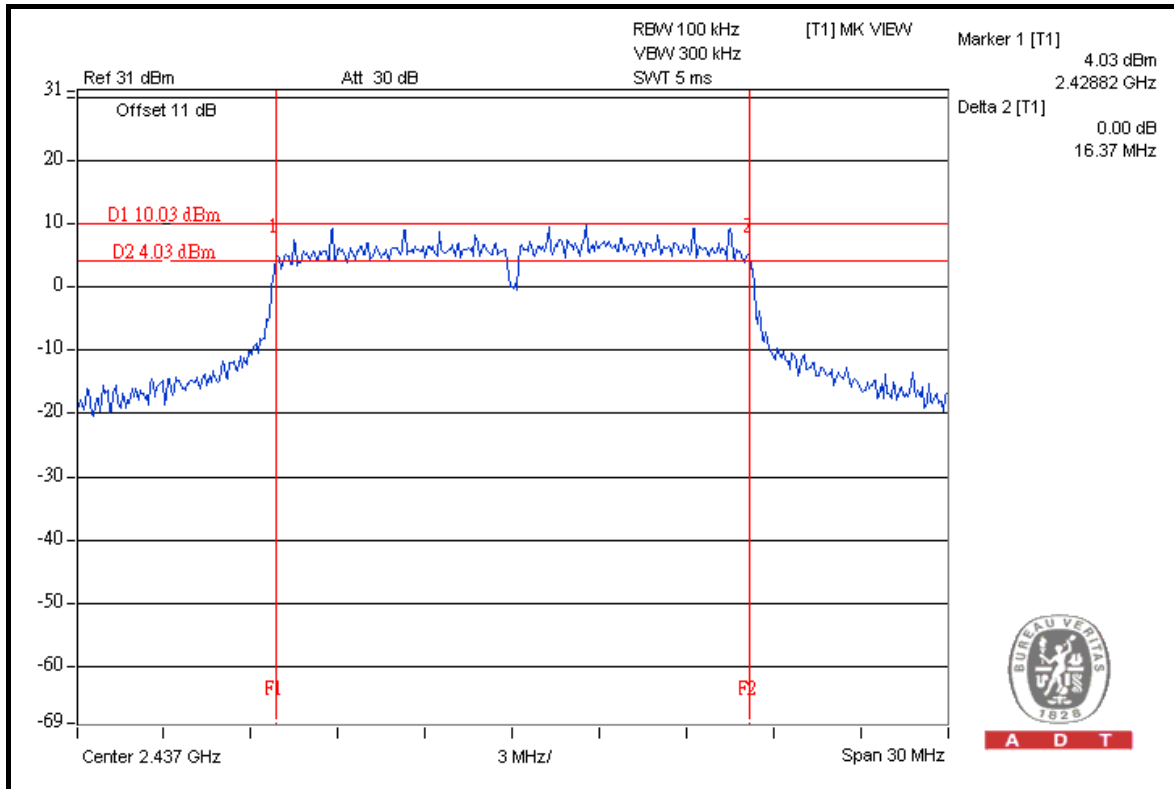

CH 11

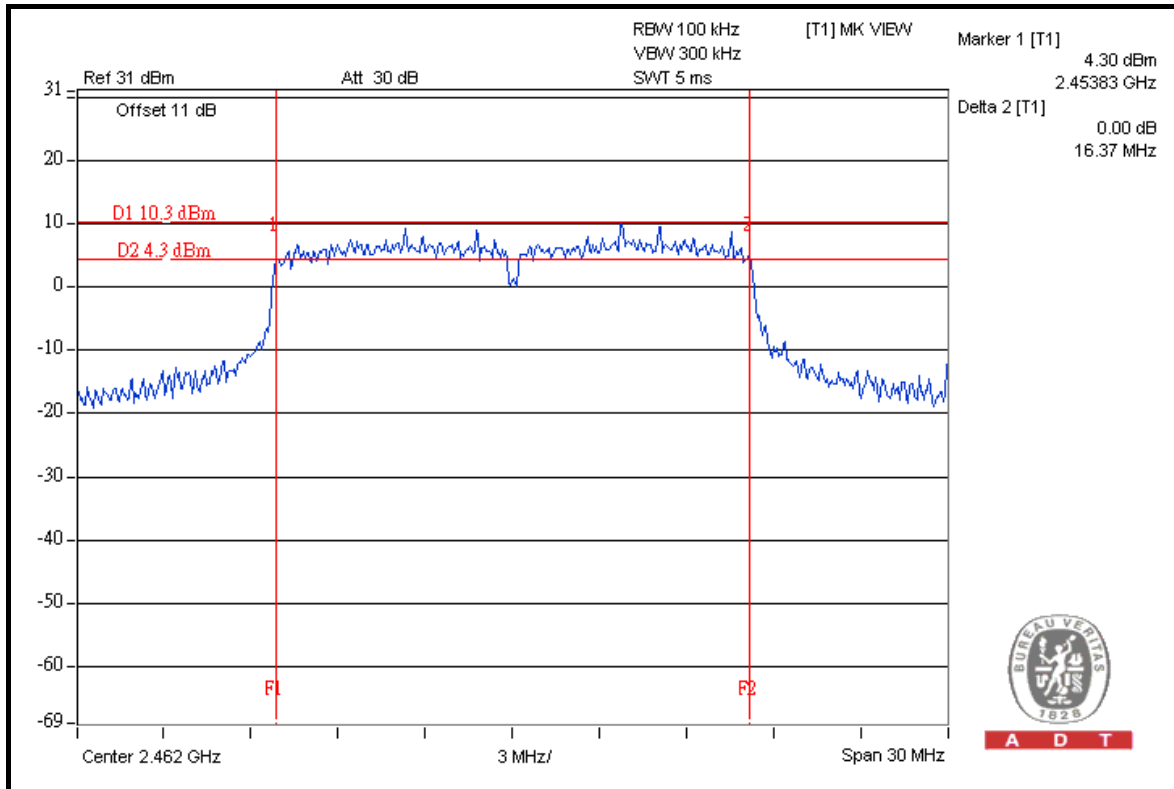



A D T

FOR CHAIN 1: CH 1

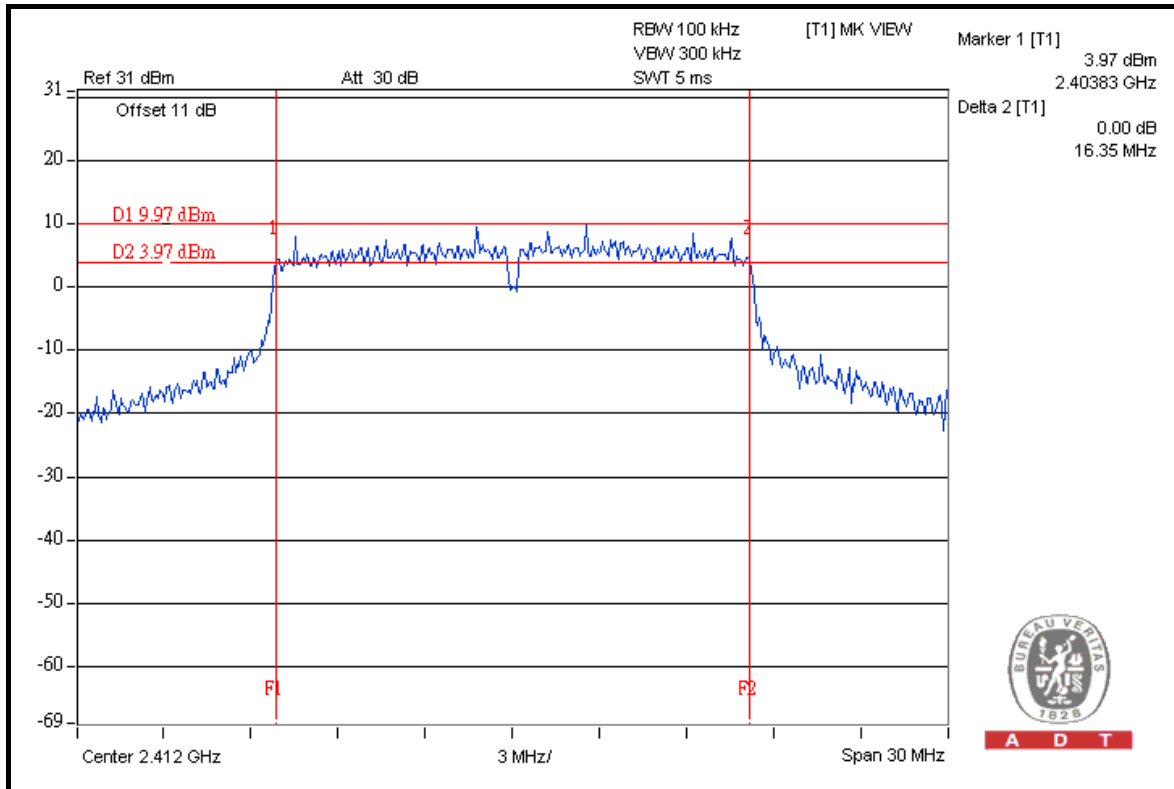

CH 6

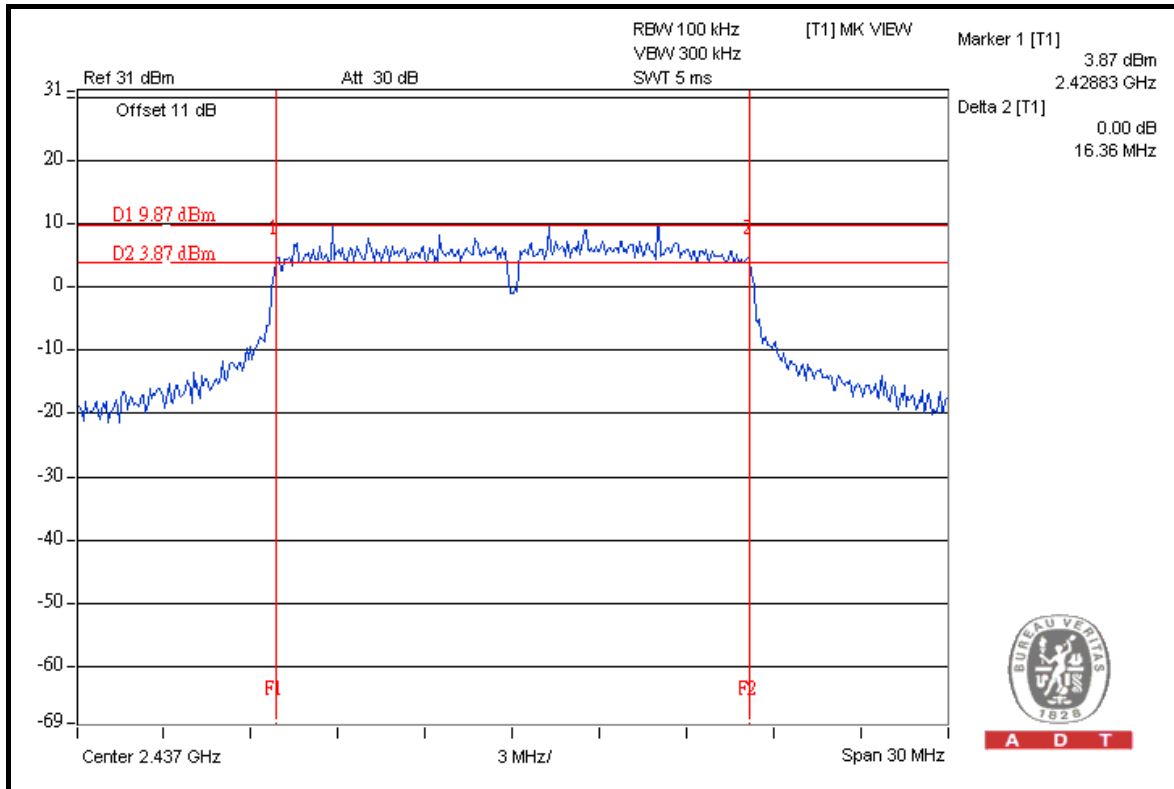



A D T

CH 11

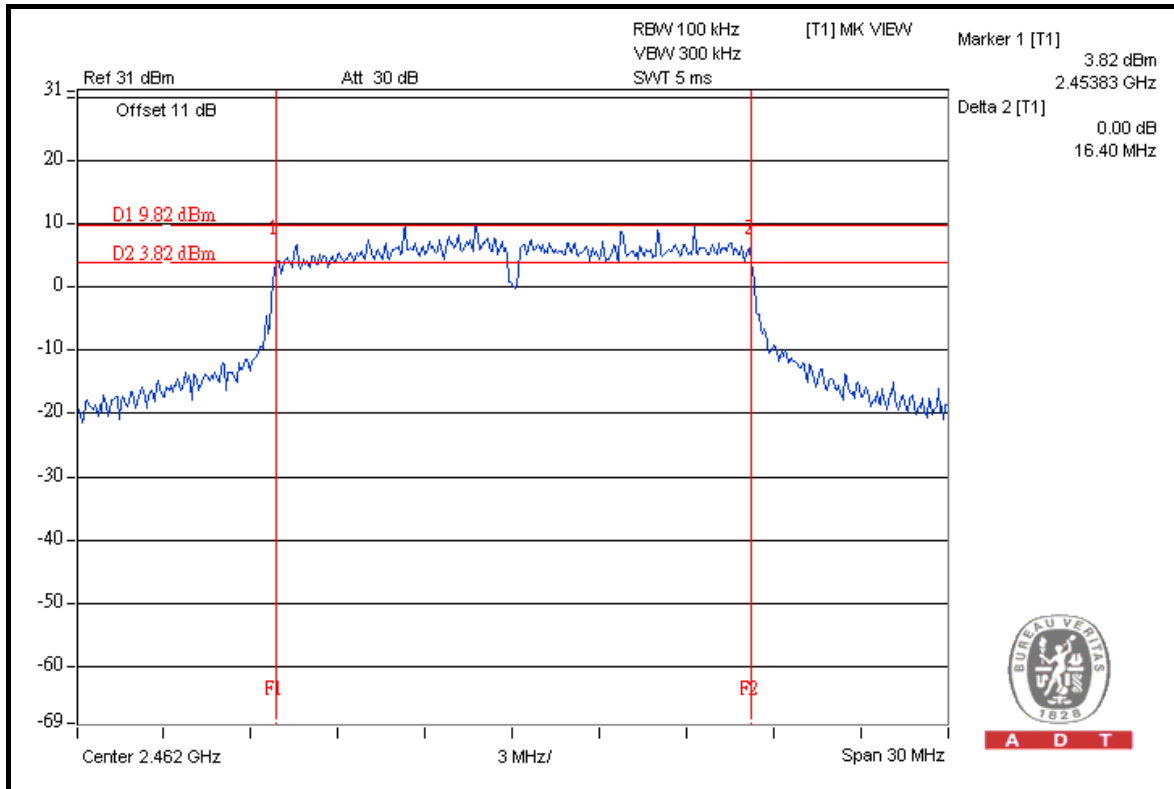

A D T

FOR CHAIN 2: CH 1

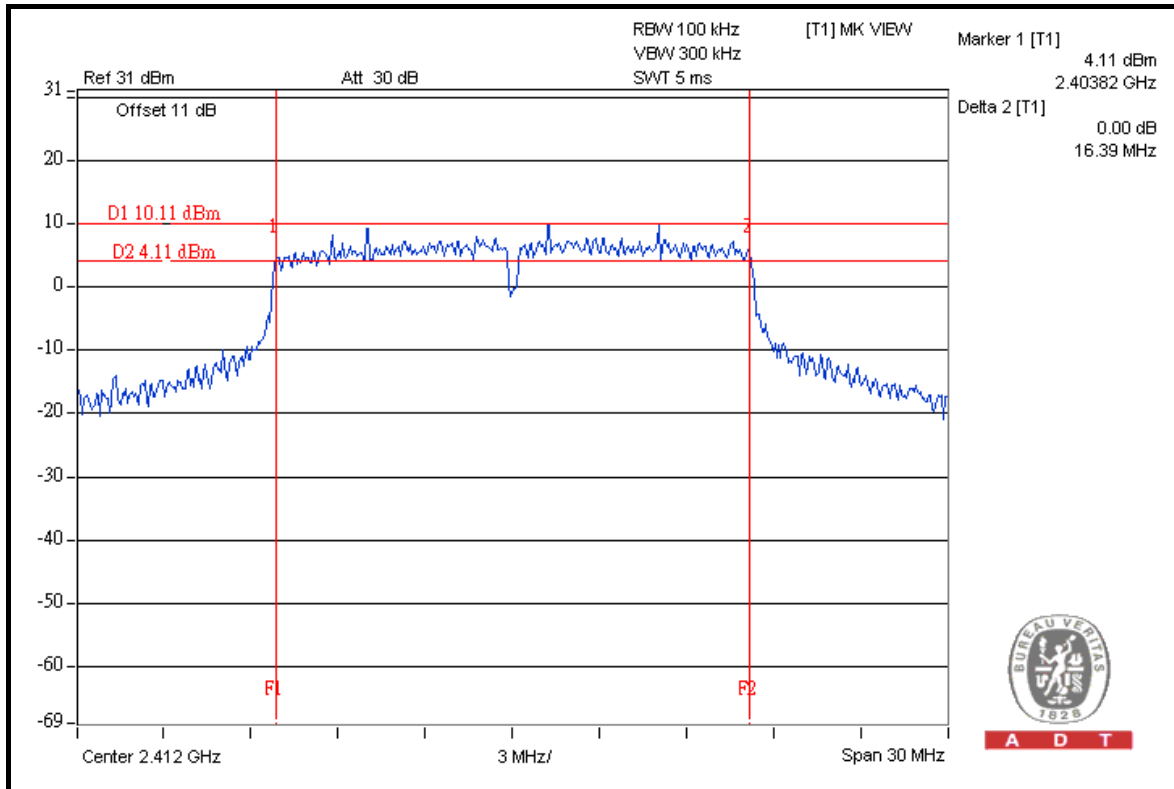

A D T



A D T

CH 6

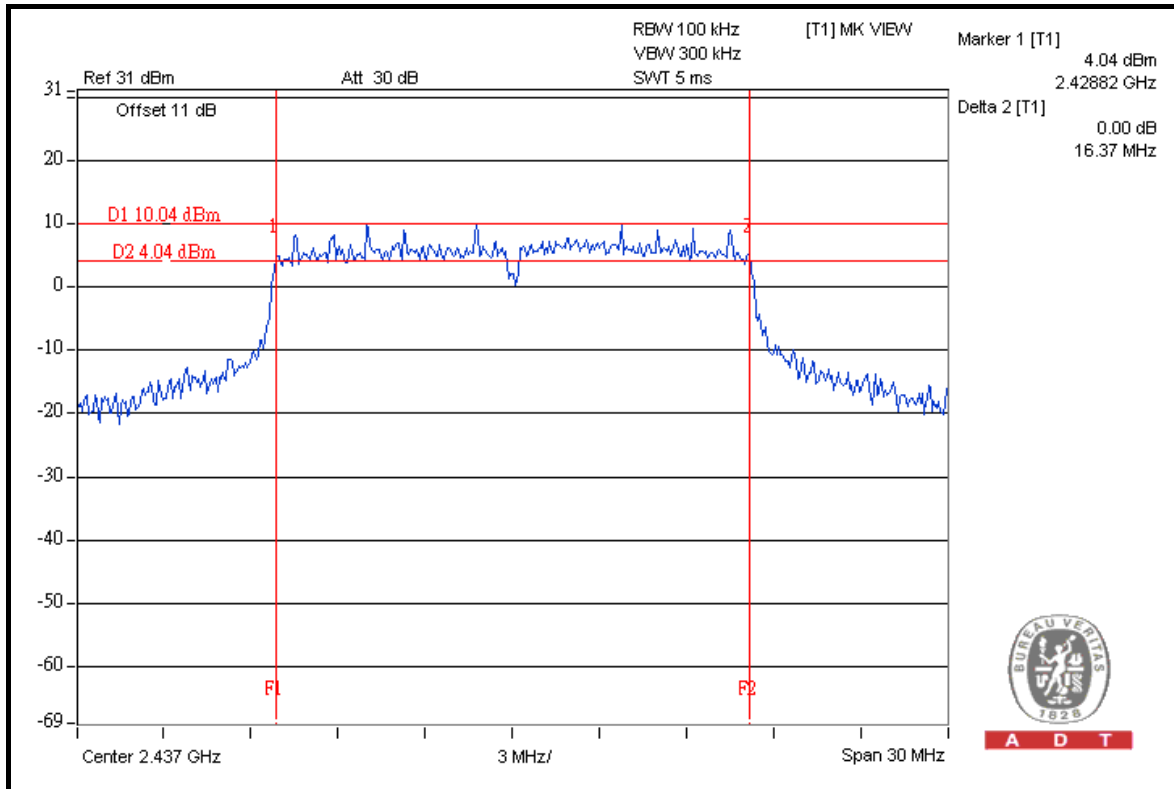

CH 11

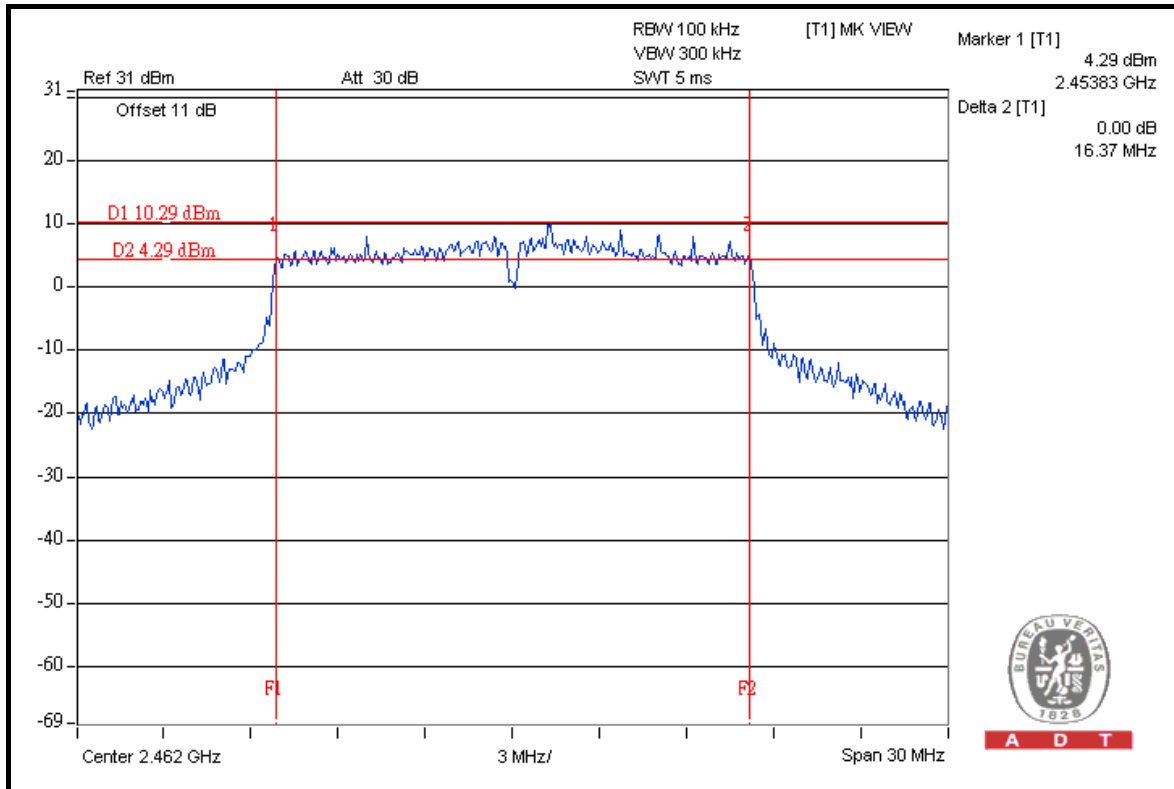



A D T

DRAFT 802.11n (20MHz) OFDM MODULATION

MODULATION TYPE	BPSK	TRANSFER RATE	6.5Mbps
INPUT POWER	120Vac, 60Hz	ENVIRONMENTAL CONDITIONS	25deg.C, 65%RH, 1021hPa
TESTED BY	Brad Wu		

CHANNEL	CHANNEL FREQUENCY (MHz)	6dB BANDWIDTH (MHz)			MINIMUM LIMIT (MHz)	PASS / FAIL
		CHAIN 0	CHAIN 1	CHAIN 2		
1	2412	17.68	17.35	17.42	0.5	PASS
6	2437	17.38	17.60	17.37	0.5	PASS
11	2462	17.66	17.26	17.35	0.5	PASS

FOR CHAIN 0: CH 1

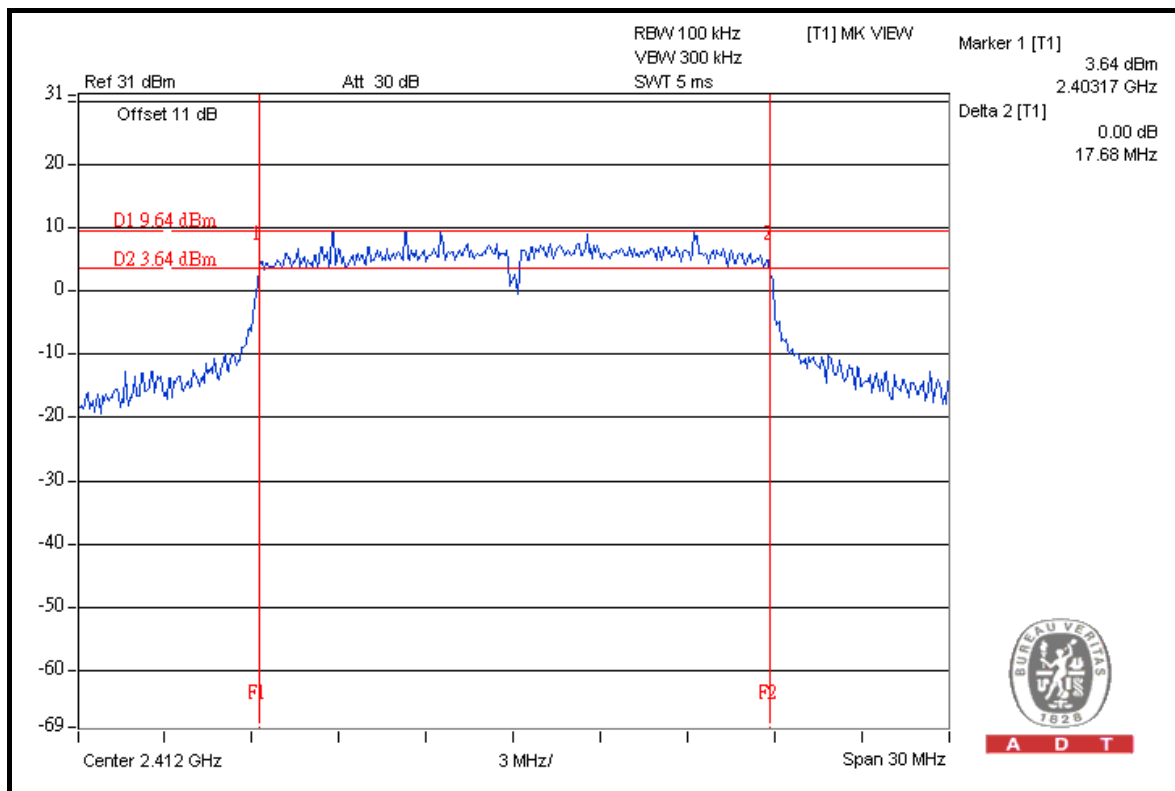

A D T



A D T

CH 6

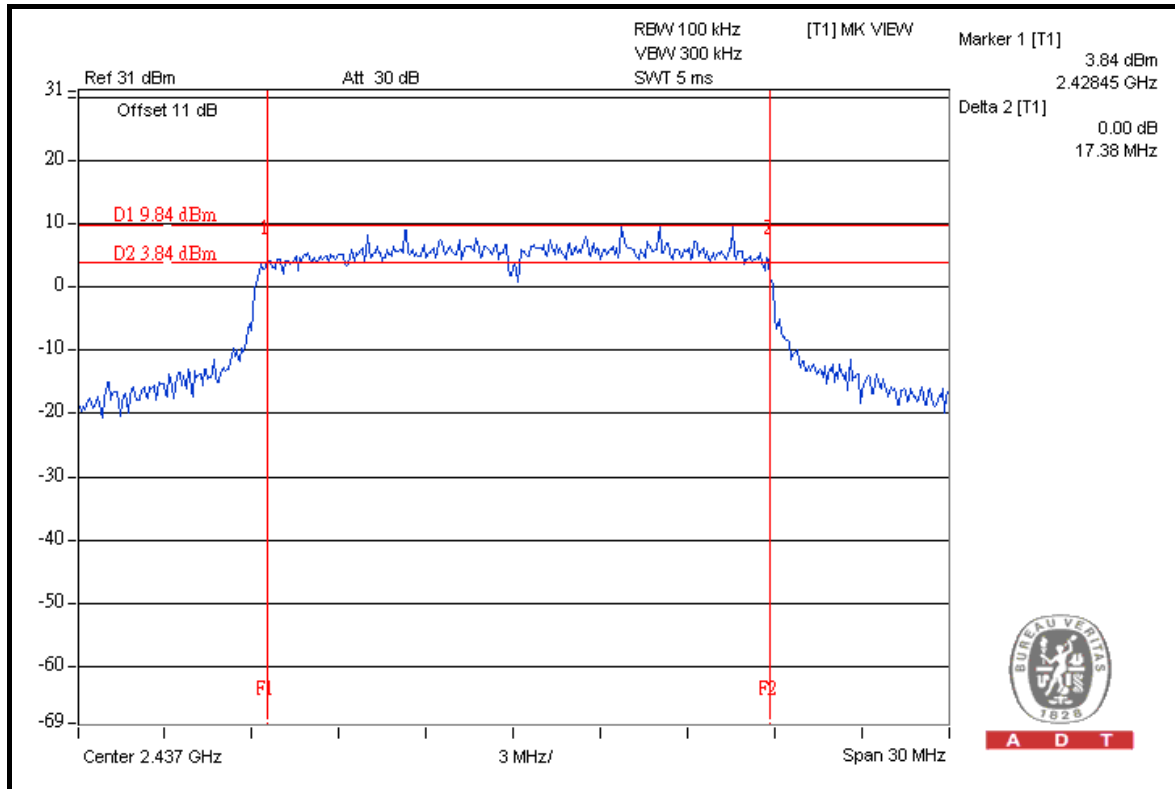

A D T

CH 11

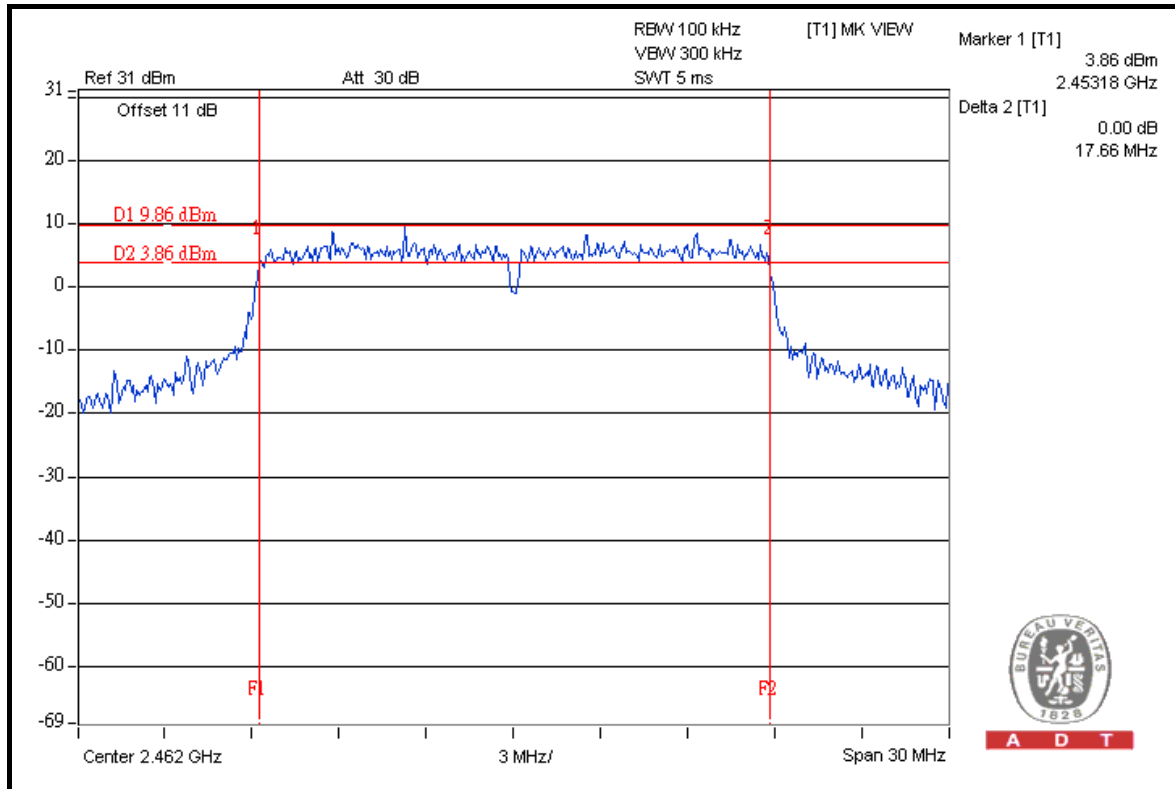

A D T



A D T

FOR CHAIN 1: CH 1

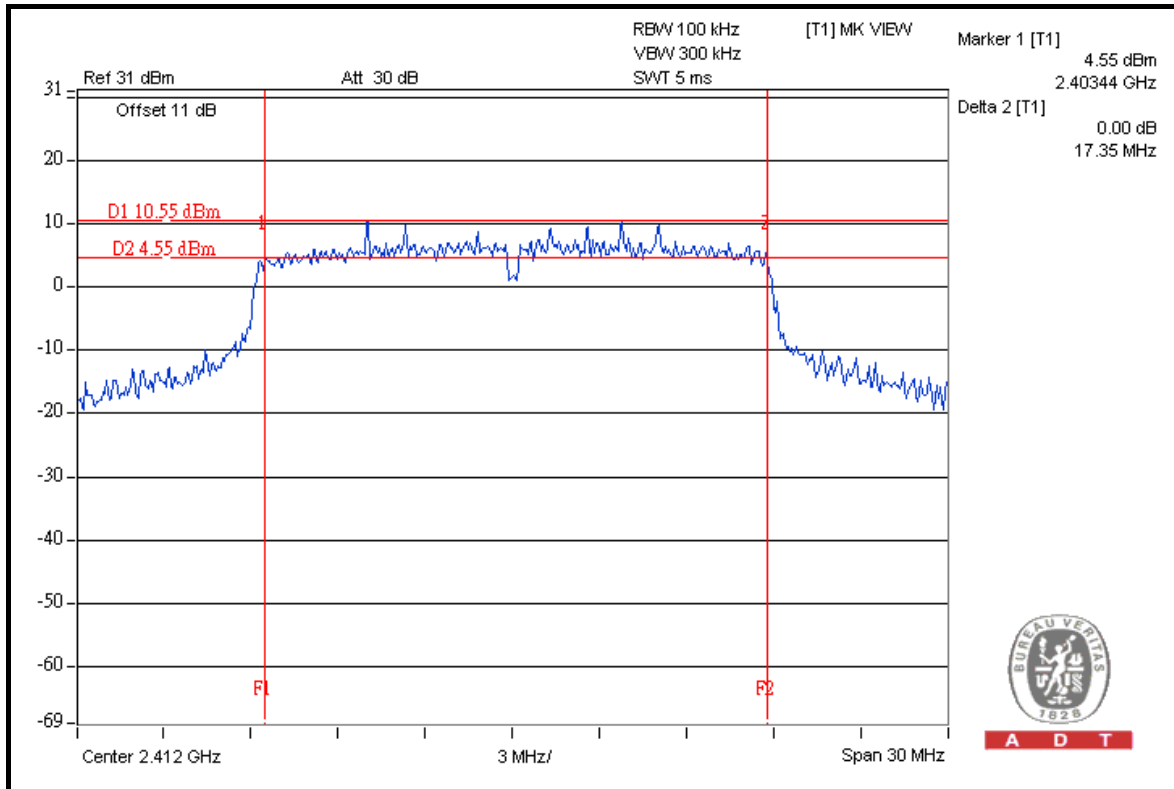

CH 6

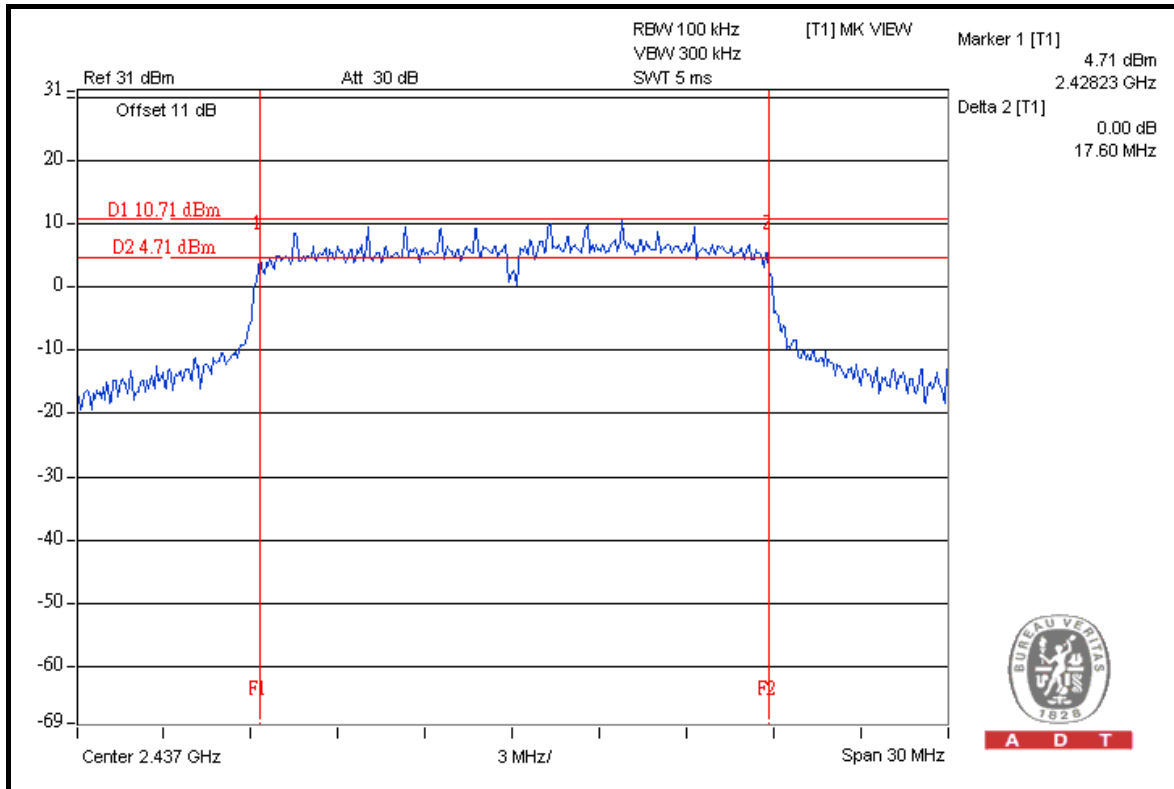



A D T

CH 11

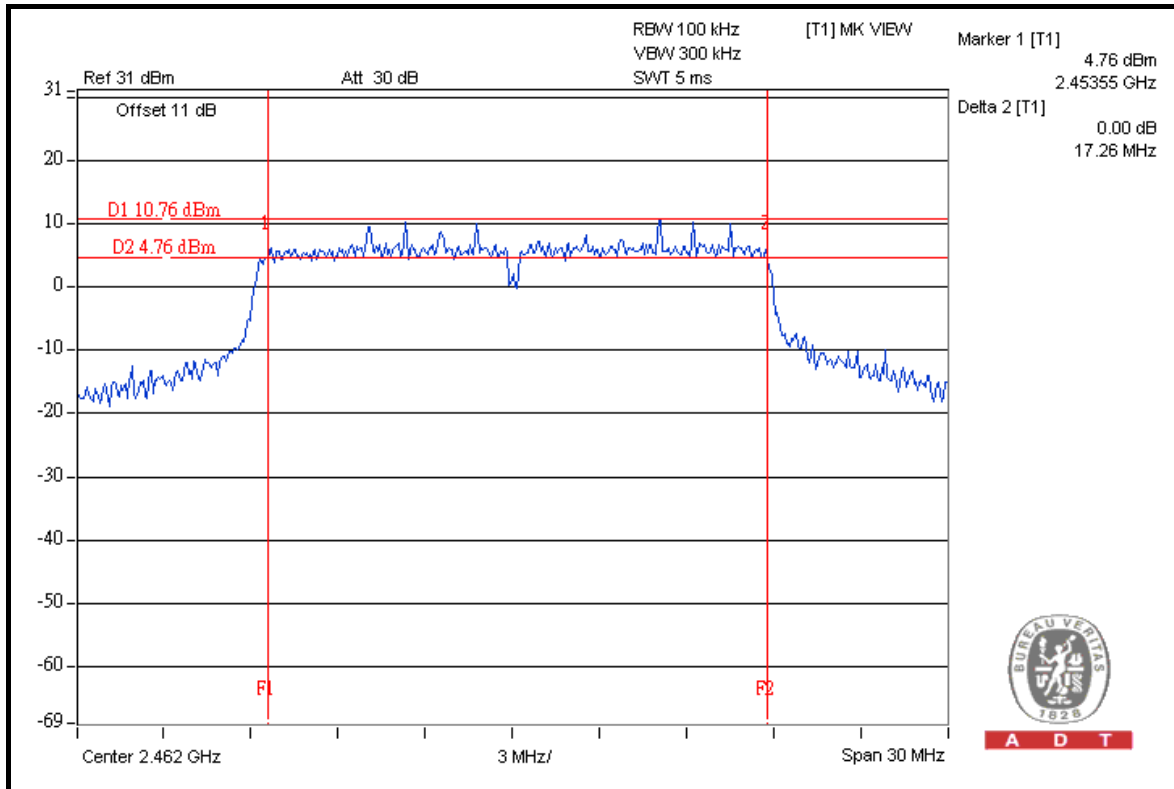

A D T

FOR CHAIN 2: CH 1

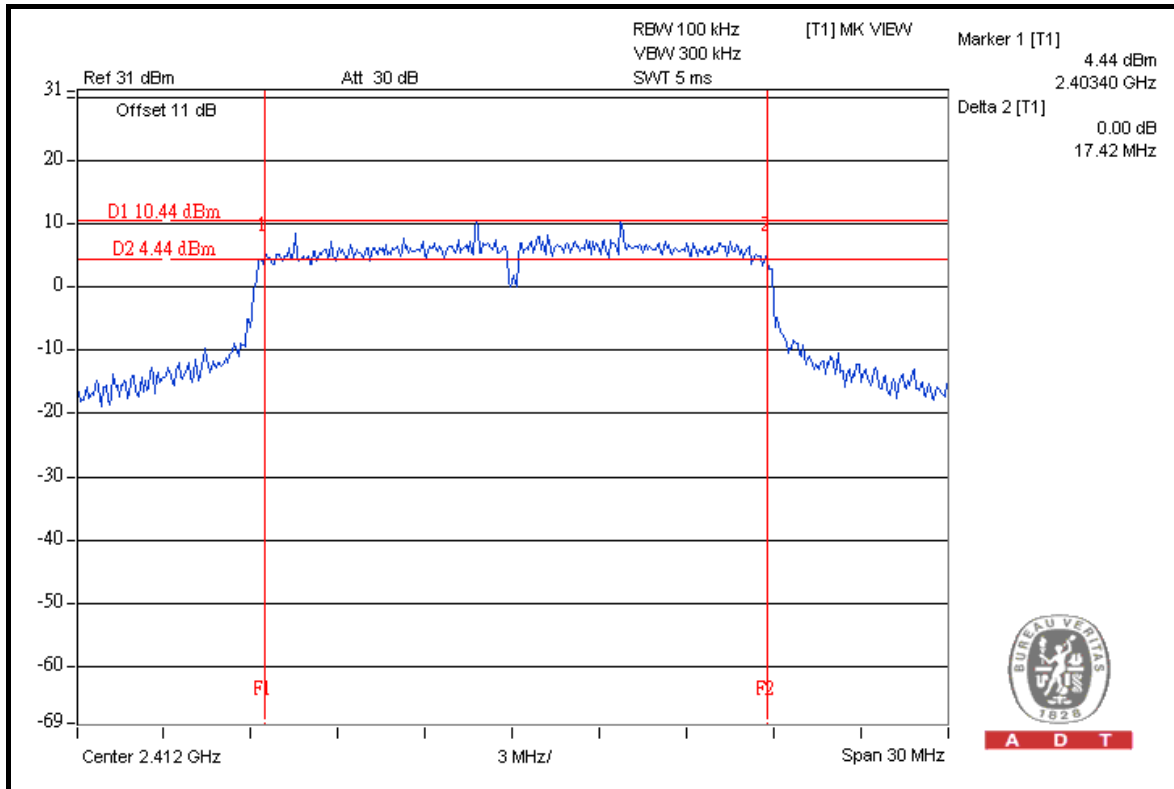

A D T



A D T

CH 6

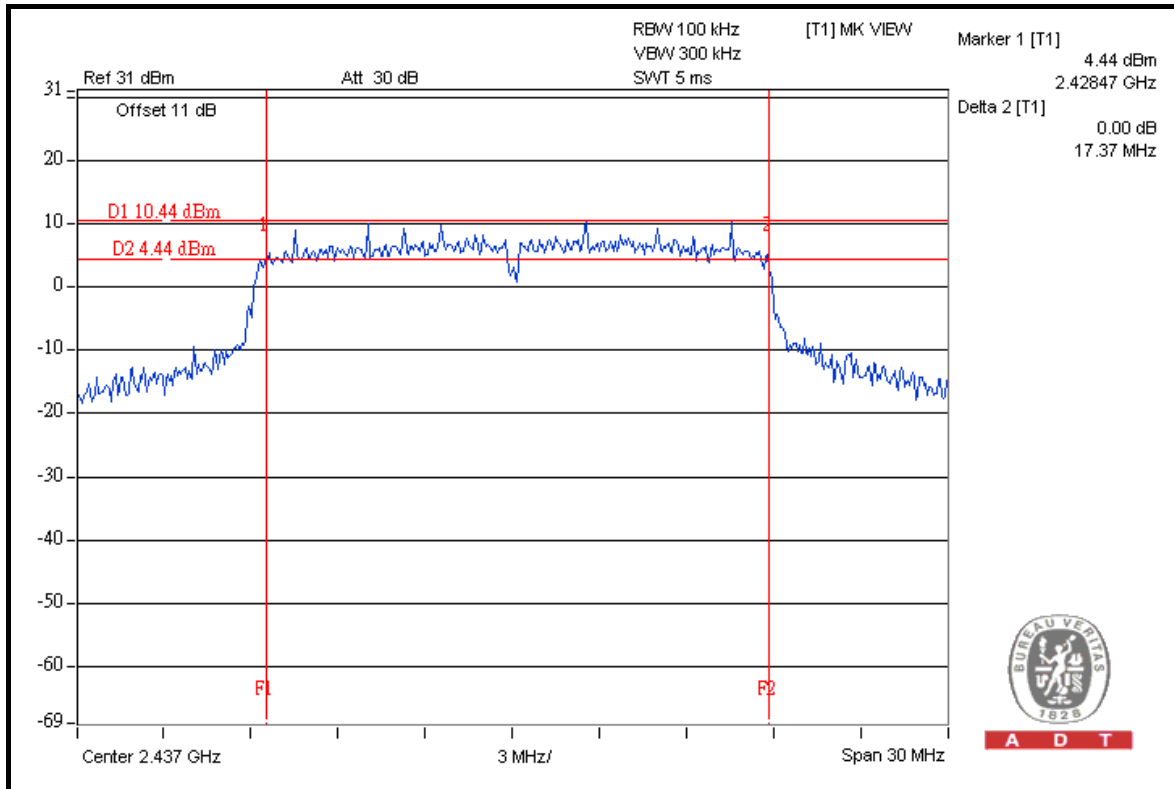

CH 11

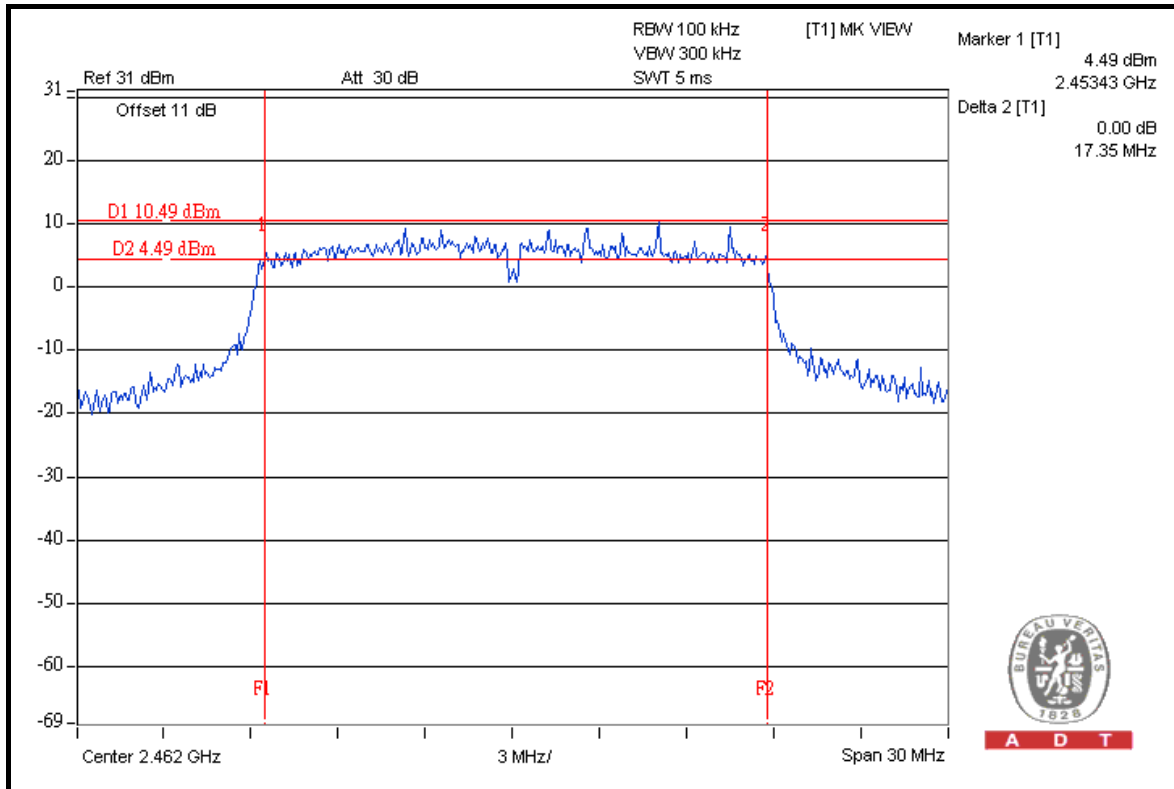



A D T

DRAFT 802.11n (40MHz) OFDM MODULATION

MODULATION TYPE	BPSK	TRANSFER RATE	13.5Mbps
INPUT POWER	120Vac, 60Hz	ENVIRONMENTAL CONDITIONS	25deg.C, 65%RH, 1021hPa
TESTED BY	Brad Wu		

CHANNEL	CHANNEL FREQUENCY (MHz)	6dB BANDWIDTH (MHz)			MINIMUM LIMIT (MHz)	PASS / FAIL
		CHAIN 0	CHAIN 1	CHAIN 2		
1	2422	36.52	35.87	36.53	0.5	PASS
4	2437	36.51	36.17	36.47	0.5	PASS
7	2452	36.45	36.43	36.22	0.5	PASS

FOR CHAIN 0: CH 1

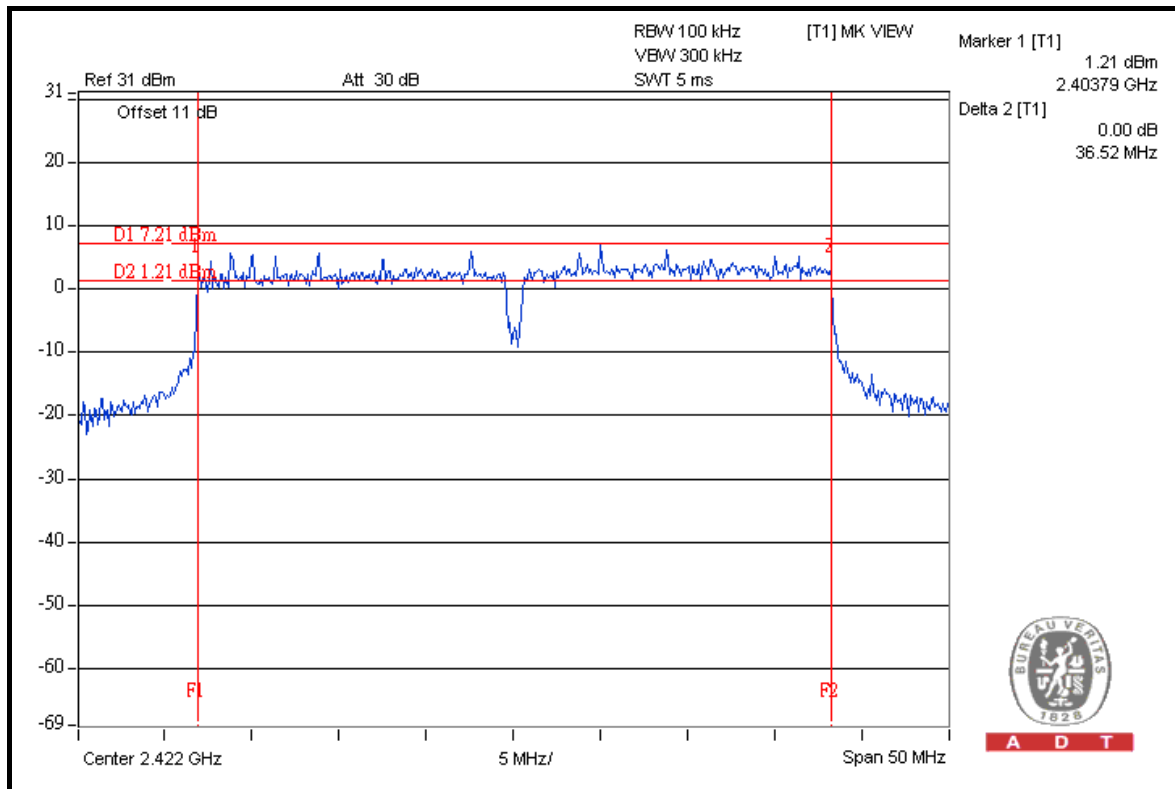



A D T

CH 6

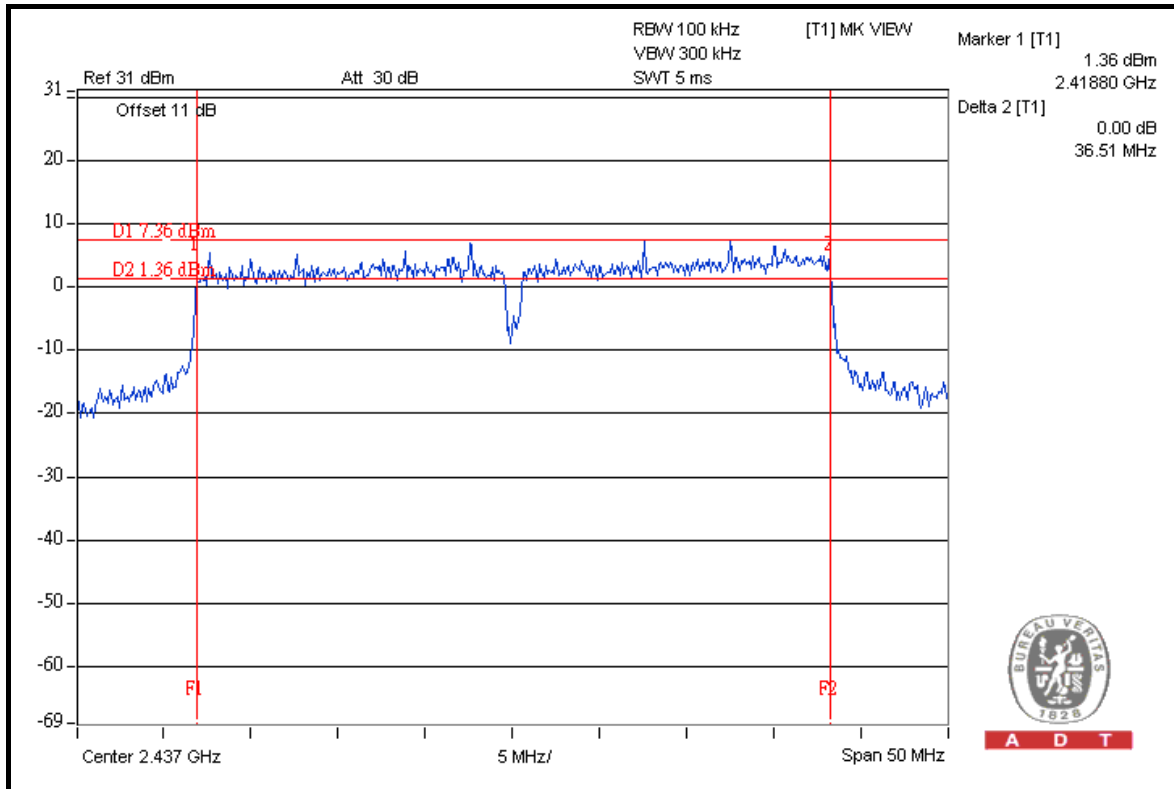

A D T

CH 11

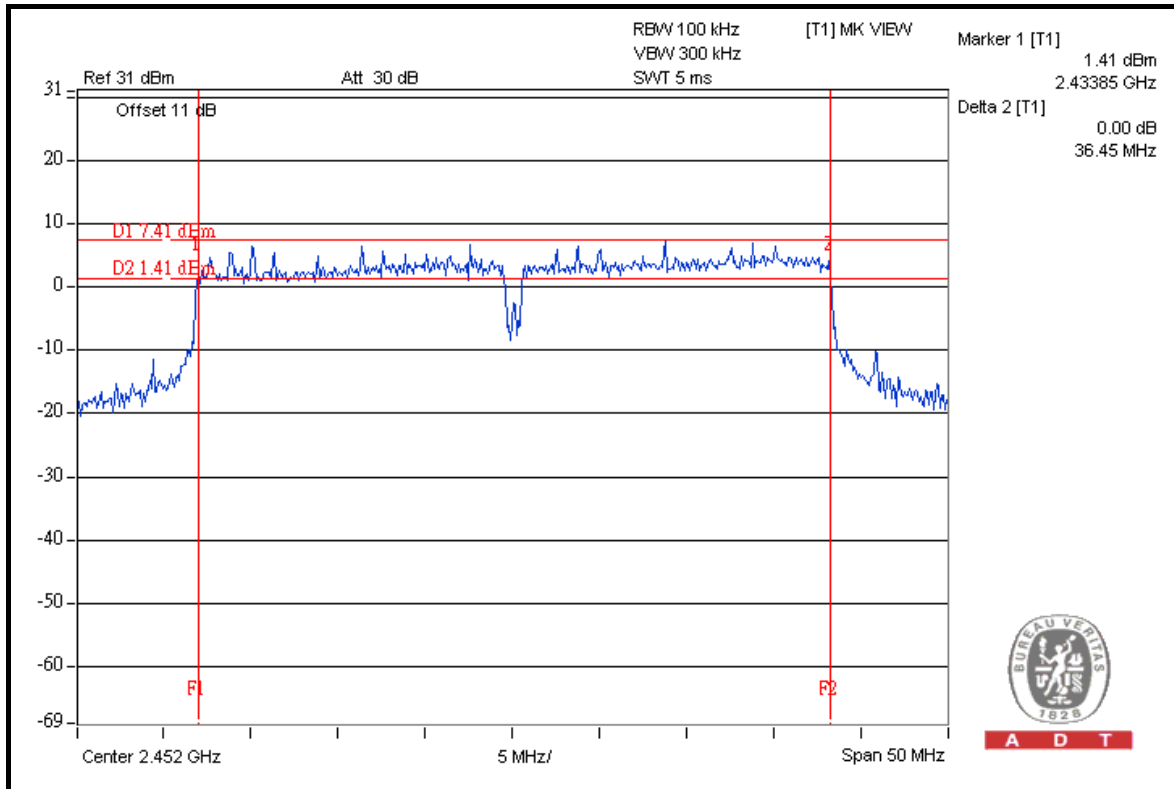

A D T



A D T

FOR CHAIN 1: CH 1

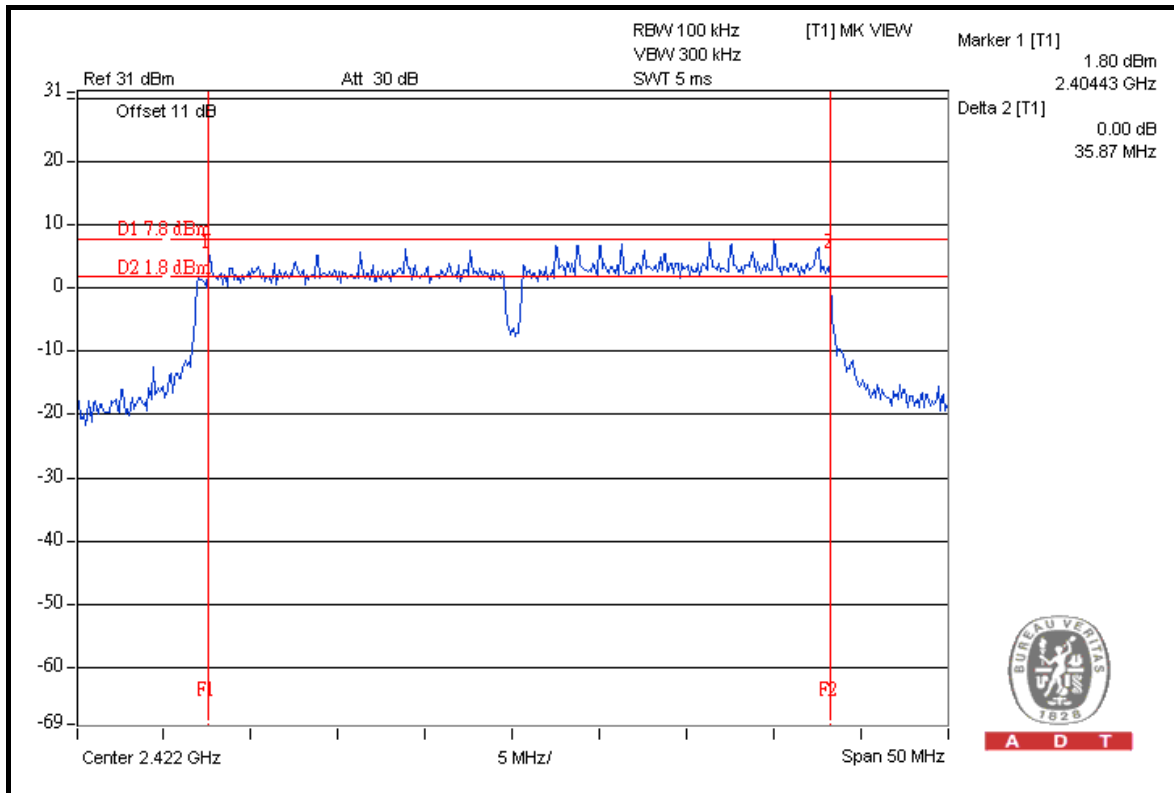

CH 6

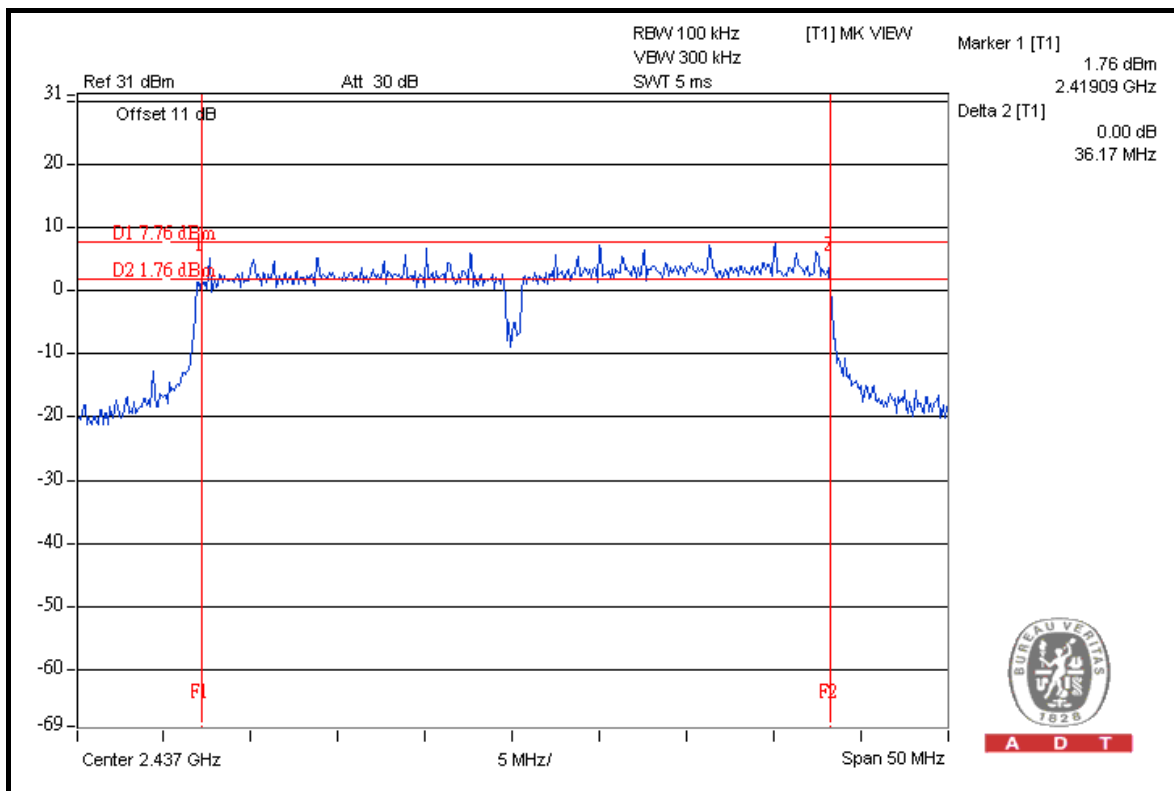



A D T

CH 11

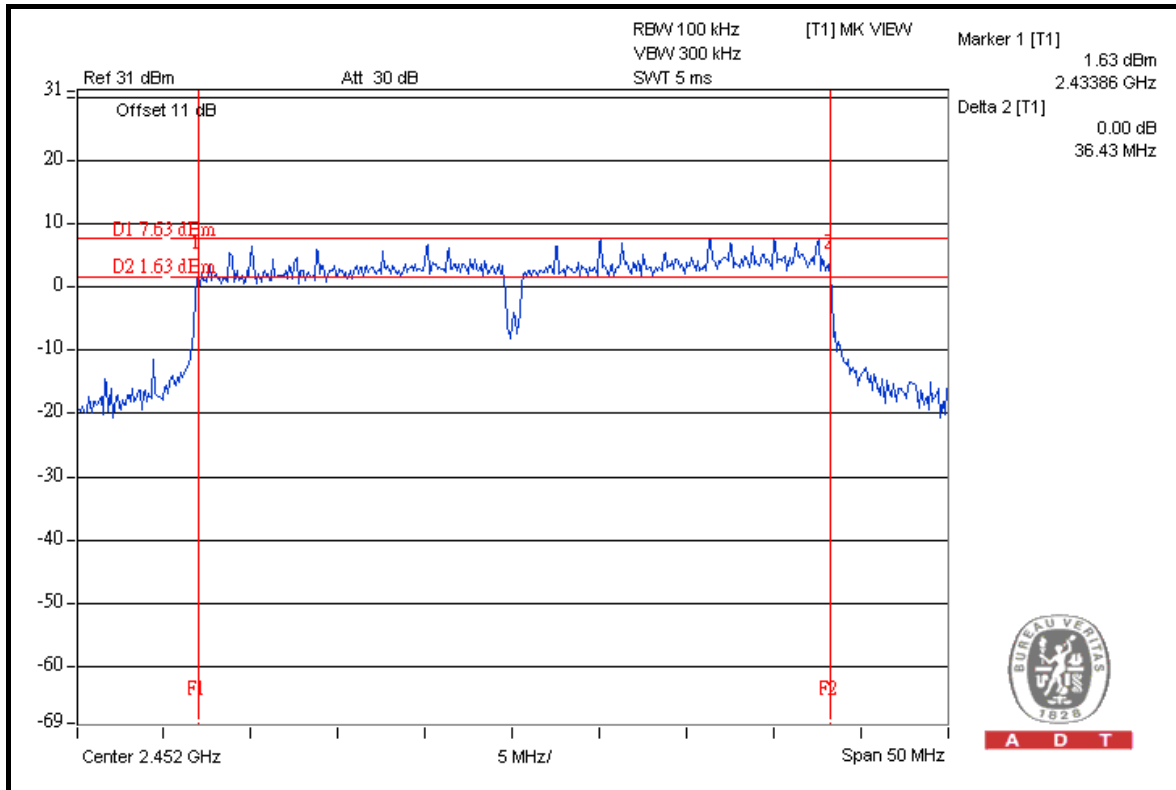

A D T

FOR CHAIN 2: CH 1

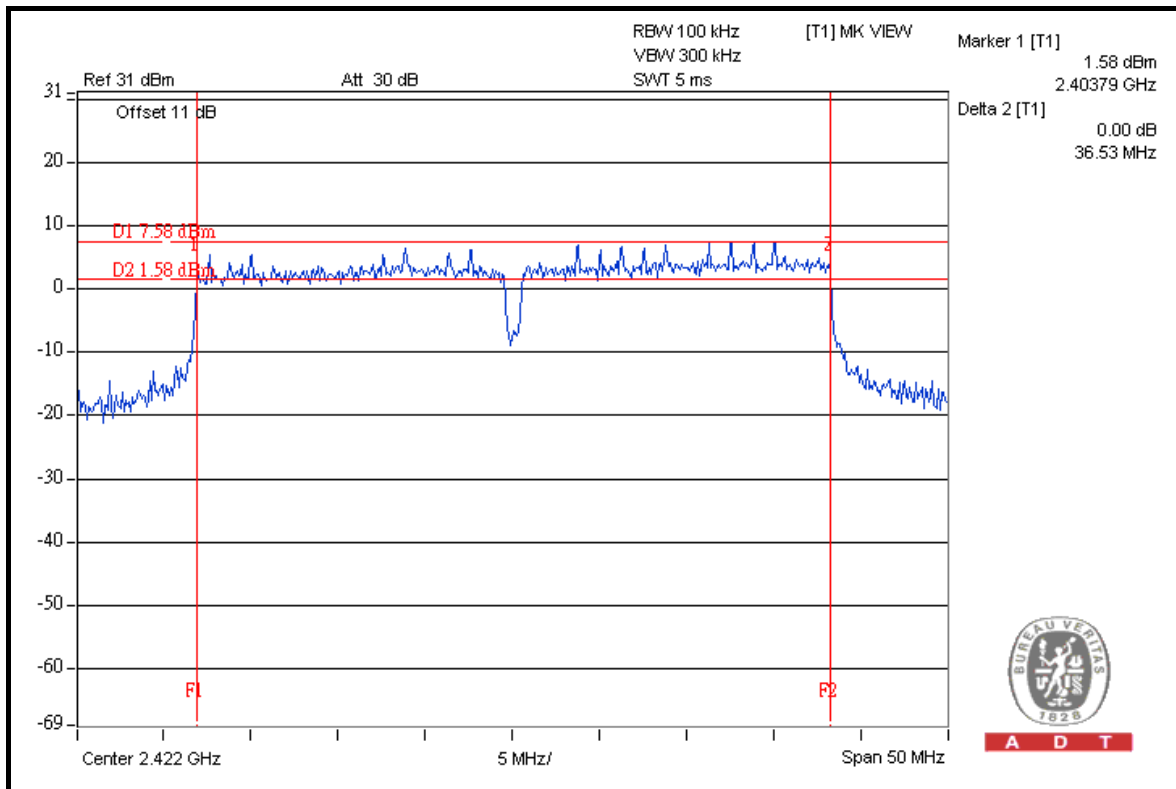

A D T



A D T

CH 6

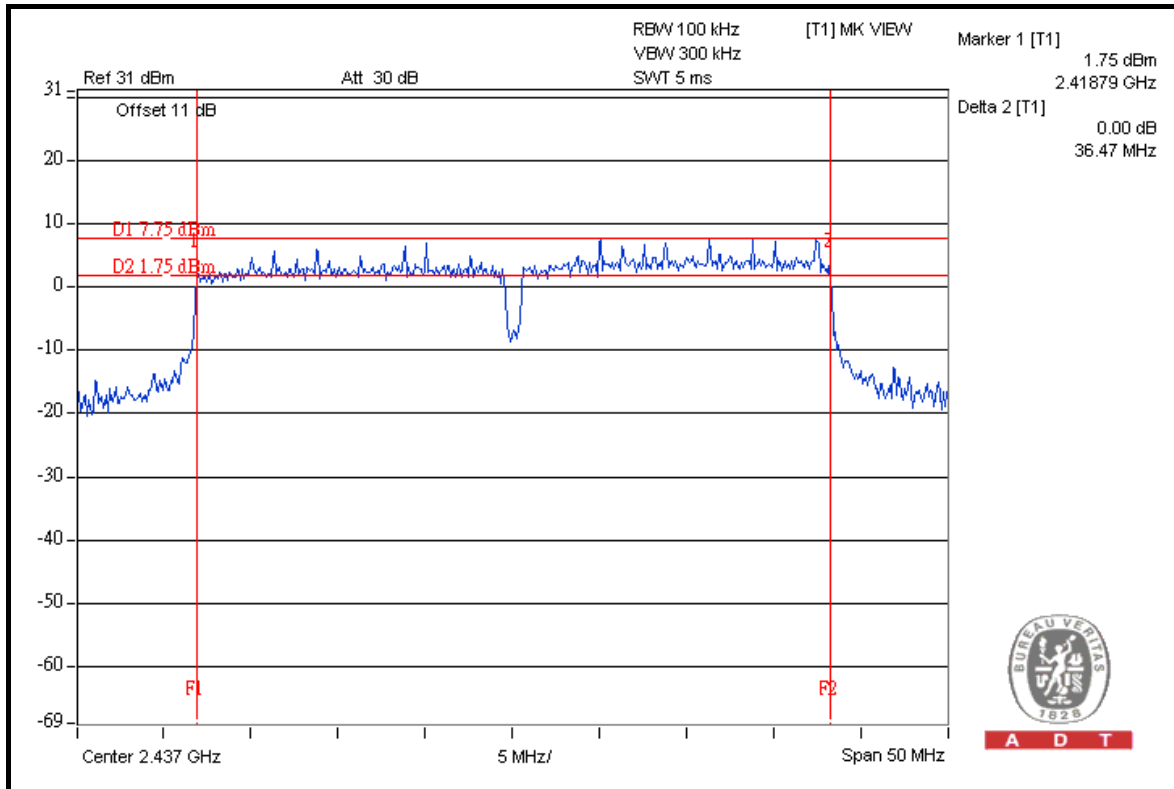

CH 11

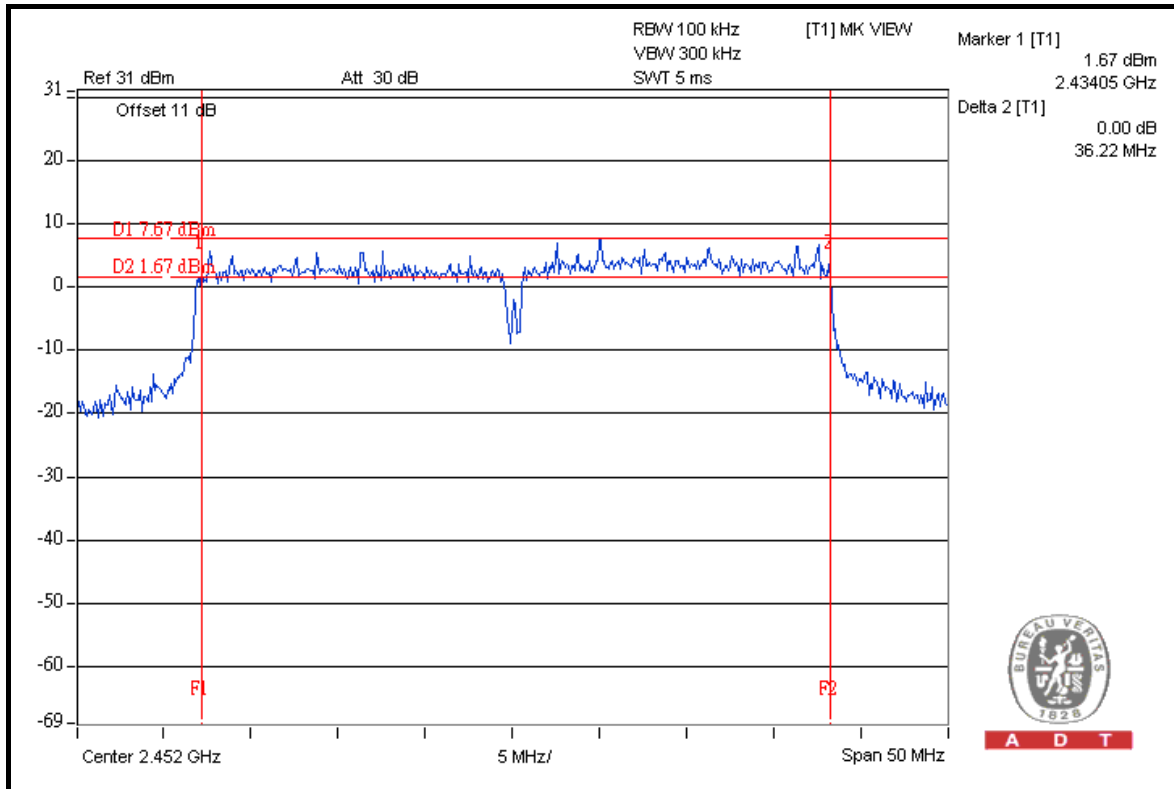



A D T

4.4 MAXIMUM PEAK OUTPUT POWER

4.4.1 LIMITS OF MAXIMUM PEAK OUTPUT POWER MEASUREMENT

The Maximum Peak Output Power Measurement is 30dBm.

4.4.2 INSTRUMENTS

DESCRIPTION & MANUFACTURER	MODEL NO.	SERIAL NO.	DATE OF CALIBRATION	DUE DATE OF CALIBRATION
Spectrum Analyzer Agilent	E4446A	MY44360128	Dec. 12, 2008	Dec.11, 2009

NOTE: The calibration interval of the above test instruments is 12 months and the calibrations are traceable to NML/ROC and NIST/USA.

4.4.3 TEST PROCEDURES

1. Follow DTS measurement (Power Output Option 2), the transmitter output was connected to the spectrum analyzer through an attenuator, the bandwidth of the fundamental frequency was measured with the spectrum analyzer.
2. Set span to encompass the entire emission bandwidth (EBW) of the signal.
3. Set RBW = 1 MHz ;VBW \geq 3 MHz.
4. Use sample detector mode and video trigger with the trigger level set to enable triggering only on full power pulses.
5. Trace average 100 traces in power averaging mode.
6. Compute power by integrating the spectrum across the 26 dB EBW of the signal.
7. Record the power level.

4.4.4 DEVIATION FROM TEST STANDARD

No deviation.

4.4.5 TEST SETUP

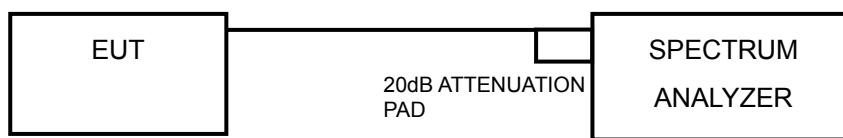

4.4.6 EUT OPERATING CONDITIONS

Same as Item 4.3.6.



A D T

4.4.7 TEST RESULTS

802.11b DSSS MODULATION

MODULATION TYPE	DBPSK	TRANSFER RATE	1.0Mbps
INPUT POWER	120Vac, 60Hz	ENVIRONMENTAL CONDITIONS	25deg.C, 65%RH, 1021hPa
TESTED BY	Brad Wu		

CHAN.	CHAN. FREQ. (MHz)	PEAK POWER OUTPUT (dBm)			TOTAL PEAK POWER (mW)	TOTAL PEAK POWER (dBm)	PEAK POWER LIMIT (dBm)	PASS / FAIL
		CHAIN 0	CHAIN 1	CHAIN 2				
1	2412	23.01	23.06	23.04	603.661	27.81	30	PASS
6	2437	23.03	23.07	23.03	604.587	27.81	30	PASS
11	2462	23.03	23.06	23.07	605.979	27.82	30	PASS

FOR CHAIN 0: CH 1

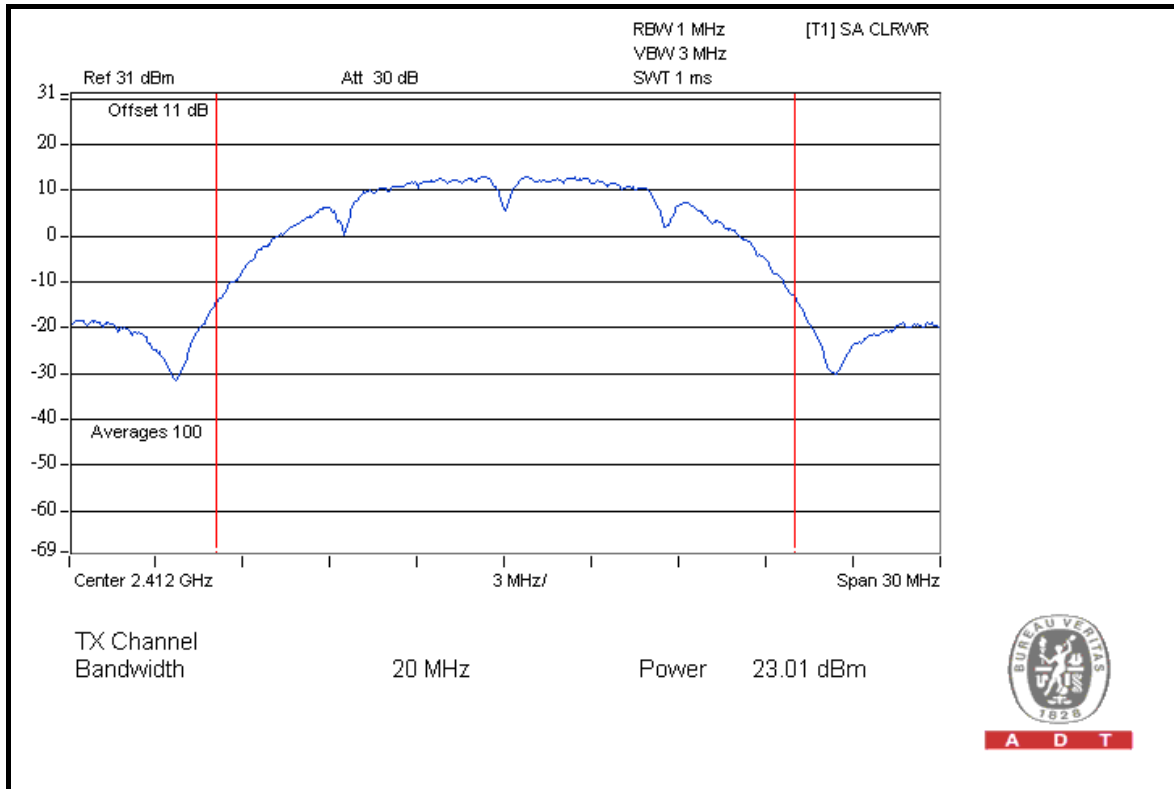

A D T



A D T

CH 6

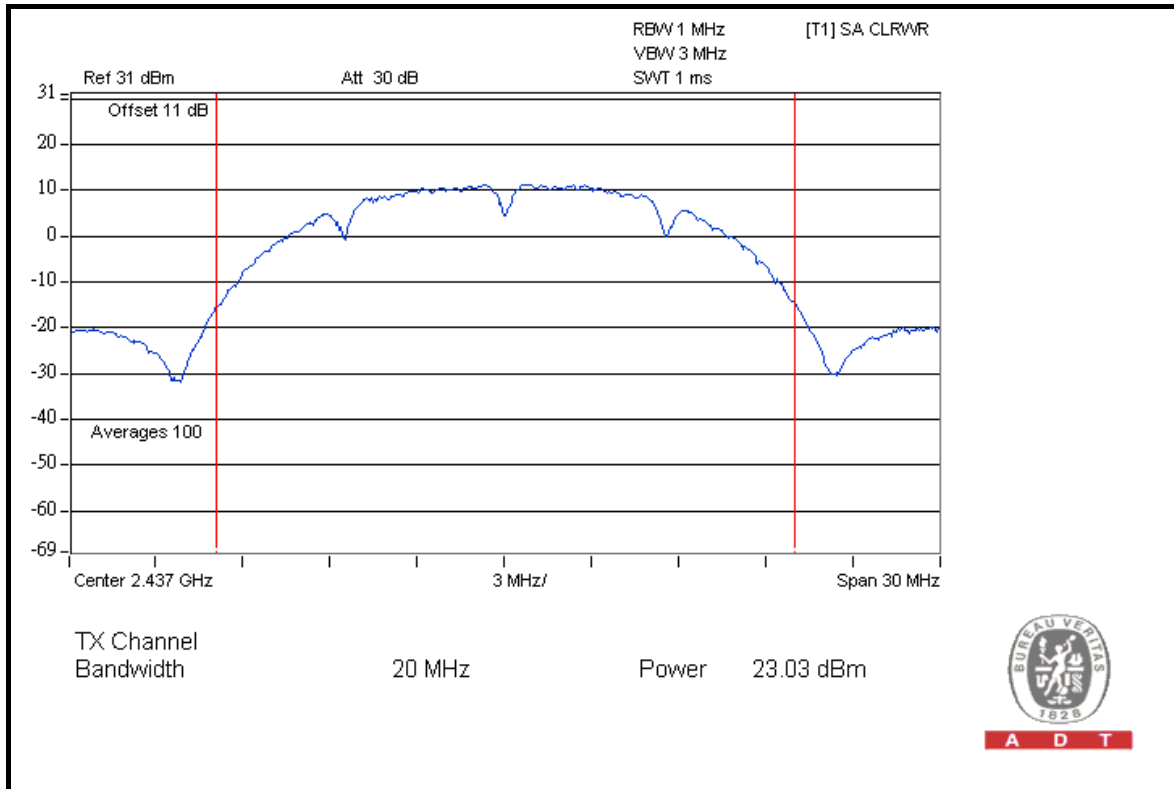

A D T

CH 11

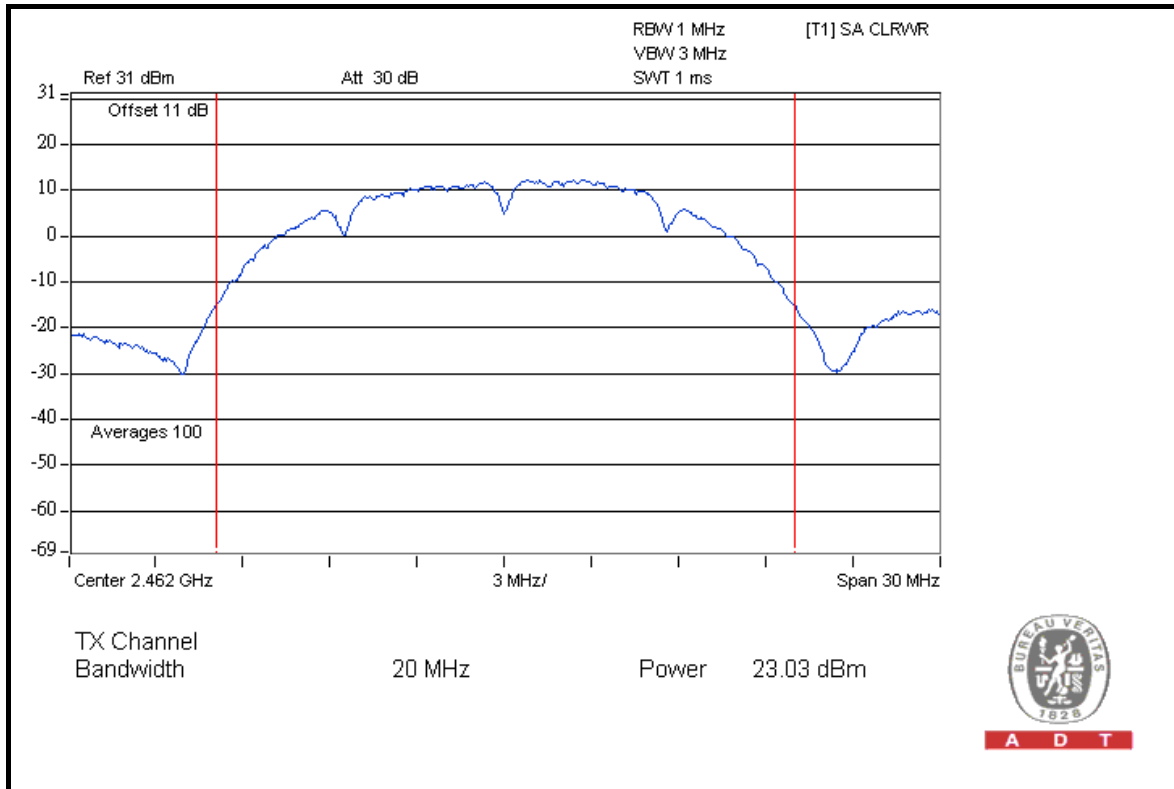

A D T



A D T

FOR CHAIN 1: CH 1

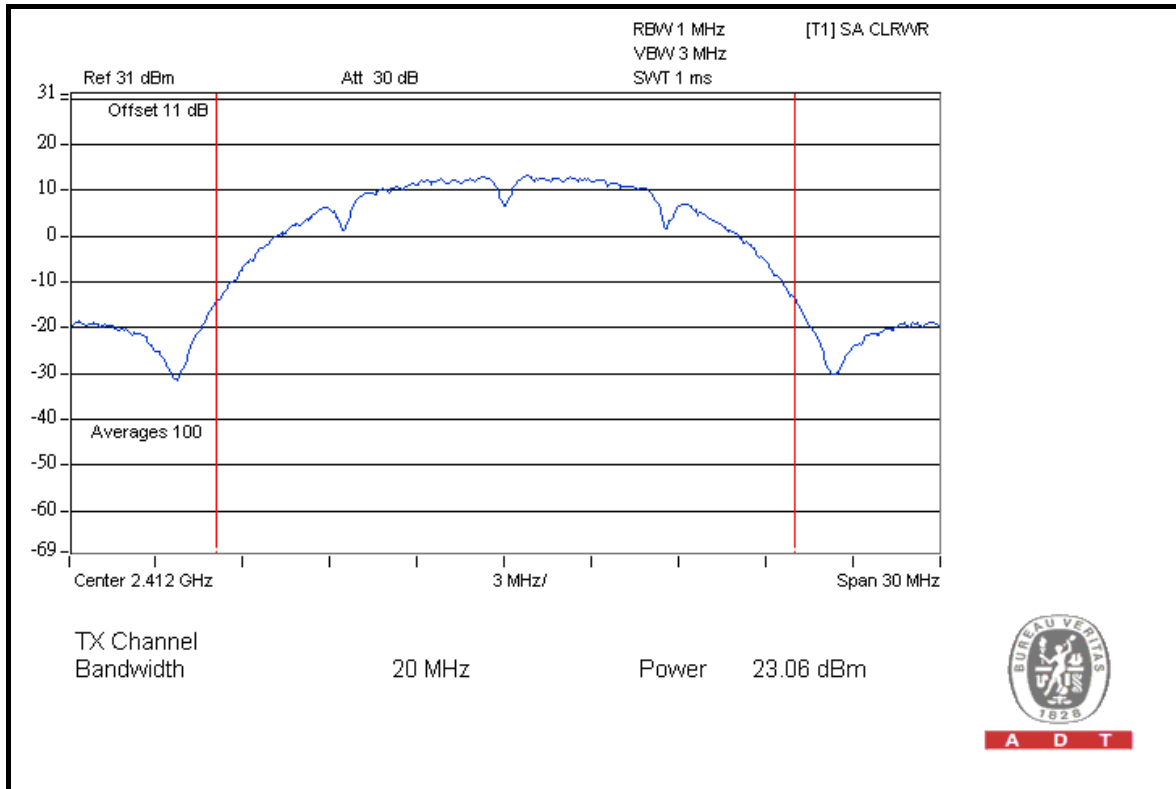

A D T

CH 6

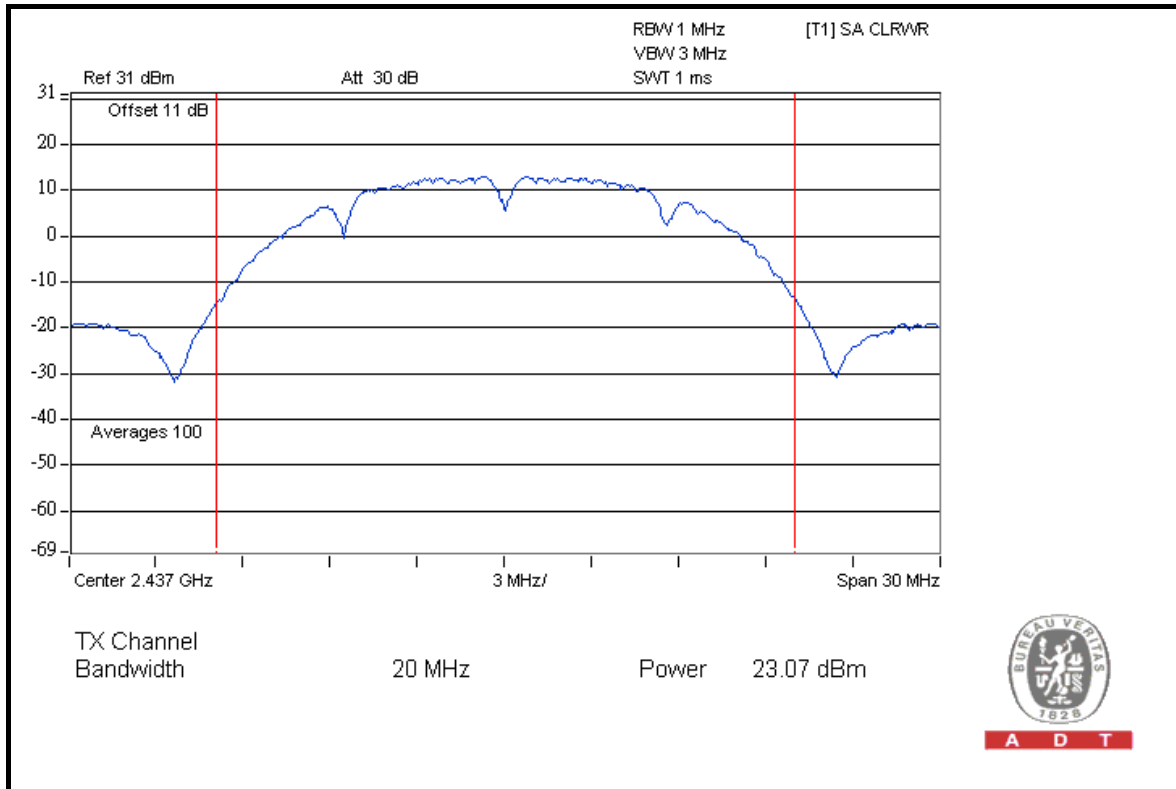

A D T



A D T

CH 11

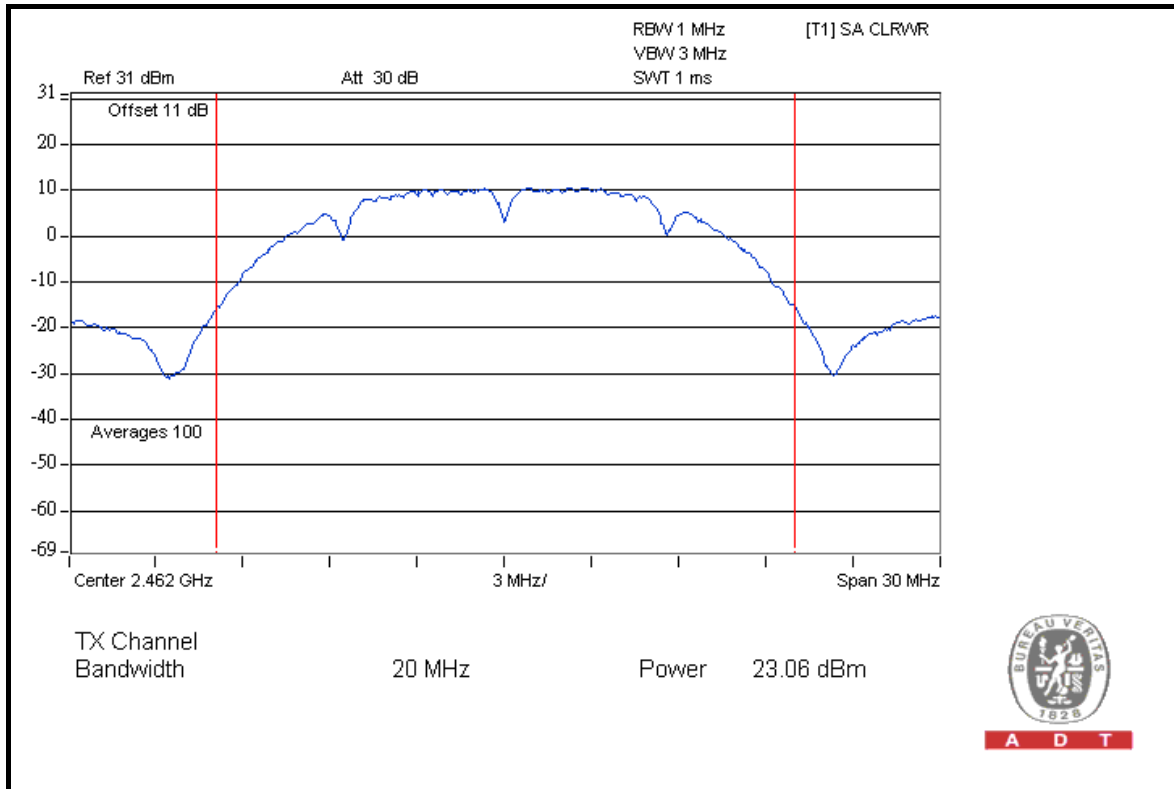

A D T

FOR CHAIN 2: CH 1

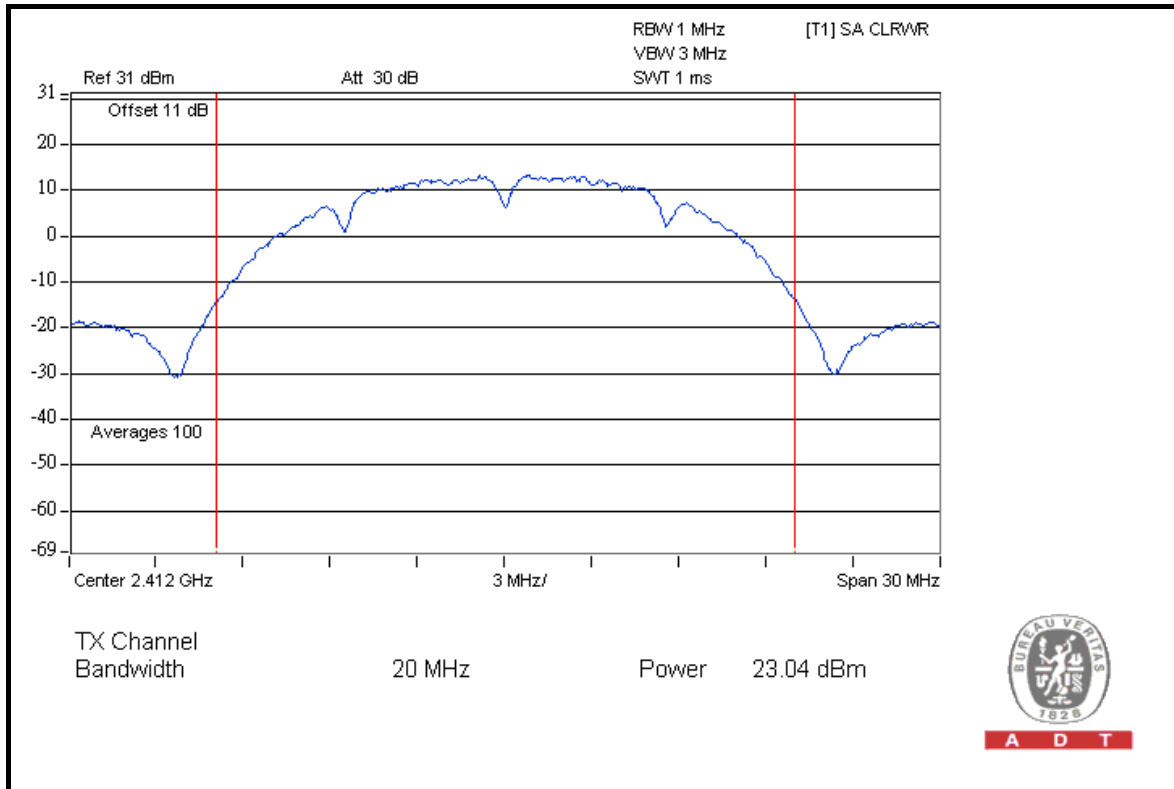

A D T



A D T

CH 6

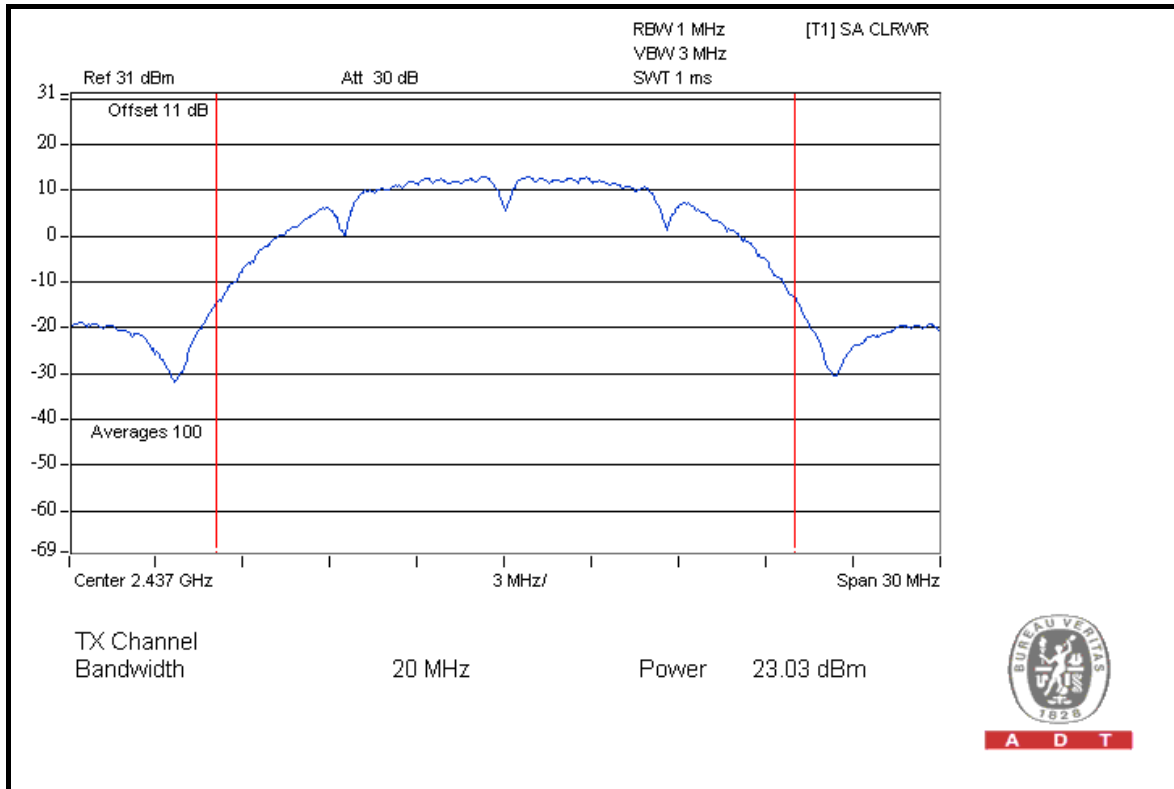

A D T

CH 11

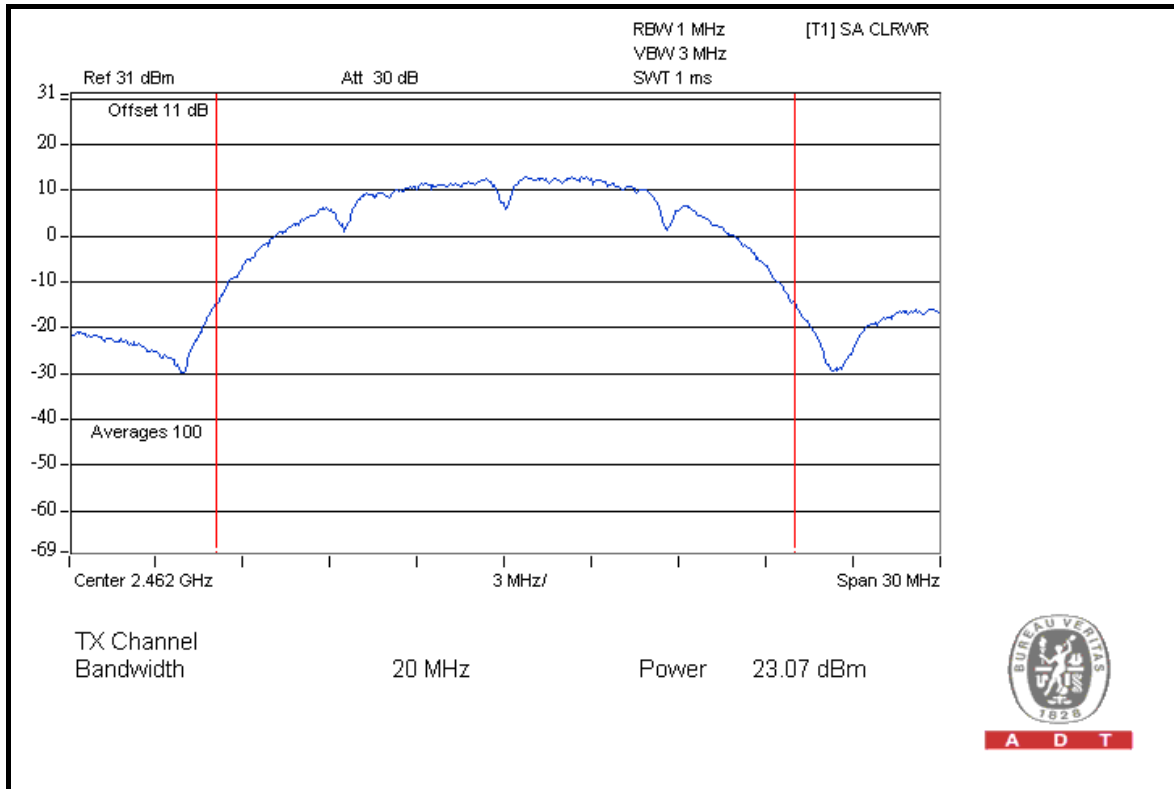

A D T



A D T

802.11g OFDM MODULATION

MODULATION TYPE	BPSK	TRANSFER RATE	6.0Mbps
INPUT POWER	120Vac, 60Hz	ENVIRONMENTAL CONDITIONS	25deg.C, 65%RH, 1021hPa
TESTED BY	Brad Wu		

CHAN.	CHAN. FREQ. (MHz)	PEAK POWER OUTPUT (dBm)			TOTAL PEAK POWER (mW)	TOTAL PEAK POWER (dBm)	PEAK POWER LIMIT (dBm)	PASS / FAIL
		CHAIN 0	CHAIN 1	CHAIN 2				
1	2412	22.06	22.12	22.09	485.432	26.86	30	PASS
6	2437	22.13	22.11	22.01	484.715	26.85	30	PASS
11	2462	22.04	22.13	22.02	482.482	26.83	30	PASS

FOR CHAIN 0: CH 1

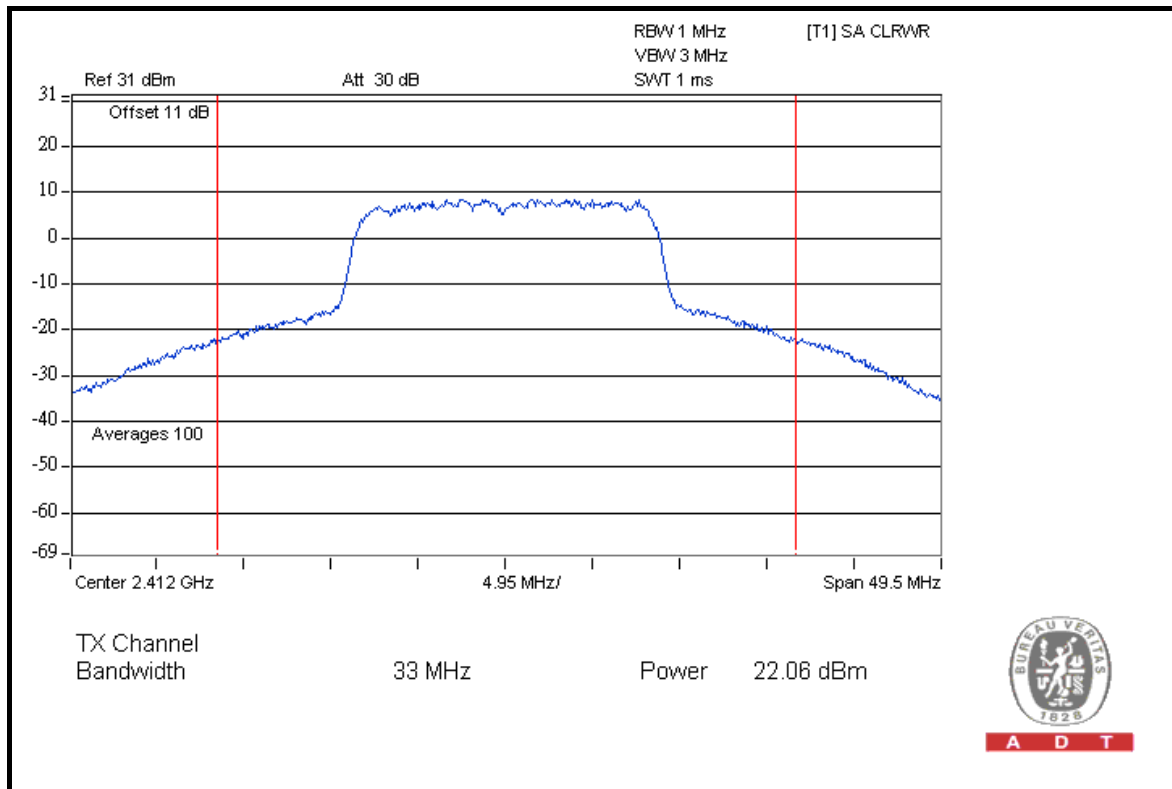

A D T



A D T

CH 6

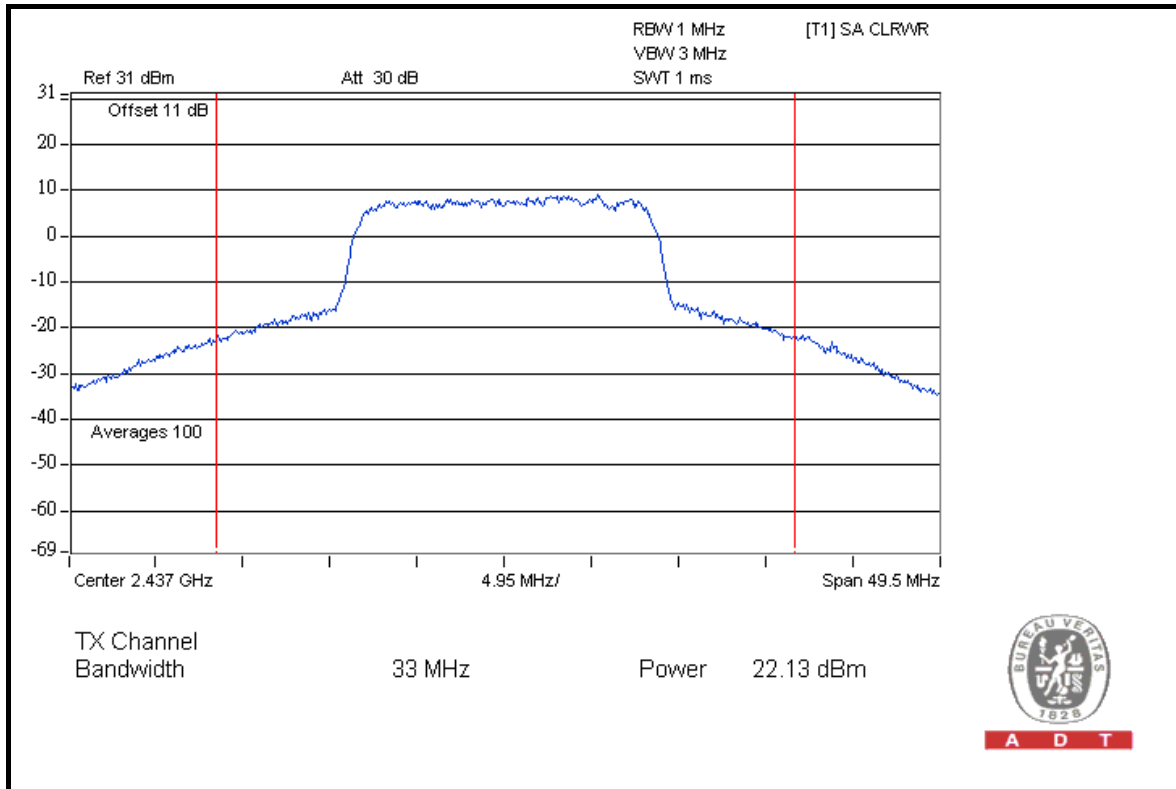

CH 11

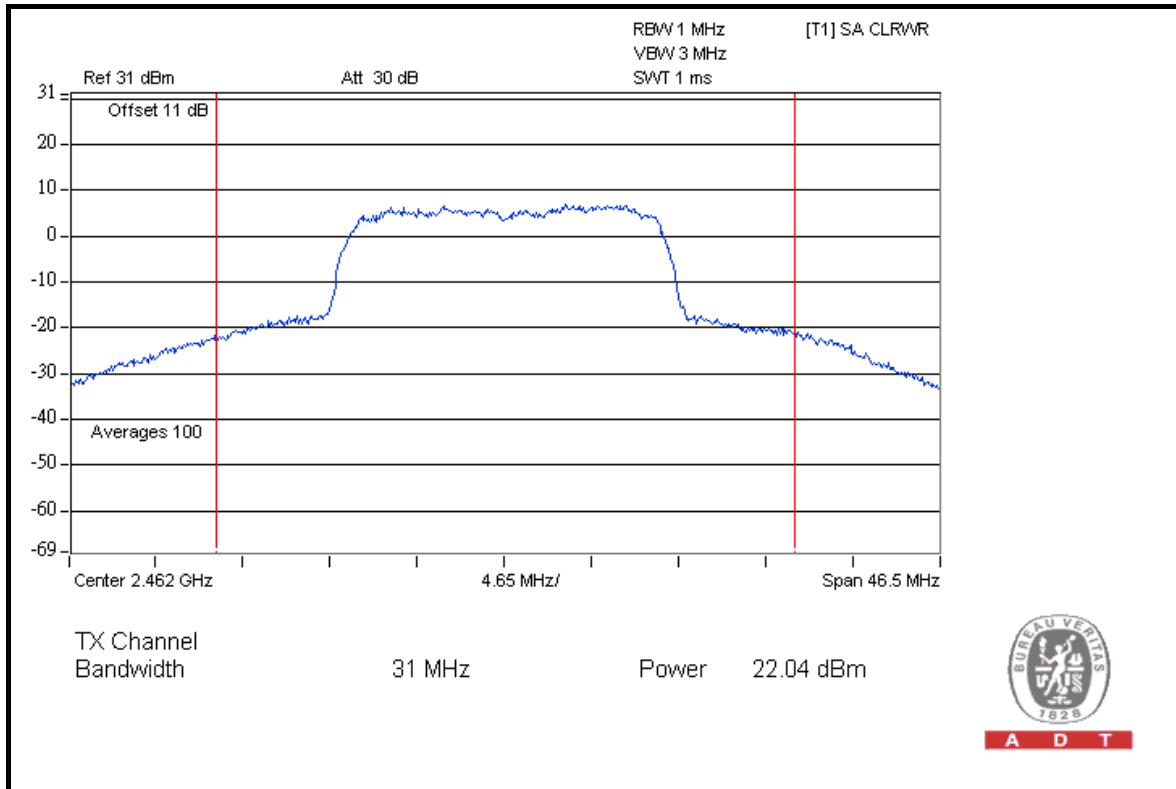



A D T

FOR CHAIN 1: CH 1

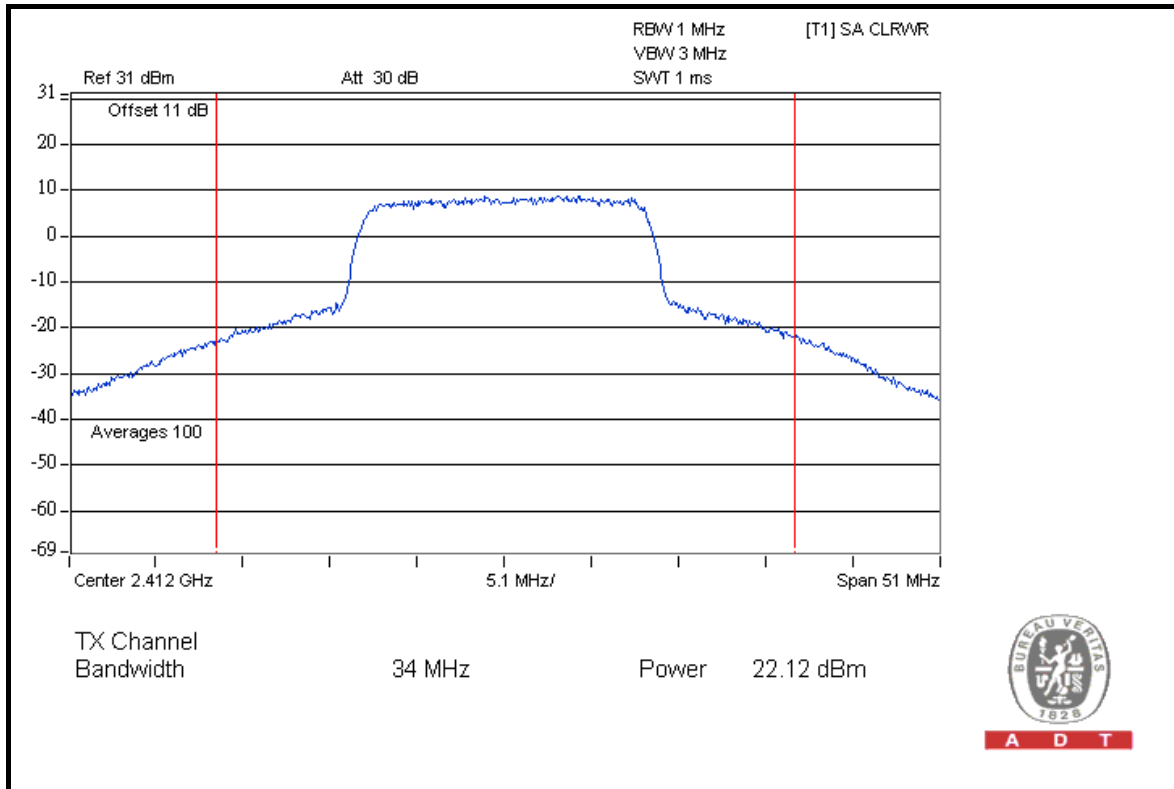

CH 6

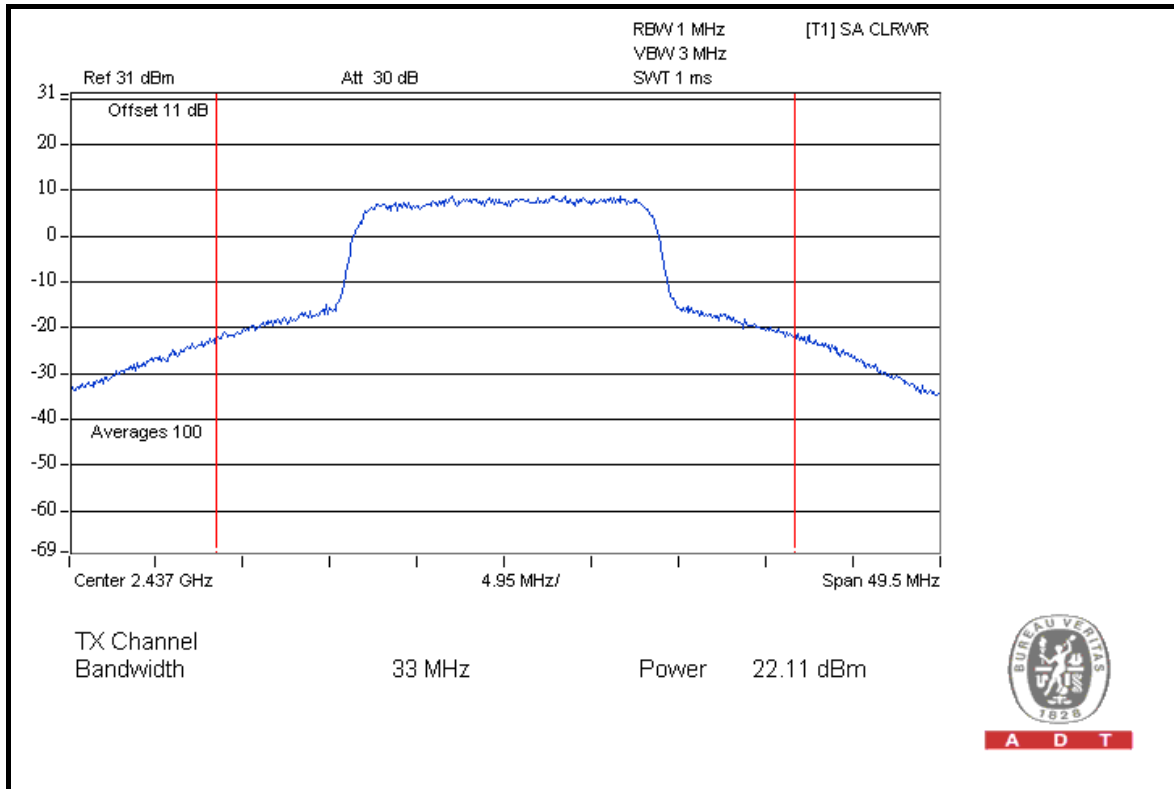



A D T

CH 11

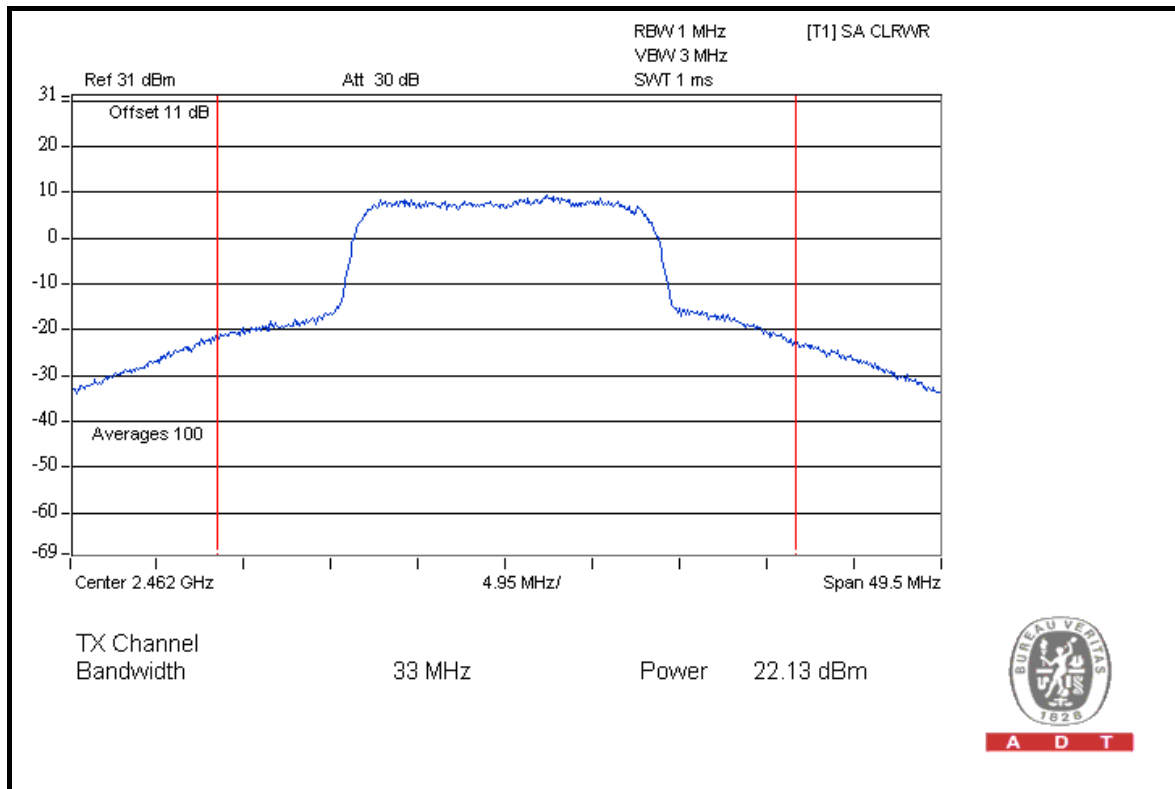

FOR CHAIN 2: CH 1

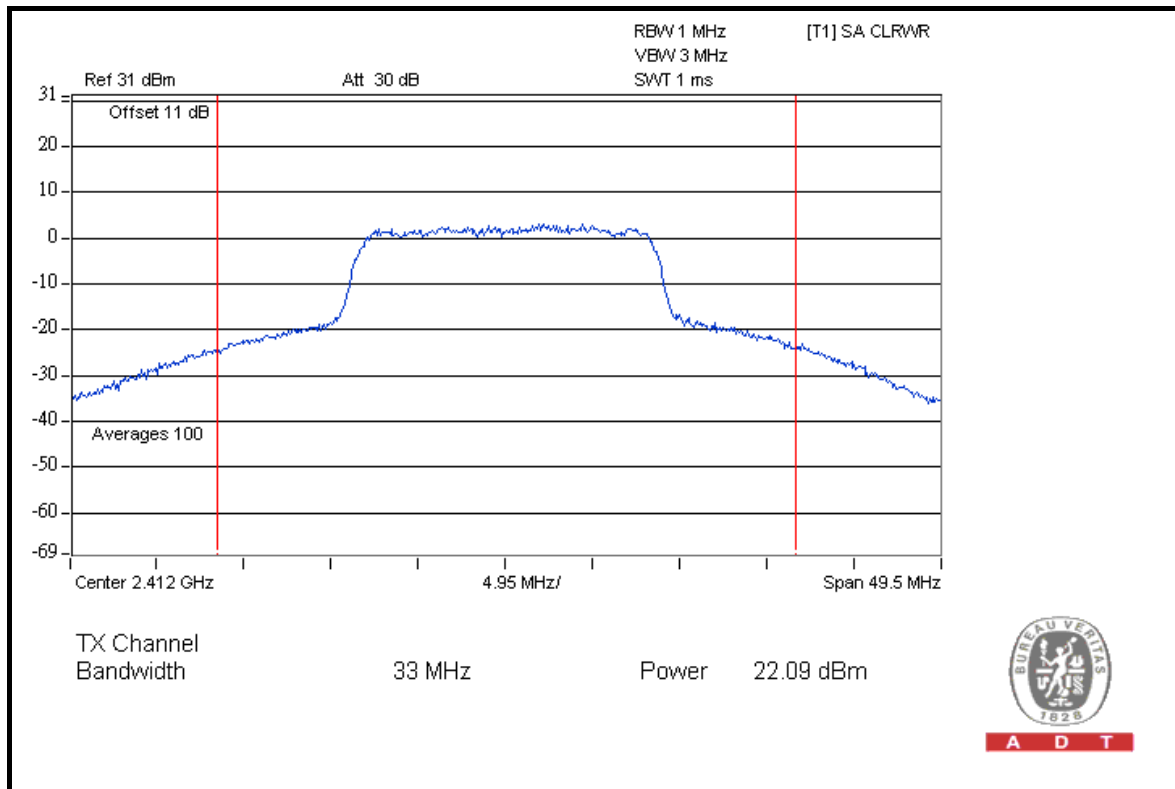



A D T

CH 6

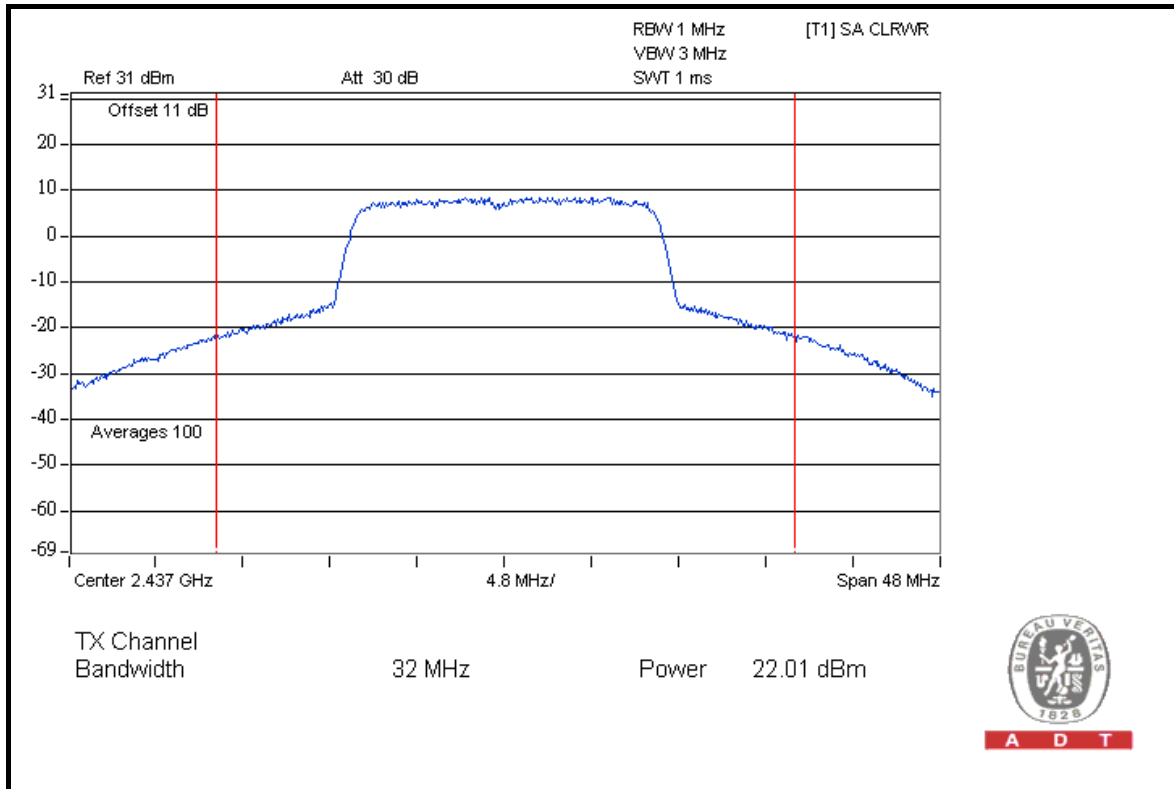

CH 11

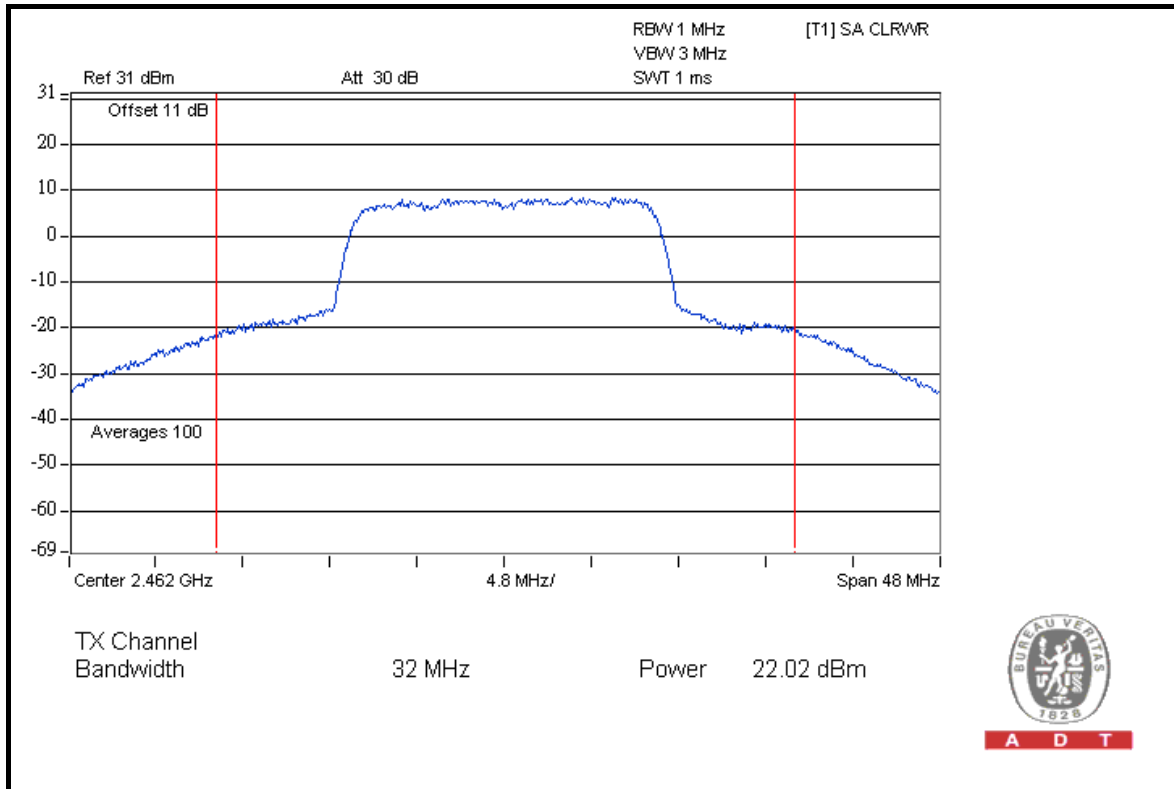



A D T

DRAFT 802.11n (20MHz) OFDM MODULATION

MODULATION TYPE	BPSK	TRANSFER RATE	6.5Mbps
INPUT POWER	120Vac, 60Hz	ENVIRONMENTAL CONDITIONS	25deg.C, 65%RH, 1021hPa
TESTED BY	Brad Wu		

CHAN.	CHAN. FREQ. (MHz)	PEAK POWER OUTPUT (dBm)			TOTAL PEAK POWER (mW)	TOTAL PEAK POWER (dBm)	PEAK POWER LIMIT (dBm)	PASS / FAIL
		CHAIN 0	CHAIN 1	CHAIN 2				
1	2412	22.01	22.04	22.14	482.492	26.83	30	PASS
6	2437	22.08	22.13	22.14	488.423	26.89	30	PASS
11	2462	22.11	22.09	22.01	483.218	26.84	30	PASS

FOR CHAIN 0: CH 1

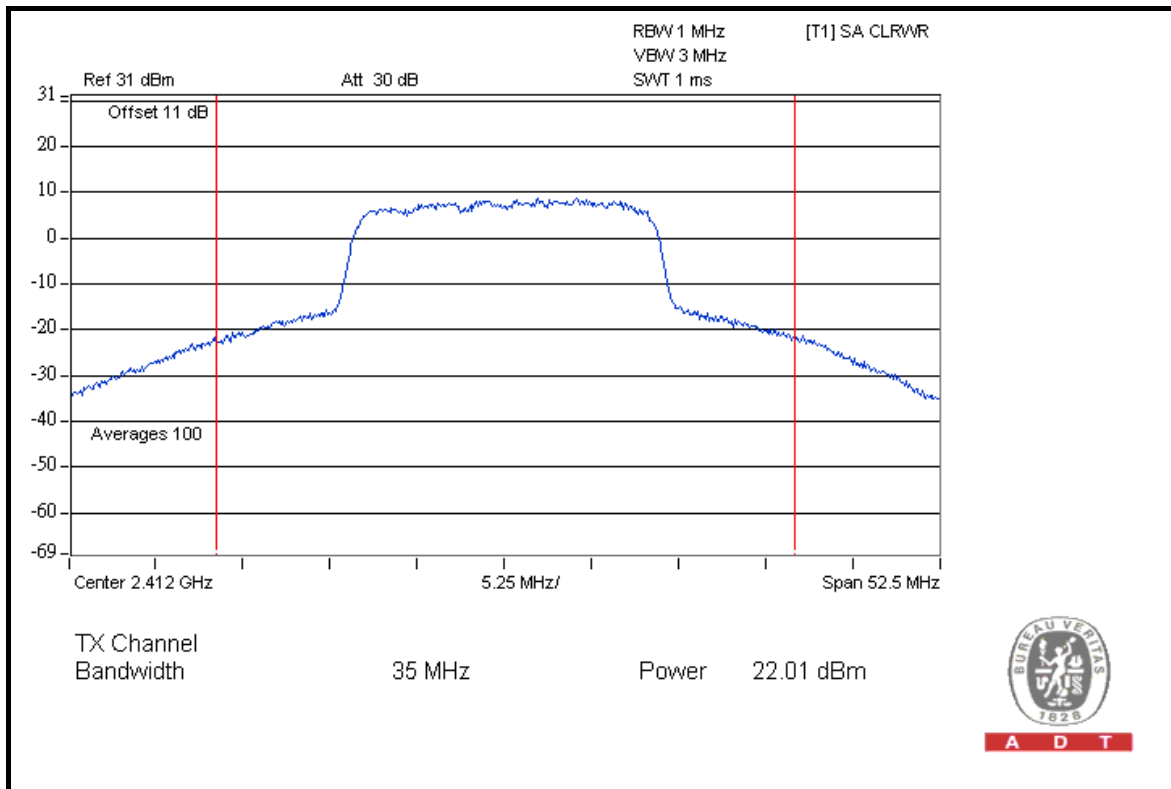

A D T



A D T

CH 6

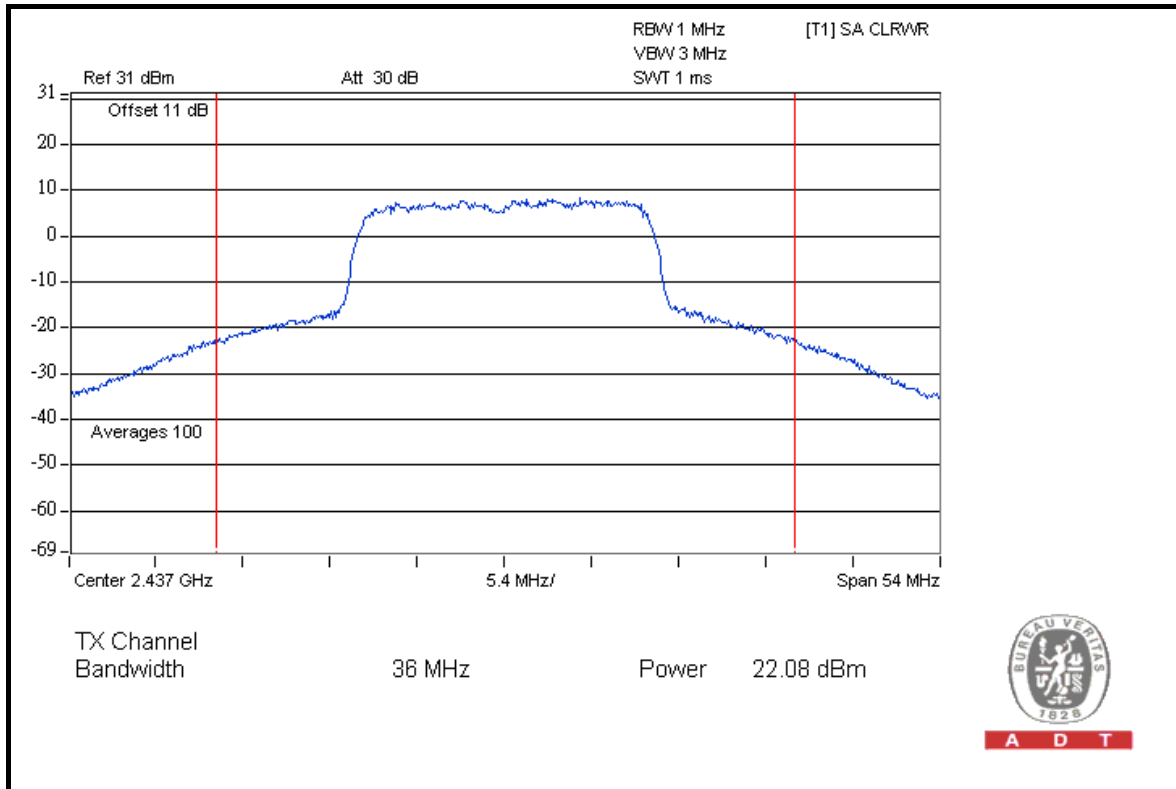

CH 11

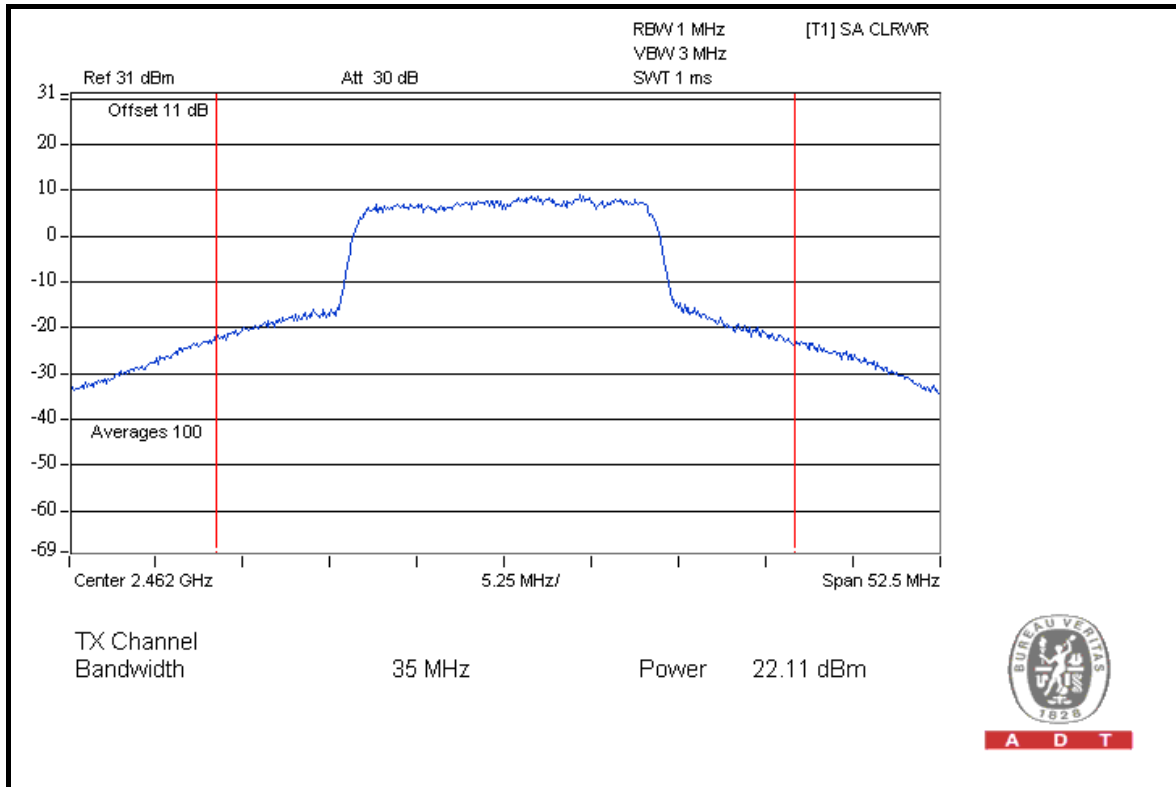



A D T

FOR CHAIN 1: CH 1

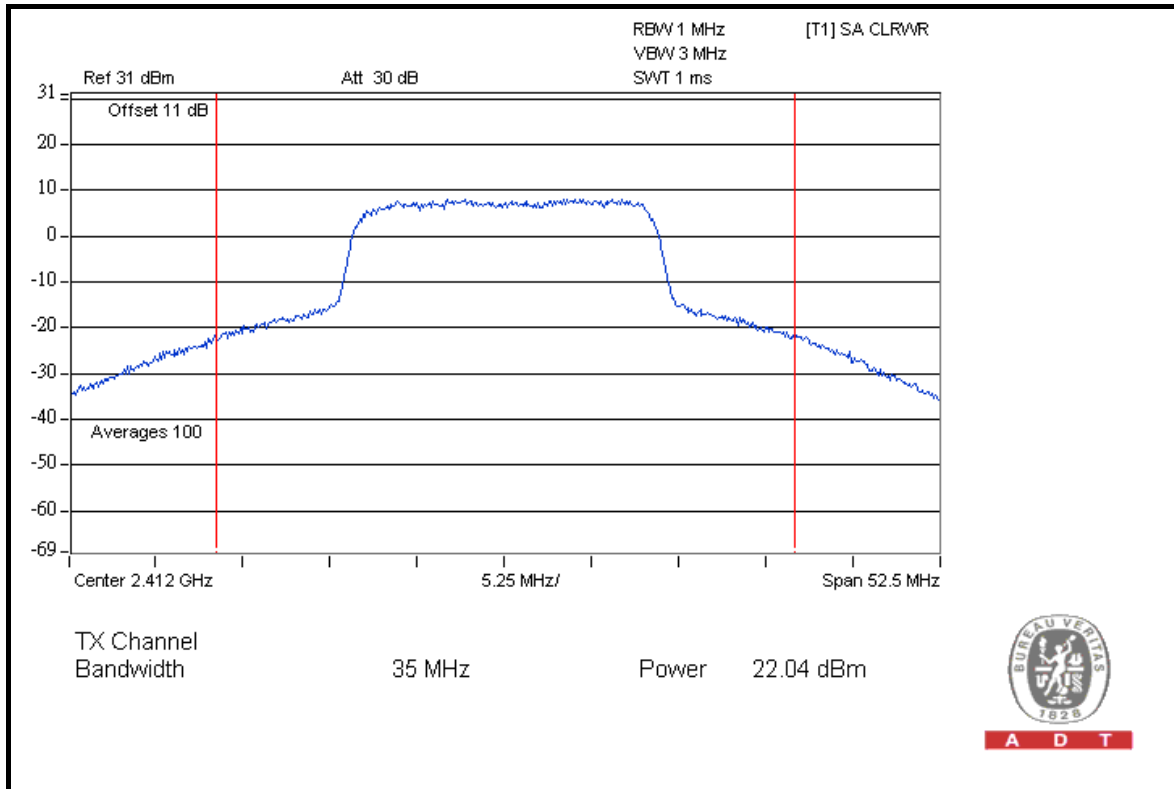

CH 6

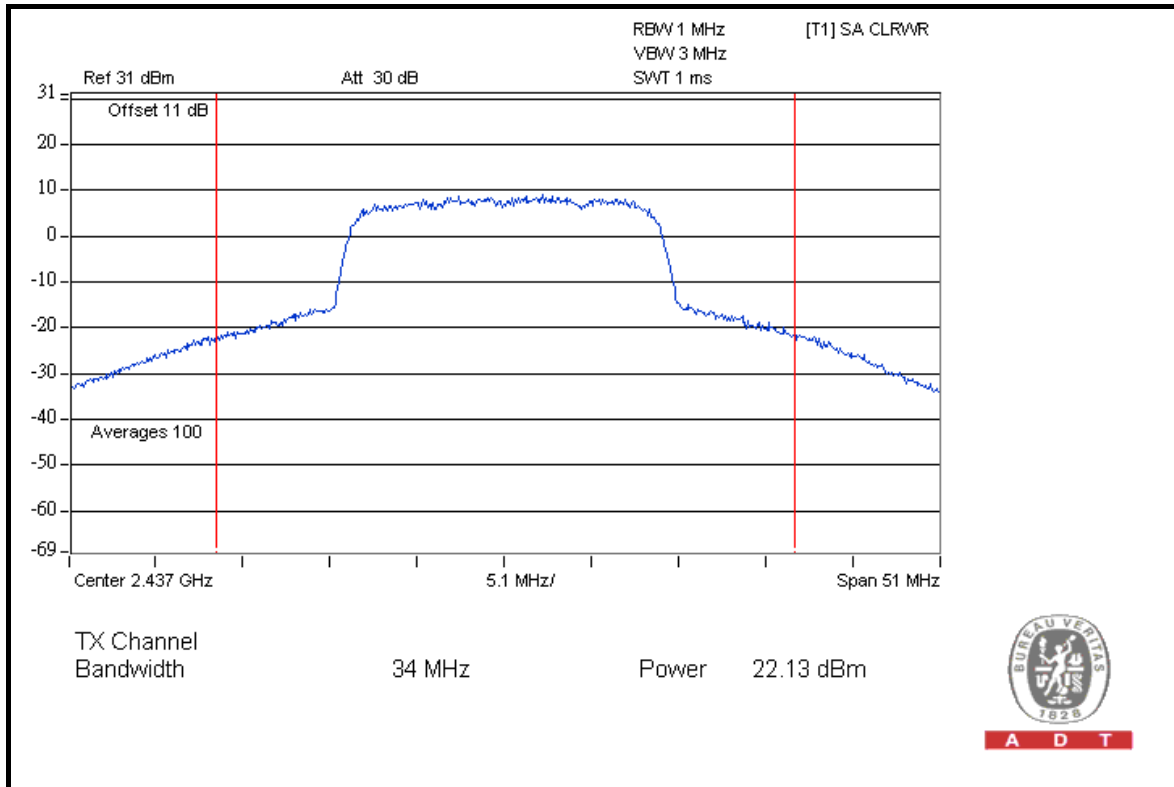



A D T

CH 11

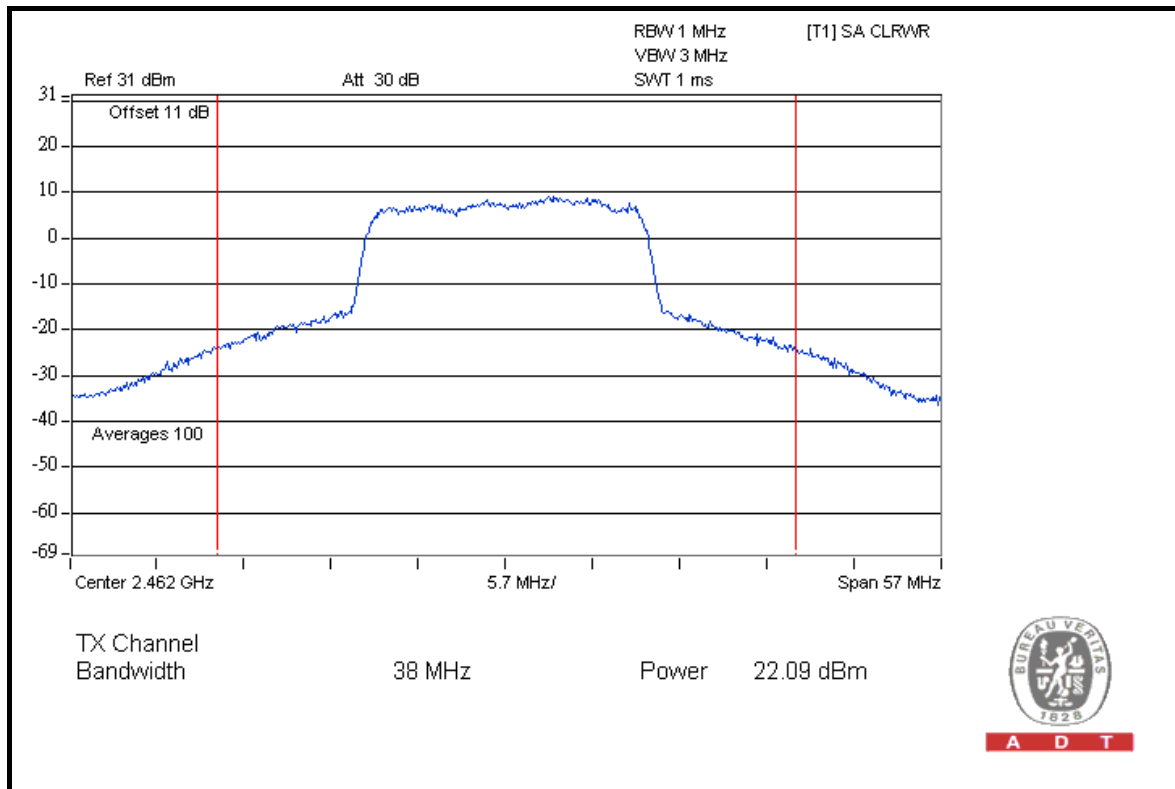

FOR CHAIN 2: CH 1

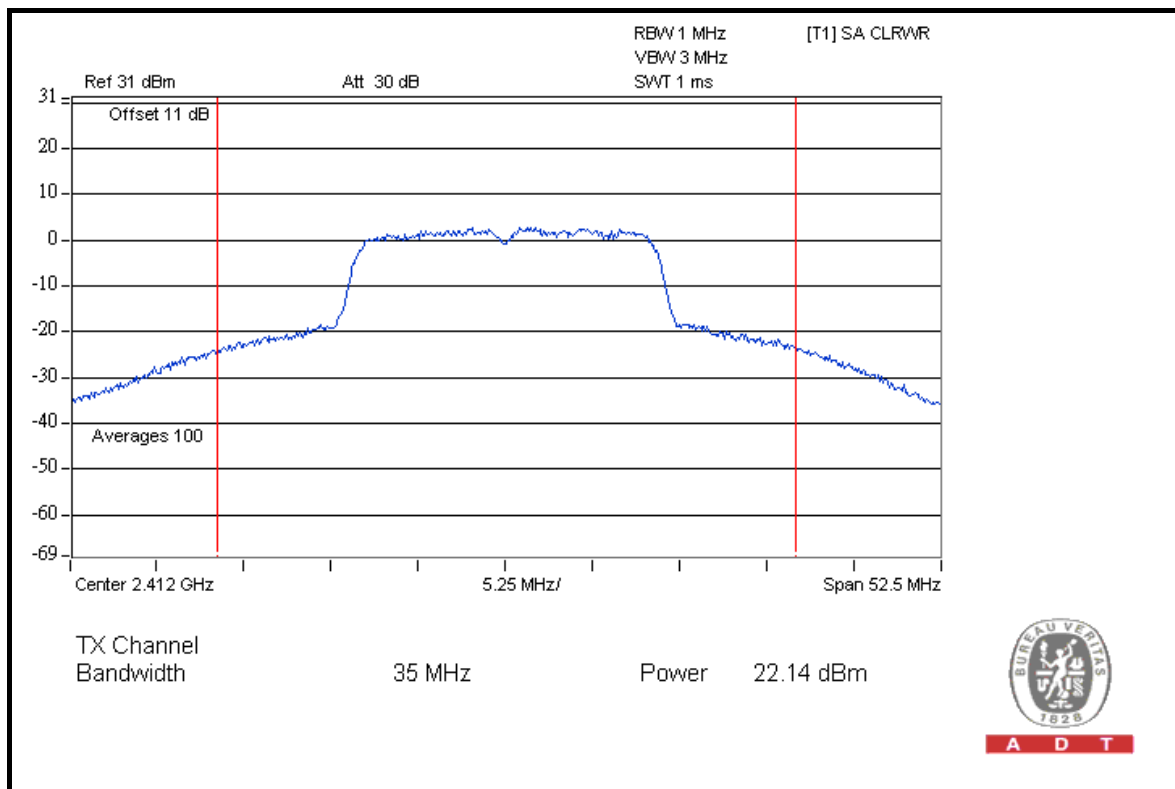



A D T

CH 6

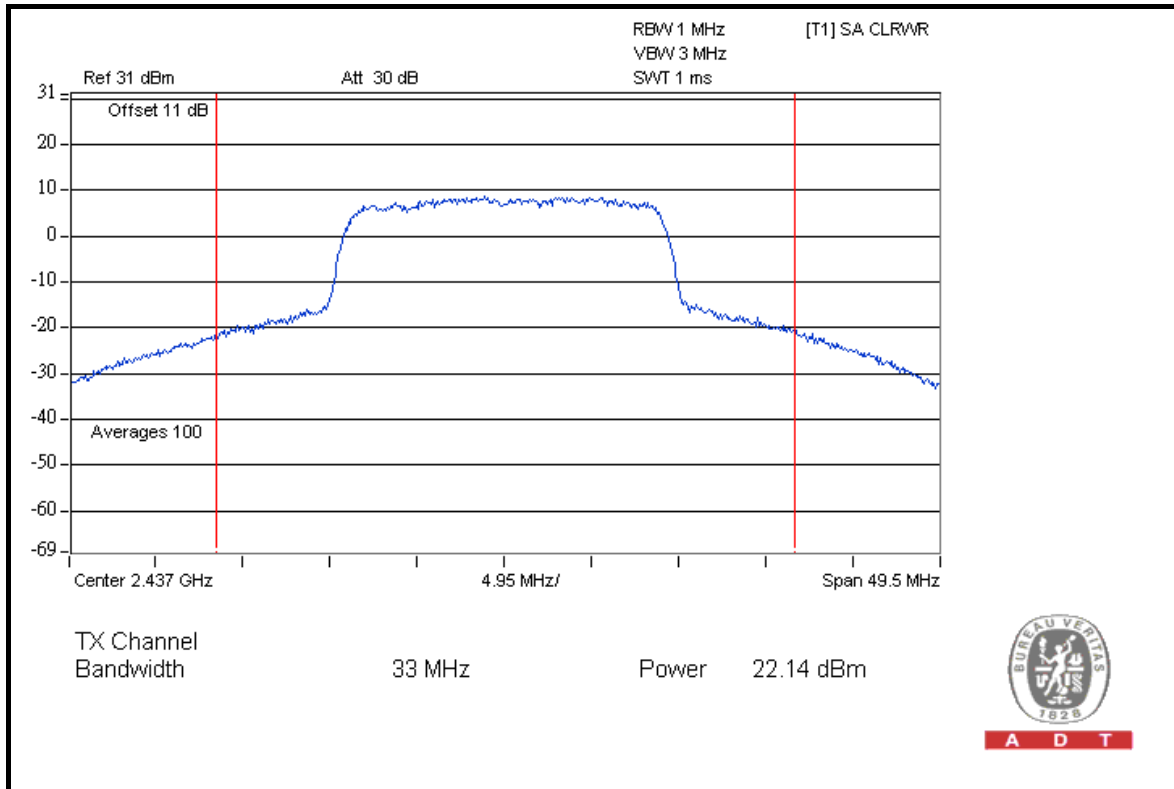

CH 11

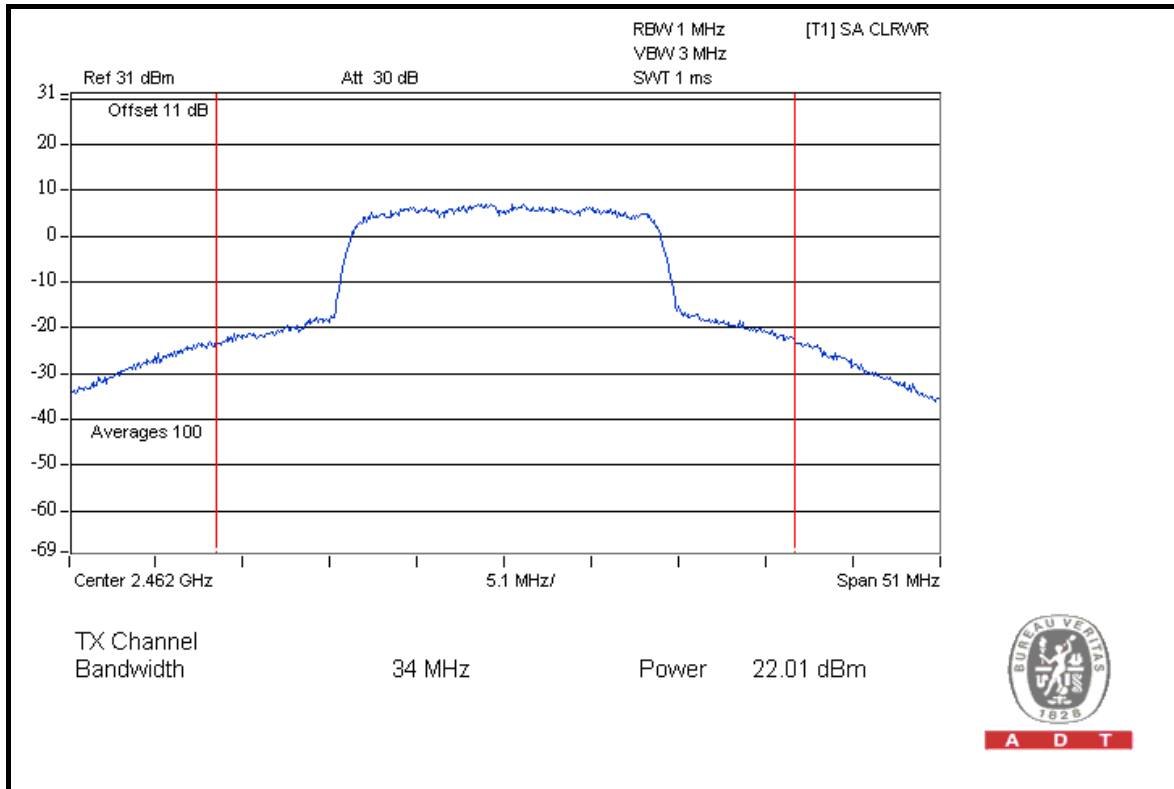



A D T

DRAFT 802.11n (40MHz) OFDM MODULATION

MODULATION TYPE	BPSK	TRANSFER RATE	13.5Mbps
INPUT POWER	120Vac, 60Hz	ENVIRONMENTAL CONDITIONS	25deg.C, 65%RH, 1021hPa
TESTED BY	Brad Wu		

CHAN.	CHAN. FREQ. (MHz)	PEAK POWER OUTPUT (dBm)			TOTAL PEAK POWER (mW)	TOTAL PEAK POWER (dBm)	PEAK POWER LIMIT (dBm)	PASS / FAIL
		CHAIN 0	CHAIN 1	CHAIN 2				
1	2422	22.11	22.11	22.12	488.039	26.88	30	PASS
4	2437	22.04	22.08	22.11	483.947	26.85	30	PASS
7	2452	22.09	22.03	22.13	484.701	26.85	30	PASS

FOR CHAIN 0: CH 1

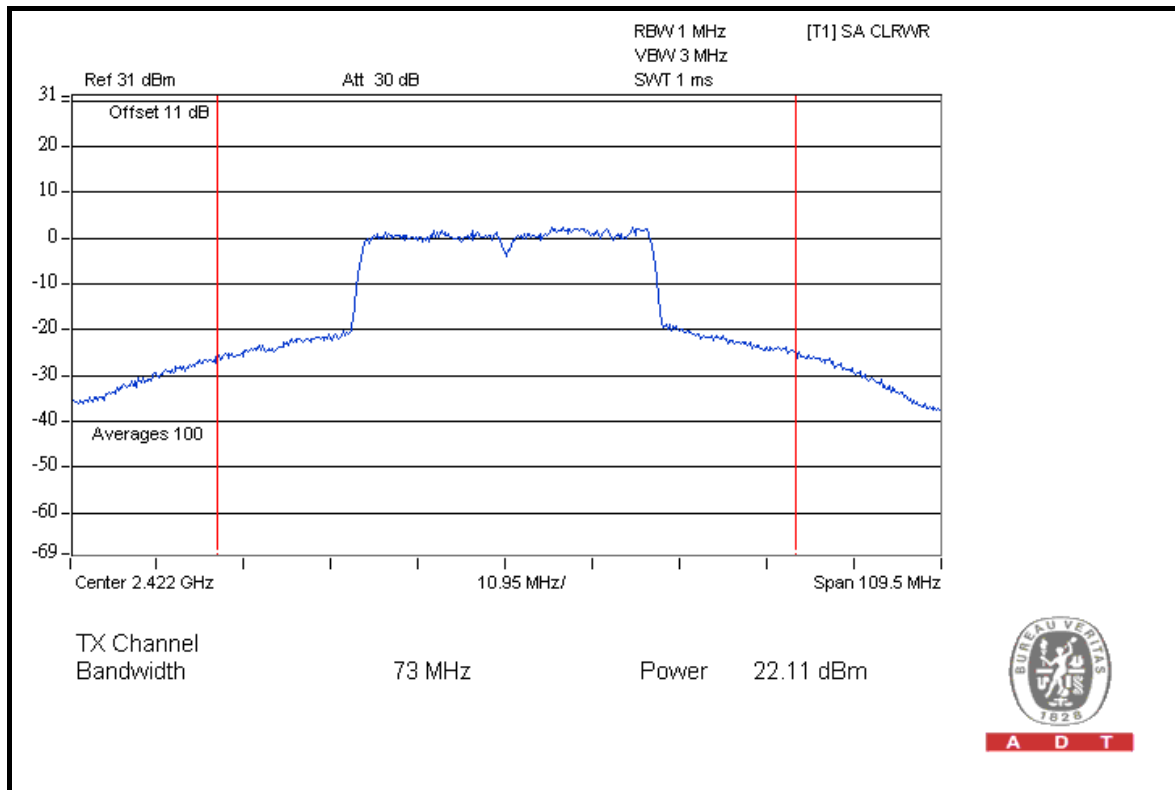

A D T



A D T

CH 4

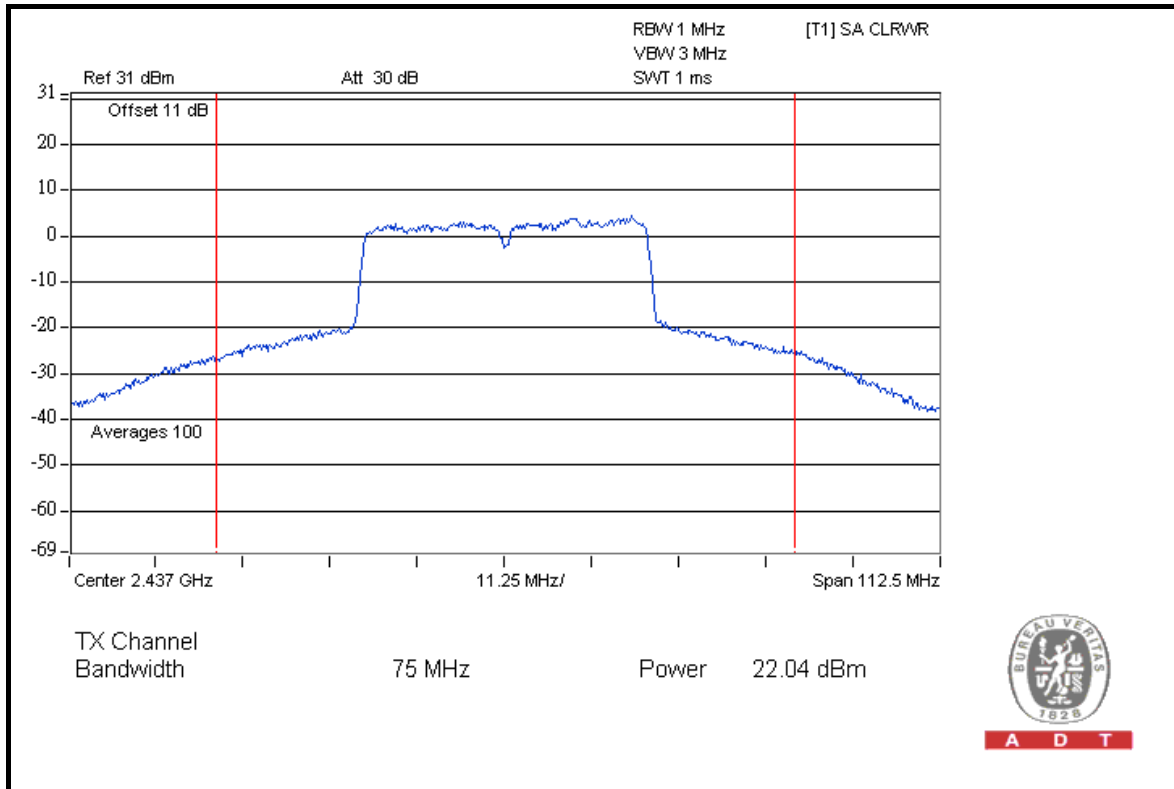

CH 7

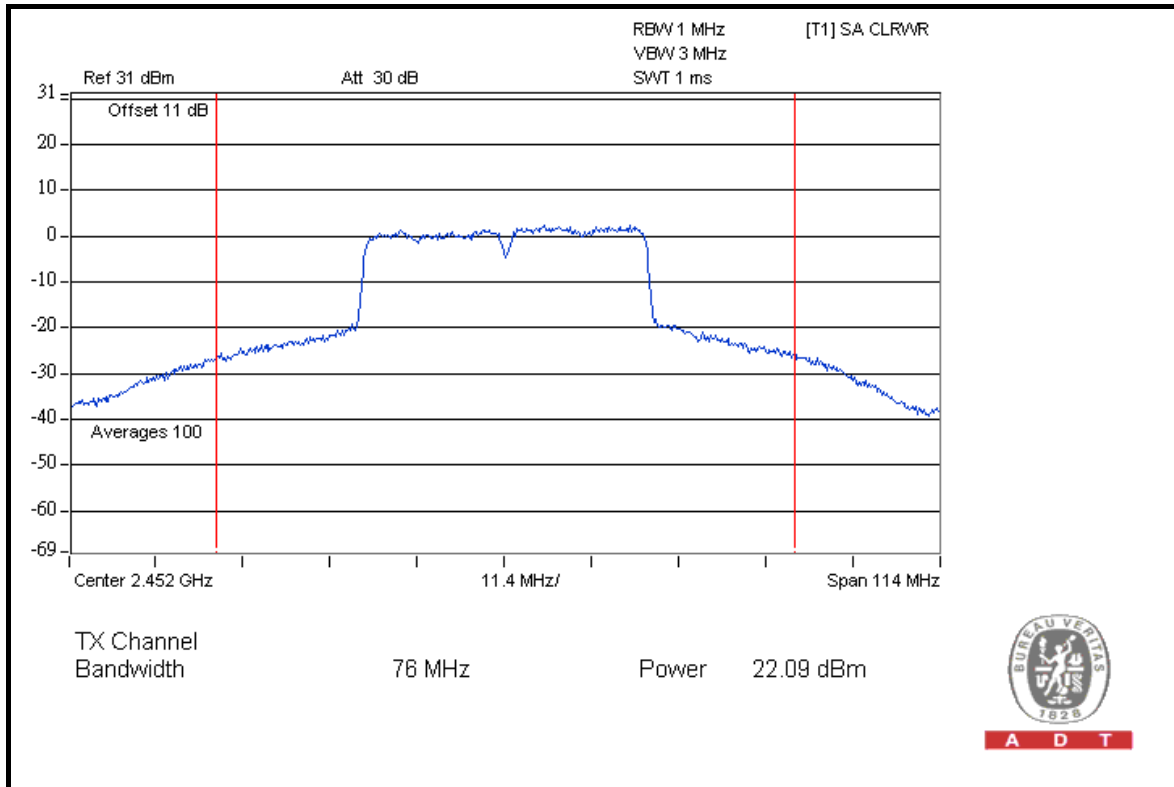



A D T

FOR CHAIN 1: CH 1

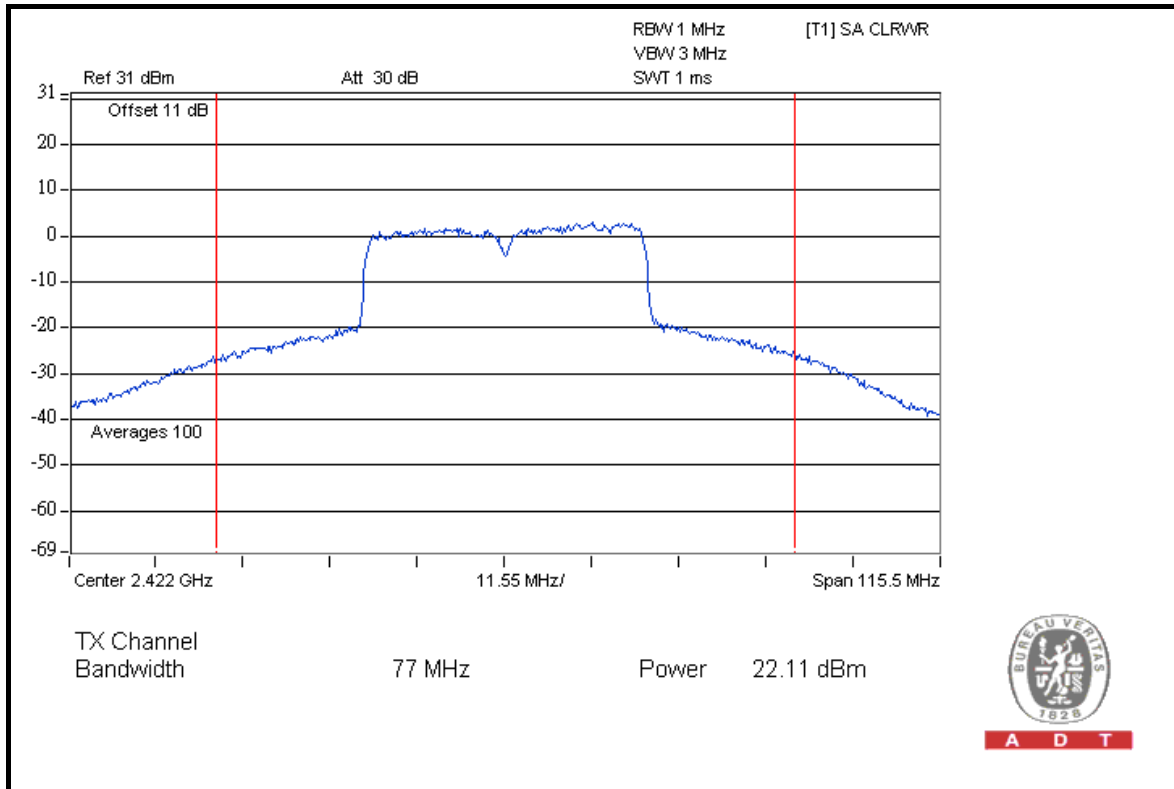

A D T

CH 4

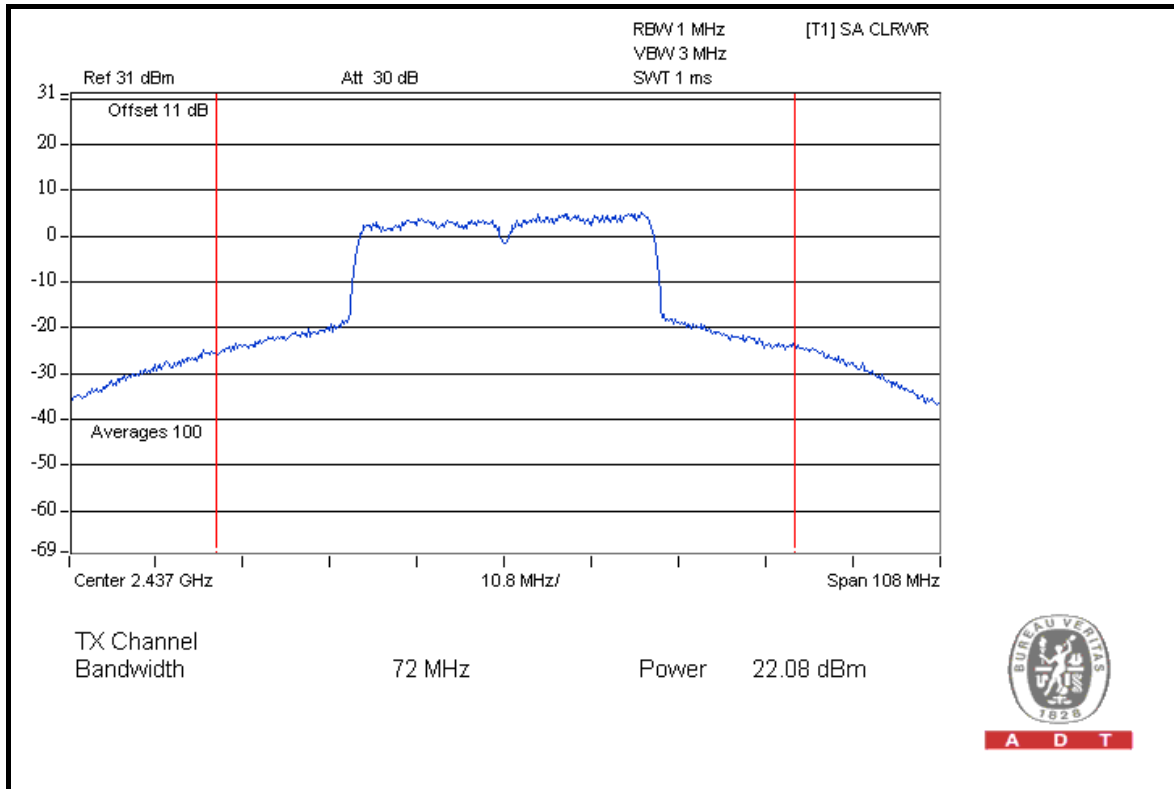

A D T



A D T

CH 7

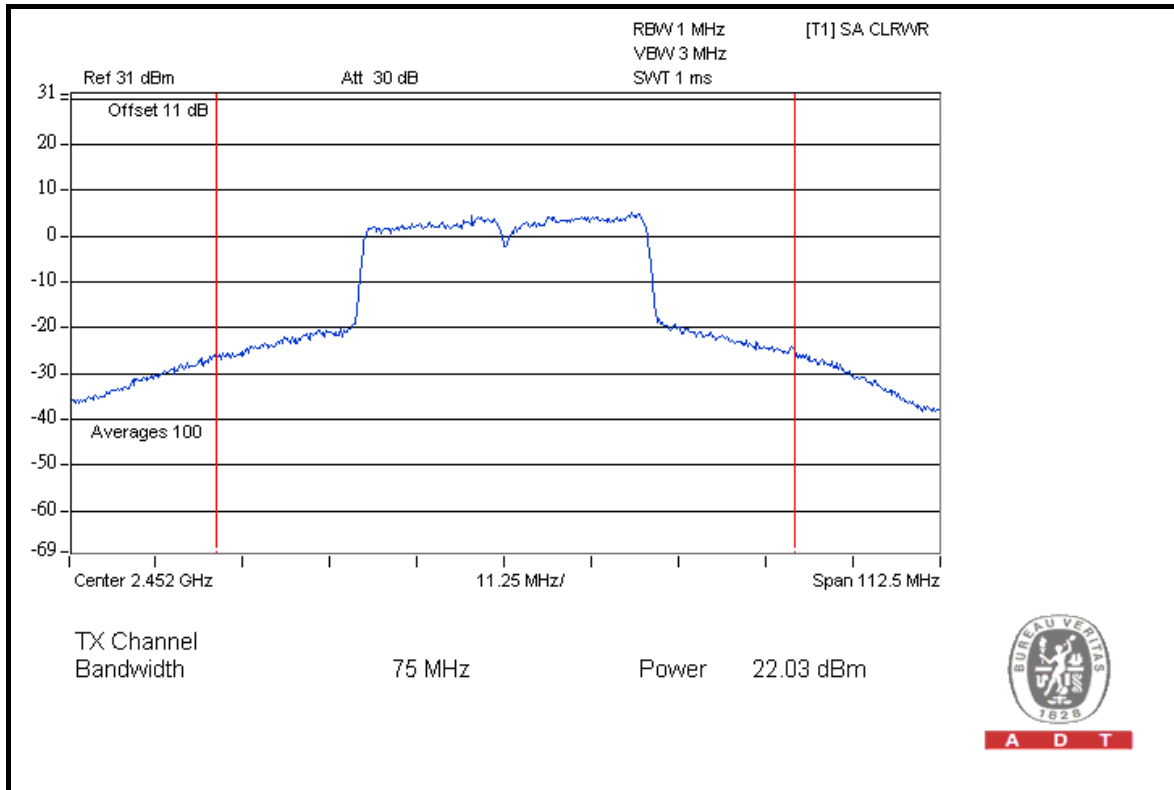

FOR CHAIN 2: CH 1

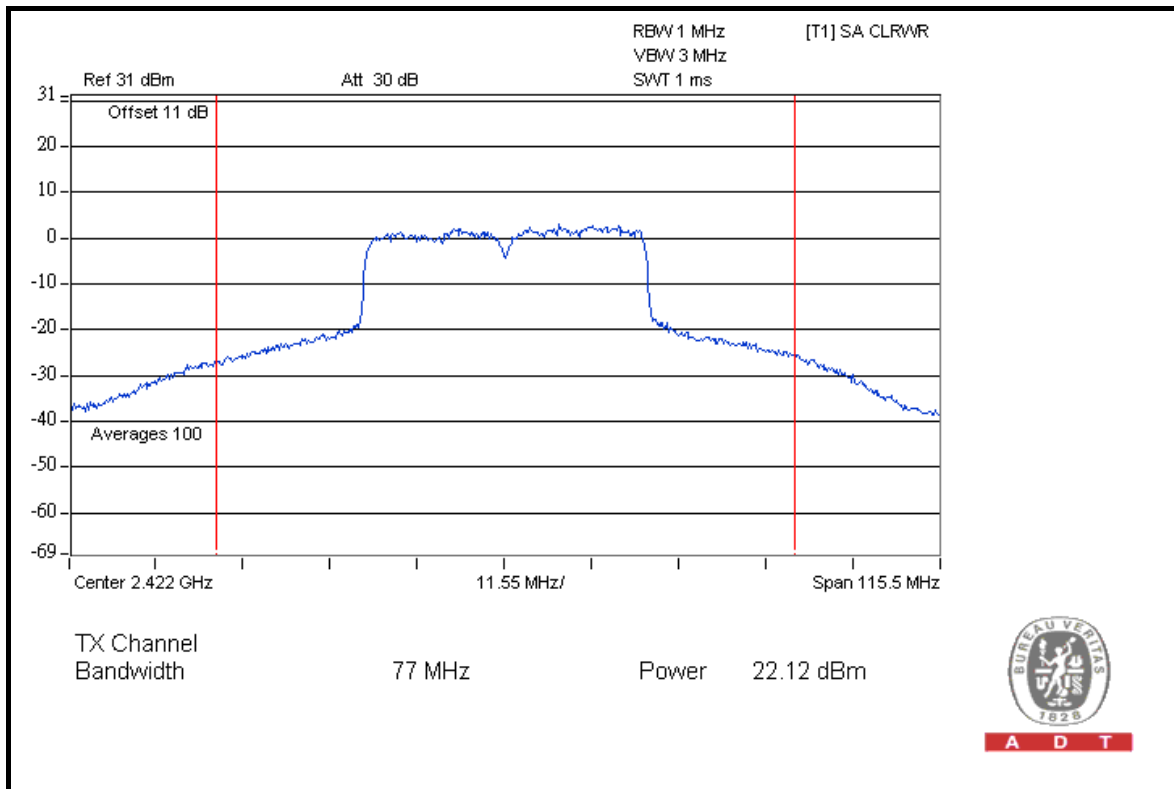



A D T

CH 4

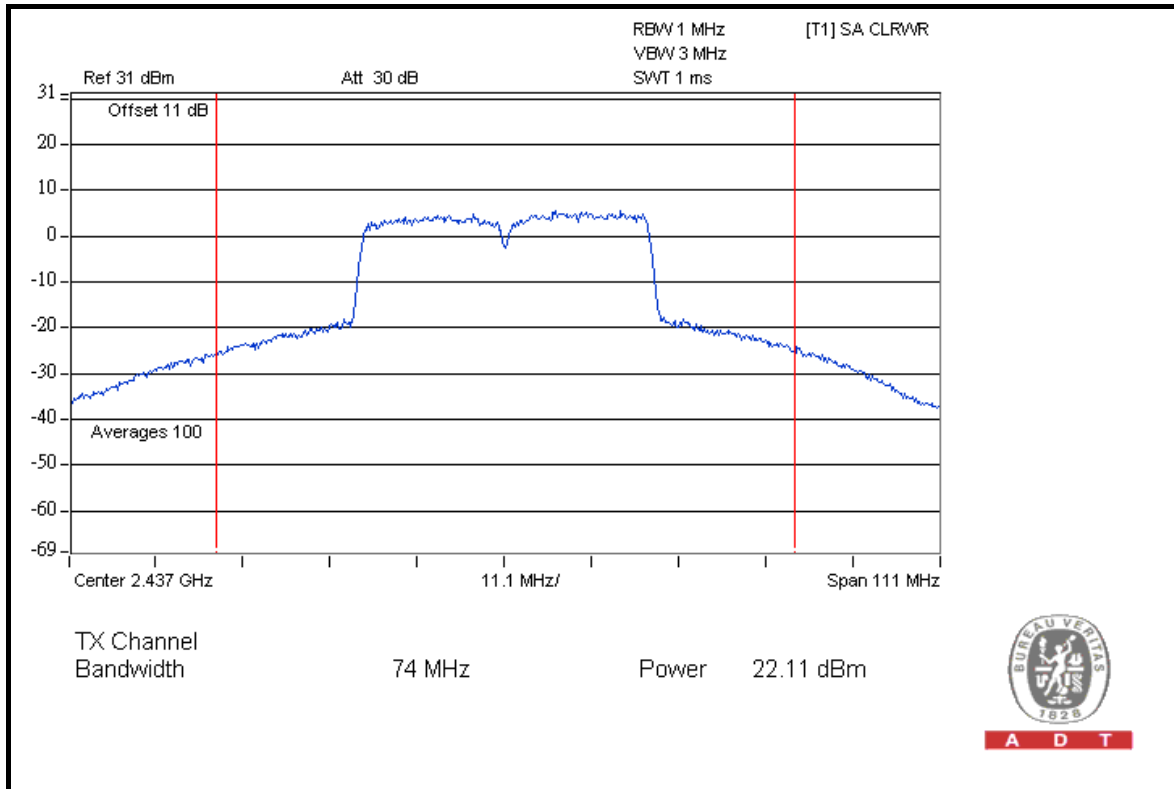

CH 7

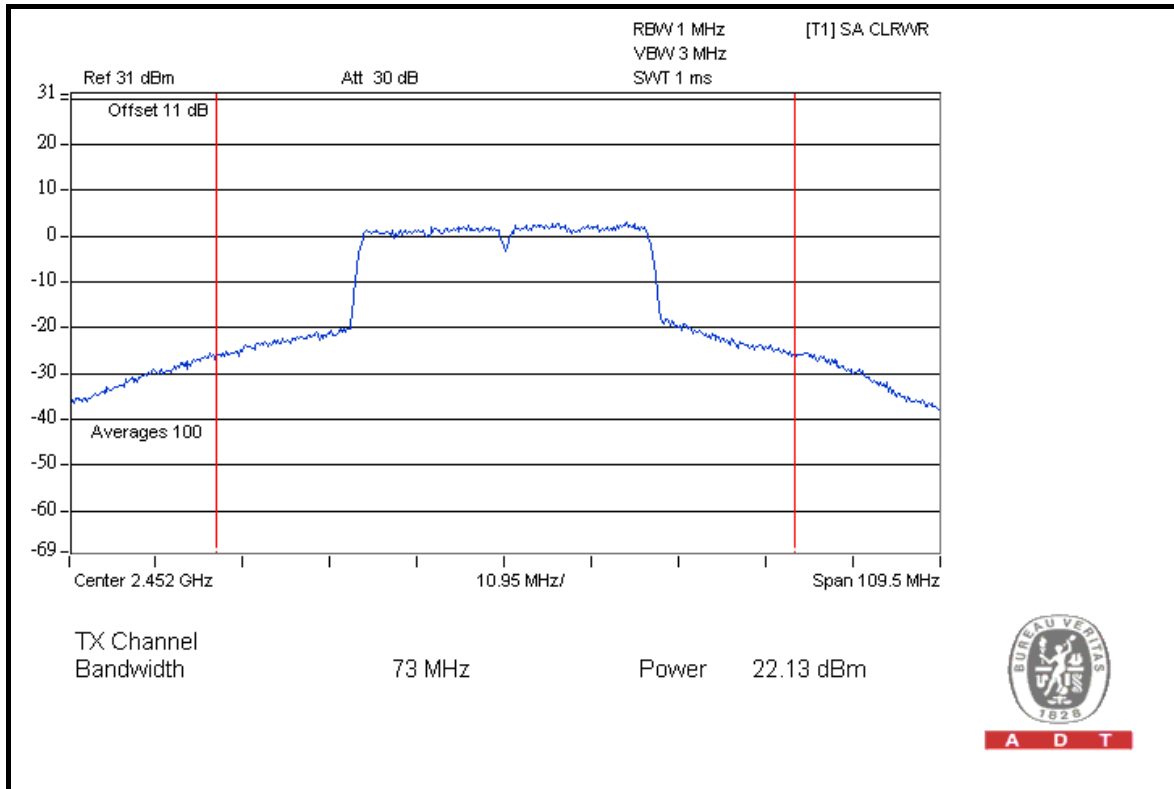



A D T

4.5 POWER SPECTRAL DENSITY MEASUREMENT

4.5.1 LIMITS OF POWER SPECTRAL DENSITY MEASUREMENT

The Maximum of Power Spectral Density Measurement is 8dBm.

4.5.2 TEST INSTRUMENTS

DESCRIPTION & MANUFACTURER	MODEL NO.	SERIAL NO.	DATE OF CALIBRATION	DUE DATE OF CALIBRATION
R&S SPECTRUM ANALYZER	FSP40	100041	May 13, 2009	May 12, 2010

NOTE: The calibration interval of the above test instruments is 12 months and the calibrations are traceable to NML/ROC and NIST/USA.

4.5.3 TEST PROCEDURE

1. Follow DTS measurement (PSD Option 2), the transmitter output was connected to the spectrum analyzer through an attenuator, the bandwidth of the fundamental frequency was measured with the spectrum analyzer. Locate and zoom in on emission peak(s) within the pass band.
2. Set RBW = 3 kHz /VBW > 9 kHz and sweep time to Automatic.
3. Detector use peak mode and a video trigger with the trigger level set to enable triggering only on full power pulses.
4. Trace average 100 traces in power averaging mode. The power spectral density was measured and recorded.

4.5.4 DEVIATION FROM TEST STANDARD

No deviation

4.5.5 TEST SETUP

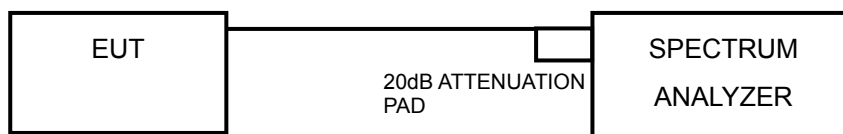

4.5.6 EUT OPERATING CONDITION

Same as Item 4.3.6



A D T

4.5.7 TEST RESULTS

802.11b DSSS MODULATION

MODULATION TYPE	DBPSK	TRANSFER RATE	1.0Mbps
INPUT POWER	120Vac, 60Hz	ENVIRONMENTAL CONDITIONS	25deg.C, 65%RH, 1021hPa
TESTED BY	Brad Wu		

CHAN.	CHAN. FREQ. (MHz)	RF POWER LEVEL IN 3kHz BW (dBm)			TOTAL POWER DENSITY (mW)	TOTAL POWER DENSITY (dBm)	MAX. LIMIT (dBm)	PASS / FAIL
		CHAIN 0	CHAIN 1	CHAIN 2				
1	2412	-5.11	-5.52	-5.10	0.898	-0.47	8	PASS
6	2437	-4.90	-5.56	-4.91	0.924	-0.34	8	PASS
11	2462	-4.90	-5.39	-5.18	0.916	-0.38	8	PASS

FOR CHAIN 0: CH 1

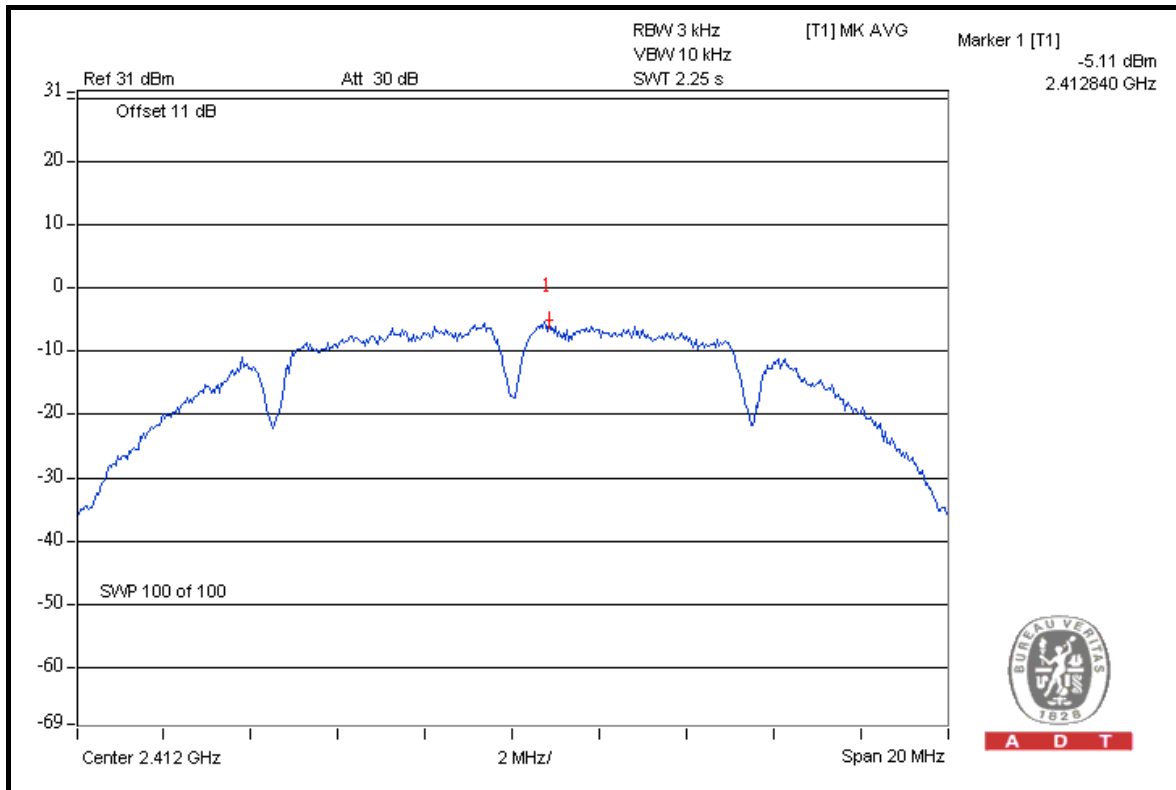

A D T



A D T

CH 6

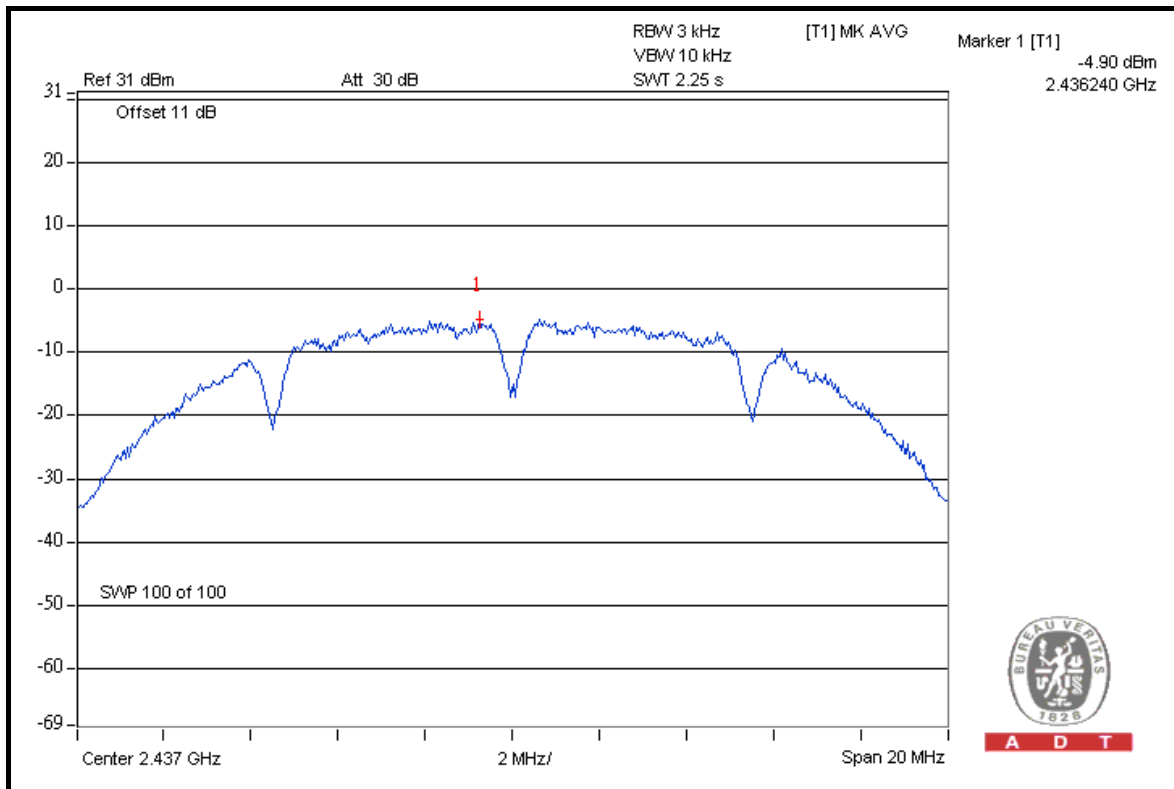

A D T

CH 11

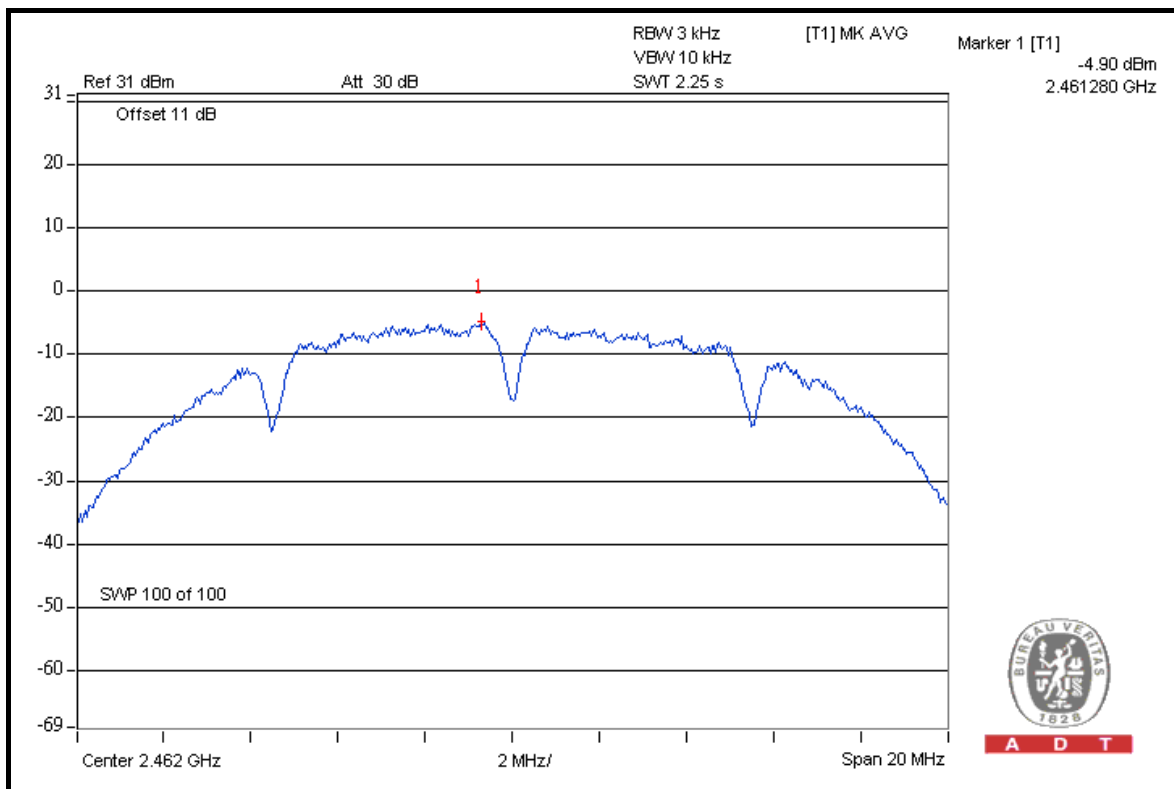

A D T



A D T

FOR CHAIN 1: CH 1

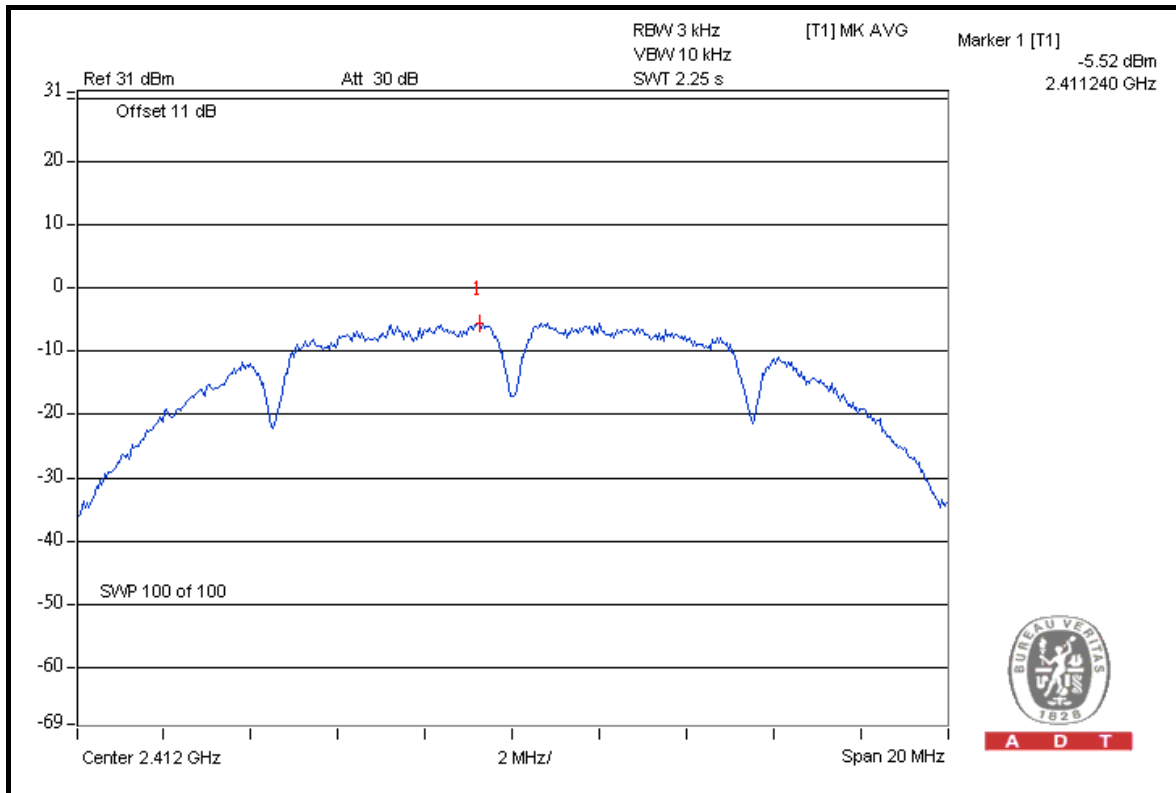

CH 6

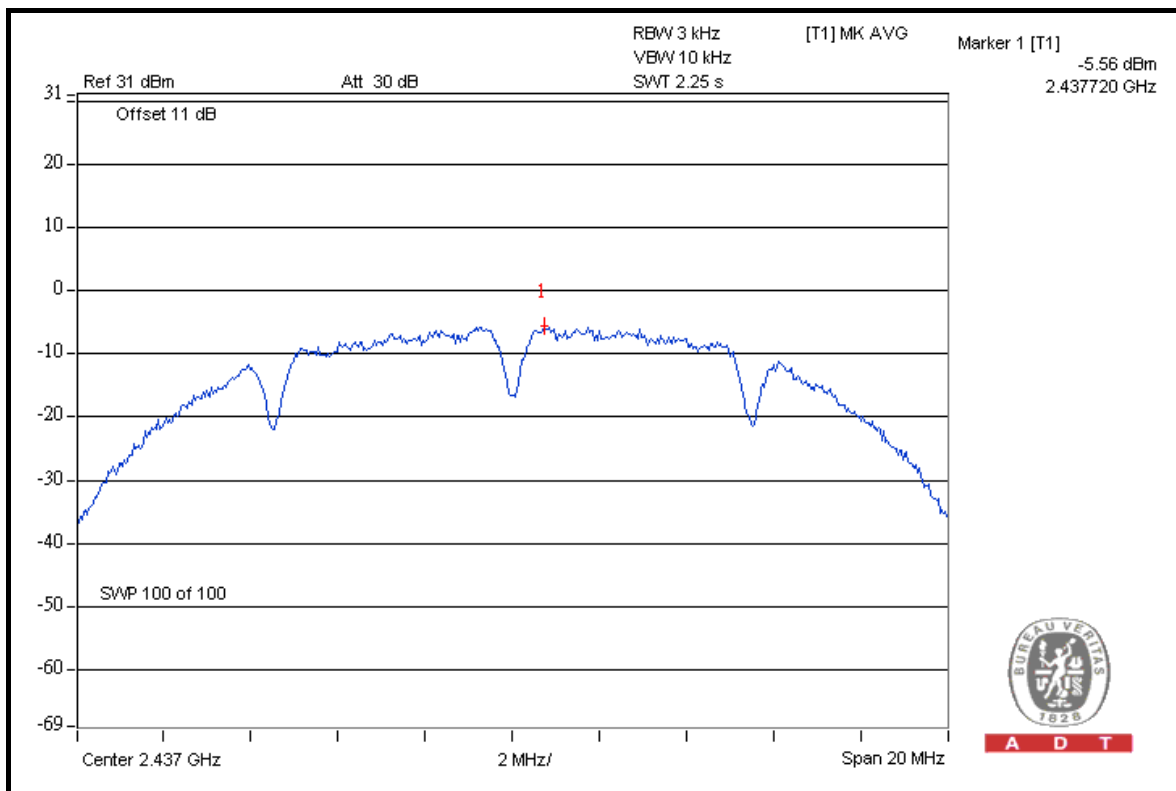



A D T

CH 11

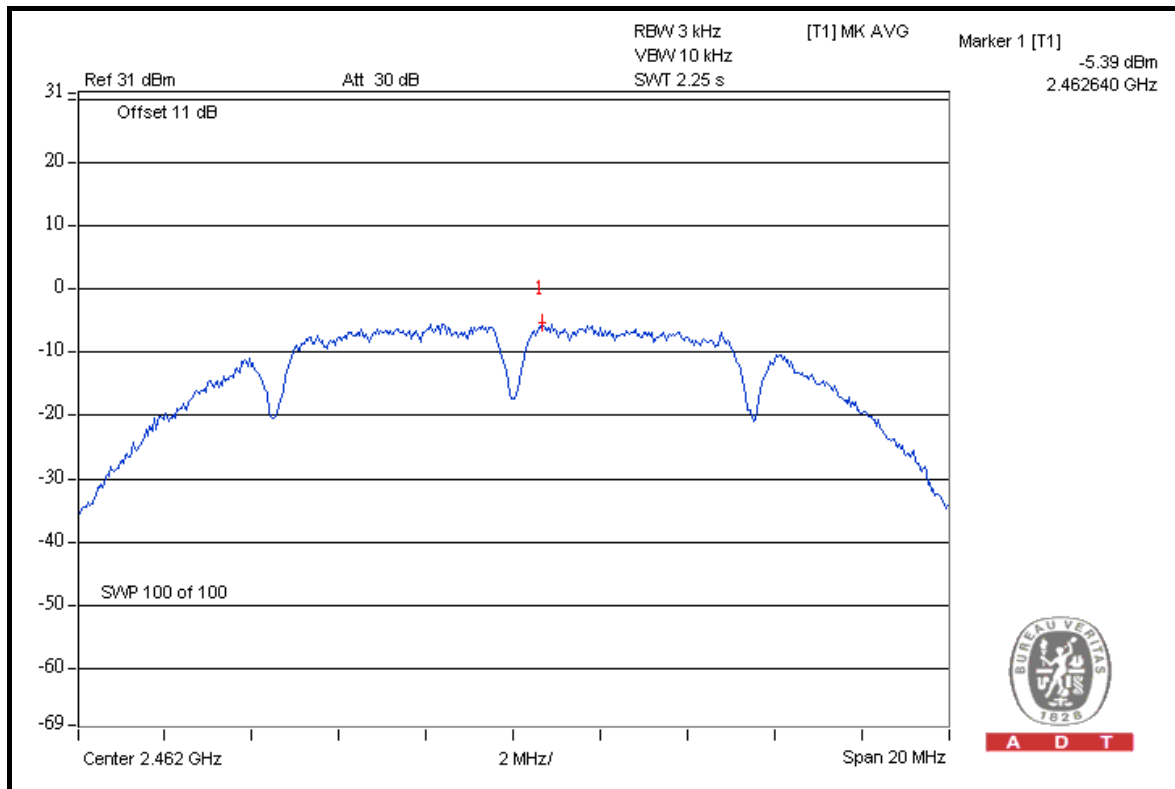

FOR CHAIN 2: CH 1

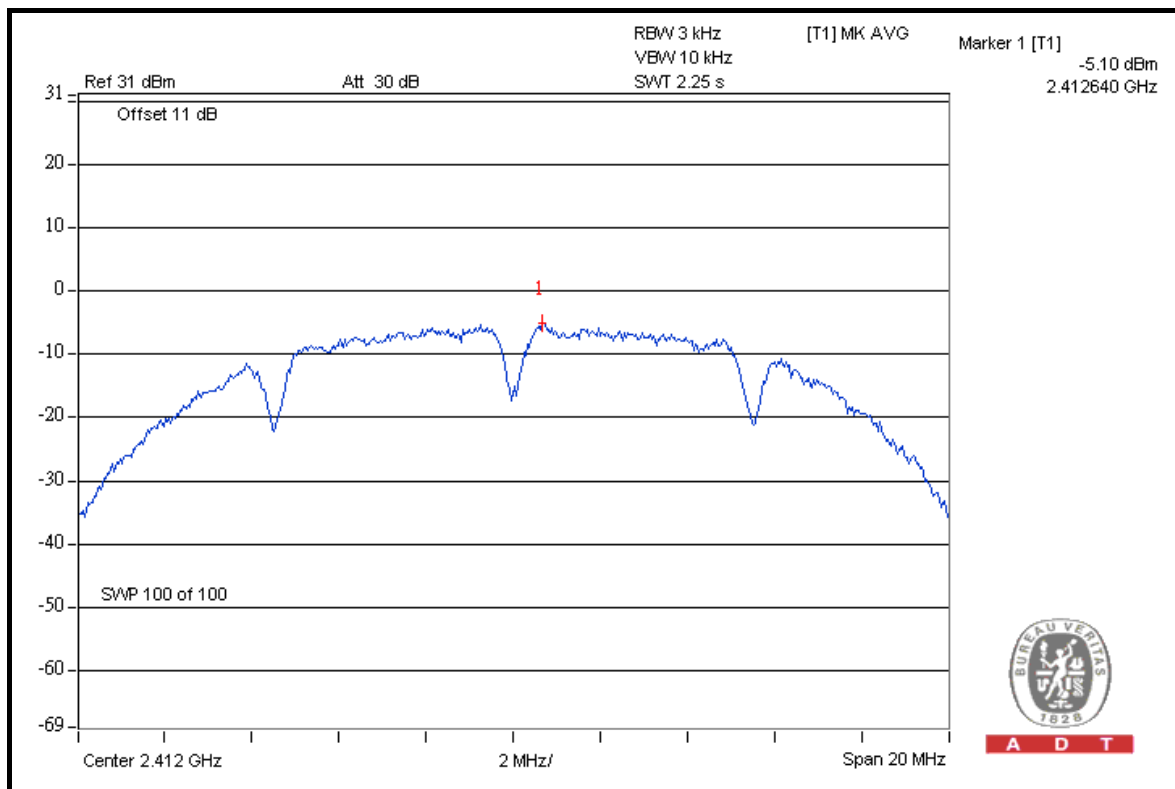



A D T

CH 6

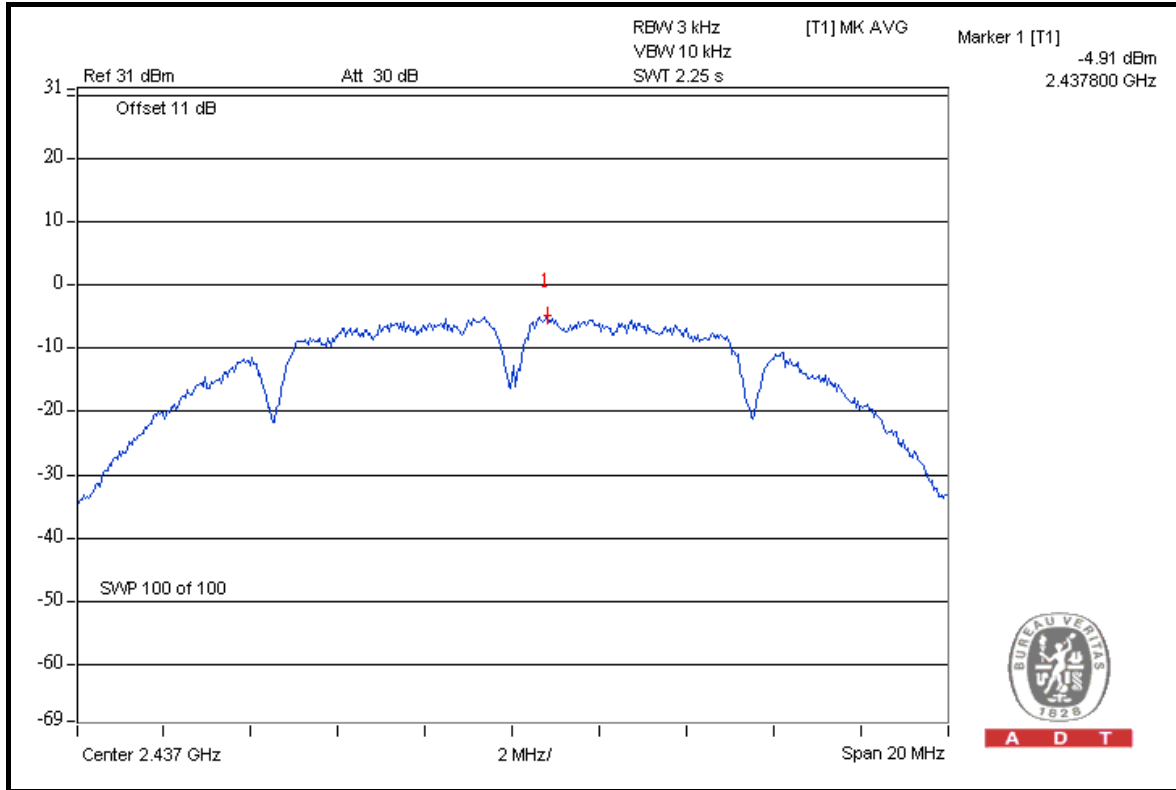

CH 11

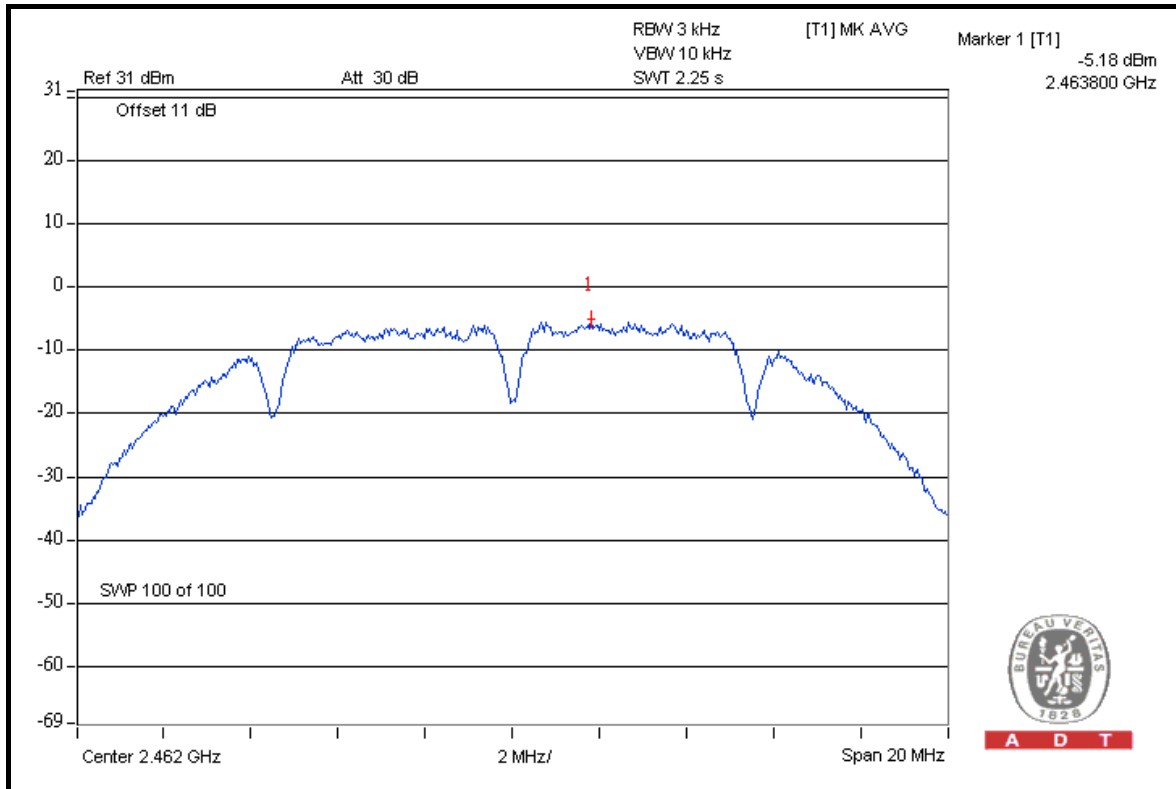



A D T

802.11g OFDM MODULATION

MODULATION TYPE	BPSK	TRANSFER RATE	6.0Mbps
INPUT POWER	120Vac, 60Hz	ENVIRONMENTAL CONDITIONS	25deg.C, 65%RH, 1021hPa
TESTED BY	Brad Wu		

CHAN.	CHAN. FREQ. (MHz)	RF POWER LEVEL IN 3kHz BW (dBm)			TOTAL POWER DENSITY (mW)	TOTAL POWER DENSITY (dBm)	MAX. LIMIT (dBm)	PASS / FAIL
		CHAIN 0	CHAIN 1	CHAIN 2				
1	2412	-6.79	-6.95	-6.59	0.631	-2.00	8	PASS
6	2437	-6.71	-6.97	-6.64	0.631	-2.00	8	PASS
11	2462	-6.68	-7.05	-6.82	0.620	-2.08	8	PASS

FOR CHAIN 0: CH 1

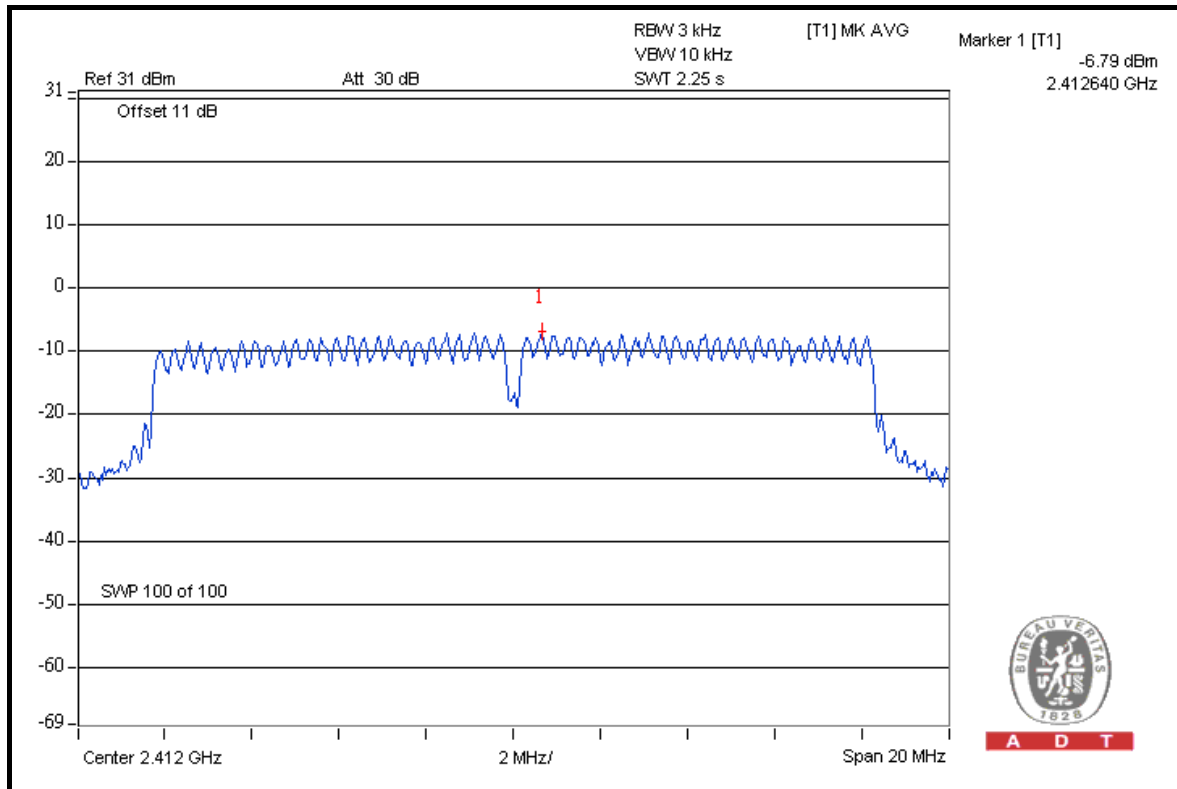



A D T

CH 6

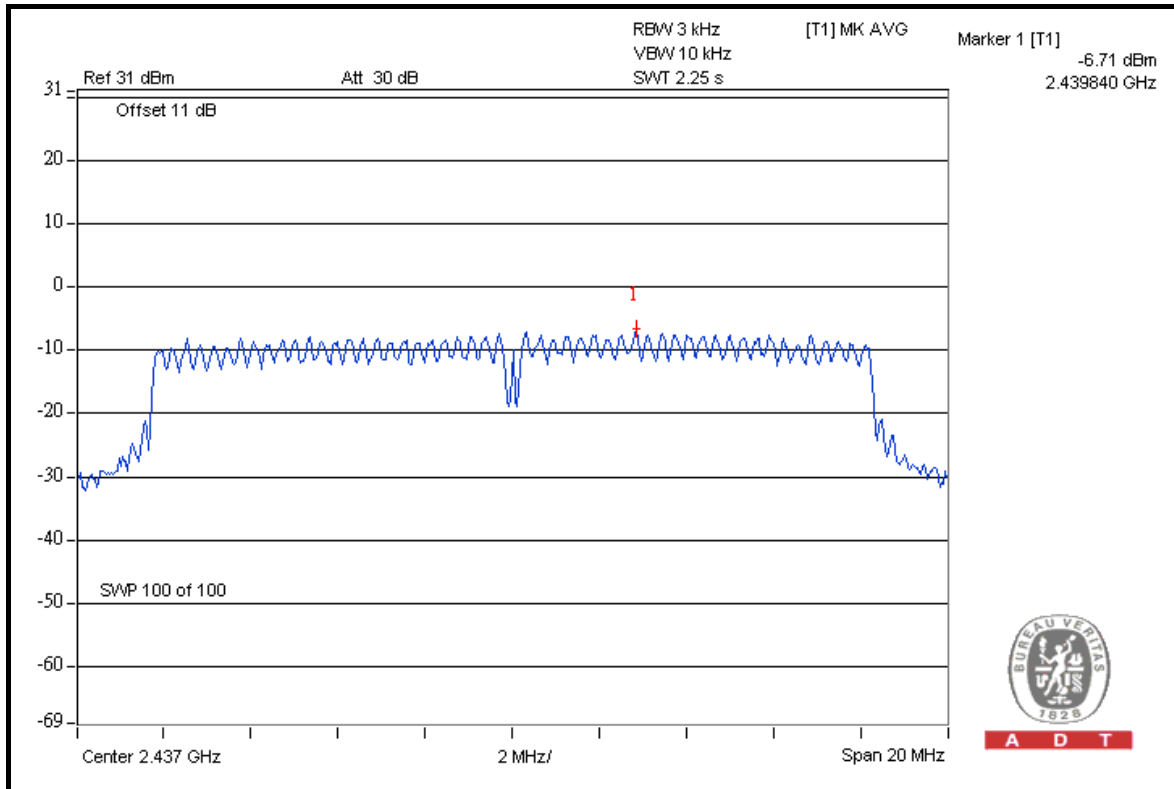

CH 11

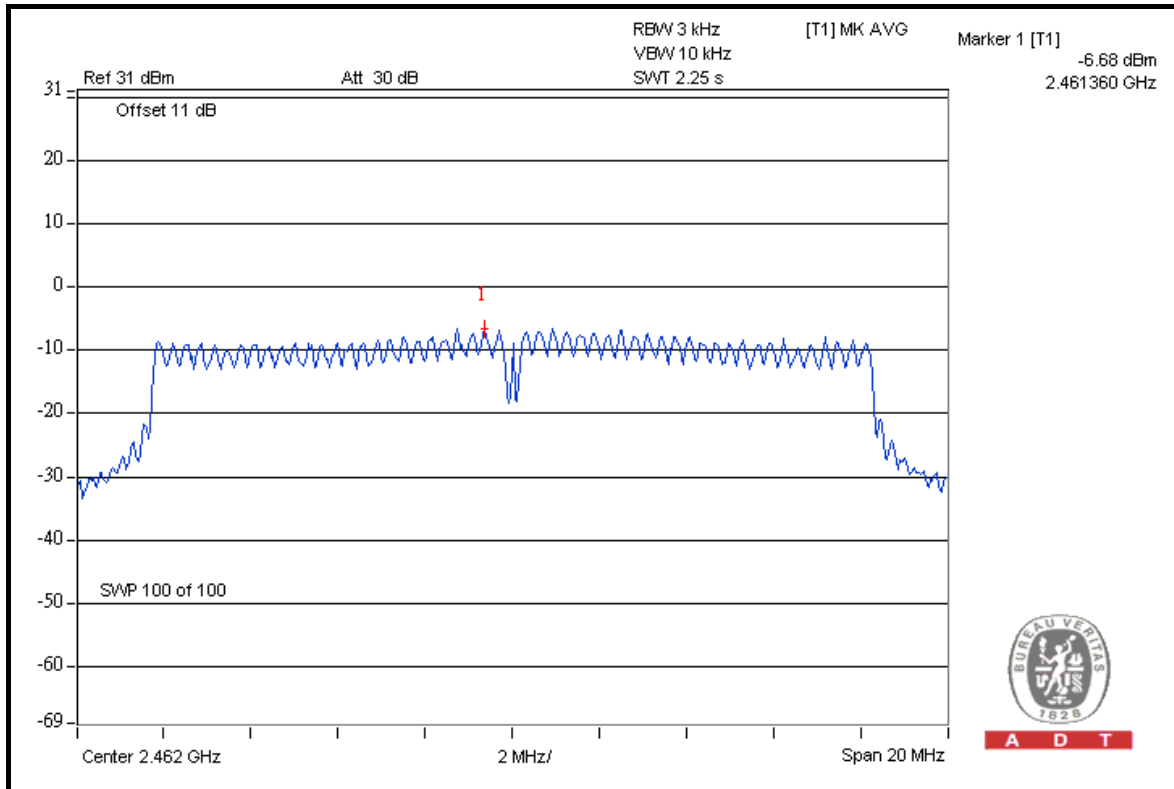



A D T

FOR CHAIN 1: CH 1

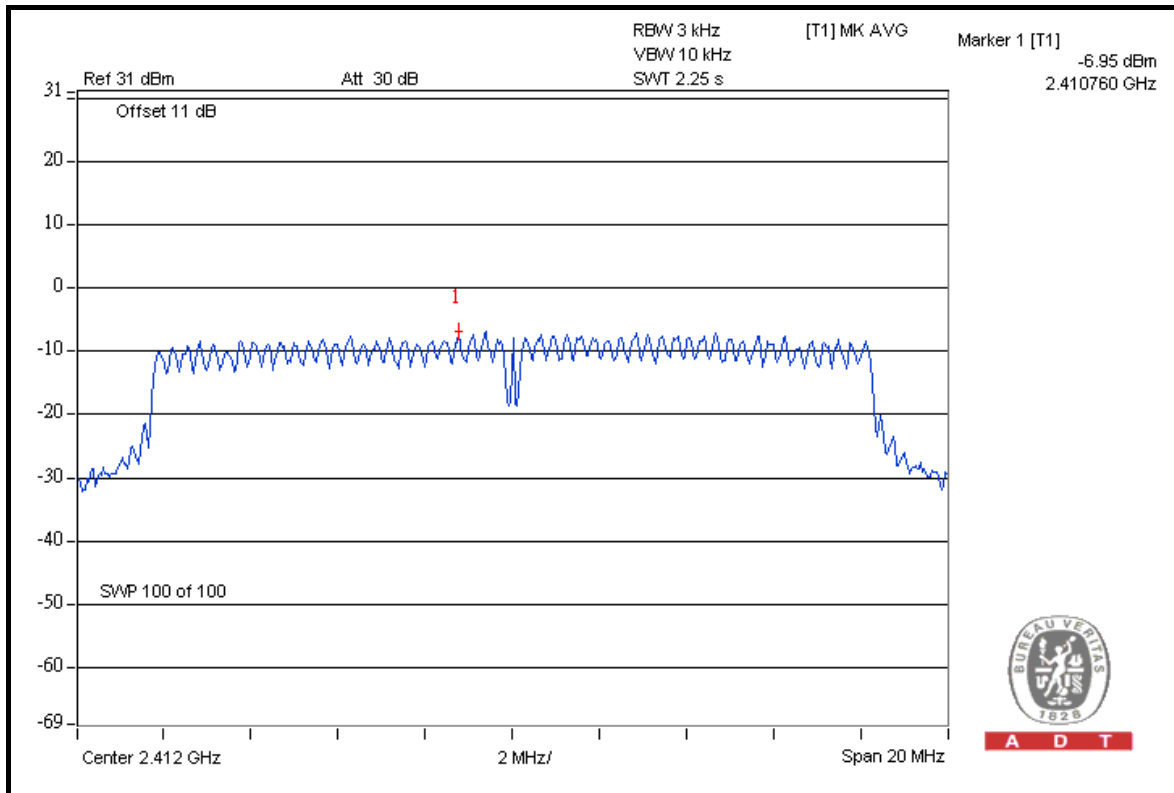

CH 6

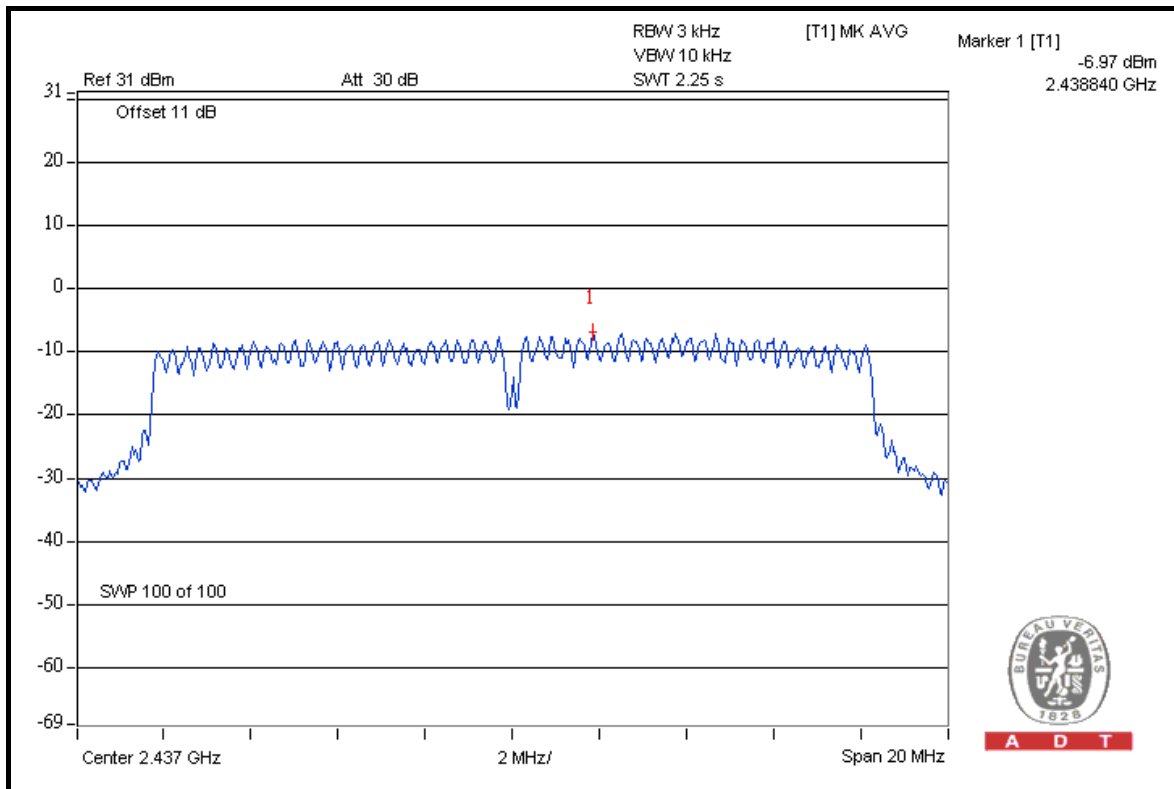



A D T

CH 11

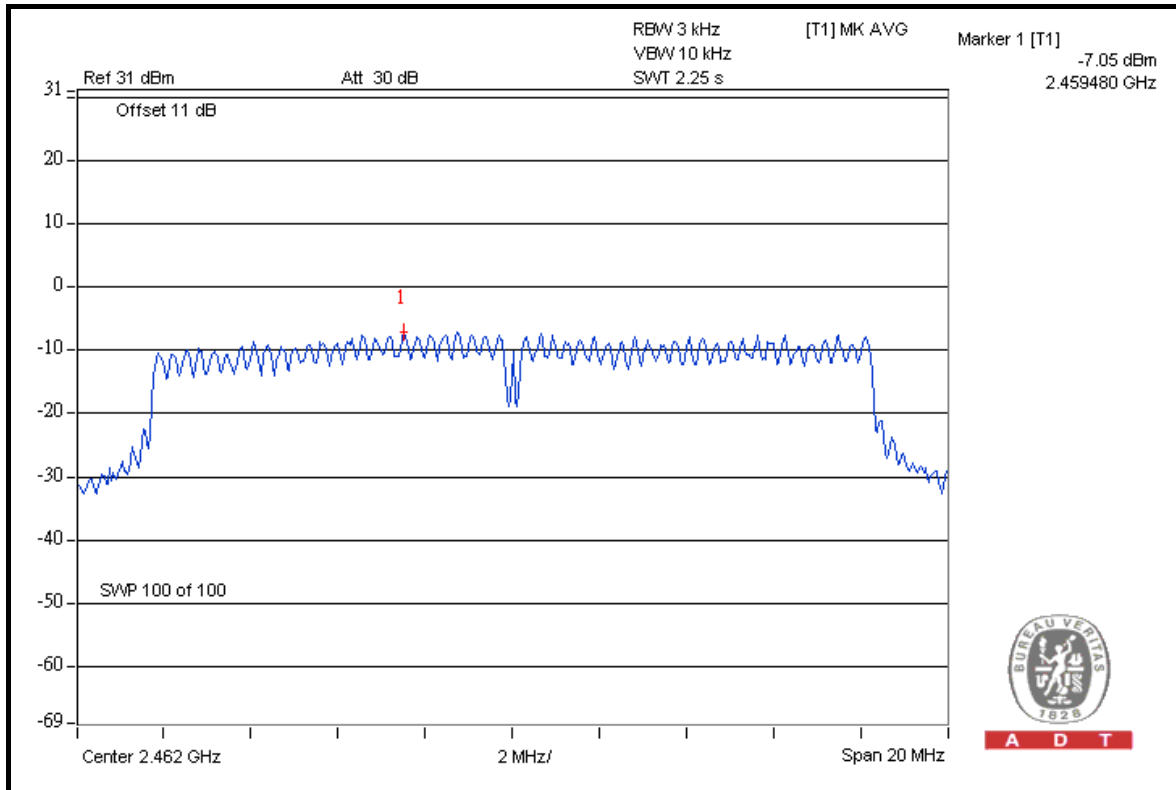

A D T

FOR CHAIN 2: CH 1

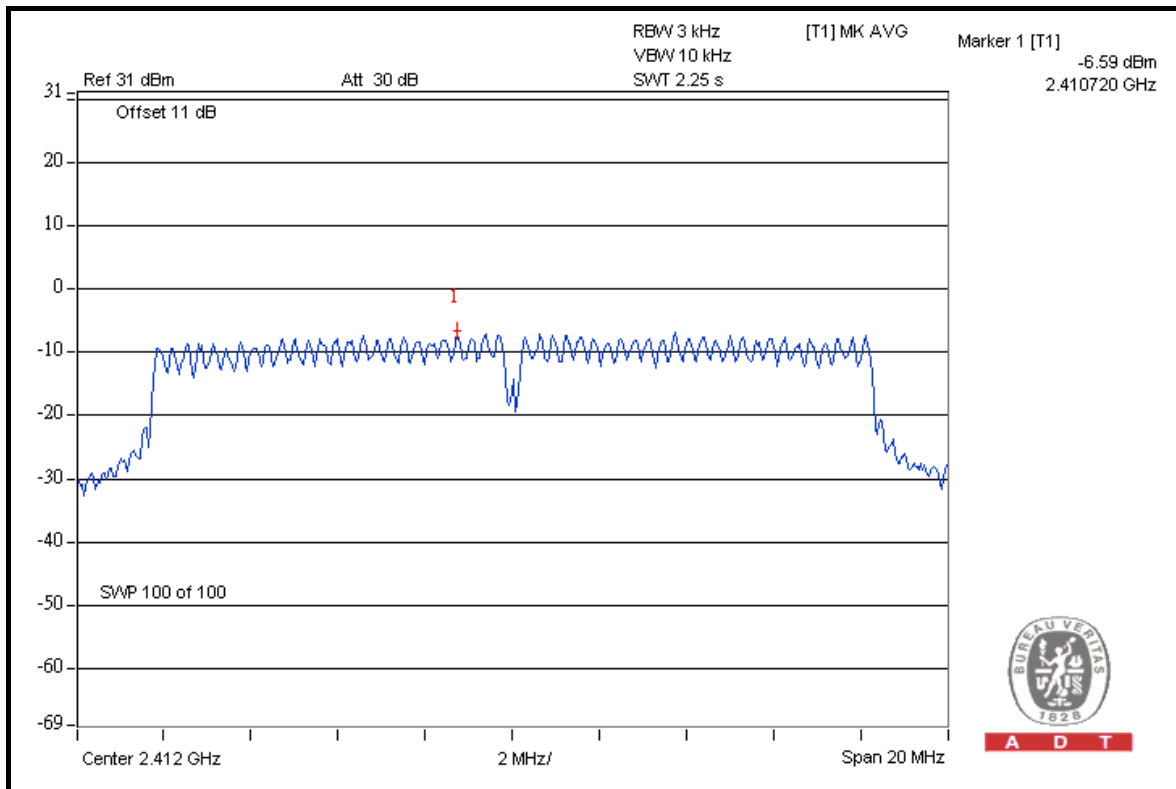

A D T



A D T

CH 6

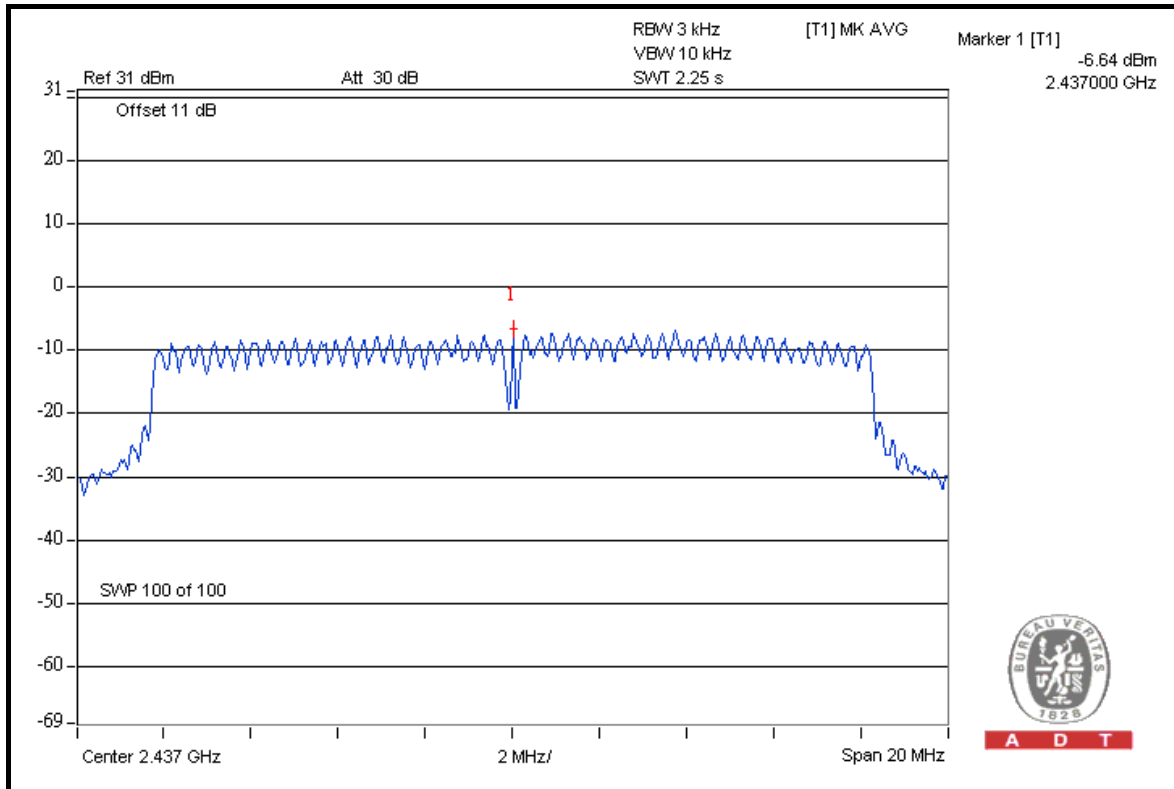

CH 11

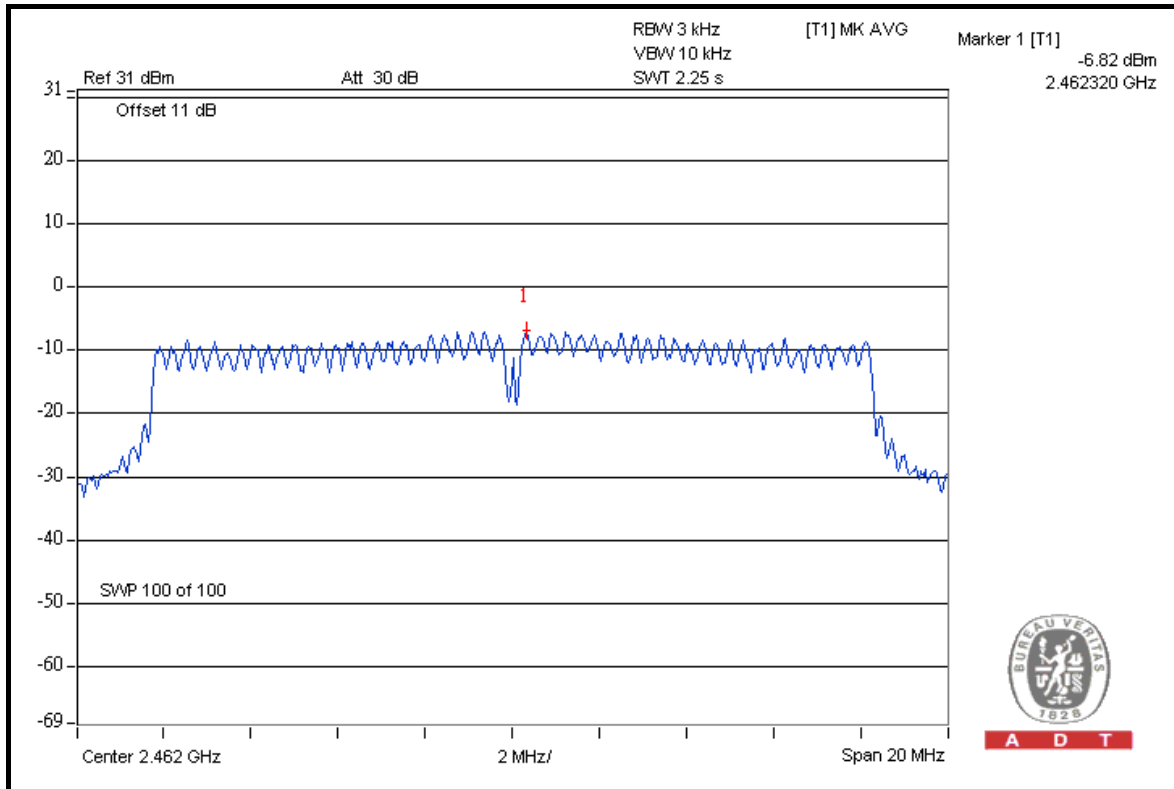



A D T

DRAFT 802.11n (20MHz) OFDM MODULATION

MODULATION TYPE	BPSK	TRANSFER RATE	6.5Mbps
INPUT POWER	120Vac, 60Hz	ENVIRONMENTAL CONDITIONS	25deg.C, 65%RH, 1021hPa
TESTED BY	Mark Liao		

CHAN.	CHAN. FREQ. (MHz)	RF POWER LEVEL IN 3kHz BW (dBm)			TOTAL POWER DENSITY (mW)	TOTAL POWER DENSITY (dBm)	MAX. LIMIT (dBm)	PASS / FAIL
		CHAIN 0	CHAIN 1	CHAIN 2				
1	2412	-6.78	-5.48	-6.51	0.716	-1.45	8	PASS
6	2437	-6.65	-5.26	-6.29	0.749	-1.26	8	PASS
11	2462	-6.61	-5.37	-6.37	0.739	-1.31	8	PASS

FOR CHAIN 0: CH 1

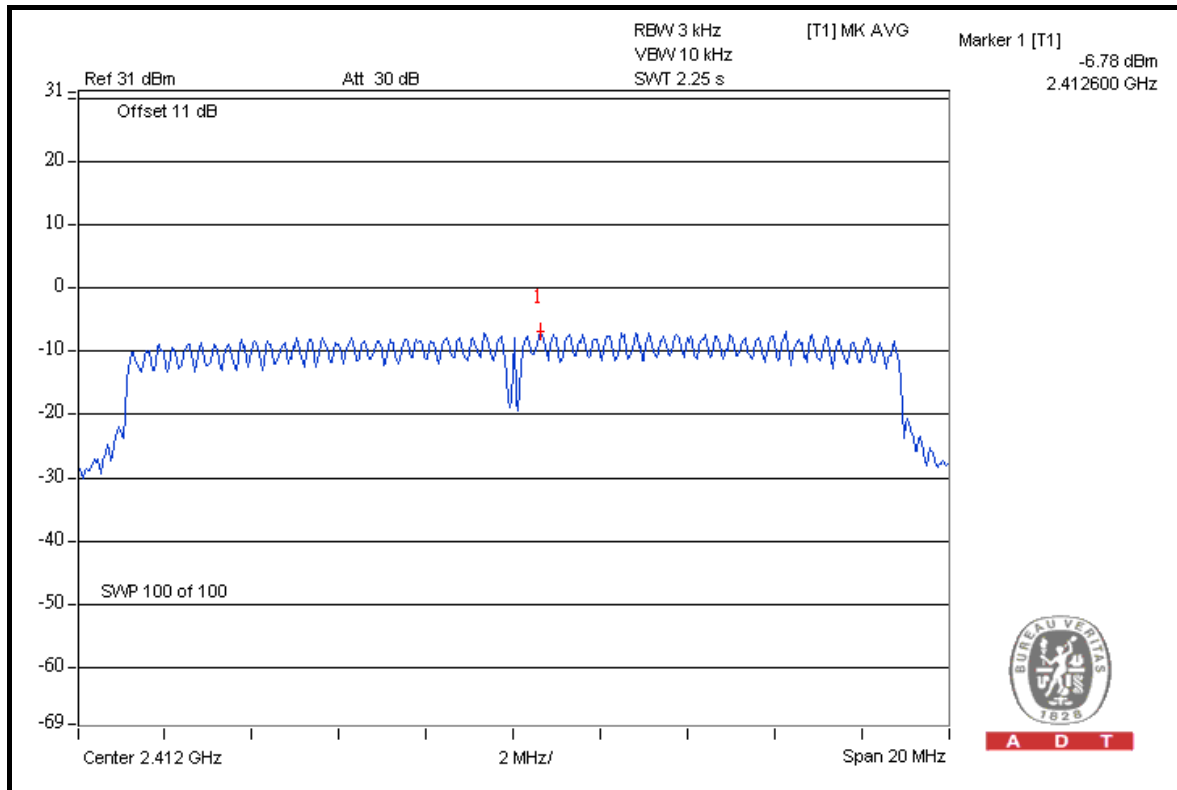



A D T

CH 6

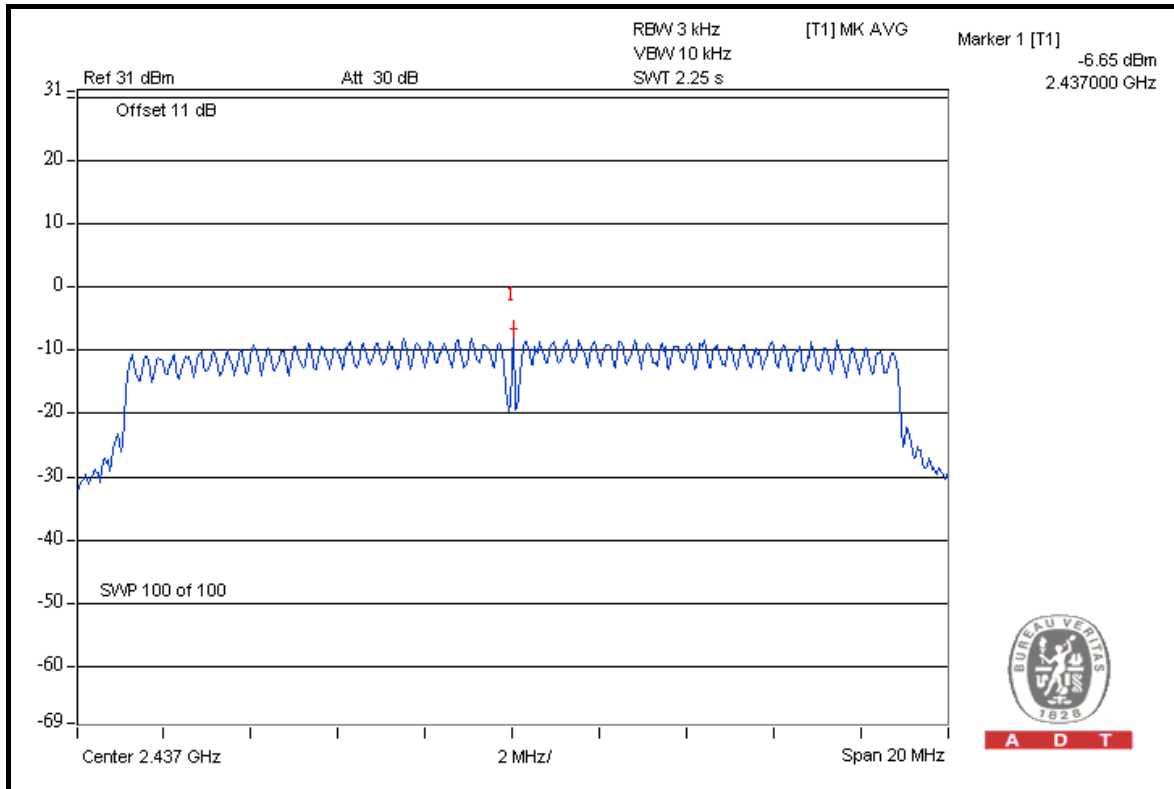

CH 11

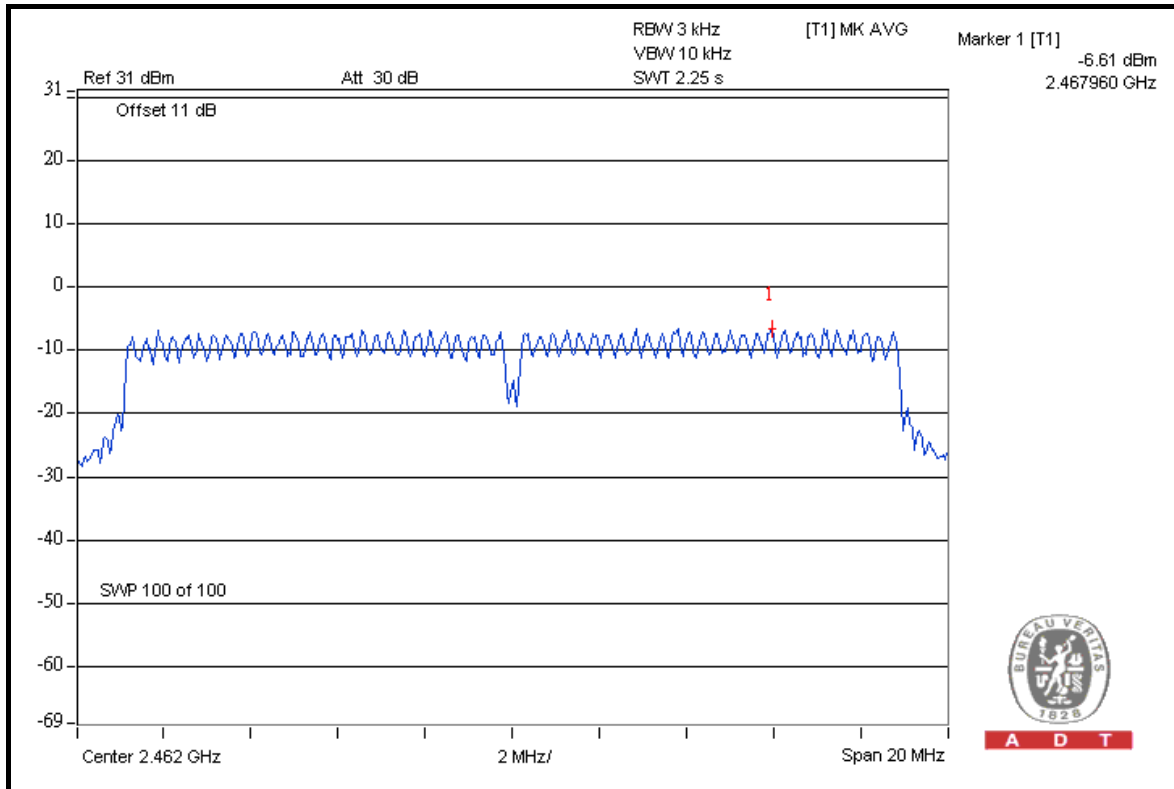



A D T

FOR CHAIN 1: CH 1

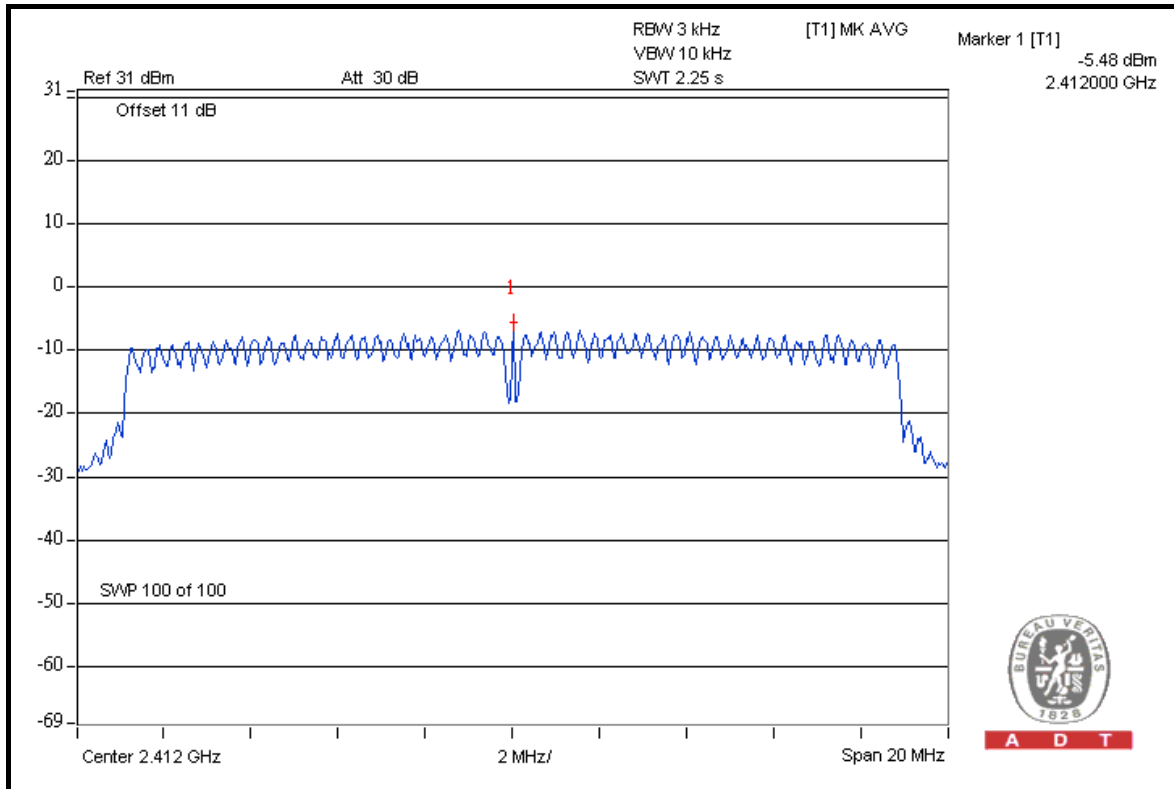

CH 6

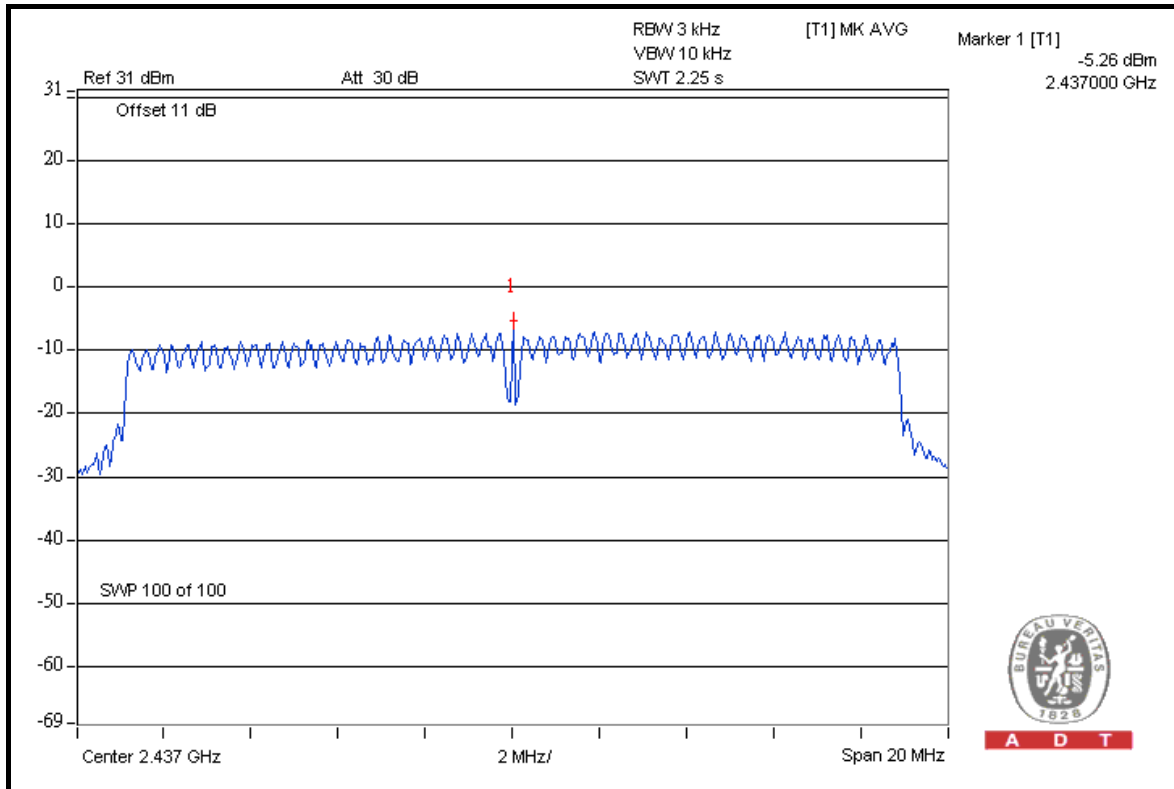



A D T

CH 11

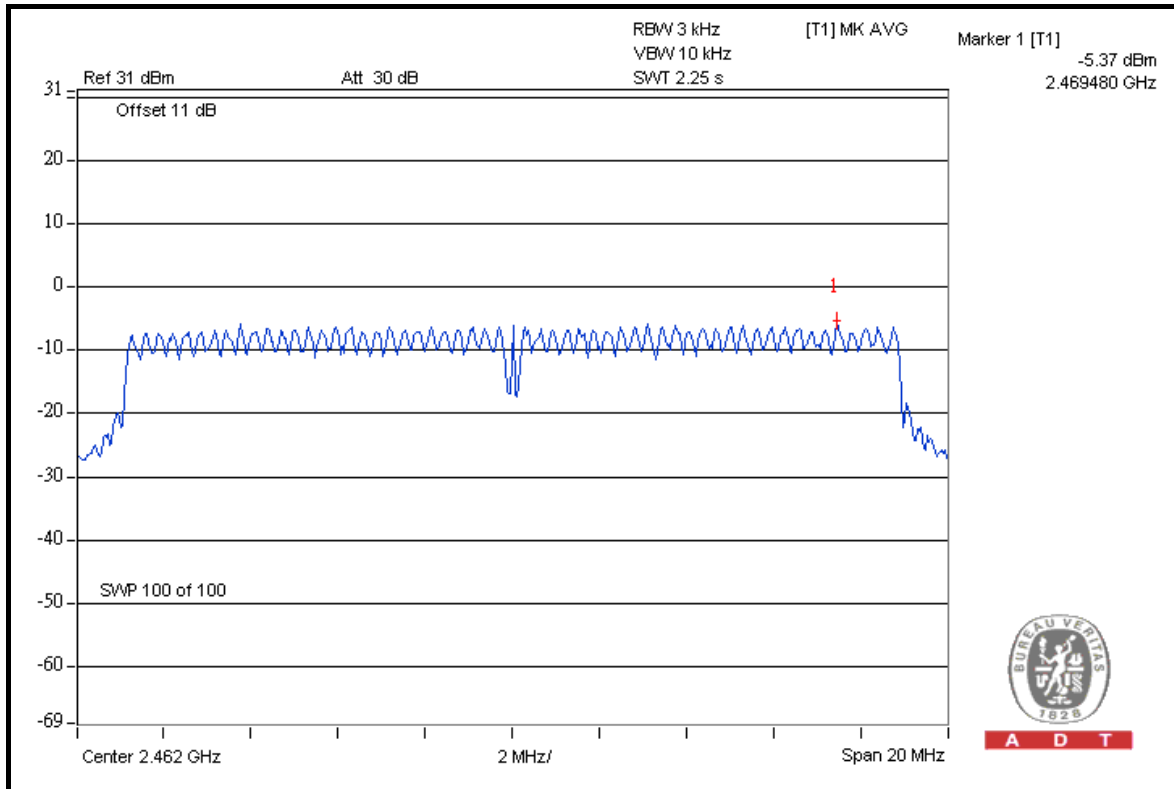

FOR CHAIN 2: CH 1

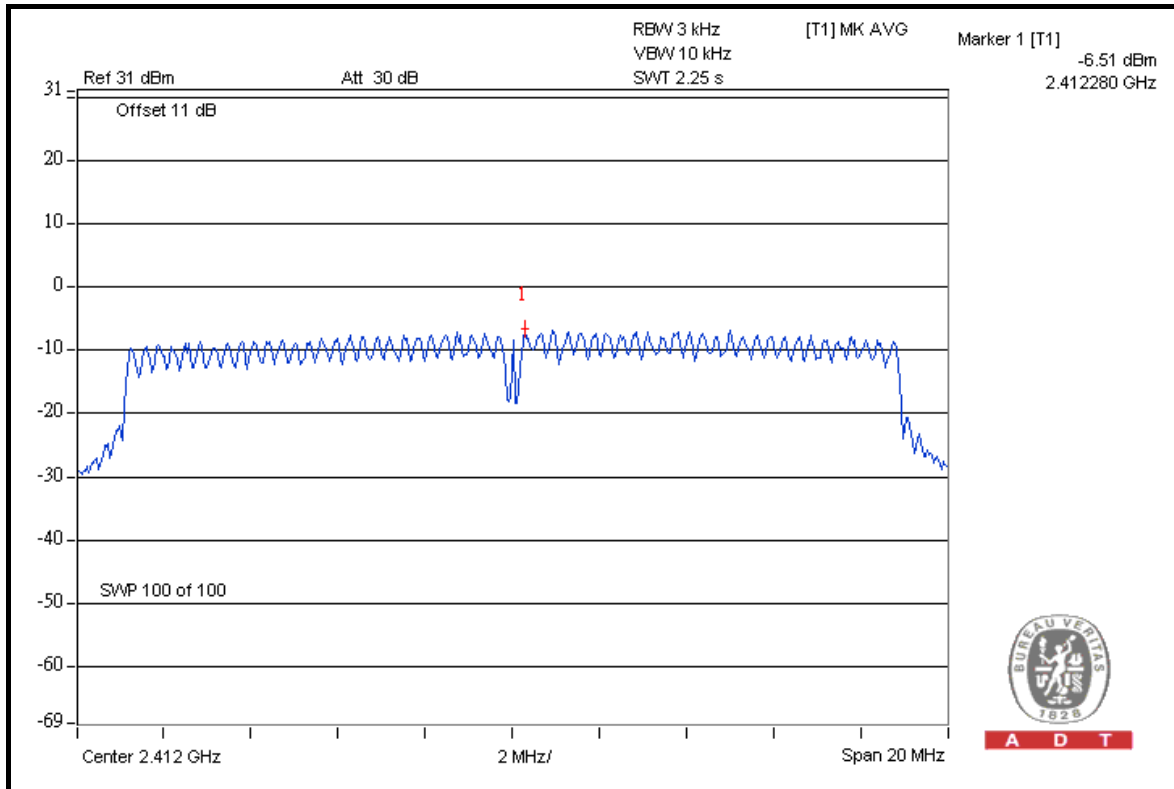



A D T

CH 6

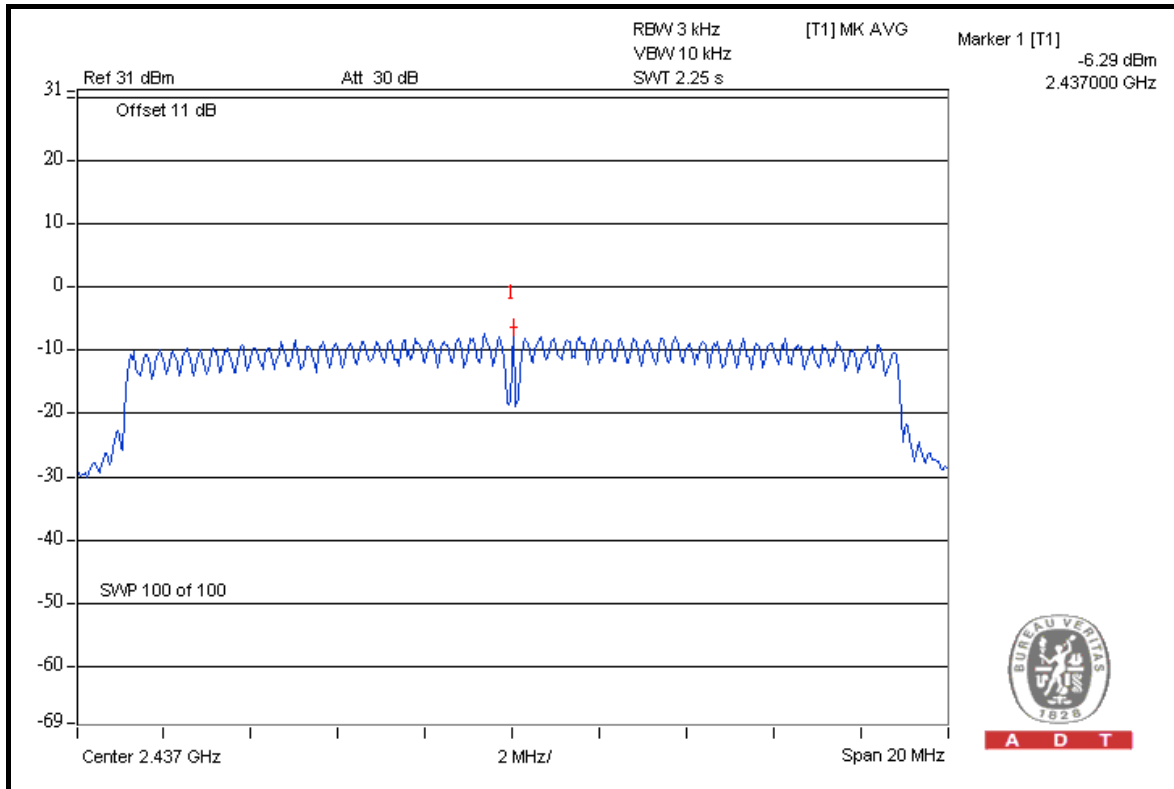

CH 11

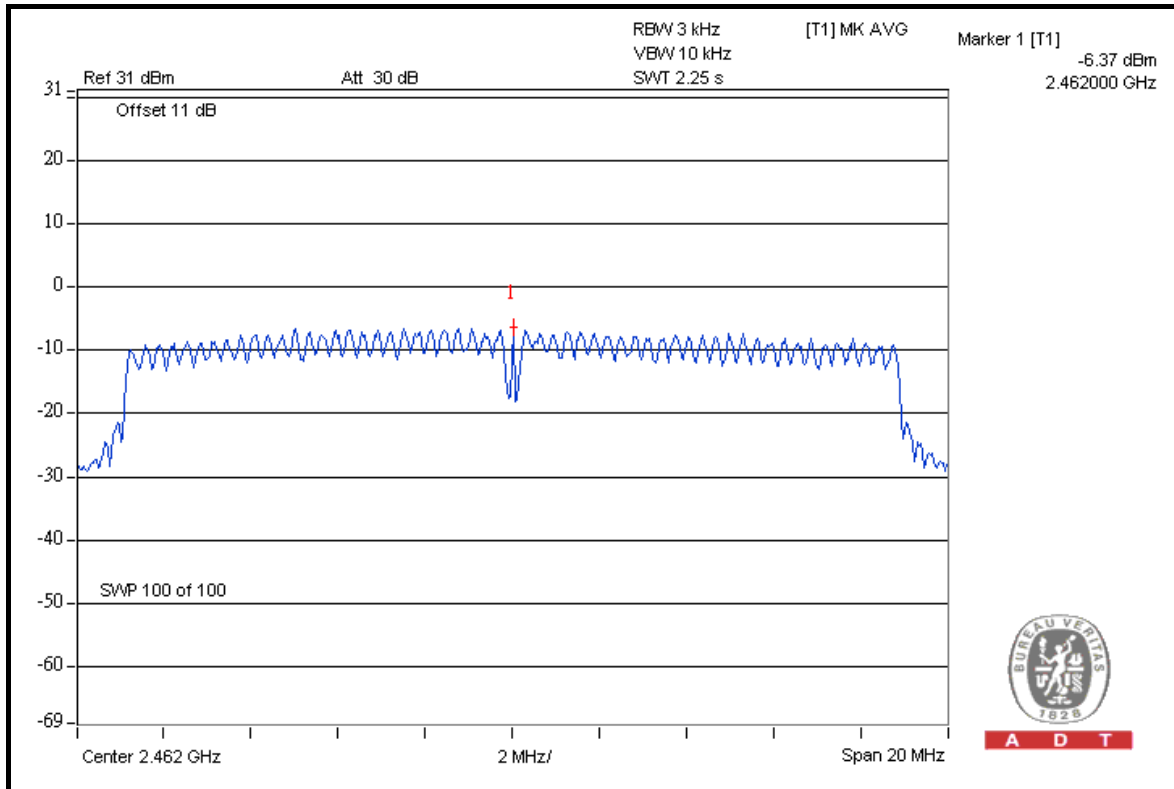



A D T

DRAFT 802.11n (40MHz) OFDM MODULATION

MODULATION TYPE	BPSK	TRANSFER RATE	13.5Mbps
INPUT POWER	120Vac, 60Hz	ENVIRONMENTAL CONDITIONS	25deg.C, 65%RH, 1021hPa
TESTED BY	Brad Wu		

CHAN.	CHAN. FREQ. (MHz)	RF POWER LEVEL IN 3kHz BW (dBm)			TOTAL POWER DENSITY (mW)	TOTAL POWER DENSITY (dBm)	MAX. LIMIT (dBm)	PASS / FAIL
		CHAIN 0	CHAIN 1	CHAIN 2				
1	2422	-8.97	-9.21	-7.79	0.413	-3.84	8	PASS
4	2437	-8.76	-9.00	-7.62	0.432	-3.65	8	PASS
7	2452	-8.82	-9.00	-7.73	0.426	-3.71	8	PASS

FOR CHAIN 0: CH 1

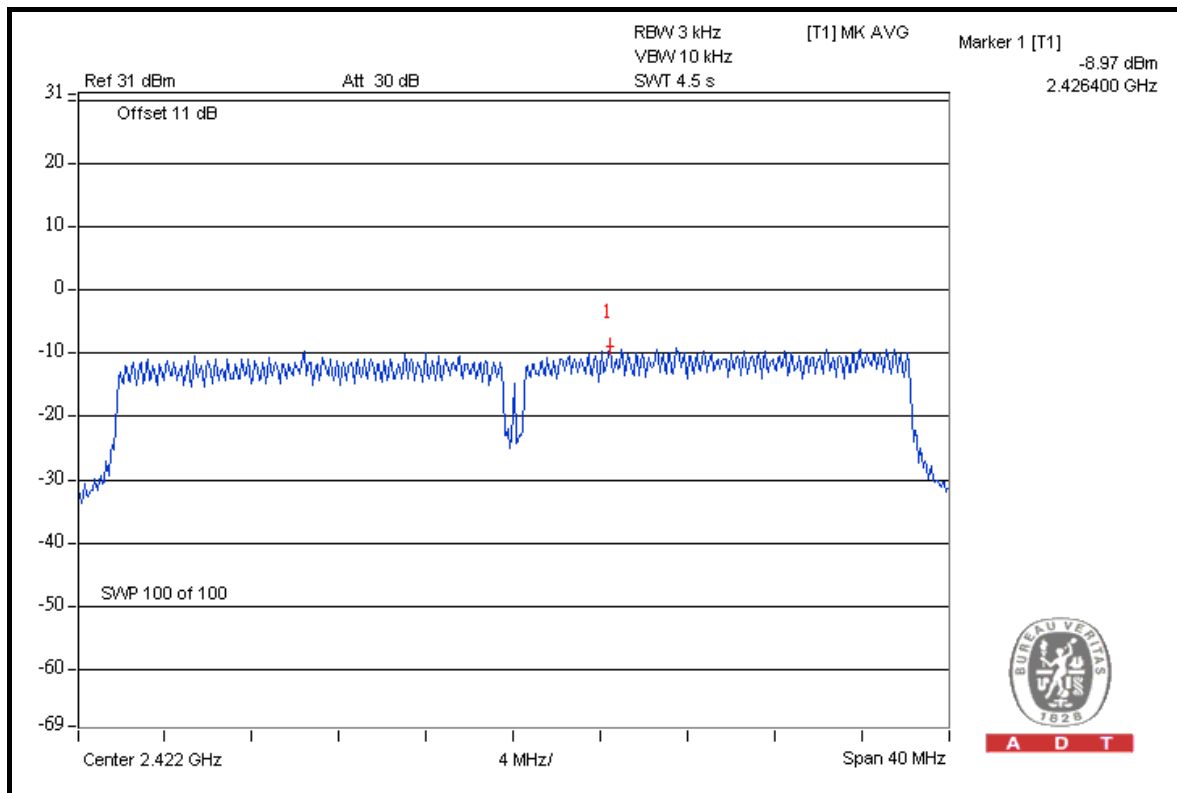

A D T



A D T

CH 4

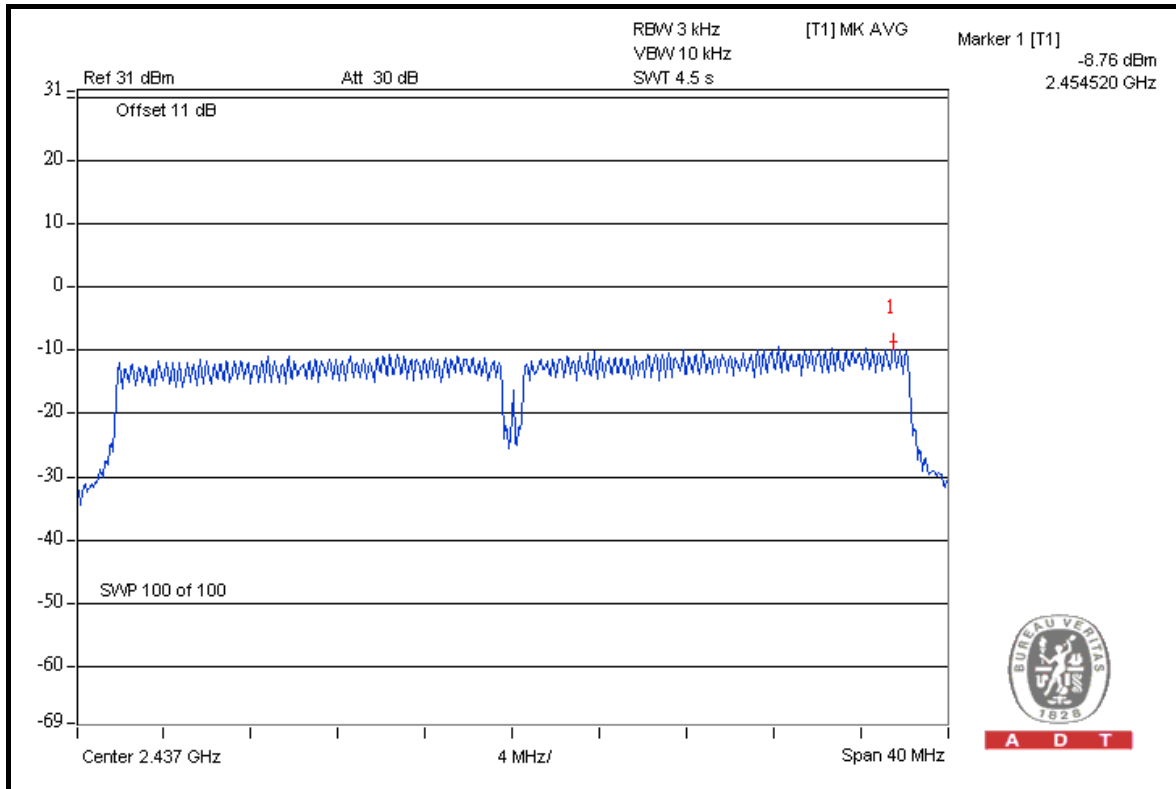

A D T

CH 7

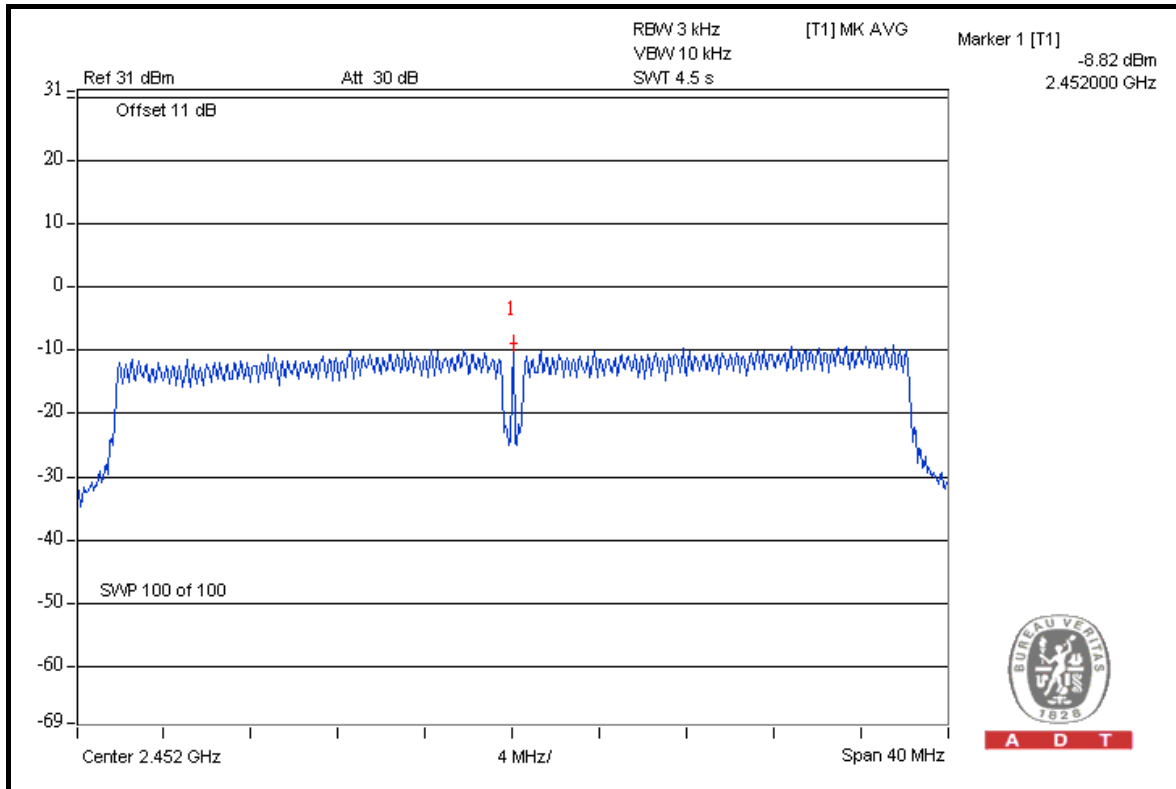

A D T



A D T

FOR CHAIN 1: CH 1

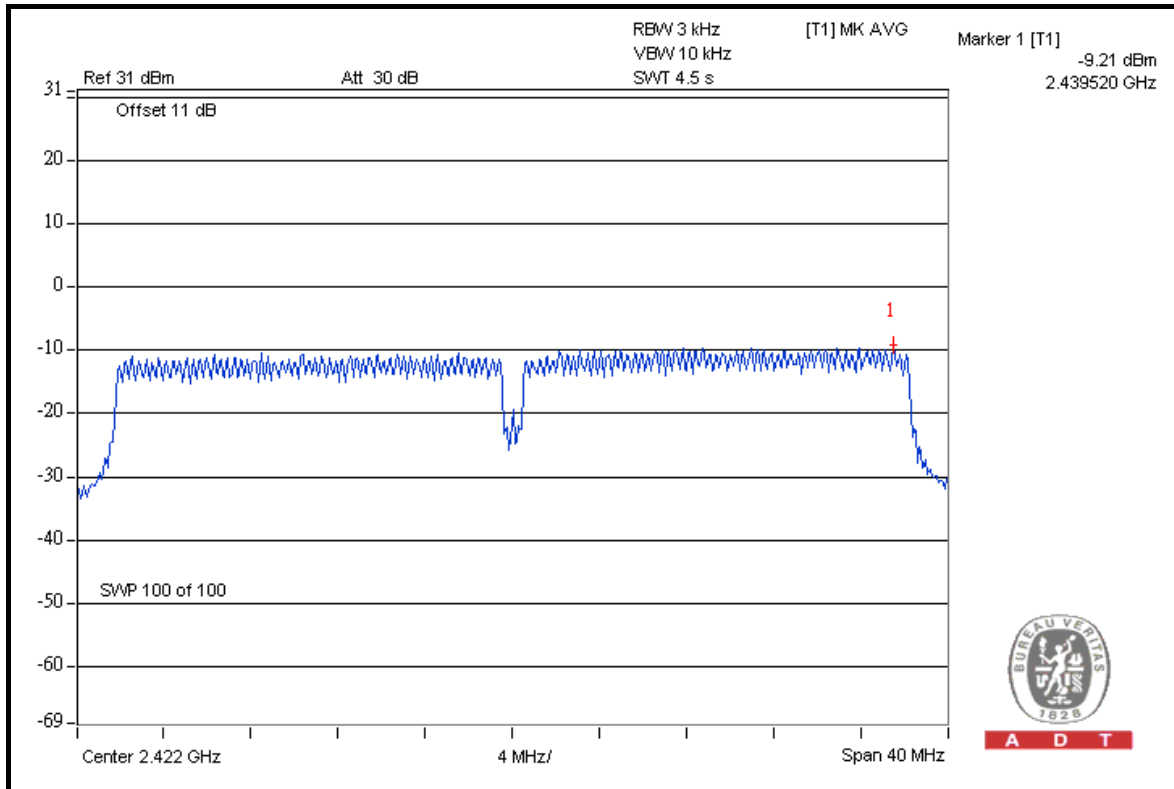

CH 4

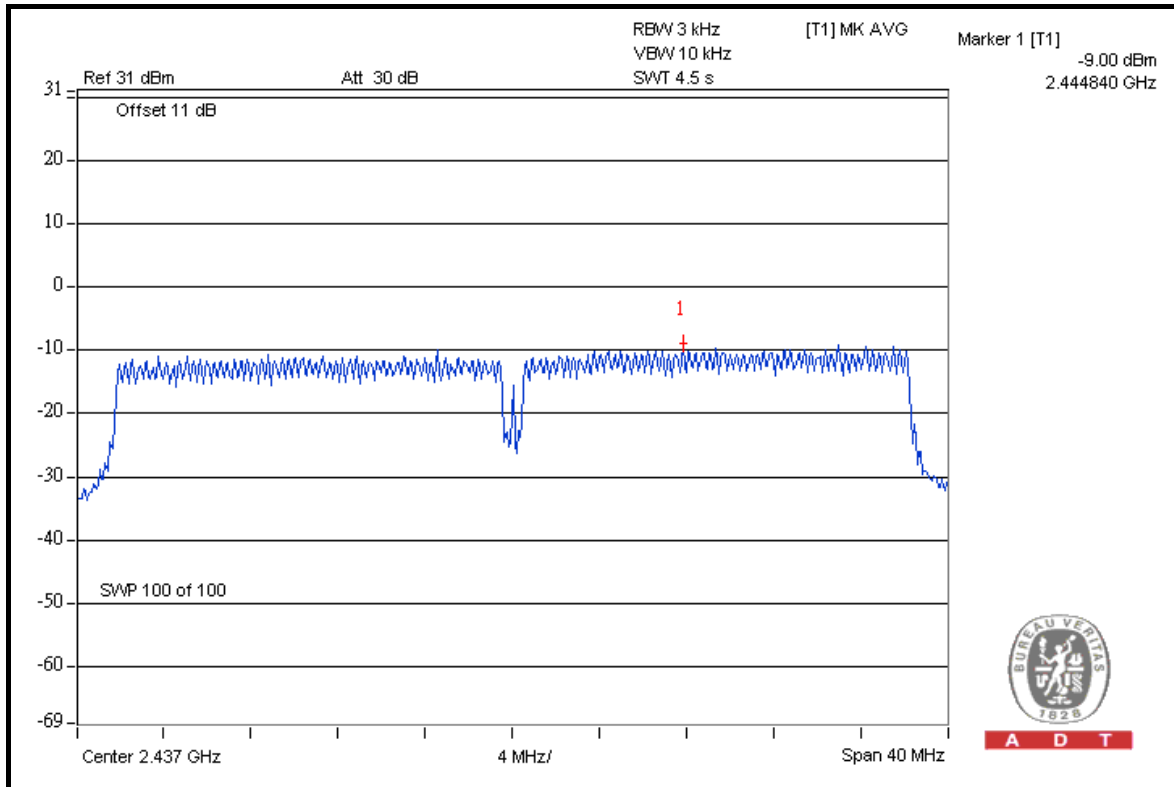



A D T

CH 7

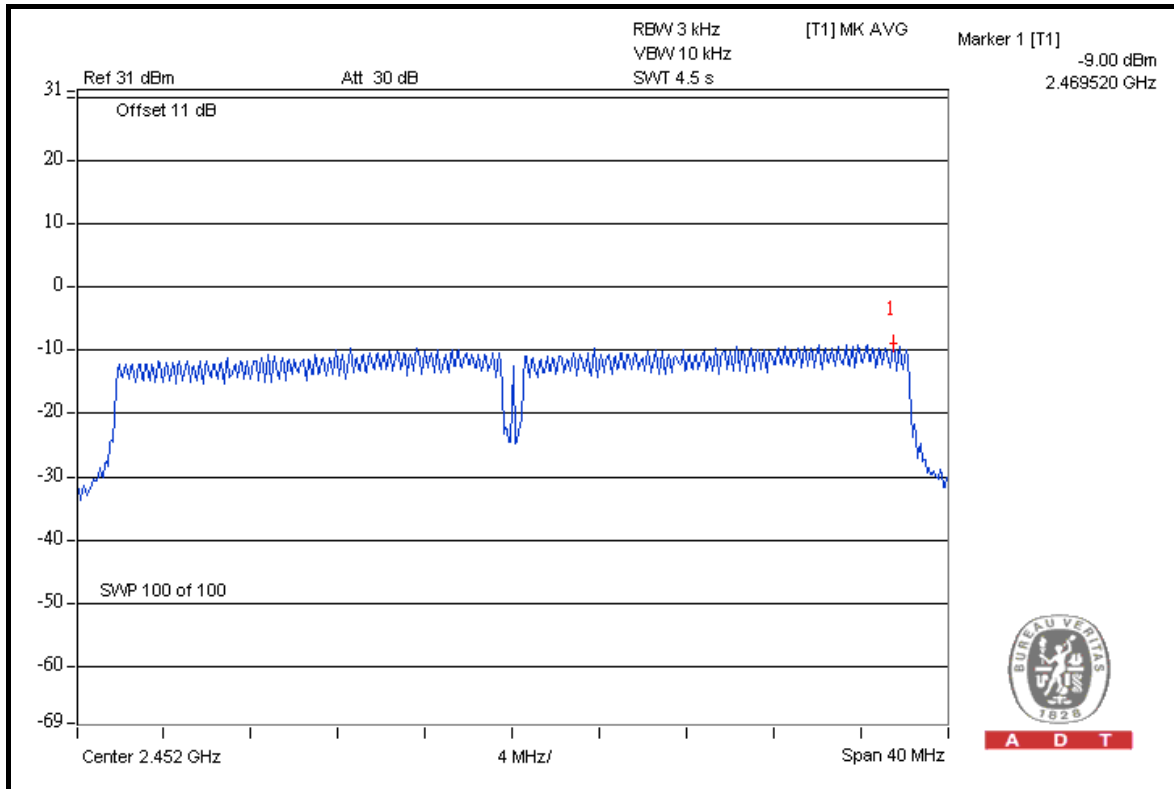

FOR CHAIN 2: CH 1

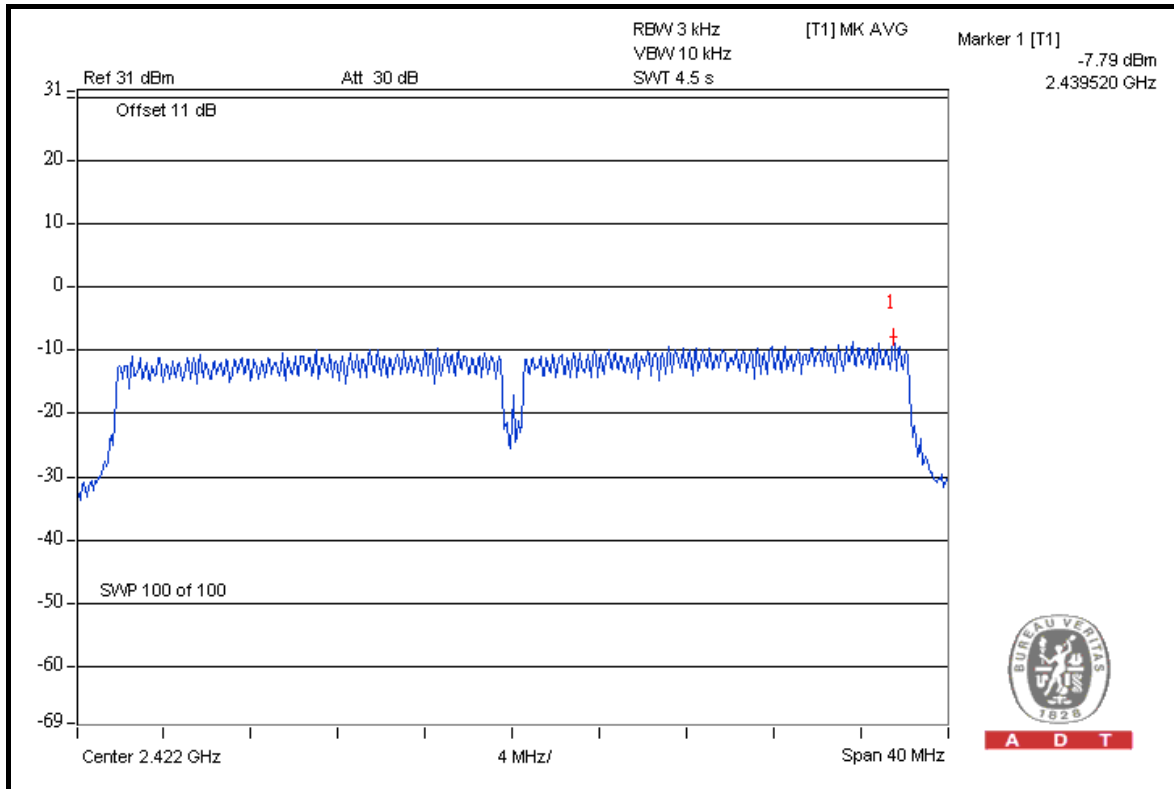



A D T

CH 4

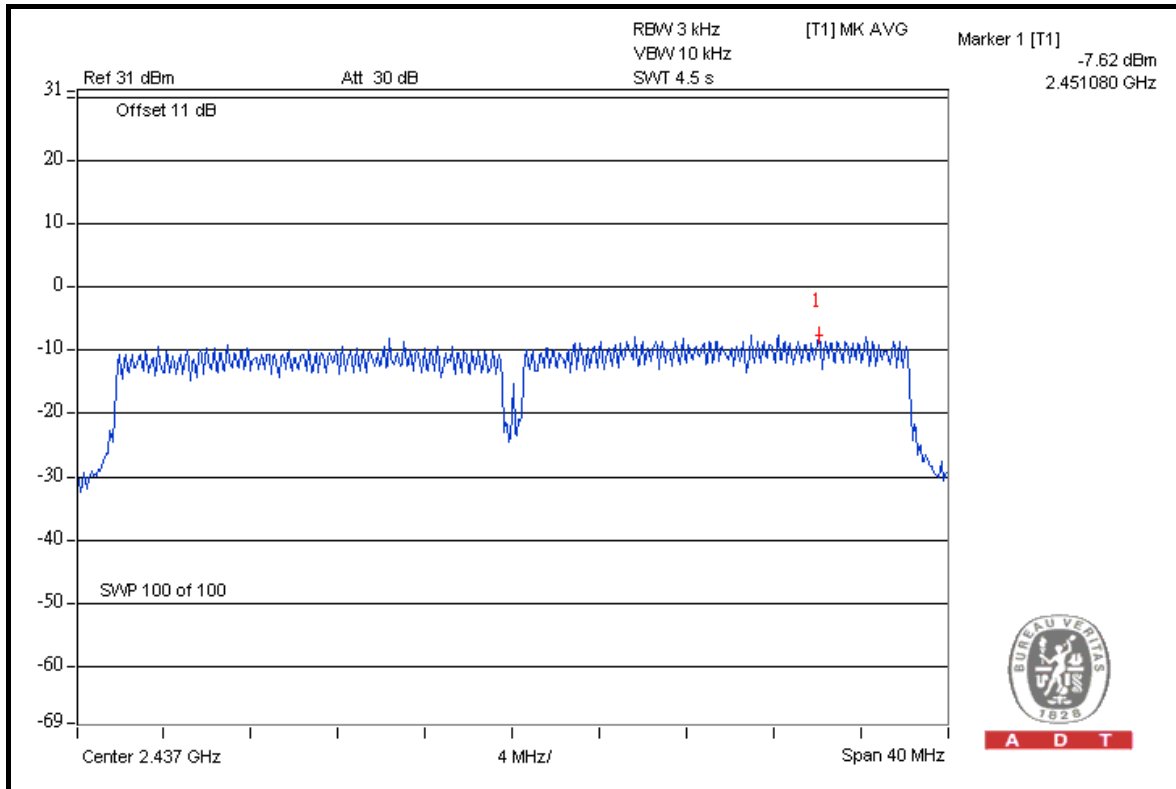

CH 7

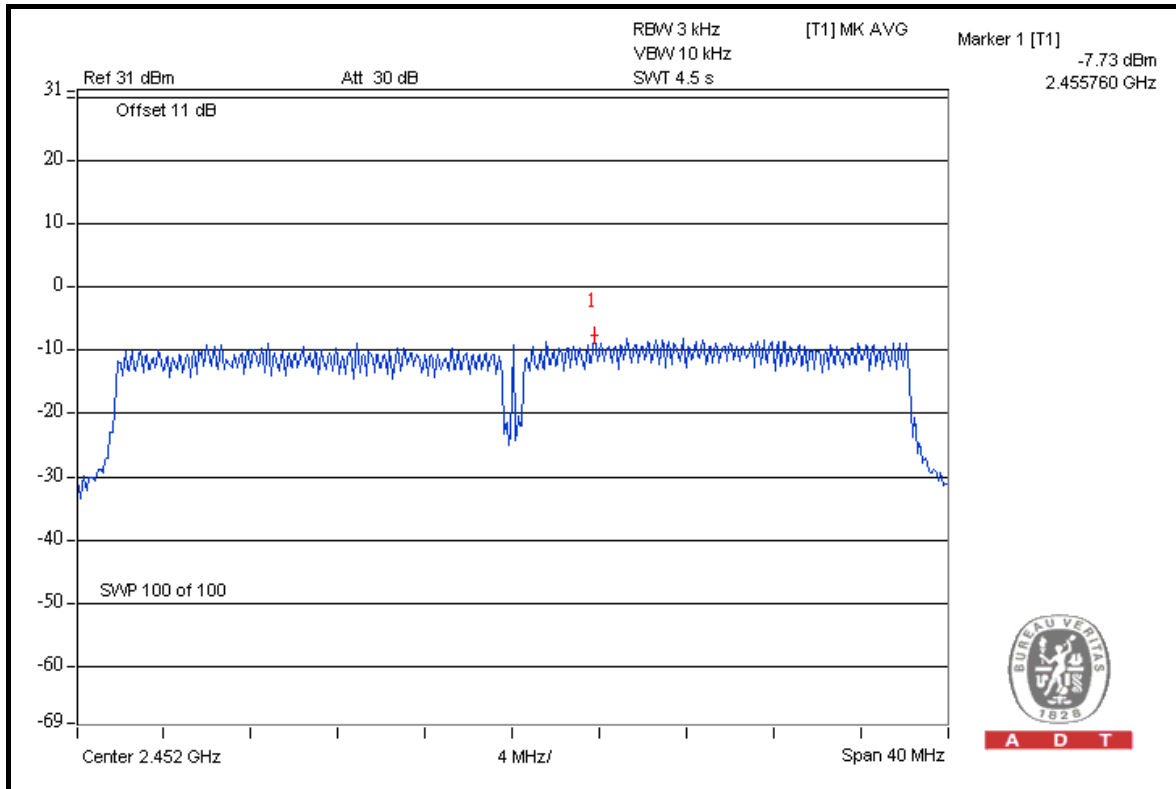



A D T

4.6 BAND EDGES MEASUREMENT

4.6.1 LIMITS OF BAND EDGES MEASUREMENT

Below -20 dB of the highest emission level of operating band (in 100kHz Resolution Bandwidth).

Note: Follow DTS measurement, if the device complies with the use of power option 2 the attenuation under this paragraph shall be 30 dB instead of 20 dB.

4.6.2 TEST INSTRUMENTS

DESCRIPTION & MANUFACTURER	MODEL NO.	SERIAL NO.	DATE OF CALIBRATION	DUE DATE OF CALIBRATION
Test Receiver ROHDE & SCHWARZ	ESI7	100033	Jul. 06, 2009	Jul. 05, 2010
Spectrum Analyzer ROHDE & SCHWARZ	FSP40	100076	May. 26, 2009	May. 25, 2010
BILOG Antenna SCHWARZBECK	VULB9168	9168-160	Apr. 27, 2009	Apr. 26, 2010
HORN Antenna SCHWARZBECK	9120D	9120D-209	Jul. 01, 2009	Jun. 30, 2010
HORN Antenna SCHWARZBECK	BBHA 9170	BBHA9170243	Dec. 25, 2008	Dec. 24, 2009
Preamplifier Agilent	8447D	2944A10633	Nov. 03, 2008	Nov. 02, 2009
Preamplifier Agilent	8449B	3008A01964	Oct. 23, 2008	Oct. 22, 2009
RF signal cable HUBER+SUHNNER	SUCOFLEX 104	238141/4	May 13, 2009	May 12, 2010
RF signal cable HUBER+SUHNNER	SUCOFLEX 104	12738/6	May 13, 2009	May 12, 2010
Software ADT.	ADT_Radiated_ V7.6.15.9.2	NA	NA	NA
Antenna Tower inn-co GmbH	MA 4000	013303	NA	NA
Antenna Tower Controller inn-co GmbH	CO2000	017303	NA	NA
Turn Table ADT.	TT100.	TT93021703	NA	NA
Turn Table Controller ADT.	SC100.	SC93021703	NA	NA

NOTE: The calibration interval of the above test instruments is 12 months and the calibrations are traceable to NML/ROC and NIST/USA.



A D T

4.6.3 TEST PROCEDURE

- a. The EUT was placed on the top of a rotating table 0.8 meters above the ground at a 3 meter semi-anechoic chamber. The table was rotated 360 degrees to determine the position of the highest radiation.
- b. The EUT was set 3 meters away from the interference-receiving antenna, which was mounted on the top of a variable-height antenna tower.
- c. The antenna is a broadband antenna, and its height is varied from one meter to four meters above the ground to determine the maximum value of the field strength. Both horizontal and vertical polarizations of the antenna are set to make the measurement.
- d. For each suspected emission, the EUT was arranged to its worst case and then the antenna was tuned to heights from 1 meter to 4 meters and the rotatable table was turned from 0 degrees to 360 degrees to find the maximum reading.
- e. Set both RBW and VBW of spectrum analyzer to 100kHz and 300kHz with suitable frequency span including 100MHz bandwidth from band edge. The band edges was measured and recorded.

The spectrum plots (Peak RBW = 100kHz, VBW = 300kHz) are attached on the following pages.

NOTE: The resolution bandwidth of test receiver/spectrum analyzer is 1MHz and the video bandwidth is 10Hz for Average detection (AV) at frequency above 1GHz.

4.6.4 DEVIATION FROM TEST STANDARD

No deviation

4.6.5 EUT OPERATING CONDITION

Same as Item 4.3.6

4.6.6 TEST RESULTS

The spectrum plots are attached on the following pages. D1 line indicates the highest level, and D2 line indicates the 20dB offset below D1. It shows compliance with the requirement in part 15.247(d).

802.11b DSSS MODULATION

NOTE 1: The band edge emission plot on the next page shows 54.54dBc between carrier maximum power and local maximum emission in restrict band (2.3876GHz). The emission of carrier strength list in the test result of channel 1 at the item 4.1.7 is 118.81dBuV/m (Peak), so the maximum field strength in restrict band is $118.81 - 54.54 = 64.27$ dBuV/m which is under 74dBuV/m limit.

The band edge emission plot of on the next page shows 61.53dBc between carrier maximum power and local maximum emission in restrict band (2.3874GHz). The emission of carrier strength list in the test result of channel 1 at the item 4.1.7 is 114.11dBuV/m (Average), so the maximum field strength in restrict band is $114.11 - 61.53 = 52.58$ dBuV/m which is under 54dBuV/m limit.

NOTE 2: The band edge emission plot on the next second page shows 56.62dBc between carrier maximum power and local maximum emission in restrict band (2.4880GHz). The emission of carrier strength list in the test result of channel 11 at the item 4.1.7 is 118.02dBuV/m (Peak), so the maximum field strength in restrict band is $118.02 - 56.62 = 61.40$ dBuV/m which is under 74dBuV/m limit.

The band edge emission plot on the next third page shows 60.93dBc between carrier maximum power and local maximum emission in restrict band (2.4878GHz). The emission of carrier strength list in the test result of channel 11 at the item 4.1.7 is 113.43dBuV/m (Average), so the maximum field strength in restrict band is $113.43 - 60.93 = 52.50$ dBuV/m which is under 54dBuV/m limit.



A D T

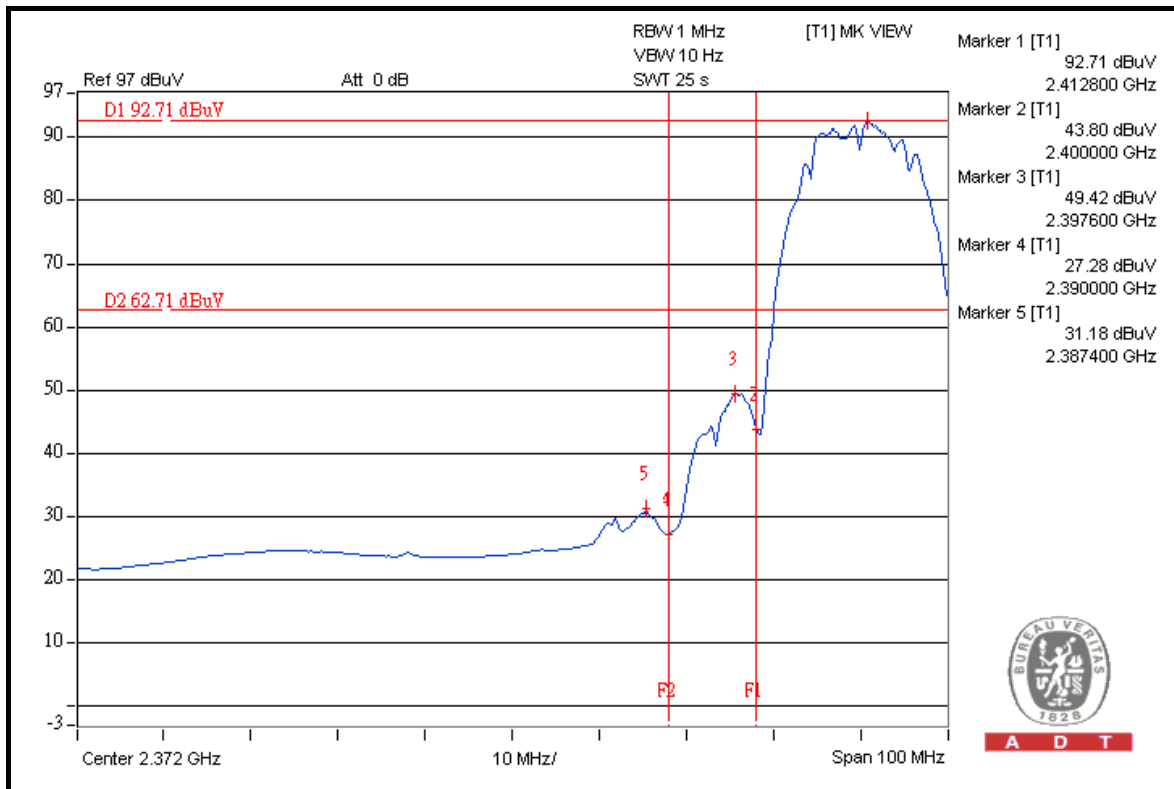
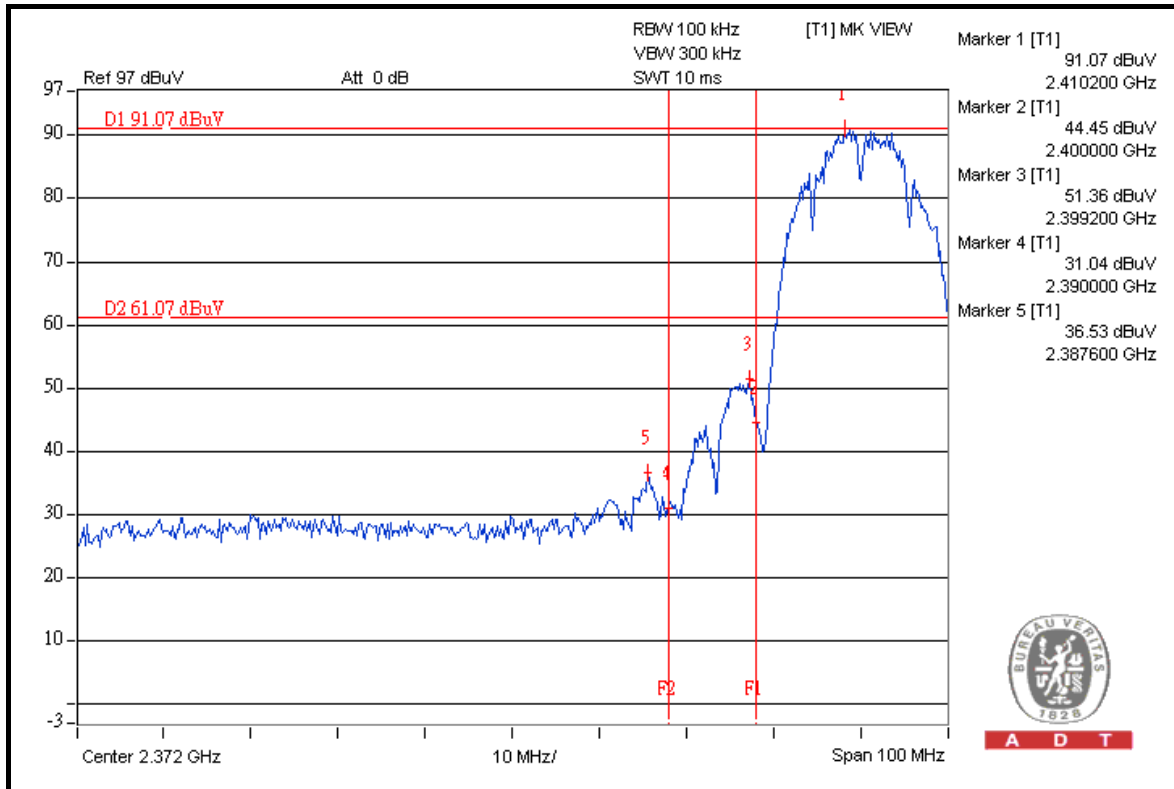



A D T

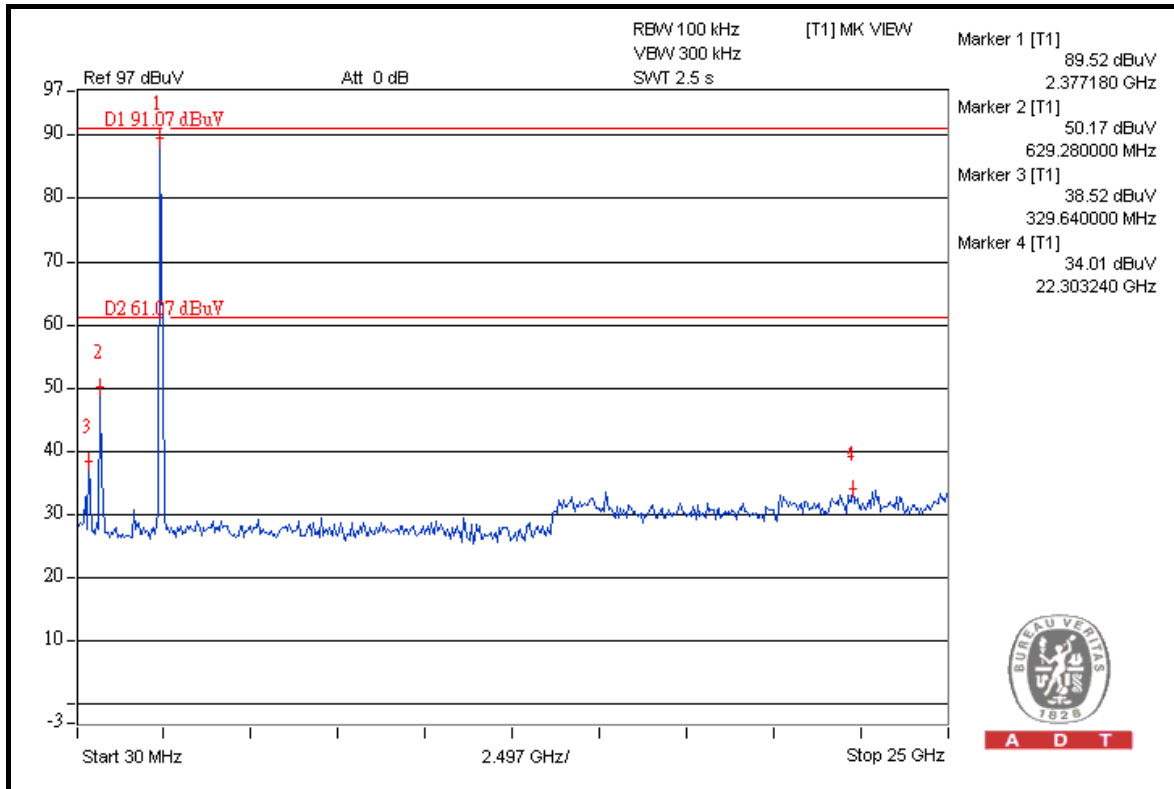

A D T

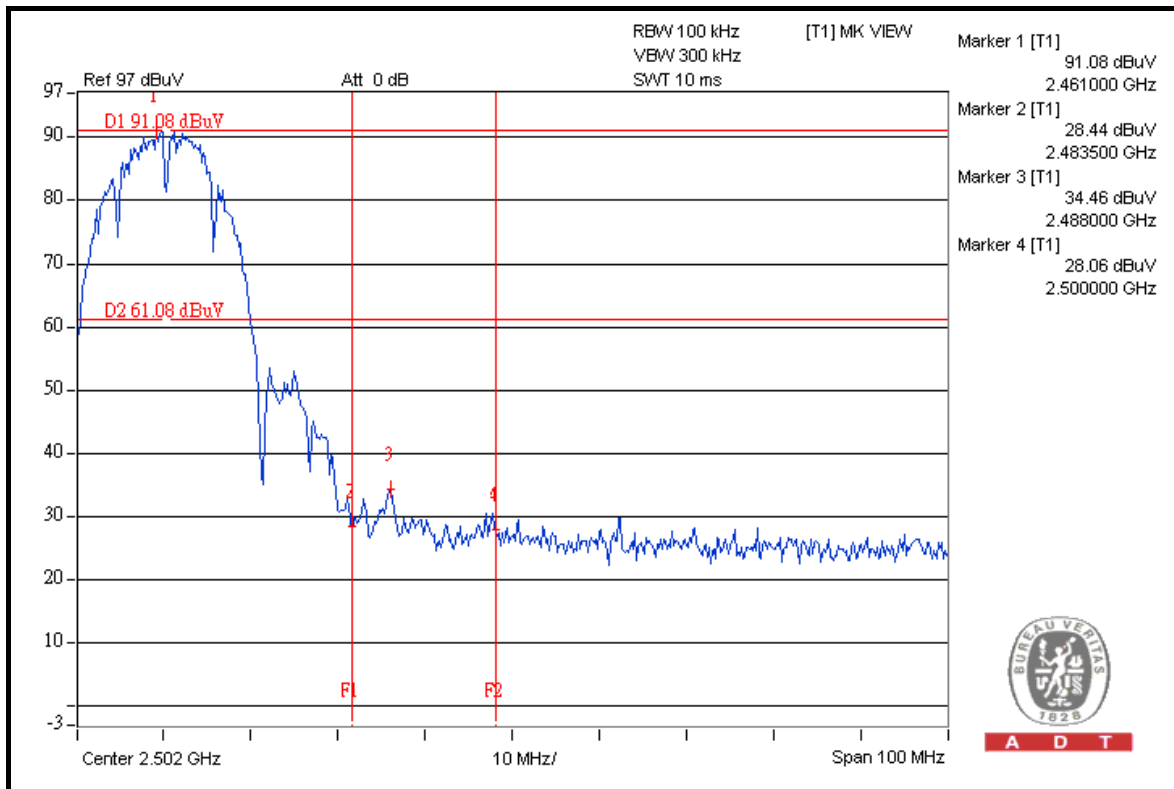

A D T



A D T

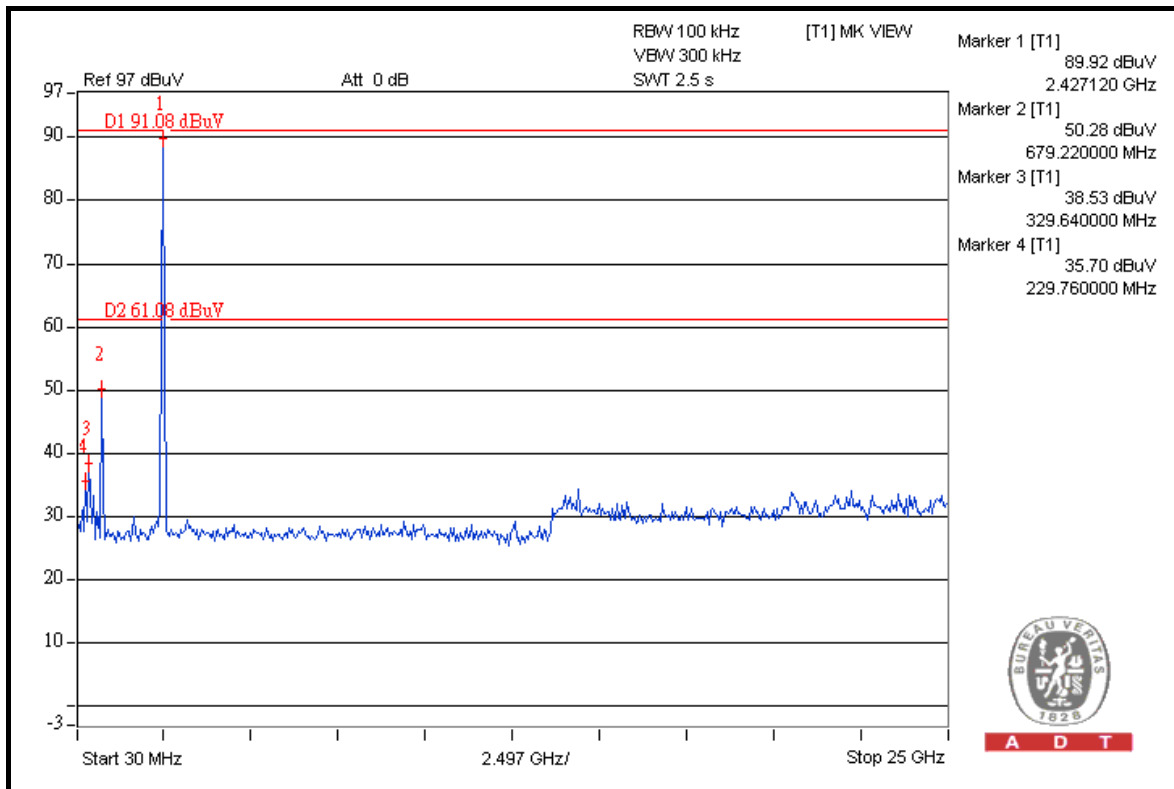
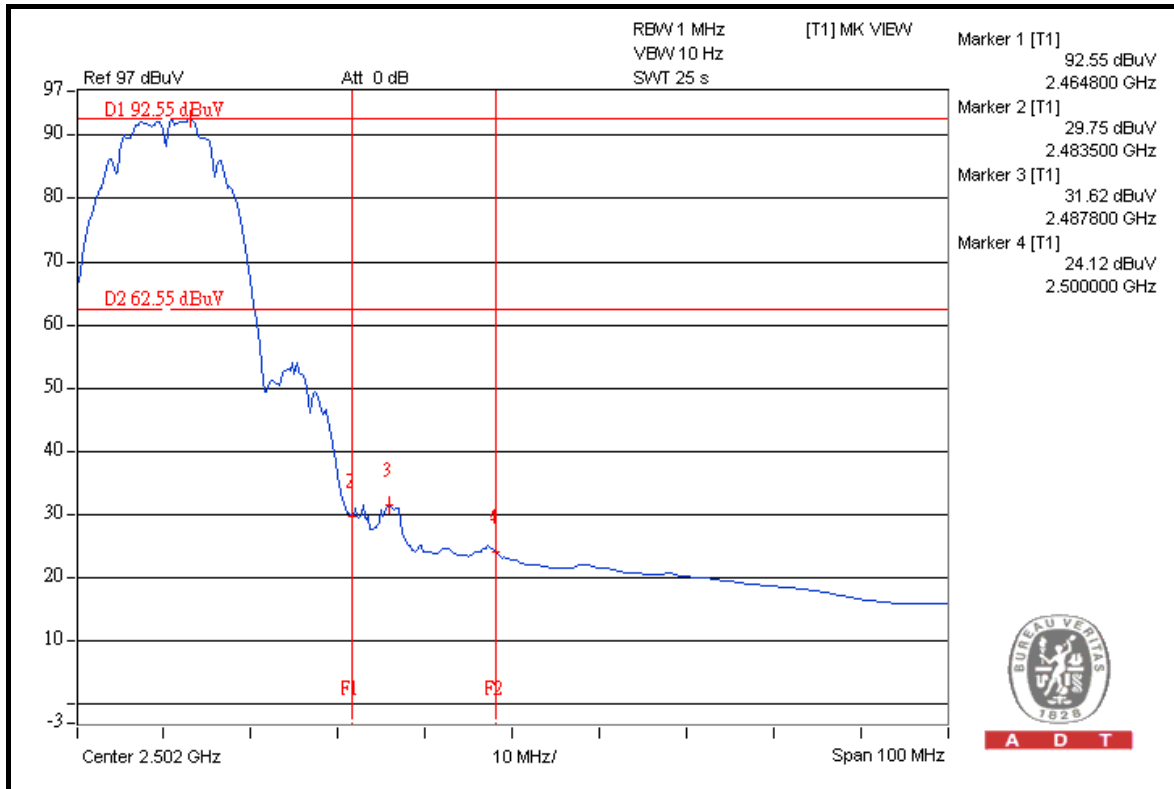



A D T

802.11g OFDM MODULATION

NOTE 1: The band edge emission plot on the next page shows 47.24dBc between carrier maximum power and local maximum emission in restrict band (2.3900GHz). The emission of carrier strength list in the test result of channel 1 at the item 4.1.7 is 120.15dBuV/m (Peak), so the maximum field strength in restrict band is $120.15 - 47.24 = 72.91$ dBuV/m which is under 74dBuV/m limit.

The band edge emission plot of on the next page shows 57.78dBc between carrier maximum power and local maximum emission in restrict band (2.3900GHz). The emission of carrier strength list in the test result of channel 1 at the item 4.1.7 is 109.72dBuV/m (Average), so the maximum field strength in restrict band is $109.72 - 57.78 = 51.94$ dBuV/m which is under 54dBuV/m limit.

NOTE 2: The band edge emission plot on the next second page shows 46.80dBc between carrier maximum power and local maximum emission in restrict band (2.4836GHz). The emission of carrier strength list in the test result of channel 11 at the item 4.1.7 is 119.62dBuV/m (Peak), so the maximum field strength in restrict band is $119.62 - 46.80 = 72.82$ dBuV/m which is under 74dBuV/m limit.

The band edge emission plot on the next third page shows 58.03dBc between carrier maximum power and local maximum emission in restrict band (2.4835GHz). The emission of carrier strength list in the test result of channel 11 at the item 4.1.7 is 109.01dBuV/m (Average), so the maximum field strength in restrict band is $109.01 - 58.03 = 50.98$ dBuV/m which is under 54dBuV/m limit.



A D T

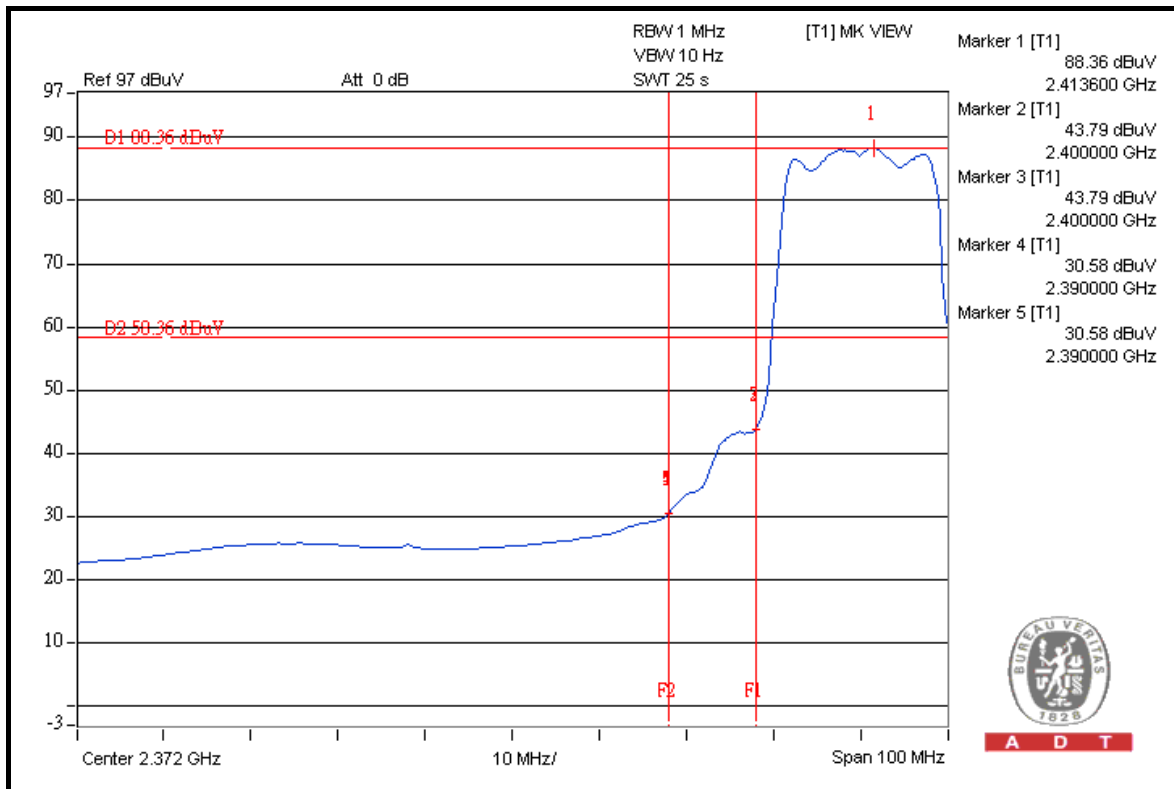
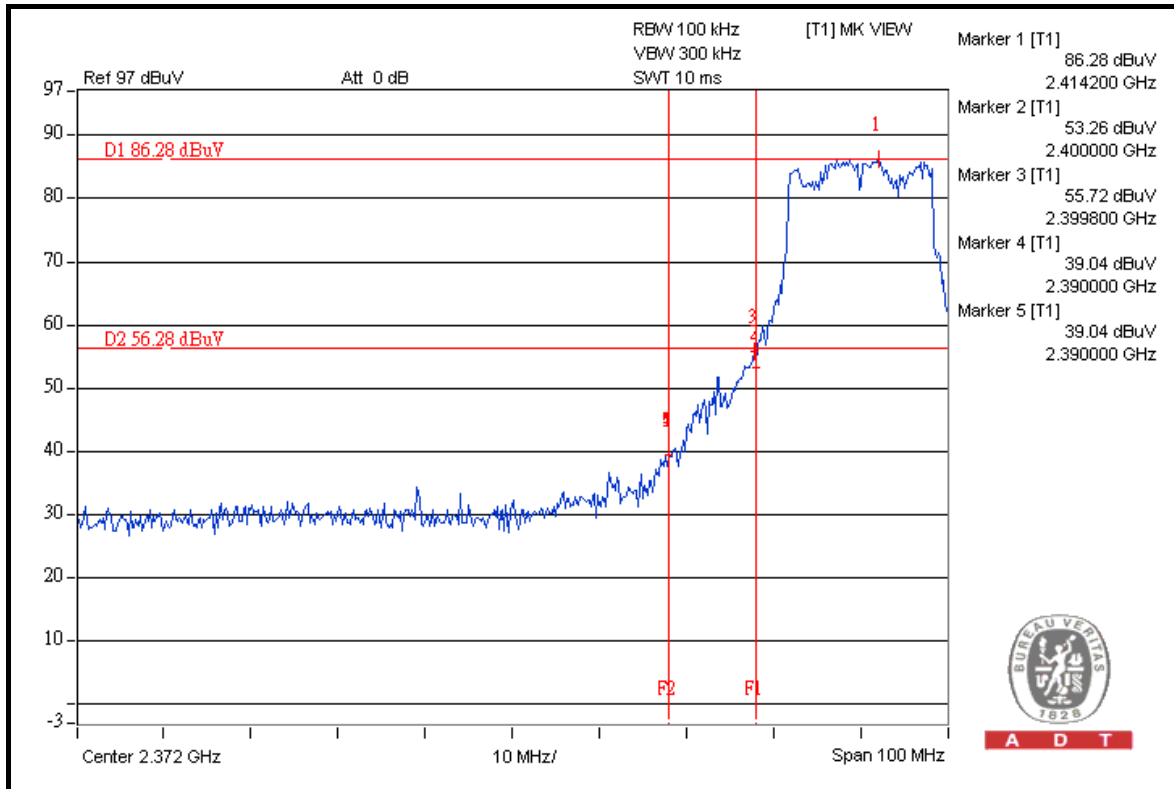



A D T

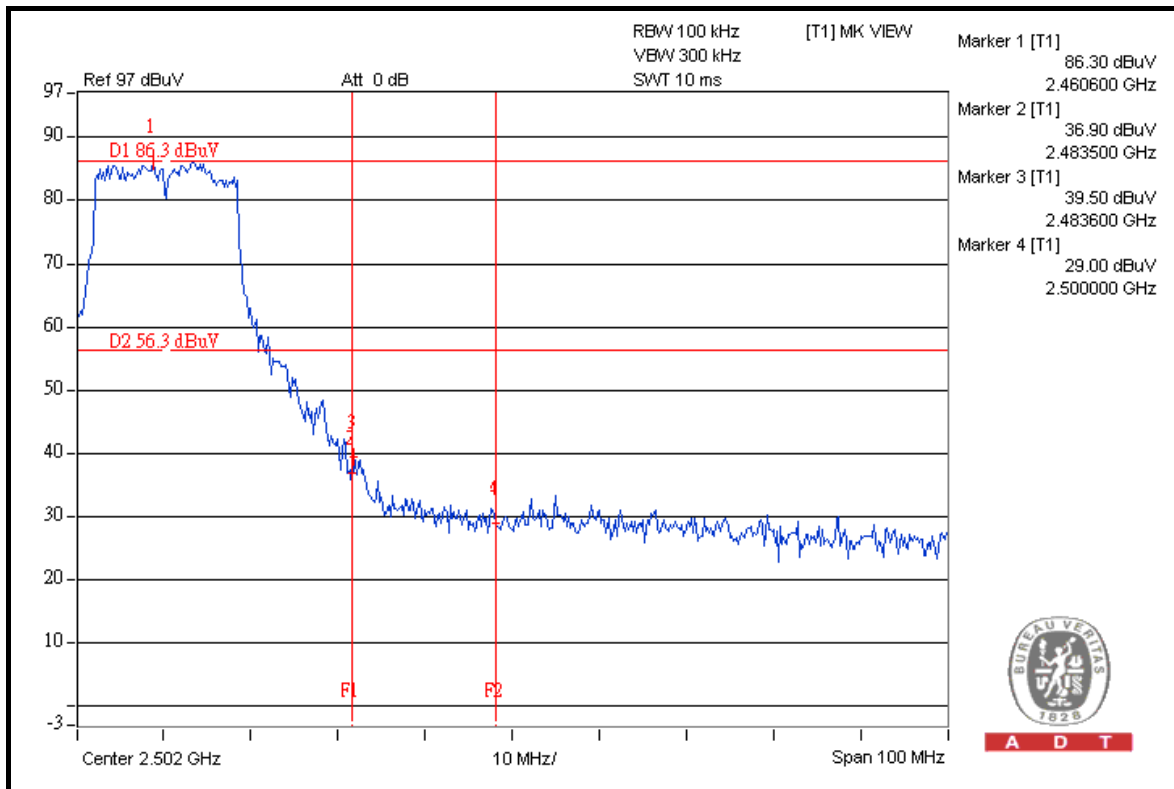
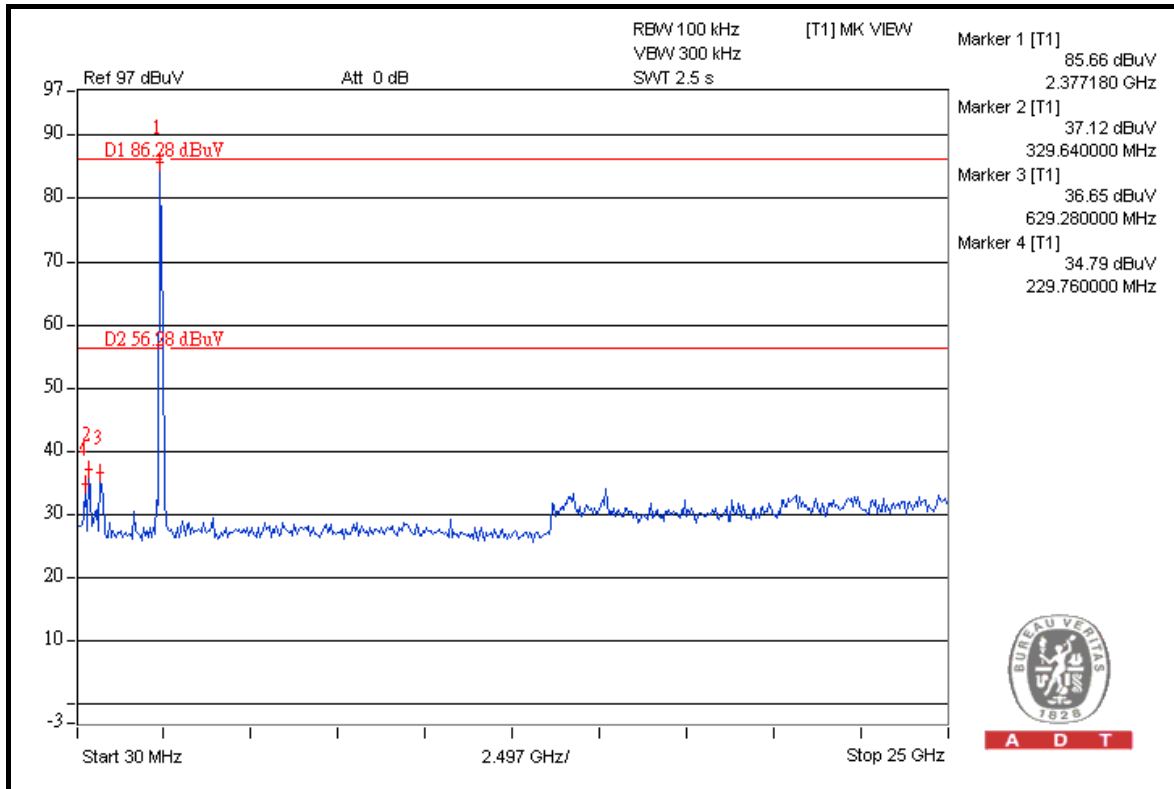



A D T

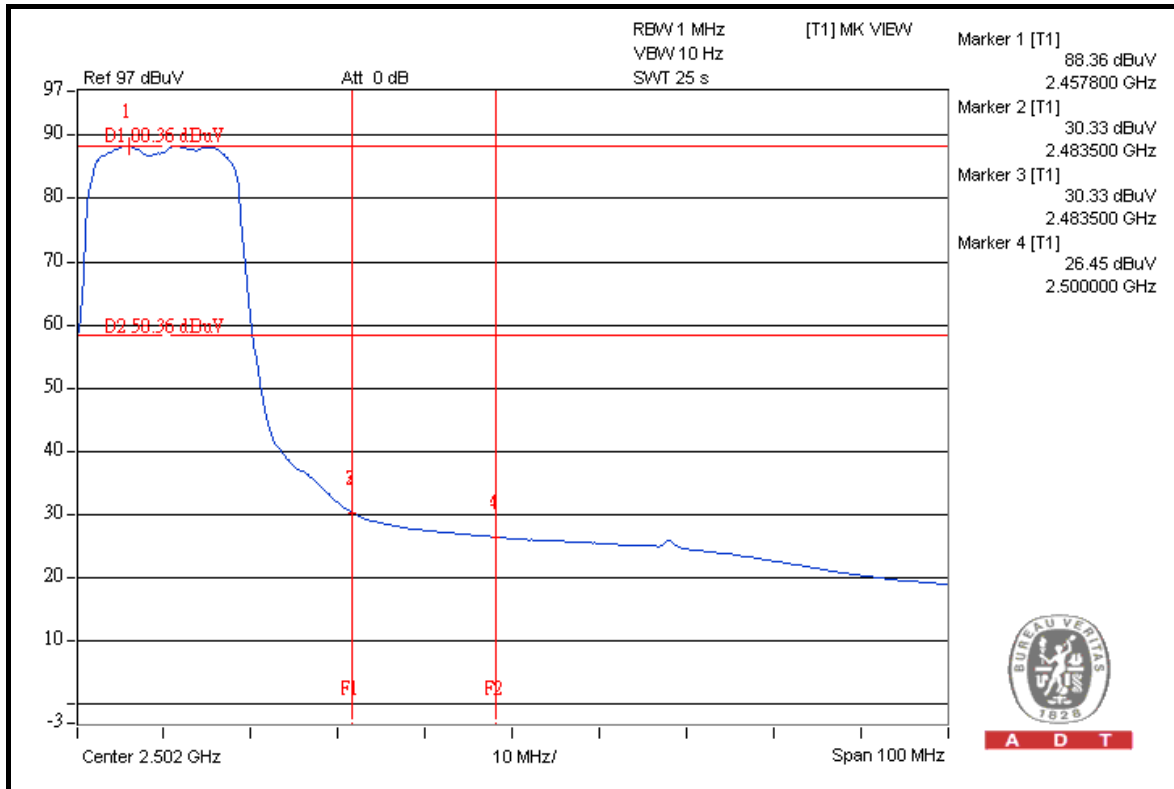

A D T

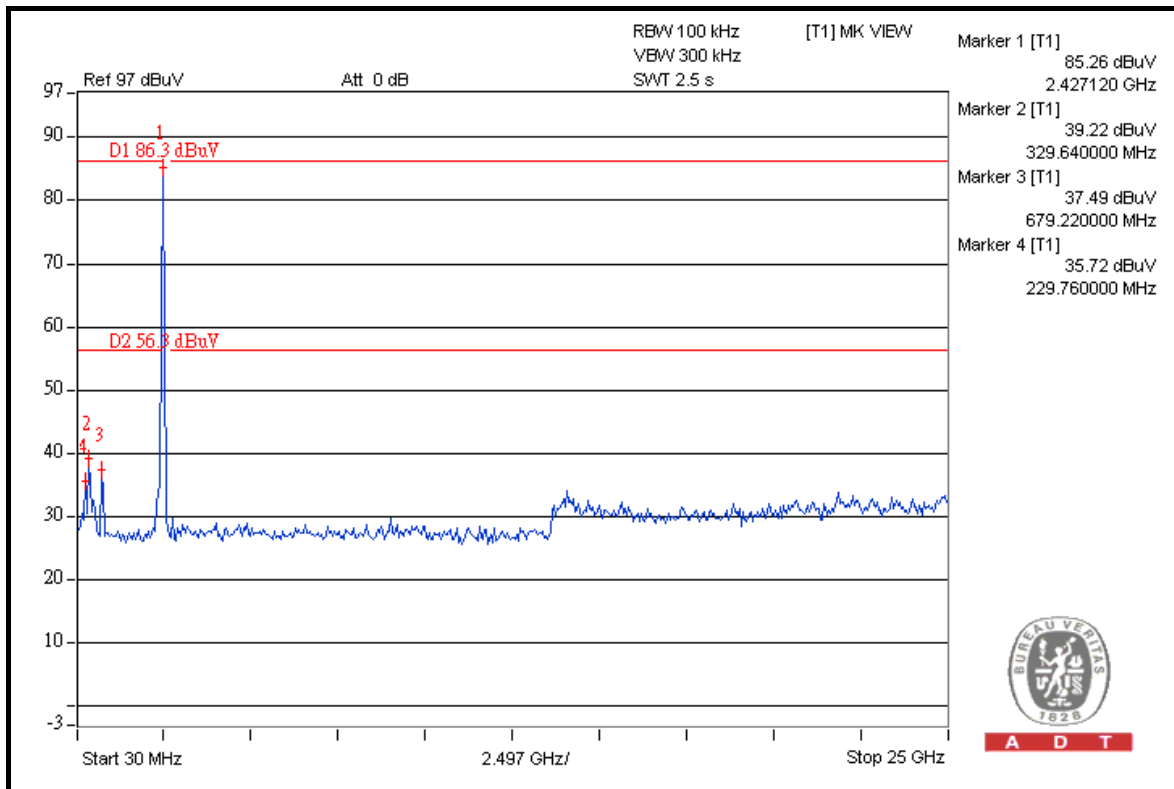

A D T



DRAFT 802.11n (20MHz) OFDM MODULATION

NOTE 1: The band edge emission plot on the next page shows 48.07dBc between carrier maximum power and local maximum emission in restrict band (2.3896GHz). The emission of carrier strength list in the test result of channel 1 at the item 4.1.7 is 119.86dBuV/m (Peak), so the maximum field strength in restrict band is $119.86 - 48.07 = 71.79$ dBuV/m which is under 74dBuV/m limit.

The band edge emission plot of on the next page shows 57.51dBc between carrier maximum power and local maximum emission in restrict band (2.3900GHz). The emission of carrier strength list in the test result of channel 1 at the item 4.1.7 is 109.51dBuV/m (Average), so the maximum field strength in restrict band is $109.51 - 57.51 = 52.00$ dBuV/m which is under 54dBuV/m limit.

NOTE 2: The band edge emission plot on the next second page shows 48.47dBc between carrier maximum power and local maximum emission in restrict band (2.4835GHz). The emission of carrier strength list in the test result of channel 11 at the item 4.1.7 is 119.45dBuV/m (Peak), so the maximum field strength in restrict band is $119.45 - 48.47 = 70.98$ dBuV/m which is under 74dBuV/m limit.

The band edge emission plot on the next third page shows 56.79dBc between carrier maximum power and local maximum emission in restrict band (2.4835GHz). The emission of carrier strength list in the test result of channel 11 at the item 4.1.7 is 108.81dBuV/m (Average), so the maximum field strength in restrict band is $108.81 - 56.79 = 52.02$ dBuV/m which is under 54dBuV/m limit.



A D T

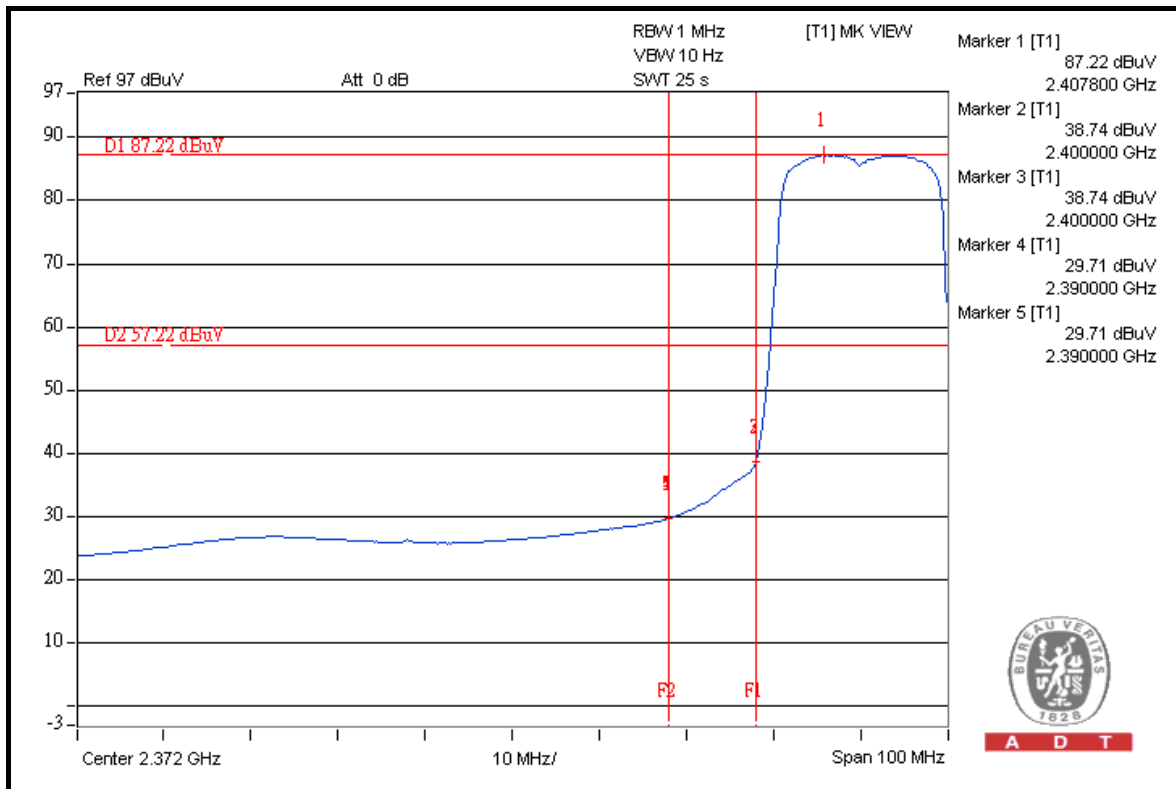
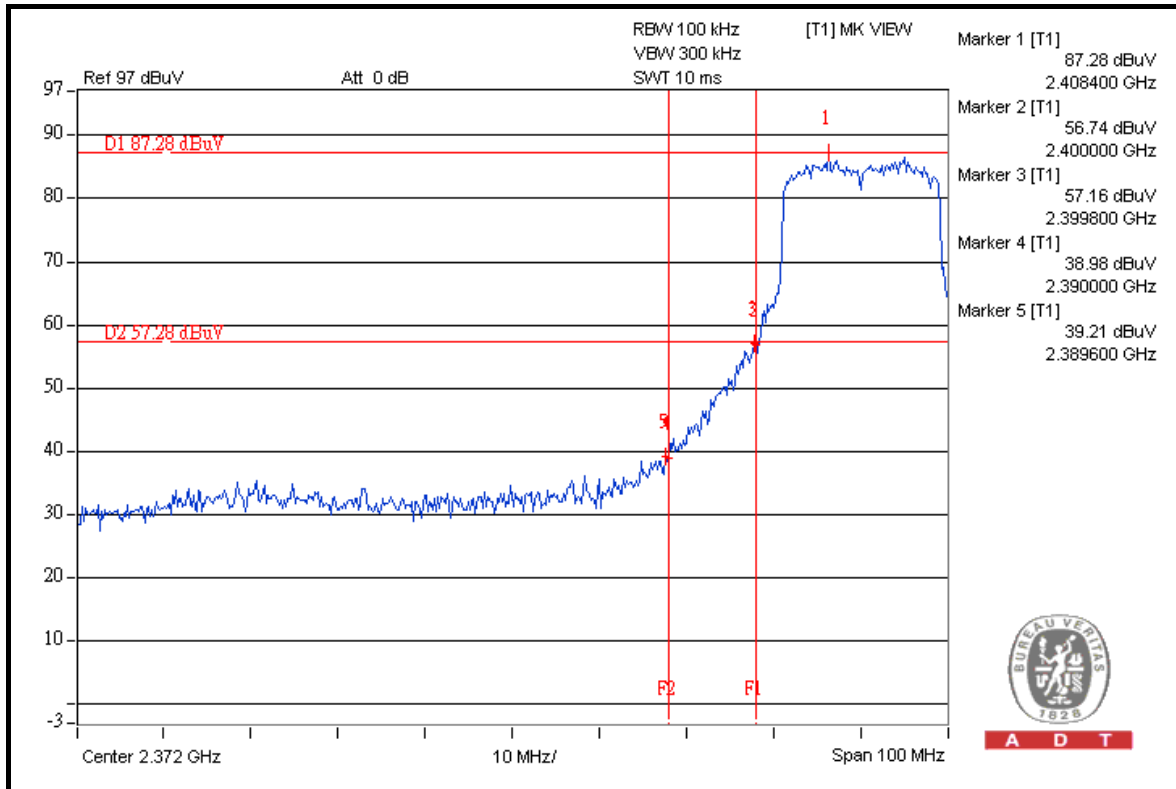



A D T

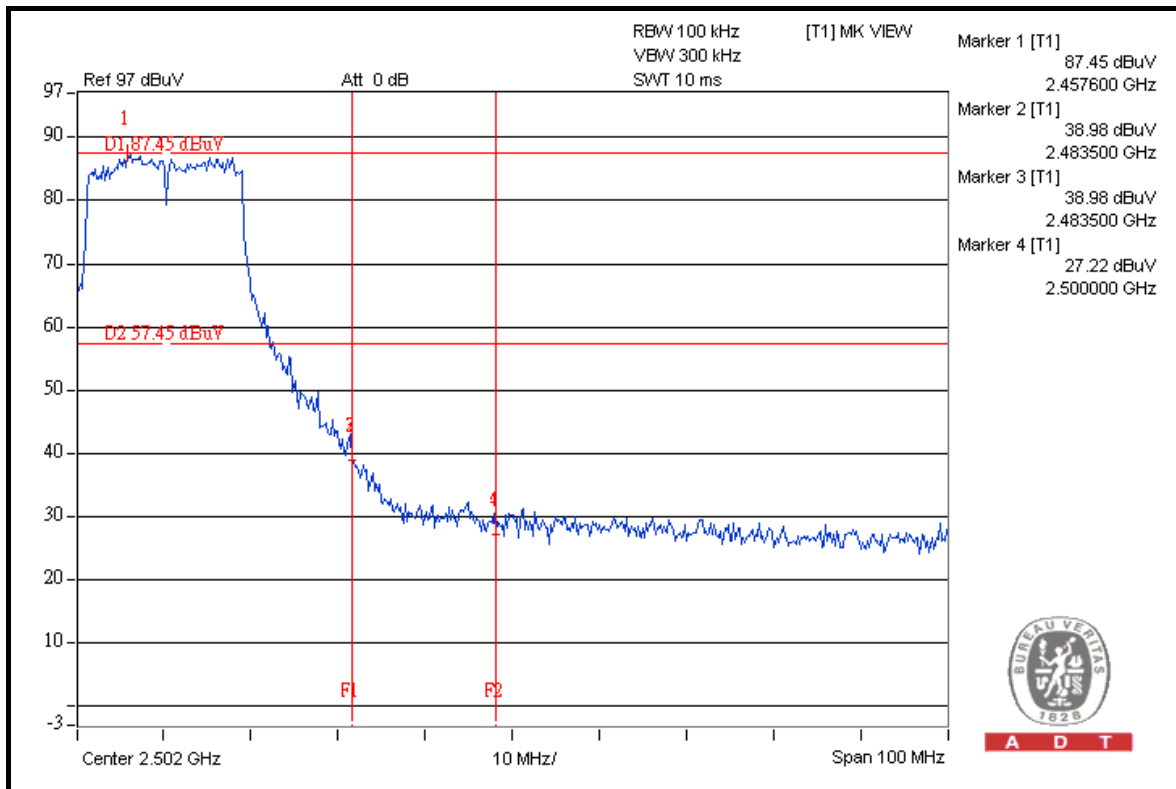
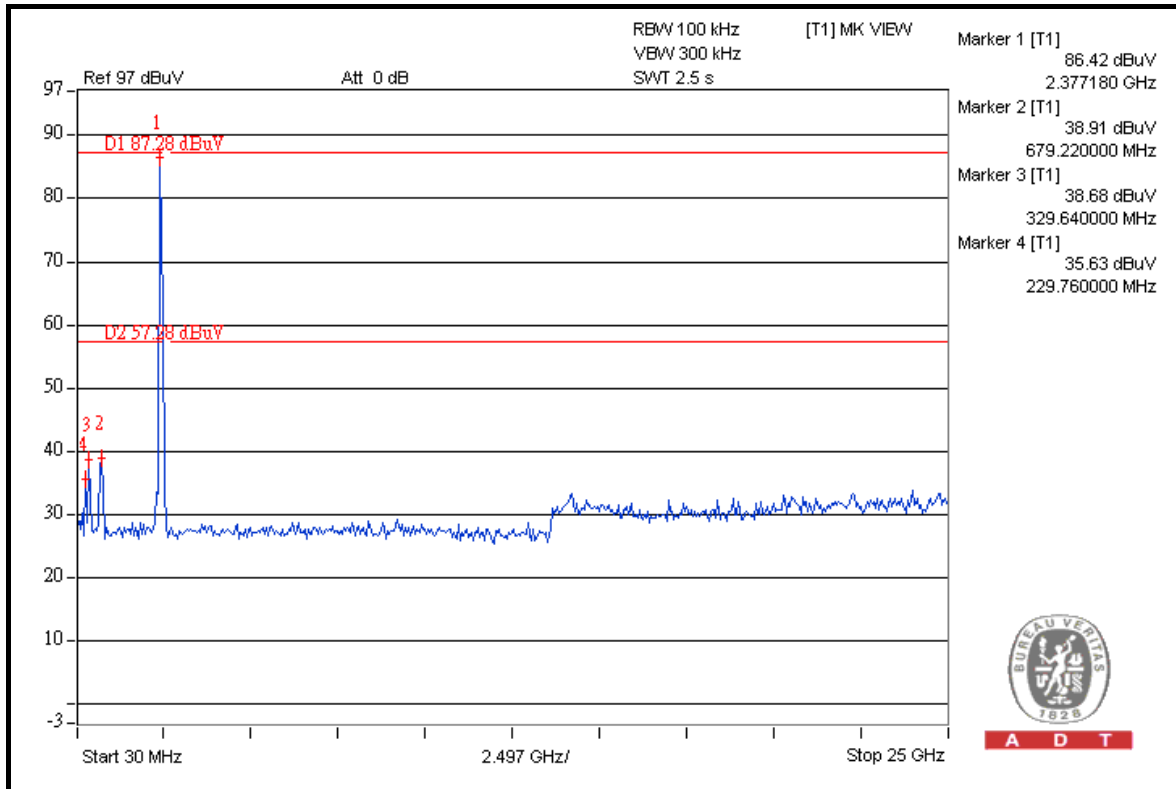



A D T

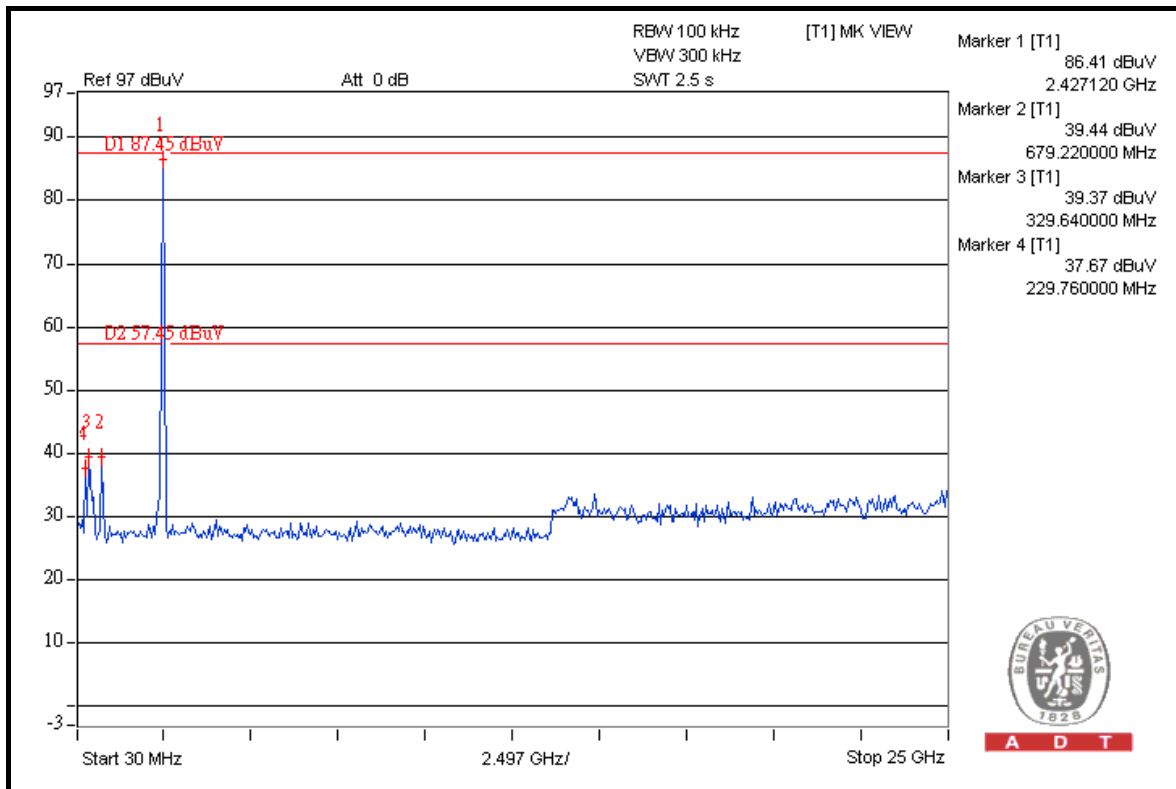
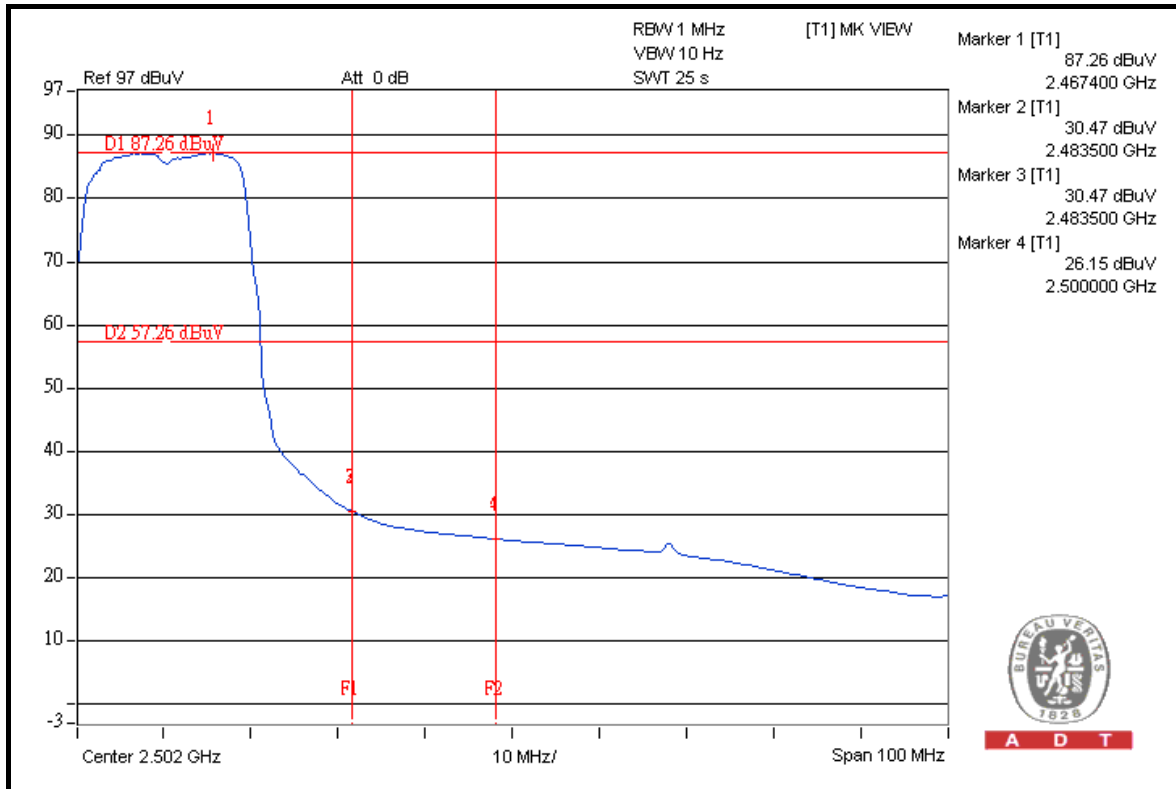



DRAFT 802.11n (40MHz) OFDM MODULATION

NOTE 1: The band edge emission plot on the next page shows 43.72dBc between carrier maximum power and local maximum emission in restrict band (2.3896GHz). The emission of carrier strength list in the test result of channel 1 at the item 4.1.7 is 117.29dBuV/m (Peak), so the maximum field strength in restrict band is $117.29 - 43.72 = 73.57$ dBuV/m which is under 74dBuV/m limit.

The band edge emission plot of on the next page shows 54.70dBc between carrier maximum power and local maximum emission in restrict band (2.3900GHz). The emission of carrier strength list in the test result of channel 1 at the item 4.1.7 is 106.94dBuV/m (Average), so the maximum field strength in restrict band is $106.94 - 54.70 = 52.24$ dBuV/m which is under 54dBuV/m limit.

NOTE 2: The band edge emission plot on the next second page shows 44.83dBc between carrier maximum power and local maximum emission in restrict band (2.4900GHz). The emission of carrier strength list in the test result of channel 7 at the item 4.1.7 is 117.04dBuV/m (Peak), so the maximum field strength in restrict band is $117.04 - 44.83 = 72.21$ dBuV/m which is under 74dBuV/m limit.

The band edge emission plot on the next third page shows 53.97dBc between carrier maximum power and local maximum emission in restrict band (2.4835GHz). The emission of carrier strength list in the test result of channel 7 at the item 4.1.7 is 106.62dBuV/m (Average), so the maximum field strength in restrict band is $106.62 - 53.97 = 52.65$ dBuV/m which is under 54dBuV/m limit.



A D T

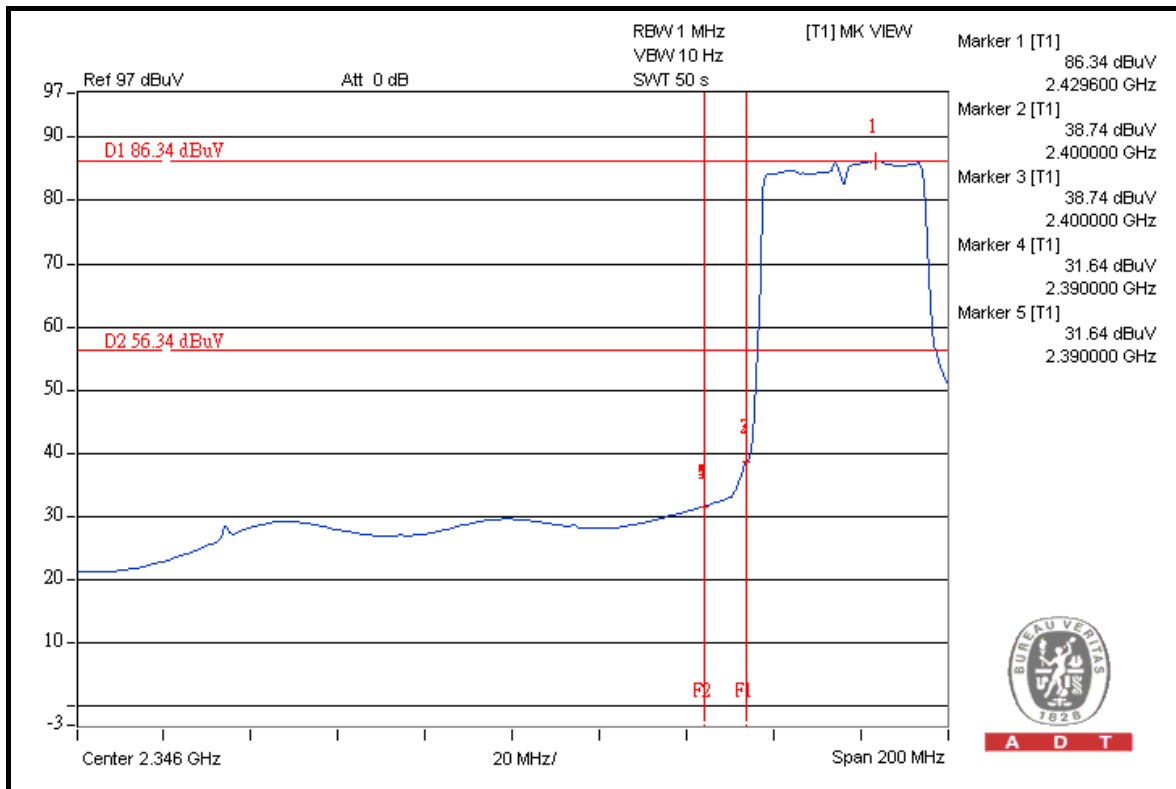
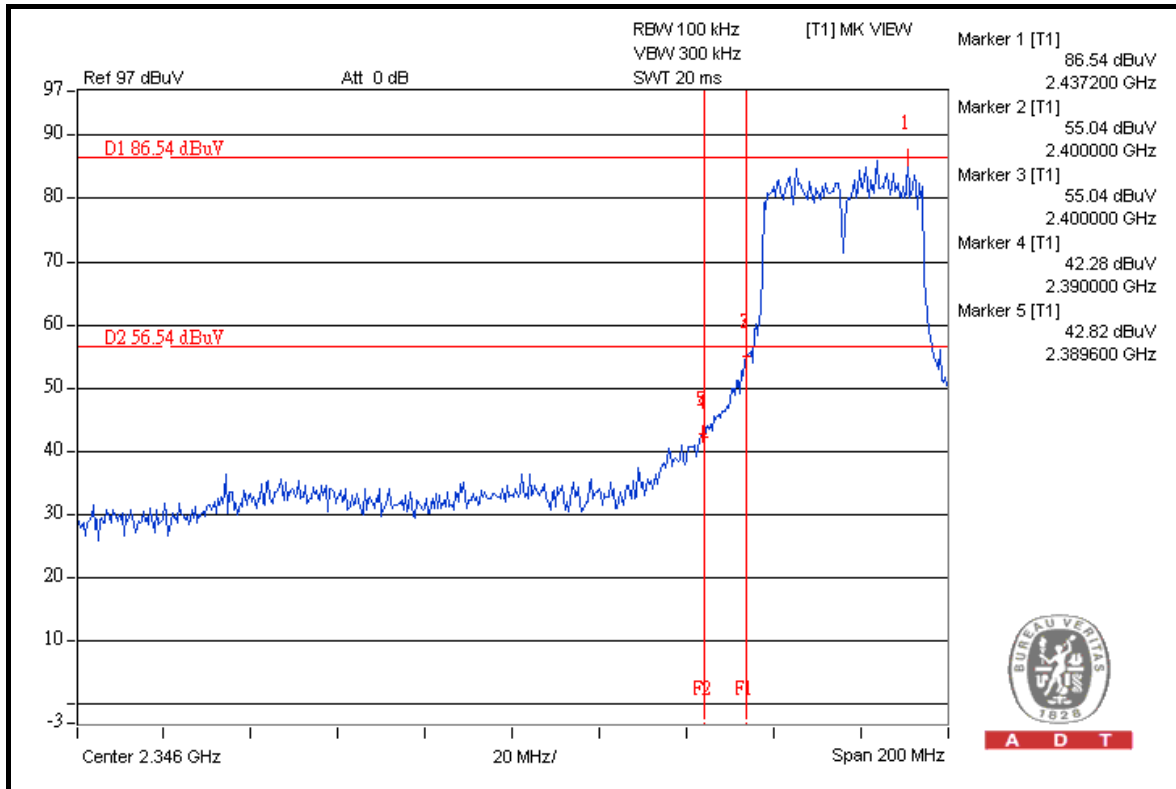



A D T

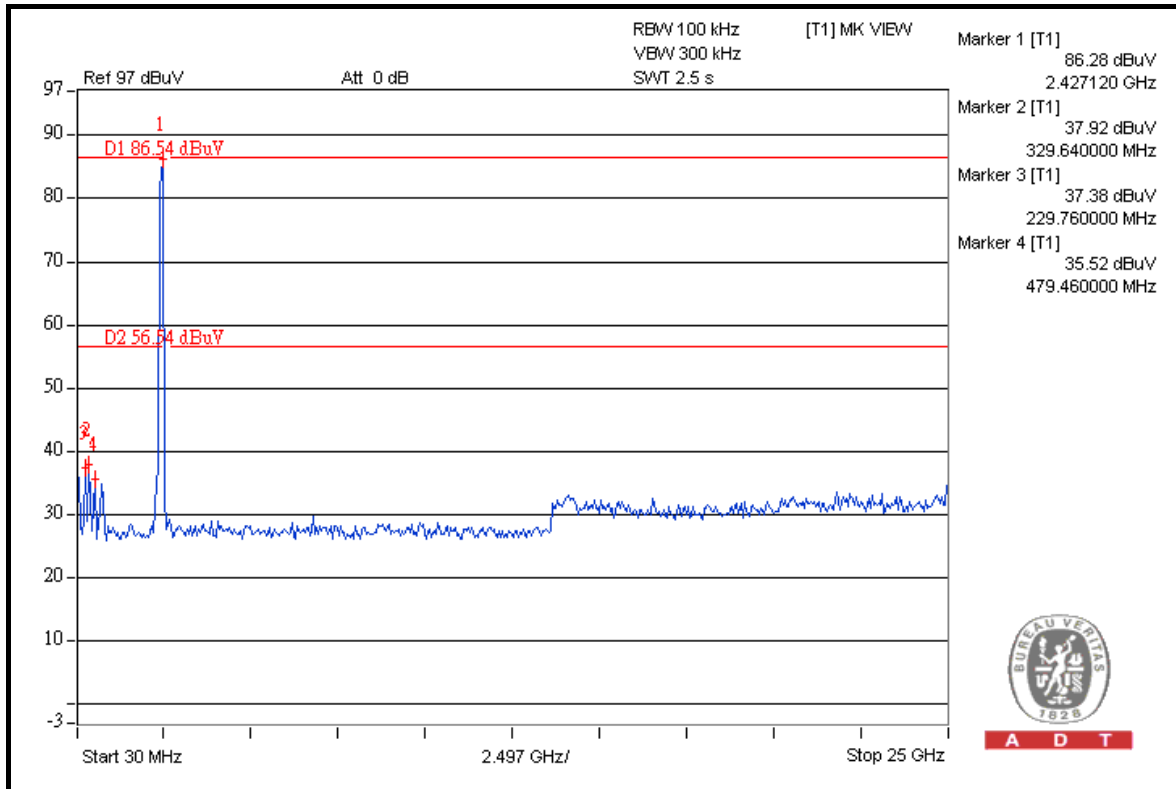

A D T

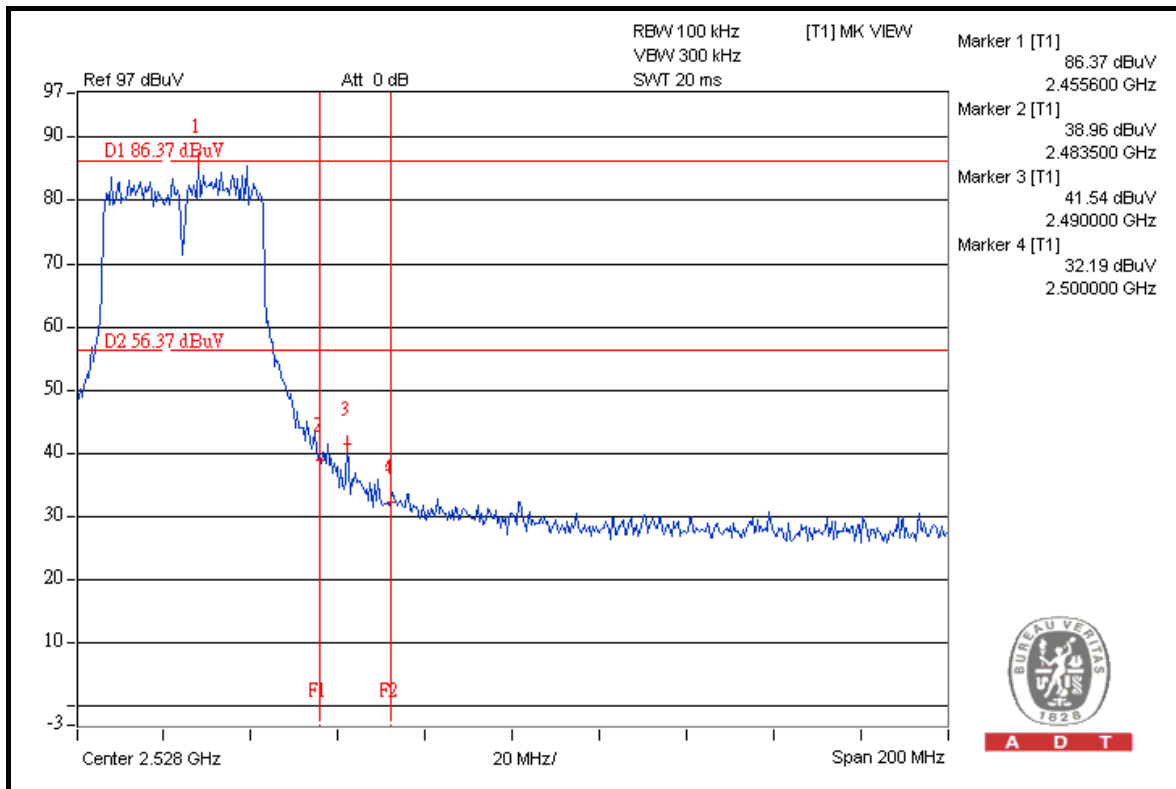

A D T



A D T

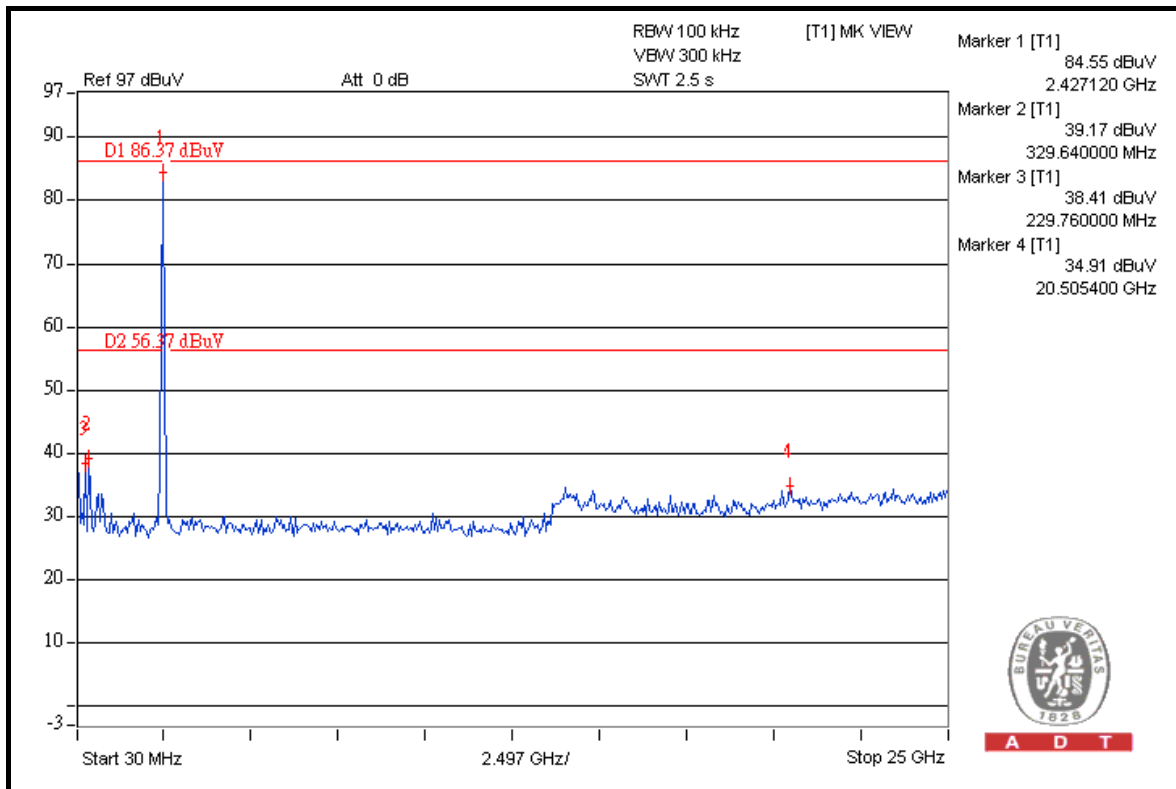
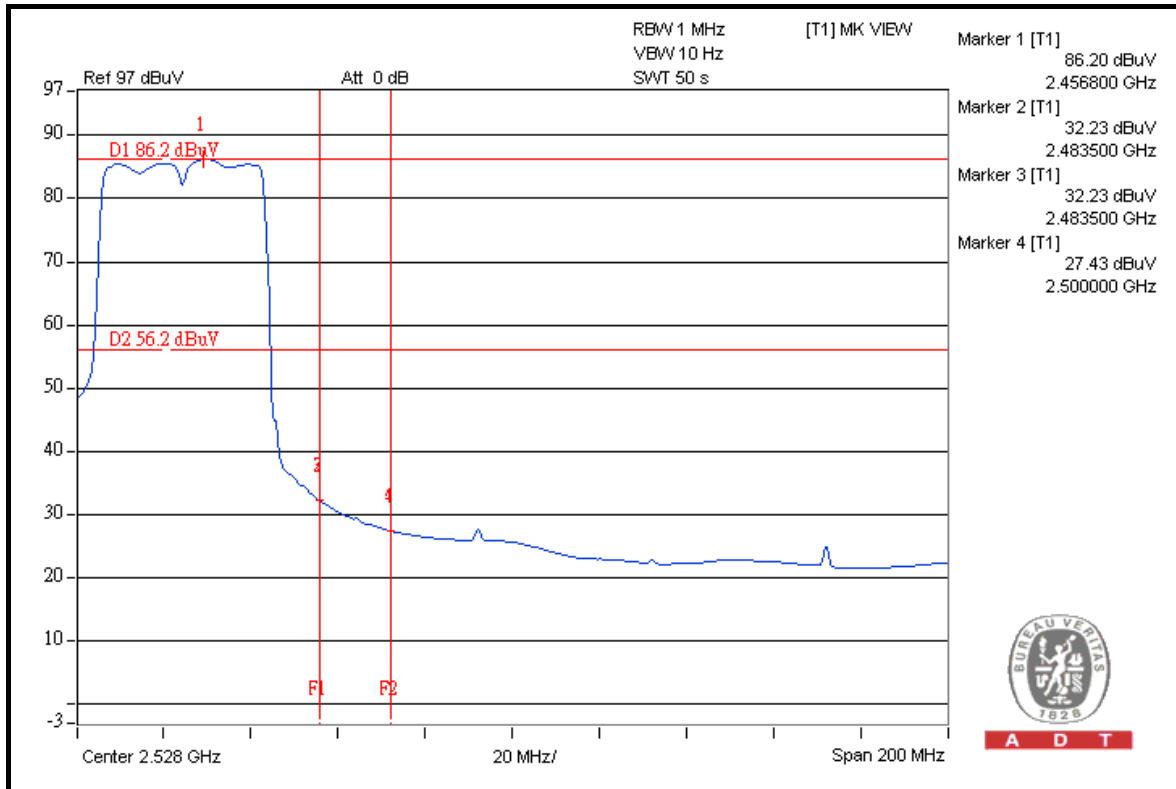



A D T

4.7 ANTENNA REQUIREMENT

4.7.1 STANDARD APPLICABLE

For intentional device, according to FCC 47 CFR Section 15.203, an intentional radiator shall be designed to ensure that no antenna other than that furnished by the responsible party shall be used with the device.

And according to FCC 47 CFR Section 15.247 (b), if transmitting antennas of directional gain greater than 6dBi are used, the power shall be reduced by the amount in dB that the directional gain of the antenna exceeds 6dBi.

4.7.2 ANTENNA CONNECTED CONSTRUCTION

The antenna used in this product is internal: Proprietary omni antenna without antenna connector. The maximum gain of the antenna is 3dBi.



5. TEST TYPES AND RESULTS (FOR 5.0GHz BAND)

5.1 RADIATED EMISSION MEASUREMENT

5.1.1 LIMITS OF RADIATED EMISSION MEASUREMENT

Emissions radiated outside of the specified bands, shall be according to the general radiated limits in 15.209 as following:

FREQUENCIES (MHz)	FIELD STRENGTH (microvolts/meter)	MEASUREMENT DISTANCE (meters)
0.009 ~ 0.490	2400/F(kHz)	300
0.490 ~ 1.705	24000/F(kHz)	30
1.705 ~ 30.0	30	30
30 ~ 88	100	3
88 ~ 216	150	3
216 ~ 960	200	3
Above 960	500	3

NOTE:

1. The lower limit shall apply at the transition frequencies.
2. Emission level (dBuV/m) = 20 log Emission level (uV/m).
3. As shown in 15.35(b), for frequencies above 1000MHz, the field strength limits are based on average detector, however, the peak field strength of any emission shall not exceed the maximum permitted average limits, specified above by more than 20dB under any condition of modulation.



A D T

5.1.2 TEST INSTRUMENTS

DESCRIPTION & MANUFACTURER	MODEL NO.	SERIAL NO.	DATE OF CALIBRATION	DUE DATE OF CALIBRATION
Test Receiver ROHDE & SCHWARZ	ESI7	100033	Jul. 06, 2009	Jul. 05, 2010
Spectrum Analyzer ROHDE & SCHWARZ	FSP40	100076	May. 26, 2009	May. 25, 2010
BILOG Antenna SCHWARZBECK	VULB9168	9168-160	Apr. 27, 2009	Apr. 26, 2010
HORN Antenna SCHWARZBECK	9120D	9120D-209	Jul. 01, 2009	Jun. 30, 2010
HORN Antenna SCHWARZBECK	BBHA 9170	BBHA9170243	Dec. 25, 2008	Dec. 24, 2009
Preamplifier Agilent	8447D	2944A10633	Nov. 03, 2008	Nov. 02, 2009
Preamplifier Agilent	8449B	3008A01964	Oct. 23, 2008	Oct. 22, 2009
RF signal cable HUBER+SUHNNER	SUCOFLEX 104	238141/4	May 13, 2009	May 12, 2010
RF signal cable HUBER+SUHNNER	SUCOFLEX 104	12738/6	May 13, 2009	May 12, 2010
Software ADT.	ADT_Radiated_ V7.6.15.9.2	NA	NA	NA
Antenna Tower inn-co GmbH	MA 4000	013303	NA	NA
Antenna Tower Controller inn-co GmbH	CO2000	017303	NA	NA
Turn Table ADT.	TT100.	TT93021703	NA	NA
Turn Table Controller ADT.	SC100.	SC93021703	NA	NA
26GHz ~ 40GHz Amplifier	EM26400	07026401	Aug. 27, 2008	Aug. 26, 2009

- NOTE:**
1. The calibration interval of the above test instruments is 12 months and the calibrations are traceable to NML/ROC and NIST/USA.
 2. The test was performed in HwaYa Chamber 3.
 3. The horn antenna and HP preamplifier (model: 8449B) are used only for the measurement of emission frequency above 1GHz if tested.
 4. The FCC Site Registration No. is 988962.
 5. The IC Site Registration No. is IC 7450F-3.

5.1.3 TEST PROCEDURES

- a. The EUT was placed on the top of a rotating table 0.8 meters above the ground at a 3 meters semi-anechoic chamber. The table was rotated 360 degrees to determine the position of the highest radiation.
- b. The EUT was set 3 meters away from the interference-receiving antenna, which was mounted on the top of a variable-height antenna tower.
- c. The antenna is a broadband antenna, and its height is varied from one meter to four meters above the ground to determine the maximum value of the field strength. Both horizontal and vertical polarizations of the antenna are set to make the measurement.
- d. For each suspected emission, the EUT was arranged to its worst case and then the antenna was tuned to heights from 1 meter to 4 meters and the rotatable table was turned from 0 degrees to 360 degrees to find the maximum reading.
- e. The test-receiver system was set to Peak Detect Function and Specified Bandwidth with Maximum Hold Mode.
- f. If the emission level of the EUT in peak mode was lower than the limit specified, then testing could be stopped and the peak values of the EUT would be reported. Otherwise the emissions would be re-tested one by one using peak, quasi-peak or average method as specified and then reported in a data sheet.

NOTE:

1. The resolution bandwidth and video bandwidth of test receiver/spectrum analyzer is 120kHz for Quasi-peak detection at frequency below 1GHz.
2. The resolution bandwidth of test receiver/spectrum analyzer is 1MHz and video bandwidth is 3MHz for Peak detection at frequency above 1GHz.
3. The resolution bandwidth of test receiver/spectrum analyzer is 1MHz and the video bandwidth is 10Hz for Average detection (AV) at frequency above 1GHz.
4. All modes of operation were investigated and the worst-case emissions are reported.

5.1.4 DEVIATION FROM TEST STANDARD

No deviation.

5.1.5 TEST SETUP

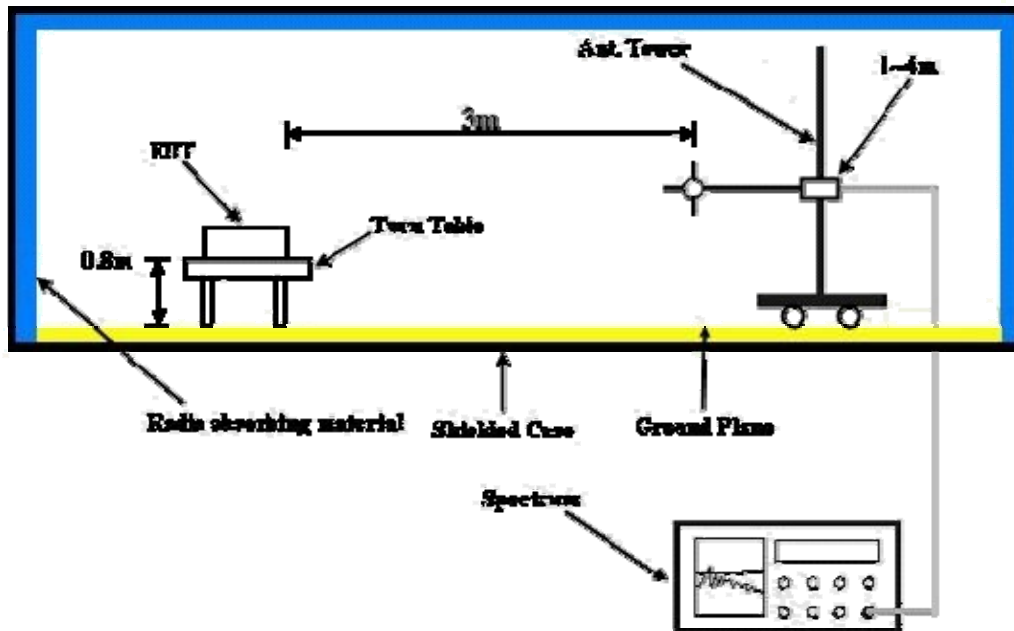

For the actual test configuration, please refer to the attached file (Test Setup Photo).

5.1.6 EUT OPERATING CONDITIONS

Same as 4.1.6.



A D T

5.1.7 TEST RESULTS

802.11a OFDM MODULATION

EUT TEST CONDITION		MEASUREMENT DETAIL	
CHANNEL	Channel 149	FREQUENCY RANGE	1 ~ 40GHz
INPUT POWER (SYSTEM)	120Vac, 60 Hz	DETECTOR FUNCTION	Peak (PK) Average (AV)
ENVIRONMENTAL CONDITIONS	24deg. C, 64%RH 1002 hPa	TESTED BY	Brad Wu
TEST MODE	A		

ANTENNA POLARITY & TEST DISTANCE: HORIZONTAL AT 3 M								
NO.	FREQ. (MHz)	EMISSION LEVEL (dBuV/m)	LIMIT (dBuV/m)	MARGIN (dB)	ANTENNA HEIGHT (m)	TABLE ANGLE (Degree)	RAW VALUE (dBuV)	CORRECTION FACTOR (dB/m)
1	#5725.00	86.18 PK	86.45	-0.27	1.18 H	113	48.08	38.10
2	#5725.00	72.64 AV	75.89	-3.25	1.18 H	113	34.54	38.10
3	*5745.00	116.45 PK			1.18 H	113	78.32	38.13
4	*5745.00	105.89 AV			1.18 H	113	67.76	38.13
5	11490.00	67.86 PK	74.00	-6.14	1.35 H	204	19.43	48.43
6	11490.00	53.57 AV	54.00	-0.43	1.35 H	204	5.14	48.43
ANTENNA POLARITY & TEST DISTANCE: VERTICAL AT 3 M								
NO.	FREQ. (MHz)	EMISSION LEVEL (dBuV/m)	LIMIT (dBuV/m)	MARGIN (dB)	ANTENNA HEIGHT (m)	TABLE ANGLE (Degree)	RAW VALUE (dBuV)	CORRECTION FACTOR (dB/m)
1	#5725.00	83.59 PK	84.61	-1.02	1.10 V	115	45.49	38.10
2	#5725.00	70.25 AV	73.92	-3.67	1.10 V	115	32.15	38.10
3	*5745.00	114.61 PK			1.10 V	115	76.48	38.13
4	*5745.00	103.92 AV			1.10 V	115	65.79	38.13
5	11490.00	67.62 PK	74.00	-6.38	1.01 V	243	19.19	48.43
6	11490.00	53.29 AV	54.00	-0.71	1.01 V	243	4.86	48.43

- REMARKS:**
1. Emission level (dBuV/m) = Raw Value (dBuV) + Correction Factor (dB/m).
 2. Correction Factor (dB/m) = Antenna Factor (dB/m) + Cable Factor (dB).
 3. The other emission levels were very low against the limit.
 4. Margin value = Emission level – Limit value.
 5. “ * “: Fundamental frequency.
 6. The limit value is defined as per 15.247.
 7. "#":The radiated frequency is out the restricted band.



A D T

EUT TEST CONDITION		MEASUREMENT DETAIL	
CHANNEL	Channel 157	FREQUENCY RANGE	1 ~ 40GHz
INPUT POWER (SYSTEM)	120Vac, 60 Hz	DETECTOR FUNCTION	Peak (PK) Average (AV)
ENVIRONMENTAL CONDITIONS	24deg. C, 64%RH 1002 hPa	TESTED BY	Brad Wu
TEST MODE	A		

ANTENNA POLARITY & TEST DISTANCE: HORIZONTAL AT 3 M								
NO.	FREQ. (MHz)	EMISSION LEVEL (dBuV/m)	LIMIT (dBuV/m)	MARGIN (dB)	ANTENNA HEIGHT (m)	TABLE ANGLE (Degree)	RAW VALUE (dBuV)	CORRECTION FACTOR (dB/m)
1	*5785.00	116.62 PK			1.19 H	115	78.42	38.20
2	*5785.00	105.94 AV			1.19 H	115	67.74	38.20
3	11570.00	67.86 PK	74.00	-6.14	1.19 H	203	19.51	48.35
4	11570.00	53.61 AV	54.00	-0.39	1.19 H	203	5.26	48.35
ANTENNA POLARITY & TEST DISTANCE: VERTICAL AT 3 M								
NO.	FREQ. (MHz)	EMISSION LEVEL (dBuV/m)	LIMIT (dBuV/m)	MARGIN (dB)	ANTENNA HEIGHT (m)	TABLE ANGLE (Degree)	RAW VALUE (dBuV)	CORRECTION FACTOR (dB/m)
1	*5785.00	114.83 PK			1.11 V	118	76.63	38.20
2	*5785.00	104.15 AV			1.11 V	118	65.95	38.20
3	11570.00	67.13 PK	74.00	-6.87	1.04 V	275	18.78	48.35
4	11570.00	52.94 AV	54.00	-1.06	1.04 V	275	4.59	48.35

- REMARKS:**
1. Emission level (dBuV/m) = Raw Value (dBuV) + Correction Factor (dB/m).
 2. Correction Factor (dB/m) = Antenna Factor (dB/m) + Cable Factor (dB).
 3. The other emission levels were very low against the limit.
 4. Margin value = Emission level – Limit value.
 5. “ * “: Fundamental frequency.
 6. The limit value is defined as per 15.247.



A D T

EUT TEST CONDITION		MEASUREMENT DETAIL	
CHANNEL	Channel 165	FREQUENCY RANGE	1 ~ 40GHz
INPUT POWER (SYSTEM)	120Vac, 60 Hz	DETECTOR FUNCTION	Peak (PK) Average (AV)
ENVIRONMENTAL CONDITIONS	24deg. C, 64%RH 1002 hPa	TESTED BY	Brad Wu
TEST MODE	A		

ANTENNA POLARITY & TEST DISTANCE: HORIZONTAL AT 3 M								
NO.	FREQ. (MHz)	EMISSION LEVEL (dBuV/m)	LIMIT (dBuV/m)	MARGIN (dB)	ANTENNA HEIGHT (m)	TABLE ANGLE (Degree)	RAW VALUE (dBuV)	CORRECTION FACTOR (dB/m)
1	*5825.00	116.53 PK			1.20 H	108	78.25	38.29
2	*5825.00	105.92 AV			1.20 H	108	67.63	38.29
3	#5850.00	82.16 PK	86.53	-4.37	1.20 H	108	43.81	38.35
4	#5850.00	67.52 AV	75.92	-8.40	1.20 H	108	29.17	38.35
5	11650.00	67.54 PK	74.00	-6.46	1.09 H	194	19.41	48.13
6	11650.00	53.12 AV	54.00	-0.88	1.09 H	194	4.99	48.13
ANTENNA POLARITY & TEST DISTANCE: VERTICAL AT 3 M								
NO.	FREQ. (MHz)	EMISSION LEVEL (dBuV/m)	LIMIT (dBuV/m)	MARGIN (dB)	ANTENNA HEIGHT (m)	TABLE ANGLE (Degree)	RAW VALUE (dBuV)	CORRECTION FACTOR (dB/m)
1	*5825.00	114.75 PK			1.08 V	116	76.47	38.29
2	*5825.00	104.06 AV			1.08 V	116	65.78	38.29
3	#5850.00	80.62 PK	84.75	-4.13	1.08 V	116	42.27	38.35
4	#5850.00	65.82 AV	74.06	-8.24	1.08 V	116	27.47	38.35
5	11650.00	67.02 PK	74.00	-6.98	1.01 V	239	18.89	48.13
6	11650.00	52.62 AV	54.00	-1.38	1.01 V	239	4.49	48.13

- REMARKS:**
1. Emission level (dBuV/m) = Raw Value (dBuV) + Correction Factor (dB/m).
 2. Correction Factor (dB/m) = Antenna Factor (dB/m) + Cable Factor (dB).
 3. The other emission levels were very low against the limit.
 4. Margin value = Emission level – Limit value.
 5. “ * “: Fundamental frequency.
 6. The limit value is defined as per 15.247.
 7. “#”:The radiated frequency is out the restricted band.



A D T

EUT TEST CONDITION		MEASUREMENT DETAIL	
CHANNEL	Channel 149	FREQUENCY RANGE	1 ~ 40GHz
INPUT POWER (SYSTEM)	120Vac, 60 Hz	DETECTOR FUNCTION	Peak (PK) Average (AV)
ENVIRONMENTAL CONDITIONS	24deg. C, 64%RH 1002 hPa	TESTED BY	Brad Wu
TEST MODE	C		

ANTENNA POLARITY & TEST DISTANCE: HORIZONTAL AT 3 M								
NO.	FREQ. (MHz)	EMISSION LEVEL (dBuV/m)	LIMIT (dBuV/m)	MARGIN (dB)	ANTENNA HEIGHT (m)	TABLE ANGLE (Degree)	RAW VALUE (dBuV)	CORRECTION FACTOR (dB/m)
1	#5725.00	68.02 PK	68.91	-0.89	1.05 H	207	29.92	38.10
2	#5725.00	57.28 AV	58.36	-1.08	1.05 H	207	19.18	38.10
3	*5745.00	98.91 PK			1.05 H	207	60.78	38.13
4	*5745.00	88.36 AV			1.05 H	207	50.23	38.13
5	11490.00	67.21 PK	74.00	-6.79	1.01 H	204	18.78	48.43
6	11490.00	52.92 AV	54.00	-1.08	1.01 H	204	4.49	48.43
ANTENNA POLARITY & TEST DISTANCE: VERTICAL AT 3 M								
NO.	FREQ. (MHz)	EMISSION LEVEL (dBuV/m)	LIMIT (dBuV/m)	MARGIN (dB)	ANTENNA HEIGHT (m)	TABLE ANGLE (Degree)	RAW VALUE (dBuV)	CORRECTION FACTOR (dB/m)
1	#5725.00	85.92 PK	86.23	-0.31	1.15 V	209	47.82	38.10
2	#5725.00	72.41 AV	75.64	-3.23	1.15 V	209	34.31	38.10
3	*5745.00	116.23 PK			1.15 V	209	78.10	38.13
4	*5745.00	105.64 AV			1.15 V	209	67.51	38.13
5	11490.00	67.52 PK	74.00	-6.48	1.32 V	194	19.09	48.43
6	11490.00	53.24 AV	54.00	-0.76	1.32 V	194	4.81	48.43

- REMARKS:**
1. Emission level (dBuV/m) = Raw Value (dBuV) + Correction Factor (dB/m).
 2. Correction Factor (dB/m) = Antenna Factor (dB/m) + Cable Factor (dB).
 3. The other emission levels were very low against the limit.
 4. Margin value = Emission level – Limit value.
 5. “ * “: Fundamental frequency.
 6. The limit value is defined as per 15.247.
 7. "#":The radiated frequency is out the restricted band.



A D T

EUT TEST CONDITION		MEASUREMENT DETAIL	
CHANNEL	Channel 157	FREQUENCY RANGE	1 ~ 40GHz
INPUT POWER (SYSTEM)	120Vac, 60 Hz	DETECTOR FUNCTION	Peak (PK) Average (AV)
ENVIRONMENTAL CONDITIONS	24deg. C, 64%RH 1002 hPa	TESTED BY	Brad Wu
TEST MODE	C		

ANTENNA POLARITY & TEST DISTANCE: HORIZONTAL AT 3 M								
NO.	FREQ. (MHz)	EMISSION LEVEL (dBuV/m)	LIMIT (dBuV/m)	MARGIN (dB)	ANTENNA HEIGHT (m)	TABLE ANGLE (Degree)	RAW VALUE (dBuV)	CORRECTION FACTOR (dB/m)
1	*5785.00	99.06 PK			1.04 H	203	60.86	38.20
2	*5785.00	88.49 AV			1.04 H	203	50.29	38.20
3	11570.00	67.14 PK	74.00	-6.86	1.04 H	196	18.79	48.35
4	11570.00	52.84 AV	54.00	-1.16	1.04 H	196	4.49	48.35
ANTENNA POLARITY & TEST DISTANCE: VERTICAL AT 3 M								
NO.	FREQ. (MHz)	EMISSION LEVEL (dBuV/m)	LIMIT (dBuV/m)	MARGIN (dB)	ANTENNA HEIGHT (m)	TABLE ANGLE (Degree)	RAW VALUE (dBuV)	CORRECTION FACTOR (dB/m)
1	*5785.00	116.44 PK			1.16 V	212	78.24	38.20
2	*5785.00	105.72 AV			1.16 V	212	67.52	38.20
3	11570.00	67.62 PK	74.00	-6.38	1.21 V	219	19.27	48.35
4	11570.00	53.40 AV	54.00	-0.60	1.21 V	219	5.05	48.35

- REMARKS:**
1. Emission level (dBuV/m) = Raw Value (dBuV) + Correction Factor (dB/m).
 2. Correction Factor (dB/m) = Antenna Factor (dB/m) + Cable Factor (dB).
 3. The other emission levels were very low against the limit.
 4. Margin value = Emission level – Limit value.
 5. “ * “: Fundamental frequency.
 6. The limit value is defined as per 15.247.



A D T

EUT TEST CONDITION		MEASUREMENT DETAIL	
CHANNEL	Channel 165	FREQUENCY RANGE	1 ~ 40GHz
INPUT POWER (SYSTEM)	120Vac, 60 Hz	DETECTOR FUNCTION	Peak (PK) Average (AV)
ENVIRONMENTAL CONDITIONS	24deg. C, 64%RH 1002 hPa	TESTED BY	Brad Wu
TEST MODE	C		

ANTENNA POLARITY & TEST DISTANCE: HORIZONTAL AT 3 M								
NO.	FREQ. (MHz)	EMISSION LEVEL (dBuV/m)	LIMIT (dBuV/m)	MARGIN (dB)	ANTENNA HEIGHT (m)	TABLE ANGLE (Degree)	RAW VALUE (dBuV)	CORRECTION FACTOR (dB/m)
1	*5825.00	98.82 PK			1.05 H	204	60.53	38.29
2	*5825.00	88.26 AV			1.05 H	204	49.98	38.29
3	#5850.00	68.01 PK	68.82	-0.81	1.05 H	204	29.66	38.35
4	#5850.00	57.41 AV	58.26	-0.85	1.05 H	204	19.06	38.35
5	11650.00	67.12 PK	74.00	-6.88	1.01 H	194	18.99	48.13
6	11650.00	52.84 AV	54.00	-1.16	1.01 H	194	4.71	48.13
ANTENNA POLARITY & TEST DISTANCE: VERTICAL AT 3 M								
NO.	FREQ. (MHz)	EMISSION LEVEL (dBuV/m)	LIMIT (dBuV/m)	MARGIN (dB)	ANTENNA HEIGHT (m)	TABLE ANGLE (Degree)	RAW VALUE (dBuV)	CORRECTION FACTOR (dB/m)
1	*5825.00	116.32 PK			1.15 V	203	78.03	38.29
2	*5825.00	105.61 AV			1.15 V	203	67.32	38.29
3	#5850.00	81.95 PK	86.32	-4.37	1.15 V	203	43.60	38.35
4	#5850.00	67.28 AV	75.61	-8.33	1.15 V	203	28.93	38.35
5	11650.00	67.31 PK	74.00	-6.69	1.05 V	201	19.18	48.13
6	11650.00	53.04 AV	54.00	-0.96	1.05 V	201	4.91	48.13

- REMARKS:**
1. Emission level (dBuV/m) = Raw Value (dBuV) + Correction Factor (dB/m).
 2. Correction Factor (dB/m) = Antenna Factor (dB/m) + Cable Factor (dB).
 3. The other emission levels were very low against the limit.
 4. Margin value = Emission level – Limit value.
 5. “ * “: Fundamental frequency.
 6. The limit value is defined as per 15.247.
 7. “#”:The radiated frequency is out the restricted band.



A D T

DRAFT 802.11n (20MHz) OFDM MODULATION

EUT TEST CONDITION		MEASUREMENT DETAIL	
CHANNEL	Channel 149	FREQUENCY RANGE	1 ~ 40GHz
INPUT POWER (SYSTEM)	120Vac, 60 Hz	DETECTOR FUNCTION	Peak (PK) Average (AV)
ENVIRONMENTAL CONDITIONS	24deg. C, 64%RH 1002 hPa	TESTED BY	Brad Wu
TEST MODE	A		

ANTENNA POLARITY & TEST DISTANCE: HORIZONTAL AT 3 M								
NO.	FREQ. (MHz)	EMISSION LEVEL (dBuV/m)	LIMIT (dBuV/m)	MARGIN (dB)	ANTENNA HEIGHT (m)	TABLE ANGLE (Degree)	RAW VALUE (dBuV)	CORRECTION FACTOR (dB/m)
1	#5725.00	86.02 PK	86.32	-0.30	1.20 H	115	47.92	38.10
2	#5725.00	72.51 AV	75.75	-3.24	1.20 H	115	34.41	38.10
3	*5745.00	116.32 PK			1.20 H	115	78.19	38.13
4	*5745.00	105.75 AV			1.20 H	115	67.62	38.13
5	11490.00	67.65 PK	74.00	-6.35	1.31 H	206	19.22	48.43
6	11490.00	53.42 AV	54.00	-0.58	1.31 H	206	4.99	48.43
ANTENNA POLARITY & TEST DISTANCE: VERTICAL AT 3 M								
NO.	FREQ. (MHz)	EMISSION LEVEL (dBuV/m)	LIMIT (dBuV/m)	MARGIN (dB)	ANTENNA HEIGHT (m)	TABLE ANGLE (Degree)	RAW VALUE (dBuV)	CORRECTION FACTOR (dB/m)
1	#5725.00	83.42 PK	84.51	-1.09	1.09 V	118	45.32	38.10
2	#5725.00	70.19 AV	73.84	-3.65	1.09 V	118	32.09	38.10
3	*5745.00	114.51 PK			1.09 V	118	76.38	38.13
4	*5745.00	103.84 AV			1.09 V	118	65.71	38.13
5	11490.00	67.51 PK	74.00	-6.49	1.05 V	259	19.08	48.43
6	11490.00	53.14 AV	54.00	-0.86	1.05 V	259	4.71	48.43

- REMARKS:**
1. Emission level (dBuV/m) = Raw Value (dBuV) + Correction Factor (dB/m).
 2. Correction Factor (dB/m) = Antenna Factor (dB/m) + Cable Factor (dB).
 3. The other emission levels were very low against the limit.
 4. Margin value = Emission level – Limit value.
 5. “ * “: Fundamental frequency.
 6. The limit value is defined as per 15.247.
 7. "#":The radiated frequency is out the restricted band.



A D T

EUT TEST CONDITION		MEASUREMENT DETAIL	
CHANNEL	Channel 157	FREQUENCY RANGE	1 ~ 40GHz
INPUT POWER (SYSTEM)	120Vac, 60 Hz	DETECTOR FUNCTION	Peak (PK) Average (AV)
ENVIRONMENTAL CONDITIONS	24deg. C, 64%RH 1002 hPa	TESTED BY	Brad Wu
TEST MODE	A		

ANTENNA POLARITY & TEST DISTANCE: HORIZONTAL AT 3 M								
NO.	FREQ. (MHz)	EMISSION LEVEL (dBuV/m)	LIMIT (dBuV/m)	MARGIN (dB)	ANTENNA HEIGHT (m)	TABLE ANGLE (Degree)	RAW VALUE (dBuV)	CORRECTION FACTOR (dB/m)
1	*5785.00	116.41 PK			1.17 H	108	78.21	38.20
2	*5785.00	105.73 AV			1.17 H	108	67.53	38.20
3	11570.00	67.61 PK	74.00	-6.39	1.06 H	218	19.26	48.35
4	11570.00	53.48 AV	54.00	-0.52	1.06 H	218	5.13	48.35
ANTENNA POLARITY & TEST DISTANCE: VERTICAL AT 3 M								
NO.	FREQ. (MHz)	EMISSION LEVEL (dBuV/m)	LIMIT (dBuV/m)	MARGIN (dB)	ANTENNA HEIGHT (m)	TABLE ANGLE (Degree)	RAW VALUE (dBuV)	CORRECTION FACTOR (dB/m)
1	*5785.00	114.65 PK			1.10 V	116	76.45	38.20
2	*5785.00	104.03 AV			1.10 V	116	65.83	38.20
3	11570.00	66.92 PK	74.00	-7.08	1.09 V	265	18.57	48.35
4	11570.00	52.68 AV	54.00	-1.32	1.09 V	265	4.33	48.35

- REMARKS:**
1. Emission level (dBuV/m) = Raw Value (dBuV) + Correction Factor (dB/m).
 2. Correction Factor (dB/m) = Antenna Factor (dB/m) + Cable Factor (dB).
 3. The other emission levels were very low against the limit.
 4. Margin value = Emission level – Limit value.
 5. “ * “: Fundamental frequency.
 6. The limit value is defined as per 15.247.



A D T

EUT TEST CONDITION		MEASUREMENT DETAIL	
CHANNEL	Channel 165	FREQUENCY RANGE	1 ~ 40GHz
INPUT POWER (SYSTEM)	120Vac, 60 Hz	DETECTOR FUNCTION	Peak (PK) Average (AV)
ENVIRONMENTAL CONDITIONS	24deg. C, 64%RH 1002 hPa	TESTED BY	Brad Wu
TEST MODE	A		

ANTENNA POLARITY & TEST DISTANCE: HORIZONTAL AT 3 M								
NO.	FREQ. (MHz)	EMISSION LEVEL (dBuV/m)	LIMIT (dBuV/m)	MARGIN (dB)	ANTENNA HEIGHT (m)	TABLE ANGLE (Degree)	RAW VALUE (dBuV)	CORRECTION FACTOR (dB/m)
1	*5825.00	116.42 PK			1.19 H	106	78.13	38.29
2	*5825.00	105.81 AV			1.19 H	106	67.53	38.29
3	#5850.00	81.93 PK	86.42	-4.49	1.19 H	106	43.58	38.35
4	#5850.00	67.04 AV	75.81	-8.77	1.19 H	106	28.69	38.35
5	11650.00	67.31 PK	74.00	-6.69	1.01 H	162	19.18	48.13
6	11650.00	52.94 AV	54.00	-1.06	1.01 H	162	4.81	48.13
ANTENNA POLARITY & TEST DISTANCE: VERTICAL AT 3 M								
NO.	FREQ. (MHz)	EMISSION LEVEL (dBuV/m)	LIMIT (dBuV/m)	MARGIN (dB)	ANTENNA HEIGHT (m)	TABLE ANGLE (Degree)	RAW VALUE (dBuV)	CORRECTION FACTOR (dB/m)
1	*5825.00	114.53 PK			1.09 V	114	76.25	38.29
2	*5825.00	103.84 AV			1.09 V	114	65.56	38.29
3	#5850.00	79.51 PK	84.53	-5.02	1.09 V	114	41.16	38.35
4	#5850.00	64.68 AV	73.84	-9.16	1.09 V	114	26.33	38.35
5	11650.00	66.95 PK	74.00	-7.05	1.05 V	247	18.82	48.13
6	11650.00	52.48 AV	54.00	-1.52	1.05 V	247	4.35	48.13

- REMARKS:**
1. Emission level (dBuV/m) = Raw Value (dBuV) + Correction Factor (dB/m).
 2. Correction Factor (dB/m) = Antenna Factor (dB/m) + Cable Factor (dB).
 3. The other emission levels were very low against the limit.
 4. Margin value = Emission level – Limit value.
 5. “ * “: Fundamental frequency.
 6. The limit value is defined as per 15.247.
 7. “#”:The radiated frequency is out the restricted band.



A D T

EUT TEST CONDITION		MEASUREMENT DETAIL	
CHANNEL	Channel 149	FREQUENCY RANGE	1 ~ 40GHz
INPUT POWER (SYSTEM)	120Vac, 60 Hz	DETECTOR FUNCTION	Peak (PK) Average (AV)
ENVIRONMENTAL CONDITIONS	24deg. C, 64%RH 1002 hPa	TESTED BY	Brad Wu
TEST MODE	C		

ANTENNA POLARITY & TEST DISTANCE: HORIZONTAL AT 3 M								
NO.	FREQ. (MHz)	EMISSION LEVEL (dBuV/m)	LIMIT (dBuV/m)	MARGIN (dB)	ANTENNA HEIGHT (m)	TABLE ANGLE (Degree)	RAW VALUE (dBuV)	CORRECTION FACTOR (dB/m)
1	#5725.00	68.24 PK	68.82	-0.58	1.06 H	208	30.14	38.10
2	#5725.00	57.06 AV	58.25	-1.19	1.06 H	208	18.96	38.10
3	*5745.00	98.82 PK			1.06 H	208	60.69	38.13
4	*5745.00	88.25 AV			1.06 H	208	50.12	38.13
5	11490.00	67.04 PK	74.00	-6.96	1.04 H	193	18.61	48.43
6	11490.00	52.81 AV	54.00	-1.19	1.04 H	193	4.38	48.43
ANTENNA POLARITY & TEST DISTANCE: VERTICAL AT 3 M								
NO.	FREQ. (MHz)	EMISSION LEVEL (dBuV/m)	LIMIT (dBuV/m)	MARGIN (dB)	ANTENNA HEIGHT (m)	TABLE ANGLE (Degree)	RAW VALUE (dBuV)	CORRECTION FACTOR (dB/m)
1	#5725.00	85.83 PK	86.14	-0.31	1.16 V	211	47.73	38.10
2	#5725.00	72.28 AV	75.53	-3.25	1.16 V	211	34.18	38.10
3	*5745.00	116.14 PK			1.16 V	211	78.01	38.13
4	*5745.00	105.53 AV			1.16 V	211	67.40	38.13
5	11490.00	67.41 PK	74.00	-6.59	1.30 V	187	18.98	48.43
6	11490.00	53.14 AV	54.00	-0.86	1.30 V	187	4.71	48.43

- REMARKS:**
1. Emission level (dBuV/m) = Raw Value (dBuV) + Correction Factor (dB/m).
 2. Correction Factor (dB/m) = Antenna Factor (dB/m) + Cable Factor (dB).
 3. The other emission levels were very low against the limit.
 4. Margin value = Emission level – Limit value.
 5. “ * “: Fundamental frequency.
 6. The limit value is defined as per 15.247.
 7. "#":The radiated frequency is out the restricted band.



A D T

EUT TEST CONDITION		MEASUREMENT DETAIL	
CHANNEL	Channel 157	FREQUENCY RANGE	1 ~ 40GHz
INPUT POWER (SYSTEM)	120Vac, 60 Hz	DETECTOR FUNCTION	Peak (PK) Average (AV)
ENVIRONMENTAL CONDITIONS	24deg. C, 64%RH 1002 hPa	TESTED BY	Brad Wu
TEST MODE	C		

ANTENNA POLARITY & TEST DISTANCE: HORIZONTAL AT 3 M								
NO.	FREQ. (MHz)	EMISSION LEVEL (dBuV/m)	LIMIT (dBuV/m)	MARGIN (dB)	ANTENNA HEIGHT (m)	TABLE ANGLE (Degree)	RAW VALUE (dBuV)	CORRECTION FACTOR (dB/m)
1	*5785.00	98.93 PK			1.02 H	208	60.73	38.20
2	*5785.00	88.36 AV			1.02 H	208	50.16	38.20
3	11570.00	67.03 PK	74.00	-6.97	1.01 H	183	18.68	48.35
4	11570.00	52.68 AV	54.00	-1.32	1.01 H	183	4.33	48.35
ANTENNA POLARITY & TEST DISTANCE: VERTICAL AT 3 M								
NO.	FREQ. (MHz)	EMISSION LEVEL (dBuV/m)	LIMIT (dBuV/m)	MARGIN (dB)	ANTENNA HEIGHT (m)	TABLE ANGLE (Degree)	RAW VALUE (dBuV)	CORRECTION FACTOR (dB/m)
1	*5785.00	116.35 PK			1.15 V	206	78.15	38.20
2	*5785.00	105.60 AV			1.15 V	206	67.40	38.20
3	11570.00	67.43 PK	74.00	-6.57	1.18 V	217	19.08	48.35
4	11570.00	53.21 AV	54.00	-0.79	1.18 V	217	4.86	48.35

- REMARKS:**
1. Emission level (dBuV/m) = Raw Value (dBuV) + Correction Factor (dB/m).
 2. Correction Factor (dB/m) = Antenna Factor (dB/m) + Cable Factor (dB).
 3. The other emission levels were very low against the limit.
 4. Margin value = Emission level – Limit value.
 5. “ * “: Fundamental frequency.
 6. The limit value is defined as per 15.247.



A D T

EUT TEST CONDITION		MEASUREMENT DETAIL	
CHANNEL	Channel 165	FREQUENCY RANGE	1 ~ 40GHz
INPUT POWER (SYSTEM)	120Vac, 60 Hz	DETECTOR FUNCTION	Peak (PK) Average (AV)
ENVIRONMENTAL CONDITIONS	24deg. C, 64%RH 1002 hPa	TESTED BY	Brad Wu
TEST MODE	C		

ANTENNA POLARITY & TEST DISTANCE: HORIZONTAL AT 3 M								
NO.	FREQ. (MHz)	EMISSION LEVEL (dBuV/m)	LIMIT (dBuV/m)	MARGIN (dB)	ANTENNA HEIGHT (m)	TABLE ANGLE (Degree)	RAW VALUE (dBuV)	CORRECTION FACTOR (dB/m)
1	*5825.00	98.71 PK			1.06 H	197	60.42	38.29
2	*5825.00	88.14 AV			1.06 H	197	49.85	38.29
3	#5850.00	67.98 PK	68.71	-0.73	1.06 H	197	29.63	38.35
4	#5850.00	57.19 AV	58.14	-0.95	1.06 H	197	18.84	38.35
5	11650.00	67.03 PK	74.00	-6.97	1.04 H	202	18.90	48.13
6	11650.00	52.69 AV	54.00	-1.31	1.04 H	202	4.56	48.13
ANTENNA POLARITY & TEST DISTANCE: VERTICAL AT 3 M								
NO.	FREQ. (MHz)	EMISSION LEVEL (dBuV/m)	LIMIT (dBuV/m)	MARGIN (dB)	ANTENNA HEIGHT (m)	TABLE ANGLE (Degree)	RAW VALUE (dBuV)	CORRECTION FACTOR (dB/m)
1	*5825.00	116.21 PK			1.13 V	202	77.92	38.29
2	*5825.00	105.48 AV			1.13 V	202	67.19	38.29
3	#5850.00	81.72 PK	86.21	-4.49	1.13 V	202	43.37	38.35
4	#5850.00	67.04 AV	75.48	-8.44	1.13 V	202	28.69	38.35
5	11650.00	67.25 PK	74.00	-6.75	1.03 V	199	19.12	48.13
6	11650.00	52.92 AV	54.00	-1.08	1.03 V	199	4.79	48.13

- REMARKS:**
1. Emission level (dBuV/m) = Raw Value (dBuV) + Correction Factor (dB/m).
 2. Correction Factor (dB/m) = Antenna Factor (dB/m) + Cable Factor (dB).
 3. The other emission levels were very low against the limit.
 4. Margin value = Emission level – Limit value.
 5. “ * “: Fundamental frequency.
 6. The limit value is defined as per 15.247.
 7. “#”:The radiated frequency is out the restricted band.



A D T

DRAFT 802.11n (40MHz) OFDM MODULATION

EUT TEST CONDITION		MEASUREMENT DETAIL	
CHANNEL	Channel 151	FREQUENCY RANGE	1 ~ 40GHz
INPUT POWER (SYSTEM)	120Vac, 60 Hz	DETECTOR FUNCTION	Peak (PK) Average (AV)
ENVIRONMENTAL CONDITIONS	24deg. C, 64%RH 1002 hPa	TESTED BY	Brad Wu
TEST MODE	A		

ANTENNA POLARITY & TEST DISTANCE: HORIZONTAL AT 3 M								
NO.	FREQ. (MHz)	EMISSION LEVEL (dBuV/m)	LIMIT (dBuV/m)	MARGIN (dB)	ANTENNA HEIGHT (m)	TABLE ANGLE (Degree)	RAW VALUE (dBuV)	CORRECTION FACTOR (dB/m)
1	#5725.00	82.76 PK	83.15	-0.39	1.19 H	125	44.66	38.10
2	#5725.00	71.15 AV	72.63	-1.48	1.19 H	125	33.05	38.10
3	*5755.00	113.15 PK			1.19 H	125	75.00	38.15
4	*5755.00	102.63 AV			1.19 H	125	64.48	38.15
5	11510.00	67.24 PK	74.00	-6.76	1.09 H	184	18.81	48.43
6	11510.00	52.93 AV	54.00	-1.07	1.09 H	184	4.50	48.43
ANTENNA POLARITY & TEST DISTANCE: VERTICAL AT 3 M								
NO.	FREQ. (MHz)	EMISSION LEVEL (dBuV/m)	LIMIT (dBuV/m)	MARGIN (dB)	ANTENNA HEIGHT (m)	TABLE ANGLE (Degree)	RAW VALUE (dBuV)	CORRECTION FACTOR (dB/m)
1	#5725.00	80.26 PK	81.62	-1.36	1.02 V	243	42.16	38.10
2	#5725.00	69.68 AV	71.12	-1.44	1.02 V	243	31.58	38.10
3	*5755.00	111.62 PK			1.02 V	243	73.47	38.15
4	*5755.00	101.12 AV			1.02 V	243	62.97	38.15
5	11510.00	67.13 PK	74.00	-6.87	1.06 V	265	18.70	48.43
6	11510.00	52.89 AV	54.00	-1.11	1.06 V	265	4.46	48.43

- REMARKS:**
1. Emission level (dBuV/m) = Raw Value (dBuV) + Correction Factor (dB/m).
 2. Correction Factor (dB/m) = Antenna Factor (dB/m) + Cable Factor (dB).
 3. The other emission levels were very low against the limit.
 4. Margin value = Emission level – Limit value.
 5. “ * “: Fundamental frequency.
 6. The limit value is defined as per 15.247.
 7. "#":The radiated frequency is out the restricted band.



A D T

EUT TEST CONDITION		MEASUREMENT DETAIL	
CHANNEL	Channel 159	FREQUENCY RANGE	1 ~ 40GHz
INPUT POWER (SYSTEM)	120Vac, 60 Hz	DETECTOR FUNCTION	Peak (PK) Average (AV)
ENVIRONMENTAL CONDITIONS	24deg. C, 64%RH 1002 hPa	TESTED BY	Brad Wu
TEST MODE	A		

ANTENNA POLARITY & TEST DISTANCE: HORIZONTAL AT 3 M								
NO.	FREQ. (MHz)	EMISSION LEVEL (dBuV/m)	LIMIT (dBuV/m)	MARGIN (dB)	ANTENNA HEIGHT (m)	TABLE ANGLE (Degree)	RAW VALUE (dBuV)	CORRECTION FACTOR (dB/m)
1	*5795.00	113.56 PK			1.20 H	131	75.35	38.21
2	*5795.00	103.03 AV			1.20 H	131	64.82	38.21
3	#5850.00	73.85 PK	83.56	-9.71	1.20 H	131	35.50	38.35
4	#5850.00	60.31 AV	73.03	-12.72	1.20 H	131	21.96	38.35
5	11590.00	67.13 PK	74.00	-6.87	1.11 H	195	18.81	48.32
6	11590.00	52.82 AV	54.00	-1.18	1.11 H	195	4.50	48.32
ANTENNA POLARITY & TEST DISTANCE: VERTICAL AT 3 M								
NO.	FREQ. (MHz)	EMISSION LEVEL (dBuV/m)	LIMIT (dBuV/m)	MARGIN (dB)	ANTENNA HEIGHT (m)	TABLE ANGLE (Degree)	RAW VALUE (dBuV)	CORRECTION FACTOR (dB/m)
1	*5795.00	111.85 PK			1.05 V	252	73.64	38.21
2	*5795.00	101.34 AV			1.05 V	252	63.13	38.21
3	#5850.00	72.24 PK	81.85	-9.61	1.05 V	252	33.89	38.35
4	#5850.00	58.93 AV	71.34	-12.41	1.05 V	252	20.58	38.35
5	11590.00	67.08 PK	74.00	-6.92	1.13 V	282	18.76	48.32
6	11590.00	52.76 AV	54.00	-1.24	1.13 V	282	4.44	48.32

- REMARKS:**
1. Emission level (dBuV/m) = Raw Value (dBuV) + Correction Factor (dB/m).
 2. Correction Factor (dB/m) = Antenna Factor (dB/m) + Cable Factor (dB).
 3. The other emission levels were very low against the limit.
 4. Margin value = Emission level – Limit value.
 5. “ * “: Fundamental frequency.
 6. The limit value is defined as per 15.247.
 7. “#”:The radiated frequency is out the restricted band.



A D T

EUT TEST CONDITION		MEASUREMENT DETAIL	
CHANNEL	Channel 151	FREQUENCY RANGE	1 ~ 40GHz
INPUT POWER (SYSTEM)	120Vac, 60 Hz	DETECTOR FUNCTION	Peak (PK) Average (AV)
ENVIRONMENTAL CONDITIONS	24deg. C, 64%RH 1002 hPa	TESTED BY	Brad Wu
TEST MODE	C		

ANTENNA POLARITY & TEST DISTANCE: HORIZONTAL AT 3 M								
NO.	FREQ. (MHz)	EMISSION LEVEL (dBuV/m)	LIMIT (dBuV/m)	MARGIN (dB)	ANTENNA HEIGHT (m)	TABLE ANGLE (Degree)	RAW VALUE (dBuV)	CORRECTION FACTOR (dB/m)
1	#5725.00	63.89 PK	65.82	-1.93	1.01 H	212	25.79	38.10
2	#5725.00	54.13 AV	55.28	-1.15	1.01 H	212	16.03	38.10
3	*5755.00	95.82 PK			1.01 H	212	57.67	38.15
4	*5755.00	85.28 AV			1.01 H	212	47.13	38.15
5	11510.00	67.02 PK	74.00	-6.98	1.06 H	188	18.59	48.43
6	11510.00	52.64 AV	54.00	-1.36	1.06 H	188	4.21	48.43
ANTENNA POLARITY & TEST DISTANCE: VERTICAL AT 3 M								
NO.	FREQ. (MHz)	EMISSION LEVEL (dBuV/m)	LIMIT (dBuV/m)	MARGIN (dB)	ANTENNA HEIGHT (m)	TABLE ANGLE (Degree)	RAW VALUE (dBuV)	CORRECTION FACTOR (dB/m)
1	#5725.00	81.03 PK	83.04	-2.01	1.14 V	210	42.93	38.10
2	#5725.00	70.52 AV	72.51	-1.99	1.14 V	210	32.42	38.10
3	*5755.00	113.04 PK			1.14 V	210	74.89	38.15
4	*5755.00	102.51 AV			1.14 V	210	64.36	38.15
5	11510.00	66.92 PK	74.00	-7.08	1.04 V	269	18.49	48.43
6	11510.00	52.65 AV	54.00	-1.35	1.04 V	269	4.22	48.43

- REMARKS:**
1. Emission level (dBuV/m) = Raw Value (dBuV) + Correction Factor (dB/m).
 2. Correction Factor (dB/m) = Antenna Factor (dB/m) + Cable Factor (dB).
 3. The other emission levels were very low against the limit.
 4. Margin value = Emission level – Limit value.
 5. “ * “: Fundamental frequency.
 6. The limit value is defined as per 15.247.
 7. "#":The radiated frequency is out the restricted band.



A D T

EUT TEST CONDITION		MEASUREMENT DETAIL	
CHANNEL	Channel 159	FREQUENCY RANGE	1 ~ 40GHz
INPUT POWER (SYSTEM)	120Vac, 60 Hz	DETECTOR FUNCTION	Peak (PK) Average (AV)
ENVIRONMENTAL CONDITIONS	24deg. C, 64%RH 1002 hPa	TESTED BY	Brad Wu
TEST MODE	C		

ANTENNA POLARITY & TEST DISTANCE: HORIZONTAL AT 3 M								
NO.	FREQ. (MHz)	EMISSION LEVEL (dBuV/m)	LIMIT (dBuV/m)	MARGIN (dB)	ANTENNA HEIGHT (m)	TABLE ANGLE (Degree)	RAW VALUE (dBuV)	CORRECTION FACTOR (dB/m)
1	*5795.00	96.14 PK			1.03 H	197	57.93	38.21
2	*5795.00	85.62 AV			1.03 H	197	47.41	38.21
3	#5850.00	64.72 PK	66.14	-1.42	1.03 H	197	26.37	38.35
4	#5850.00	53.98 AV	55.62	-1.64	1.03 H	197	15.63	38.35
5	11590.00	66.81 PK	74.00	-7.19	1.05 H	191	18.49	48.32
6	11590.00	52.42 AV	54.00	-1.58	1.05 H	191	4.10	48.32
ANTENNA POLARITY & TEST DISTANCE: VERTICAL AT 3 M								
NO.	FREQ. (MHz)	EMISSION LEVEL (dBuV/m)	LIMIT (dBuV/m)	MARGIN (dB)	ANTENNA HEIGHT (m)	TABLE ANGLE (Degree)	RAW VALUE (dBuV)	CORRECTION FACTOR (dB/m)
1	*5795.00	113.42 PK			1.21 V	158	75.21	38.21
2	*5795.00	102.95 AV			1.21 V	158	64.74	38.21
3	#5850.00	73.14 PK	83.42	-10.28	1.21 V	158	34.79	38.35
4	#5850.00	59.82 AV	72.95	-13.13	1.21 V	158	21.47	38.35
5	11590.00	66.84 PK	74.00	-7.16	1.08 V	263	18.52	48.32
6	11590.00	52.49 AV	54.00	-1.51	1.08 V	263	4.17	48.32

- REMARKS:**
1. Emission level (dBuV/m) = Raw Value (dBuV) + Correction Factor (dB/m).
 2. Correction Factor (dB/m) = Antenna Factor (dB/m) + Cable Factor (dB).
 3. The other emission levels were very low against the limit.
 4. Margin value = Emission level – Limit value.
 5. “ * “: Fundamental frequency.
 6. The limit value is defined as per 15.247.
 7. “#“:The radiated frequency is out the restricted band.



A D T

BELOW 1GHz WORST-CASE DATA : 802.11a OFDM MODULATION

EUT TEST CONDITION		MEASUREMENT DETAIL	
CHANNEL	Channel 157	FREQUENCY RANGE	Below 1000MHz
INPUT POWER (SYSTEM)	120Vac, 60 Hz	DETECTOR FUNCTION	Quasi-Peak
ENVIRONMENTAL CONDITIONS	25deg. C, 65%RH 1000 hPa	TESTED BY	Brad Wu
TEST MODE	A		

ANTENNA POLARITY & TEST DISTANCE: HORIZONTAL AT 3 M								
NO.	FREQ. (MHz)	EMISSION LEVEL (dBuV/m)	LIMIT (dBuV/m)	MARGIN (dB)	ANTENNA HEIGHT (m)	TABLE ANGLE (Degree)	RAW VALUE (dBuV)	CORRECTION FACTOR (dB/m)
1	97.95	35.71 QP	43.50	-7.79	1.50 H	322	24.87	10.84
2	249.60	42.09 QP	46.00	-3.91	1.00 H	256	28.28	13.80
3	510.14	37.06 QP	46.00	-8.94	1.50 H	73	16.42	20.64
4	681.24	37.29 QP	46.00	-8.71	1.00 H	316	12.72	24.57
5	751.23	39.25 QP	46.00	-6.75	1.00 H	319	13.74	25.51
6	865.94	41.06 QP	46.00	-4.94	1.25 H	16	13.82	27.24
7	932.05	39.60 QP	46.00	-6.40	1.25 H	112	11.27	28.32
ANTENNA POLARITY & TEST DISTANCE: VERTICAL AT 3 M								
NO.	FREQ. (MHz)	EMISSION LEVEL (dBuV/m)	LIMIT (dBuV/m)	MARGIN (dB)	ANTENNA HEIGHT (m)	TABLE ANGLE (Degree)	RAW VALUE (dBuV)	CORRECTION FACTOR (dB/m)
1	39.62	38.17 QP	40.00	-1.83	1.00 V	88	23.09	15.09
2	70.73	36.30 QP	40.00	-3.70	1.25 V	310	23.41	12.88
3	265.16	40.22 QP	46.00	-5.78	1.25 V	10	26.43	13.79
4	630.69	39.36 QP	46.00	-6.64	1.25 V	349	16.10	23.26
5	867.89	43.02 QP	46.00	-2.98	1.00 V	352	15.74	27.28
6	930.11	43.38 QP	46.00	-2.62	1.25 V	346	15.08	28.30

- REMARKS:**
1. Emission level (dBuV/m) = Raw Value (dBuV) + Correction Factor (dB/m).
 2. Correction Factor (dB/m) = Antenna Factor (dB/m) + Cable Factor (dB).
 3. The other emission levels were very low against the limit.
 4. Margin value = Emission level – Limit value.



A D T

EUT TEST CONDITION		MEASUREMENT DETAIL	
CHANNEL	Channel 157	FREQUENCY RANGE	Below 1000MHz
INPUT POWER (SYSTEM)	120Vac, 60 Hz	DETECTOR FUNCTION	Quasi-Peak
ENVIRONMENTAL CONDITIONS	25deg. C, 65%RH 1000 hPa	TESTED BY	Brad Wu
TEST MODE	B		

ANTENNA POLARITY & TEST DISTANCE: HORIZONTAL AT 3 M								
NO.	FREQ. (MHz)	EMISSION LEVEL (dBuV/m)	LIMIT (dBuV/m)	MARGIN (dB)	ANTENNA HEIGHT (m)	TABLE ANGLE (Degree)	RAW VALUE (dBuV)	CORRECTION FACTOR (dB/m)
1	222.38	38.17 QP	46.00	-7.83	1.50 H	43	26.20	11.97
2	249.60	44.27 QP	46.00	-1.73	1.00 H	73	30.47	13.80
3	681.24	40.92 QP	46.00	-5.08	1.00 H	37	16.35	24.57
4	751.23	39.20 QP	46.00	-6.80	1.25 H	28	13.69	25.51
5	867.89	40.11 QP	46.00	-5.89	1.00 H	10	12.83	27.28
6	918.44	38.26 QP	46.00	-7.74	1.25 H	292	10.11	28.15
ANTENNA POLARITY & TEST DISTANCE: VERTICAL AT 3 M								
NO.	FREQ. (MHz)	EMISSION LEVEL (dBuV/m)	LIMIT (dBuV/m)	MARGIN (dB)	ANTENNA HEIGHT (m)	TABLE ANGLE (Degree)	RAW VALUE (dBuV)	CORRECTION FACTOR (dB/m)
1	45.45	35.39 QP	40.00	-4.61	1.50 V	256	21.25	14.14
2	86.28	35.26 QP	40.00	-4.74	1.00 V	289	27.31	7.95
3	249.60	37.98 QP	46.00	-8.02	1.25 V	37	24.17	13.80
4	729.84	38.73 QP	46.00	-7.27	1.25 V	355	13.42	25.31
5	864.00	40.15 QP	46.00	-5.85	1.00 V	10	12.95	27.20
6	930.11	42.13 QP	46.00	-3.87	1.25 V	94	13.84	28.30

- REMARKS:**
1. Emission level (dBuV/m) = Raw Value (dBuV) + Correction Factor (dB/m).
 2. Correction Factor (dB/m) = Antenna Factor (dB/m) + Cable Factor (dB).
 3. The other emission levels were very low against the limit.
 4. Margin value = Emission level – Limit value.



A D T

DRAFT 802.11n (20MHz) OFDM MODULATION

EUT TEST CONDITION		MEASUREMENT DETAIL	
CHANNEL	Channel 149	FREQUENCY RANGE	Below 1000MHz
INPUT POWER (SYSTEM)	120Vac, 60 Hz	DETECTOR FUNCTION	Quasi-Peak
ENVIRONMENTAL CONDITIONS	25deg. C, 65%RH 1000 hPa	TESTED BY	Brad Wu
TEST MODE	C		

ANTENNA POLARITY & TEST DISTANCE: HORIZONTAL AT 3 M								
NO.	FREQ. (MHz)	EMISSION LEVEL (dBuV/m)	LIMIT (dBuV/m)	MARGIN (dB)	ANTENNA HEIGHT (m)	TABLE ANGLE (Degree)	RAW VALUE (dBuV)	CORRECTION FACTOR (dB/m)
1	115.45	33.27 QP	43.50	-10.23	1.50 H	238	21.89	11.38
2	249.60	40.18 QP	46.00	-5.82	1.00 H	43	26.37	13.80
3	500.42	34.75 QP	46.00	-11.25	1.50 H	100	14.31	20.44
4	681.24	39.57 QP	46.00	-6.43	1.00 H	211	15.00	24.57
5	729.84	36.60 QP	46.00	-9.40	1.50 H	49	11.29	25.31
6	867.89	36.37 QP	46.00	-9.63	1.00 H	160	9.09	27.28
ANTENNA POLARITY & TEST DISTANCE: VERTICAL AT 3 M								
NO.	FREQ. (MHz)	EMISSION LEVEL (dBuV/m)	LIMIT (dBuV/m)	MARGIN (dB)	ANTENNA HEIGHT (m)	TABLE ANGLE (Degree)	RAW VALUE (dBuV)	CORRECTION FACTOR (dB/m)
1	70.73	38.33 QP	40.00	-1.67	1.00 V	175	25.45	12.88
2	113.50	39.01 QP	43.50	-4.49	1.00 V	157	27.60	11.41
3	249.60	38.12 QP	46.00	-7.88	1.50 V	121	24.32	13.80
4	500.42	39.26 QP	46.00	-6.74	1.00 V	172	18.82	20.44
5	727.90	38.69 QP	46.00	-7.31	1.00 V	175	13.40	25.29
6	867.89	38.83 QP	46.00	-7.17	1.50 V	166	11.56	27.28

- REMARKS:**
1. Emission level (dBuV/m) = Raw Value (dBuV) + Correction Factor (dB/m).
 2. Correction Factor (dB/m) = Antenna Factor (dB/m) + Cable Factor (dB).
 3. The other emission levels were very low against the limit.
 4. Margin value = Emission level – Limit value.



A D T

EUT TEST CONDITION		MEASUREMENT DETAIL	
CHANNEL	Channel 149	FREQUENCY RANGE	Below 1000MHz
INPUT POWER (SYSTEM)	120Vac, 60 Hz	DETECTOR FUNCTION	Quasi-Peak
ENVIRONMENTAL CONDITIONS	25deg. C, 65%RH 1000 hPa	TESTED BY	Brad Wu
TEST MODE	D		

ANTENNA POLARITY & TEST DISTANCE: HORIZONTAL AT 3 M								
NO.	FREQ. (MHz)	EMISSION LEVEL (dBuV/m)	LIMIT (dBuV/m)	MARGIN (dB)	ANTENNA HEIGHT (m)	TABLE ANGLE (Degree)	RAW VALUE (dBuV)	CORRECTION FACTOR (dB/m)
1	154.33	35.93 QP	43.50	-7.57	1.00 H	88	21.78	14.15
2	249.60	32.98 QP	46.00	-13.02	1.50 H	178	19.17	13.80
3	510.14	34.25 QP	46.00	-11.75	1.50 H	265	13.61	20.64
4	681.24	37.95 QP	46.00	-8.05	1.00 H	79	13.38	24.57
5	751.23	41.71 QP	46.00	-4.29	1.00 H	181	16.20	25.51
6	867.89	36.07 QP	46.00	-9.93	1.50 H	118	8.79	27.28
ANTENNA POLARITY & TEST DISTANCE: VERTICAL AT 3 M								
NO.	FREQ. (MHz)	EMISSION LEVEL (dBuV/m)	LIMIT (dBuV/m)	MARGIN (dB)	ANTENNA HEIGHT (m)	TABLE ANGLE (Degree)	RAW VALUE (dBuV)	CORRECTION FACTOR (dB/m)
1	45.45	38.20 QP	40.00	-1.80	1.50 V	10	24.06	14.14
2	68.79	35.04 QP	40.00	-4.96	1.00 V	142	21.82	13.22
3	113.50	37.91 QP	43.50	-5.59	1.00 V	175	26.50	11.41
4	599.58	36.77 QP	46.00	-9.23	1.00 V	166	14.38	22.39
5	733.73	41.60 QP	46.00	-4.40	1.00 V	136	16.26	25.35
6	867.89	39.72 QP	46.00	-6.28	1.50 V	166	12.44	27.28

- REMARKS:**
1. Emission level (dBuV/m) = Raw Value (dBuV) + Correction Factor (dB/m).
 2. Correction Factor (dB/m) = Antenna Factor (dB/m) + Cable Factor (dB).
 3. The other emission levels were very low against the limit.
 4. Margin value = Emission level – Limit value.



5.2 CONDUCTED EMISSION MEASUREMENT

5.2.1 LIMITS OF CONDUCTED EMISSION MEASUREMENT

FREQUENCY OF EMISSION (MHz)	CONDUCTED LIMIT (dB μ V)	
	Quasi-peak	Average
0.15 ~ 0.5	66 to 56	56 to 46
0.5 ~ 5	56	46
5 ~ 30	60	50

- NOTE:** 1. The lower limit shall apply at the transition frequencies.
2. The limit decreases in line with the logarithm of the frequency in the range of 0.15 to 0.50MHz.
3. All emanations from a class A/B digital device or system, including any network of conductors and apparatus connected thereto, shall not exceed the level of field strengths specified above.

5.2.2 TEST INSTRUMENTS

DESCRIPTION & MANUFACTURER	MODEL NO.	SERIAL NO.	DATE OF CALIBRATION	DUE DATE OF CALIBRATION
Test Receiver ROHDE & SCHWARZ	ESCS30	100288	Sep. 22, 2008	Sep. 21, 2009
RF signal cable Woken	5D-FB	Cable-HYCO2-01	Dec. 31, 2008	Dec. 30, 2009
LISN ROHDE & SCHWARZ	ESH2-Z5	100100	Dec. 29, 2008	Dec. 28, 2009
LISN ROHDE & SCHWARZ	ESH3-Z5	100311	Jul. 29, 2009	Jul. 28, 2010
Software ADT	ADT_Cond_ V7.3.7	NA	NA	NA

- NOTE:** 1. The calibration interval of the above test instruments is 12 months and the calibrations are traceable to NML/ROC and NIST/USA.
2. The test was performed in HwaYa Shielded Room 2.
3. The VCCI Site Registration No. is C-2047.



A D T

5.2.3 TEST PROCEDURES

- a. The EUT was placed 0.4 meters from the conducting wall of the shielded room with EUT being connected to the power mains through a line impedance stabilization network (LISN). Other support units were connected to the power mains through another LISN. The two LISNs provide 50 ohm/ 50uH of coupling impedance for the measuring instrument.
- b. Both lines of the power mains connected to the EUT were checked for maximum conducted interference.
- c. The frequency range from 150kHz to 30MHz was searched. Emission levels under (Limit - 20dB) was not recorded.

5.2.4 DEVIATION FROM TEST STANDARD

No deviation.

5.2.5 TEST SETUP

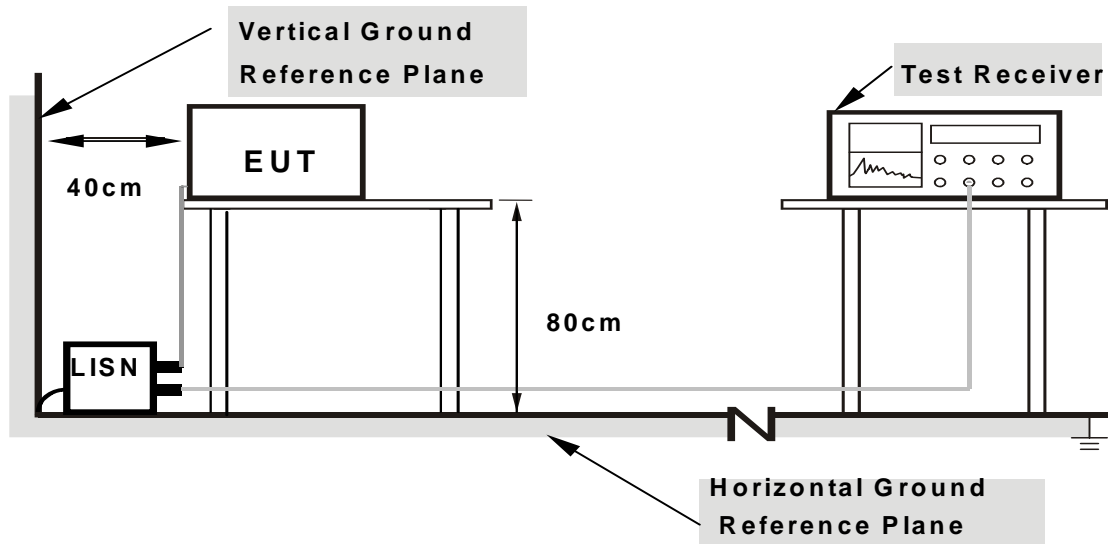

- Note:**
1. Support units were connected to second LISN.
 2. Both of LISNs (AMN) are 80 cm from EUT and at least 80 from other units and other metal planes

For the actual test configuration, please refer to the attached file (Test Setup Photo).

5.2.6 EUT OPERATING CONDITIONS

Same as 4.1.6



5.2.7 TEST RESULTS

CONDUCTED WORST-CASE DATA : 802.11a OFDM MODULATION

EUT TEST CONDITION		MEASUREMENT DETAIL	
CHANNEL	Channel 157	PHASE	Line 1
MODULATION TYPE	BPSK	INPUT POWER	120Vac, 60Hz
TRANSFER RATE	6.0Mbps	6dB BANDWIDTH	9kHz
ENVIRONMENTAL CONDITIONS	25deg. C, 77%RH, 1021hPa	TEST MODE	A
TESTED BY	Scott Yang		

No	Freq. [MHz]	Corr. Factor (dB)	Reading Value		Emission Level		Limit		Margin	
			[dB (uV)]		[dB (uV)]		[dB (uV)]		(dB)	
			Q.P.	AV.	Q.P.	AV.	Q.P.	AV.	Q.P.	AV.
1	0.198	0.13	52.84	-	52.97	-	63.68	53.68	-10.71	-
2	0.278	0.13	53.45	42.13	53.58	42.26	60.86	50.86	-7.28	-8.60
3	0.345	0.14	58.72	48.72	58.86	48.86	59.07	49.07	-0.22	-0.22
4	0.373	0.14	57.43	41.67	57.57	41.81	58.44	48.44	-0.87	-6.63
5	0.482	0.14	54.53	42.56	54.67	42.70	56.30	46.30	-1.63	-3.60
6	0.556	0.15	52.96	39.73	53.11	39.88	56.00	46.00	-2.89	-6.12
7	0.685	0.15	54.04	39.69	54.19	39.84	56.00	46.00	-1.81	-6.16
8	0.806	0.16	52.29	37.48	52.45	37.64	56.00	46.00	-3.55	-8.36
9	0.896	0.16	55.11	40.35	55.27	40.51	56.00	46.00	-0.73	-5.49
10	1.055	0.17	55.05	40.24	55.22	40.41	56.00	46.00	-0.78	-5.59
11	1.324	0.18	54.53	38.90	54.71	39.08	56.00	46.00	-1.29	-6.92
12	1.598	0.18	51.87	38.50	52.05	38.68	56.00	46.00	-3.95	-7.32
13	1.977	0.19	48.92	34.51	49.11	34.70	56.00	46.00	-6.89	-11.30
14	2.723	0.22	43.99	-	44.21	-	56.00	46.00	-11.79	-

- REMARKS:**
1. Q.P. and AV. are abbreviations of quasi-peak and average individually.
 2. "-": The Quasi-peak reading value also meets average limit and measurement with the average detector is unnecessary.
 3. The emission levels of other frequencies were very low against the limit.
 4. Margin value = Emission level - Limit value
 5. Correction factor = Insertion loss + Cable loss
 6. Emission Level = Correction Factor + Reading Value.



A D T

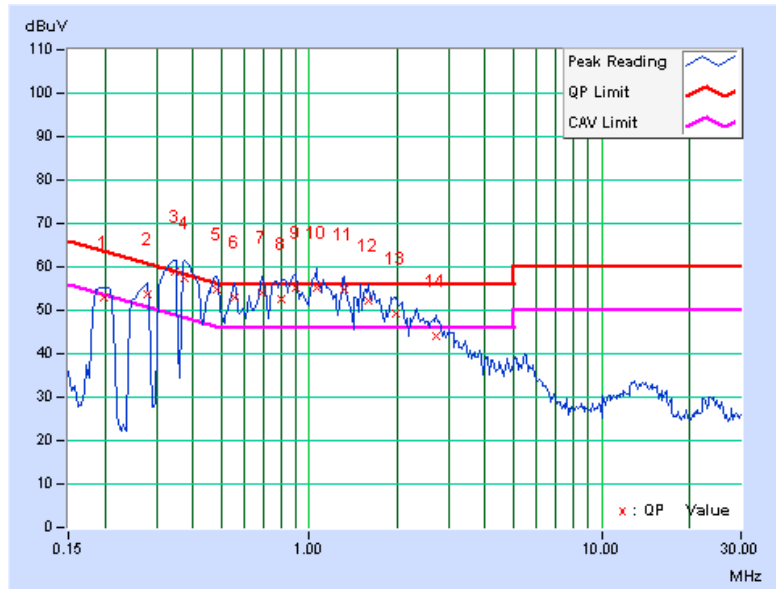



A D T

EUT TEST CONDITION		MEASUREMENT DETAIL	
CHANNEL	Channel 157	PHASE	Line 2
MODULATION TYPE	BPSK	INPUT POWER	120Vac, 60Hz
TRANSFER RATE	6.0Mbps	6dB BANDWIDTH	9kHz
ENVIRONMENTAL CONDITIONS	25deg. C, 77%RH, 1021hPa	TEST MODE	A
TESTED BY	Scott Yang		

No	Freq. [MHz]	Corr. Factor (dB)	Reading Value		Emission Level		Limit		Margin	
			[dB (uV)]		[dB (uV)]		[dB (uV)]		(dB)	
			Q.P.	AV.	Q.P.	AV.	Q.P.	AV.	Q.P.	AV.
1	0.197	0.13	51.69	-	51.82	-	63.74	53.74	-11.92	-
2	0.279	0.14	52.21	40.33	52.35	40.47	60.85	50.85	-8.50	-10.38
3	0.339	0.14	57.47	47.45	57.61	47.59	59.22	49.22	-1.60	-1.62
4	0.373	0.15	57.52	40.94	57.67	41.09	58.44	48.44	-0.77	-7.35
5	0.482	0.15	53.58	41.54	53.73	41.69	56.30	46.30	-2.57	-4.61
6	0.552	0.16	51.46	39.21	51.62	39.37	56.00	46.00	-4.38	-6.63
7	0.681	0.16	53.26	37.49	53.42	37.65	56.00	46.00	-2.58	-8.35
8	0.767	0.16	51.98	34.67	52.14	34.83	56.00	46.00	-3.86	-11.17
9	0.892	0.17	54.01	38.70	54.18	38.87	56.00	46.00	-1.82	-7.13
10	1.113	0.17	51.96	36.25	52.13	36.42	56.00	46.00	-3.87	-9.58
11	1.305	0.18	52.16	37.03	52.34	37.21	56.00	46.00	-3.66	-8.79
12	1.570	0.19	50.54	36.39	50.73	36.58	56.00	46.00	-5.27	-9.42
13	2.012	0.20	48.47	35.29	48.67	35.49	56.00	46.00	-7.33	-10.51
14	2.352	0.22	46.06	33.45	46.28	33.67	56.00	46.00	-9.72	-12.33
15	2.762	0.24	43.04	-	43.28	-	56.00	46.00	-12.72	-

- REMARKS:**
1. Q.P. and AV. are abbreviations of quasi-peak and average individually.
 2. "-": The Quasi-peak reading value also meets average limit and measurement with the average detector is unnecessary.
 3. The emission levels of other frequencies were very low against the limit.
 4. Margin value = Emission level - Limit value
 5. Correction factor = Insertion loss + Cable loss
 6. Emission Level = Correction Factor + Reading Value.



A D T

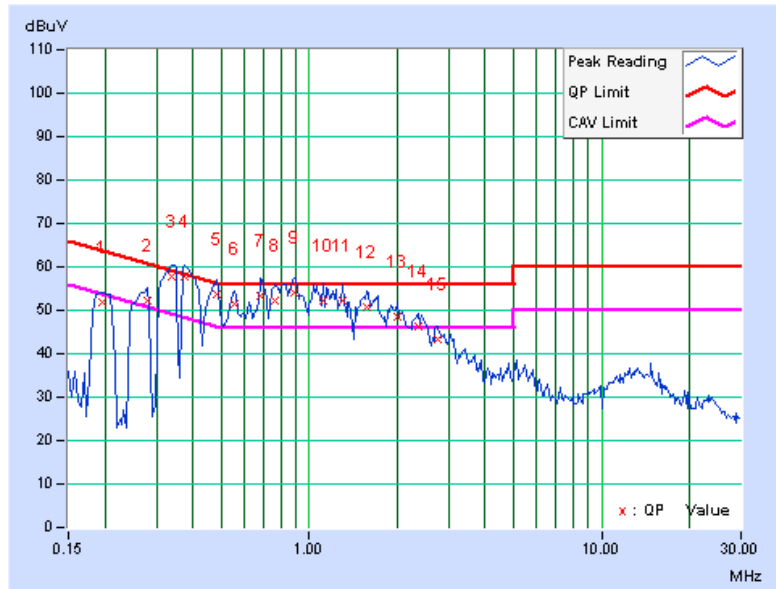



A D T

802.11a OFDM MODULATION

EUT TEST CONDITION		MEASUREMENT DETAIL	
CHANNEL	Channel 157	PHASE	Line 1
MODULATION TYPE	BPSK	INPUT POWER	120Vac, 60Hz
TRANSFER RATE	6.0Mbps	6dB BANDWIDTH	9kHz
ENVIRONMENTAL CONDITIONS	25deg. C, 77%RH, 1021hPa	TEST MODE	B
TESTED BY	Scott Yang		

No	Freq. [MHz]	Corr. Factor (dB)	Reading Value [dB (uV)]		Emission Level [dB (uV)]		Limit [dB (uV)]		Margin (dB)	
			Q.P.	AV.	Q.P.	AV.	Q.P.	AV.	Q.P.	AV.
			1	0.150	0.13	48.27	-	48.40	-	66.00
2	0.166	0.13	45.17	-	45.30	-	65.18	55.18	-19.88	-
3	0.279	0.13	39.68	-	39.81	-	60.85	50.85	-21.03	-
4	0.369	0.14	39.79	-	39.93	-	58.53	48.53	-18.60	-
5	0.420	0.14	40.65	-	40.79	-	57.46	47.46	-16.67	-
6	0.451	0.14	40.03	-	40.17	-	56.86	46.86	-16.69	-
7	12.273	0.49	30.20	-	30.69	-	60.00	50.00	-29.31	-

- REMARKS:**
1. Q.P. and AV. are abbreviations of quasi-peak and average individually.
 2. "-": The Quasi-peak reading value also meets average limit and measurement with the average detector is unnecessary.
 3. The emission levels of other frequencies were very low against the limit.
 4. Margin value = Emission level - Limit value
 5. Correction factor = Insertion loss + Cable loss
 6. Emission Level = Correction Factor + Reading Value.

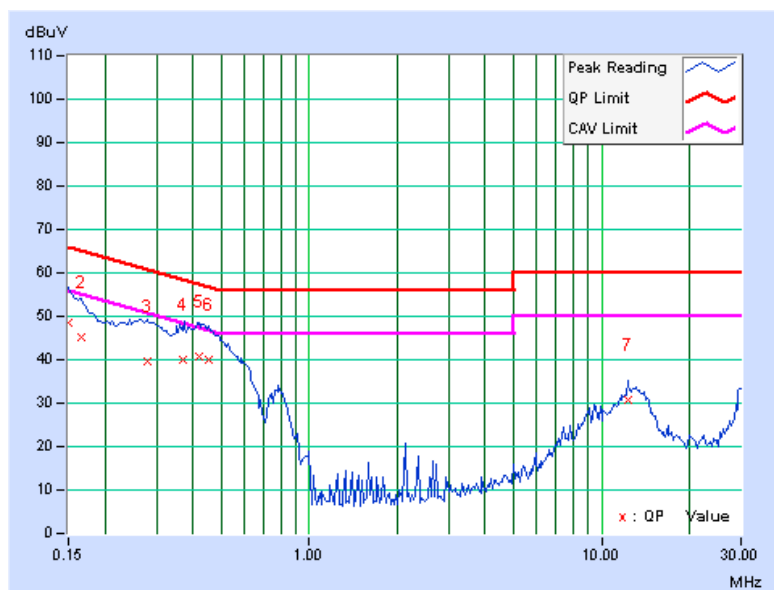

EUT TEST CONDITION		MEASUREMENT DETAIL	
CHANNEL	Channel 157	PHASE	Line 2
MODULATION TYPE	BPSK	INPUT POWER	120Vac, 60Hz
TRANSFER RATE	6.0Mbps	6dB BANDWIDTH	9kHz
ENVIRONMENTAL CONDITIONS	25deg. C, 77%RH, 1021hPa	TEST MODE	B
TESTED BY	Scott Yang		

No	Freq. [MHz]	Corr. Factor (dB)	Reading Value		Emission Level		Limit		Margin	
			[dB (uV)]		[dB (uV)]		[dB (uV)]		(dB)	
			Q.P.	AV.	Q.P.	AV.	Q.P.	AV.	Q.P.	AV.
1	0.150	0.13	48.85	-	48.98	-	66.00	56.00	-17.02	-
2	0.162	0.13	46.71	-	46.84	-	65.38	55.38	-18.54	-
3	0.271	0.14	39.85	-	39.99	-	61.08	51.08	-21.10	-
4	0.420	0.15	39.69	-	39.84	-	57.46	47.46	-17.62	-
5	0.455	0.15	38.75	-	38.90	-	56.79	46.79	-17.89	-
6	13.242	0.61	33.12	-	33.73	-	60.00	50.00	-26.27	-

- REMARKS:**
1. Q.P. and AV. are abbreviations of quasi-peak and average individually.
 2. "-": The Quasi-peak reading value also meets average limit and measurement with the average detector is unnecessary.
 3. The emission levels of other frequencies were very low against the limit.
 4. Margin value = Emission level - Limit value
 5. Correction factor = Insertion loss + Cable loss
 6. Emission Level = Correction Factor + Reading Value.

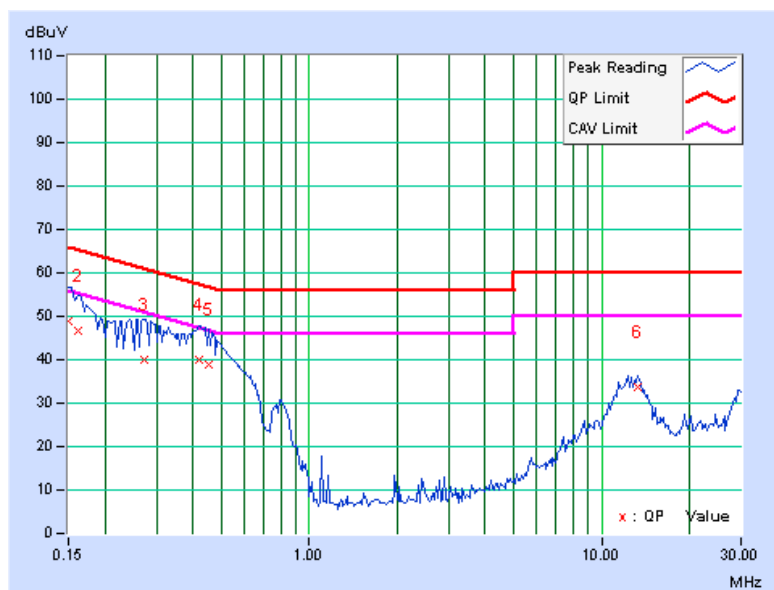



A D T

DRAFT 802.11n (20MHz) OFDM MODULATION

EUT TEST CONDITION		MEASUREMENT DETAIL	
CHANNEL	Channel 149	PHASE	Line 1
MODULATION TYPE	BPSK	INPUT POWER	120Vac, 60Hz
TRANSFER RATE	6.5Mbps	6dB BANDWIDTH	9kHz
ENVIRONMENTAL CONDITIONS	25deg. C, 77%RH, 1021hPa	TEST MODE	C
TESTED BY	Scott Yang		

No	Freq. [MHz]	Corr. Factor (dB)	Reading Value		Emission Level		Limit		Margin	
			[dB (uV)]		[dB (uV)]		[dB (uV)]		(dB)	
			Q.P.	AV.	Q.P.	AV.	Q.P.	AV.	Q.P.	AV.
1	0.201	0.13	53.02	-	53.15	-	63.58	53.58	-10.43	-
2	0.275	0.13	52.46	43.41	52.59	43.54	60.97	50.97	-8.37	-7.42
3	0.338	0.14	56.93	46.59	57.07	46.73	59.26	49.26	-2.20	-2.54
4	0.373	0.14	57.82	42.99	57.96	43.13	58.44	48.44	-0.48	-5.31
5	0.486	0.14	53.56	38.88	53.70	39.02	56.24	46.24	-2.53	-7.21
6	0.556	0.15	51.51	38.74	51.66	38.89	56.00	46.00	-4.34	-7.11
7	0.681	0.15	53.54	39.72	53.69	39.87	56.00	46.00	-2.31	-6.13
8	0.822	0.16	51.82	39.29	51.98	39.45	56.00	46.00	-4.02	-6.55
9	0.900	0.17	54.56	39.95	54.73	40.12	56.00	46.00	-1.27	-5.88
10	1.063	0.17	55.28	40.27	55.45	40.44	56.00	46.00	-0.55	-5.56
11	1.309	0.18	51.62	37.58	51.80	37.76	56.00	46.00	-4.20	-8.24
12	1.484	0.18	50.84	34.96	51.02	35.14	56.00	46.00	-4.98	-10.86
13	1.723	0.18	50.39	37.30	50.57	37.48	56.00	46.00	-5.43	-8.52
14	2.016	0.19	48.90	34.22	49.09	34.41	56.00	46.00	-6.91	-11.59
15	2.430	0.21	46.27	32.84	46.48	33.05	56.00	46.00	-9.52	-12.95

- REMARKS:**
1. Q.P. and AV. are abbreviations of quasi-peak and average individually.
 2. "-": The Quasi-peak reading value also meets average limit and measurement with the average detector is unnecessary.
 3. The emission levels of other frequencies were very low against the limit.
 4. Margin value = Emission level - Limit value
 5. Correction factor = Insertion loss + Cable loss
 6. Emission Level = Correction Factor + Reading Value.



A D T

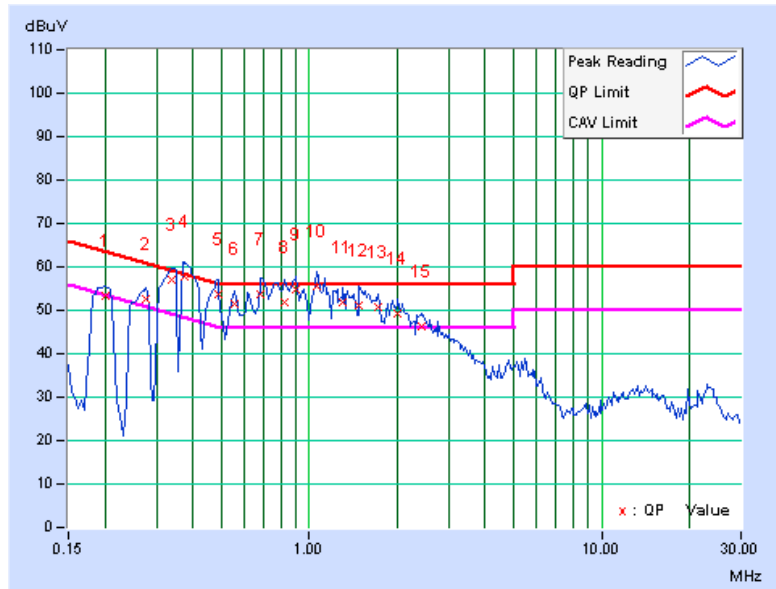



EUT TEST CONDITION		MEASUREMENT DETAIL	
CHANNEL	Channel 149	PHASE	Line 2
MODULATION TYPE	BPSK	INPUT POWER	120Vac, 60Hz
TRANSFER RATE	6.5Mbps	6dB BANDWIDTH	9kHz
ENVIRONMENTAL CONDITIONS	25deg. C, 77%RH, 1021hPa	TEST MODE	C
TESTED BY	Scott Yang		

No	Freq. [MHz]	Corr. Factor (dB)	Reading Value		Emission Level		Limit		Margin	
			[dB (uV)]		[dB (uV)]		[dB (uV)]		(dB)	
			Q.P.	AV.	Q.P.	AV.	Q.P.	AV.	Q.P.	AV.
1	0.201	0.13	51.64	-	51.77	-	63.58	53.58	-11.81	-
2	0.275	0.14	51.42	42.11	51.56	42.25	60.97	50.97	-9.41	-8.72
3	0.341	0.14	56.47	46.72	56.61	46.86	59.17	49.17	-2.55	-2.30
4	0.373	0.15	56.93	41.79	57.08	41.94	58.44	48.44	-1.37	-6.51
5	0.486	0.15	52.55	37.74	52.70	37.89	56.24	46.24	-3.53	-8.34
6	0.556	0.16	50.47	37.54	50.63	37.70	56.00	46.00	-5.37	-8.30
7	0.615	0.16	49.07	34.11	49.23	34.27	56.00	46.00	-6.77	-11.73
8	0.689	0.16	52.73	39.40	52.89	39.56	56.00	46.00	-3.11	-6.44
9	0.771	0.16	51.61	33.25	51.77	33.41	56.00	46.00	-4.23	-12.59
10	0.896	0.17	53.31	38.87	53.48	39.04	56.00	46.00	-2.52	-6.96
11	1.059	0.17	54.51	39.00	54.68	39.17	56.00	46.00	-1.32	-6.83
12	1.250	0.18	50.95	36.56	51.13	36.74	56.00	46.00	-4.87	-9.26
13	1.559	0.19	49.32	34.90	49.51	35.09	56.00	46.00	-6.49	-10.91
14	2.000	0.20	47.42	34.14	47.62	34.34	56.00	46.00	-8.38	-11.66
15	2.336	0.22	44.16	-	44.38	-	56.00	46.00	-11.62	-

- REMARKS:**
1. Q.P. and AV. are abbreviations of quasi-peak and average individually.
 2. "-": The Quasi-peak reading value also meets average limit and measurement with the average detector is unnecessary.
 3. The emission levels of other frequencies were very low against the limit.
 4. Margin value = Emission level - Limit value
 5. Correction factor = Insertion loss + Cable loss
 6. Emission Level = Correction Factor + Reading Value.

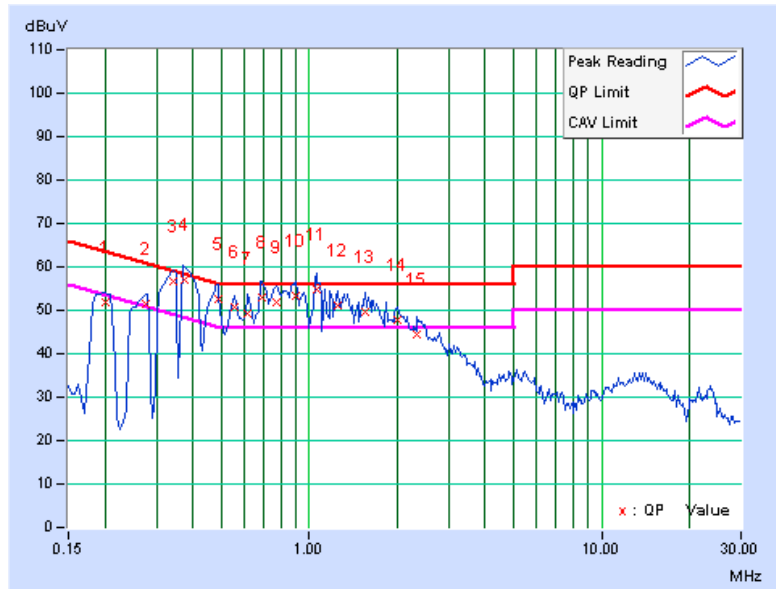



A D T

DRAFT 802.11n (20MHz) OFDM MODULATION

EUT TEST CONDITION		MEASUREMENT DETAIL	
CHANNEL	Channel 149	PHASE	Line 1
MODULATION TYPE	BPSK	INPUT POWER	120Vac, 60Hz
TRANSFER RATE	6.5Mbps	6dB BANDWIDTH	9kHz
ENVIRONMENTAL CONDITIONS	25deg. C, 77%RH, 1021hPa	TEST MODE	D
TESTED BY	Scott Yang		

No	Freq. [MHz]	Corr. Factor (dB)	Reading Value		Emission Level		Limit		Margin	
			[dB (uV)]		[dB (uV)]		[dB (uV)]		(dB)	
			Q.P.	AV.	Q.P.	AV.	Q.P.	AV.	Q.P.	AV.
1	0.150	0.13	48.31	-	48.44	-	66.00	56.00	-17.56	-
2	0.170	0.13	45.27	-	45.40	-	64.98	54.98	-19.58	-
3	0.275	0.13	40.17	-	40.30	-	60.97	50.97	-20.66	-
4	0.420	0.14	40.67	-	40.81	-	57.46	47.46	-16.65	-
5	0.470	0.14	38.93	-	39.07	-	56.51	46.51	-17.43	-
6	13.016	0.51	31.96	-	32.47	-	60.00	50.00	-27.53	-

- REMARKS:**
1. Q.P. and AV. are abbreviations of quasi-peak and average individually.
 2. "-": The Quasi-peak reading value also meets average limit and measurement with the average detector is unnecessary.
 3. The emission levels of other frequencies were very low against the limit.
 4. Margin value = Emission level - Limit value
 5. Correction factor = Insertion loss + Cable loss
 6. Emission Level = Correction Factor + Reading Value.

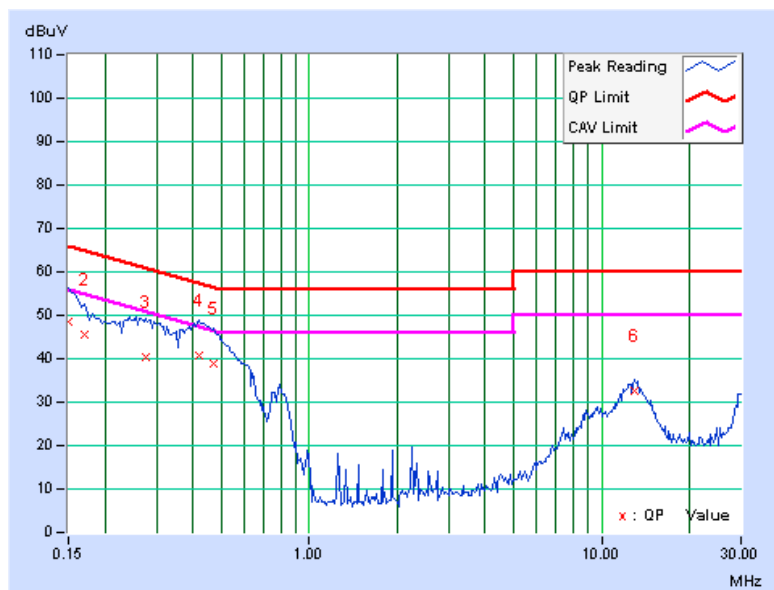

EUT TEST CONDITION		MEASUREMENT DETAIL	
CHANNEL	Channel 149	PHASE	Line 2
MODULATION TYPE	BPSK	INPUT POWER	120Vac, 60Hz
TRANSFER RATE	6.5Mbps	6dB BANDWIDTH	9kHz
ENVIRONMENTAL CONDITIONS	25deg. C, 77%RH, 1021hPa	TEST MODE	D
TESTED BY	Scott Yang		

No	Freq. [MHz]	Corr. Factor (dB)	Reading Value		Emission Level		Limit		Margin	
			[dB (uV)]		[dB (uV)]		[dB (uV)]		(dB)	
			Q.P.	AV.	Q.P.	AV.	Q.P.	AV.	Q.P.	AV.
1	0.150	0.13	48.93	-	49.06	-	66.00	56.00	-16.94	-
2	0.166	0.13	46.10	-	46.23	-	65.18	55.18	-18.95	-
3	0.259	0.14	39.94	-	40.08	-	61.45	51.45	-21.38	-
4	0.369	0.15	37.48	-	37.63	-	58.53	48.53	-20.90	-
5	0.431	0.15	39.65	-	39.80	-	57.23	47.23	-17.43	-
6	12.676	0.59	33.49	-	34.08	-	60.00	50.00	-25.92	-

- REMARKS:**
1. Q.P. and AV. are abbreviations of quasi-peak and average individually.
 2. "-": The Quasi-peak reading value also meets average limit and measurement with the average detector is unnecessary.
 3. The emission levels of other frequencies were very low against the limit.
 4. Margin value = Emission level - Limit value
 5. Correction factor = Insertion loss + Cable loss
 6. Emission Level = Correction Factor + Reading Value.

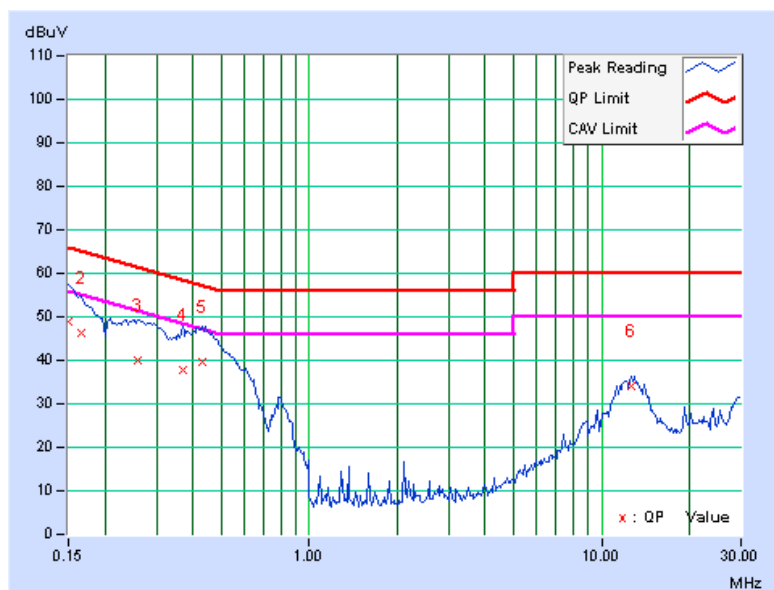

5.3 6dB BANDWIDTH MEASUREMENT

5.3.1 LIMITS OF 6dB BANDWIDTH MEASUREMENT

The minimum of 6dB Bandwidth Measurement is 0.5MHz.

5.3.2 TEST INSTRUMENTS

DESCRIPTION & MANUFACTURER	MODEL NO.	SERIAL NO.	DATE OF CALIBRATION	DUE DATE OF CALIBRATION
R&S SPECTRUM ANALYZER	FSP40	100041	May 13, 2009	May 12, 2010

NOTE: The calibration interval of the above test instruments is 12 months and the calibrations are traceable to NML/ROC and NIST/USA.

5.3.3 TEST PROCEDURE

The transmitter output was connected to the spectrum analyzer through an attenuator. The bandwidth of the fundamental frequency was measured by spectrum analyzer with 100kHz RBW and 300kHz VBW. The 6dB bandwidth is defined as the total spectrum the power of which is higher than peak power minus 6dB.

5.3.4 DEVIATION FROM TEST STANDARD

No deviation

5.3.5 TEST SETUP

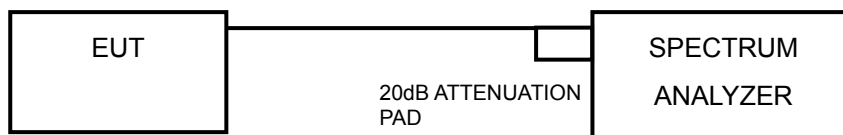

5.3.6 EUT OPERATING CONDITIONS

The software provided by client to enable the EUT under transmission condition continuously at lowest, middle and highest channel frequencies individually.



A D T

5.3.7 TEST RESULTS

802.11a OFDM MODULATION

MODULATION TYPE	BPSK	TRANSFER RATE	6.0Mbps
INPUT POWER	120Vac, 60Hz	ENVIRONMENTAL CONDITIONS	25 deg.C, 65%RH, 1021hPa
TESTED BY	Brad Wu	TEST MODE	A

CHANNEL	CHANNEL FREQUENCY (MHz)	6dB BANDWIDTH (MHz)			MINIMUM LIMIT (MHz)	PASS / FAIL
		CHAIN 0	CHAIN 1	CHAIN 2		
149	5745	16.34	16.35	16.28	0.5	PASS
157	5785	16.12	16.36	16.00	0.5	PASS
165	5825	16.42	16.38	16.39	0.5	PASS

FOR CHAIN 0: CH 149

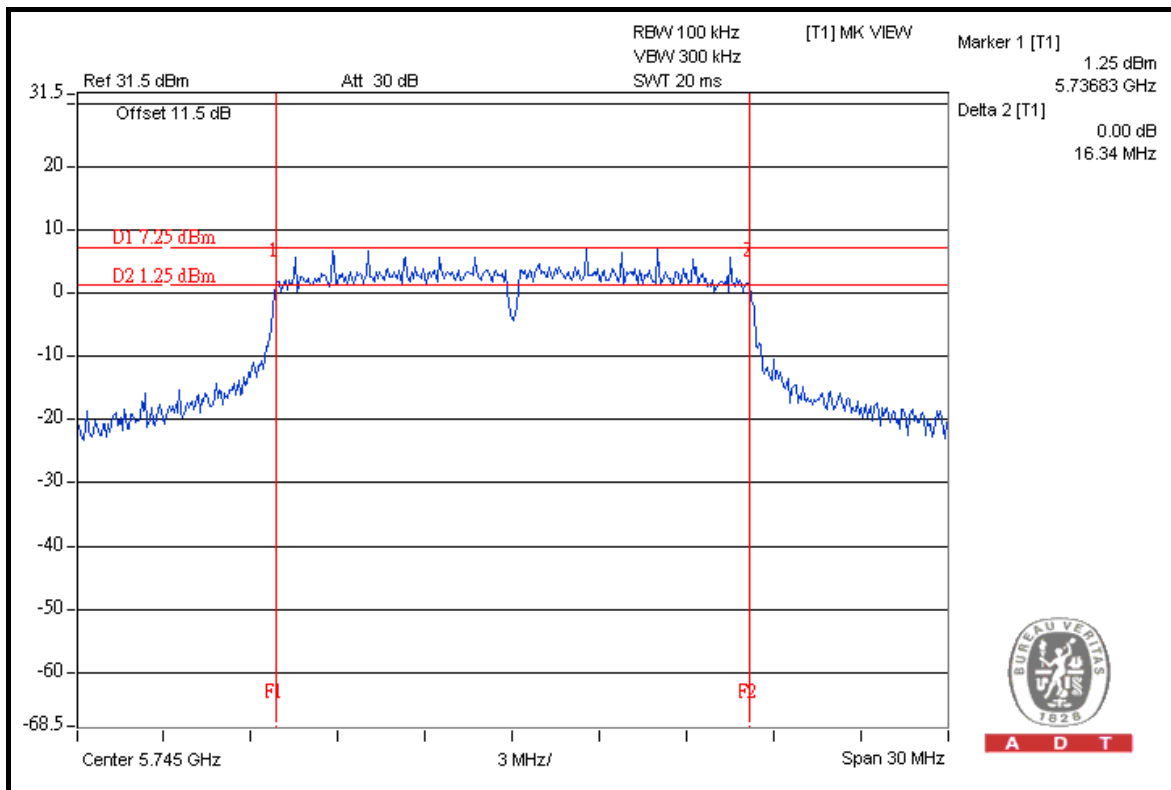



A D T

CH 157

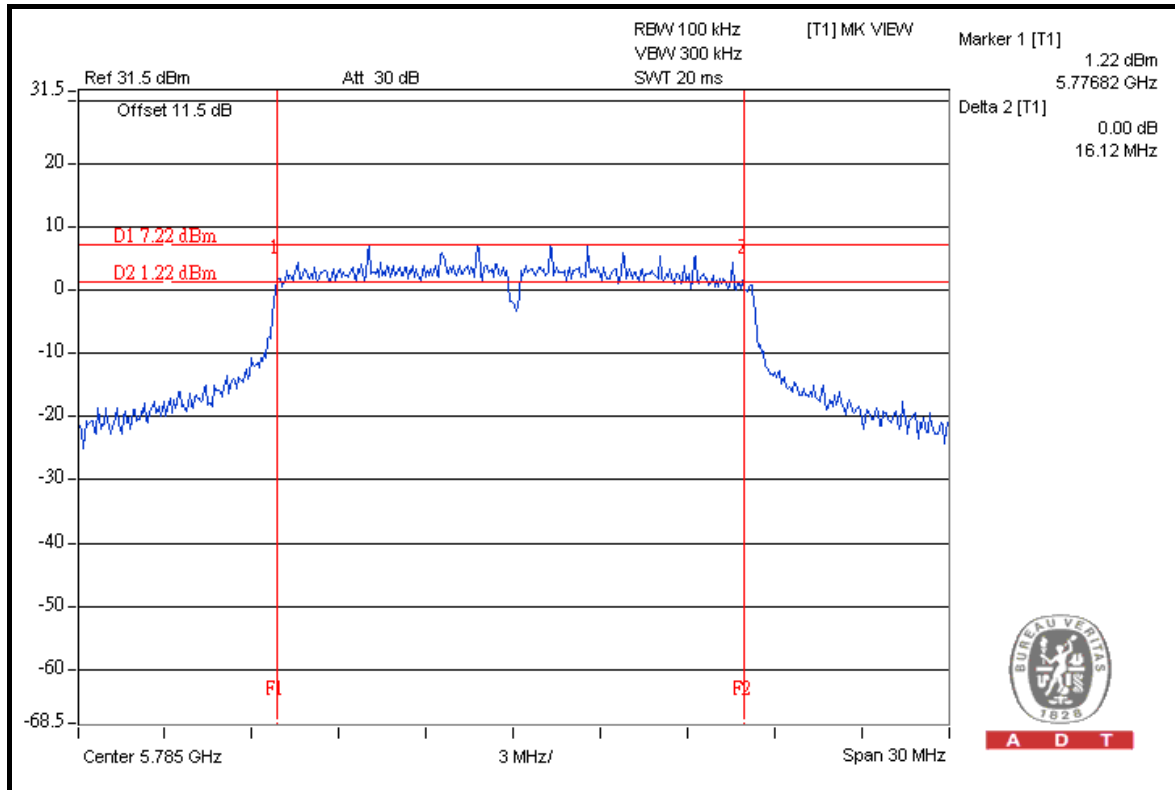

CH 165

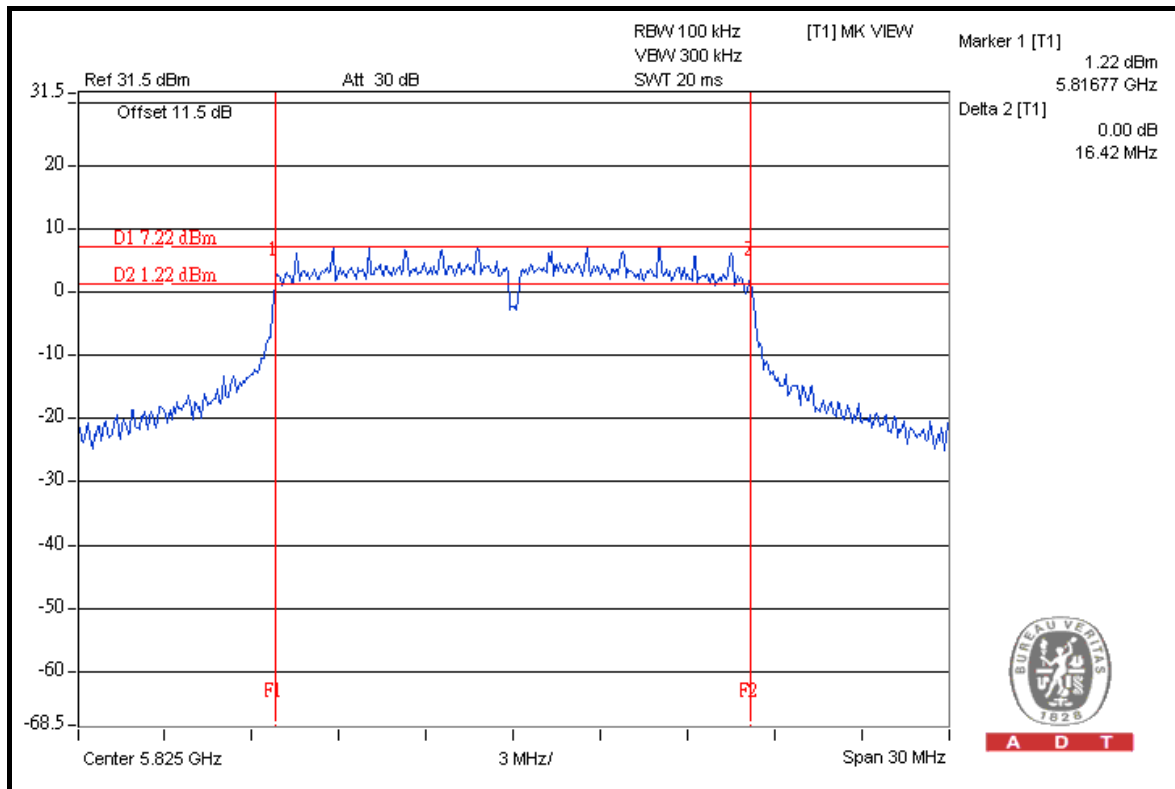



A D T

FOR CHAIN 1: CH 149

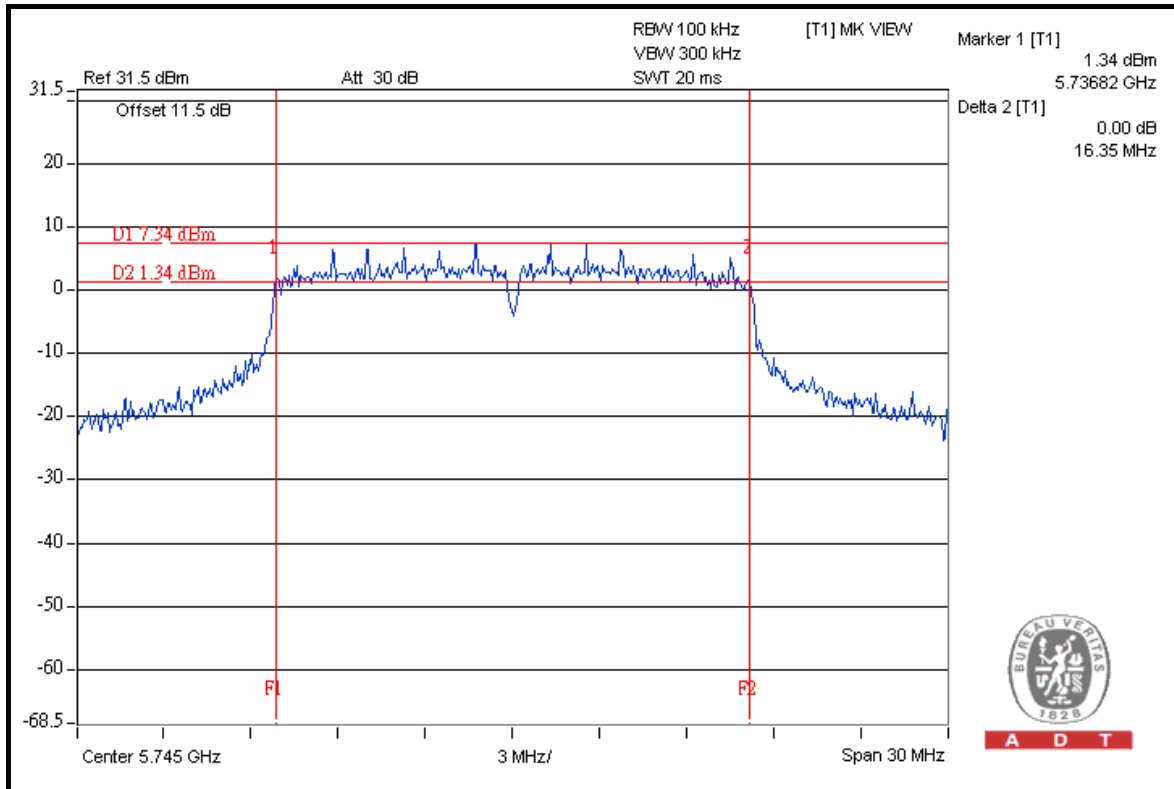

CH 157

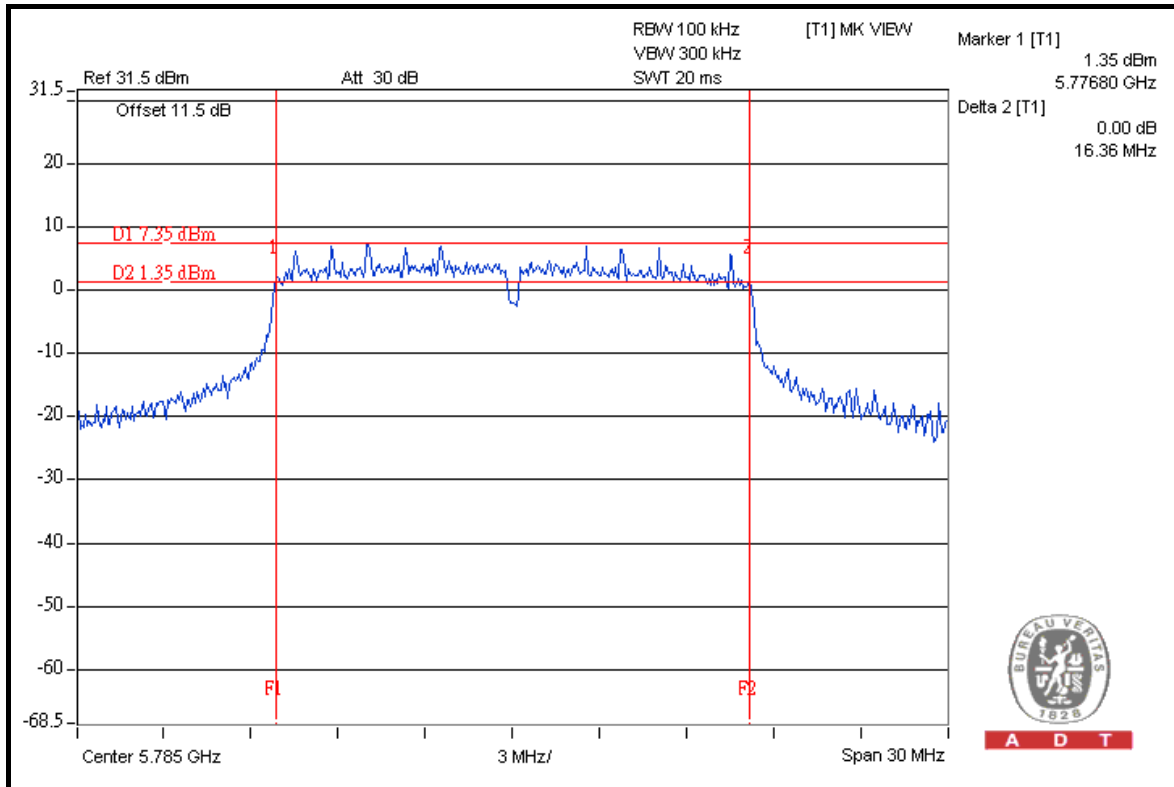



A D T

CH 165

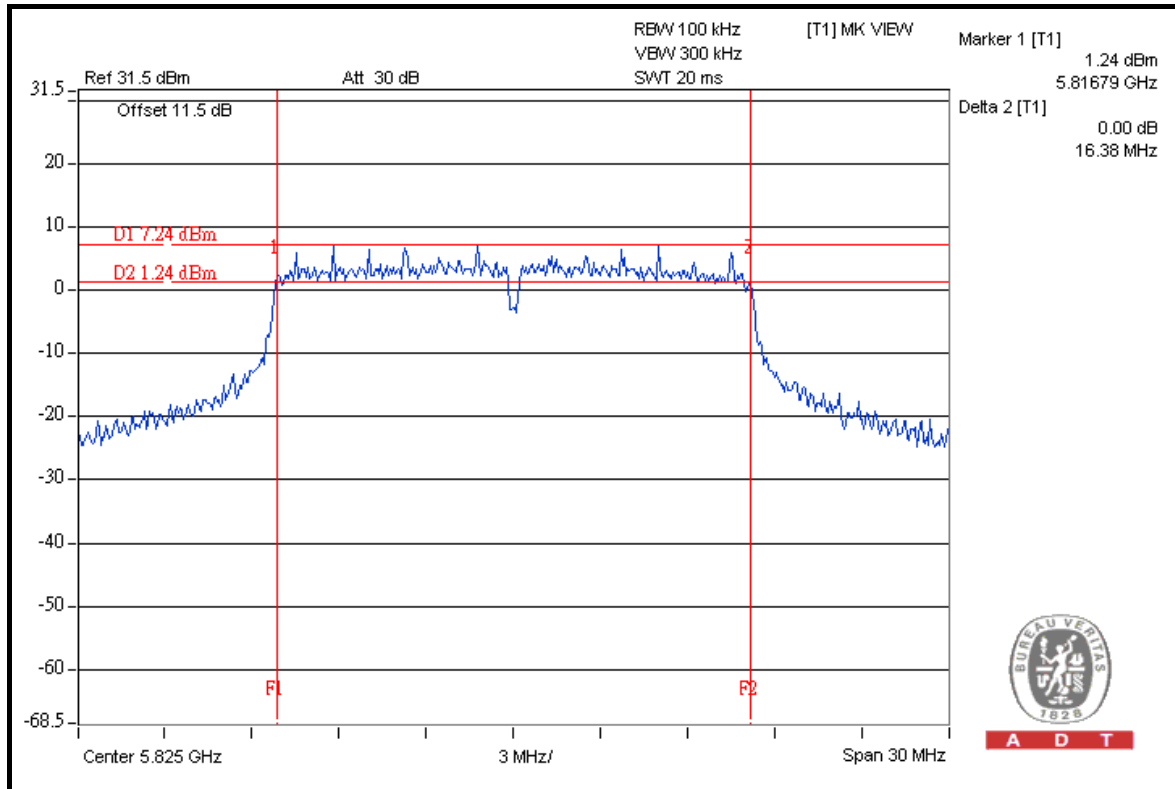

FOR CHAIN 2: CH 149

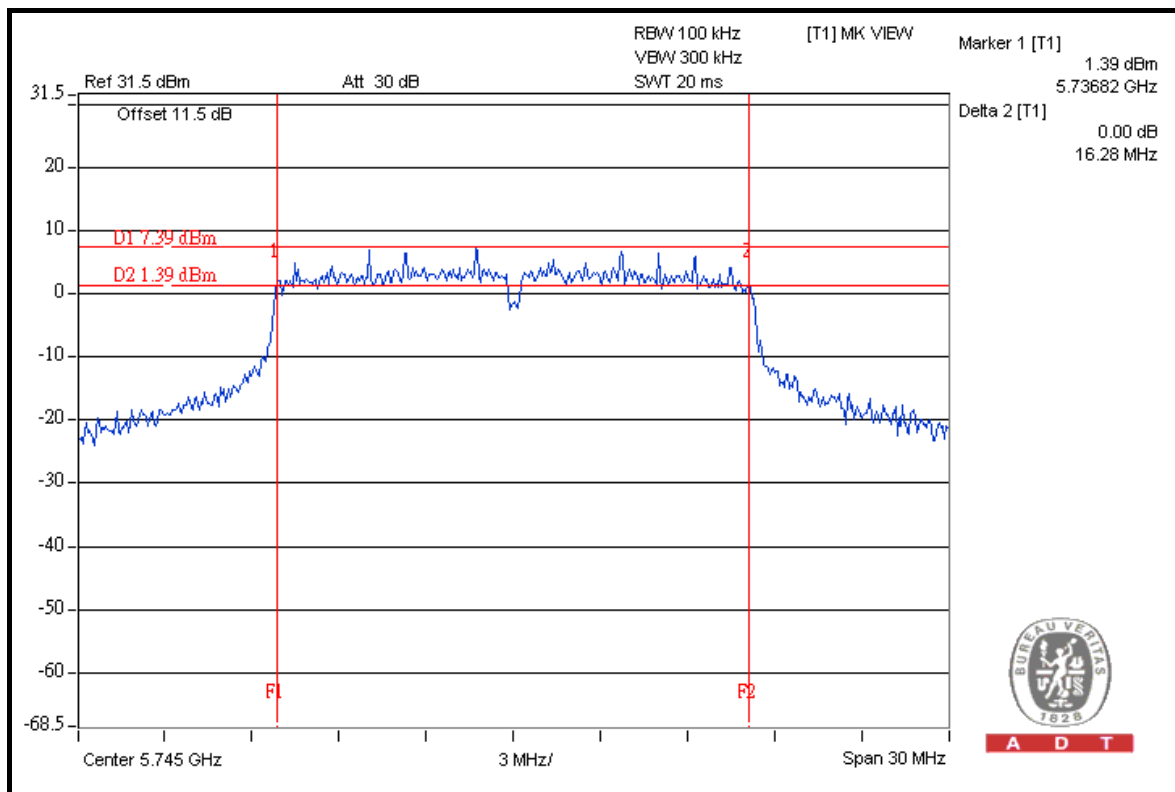



A D T

CH 157

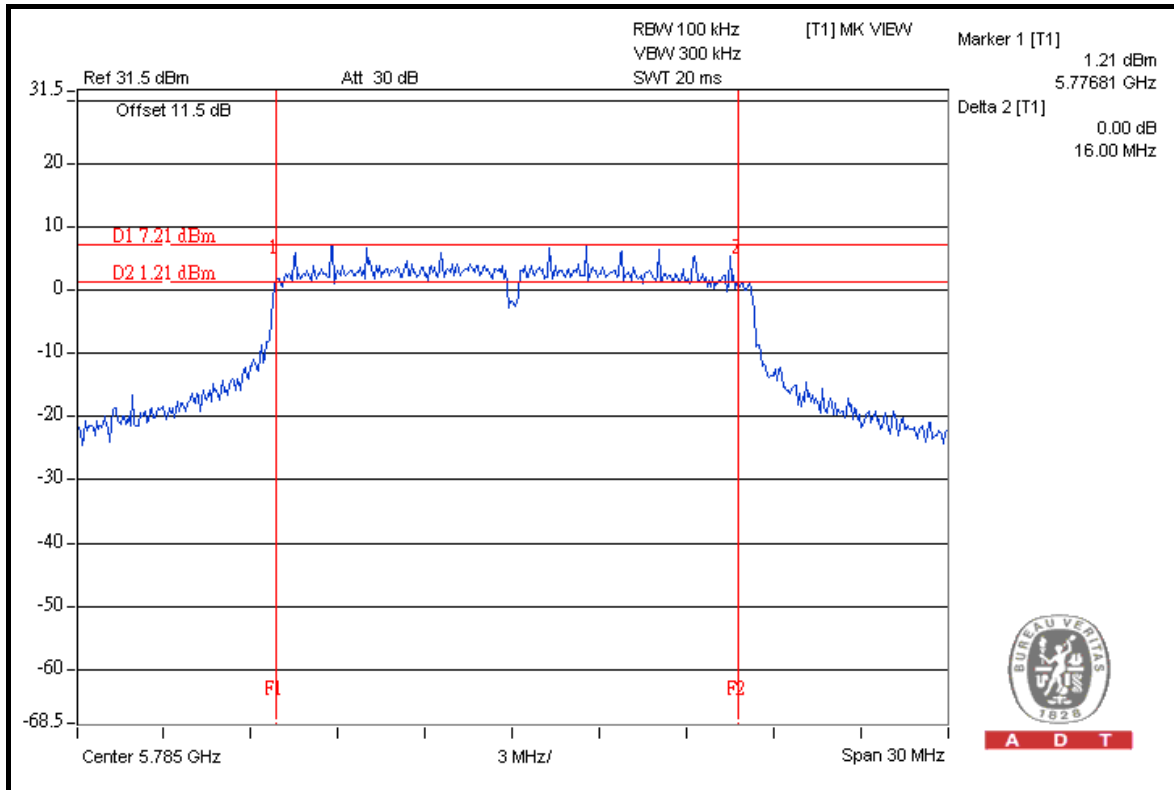

CH 165

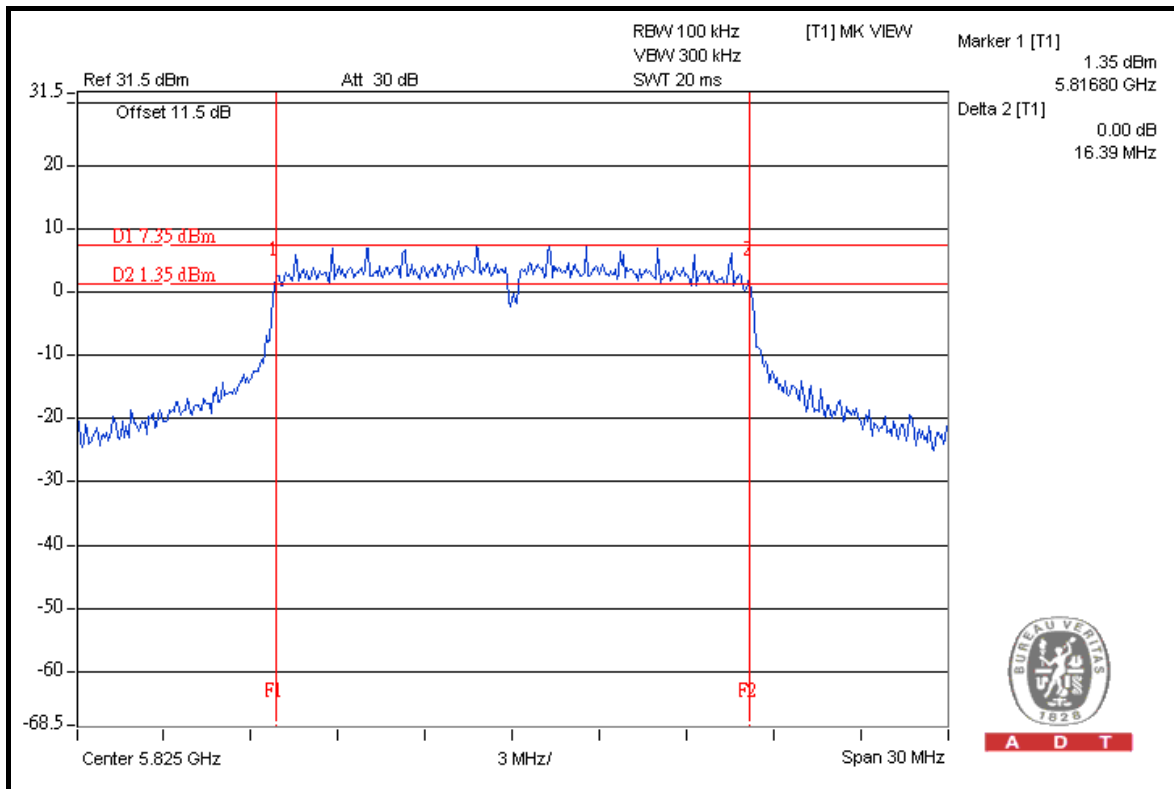



A D T

802.11a OFDM MODULATION

MODULATION TYPE	BPSK	TRANSFER RATE	6.0Mbps
INPUT POWER	120Vac, 60Hz	ENVIRONMENTAL CONDITIONS	25 deg.C, 65%RH, 1021hPa
TESTED BY	Brad Wu	TEST MODE	C

CHANNEL	CHANNEL FREQUENCY (MHz)	6dB BANDWIDTH (MHz)		MINIMUM LIMIT (MHz)	PASS / FAIL
		CHAIN 0	CHAIN 1		
149	5745	16.14	16.39	0.5	PASS
157	5785	16.47	16.44	0.5	PASS
165	5825	16.40	16.45	0.5	PASS



A D T

FOR CHAIN 0: CH 149

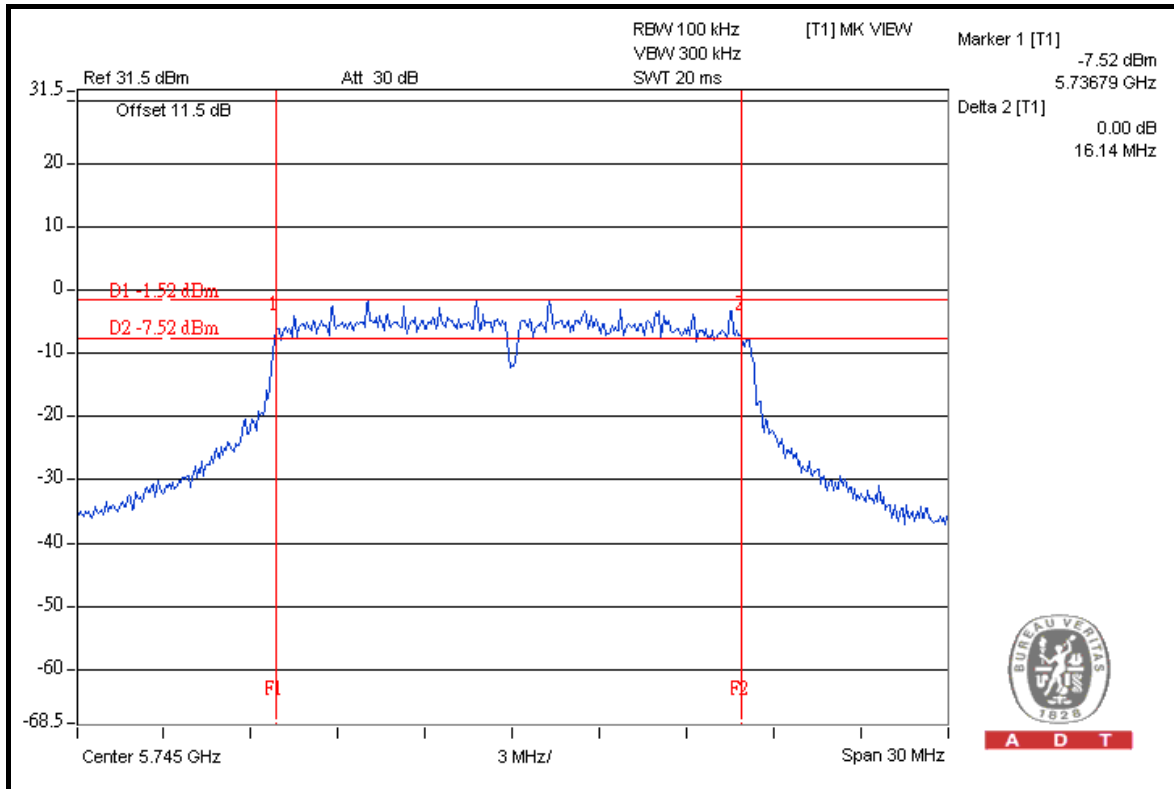

CH 157

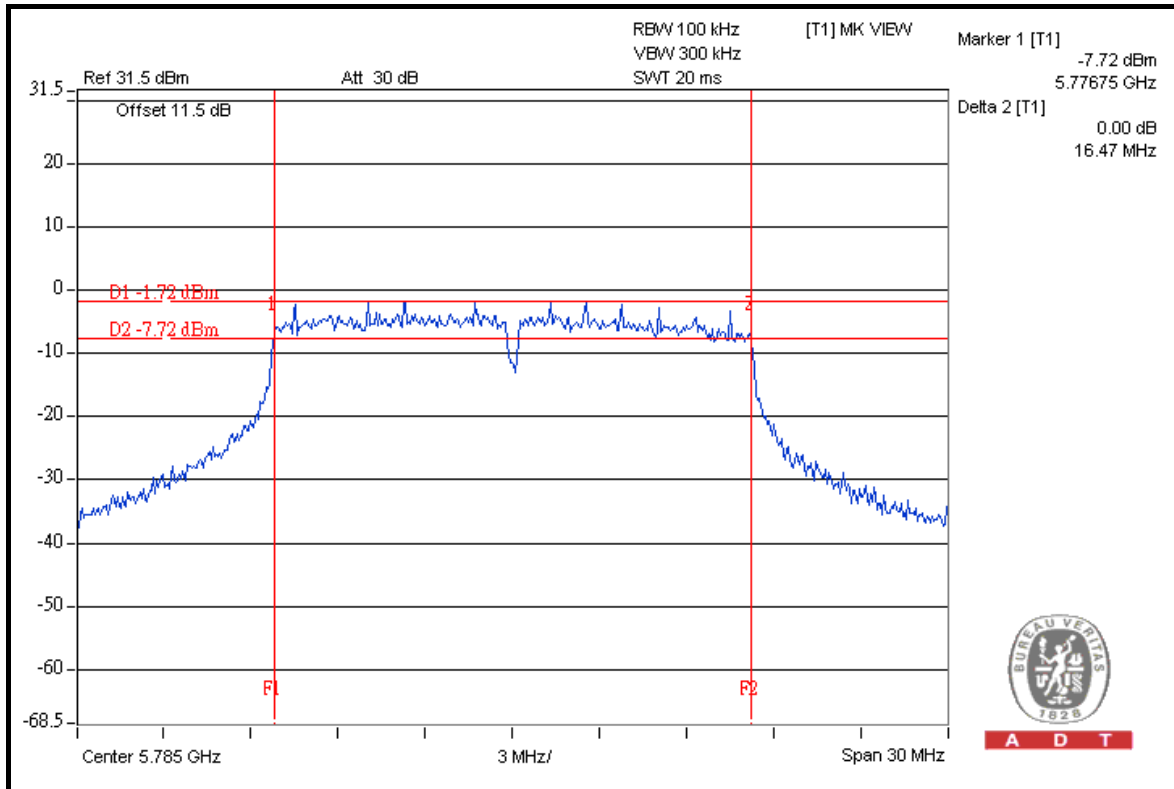



A D T

CH 165

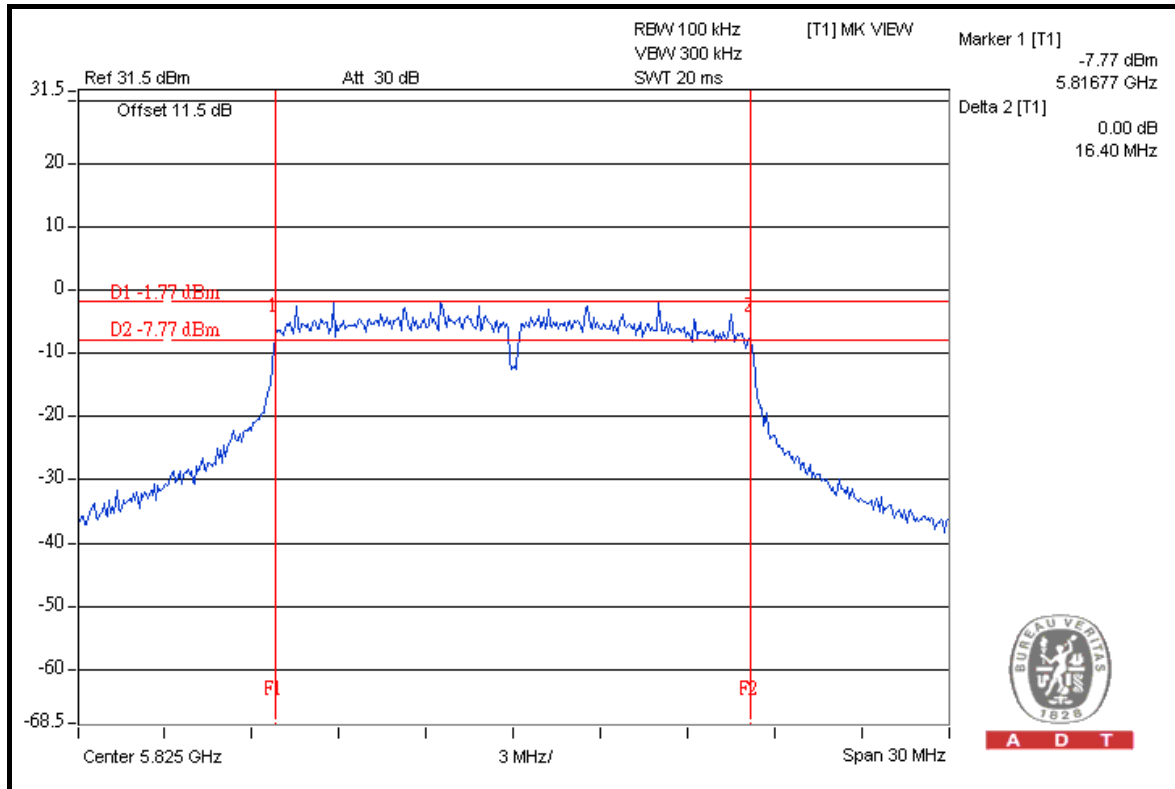

FOR CHAIN 1: CH 149

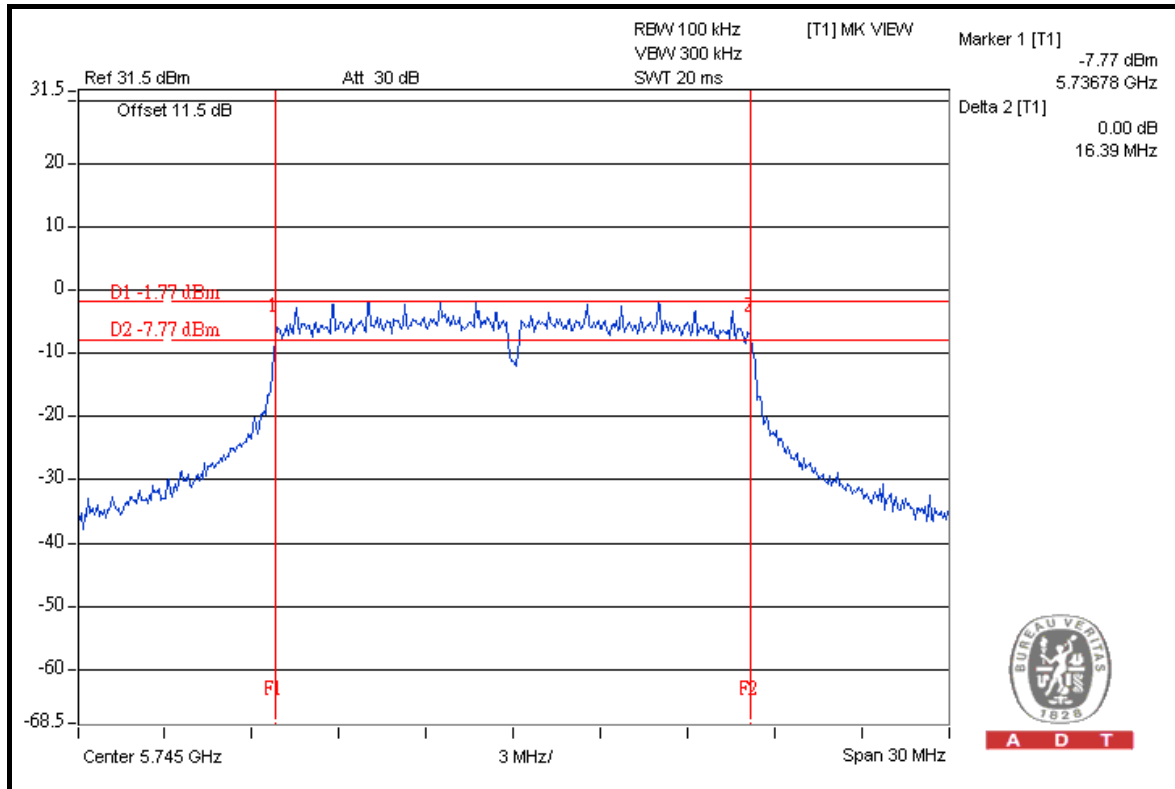



A D T

CH 157

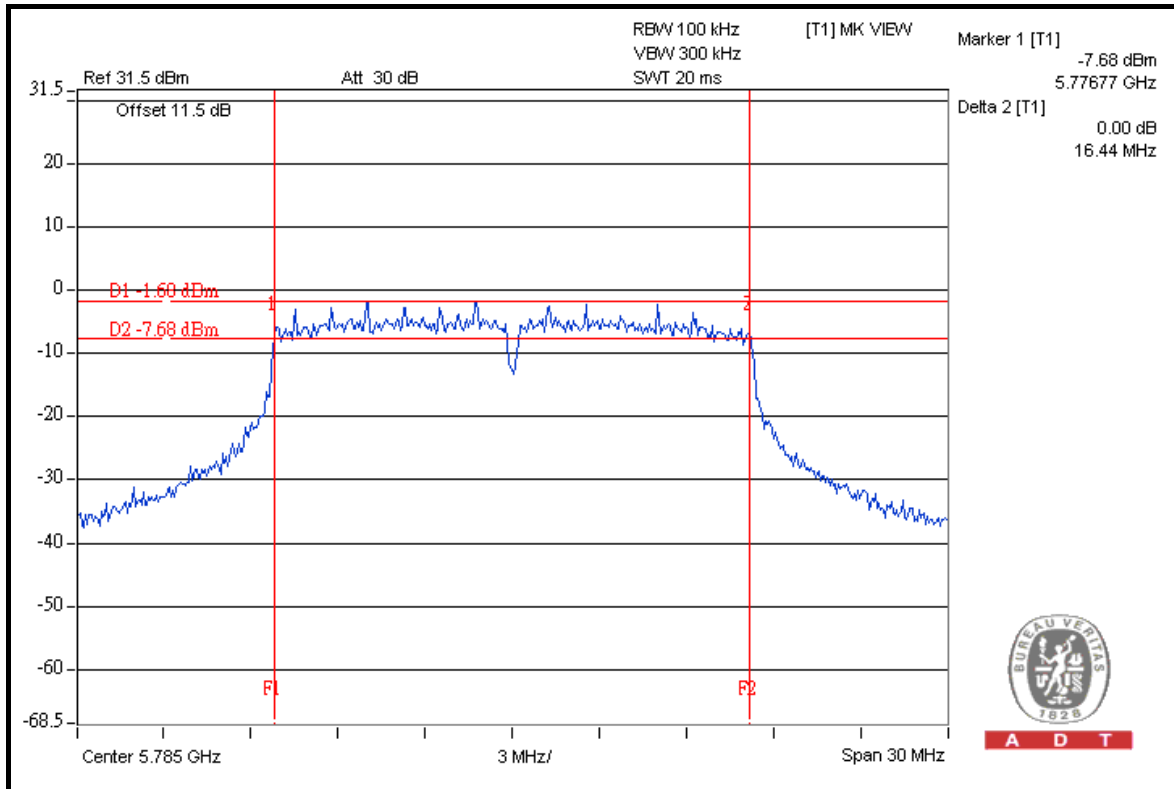

A D T

CH 165

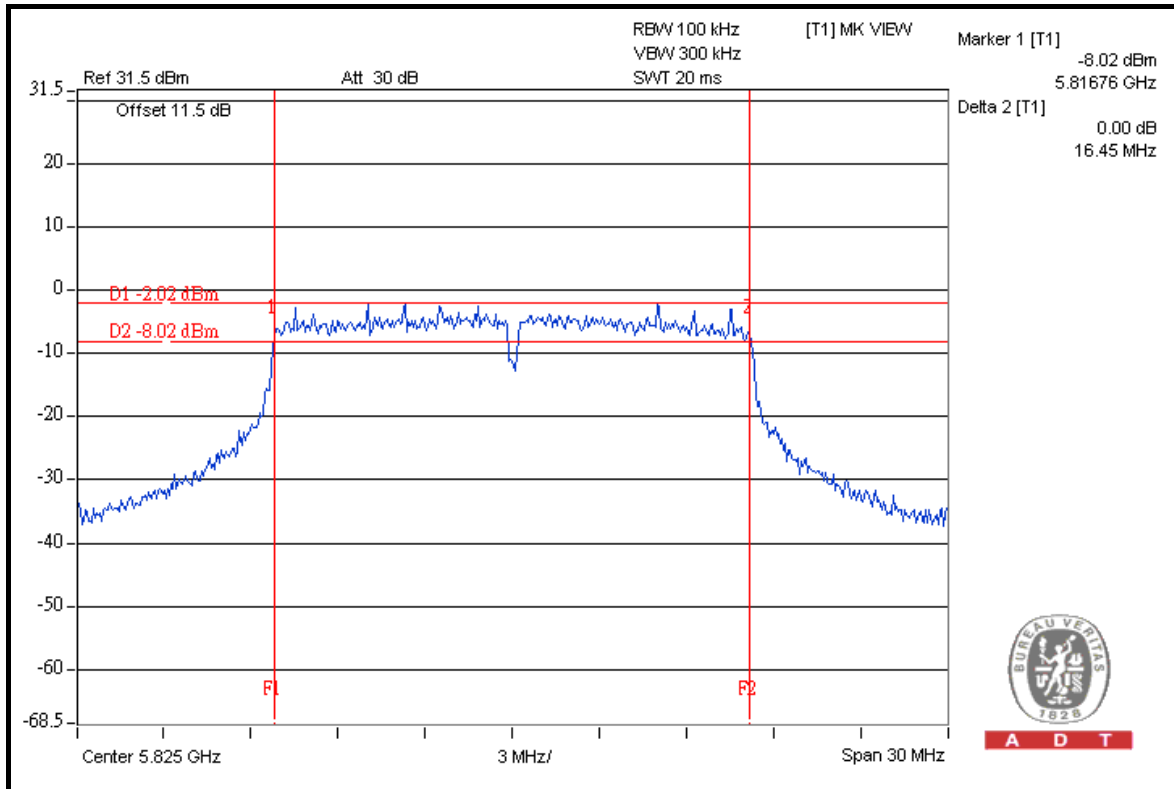

A D T



A D T

DRAFT 802.11n (20MHz) OFDM MODULATION

MODULATION TYPE	BPSK	TRANSFER RATE	6.5Mbps
INPUT POWER	120Vac, 60Hz	ENVIRONMENTAL CONDITIONS	25 deg.C, 65%RH, 1021hPa
TESTED BY	Brad Wu	TEST MODE	A

CHANNEL	CHANNEL FREQUENCY (MHz)	6dB BANDWIDTH (MHz)			MINIMUM LIMIT (MHz)	PASS / FAIL
		CHAIN 0	CHAIN 1	CHAIN 2		
149	5745	16.93	17.04	16.90	0.5	PASS
157	5785	17.24	17.26	17.13	0.5	PASS
165	5825	16.96	17.36	17.58	0.5	PASS

FOR CHAIN 0: CH 149

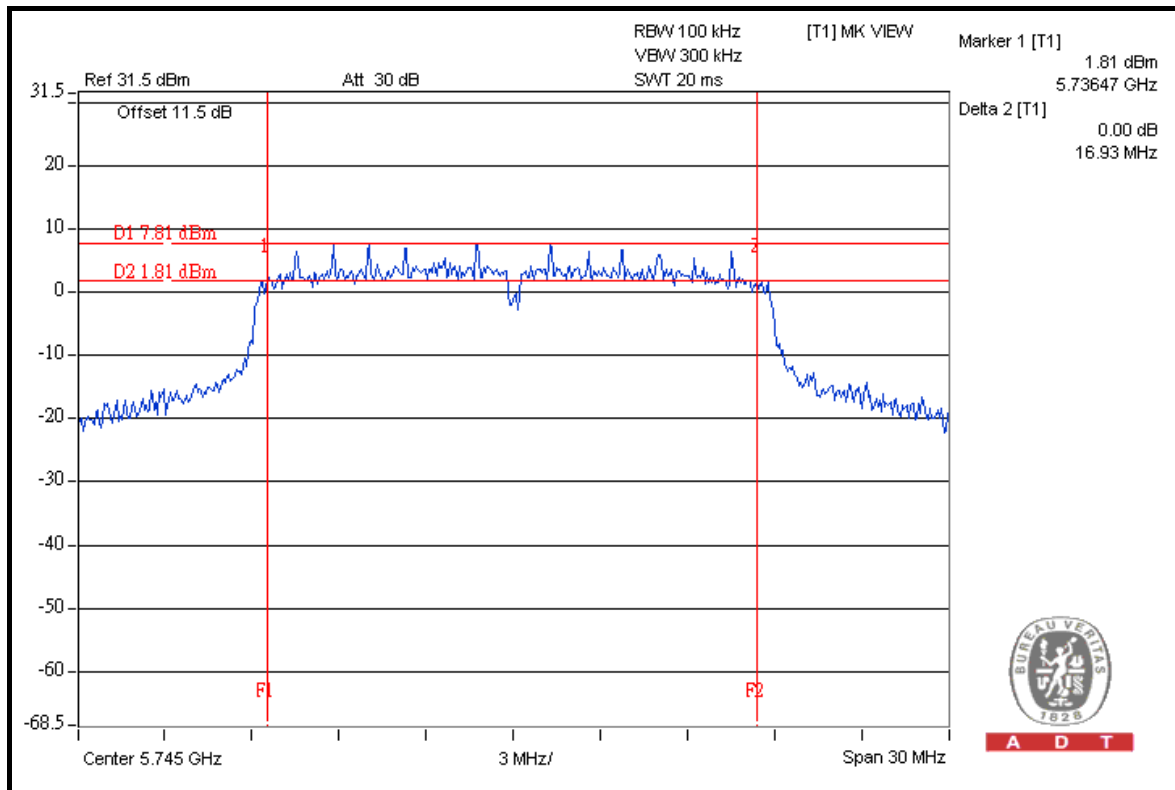



A D T

CH 157

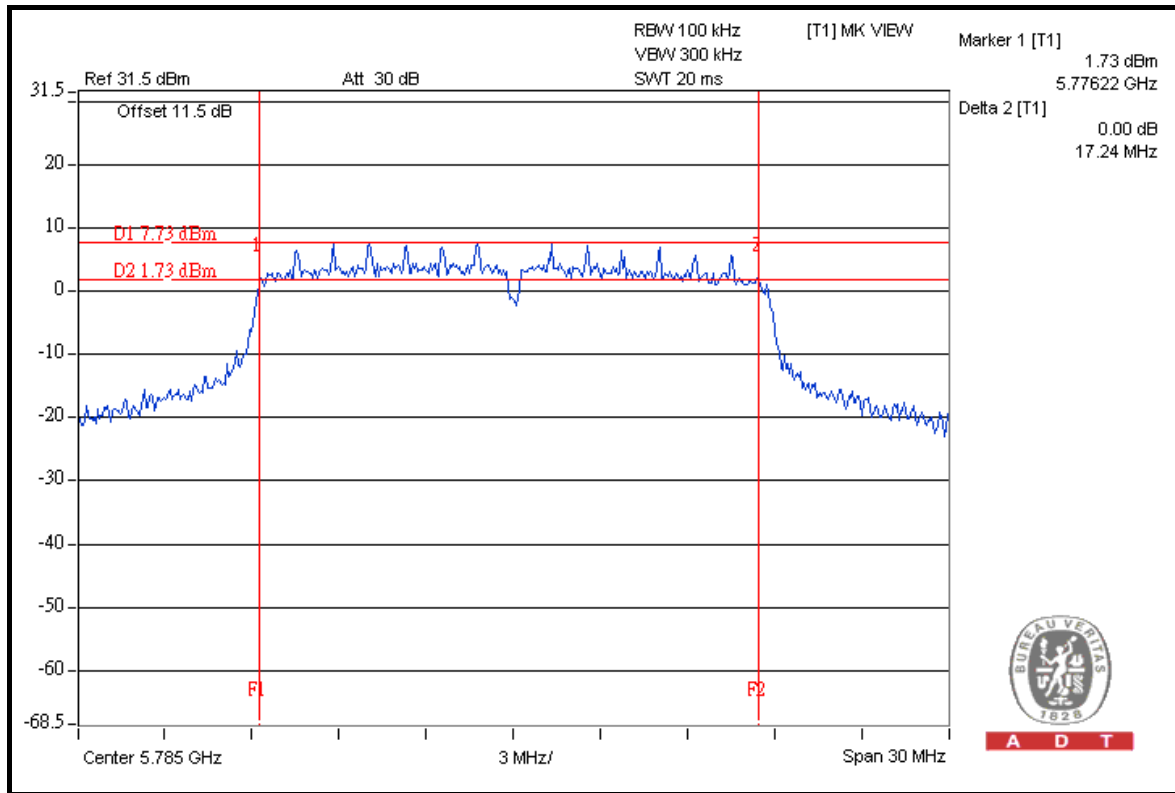

CH 165

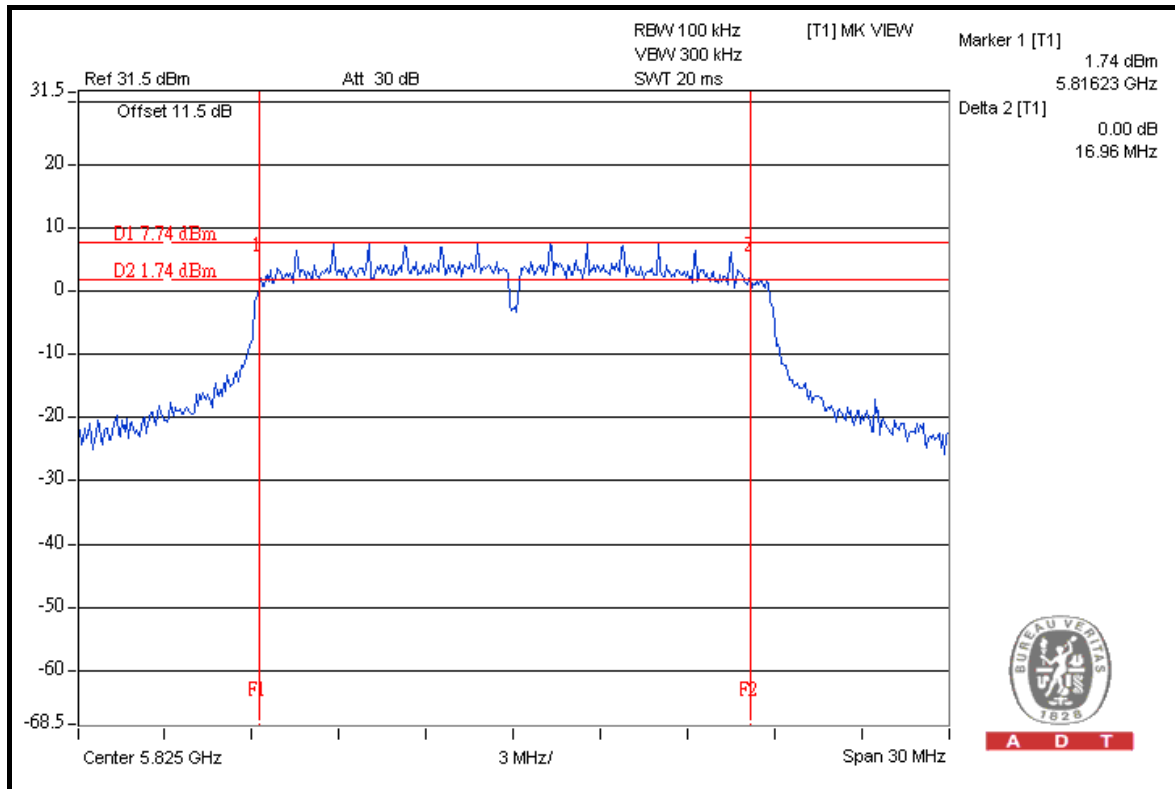



A D T

FOR CHAIN 1: CH 149

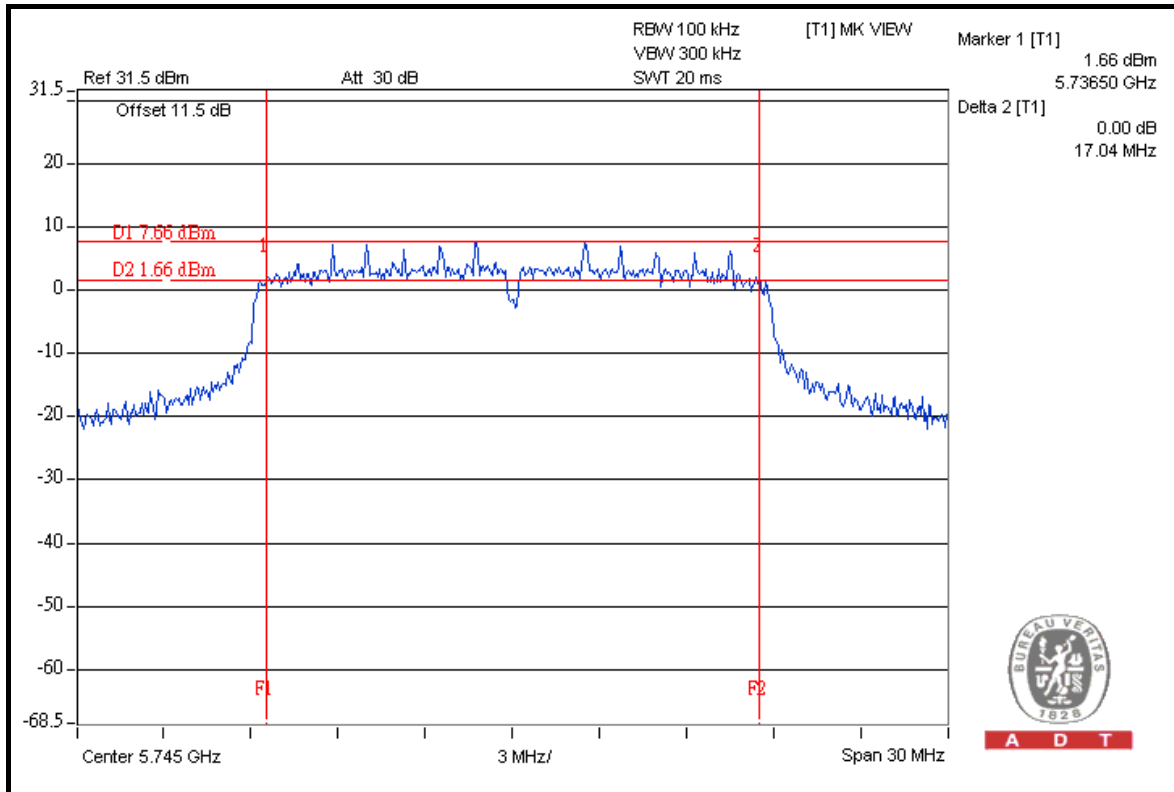

A D T

CH 157

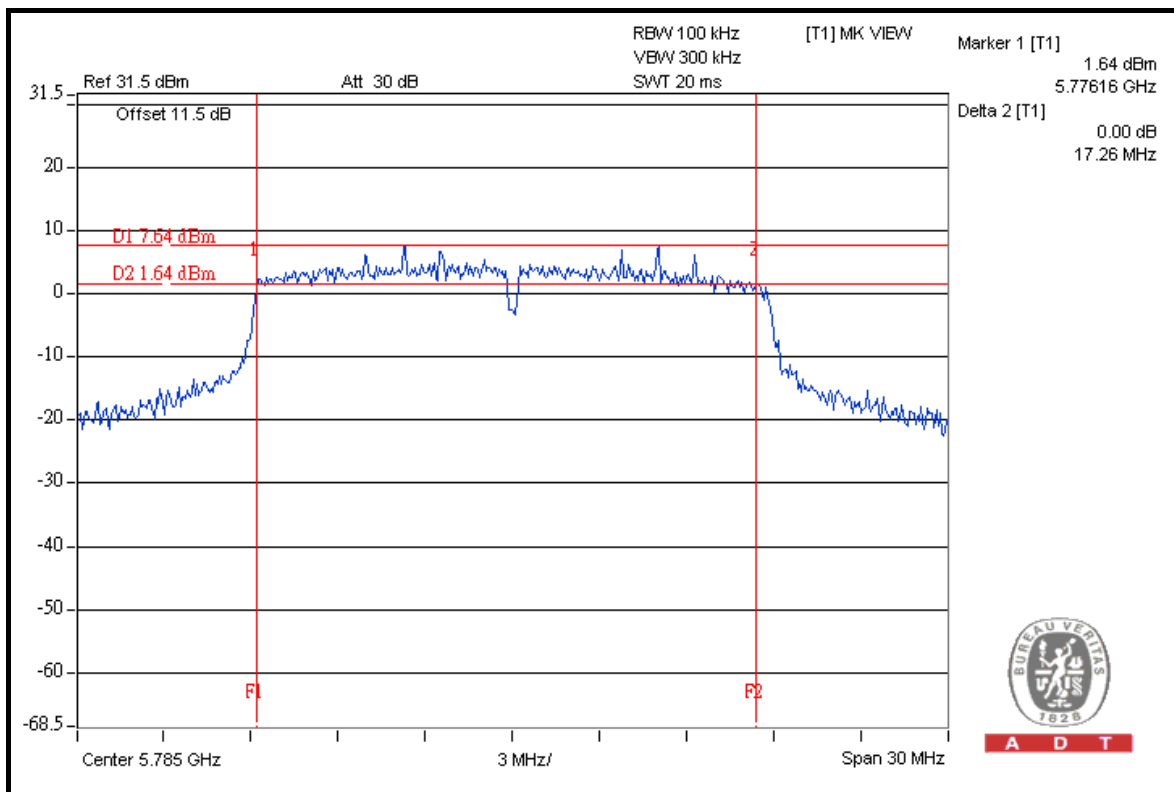

A D T



A D T

CH 165

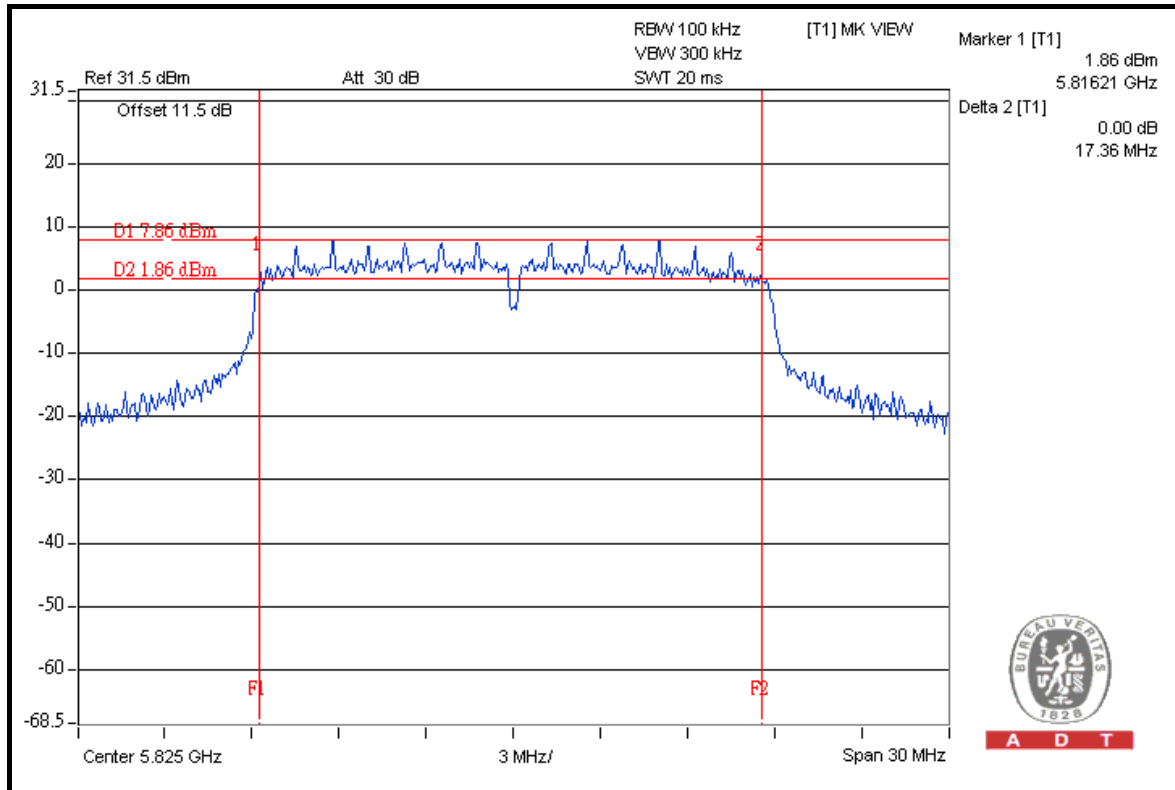

FOR CHAIN 2: CH 149

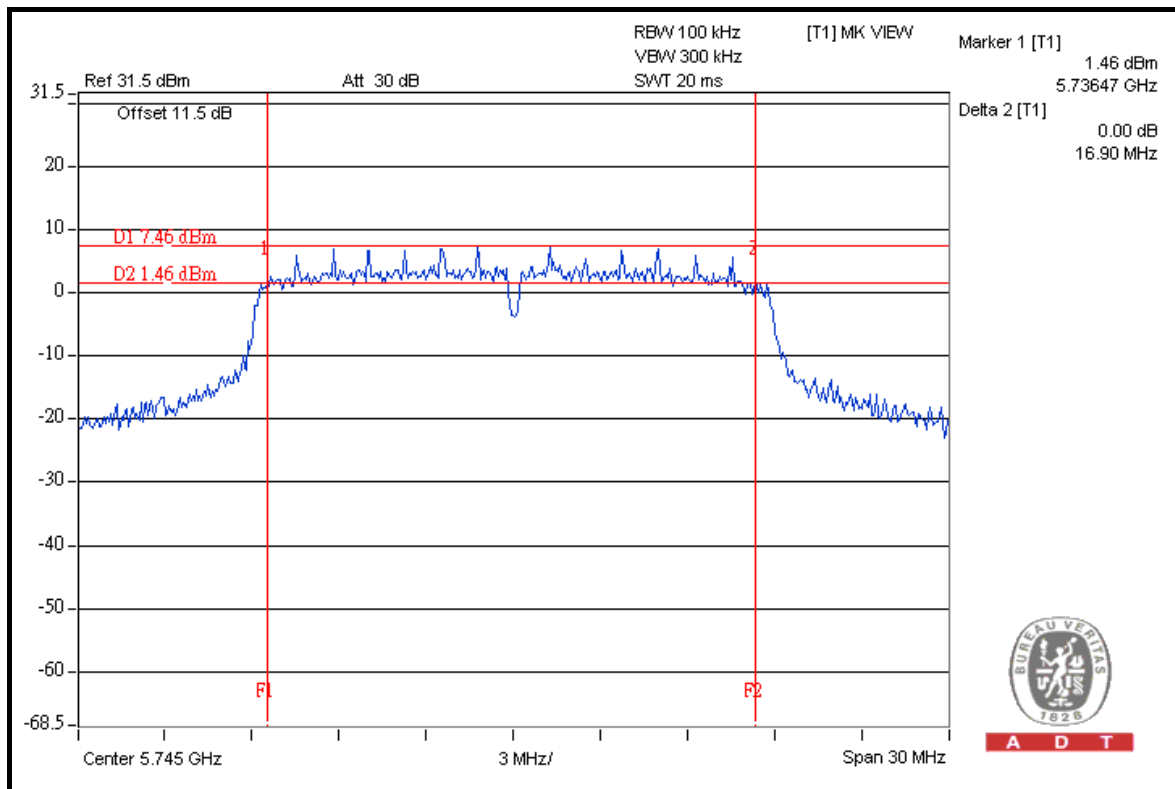



A D T

CH 157

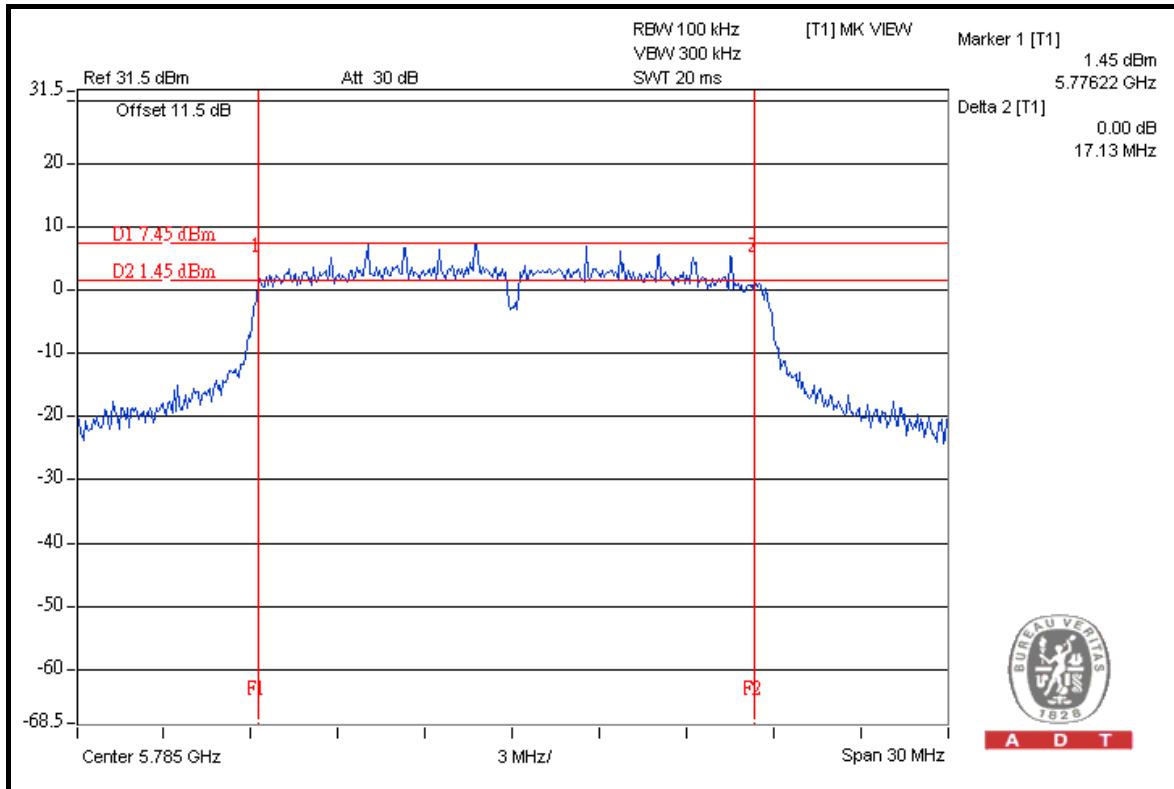

CH 165

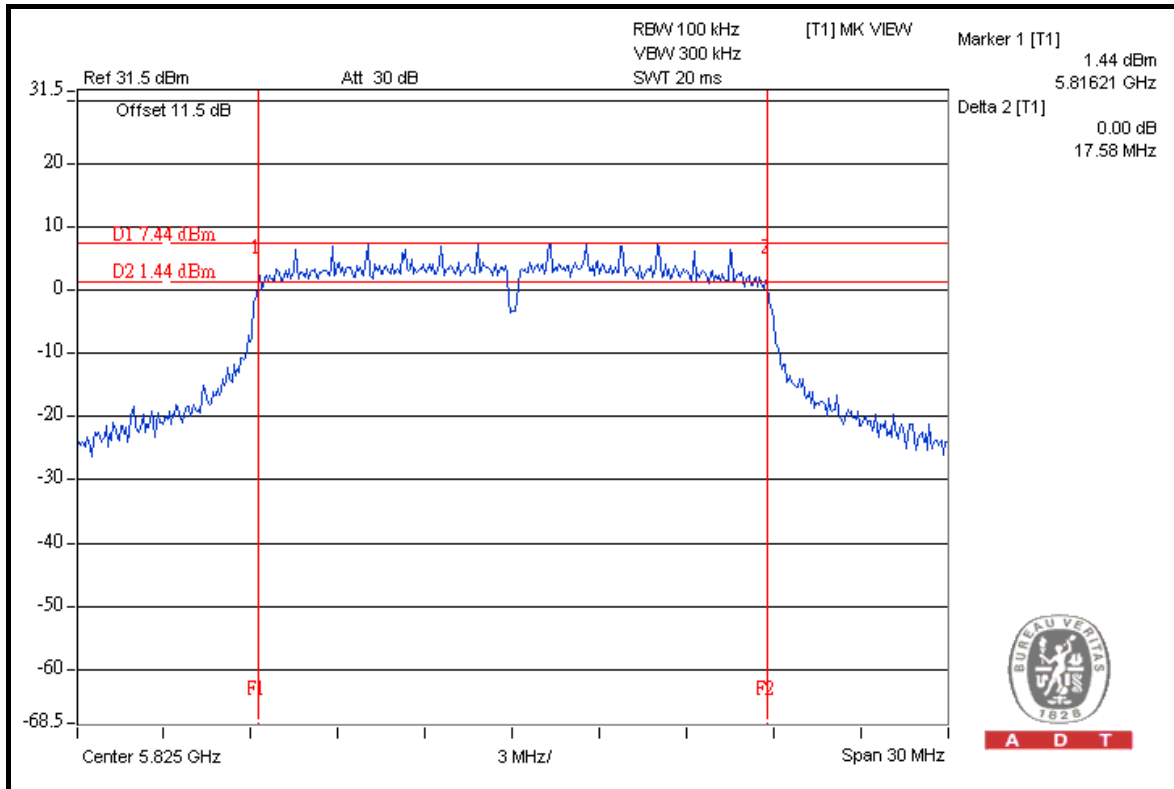



A D T

DRAFT 802.11n (20MHz) OFDM MODULATION

MODULATION TYPE	BPSK	TRANSFER RATE	6.5Mbps
INPUT POWER	120Vac, 60Hz	ENVIRONMENTAL CONDITIONS	25 deg.C, 65%RH, 1021hPa
TESTED BY	Brad Wu	TEST MODE	C

CHANNEL	CHANNEL FREQUENCY (MHz)	6dB BANDWIDTH (MHz)		MINIMUM LIMIT (MHz)	PASS / FAIL
		CHAIN 0	CHAIN 1		
149	5745	16.41	16.41	0.5	PASS
157	5785	16.18	16.44	0.5	PASS
165	5825	16.40	16.41	0.5	PASS



A D T

FOR CHAIN 0: CH 149

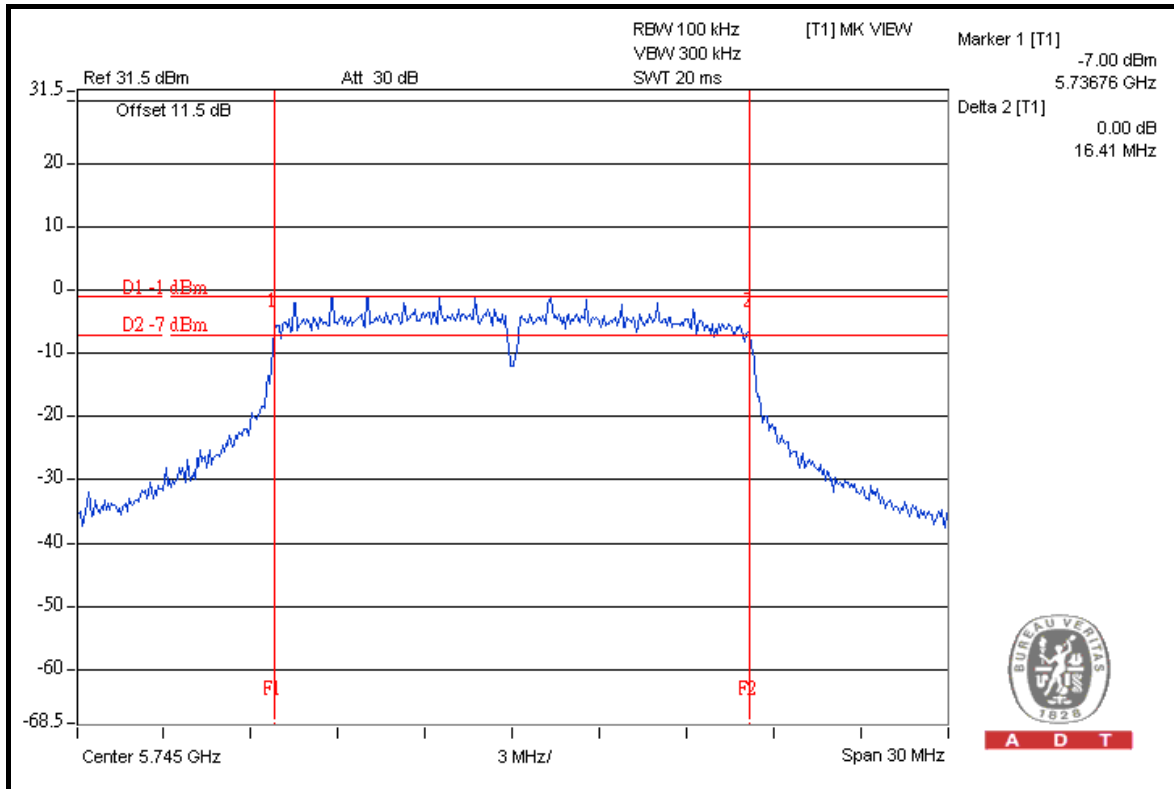

A D T

CH 157

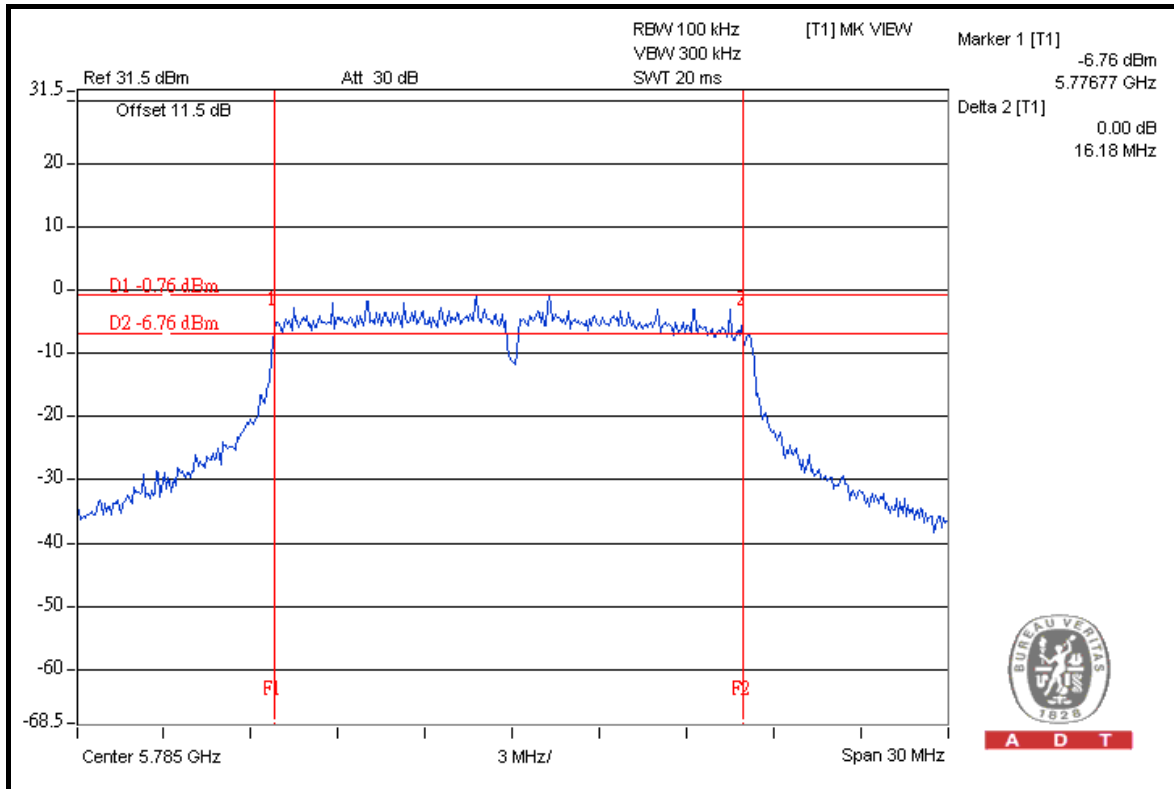

A D T



A D T

CH 165

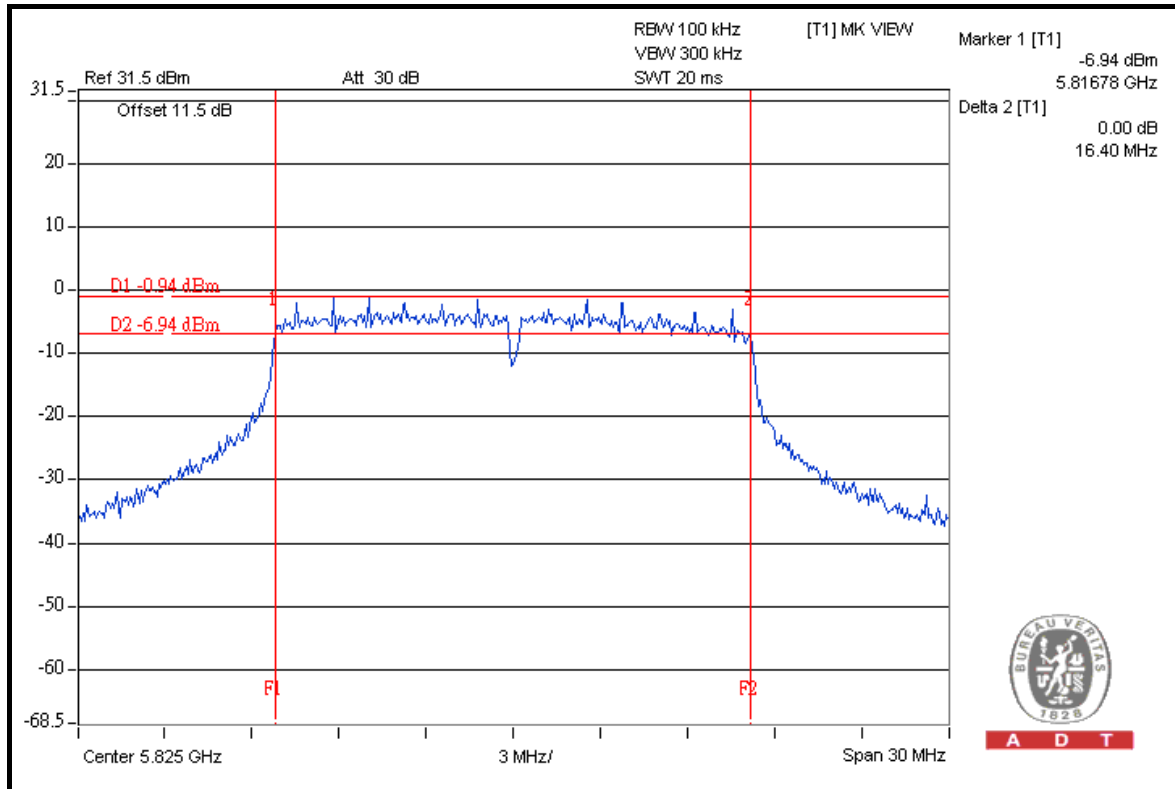

FOR CHAIN 1: CH 149

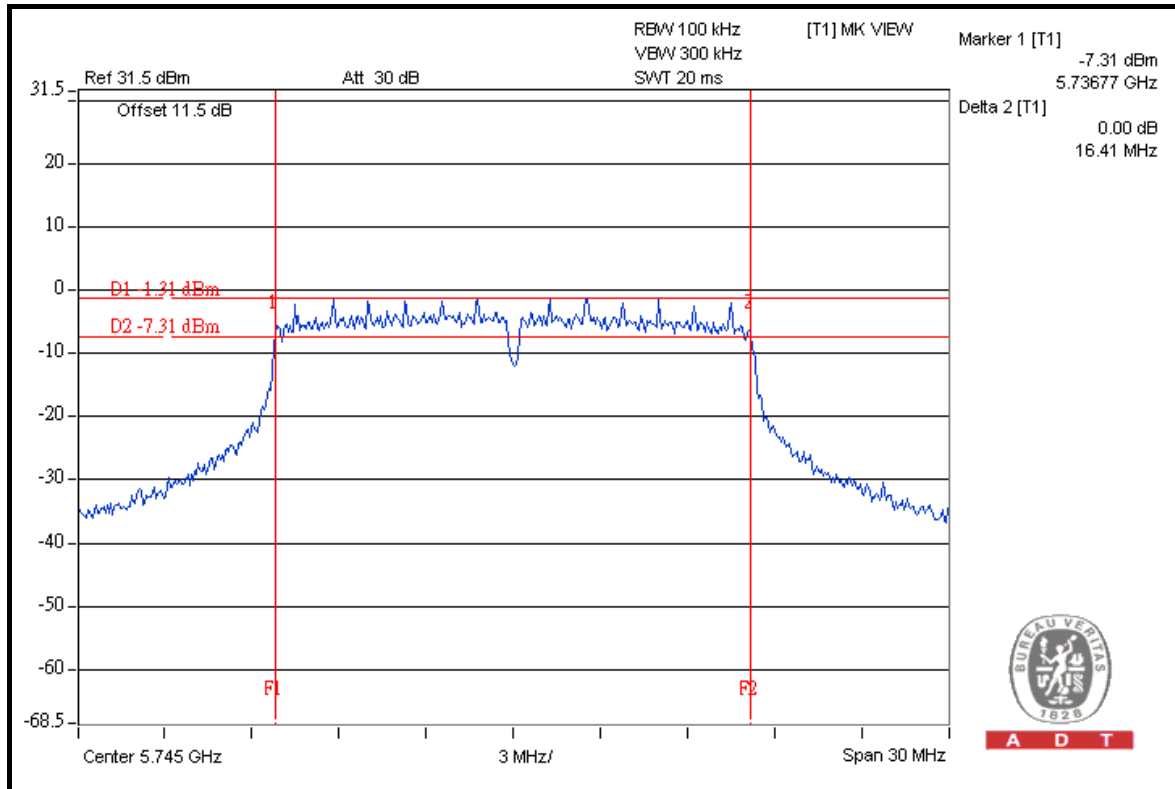



A D T

CH 157

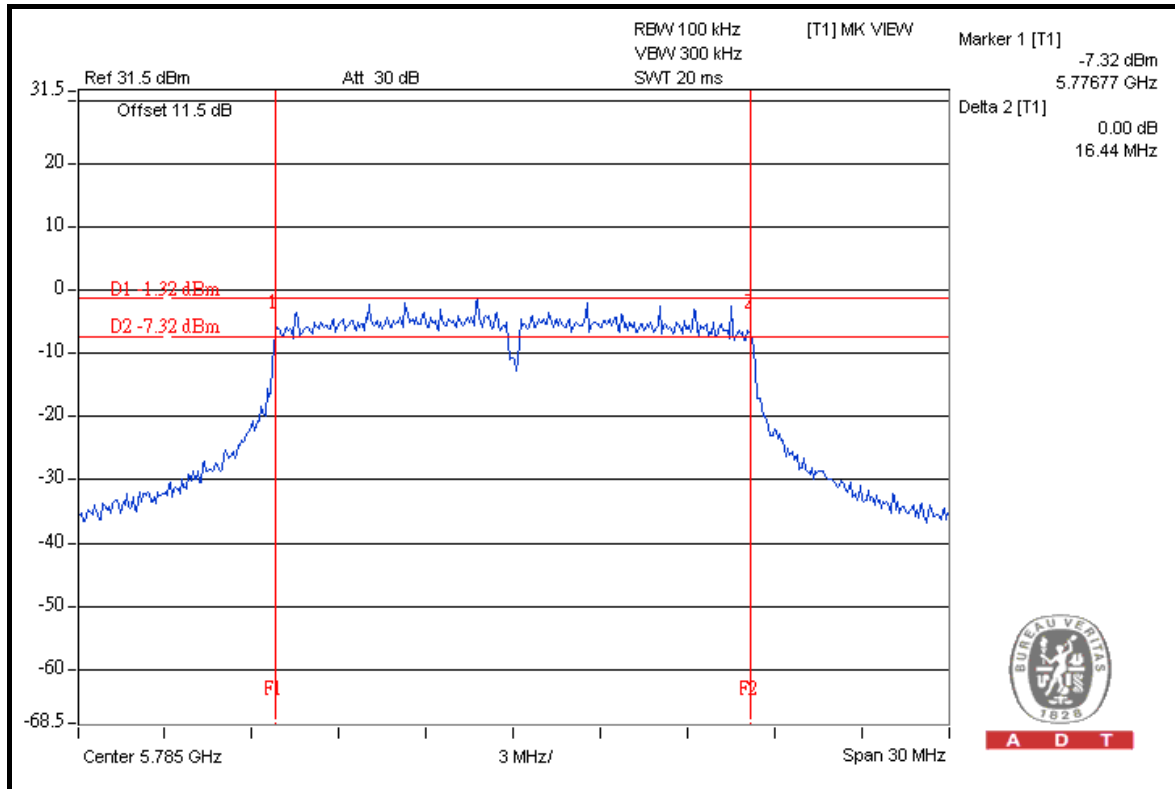

A D T

CH 165

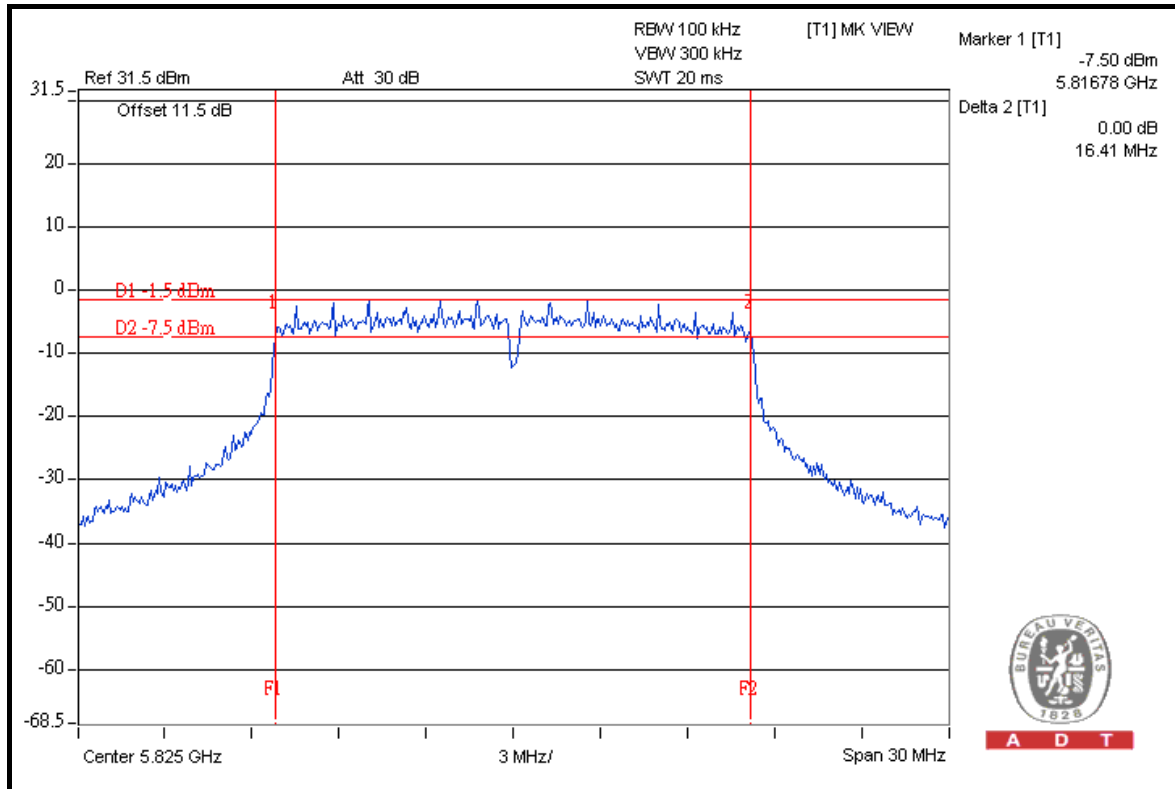

A D T



A D T

DRAFT 802.11n (40MHz) OFDM MODULATION

MODULATION TYPE	BPSK	TRANSFER RATE	13.5Mbps
INPUT POWER	120Vac, 60Hz	ENVIRONMENTAL CONDITIONS	25 deg.C, 65%RH, 1021hPa
TESTED BY	Brad Wu	TEST MODE	A

CHANNEL	CHANNEL FREQUENCY (MHz)	6dB BANDWIDTH (MHz)			MINIMUM LIMIT (MHz)	PASS / FAIL
		CHAIN 0	CHAIN 1	CHAIN 2		
151	5755	36.45	36.44	36.44	0.5	PASS
159	5795	36.43	36.46	36.46	0.5	PASS



A D T

FOR CHAIN 0: CH 151

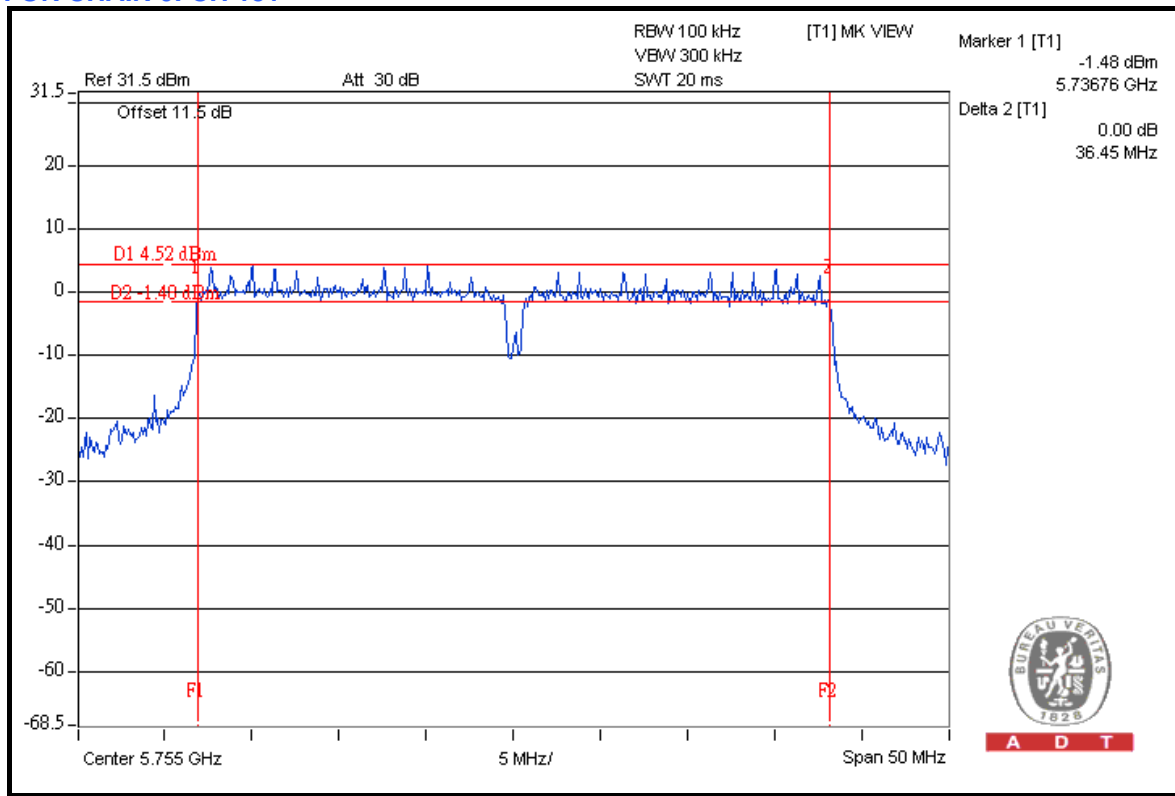

CH 159

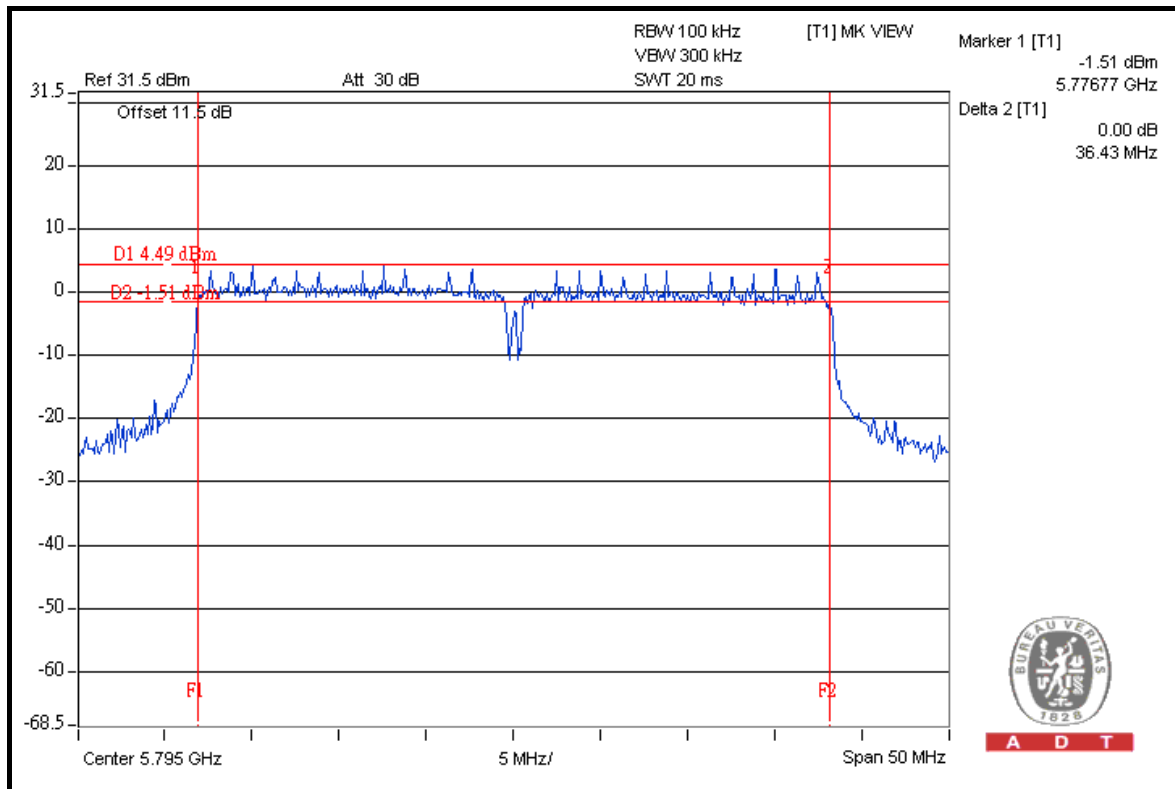



A D T

FOR CHAIN 1: CH 151

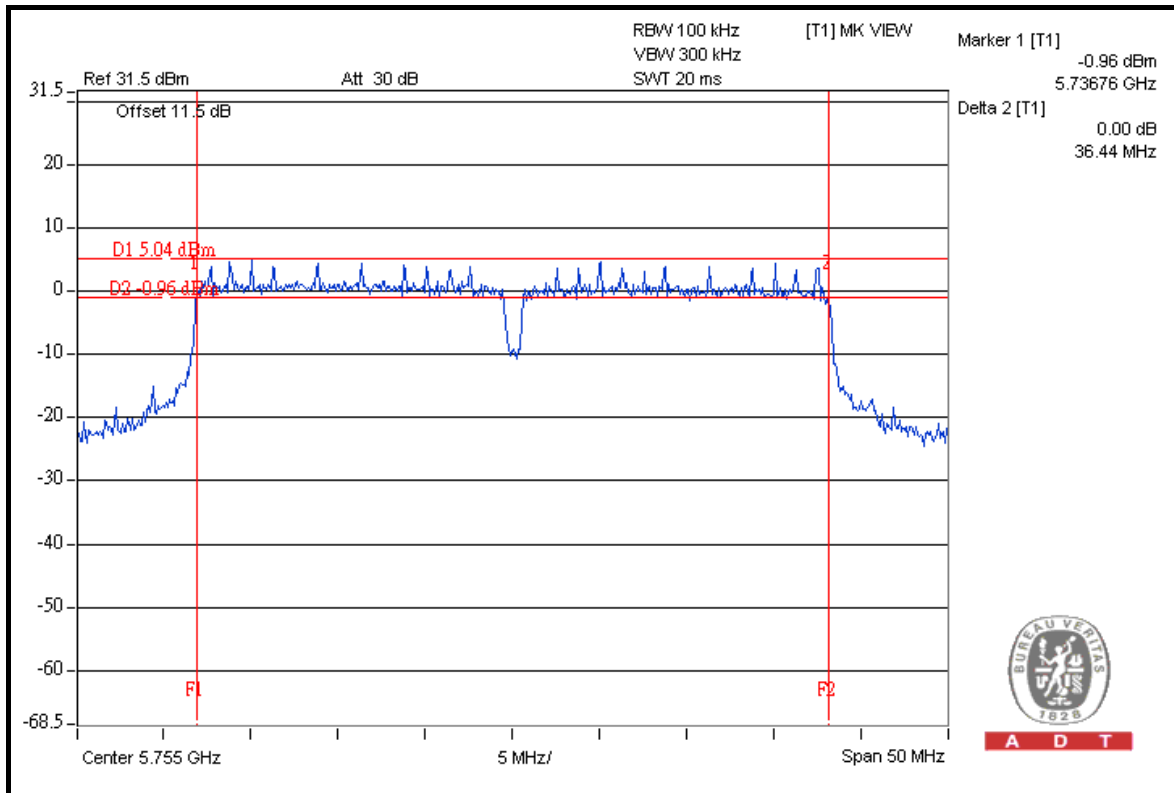

A D T

CH 159

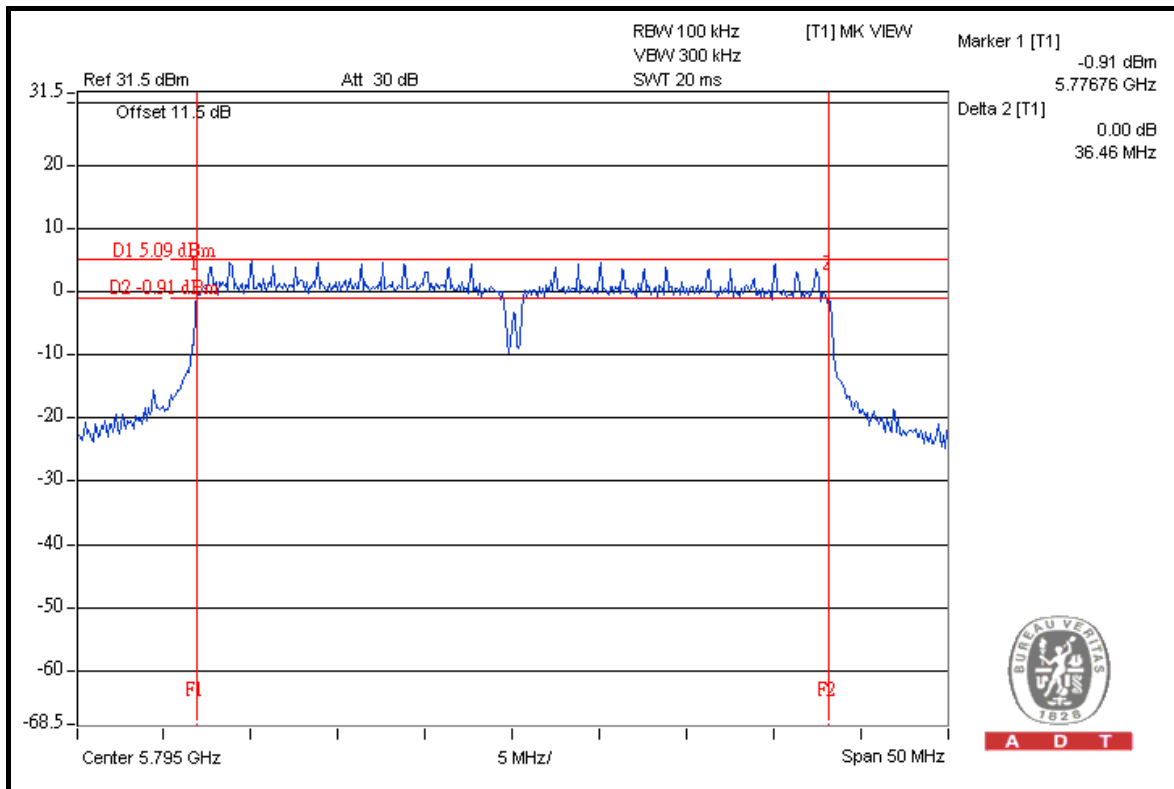

A D T



A D T

FOR CHAIN 2: CH 151

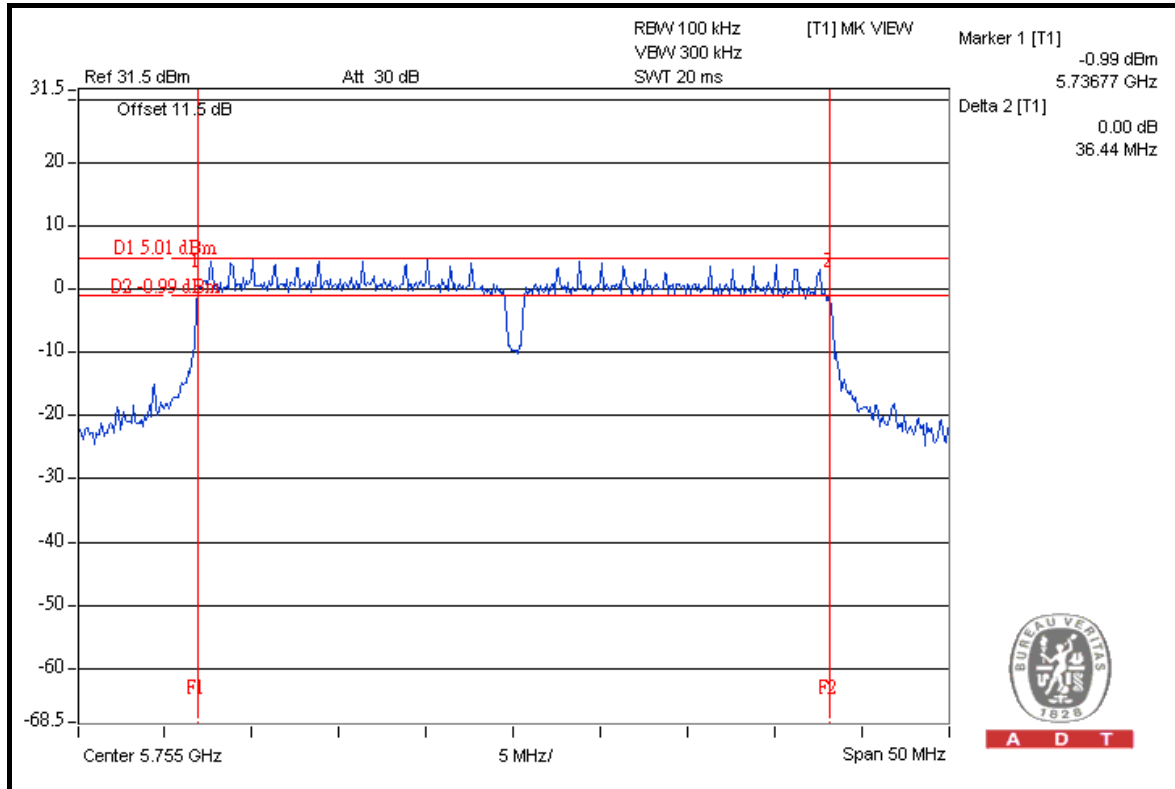

CH 159

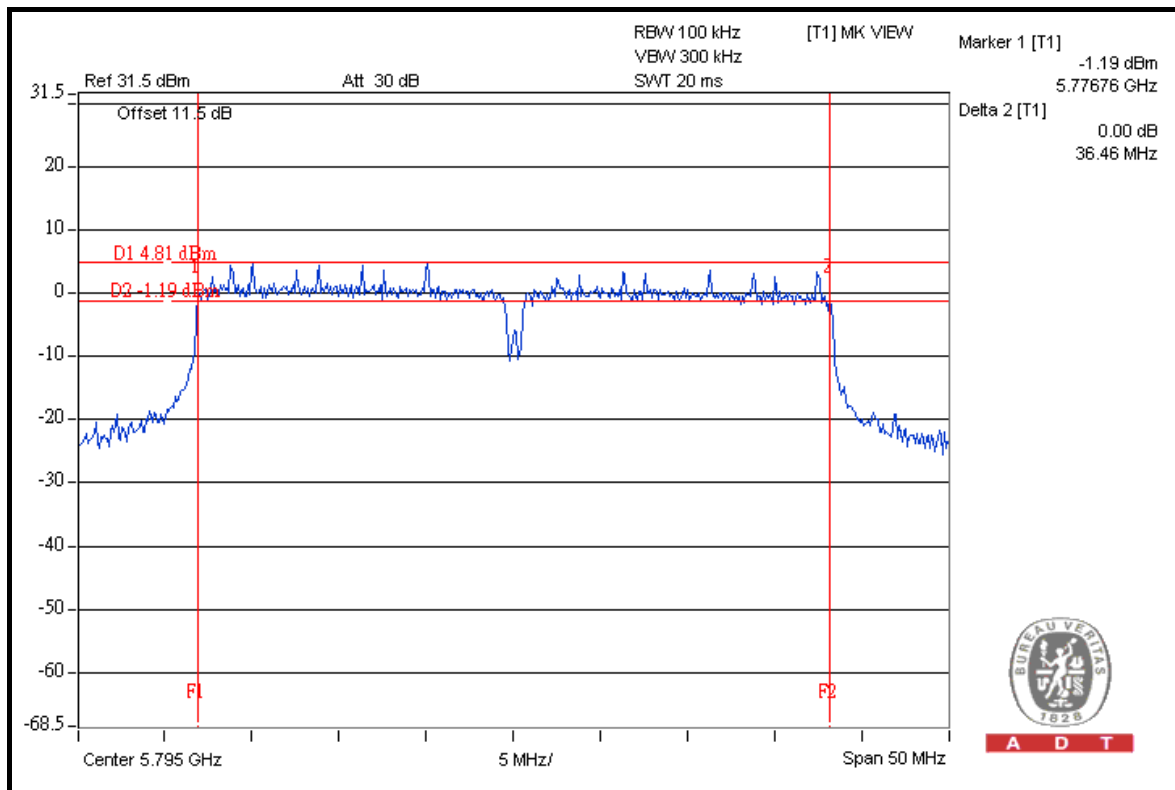



A D T

DRAFT 802.11n (40MHz) OFDM MODULATION

MODULATION TYPE	BPSK	TRANSFER RATE	13.5Mbps
INPUT POWER	120Vac, 60Hz	ENVIRONMENTAL CONDITIONS	25 deg.C, 65%RH, 1021hPa
TESTED BY	Brad Wu	TEST MODE	C

CHANNEL	CHANNEL FREQUENCY (MHz)	6dB BANDWIDTH (MHz)		MINIMUM LIMIT (MHz)	PASS / FAIL
		CHAIN 0	CHAIN 1		
151	5755	35.91	36.44	0.5	PASS
159	5795	35.89	36.45	0.5	PASS



A D T

FOR CHAIN 0: CH 151

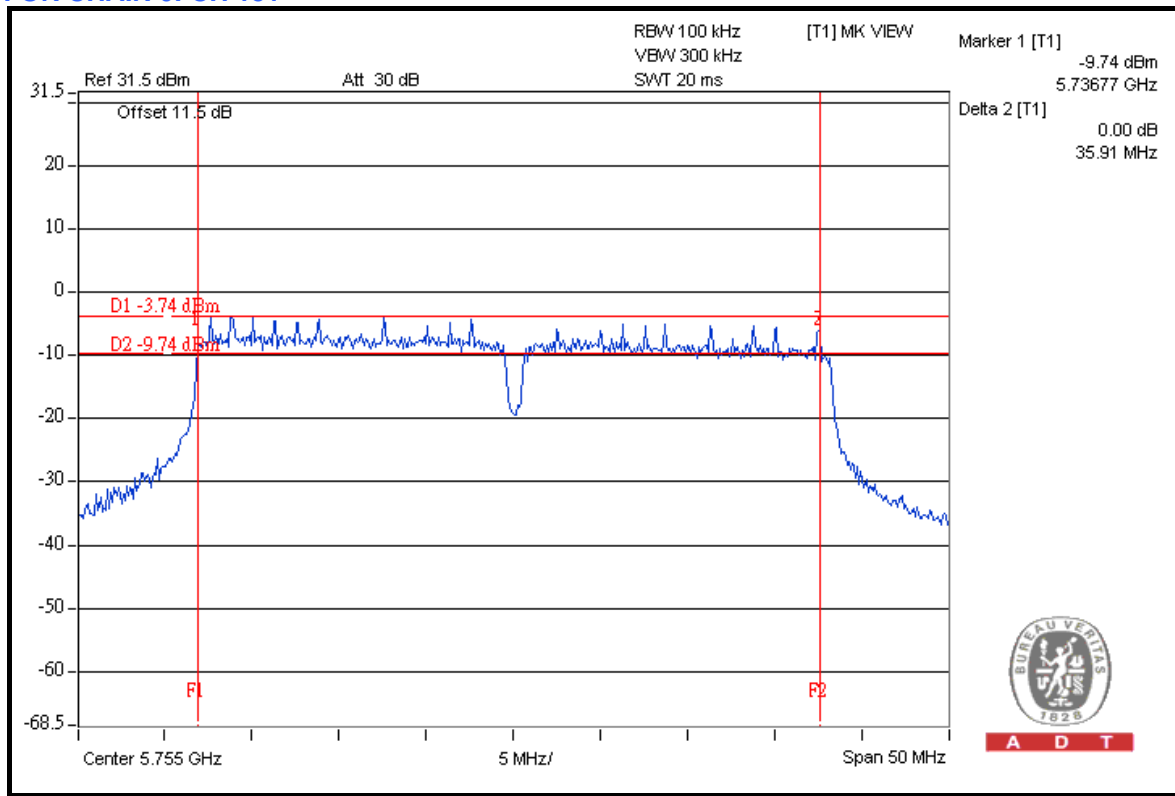

CH 159

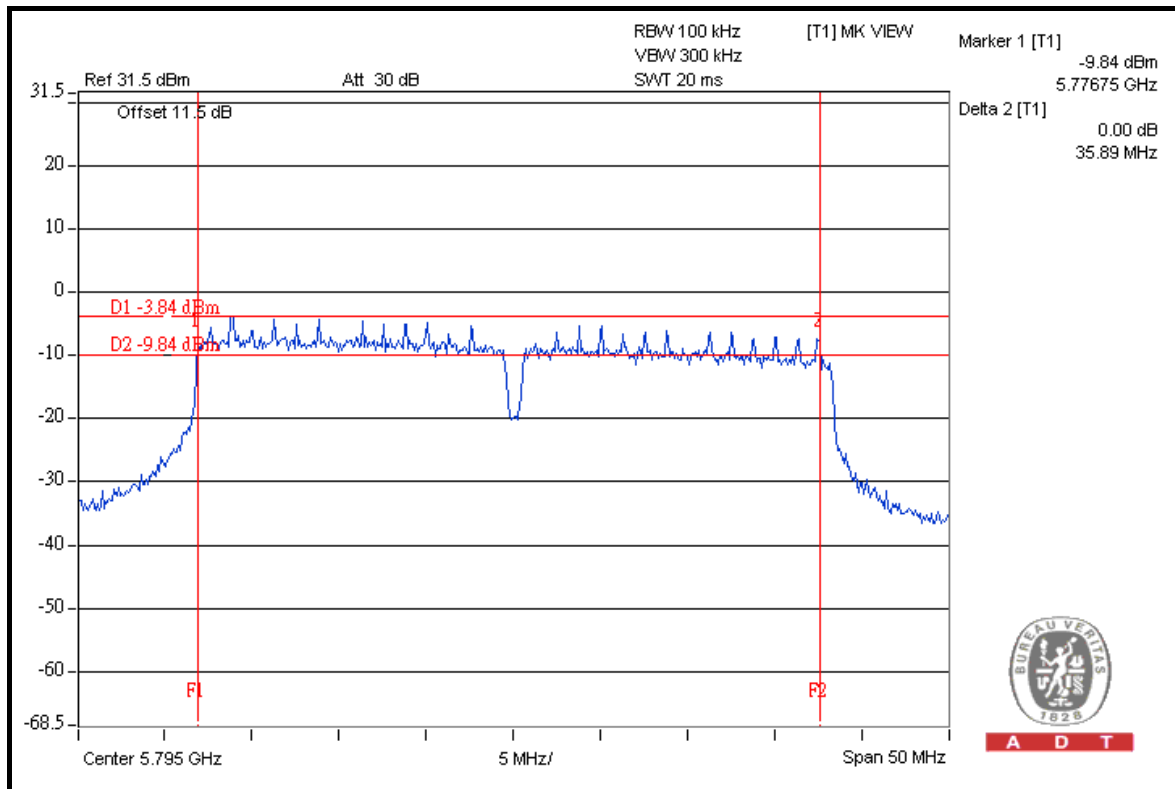



A D T

FOR CHAIN 1: CH 151

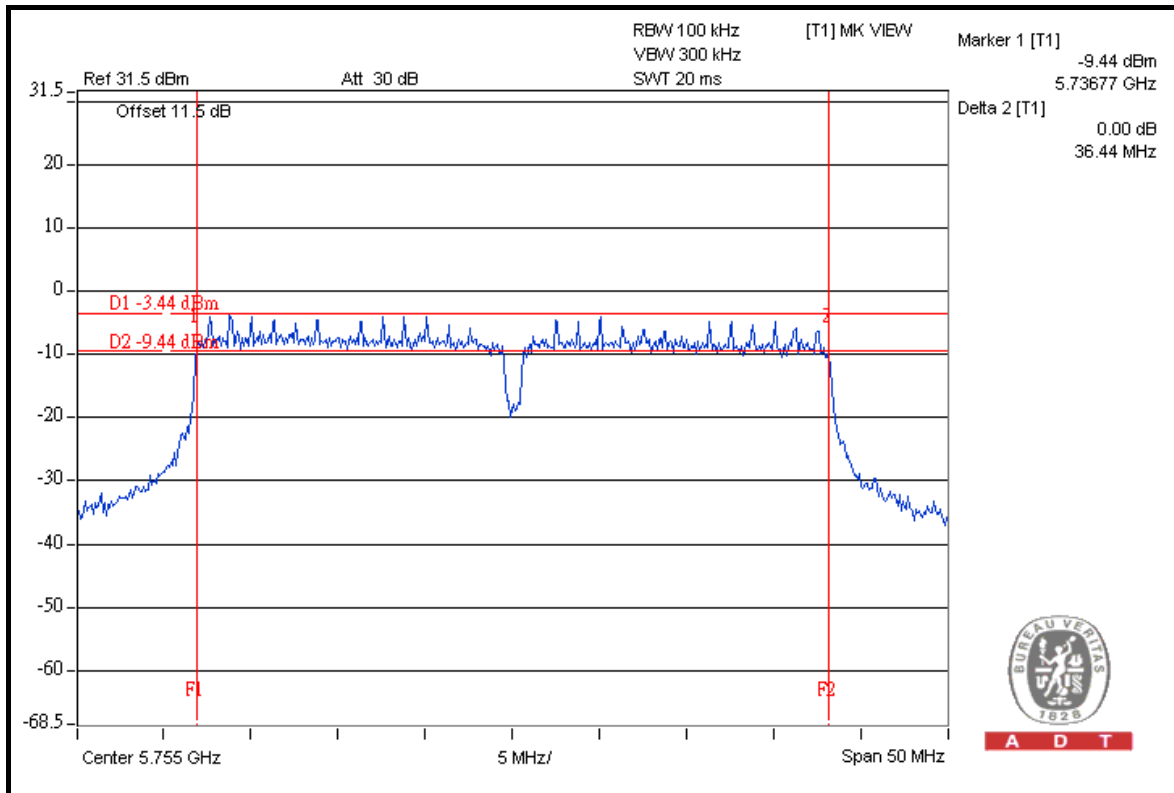

CH 159

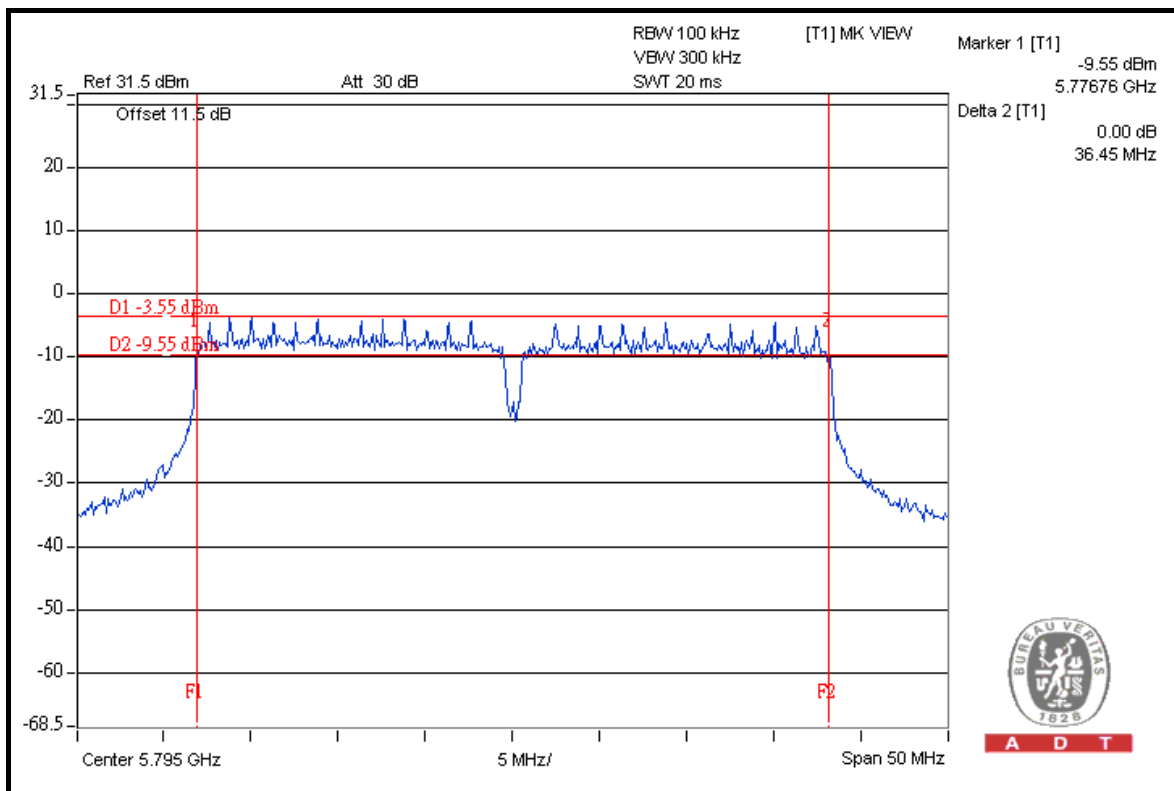



A D T

5.4 MAXIMUM PEAK OUTPUT POWER

5.4.1 LIMITS OF MAXIMUM PEAK OUTPUT POWER MEASUREMENT

The Maximum Peak Output Power Measurement is 30dBm.

5.4.2 INSTRUMENTS

DESCRIPTION & MANUFACTURER	MODEL NO.	SERIAL NO.	DATE OF CALIBRATION	DUE DATE OF CALIBRATION
Spectrum Analyzer Agilent	E4446A	MY44360128	Dec. 12, 2008	Dec.11, 2009

Note: The calibration interval of the above test instruments is 12 months and the calibrations are traceable to NML/ROC and NIST/USA.

5.4.3 TEST PROCEDURES

1. Follow DTS measurement (Power Output Option 2), the transmitter output was connected to the spectrum analyzer through an attenuator, the bandwidth of the fundamental frequency was measured with the spectrum analyzer.
2. Set span to encompass the entire emission bandwidth (EBW) of the signal.
3. Set RBW = 1 MHz ; VBW \geq 3 MHz.
4. Use sample detector mode and video trigger with the trigger level set to enable triggering only on full power pulses.
5. Trace average 100 traces in power averaging mode.
6. Compute power by integrating the spectrum across the 26 dB EBW of the signal.
7. Record the power level.

5.4.4 DEVIATION FROM TEST STANDARD

No deviation.

5.4.5 TEST SETUP

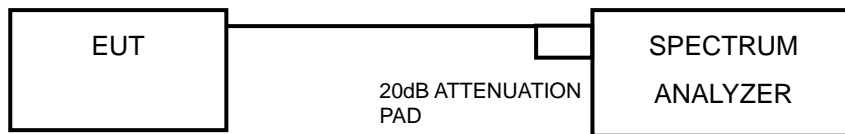

5.4.6 EUT OPERATING CONDITIONS

Same as Item 5.3.6



A D T

5.4.7 TEST RESULTS

802.11a OFDM MODULATION

MODULATION TYPE	BPSK	TRANSFER RATE	6.0Mbps
INPUT POWER	120Vac, 60Hz	ENVIRONMENTAL CONDITIONS	25 deg.C, 65%RH, 1021hPa
TESTED BY	Brad Wu	TEST MODE	A

CHAN.	CHAN. FREQ. (MHz)	PEAK POWER OUTPUT (dBm)			TOTAL PEAK POWER (mW)	TOTAL PEAK POWER (dBm)	PEAK POWER LIMIT (dBm)	PASS / FAIL
		CHAIN 0	CHAIN 1	CHAIN 2				
149	5745	19.01	19.11	19.10	242.369	23.84	30	PASS
157	5785	19.12	19.05	19.10	243.294	23.86	30	PASS
165	5825	19.09	19.08	19.07	242.729	23.85	30	PASS

FOR CHAIN 0: CH 149

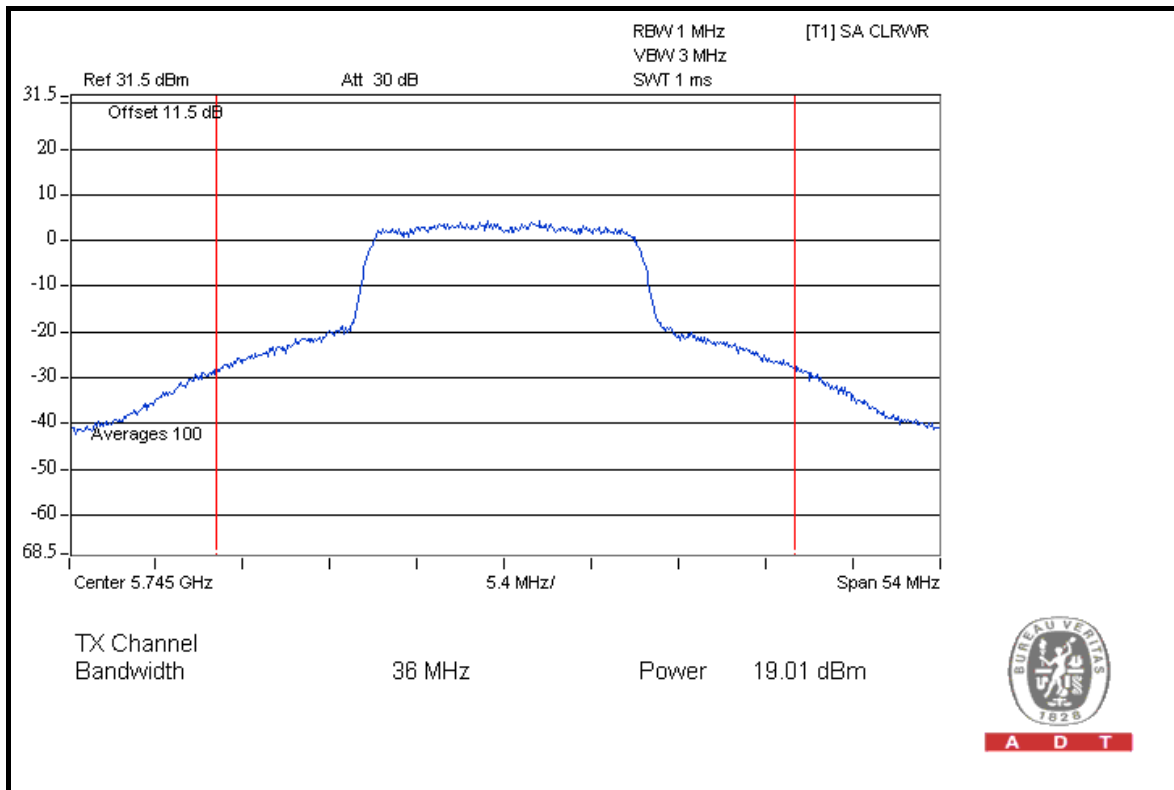

A D T



A D T

CH 157

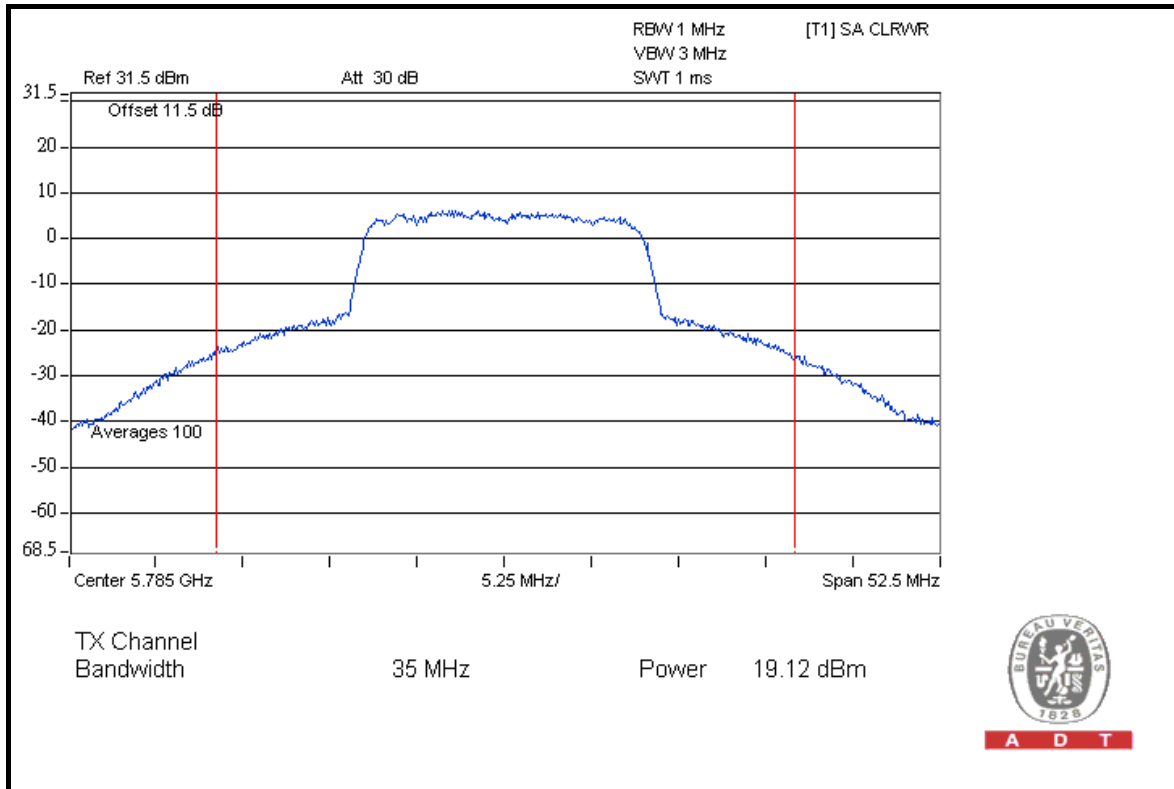

CH 165

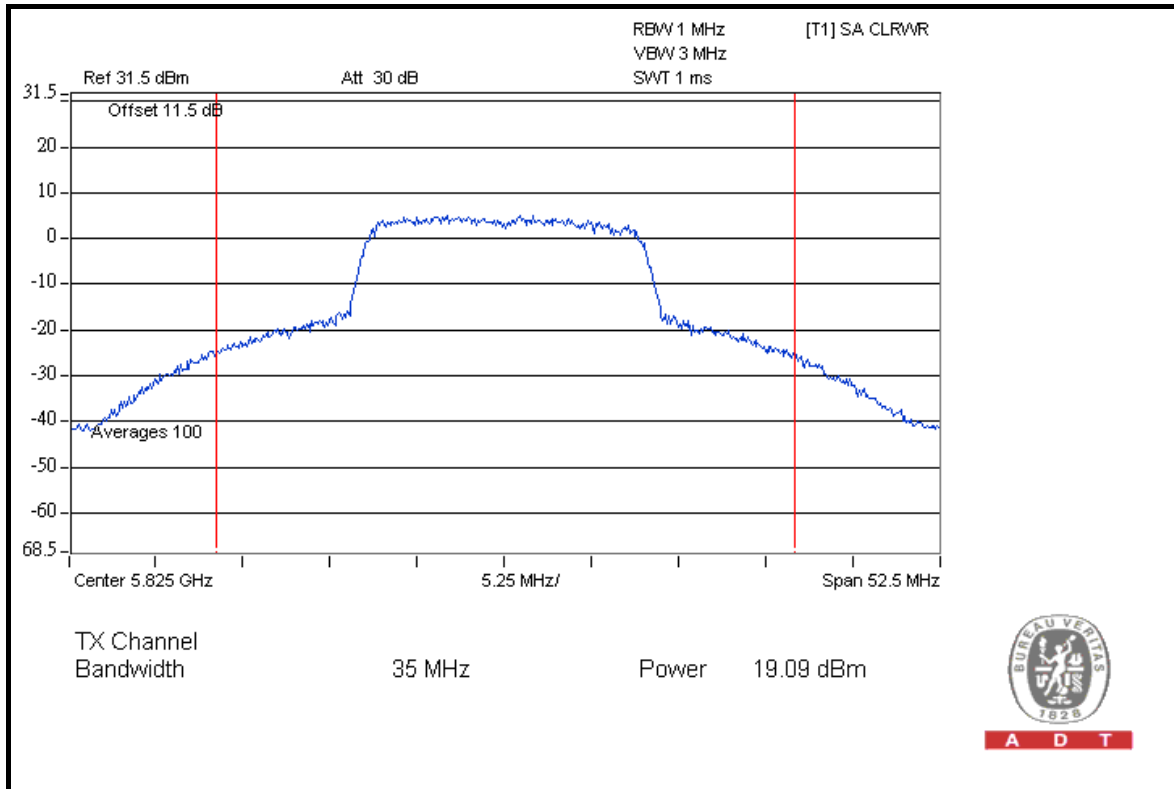



A D T

FOR CHAIN 1: CH 149

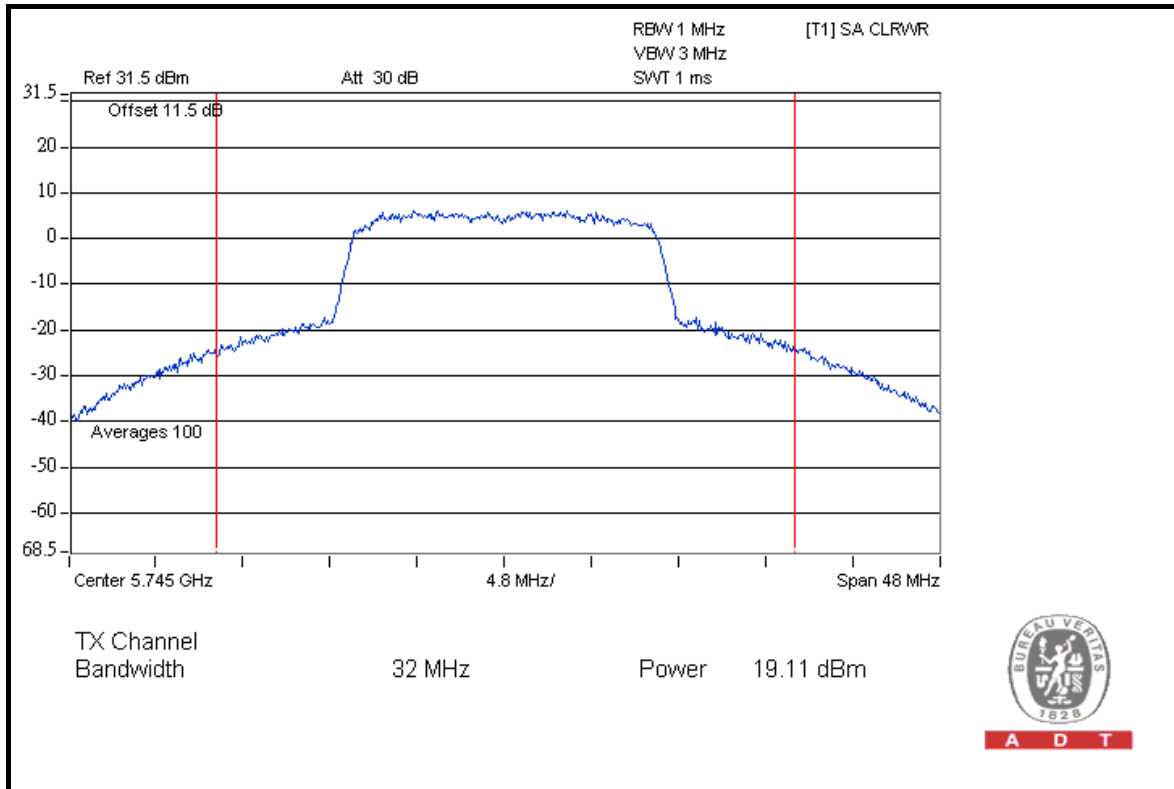

CH 157

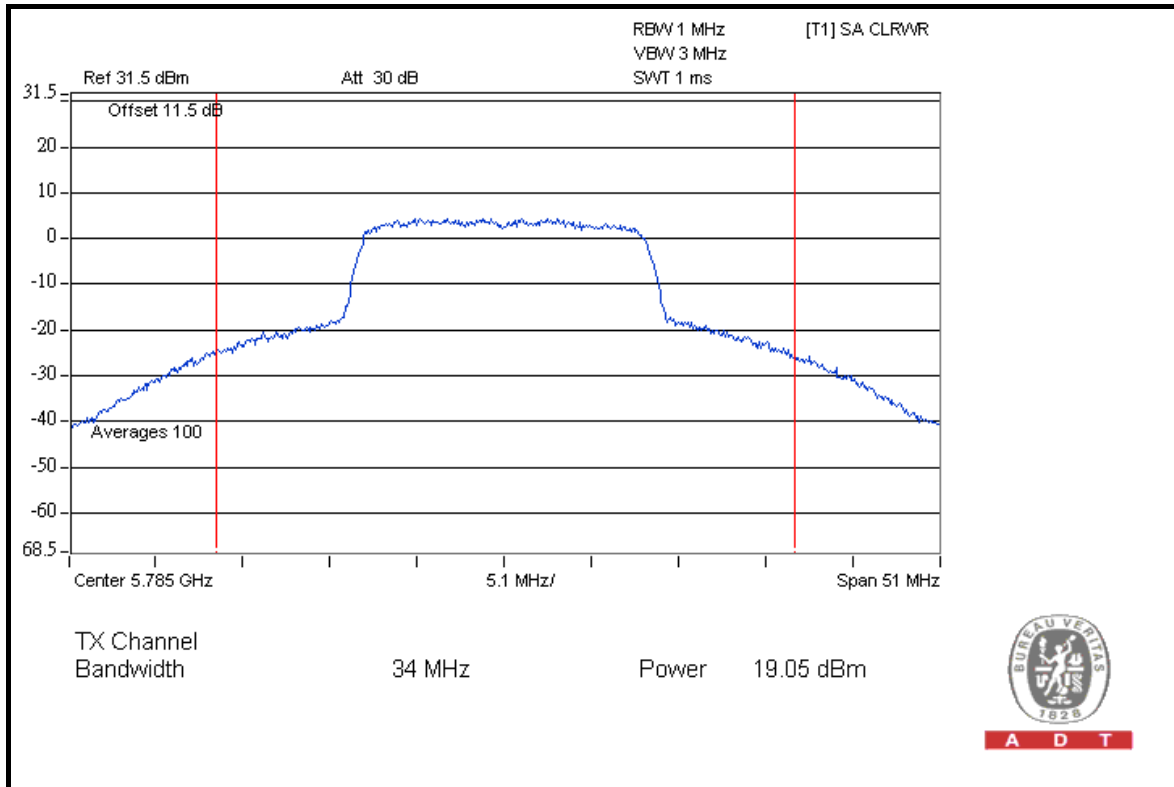



A D T

CH 165

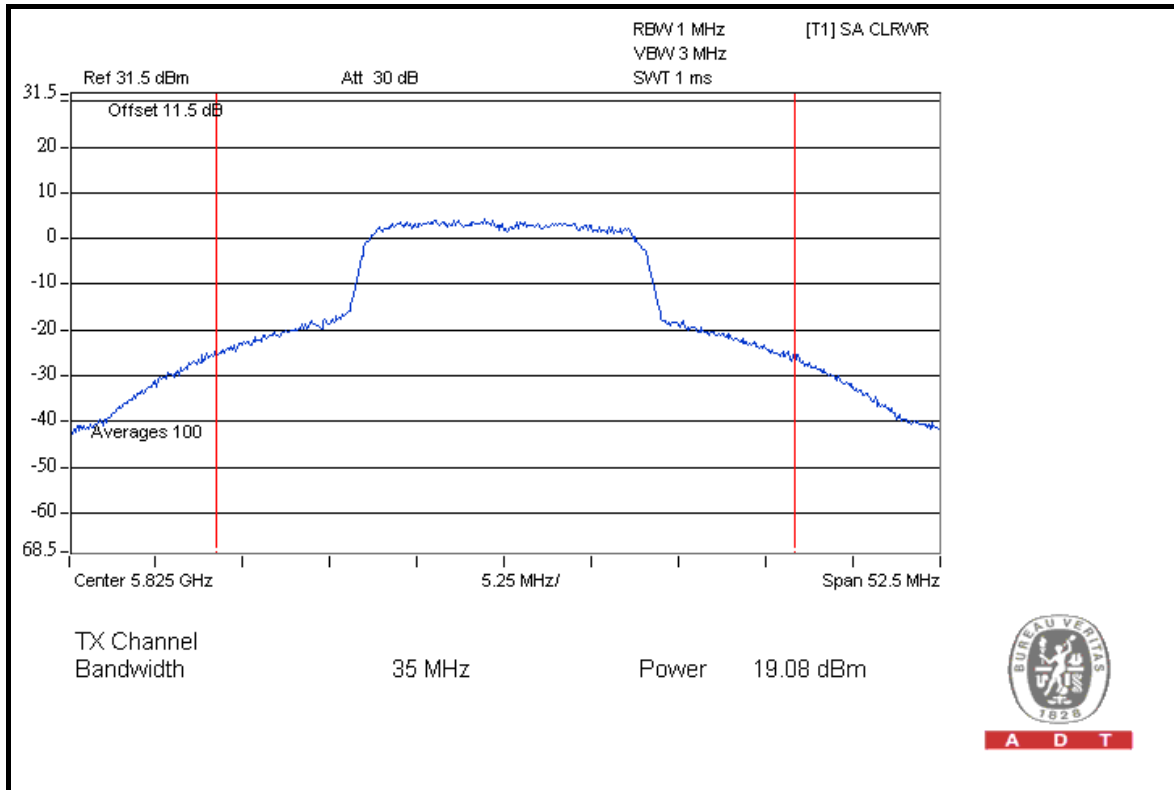

FOR CHAIN 2: CH 149

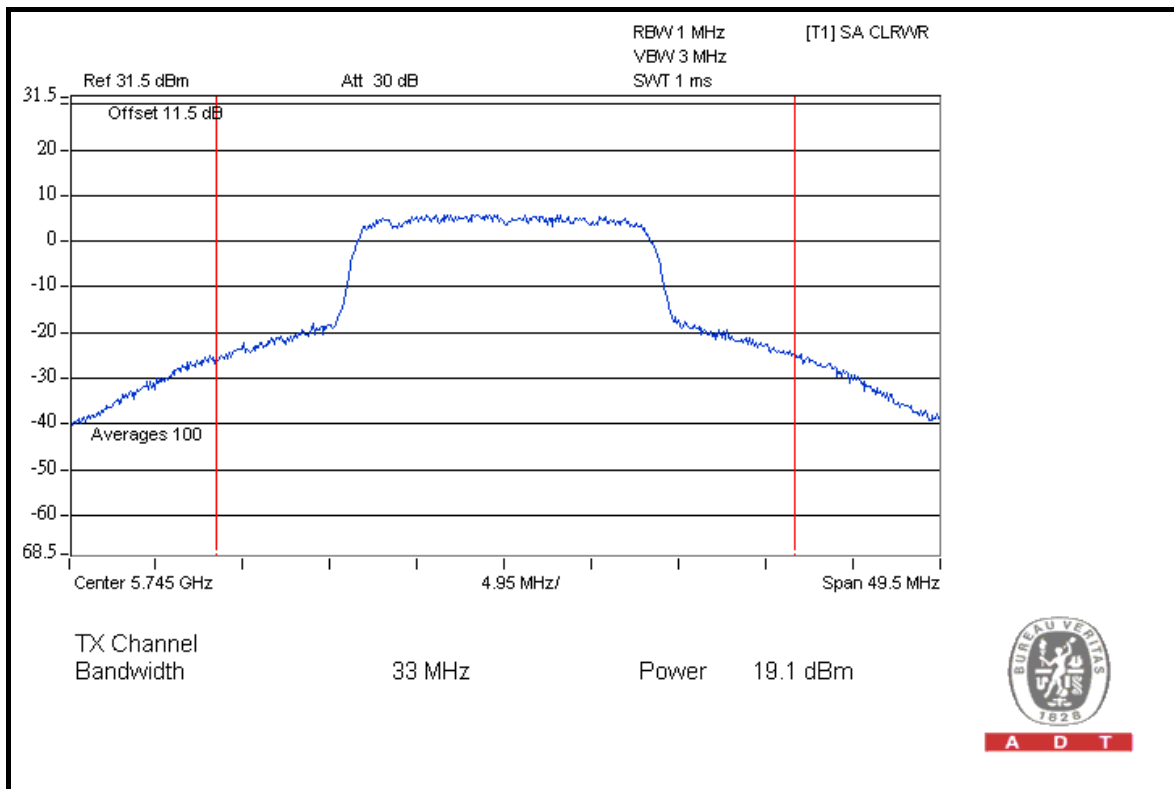



A D T

CH 157

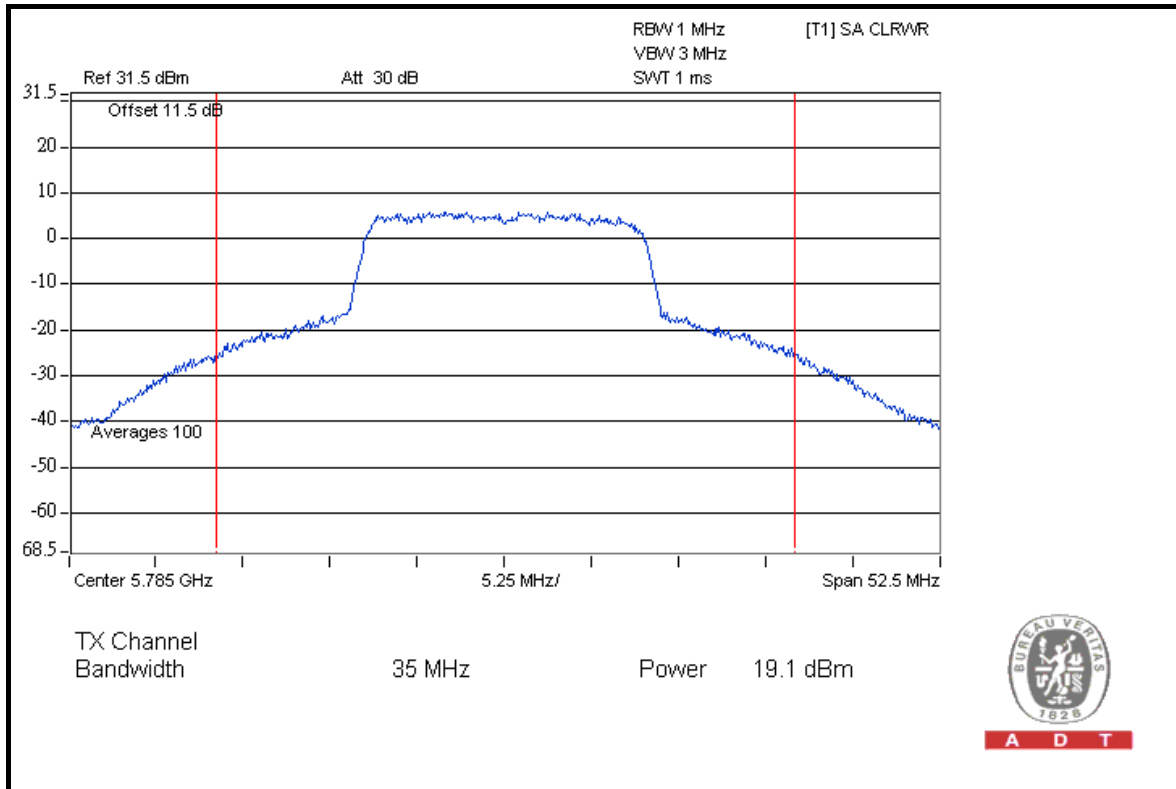

CH 165

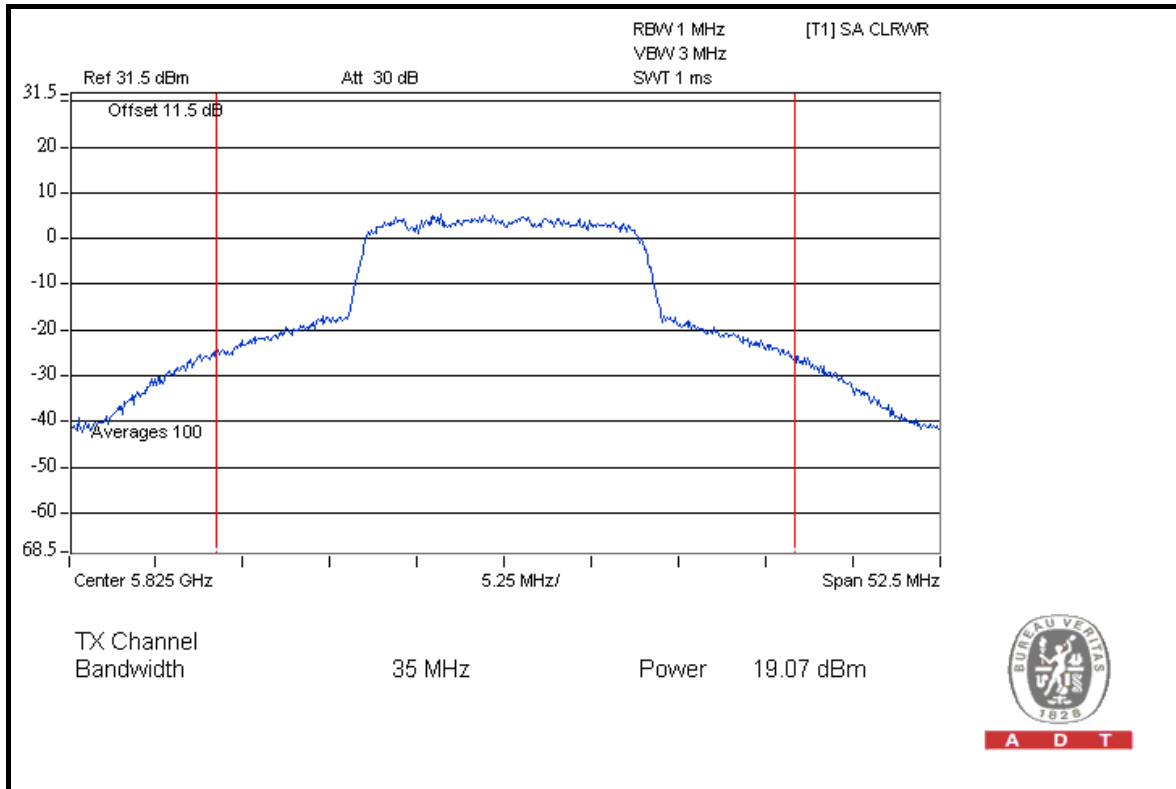



A D T

802.11a OFDM MODULATION

MODULATION TYPE	BPSK	TRANSFER RATE	6.0Mbps
INPUT POWER	120Vac, 60Hz	ENVIRONMENTAL CONDITIONS	25 deg.C, 65%RH, 1021hPa
TESTED BY	Brad Wu	TEST MODE	C

CHAN.	CHAN. FREQ. (MHz)	PEAK POWER OUTPUT (dBm)		TOTAL PEAK POWER (mW)	TOTAL PEAK POWER (dBm)	PEAK POWER LIMIT (dBm)	PASS / FAIL
		CHAIN 0	CHAIN 1				
149	5745	10.02	10.13	20.350	13.09	30	PASS
157	5785	10.05	10.06	20.255	13.07	30	PASS
165	5825	10.07	10.04	20.255	13.07	30	PASS

FOR CHAIN 0: CH 149

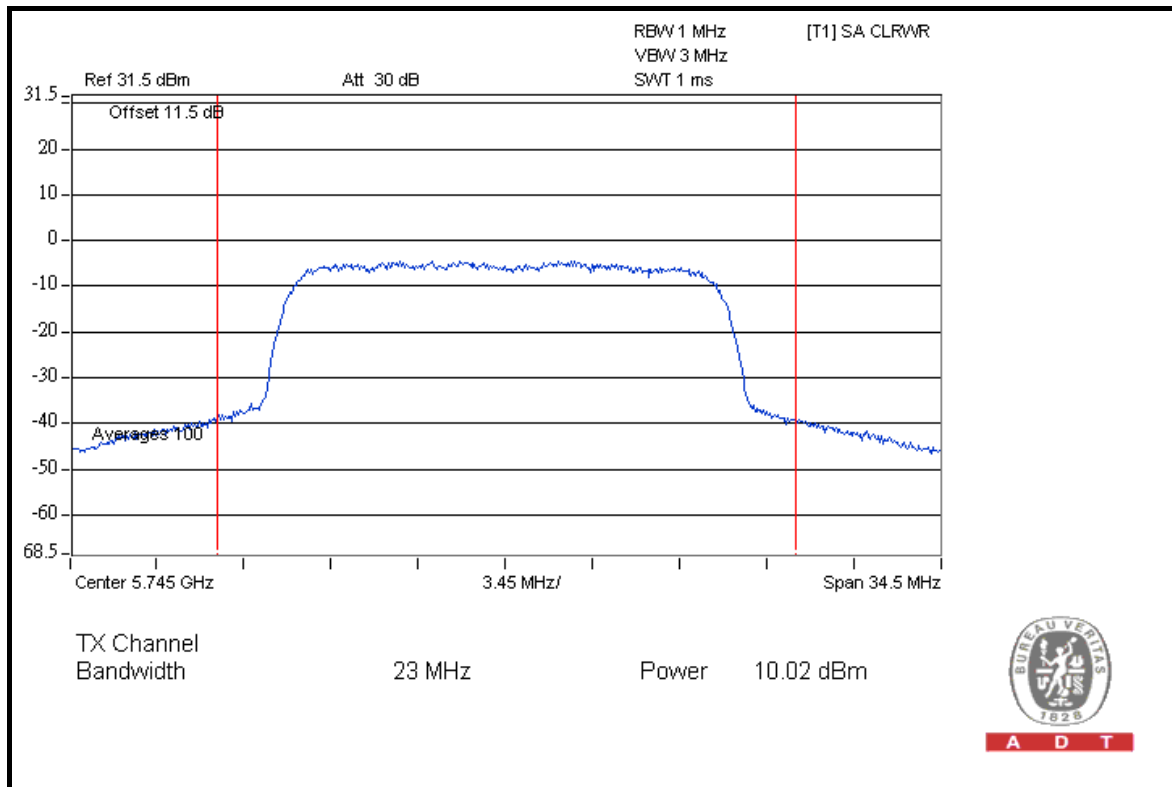

A D T



A D T

CH 157

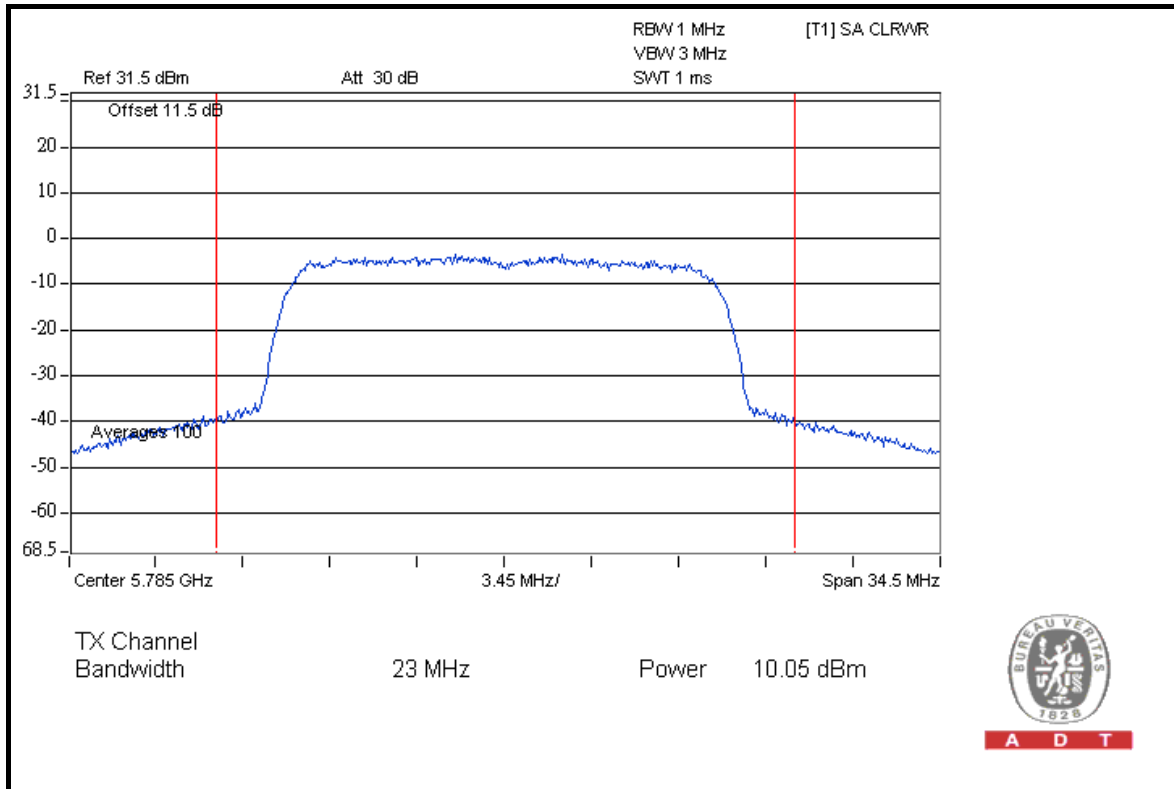

A D T

CH 165

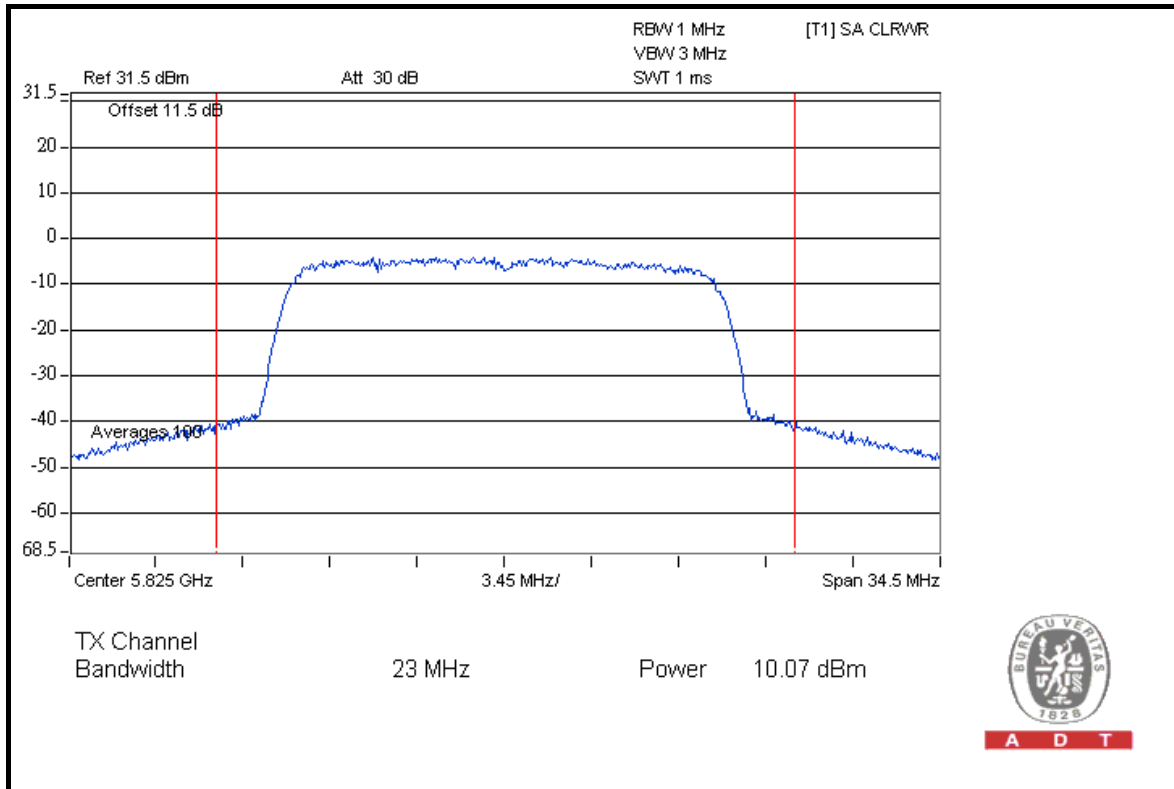

A D T



A D T

FOR CHAIN 1: CH 149

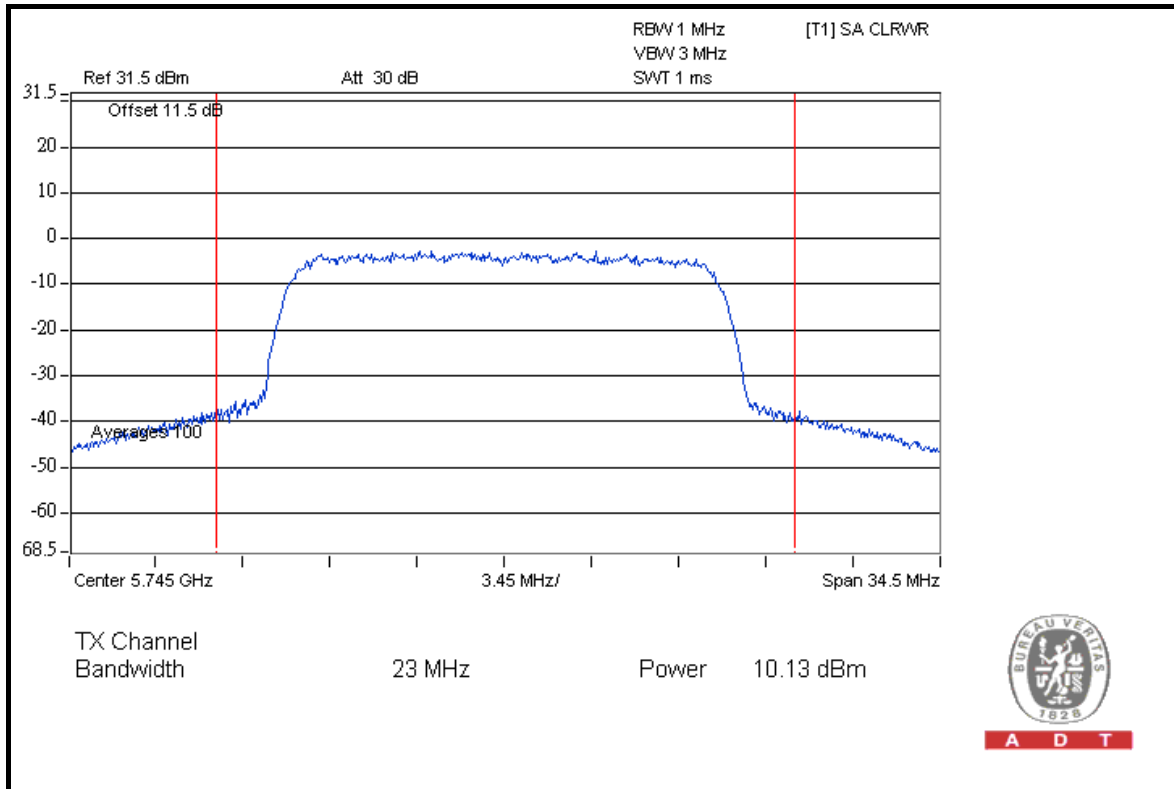

A D T

CH 157

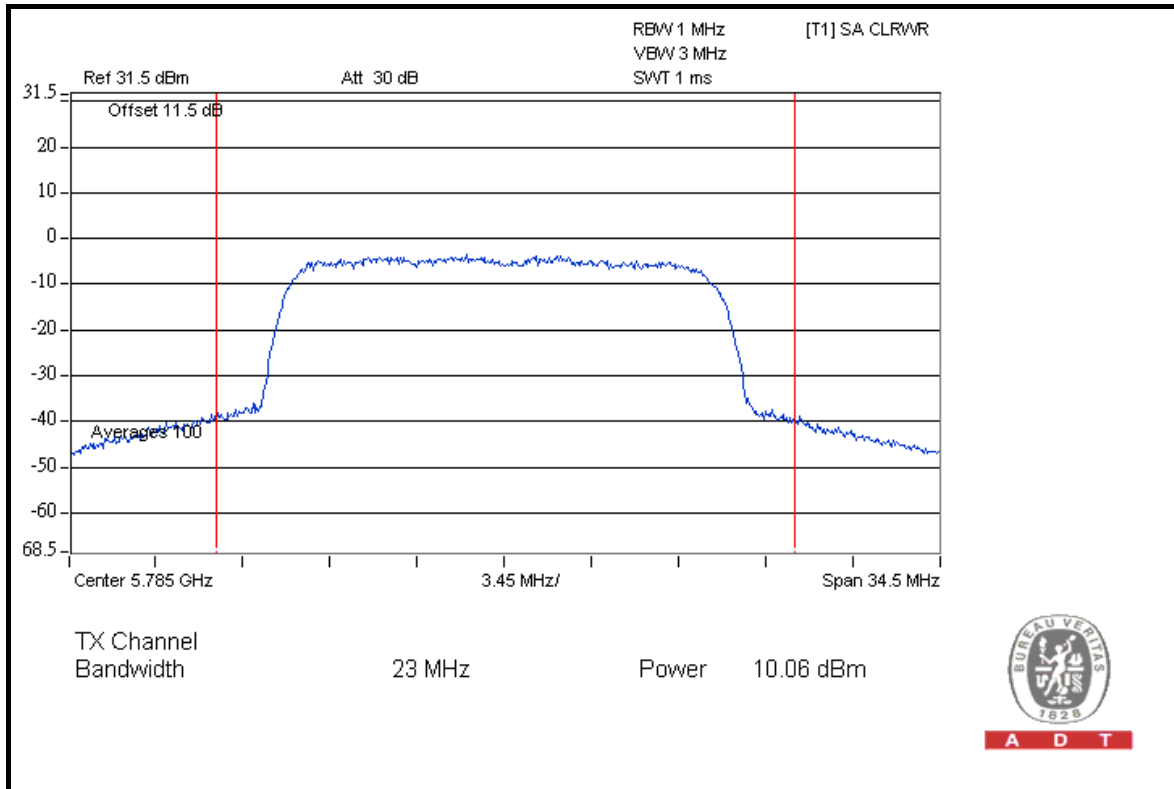

A D T



A D T

CH 165

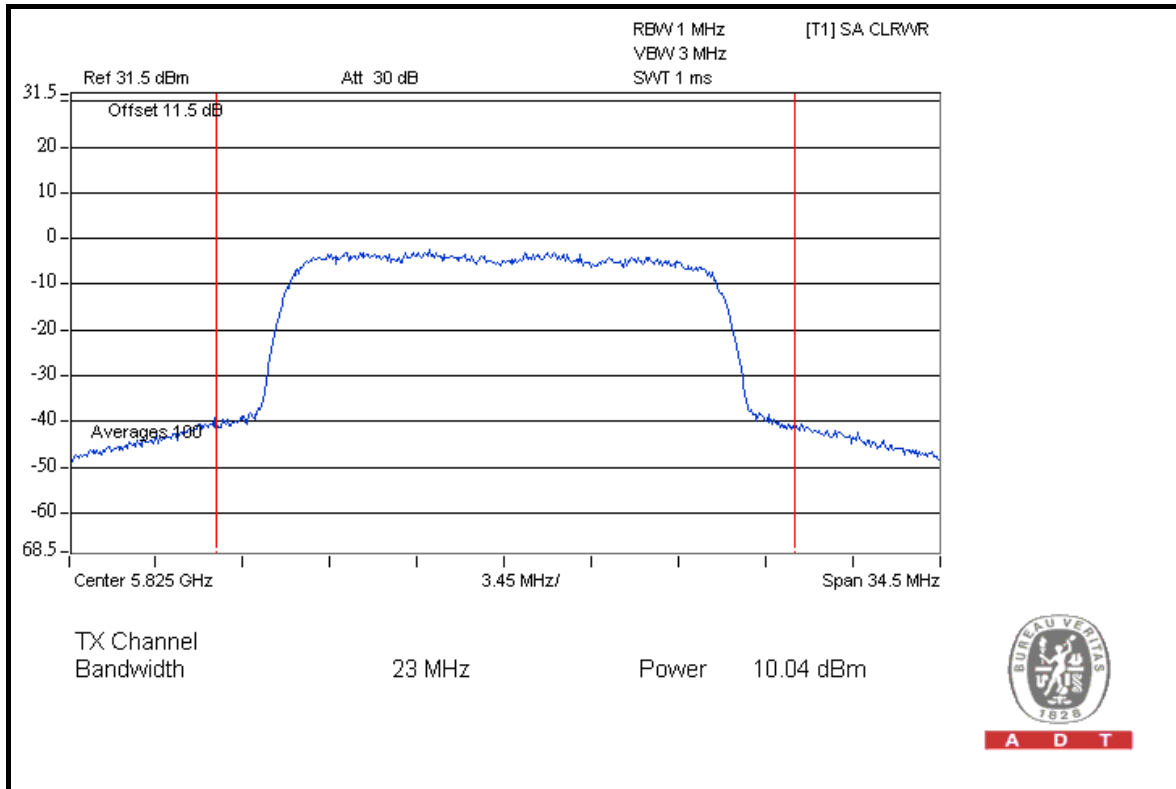

A D T



A D T

DRAFT 802.11n (20MHz) OFDM MODULATION

MODULATION TYPE	BPSK	TRANSFER RATE	6.5Mbps
INPUT POWER	120Vac, 60Hz	ENVIRONMENTAL CONDITIONS	25 deg.C, 65%RH, 1021hPa
TESTED BY	Brad Wu	TEST MODE	A

CHAN.	CHAN. FREQ. (MHz)	PEAK POWER OUTPUT (dBm)			TOTAL PEAK POWER (mW)	TOTAL PEAK POWER (dBm)	PEAK POWER LIMIT (dBm)	PASS / FAIL
		CHAIN 0	CHAIN 1	CHAIN 2				
149	5745	19.09	19.08	19.08	242.915	23.85	30	PASS
157	5785	19.09	19.03	19.10	242.363	23.84	30	PASS
165	5825	19.13	19.08	19.04	242.924	23.85	30	PASS

FOR CHAIN 0: CH 149

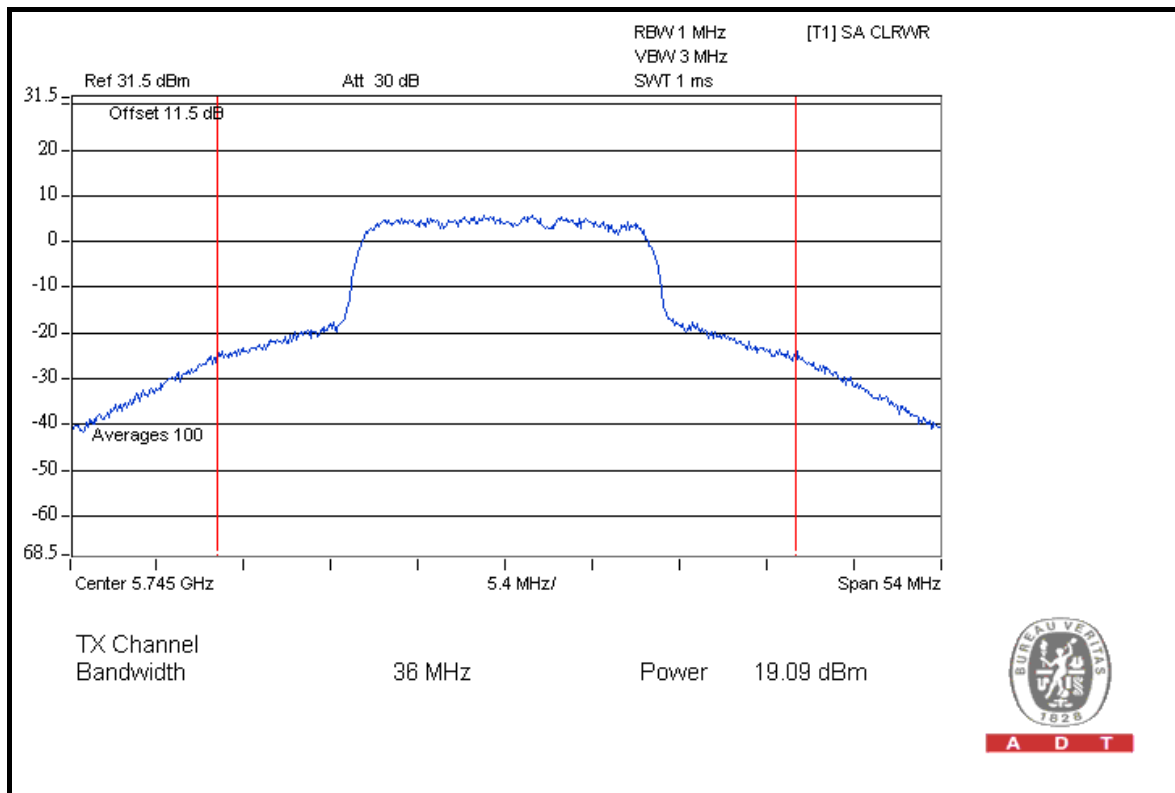

A D T



A D T

CH 157

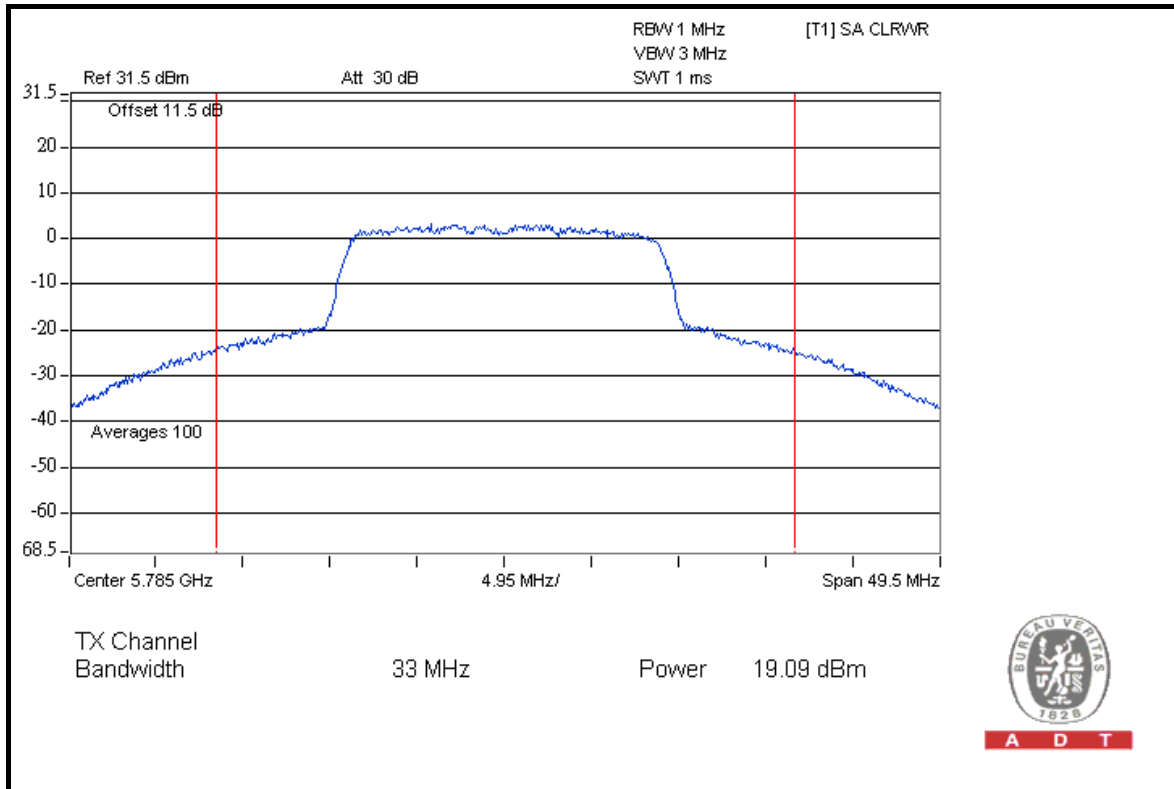

CH 165

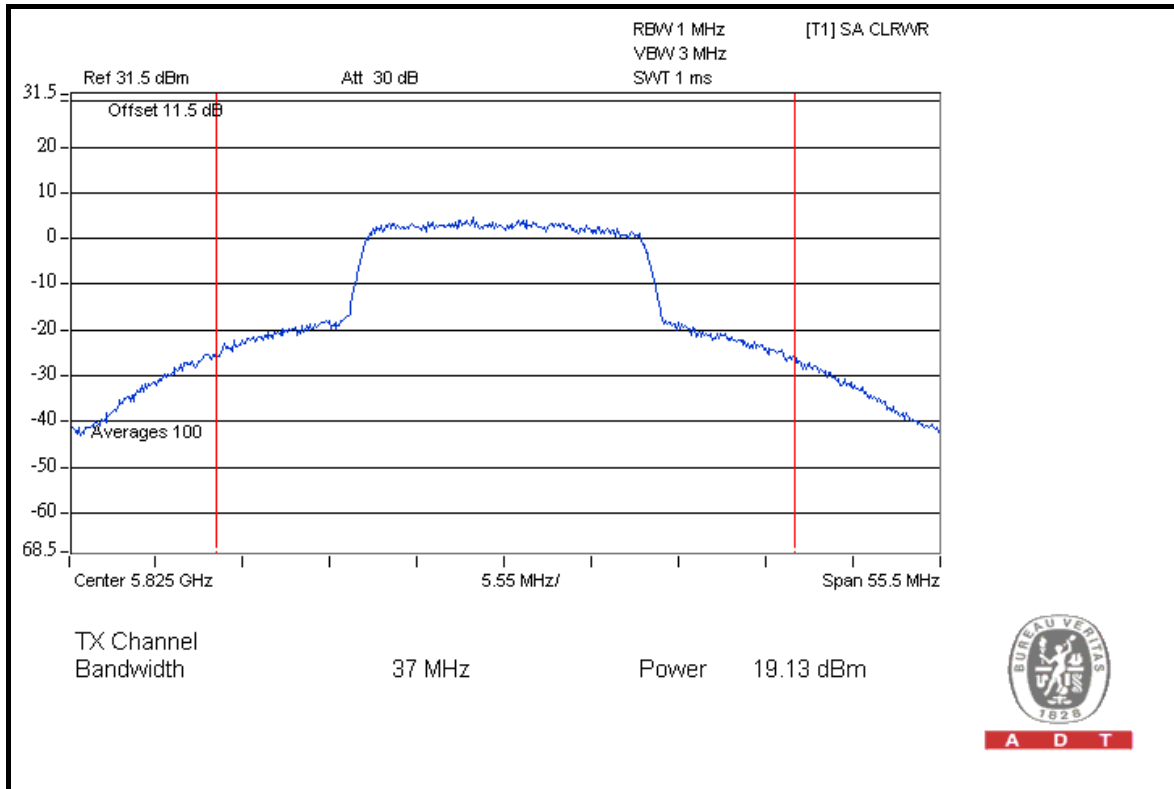



A D T

FOR CHAIN 1: CH 149

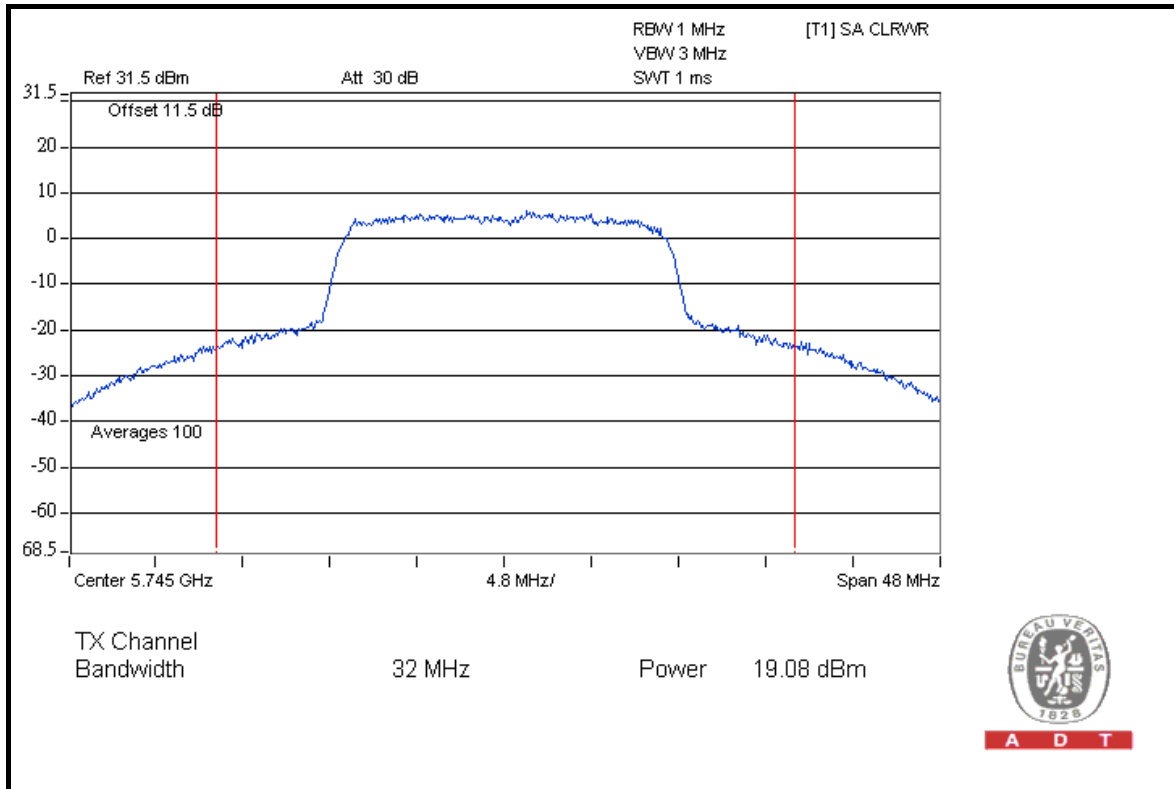

CH 157

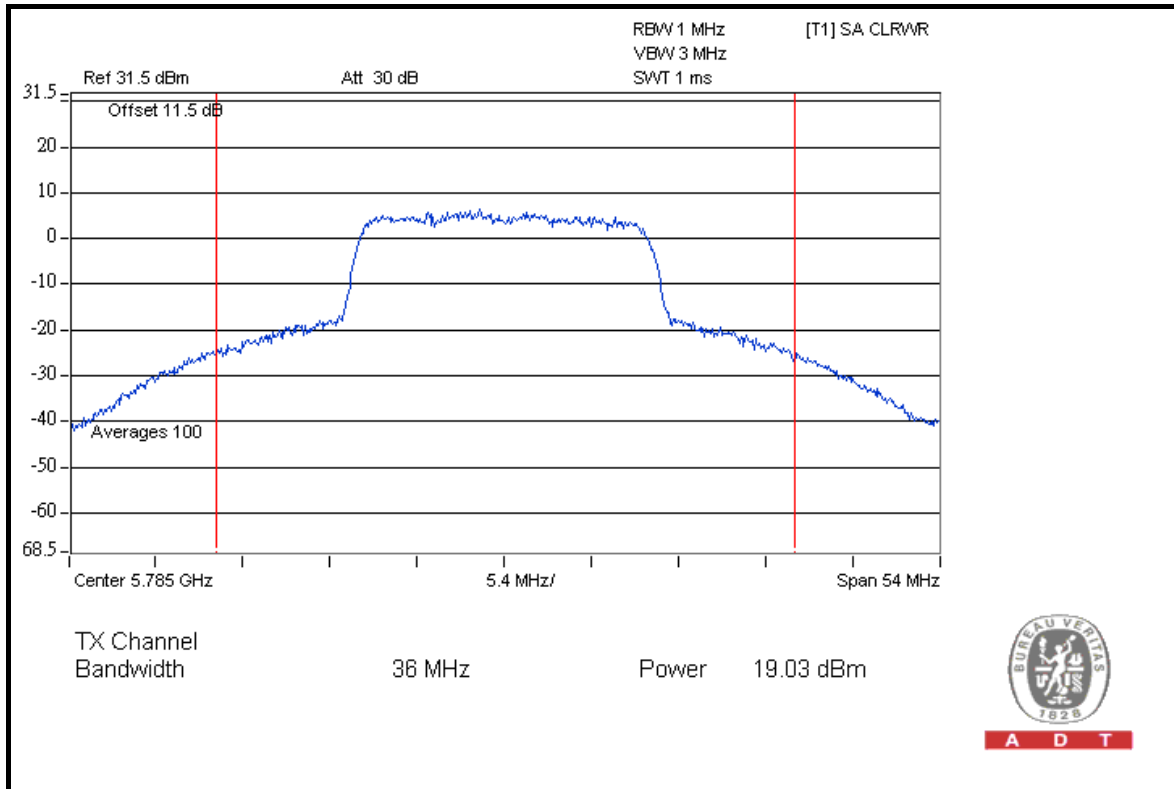



A D T

CH 165

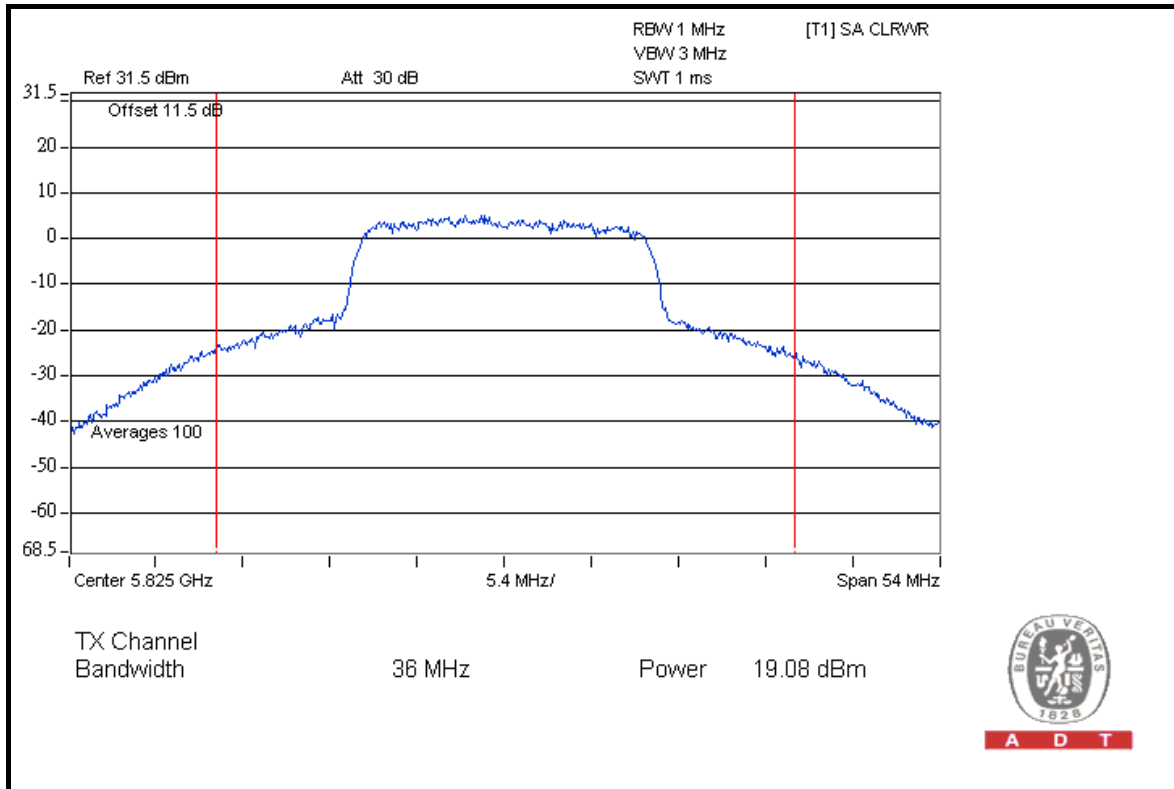

FOR CHAIN 2: CH 149

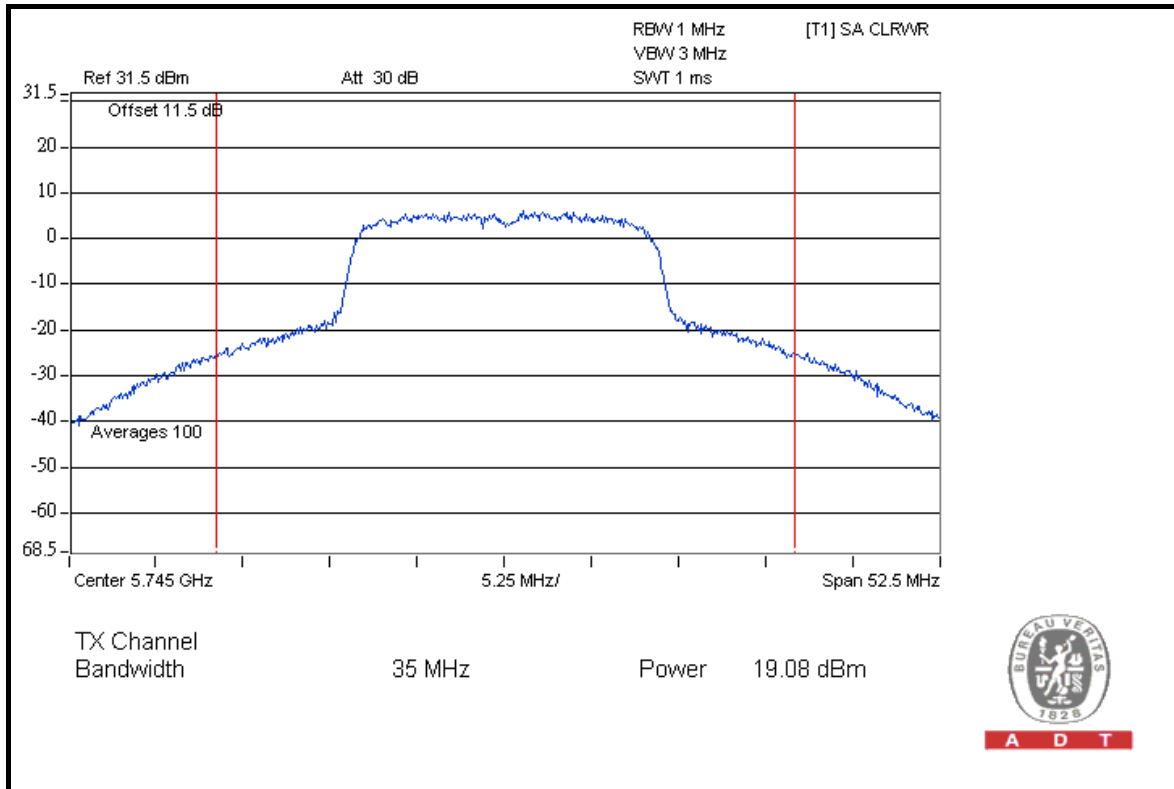



A D T

CH 157

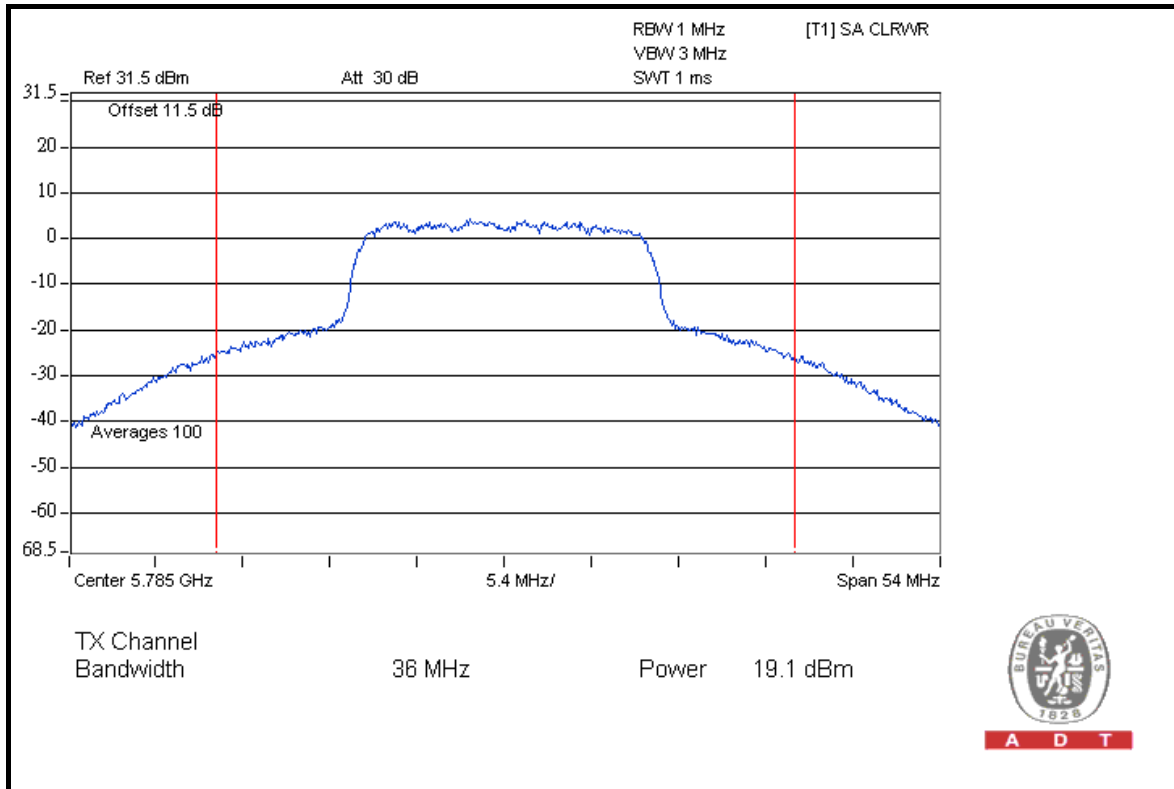

CH 165

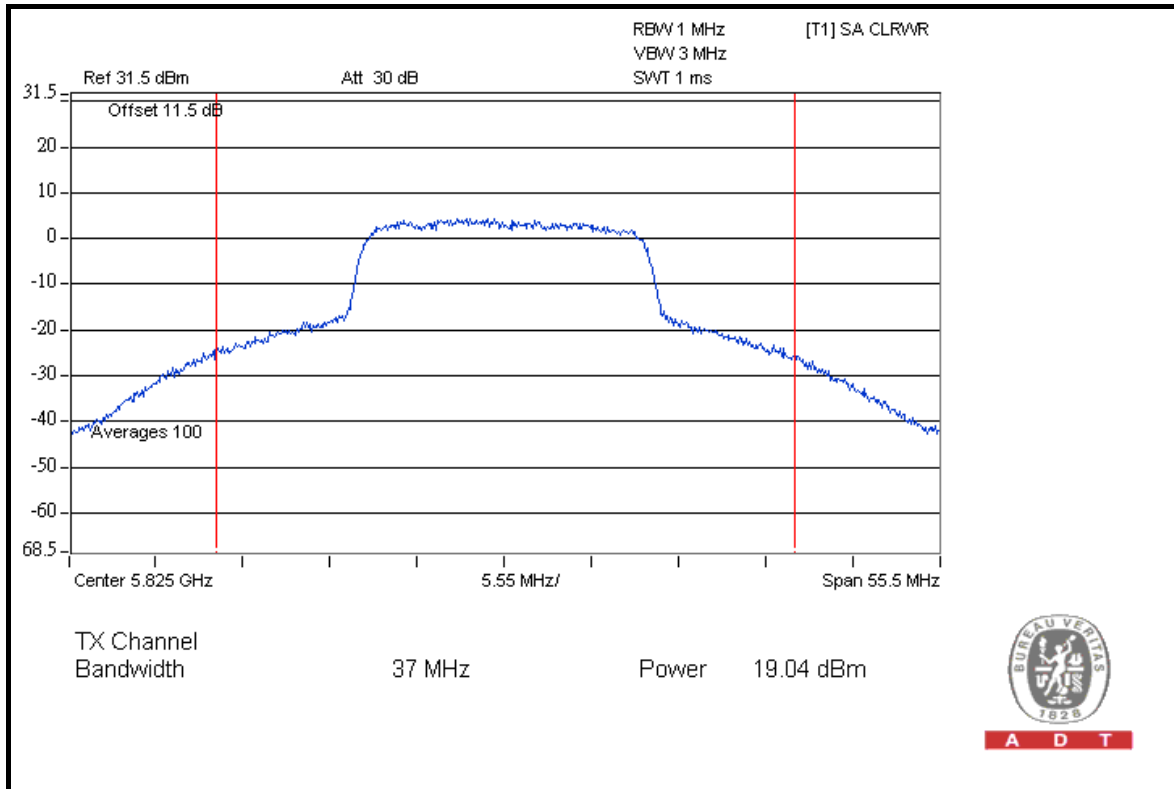



A D T

DRAFT 802.11n (20MHz) OFDM MODULATION

MODULATION TYPE	BPSK	TRANSFER RATE	6.5Mbps
INPUT POWER	120Vac, 60Hz	ENVIRONMENTAL CONDITIONS	25 deg.C, 65%RH, 1021hPa
TESTED BY	Brad Wu	TEST MODE	C

CHAN.	CHAN. FREQ. (MHz)	PEAK POWER OUTPUT (dBm)		TOTAL PEAK POWER (mW)	TOTAL PEAK POWER (dBm)	PEAK POWER LIMIT (dBm)	PASS / FAIL
		CHAIN 0	CHAIN 1				
149	5745	10.13	10.14	20.631	13.15	30	PASS
157	5785	10.08	10.08	20.372	13.09	30	PASS
165	5825	10.13	10.08	20.490	13.12	30	PASS

FOR CHAIN 0: CH 149

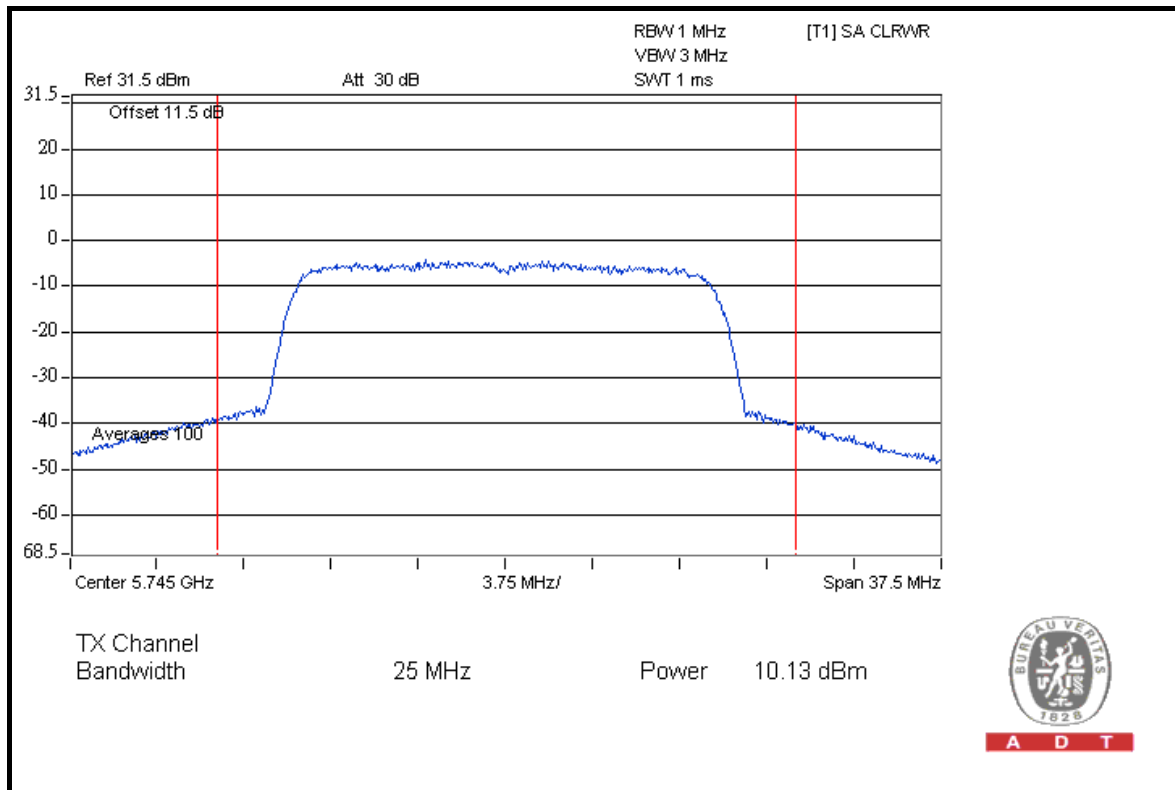

A D T



A D T

CH 157

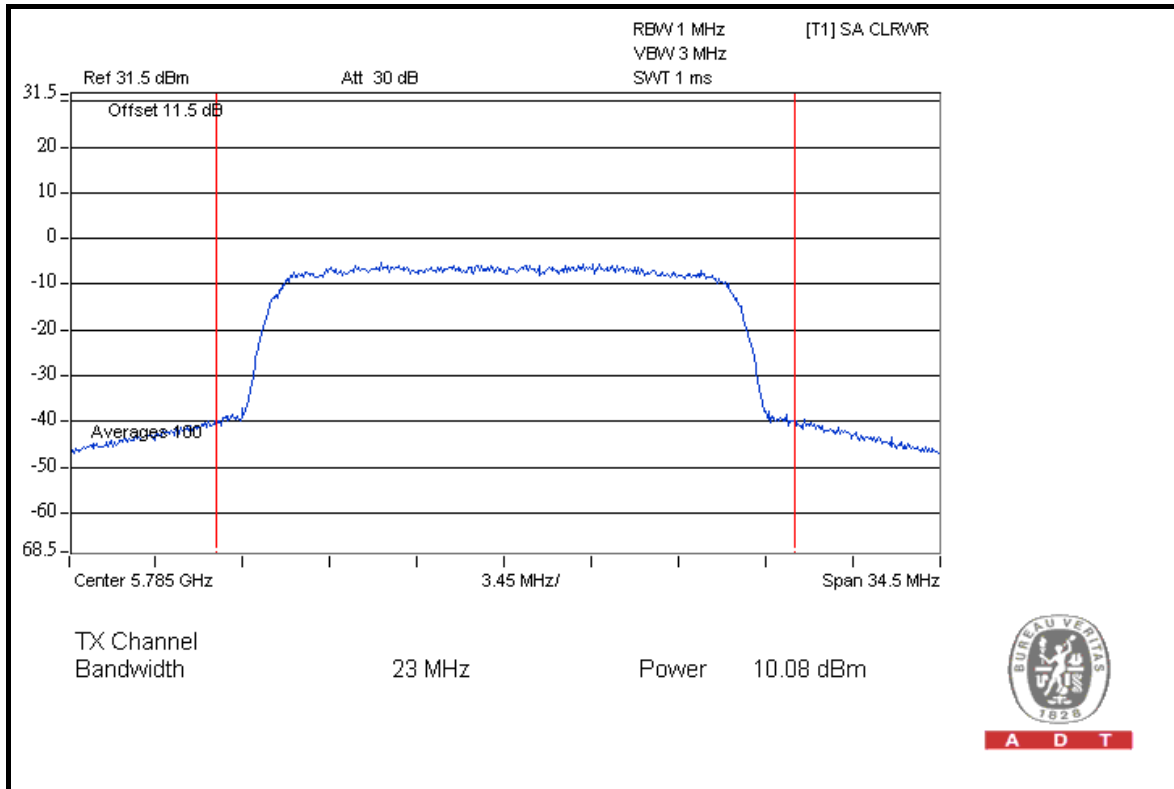

CH 165

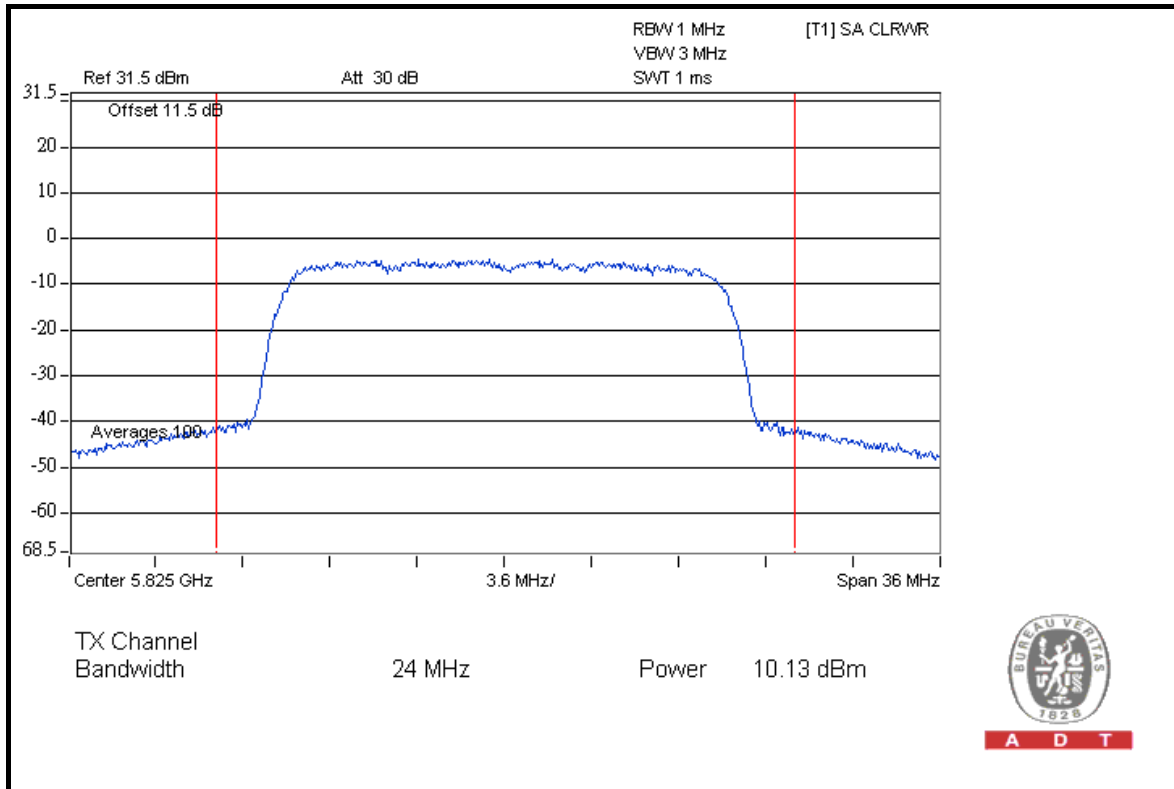



A D T

FOR CHAIN 1: CH 149

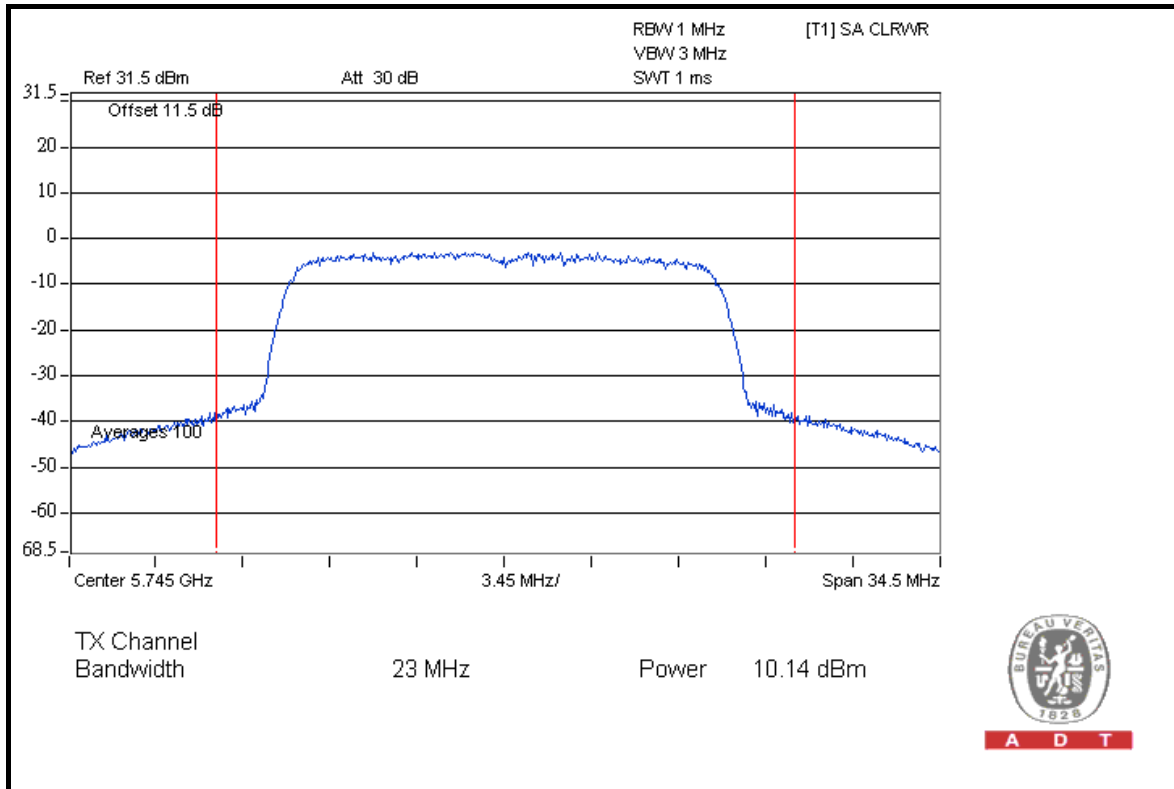

A D T

CH 157

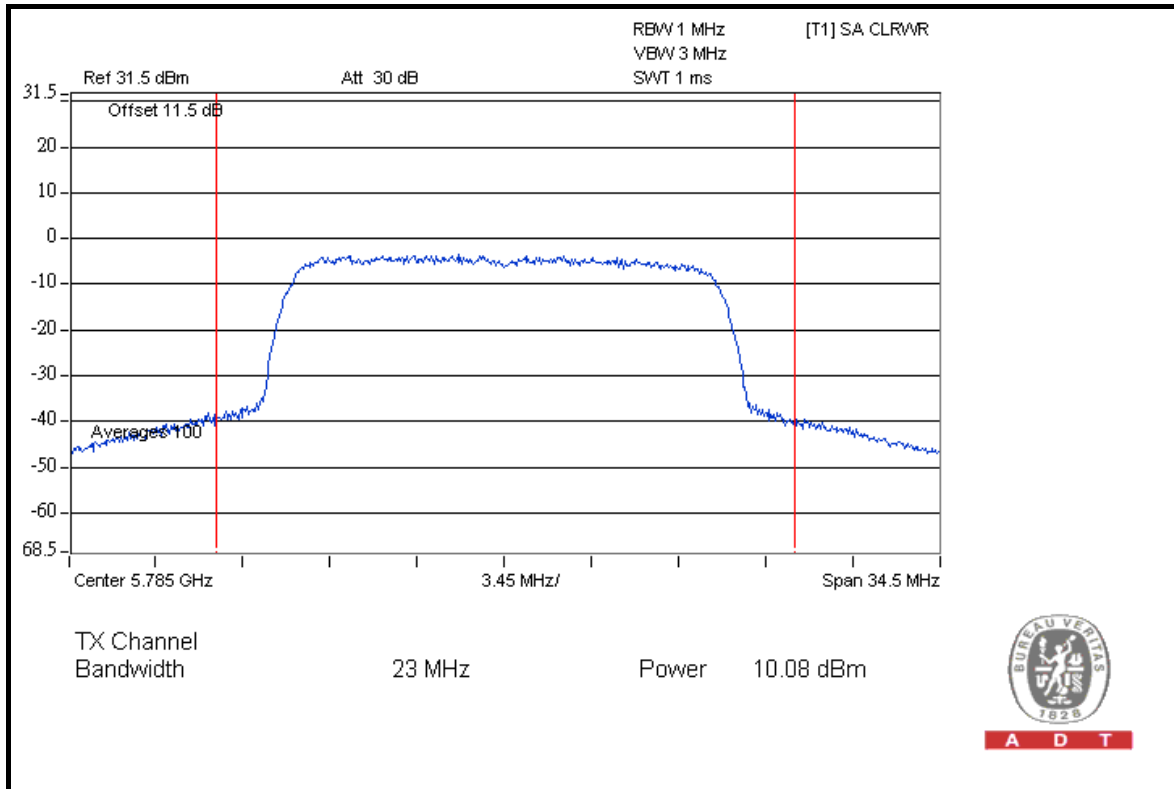

A D T



A D T

CH 165

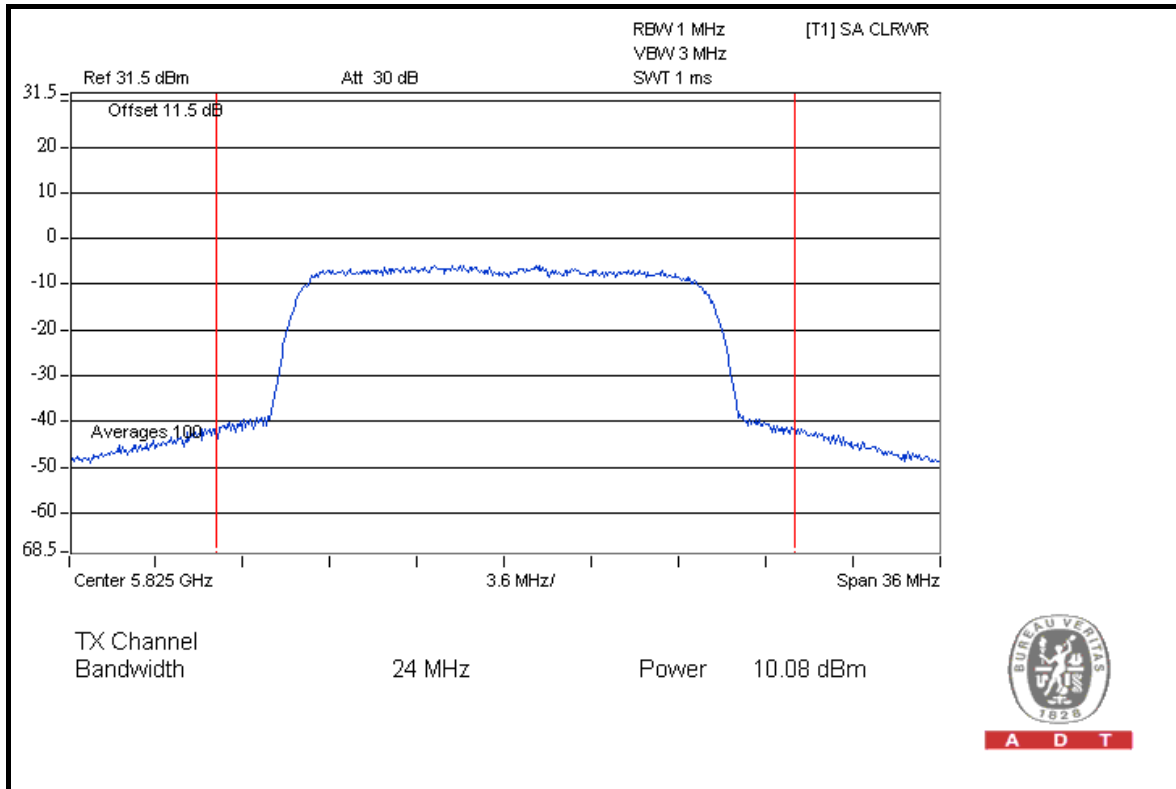

A D T



A D T

DRAFT 802.11n (40MHz) OFDM MODULATION

MODULATION TYPE	BPSK	TRANSFER RATE	13.5Mbps
INPUT POWER	120Vac, 60Hz	ENVIRONMENTAL CONDITIONS	25 deg.C, 65%RH, 1021hPa
TESTED BY	Brad Wu	TEST MODE	A

CHAN.	CHAN. FREQ. (MHz)	PEAK POWER OUTPUT (dBm)			TOTAL PEAK POWER (mW)	TOTAL PEAK POWER (dBm)	PEAK POWER LIMIT (dBm)	PASS / FAIL
		CHAIN 0	CHAIN 1	CHAIN 2				
151	5755	19.11	19.11	19.05	243.293	23.86	30	PASS
159	5795	19.14	19.01	19.02	241.451	23.83	30	PASS



A D T

FOR CHAIN 0: CH 151

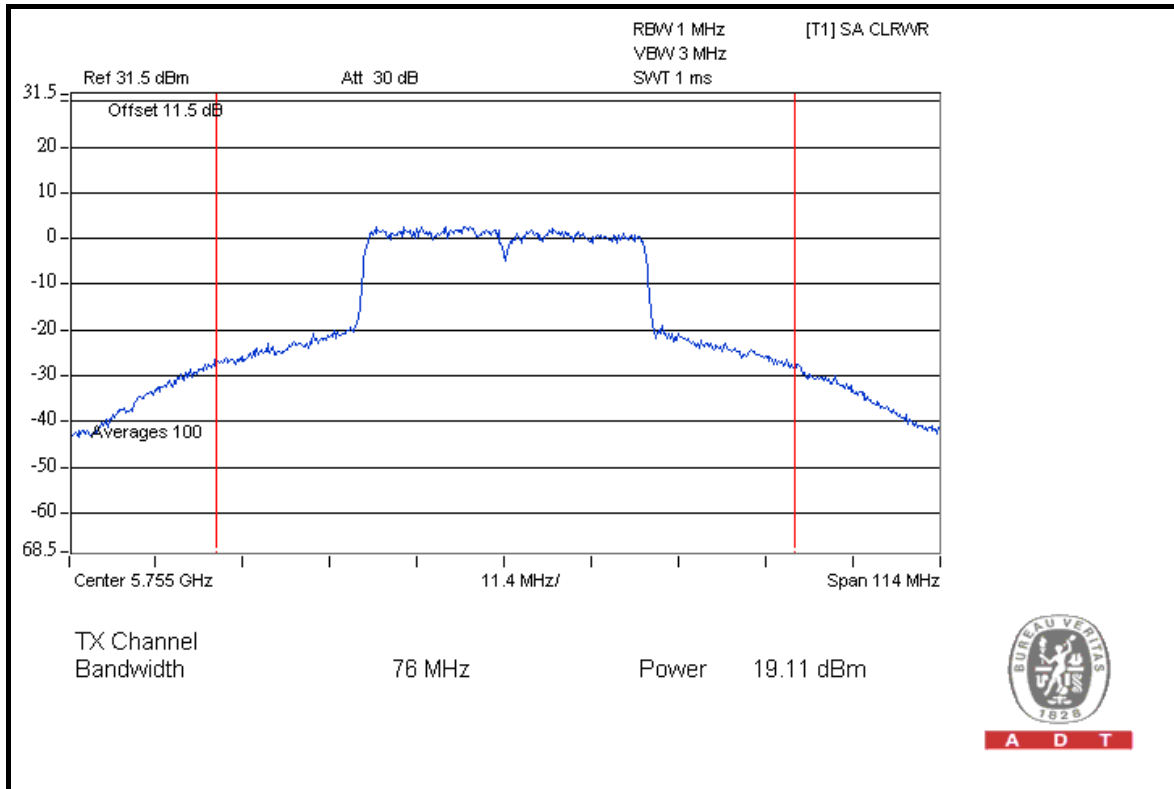

A D T

CH 159

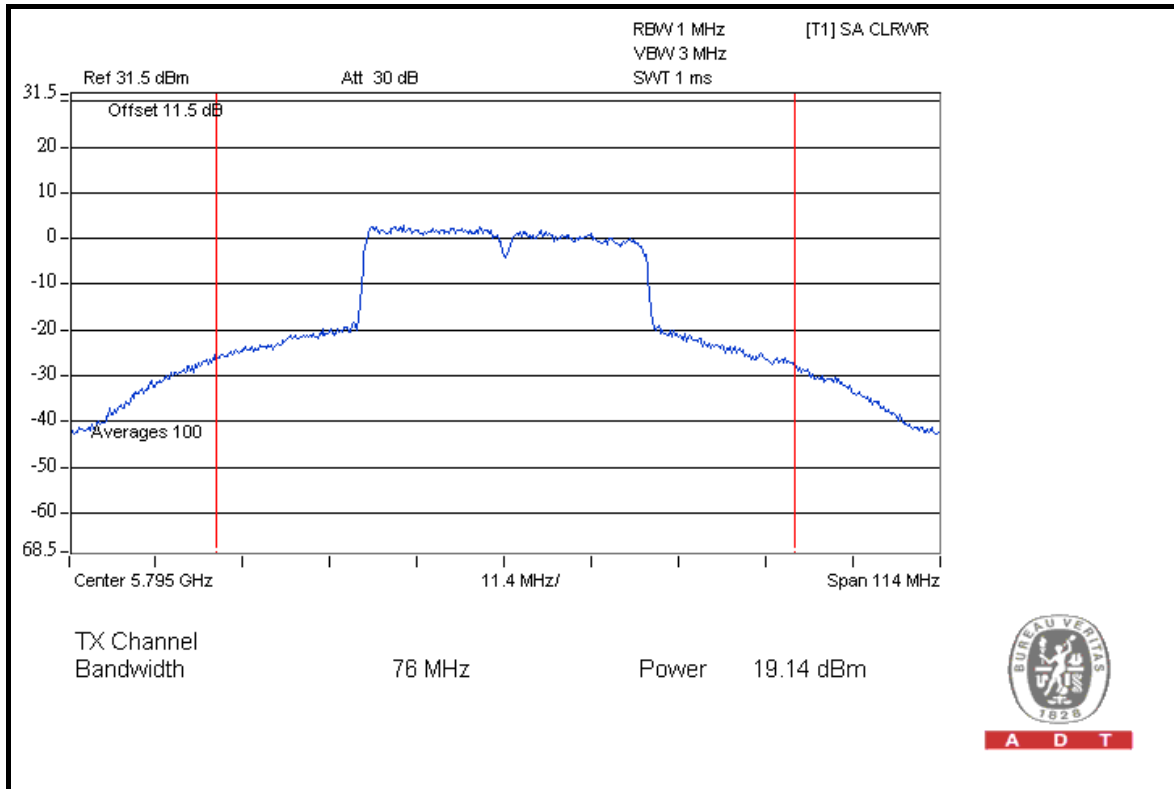

A D T



A D T

FOR CHAIN 1: CH 151

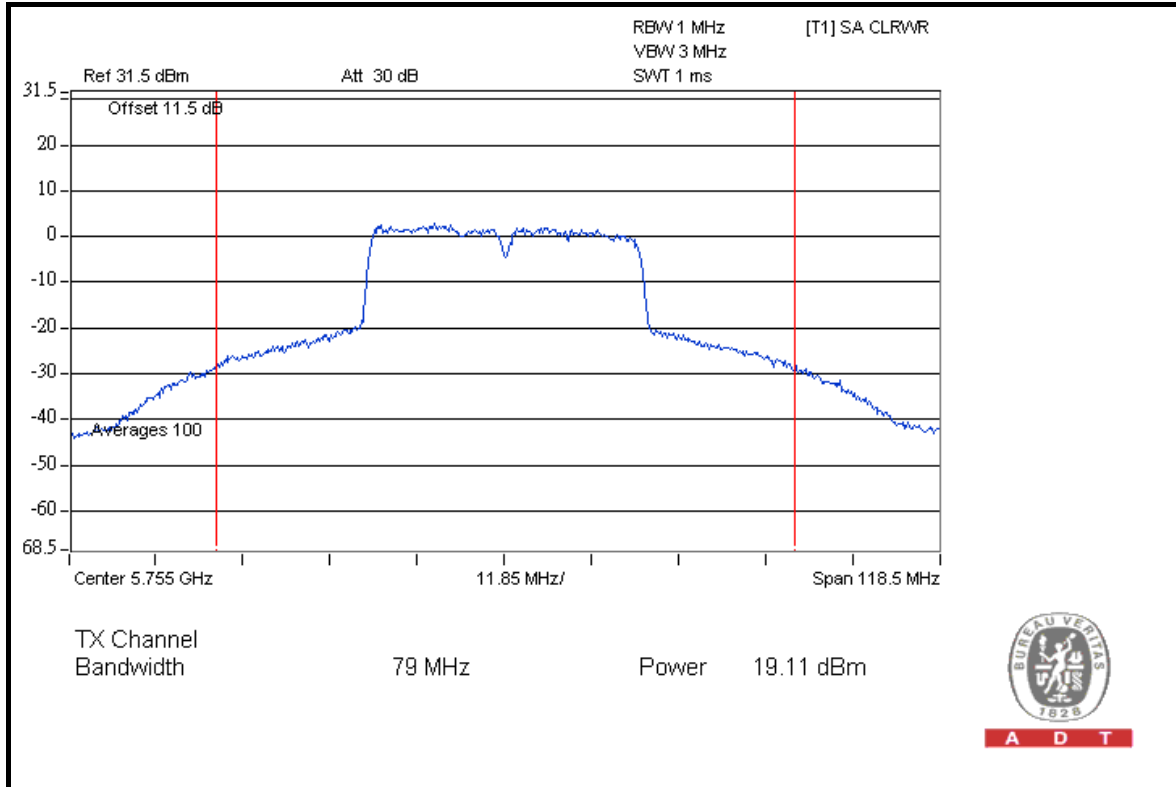

CH 159

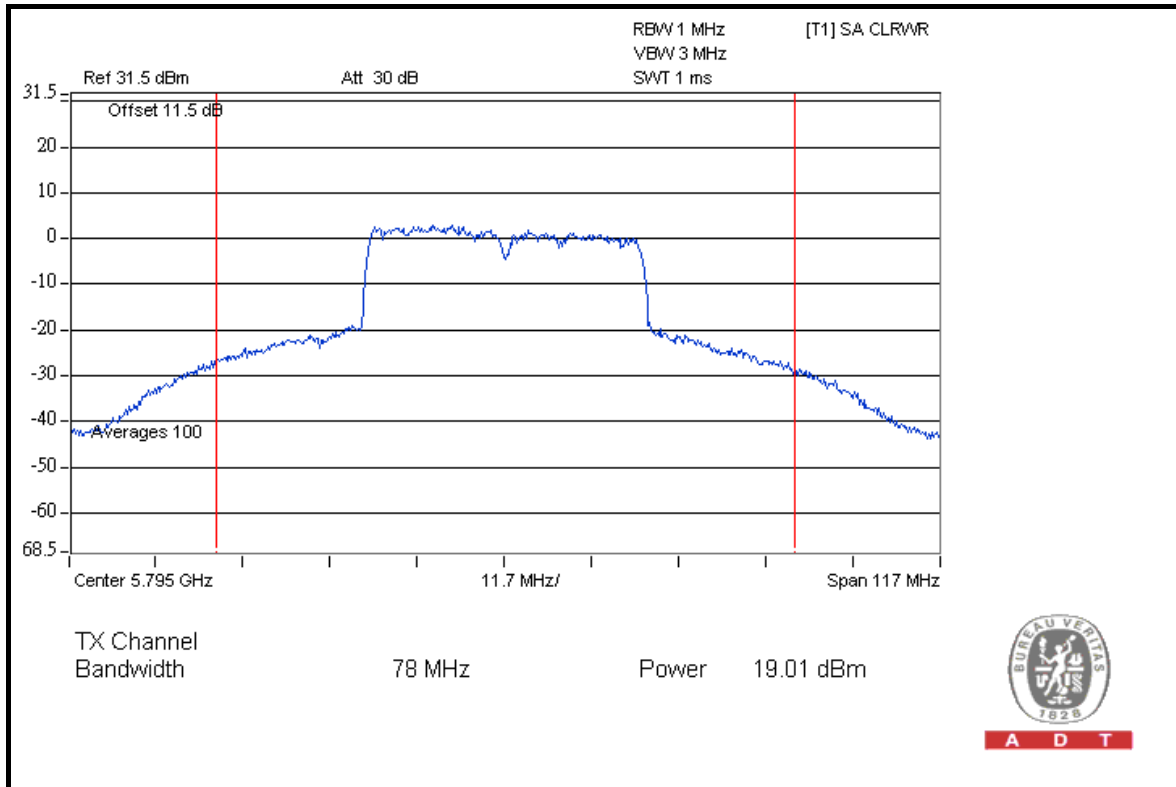



A D T

FOR CHAIN 2: CH 151

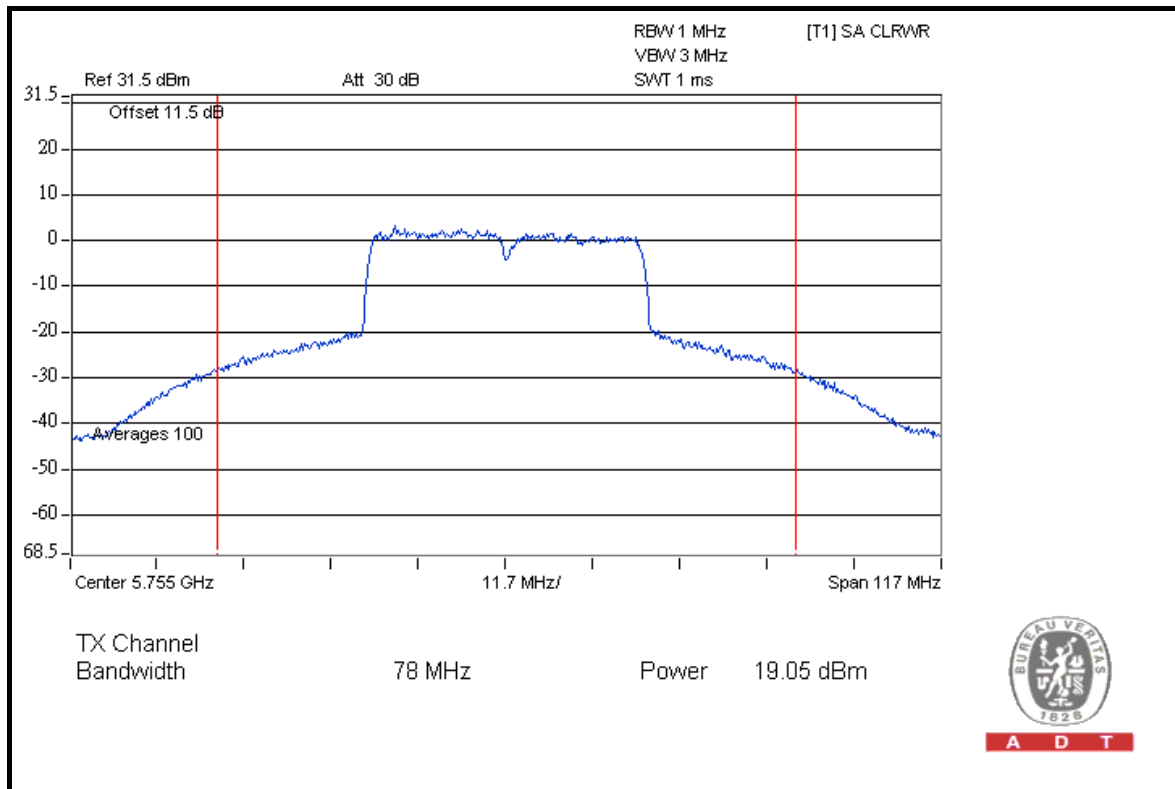

CH 159

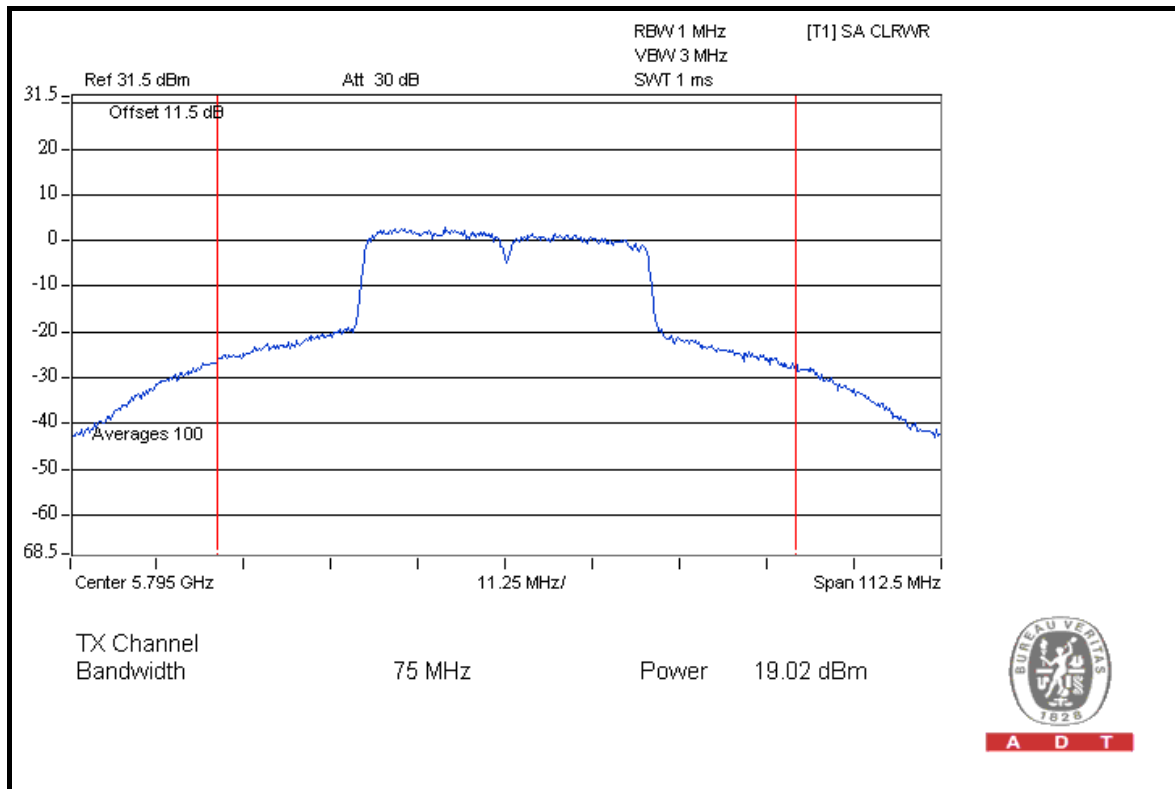



A D T

MODULATION TYPE	BPSK	TRANSFER RATE	13.5Mbps
INPUT POWER	120Vac, 60Hz	ENVIRONMENTAL CONDITIONS	25 deg.C, 65%RH, 1021hPa
TESTED BY	Brad Wu	TEST MODE	C

CHAN.	CHAN. FREQ. (MHz)	PEAK POWER OUTPUT (dBm)		TOTAL PEAK POWER (mW)	TOTAL PEAK POWER (dBm)	PEAK POWER LIMIT (dBm)	PASS / FAIL
		CHAIN 0	CHAIN 1				
151	5755	10.07	10.03	20.232	13.06	30	PASS
159	5795	10.07	10.12	20.443	13.11	30	PASS



A D T

FOR CHAIN 0: CH 151

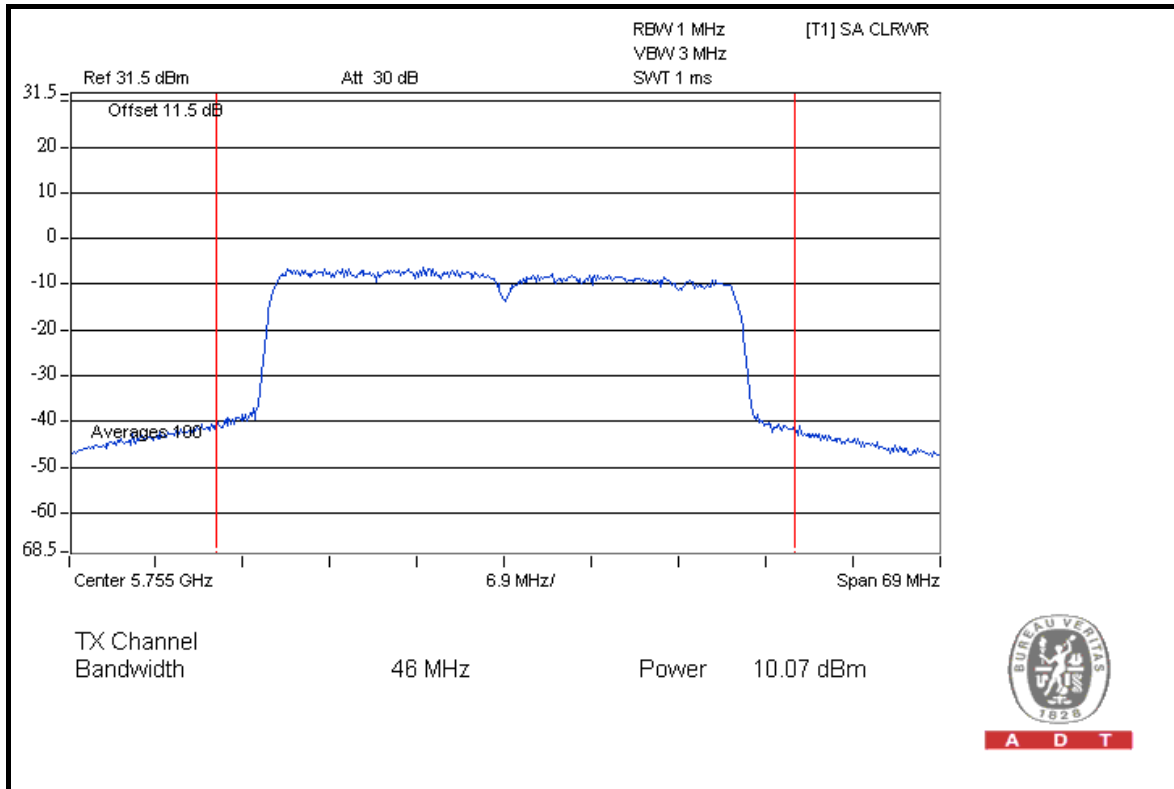

A D T

CH 159

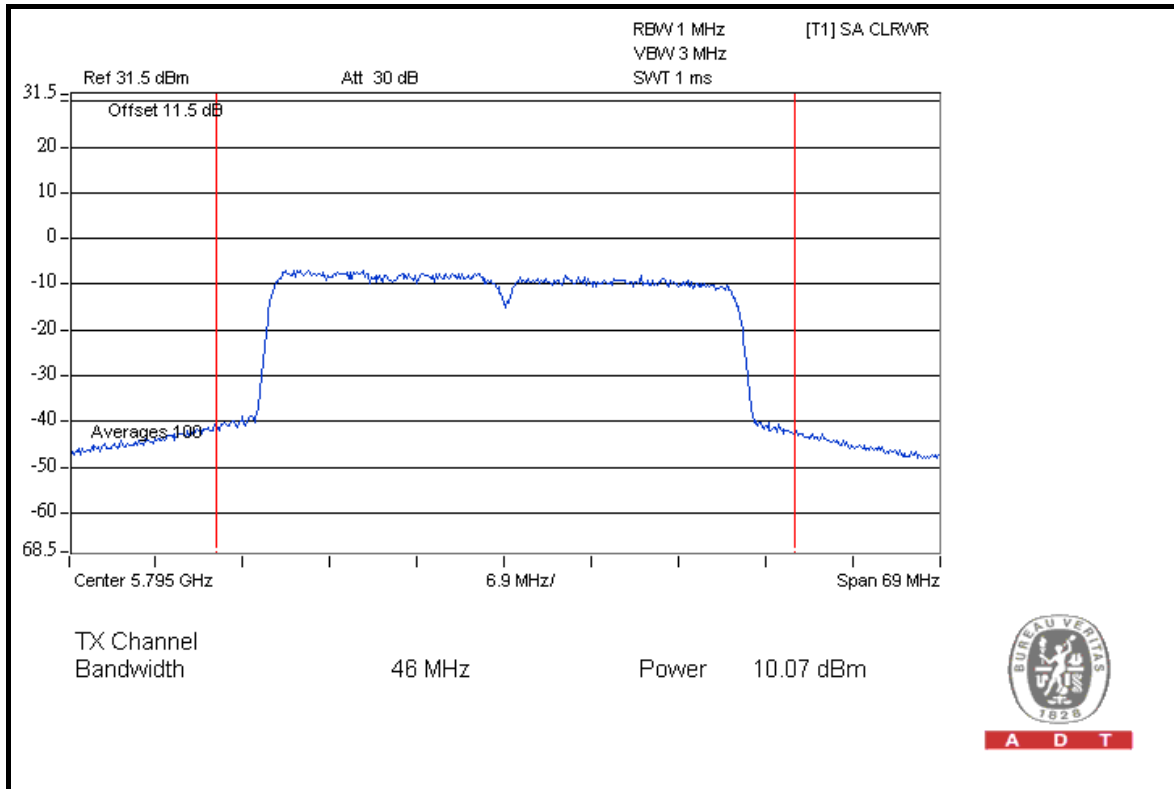

A D T



A D T

FOR CHAIN 2: CH 151

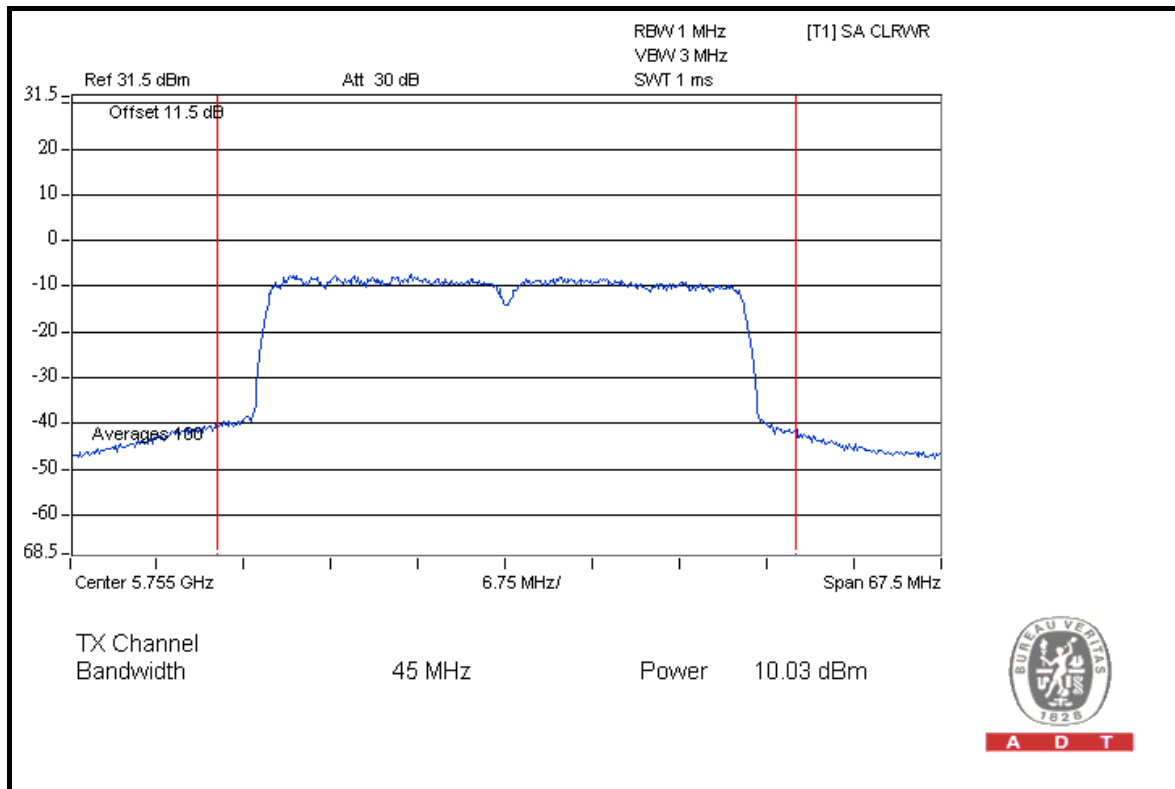

CH 159

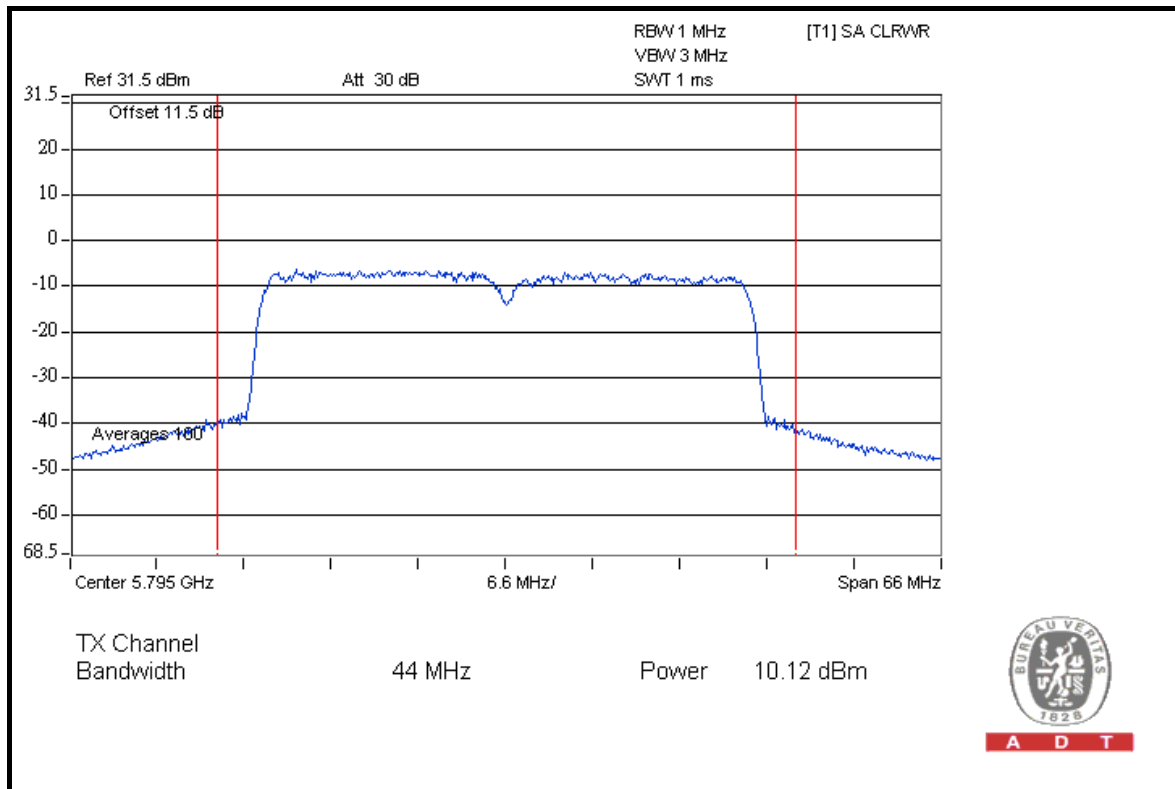



A D T

26dB OCCUPIED BANDWIDTH: 802.11a OFDM MODULATION

MODULATION TYPE	OFDM	TRANSFER RATE	6.0Mbps
INPUT POWER (SYSTEM)	120Vac, 60Hz	ENVIRONMENTAL CONDITIONS	25deg.C, 65%RH, 991hPa
TESTED BY	Brad Wu	TEST MODE	A

CHANNEL	CHANNEL FREQUENCY (MHz)	26dBc OCCUPIED BANDWIDTH (MHz)			PASS / FAIL
		CHAIN 0	CHAIN 1	CHAIN 2	
149	5745	35.12	31.43	34.67	PASS
157	5785	32.17	35.49	35.16	PASS
165	5825	36.92	35.61	36.80	PASS

FOR CHAIN 0: CH 149

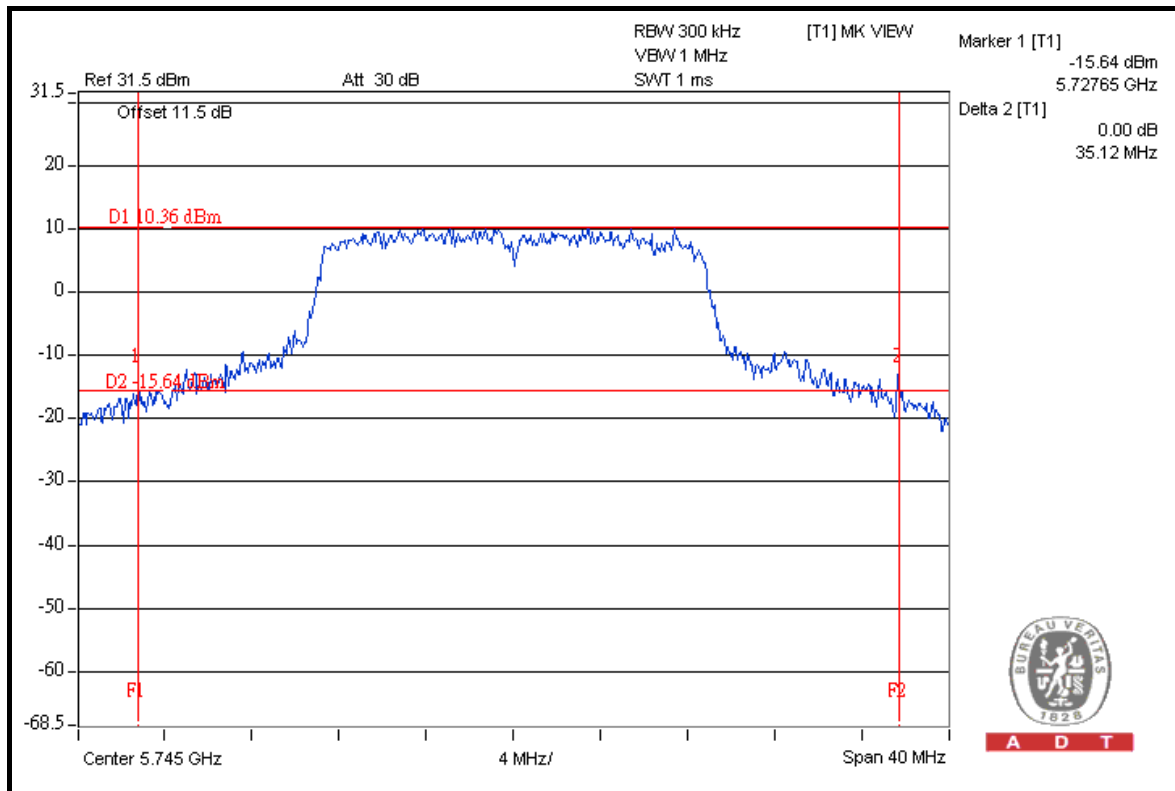

A D T



A D T

CH 157

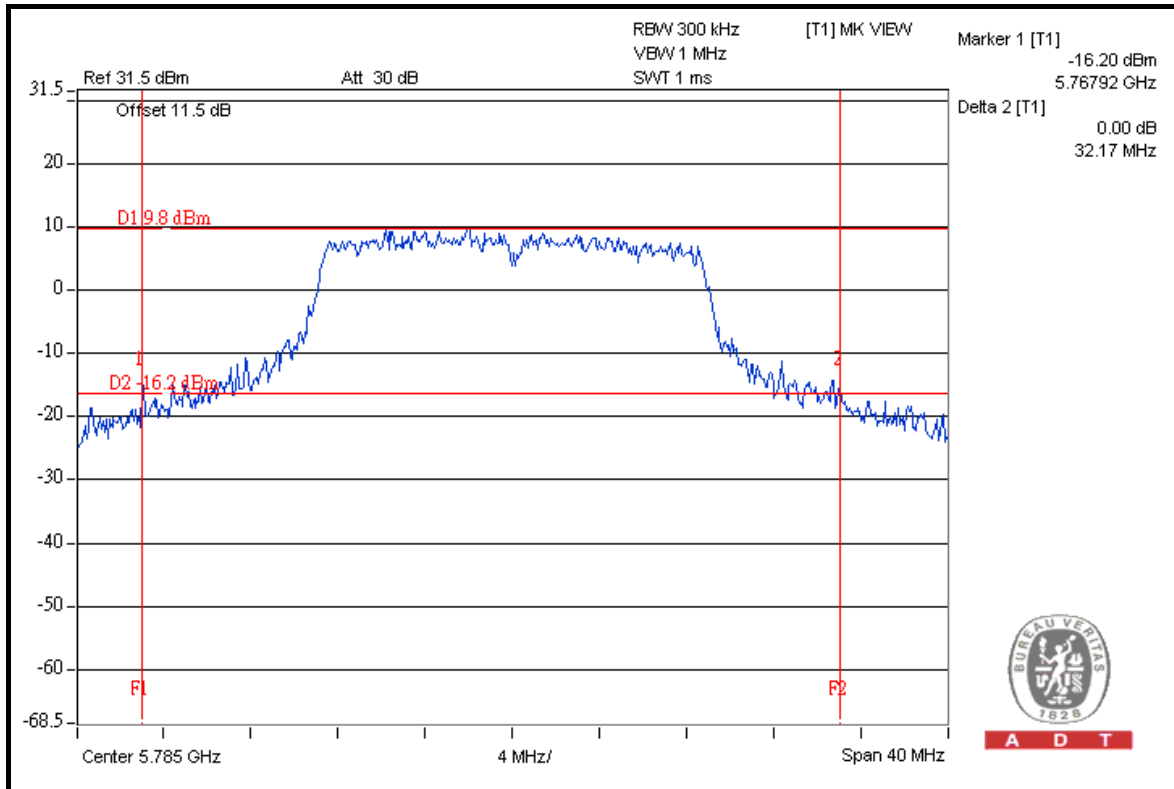

A D T

CH 165

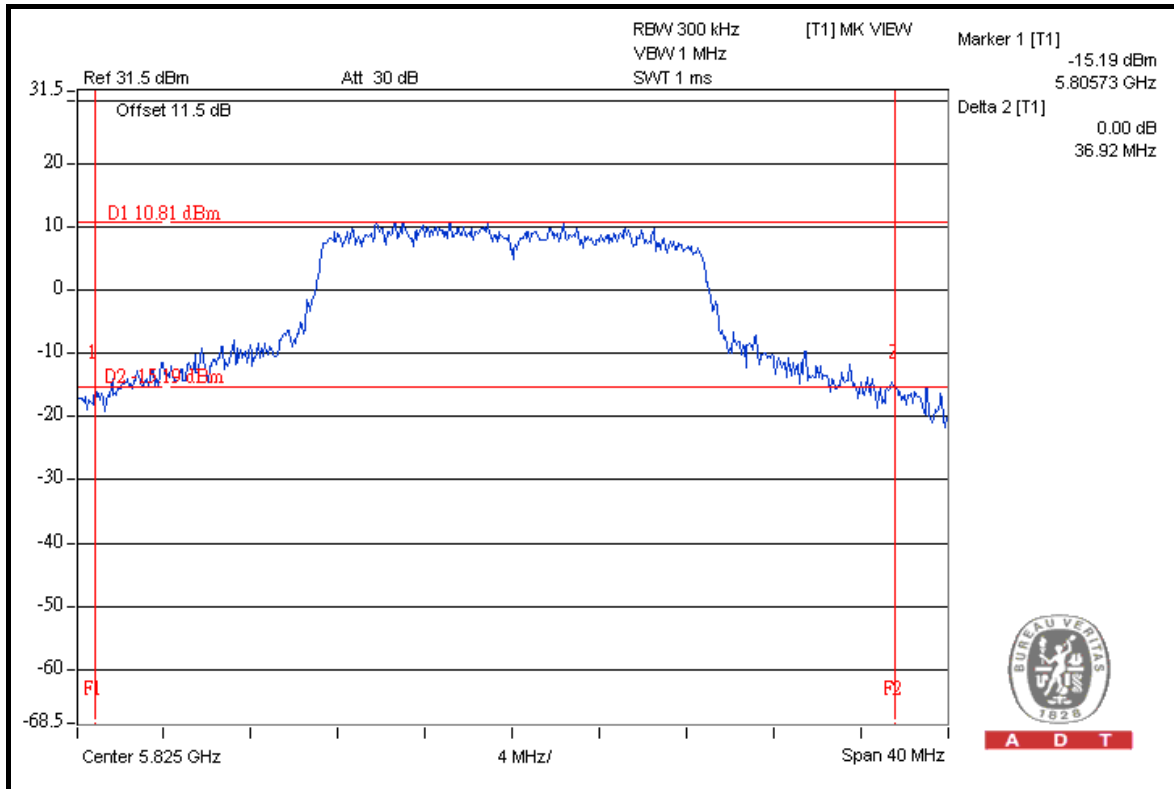

A D T



A D T

FOR CHAIN 1: CH 149

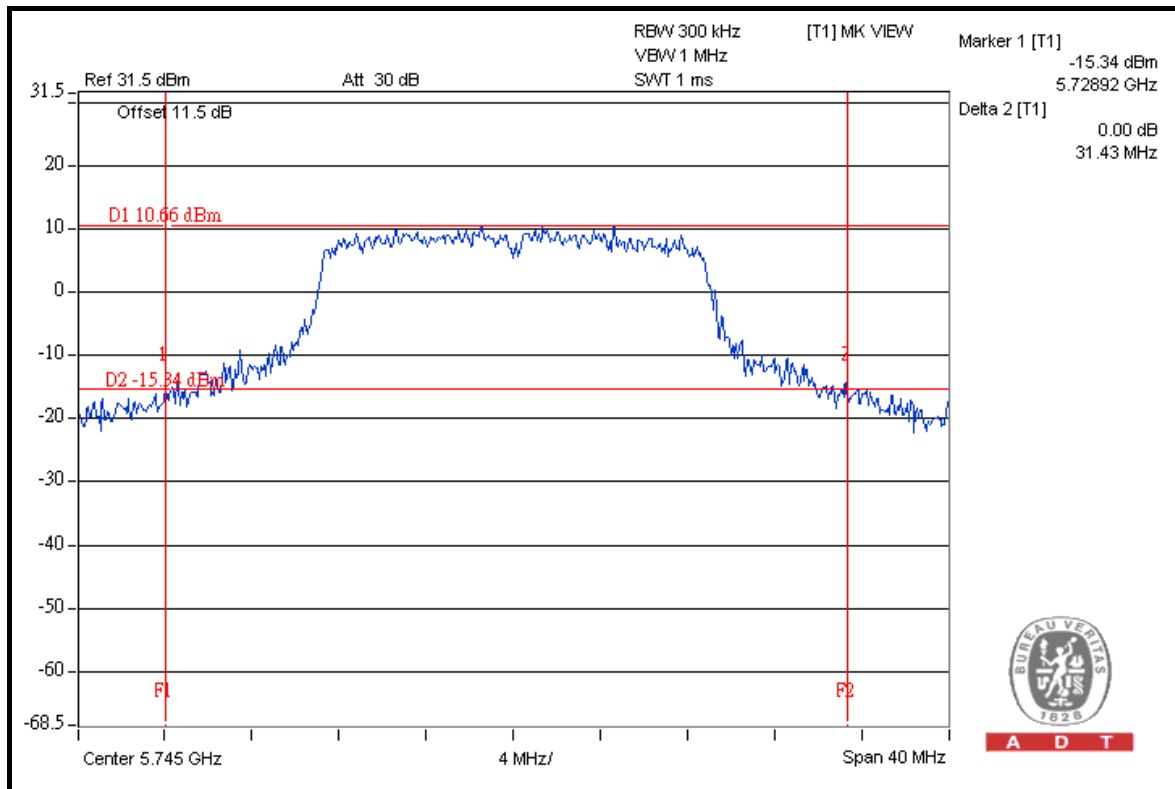

CH 157

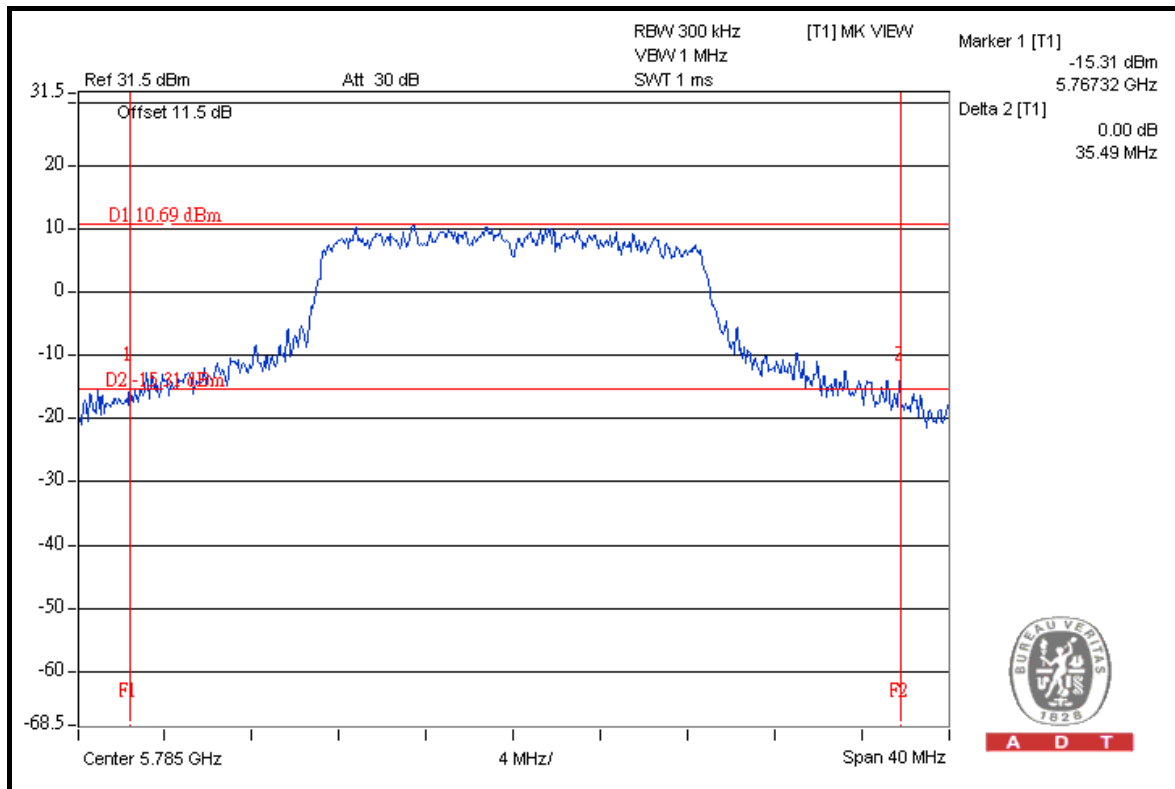



A D T

CH 165

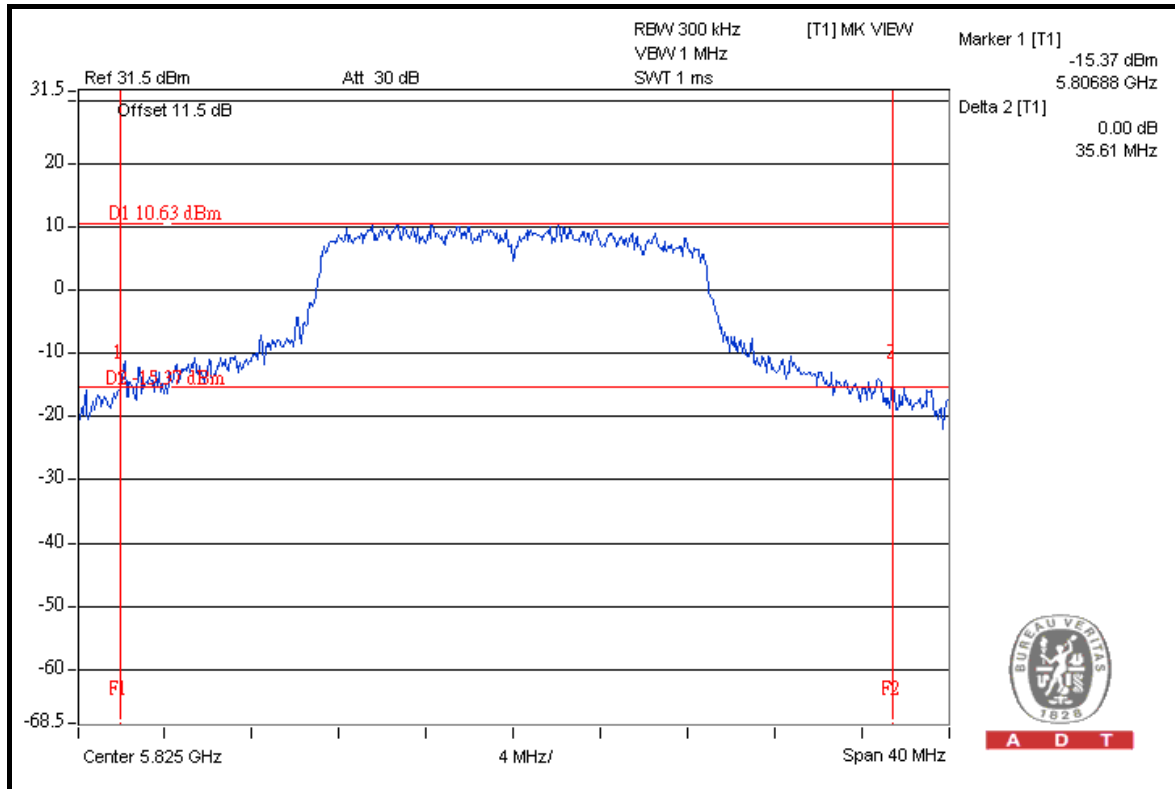

A D T

FOR CHAIN 2: CH 149

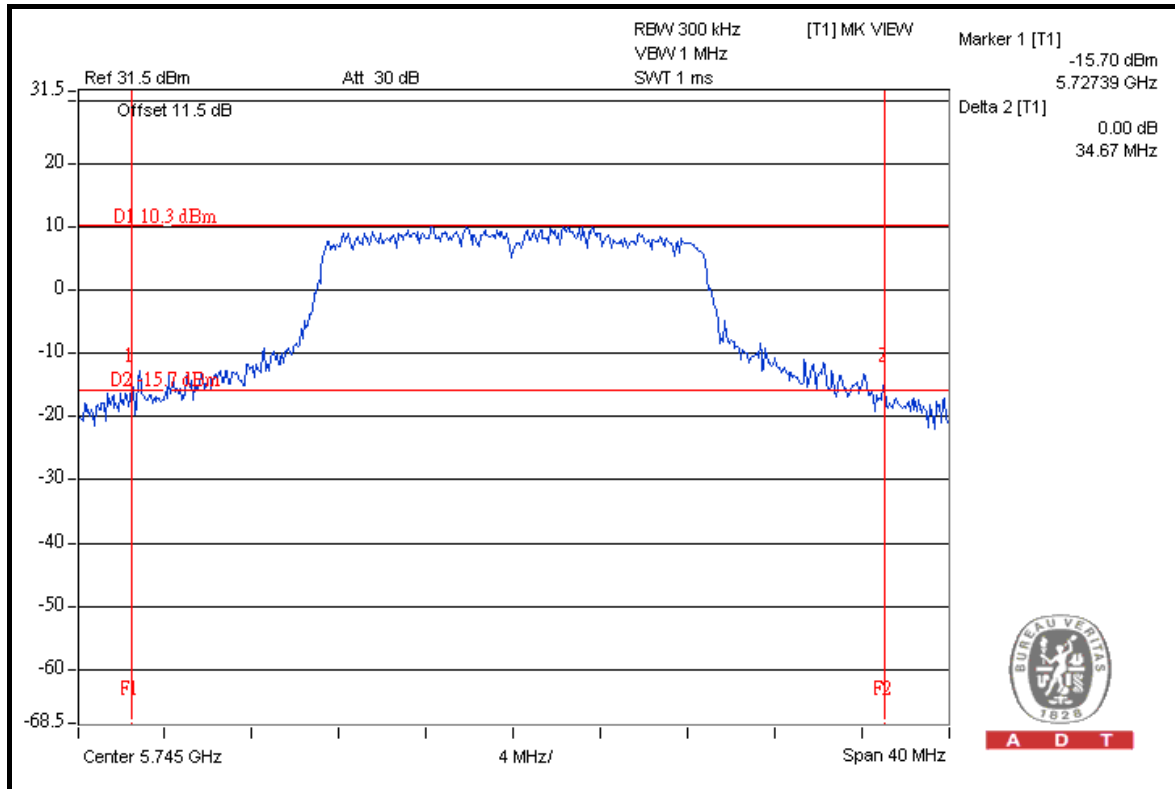

A D T



A D T

CH 157

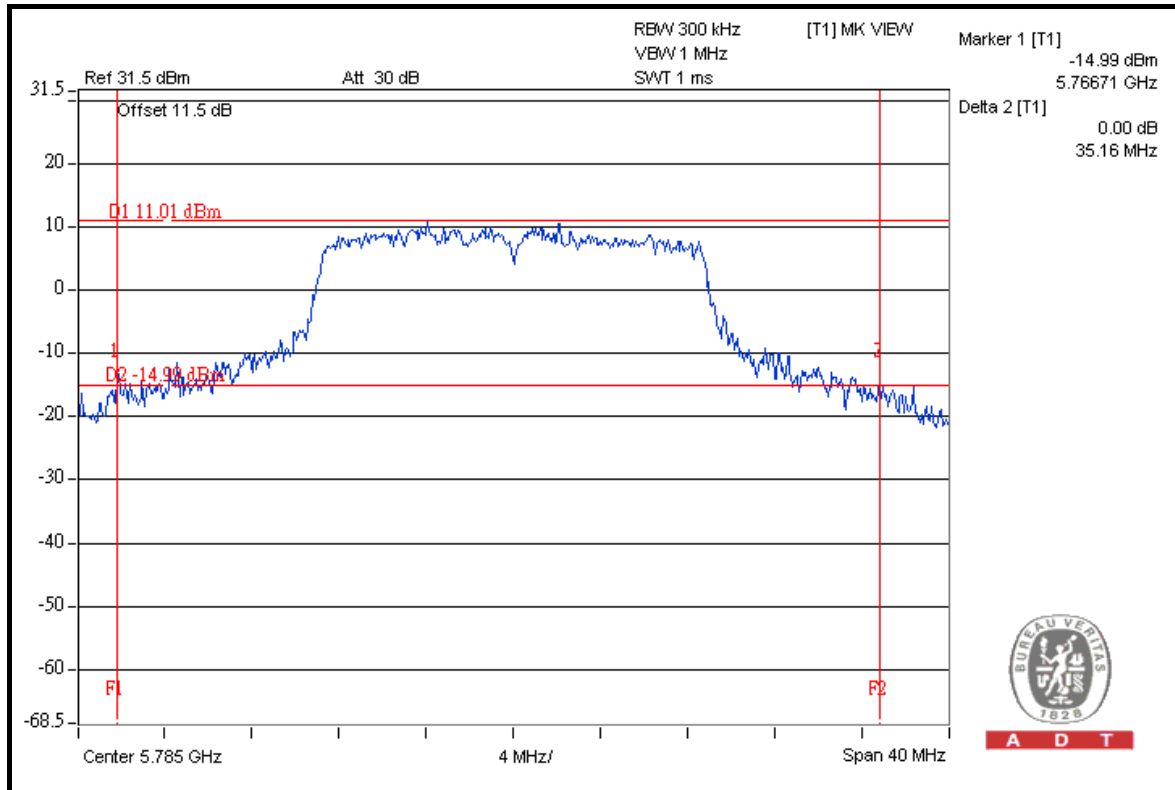

A D T

CH 165

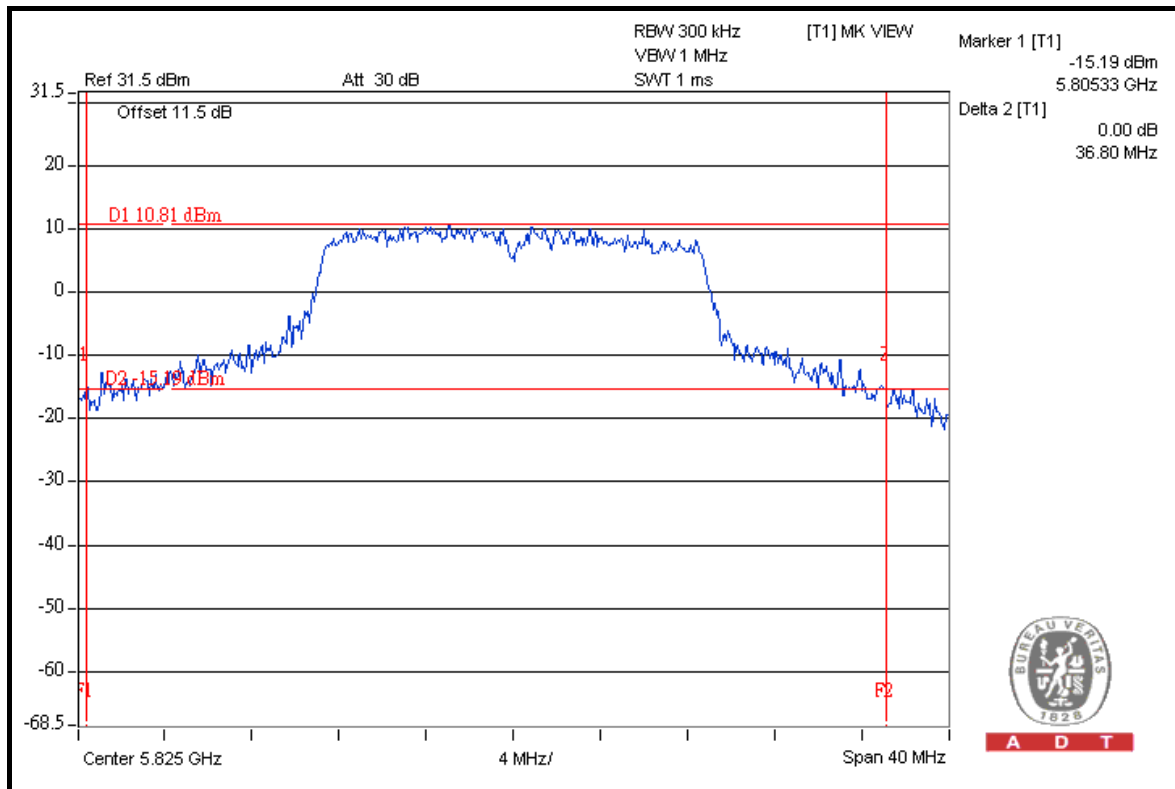

A D T



A D T

26dB OCCUPIED BANDWIDTH: 802.11a OFDM MODULATION

MODULATION TYPE	OFDM	TRANSFER RATE	6.0Mbps
INPUT POWER (SYSTEM)	120Vac, 60Hz	ENVIRONMENTAL CONDITIONS	25deg.C, 65%RH, 991hPa
TESTED BY	Brad Wu	TEST MODE	C

CHANNEL	CHANNEL FREQUENCY (MHz)	26dBc OCCUPIED BANDWIDTH (MHz)		PASS / FAIL
		CHAIN 0	CHAIN 1	
149	5745	22.97	22.58	PASS
157	5785	22.33	22.92	PASS
165	5825	22.78	22.77	PASS



A D T

FOR CHAIN 0: CH 149

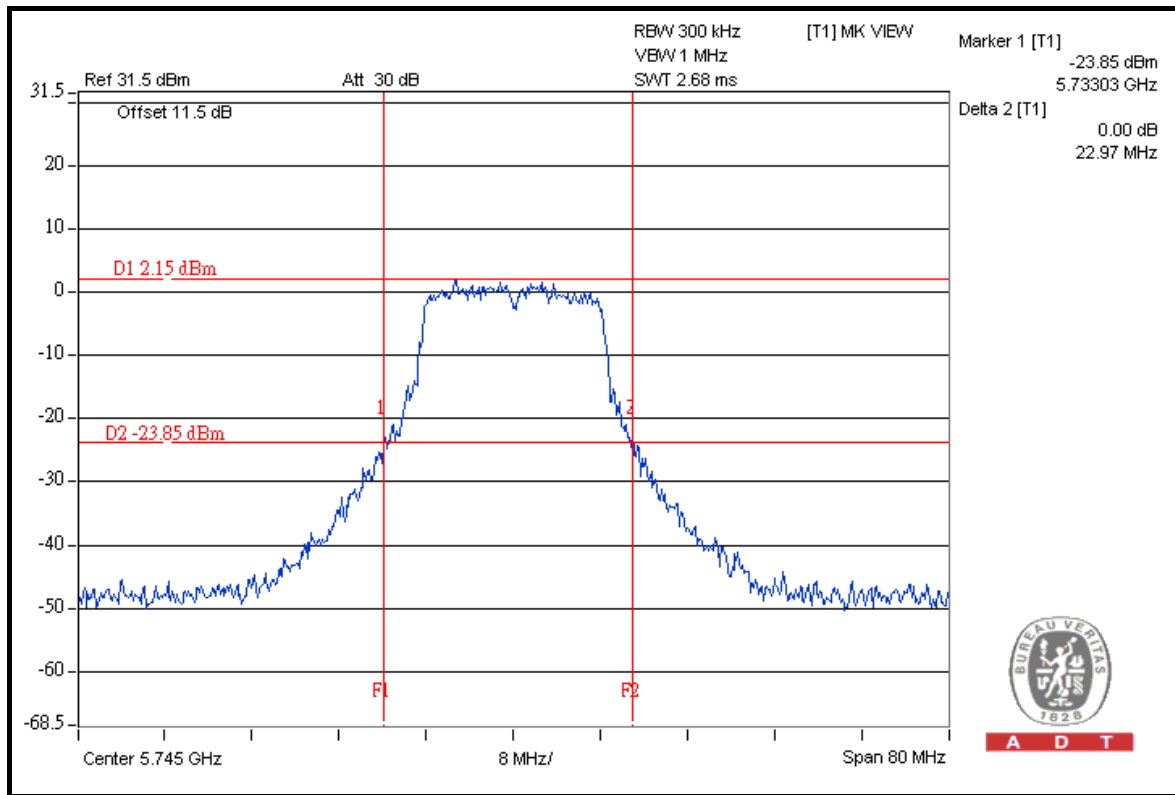

CH 157

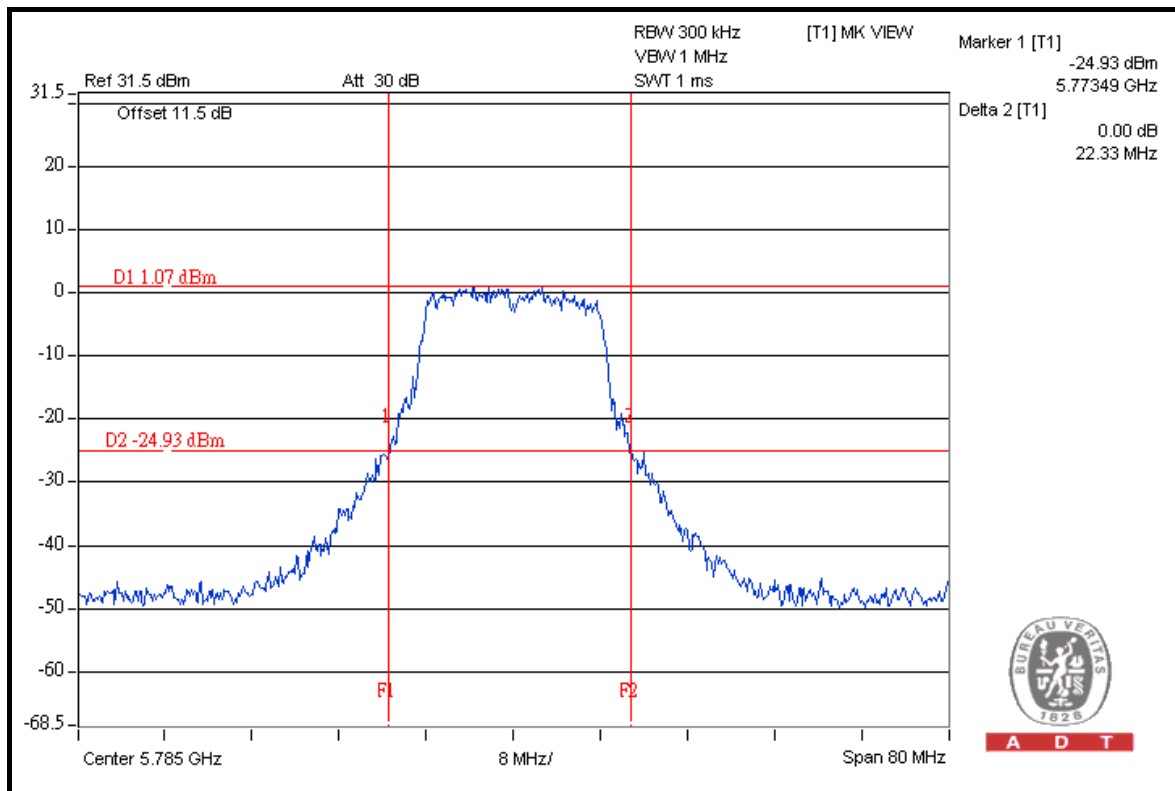



A D T

CH 165

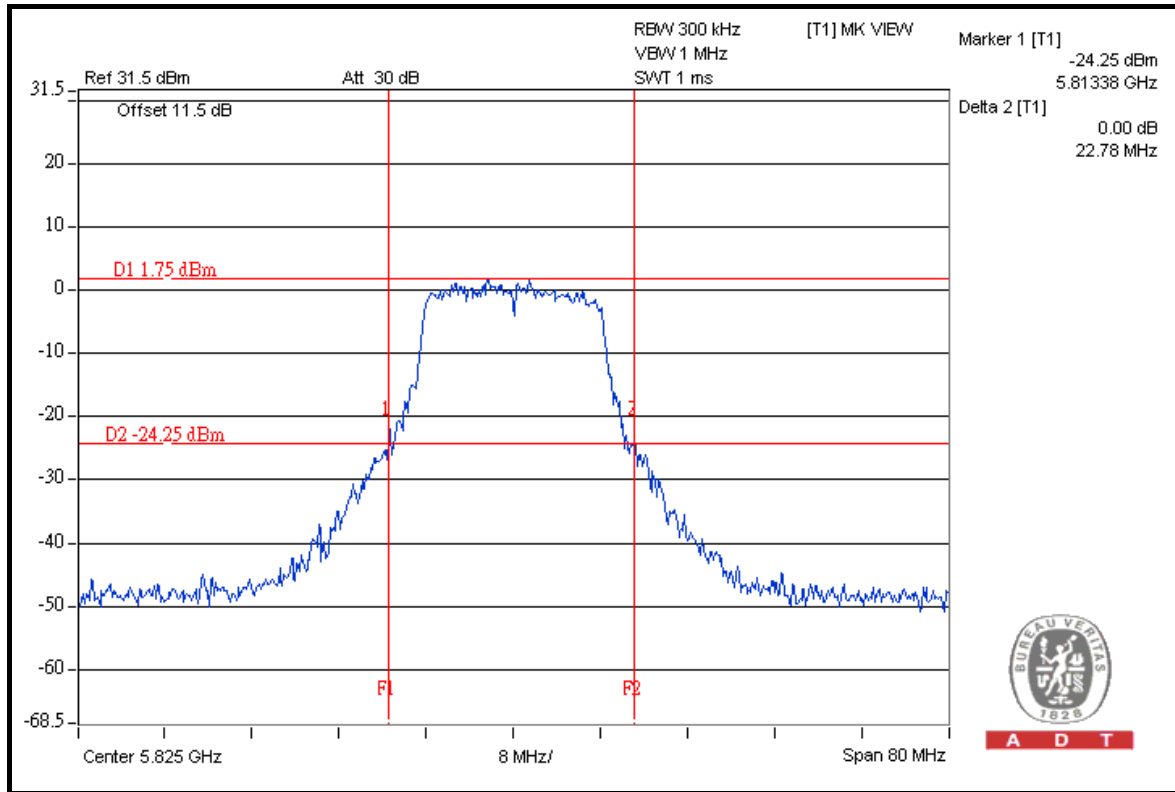

FOR CHAIN 1: CH 149

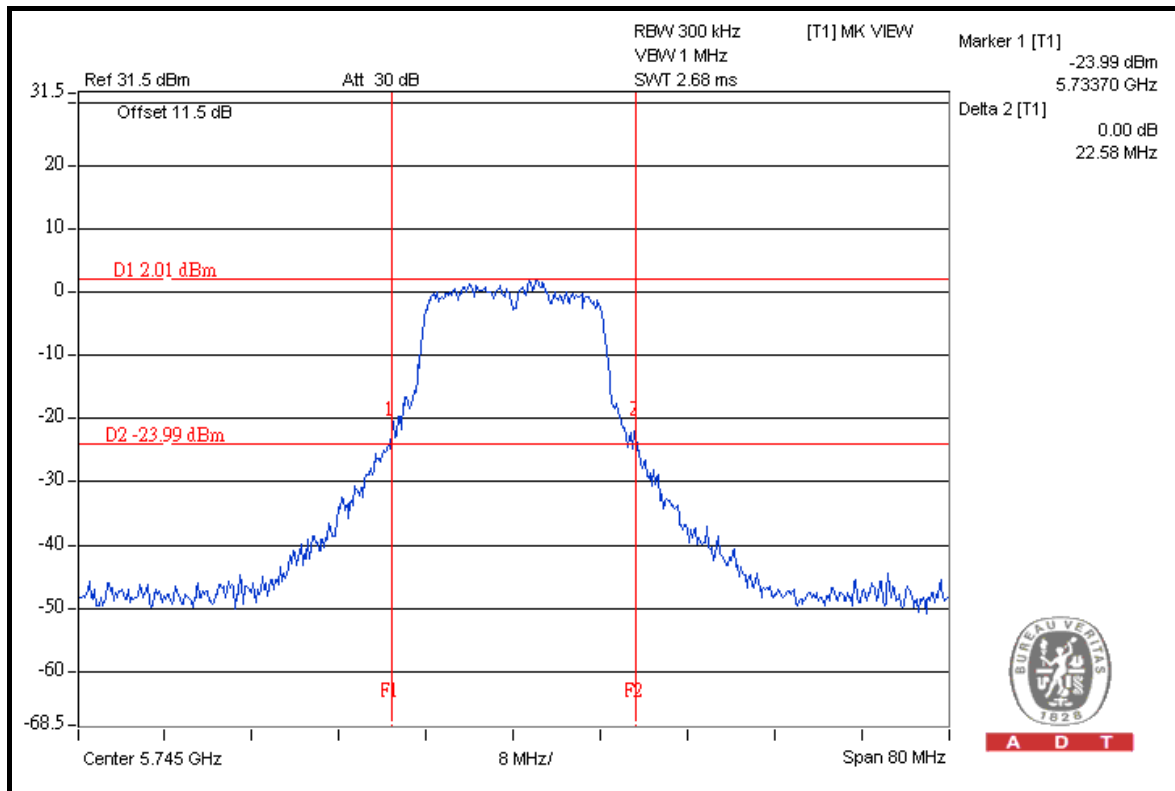



A D T

CH 157

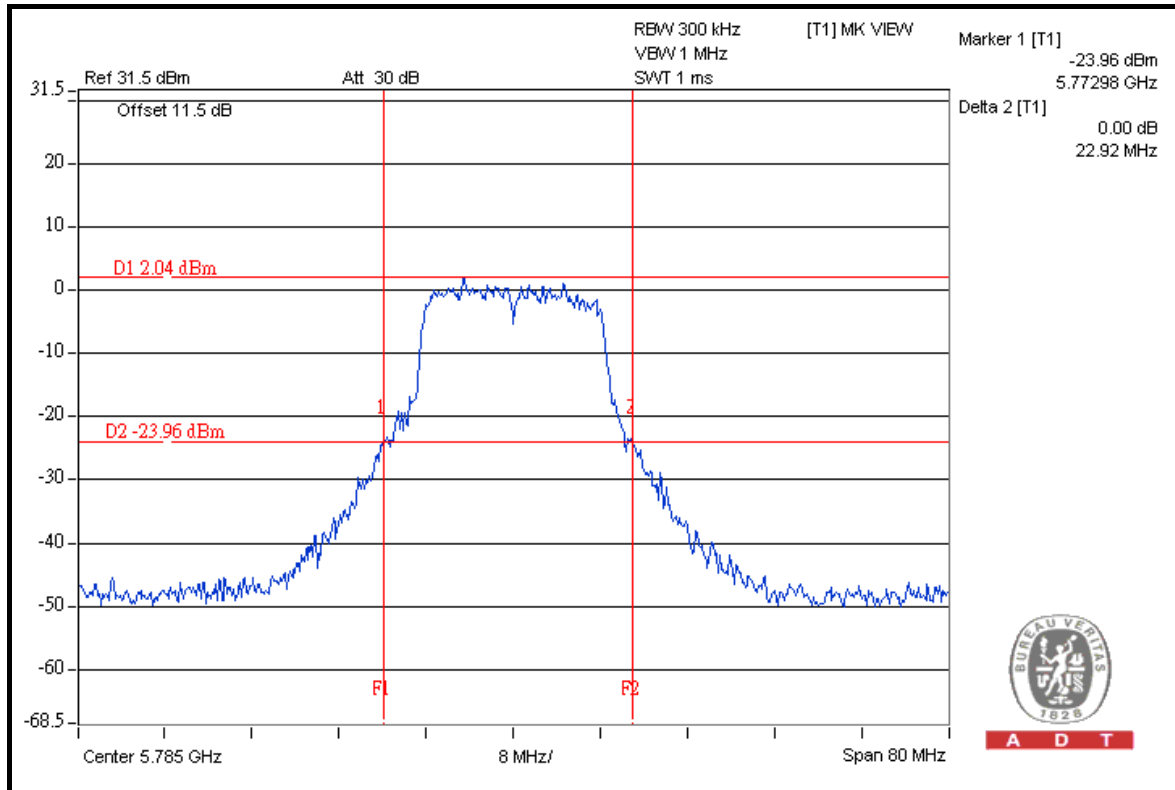

CH 165

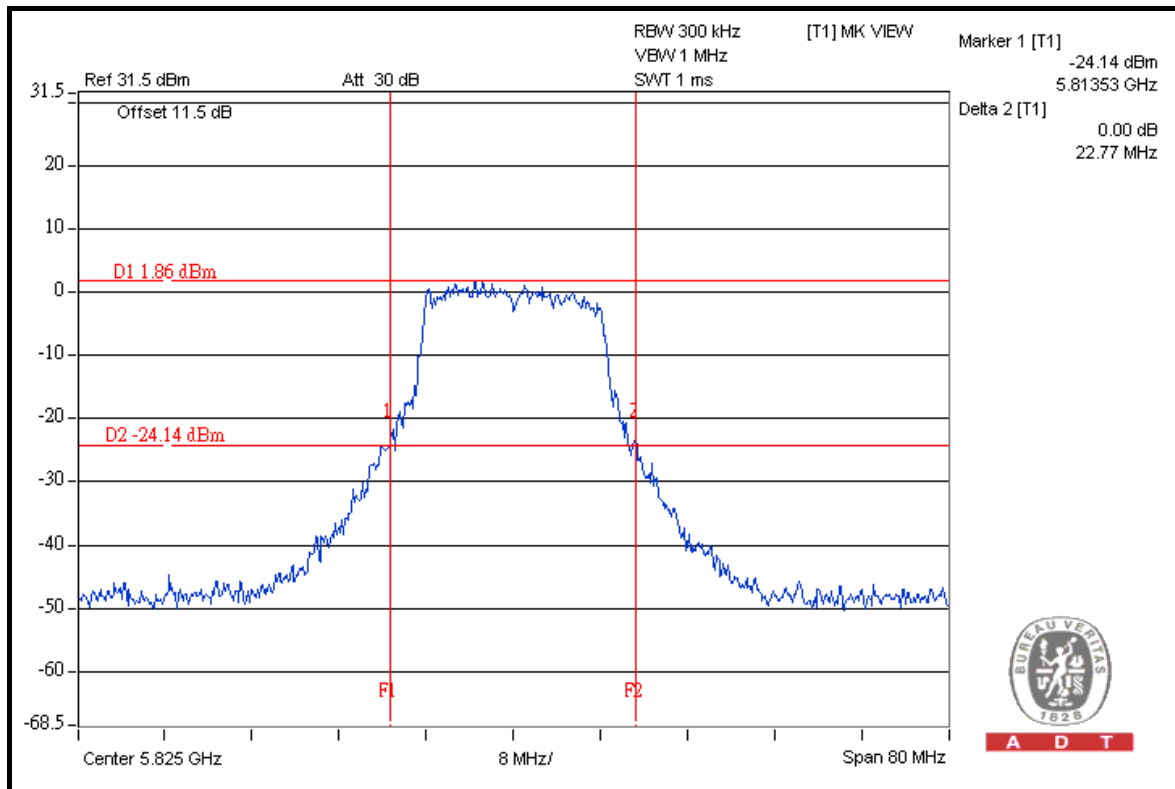



A D T

DRAFT 802.11n (20MHz) OFDM MODULATION

MODULATION TYPE	OFDM	TRANSFER RATE	6.5Mbps
INPUT POWER (SYSTEM)	120Vac, 60Hz	ENVIRONMENTAL CONDITIONS	25deg.C, 65%RH, 991hPa
TESTED BY	Brad Wu	TEST MODE	A

CHANNEL	CHANNEL FREQUENCY (MHz)	26dBc OCCUPIED BANDWIDTH (MHz)			PASS / FAIL
		CHAIN 0	CHAIN 1	CHAIN 2	
149	5745	35.12	31.43	34.67	PASS
157	5785	32.17	35.49	35.16	PASS
165	5825	36.92	35.61	36.80	PASS

FOR CHAIN 0: CH 149

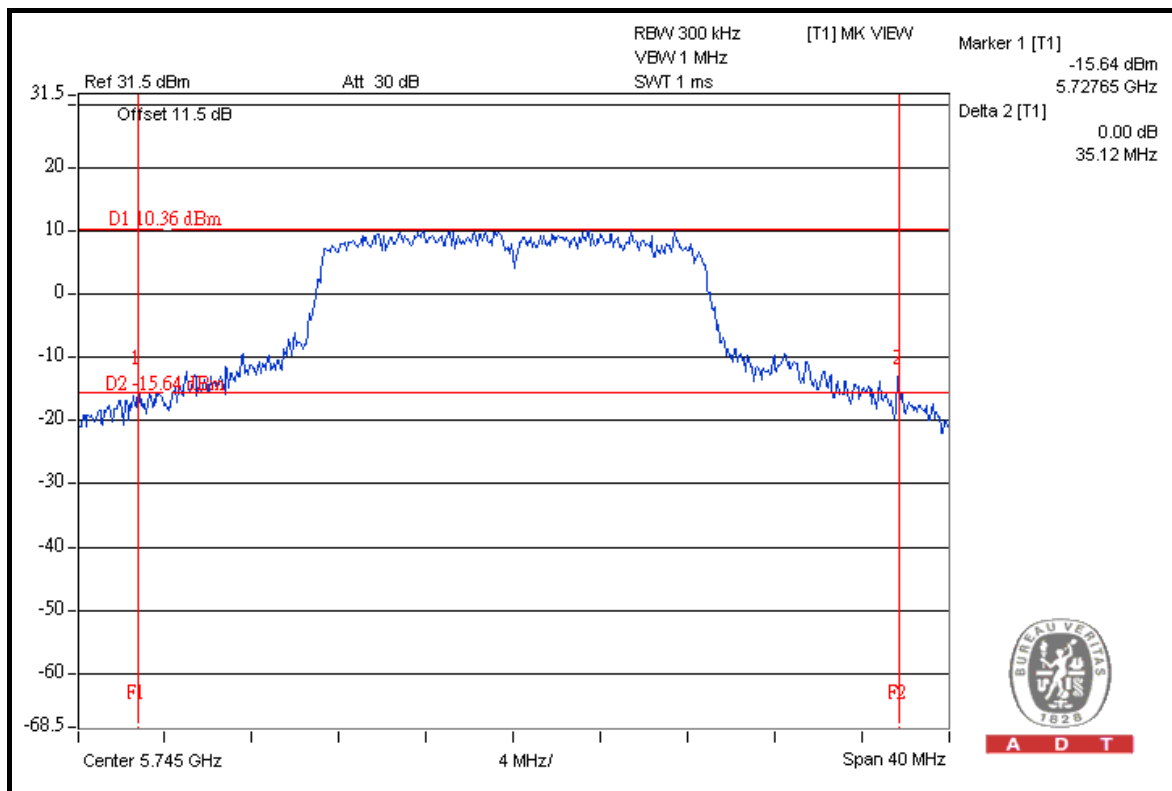

A D T



A D T

CH 157

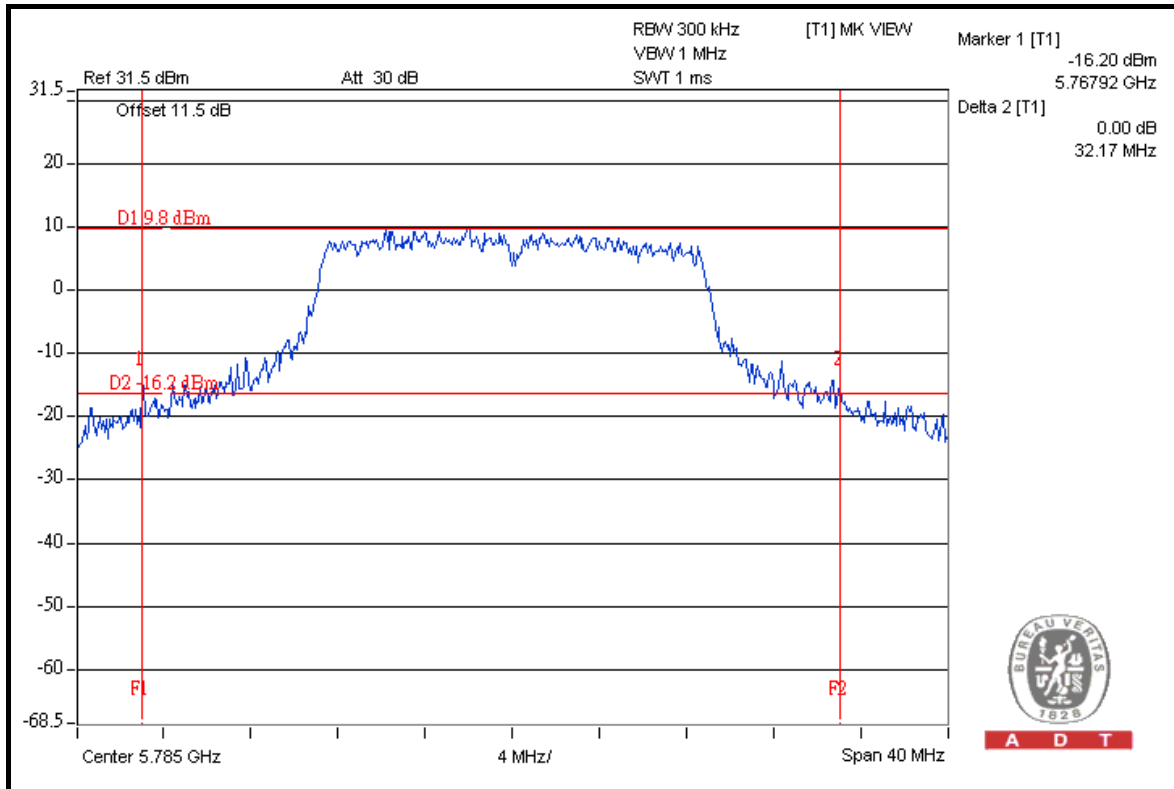

CH 165

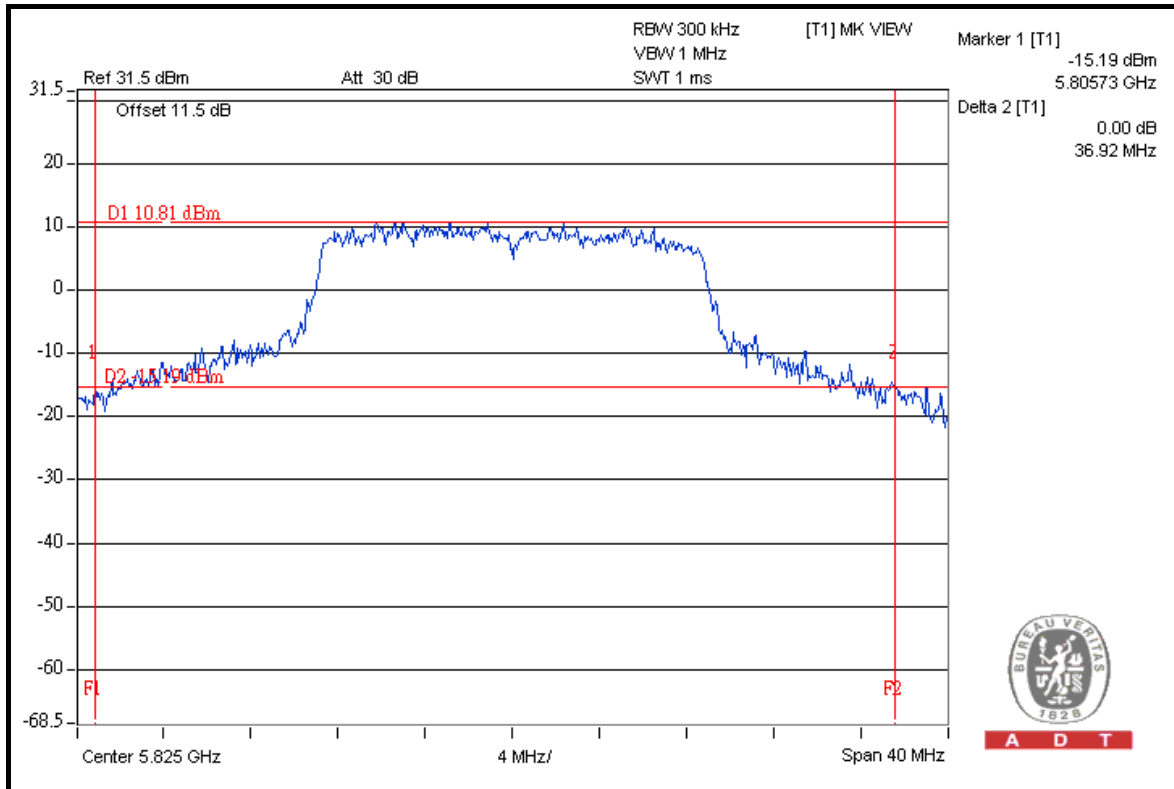



A D T

FOR CHAIN 1: CH 149

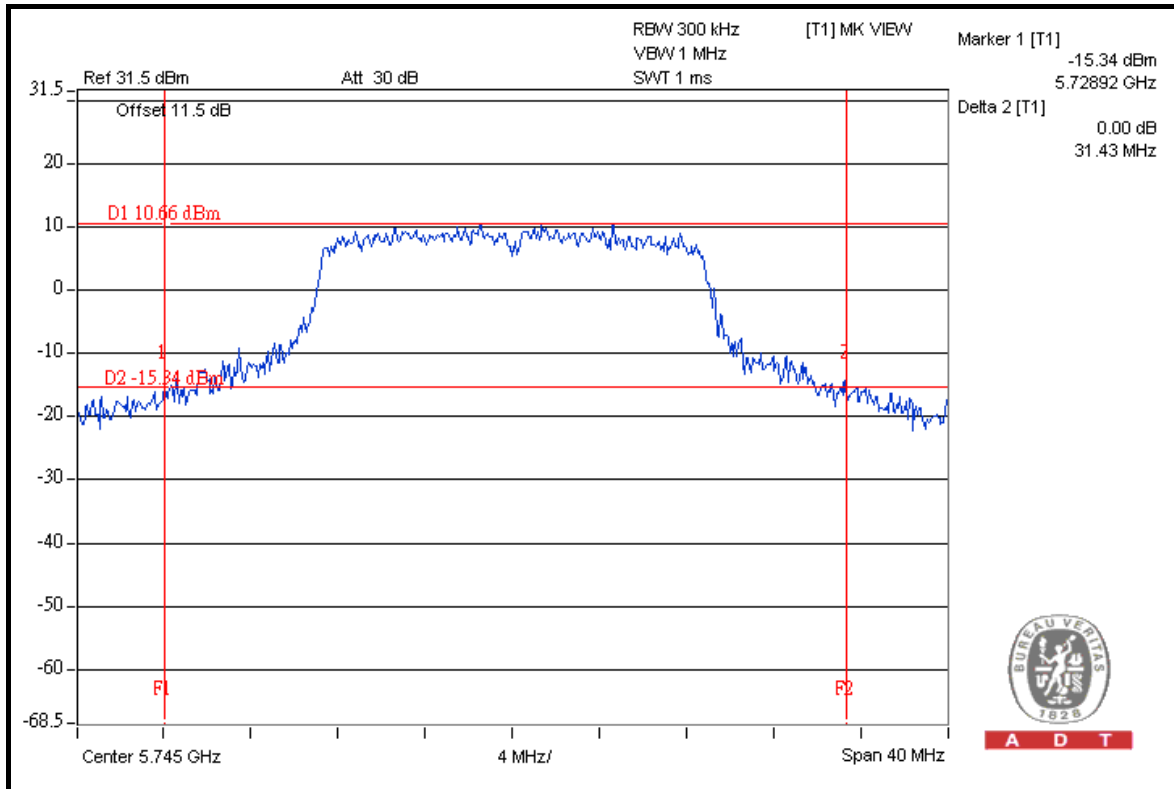

CH 157

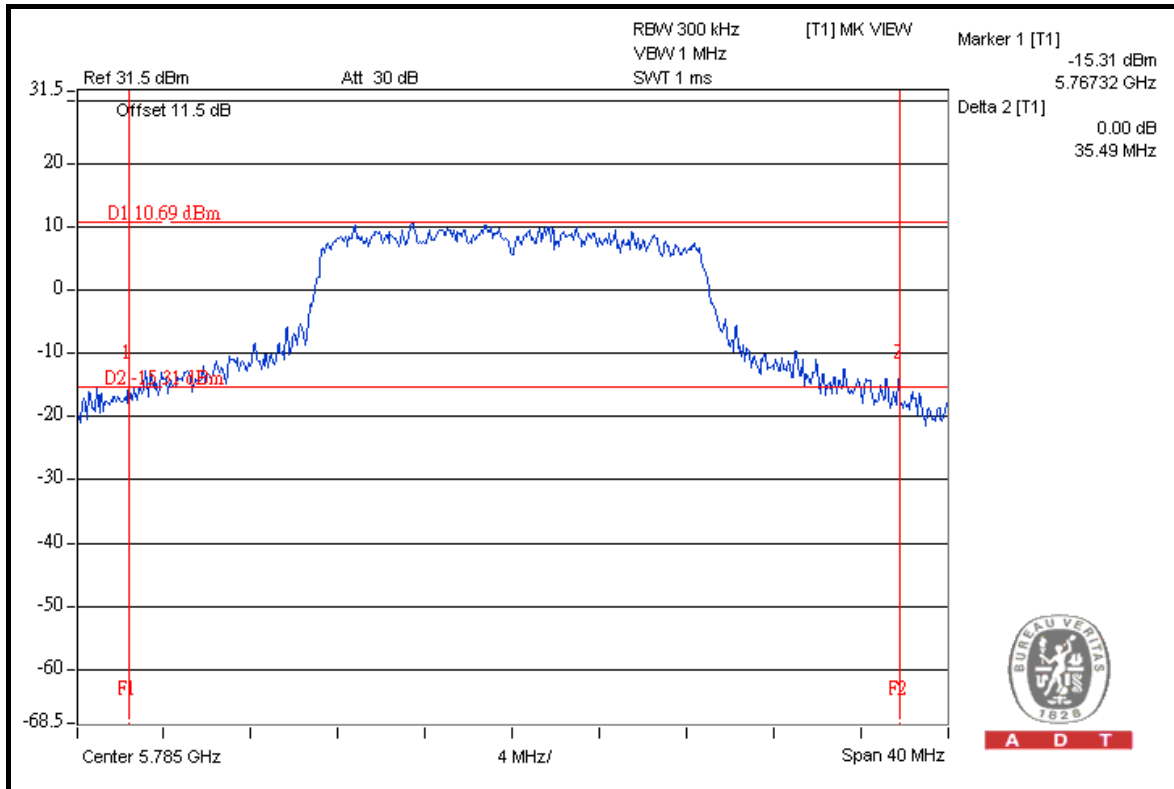



A D T

CH 165

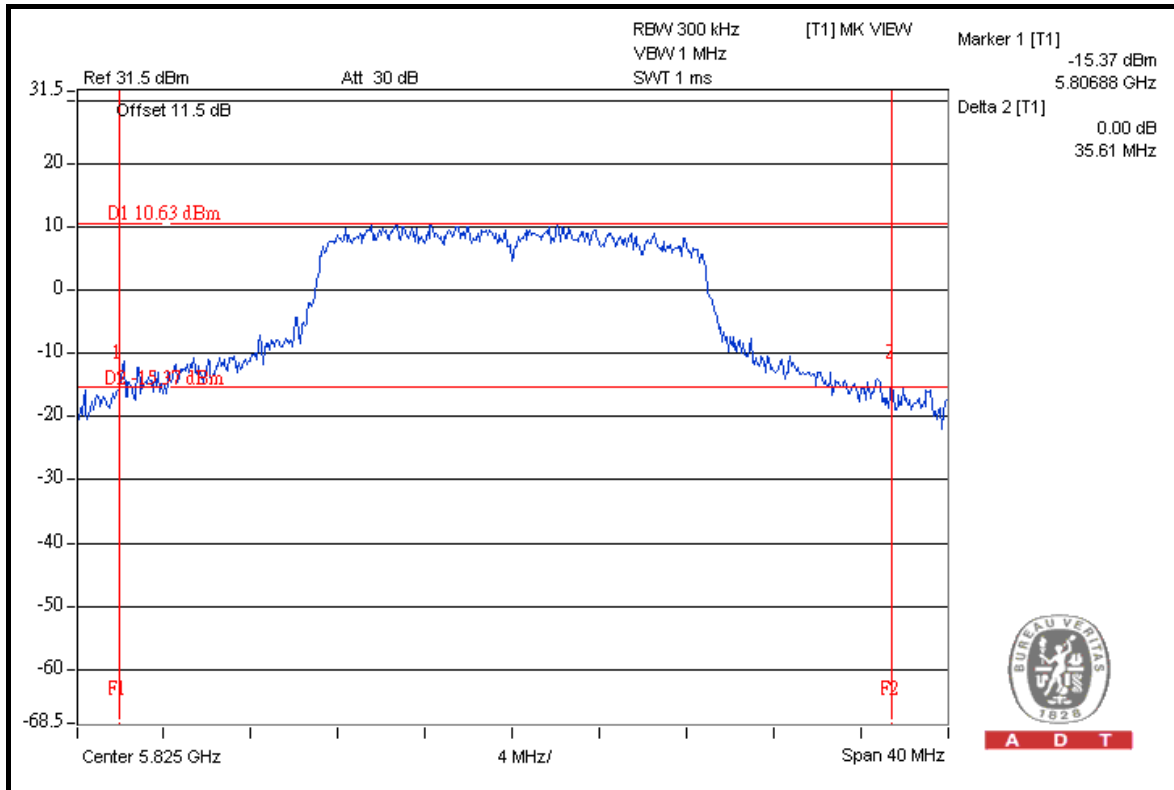

A D T

FOR CHAIN 0: CH 149

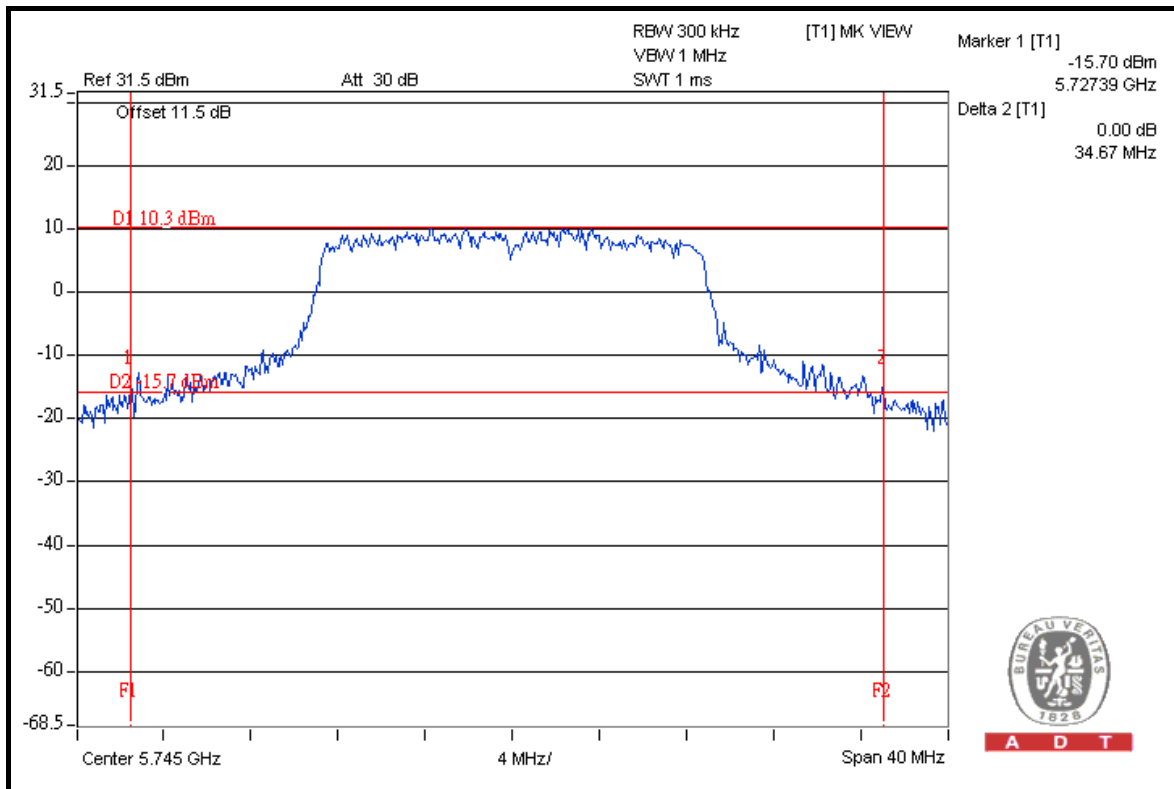

A D T



A D T

CH 157

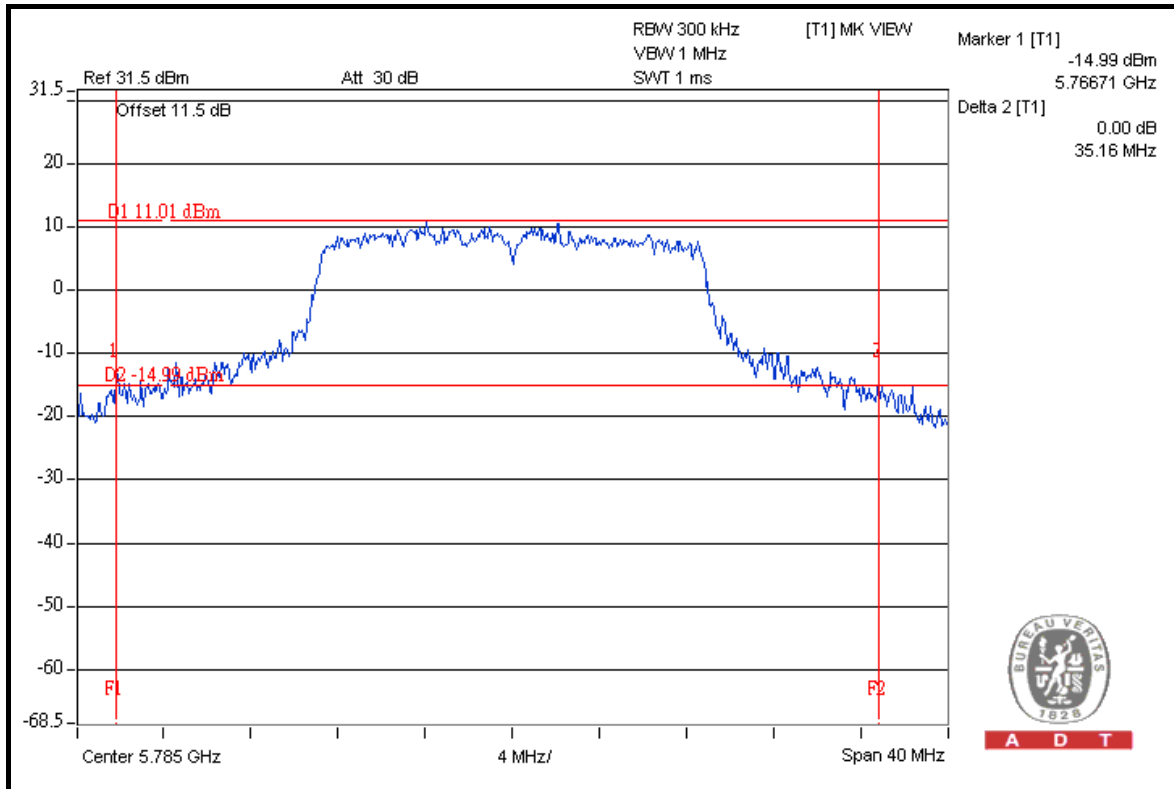

A D T

CH 165

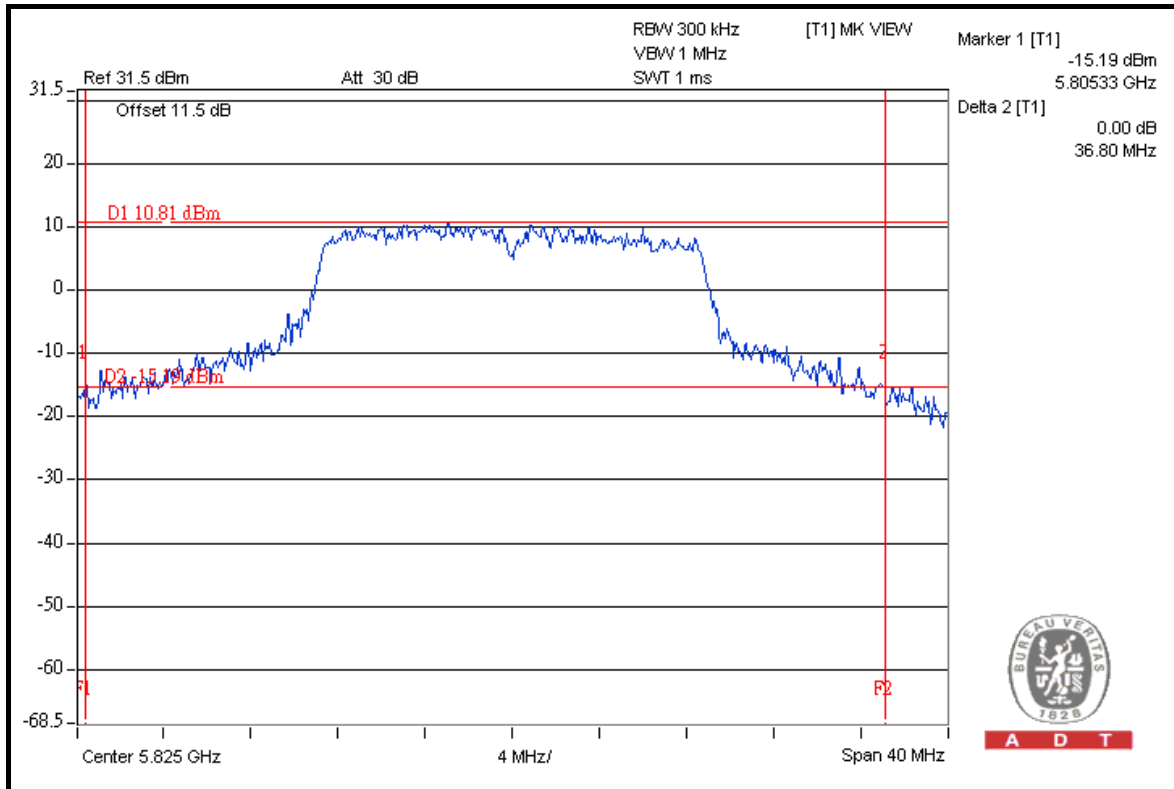

A D T



A D T

DRAFT 802.11n (20MHz) OFDM MODULATION

MODULATION TYPE	OFDM	TRANSFER RATE	6.5Mbps
INPUT POWER (SYSTEM)	120Vac, 60Hz	ENVIRONMENTAL CONDITIONS	25deg.C, 65%RH, 991hPa
TESTED BY	Brad Wu	TEST MODE	C

CHANNEL	CHANNEL FREQUENCY (MHz)	26dBc OCCUPIED BANDWIDTH (MHz)		PASS / FAIL
		CHAIN 0	CHAIN 1	
149	5745	24.00	22.58	PASS
157	5785	22.92	22.72	PASS
165	5825	23.80	23.20	PASS



A D T

FOR CHAIN 0: CH 149

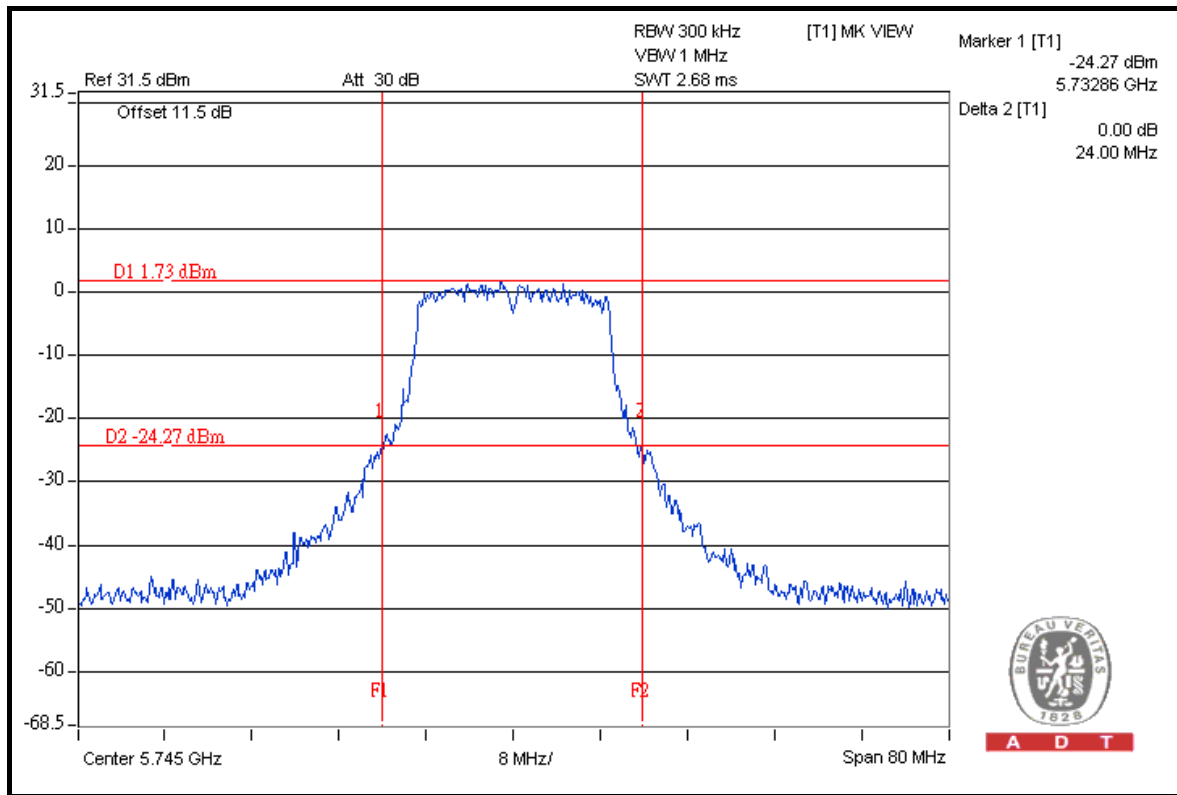

CH 157

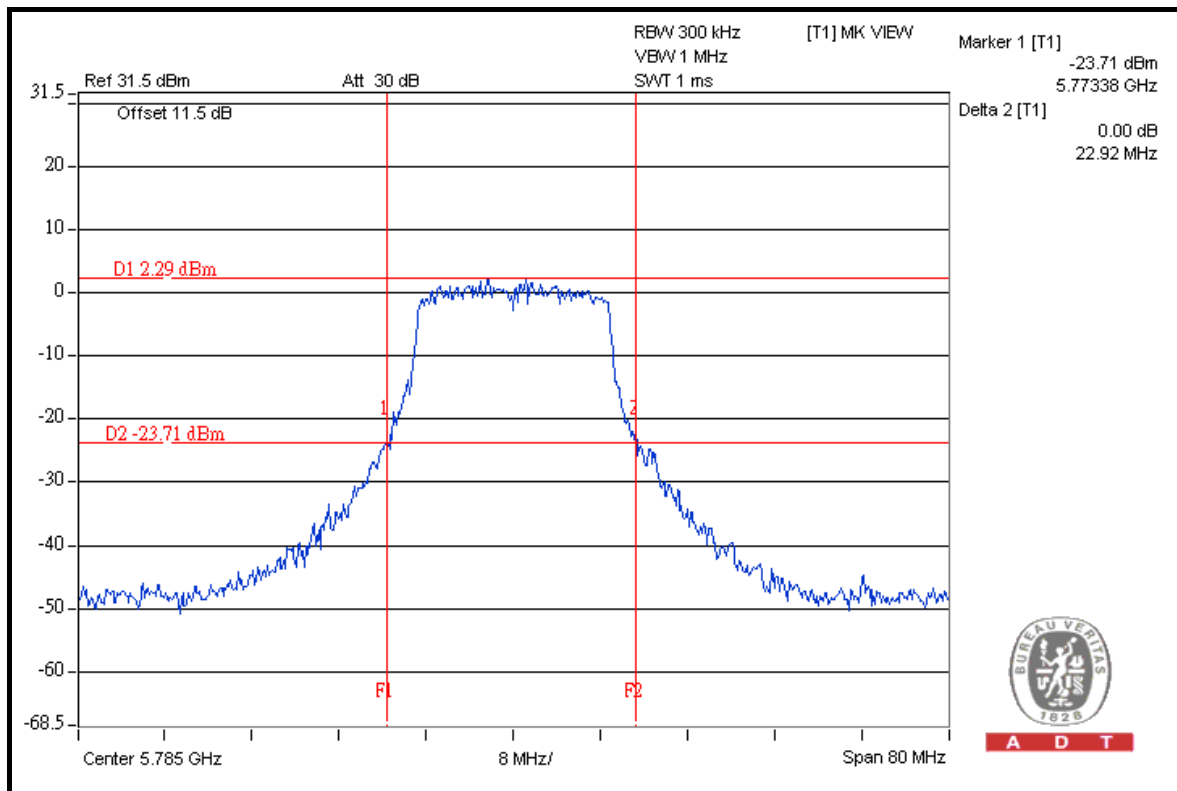



A D T

CH 165

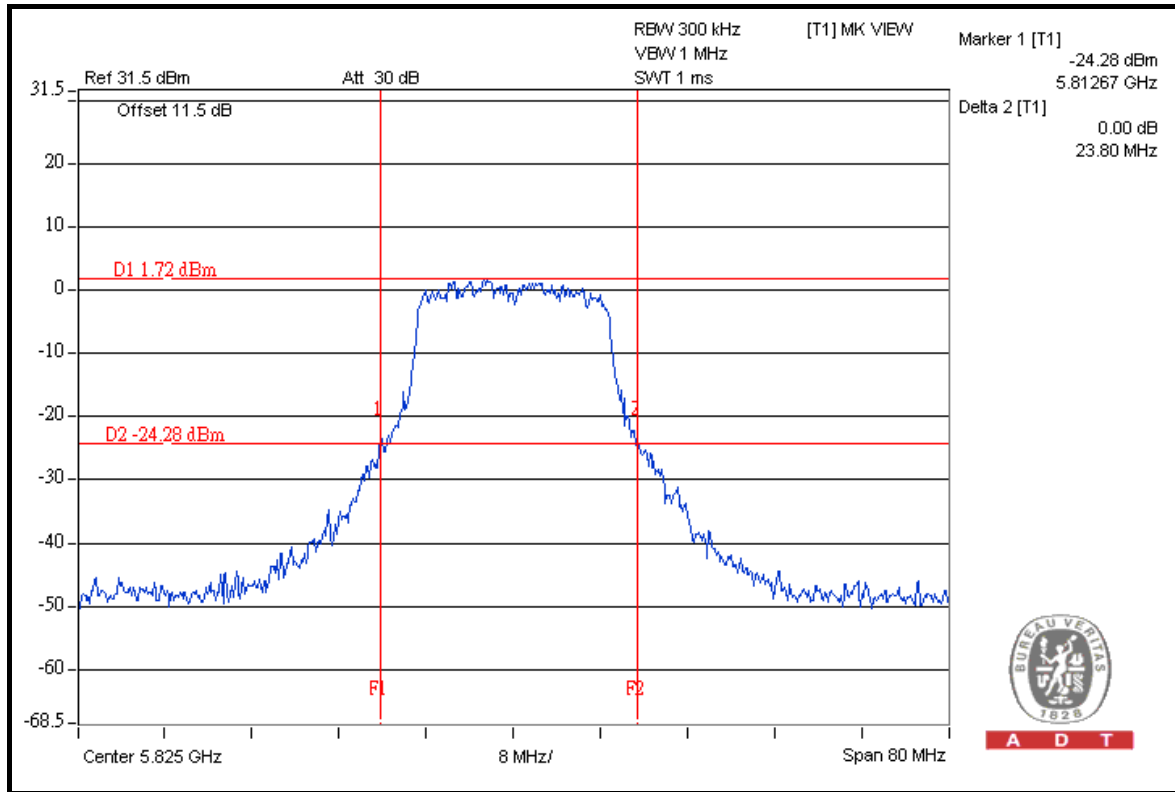

FOR CHAIN 1: CH 149

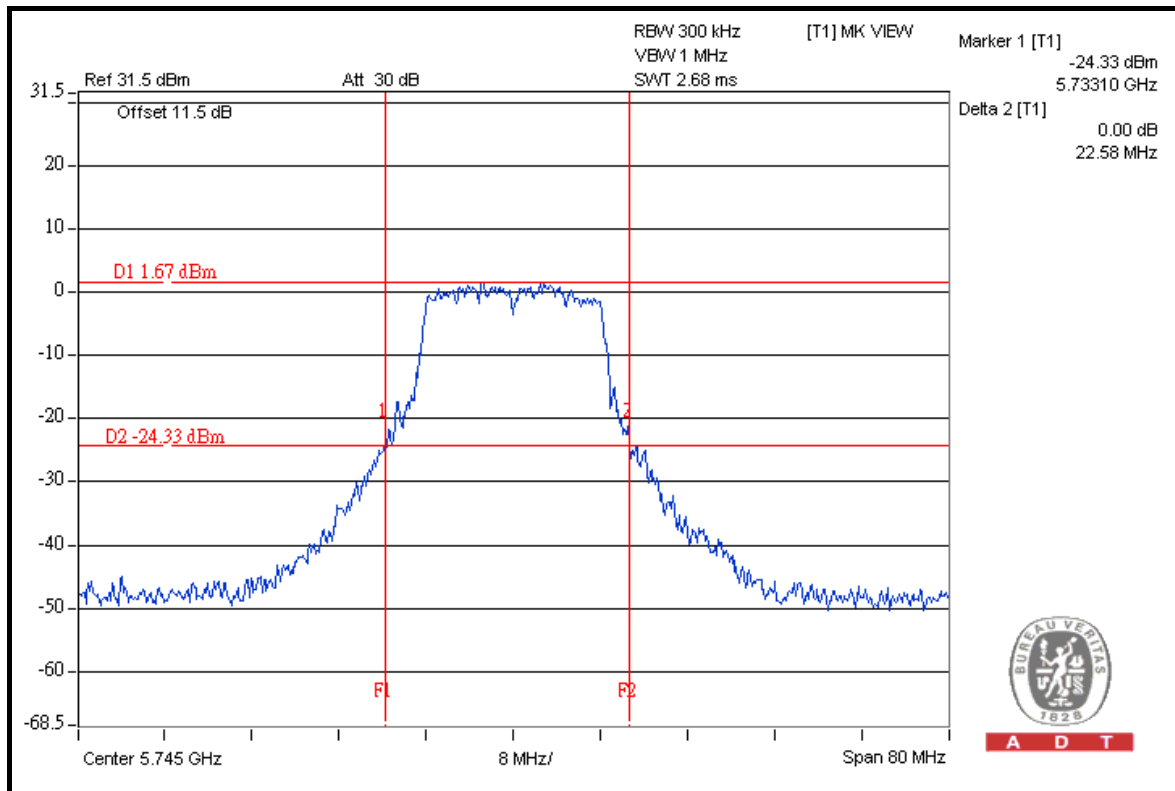



A D T

CH 157

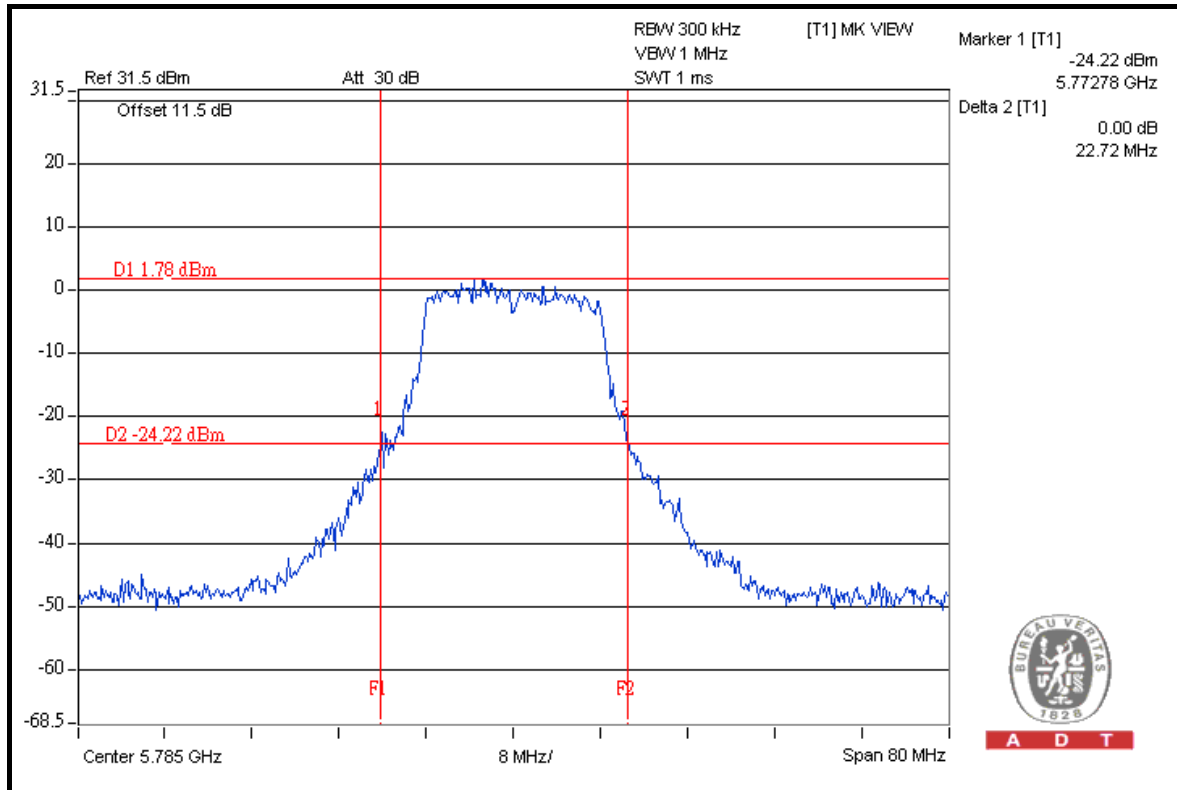

A D T

CH 165

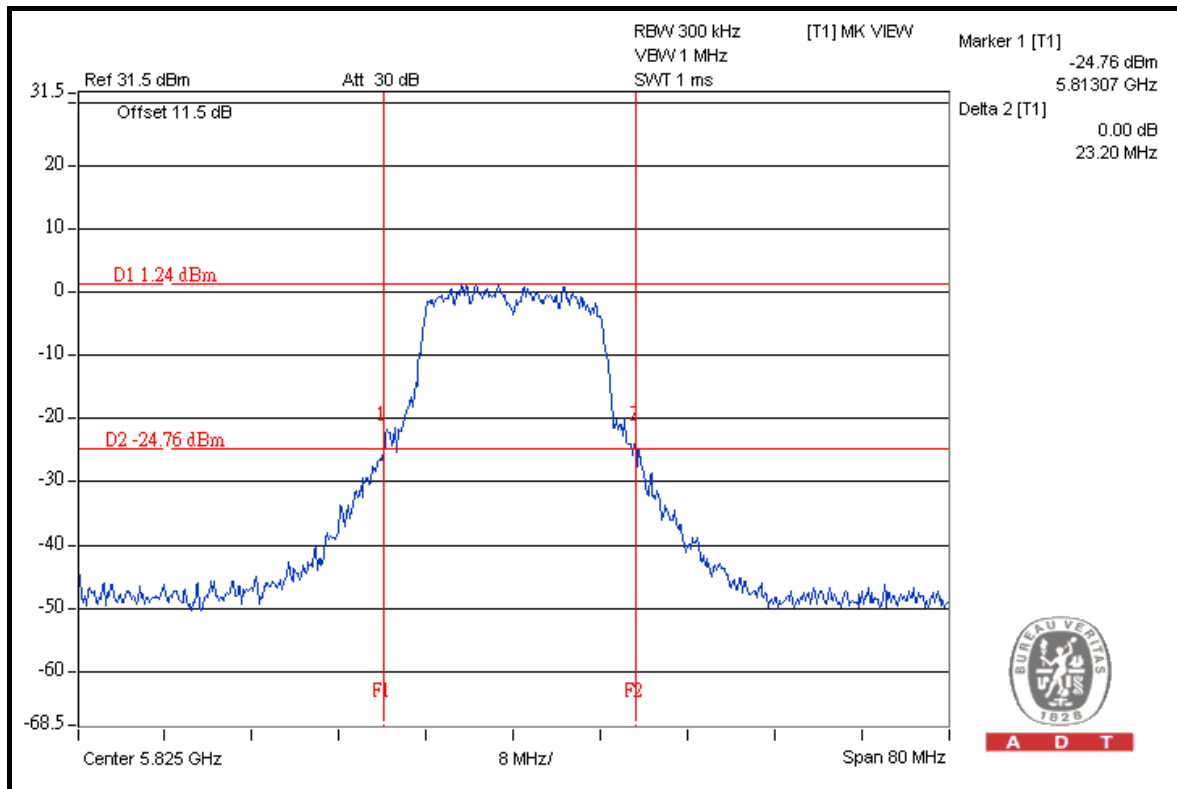

A D T



A D T

DRAFT 802.11n (40MHz) OFDM MODULATION

MODULATION TYPE	OFDM	TRANSFER RATE	13.5Mbps
INPUT POWER (SYSTEM)	120Vac, 60Hz	ENVIRONMENTAL CONDITIONS	25deg.C, 65%RH, 991hPa
TESTED BY	Brad Wu	TEST MODE	A

CHANNEL	CHANNEL FREQUENCY (MHz)	26dBc OCCUPIED BANDWIDTH (MHz)			PASS / FAIL
		CHAIN 0	CHAIN 1	CHAIN 2	
151	5755	75.69	78.08	77.17	PASS
159	5795	75.83	77.27	74.80	PASS



A D T

FOR CHAIN 0: CH 151

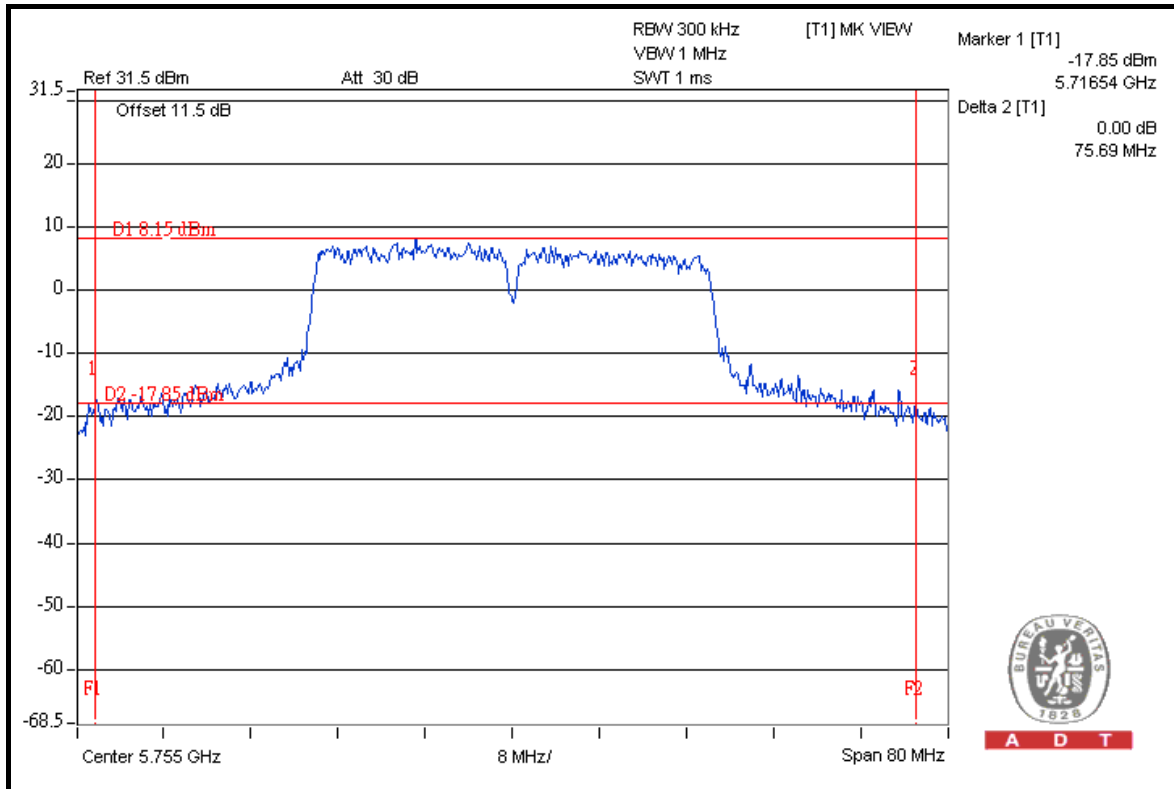

CH 159

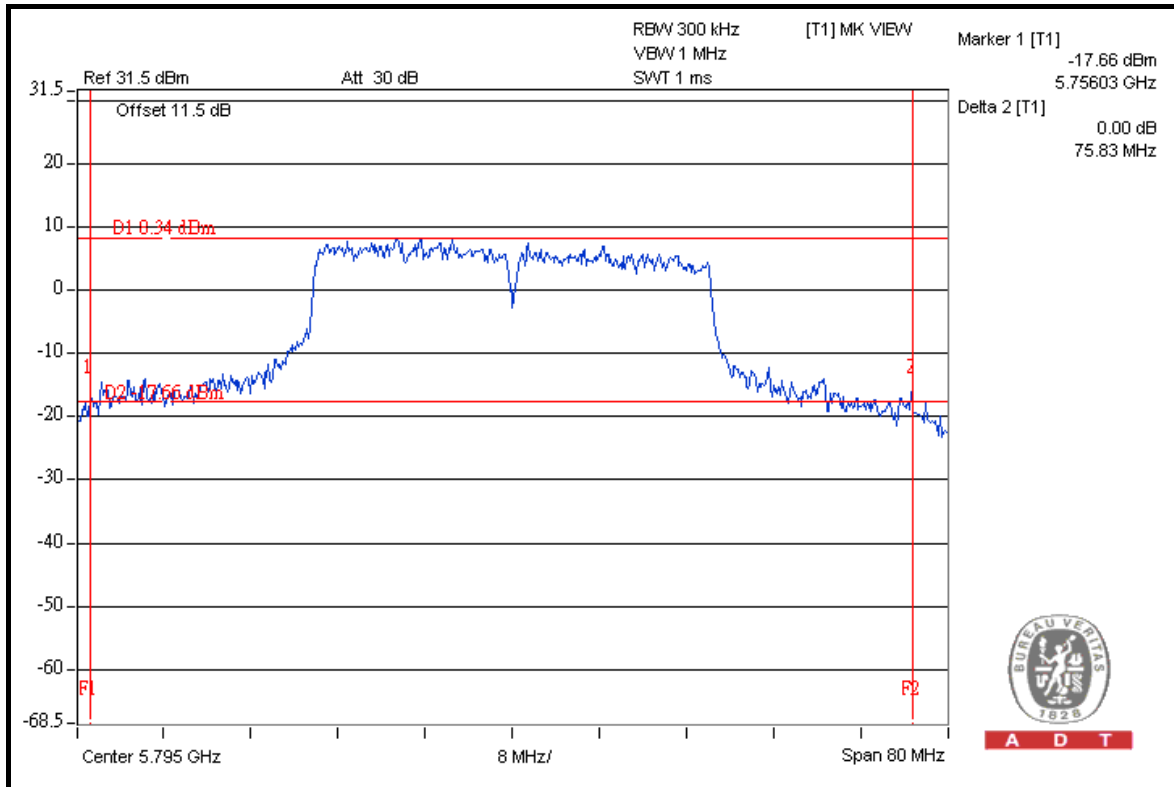



A D T

FOR CHAIN 1: CH 151

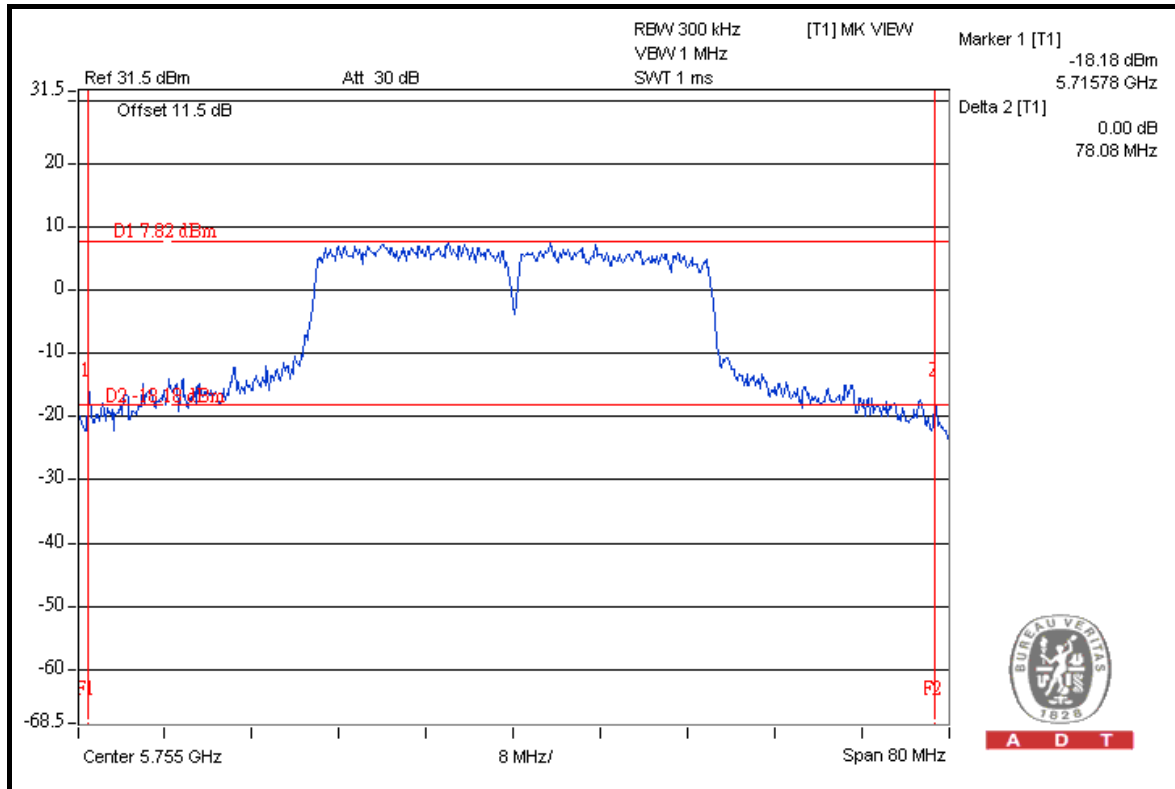

A D T

CH 159

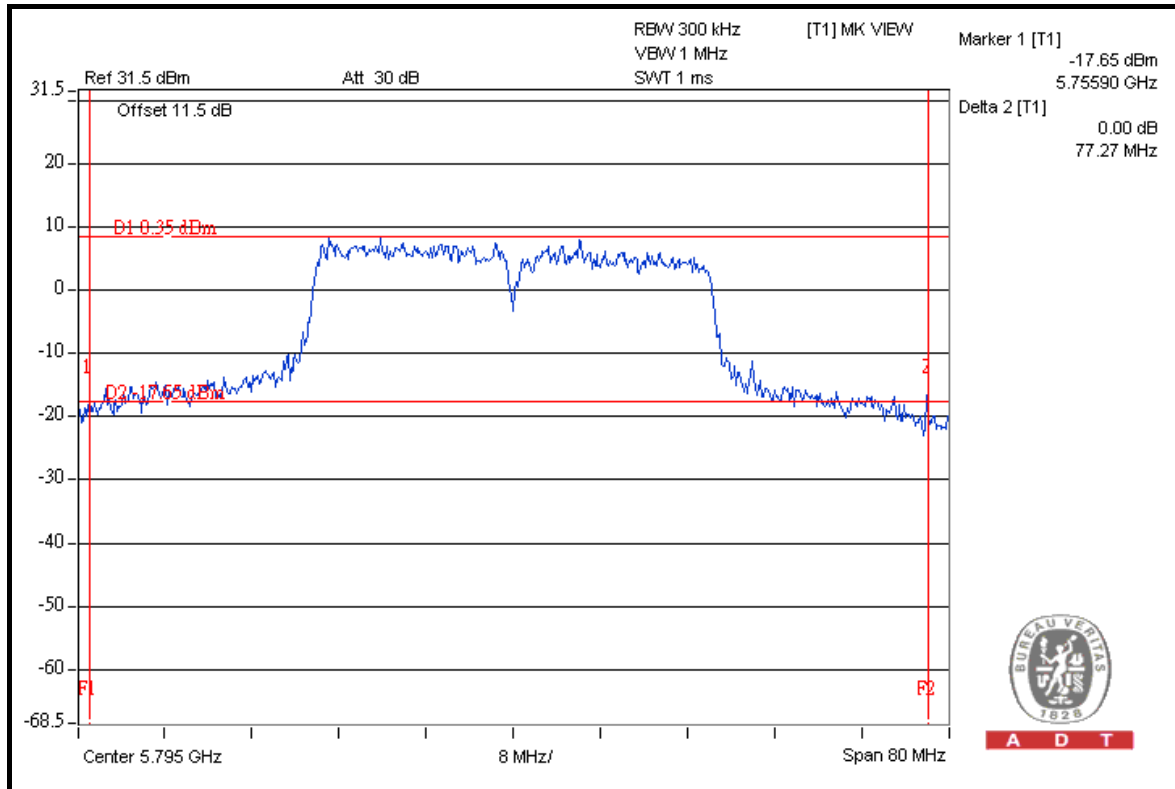

A D T



A D T

FOR CHAIN 2: CH 151

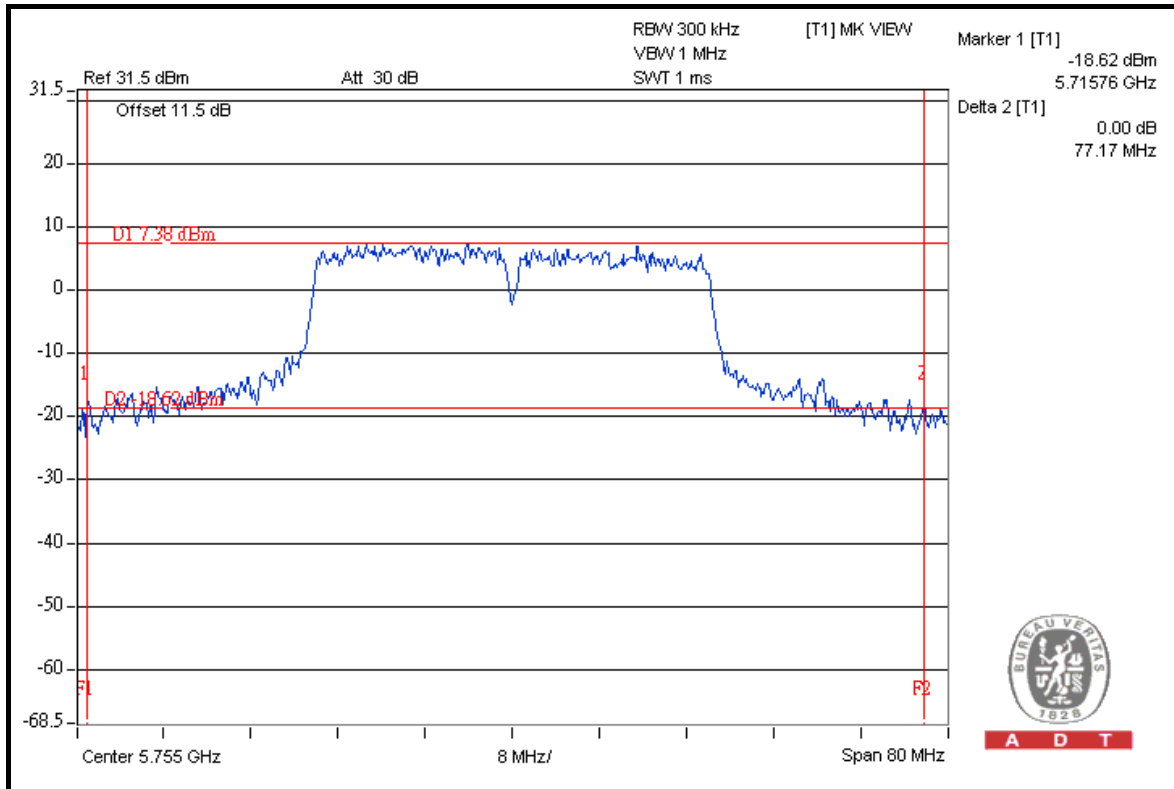

A D T

CH 159

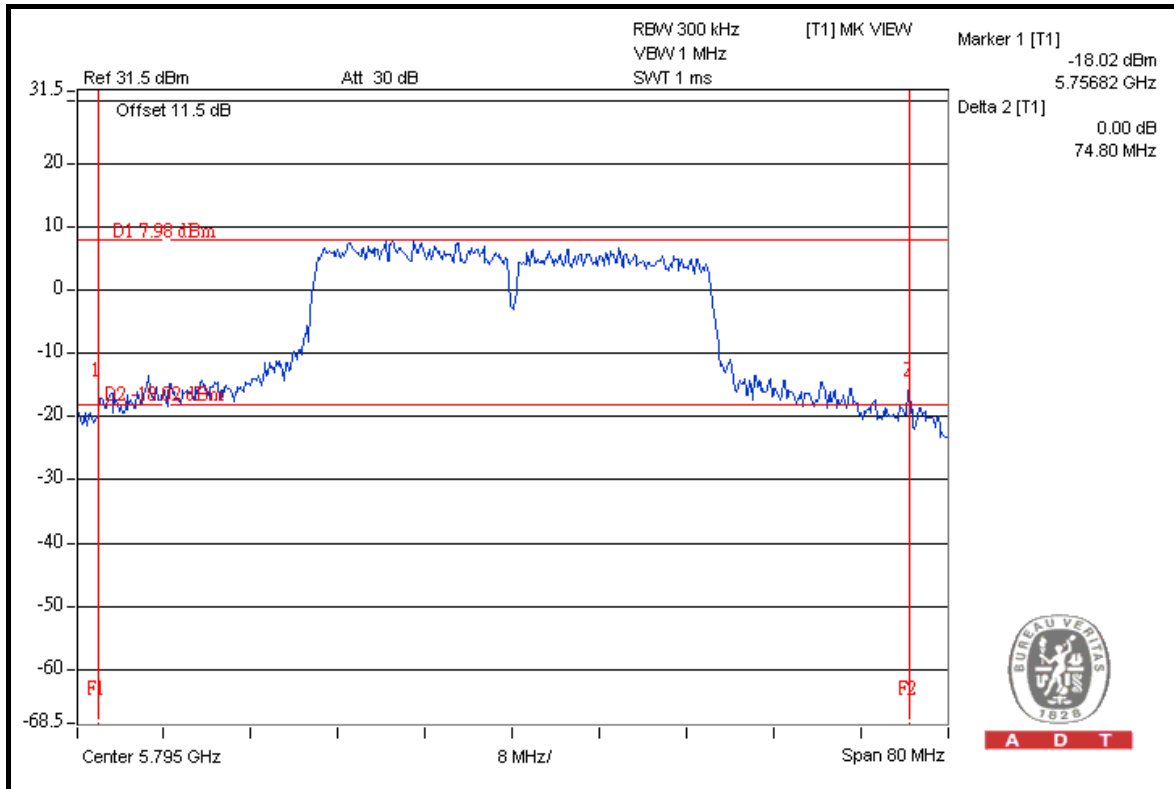

A D T



A D T

DRAFT 802.11n (40MHz) OFDM MODULATION

MODULATION TYPE	OFDM	TRANSFER RATE	13.5Mbps
INPUT POWER (SYSTEM)	120Vac, 60Hz	ENVIRONMENTAL CONDITIONS	25deg.C, 65%RH, 991hPa
TESTED BY	Brad Wu	TEST MODE	C

CHANNEL	CHANNEL FREQUENCY (MHz)	26dBc OCCUPIED BANDWIDTH (MHz)		PASS / FAIL
		CHAIN 0	CHAIN 1	
151	5755	45.16	44.19	PASS
159	5795	45.31	43.97	PASS



A D T

FOR CHAIN 0: CH 151

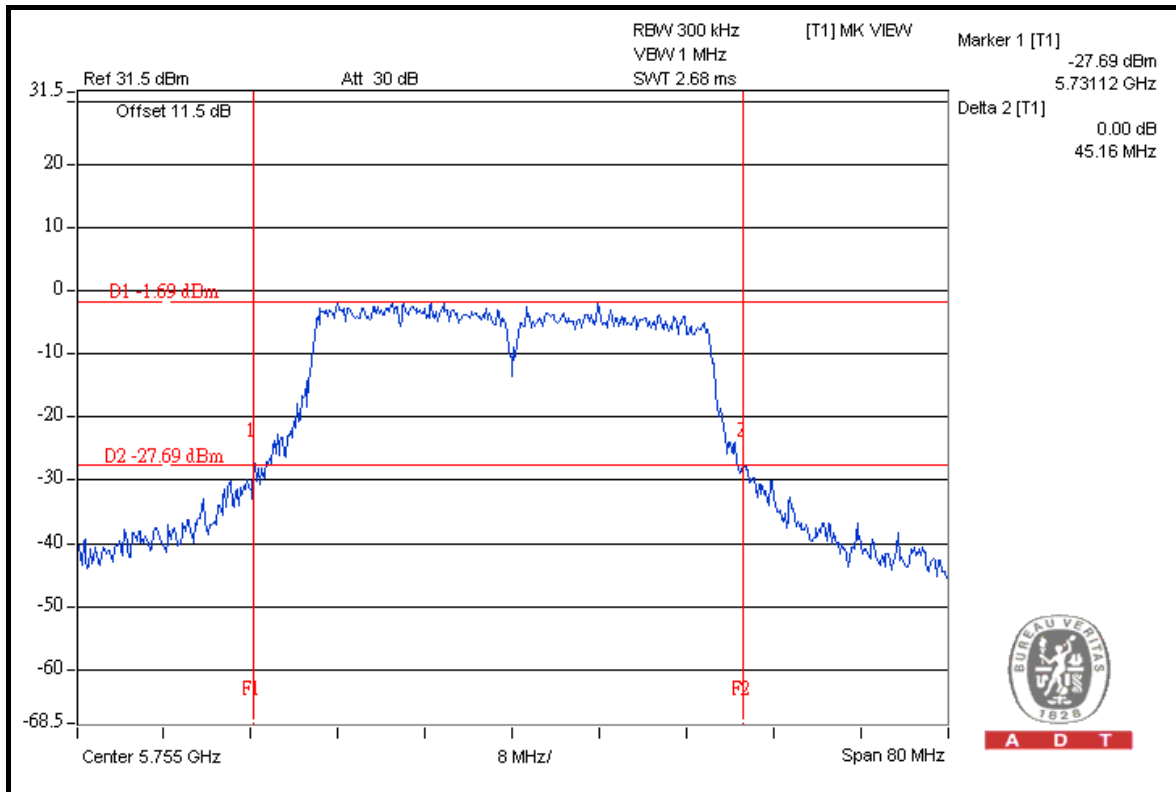

CH 159

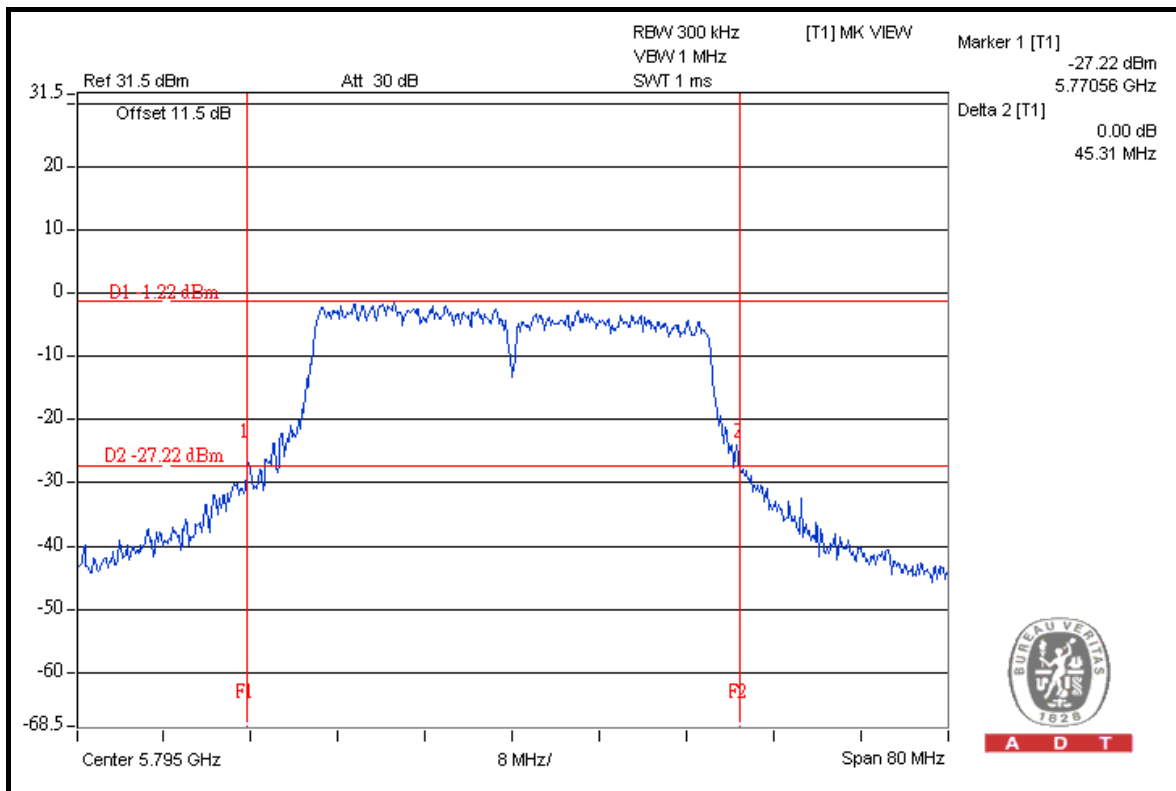



A D T

FOR CHAIN 1: CH 151

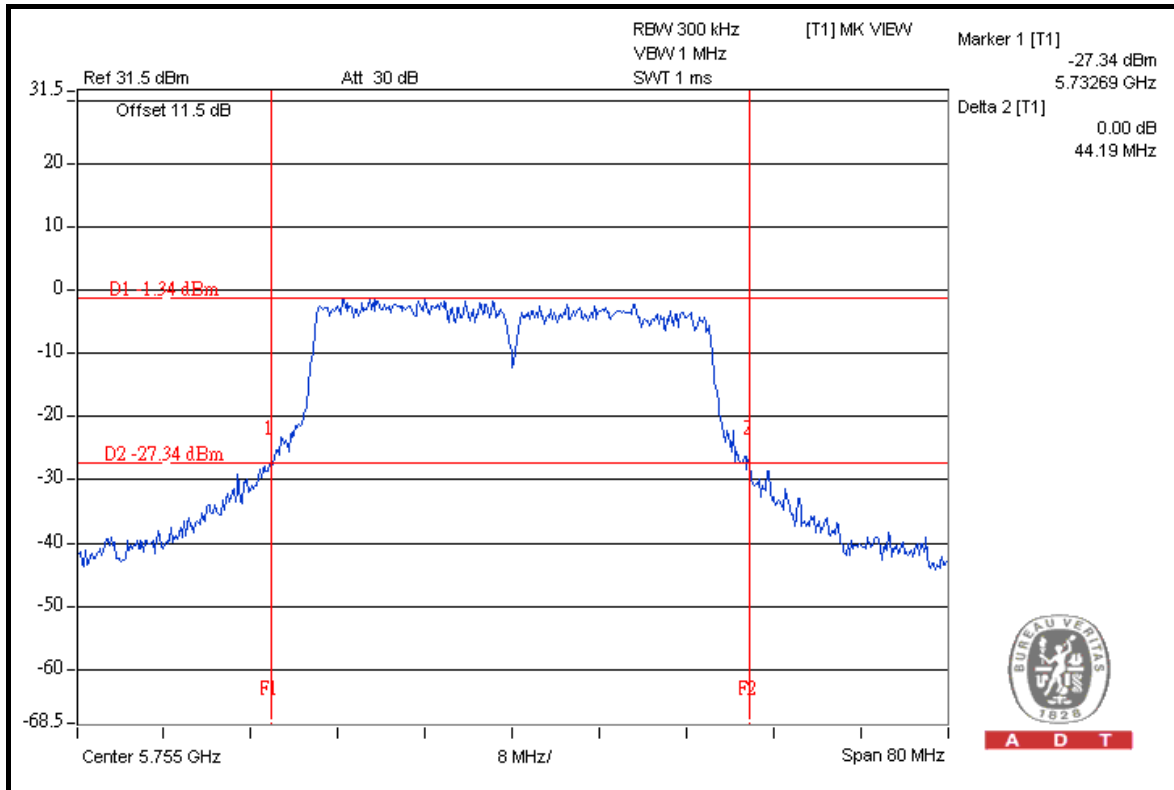

CH 159

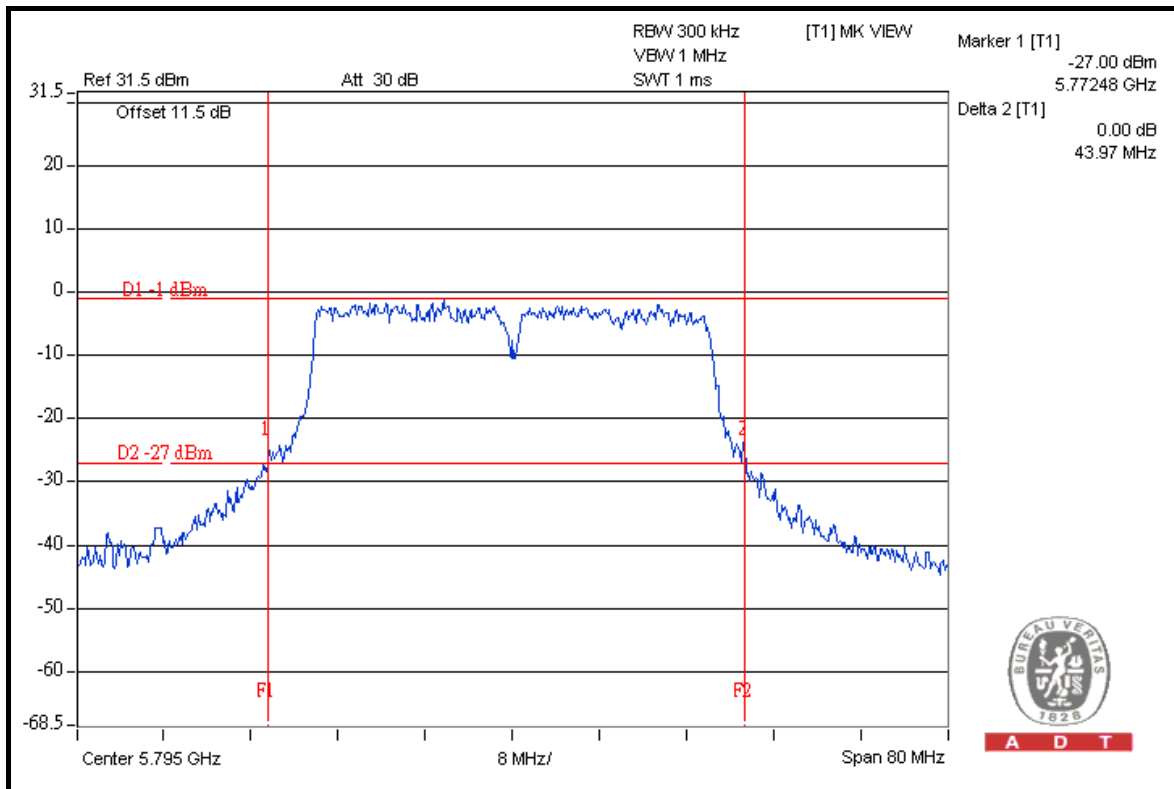



5.5 POWER SPECTRAL DENSITY MEASUREMENT

5.5.1 LIMITS OF POWER SPECTRAL DENSITY MEASUREMENT

The Maximum of Power Spectral Density Measurement is 8dBm.

5.5.2 TEST INSTRUMENTS

DESCRIPTION & MANUFACTURER	MODEL NO.	SERIAL NO.	DATE OF CALIBRATION	DUE DATE OF CALIBRATION
R&S SPECTRUM ANALYZER	FSP40	100041	May 13, 2009	May 12, 2010

NOTE: The calibration interval of the above test instruments is 12 months and the calibrations are traceable to NML/ROC and NIST/USA.

5.5.3 TEST PROCEDURE

1. Follow DTS measurement (PSD Option 2), the transmitter output was connected to the spectrum analyzer through an attenuator, the bandwidth of the fundamental frequency was measured with the spectrum analyzer. Locate and zoom in on emission peak(s) within the pass band.
2. Set RBW = 3 kHz /VBW > 9 kHz and sweep time to Automatic.
3. Detector use peak mode and a video trigger with the trigger level set to enable triggering only on full power pulses.
4. Trace average 100 traces in power averaging mode. The power spectral density was measured and recorded.

5.5.4 DEVIATION FROM TEST STANDARD

No deviation.

5.5.5 TEST SETUP

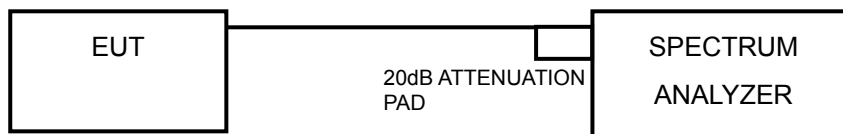

5.5.6 EUT OPERATING CONDITION

Same as Item 5.3.6.



A D T

5.5.7 TEST RESULTS

802.11a OFDM MODULATION

MODULATION TYPE	BPSK	TRANSFER RATE	6.0Mbps
INPUT POWER	120Vac, 60Hz	ENVIRONMENTAL CONDITIONS	25 deg.C, 65%RH, 1021hPa
TESTED BY	Brad Wu	TEST MODE	A

CHAN.	CHAN. FREQ. (MHz)	RF POWER LEVEL IN 3kHz BW (dBm)			TOTAL POWER DENSITY (mW)	TOTAL POWER DENSITY (dBm)	MAX. LIMIT (dBm)	PASS / FAIL
		CHAIN 0	CHAIN 1	CHAIN 2				
149	5745	-9.83	-9.80	-9.72	0.315	-5.02	8	PASS
157	5785	-9.68	-9.67	-9.50	0.328	-4.84	8	PASS
165	5825	-9.68	-9.93	-9.55	0.320	-4.95	8	PASS

FOR CHAIN 0: CH 149

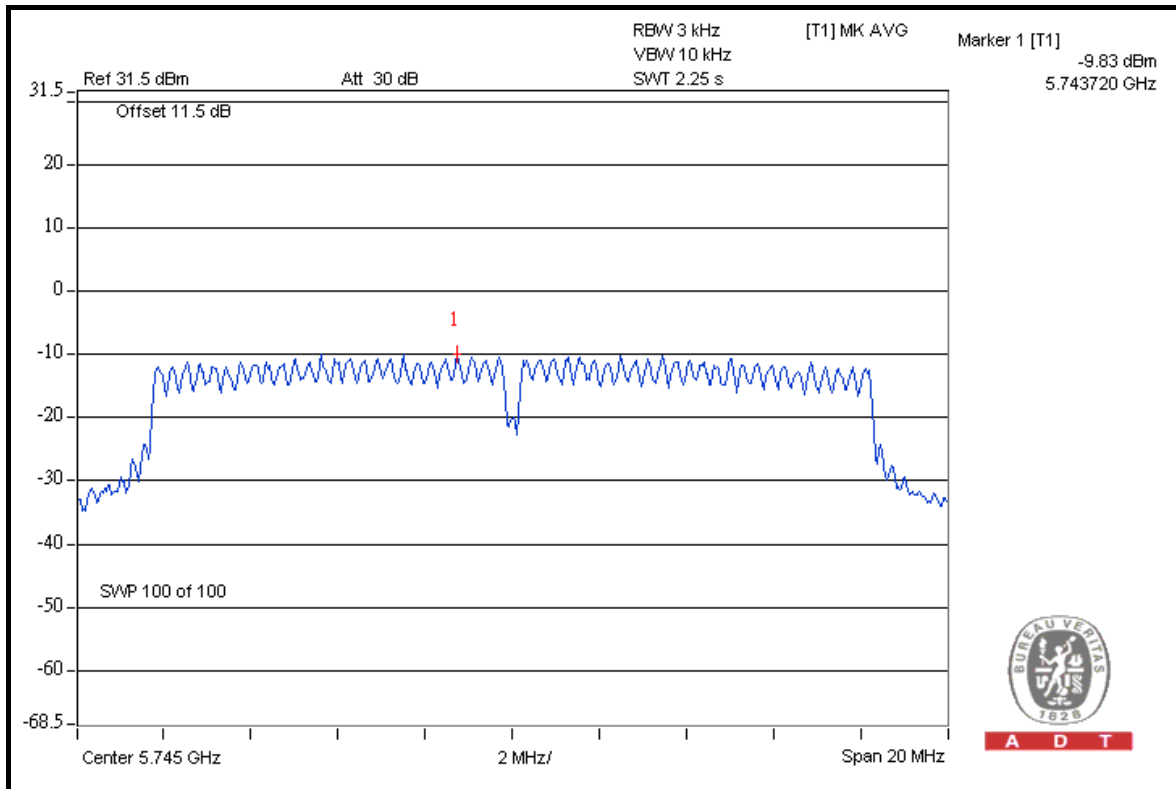

A D T



A D T

CH 157

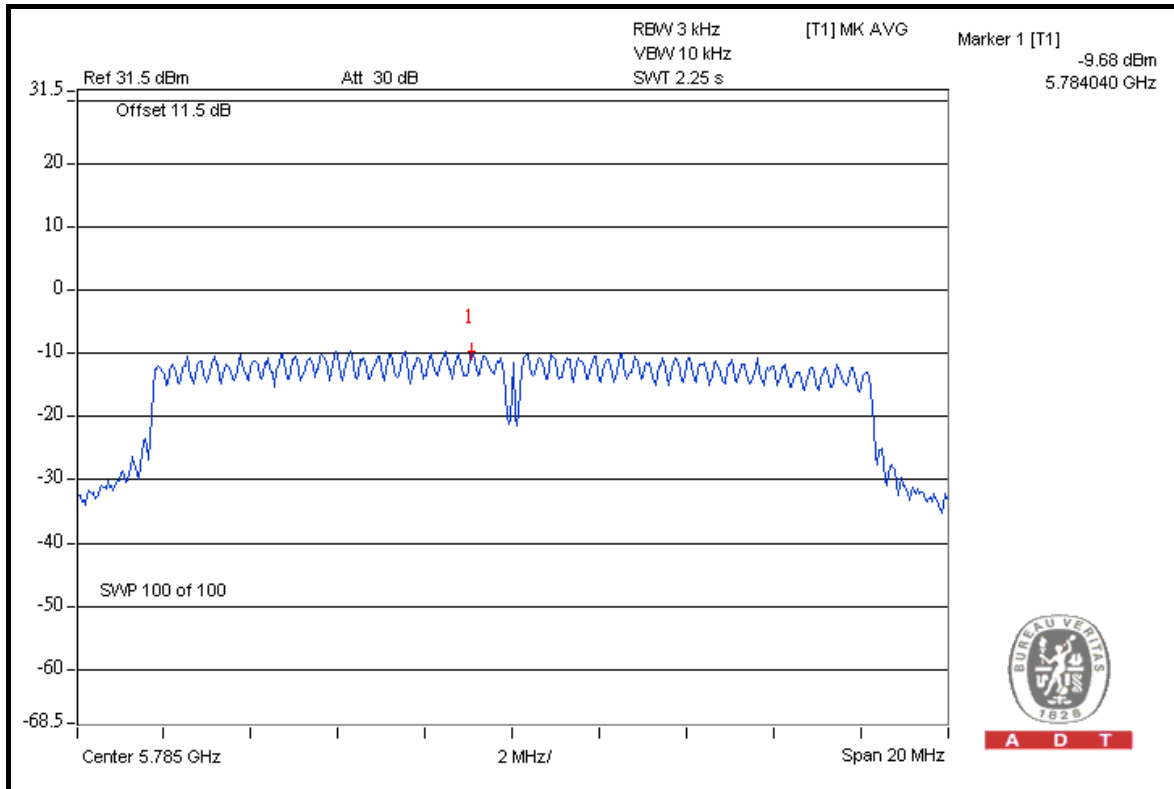

A D T

CH 165

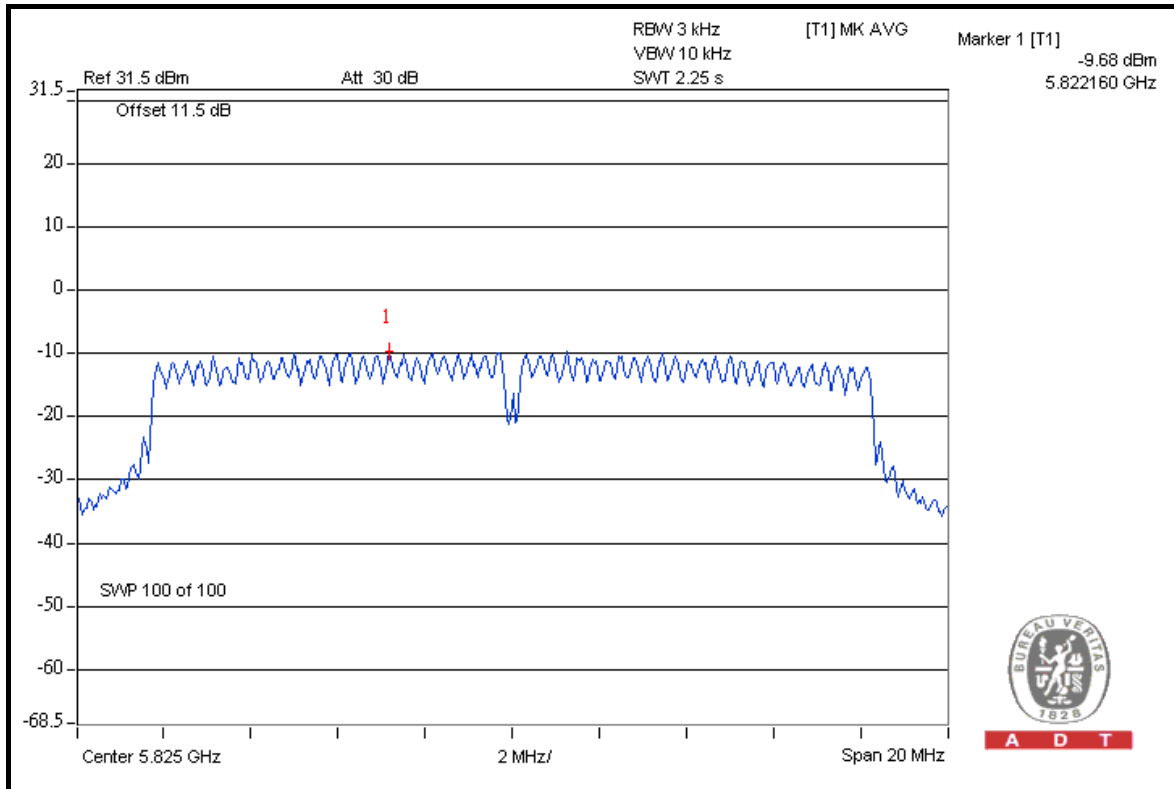

A D T



A D T

FOR CHAIN 1: CH 149

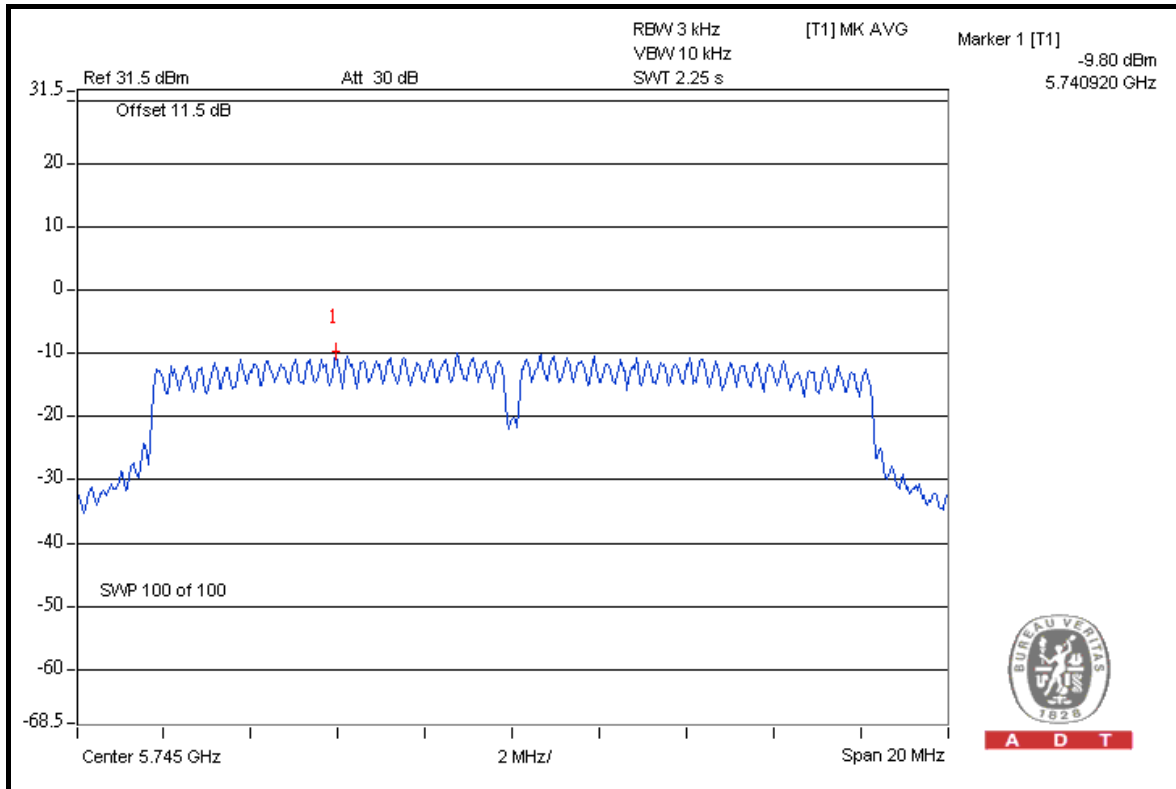

CH 157

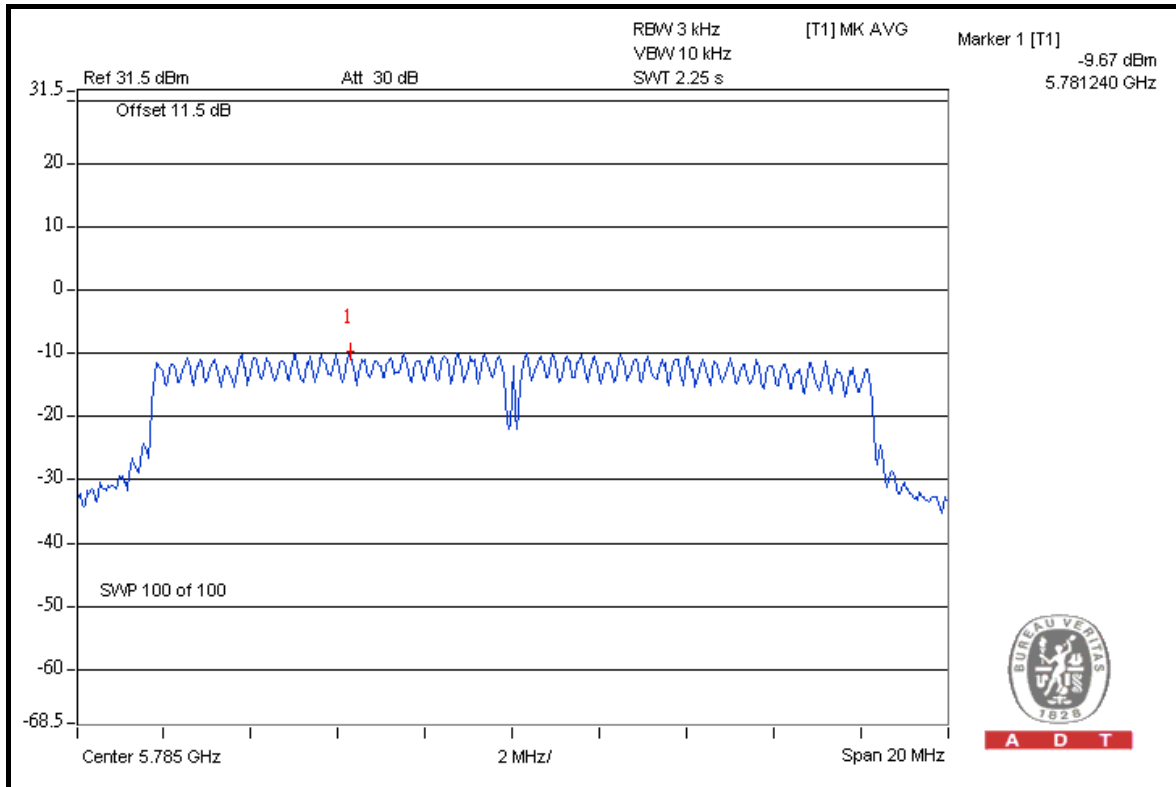



A D T

CH 165

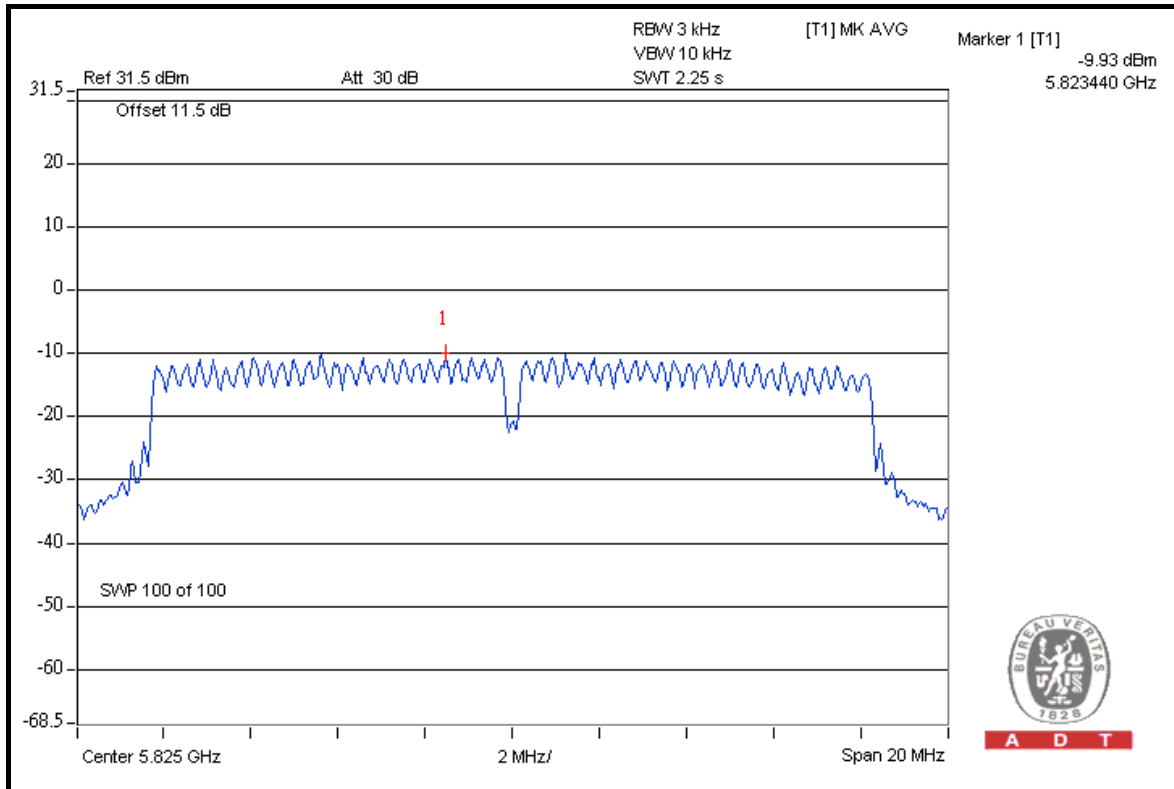

FOR CHAIN 2: CH 149

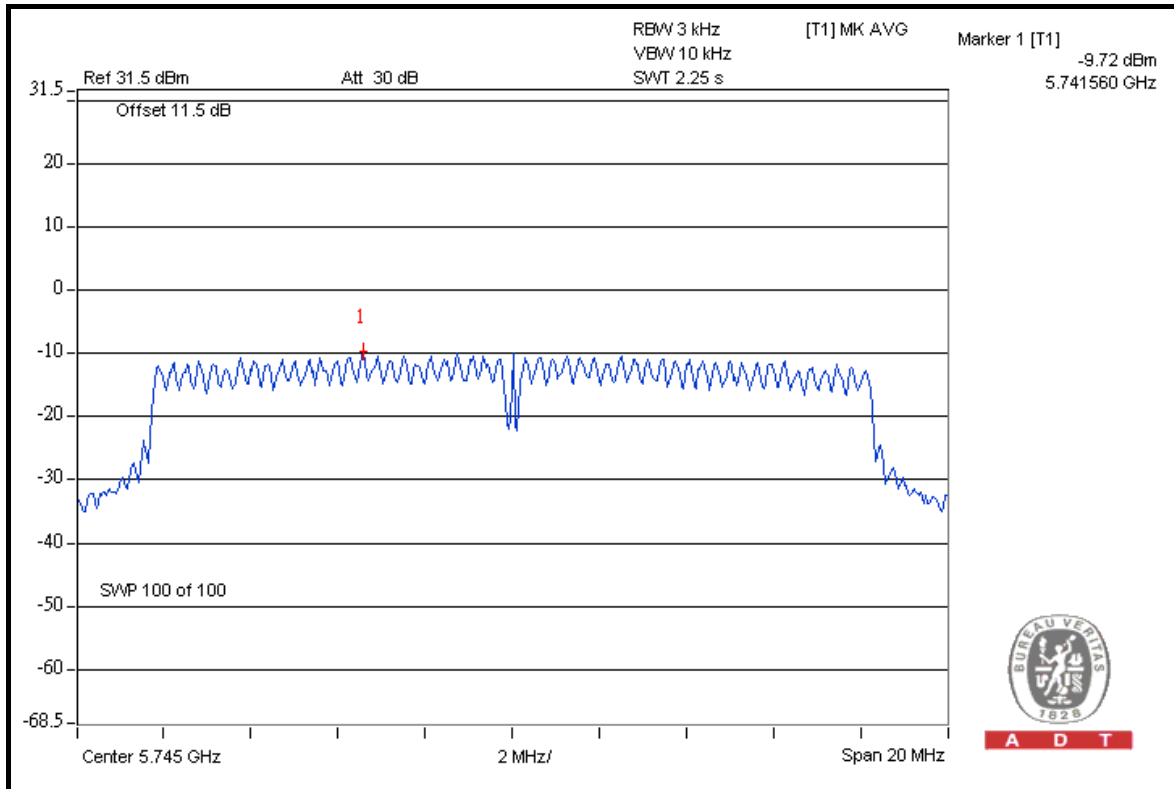



A D T

CH 157

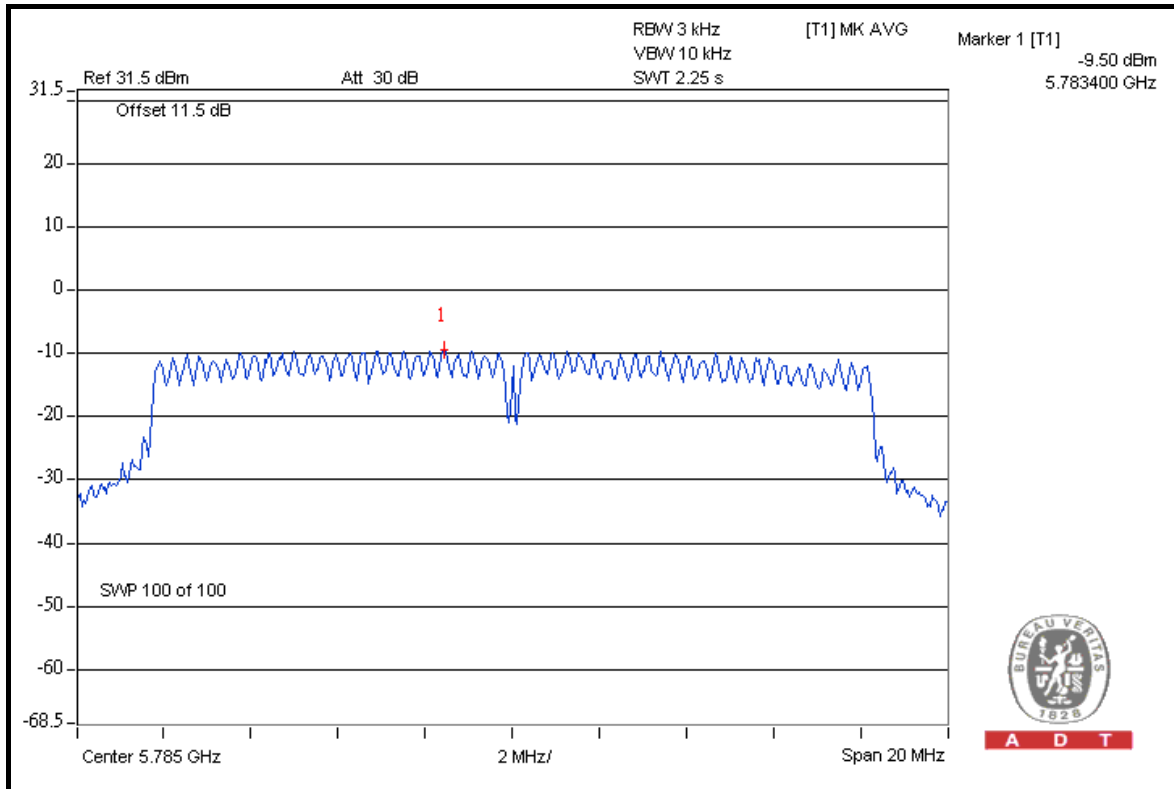

CH 165

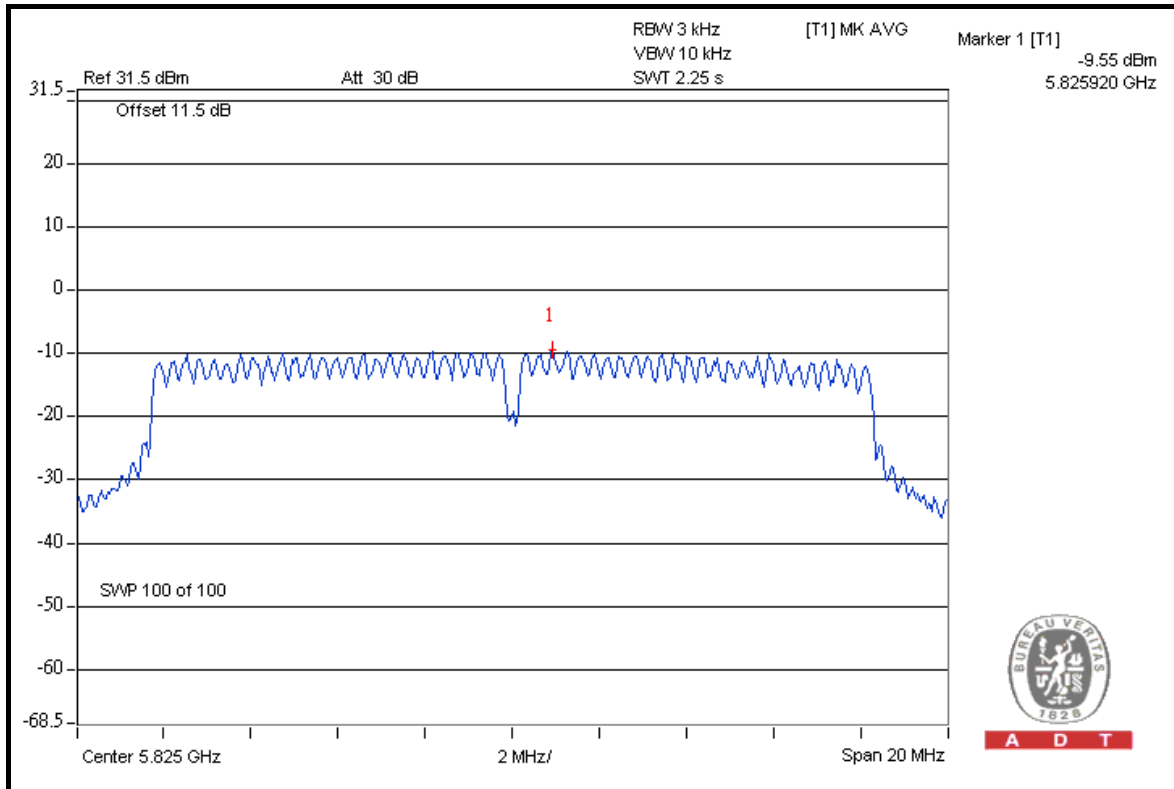



A D T

802.11a OFDM MODULATION

MODULATION TYPE	BPSK	TRANSFER RATE	6.0Mbps
INPUT POWER	120Vac, 60Hz	ENVIRONMENTAL CONDITIONS	25 deg.C, 65%RH, 1021hPa
TESTED BY	Brad Wu	TEST MODE	C

CHAN.	CHAN. FREQ. (MHz)	RF POWER LEVEL IN 3kHz BW (dBm)		TOTAL POWER DENSITY (mW)	TOTAL POWER DENSITY (dBm)	MAX. LIMIT (dBm)	PASS / FAIL
		CHAIN 0	CHAIN 1				
149	5745	-18.25	-17.97	0.031	-15.09	8	PASS
157	5785	-18.10	-18.19	0.031	-15.09	8	PASS
165	5825	-18.46	-17.78	0.031	-15.09	8	PASS



A D T

FOR CHAIN 0: CH 149

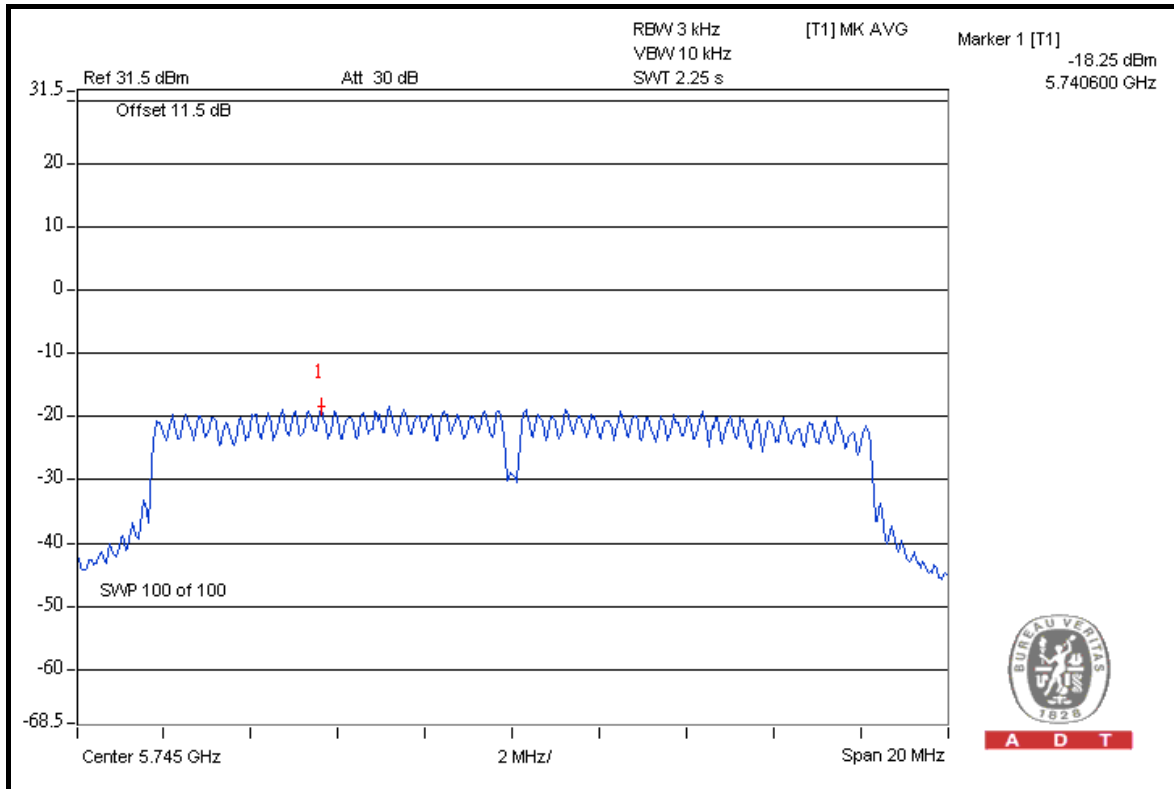

CH 157

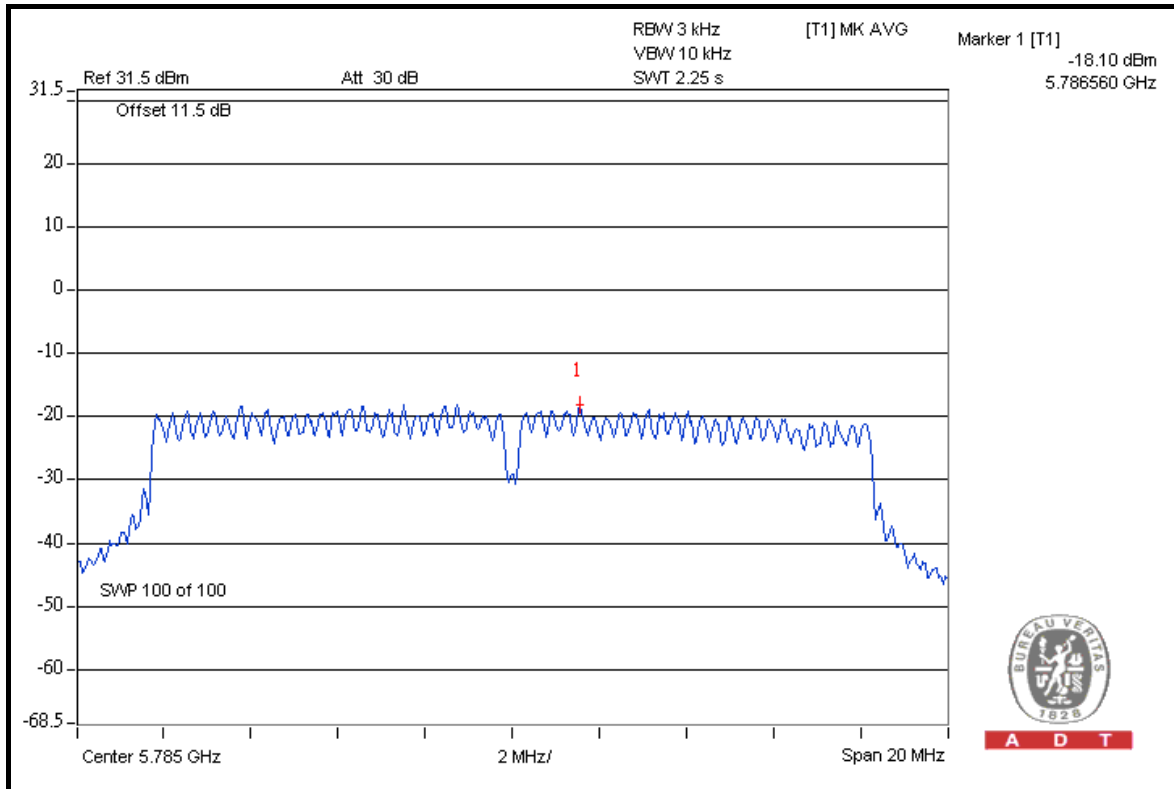



A D T

CH 165

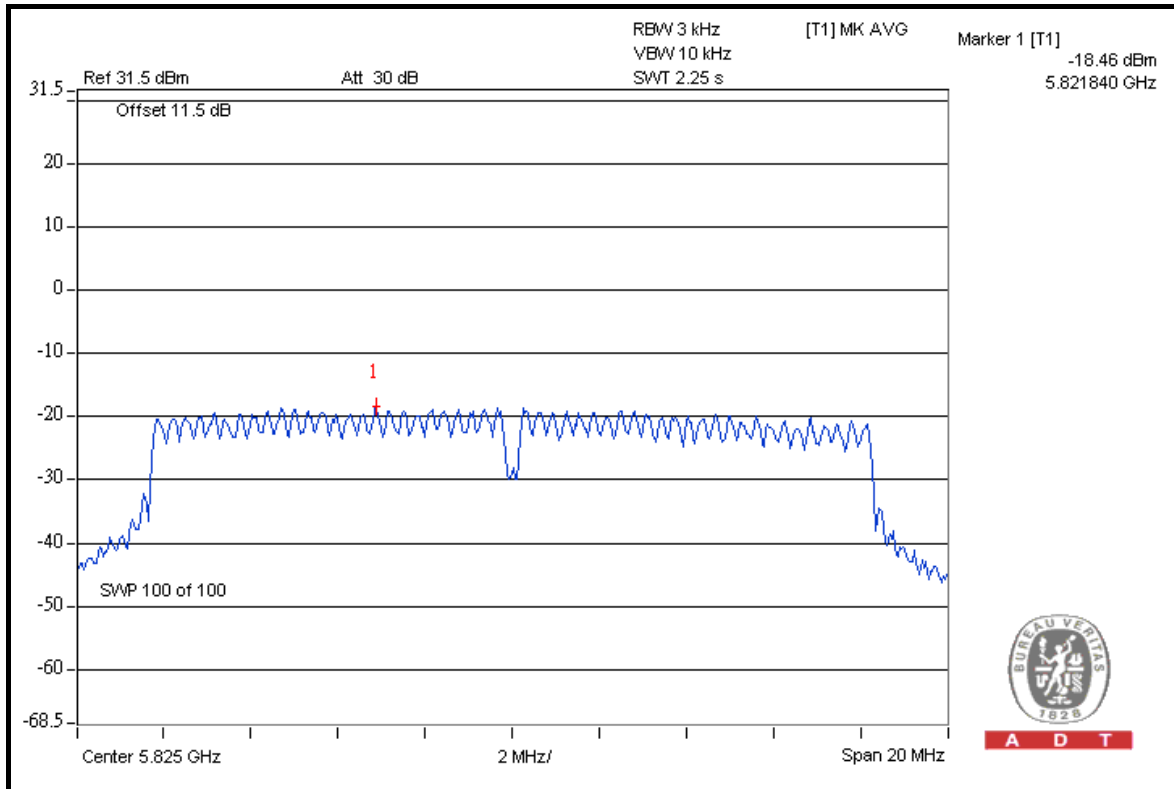

FOR CHAIN 1: CH 149

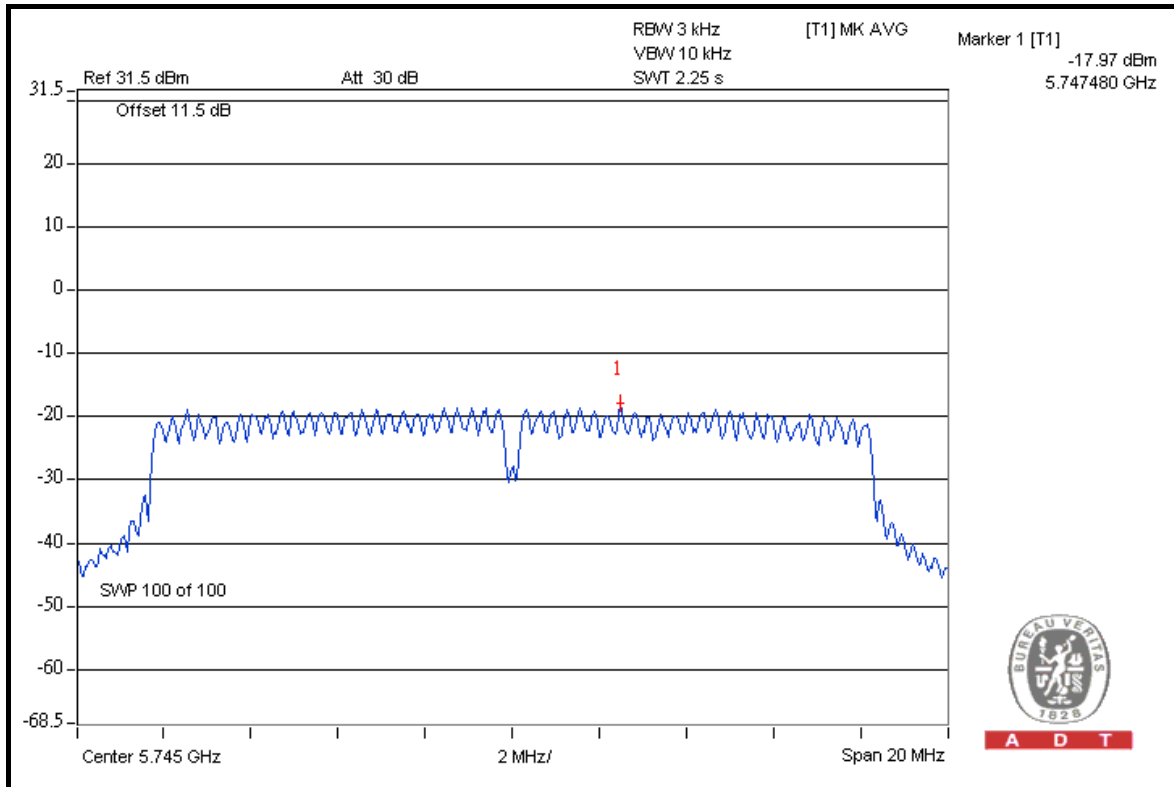



A D T

CH 157

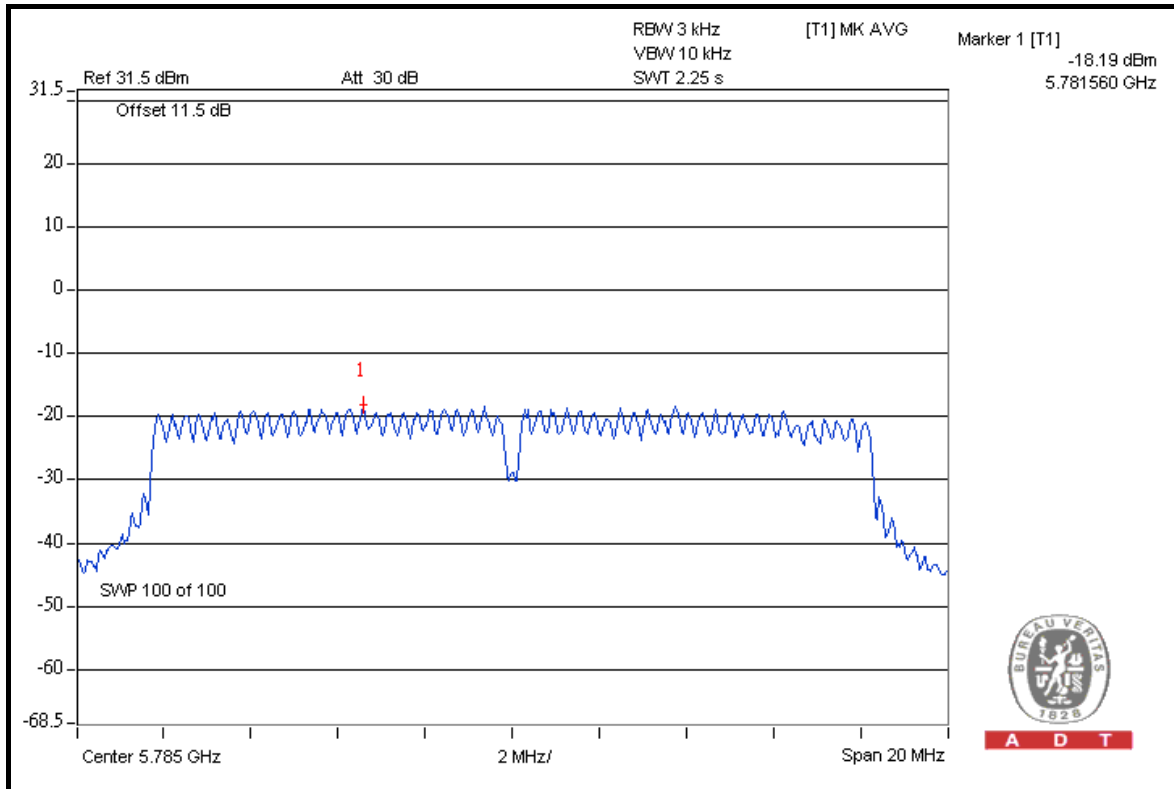

CH 165

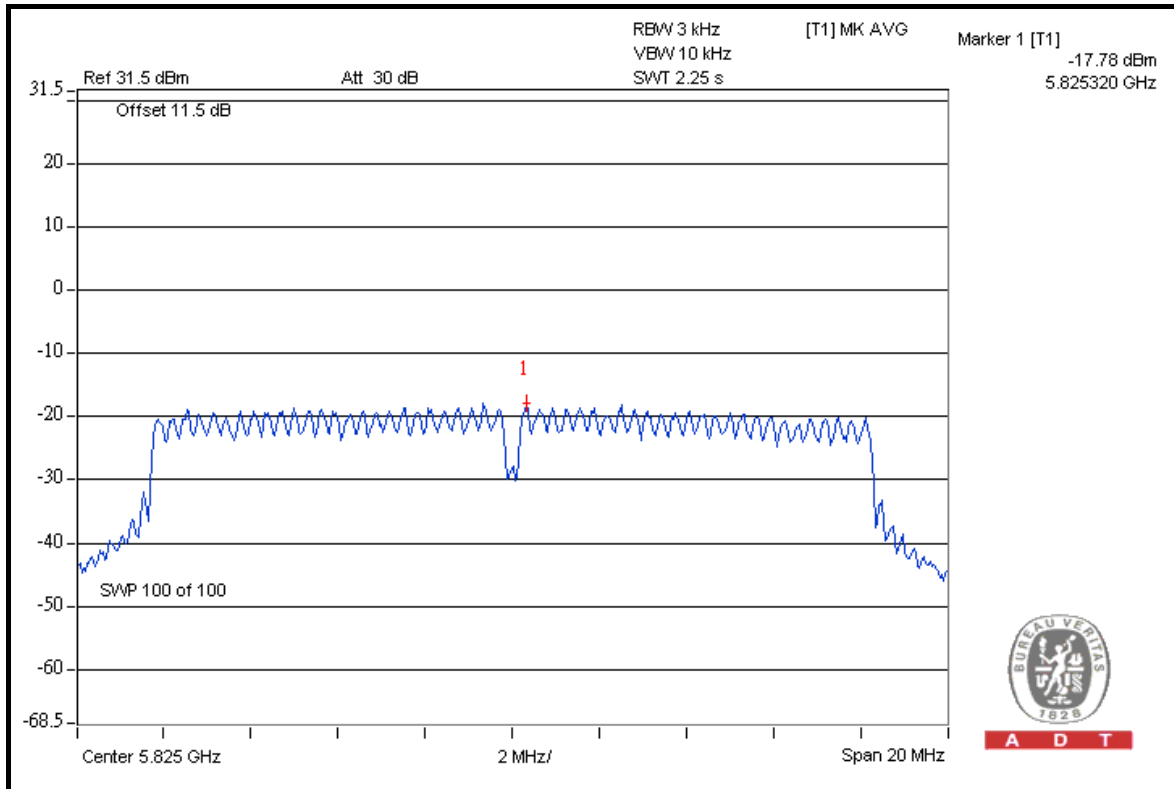



A D T

DRAFT 802.11n (20MHz) OFDM MODULATION

MODULATION TYPE	BPSK	TRANSFER RATE	6.5Mbps
INPUT POWER	120Vac, 60Hz	ENVIRONMENTAL CONDITIONS	25 deg.C, 65%RH, 991hPa
TESTED BY	Brad Wu	TEST MODE	A

CHAN.	CHAN. FREQ. (MHz)	RF POWER LEVEL IN 3kHz BW (dBm)			TOTAL POWER DENSITY (mW)	TOTAL POWER DENSITY (dBm)	MAX. LIMIT (dBm)	PASS / FAIL
		CHAIN 0	CHAIN 1	CHAIN 2				
149	5745	-9.03	-9.84	-10.02	0.328	-4.84	8	PASS
157	5785	-8.87	-9.62	-10.13	0.336	-4.74	8	PASS
165	5825	-8.89	-9.66	-9.88	0.340	-4.69	8	PASS

FOR CHAIN 0: CH 149

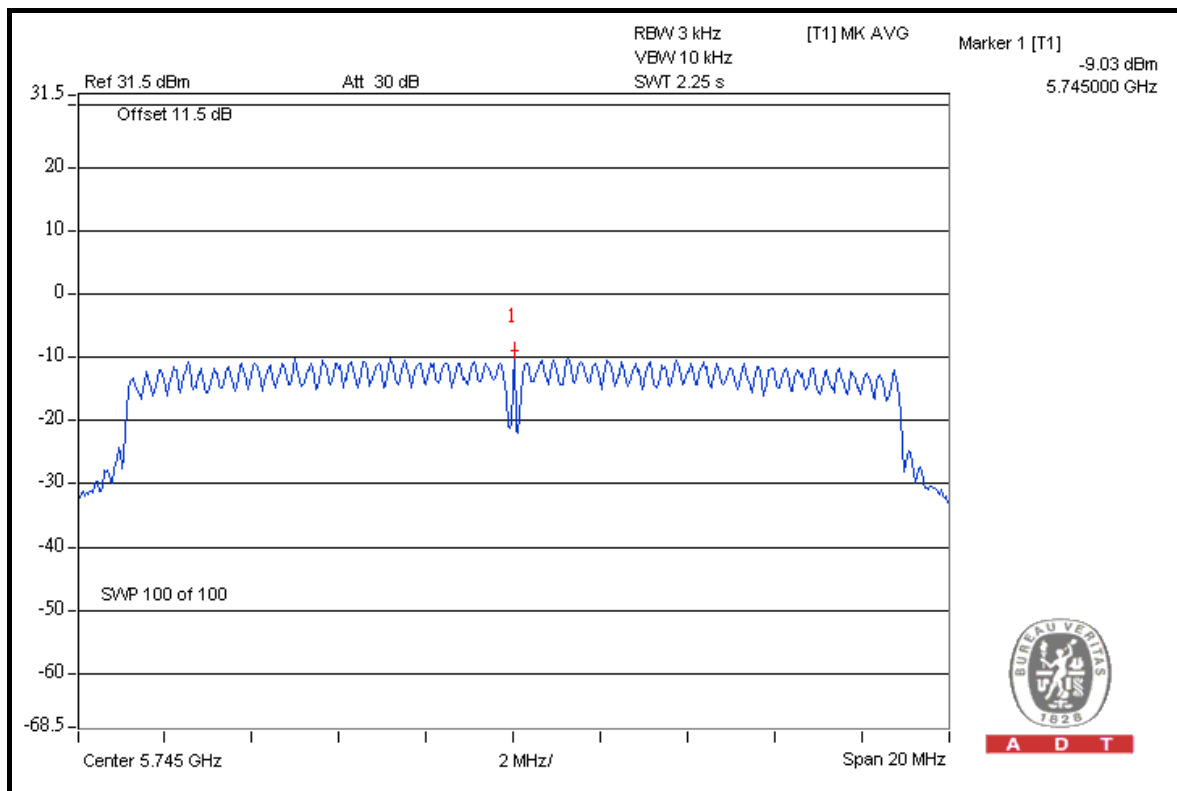

A D T



A D T

CH 157

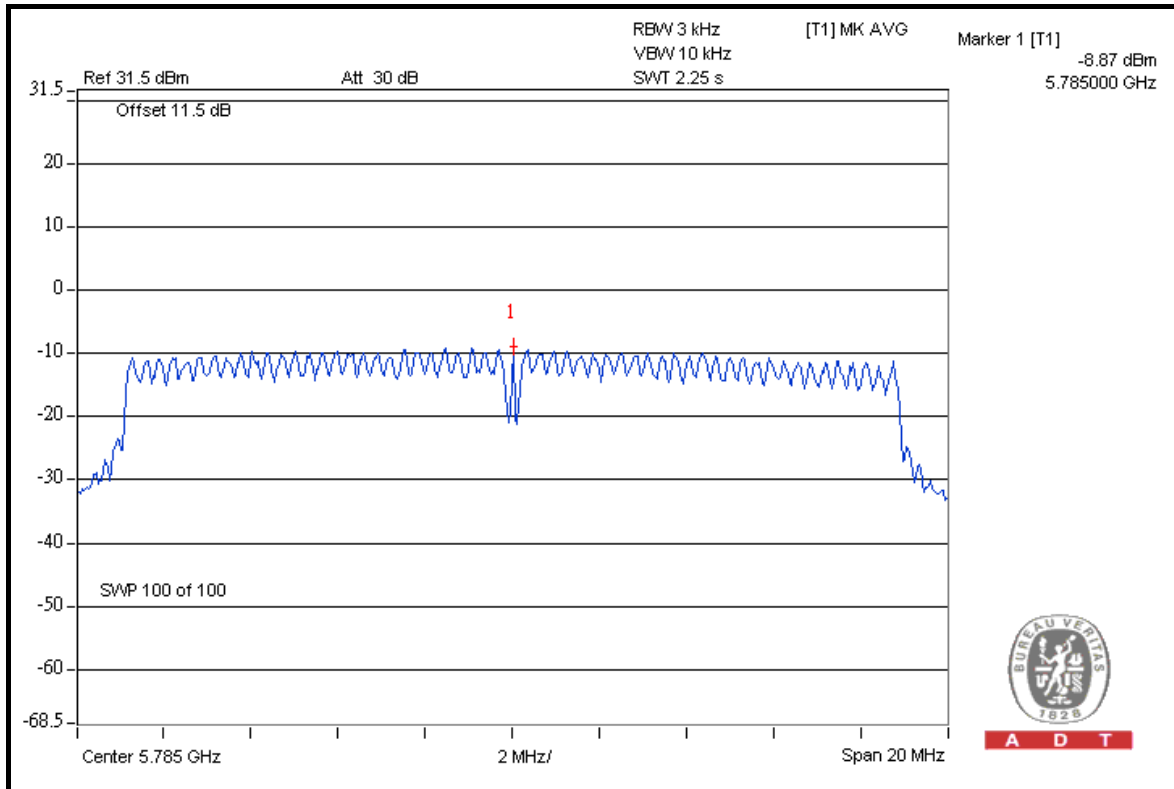

A D T

CH 165

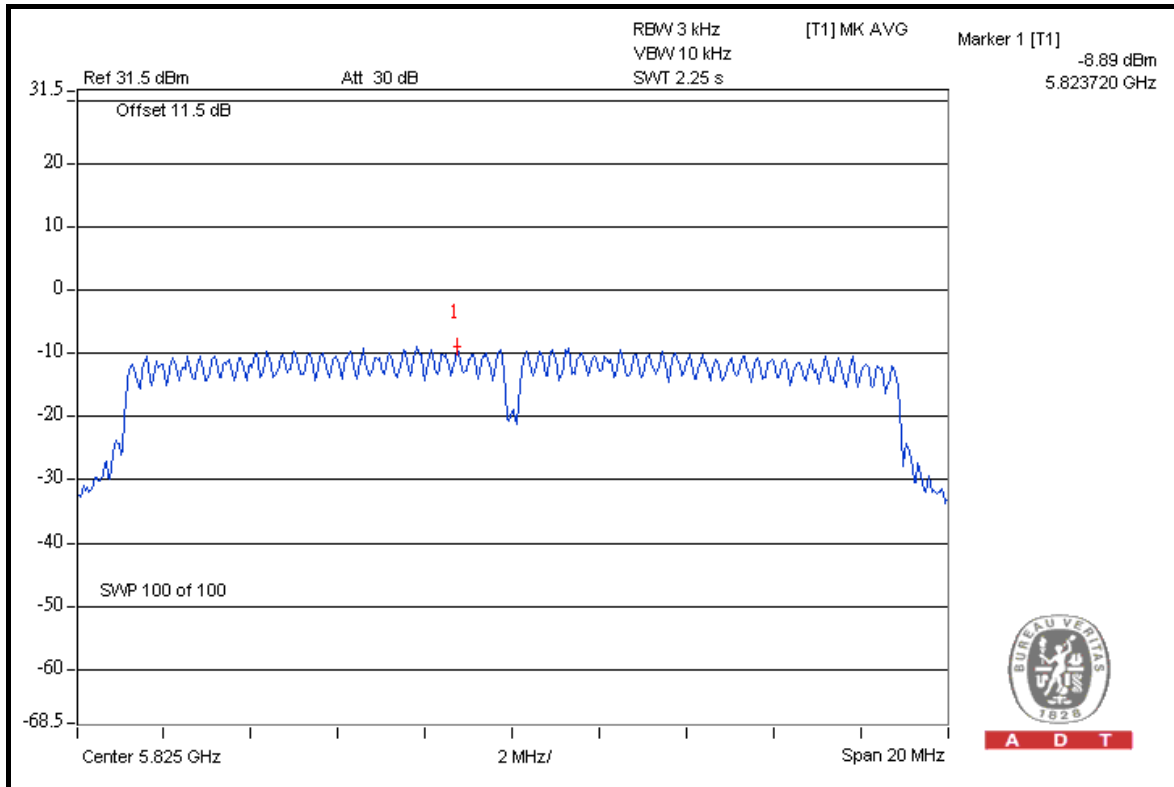

A D T



A D T

FOR CHAIN 1: CH 149

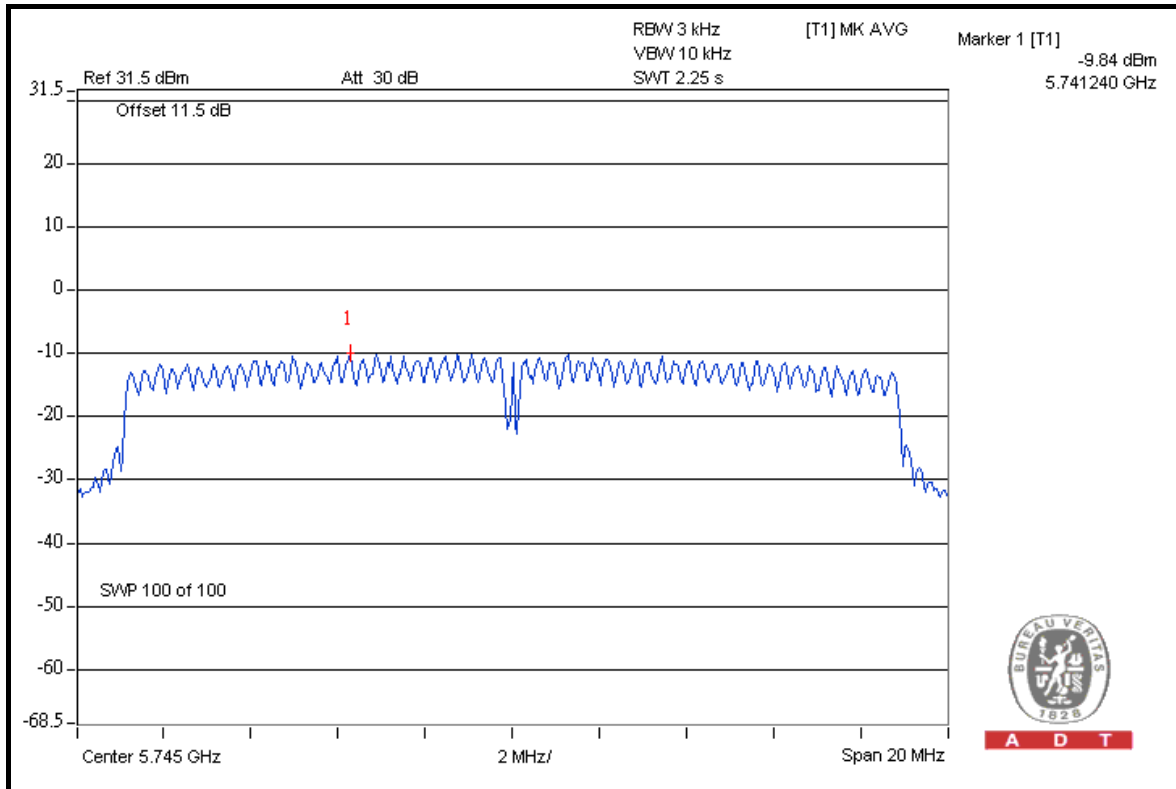

A D T

CH 157

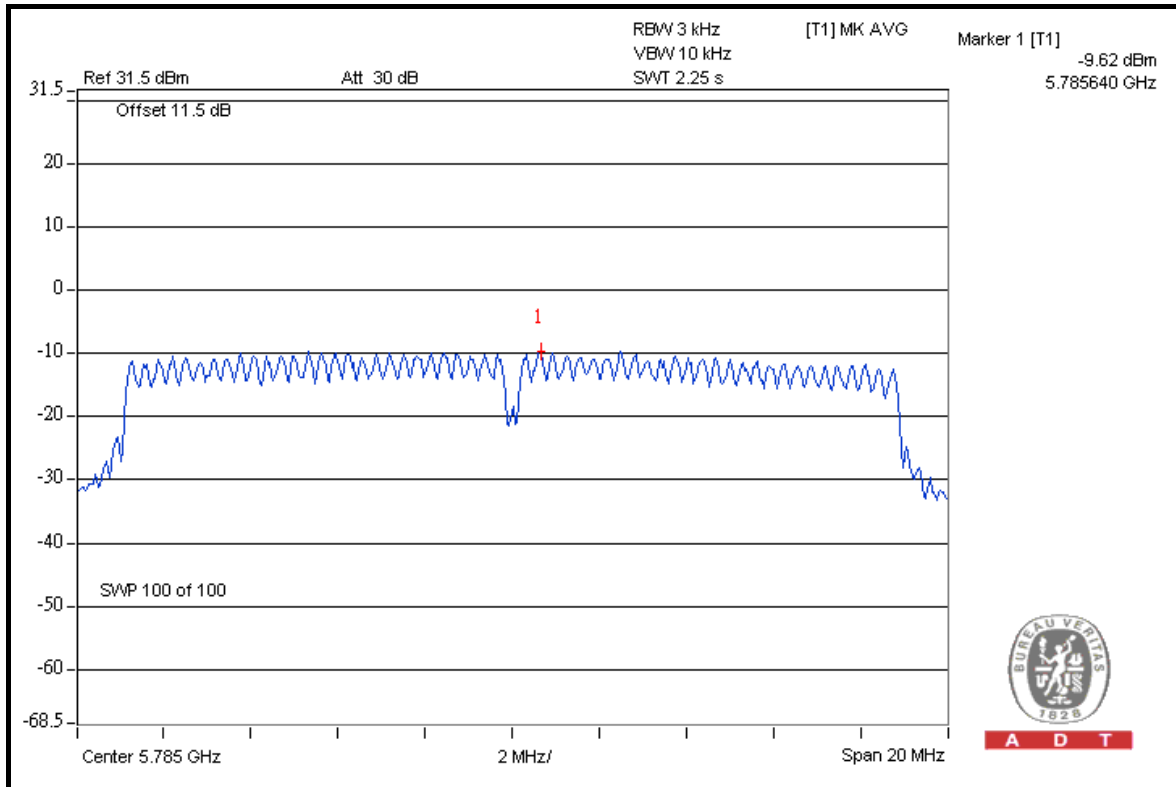

A D T



A D T

CH 165

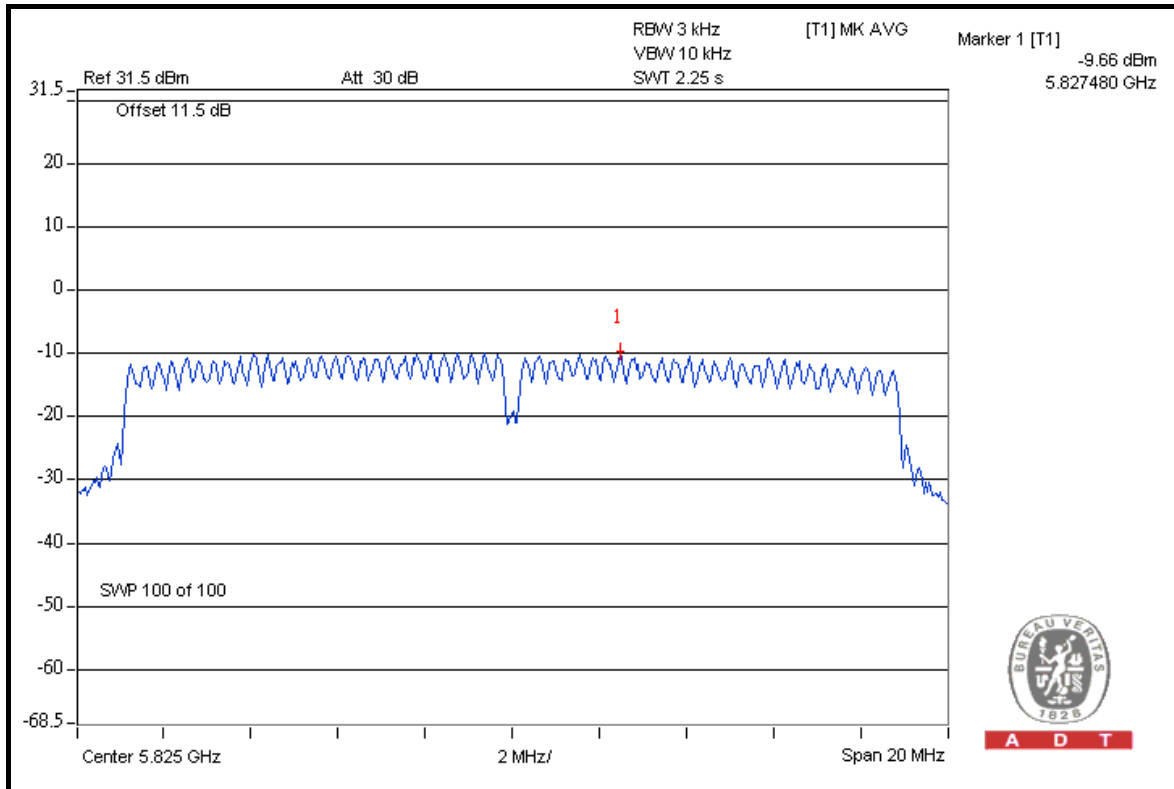

FOR CHAIN 2: CH 149

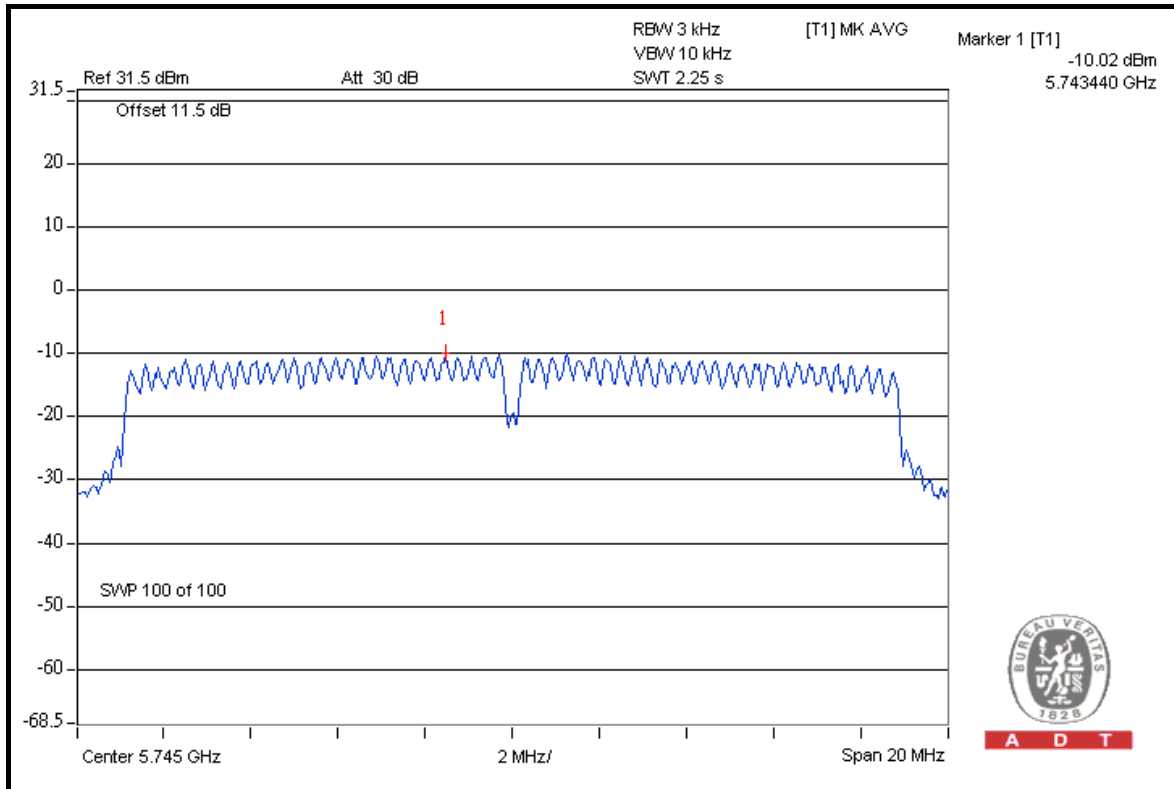



A D T

CH 157

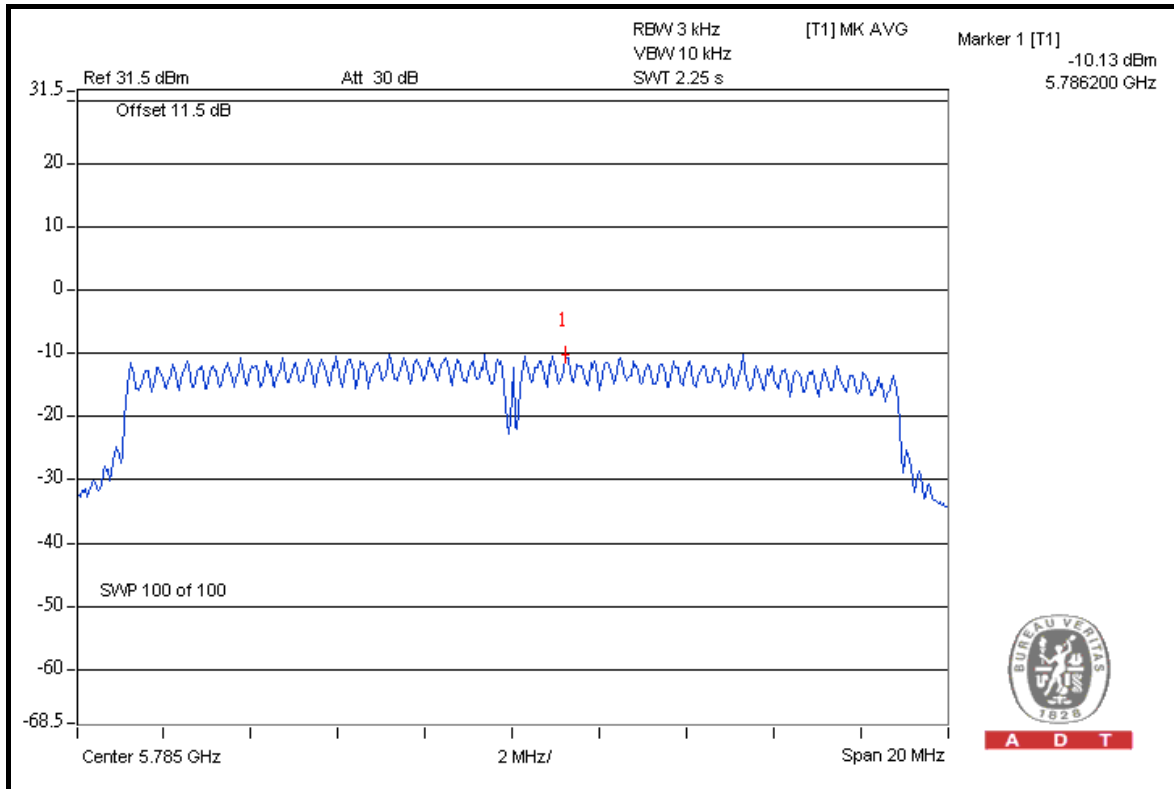

CH 165

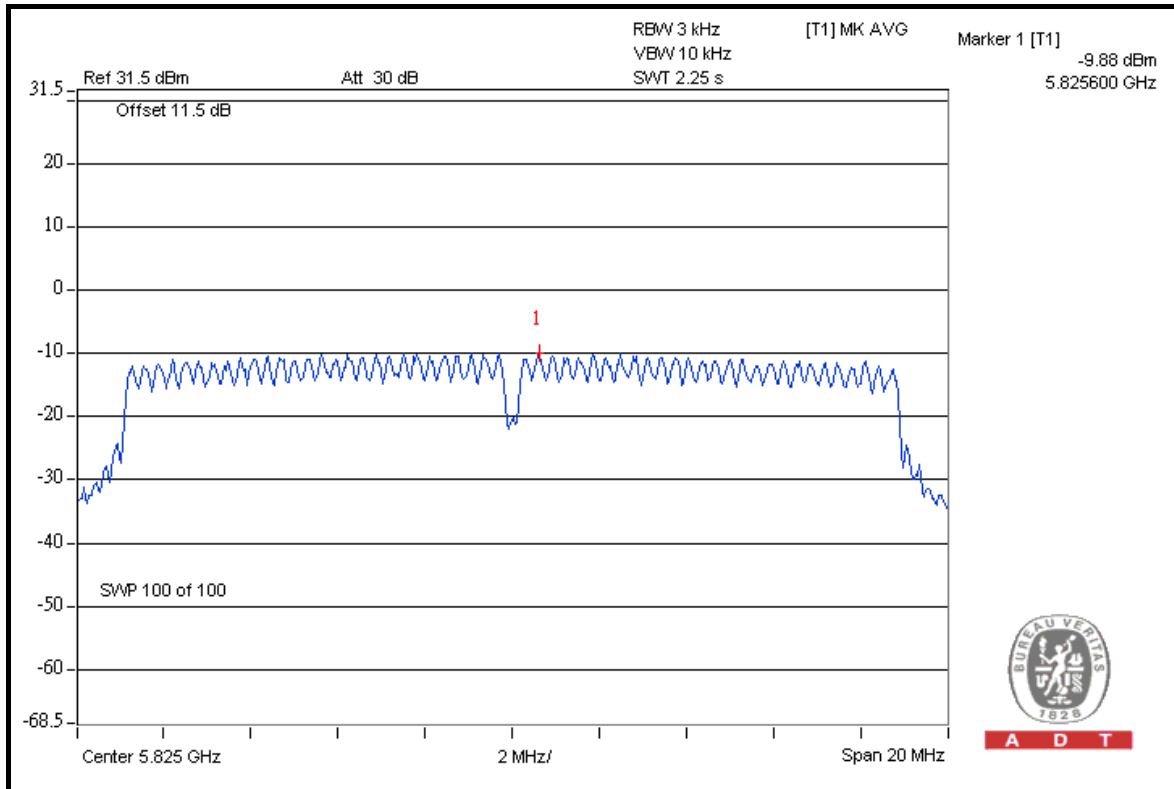



A D T

DRAFT 802.11n (20MHz) OFDM MODULATION

MODULATION TYPE	BPSK	TRANSFER RATE	6.5Mbps
INPUT POWER	120Vac, 60Hz	ENVIRONMENTAL CONDITIONS	25 deg.C, 65%RH, 991hPa
TESTED BY	Brad Wu	TEST MODE	C

CHAN.	CHAN. FREQ. (MHz)	RF POWER LEVEL IN 3kHz BW (dBm)		TOTAL POWER DENSITY (mW)	TOTAL POWER DENSITY (dBm)	MAX. LIMIT (dBm)	PASS / FAIL
		CHAIN 0	CHAIN 1				
149	5745	-17.60	-17.93	0.033	-14.81	8	PASS
157	5785	-17.49	-17.72	0.035	-14.56	8	PASS
165	5825	-17.53	-18.16	0.033	-14.81	8	PASS



A D T

FOR CHAIN 0: CH 149

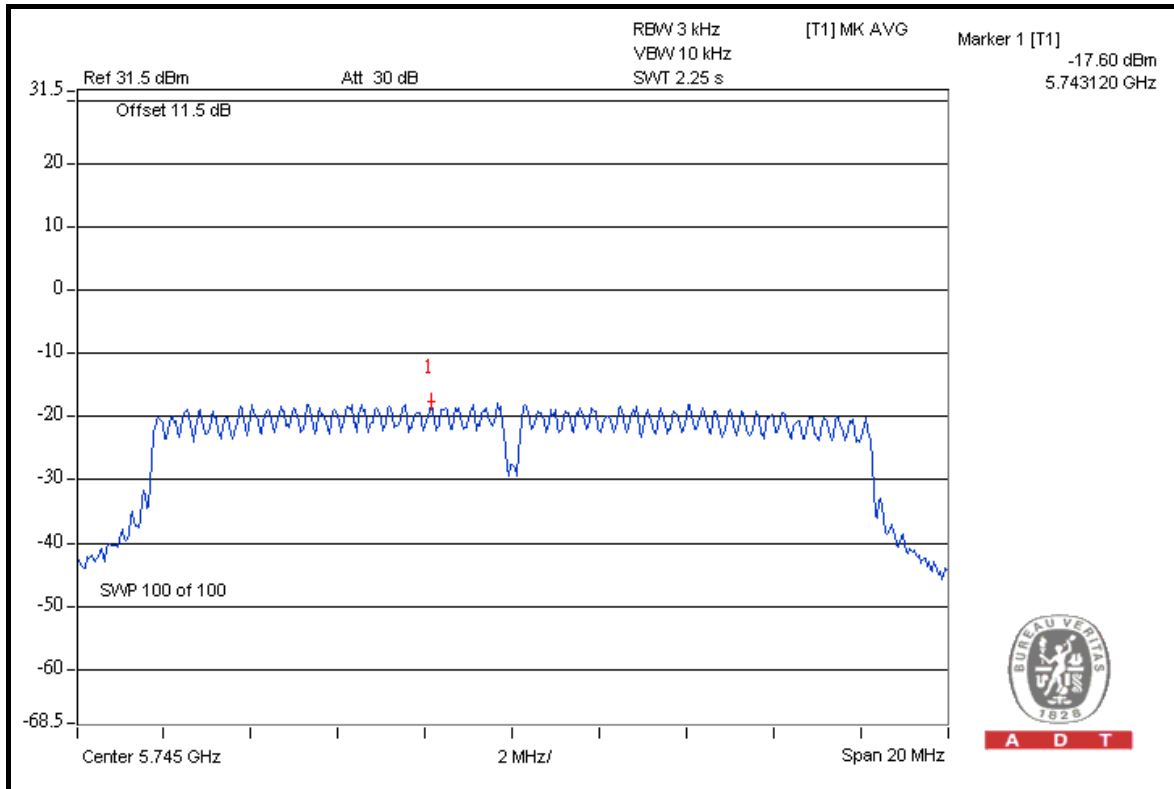

CH 157

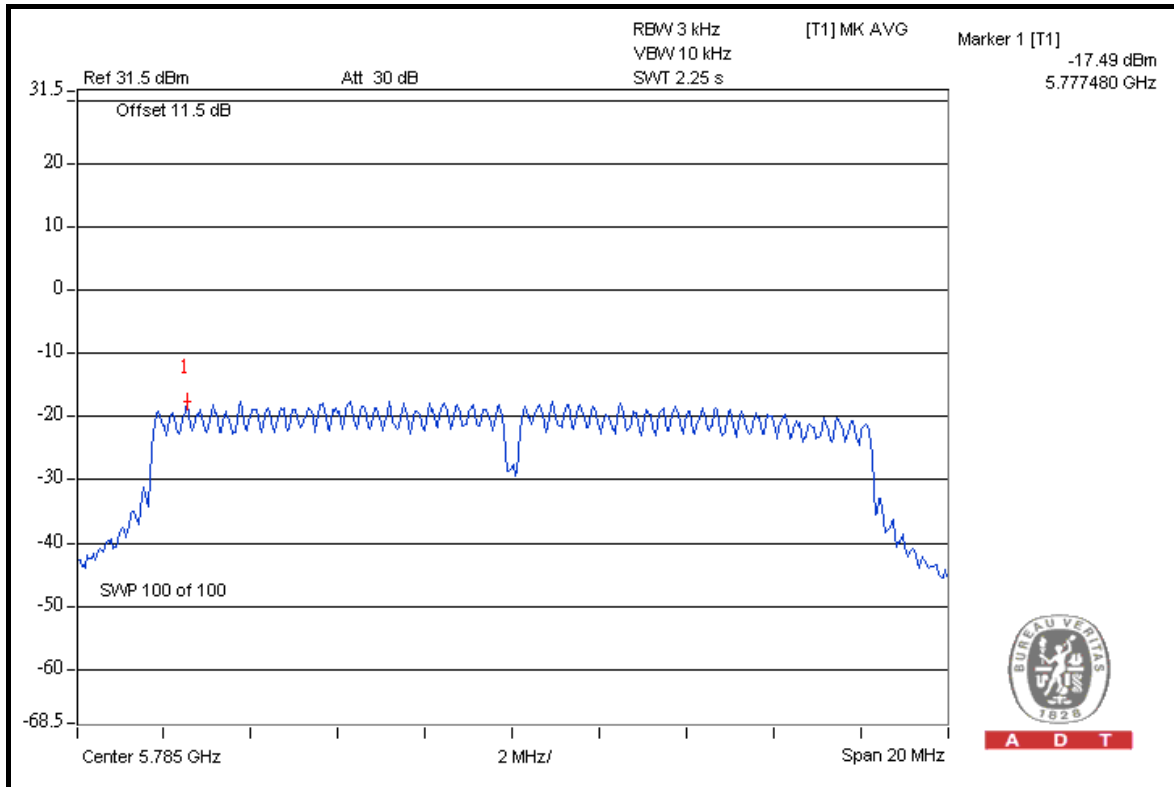



A D T

CH 165

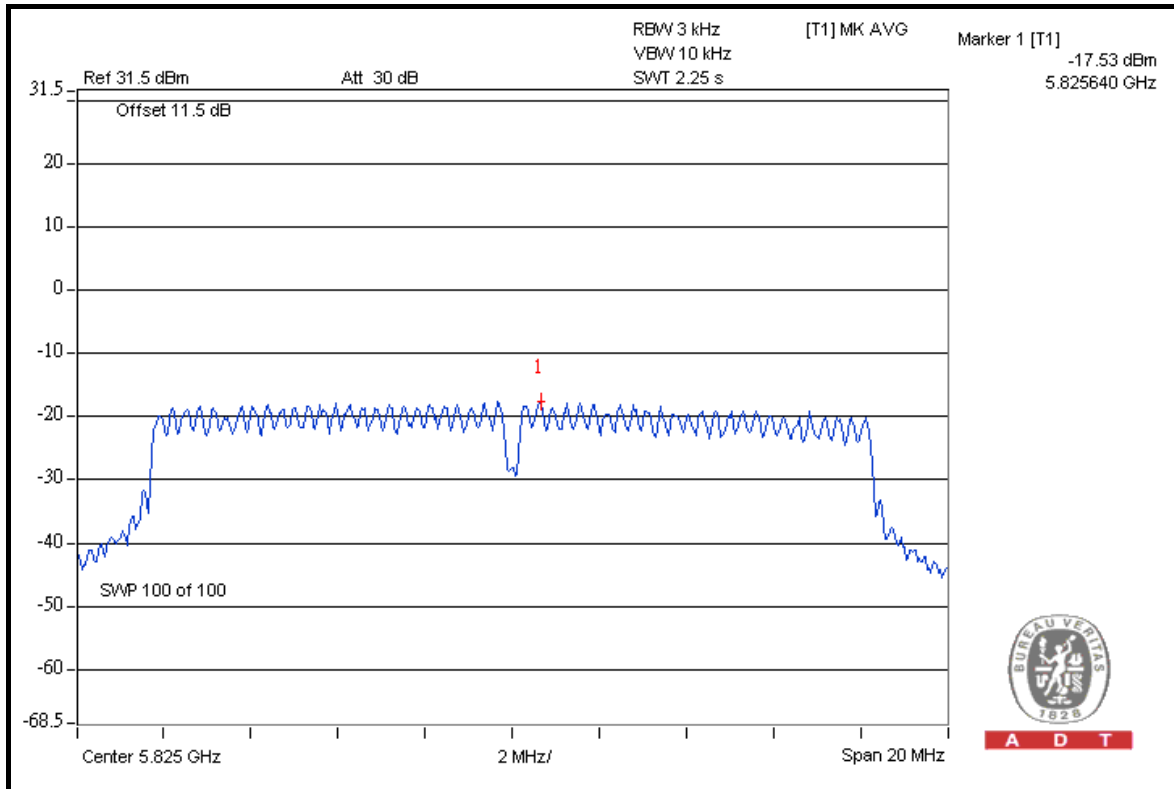

FOR CHAIN 1: CH 149

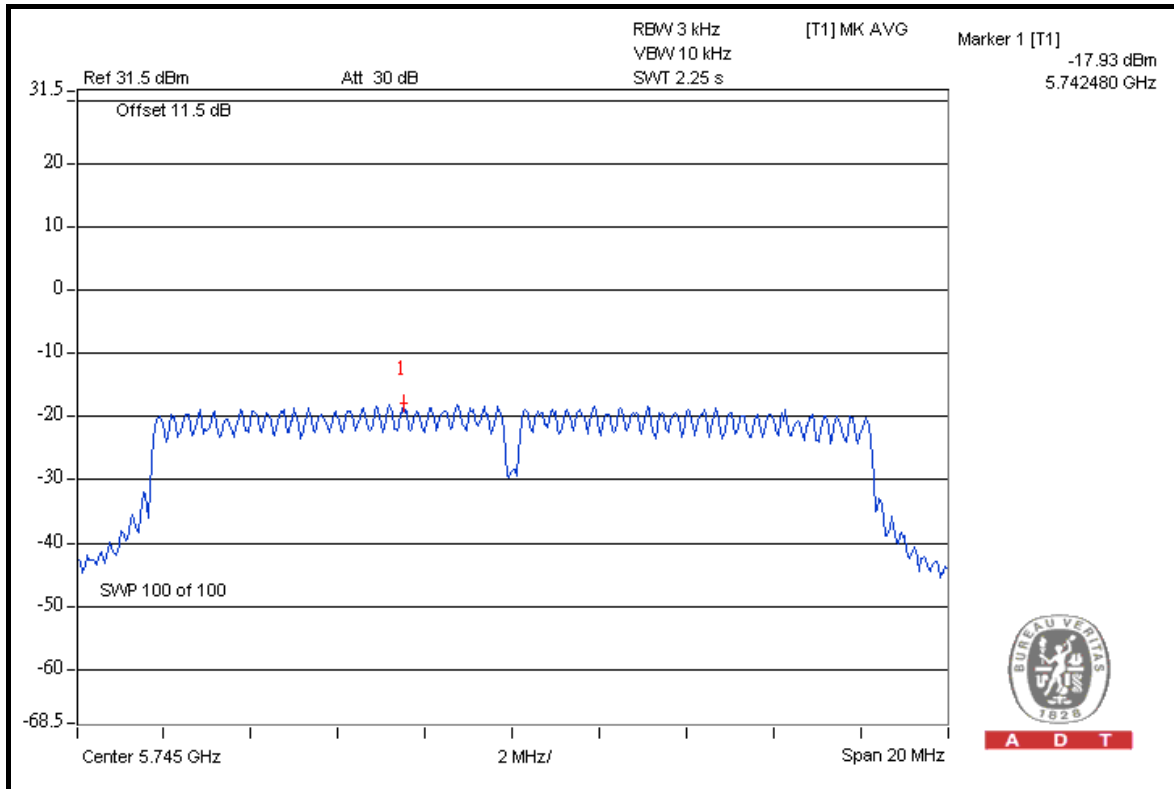



A D T

CH 157

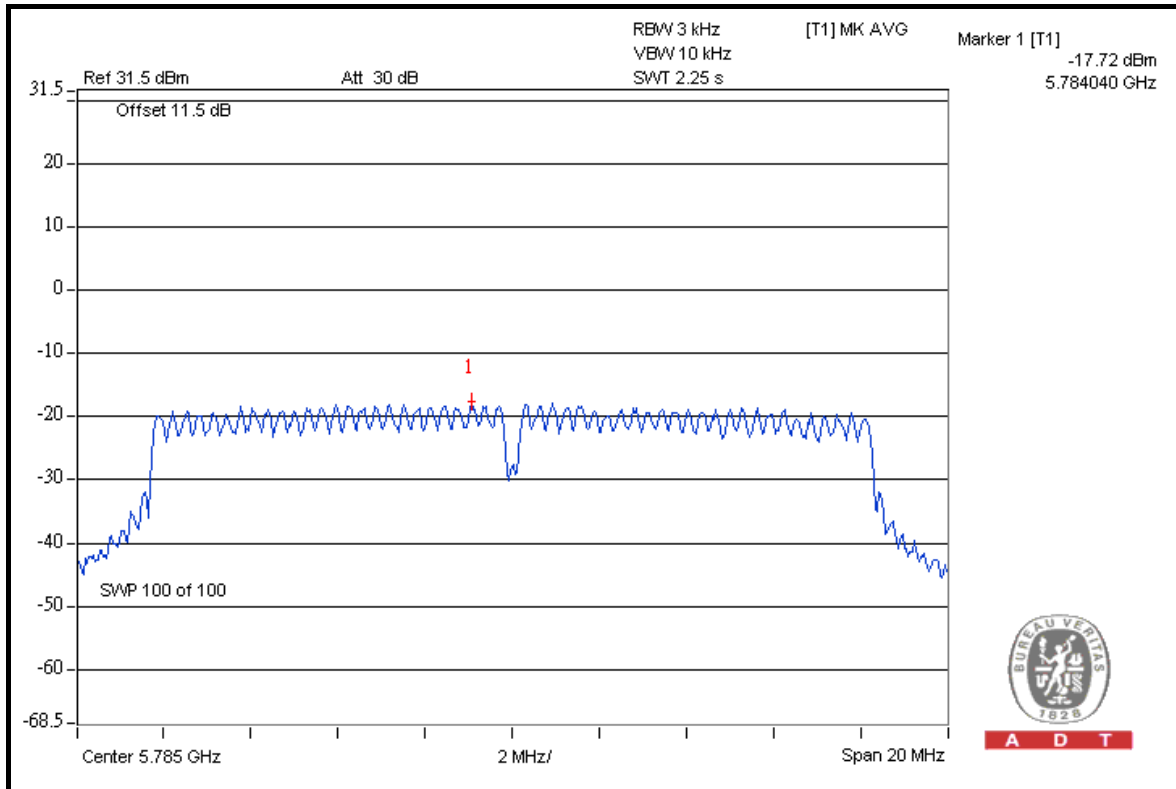

CH 165

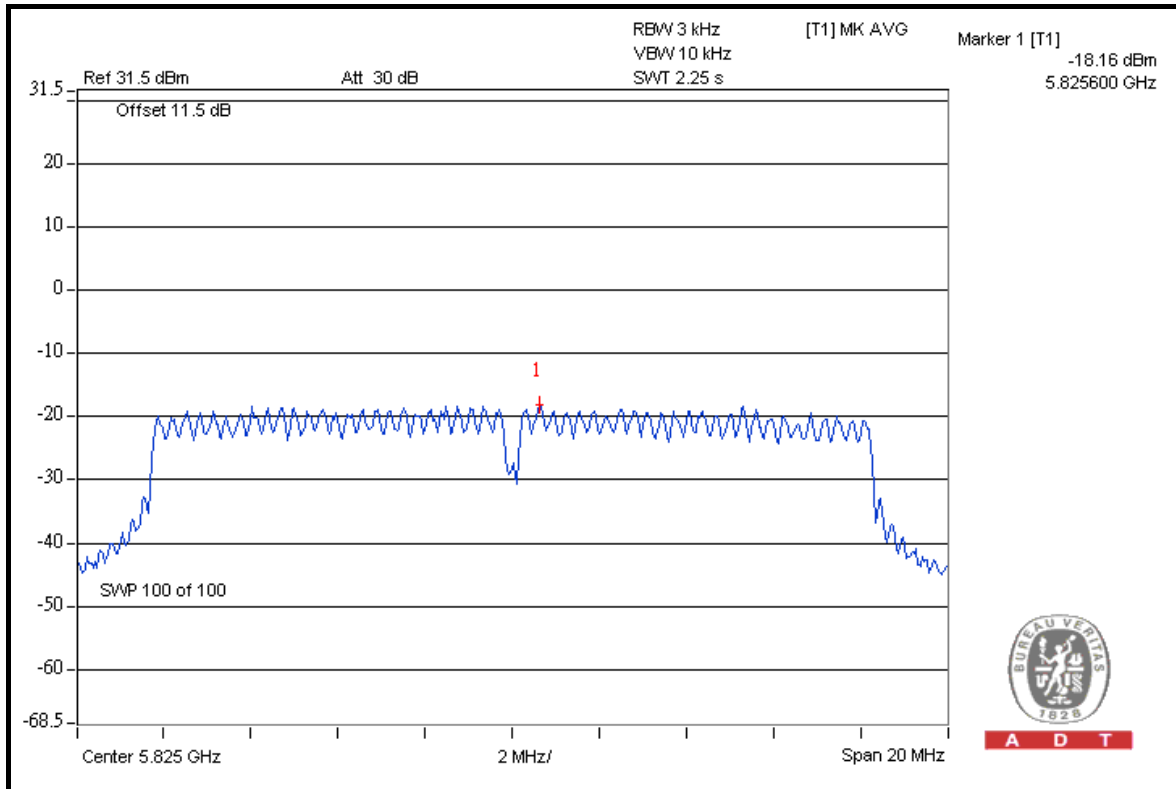



A D T

DRAFT 802.11n (40MHz) OFDM MODULATION

MODULATION TYPE	BPSK	TRANSFER RATE	13.5Mbps
INPUT POWER	120Vac, 60Hz	ENVIRONMENTAL CONDITIONS	25 deg.C, 65%RH, 1021hPa
TESTED BY	Brad Wu	TEST MODE	A

CHAN.	CHAN. FREQ. (MHz)	RF POWER LEVEL IN 3kHz BW (dBm)			TOTAL POWER DENSITY (mW)	TOTAL POWER DENSITY (dBm)	MAX. LIMIT (dBm)	PASS / FAIL
		CHAIN 0	CHAIN 1	CHAIN 2				
151	5755	-12.26	-12.17	-12.11	0.182	-7.40	8	PASS
159	5795	-12.17	-11.99	-11.89	0.189	-7.24	8	PASS



A D T

FOR CHAIN 0: CH 151

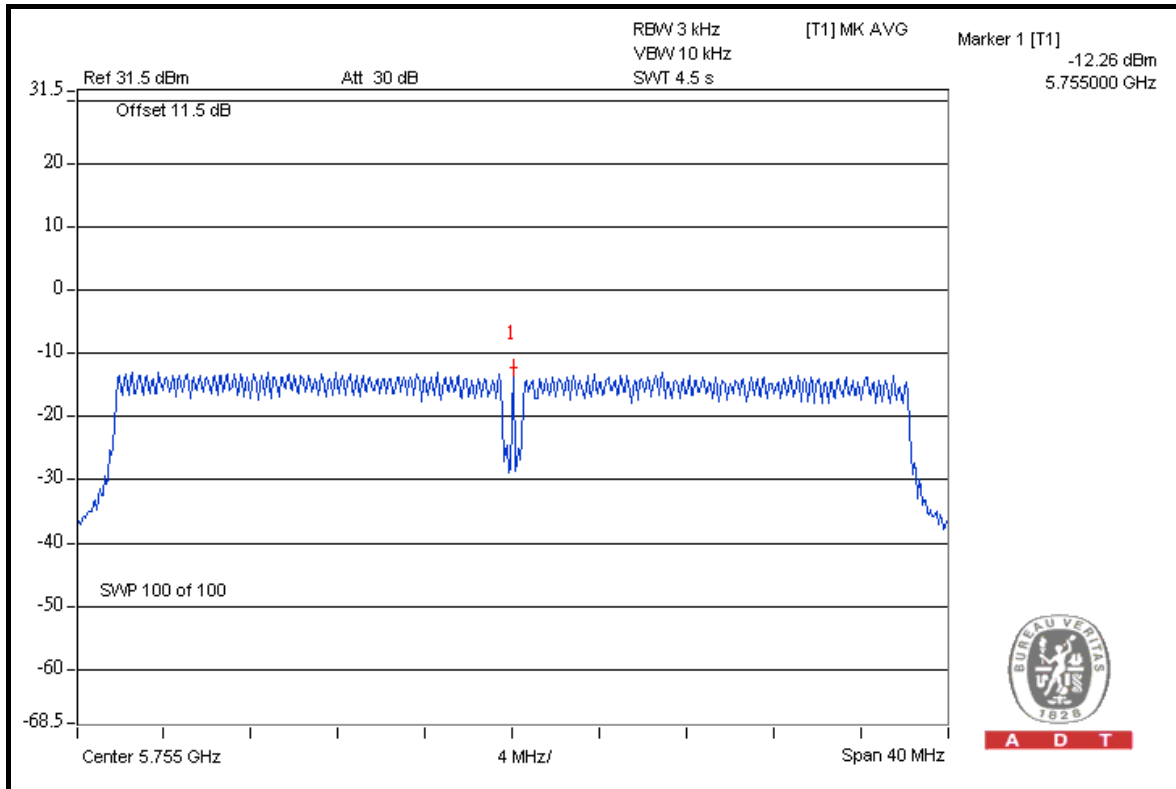

A D T

CH 159

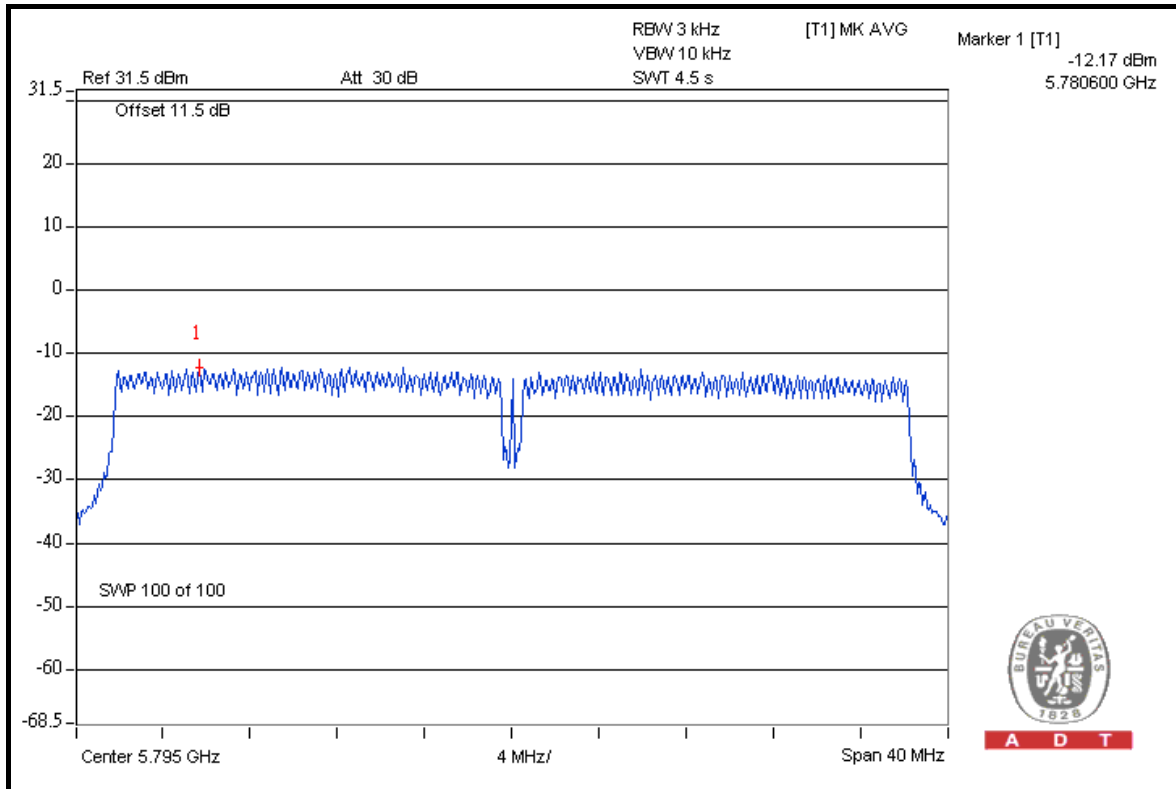

A D T



A D T

FOR CHAIN 1: CH 151

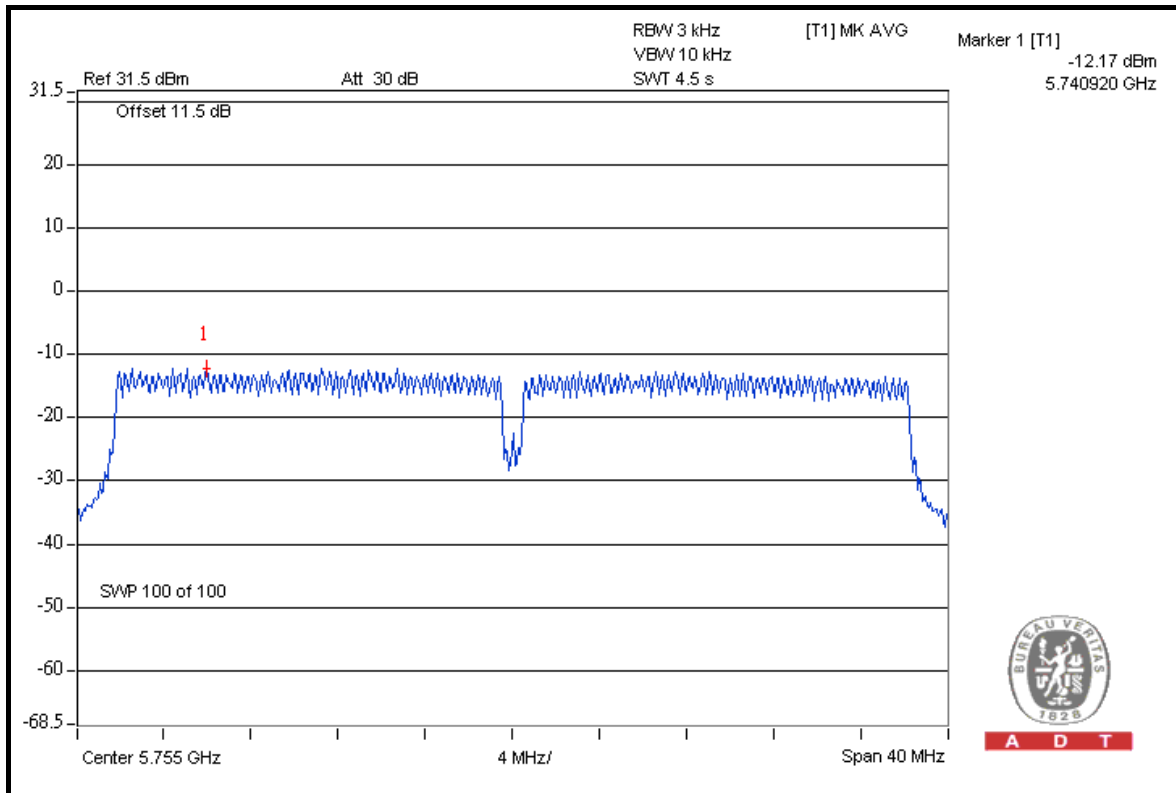

CH 159

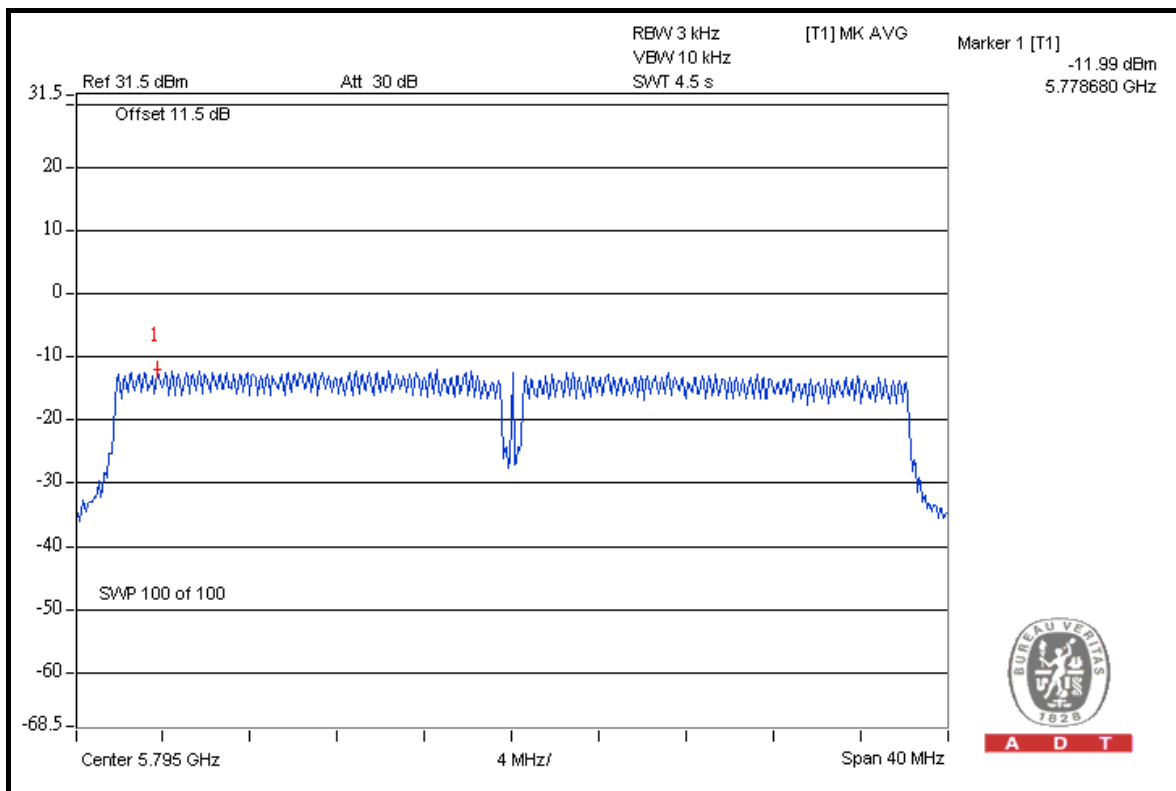



A D T

FOR CHAIN 2: CH 151

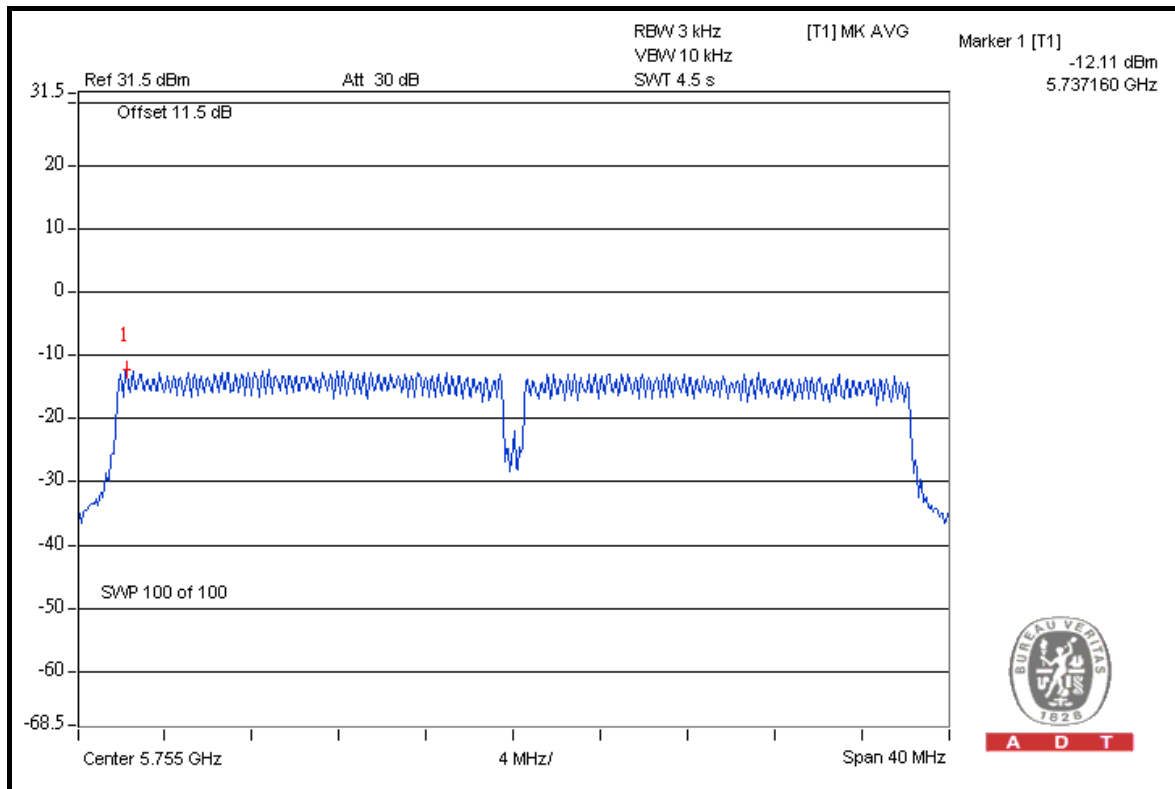

A D T

CH 159

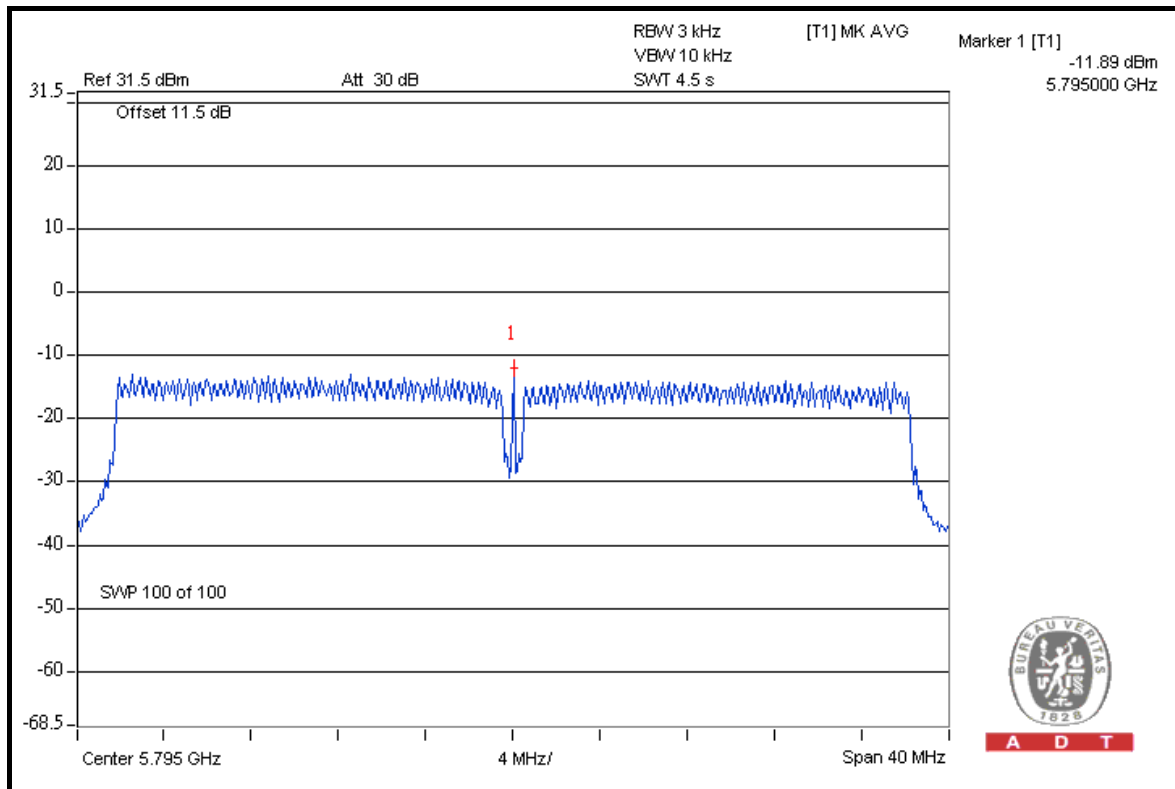

A D T



A D T

DRAFT 802.11n (40MHz) OFDM MODULATION

MODULATION TYPE	BPSK	TRANSFER RATE	13.5Mbps
INPUT POWER	120Vac, 60Hz	ENVIRONMENTAL CONDITIONS	25 deg.C, 65%RH, 1021hPa
TESTED BY	Brad Wu	TEST MODE	C

CHAN.	CHAN. FREQ. (MHz)	RF POWER LEVEL IN 3kHz BW (dBm)		TOTAL POWER DENSITY (mW)	TOTAL POWER DENSITY (dBm)	MAX. LIMIT (dBm)	PASS / FAIL
		CHAIN 0	CHAIN 1				
151	5755	-20.26	-20.53	0.018	-17.45	8	PASS
159	5795	-20.09	-20.64	0.018	-17.45	8	PASS



A D T

FOR CHAIN 0: CH 151

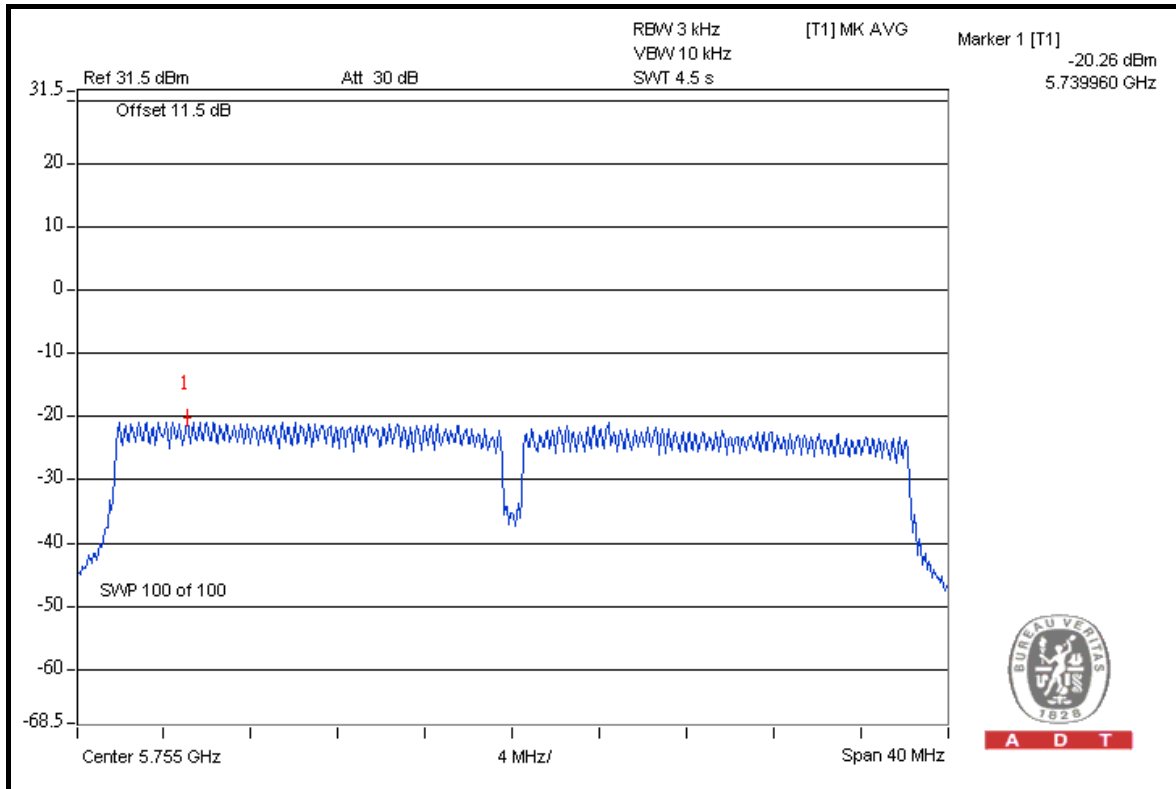

CH 159

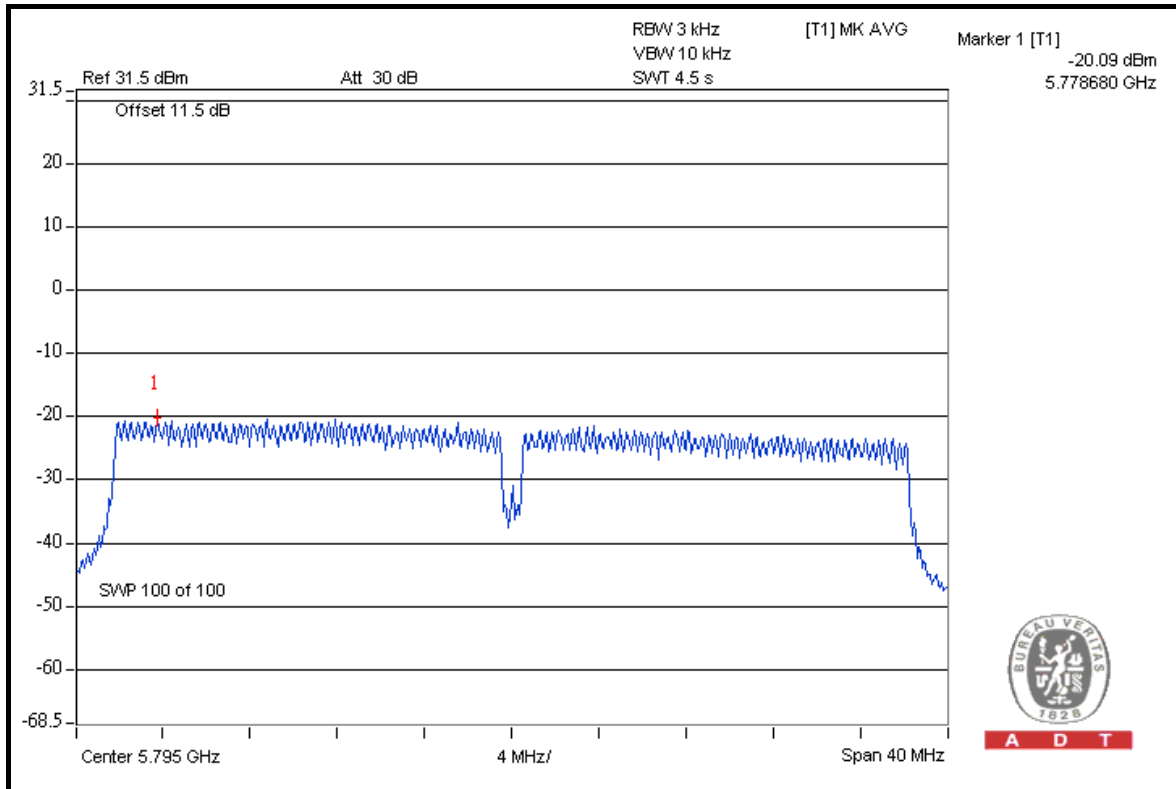



A D T

FOR CHAIN 1: CH 151

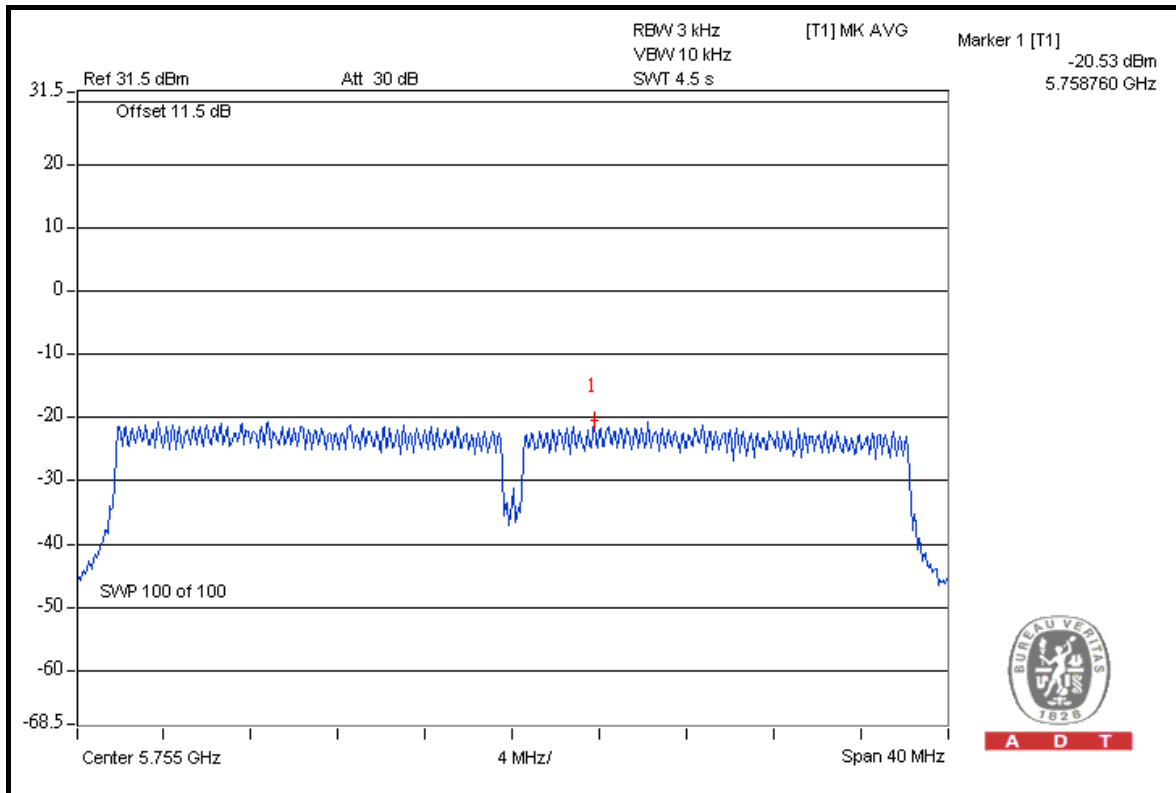

CH 159

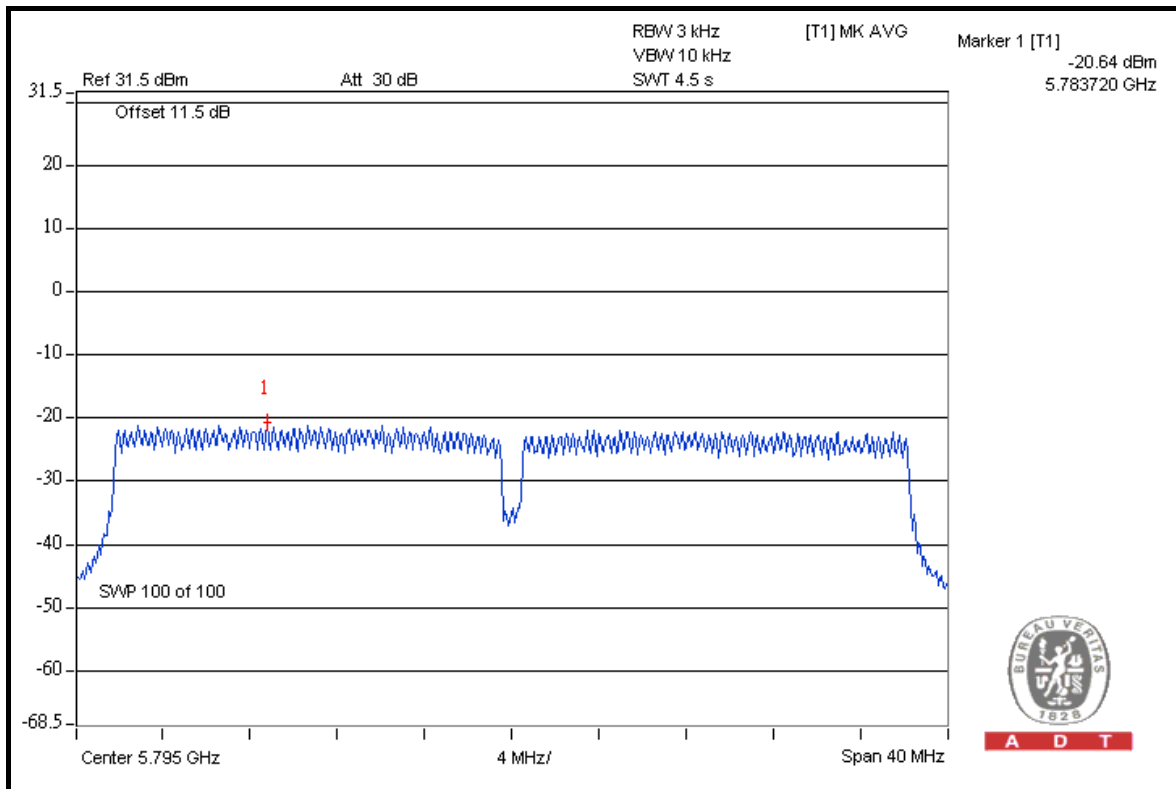



A D T

5.6 BAND EDGES MEASUREMENT

5.6.1 LIMITS OF BAND EDGES MEASUREMENT

Below -20dB of the highest emission level of operating band (in 100kHz Resolution Bandwidth).

Note: Follow DTS measurement, if the device complies with the use of power option 2 the attenuation under this paragraph shall be 30 dB instead of 20 dB.

5.6.2 TEST INSTRUMENTS

DESCRIPTION & MANUFACTURER	MODEL NO.	SERIAL NO.	DATE OF CALIBRATION	DUE DATE OF CALIBRATION
Test Receiver ROHDE & SCHWARZ	ESI7	100033	Jul. 06, 2009	Jul. 05, 2010
Spectrum Analyzer ROHDE & SCHWARZ	FSP40	100076	May. 26, 2009	May. 25, 2010
BILOG Antenna SCHWARZBECK	VULB9168	9168-160	Apr. 27, 2009	Apr. 26, 2010
HORN Antenna SCHWARZBECK	9120D	9120D-209	Jul. 01, 2009	Jun. 30, 2010
HORN Antenna SCHWARZBECK	BBHA 9170	BBHA9170243	Dec. 25, 2008	Dec. 24, 2009
Preamplifier Agilent	8447D	2944A10633	Nov. 03, 2008	Nov. 02, 2009
Preamplifier Agilent	8449B	3008A01964	Oct. 23, 2008	Oct. 22, 2009
RF signal cable HUBER+SUHNNER	SUCOFLEX 104	238141/4	May 13, 2009	May 12, 2010
RF signal cable HUBER+SUHNNER	SUCOFLEX 104	12738/6	May 13, 2009	May 12, 2010
Software ADT.	ADT_Radiated_ V7.6.15.9.2	NA	NA	NA
Antenna Tower inn-co GmbH	MA 4000	013303	NA	NA
Antenna Tower Controller inn-co GmbH	CO2000	017303	NA	NA
Turn Table ADT.	TT100.	TT93021703	NA	NA
Turn Table Controller ADT.	SC100.	SC93021703	NA	NA
26GHz ~ 40GHz Amplifier	EM26400	07026401	Aug. 27, 2008	Aug. 26, 2009

NOTE: The calibration interval of the above test instruments is 12 months and the calibrations are traceable to NML/ROC and NIST/USA.



A D T

5.6.3 TEST PROCEDURE

- a. The EUT was placed on the top of a rotating table 0.8 meters above the ground at a 3 meter semi-anechoic chamber. The table was rotated 360 degrees to determine the position of the highest radiation.
- b. The EUT was set 3 meters away from the interference-receiving antenna, which was mounted on the top of a variable-height antenna tower.
- c. The antenna is a broadband antenna, and its height is varied from one meter to four meters above the ground to determine the maximum value of the field strength. Both horizontal and vertical polarizations of the antenna are set to make the measurement.
- d. For each suspected emission, the EUT was arranged to its worst case and then the antenna was tuned to heights from 1 meter to 4 meters and the rotatable table was turned from 0 degrees to 360 degrees to find the maximum reading.
- e. Set both RBW and VBW of spectrum analyzer to 100kHz and 300kHz with suitable frequency span including 100MHz bandwidth from band edge. The band edges was measured and recorded.

NOTE: The resolution bandwidth of test receiver/spectrum analyzer is 1MHz and the video bandwidth is 10Hz for Average detection (AV) at frequency above 1GHz.



A D T

5.6.4 DEVIATION FROM TEST STANDARD

No deviation.

5.6.5 EUT OPERATING CONDITION

Same as Item 5.3.6.

5.6.6 TEST RESULTS

The spectrum plots are attached on the following pages. D1 line indicates the highest level, D2 line indicates the 20dB offset below D1. It shows compliance with the requirement in part 15.247(d).



A D T

802.11a OFDM MODULATION

TEST MODE A

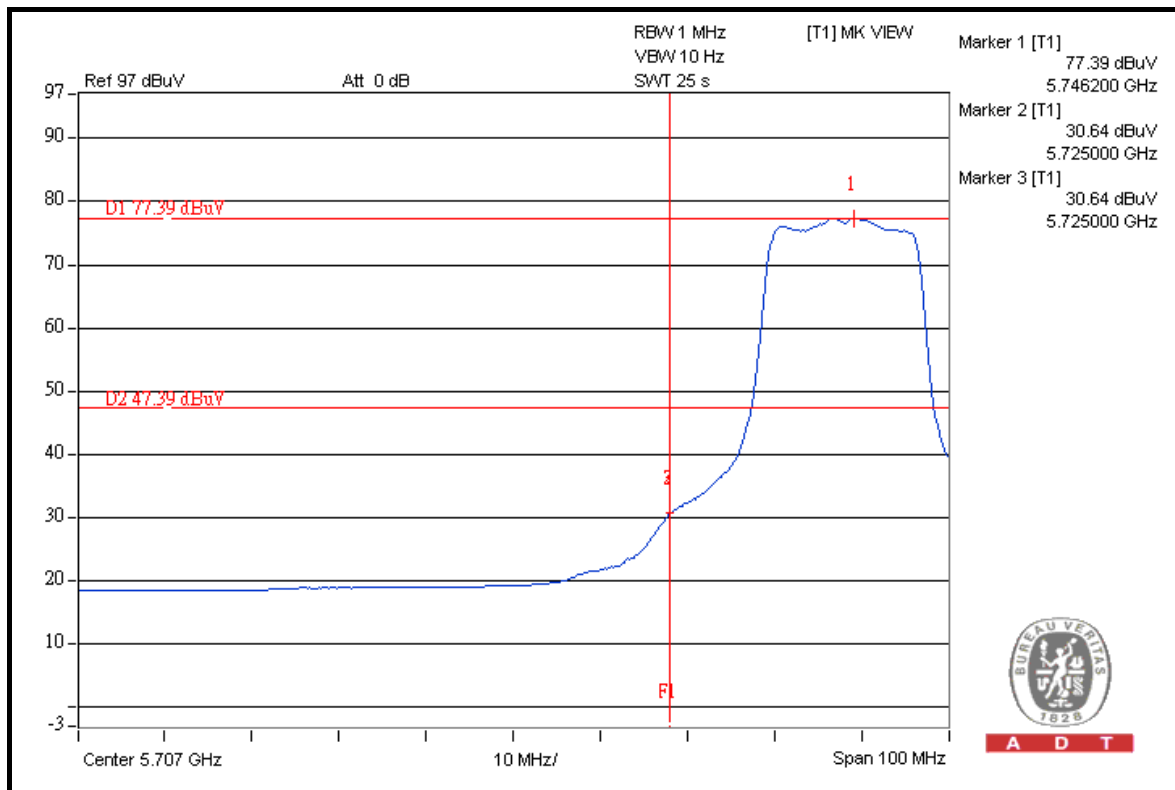
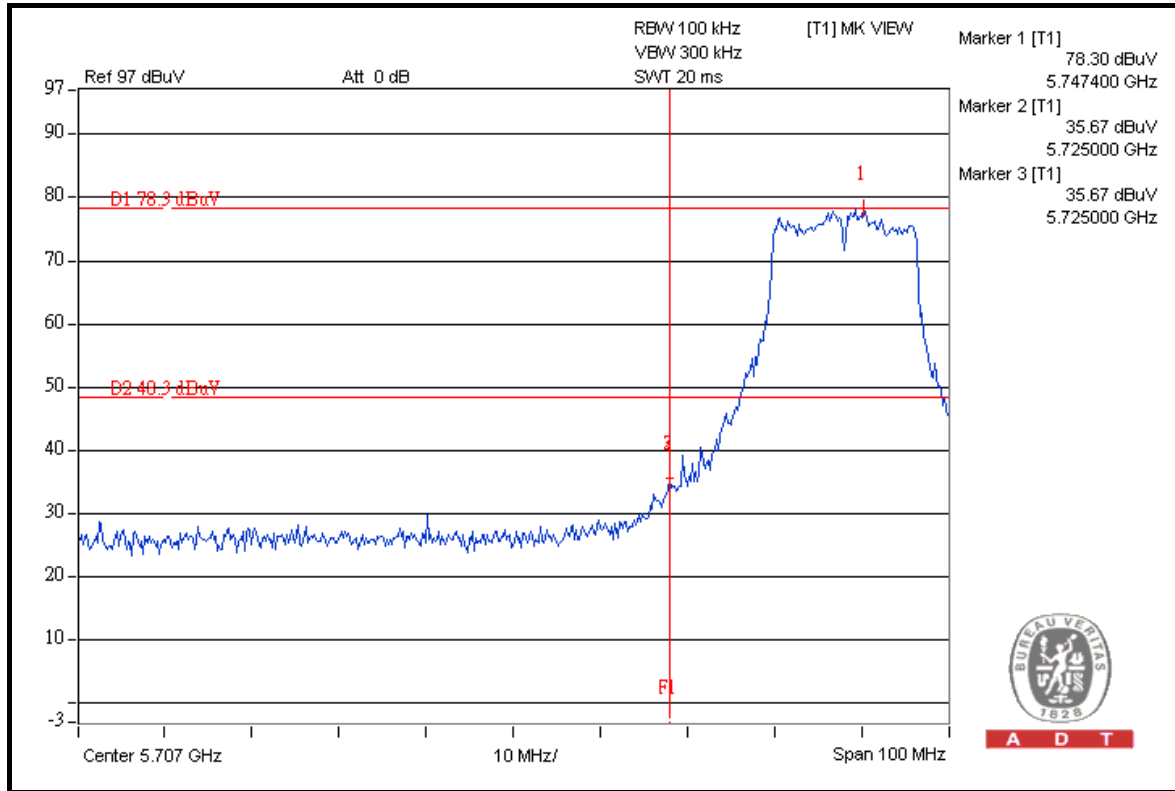



A D T

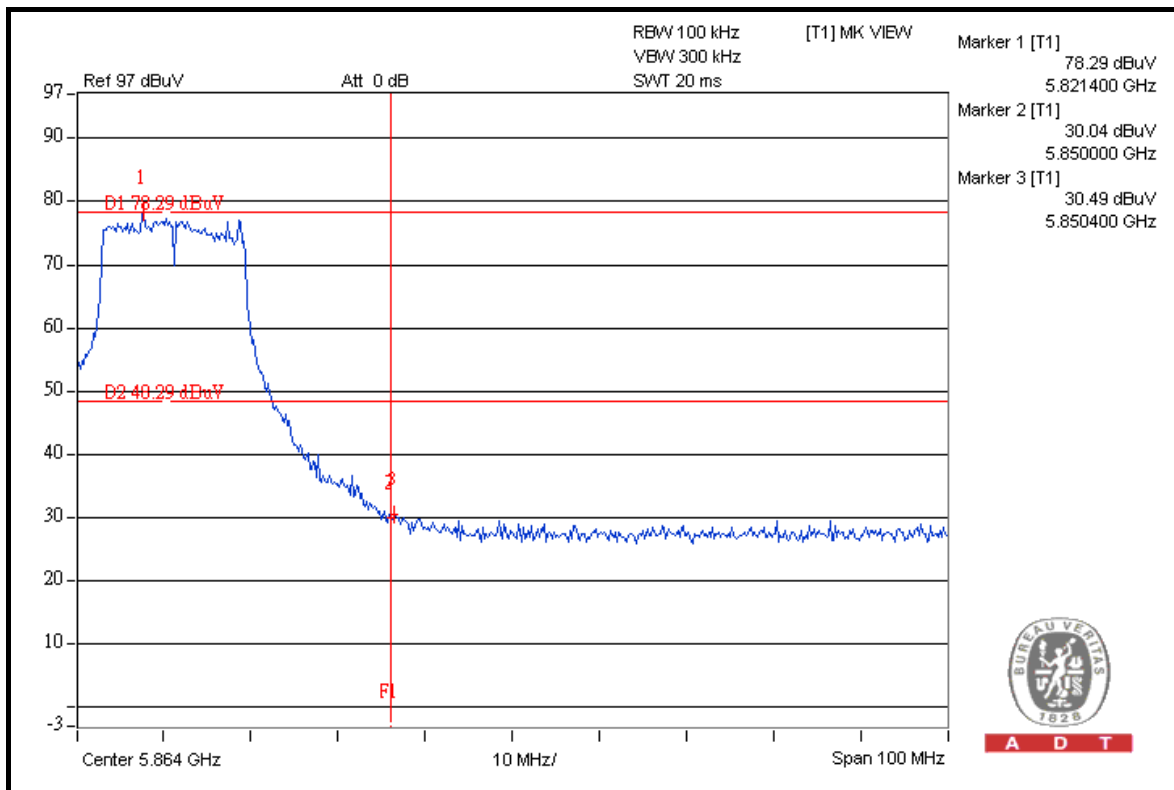
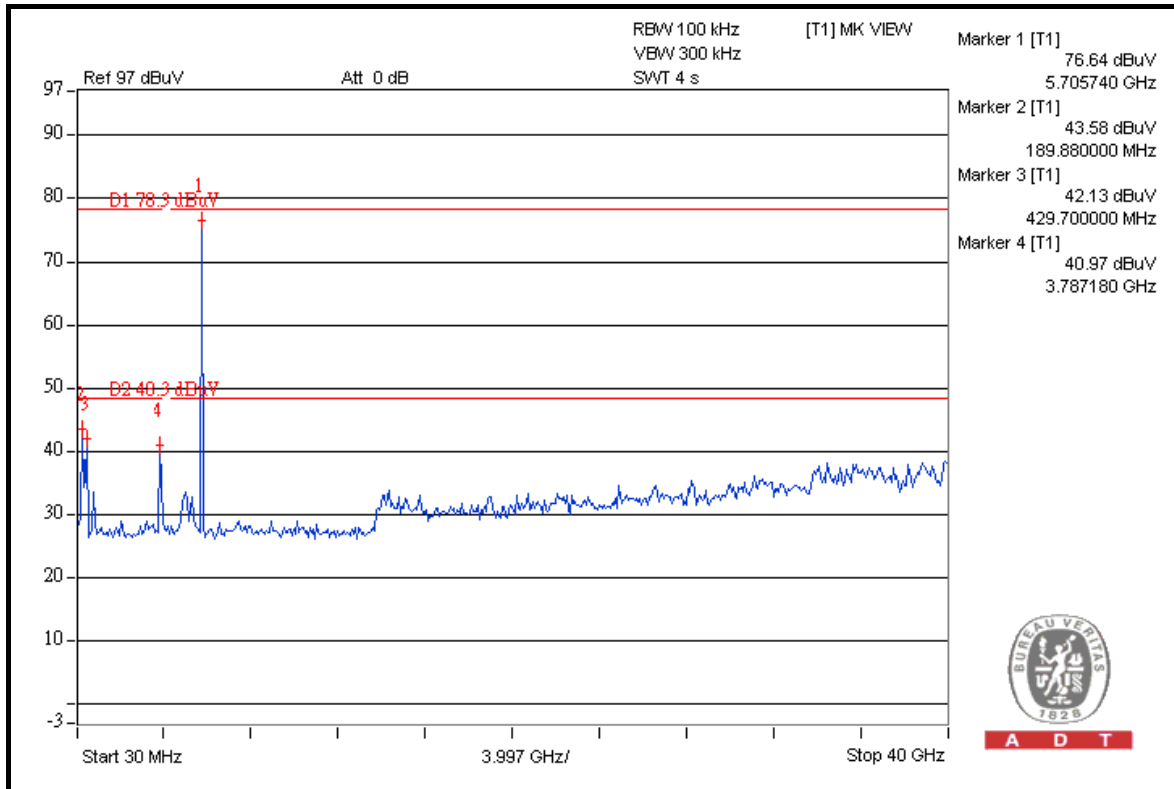



A D T

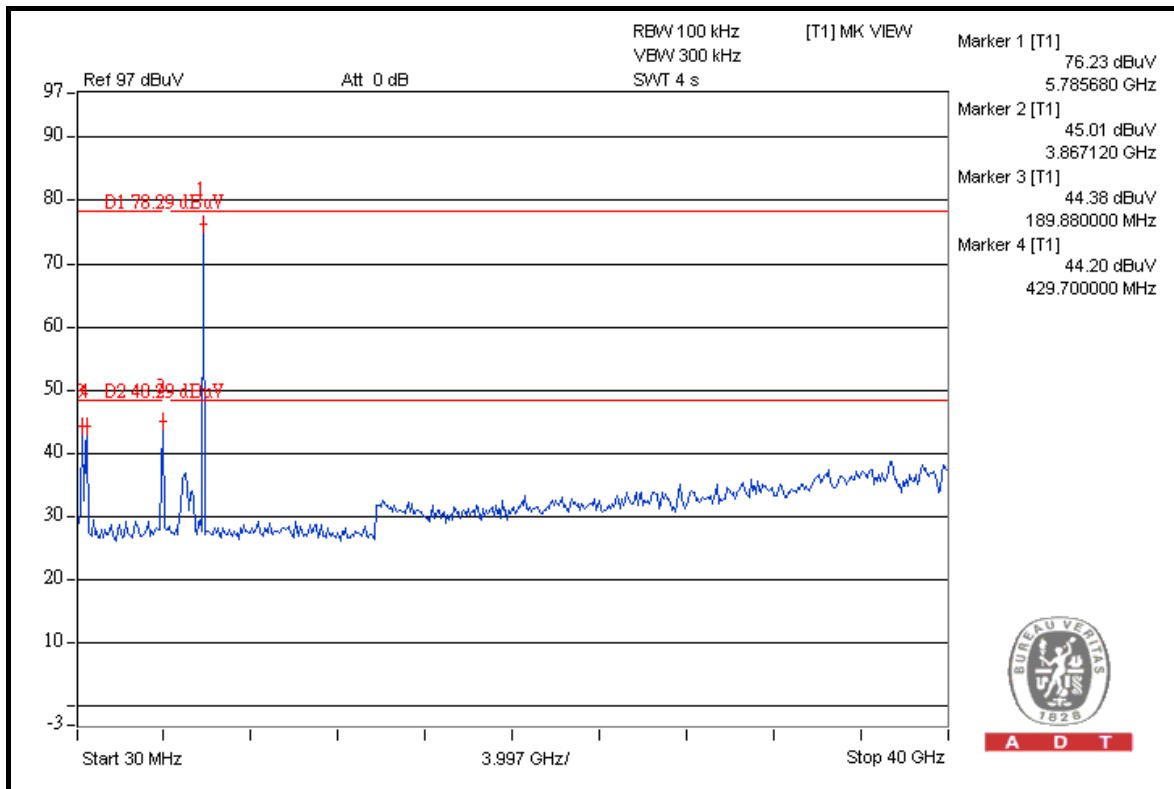
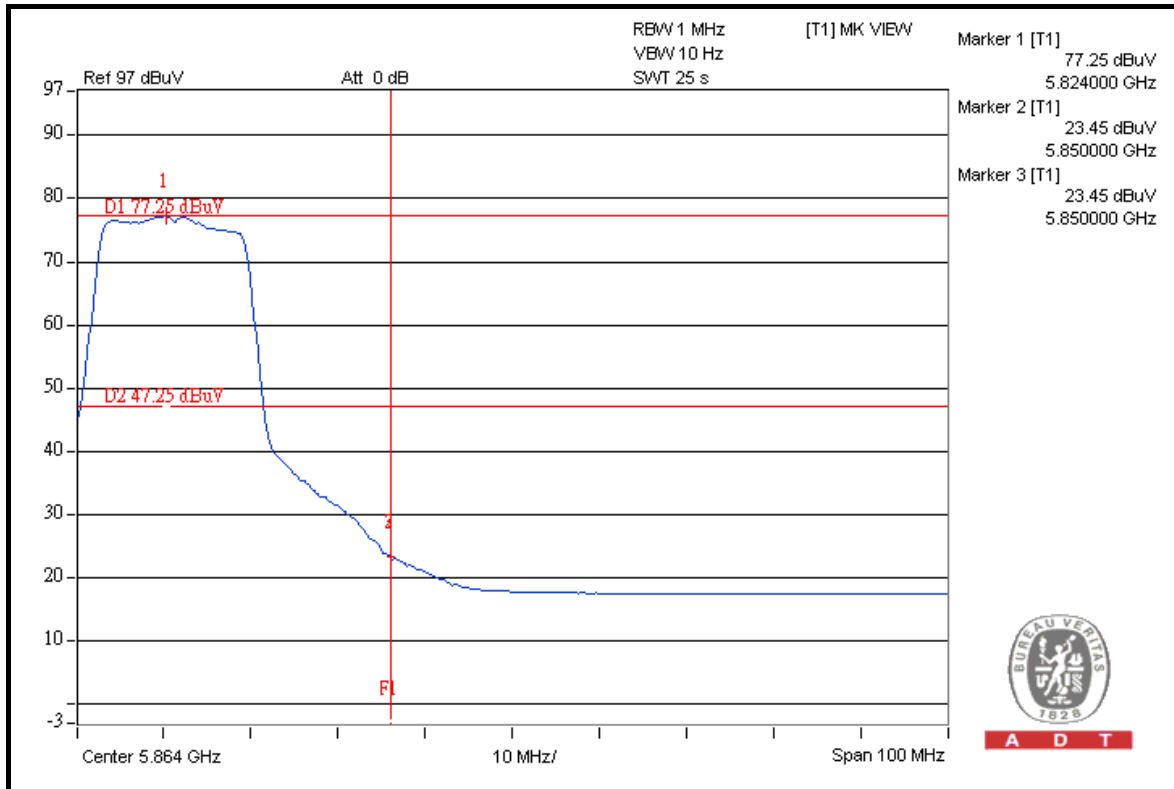



A D T

TEST MODE C

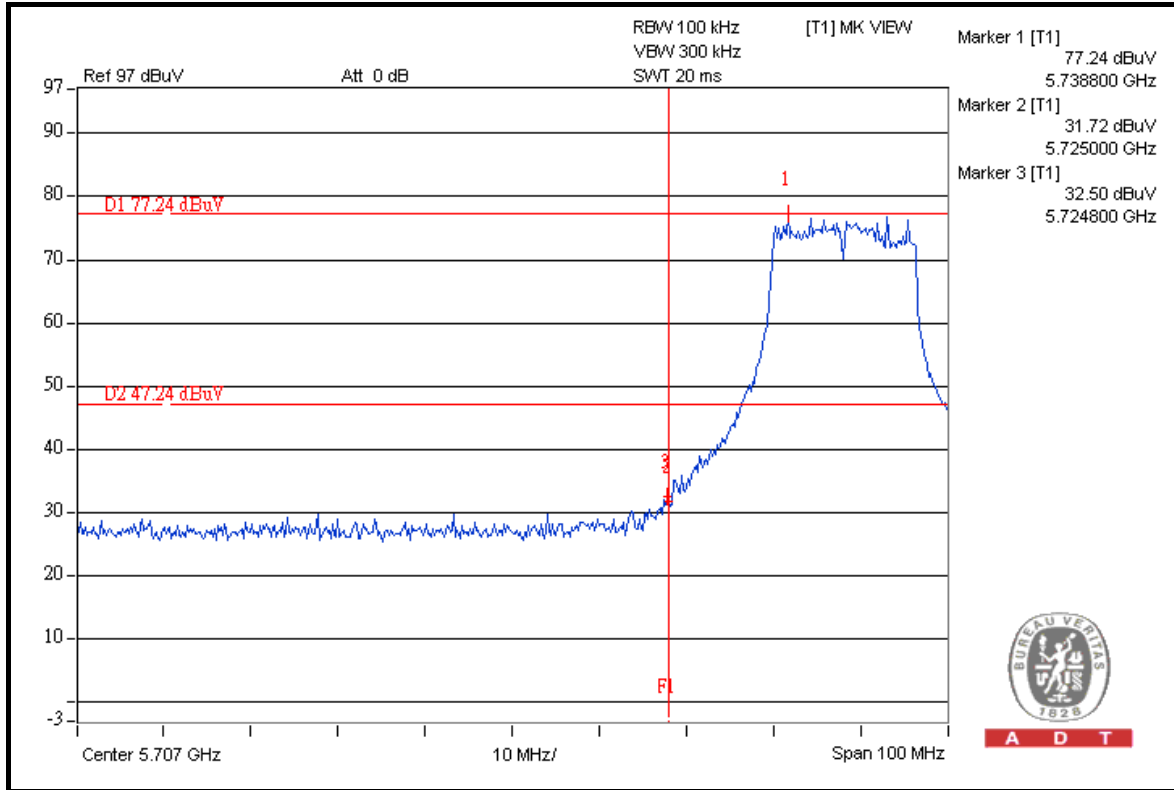

A D T

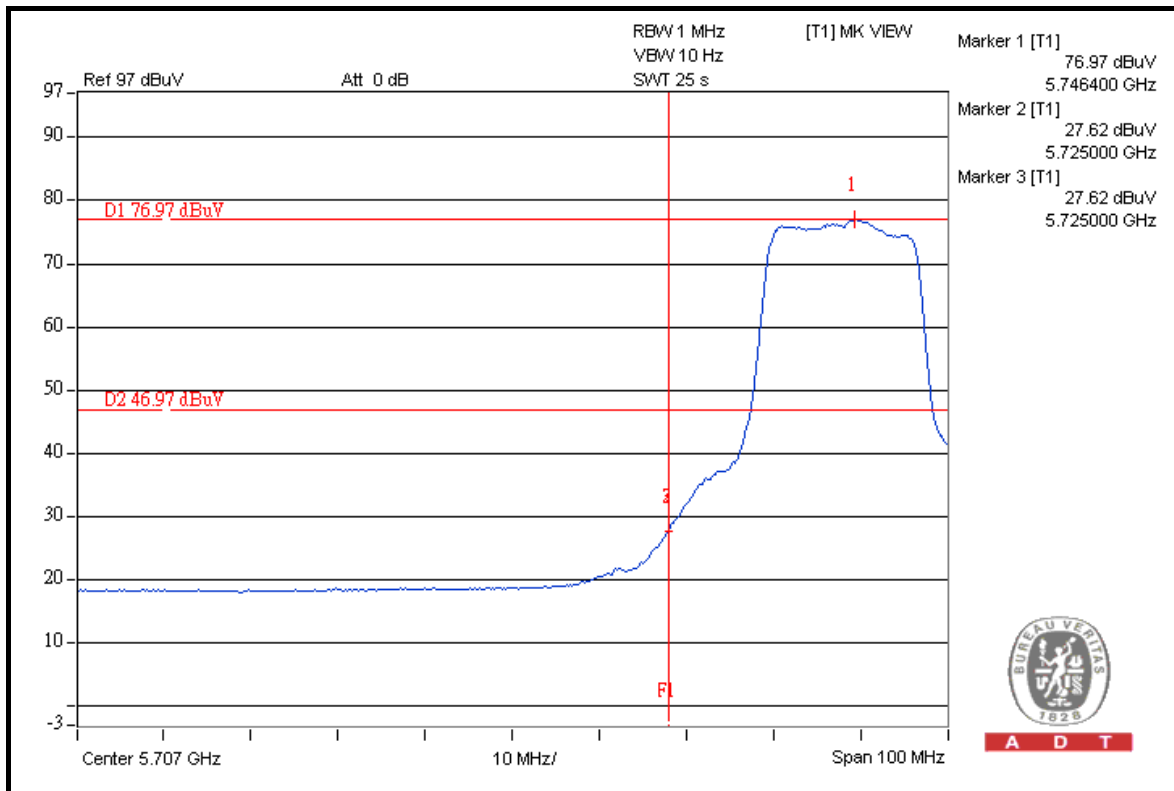

A D T



A D T

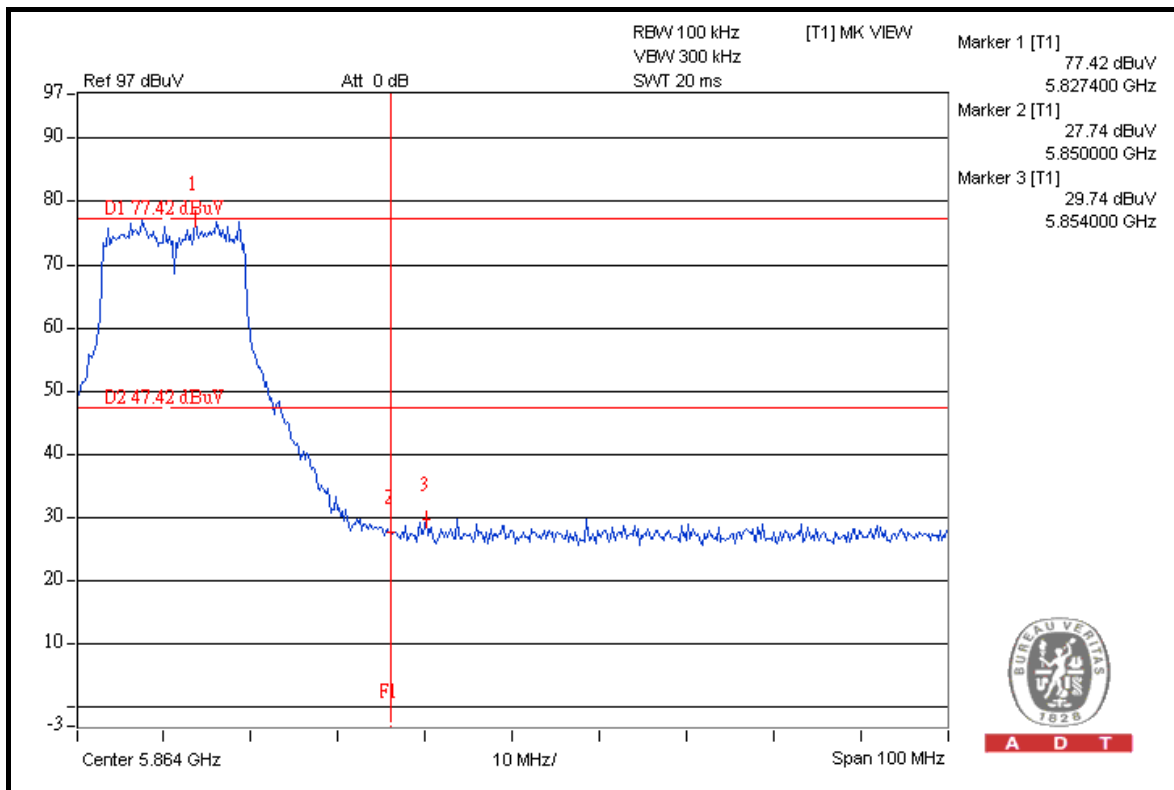
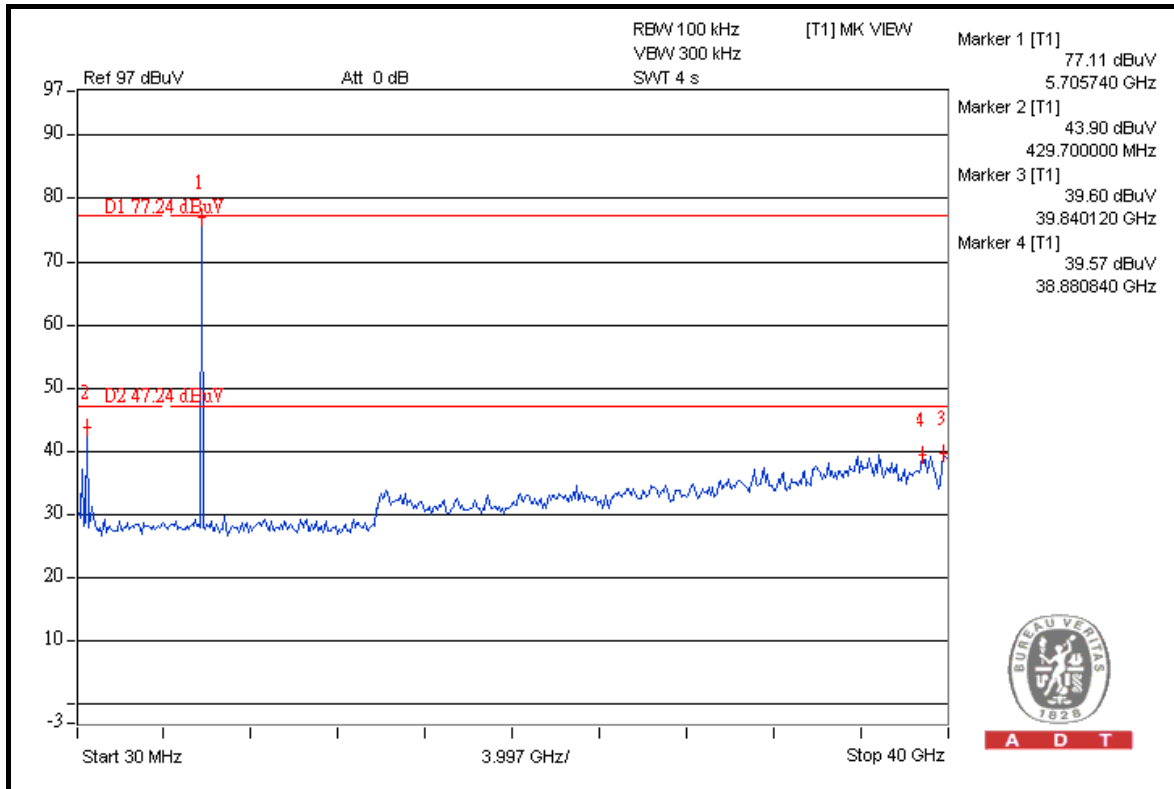



A D T

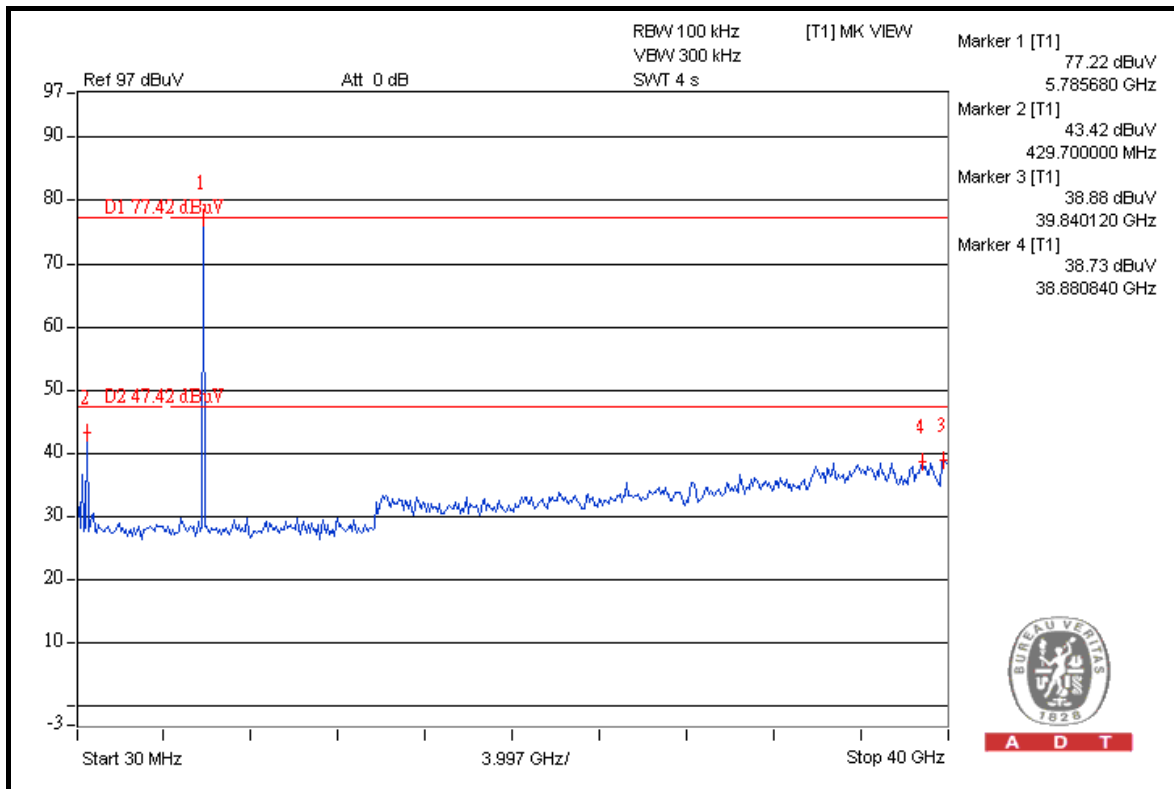
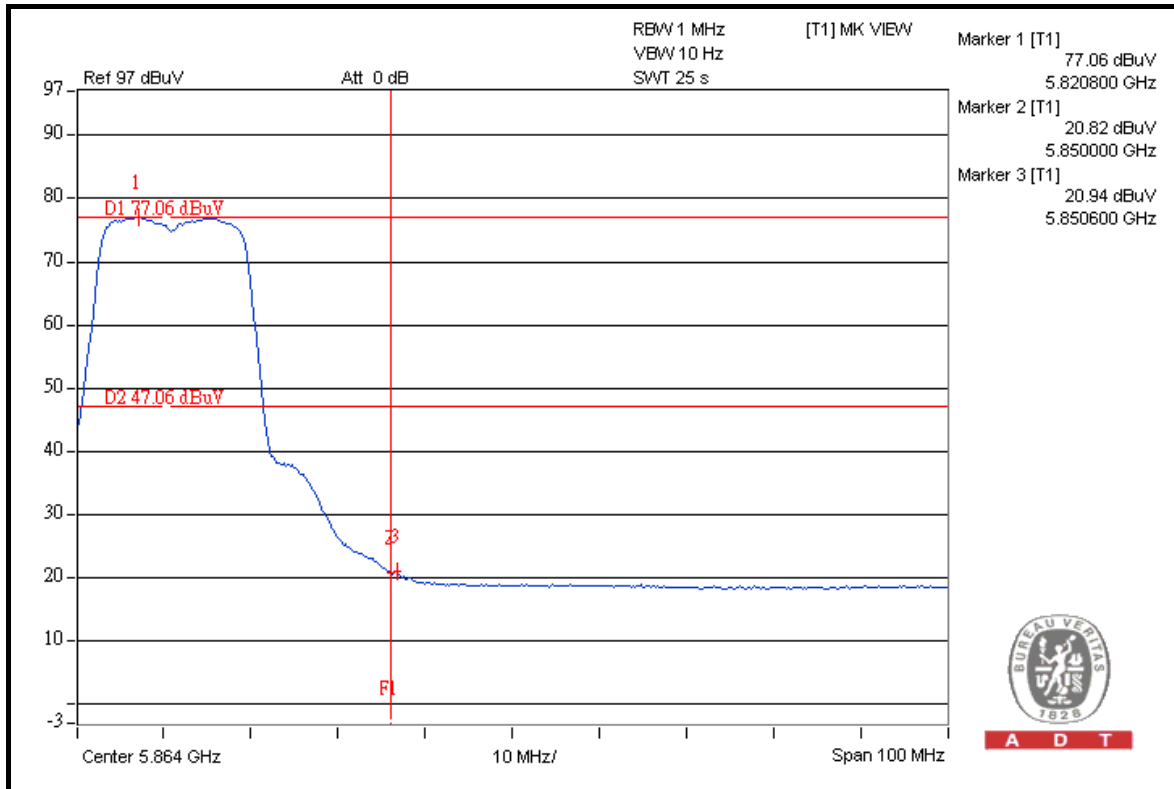



A D T

DRAFT 802.11n (20MHz) OFDM MODULATION

TEST MODE A

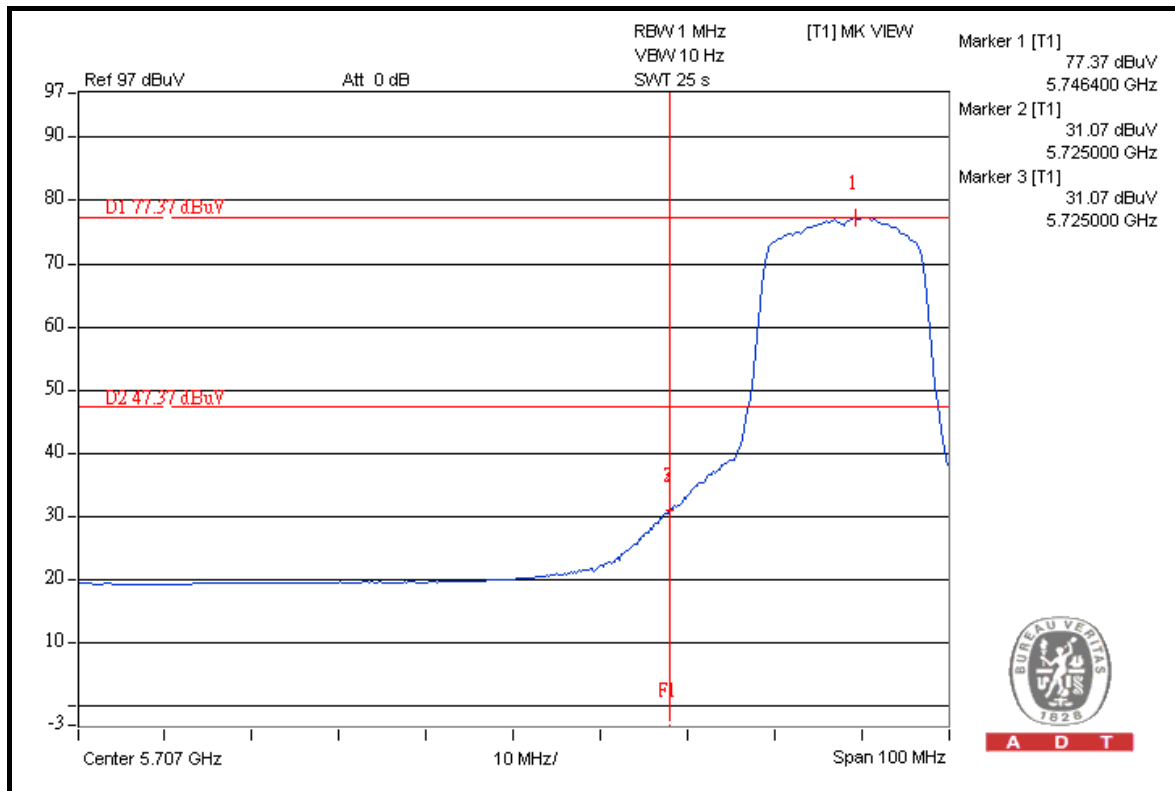
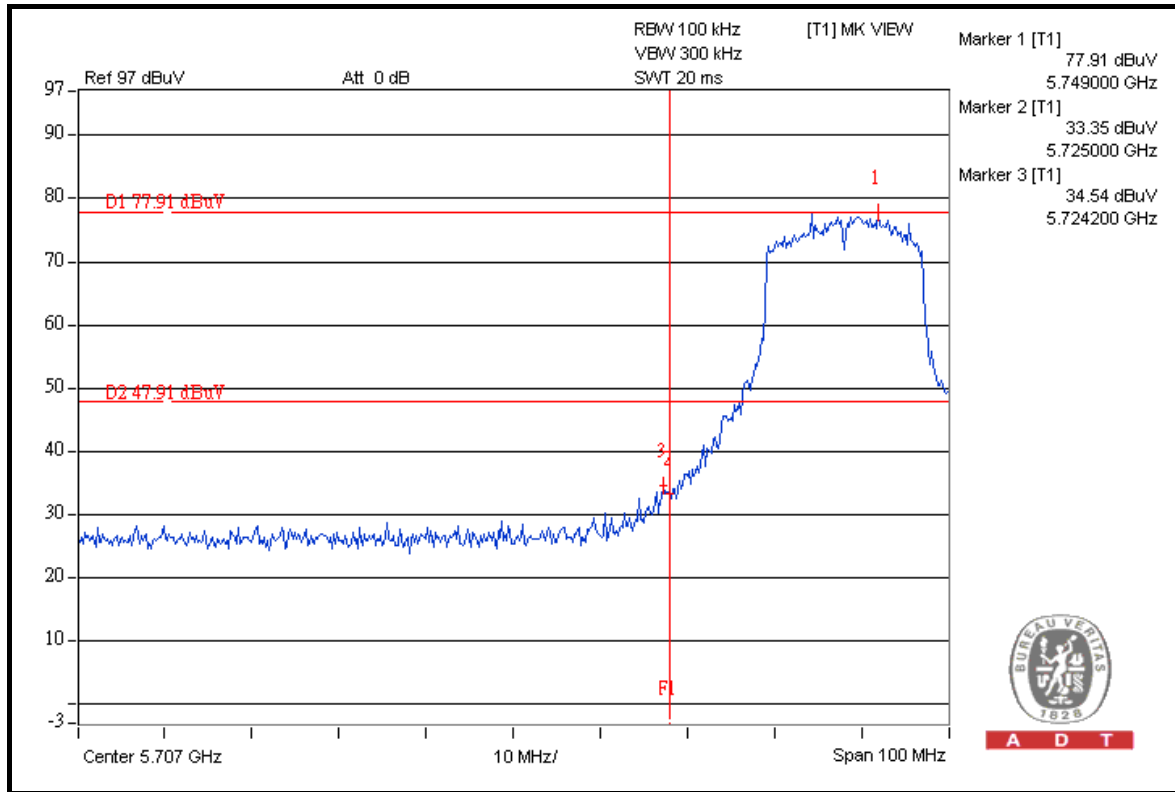



A D T

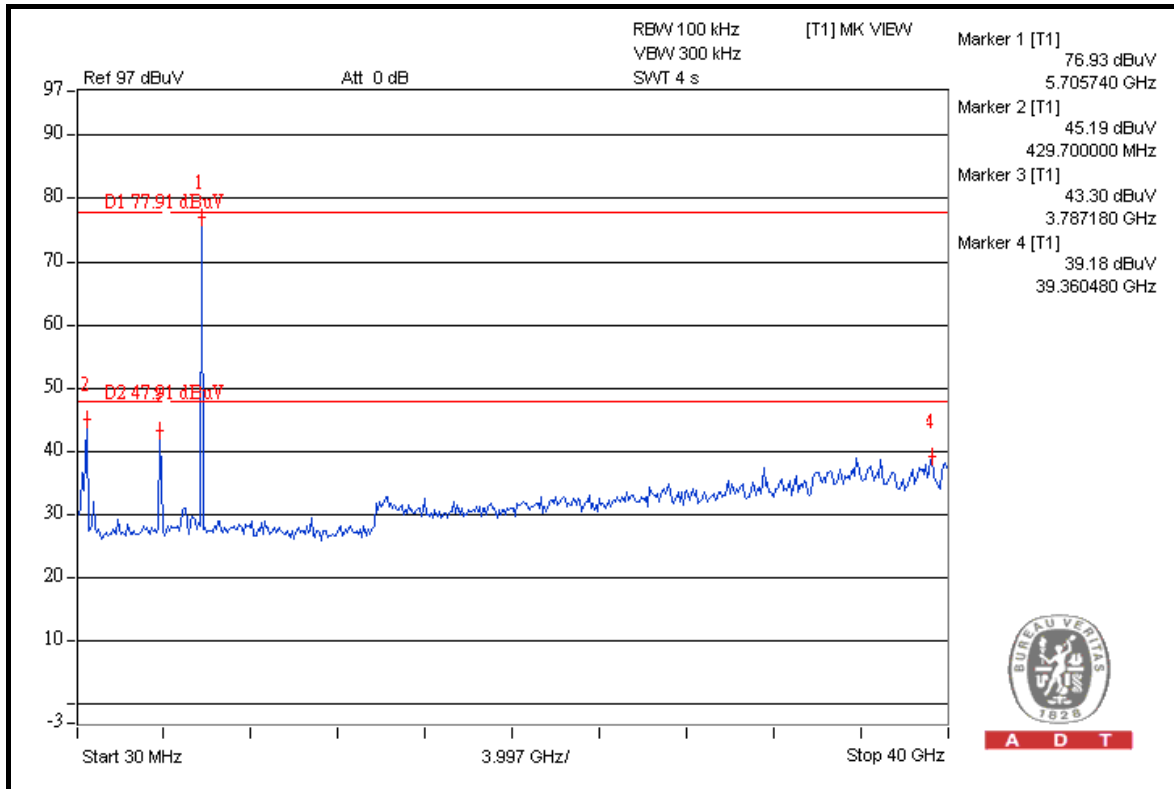

A D T

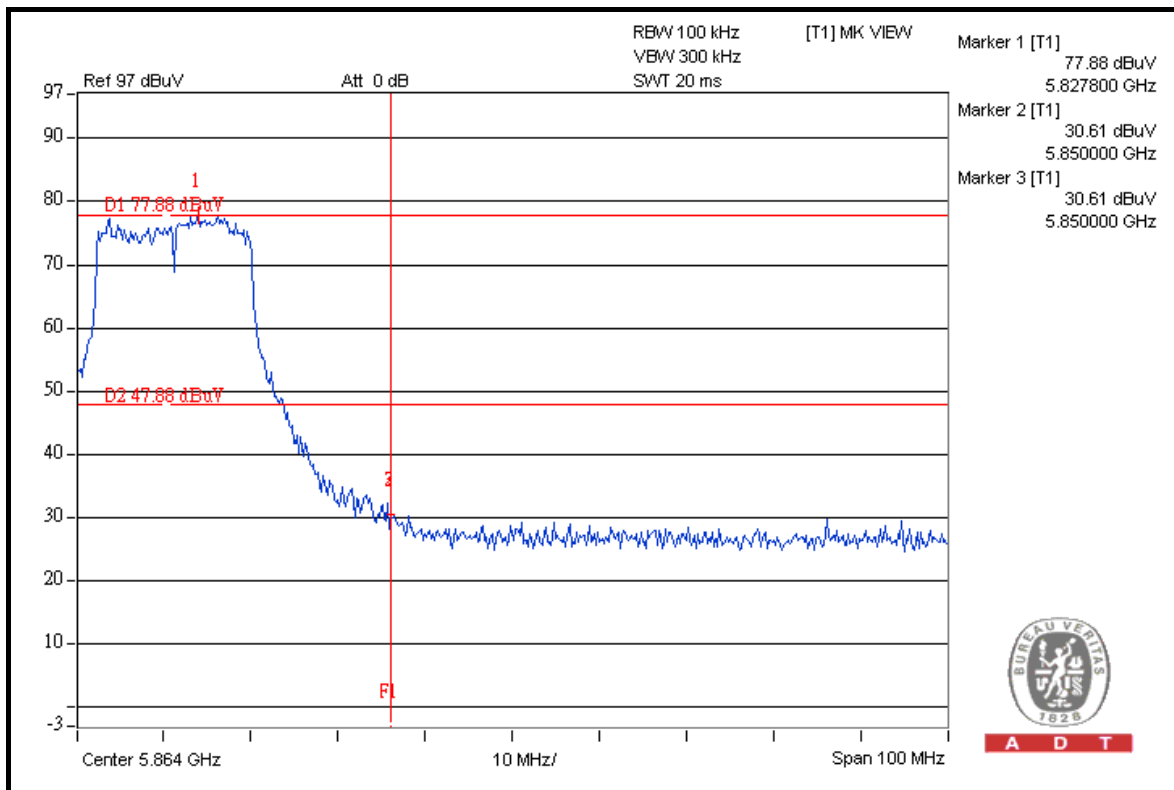

A D T



A D T

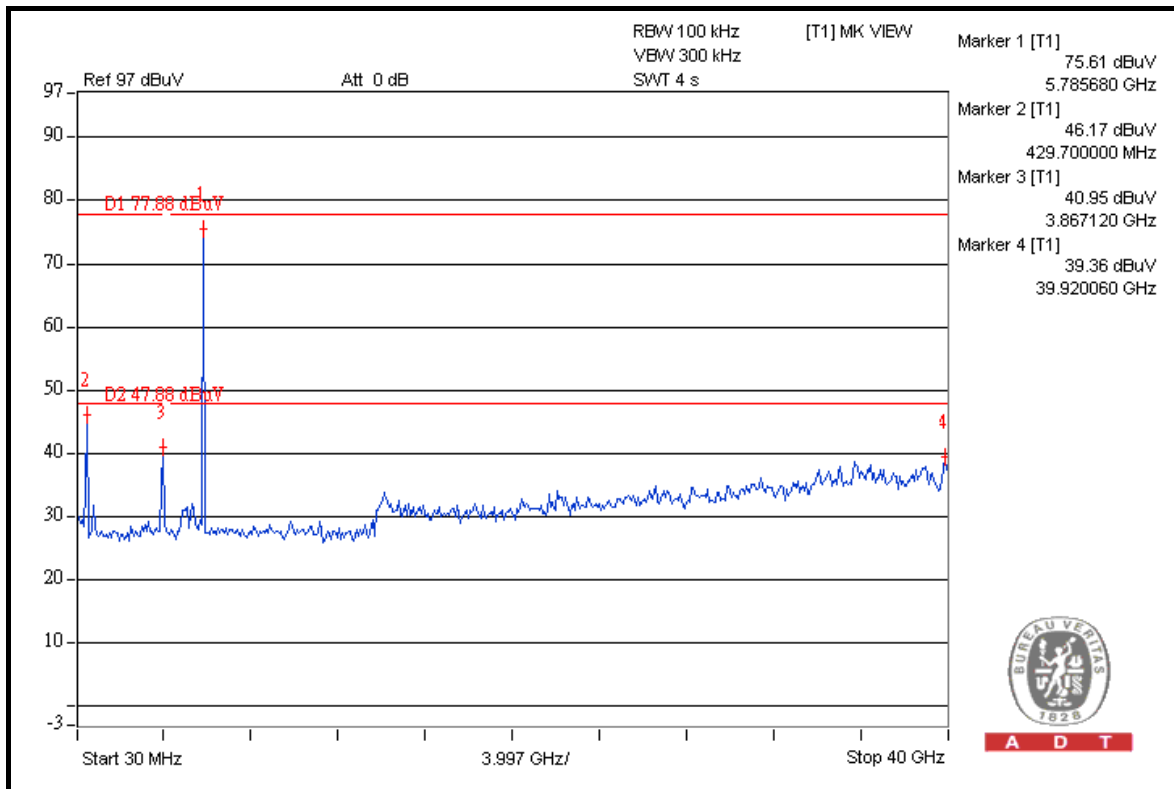
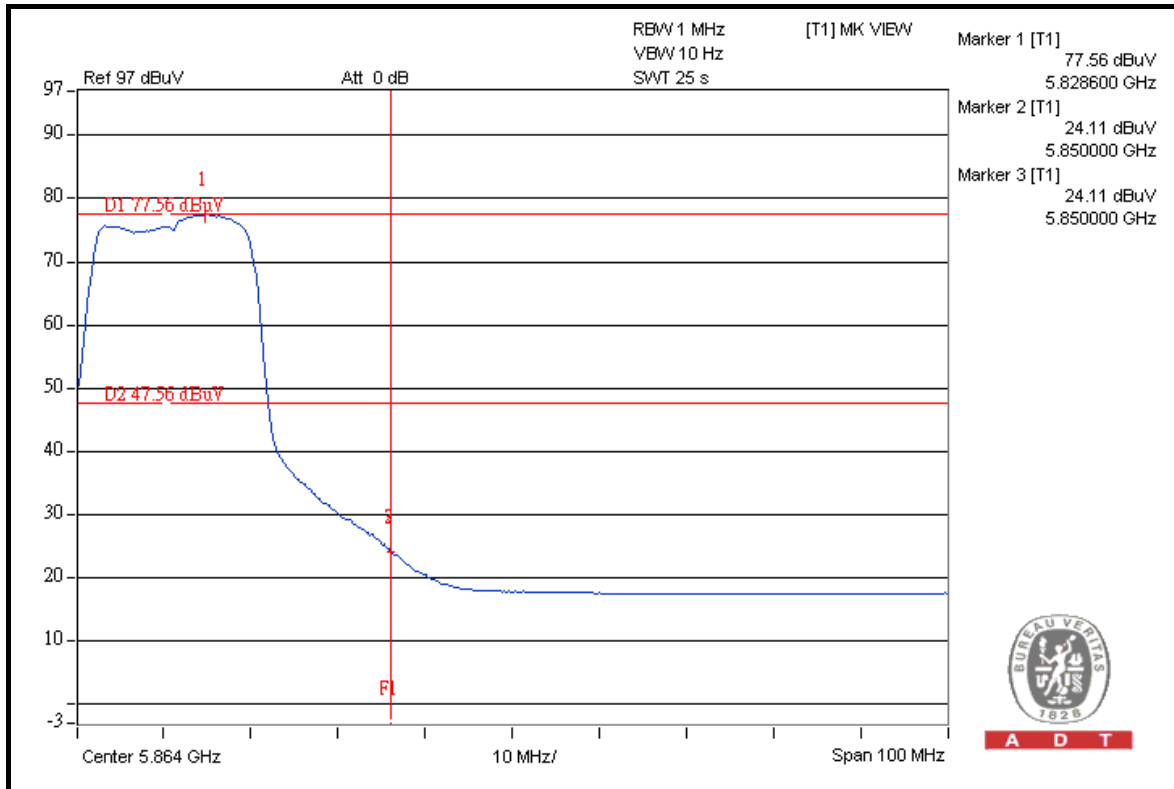



A D T

TEST MODE C

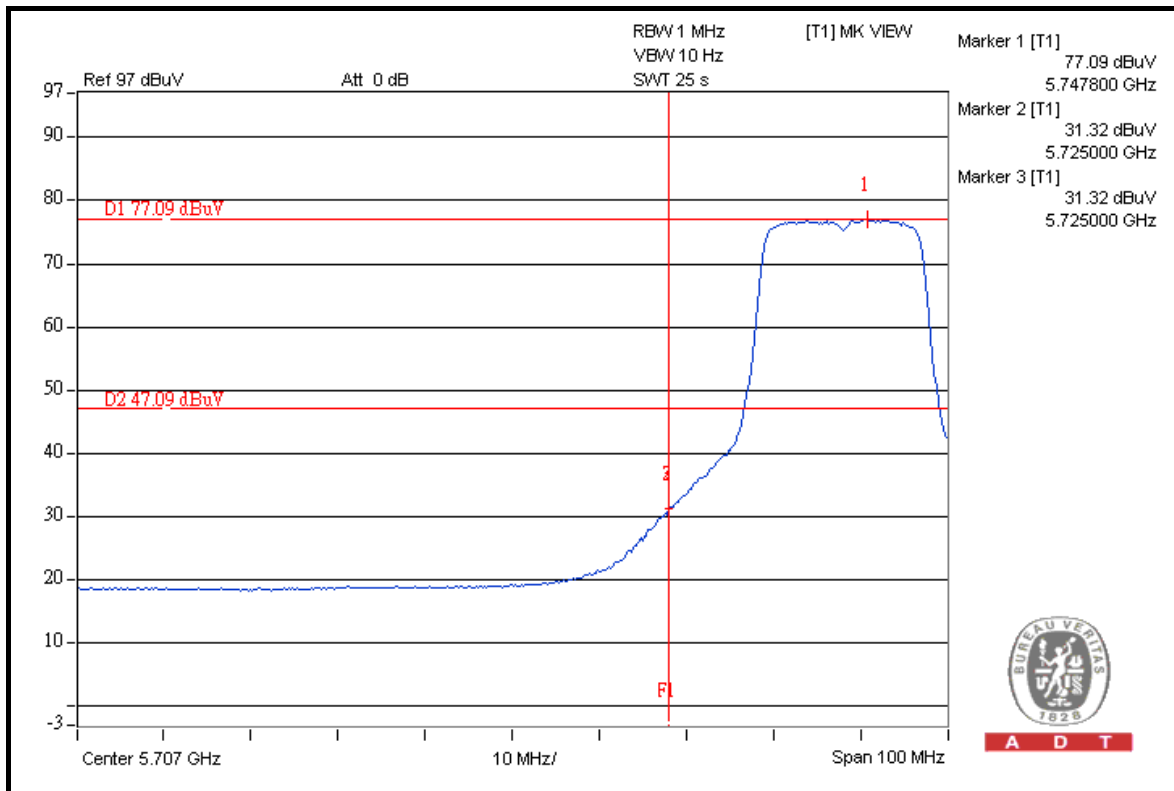
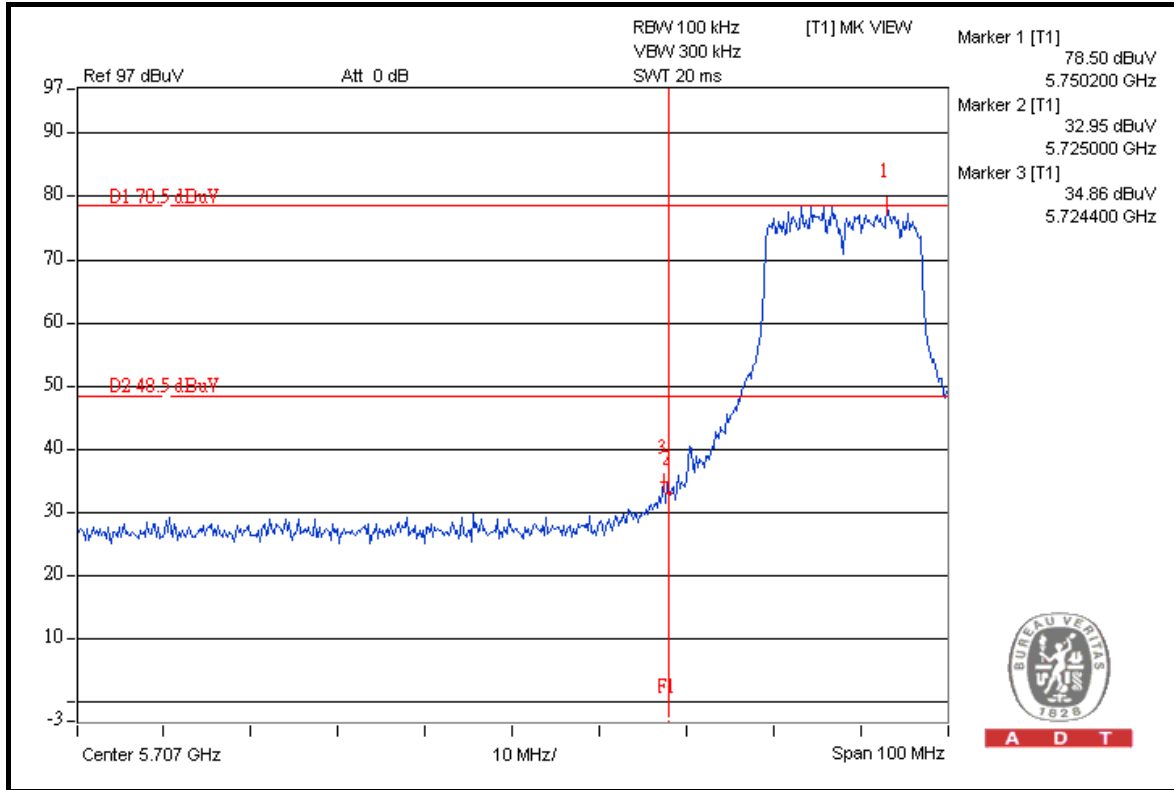



A D T

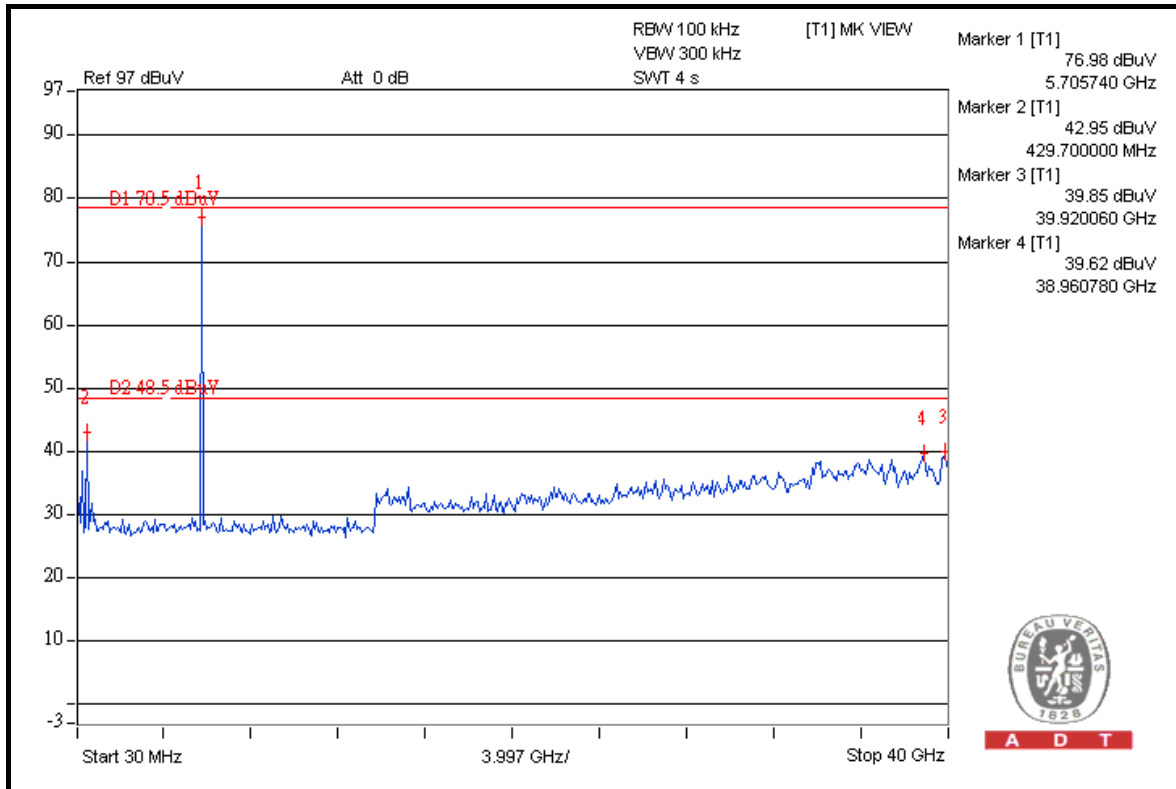

A D T

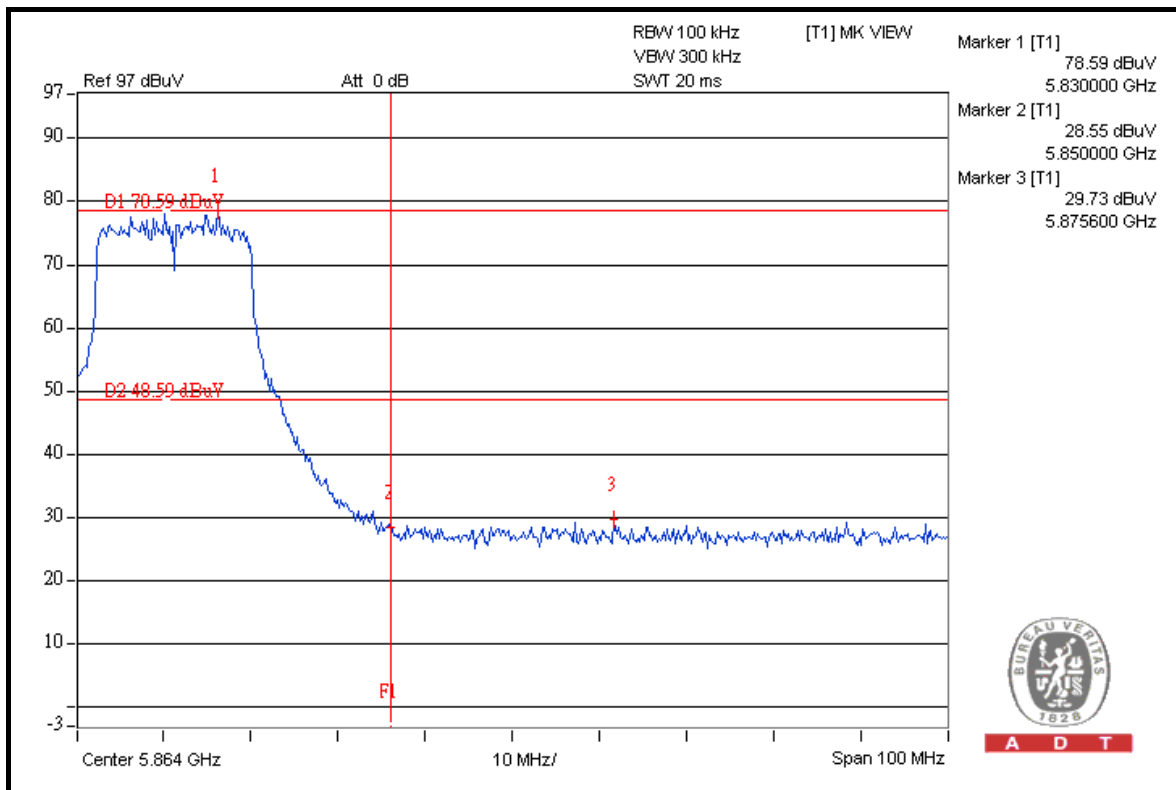

A D T



A D T

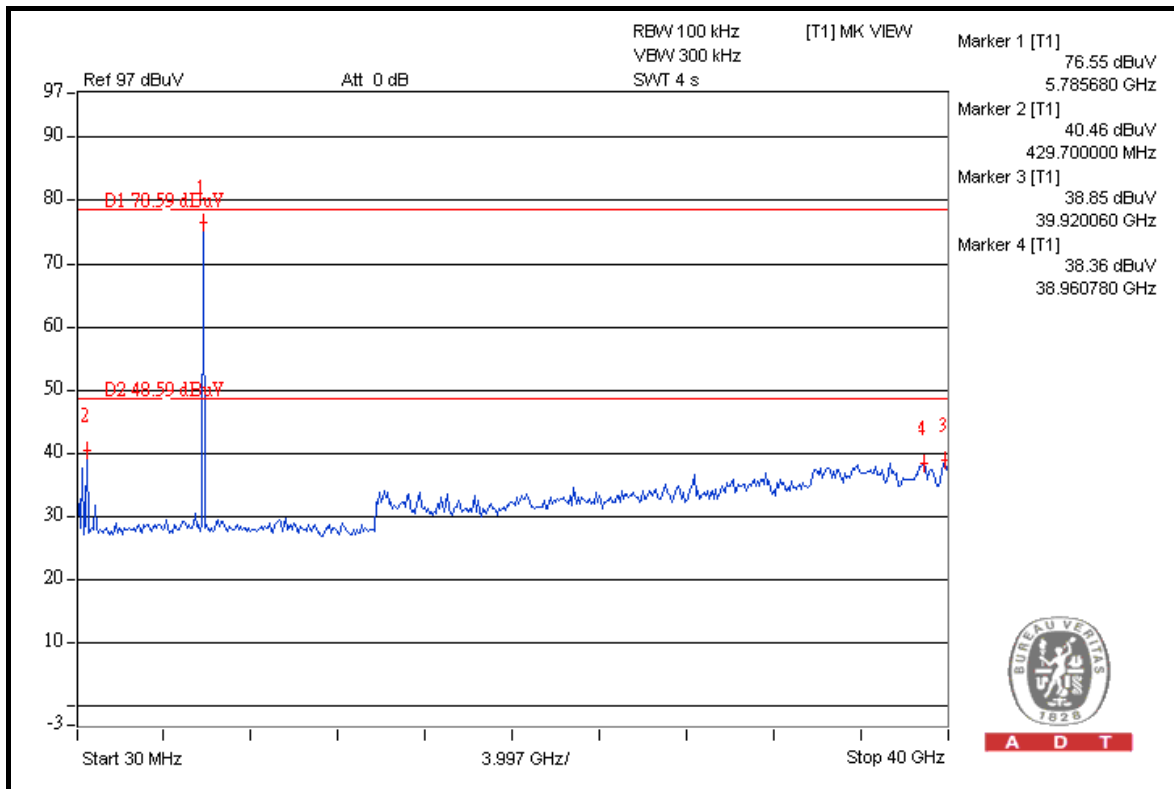
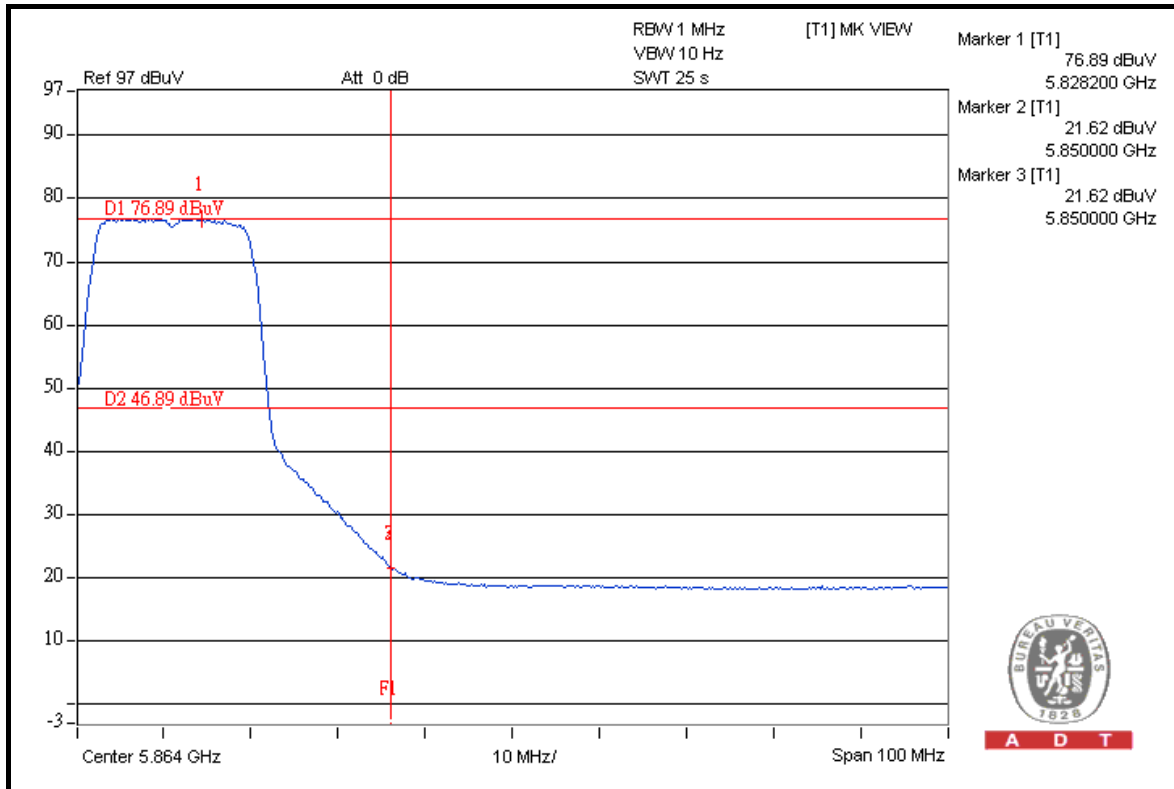



A D T

DRAFT 802.11n (40MHz) OFDM MODULATION

TEST MODE A

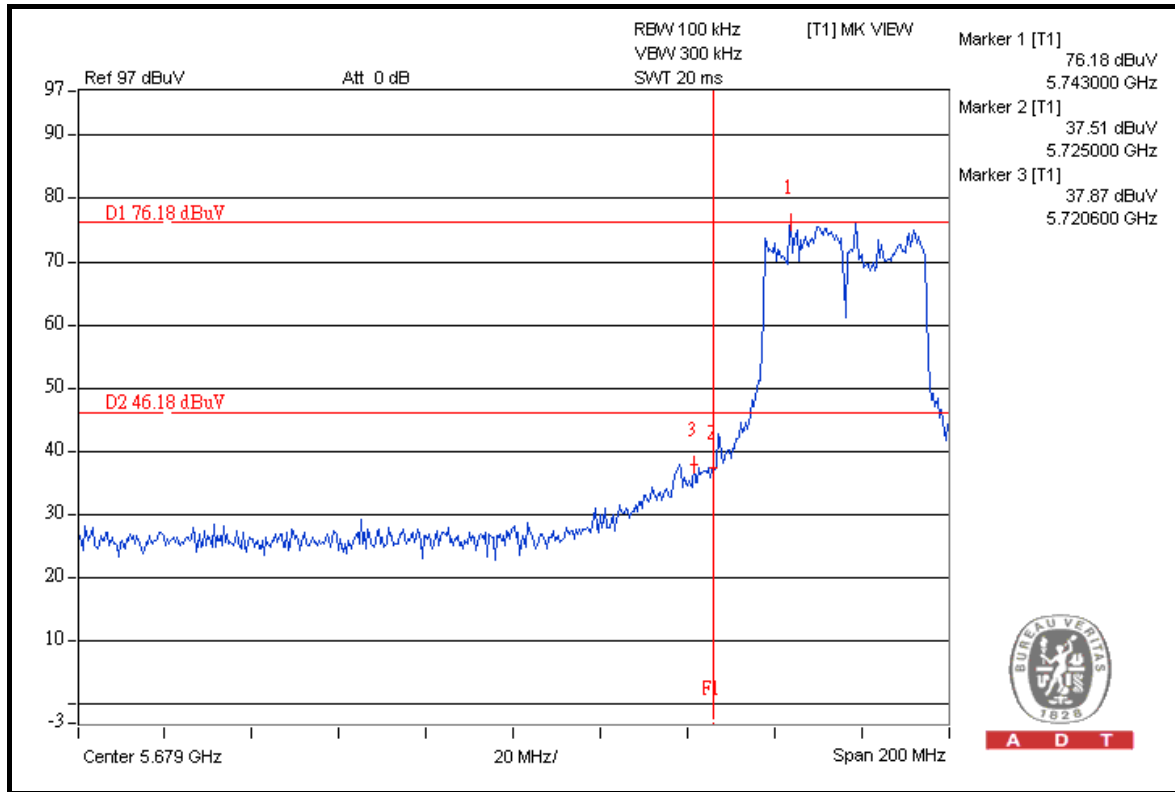

A D T

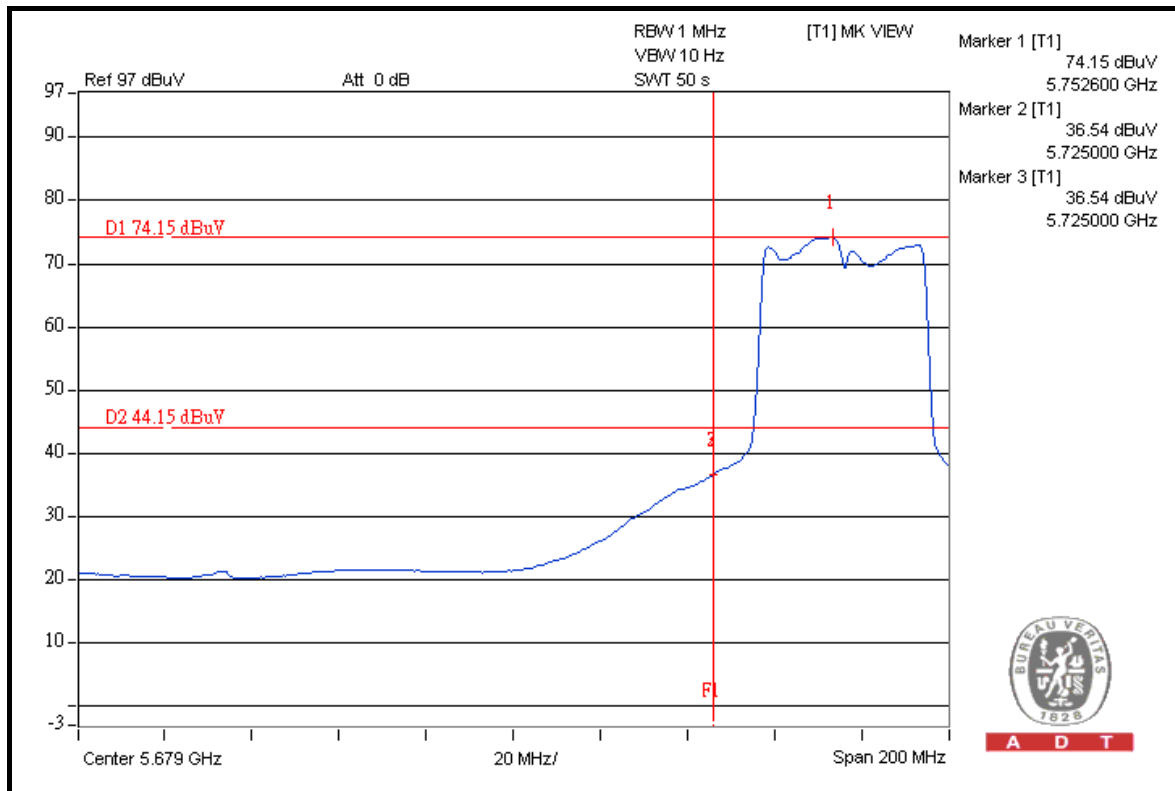

A D T



A D T

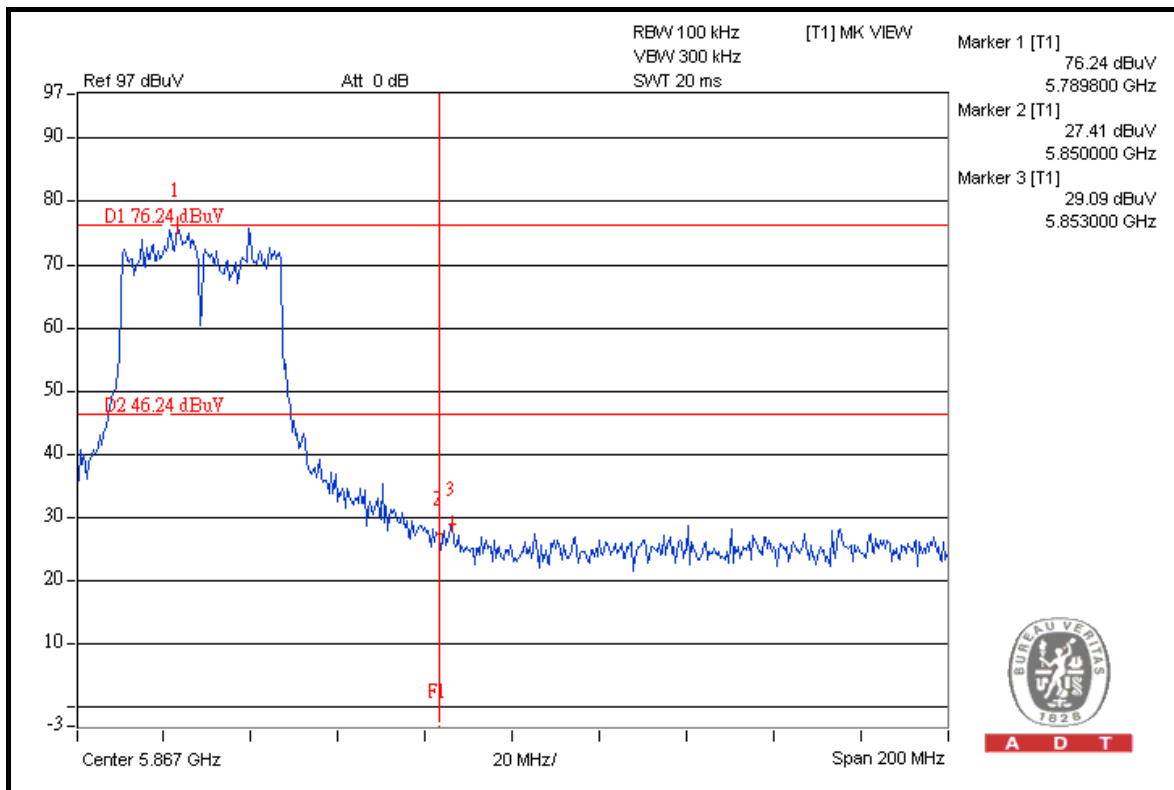
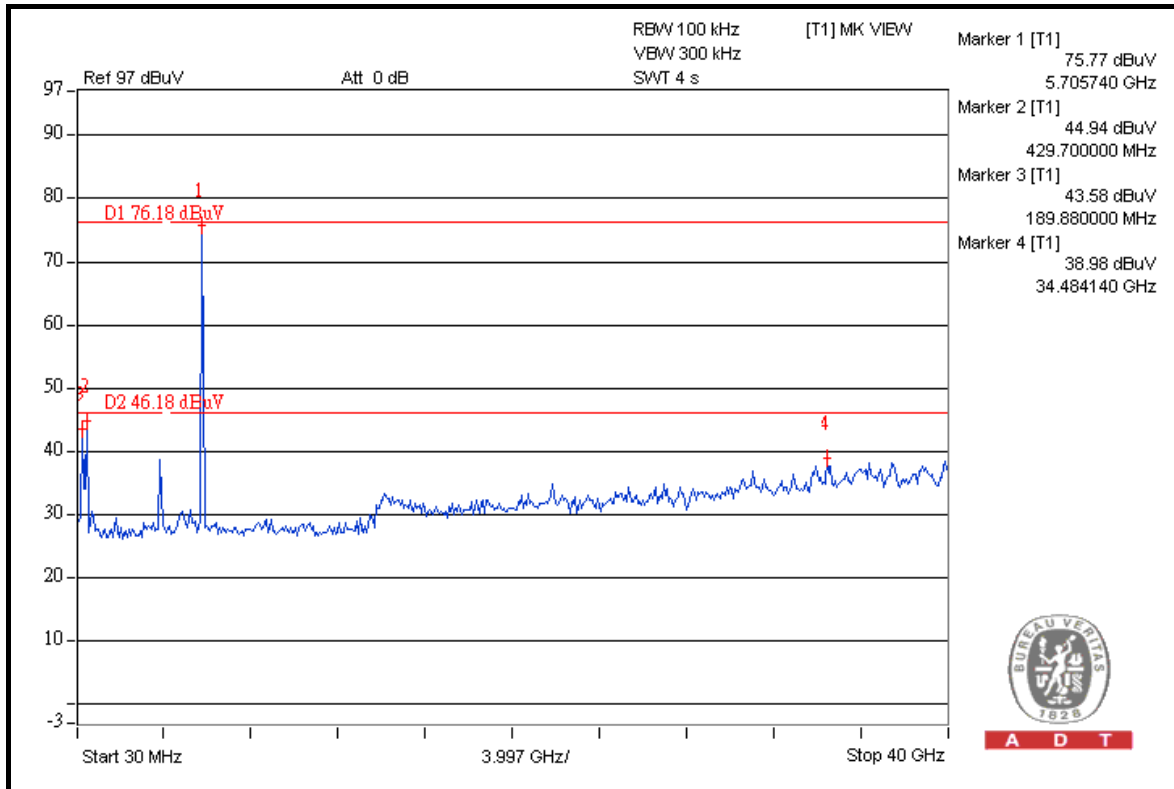



A D T

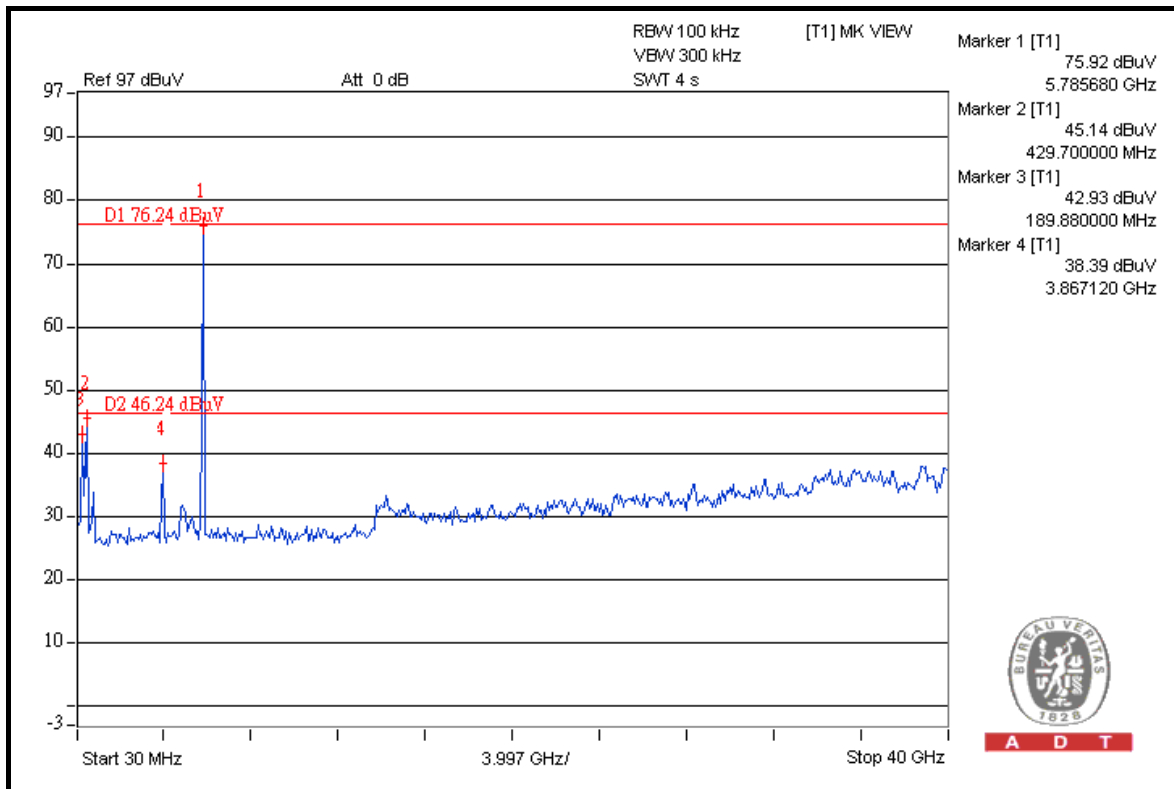
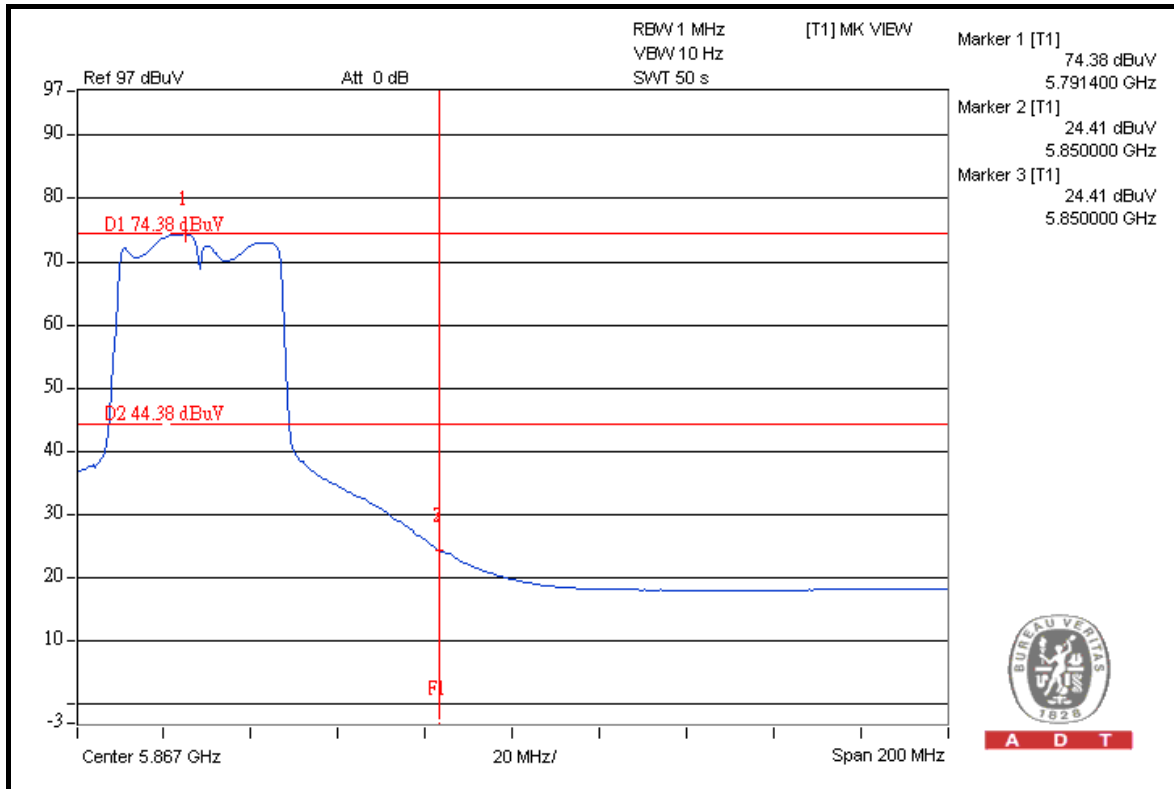



A D T

TEST MODE C

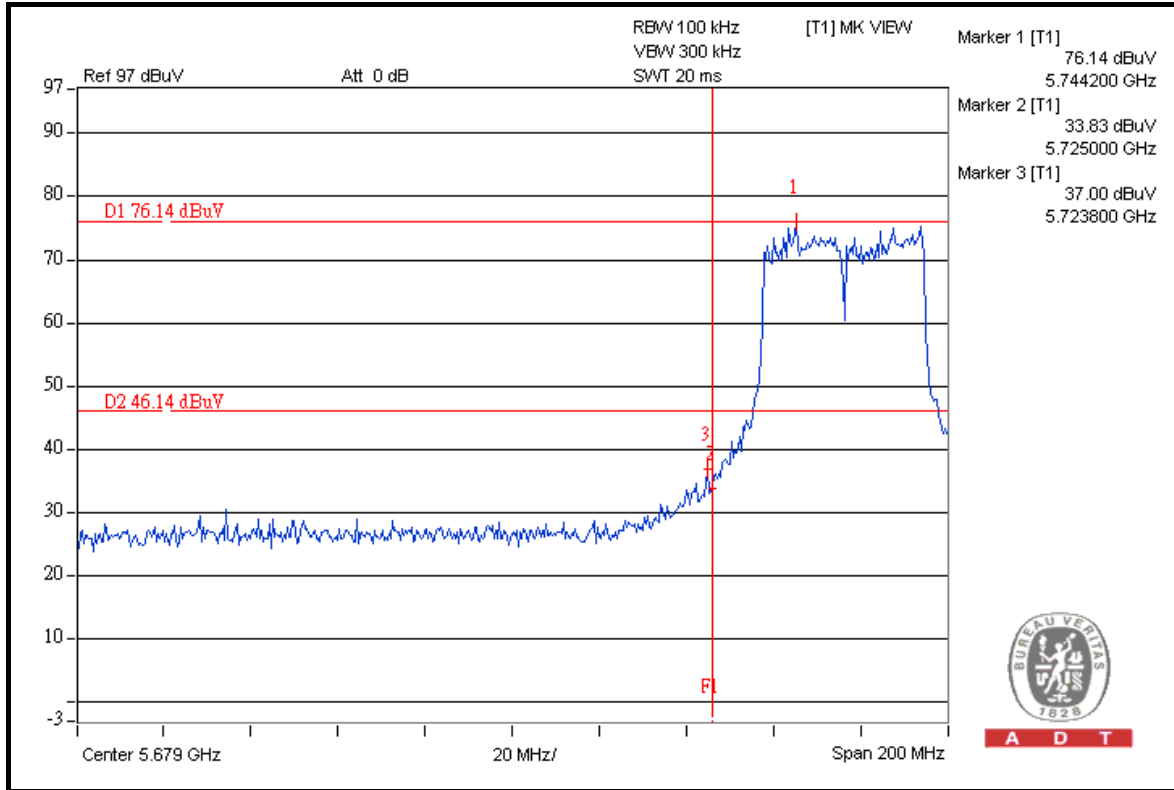

A D T

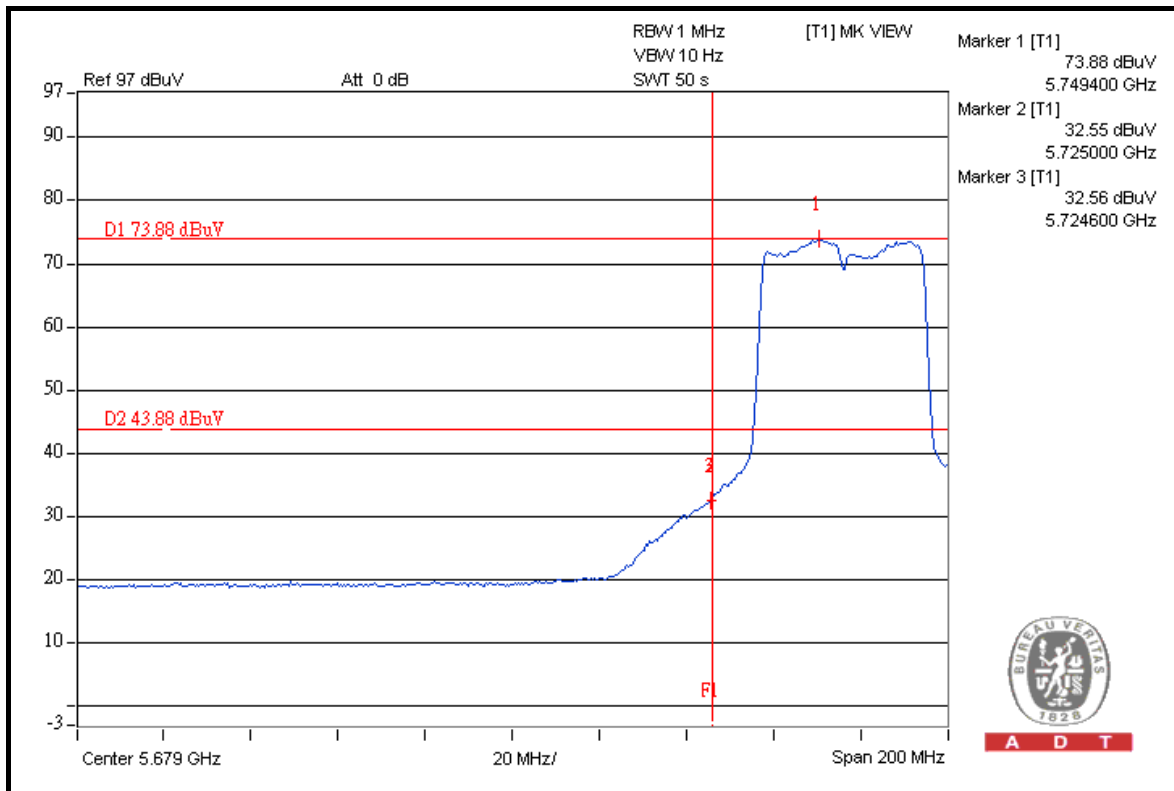

A D T



A D T

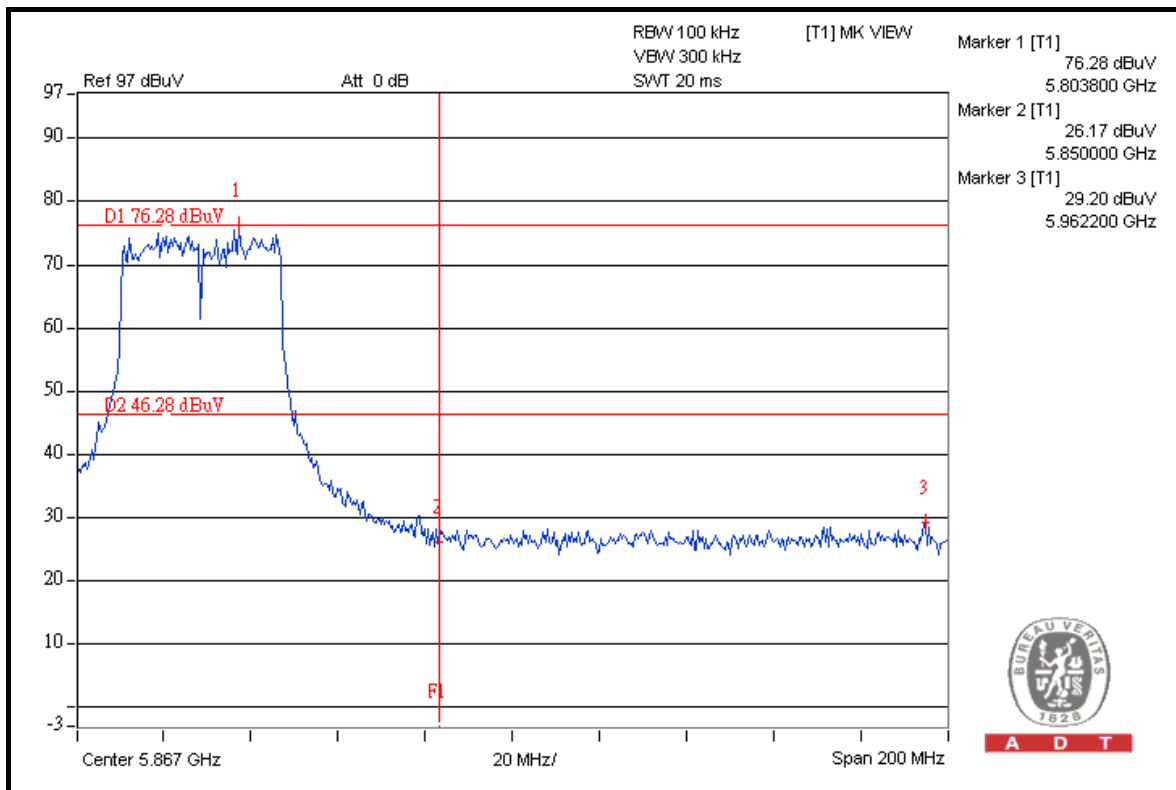
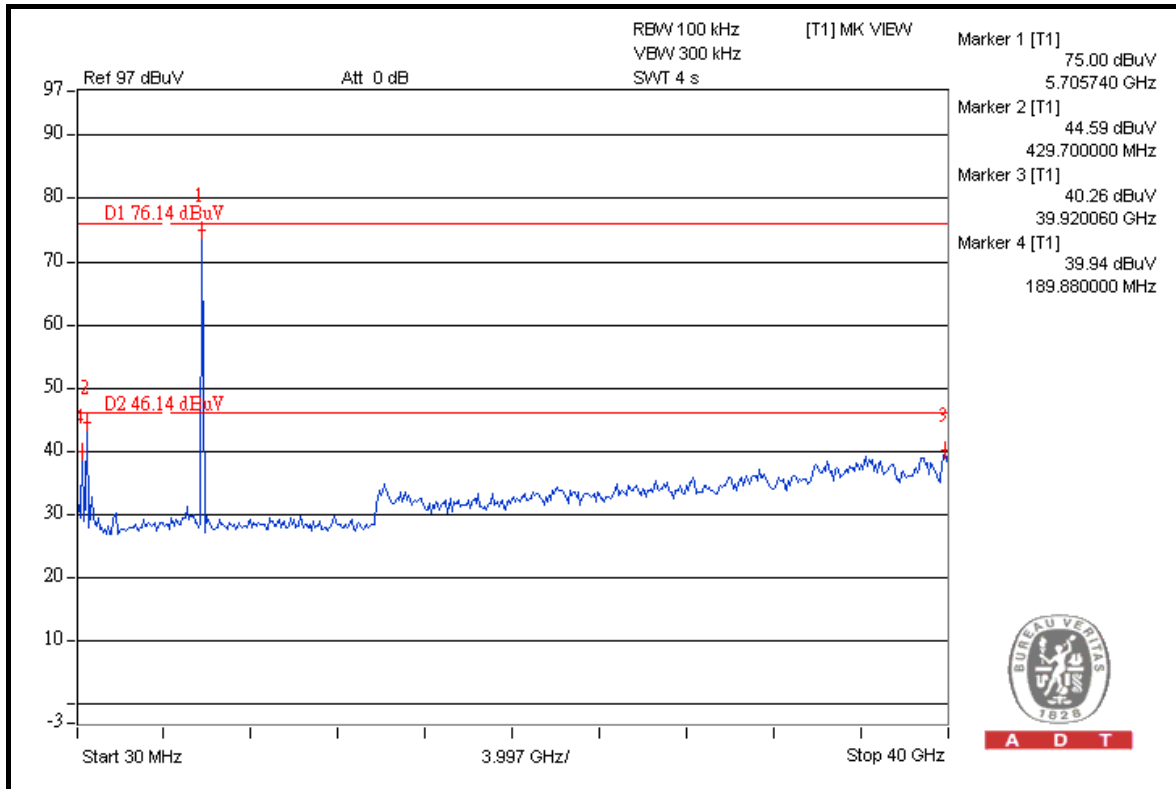



A D T

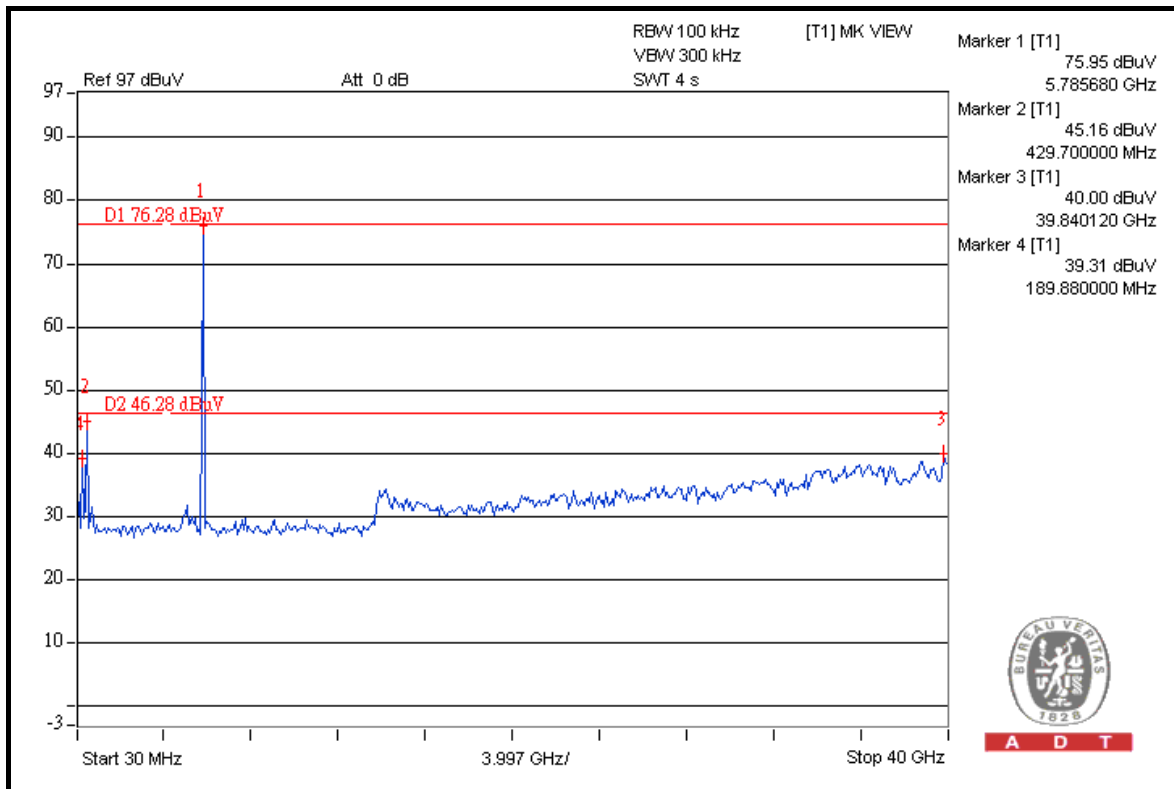
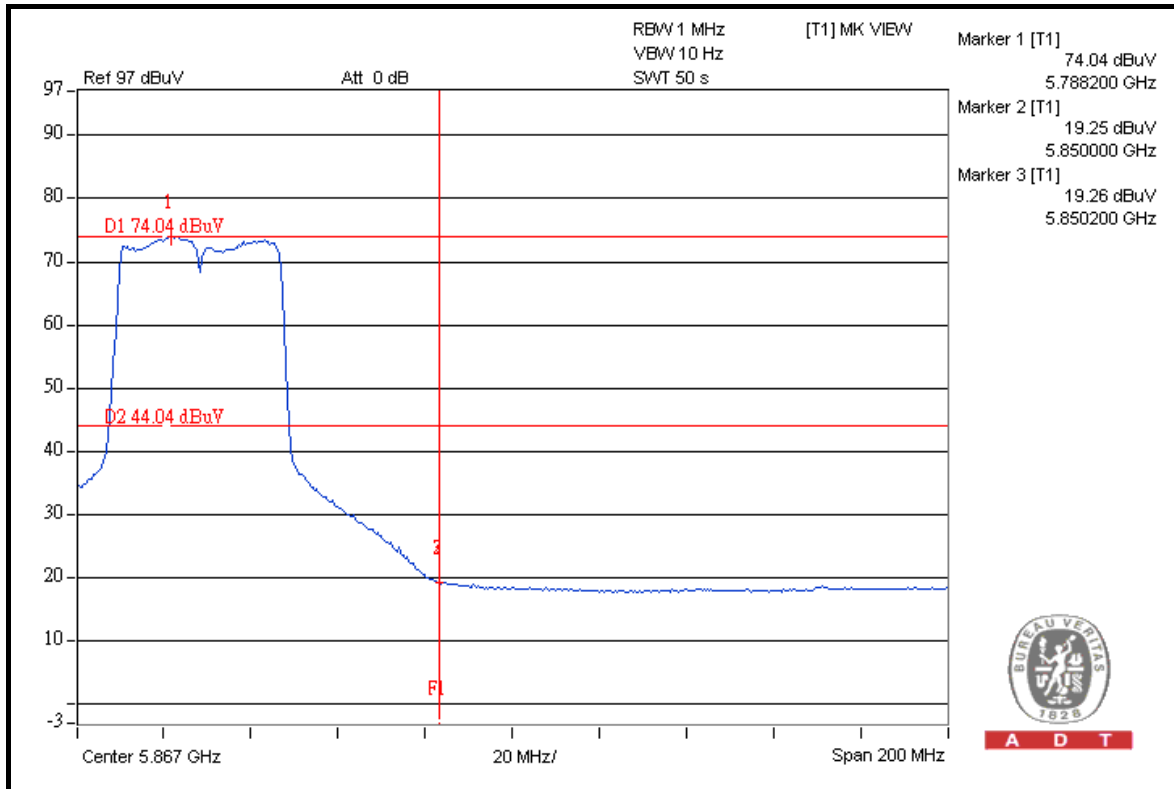

5.7 ANTENNA REQUIREMENT

5.7.1 STANDARD APPLICABLE

For intentional device, according to FCC 47 CFR Section 15.203, an intentional radiator shall be designed to ensure that no antenna other than that furnished by the responsible party shall be used with the device.

And according to FCC 47 CFR Section 15.247(a), if transmitting antennas of directional gain greater than 6dBi are used, the power shall be reduced by the amount in dB that the directional gain of the antenna exceeds 6dBi.

5.7.2 ANTENNA CONNECTED CONSTRUCTION

The antennas used in this product are internal: proprietary omni antenna without connector and external: directional panel antenna with female N-Type connector. The maximum gain of the antenna is 14dBi.



A D T

6. PHOTOGRAPHS OF THE TEST CONFIGURATION

Please refer to the attached file (Test Setup Photo).



A D T

7. INFORMATION ON THE TESTING LABORATORIES

We, Bureau Veritas Consumer Products Services (H.K.) Ltd., Taoyuan Branch, were founded in 1988 to provide our best service in EMC, Radio, Telecom and Safety consultation. Our laboratories are accredited and approved by the following approval agencies according to ISO/IEC 17025.

USA	FCC, NVLAP
Germany	TUV Rheinland
Japan	VCCI
Norway	NEMKO
Canada	INDUSTRY CANADA, CSA
R.O.C.	TAF, BSMI, NCC
Netherlands	Telefication
Singapore	GOST-ASIA(MOU)
Russia	CERTIS(MOU)

Copies of accreditation certificates of our laboratories obtained from approval agencies can be downloaded from our web site:

www.adt.com.tw/index.5/phtml. If you have any comments, please feel free to contact us at the following:

Linko EMC/RF Lab:

Tel: 886-2-26052180

Fax: 886-2-26051924

Hsin Chu EMC/RF Lab:

Tel: 886-3-5935343

Fax: 886-3-5935342

Hwa Ya EMC/RF/Safety Telecom Lab:

Tel: 886-3-3183232

Fax: 886-3-3185050

Web Site: www.adt.com.tw

The address and road map of all our labs can be found in our web site also.



A D T

8. APPENDIX A - MODIFICATIONS RECORDERS FOR ENGINEERING CHANGES TO THE EUT BY THE LAB

No any modifications are made to the EUT by the lab during the test.

---END---