



# FCC TEST REPORT (15.407)

**REPORT NO.:** RF981021L10A

**MODEL NO.:** ZF7363

**RECEIVED:** Nov. 23, 2009

**TESTED:** Nov. 25 ~ Nov. 30, 2009

**ISSUED:** Dec. 02, 2009

<b>APPLICANT:</b>	Senao Networks Inc.
<b>ADDRESS:</b>	3F, No. 529, Chung Cheng Rd., Hsintien, Taipei, Taiwan, R.O.C.
<b>FCC ID:</b>	U2M-ZF73XX-1
<b>MANUFACTURER'S COMPANY:</b>	Senao Networks, Inc.
<b>MANUFACTURER ADDRESS:</b>	3F, No. 529, Chung Cheng Rd., Hsintien, Taipei, Taiwan

**ISSUED BY:** Bureau Veritas Consumer Products Services (H.K.) Ltd., Taoyuan Branch

**LAB ADDRESS:** No. 47, 14th Ling, Chia Pau Tsuen, Lin Kou Hsiang, Taipei Hsien 244, Taiwan, R.O.C.

This test report consists of 103 pages in total. It may be duplicated completely for legal use with the approval of the applicant. It should not be reproduced except in full, without the written approval of our laboratory. The client should not use it to claim product endorsement by TAF or any government agencies. The test results in the report only apply to the tested sample.





## TABLE OF CONTENTS

1.	CERTIFICATION.....	4
2.	SUMMARY OF TEST RESULTS .....	5
2.1	MEASUREMENT UNCERTAINTY .....	5
3.	GENERAL INFORMATION.....	6
3.1	GENERAL DESCRIPTION OF EUT .....	6
3.2	DESCRIPTION OF TEST MODES .....	8
3.2.1	CONFIGURATION OF SYSTEM UNDER TEST .....	10
3.2.2	TEST MODE APPLICABILITY AND TESTED CHANNEL DETAIL .....	11
3.3	GENERAL DESCRIPTION OF APPLIED STANDARDS .....	14
3.4	DESCRIPTION OF SUPPORT UNITS .....	14
4.	TEST TYPES AND RESULTS .....	15
4.1	RADIATED EMISSION MEASUREMENT .....	15
4.1.1	LIMITS OF RADIATED EMISSION MEASUREMENT .....	15
4.1.2	LIMITS OF UNWANTED EMISSION OUT OF THE RESTRICTED BANDS .....	15
4.1.3	TEST INSTRUMENTS.....	16
4.1.4	TEST PROCEDURES .....	17
4.1.5	DEVIATION FROM TEST STANDARD.....	17
4.1.6	TEST SETUP .....	18
4.1.7	EUT OPERATING CONDITION.....	18
4.1.8	TEST RESULTS .....	19
4.2	CONDUCTED EMISSION MEASUREMENT .....	40
4.2.1	LIMITS OF CONDUCTED EMISSION MEASUREMENT .....	40
4.2.2	TEST INSTRUMENTS.....	40
4.2.3	TEST PROCEDURES .....	41
4.2.4	DEVIATION FROM TEST STANDARD.....	41
4.2.5	TEST SETUP .....	42
4.2.6	EUT OPERATING CONDITIONS .....	42
4.2.7	TEST RESULTS .....	43
4.3	MAXIMUM CONDUCTED OUTPUT POWER MEASUREMENT .....	51
4.3.1	LIMITS OF MAXIMUM CONDUCTED OUTPUT POWER MEASUREMENT.....	51
4.3.2	TEST INSTRUMENTS.....	51
4.3.3	TEST PROCEDURE.....	51
4.3.4	DEVIATION FROM TEST STANDARD.....	52
4.3.5	TEST SETUP .....	52
4.3.6	EUT OPERATING CONDITIONS .....	52
4.3.7	TEST RESULTS .....	53
4.4	PEAK POWER EXCURSION MEASUREMENT .....	59
4.4.1	LIMITS OF PEAK POWER EXCURSION MEASUREMENT .....	59
4.4.2	TEST INSTRUMENTS.....	59
4.4.3	TEST PROCEDURE.....	59
4.4.4	DEVIATION FROM TEST STANDARD.....	60
4.4.5	TEST SETUP .....	60
4.4.6	EUT OPERATING CONDITIONS .....	60
4.4.7	TEST RESULTS .....	61
4.5	PEAK POWER SPECTRAL DENSITY MEASUREMENT .....	67
4.5.1	LIMITS OF PEAK POWER SPECTRAL DENSITY MEASUREMENT .....	67
4.5.2	TEST INSTRUMENTS.....	67
4.5.3	TEST PROCEDURES .....	67



4.5.4	DEVIATION FROM TEST STANDARD.....	68
4.5.5	TEST SETUP.....	68
4.5.6	EUT OPERATING CONDITIONS.....	68
4.5.7	TEST RESULTS.....	69
4.6	FREQUENCY STABILITY.....	72
4.6.1	LIMITS OF FREQUENCY STABILITY MEASUREMENT.....	72
4.6.2	TEST INSTRUMENTS.....	72
4.6.3	TEST PROCEDURE.....	72
4.6.4	DEVIATION FROM TEST STANDARD.....	73
4.6.5	TEST SETUP.....	73
4.6.6	EUT OPERATING CONDITION.....	73
4.6.7	TEST RESULTS.....	74
4.7	BAND EDGES MEASUREMENT.....	75
4.7.1	TEST INSTRUMENTS.....	75
4.7.2	TEST PROCEDURE.....	76
4.7.3	EUT OPERATING CONDITION.....	76
4.7.4	TEST RESULTS.....	76
5.	PHOTOGRAPHS OF THE TEST CONFIGURATION.....	101
6.	INFORMATION ON THE TESTING LABORATORIES.....	102
7.	APPENDIX A - MODIFICATIONS RECORDERS FOR ENGINEERING CHANGES TO THE EUT BY THE LAB.....	103



# 1. CERTIFICATION

**PRODUCT:** ZoneFlex 7363 Access Point

**MODEL:** ZF7363

**BRAND:** Ruckus

**APPLICANT:** Senao Networks Inc.

**TEST SAMPLE:** ENGINEERING SAMPLE

**TESTED:** Nov. 25 ~ Nov. 30, 2009

**STANDARDS: FCC Part 15, Subpart E (Section 15.407)**

ANSI C63.4-2003

The above equipment (Model: ZF7363) has been tested by **Bureau Veritas Consumer Products Services (H.K.) Ltd., Taoyuan Branch**, and found compliance with the requirement of the above standards. The test record, data evaluation & Equipment Under Test (EUT) configurations represented herein are true and accurate accounts of the measurements of the sample's EMC characteristics under the conditions specified in this report.

**PREPARED BY** : Andrea Hsia , **DATE** : Dec. 02, 2009  
Andrea Hsia / Specialist

**TECHNICAL ACCEPTANCE** : Long Chen , **DATE** : Dec. 02, 2009  
Responsible for RF Long Chen / Senior Engineer

**APPROVED BY** : Gary Chang , **DATE** : Dec. 02, 2009  
Gary Chang / Assistant Manager

## 2. SUMMARY OF TEST RESULTS

The EUT has been tested according to the following specifications:

APPLIED STANDARD: FCC PART 15, SUBPART E (SECTION 15.407)			
STANDARD SECTION	TEST TYPE AND LIMIT	RESULT	REMARK
15.407(b)(5)	AC Power Conducted Emission	PASS	Meet the requirement of limit. Minimum passing margin is -17.17dB at 0.177MHz.
15.407(b)(1/2/3)(b)(5)	Electric Field Strength Spurious Emissions, 30MHz ~ 40000MHz	PASS	Meet the requirement of limit. Minimum passing margin is -0.3dB at 340.02 & 340.01MHz.
15.407(a)(1/2/3)	Peak Transmit Power	PASS	Meet the requirement of limit.
15.407(a)(6)	Peak Power Excursion	PASS	Meet the requirement of limit.
15.407(a)(1/2/3)	Peak Power Spectral Density	PASS	Meet the requirement of limit.
15.407(g)	Frequency Stability	PASS	Meet the requirement of limit.
15.203	Antenna Requirement	PASS	No antenna connector is used.

### 2.1 MEASUREMENT UNCERTAINTY

Where relevant, the following measurement uncertainty levels have been estimated for tests performed on the EUT as specified in CISPR 16-4-2:

MEASUREMENT	FREQUENCY	UNCERTAINTY
Conducted emissions	150kHz~30MHz	2.44 dB
Radiated emissions	30MHz ~ 1000MHz	3.52 dB
	1GHz ~ 40GHz	2.89 dB

This uncertainty represents an expanded uncertainty expressed at approximately the 95% confidence level using a coverage factor of  $k = 2$ .

### 3. GENERAL INFORMATION

#### 3.1 GENERAL DESCRIPTION OF EUT

<b>EUT</b>	ZoneFlex 7363 Access Point
<b>MODEL NO.</b>	ZF7363
<b>FCC ID</b>	U2M-ZF73XX-1
<b>POWER SUPPLY</b>	12Vdc (adapter) 48Vdc (POE)
<b>MODULATION TYPE</b>	64QAM, 16QAM, QPSK, BPSK for OFDM
<b>MODULATION TECHNOLOGY</b>	OFDM
<b>TRANSFER RATE</b>	802.11a: 54.0/ 48.0/ 36.0/ 24.0/ 18.0/ 12.0/ 9.0/ 6.0Mbps 802.11n: up to 270.0Mbps
<b>OPERATING FREQUENCY</b>	5260 ~ 5320MHz, 5500 ~ 5700MHz
<b>NUMBER OF CHANNEL</b>	5260 ~ 5320MHz: 4 for 802.11a, 802.11n (20MHz) 2 for 802.11n (40MHz) 5500 ~ 5700MHz: 8 for 802.11a, 802.11n (20MHz) 3 for 802.11n (40MHz)
<b>OUTPUT POWER</b>	95.7mW for 5260 ~ 5320MHz 148.4mW for 5500 ~ 5700MHz
<b>ANTENNA TYPE</b>	PIFA antenna with 2dBi gain
<b>ANTENNA CONNECTOR</b>	NA
<b>I/O PORTS</b>	USB, RJ45
<b>DATA CABLE</b>	NA
<b>ACCESSORY DEVICES</b>	AC adapter

**NOTE:**

1. This report is prepared for FCC class II permissive change. The difference compared with the original report is adding frequency band from 5.26 to 5.32GHz and 5.50 to 5.70GHz by software.
2. The EUT is a ZoneFlex 7363 Access Point. The functions of EUT listed as below:

	TEST STANDARD	REFERENCE REPORT
WLAN 802.11a, 802.11n	FCC Part 15, Subpart E (Section 15.407)	RF981021L10A
WLAN 802.11a, 802.11n (For DFS report)		RF981021L10A-1

3. The frequency bands used in this EUT are listed as follows:

Frequency Band (MHz)	5260~5320	5500~5700
802.11a	√	√
802.11n (20MHz)	√	√
802.11n (40MHz)	√	√

4. The EUT were powered by the following adapter & POE:

<b>ADAPTER</b>	
<b>BRAND:</b>	Ruckus
<b>MODEL:</b>	DSA-12G-12 FUS 120120
<b>INPUT:</b>	100-240Vac, 0.3A, 50/60Hz
<b>OUTPUT:</b>	12Vdc, 1A
<b>POWER LINE:</b>	1.8m non-shielded cable without core

<b>POE</b>	
<b>BRAND:</b>	SonicWall
<b>MODEL:</b>	PD-6083G300
<b>OUTPUT:</b>	48Vdc

\*\*POE was for tested only and optional accessory.

5. The EUT incorporates a MIMO function. Physically, the EUT provides two completed transmitters and two receivers.

<b>MODULATION MODE</b>	<b>TX FUNCTION</b>
<b>802.11b</b>	2TX
<b>802.11g</b>	2TX
<b>802.11a</b>	2TX
<b>802.11n (20MHz)</b>	2TX
<b>802.11n (40MHz)</b>	2TX

6. Spurious emission of the simultaneous operation has been evaluated and no non-compliance found.
7. The EUT has disabled the 5600-5650MHz band by S/W.
8. The above EUT information was declared by manufacturer and for more detailed features description, please refer to the manufacturer's specifications or user's manual.

### 3.2 DESCRIPTION OF TEST MODES

#### Operated in 5260 ~ 5320MHz

4 channels are provided for 802.11a, 802.11n (20MHz):

CHANNEL	FREQUENCY	CHANNEL	FREQUENCY
52	5260 MHz	60	5300 MHz
56	5280 MHz	64	5320 MHz

2 channels are provided for 802.11n (40MHz):

CHANNEL	FREQUENCY	CHANNEL	FREQUENCY
54	5270 MHz	62	5310 MHz

#### Operated in 5500 ~ 5700MHz

8 channels are provided for 802.11a, 802.11n (20MHz):

CHANNEL	FREQUENCY	CHANNEL	FREQUENCY
100	5500 MHz	116	5580 MHz
104	5520 MHz	132	5660 MHz
108	5540 MHz	136	5680 MHz
112	5560 MHz	140	5700 MHz

3 channels are provided for 802.11n (40MHz):

CHANNEL	FREQUENCY	CHANNEL	FREQUENCY
102	5510 MHz	134	5670 MHz
110	5550 MHz		





### POWER SETTING

802.11a			802.11n (20MHz)		
CHANNEL	POWER SETTING		CHANNEL	POWER SETTING	
52	Chain 0	17.0	52	Chain 0	17.0
	Chain 1	17.0		Chain 1	17.0
60	Chain 0	17.0	60	Chain 0	17.0
	Chain 1	17.0		Chain 1	17.0
64	Chain 0	17.0	64	Chain 0	17.0
	Chain 1	17.0		Chain 1	17.0
100	Chain 0	18.5	100	Chain 0	18.5
	Chain 1	18.5		Chain 1	18.5
116	Chain 0	18.5	116	Chain 0	18.5
	Chain 1	18.5		Chain 1	18.5
140	Chain 0	18.5	140	Chain 0	18.5
	Chain 1	18.5		Chain 1	18.5

802.11n (40MHz)		
CHANNEL	POWER SETTING	
54	Chain 0	15.0
	Chain 1	15.0
62	Chain 0	15.0
	Chain 1	15.0
102	Chain 0	14.5
	Chain 1	14.5
110	Chain 0	14.5
	Chain 1	14.5
134	Chain 0	14.0
	Chain 1	14.0

### 3.2.1 CONFIGURATION OF SYSTEM UNDER TEST

#### TEST MODE A

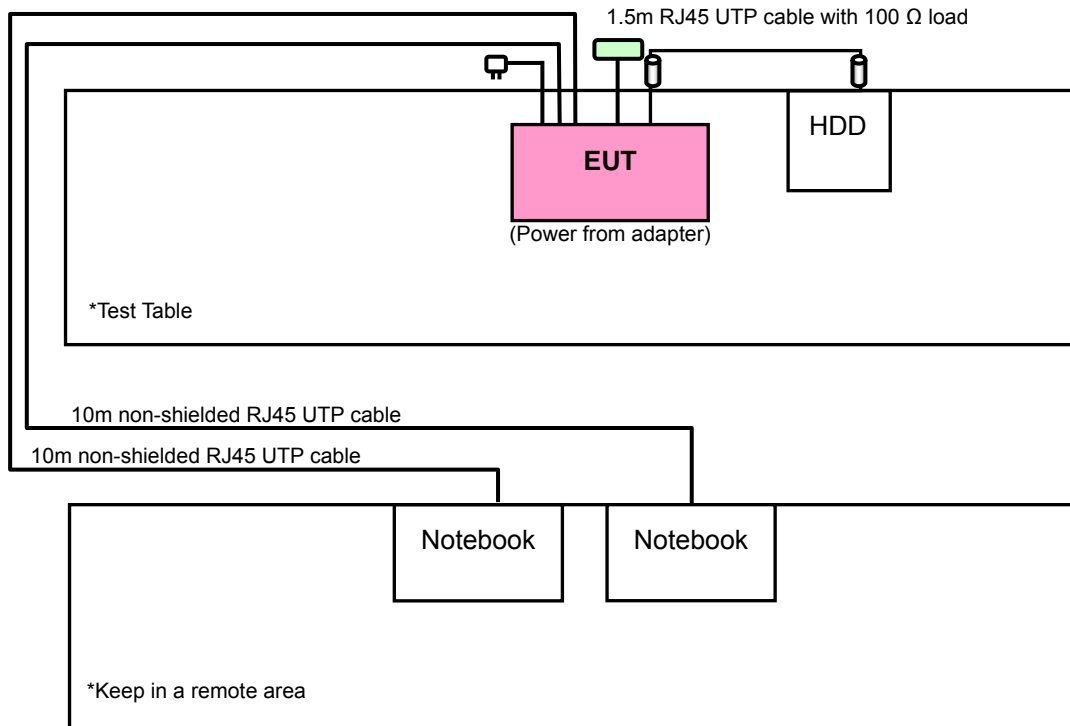

#### TEST MODE B

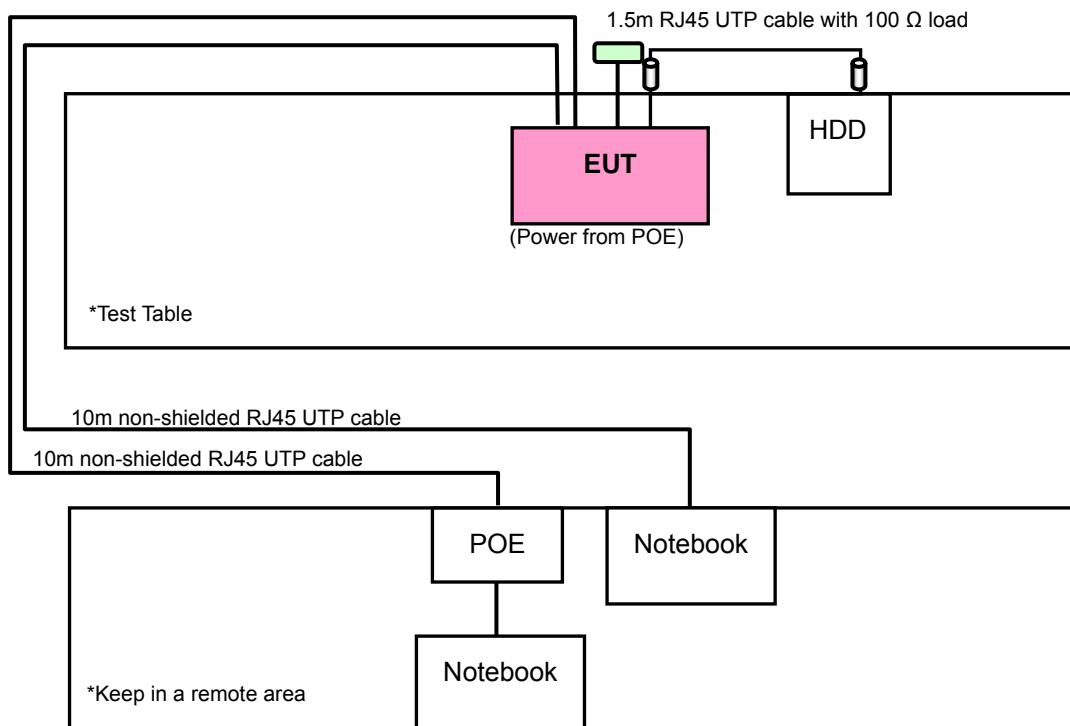

### 3.2.2 TEST MODE APPLICABILITY AND TESTED CHANNEL DETAIL

EUT CONFIGURE MODE	APPLICABLE TO				DESCRIPTION
	RE≥1G	RE<1G	PLC	APCM	
A	√	√	√	√	Power from AC Adapter
B	-	√	√	-	Power from POE

Where **RE≥1G**: Radiated Emission above 1GHz      **RE<1G**: Radiated Emission below 1GHz  
**PLC**: Power Line Conducted Emission      **APCM**: Antenna Port Conducted Measurement

**NOTE**: "-" means no effect.

#### RADIATED EMISSION TEST (ABOVE 1GHz):

- Pre-Scan has been conducted to determine the worst-case mode from all possible combinations between available modulations, XYZ axis and antenna ports (if EUT with antenna diversity architecture).
- Following channel(s) was (were) selected for the final test as listed below.

EUT CONFIGURE MODE	MODE	FREQ. BAND (MHz)	AVAILABLE CHANNEL	TESTED CHANNEL	MODULATION TECHNOLOGY	MODULATION TYPE	DATA RATE (Mbps)	AXIS
A	802.11a	5260-5320	52 to 64	52, 60, 64	OFDM	BPSK	6.0	X
A	802.11n (20MHz)		52 to 64	52, 60, 64	OFDM	BPSK	6.5	X
A	802.11n (40MHz)		54 to 62	54, 62	OFDM	BPSK	13.5	X
A	802.11a	5500-5700	100 to 140	100, 116, 140	OFDM	BPSK	6.0	X
A	802.11n (20MHz)		100 to 140	100, 116, 140	OFDM	BPSK	6.5	X
A	802.11n (40MHz)		102 to 134	102, 110, 134	OFDM	BPSK	13.5	X

#### RADIATED EMISSION TEST (BELOW 1GHz):

- Pre-Scan has been conducted to determine the worst-case mode from all possible combinations between available modulations, XYZ axis and antenna ports (if EUT with antenna diversity architecture).
- Following channel(s) was (were) selected for the final test as listed below.

EUT CONFIGURE MODE	MODE	FREQ. BAND (MHz)	AVAILABLE CHANNEL	TESTED CHANNEL	MODULATION TECHNOLOGY	MODULATION TYPE	DATA RATE (Mbps)	AXIS
A	802.11n (20MHz)	5260-5320	52 to 64	52	OFDM	BPSK	6.5	X
B	802.11n (20MHz)		52 to 64	52	OFDM	BPSK	6.5	X
A	802.11n (20MHz)	5500-5700	100 to 140	116	OFDM	BPSK	6.5	X
B	802.11n (20MHz)		100 to 140	116	OFDM	BPSK	6.5	X

**POWER LINE CONDUCTED EMISSION TEST:**

- Pre-Scan has been conducted to determine the worst-case mode from all possible combinations between available modulations, data rates and antenna ports (if EUT with antenna diversity architecture).
- Following channel(s) was (were) selected for the final test as listed below.

EUT CONFIGURE MODE	MODE	FREQ. BAND (MHz)	AVAILABLE CHANNEL	TESTED CHANNEL	MODULATION TECHNOLOGY	MODULATION TYPE	DATA RATE (Mbps)
A	802.11n (20MHz)	5260-5320	52 to 64	60	OFDM	BPSK	6.5
B	802.11n (20MHz)		52 to 64	60	OFDM	BPSK	6.5
A	802.11n (20MHz)	5500-5700	100 to 140	116	OFDM	BPSK	6.5
B	802.11n (20MHz)		100 to 140	116	OFDM	BPSK	6.5

**BANDEDGE MEASUREMENT:**

- Pre-Scan has been conducted to determine the worst-case mode from all possible combinations between available modulations, data rates and antenna ports (if EUT with antenna diversity architecture).
- Following channel(s) was (were) selected for the final test as listed below.

EUT CONFIGURE MODE	MODE	FREQ. BAND (MHz)	AVAILABLE CHANNEL	TESTED CHANNEL	MODULATION TECHNOLOGY	MODULATION TYPE	DATA RATE (Mbps)
A	802.11a	5260-5320	52 to 64	52, 60, 64	OFDM	BPSK	6.0
A	802.11n (20MHz)		52 to 64	52, 60, 64	OFDM	BPSK	6.5
A	802.11n (40MHz)		54 to 62	54, 62	OFDM	BPSK	13.5
A	802.11a	5500-5700	100 to 140	100, 140	OFDM	BPSK	6.0
A	802.11n (20MHz)		100 to 140	100, 140	OFDM	BPSK	6.5
A	802.11n (40MHz)		102 to 134	102, 134	OFDM	BPSK	13.5

**ANTENNA PORT CONDUCTED MEASUREMENT:**

- This item includes all test value of each mode, but only includes spectrum plot of worst value of each mode.
- Pre-Scan has been conducted to determine the worst-case mode from all possible combinations between available modulations, data rates and antenna ports (if EUT with antenna diversity architecture).
- Following channel(s) was (were) selected for the final test as listed below.

EUT CONFIGURE MODE	MODE	FREQ. BAND (MHz)	AVAILABLE CHANNEL	TESTED CHANNEL	MODULATION TECHNOLOGY	MODULATION TYPE	DATA RATE (Mbps)
A	802.11a	5260-5320	52 to 64	52, 60, 64	OFDM	BPSK	6.0
A	802.11n (20MHz)		52 to 64	52, 60, 64	OFDM	BPSK	6.5
A	802.11n (40MHz)		54 to 62	54, 62	OFDM	BPSK	13.5
A	802.11a	5500-5700	100 to 140	100, 116, 140	OFDM	BPSK	6.0
A	802.11n (20MHz)		100 to 140	100, 116, 140	OFDM	BPSK	6.5
A	802.11n (40MHz)		102 to 134	102, 110, 134	OFDM	BPSK	13.5

**TEST CONDITION:**

APPLICABLE TO	ENVIRONMENTAL CONDITIONS	INPUT POWER (SYSTEM)	TESTED BY
RE≥1G	22deg. C, 62%RH, 1006 hPa	120Vac, 60Hz	Nick Chen
RE<1G	22deg. C, 62%RH, 1006 hPa	120Vac, 60Hz	Nick Chen
PLC	25deg. C, 76%RH, 1006 hPa	120Vac, 60Hz	Nick Chen
APCM	22deg. C, 70%RH, 1006 hPa	120Vac, 60Hz	Nick Chen

### 3.3 GENERAL DESCRIPTION OF APPLIED STANDARDS

The EUT is a RF Product. According to the specifications of the manufacturer, it must comply with the requirements of the following standards:

**FCC Part 15, Subpart E (15.407)**  
**ANSI C63.4-2003**

All test items have been performed and recorded as per the above standards.

**NOTE:** The EUT is also considered as a kind of computer peripheral, because the connection to computer is necessary for typical use. It has been verified to comply with the requirements of FCC Part 15, Subpart B, Class B (DoC). The test report has been issued separately.

### 3.4 DESCRIPTION OF SUPPORT UNITS

The EUT has been tested as an independent unit together with other necessary accessories or support units. The following support units or accessories were used to form a representative test configuration during the tests.

NO.	PRODUCT	BRAND	MODEL NO.	SERIAL NO.	FCC ID
1	NOTEBOOK	DELL	PP05L	24729091408	FCC DoC Approved
2	NOTEBOOK	DELL	PP05L	20375526736	FCC DoC Approved
3	EXTERNAL HARD DISK	DELL	RD1000	HK-0XM763-72953-77Q-0021	NA
4	POE	SonicWall	PD-6083G300	NA	NA

NO.	SIGNAL CABLE DESCRIPTION OF THE ABOVE SUPPORT UNITS
1	10m non-shielded RJ45 UTP cable.
2	1m non-shielded RJ45 UTP cable.
3	2m shielded cable, terminated with USB connector, with 2 cores.
4	10m non-shielded RJ45 UTP cable.

**NOTE:**

1. All power cords of the above support units are non shielded (1.8m).
2. Items 1 ~ 2 acted as communication partners to transfer data.
3. Item 4 was provided by the client and for test mode B.

## 4. TEST TYPES AND RESULTS

### 4.1 RADIATED EMISSION MEASUREMENT

#### 4.1.1 LIMITS OF RADIATED EMISSION MEASUREMENT

Emissions radiated outside of the specified bands, shall be according to the general radiated limits in 15.209 as following:

FREQUENCIES (MHz)	FIELD STRENGTH (microvolts/meter)	MEASUREMENT DISTANCE (meters)
0.009 ~ 0.490	2400/F(kHz)	300
0.490 ~ 1.705	24000/F(kHz)	30
1.705 ~ 30.0	30	30
30 ~ 88	100	3
88 ~ 216	150	3
216 ~ 960	200	3
Above 960	500	3

**NOTE:**

1. The lower limit shall apply at the transition frequencies.
2. Emission level (dBuV/m) = 20 log Emission level (uV/m).
3. As shown in 15.35(b), for frequencies above 1000MHz, the field strength limits are based on average detector, however, the peak field strength of any emission shall not exceed the maximum permitted average limits, specified above by more than 20dB under any condition of modulation.

#### 4.1.2 LIMITS OF UNWANTED EMISSION OUT OF THE RESTRICTED BANDS

FREQUENCIES (MHz)	EIRP LIMIT (dBm)		EQUIVALENT FIELD STRENGTH AT 3m (dBμV/m) *NOTE 3	
	PK	AV	PK	AV
5150 ~ 5250	-7	-27	88.3	68.3

**NOTE:**

1. For frequencies 10MHz or greater above or below the band edge.
2. All emissions within the frequency range from the band edge to 10MHz above or below the band edge.
3. The following formula is used to convert the equipment isotropic radiated power (eirp) to field strength:

$$E = \frac{1000000\sqrt{30P}}{3} \mu\text{V/m, where P is the eirp (Watts).$$



A D T

### 4.1.3 TEST INSTRUMENTS

#### FOR FREQUENCY ABOVE 1 GHz:

DESCRIPTION & MANUFACTURER	MODEL NO.	SERIAL NO.	CALIBRATED DATE	CALIBRATED UNTIL
Agilent Spectrum	8564EC	4208A00659	Jul. 24, 2009	Jul. 23, 2010
Agilent Preamplifier	8449B	3008A01924	Aug. 31, 2009	Aug. 30, 2010
Agilent Preamplifier	8449B	3008A01292	Aug. 10, 2009	Aug. 09, 2010
MITEQ Preamplifier	AMF-6F-260400-33-8P	892164	Aug. 31, 2009	Aug. 30, 2010
Schwarzbeck Horn Antenna	BBHA-9170	BBHA9170190	Sep. 24, 2009	Sep. 23, 2010
Schwarzbeck Horn Antenna	BBHA-9120	D130	May 15, 2009	May 14, 2010
CT Turn Table	TT100	CT-0079	NA	NA
CT Tower	AT100	CT-0079	NA	NA
Software	ADT_Radiated_V 7.6.15.9.2	NA	NA	NA
SUHNER RF cable	SF106-18	PHACAB-1G-40GHz	Aug. 20, 2009	Aug. 19, 2010

- NOTE:**
1. The calibration interval of the above test instruments is 12 months. And the calibrations are traceable to NML/ROC and NIST/USA.
  2. The test was performed in Open Site No. 9.
  3. The VCCI Site Registration No. R-1248.
  4. The Industry Canada Reference No. IC 7450E-9.
  5. The FCC Site Registration No. 99976.

#### FOR FREQUENCY BELOW 1 GHz:

DESCRIPTION & MANUFACTURER	MODEL NO.	SERIAL NO.	CALIBRATED DATE	CALIBRATED UNTIL
ROHDE & SCHWARZ TEST RECEIVER	ESCI	100744	Apr. 16, 2009	Apr. 15, 2010
CHASE BILOG Antenna	CBL6112B	2695	Apr. 29, 2009	Apr. 28, 2010
CT Turn Table	TT100	CT-0079	NA	NA
CT Tower	AT100	CT-0079	NA	NA
Software	ADT_Radiated_V7 .6.15.9.2	NA	NA	NA
ADT RF Switches BOX	EMH-011	08007	Apr. 02, 2009	Apr. 01, 2010
WOKEN RF cable	8D	CABLE-ST9-01	Apr. 02, 2009	Apr. 01, 2010

- NOTE:**
1. The calibration interval of the above test instruments is 12 months. And the calibrations are traceable to NML/ROC and NIST/USA.
  2. The test was performed in Open Site No. 9.
  3. The VCCI Site Registration No. R-1248.
  4. The Industry Canada Reference No. IC 7450E-9.
  5. The FCC Site Registration No. 99976.



#### 4.1.4 TEST PROCEDURES

- a. The EUT was placed on the top of a rotating table 0.8 meters above the ground at a 10 meter open area test site. The table was rotated 360 degrees to determine the position of the highest radiation.
- b. The EUT was set 3 meters away from the interference-receiving antenna, which was mounted on the top of a variable-height antenna tower.
- c. The antenna is a broadband antenna, and its height is varied from one meter to four meters above the ground to determine the maximum value of the field strength. Both horizontal and vertical polarizations of the antenna are set to make the measurement.
- d. For each suspected emission, the EUT was arranged to its worst case and then the antenna was tuned to heights from 1 meter to 4 meters and the rotatable table was turned from 0 degrees to 360 degrees to find the maximum reading.
- e. The test-receiver system was set to Peak Detect Function and Specified Bandwidth with Maximum Hold Mode.
- f. If the emission level of the EUT in peak mode was 10dB lower than the limit specified, then testing could be stopped and the peak values of the EUT would be reported. Otherwise the emissions that did not have 10dB margin would be re-tested one by one using peak, quasi-peak or average method as specified and then reported in a data sheet.

**NOTE:**

1. The resolution bandwidth and video bandwidth of test receiver/spectrum analyzer is 120kHz for Peak detection (PK) and Quasi-peak detection (QP) at frequency below 1GHz.
2. The resolution bandwidth of test receiver/spectrum analyzer is 1MHz and video bandwidth is 3MHz for Peak detection at frequency above 1GHz.
3. The resolution bandwidth of test receiver/spectrum analyzer is 1MHz and the video bandwidth is 10Hz for Average detection (AV) at frequency above 1GHz.
4. All modes of operation were investigated and the worst-case emissions are reported.

#### 4.1.5 DEVIATION FROM TEST STANDARD

No deviation.

#### 4.1.6 TEST SETUP

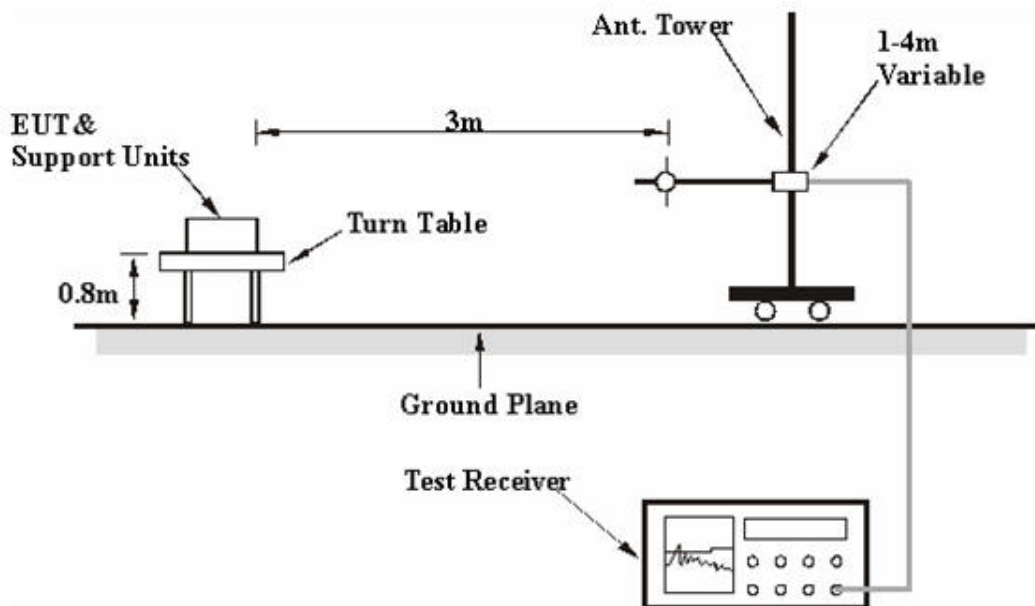

For the actual test configuration, please refer to the attached file (Test Setup Photo).

#### 4.1.7 EUT OPERATING CONDITION

- a. Placed the EUT on the testing table.
- b. Prepared notebook system outside of testing area to act as a communication partners.
- c. The communication partner connected with EUT via a RJ45 UTP cable and run a test program (provided by manufacturer) to enable EUT under transmission condition continuously at specific channel frequency.
- d. The communication partner sent data to EUT by command "PING".

#### 4.1.8 TEST RESULTS

##### 802.11a

EUT TEST CONDITION		MEASUREMENT DETAIL	
CHANNEL	Channel 52	FREQUENCY RANGE	1 ~ 40GHz
INPUT POWER (SYSTEM)	120Vac, 60 Hz	DETECTOR FUNCTION	Peak (PK) Average (AV)
ENVIRONMENTAL CONDITIONS	22deg. C, 62%RH 1000 hPa	TESTED BY	Nick Chen

ANTENNA POLARITY & TEST DISTANCE: HORIZONTAL AT 3 M								
NO.	FREQ. (MHz)	EMISSION LEVEL (dBuV/m)	LIMIT (dBuV/m)	MARGIN (dB)	ANTENNA HEIGHT (m)	TABLE ANGLE (Degree)	RAW VALUE (dBuV)	CORRECTION FACTOR (dB/m)
1	5150.00	60.2 PK	74.00	-13.8	1.69 H	251	21.88	38.35
2	5150.00	47.7 AV	54.00	-6.4	1.69 H	251	9.30	38.35
3	*5260.00	106.5 PK			1.69 H	251	68.01	38.52
4	*5260.00	95.0 AV			1.69 H	251	56.50	38.52
5	#7013.00	53.8 PK	88.30	-34.5	1.52 H	44	10.47	43.35
6	#7013.00	41.3 AV	68.30	-27.0	1.52 H	44	-2.09	43.35
7	#10520.00	58.9 PK	88.30	-29.4	1.49 H	229	9.60	49.33
8	#10520.00	45.7 AV	68.30	-22.6	1.49 H	229	-3.59	49.33
ANTENNA POLARITY & TEST DISTANCE: VERTICAL AT 3 M								
NO.	FREQ. (MHz)	EMISSION LEVEL (dBuV/m)	LIMIT (dBuV/m)	MARGIN (dB)	ANTENNA HEIGHT (m)	TABLE ANGLE (Degree)	RAW VALUE (dBuV)	CORRECTION FACTOR (dB/m)
1	5150.00	62.6 PK	74.00	-11.4	1.63 V	108	24.23	38.35
2	5150.00	50.1 AV	54.00	-3.9	1.63 V	108	11.72	38.35
3	*5260.00	114.7 PK			1.63 V	100	76.15	38.52
4	*5260.00	101.5 AV			1.63 V	100	63.02	38.52
5	#7013.00	54.4 PK	88.30	-33.9	1.37 V	68	11.03	43.35
6	#7013.00	41.4 AV	68.30	-26.9	1.37 V	68	-1.96	43.35
7	#10520.00	58.1 PK	88.30	-30.2	1.48 V	328	8.81	49.33
8	#10520.00	45.6 AV	68.30	-22.7	1.48 V	328	-3.72	49.33

- REMARKS:**
1. Emission level (dBuV/m) = Raw Value (dBuV) + Correction Factor (dB/m).
  2. Correction Factor (dB/m) = Antenna Factor (dB/m) + Cable Factor (dB).
  3. The other emission levels were very low against the limit.
  4. Margin value = Emission level – Limit value.
  5. “ \* “: Fundamental frequency.
  6. “#”:The radiated frequency is out the restricted band.



A D T

EUT TEST CONDITION		MEASUREMENT DETAIL	
CHANNEL	Channel 60	FREQUENCY RANGE	1 ~ 40GHz
INPUT POWER (SYSTEM)	120Vac, 60 Hz	DETECTOR FUNCTION	Peak (PK) Average (AV)
ENVIRONMENTAL CONDITIONS	22deg. C, 62%RH 1000 hPa	TESTED BY	Nick Chen

ANTENNA POLARITY & TEST DISTANCE: HORIZONTAL AT 3 M								
NO.	FREQ. (MHz)	EMISSION LEVEL (dBuV/m)	LIMIT (dBuV/m)	MARGIN (dB)	ANTENNA HEIGHT (m)	TABLE ANGLE (Degree)	RAW VALUE (dBuV)	CORRECTION FACTOR (dB/m)
1	*5300.00	106.6 PK			1.65 H	226	68.07	38.55
2	*5300.00	93.9 AV			1.65 H	226	55.38	38.55
3	#7066.00	54.8 PK	88.30	-33.5	1.62 H	231	11.39	43.44
4	#7066.00	41.3 AV	68.30	-27.0	1.62 H	231	-2.10	43.44
5	10600.00	60.1 PK	74.00	-13.9	1.57 H	68	10.62	49.49
6	10600.00	47.1 AV	54.00	-6.9	1.57 H	68	-2.41	49.49
ANTENNA POLARITY & TEST DISTANCE: VERTICAL AT 3 M								
NO.	FREQ. (MHz)	EMISSION LEVEL (dBuV/m)	LIMIT (dBuV/m)	MARGIN (dB)	ANTENNA HEIGHT (m)	TABLE ANGLE (Degree)	RAW VALUE (dBuV)	CORRECTION FACTOR (dB/m)
1	*5300.00	115.3 PK			1.59 V	101	76.72	38.55
2	*5300.00	102.1 AV			1.59 V	101	63.58	38.55
3	#7066.00	54.3 PK	88.30	-34.0	1.57 V	78	10.82	43.44
4	#7066.00	41.7 AV	68.30	-26.6	1.57 V	78	-1.73	43.44
5	10600.00	67.6 PK	74.00	-6.4	1.46 V	127	18.09	49.49
6	10600.00	50.7 AV	54.00	-3.3	1.46 V	127	1.22	49.49

- REMARKS:**
1. Emission level (dBuV/m) = Raw Value (dBuV) + Correction Factor (dB/m).
  2. Correction Factor (dB/m) = Antenna Factor (dB/m) + Cable Factor (dB).
  3. The other emission levels were very low against the limit.
  4. Margin value = Emission level – Limit value.
  5. “ \* “: Fundamental frequency.
  6. "#":The radiated frequency is out the restricted band.



A D T

EUT TEST CONDITION		MEASUREMENT DETAIL	
CHANNEL	Channel 64	FREQUENCY RANGE	1 ~ 40GHz
INPUT POWER (SYSTEM)	120Vac, 60 Hz	DETECTOR FUNCTION	Peak (PK) Average (AV)
ENVIRONMENTAL CONDITIONS	22deg. C, 62%RH 1000 hPa	TESTED BY	Nick Chen

ANTENNA POLARITY & TEST DISTANCE: HORIZONTAL AT 3 M								
NO.	FREQ. (MHz)	EMISSION LEVEL (dBuV/m)	LIMIT (dBuV/m)	MARGIN (dB)	ANTENNA HEIGHT (m)	TABLE ANGLE (Degree)	RAW VALUE (dBuV)	CORRECTION FACTOR (dB/m)
1	*5320.00	105.2 PK			1.57 H	268	66.60	38.58
2	*5320.00	94.0 AV			1.57 H	268	55.41	38.58
3	5350.00	59.8 PK	74.00	-14.3	1.57 H	268	21.12	38.63
4	5350.00	46.9 AV	54.00	-7.1	1.57 H	268	8.28	38.63
5	#7093.00	53.9 PK	88.30	-34.4	1.56 H	195	10.40	43.48
6	#7093.00	40.9 AV	68.30	-27.4	1.56 H	195	-2.56	43.48
7	10640.00	59.3 PK	74.00	-14.7	1.52 H	85	9.71	49.56
8	10640.00	46.4 AV	54.00	-7.6	1.52 H	85	-3.17	49.56
ANTENNA POLARITY & TEST DISTANCE: VERTICAL AT 3 M								
NO.	FREQ. (MHz)	EMISSION LEVEL (dBuV/m)	LIMIT (dBuV/m)	MARGIN (dB)	ANTENNA HEIGHT (m)	TABLE ANGLE (Degree)	RAW VALUE (dBuV)	CORRECTION FACTOR (dB/m)
1	*5320.00	114.4 PK			1.60 V	107	75.81	38.58
2	*5320.00	101.7 AV			1.60 V	107	63.10	38.58
3	5350.00	73.5 PK	74.00	-0.5	1.60 V	107	34.85	38.63
4	5350.00	52.2 AV	54.00	-1.8	1.60 V	107	13.56	38.63
5	#7093.00	53.5 PK	88.30	-34.8	1.51 V	69	10.00	43.48
6	#7093.00	40.8 AV	68.30	-27.5	1.51 V	69	-2.65	43.48
7	10640.00	63.1 PK	74.00	-10.9	1.50 V	158	13.55	49.56
8	10640.00	48.5 AV	54.00	-5.5	1.50 V	158	-1.04	49.56

- REMARKS:**
1. Emission level (dBuV/m) = Raw Value (dBuV) + Correction Factor (dB/m).
  2. Correction Factor (dB/m) = Antenna Factor (dB/m) + Cable Factor (dB).
  3. The other emission levels were very low against the limit.
  4. Margin value = Emission level – Limit value.
  5. “ \* “: Fundamental frequency.
  6. “#”:The radiated frequency is out the restricted band.



A D T

EUT TEST CONDITION		MEASUREMENT DETAIL	
CHANNEL	Channel 100	FREQUENCY RANGE	1 ~ 40GHz
INPUT POWER (SYSTEM)	120Vac, 60 Hz	DETECTOR FUNCTION	Peak (PK) Average (AV)
ENVIRONMENTAL CONDITIONS	22deg. C, 62%RH 1000 hPa	TESTED BY	Nick Chen

ANTENNA POLARITY & TEST DISTANCE: HORIZONTAL AT 3 M								
NO.	FREQ. (MHz)	EMISSION LEVEL (dBuV/m)	LIMIT (dBuV/m)	MARGIN (dB)	ANTENNA HEIGHT (m)	TABLE ANGLE (Degree)	RAW VALUE (dBuV)	CORRECTION FACTOR (dB/m)
1	5460.00	59.0 PK	74.00	-15.0	1.57 H	173	20.19	38.84
2	5460.00	47.0 AV	54.00	-7.0	1.57 H	173	8.18	38.84
3	#5470.00	64.8 PK	88.30	-23.5	1.57 H	173	25.89	38.86
4	#5470.00	48.8 AV	68.30	-19.5	1.57 H	173	9.95	38.86
5	*5500.00	105.0 PK			1.57 H	173	66.06	38.92
6	*5500.00	93.3 AV			1.57 H	173	54.39	38.92
7	7333.00	52.7 PK	74.00	-21.3	1.49 H	150	8.45	44.21
8	7333.00	39.9 AV	54.00	-14.1	1.49 H	150	-4.29	44.21
9	11000.00	61.0 PK	74.00	-13.0	1.65 H	327	10.74	50.29
10	11000.00	48.2 AV	54.00	-5.9	1.65 H	327	-2.14	50.29
ANTENNA POLARITY & TEST DISTANCE: VERTICAL AT 3 M								
NO.	FREQ. (MHz)	EMISSION LEVEL (dBuV/m)	LIMIT (dBuV/m)	MARGIN (dB)	ANTENNA HEIGHT (m)	TABLE ANGLE (Degree)	RAW VALUE (dBuV)	CORRECTION FACTOR (dB/m)
1	5460.00	63.5 PK	74.00	-10.5	1.55 V	103	24.62	38.84
2	5460.00	41.6 AV	54.00	-12.4	1.55 V	103	2.73	38.84
3	#5470.00	65.9 PK	88.30	-22.4	1.55 V	103	27.02	38.86
4	#5470.00	47.0 AV	68.30	-21.3	1.55 V	103	8.17	38.86
5	*5500.00	116.7 PK			1.55 V	103	77.82	38.92
6	*5500.00	104.8 AV			1.55 V	103	65.85	38.92
7	7333.00	53.5 PK	74.00	-20.5	1.37 V	167	9.25	44.21
8	7333.00	39.6 AV	54.00	-14.4	1.37 V	167	-4.65	44.21
9	11000.00	70.7 PK	74.00	-3.3	1.41 V	123	20.39	50.29
10	11000.00	53.6 AV	54.00	-0.5	1.41 V	123	3.26	50.29

- REMARKS:**
1. Emission level (dBuV/m) = Raw Value (dBuV) + Correction Factor (dB/m).
  2. Correction Factor (dB/m) = Antenna Factor (dB/m) + Cable Factor (dB).
  3. The other emission levels were very low against the limit.
  4. Margin value = Emission level – Limit value.
  5. “ \* “: Fundamental frequency.
  6. "#":The radiated frequency is out the restricted band.



A D T

EUT TEST CONDITION		MEASUREMENT DETAIL	
CHANNEL	Channel 116	FREQUENCY RANGE	1 ~ 40GHz
INPUT POWER (SYSTEM)	120Vac, 60 Hz	DETECTOR FUNCTION	Peak (PK) Average (AV)
ENVIRONMENTAL CONDITIONS	22deg. C, 62%RH 1000 hPa	TESTED BY	Nick Chen

ANTENNA POLARITY & TEST DISTANCE: HORIZONTAL AT 3 M								
NO.	FREQ. (MHz)	EMISSION LEVEL (dBuV/m)	LIMIT (dBuV/m)	MARGIN (dB)	ANTENNA HEIGHT (m)	TABLE ANGLE (Degree)	RAW VALUE (dBuV)	CORRECTION FACTOR (dB/m)
1	*5580.00	106.0 PK			1.59 H	206	66.94	39.09
2	*5580.00	94.8 AV			1.59 H	206	55.67	39.09
3	7440.00	54.1 PK	74.00	-19.9	1.52 H	175	9.55	44.51
4	7440.00	40.4 AV	54.00	-13.6	1.52 H	175	-4.08	44.51
5	11160.00	63.5 PK	74.00	-10.5	1.61 H	102	13.27	50.20
6	11160.00	48.8 AV	54.00	-5.2	1.61 H	102	-1.41	50.20
ANTENNA POLARITY & TEST DISTANCE: VERTICAL AT 3 M								
NO.	FREQ. (MHz)	EMISSION LEVEL (dBuV/m)	LIMIT (dBuV/m)	MARGIN (dB)	ANTENNA HEIGHT (m)	TABLE ANGLE (Degree)	RAW VALUE (dBuV)	CORRECTION FACTOR (dB/m)
1	*5580.00	116.5 PK			1.69 V	98	77.43	39.09
2	*5580.00	104.3 AV			1.69 V	98	65.18	39.09
3	7440.00	53.4 PK	74.00	-20.6	1.53 V	258	8.91	44.51
4	7440.00	40.4 AV	54.00	-13.6	1.53 V	258	-4.14	44.51
5	11160.00	67.5 PK	74.00	-6.5	1.38 V	116	17.27	50.20
6	11160.00	53.5 AV	54.00	-0.5	1.38 V	116	3.34	50.20

- REMARKS:**
1. Emission level (dBuV/m) = Raw Value (dBuV) + Correction Factor (dB/m).
  2. Correction Factor (dB/m) = Antenna Factor (dB/m) + Cable Factor (dB).
  3. The other emission levels were very low against the limit.
  6. "#":The radiated frequency is out the restricted band.
  4. Margin value = Emission level – Limit value.



A D T

EUT TEST CONDITION		MEASUREMENT DETAIL	
CHANNEL	Channel 140	FREQUENCY RANGE	1 ~ 40GHz
INPUT POWER (SYSTEM)	120Vac, 60 Hz	DETECTOR FUNCTION	Peak (PK) Average (AV)
ENVIRONMENTAL CONDITIONS	22deg. C, 62%RH 1000 hPa	TESTED BY	Nick Chen

ANTENNA POLARITY & TEST DISTANCE: HORIZONTAL AT 3 M								
NO.	FREQ. (MHz)	EMISSION LEVEL (dBuV/m)	LIMIT (dBuV/m)	MARGIN (dB)	ANTENNA HEIGHT (m)	TABLE ANGLE (Degree)	RAW VALUE (dBuV)	CORRECTION FACTOR (dB/m)
1	*5700.00	106.5 PK			1.41 H	72	67.15	39.39
2	*5700.00	94.7 AV			1.41 H	72	55.34	39.39
3	#5725.00	65.8 PK	88.30	-22.5	1.41 H	72	26.38	39.45
4	#5725.00	49.8 AV	68.30	-18.5	1.41 H	72	10.36	39.45
5	7600.00	55.2 PK	74.00	-18.8	1.46 H	337	10.28	44.89
6	7600.00	41.2 AV	54.00	-12.8	1.46 H	337	-3.66	44.89
7	11400.00	65.6 PK	74.00	-8.4	1.41 H	110	15.59	50.04
8	11400.00	50.2 AV	54.00	-3.8	1.41 H	110	0.20	50.04
ANTENNA POLARITY & TEST DISTANCE: VERTICAL AT 3 M								
NO.	FREQ. (MHz)	EMISSION LEVEL (dBuV/m)	LIMIT (dBuV/m)	MARGIN (dB)	ANTENNA HEIGHT (m)	TABLE ANGLE (Degree)	RAW VALUE (dBuV)	CORRECTION FACTOR (dB/m)
1	*5700.00	116.3 PK			1.65 V	117	76.93	39.39
2	*5700.00	104.5 AV			1.65 V	117	65.09	39.39
3	#5725.00	76.5 PK	88.30	-11.8	1.65 V	117	37.08	39.45
4	#5725.00	59.4 AV	68.30	-8.9	1.65 V	117	19.96	39.45
5	7600.00	53.8 PK	74.00	-20.2	1.35 V	92	8.93	44.89
6	7600.00	41.2 AV	54.00	-12.8	1.35 V	92	-3.70	44.89
7	11400.00	68.2 PK	74.00	-5.8	1.72 V	329	18.18	50.04
8	11400.00	53.4 AV	54.00	-0.6	1.72 V	329	3.37	50.04

- REMARKS:**
1. Emission level (dBuV/m) = Raw Value (dBuV) + Correction Factor (dB/m).
  2. Correction Factor (dB/m) = Antenna Factor (dB/m) + Cable Factor (dB).
  3. The other emission levels were very low against the limit.
  4. Margin value = Emission level – Limit value.
  5. “ \* “: Fundamental frequency.
  6. “#”: The radiated frequency is out the restricted band.





A D T

802.11n (20MHz)

EUT TEST CONDITION		MEASUREMENT DETAIL	
CHANNEL	Channel 52	FREQUENCY RANGE	1 ~ 40GHz
INPUT POWER (SYSTEM)	120Vac, 60 Hz	DETECTOR FUNCTION	Peak (PK) Average (AV)
ENVIRONMENTAL CONDITIONS	22deg. C, 62%RH 1000 hPa	TESTED BY	Nick Chen

ANTENNA POLARITY & TEST DISTANCE: HORIZONTAL AT 3 M								
NO.	FREQ. (MHz)	EMISSION LEVEL (dBuV/m)	LIMIT (dBuV/m)	MARGIN (dB)	ANTENNA HEIGHT (m)	TABLE ANGLE (Degree)	RAW VALUE (dBuV)	CORRECTION FACTOR (dB/m)
1	5150.00	60.3 PK	74.00	-13.7	1.73 H	246	21.96	38.35
2	5150.00	47.7 AV	54.00	-6.3	1.73 H	246	9.32	38.35
3	*5260.00	106.7 PK			1.73 H	246	68.20	38.52
4	*5260.00	95.1 AV			1.73 H	246	56.57	38.52
5	#7013.00	54.0 PK	88.30	-34.3	1.60 H	37	10.62	43.35
6	#7013.00	41.3 AV	68.30	-27.0	1.60 H	37	-2.04	43.35
7	#10520.00	59.0 PK	88.30	-29.3	1.54 H	236	9.69	49.33
8	#10540.00	46.8 AV	68.30	-21.5	1.34 H	241	-2.53	49.37
ANTENNA POLARITY & TEST DISTANCE: VERTICAL AT 3 M								
NO.	FREQ. (MHz)	EMISSION LEVEL (dBuV/m)	LIMIT (dBuV/m)	MARGIN (dB)	ANTENNA HEIGHT (m)	TABLE ANGLE (Degree)	RAW VALUE (dBuV)	CORRECTION FACTOR (dB/m)
1	5150.00	62.6 PK	74.00	-11.4	1.66 V	100	24.29	38.35
2	5150.00	50.2 AV	54.00	-3.8	1.66 V	100	11.83	38.35
3	*5260.00	115.8 PK			1.66 V	100	77.26	38.52
4	*5260.00	102.6 AV			1.66 V	100	64.10	38.52
5	#7013.00	54.4 PK	88.30	-33.9	1.38 V	59	11.09	43.35
6	#7013.00	41.5 AV	68.30	-26.9	1.38 V	59	-1.90	43.35
7	#10520.00	58.3 PK	88.30	-30.0	1.51 V	341	8.94	49.33
8	#10540.00	46.1 AV	68.30	-22.2	1.31 V	293	-3.30	49.37

- REMARKS:**
1. Emission level (dBuV/m) = Raw Value (dBuV) + Correction Factor (dB/m).
  2. Correction Factor (dB/m) = Antenna Factor (dB/m) + Cable Factor (dB).
  3. The other emission levels were very low against the limit.
  4. Margin value = Emission level – Limit value.
  5. “ \* “: Fundamental frequency.
  6. “#“: The radiated frequency is out the restricted band.



A D T

EUT TEST CONDITION		MEASUREMENT DETAIL	
CHANNEL	Channel 60	FREQUENCY RANGE	1 ~ 40GHz
INPUT POWER (SYSTEM)	120Vac, 60 Hz	DETECTOR FUNCTION	Peak (PK) Average (AV)
ENVIRONMENTAL CONDITIONS	22deg. C, 62%RH 1000 hPa	TESTED BY	Nick Chen

ANTENNA POLARITY & TEST DISTANCE: HORIZONTAL AT 3 M								
NO.	FREQ. (MHz)	EMISSION LEVEL (dBuV/m)	LIMIT (dBuV/m)	MARGIN (dB)	ANTENNA HEIGHT (m)	TABLE ANGLE (Degree)	RAW VALUE (dBuV)	CORRECTION FACTOR (dB/m)
1	*5300.00	106.7 PK			1.73 H	210	68.13	38.55
2	*5300.00	94.0 AV			1.73 H	210	55.43	38.55
3	#7066.00	54.9 PK	88.30	-33.4	1.57 H	241	11.47	43.44
4	#7066.00	41.4 AV	68.30	-26.9	1.57 H	241	-2.04	43.44
5	10600.00	60.2 PK	74.00	-13.8	1.62 H	56	10.71	49.49
6	10600.00	47.2 AV	54.00	-6.8	1.62 H	56	-2.33	49.49
ANTENNA POLARITY & TEST DISTANCE: VERTICAL AT 3 M								
NO.	FREQ. (MHz)	EMISSION LEVEL (dBuV/m)	LIMIT (dBuV/m)	MARGIN (dB)	ANTENNA HEIGHT (m)	TABLE ANGLE (Degree)	RAW VALUE (dBuV)	CORRECTION FACTOR (dB/m)
1	*5300.00	115.4 PK			1.64 V	98	76.80	38.55
2	*5300.00	102.2 AV			1.64 V	98	63.67	38.55
3	#7066.00	54.3 PK	88.30	-34.0	1.60 V	63	10.91	43.44
4	#7066.00	41.9 AV	68.30	-26.4	1.60 V	63	-1.55	43.44
5	10600.00	67.7 PK	74.00	-6.3	1.50 V	118	18.20	49.49
6	10600.00	50.8 AV	54.00	-3.2	1.50 V	118	1.34	49.49

- REMARKS:**
1. Emission level (dBuV/m) = Raw Value (dBuV) + Correction Factor (dB/m).
  2. Correction Factor (dB/m) = Antenna Factor (dB/m) + Cable Factor (dB).
  3. The other emission levels were very low against the limit.
  4. Margin value = Emission level – Limit value.
  5. “ \* “: Fundamental frequency.
  6. “#”:The radiated frequency is out the restricted band.



A D T

EUT TEST CONDITION		MEASUREMENT DETAIL	
CHANNEL	Channel 64	FREQUENCY RANGE	1 ~ 40GHz
INPUT POWER (SYSTEM)	120Vac, 60 Hz	DETECTOR FUNCTION	Peak (PK) Average (AV)
ENVIRONMENTAL CONDITIONS	22deg. C, 62%RH 1000 hPa	TESTED BY	Nick Chen

ANTENNA POLARITY & TEST DISTANCE: HORIZONTAL AT 3 M								
NO.	FREQ. (MHz)	EMISSION LEVEL (dBuV/m)	LIMIT (dBuV/m)	MARGIN (dB)	ANTENNA HEIGHT (m)	TABLE ANGLE (Degree)	RAW VALUE (dBuV)	CORRECTION FACTOR (dB/m)
1	*5320.00	105.3 PK			1.62 H	272	66.67	38.58
2	*5320.00	94.0 AV			1.62 H	272	55.45	38.58
3	5350.00	59.8 PK	74.00	-14.2	1.62 H	272	21.19	38.63
4	5350.00	47.0 AV	54.00	-7.0	1.62 H	272	8.35	38.63
5	#7093.00	53.9 PK	88.30	-34.4	1.58 H	186	10.46	43.48
6	#7093.00	41.0 AV	68.30	-27.3	1.58 H	186	-2.49	43.48
7	10640.00	59.3 PK	74.00	-14.7	1.50 H	76	9.77	49.56
8	10640.00	46.6 AV	54.00	-7.5	1.50 H	76	-3.00	49.56
ANTENNA POLARITY & TEST DISTANCE: VERTICAL AT 3 M								
NO.	FREQ. (MHz)	EMISSION LEVEL (dBuV/m)	LIMIT (dBuV/m)	MARGIN (dB)	ANTENNA HEIGHT (m)	TABLE ANGLE (Degree)	RAW VALUE (dBuV)	CORRECTION FACTOR (dB/m)
1	*5320.00	114.5 PK			1.63 V	98	75.94	38.58
2	*5320.00	101.8 AV			1.63 V	98	63.17	38.58
3	5350.00	73.5 PK	74.00	-0.5	1.63 V	98	34.89	38.63
4	5350.00	52.3 AV	54.00	-1.7	1.63 V	98	13.67	38.63
5	#7093.00	53.5 PK	88.30	-34.8	1.53 V	59	10.03	43.48
6	#7093.00	41.0 AV	68.30	-27.3	1.53 V	59	-2.48	43.48
7	10640.00	63.2 PK	74.00	-10.8	1.63 V	133	13.63	49.56
8	10640.00	48.7 AV	54.00	-5.3	1.63 V	133	-0.86	49.56

- REMARKS:**
1. Emission level (dBuV/m) = Raw Value (dBuV) + Correction Factor (dB/m).
  2. Correction Factor (dB/m) = Antenna Factor (dB/m) + Cable Factor (dB).
  3. The other emission levels were very low against the limit.
  4. Margin value = Emission level – Limit value.
  5. “ \* “: Fundamental frequency.
  6. “#”: The radiated frequency is out the restricted band.



A D T

EUT TEST CONDITION		MEASUREMENT DETAIL	
CHANNEL	Channel 100	FREQUENCY RANGE	1 ~ 40GHz
INPUT POWER (SYSTEM)	120Vac, 60 Hz	DETECTOR FUNCTION	Peak (PK) Average (AV)
ENVIRONMENTAL CONDITIONS	22deg. C, 62%RH 1000 hPa	TESTED BY	Nick Chen

ANTENNA POLARITY & TEST DISTANCE: HORIZONTAL AT 3 M								
NO.	FREQ. (MHz)	EMISSION LEVEL (dBuV/m)	LIMIT (dBuV/m)	MARGIN (dB)	ANTENNA HEIGHT (m)	TABLE ANGLE (Degree)	RAW VALUE (dBuV)	CORRECTION FACTOR (dB/m)
1	5460.00	59.1 PK	74.00	-14.9	1.63 H	161	20.27	38.84
2	5460.00	47.1 AV	54.00	-6.9	1.63 H	161	8.25	38.84
3	#5470.00	64.8 PK	88.30	-23.5	1.63 H	161	25.95	38.86
4	#5470.00	48.9 AV	68.30	-19.4	1.63 H	161	10.02	38.86
5	*5500.00	106.1 PK			1.63 H	161	67.14	38.92
6	*5500.00	94.5 AV			1.63 H	161	55.54	38.92
7	7333.00	52.8 PK	74.00	-21.2	1.52 H	139	8.55	44.21
8	7333.00	40.0 AV	54.00	-14.0	1.52 H	139	-4.20	44.21
9	11000.00	61.1 PK	74.00	-12.9	1.61 H	335	10.82	50.29
10	11000.00	48.2 AV	54.00	-5.8	1.61 H	335	-2.10	50.29
ANTENNA POLARITY & TEST DISTANCE: VERTICAL AT 3 M								
NO.	FREQ. (MHz)	EMISSION LEVEL (dBuV/m)	LIMIT (dBuV/m)	MARGIN (dB)	ANTENNA HEIGHT (m)	TABLE ANGLE (Degree)	RAW VALUE (dBuV)	CORRECTION FACTOR (dB/m)
1	5460.00	63.5 PK	74.00	-10.5	1.59 V	99	24.66	38.84
2	5460.00	41.6 AV	54.00	-12.4	1.59 V	99	2.76	38.84
3	#5470.00	65.9 PK	88.30	-22.4	1.59 V	99	27.08	38.86
4	#5470.00	47.2 AV	68.30	-21.1	1.59 V	99	8.29	38.86
5	*5500.00	116.8 PK			1.59 V	99	77.91	38.92
6	*5500.00	104.8 AV			1.59 V	99	65.89	38.92
7	7333.00	53.6 PK	74.00	-20.4	1.38 V	176	9.38	44.21
8	7333.00	39.7 AV	54.00	-14.3	1.38 V	176	-4.54	44.21
9	11000.00	70.7 PK	74.00	-3.3	1.42 V	113	20.43	50.29
10	11000.00	53.6 AV	54.00	-0.4	1.42 V	113	3.34	50.29

- REMARKS:**
1. Emission level (dBuV/m) = Raw Value (dBuV) + Correction Factor (dB/m).
  2. Correction Factor (dB/m) = Antenna Factor (dB/m) + Cable Factor (dB).
  3. The other emission levels were very low against the limit.
  4. Margin value = Emission level – Limit value.
  5. " \* ": Fundamental frequency.
  6. "#": The radiated frequency is out the restricted band.



A D T

EUT TEST CONDITION		MEASUREMENT DETAIL	
CHANNEL	Channel 116	FREQUENCY RANGE	1 ~ 40GHz
INPUT POWER (SYSTEM)	120Vac, 60 Hz	DETECTOR FUNCTION	Peak (PK) Average (AV)
ENVIRONMENTAL CONDITIONS	22deg. C, 62%RH 1000 hPa	TESTED BY	Nick Chen

ANTENNA POLARITY & TEST DISTANCE: HORIZONTAL AT 3 M								
NO.	FREQ. (MHz)	EMISSION LEVEL (dBuV/m)	LIMIT (dBuV/m)	MARGIN (dB)	ANTENNA HEIGHT (m)	TABLE ANGLE (Degree)	RAW VALUE (dBuV)	CORRECTION FACTOR (dB/m)
1	*5580.00	106.1 PK			1.62 H	199	67.02	39.09
2	*5580.00	94.8 AV			1.62 H	199	55.75	39.09
3	7440.00	54.1 PK	74.00	-19.9	1.56 H	182	9.61	44.51
4	7440.00	40.6 AV	54.00	-13.4	1.56 H	182	-3.96	44.51
5	11160.00	63.6 PK	74.00	-10.4	1.63 H	88	13.36	50.20
6	11160.00	48.9 AV	54.00	-5.1	1.63 H	88	-1.32	50.20
ANTENNA POLARITY & TEST DISTANCE: VERTICAL AT 3 M								
NO.	FREQ. (MHz)	EMISSION LEVEL (dBuV/m)	LIMIT (dBuV/m)	MARGIN (dB)	ANTENNA HEIGHT (m)	TABLE ANGLE (Degree)	RAW VALUE (dBuV)	CORRECTION FACTOR (dB/m)
1	*5580.00	116.6 PK			1.70 V	92	77.52	39.09
2	*5580.00	104.4 AV			1.70 V	92	65.29	39.09
3	7440.00	53.5 PK	74.00	-20.5	1.51 V	249	9.01	44.51
4	7440.00	40.5 AV	54.00	-13.5	1.51 V	249	-4.04	44.51
5	11160.00	67.5 PK	74.00	-6.5	1.45 V	107	17.33	50.20
6	11160.00	53.6 AV	54.00	-0.4	1.45 V	107	3.41	50.20

- REMARKS:**
1. Emission level (dBuV/m) = Raw Value (dBuV) + Correction Factor (dB/m).
  2. Correction Factor (dB/m) = Antenna Factor (dB/m) + Cable Factor (dB).
  3. The other emission levels were very low against the limit.
  6. "#":The radiated frequency is out the restricted band.
  4. Margin value = Emission level – Limit value.



A D T

EUT TEST CONDITION		MEASUREMENT DETAIL	
CHANNEL	Channel 140	FREQUENCY RANGE	1 ~ 40GHz
INPUT POWER (SYSTEM)	120Vac, 60 Hz	DETECTOR FUNCTION	Peak (PK) Average (AV)
ENVIRONMENTAL CONDITIONS	22deg. C, 62%RH 1000 hPa	TESTED BY	Nick Chen

ANTENNA POLARITY & TEST DISTANCE: HORIZONTAL AT 3 M								
NO.	FREQ. (MHz)	EMISSION LEVEL (dBuV/m)	LIMIT (dBuV/m)	MARGIN (dB)	ANTENNA HEIGHT (m)	TABLE ANGLE (Degree)	RAW VALUE (dBuV)	CORRECTION FACTOR (dB/m)
1	*5700.00	106.6 PK			1.43 H	67	67.24	39.39
2	*5700.00	94.9 AV			1.43 H	67	55.50	39.39
3	#5725.00	66.0 PK	88.30	-22.3	1.43 H	67	26.53	39.45
4	#5725.00	49.9 AV	68.30	-18.4	1.43 H	67	10.47	39.45
5	7600.00	55.2 PK	74.00	-18.8	1.51 H	327	10.33	44.89
6	7600.00	41.3 AV	54.00	-12.7	1.51 H	327	-3.59	44.89
7	11400.00	65.8 PK	74.00	-8.2	1.42 H	107	15.75	50.04
8	11400.00	50.4 AV	54.00	-3.6	1.42 H	107	0.32	50.04
ANTENNA POLARITY & TEST DISTANCE: VERTICAL AT 3 M								
NO.	FREQ. (MHz)	EMISSION LEVEL (dBuV/m)	LIMIT (dBuV/m)	MARGIN (dB)	ANTENNA HEIGHT (m)	TABLE ANGLE (Degree)	RAW VALUE (dBuV)	CORRECTION FACTOR (dB/m)
1	*5700.00	116.4 PK			1.68 V	108	77.02	39.39
2	*5700.00	104.5 AV			1.68 V	108	65.15	39.39
3	#5725.00	76.6 PK	88.30	-11.7	1.68 V	108	37.15	39.45
4	#5725.00	59.5 AV	68.30	-8.8	1.68 V	108	20.03	39.45
5	7600.00	54.0 PK	74.00	-20.0	1.29 V	65	9.11	44.89
6	7600.00	41.3 AV	54.00	-12.7	1.29 V	65	-3.56	44.89
7	11400.00	68.4 PK	74.00	-5.7	1.79 V	318	18.31	50.04
8	11400.00	53.5 AV	54.00	-0.5	1.79 V	318	3.49	50.04

- REMARKS:**
1. Emission level (dBuV/m) = Raw Value (dBuV) + Correction Factor (dB/m).
  2. Correction Factor (dB/m) = Antenna Factor (dB/m) + Cable Factor (dB).
  3. The other emission levels were very low against the limit.
  4. Margin value = Emission level – Limit value.
  5. “ \* “: Fundamental frequency.
  6. “#”: The radiated frequency is out the restricted band.



802.11n (40MHz)

EUT TEST CONDITION		MEASUREMENT DETAIL	
CHANNEL	Channel 54	FREQUENCY RANGE	1 ~ 40GHz
INPUT POWER (SYSTEM)	120Vac, 60 Hz	DETECTOR FUNCTION	Peak (PK) Average (AV)
ENVIRONMENTAL CONDITIONS	22deg. C, 62%RH 1000 hPa	TESTED BY	Nick Chen

ANTENNA POLARITY & TEST DISTANCE: HORIZONTAL AT 3 M								
NO.	FREQ. (MHz)	EMISSION LEVEL (dBuV/m)	LIMIT (dBuV/m)	MARGIN (dB)	ANTENNA HEIGHT (m)	TABLE ANGLE (Degree)	RAW VALUE (dBuV)	CORRECTION FACTOR (dB/m)
1	5150.00	65.4 PK	74.00	-8.6	1.72 H	246	27.05	38.35
2	5150.00	44.4 AV	54.00	-9.6	1.72 H	246	6.05	38.35
3	*5270.00	102.1 PK			1.72 H	246	63.58	38.53
4	*5270.00	89.0 AV			1.72 H	246	50.50	38.53
5	#7026.00	54.5 PK	88.30	-33.8	1.42 H	247	11.16	43.37
6	#7026.00	41.0 AV	68.30	-27.3	1.42 H	247	-2.43	43.37
7	#10540.00	59.0 PK	88.30	-29.3	1.34 H	241	9.66	49.37
8	#10540.00	46.8 AV	68.30	-21.5	1.34 H	241	-2.53	49.37
ANTENNA POLARITY & TEST DISTANCE: VERTICAL AT 3 M								
NO.	FREQ. (MHz)	EMISSION LEVEL (dBuV/m)	LIMIT (dBuV/m)	MARGIN (dB)	ANTENNA HEIGHT (m)	TABLE ANGLE (Degree)	RAW VALUE (dBuV)	CORRECTION FACTOR (dB/m)
1	5150.00	66.8 PK	74.00	-7.2	1.69 V	287	28.44	38.35
2	5150.00	44.3 AV	54.00	-9.7	1.69 V	287	5.91	38.35
3	*5270.00	110.9 PK			1.69 V	287	72.33	38.53
4	*5270.00	98.5 AV			1.69 V	287	59.95	38.53
5	#7026.00	53.5 PK	88.30	-34.8	1.29 V	16	10.15	43.37
6	#7026.00	42.3 AV	68.30	-26.0	1.29 V	16	-1.12	43.37
7	#10540.00	58.3 PK	88.30	-30.0	1.31 V	293	8.91	49.37
8	#10540.00	46.1 AV	68.30	-22.2	1.31 V	293	-3.30	49.37

- REMARKS:**
1. Emission level (dBuV/m) = Raw Value (dBuV) + Correction Factor (dB/m).
  2. Correction Factor (dB/m) = Antenna Factor (dB/m) + Cable Factor (dB).
  3. The other emission levels were very low against the limit.
  4. Margin value = Emission level – Limit value.
  5. “ \* “: Fundamental frequency.
  6. “#”: The radiated frequency is out the restricted band.



A D T

EUT TEST CONDITION		MEASUREMENT DETAIL	
CHANNEL	Channel 62	FREQUENCY RANGE	1 ~ 40GHz
INPUT POWER (SYSTEM)	120Vac, 60 Hz	DETECTOR FUNCTION	Peak (PK) Average (AV)
ENVIRONMENTAL CONDITIONS	22deg. C, 62%RH 1000 hPa	TESTED BY	Nick Chen

ANTENNA POLARITY & TEST DISTANCE: HORIZONTAL AT 3 M								
NO.	FREQ. (MHz)	EMISSION LEVEL (dBuV/m)	LIMIT (dBuV/m)	MARGIN (dB)	ANTENNA HEIGHT (m)	TABLE ANGLE (Degree)	RAW VALUE (dBuV)	CORRECTION FACTOR (dB/m)
1	*5310.00	102.0 PK			1.84 H	161	63.46	38.57
2	*5310.00	89.4 AV			1.84 H	161	50.82	38.57
3	5350.00	62.3 PK	74.00	-11.7	1.84 H	161	23.69	38.63
4	5350.00	49.1 AV	54.00	-4.9	1.84 H	161	10.45	38.63
5	#7080.00	54.3 PK	88.30	-34.0	1.43 H	257	10.82	43.46
6	#7080.00	40.8 AV	68.30	-27.5	1.43 H	257	-2.63	43.46
7	10620.00	59.9 PK	74.00	-14.1	1.30 H	56	10.40	49.52
8	10620.00	47.0 AV	54.00	-7.0	1.30 H	56	-2.53	49.52
ANTENNA POLARITY & TEST DISTANCE: VERTICAL AT 3 M								
NO.	FREQ. (MHz)	EMISSION LEVEL (dBuV/m)	LIMIT (dBuV/m)	MARGIN (dB)	ANTENNA HEIGHT (m)	TABLE ANGLE (Degree)	RAW VALUE (dBuV)	CORRECTION FACTOR (dB/m)
1	*5310.00	110.7 PK			1.78 V	92	72.14	38.57
2	*5310.00	98.0 AV			1.78 V	92	59.38	38.57
3	5350.00	70.4 PK	74.00	-3.6	1.78 V	92	31.75	38.63
4	5350.00	53.6 AV	54.00	-0.4	1.78 V	92	14.98	38.63
5	#7080.00	54.2 PK	88.30	-34.1	1.53 V	283	10.74	43.46
6	#7080.00	40.7 AV	68.30	-27.6	1.53 V	283	-2.73	43.46
7	10620.00	59.7 PK	74.00	-14.3	1.68 V	31	10.18	49.52
8	10620.00	47.5 AV	54.00	-6.5	1.68 V	31	-2.02	49.52

- REMARKS:**
1. Emission level (dBuV/m) = Raw Value (dBuV) + Correction Factor (dB/m).
  2. Correction Factor (dB/m) = Antenna Factor (dB/m) + Cable Factor (dB).
  3. The other emission levels were very low against the limit.
  4. Margin value = Emission level – Limit value.
  5. “ \* “: Fundamental frequency.
  6. “#”: The radiated frequency is out the restricted band.





EUT TEST CONDITION		MEASUREMENT DETAIL	
CHANNEL	Channel 102	FREQUENCY RANGE	1 ~ 40GHz
INPUT POWER (SYSTEM)	120Vac, 60 Hz	DETECTOR FUNCTION	Peak (PK) Average (AV)
ENVIRONMENTAL CONDITIONS	22deg. C, 62%RH 1000 hPa	TESTED BY	Nick Chen

ANTENNA POLARITY & TEST DISTANCE: HORIZONTAL AT 3 M								
NO.	FREQ. (MHz)	EMISSION LEVEL (dBuV/m)	LIMIT (dBuV/m)	MARGIN (dB)	ANTENNA HEIGHT (m)	TABLE ANGLE (Degree)	RAW VALUE (dBuV)	CORRECTION FACTOR (dB/m)
1	5460.00	61.8 PK	74.00	-12.2	1.77 H	82	22.99	38.84
2	5460.00	47.8 AV	54.00	-6.2	1.77 H	82	8.97	38.84
3	#5470.00	60.6 PK	88.30	-27.7	1.77 H	82	21.77	38.86
4	#5470.00	48.3 AV	68.30	-20.0	1.77 H	82	9.39	38.86
5	*5510.00	101.5 PK			1.77 H	82	62.57	38.94
6	*5510.00	89.3 AV			1.77 H	82	50.38	38.94
7	7346.00	54.4 PK	74.00	-19.7	1.38 H	266	10.11	44.24
8	7346.00	40.3 AV	54.00	-13.7	1.38 H	266	-3.93	44.24
9	11020.00	60.6 PK	74.00	-13.5	1.58 H	32	10.27	50.28
10	11020.00	47.6 AV	54.00	-6.4	1.58 H	32	-2.69	50.28
ANTENNA POLARITY & TEST DISTANCE: VERTICAL AT 3 M								
NO.	FREQ. (MHz)	EMISSION LEVEL (dBuV/m)	LIMIT (dBuV/m)	MARGIN (dB)	ANTENNA HEIGHT (m)	TABLE ANGLE (Degree)	RAW VALUE (dBuV)	CORRECTION FACTOR (dB/m)
1	5460.00	69.3 PK	74.00	-4.7	1.68 V	96	30.45	38.84
2	5460.00	52.7 AV	54.00	-1.3	1.68 V	96	13.88	38.84
3	#5470.00	74.3 PK	88.30	-14.0	1.68 V	96	35.44	38.86
4	#5470.00	58.1 AV	68.30	-10.2	1.68 V	96	19.24	38.86
5	*5510.00	109.6 PK			1.68 V	96	70.64	38.94
6	*5510.00	97.9 AV			1.68 V	96	58.92	38.94
7	7346.00	53.9 PK	74.00	-20.1	1.39 V	266	9.66	44.24
8	7346.00	40.2 AV	54.00	-13.8	1.39 V	266	-4.05	44.24
9	11020.00	62.6 PK	74.00	-11.4	1.43 V	118	12.36	50.28
10	11020.00	49.2 AV	54.00	-4.9	1.43 V	118	-1.13	50.28

- REMARKS:**
1. Emission level (dBuV/m) = Raw Value (dBuV) + Correction Factor (dB/m).
  2. Correction Factor (dB/m) = Antenna Factor (dB/m) + Cable Factor (dB).
  3. The other emission levels were very low against the limit.
  4. Margin value = Emission level – Limit value.
  5. “ \* “: Fundamental frequency.
  6. “#”:The radiated frequency is out the restricted band.



A D T

EUT TEST CONDITION		MEASUREMENT DETAIL	
CHANNEL	Channel 110	FREQUENCY RANGE	1 ~ 40GHz
INPUT POWER (SYSTEM)	120Vac, 60 Hz	DETECTOR FUNCTION	Peak (PK) Average (AV)
ENVIRONMENTAL CONDITIONS	22deg. C, 62%RH 1000 hPa	TESTED BY	Nick Chen

ANTENNA POLARITY & TEST DISTANCE: HORIZONTAL AT 3 M								
NO.	FREQ. (MHz)	EMISSION LEVEL (dBuV/m)	LIMIT (dBuV/m)	MARGIN (dB)	ANTENNA HEIGHT (m)	TABLE ANGLE (Degree)	RAW VALUE (dBuV)	CORRECTION FACTOR (dB/m)
1	*5550.00	100.1 PK			1.76 H	241	61.07	39.02
2	*5550.00	87.9 AV			1.76 H	241	48.87	39.02
3	7400.00	53.2 PK	74.00	-20.9	1.46 H	318	8.80	44.35
4	7400.00	40.4 AV	54.00	-13.6	1.46 H	318	-3.96	44.35
5	11100.00	60.7 PK	74.00	-13.3	1.55 H	244	10.49	50.24
6	11100.00	47.4 AV	54.00	-6.7	1.55 H	244	-2.89	50.24
ANTENNA POLARITY & TEST DISTANCE: VERTICAL AT 3 M								
NO.	FREQ. (MHz)	EMISSION LEVEL (dBuV/m)	LIMIT (dBuV/m)	MARGIN (dB)	ANTENNA HEIGHT (m)	TABLE ANGLE (Degree)	RAW VALUE (dBuV)	CORRECTION FACTOR (dB/m)
1	*5550.00	110.2 PK			1.57 V	100	71.16	39.02
2	*5550.00	98.2 AV			1.57 V	100	59.13	39.02
3	7400.00	53.5 PK	74.00	-20.5	1.40 V	238	9.19	44.35
4	7400.00	40.7 AV	54.00	-13.4	1.40 V	238	-3.70	44.35
5	11100.00	62.1 PK	74.00	-11.9	1.56 V	103	11.87	50.24
6	11100.00	49.3 AV	54.00	-4.7	1.56 V	103	-0.98	50.24

- REMARKS:**
1. Emission level (dBuV/m) = Raw Value (dBuV) + Correction Factor (dB/m).
  2. Correction Factor (dB/m) = Antenna Factor (dB/m) + Cable Factor (dB).
  3. The other emission levels were very low against the limit.
  6. "#": The radiated frequency is out the restricted band.
  4. Margin value = Emission level – Limit value.



A D T

EUT TEST CONDITION		MEASUREMENT DETAIL	
CHANNEL	Channel 134	FREQUENCY RANGE	1 ~ 40GHz
INPUT POWER (SYSTEM)	120Vac, 60 Hz	DETECTOR FUNCTION	Peak (PK) Average (AV)
ENVIRONMENTAL CONDITIONS	22deg. C, 62%RH 1000 hPa	TESTED BY	Nick Chen

ANTENNA POLARITY & TEST DISTANCE: HORIZONTAL AT 3 M								
NO.	FREQ. (MHz)	EMISSION LEVEL (dBuV/m)	LIMIT (dBuV/m)	MARGIN (dB)	ANTENNA HEIGHT (m)	TABLE ANGLE (Degree)	RAW VALUE (dBuV)	CORRECTION FACTOR (dB/m)
1	*5670.00	101.0 PK			1.66 H	147	61.66	39.31
2	*5670.00	89.1 AV			1.66 H	147	49.74	39.31
3	#5725.00	61.1 PK	88.30	-27.2	1.66 H	147	21.62	39.45
4	#5725.00	48.4 AV	68.30	-19.9	1.66 H	147	8.95	39.45
5	7560.00	54.9 PK	74.00	-19.1	1.46 H	97	10.03	44.84
6	7560.00	41.9 AV	54.00	-12.1	1.46 H	97	-2.94	44.84
7	11340.00	61.0 PK	74.00	-13.0	1.58 H	281	10.93	50.09
8	11340.00	47.8 AV	54.00	-6.2	1.58 H	281	-2.28	50.09
ANTENNA POLARITY & TEST DISTANCE: VERTICAL AT 3 M								
NO.	FREQ. (MHz)	EMISSION LEVEL (dBuV/m)	LIMIT (dBuV/m)	MARGIN (dB)	ANTENNA HEIGHT (m)	TABLE ANGLE (Degree)	RAW VALUE (dBuV)	CORRECTION FACTOR (dB/m)
1	*5670.00	110.9 PK			1.68 V	100	71.61	39.31
2	*5670.00	98.5 AV			1.68 V	100	59.21	39.31
3	#5725.00	67.5 PK	88.30	-20.8	1.68 V	100	28.06	39.45
4	#5725.00	53.0 AV	68.30	-15.3	1.68 V	100	13.58	39.45
5	7560.00	55.0 PK	74.00	-19.0	1.53 V	298	10.16	44.84
6	7560.00	41.7 AV	54.00	-12.3	1.53 V	298	-3.12	44.84
7	11340.00	61.3 PK	74.00	-12.7	1.64 V	168	11.19	50.09
8	11340.00	48.6 AV	54.00	-5.4	1.64 V	168	-1.46	50.09

- REMARKS:**
1. Emission level (dBuV/m) = Raw Value (dBuV) + Correction Factor (dB/m).
  2. Correction Factor (dB/m) = Antenna Factor (dB/m) + Cable Factor (dB).
  3. The other emission levels were very low against the limit.
  4. Margin value = Emission level – Limit value.
  5. “ \* “: Fundamental frequency.
  6. “#”: The radiated frequency is out the restricted band.

**BELOW 1GHz WORST-CASE DATA**  
**FOR 5260-5320MHz BAND: 802.11n (20MHz)**

EUT TEST CONDITION		MEASUREMENT DETAIL	
CHANNEL	Channel 52	FREQUENCY RANGE	Below 1000MHz
INPUT POWER (SYSTEM)	120Vac, 60 Hz	DETECTOR FUNCTION	Quasi-Peak
ENVIRONMENTAL CONDITIONS	22deg. C, 62%RH 999 hPa	TEST MODE	A
TESTED BY	Nick Chen		

ANTENNA POLARITY & TEST DISTANCE: HORIZONTAL AT 3 M								
NO.	FREQ. (MHz)	EMISSION LEVEL (dBuV/m)	LIMIT (dBuV/m)	MARGIN (dB)	ANTENNA HEIGHT (m)	TABLE ANGLE (Degree)	RAW VALUE (dBuV)	CORRECTION FACTOR (dB/m)
1	62.73	28.0 QP	40.00	-12.0	1.22 H	249	21.13	6.90
2	250.00	38.6 QP	46.00	-7.4	1.07 H	253	23.37	15.19
3	<b>340.02</b>	<b>45.7 QP</b>	<b>46.00</b>	<b>-0.3</b>	<b>1.43 H</b>	<b>308</b>	<b>28.24</b>	<b>17.43</b>
4	500.02	36.1 QP	46.00	-9.9	1.11 H	218	14.75	21.32
5	600.03	39.6 QP	46.00	-6.4	1.26 H	300	16.69	22.88
6	680.00	45.6 QP	46.00	-0.4	1.47 H	284	22.13	23.50
7	1000.00	41.2 QP	54.00	-12.8	1.03 H	97	13.87	27.32
ANTENNA POLARITY & TEST DISTANCE: VERTICAL AT 3 M								
NO.	FREQ. (MHz)	EMISSION LEVEL (dBuV/m)	LIMIT (dBuV/m)	MARGIN (dB)	ANTENNA HEIGHT (m)	TABLE ANGLE (Degree)	RAW VALUE (dBuV)	CORRECTION FACTOR (dB/m)
1	65.02	31.7 QP	40.00	-8.3	1.51 V	294	24.67	7.02
2	125.02	35.5 QP	43.50	-8.0	1.50 V	290	22.48	13.01
3	250.01	38.6 QP	46.00	-7.4	1.57 V	244	23.42	15.19
4	500.02	38.5 QP	46.00	-7.5	1.06 V	307	17.18	21.32
5	625.01	38.0 QP	46.00	-8.0	1.00 V	287	14.89	23.08
6	680.02	42.2 QP	46.00	-3.8	1.08 V	208	18.69	23.50
7	1000.00	44.7 QP	54.00	-9.3	1.52 V	207	17.41	27.32

- REMARKS:**
1. Emission level (dBuV/m) = Raw Value (dBuV) + Correction Factor (dB/m).
  2. Correction Factor (dB/m) = Antenna Factor (dB/m) + Cable Factor (dB).
  3. The other emission levels were very low against the limit.
  4. Margin value = Emission level – Limit value.



A D T

EUT TEST CONDITION		MEASUREMENT DETAIL	
CHANNEL	Channel 52	FREQUENCY RANGE	Below 1000MHz
INPUT POWER (SYSTEM)	120Vac, 60 Hz	DETECTOR FUNCTION	Quasi-Peak
ENVIRONMENTAL CONDITIONS	22deg. C, 62%RH 999 hPa	TEST MODE	B
TESTED BY	Nick Chen		

ANTENNA POLARITY & TEST DISTANCE: HORIZONTAL AT 3 M								
NO.	FREQ. (MHz)	EMISSION LEVEL (dBuV/m)	LIMIT (dBuV/m)	MARGIN (dB)	ANTENNA HEIGHT (m)	TABLE ANGLE (Degree)	RAW VALUE (dBuV)	CORRECTION FACTOR (dB/m)
1	57.13	29.5 QP	40.00	-10.5	1.19 H	241	22.54	7.00
2	125.01	33.3 QP	43.50	-10.2	1.24 H	319	20.25	13.01
3	250.02	41.8 QP	46.00	-4.2	2.18 H	335	26.64	15.19
4	<b>340.01</b>	<b>45.7 QP</b>	<b>46.00</b>	<b>-0.3</b>	<b>1.05 H</b>	<b>233</b>	<b>28.30</b>	<b>17.43</b>
5	625.03	35.7 QP	46.00	-10.3	1.27 H	259	12.60	23.08
6	750.02	37.5 QP	46.00	-8.5	1.21 H	287	13.27	24.27
7	1000.00	40.2 QP	54.00	-13.8	1.08 H	240	12.92	27.32
ANTENNA POLARITY & TEST DISTANCE: VERTICAL AT 3 M								
NO.	FREQ. (MHz)	EMISSION LEVEL (dBuV/m)	LIMIT (dBuV/m)	MARGIN (dB)	ANTENNA HEIGHT (m)	TABLE ANGLE (Degree)	RAW VALUE (dBuV)	CORRECTION FACTOR (dB/m)
1	52.76	38.0 QP	40.00	-2.0	1.82 V	169	30.66	7.37
2	70.49	35.2 QP	40.00	-4.8	1.55 V	67	27.90	7.34
3	125.01	35.1 QP	43.50	-8.4	1.37 V	241	22.10	13.01
4	340.02	35.7 QP	46.00	-10.3	1.39 V	227	18.28	17.43
5	600.01	40.9 QP	46.00	-5.1	1.29 V	51	18.00	22.88
6	625.01	39.5 QP	46.00	-6.5	1.69 V	327	16.43	23.08
7	750.02	40.0 QP	46.00	-6.0	1.00 V	19	15.76	24.27

- REMARKS:**
1. Emission level (dBuV/m) = Raw Value (dBuV) + Correction Factor (dB/m).
  2. Correction Factor (dB/m) = Antenna Factor (dB/m) + Cable Factor (dB).
  3. The other emission levels were very low against the limit.
  4. Margin value = Emission level – Limit value.



A D T

FOR 5500-5700MHz BAND: 802.11n (20MHz)

EUT TEST CONDITION		MEASUREMENT DETAIL	
CHANNEL	Channel 116	FREQUENCY RANGE	Below 1000MHz
INPUT POWER (SYSTEM)	120Vac, 60 Hz	DETECTOR FUNCTION	Quasi-Peak
ENVIRONMENTAL CONDITIONS	23deg. C, 83%RH 999 hPa	TEST MODE	A
TESTED BY	Nick Chen		

ANTENNA POLARITY & TEST DISTANCE: HORIZONTAL AT 3 M								
NO.	FREQ. (MHz)	EMISSION LEVEL (dBuV/m)	LIMIT (dBuV/m)	MARGIN (dB)	ANTENNA HEIGHT (m)	TABLE ANGLE (Degree)	RAW VALUE (dBuV)	CORRECTION FACTOR (dB/m)
1	62.65	28.4 QP	40.00	-11.6	1.29 H	241	21.50	6.89
2	250.01	38.5 QP	46.00	-7.5	1.18 H	19	23.27	15.19
3	340.01	45.6 QP	46.00	-0.5	1.37 H	301	28.12	17.43
4	500.01	36.2 QP	46.00	-9.8	1.15 H	197	14.86	21.32
5	600.01	39.5 QP	46.00	-6.5	1.33 H	318	16.58	22.88
6	680.02	45.6 QP	46.00	-0.4	1.55 H	294	22.08	23.50
7	1000.00	41.3 QP	54.00	-12.7	1.01 H	83	13.97	27.32
ANTENNA POLARITY & TEST DISTANCE: VERTICAL AT 3 M								
NO.	FREQ. (MHz)	EMISSION LEVEL (dBuV/m)	LIMIT (dBuV/m)	MARGIN (dB)	ANTENNA HEIGHT (m)	TABLE ANGLE (Degree)	RAW VALUE (dBuV)	CORRECTION FACTOR (dB/m)
1	65.05	32.2 QP	40.00	-7.8	1.26 V	182	25.15	7.02
2	125.01	35.2 QP	43.50	-8.3	1.42 V	288	22.17	13.01
3	250.00	38.6 QP	46.00	-7.4	1.55 V	143	23.40	15.19
4	500.01	38.4 QP	46.00	-7.6	1.18 V	318	17.09	21.32
5	625.02	37.8 QP	46.00	-8.2	1.02 V	224	14.73	23.08
6	680.01	42.3 QP	46.00	-3.7	1.16 V	197	18.79	23.50
7	1000.00	44.8 QP	54.00	-9.2	1.49 V	193	17.49	27.32

- REMARKS:**
1. Emission level (dBuV/m) = Raw Value (dBuV) + Correction Factor (dB/m).
  2. Correction Factor (dB/m) = Antenna Factor (dB/m) + Cable Factor (dB).
  3. The other emission levels were very low against the limit.
  4. Margin value = Emission level – Limit value.



A D T

EUT TEST CONDITION		MEASUREMENT DETAIL	
CHANNEL	Channel 116	FREQUENCY RANGE	Below 1000MHz
INPUT POWER (SYSTEM)	120Vac, 60 Hz	DETECTOR FUNCTION	Quasi-Peak
ENVIRONMENTAL CONDITIONS	23deg. C, 83%RH 999 hPa	TEST MODE	B
TESTED BY	Nick Chen		

ANTENNA POLARITY & TEST DISTANCE: HORIZONTAL AT 3 M								
NO.	FREQ. (MHz)	EMISSION LEVEL (dBuV/m)	LIMIT (dBuV/m)	MARGIN (dB)	ANTENNA HEIGHT (m)	TABLE ANGLE (Degree)	RAW VALUE (dBuV)	CORRECTION FACTOR (dB/m)
1	57.15	29.5 QP	40.00	-10.5	1.21 H	24	22.47	7.00
2	125.00	33.2 QP	43.50	-10.3	1.34 H	274	20.17	13.01
3	250.01	41.7 QP	46.00	-4.3	2.17 H	330	26.53	15.19
4	340.01	45.6 QP	46.00	-0.4	1.14 H	27	28.18	17.43
5	625.01	35.5 QP	46.00	-10.5	1.31 H	255	12.45	23.08
6	750.01	37.5 QP	46.00	-8.5	1.19 H	224	13.21	24.27
7	1000.00	40.1 QP	54.00	-13.9	1.05 H	328	12.79	27.32
ANTENNA POLARITY & TEST DISTANCE: VERTICAL AT 3 M								
NO.	FREQ. (MHz)	EMISSION LEVEL (dBuV/m)	LIMIT (dBuV/m)	MARGIN (dB)	ANTENNA HEIGHT (m)	TABLE ANGLE (Degree)	RAW VALUE (dBuV)	CORRECTION FACTOR (dB/m)
1	52.72	38.2 QP	40.00	-1.8	1.53 V	218	30.78	7.38
2	70.52	36.3 QP	40.00	-3.7	1.08 V	127	28.95	7.34
3	125.02	35.3 QP	43.50	-8.2	1.22 V	274	22.25	13.01
4	340.01	35.2 QP	46.00	-10.8	1.43 V	169	17.76	17.43
5	600.01	40.7 QP	46.00	-5.3	1.37 V	245	17.84	22.88
6	625.01	39.4 QP	46.00	-6.6	1.53 V	127	16.34	23.08
7	750.01	40.0 QP	46.00	-6.0	1.01 V	224	15.69	24.27

- REMARKS:**
1. Emission level (dBuV/m) = Raw Value (dBuV) + Correction Factor (dB/m).
  2. Correction Factor (dB/m) = Antenna Factor (dB/m) + Cable Factor (dB).
  3. The other emission levels were very low against the limit.
  4. Margin value = Emission level – Limit value.

## 4.2 CONDUCTED EMISSION MEASUREMENT

### 4.2.1 LIMITS OF CONDUCTED EMISSION MEASUREMENT

FREQUENCY OF EMISSION (MHz)	CONDUCTED LIMIT (dB $\mu$ V)	
	Quasi-peak	Average
0.15 ~ 0.5	66 to 56	56 to 46
0.5 ~ 5	56	46
5 ~ 30	60	50

- NOTE:** 1. The lower limit shall apply at the transition frequencies.  
 2. The limit decreases in line with the logarithm of the frequency in the range of 0.15 to 0.50MHz.  
 3. All emanations from a class A/B digital device or system, including any network of conductors and apparatus connected thereto, shall not exceed the level of field strengths specified above.

### 4.2.2 TEST INSTRUMENTS

DESCRIPTION & MANUFACTURER	MODEL NO.	SERIAL NO.	CALIBRATED DATE	CALIBRATED UNTIL
ROHDE & SCHWARZ Test Receiver	ESCS 30	838251/021	Mar. 05, 2009	Mar. 04, 2010
ROHDE & SCHWARZ Artificial Mains Network (for EUT)	ESH3-Z5	100218	Nov. 24, 2009	Nov. 23, 2010
LISN With Adapter (for EUT)	AD10	C10Ada-001	Nov. 24, 2009	Nov. 23, 2010
ROHDE & SCHWARZ Artificial Mains Network (for peripherals)	ESH3-Z5	100219	Nov. 23, 2009	Nov. 22, 2010
Software	ADT_Cond_V7.3.7	NA	NA	NA
Software	ADT_ISN_V7.3.7	NA	NA	NA
RF cable (JYEBAO)	5D-FB	Cable-C10.01	Feb. 26, 2009	Feb. 25, 2010
SUHNER Terminator (For ROHDE & SCHWARZ LISN)	65BNC-5001	E1-010773	Feb. 27, 2009	Feb. 26, 2010

- NOTE:** 1. The calibration interval of the above test instruments is 12 months and the calibrations are traceable to NML/ROC and NIST/USA.  
 2. The test was performed in Shielded Room No. 10.  
 3. The VCCI Site Registration No. C-1852.



#### 4.2.3 TEST PROCEDURES

- a. The EUT was placed 0.4 meters from the conducting wall of the shielded room with EUT being connected to the power mains through a line impedance stabilization network (LISN). Other support units were connected to the power mains through another LISN. The two LISNs provide 50 ohm/ 50uH of coupling impedance for the measuring instrument.
- b. Both lines of the power mains connected to the EUT were checked for maximum conducted interference.
- c. The frequency range from 150kHz to 30MHz was searched. Emission levels under (Limit - 20dB) was not recorded.

#### 4.2.4 DEVIATION FROM TEST STANDARD

No deviation.

#### 4.2.5 TEST SETUP

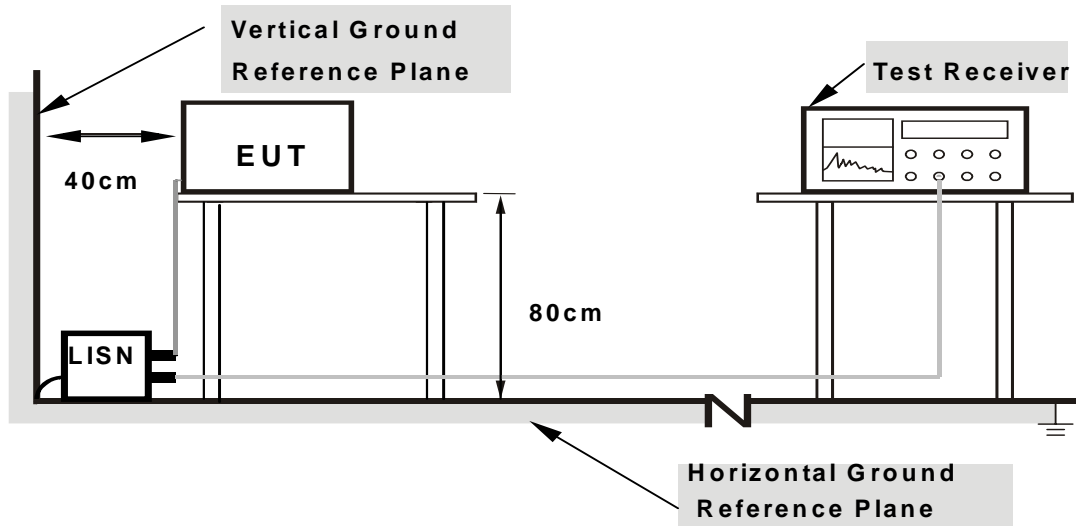

**Note: 1.Support units were connected to second LISN.**

**2.Both of LISNs (AMN) are 80 cm from EUT and at least 80 from other units and other metal planes**

For the actual test configuration, please refer to the attached file (Test Setup Photo).

#### 4.2.6 EUT OPERATING CONDITIONS

Same as 4.1.6.

#### 4.2.7 TEST RESULTS

##### CONDUCTED WORST-CASE DATA

FOR 5260-5320MHz BAND: 802.11n (20MHz)

PHASE	Line 1	6dB BANDWIDTH	9kHz
TEST MODE	A		

No	Freq. [MHz]	Corr. Factor (dB)	Reading Value		Emission Level		Limit		Margin	
			[dB (uV)]		[dB (uV)]		[dB (uV)]		(dB)	
			Q.P.	AV.	Q.P.	AV.	Q.P.	AV.	Q.P.	AV.
1	0.197	0.13	33.62	-	33.75	-	63.74	53.74	-29.99	-
2	0.326	0.19	31.57	-	31.76	-	59.55	49.55	-27.79	-
3	0.590	0.25	29.89	-	30.14	-	56.00	46.00	-25.86	-
4	1.049	0.28	26.21	-	26.49	-	56.00	46.00	-29.51	-
5	1.825	0.35	20.30	-	20.65	-	56.00	46.00	-35.35	-
6	28.365	2.03	23.61	-	25.64	-	60.00	50.00	-34.36	-

- REMARKS:**
1. Q.P. and AV. are abbreviations of quasi-peak and average individually.
  2. "-": The Quasi-peak reading value also meets average limit and measurement with the average detector is unnecessary.
  3. The emission levels of other frequencies were very low against the limit.
  4. Margin value = Emission level - Limit value
  5. Correction factor = Insertion loss + Cable loss
  6. Emission Level = Correction Factor + Reading Value.

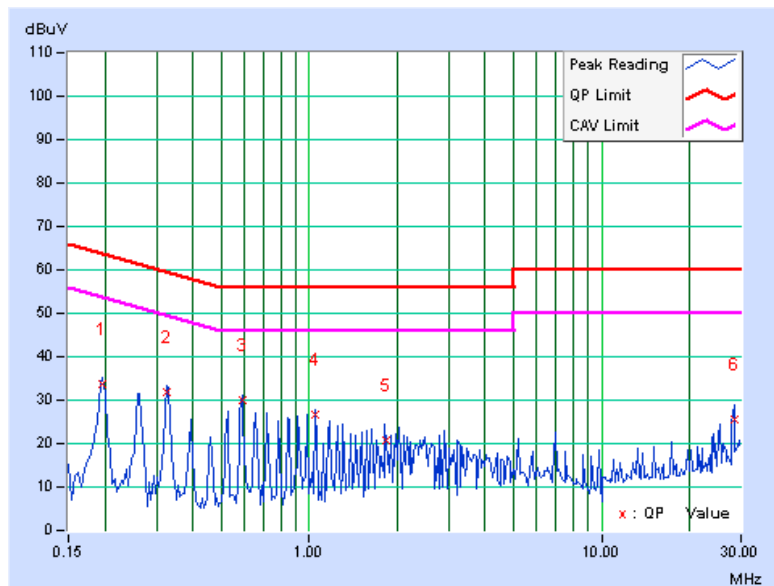



A D T

PHASE	Line 2	6dB BANDWIDTH	9kHz
TEST MODE	A		

No	Freq. [MHz]	Corr. Factor (dB)	Reading Value [dB (uV)]		Emission Level [dB (uV)]		Limit [dB (uV)]		Margin (dB)	
			Q.P.	AV.	Q.P.	AV.	Q.P.	AV.	Q.P.	AV.
1	0.197	0.13	33.76	-	33.89	-	63.74	53.74	-29.85	-
2	0.330	0.19	28.80	-	28.99	-	59.46	49.46	-30.46	-
3	0.591	0.27	28.69	-	28.96	-	56.00	46.00	-27.04	-
4	0.986	0.37	25.16	-	25.53	-	56.00	46.00	-30.47	-
5	1.510	0.41	24.77	-	25.18	-	56.00	46.00	-30.82	-
6	28.367	1.86	22.91	-	24.77	-	60.00	50.00	-35.23	-

- REMARKS:**
1. Q.P. and AV. are abbreviations of quasi-peak and average individually.
  2. "-": The Quasi-peak reading value also meets average limit and measurement with the average detector is unnecessary.
  3. The emission levels of other frequencies were very low against the limit.
  4. Margin value = Emission level - Limit value
  5. Correction factor = Insertion loss + Cable loss
  6. Emission Level = Correction Factor + Reading Value.

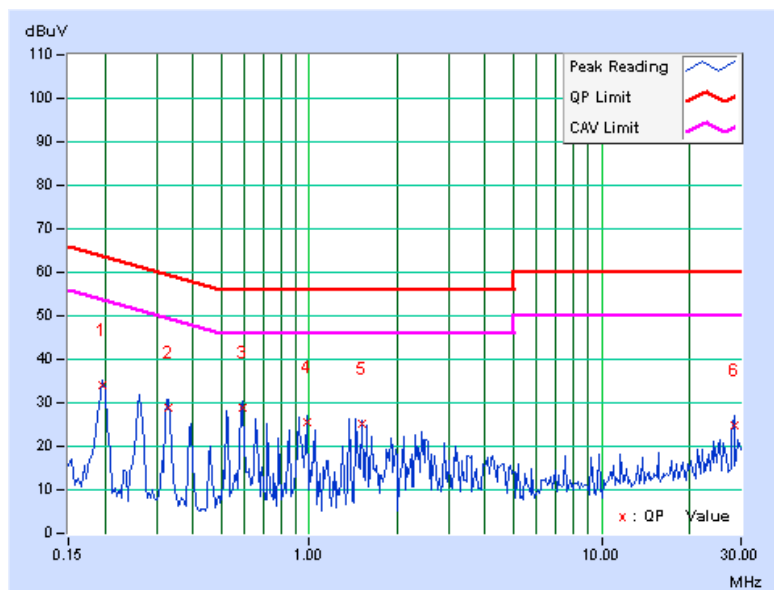



A D T

PHASE	Line 1	6dB BANDWIDTH	9kHz
TEST MODE	B		

No	Freq. [MHz]	Corr. Factor (dB)	Reading Value [dB (uV)]		Emission Level [dB (uV)]		Limit [dB (uV)]		Margin (dB)	
			Q.P.	AV.	Q.P.	AV.	Q.P.	AV.	Q.P.	AV.
1	0.177	0.13	47.34	-	47.47	-	64.63	54.63	-17.17	-
2	0.357	0.21	35.37	-	35.58	-	58.81	48.81	-23.23	-
3	0.709	0.26	28.83	-	29.09	-	56.00	46.00	-26.91	-
4	3.902	0.51	35.56	-	36.07	-	56.00	46.00	-19.93	-
5	9.844	0.71	38.11	-	38.82	-	60.00	50.00	-21.18	-
6	24.118	1.84	37.70	-	39.54	-	60.00	50.00	-20.46	-

- REMARKS:**
1. Q.P. and AV. are abbreviations of quasi-peak and average individually.
  2. "-": The Quasi-peak reading value also meets average limit and measurement with the average detector is unnecessary.
  3. The emission levels of other frequencies were very low against the limit.
  4. Margin value = Emission level - Limit value
  5. Correction factor = Insertion loss + Cable loss
  6. Emission Level = Correction Factor + Reading Value.

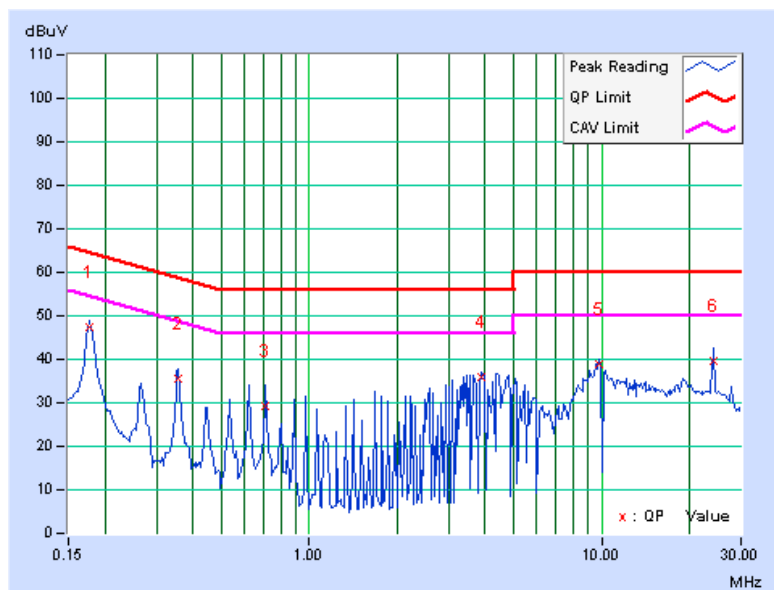

PHASE	Line 2	6dB BANDWIDTH	9kHz
TEST MODE	B		

No	Freq. [MHz]	Corr. Factor (dB)	Reading Value [dB (uV)]		Emission Level [dB (uV)]		Limit [dB (uV)]		Margin (dB)	
			Q.P.	AV.	Q.P.	AV.	Q.P.	AV.	Q.P.	AV.
1	0.177	0.13	45.40	-	45.53	-	64.61	54.61	-19.08	-
2	0.354	0.21	33.97	-	34.18	-	58.86	48.86	-24.68	-
3	0.709	0.30	32.07	-	32.37	-	56.00	46.00	-23.63	-
4	1.688	0.43	30.01	-	30.44	-	56.00	46.00	-25.56	-
5	3.656	0.57	35.87	-	36.44	-	56.00	46.00	-19.56	-
6	24.117	1.66	37.89	-	39.55	-	60.00	50.00	-20.45	-

- REMARKS:**
1. Q.P. and AV. are abbreviations of quasi-peak and average individually.
  2. "-": The Quasi-peak reading value also meets average limit and measurement with the average detector is unnecessary.
  3. The emission levels of other frequencies were very low against the limit.
  4. Margin value = Emission level - Limit value
  5. Correction factor = Insertion loss + Cable loss
  6. Emission Level = Correction Factor + Reading Value.

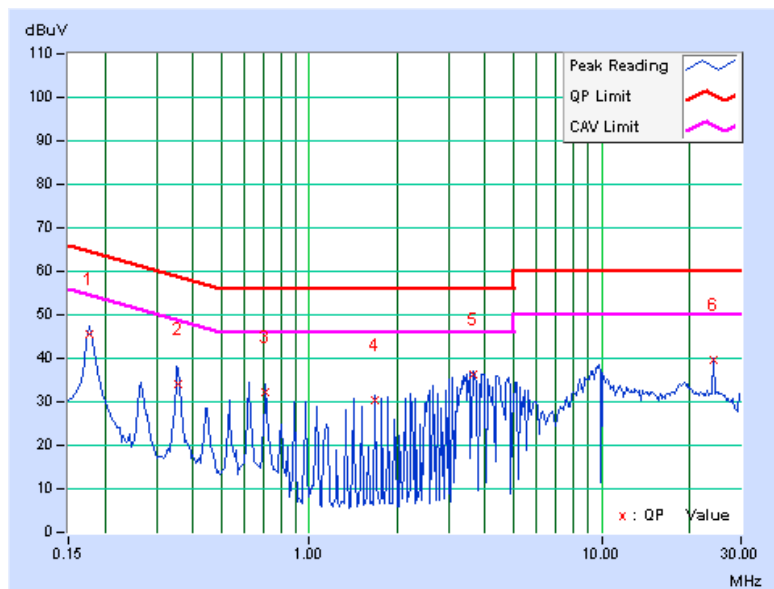

**FOR 5500-5700MHz BAND: 802.11n (20MHz)**

<b>PHASE</b>	Line 1	<b>6dB BANDWIDTH</b>	9kHz
<b>TEST MODE</b>	A		

No	Freq. [MHz]	Corr. Factor (dB)	Reading Value [dB (uV)]		Emission Level [dB (uV)]		Limit [dB (uV)]		Margin (dB)	
			Q.P.	AV.	Q.P.	AV.	Q.P.	AV.	Q.P.	AV.
1	0.197	0.12	29.35	-	29.47	-	63.74	53.74	-34.27	-
2	0.326	0.18	31.41	-	31.59	-	59.56	49.56	-27.97	-
3	0.588	0.23	25.44	-	25.67	-	56.00	46.00	-30.33	-
4	0.923	0.24	24.86	-	25.10	-	56.00	46.00	-30.90	-
5	1.500	0.26	16.49	-	16.75	-	56.00	46.00	-39.25	-
6	21.988	1.45	15.23	-	16.68	-	60.00	50.00	-43.32	-

- REMARKS:**
1. Q.P. and AV. are abbreviations of quasi-peak and average individually.
  2. "-": The Quasi-peak reading value also meets average limit and measurement with the average detector is unnecessary.
  3. The emission levels of other frequencies were very low against the limit.
  4. Margin value = Emission level - Limit value
  5. Correction factor = Insertion loss + Cable loss
  6. Emission Level = Correction Factor + Reading Value.

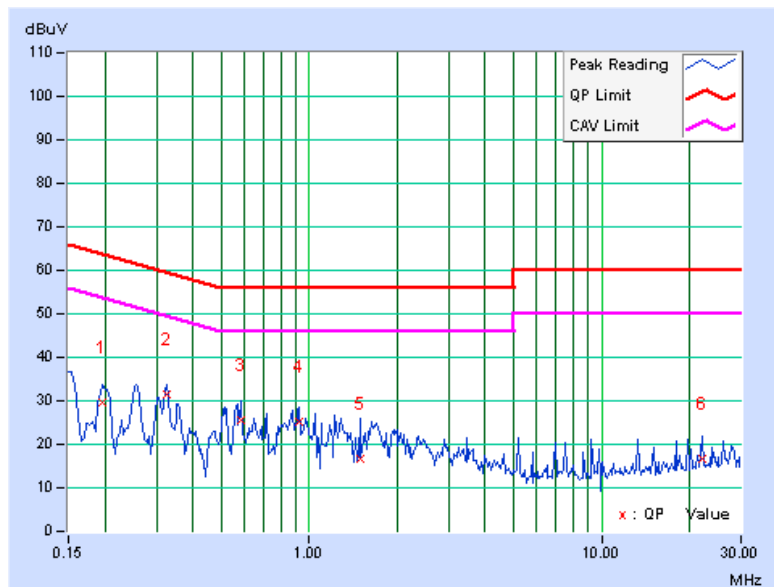

PHASE	Line 2	6dB BANDWIDTH	9kHz
TEST MODE	A		

No	Freq. [MHz]	Corr. Factor (dB)	Reading Value [dB (uV)]		Emission Level [dB (uV)]		Limit [dB (uV)]		Margin (dB)	
			Q.P.	AV.	Q.P.	AV.	Q.P.	AV.	Q.P.	AV.
1	0.197	0.09	31.40	-	31.49	-	63.74	53.74	-32.25	-
2	0.255	0.12	32.23	-	32.35	-	61.58	51.58	-29.23	-
3	0.326	0.16	30.49	-	30.65	-	59.56	49.56	-28.91	-
4	0.564	0.21	25.84	-	26.05	-	56.00	46.00	-29.95	-
5	0.923	0.22	23.34	-	23.56	-	56.00	46.00	-32.44	-
6	19.668	1.04	11.22	-	12.26	-	60.00	50.00	-47.74	-

- REMARKS:**
1. Q.P. and AV. are abbreviations of quasi-peak and average individually.
  2. "-": The Quasi-peak reading value also meets average limit and measurement with the average detector is unnecessary.
  3. The emission levels of other frequencies were very low against the limit.
  4. Margin value = Emission level - Limit value
  5. Correction factor = Insertion loss + Cable loss
  6. Emission Level = Correction Factor + Reading Value.

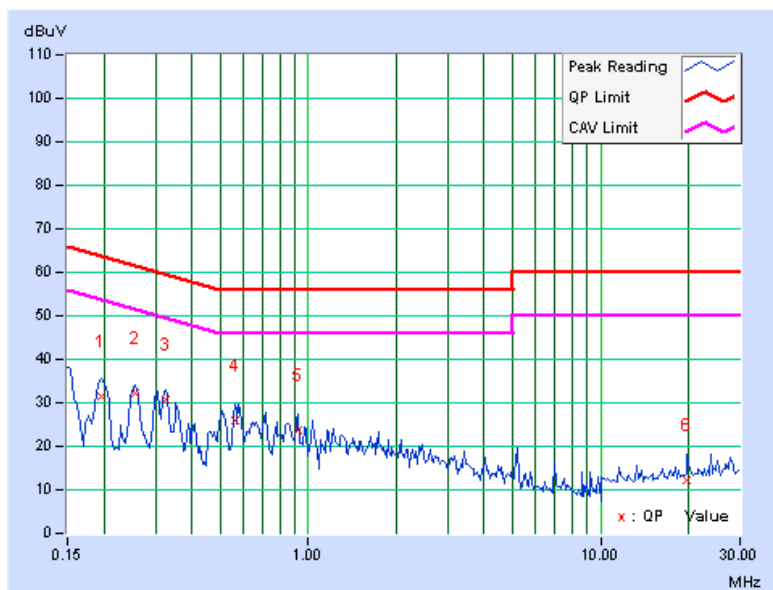



PHASE	Line 1	6dB BANDWIDTH	9kHz
TEST MODE	B		

No	Freq. [MHz]	Corr. Factor (dB)	Reading Value [dB (uV)]		Emission Level [dB (uV)]		Limit [dB (uV)]		Margin (dB)	
			Q.P.	AV.	Q.P.	AV.	Q.P.	AV.	Q.P.	AV.
1	0.177	0.12	46.03	-	46.15	-	64.61	54.61	-18.46	-
2	0.357	0.20	36.68	-	36.88	-	58.80	48.80	-21.92	-
3	0.623	0.23	31.83	-	32.06	-	56.00	46.00	-23.94	-
4	3.555	0.34	35.04	-	35.38	-	56.00	46.00	-20.62	-
5	18.840	1.32	32.96	-	34.28	-	60.00	50.00	-25.72	-
6	24.117	1.49	40.18	-	41.67	-	60.00	50.00	-18.33	-

- REMARKS:**
1. Q.P. and AV. are abbreviations of quasi-peak and average individually.
  2. "-": The Quasi-peak reading value also meets average limit and measurement with the average detector is unnecessary.
  3. The emission levels of other frequencies were very low against the limit.
  4. Margin value = Emission level - Limit value
  5. Correction factor = Insertion loss + Cable loss
  6. Emission Level = Correction Factor + Reading Value.

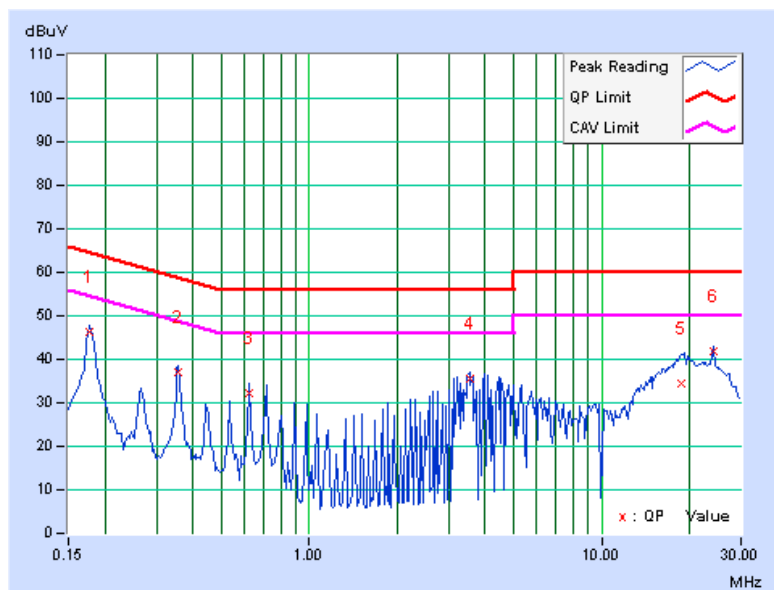



A D T

PHASE	Line 2	6dB BANDWIDTH	9kHz
TEST MODE	B		

No	Freq. [MHz]	Corr. Factor (dB)	Reading Value [dB (uV)]		Emission Level [dB (uV)]		Limit [dB (uV)]		Margin (dB)	
			Q.P.	AV.	Q.P.	AV.	Q.P.	AV.	Q.P.	AV.
1	0.177	0.09	45.68	-	45.77	-	64.61	54.61	-18.84	-
2	0.353	0.17	32.07	-	32.24	-	58.89	48.89	-26.64	-
3	0.623	0.21	31.91	-	32.12	-	56.00	46.00	-23.88	-
4	3.105	0.28	33.90	-	34.18	-	56.00	46.00	-21.82	-
5	18.816	1.00	38.78	-	39.78	-	60.00	50.00	-20.22	-
6	24.117	1.12	39.93	-	41.05	-	60.00	50.00	-18.95	-

- REMARKS:**
1. Q.P. and AV. are abbreviations of quasi-peak and average individually.
  2. "-": The Quasi-peak reading value also meets average limit and measurement with the average detector is unnecessary.
  3. The emission levels of other frequencies were very low against the limit.
  4. Margin value = Emission level - Limit value
  5. Correction factor = Insertion loss + Cable loss
  6. Emission Level = Correction Factor + Reading Value.

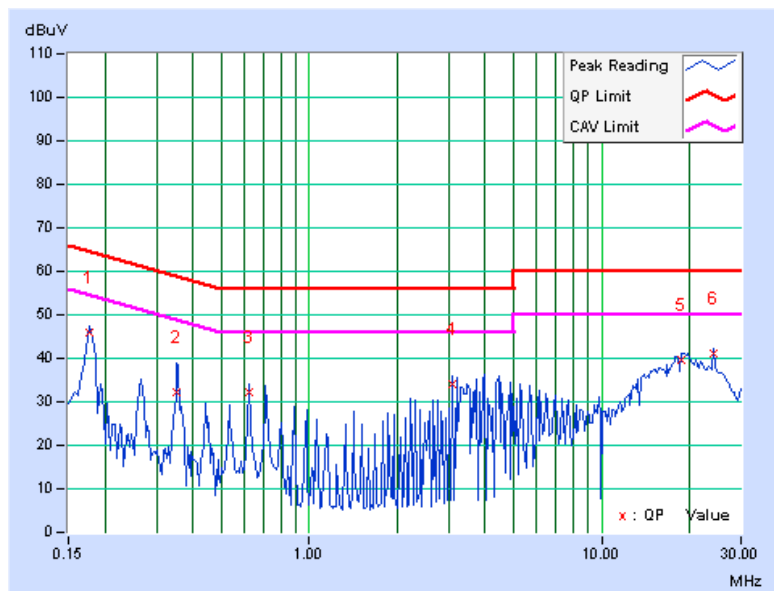

### 4.3 MAXIMUM CONDUCTED OUTPUT POWER MEASUREMENT

#### 4.3.1 LIMITS OF MAXIMUM CONDUCTED OUTPUT POWER MEASUREMENT

FREQUENCY BAND	LIMIT
5.250 ~ 5.350GHz	The lesser of 250mW (24dBm) or 11dBm + 10logB
5.470 ~ 5.725GHz	The lesser of 250mW (24dBm) or 11dBm + 10logB

**NOTE:** Where B is the 26dB emission bandwidth in MHz.

#### 4.3.2 TEST INSTRUMENTS

DESCRIPTION & MANUFACTURER	MODEL NO.	SERIAL NO.	DATE OF CALIBRATION	DUE DATE OF CALIBRATION
R&S SPECTRUM ANALYZER	FSP40	100040	Jul. 07, 2009	Jul. 06, 2010

**NOTE:** The calibration interval of the above test instruments is 12 months and the calibrations are traceable to NML/ROC and NIST/USA.

#### 4.3.3 TEST PROCEDURE

- a. The transmitter output was connected to the spectrum analyzer.
- b. Set span to encompass the entire emission bandwidth of the signal.
- c. Set RBW to 1MHz, VBW to 3MHz.
- d. Using the spectrum analyzer's channel power measurement function to measure the output power.

**NOTE:** The test is performed in accordance with FCC Public Notice: APPENDIX A Guidelines for Assessing Unlicensed National Information Infrastructure (U-NII) Devices – Part 15, Subpart E, August 2002.

The transmitter output operates continuously therefore Method # 1 is used.

#### 4.3.4 DEVIATION FROM TEST STANDARD

No deviation.

#### 4.3.5 TEST SETUP

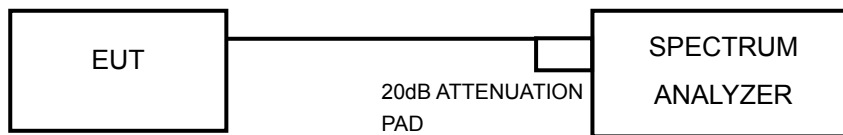

#### 4.3.6 EUT OPERATING CONDITIONS

The software provided by client to enable the EUT under transmission condition continuously at specific channel frequencies individually.



A D T

### 4.3.7 TEST RESULTS

#### PEAK POWER OUTPUT: 802.11a

CHAN.	CHAN. FREQ. (MHz)	POWER OUTPUT (dBm)		TOTAL POWER (mW)	TOTAL POWER (dBm)	PEAK LIMIT (dBm)	PASS / FAIL
		CHAIN 0	CHAIN 1				
52	5260	16.7	16.8	94.6	19.8	24	PASS
60	5300	16.1	17.2	93.2	19.7	24	PASS
64	5320	16.0	17.1	91.0	19.6	24	PASS
100	5500	18.3	19.0	147.0	21.7	24	PASS
116	5580	18.1	19.1	145.8	21.6	24	PASS
140	5700	18.1	18.9	141.7	21.5	24	PASS

#### FOR CHAIN 1: CH 116

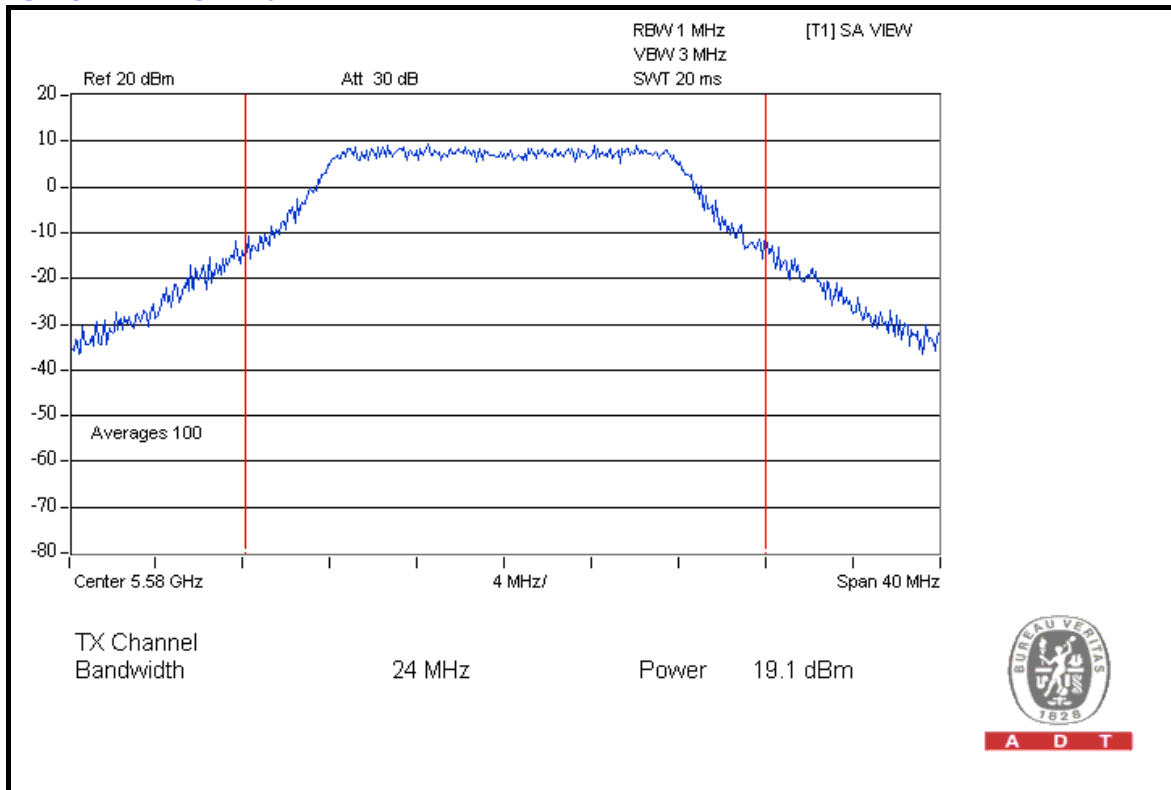



A D T

### 802.11n (20MHz)

CHAN.	CHAN. FREQ. (MHz)	POWER OUTPUT (dBm)		TOTAL POWER (mW)	TOTAL POWER (dBm)	POWER LIMIT (dBm)	PASS / FAIL
		CHAIN 0	CHAIN 1				
52	5260	16.8	16.8	95.7	19.8	24	PASS
60	5300	16.1	17.0	90.8	19.6	24	PASS
64	5320	15.8	17.1	89.3	19.5	24	PASS
100	5500	18.3	18.9	144.9	21.6	24	PASS
116	5580	18.3	19.1	148.4	21.7	24	PASS
140	5700	17.9	18.9	139.0	21.4	24	PASS

### FOR CHAIN 1: CH 116

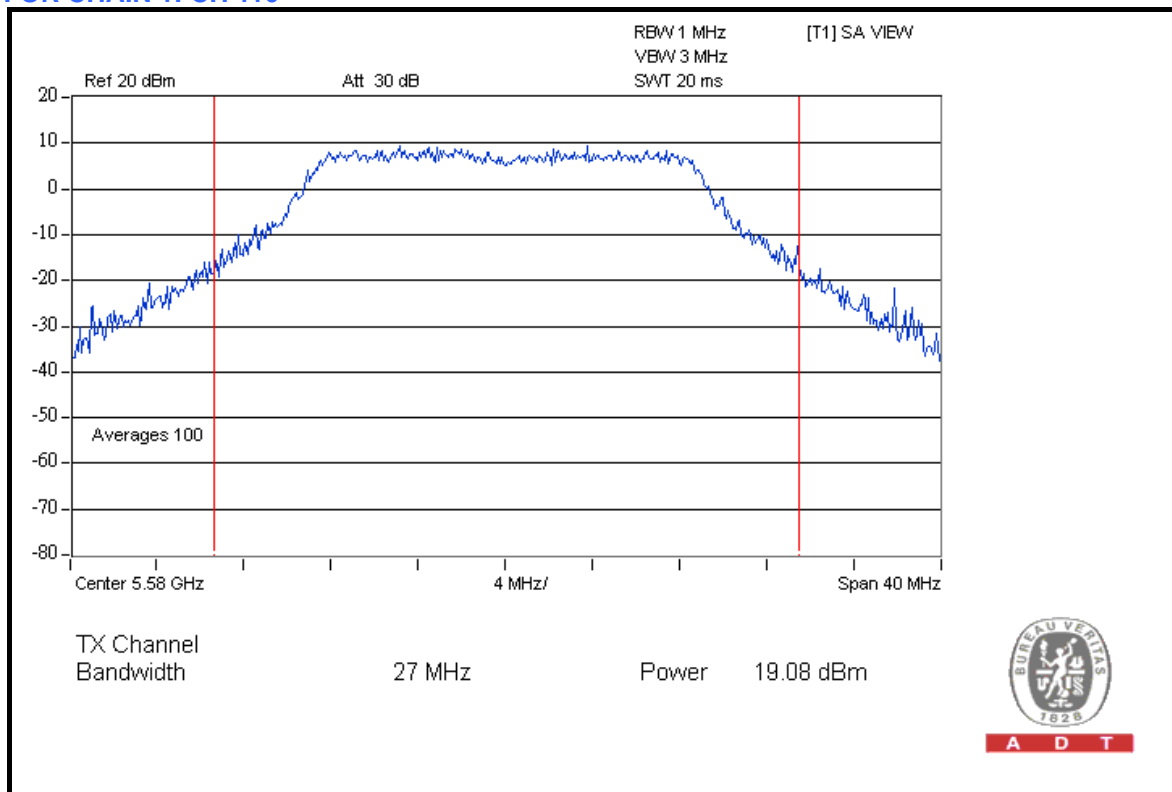



A D T

### 802.11n (40MHz)

CHAN.	CHAN. FREQ. (MHz)	POWER OUTPUT (dBm)		TOTAL POWER (mW)	TOTAL POWER (dBm)	POWER LIMIT (dBm)	PASS / FAIL
		CHAIN 0	CHAIN 1				
54	5270	13.7	14.5	51.6	17.1	24	PASS
62	5310	12.6	15.2	51.3	17.1	24	PASS
102	5510	13.1	14.0	45.5	16.6	24	PASS
110	5550	13.7	14.0	48.5	16.9	24	PASS
134	5670	13.4	14.4	49.3	16.9	24	PASS

### FOR CHAIN 1: CH 62

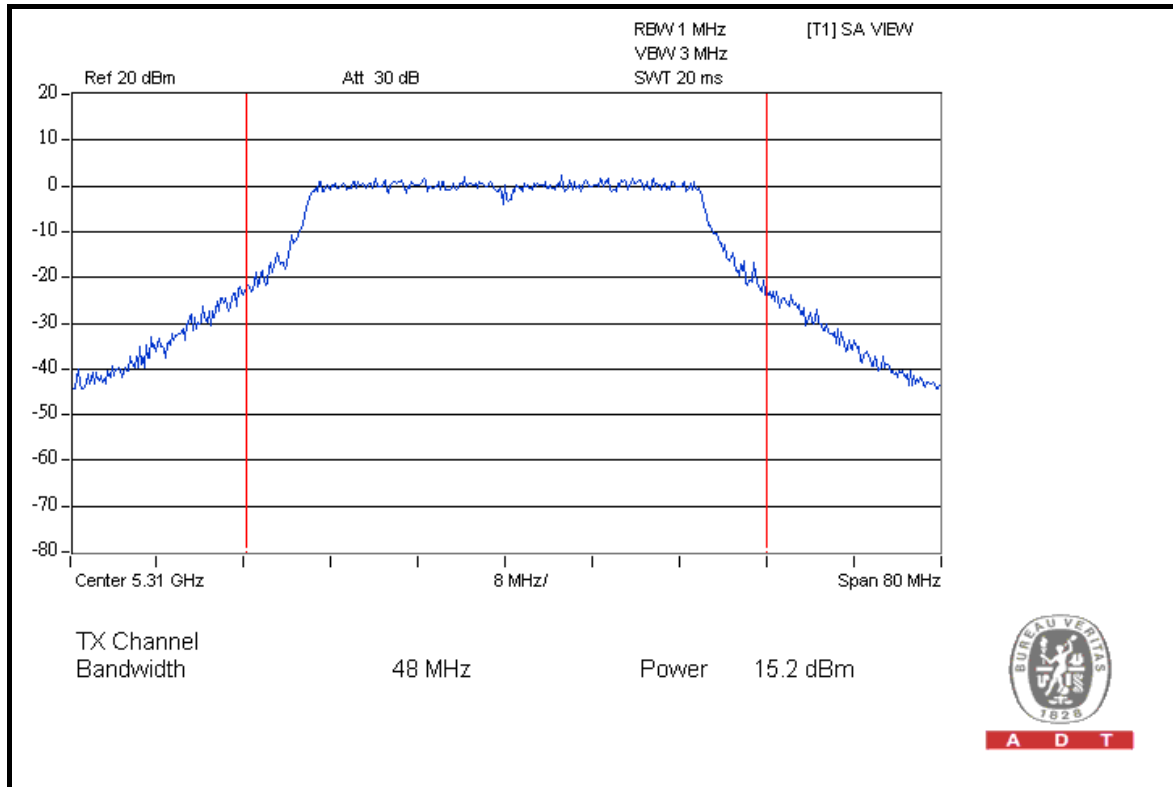

A D T



A D T

26dB OCCUPIED BANDWIDTH: 802.11a

CHANNEL	CHANNEL FREQUENCY (MHz)	26dBc OCCUPIED BANDWIDTH (MHz)		PASS / FAIL
		CHAIN 0	CHAIN 1	
52	5260	24.73	23.96	PASS
60	5300	23.88	24.12	PASS
64	5320	23.89	24.44	PASS
100	5500	24.15	24.57	PASS
116	5580	24.51	23.98	PASS
140	5700	23.96	24.60	PASS

FOR CHAIN 0: CH 52

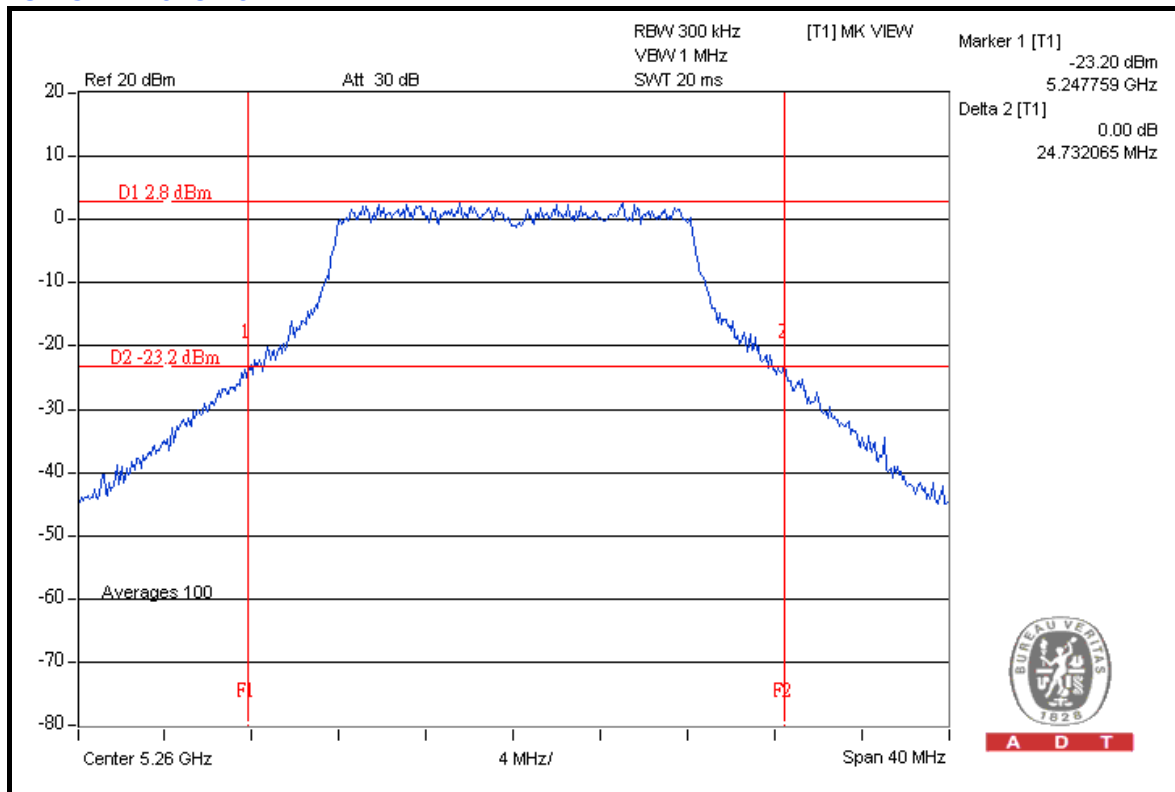





A D T

### 802.11n (20MHz)

CHANNEL	CHANNEL FREQUENCY (MHz)	26dBc OCCUPIED BANDWIDTH (MHz)		PASS / FAIL
		CHAIN 0	CHAIN 1	
52	5260	25.29	25.71	PASS
60	5300	25.38	25.49	PASS
64	5320	25.39	25.89	PASS
100	5500	25.51	25.38	PASS
116	5580	25.85	26.06	PASS
140	5700	26.13	26.06	PASS

### FOR CHAIN 0: CH 140

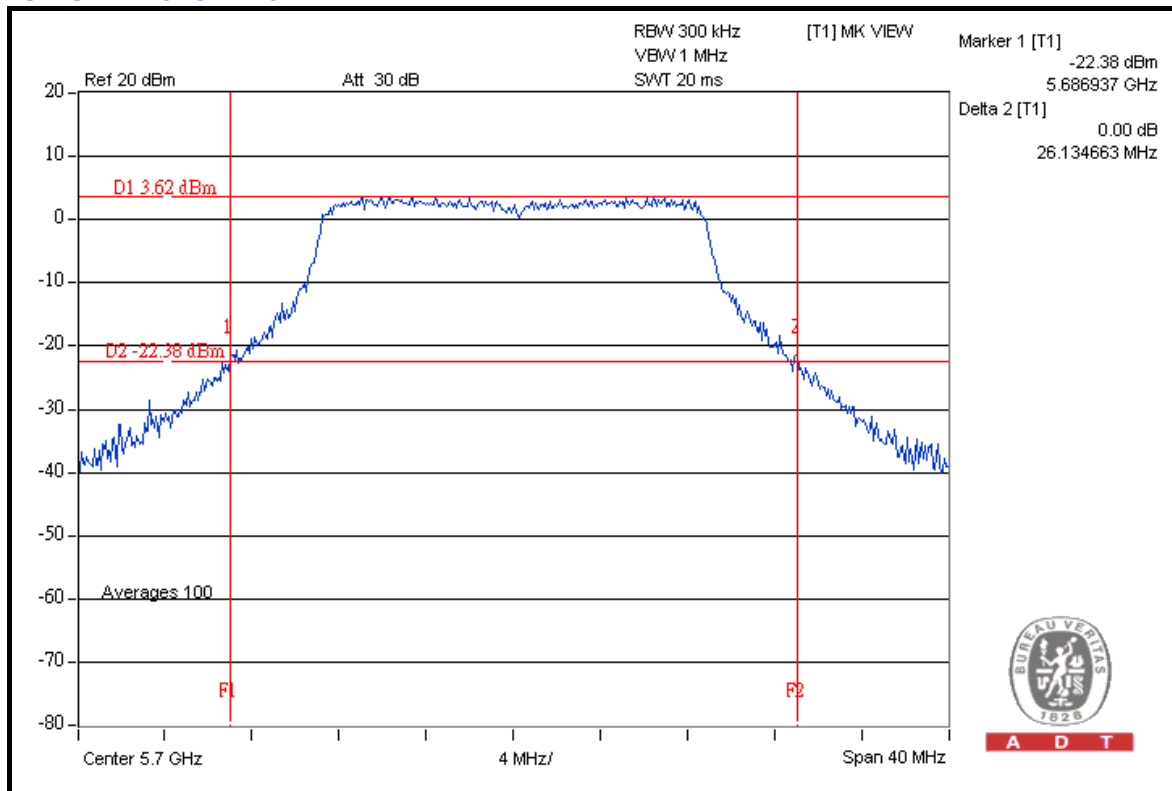

A D T



A D T

### 802.11n (40MHz)

CHANNEL	CHANNEL FREQUENCY (MHz)	26dBc OCCUPIED BANDWIDTH (MHz)		PASS / FAIL
		CHAIN 0	CHAIN 1	
54	5270	46.40	47.65	PASS
62	5310	47.57	47.41	PASS
102	5510	46.86	46.89	PASS
110	5550	46.97	47.43	PASS
134	5670	47.49	46.90	PASS

### CHAIN 1: CH 54

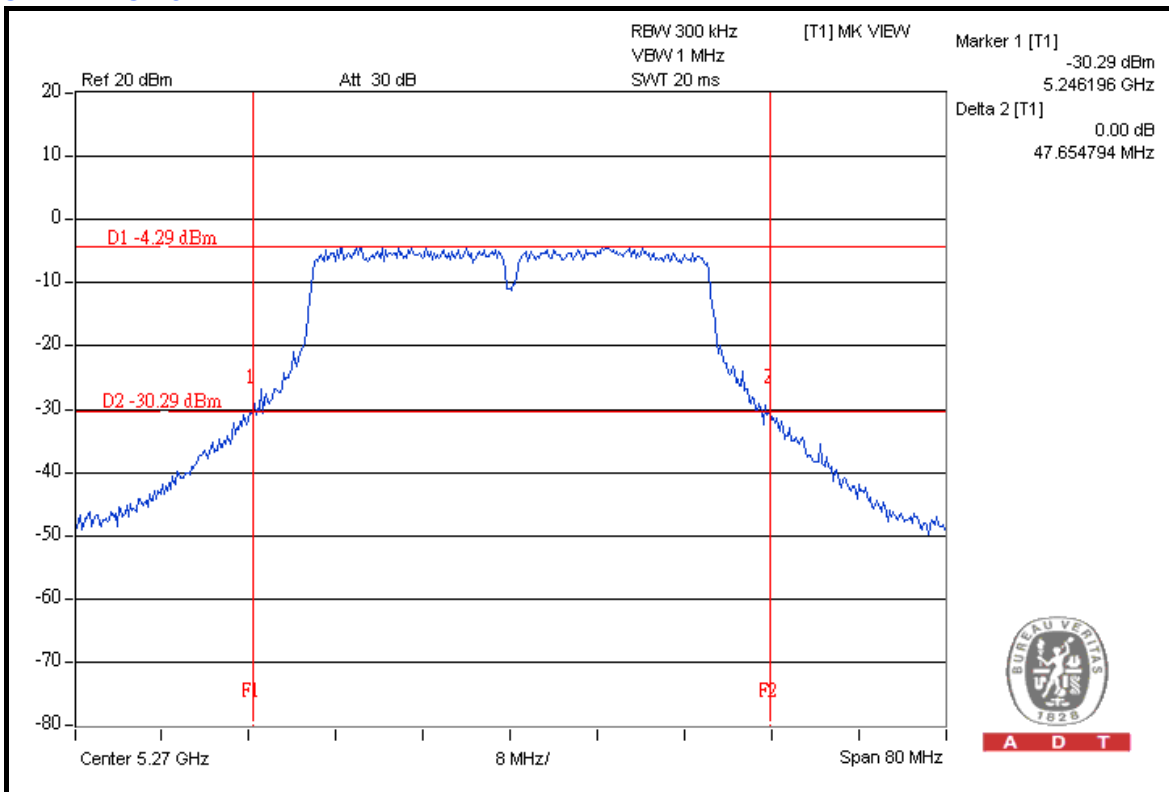

#### 4.4 PEAK POWER EXCURSION MEASUREMENT

##### 4.4.1 LIMITS OF PEAK POWER EXCURSION MEASUREMENT

FREQUENCY BAND	LIMIT
5.250 ~ 5.350GHz	13dB
5.470 ~ 5.725GHz	13dB

##### 4.4.2 TEST INSTRUMENTS

DESCRIPTION & MANUFACTURER	MODEL NO.	SERIAL NO.	DATE OF CALIBRATION	CALIBRATED UNTIL
R&S SPECTRUM ANALYZER	FSP40	100040	Jul. 07, 2009	Jul. 06, 2010

**NOTE:** The calibration interval of the above test instruments is 12 months and the calibrations are traceable to NML/ROC and NIST/USA.

##### 4.4.3 TEST PROCEDURE

- a. The transmitter output was connected to the spectrum analyzer.
- b. Set the spectrum bandwidth span to view the entire spectrum.
- c. Using peak detector and Max-hold function for Trace 1 (RB = 1MHz, VB = 3MHz) and 2 (RB = 1MHz, VB = 300kHz).
- d. The differences between Trace1 and Trace 2 in any 1MHz band at f1 to f2 range were recorded and showed to another trace.

#### 4.4.4 DEVIATION FROM TEST STANDARD

No deviation.

#### 4.4.5 TEST SETUP

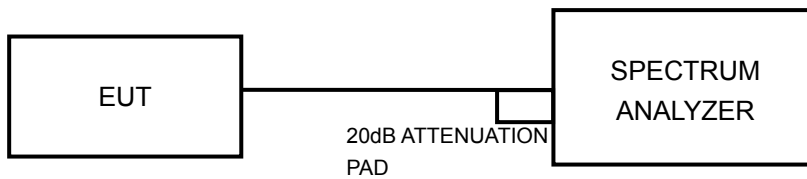

#### 4.4.6 EUT OPERATING CONDITIONS

The software provided by client to enable the EUT under transmission condition continuously at specific channel frequencies individually.



A D T

#### 4.4.7 TEST RESULTS

##### 802.11a

CHANNEL	CHANNEL FREQUENCY (MHz)	PEAK POWER EXCURSION (dB)		PEAK to AVERAGE EXCURSION LIMIT (dB)	PASS/FAIL
		CHAIN 0	CHAIN 1		
52	5260	9.47	7.89	13	PASS
60	5300	8.29	9.14	13	PASS
64	5320	9.80	7.78	13	PASS
100	5500	9.30	8.16	13	PASS
116	5580	8.24	7.56	13	PASS
140	5700	8.45	8.57	13	PASS



A D T

### CHAIN 0: CH 64

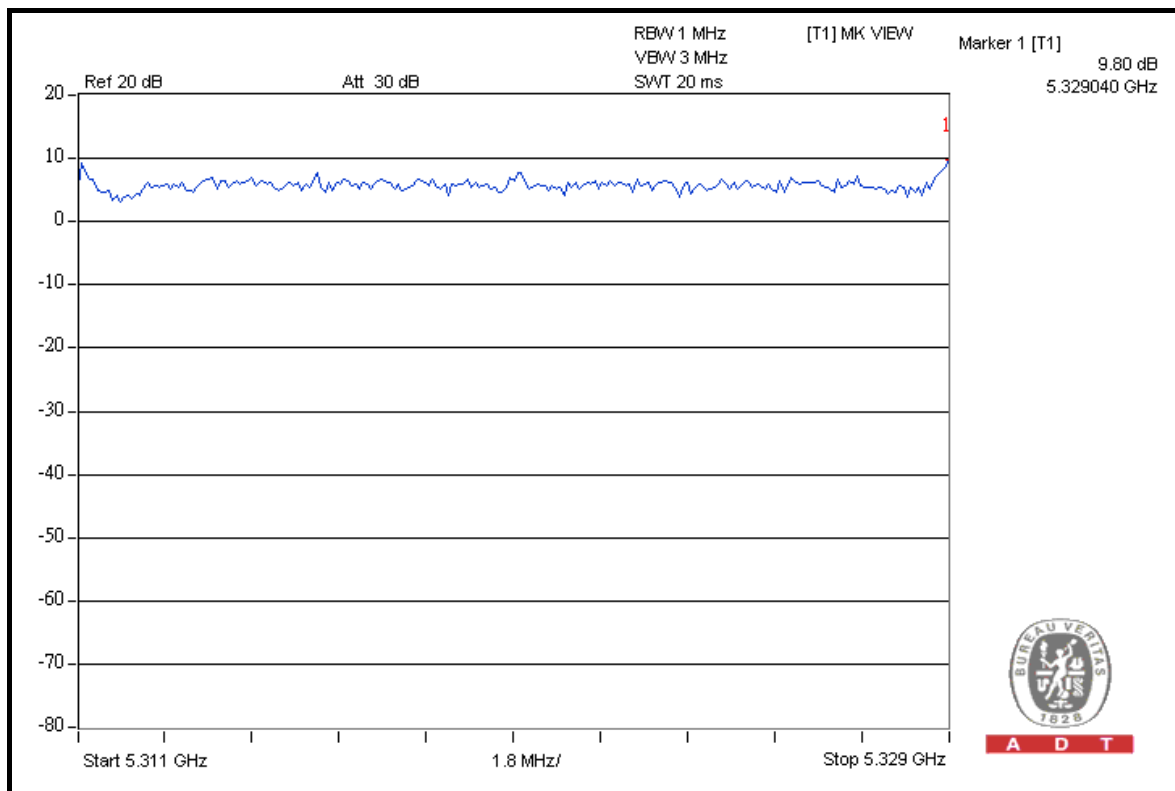
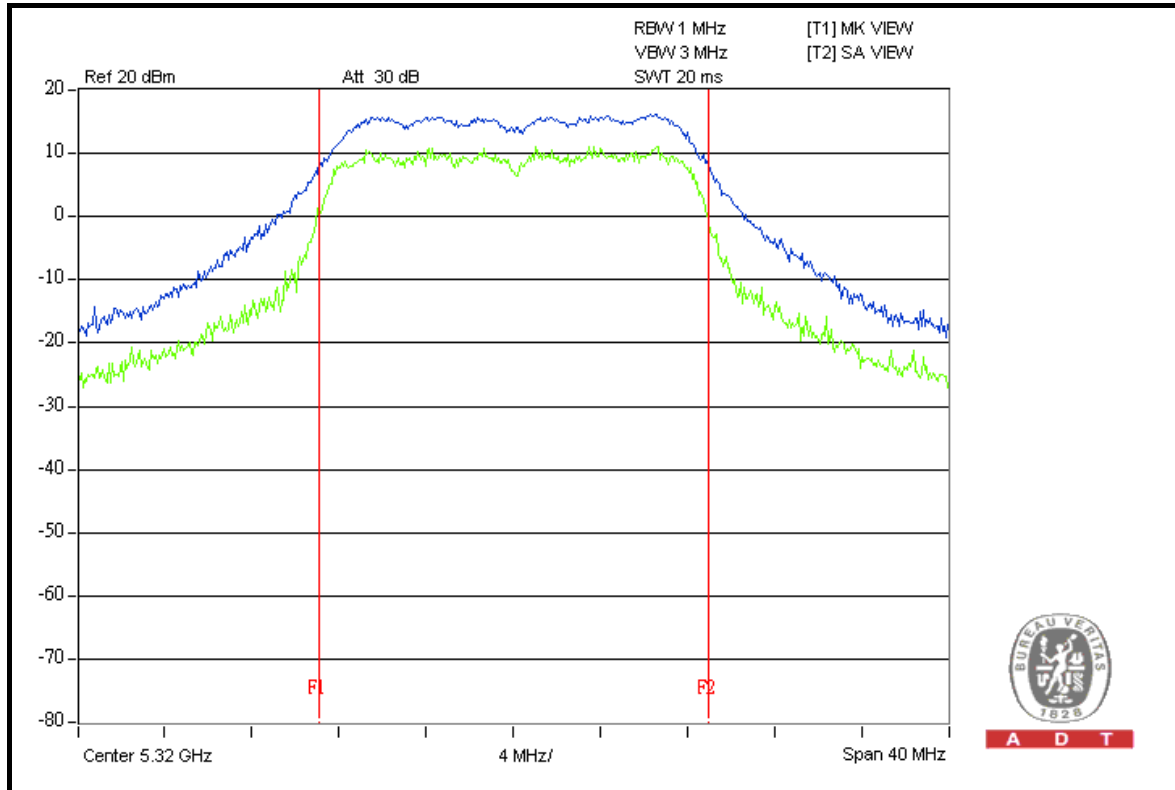



802.11n (20MHz)

CHANNEL	CHANNEL FREQUENCY (MHz)	PEAK POWER EXCURSION (dB)		PEAK to AVERAGE EXCURSION LIMIT (dB)	PASS/FAIL
		CHAIN 0	CHAIN 1		
52	5260	9.40	8.06	13	PASS
60	5300	9.82	7.99	13	PASS
64	5320	9.89	8.47	13	PASS
100	5500	9.74	8.04	13	PASS
116	5580	9.12	8.10	13	PASS
140	5700	9.18	8.34	13	PASS



A D T

### CHAIN 0: CH 64

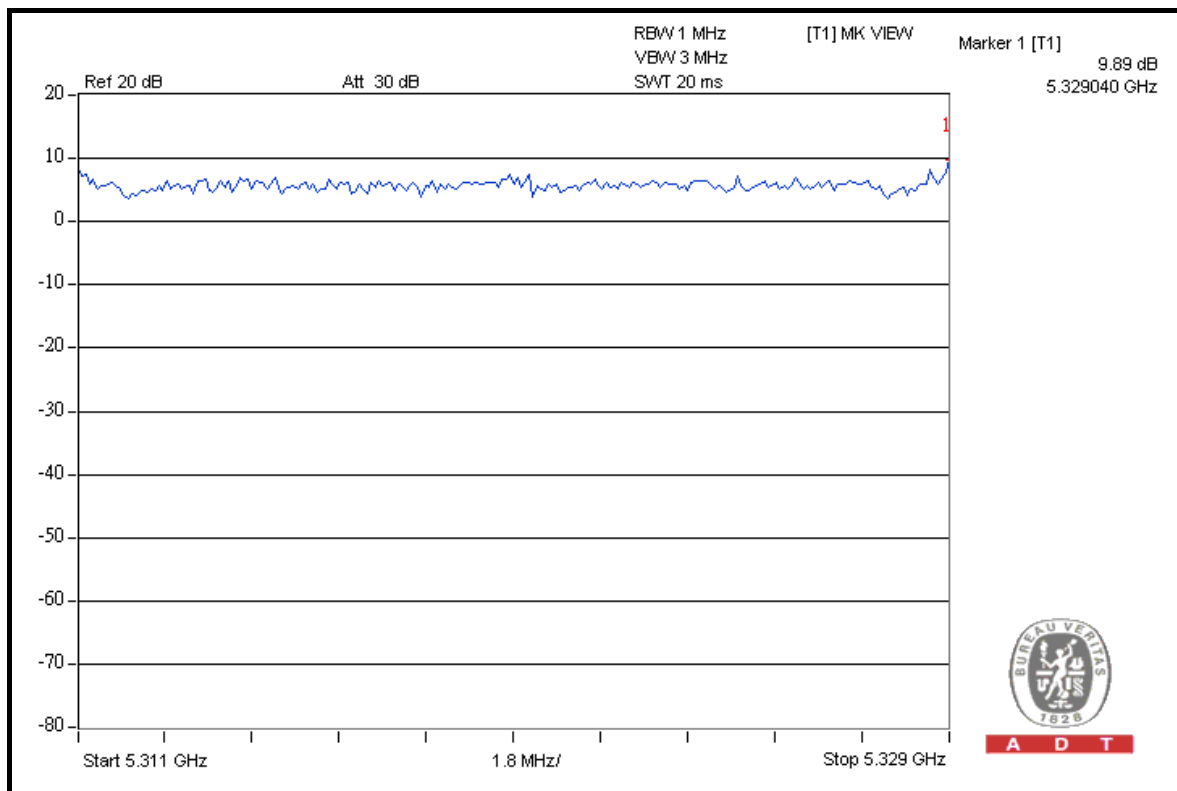
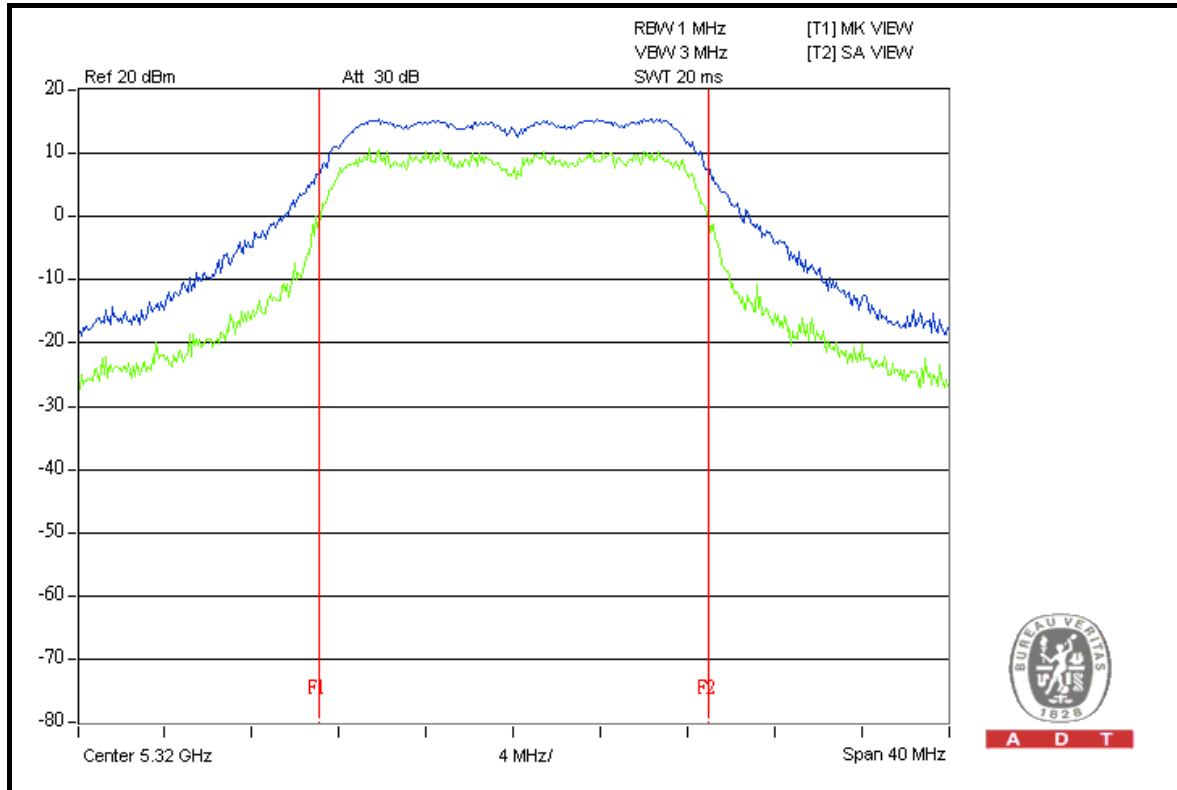





A D T

802.11n (40MHz)

CHANNEL	CHANNEL FREQUENCY (MHz)	PEAK POWER EXCURSION (dB)		PEAK to AVERAGE EXCURSION LIMIT (dB)	PASS/FAIL
		CHAIN 0	CHAIN 1		
54	5270	8.97	8.81	13	PASS
62	5310	10.23	8.51	13	PASS
102	5510	9.41	9.87	13	PASS
110	5550	11.54	9.23	13	PASS
134	5670	8.29	9.08	13	PASS



A D T

### CHAIN 0: CH 110

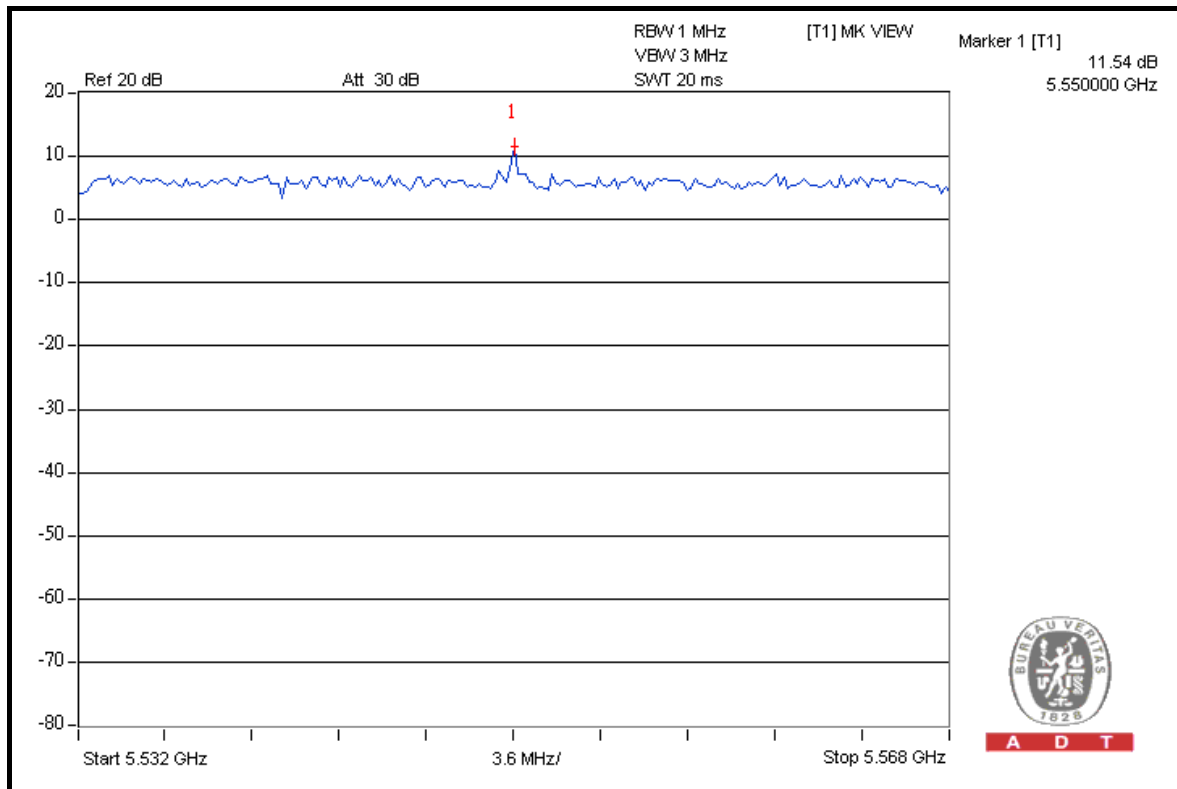
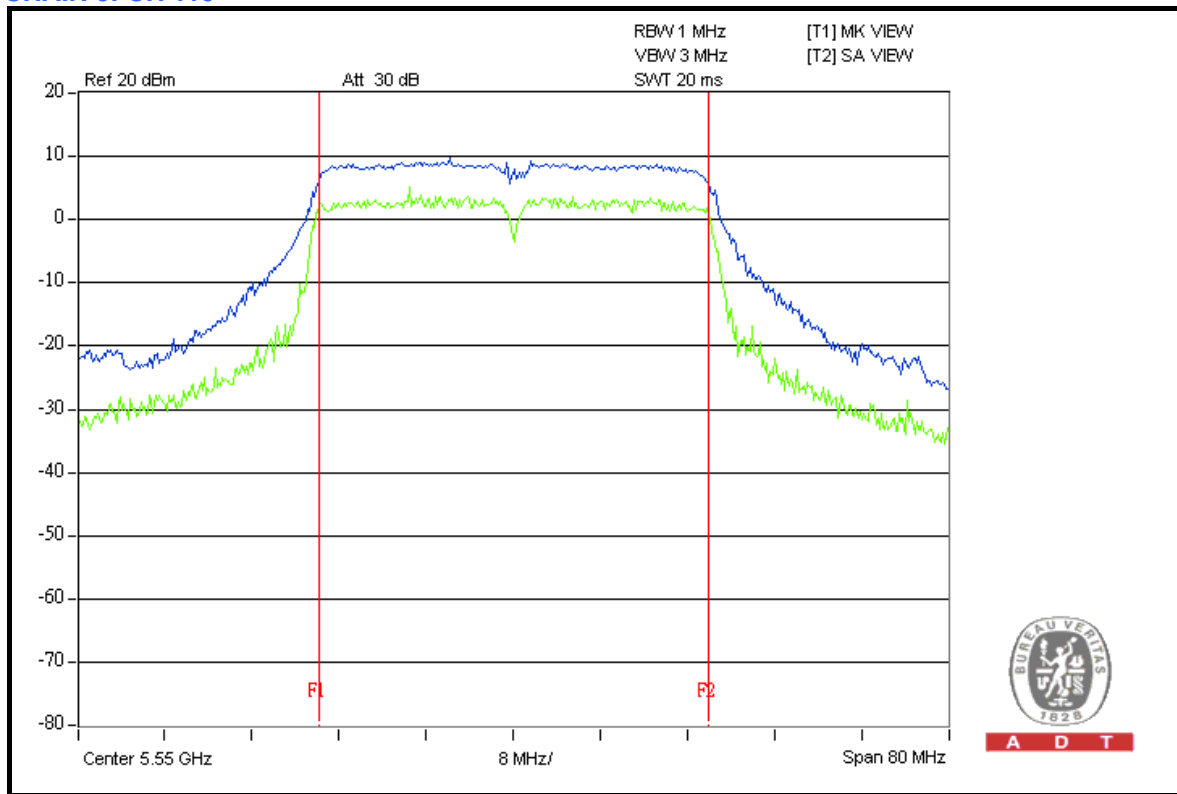

## 4.5 PEAK POWER SPECTRAL DENSITY MEASUREMENT

### 4.5.1 LIMITS OF PEAK POWER SPECTRAL DENSITY MEASUREMENT

FREQUENCY BAND	LIMIT
5.250 ~ 5.350GHz	11dBm
5.470 ~ 5.725GHz	11dBm

### 4.5.2 TEST INSTRUMENTS

DESCRIPTION & MANUFACTURER	MODEL NO.	SERIAL NO.	DATE OF CALIBRATION	CALIBRATED UNTIL
R&S SPECTRUM ANALYZER	FSP40	100040	Jul. 07, 2009	Jul. 06, 2010

**NOTE:** The calibration interval of the above test instruments is 12 months and the calibrations are traceable to NML/ROC and NIST/USA.

### 4.5.3 TEST PROCEDURES

- a. The transmitter output was connected to the spectrum analyzer.
- b. Set RBW = 1MHz, VBW = 3MHz. The PPSD is the highest level found across the emission in any 1MHz band.

#### 4.5.4 DEVIATION FROM TEST STANDARD

No deviation.

#### 4.5.5 TEST SETUP

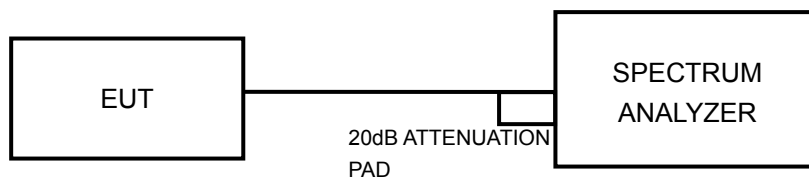

#### 4.5.6 EUT OPERATING CONDITIONS

Same as 5.3.6.



A D T

### 4.5.7 TEST RESULTS

#### 802.11a

CHAN.	CHAN. FREQ. (MHz)	RF POWER LEVEL IN 1MHz BW (dBm)		TOTAL POWER DENSITY (mW)	TOTAL POWER DENSITY (dBm)	MAX. LIMIT (dBm)	PASS / FAIL
		CHAIN 0	CHAIN 1				
52	5260	4.9	3.5	5.3	7.3	11	PASS
60	5300	4.4	3.2	4.8	6.9	11	PASS
64	5320	3.8	3.1	4.4	6.5	11	PASS
100	5500	5.6	5.3	7.0	8.5	11	PASS
116	5580	6.4	5.0	7.5	8.8	11	PASS
140	5700	7.2	6.2	9.4	9.7	11	PASS

#### CHAIN 0: CH 140

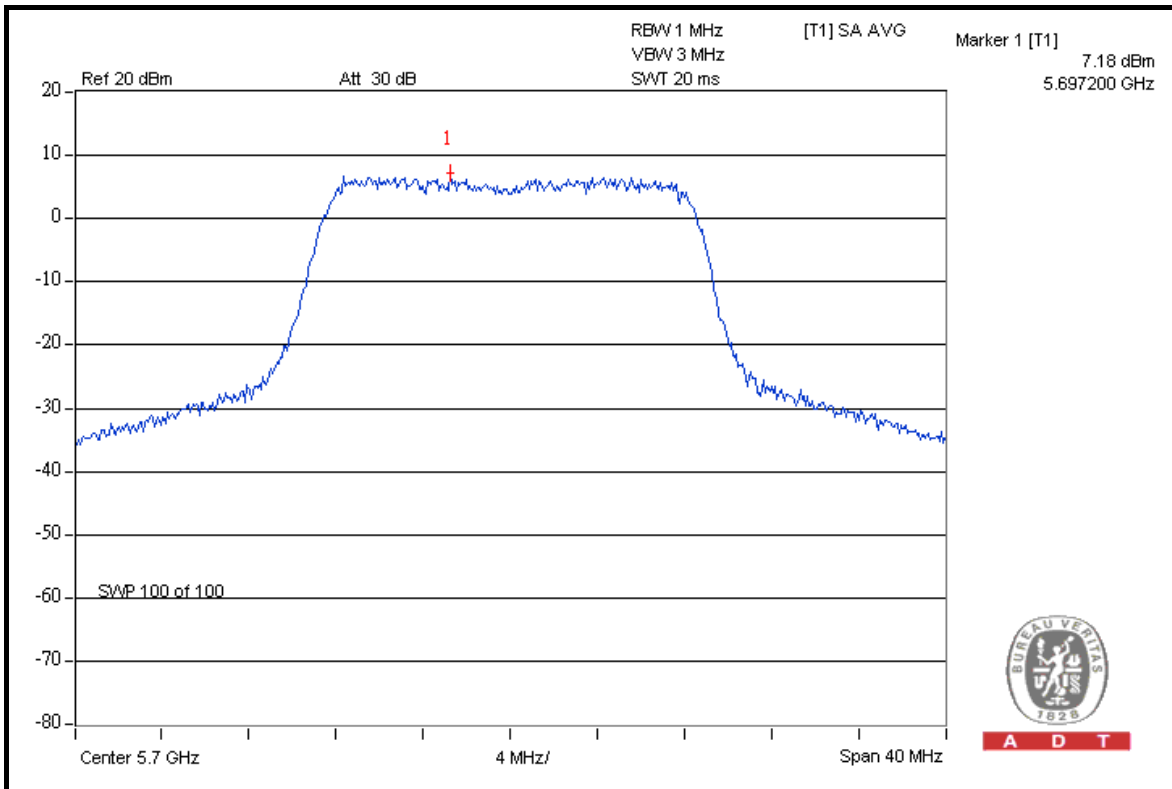



A D T

### 802.11n (20MHz)

CHAN.	CHAN. FREQ. (MHz)	RF POWER LEVEL IN 1MHz BW (dBm)		TOTAL POWER DENSITY (mW)	TOTAL POWER DENSITY (dBm)	MAX. LIMIT (dBm)	PASS / FAIL
		CHAIN 0	CHAIN 1				
52	5260	4.4	3.6	5.0	7.0	11	PASS
60	5300	3.5	3.0	4.2	6.3	11	PASS
64	5320	3.9	3.0	4.5	6.5	11	PASS
100	5500	5.4	4.4	6.2	7.9	11	PASS
116	5580	5.4	4.4	6.2	7.9	11	PASS
140	5700	5.4	6.3	7.7	8.9	11	PASS

### CHAIN 0: CH 116

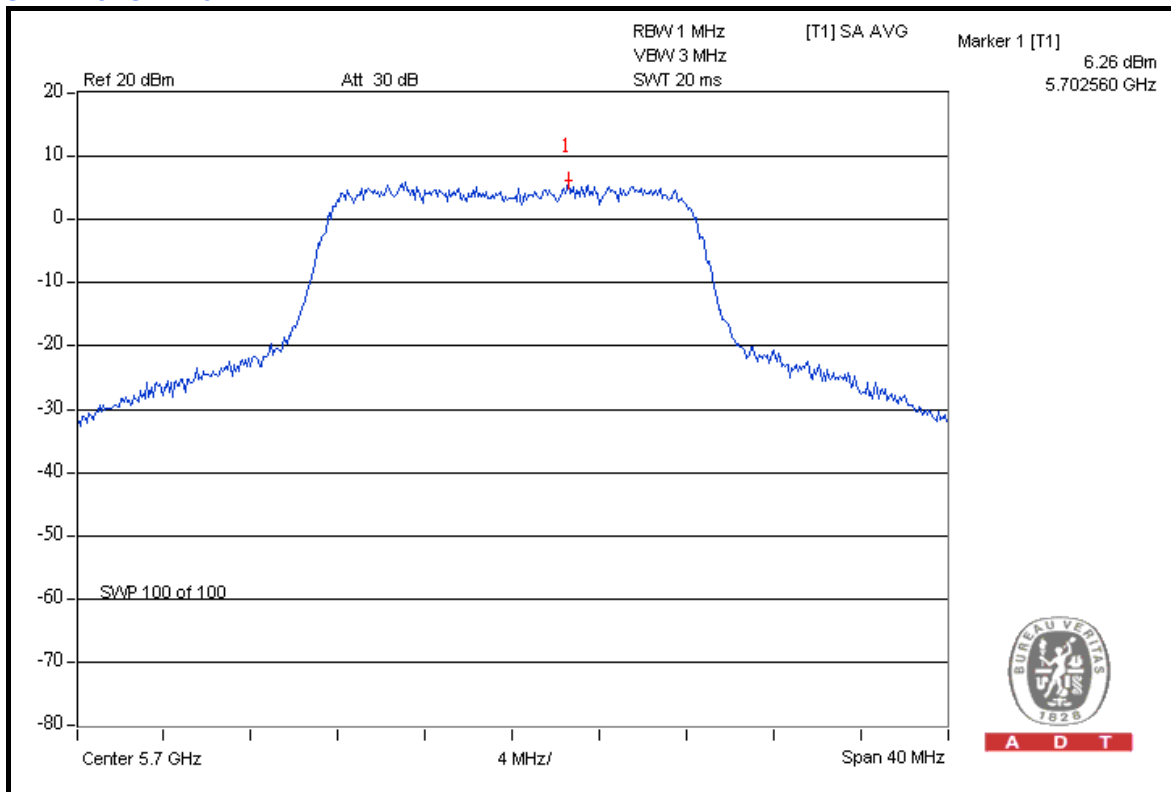

A D T



A D T

### 802.11n (40MHz)

CHAN.	CHAN. FREQ. (MHz)	RF POWER LEVEL IN 1MHz BW (dBm)		TOTAL POWER DENSITY (mW)	TOTAL POWER DENSITY (dBm)	MAX. LIMIT (dBm)	PASS / FAIL
		CHAIN 0	CHAIN 1				
54	5270	-1.7	-2.0	1.3	1.2	11	PASS
62	5310	-3.0	-1.4	1.2	0.9	11	PASS
102	5510	-3.1	-2.0	1.1	0.5	11	PASS
110	5550	-2.4	-1.8	1.2	0.9	11	PASS
134	5670	-2.2	-1.8	1.3	1.0	11	PASS

### CHAIN 1: CH 62

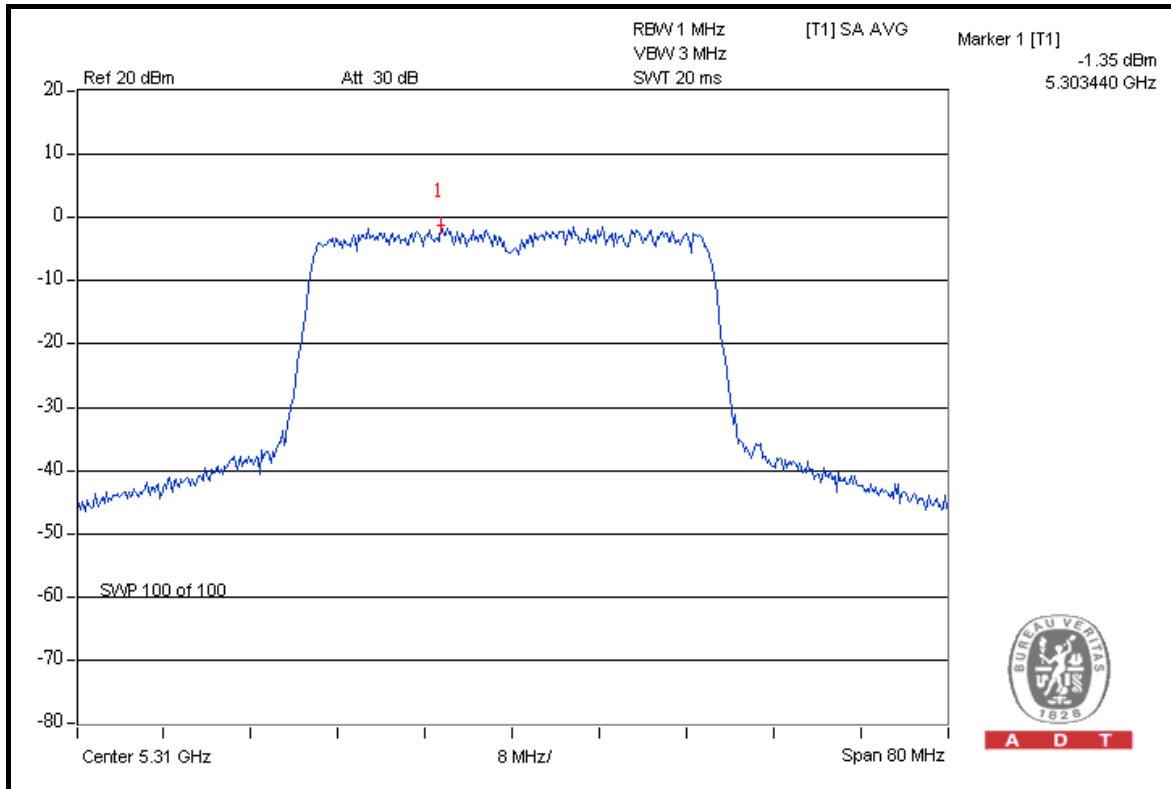

A D T

## 4.6 FREQUENCY STABILITY

### 4.6.1 LIMITS OF FREQUENCY STABILITY MEASUREMENT

The frequency tolerance of the carrier signal shall be maintained within the band of operation frequency over a temperature variation of –30 degrees to 50 degrees C at normal supply voltage, and for a variation in the primary supply voltage from 85% to 115% of the rated supply voltage at a temperature of 20 degrees C.

### 4.6.2 TEST INSTRUMENTS

DESCRIPTION & MANUFACTURER	MODEL NO.	SERIAL NO.	DATE OF CALIBRATION	CALIBRATED UNTIL
R&S SPECTRUM ANALYZER	FSP40	100040	Jul. 07, 2009	Jul. 06, 2010
WIT STANDARD TEMPERATURE AND HUMIDITY CHAMBER	TH-4S-C	W981030	Jun. 24, 2009	Jun. 23, 2010

**NOTE:** The calibration interval of the above test instruments is 12 months and the calibrations are traceable to NML/ROC and NIST/USA.

### 4.6.3 TEST PROCEDURE

- a. The EUT was placed inside the environmental test chamber and powered by nominal DC voltage.
- b. Turn the EUT on and couple its output to a spectrum analyzer.
- c. Turn the EUT off and set the chamber to the highest temperature specified.
- d. Allow sufficient time (approximately 30 min) for the temperature of the chamber to stabilize, turn the EUT on and measure the operating frequency after 2, 5, and 10 minutes.
- e. Repeat step 2 and 3 with the temperature chamber set to the lowest temperature.
- f. The test chamber was allowed to stabilize at +20 degree C for a minimum of 30 minutes. The supply voltage was then adjusted on the EUT from 85% to 115% and the frequency record.



#### 4.6.4 DEVIATION FROM TEST STANDARD

No deviation.

#### 4.6.5 TEST SETUP

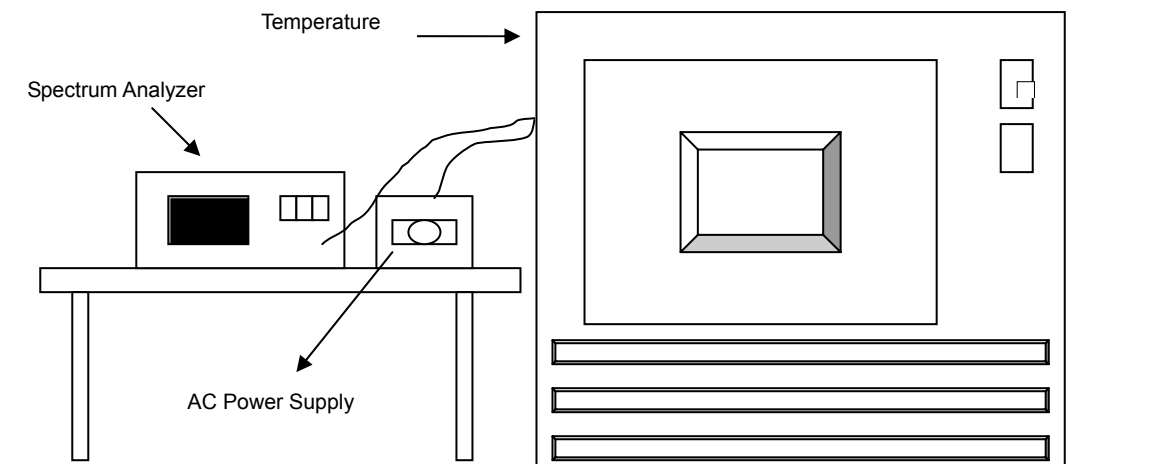

#### 4.6.6 EUT OPERATING CONDITION

Same as Item 4.1.6.

#### 4.6.7 TEST RESULTS

FREQUENCY STABILITY VERSUS TEMP.									
OPERATING FREQUENCY: 5320MHz									
TEMP. (°C)	POWER SUPPLY (Vac)	0 MINUTE		2 MINUTE		5 MINUTE		10 MINUTE	
		Measured Frequency (MHz)	Frequency Drift (ppm)	Measured Frequency (MHz)	Frequency Drift (ppm)	Measured Frequency (MHz)	Frequency Drift (ppm)	Measured Frequency (MHz)	Frequency Drift (ppm)
65	120.0	5319.968498	-0.0005921	5319.968438	-0.0005933	5319.96885	-0.0005855	5319.968255	-0.0005967
60	120.0	5319.966416	-0.0006313	5319.968361	-0.0005947	5319.968253	-0.0005967	5319.968182	-0.0005981
50	120.0	5319.968024	-0.0006011	5319.967855	-0.0006042	5319.967973	-0.0006020	5319.967992	-0.0006017
40	120.0	5319.968	-0.0006015	5319.968285	-0.0005961	5319.967656	-0.0006080	5319.968108	-0.0005995
30	120.0	5319.967751	-0.0006062	5319.968208	-0.0005976	5319.967059	-0.0006192	5319.968035	-0.0006009
20	120.0	5319.967502	-0.0006109	5319.968132	-0.0005990	5319.966462	-0.0006304	5319.967961	-0.0006022
10	120.0	5319.967253	-0.0006155	5319.968055	-0.0006005	5319.965865	-0.0006416	5319.967888	-0.0006036
0	120.0	5319.967004	-0.0006202	5319.967979	-0.0006019	5319.965268	-0.0006529	5319.967814	-0.0006050
-10	120.0	5319.966755	-0.0006249	5319.967902	-0.0006033	5319.964671	-0.0006641	5319.967741	-0.0006064
-20	120.0	5319.966506	-0.0006296	5319.967826	-0.0006048	5319.964074	-0.0006753	5319.967667	-0.0006078
-30	120.0	5319.966257	-0.0006343	5319.967749	-0.0006062	5319.963477	-0.0006865	5319.967594	-0.0006091
-40	120.0	5319.966008	-0.0006389	5319.967673	-0.0006077	5319.96288	-0.0006977	5319.96752	-0.0006105

FREQUENCY STABILITY VERSUS VOLTAGE									
OPERATING FREQUENCY: 5320MHz									
TEMP. (°C)	POWER SUPPLY (Vac)	0 MINUTE		2 MINUTE		5 MINUTE		10 MINUTE	
		Measured Frequency (MHz)	Frequency Drift (ppm)	Measured Frequency (MHz)	Frequency Drift (ppm)	Measured Frequency (MHz)	Frequency Drift (ppm)	Measured Frequency (MHz)	Frequency Drift (ppm)
20	138.0	5319.967585	-0.0006093	5319.968157	-0.0005985	5319.966661	-0.0006267	5319.967986	-0.0006018
	120.0	5319.967502	-0.0006109	5319.968132	-0.0005990	5319.966462	-0.0006304	5319.967961	-0.0006022
	102.0	5319.967419	-0.0006124	5319.968106	-0.0005995	5319.966263	-0.0006342	5319.967937	-0.0006027

## 4.7 BAND EDGES MEASUREMENT

### 4.7.1 TEST INSTRUMENTS

DESCRIPTION & MANUFACTURER	MODEL NO.	SERIAL NO.	DATE OF CALIBRATION	CALIBRATED UNTIL
Agilent Spectrum	8564EC	4208A00659	Jul. 24, 2009	Jul. 23, 2010
Agilent Preamplifier	8449B	3008A01924	Aug. 31, 2009	Aug. 30, 2010
Agilent Preamplifier	8449B	3008A01292	Aug. 10, 2009	Aug. 09, 2010
MITEQ Preamplifier	AMF-6F-260400-33-8P	892164	Aug. 31, 2009	Aug. 30, 2010
Schwarzbeck Horn Antenna	BBHA-9170	BBHA9170190	Sep. 24, 2009	Sep. 23, 2010
Schwarzbeck Horn Antenna	BBHA-9120	D130	May 15, 2009	May 14, 2010
CT Turn Table	TT100	CT-0079	NA	NA
CT Tower	AT100	CT-0079	NA	NA
Software	ADT_Radiated_V 7.6.15.9.2	NA	NA	NA
SUHNER RF cable	SF106-18	PHACAB-1G-40GHz	Aug. 20, 2009	Aug. 19, 2010

**NOTE:** The calibration interval of the above test instruments is 12 months and the calibrations are traceable to NML/ROC and NIST/USA.

#### 4.7.2 TEST PROCEDURE

- a. The EUT was placed on the top of a rotating table 0.8 meters above the ground at a 10 meter open area test site. The table was rotated 360 degrees to determine the position of the highest radiation.
- b. The EUT was set 3 meters away from the interference-receiving antenna, which was mounted on the top of a variable-height antenna tower.
- c. The antenna is a broadband antenna, and its height is varied from one meter to four meters above the ground to determine the maximum value of the field strength. Both horizontal and vertical polarizations of the antenna are set to make the measurement.
- d. For each suspected emission, the EUT was arranged to its worst case and then the antenna was tuned to heights from 1 meter to 4 meters and the rotatable table was turned from 0 degrees to 360 degrees to find the maximum reading.
- e. Set both RBW and VBW of spectrum analyzer to 100kHz and 300kHz with suitable frequency span including 100MHz bandwidth from band edge. The band edges was measured and recorded.

The spectrum plots (Peak RBW = 1MHz, VBW = 3MHz) are attached on the following pages.

**NOTE:** The resolution bandwidth of test receiver/spectrum analyzer is 1MHz and the video bandwidth is 10Hz for Average detection (AV) at frequency above 1GHz.

#### 4.7.3 EUT OPERATING CONDITION

The software provided by client to enable the EUT under transmission condition continuously at specific channel frequencies individually.

#### 4.7.4 TEST RESULTS

For signals in the restricted bands above and below the 5.15 to 5.35GHz and 5.47 to 5.725GHz allocated band a measurement was made of the amplitude of the spurious emissions with respect to the intentional signals. The relative amplitude, in dBc, was applied to the average and peak field strength of the intentional signal made on the OATS to calculate the field strength of the unintentional signals.

The spectrum plots (Peak RBW = 1MHz, VBW = 3MHz) are attached on the following pages.

**802.11a**

**FOR 5260-5320MHz BAND:**

**RESTRICT BAND (4500 ~ 5150 MHz)**

FREQUENCY (MHz)	FUNDAMENTAL EMISSION (dBuV/m)	DELTA (dB)	MAXIMUM FIELD STRENGTH IN RESTRICT BAND (dBuV/m)	LIMIT (dBuV/m)
5260.00 (PK)	114.7	50.90	63.80	74.00
5260.00 (AV)	101.5	48.45	53.05	54.00

**RESTRICT BAND (5350 ~ 5460 MHz)**

FREQUENCY (MHz)	FUNDAMENTAL EMISSION (dBuV/m)	DELTA (dB)	MAXIMUM FIELD STRENGTH IN RESTRICT BAND (dBuV/m)	LIMIT (dBuV/m)
5320.00 (PK)	114.4	43.08	71.32	74.00
5320.00 (AV)	101.7	52.52	49.18	54.00

**NOTE:**

1. Delta = Amplitude between the peak of the fundamental and the peak of the band edge emission. Please check following 3 pages.
2. Maximum field strength in restrict band = Fundamental emission – Delta.



A D T

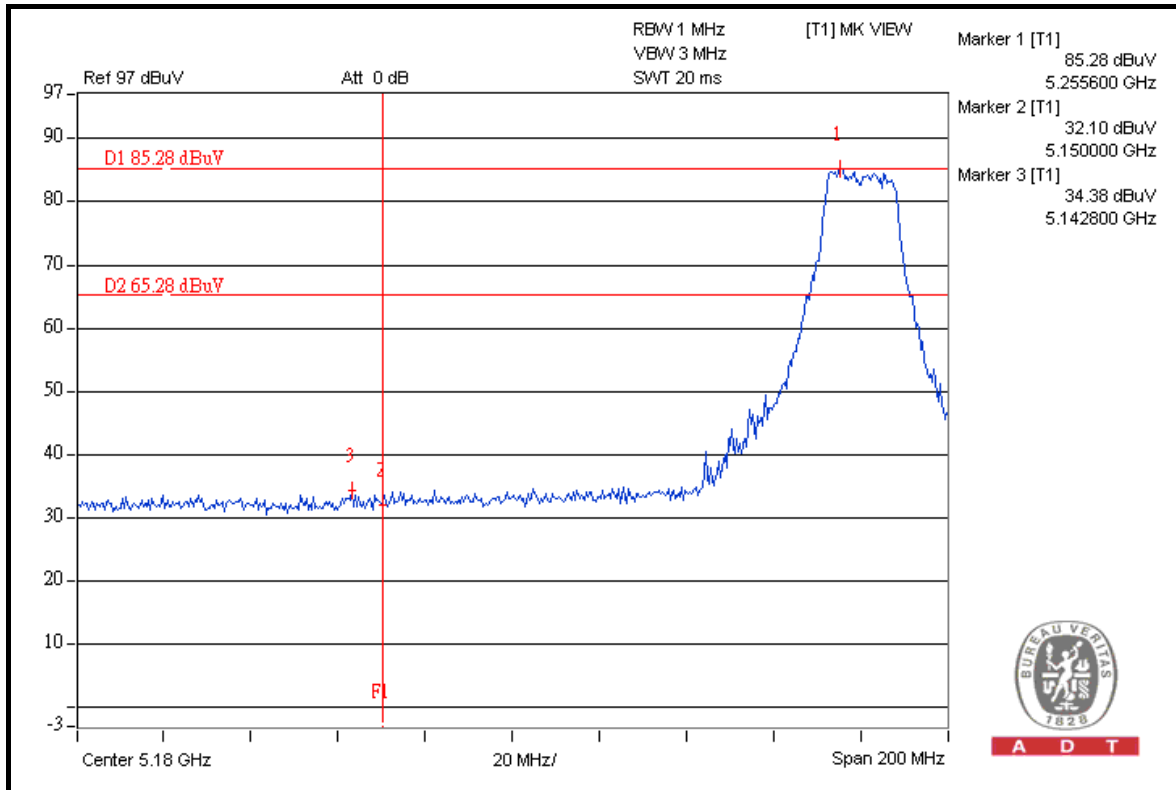

A D T

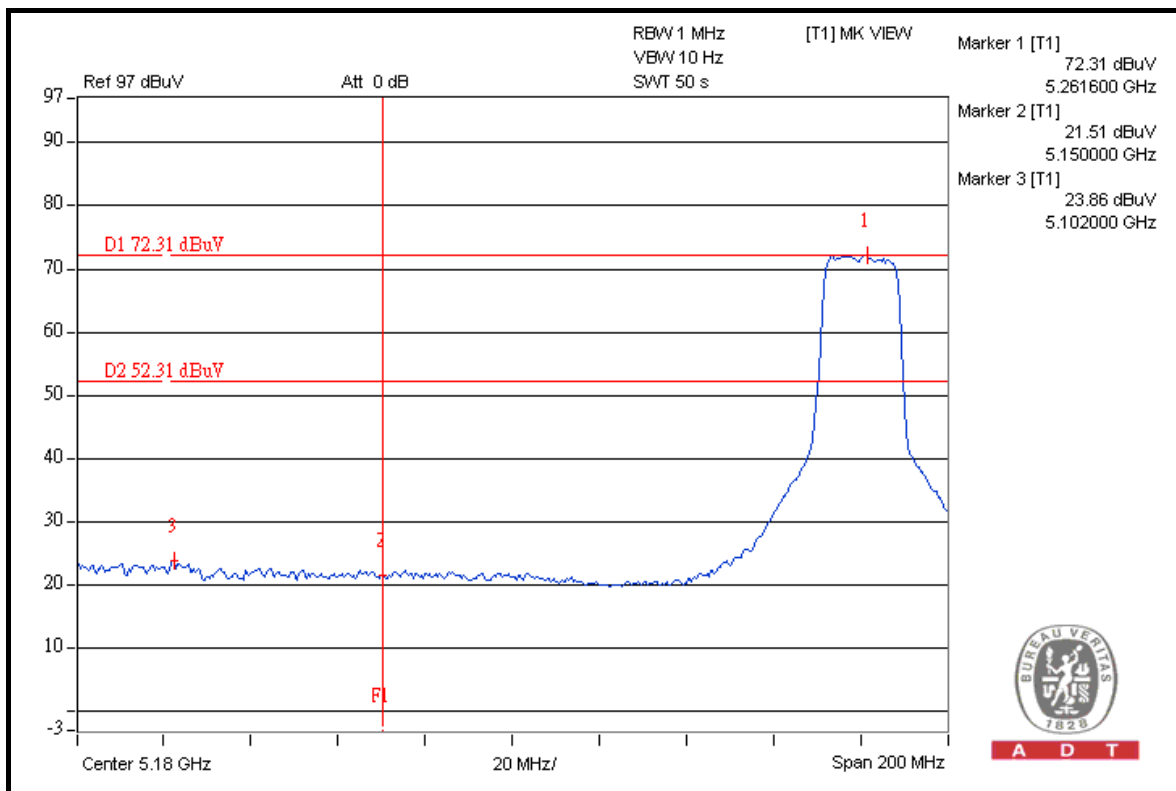

A D T



A D T

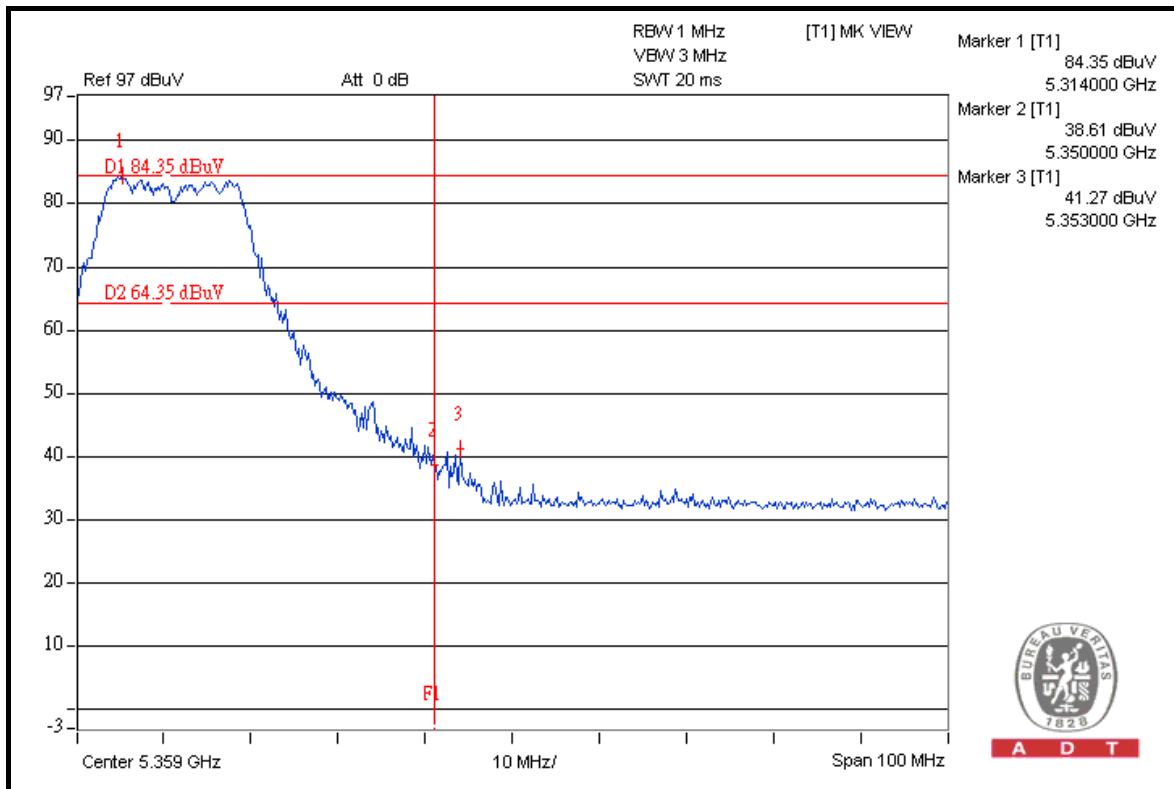
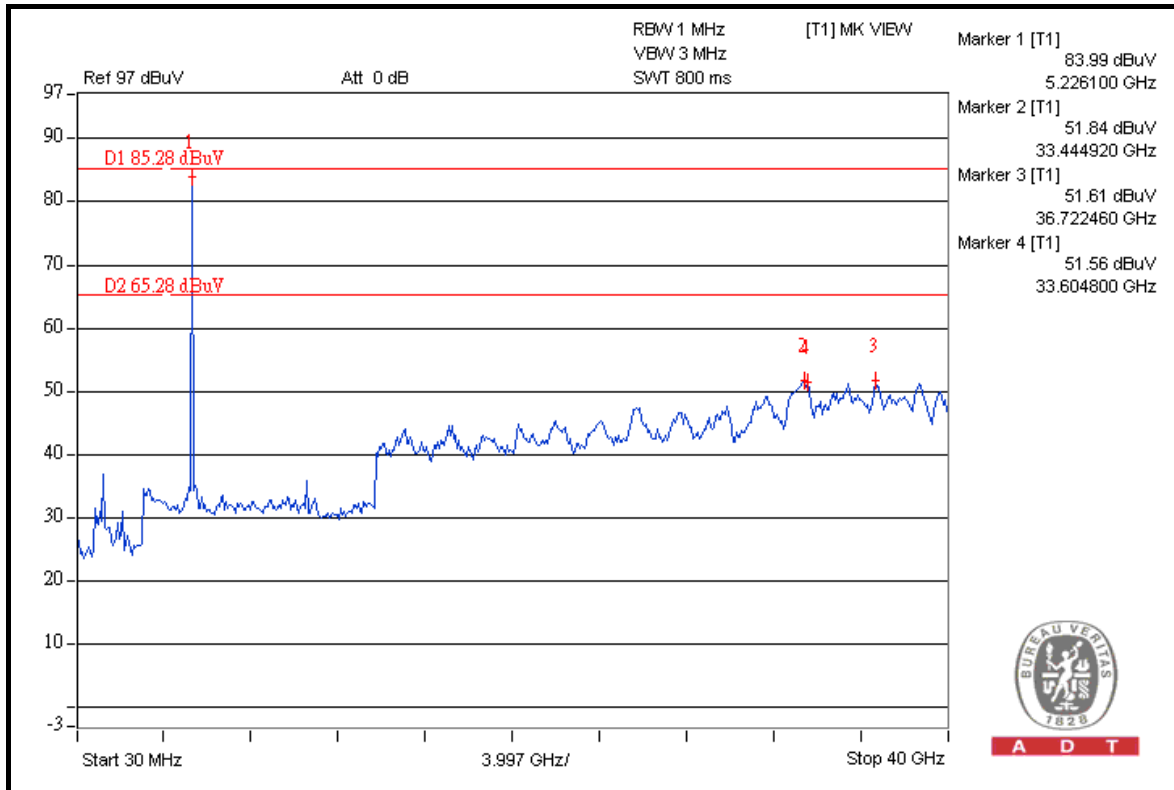



A D T

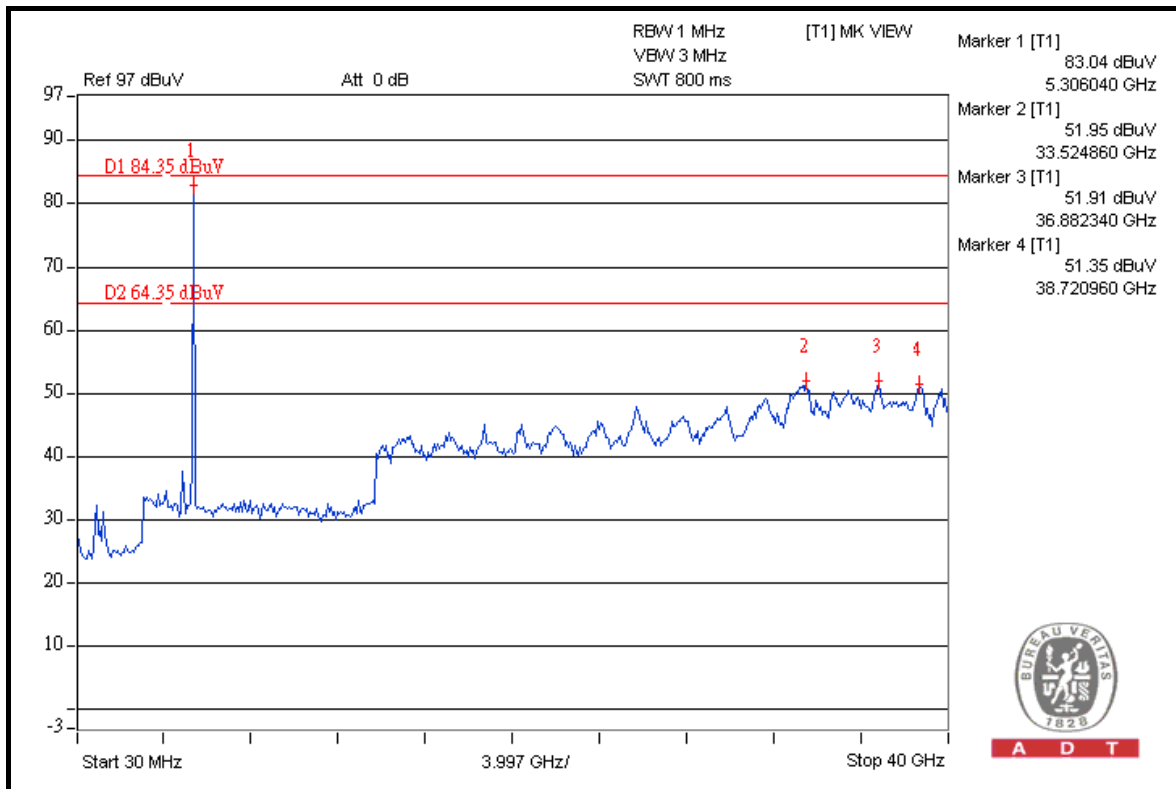
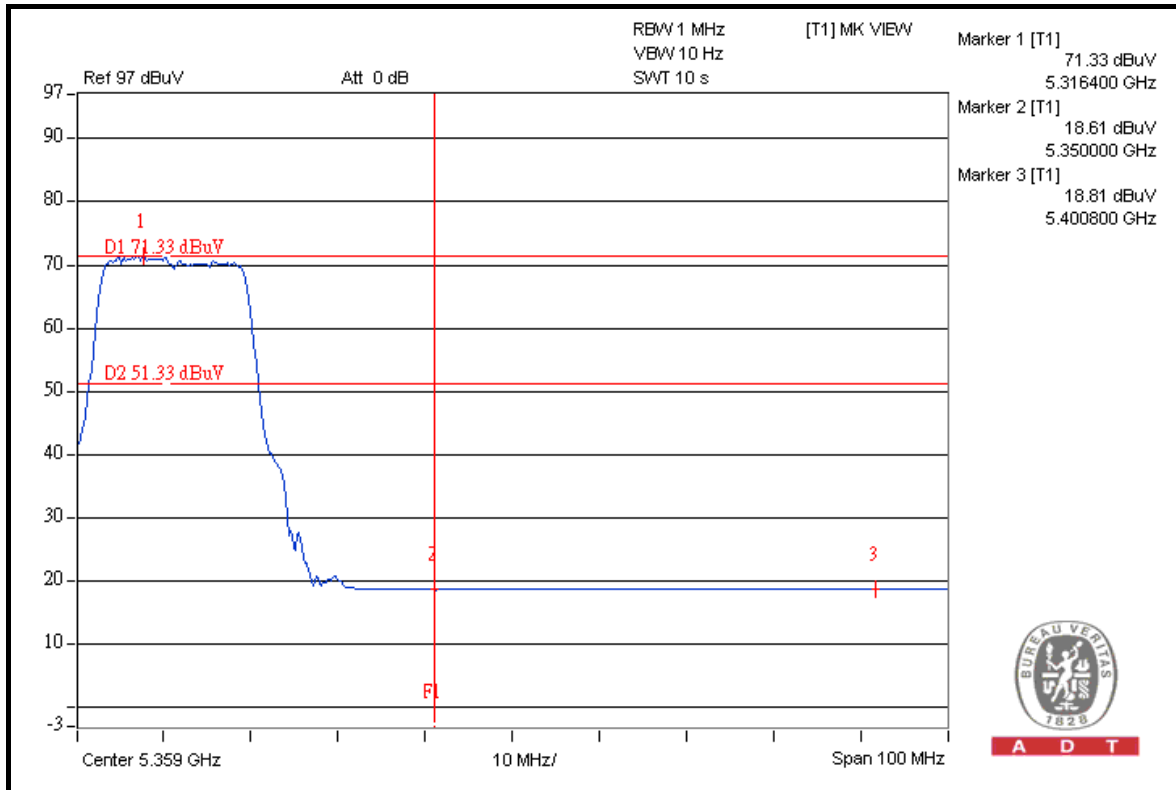



**FOR 5500-5700MHz BAND:**

**RESTRICT BAND (5350 ~ 5460 MHz)**

FREQUENCY (MHz)	FUNDAMENTAL EMISSION (dBuV/m)	DELTA (dB)	MAXIMUM FIELD STRENGTH IN RESTRICT BAND (dBuV/m)	LIMIT (dBuV/m)
5500.00 (PK)	116.7	49.04	67.66	74.00
5500.00 (AV)	104.8	52.40	52.40	54.00

**FREQUENCY BAND (5460 ~ 5470 MHz)**

FREQUENCY (MHz)	FUNDAMENTAL EMISSION (dBuV/m)	DELTA (dB)	MAXIMUM FIELD STRENGTH (dBuV/m)	LIMIT (dBuV/m)
5500.00 (PK)	116.7	50.42	66.28	68.30

**5700MHz**

**ABOVE 5725 MHz**

FREQUENCY (MHz)	FUNDAMENTAL EMISSION (dBuV/m)	DELTA (dB)	MAXIMUM FIELD STRENGTH (dBuV/m)	LIMIT (dBuV/m)
5700.00 (PK)	116.3	50.78	65.52	68.30

**NOTE:**

1. Delta = Amplitude between the peak of the fundamental and the peak of the band edge emission. Please check following 3 pages.
2. Maximum field strength in restrict band = Fundamental emission – Delta.



A D T

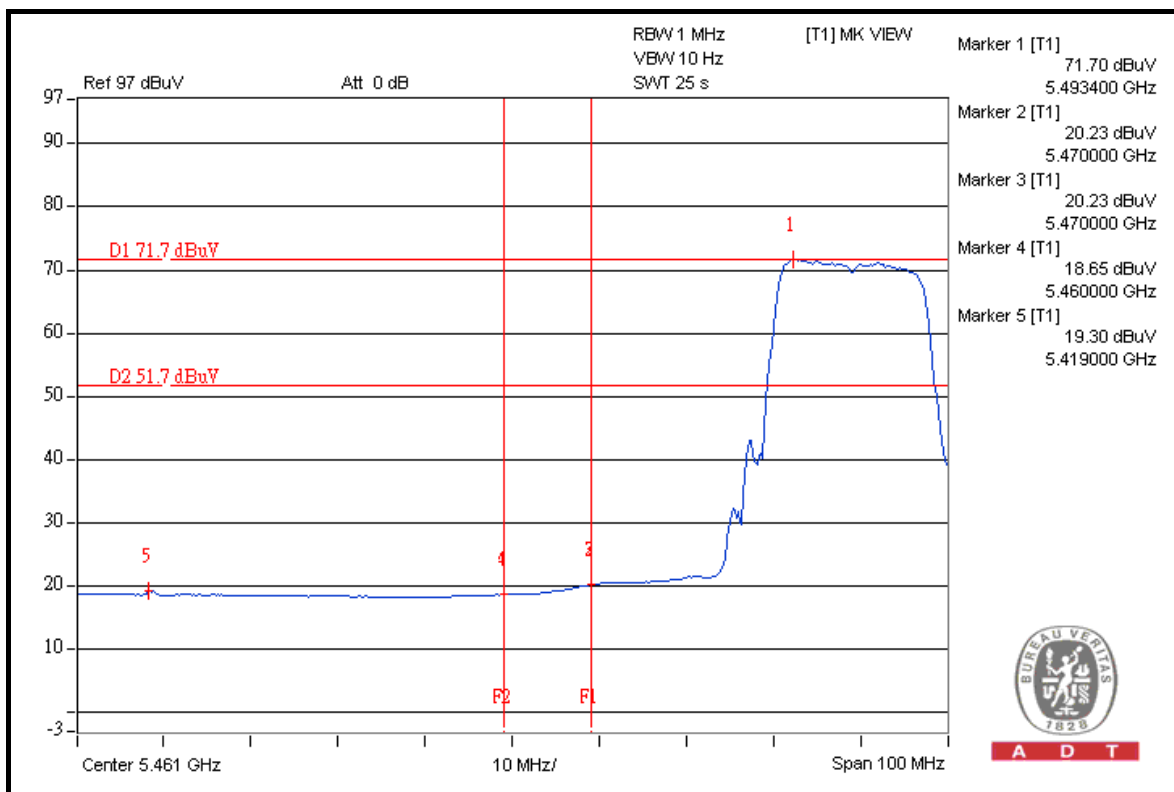
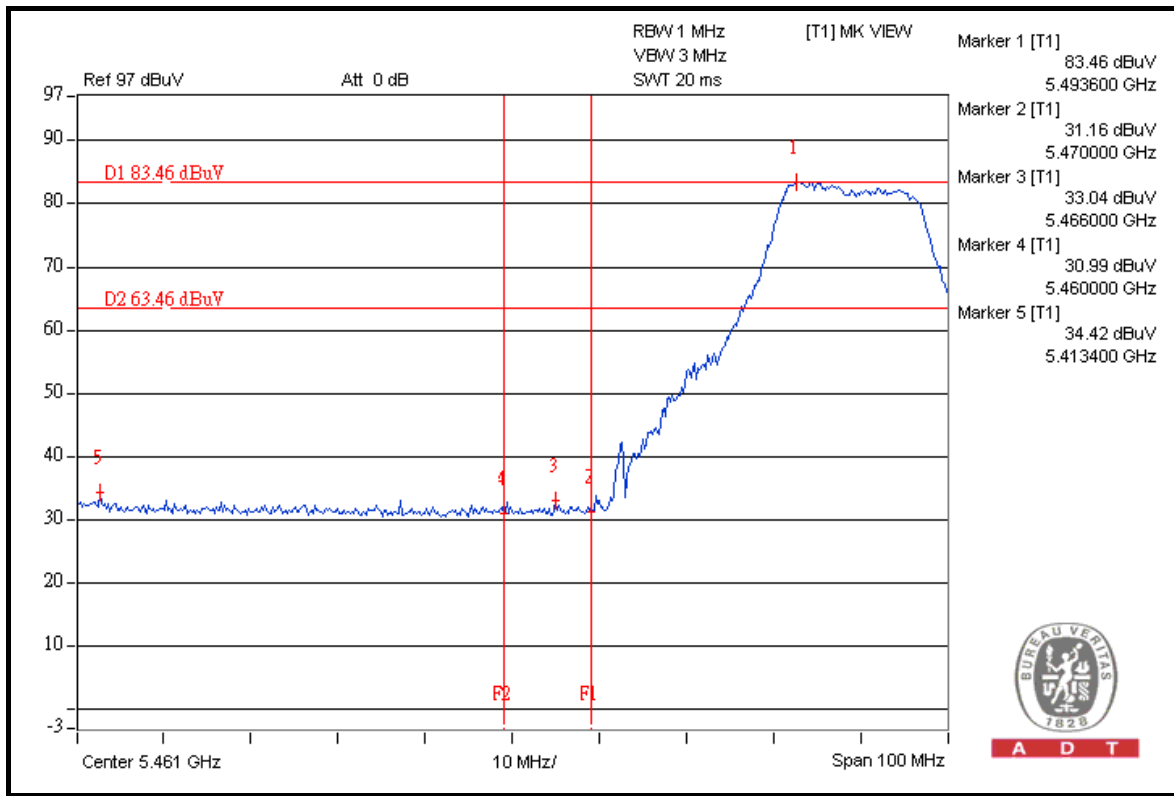



A D T

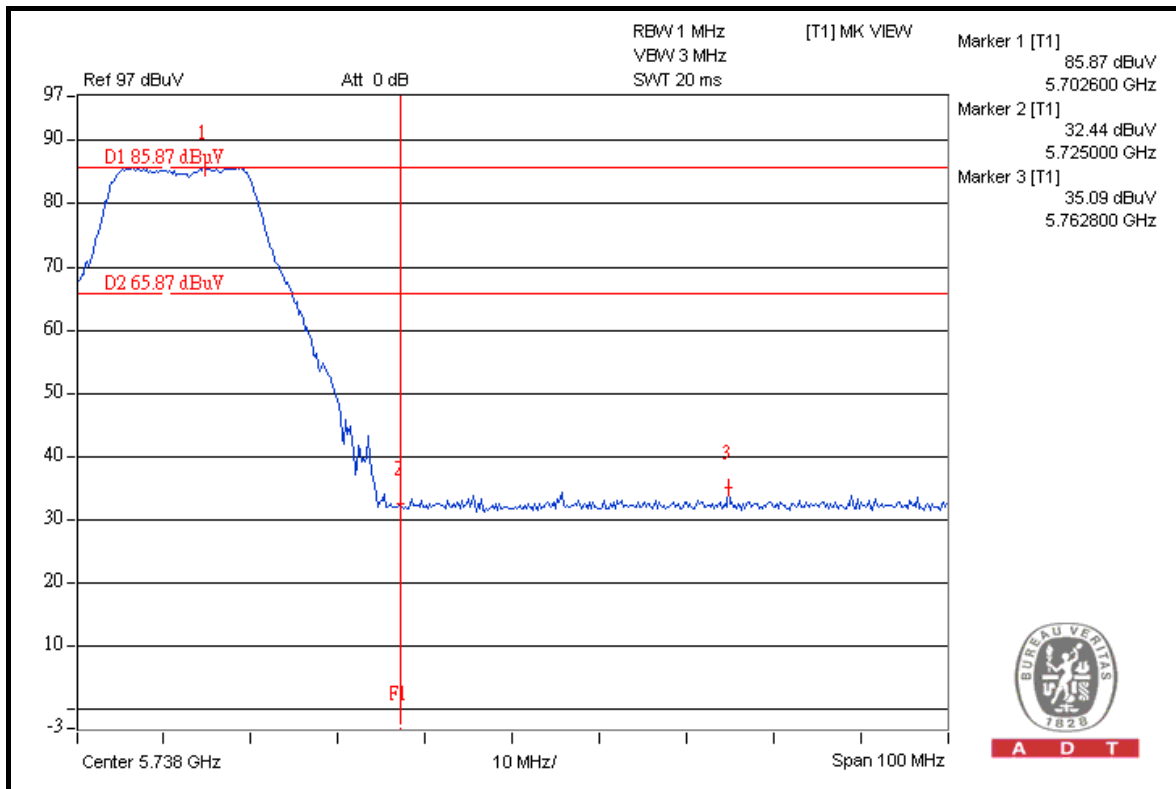
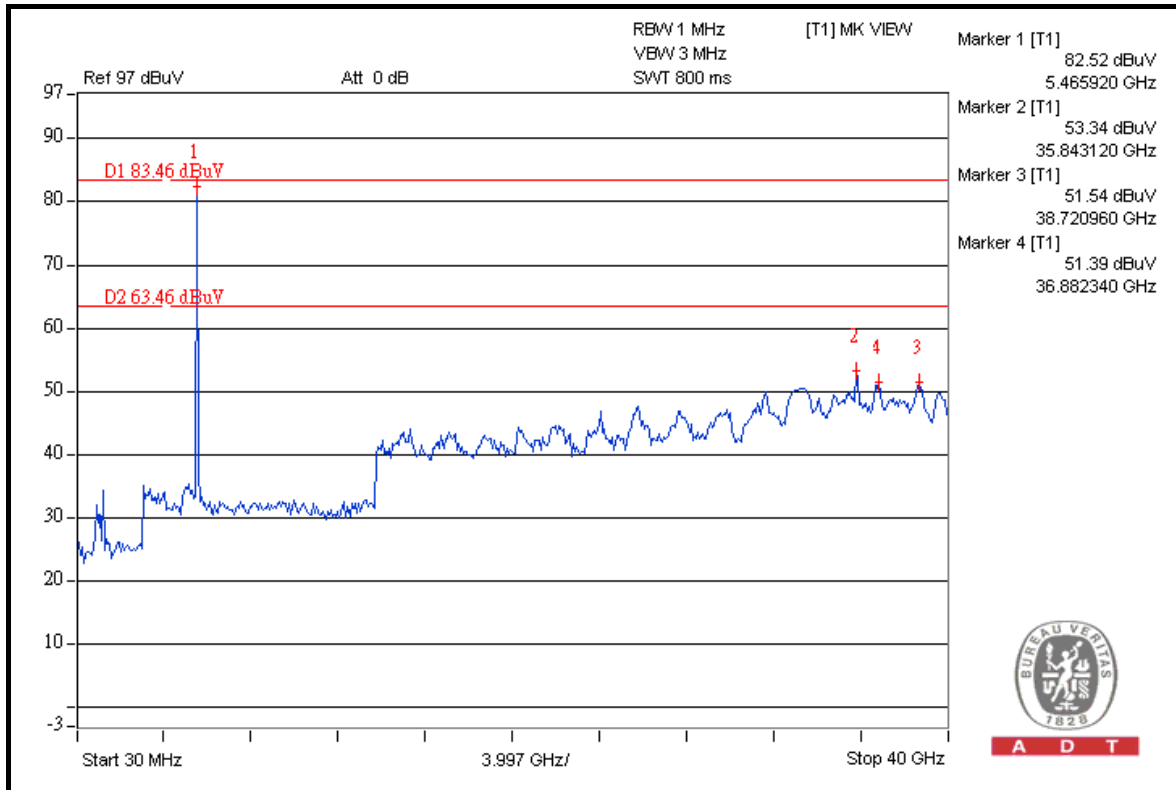



A D T

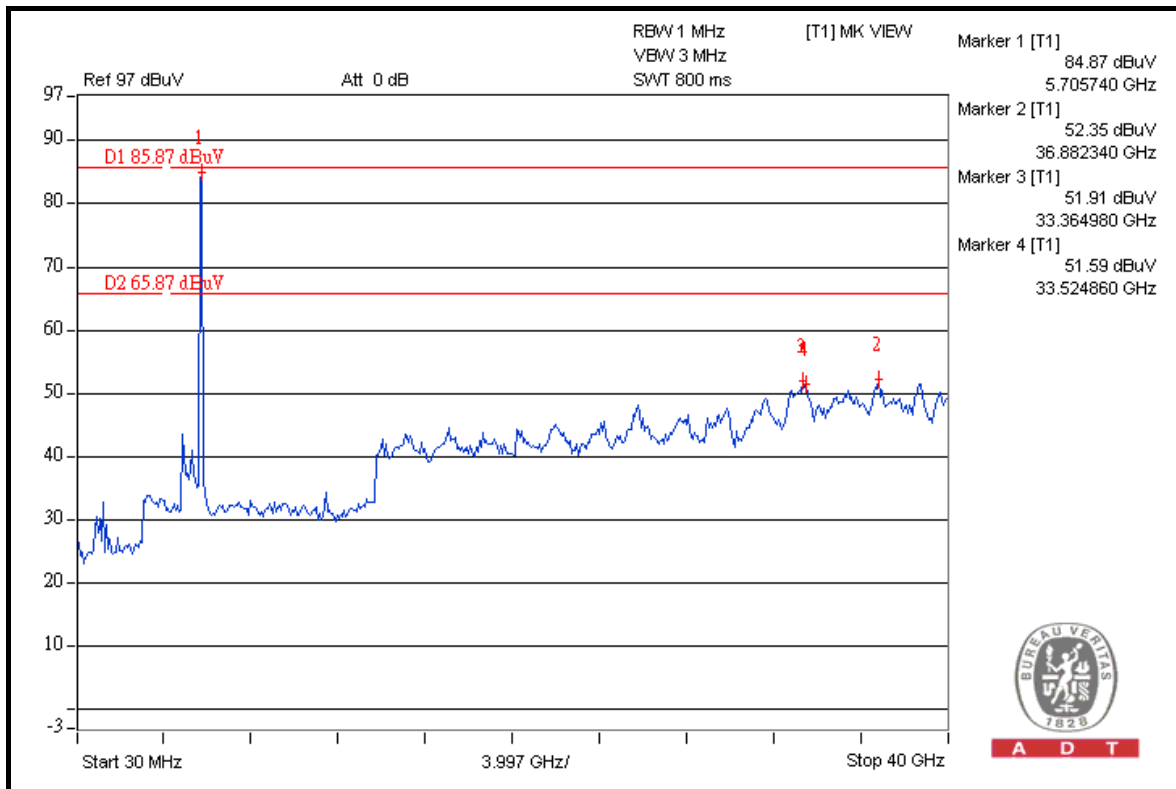
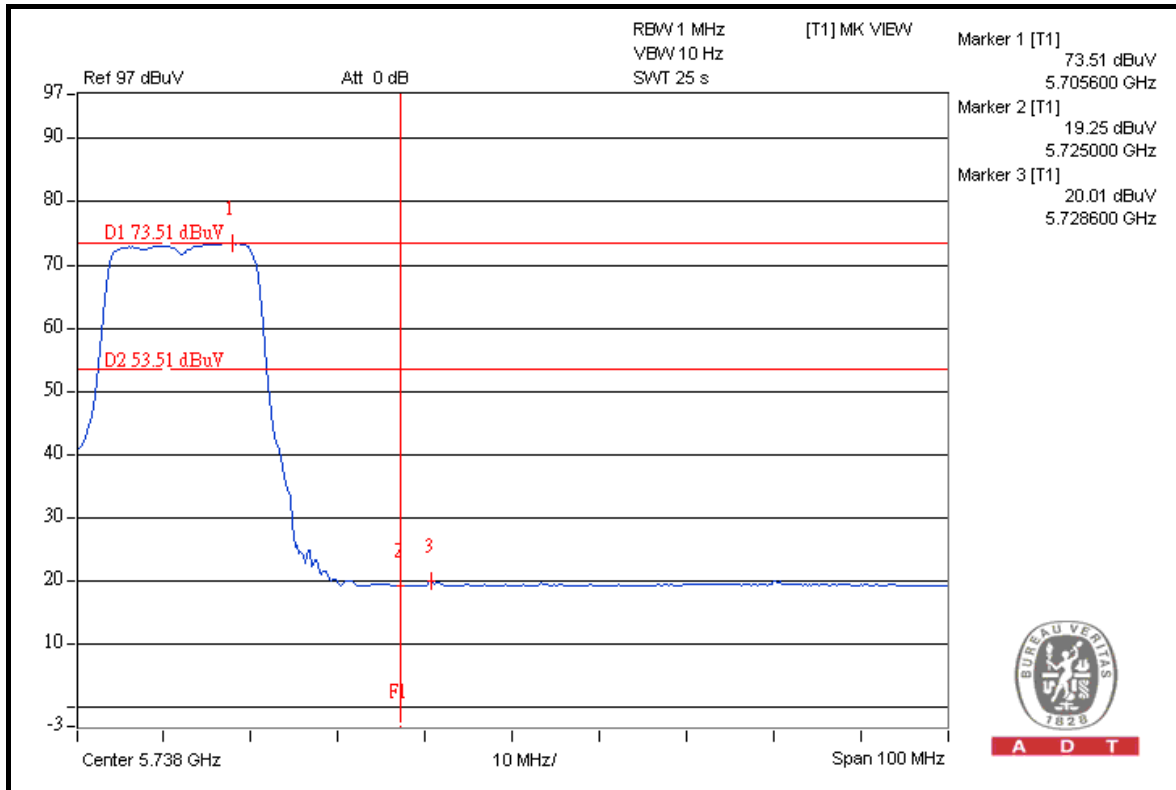

**802.11n (20MHz)**

**FOR 5260-5320MHz BAND:**

**RESTRICT BAND (4500 ~ 5150 MHz)**

FREQUENCY (MHz)	FUNDAMENTAL EMISSION (dBuV/m)	DELTA (dB)	MAXIMUM FIELD STRENGTH IN RESTRICT BAND (dBuV/m)	LIMIT (dBuV/m)
5260.00 (PK)	115.8	48.91	66.89	74.00
5260.00 (AV)	102.6	49.48	53.12	54.00

**RESTRICT BAND (5350 ~ 5460 MHz)**

FREQUENCY (MHz)	FUNDAMENTAL EMISSION (dBuV/m)	DELTA (dB)	MAXIMUM FIELD STRENGTH IN RESTRICT BAND (dBuV/m)	LIMIT (dBuV/m)
5320.00 (PK)	114.5	48.62	65.88	74.00
5320.00 (AV)	101.8	51.28	50.52	54.00

**NOTE:**

1. Delta = Amplitude between the peak of the fundamental and the peak of the band edge emission. Please check following 3 pages.
2. Maximum field strength in restrict band = Fundamental emission – Delta.



A D T

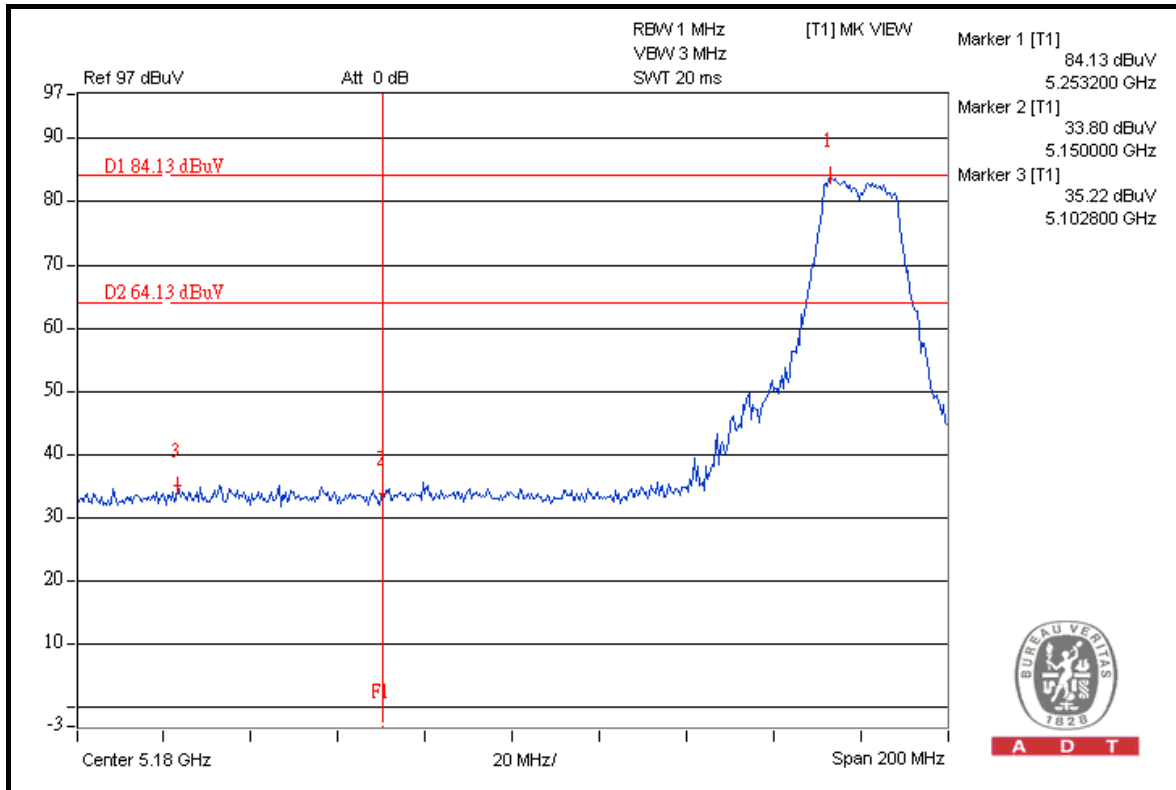

A D T

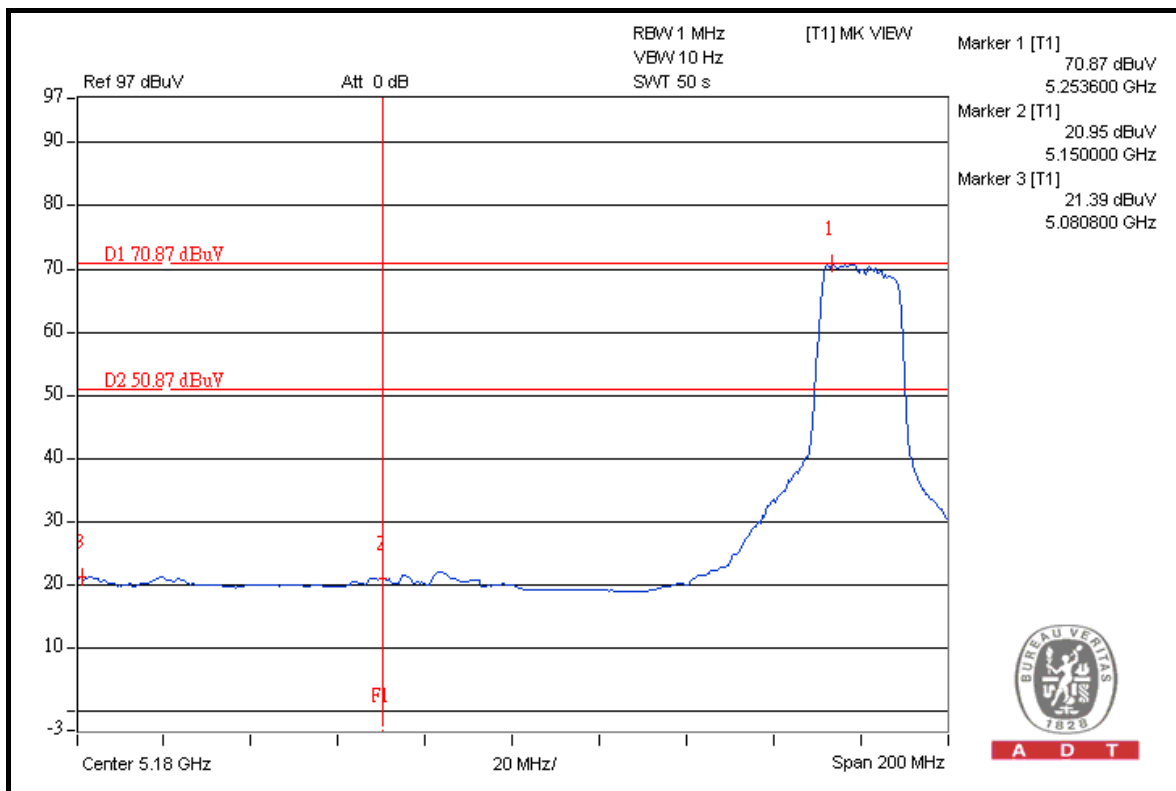

A D T



A D T

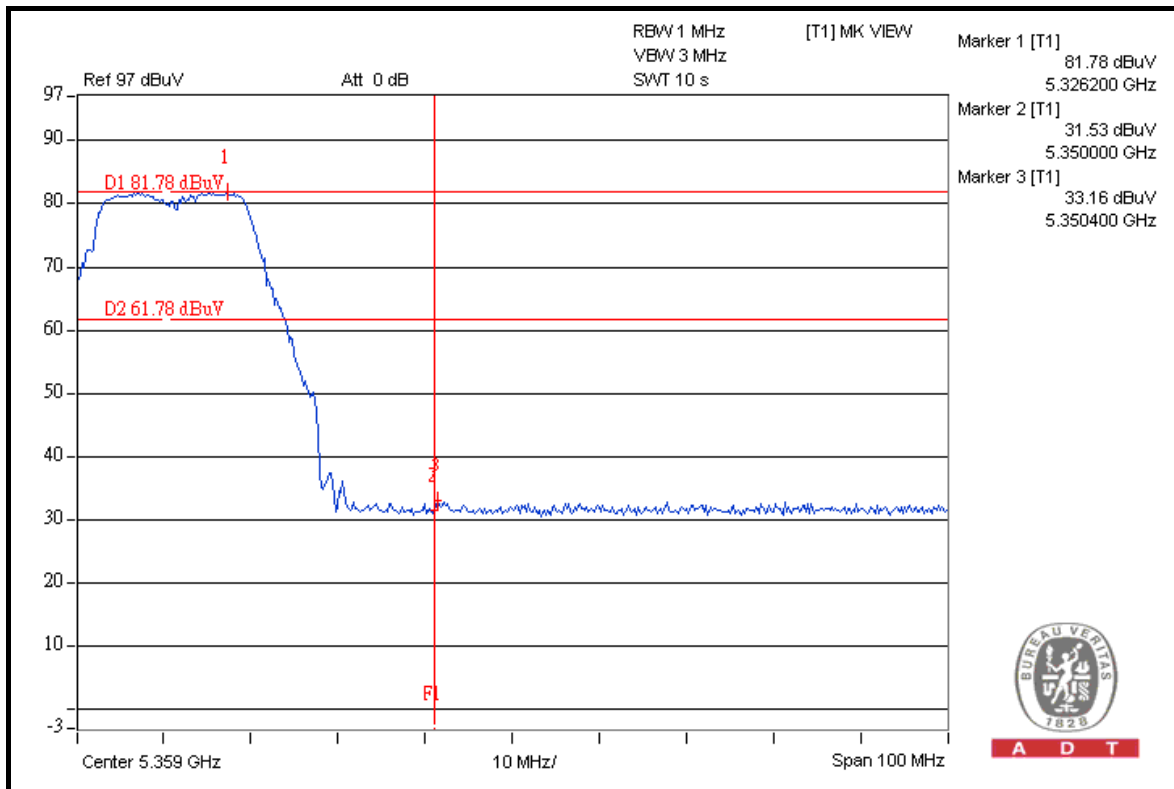
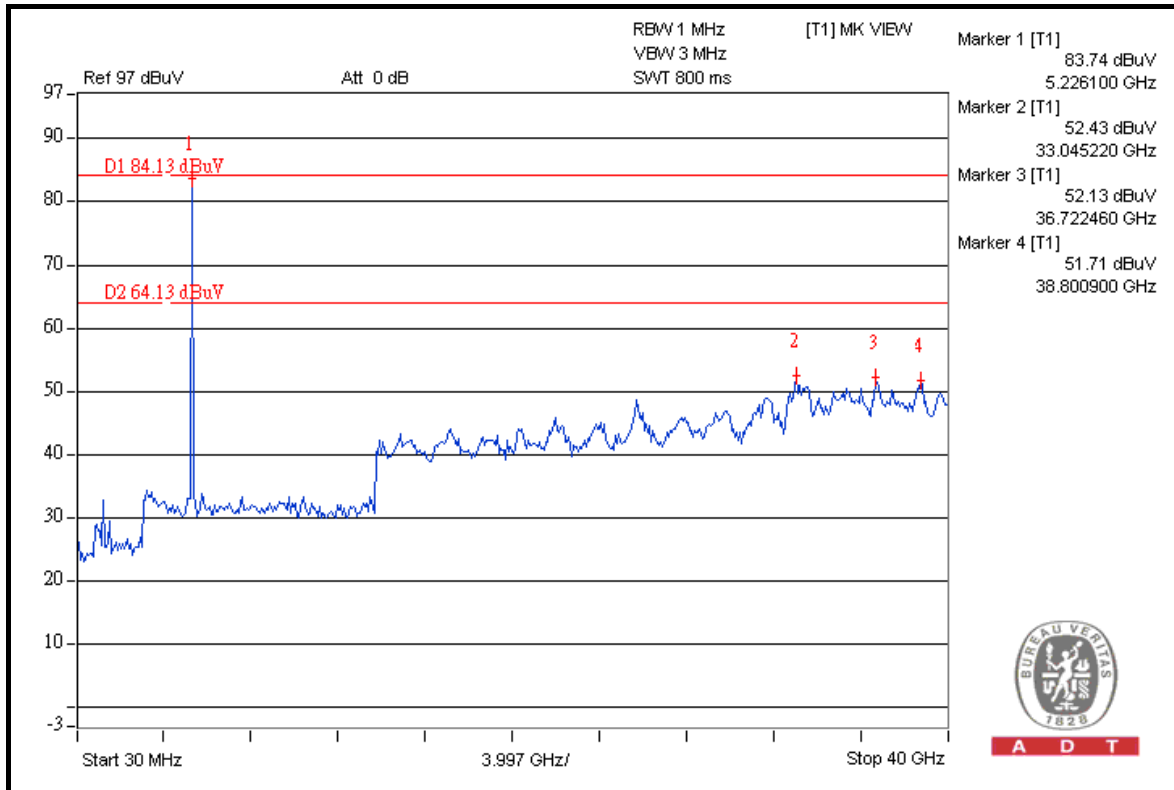



A D T

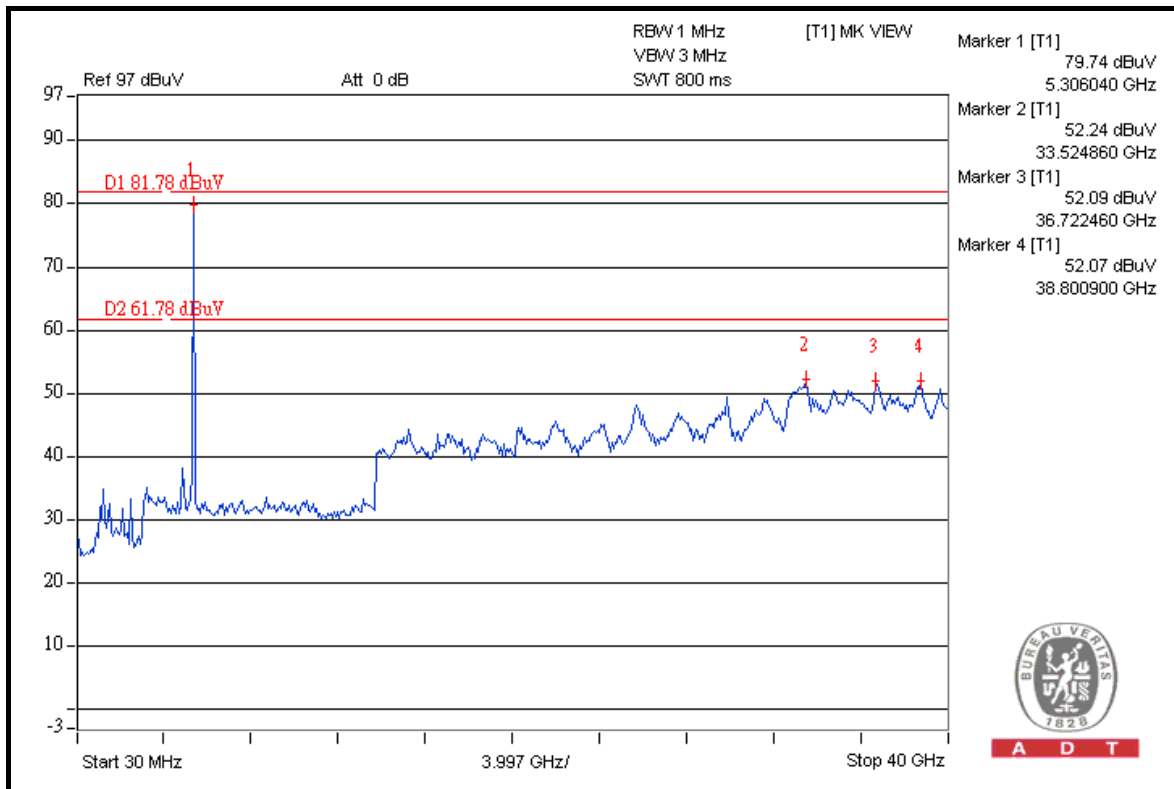
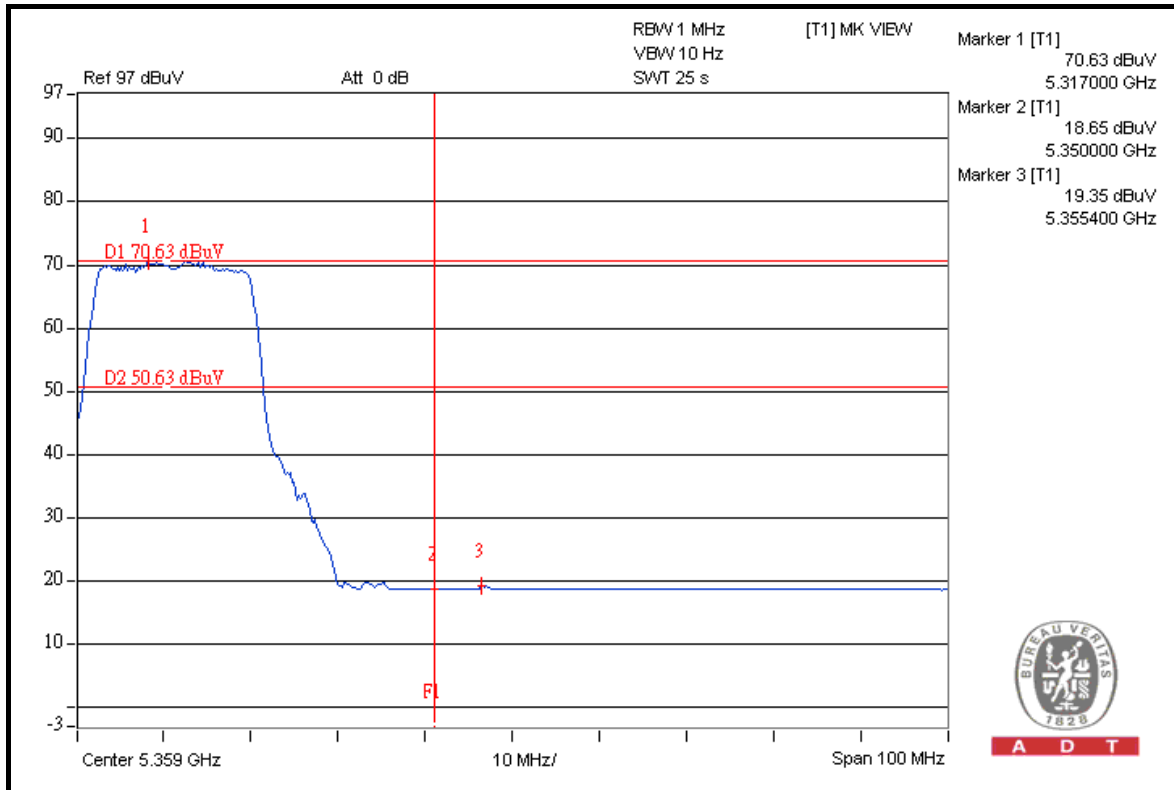



**FOR 5500-5700MHz BAND:**

**5500MHz**

**RESTRICT BAND (5350 ~ 5460 MHz)**

FREQUENCY (MHz)	FUNDAMENTAL EMISSION (dBuV/m)	DELTA (dB)	MAXIMUM FIELD STRENGTH IN RESTRICT BAND (dBuV/m)	LIMIT (dBuV/m)
5500.00 (PK)	116.8	52.26	64.54	74.00
5500.00 (AV)	104.8	50.86	53.94	54.00

**FREQUENCY BAND (5460 ~ 5470 MHz)**

FREQUENCY (MHz)	FUNDAMENTAL EMISSION (dBuV/m)	DELTA (dB)	MAXIMUM FIELD STRENGTH (dBuV/m)	LIMIT (dBuV/m)
5500.00 (PK)	116.8	53.33	63.47	68.30

**5700MHz**

**ABOVE 5725 MHz**

FREQUENCY (MHz)	FUNDAMENTAL EMISSION (dBuV/m)	DELTA (dB)	MAXIMUM FIELD STRENGTH (dBuV/m)	LIMIT (dBuV/m)
5700.00 (PK)	116.4	51.04	65.36	68.30

**NOTE:**

- Delta = Amplitude between the peak of the fundamental and the peak of the band edge emission. Please check following 3 pages.
- Maximum field strength in restrict band = Fundamental emission – Delta.



A D T

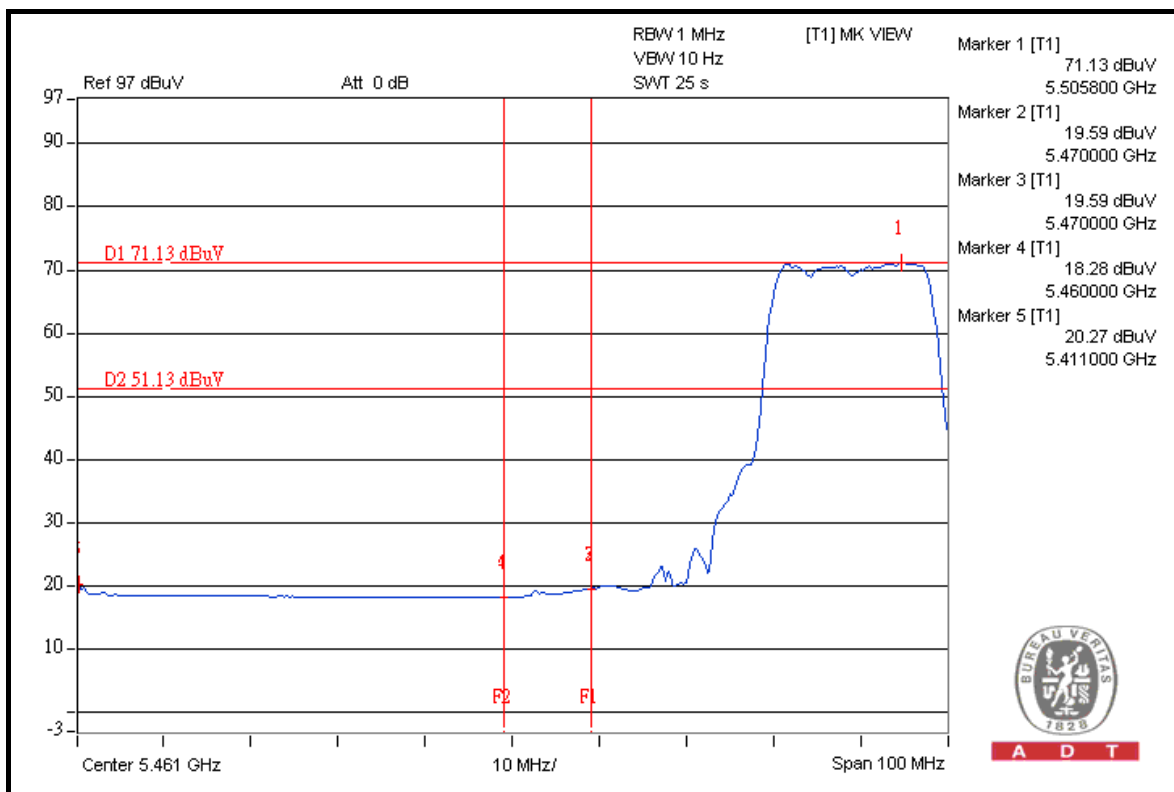
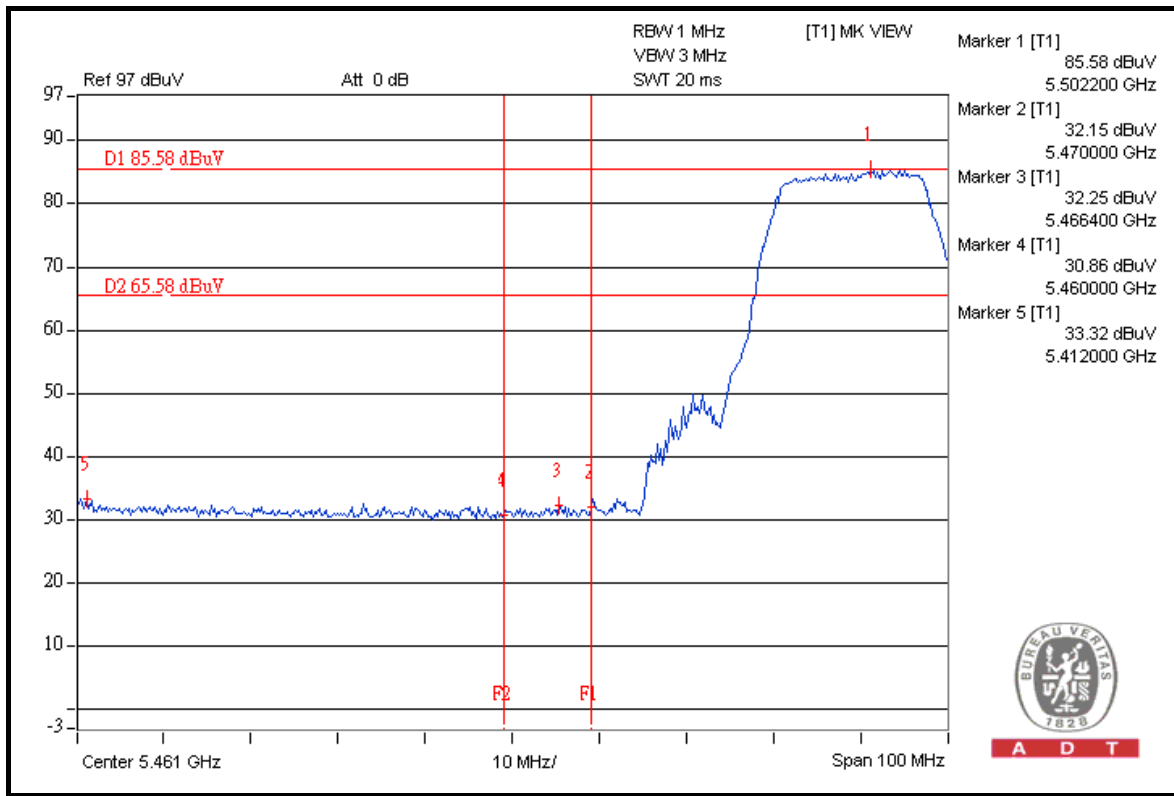



A D T

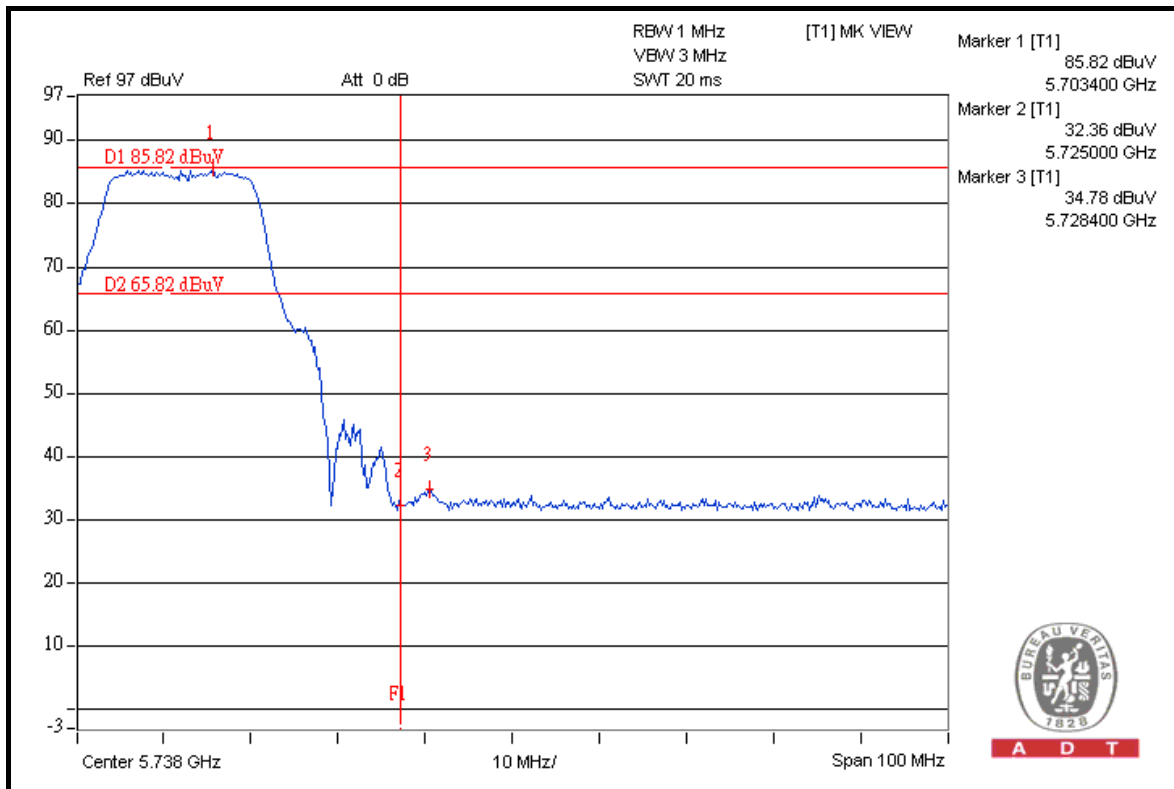
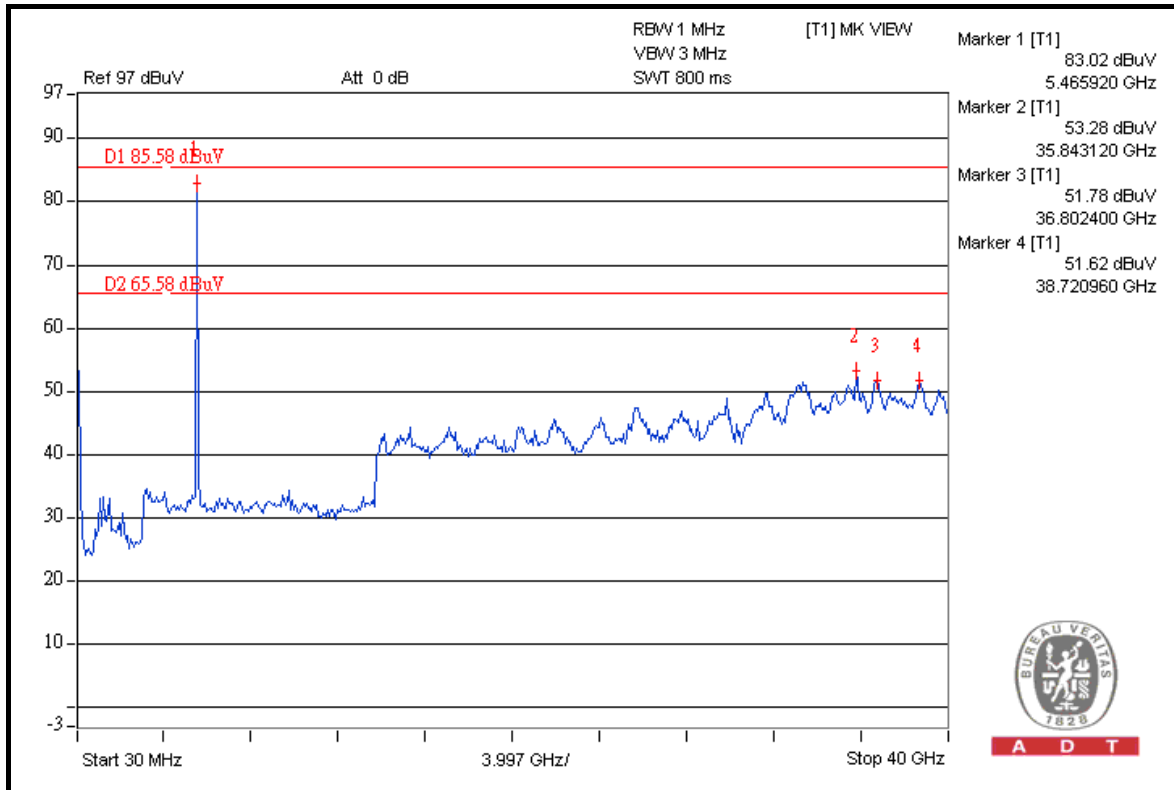



A D T

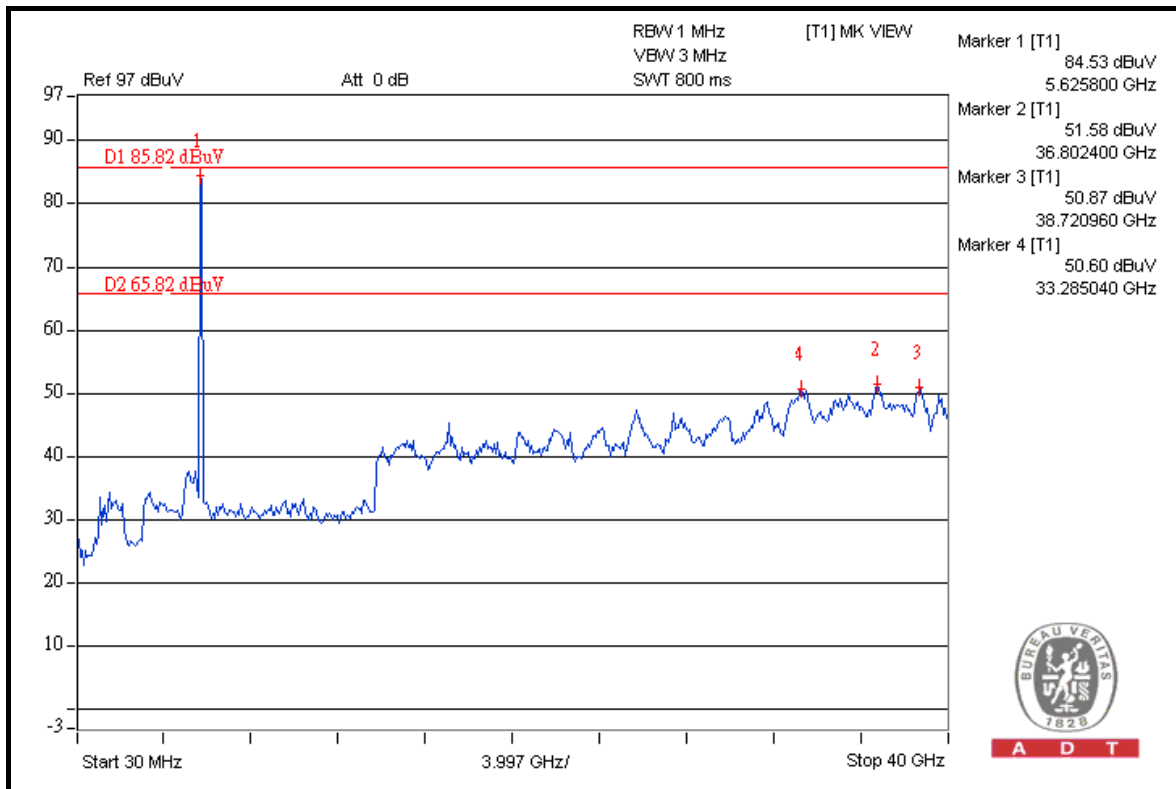
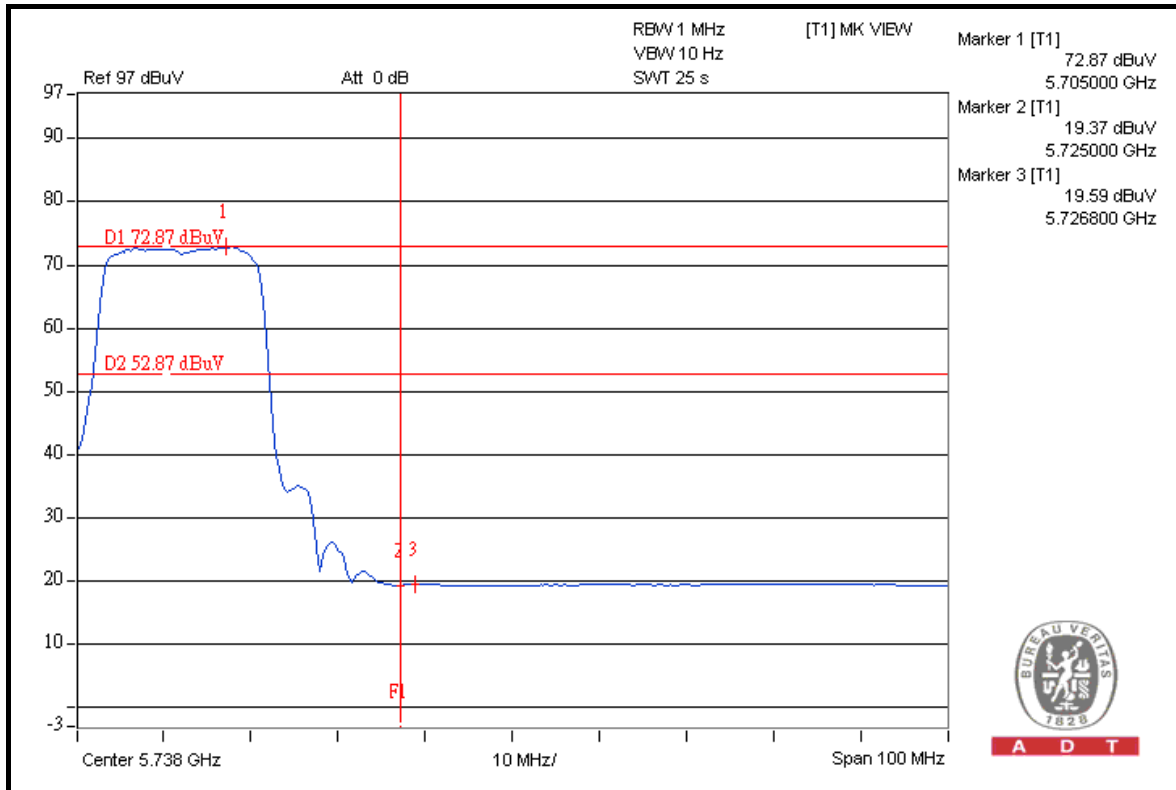

**802.11n (40MHz)**

**FOR 5260-5320MHz BAND:**

**RESTRICT BAND (4500 ~ 5150 MHz)**

FREQUENCY (MHz)	FUNDAMENTAL EMISSION (dBuV/m)	DELTA (dB)	MAXIMUM FIELD STRENGTH IN RESTRICT BAND (dBuV/m)	LIMIT (dBuV/m)
5270.00 (PK)	110.9	45.32	65.58	74.00
5270.00 (AV)	98.5	48.55	49.95	54.00

**RESTRICT BAND (5350 ~ 5460 MHz)**

FREQUENCY (MHz)	FUNDAMENTAL EMISSION (dBuV/m)	DELTA (dB)	MAXIMUM FIELD STRENGTH IN RESTRICT BAND (dBuV/m)	LIMIT (dBuV/m)
5310.00 (PK)	110.7	43.50	67.20	74.00
5310.00 (AV)	98.0	45.62	52.38	54.00

**NOTE:**

1. Delta = Amplitude between the peak of the fundamental and the peak of the band edge emission. Please check following 3 pages.
2. Maximum field strength in restrict band = Fundamental emission – Delta.



A D T

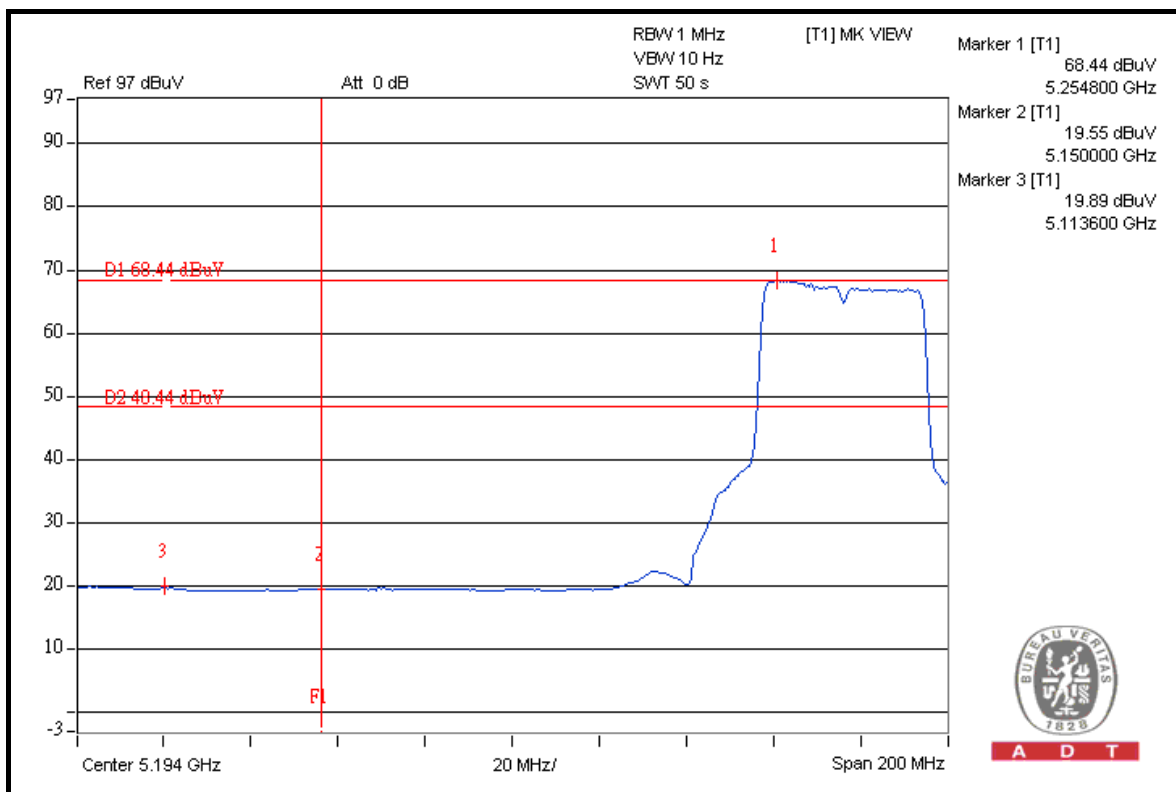
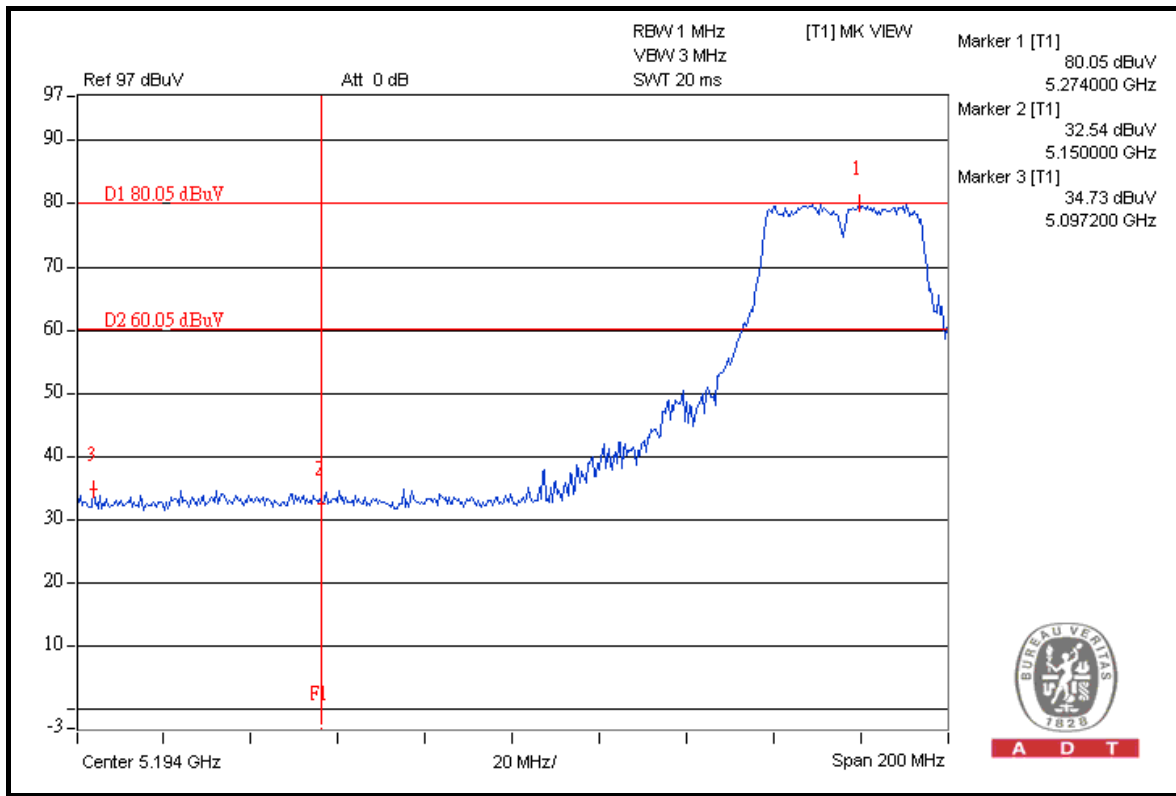



A D T

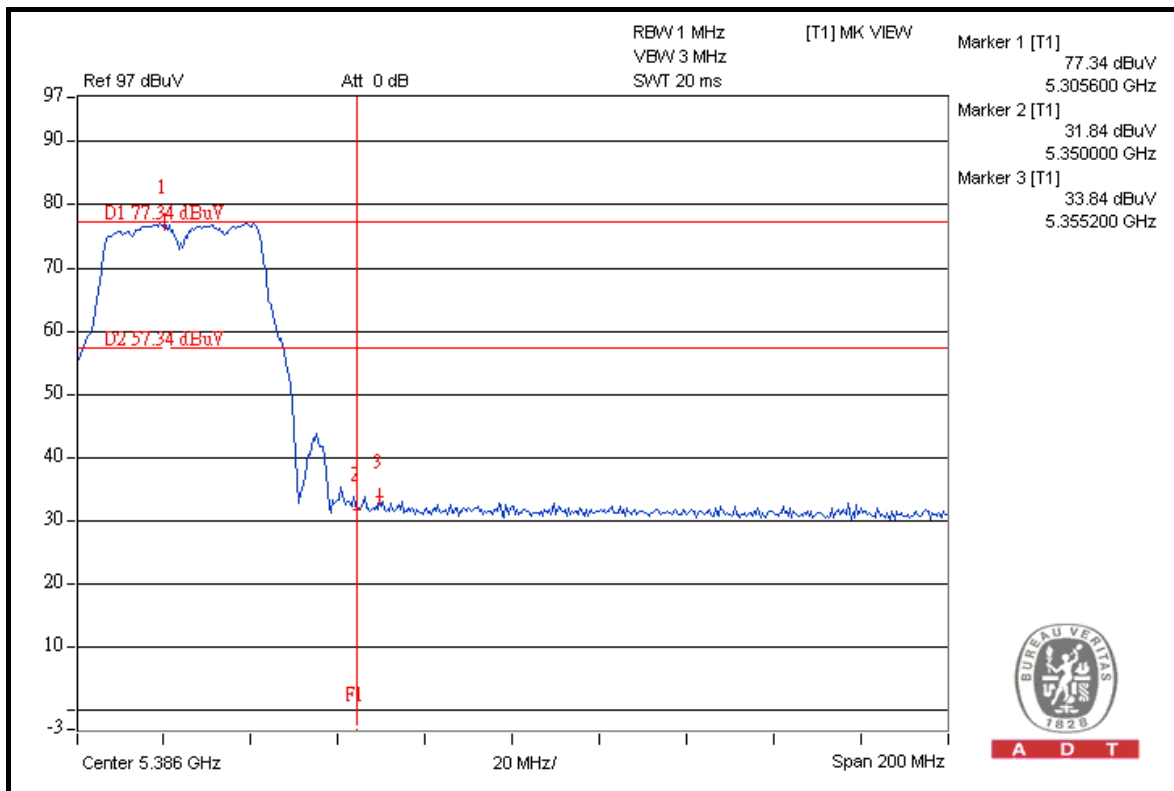
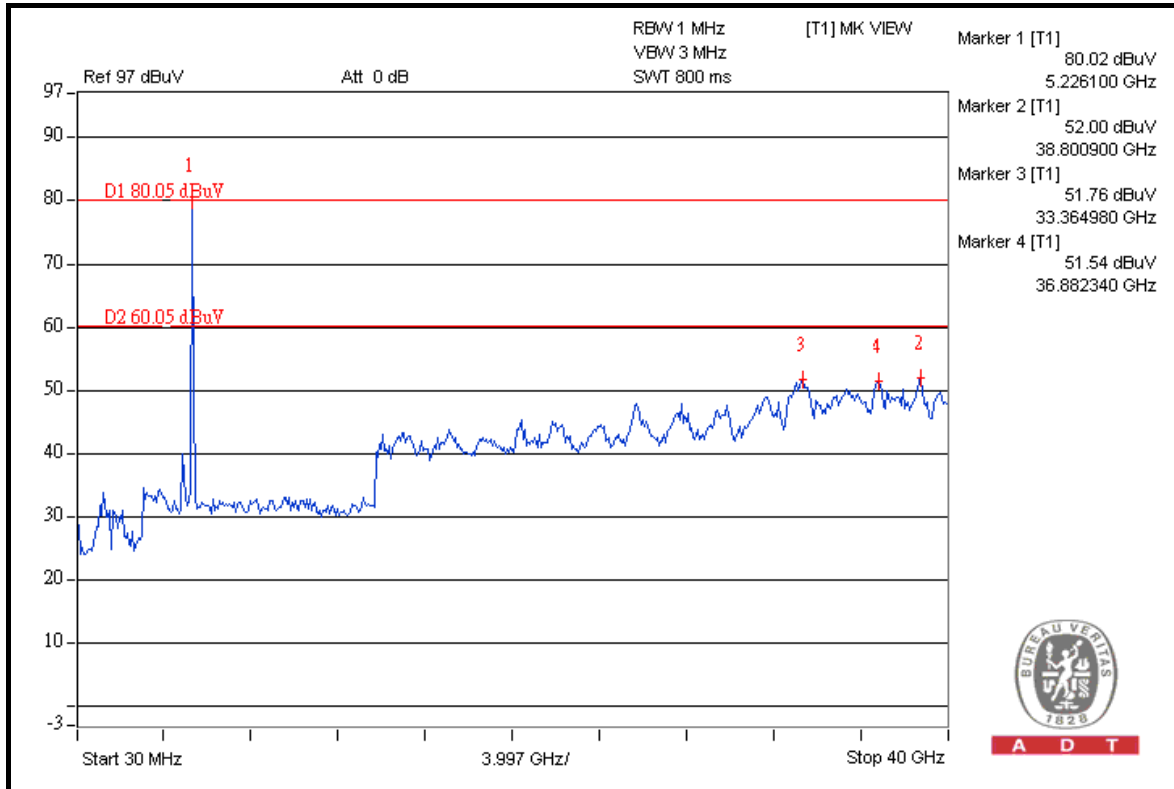



A D T

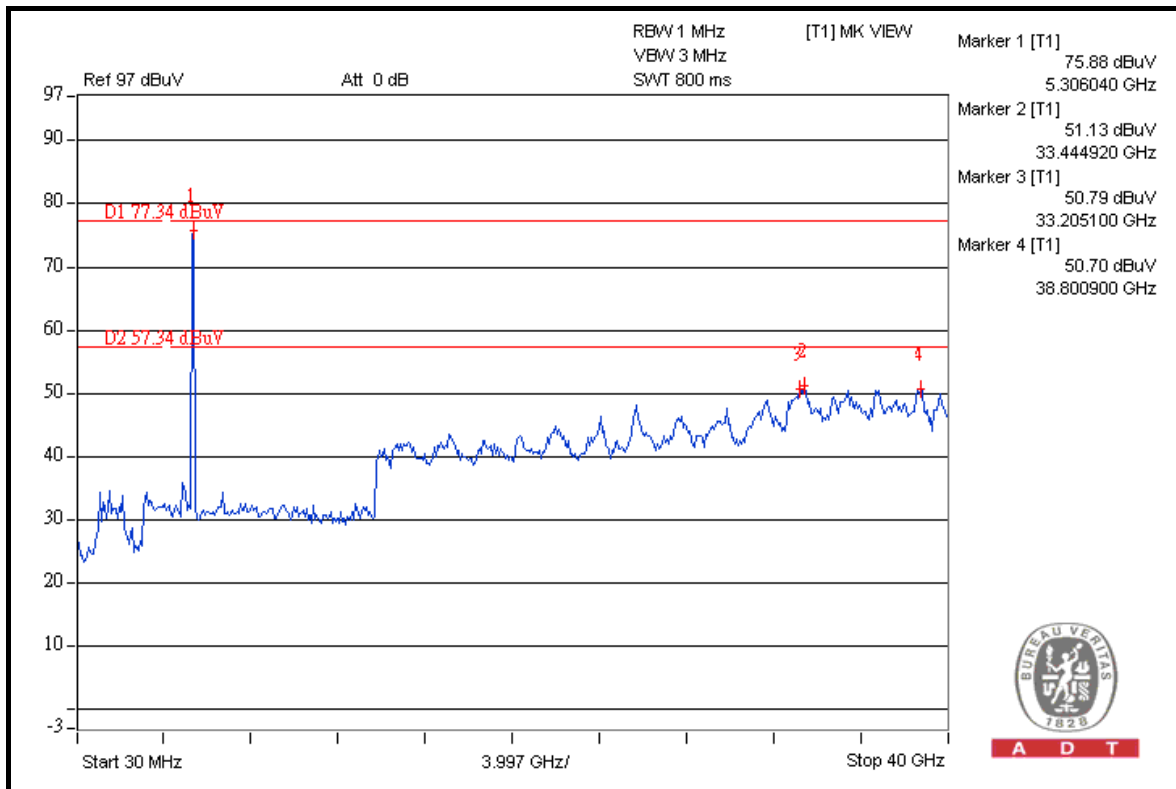
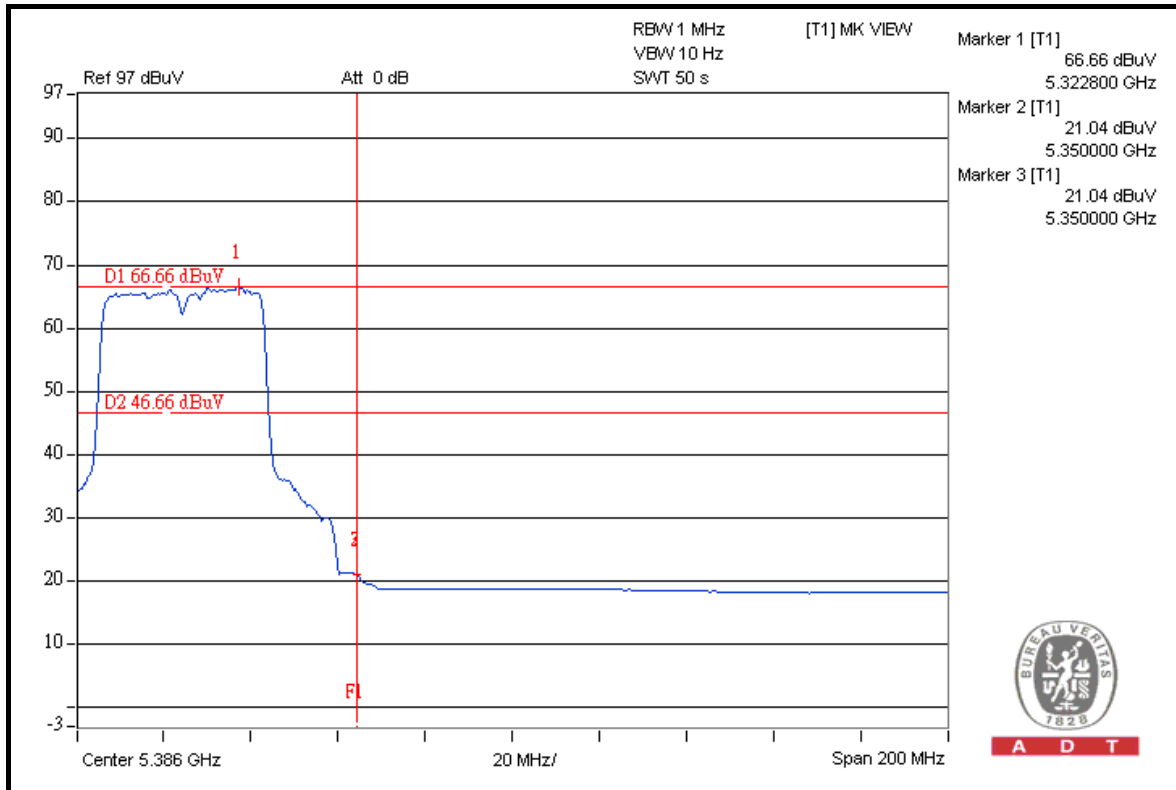



**FOR 5500-5700MHz BAND:**

**5510MHz**

**RESTRICT BAND (5350 ~ 5460 MHz)**

FREQUENCY (MHz)	FUNDAMENTAL EMISSION (dBuV/m)	DELTA (dB)	MAXIMUM FIELD STRENGTH IN RESTRICT BAND (dBuV/m)	LIMIT (dBuV/m)
5510.00 (PK)	109.6	43.89	65.71	74.00
5510.00 (AV)	97.9	45.26	52.64	54.00

**FREQUENCY BAND (5460 ~ 5470 MHz)**

FREQUENCY (MHz)	FUNDAMENTAL EMISSION (dBuV/m)	DELTA (dB)	MAXIMUM FIELD STRENGTH (dBuV/m)	LIMIT (dBuV/m)
5510.00 (PK)	109.6	45.28	64.32	68.30

**5670MHz**

**ABOVE 5725 MHz**

FREQUENCY (MHz)	FUNDAMENTAL EMISSION (dBuV/m)	DELTA (dB)	MAXIMUM FIELD STRENGTH (dBuV/m)	LIMIT (dBuV/m)
5670.00 (PK)	110.9	44.53	66.37	68.30

**NOTE:**

- Delta = Amplitude between the peak of the fundamental and the peak of the band edge emission. Please check following 3 pages.
- Maximum field strength in restrict band = Fundamental emission – Delta.



A D T

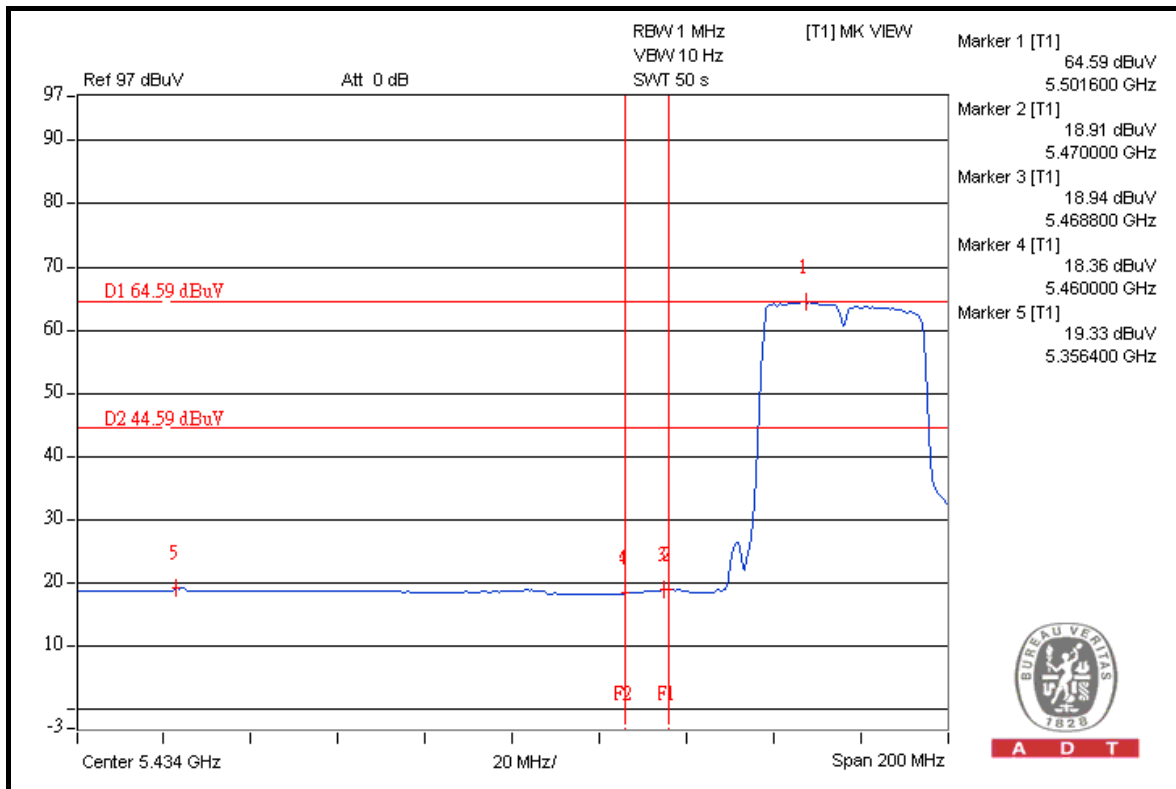
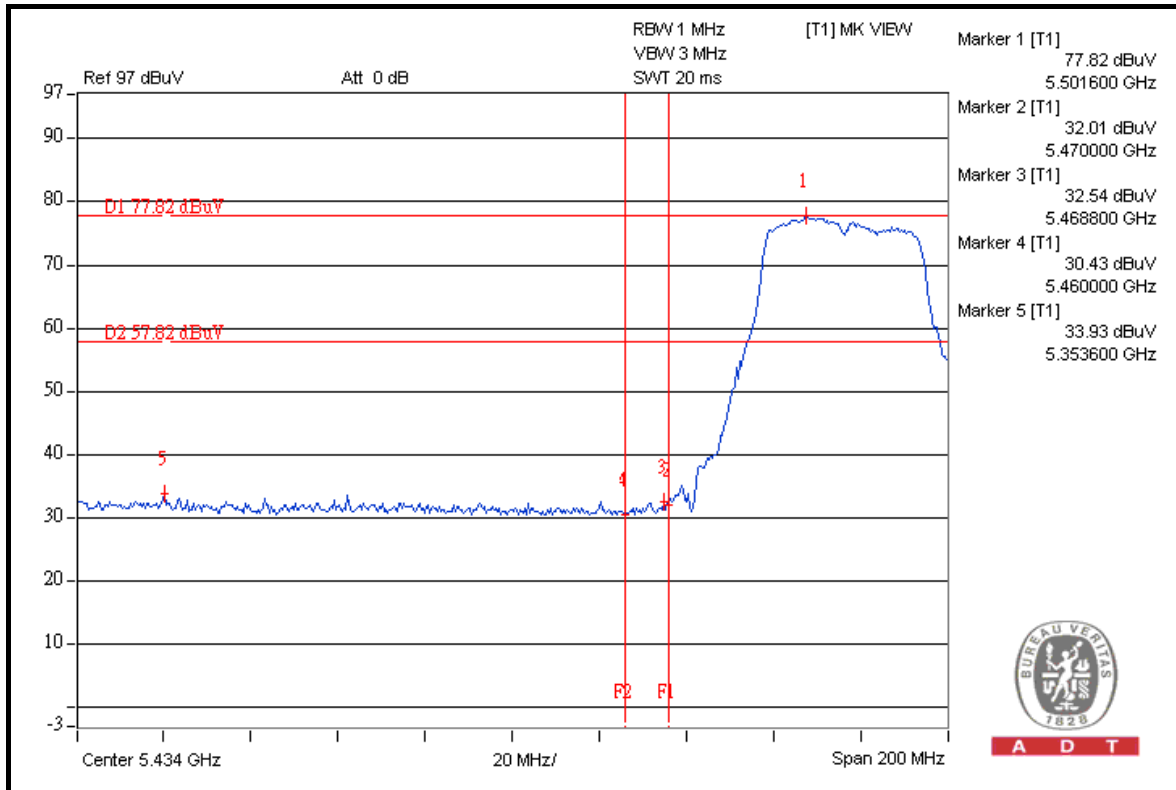



A D T

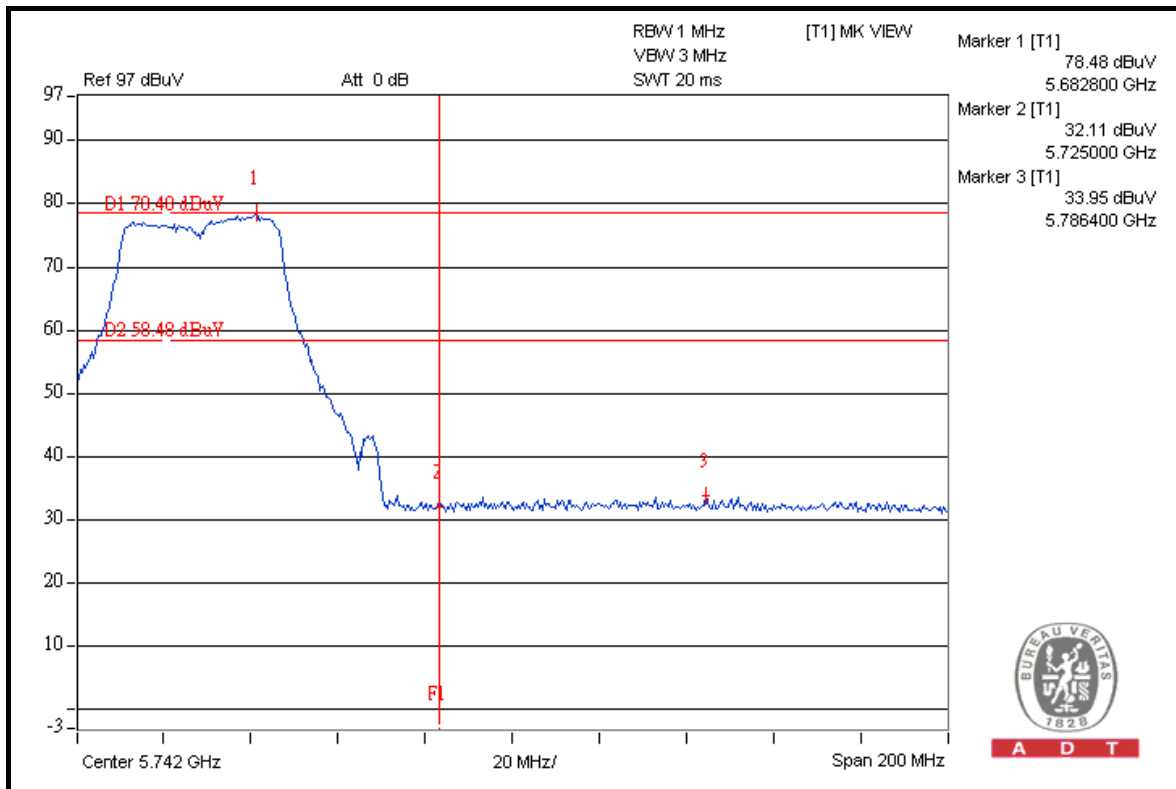
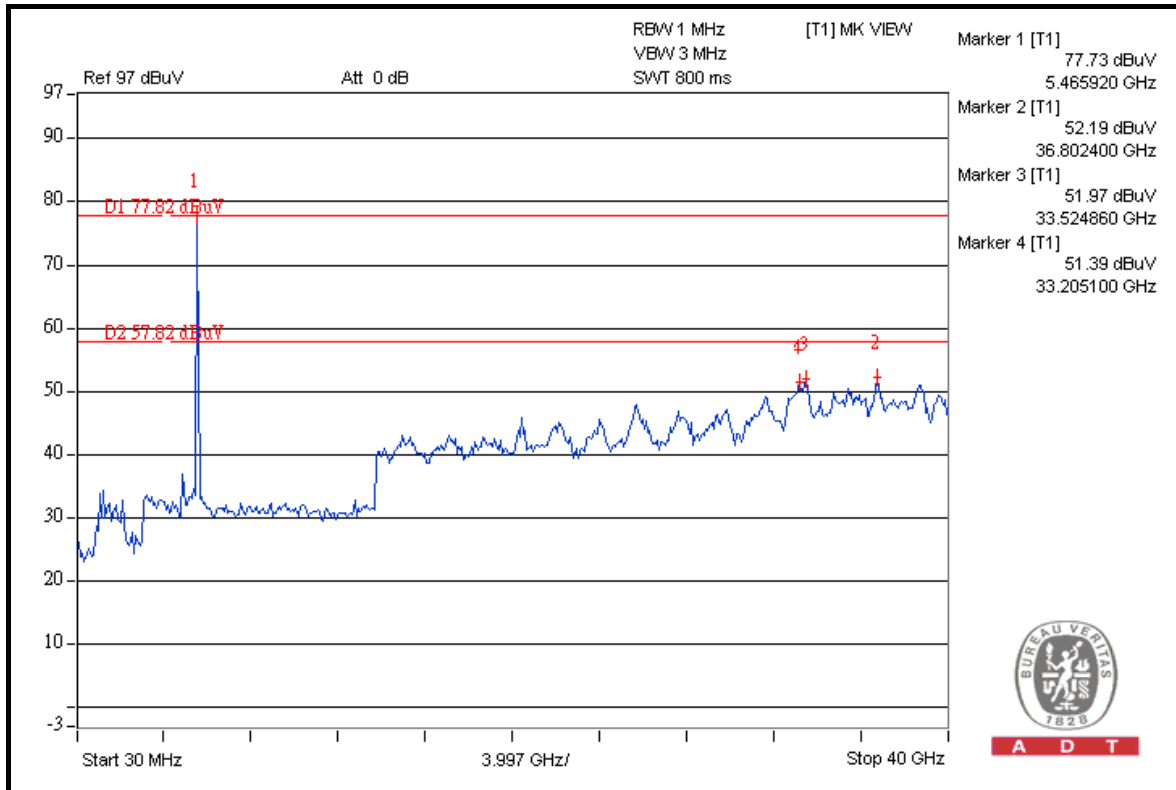



A D T

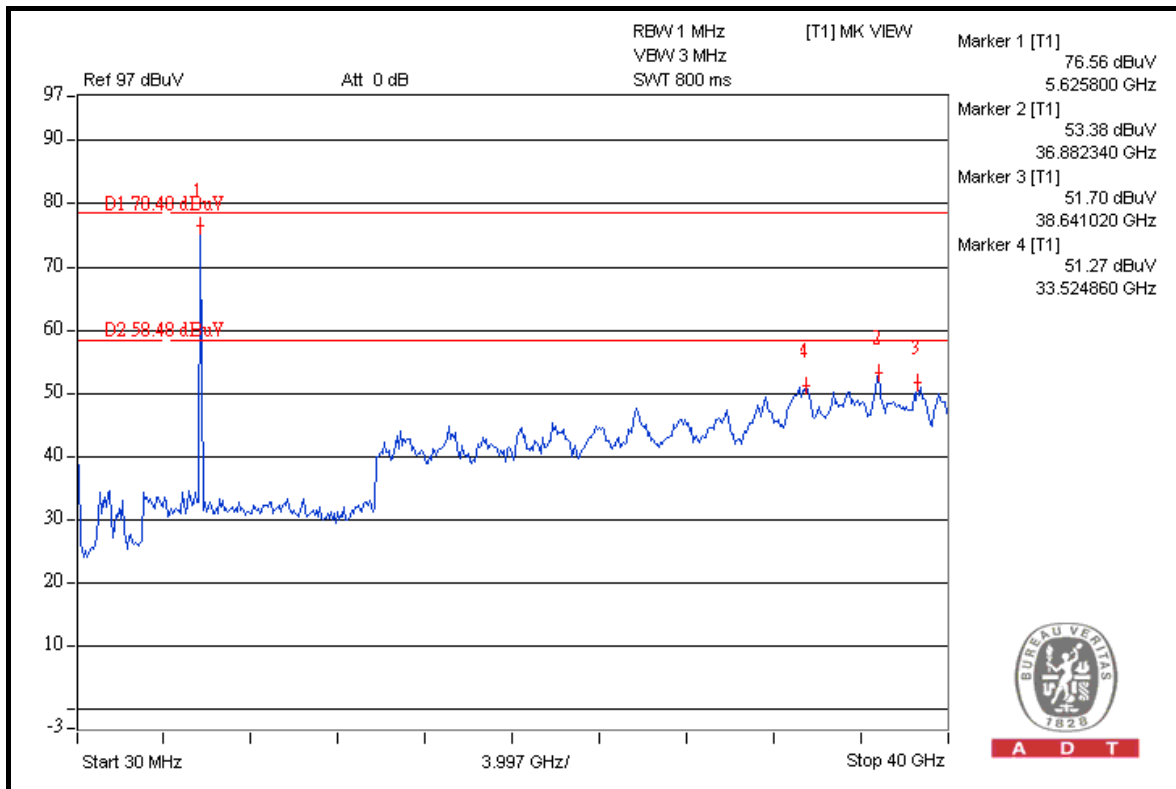
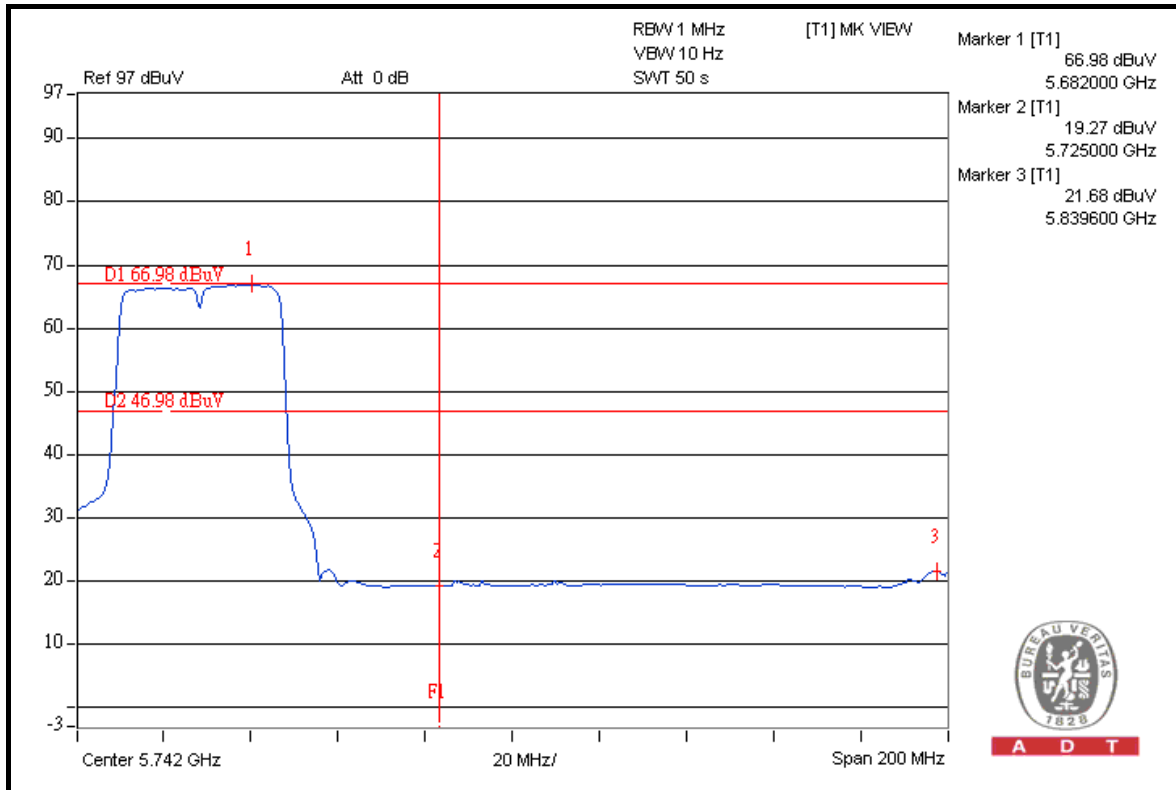

## 5. PHOTOGRAPHS OF THE TEST CONFIGURATION

Please refer to the attached file (Test Setup Photo).

## 6. INFORMATION ON THE TESTING LABORATORIES

We, Bureau Veritas Consumer Products Services (H.K.) Ltd., Taoyuan Branch, were founded in 1988 to provide our best service in EMC, Radio, Telecom and Safety consultation. Our laboratories are accredited and approved by the following approval agencies according to ISO/IEC 17025.

<b>USA</b>	FCC, NVLAP
<b>Germany</b>	TUV Rheinland
<b>Japan</b>	VCCI
<b>Norway</b>	NEMKO
<b>Canada</b>	INDUSTRY CANADA , CSA
<b>R.O.C.</b>	TAF, BSMI, NCC
<b>Netherlands</b>	Telefication
<b>Singapore</b>	GOST-ASIA(MOU)
<b>Russia</b>	CERTIS(MOU)

Copies of accreditation certificates of our laboratories obtained from approval agencies can be downloaded from our web site:  
[www.adt.com.tw/index.5/phtml](http://www.adt.com.tw/index.5/phtml). If you have any comments, please feel free to contact us at the following:

**Linko EMC/RF Lab:**  
Tel: 886-2-26052180  
Fax: 886-2-26051924

**Hsin Chu EMC/RF Lab:**  
Tel: 886-3-5935343  
Fax: 886-3-5935342

**Hwa Ya EMC/RF/Safety Telecom Lab:**  
Tel: 886-3-3183232  
Fax: 886-3-3185050

**Web Site:** [www.adt.com.tw](http://www.adt.com.tw)

The address and road map of all our labs can be found in our web site also.

## **7. APPENDIX A - MODIFICATIONS RECORDERS FOR ENGINEERING CHANGES TO THE EUT BY THE LAB**

No any modifications are made to the EUT by the lab during the test.

**---END---**