



FCC TEST REPORT (15.407)

REPORT NO.: RF981021L10-1

MODEL NO.: ZF7363

RECEIVED: Oct. 21, 2009

TESTED: Oct. 23 ~ Oct. 29, 2009

ISSUED: Nov. 04, 2009

APPLICANT:	Senao Networks Inc.
ADDRESS:	3F, No. 529, Chung Cheng Rd., Hsintien, Taipei, Taiwan, R.O.C.
FCC ID:	U2M-ZF73XX-1
MANUFACTURER'S COMPANY:	Senao Networks, Inc.
MANUFACTURER ADDRESS:	3F, No. 529, Chung Cheng Rd., Hsintien, Taipei, Taiwan

ISSUED BY: Bureau Veritas Consumer Products Services (H.K.) Ltd., Taoyuan Branch

LAB ADDRESS: No. 47, 14th Ling, Chia Pau Tsuen, Lin Kou Hsiang, Taipei Hsien 244, Taiwan, R.O.C.

This test report consists of 75 pages in total. It may be duplicated completely for legal use with the approval of the applicant. It should not be reproduced except in full, without the written approval of our laboratory. The client should not use it to claim product endorsement by TAF or any government agencies. The test results in the report only apply to the tested sample.



TABLE OF CONTENTS

1.	CERTIFICATION.....	4
2.	SUMMARY OF TEST RESULTS	5
2.1	MEASUREMENT UNCERTAINTY.....	5
3.	GENERAL INFORMATION.....	6
3.1	GENERAL DESCRIPTION OF EUT	6
3.2	DESCRIPTION OF TEST MODES	8
3.2.1	CONFIGURATION OF SYSTEM UNDER TEST	9
3.2.2	TEST MODE APPLICABILITY AND TESTED CHANNEL DETAIL	10
3.3	GENERAL DESCRIPTION OF APPLIED STANDARDS	12
3.4	DESCRIPTION OF SUPPORT UNITS	12
4.	TEST TYPES AND RESULTS	13
4.1	RADIATED EMISSION MEASUREMENT	13
4.1.1	LIMITS OF RADIATED EMISSION MEASUREMENT.....	13
4.1.2	LIMITS OF UNWANTED EMISSION OUT OF THE RESTRICTED BANDS.....	13
4.1.3	TEST INSTRUMENTS.....	13
4.1.4	TEST PROCEDURES	15
4.1.5	DEVIATION FROM TEST STANDARD.....	15
4.1.6	TEST SETUP.....	16
4.1.7	EUT OPERATING CONDITION.....	16
4.1.8	TEST RESULTS	17
4.2	CONDUCTED EMISSION MEASUREMENT	27
4.2.1	LIMITS OF CONDUCTED EMISSION MEASUREMENT.....	27
4.2.2	TEST INSTRUMENTS.....	27
4.2.3	TEST PROCEDURES	28
4.2.4	DEVIATION FROM TEST STANDARD.....	28
4.2.5	TEST SETUP.....	29
4.2.6	EUT OPERATING CONDITIONS	29
4.2.7	TEST RESULTS	30
4.3	MAXIMUM CONDUCTED OUTPUT POWER MEASUREMENT	34
4.3.1	LIMITS OF MAXIMUM CONDUCTED OUTPUT POWER MEASUREMENT.....	34
4.3.2	TEST INSTRUMENTS.....	34
4.3.3	TEST PROCEDURE.....	34
4.3.4	DEVIATION FROM TEST STANDARD.....	35
4.3.5	TEST SETUP.....	35
4.3.6	EUT OPERATING CONDITIONS	35
4.3.7	TEST RESULTS	36
4.4	PEAK POWER EXCURSION MEASUREMENT	43
4.4.1	LIMITS OF PEAK POWER EXCURSION MEASUREMENT.....	43
4.4.2	TEST INSTRUMENTS.....	43
4.4.3	TEST PROCEDURE.....	43
4.4.4	DEVIATION FROM TEST STANDARD.....	44
4.4.5	TEST SETUP.....	44
4.4.6	EUT OPERATING CONDITIONS	44
4.4.7	TEST RESULTS	45
4.5	PEAK POWER SPECTRAL DENSITY MEASUREMENT	51
4.5.1	LIMITS OF PEAK POWER SPECTRAL DENSITY MEASUREMENT.....	51
4.5.2	TEST INSTRUMENTS.....	51
4.5.3	TEST PROCEDURES	51



4.5.4	DEVIATION FROM TEST STANDARD.....	52
4.5.5	TEST SETUP.....	52
4.5.6	EUT OPERATING CONDITIONS.....	52
4.5.7	TEST RESULTS.....	53
4.6	FREQUENCY STABILITY.....	56
4.6.1	LIMITS OF FREQUENCY STABILITY MEASUREMENT.....	56
4.6.2	TEST INSTRUMENTS.....	56
4.6.3	TEST PROCEDURE.....	56
4.6.4	DEVIATION FROM TEST STANDARD.....	57
4.6.5	TEST SETUP.....	57
4.6.6	EUT OPERATING CONDITION.....	57
4.6.7	TEST RESULTS.....	58
4.7	BAND EDGES MEASUREMENT.....	59
4.7.1	TEST INSTRUMENTS.....	59
4.7.2	TEST PROCEDURE.....	60
4.7.3	EUT OPERATING CONDITION.....	60
4.7.4	TEST RESULTS.....	60
5.	PHOTOGRAPHS OF THE TEST CONFIGURATION.....	73
6.	INFORMATION ON THE TESTING LABORATORIES.....	74
7.	APPENDIX A - MODIFICATIONS RECORDERS FOR ENGINEERING CHANGES TO THE EUT BY THE LAB.....	75



1. CERTIFICATION

PRODUCT: ZoneFlex 7363 Access Point

MODEL: ZF7363

BRAND: Ruckus

APPLICANT: Senao Networks Inc.

TEST SAMPLE: ENGINEERING SAMPLE

TESTED: Oct. 23 ~ Oct. 29, 2009

STANDARDS: FCC Part 15, Subpart E (Section 15.407)

ANSI C63.4-2003

The above equipment (Model: ZF7363) has been tested by **Bureau Veritas Consumer Products Services (H.K.) Ltd., Taoyuan Branch**, and found compliance with the requirement of the above standards. The test record, data evaluation & Equipment Under Test (EUT) configurations represented herein are true and accurate accounts of the measurements of the sample's EMC characteristics under the conditions specified in this report.

PREPARED BY : Andrea Hsia , **DATE** : Nov. 04, 2009
Andrea Hsia / Specialist

TECHNICAL ACCEPTANCE : Long Chen , **DATE** : Nov. 04, 2009
Responsible for RF Long Chen / Senior Engineer

APPROVED BY : Gary Chang , **DATE** : Nov. 04, 2009
Gary Chang / Assistant Manager

2. SUMMARY OF TEST RESULTS

The EUT has been tested according to the following specifications:

APPLIED STANDARD: FCC PART 15, SUBPART E (SECTION 15.407)			
STANDARD SECTION	TEST TYPE AND LIMIT	RESULT	REMARK
15.407(b)(5)	AC Power Conducted Emission	PASS	Meet the requirement of limit. Minimum passing margin is -14.0dB at 0.291MHz.
15.407(b/1/2/3)(b)(5)	Electric Field Strength Spurious Emissions, 30MHz ~ 40000MHz	PASS	Meet the requirement of limit. Minimum passing margin is -0.2dB at 340.03MHz.
15.407(a/1/2/3)	Peak Transmit Power	PASS	Meet the requirement of limit.
15.407(a)(6)	Peak Power Excursion	PASS	Meet the requirement of limit.
15.407(a/1/2/3)	Peak Power Spectral Density	PASS	Meet the requirement of limit.
15.407(g)	Frequency Stability	PASS	Meet the requirement of limit.
15.203	Antenna Requirement	PASS	No antenna connector is used.

2.1 MEASUREMENT UNCERTAINTY

Where relevant, the following measurement uncertainty levels have been estimated for tests performed on the EUT as specified in CISPR 16-4-2:

MEASUREMENT	FREQUENCY	UNCERTAINTY
Conducted emissions	150kHz~30MHz	2.44 dB
Radiated emissions	30MHz ~ 1000MHz	3.78 dB
	1GHz ~ 40GHz	2.89 dB

This uncertainty represents an expanded uncertainty expressed at approximately the 95% confidence level using a coverage factor of $k = 2$.

3. GENERAL INFORMATION

3.1 GENERAL DESCRIPTION OF EUT

EUT	ZoneFlex 7363 Access Point
MODEL NO.	ZF7363
FCC ID	U2M-ZF73XX-1
POWER SUPPLY	12Vdc (adapter) 48Vdc (POE)
MODULATION TYPE	64QAM, 16QAM, QPSK, BPSK for OFDM
MODULATION TECHNOLOGY	OFDM
TRANSFER RATE	54.0/ 48.0/ 36.0/ 24.0/ 18.0/ 12.0/ 9.0/ 6.0Mbps 802.11n: up to 270.0Mbps
OPERATING FREQUENCY	5180.0 ~ 5240.0MHz
NUMBER OF CHANNEL	4 for 802.11a, 802.11n (20MHz) 2 for 802.11n (40MHz)
OUTPUT POWER	53.2mW
ANTENNA TYPE	PIFA antenna with 2dBi gain
ANTENNA CONNECTOR	NA
I/O PORTS	USB, RJ45
DATA CABLE	NA
ACCESSORY DEVICES	AC adapter

NOTE:

1. The EUT is a ZoneFlex 7363 Access Point. The functions of EUT listed as below:

	TEST STANDARD	REFERENCE REPORT
WLAN 802.11b/g, 802.11n	FCC Part 15, Subpart C (Section 15.247)	RF981021L10
WLAN 802.11a, 802.11n (5745~5825 MHz)		
WLAN 802.11a, 802.11n (5180~ 5240MHz)	FCC Part 15, Subpart E (Section 15.407)	RF981021L10-1

2. The frequency bands used in this EUT are listed as follows:

Frequency Band (MHz)	2412~2462	5180~5240	5745~5825
802.11b	√		
802.11g	√		
802.11a		√	√
802.11n (20MHz)	√	√	√
802.11n (40MHz)	√	√	√

3. The EUT were powered by the following adapter & POE:

ADAPTER	
BRAND:	Ruckus
MODEL:	DSA-12G-12 FUS 120120
INPUT:	100-240Vac, 0.3A, 50/60Hz
OUTPUT:	12Vdc, 1A
POWER LINE:	1.8m non-shielded cable without core

POE	
BRAND:	SonicWall
MODEL:	PD-6083G300
OUTPUT:	48Vdc

**POE was for tested only and optional accessory.

4. The EUT incorporates a MIMO function. Physically, the EUT provides two completed transmitters and two receivers.

MODULATION MODE	TX FUNCTION
802.11b	2TX
802.11g	2TX
802.11a	2TX
802.11n (20MHz)	2TX
802.11n (40MHz)	2TX

5. Spurious emission of the simultaneous operation has been evaluated and no non-compliance found.

6. The above EUT information was declared by manufacturer and for more detailed features description, please refer to the manufacturer's specifications or user's manual.

3.2 DESCRIPTION OF TEST MODES

4 channels are provided for 802.11a, 802.11n (20MHz):

CHANNEL	FREQUENCY	CHANNEL	FREQUENCY
36	5180MHz	44	5220MHz
40	5200MHz	48	5240MHz

2 channels are provided for 802.11n (40MHz):

CHANNEL	FREQUENCY	CHANNEL	FREQUENCY
38	5190MHz	46	5230MHz

POWER SETTING

802.11a			802.11n (20MHz)		
CHANNEL	POWER SETTING		CHANNEL	POWER SETTING	
36	Chain 0	16.0	36	Chain 0	16.0
	Chain 1	16.0		Chain 1	16.0
40	Chain 0	15.5	40	Chain 0	15.5
	Chain 1	15.5		Chain 1	15.5
48	Chain 0	15.5	48	Chain 0	15.5
	Chain 1	15.5		Chain 1	15.5

802.11n (40MHz)		
CHANNEL	POWER SETTING	
38	Chain 0	16.0
	Chain 1	16.0
46	Chain 0	15.5
	Chain 1	15.5

3.2.1 CONFIGURATION OF SYSTEM UNDER TEST

TEST MODE A

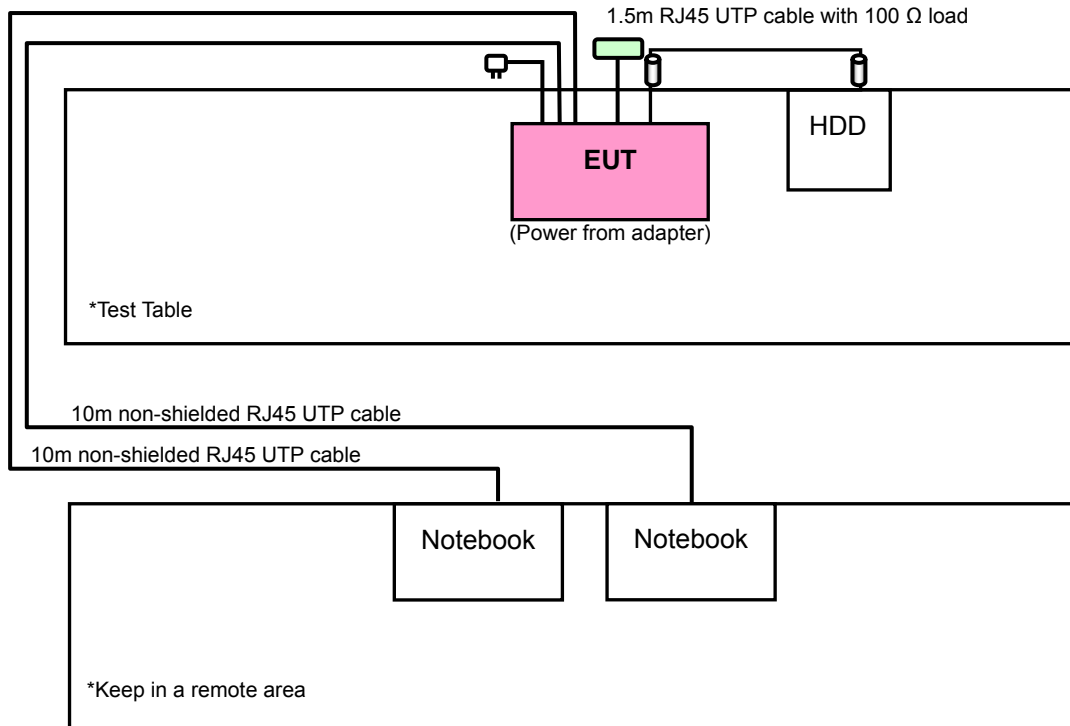

TEST MODE B

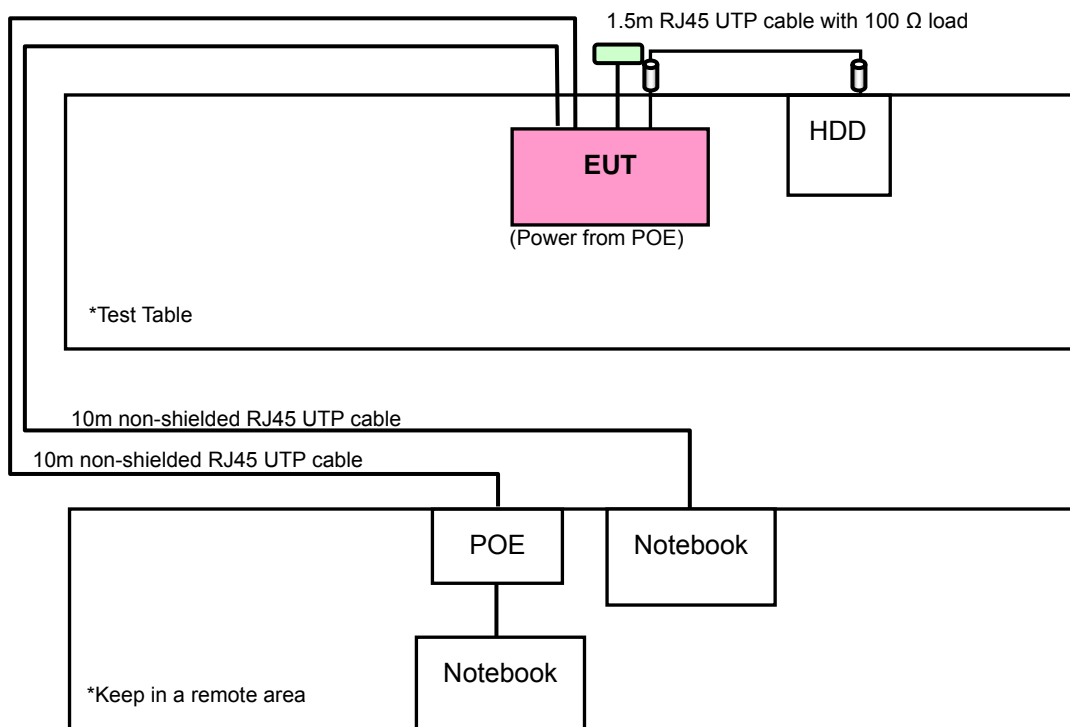



3.2.2 TEST MODE APPLICABILITY AND TESTED CHANNEL DETAIL

EUT CONFIGURE MODE	APPLICABLE TO				DESCRIPTION
	RE≥1G	RE<1G	PLC	APCM	
A	√	√	√	√	Power from AC Adapter
B	-	√	√	-	Power from POE

Where **RE≥1G**: Radiated Emission above 1GHz **RE<1G**: Radiated Emission below 1GHz
PLC: Power Line Conducted Emission **APCM**: Antenna Port Conducted Measurement
NOTE: “-” means no effect.

RADIATED EMISSION TEST (ABOVE 1GHz):

- Pre-Scan has been conducted to determine the worst-case mode from all possible combinations between available modulations, XYZ axis and antenna ports (if EUT with antenna diversity architecture).
- Following channel(s) was (were) selected for the final test as listed below.

EUT CONFIGURE MODE	MODE	AVAILABLE CHANNEL	TESTED CHANNEL	MODULATION TECHNOLOGY	MODULATION TYPE	DATA RATE (Mbps)	AXIS
A	802.11a	36 to 48	36, 40, 48	OFDM	BPSK	6.0	X
A	802.11n (20MHz)	36 to 48	36, 40, 48	OFDM	BPSK	6.5	X
A	802.11n (40MHz)	38 to 46	38, 46	OFDM	BPSK	13.5	X

RADIATED EMISSION TEST (BELOW 1GHz):

- Pre-Scan has been conducted to determine the worst-case mode from all possible combinations between available modulations, XYZ axis and antenna ports (if EUT with antenna diversity architecture).
- Following channel(s) was (were) selected for the final test as listed below.

EUT CONFIGURE MODE	MODE	AVAILABLE CHANNEL	TESTED CHANNEL	MODULATION TECHNOLOGY	MODULATION TYPE	DATA RATE (Mbps)	AXIS
A	802.11n (40MHz)	38 to 46	38	OFDM	BPSK	13.5	X
B	802.11n (40MHz)	38 to 46	38	OFDM	BPSK	13.5	X

POWER LINE CONDUCTED EMISSION TEST:

- Pre-Scan has been conducted to determine the worst-case mode from all possible combinations between available modulations, XYZ axis and antenna ports (if EUT with antenna diversity architecture).
- Following channel(s) was (were) selected for the final test as listed below.

EUT CONFIGURE MODE	MODE	AVAILABLE CHANNEL	TESTED CHANNEL	MODULATION TECHNOLOGY	MODULATION TYPE	DATA RATE (Mbps)
A	802.11n (40MHz)	38 to 46	38	OFDM	BPSK	13.5
B	802.11n (40MHz)	38 to 46	38	OFDM	BPSK	13.5



BANDEDGE MEASUREMENT:

- Pre-Scan has been conducted to determine the worst-case mode from all possible combinations between available modulations, data rates and antenna ports (if EUT with antenna diversity architecture).
- Following channel(s) was (were) selected for the final test as listed below.

EUT CONFIGURE MODE	MODE	AVAILABLE CHANNEL	TESTED CHANNEL	MODULATION TECHNOLOGY	MODULATION TYPE	DATA RATE (Mbps)
A	802.11a	36 to 48	36, 48	OFDM	BPSK	6.0
A	802.11n (20MHz)	36 to 48	36, 48	OFDM	BPSK	6.5
A	802.11n (40MHz)	38 to 46	38, 46	OFDM	BPSK	13.5

ANTENNA PORT CONDUCTED MEASUREMENT:

- This item includes all test value of each mode, but only includes spectrum plot of worst value of each mode.
- Pre-Scan has been conducted to determine the worst-case mode from all possible combinations between available modulations, data rates and antenna ports (if EUT with antenna diversity architecture).
- Following channel(s) was (were) selected for the final test as listed below.

EUT CONFIGURE MODE	MODE	AVAILABLE CHANNEL	TESTED CHANNEL	MODULATION TECHNOLOGY	MODULATION TYPE	DATA RATE (Mbps)
A	802.11a	36 to 48	36, 40, 48	OFDM	BPSK	6.0
A	802.11n (20MHz)	36 to 48	36, 40, 48	OFDM	BPSK	6.5
A	802.11n (40MHz)	38 to 46	38, 46	OFDM	BPSK	13.5

TEST CONDITION:

APPLICABLE TO	ENVIRONMENTAL CONDITIONS	INPUT POWER (SYSTEM)	TESTED BY
RE≥1G	22deg. C, 83%RH, 1008 hPa	120Vac, 60Hz	Nick Chen
RE<1G	23deg. C, 76%RH, 1008 hPa	120Vac, 60Hz	Nick Chen
PLC	24deg. C, 70%RH, 1008 hPa	120Vac, 60Hz	Nick Chen
APCM	23deg. C, 71%RH, 1008 hPa	120Vac, 60Hz	Nick Chen

3.3 GENERAL DESCRIPTION OF APPLIED STANDARDS

The EUT is a RF Product. According to the specifications of the manufacturer, it must comply with the requirements of the following standards:

FCC Part 15, Subpart E (15.407)
ANSI C63.4-2003

All test items have been performed and recorded as per the above standards.

NOTE: The EUT is also considered as a kind of computer peripheral, because the connection to computer is necessary for typical use. It has been verified to comply with the requirements of FCC Part 15, Subpart B, Class B (DoC). The test report has been issued separately.

3.4 DESCRIPTION OF SUPPORT UNITS

The EUT has been tested as an independent unit together with other necessary accessories or support units. The following support units or accessories were used to form a representative test configuration during the tests.

NO.	PRODUCT	BRAND	MODEL NO.	SERIAL NO.	FCC ID
1	NOTEBOOK	DELL	PP05L	24729091408	FCC DoC Approved
2	NOTEBOOK	DELL	PP05L	20375526736	FCC DoC Approved
3	EXTERNAL HARD DISK	DELL	RD1000	HK-0XM763-72953-77Q-0021	NA
4	POE	SonicWall	PD-6083G300	NA	NA

NO.	SIGNAL CABLE DESCRIPTION OF THE ABOVE SUPPORT UNITS
1	10m non-shielded RJ45 UTP cable.
2	1m non-shielded RJ45 UTP cable.
3	2m shielded cable, terminated with USB connector, with 2 cores.
4	10m non-shielded RJ45 UTP cable.

NOTE: 1. All power cords of the above support units are non shielded (1.8m).
 2. Items 1 ~ 2 acted as communication partners to transfer data.
 3. Item 4 was provided by the client and for test mode B.

4. TEST TYPES AND RESULTS

4.1 RADIATED EMISSION MEASUREMENT

4.1.1 LIMITS OF RADIATED EMISSION MEASUREMENT

Emissions radiated outside of the specified bands, shall be according to the general radiated limits in 15.209 as following:

FREQUENCIES (MHz)	FIELD STRENGTH (microvolts/meter)	MEASUREMENT DISTANCE (meters)
0.009 ~ 0.490	2400/F(kHz)	300
0.490 ~ 1.705	24000/F(kHz)	30
1.705 ~ 30.0	30	30
30 ~ 88	100	3
88 ~ 216	150	3
216 ~ 960	200	3
Above 960	500	3

NOTE:

1. The lower limit shall apply at the transition frequencies.
2. Emission level (dBuV/m) = 20 log Emission level (uV/m).
3. As shown in 15.35(b), for frequencies above 1000MHz, the field strength limits are based on average detector, however, the peak field strength of any emission shall not exceed the maximum permitted average limits, specified above by more than 20dB under any condition of modulation.

4.1.2 LIMITS OF UNWANTED EMISSION OUT OF THE RESTRICTED BANDS

FREQUENCIES (MHz)	EIRP LIMIT (dBm)		EQUIVALENT FIELD STRENGTH AT 3m (dBµV/m) *NOTE 3	
	PK	AV	PK	AV
5150 ~ 5250	-7	-27	88.3	68.3

NOTE:

1. For frequencies 10MHz or greater above or below the band edge.
2. All emissions within the frequency range from the band edge to 10MHz above or below the band edge.
3. The following formula is used to convert the equipment isotropic radiated power (eirp) to field strength:

$$E = \frac{1000000\sqrt{30P}}{3} \mu\text{V/m, where P is the eirp (Watts).}$$



A D T

4.1.3 TEST INSTRUMENTS

FOR FREQUENCY ABOVE 1 GHz:

DESCRIPTION & MANUFACTURER	MODEL NO.	SERIAL NO.	DATE OF CALIBRATION	DUE DATE OF CALIBRATION
Agilent Spectrum	8564EC	4208A00659	Jul. 24, 2009	Jul. 23, 2010
Agilent Preamplifier	8449B	3008A01924	Aug. 31, 2009	Aug. 30, 2010
Agilent Preamplifier	8449B	3008A01292	Aug. 10, 2009	Aug. 09, 2010
MITEQ Preamplifier	AMF-6F-260400-33 -8P	892164	Aug. 31, 2009	Aug. 30, 2010
Schwarzbeck Horn Antenna	BBHA-9170	BBHA9170190	Sep. 24, 2009	Sep. 23, 2010
Schwarzbeck Horn Antenna	BBHA-9120	D130	May 15, 2009	May 14, 2010
ADT. Turn Table	TT100	0201	NA	NA
ADT. Tower	AT100	0201	NA	NA
Software	ADT_Radiated_V7. 6.15.9.2	NA	NA	NA
SUHNER RF cable	SF106-18	PHACAB-1G- 40GHz	Aug. 20, 2009	Aug. 19, 2010

- NOTE:**
1. The calibration interval of the above test instruments is 12 months. And the calibrations are traceable to NML/ROC and NIST/USA.
 2. The test was performed in Open Site No. 10.
 3. The Industry Canada Reference No. IC 7450E-10.
 4. The FCC Site Registration No. 698148.

FOR FREQUENCY BELOW 1 GHz:

DESCRIPTION & MANUFACTURER	MODEL NO.	SERIAL NO.	DATE OF CALIBRATION	DUE DATE OF CALIBRATION
ROHDE & SCHWARZ TEST RECEIVER	ESVS 30	841977/008	Apr. 24, 2009	Apr. 23, 2010
SCHAFFNER BILOG Antenna	CBL6111C	2793	Apr. 29, 2009	Apr. 28, 2010
ADT. Turn Table	TT100	0201	NA	NA
ADT. Tower	AT100	0201	NA	NA
Software	ADT_Radiated_V7. 6.15.9.2	NA	NA	NA
ADT RF Switches BOX	EM-H-01-1	1004	Dec. 19, 2008	Dec. 18, 2009
WOKEN RF cable	8D	CABLE-ST10-01	Dec. 19, 2008	Dec. 18, 2009

- NOTE:**
1. The calibration interval of the above test instruments is 12 months. And the calibrations are traceable to NML/ROC and NIST/USA.
 2. The test was performed in Open Site No. 10.
 3. The VCCI Site Registration No. R-1625.
 4. The Industry Canada Reference No. IC 7450E-10.
 5. The FCC Site Registration No. 698148.

4.1.4 TEST PROCEDURES

- a. The EUT was placed on the top of a rotating table 0.8 meters above the ground at a 10 meter open area test site. The table was rotated 360 degrees to determine the position of the highest radiation.
- b. The EUT was set 3 meters away from the interference-receiving antenna, which was mounted on the top of a variable-height antenna tower.
- c. The antenna is a broadband antenna, and its height is varied from one meter to four meters above the ground to determine the maximum value of the field strength. Both horizontal and vertical polarizations of the antenna are set to make the measurement.
- d. For each suspected emission, the EUT was arranged to its worst case and then the antenna was tuned to heights from 1 meter to 4 meters and the rotatable table was turned from 0 degrees to 360 degrees to find the maximum reading.
- e. The test-receiver system was set to Peak Detect Function and Specified Bandwidth with Maximum Hold Mode.
- f. If the emission level of the EUT in peak mode was 10dB lower than the limit specified, then testing could be stopped and the peak values of the EUT would be reported. Otherwise the emissions that did not have 10dB margin would be re-tested one by one using peak, quasi-peak or average method as specified and then reported in a data sheet.

NOTE:

1. The resolution bandwidth and video bandwidth of test receiver/spectrum analyzer is 120kHz for Peak detection (PK) and Quasi-peak detection (QP) at frequency below 1GHz.
2. The resolution bandwidth of test receiver/spectrum analyzer is 1MHz and video bandwidth is 3MHz for Peak detection at frequency above 1GHz.
3. The resolution bandwidth of test receiver/spectrum analyzer is 1MHz and the video bandwidth is 10Hz for Average detection (AV) at frequency above 1GHz.
4. All modes of operation were investigated and the worst-case emissions are reported.

4.1.5 DEVIATION FROM TEST STANDARD

No deviation.

4.1.6 TEST SETUP

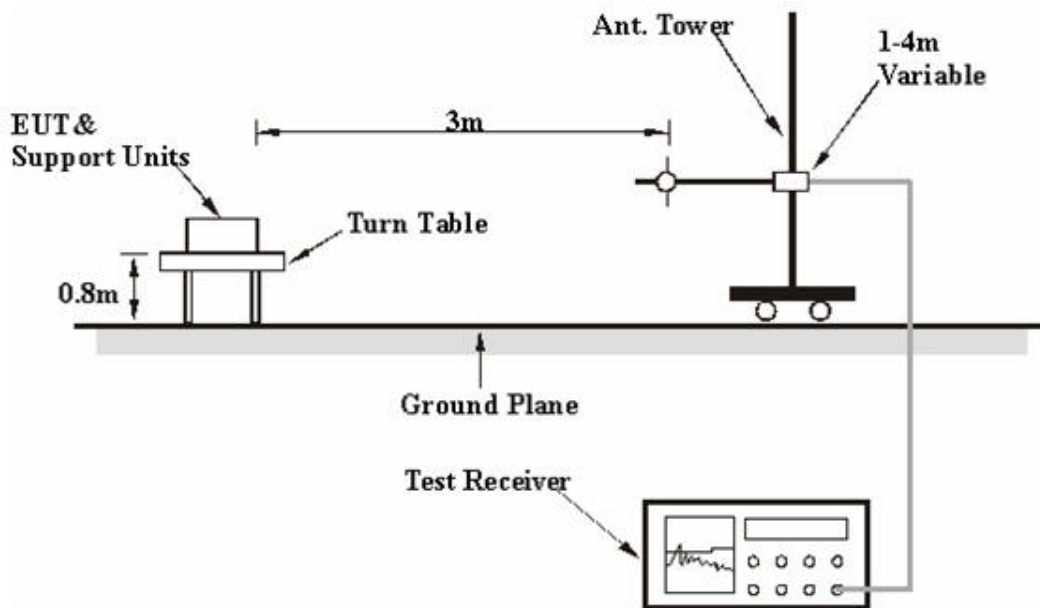

For the actual test configuration, please refer to the attached file (Test Setup Photo).

4.1.7 EUT OPERATING CONDITION

- a. Placed the EUT on the testing table.
- b. Prepared notebook system outside of testing area to act as a communication partners.
- c. The communication partner connected with EUT via a RJ45 UTP cable and run a test program (provided by manufacturer) to enable EUT under transmission condition continuously at specific channel frequency.
- d. The communication partner sent data to EUT by command "PING".

4.1.8 TEST RESULTS

802.11a

EUT TEST CONDITION		MEASUREMENT DETAIL	
CHANNEL	Channel 36	FREQUENCY RANGE	1 ~ 40GHz
INPUT POWER (SYSTEM)	120Vac, 60 Hz	DETECTOR FUNCTION	Peak (PK) Average (AV)
ENVIRONMENTAL CONDITIONS	22deg. C, 83%RH 1000 hPa	TESTED BY	Nick Chen

ANTENNA POLARITY & TEST DISTANCE: HORIZONTAL AT 3 M								
NO.	FREQ. (MHz)	EMISSION LEVEL (dBuV/m)	LIMIT (dBuV/m)	MARGIN (dB)	ANTENNA HEIGHT (m)	TABLE ANGLE (Degree)	RAW VALUE (dBuV)	CORRECTION FACTOR (dB/m)
1	5150.00	57.8 PK	74.00	-16.2	1.49 H	214	19.43	38.35
2	5150.00	46.7 AV	54.00	-7.3	1.49 H	214	8.33	38.35
3	*5180.00	100.0 PK			1.49 H	214	61.54	38.42
4	*5180.00	86.1 AV			1.49 H	214	47.71	38.42
5	#6906.00	68.8 PK	88.30	-19.5	1.59 H	198	25.80	43.03
6	#6906.00	54.4 AV	68.30	-13.9	1.59 H	198	11.36	43.03
7	##10360.00	59.5 PK	68.30	-8.8	1.38 H	98	10.44	49.09
ANTENNA POLARITY & TEST DISTANCE: VERTICAL AT 3 M								
NO.	FREQ. (MHz)	EMISSION LEVEL (dBuV/m)	LIMIT (dBuV/m)	MARGIN (dB)	ANTENNA HEIGHT (m)	TABLE ANGLE (Degree)	RAW VALUE (dBuV)	CORRECTION FACTOR (dB/m)
1	5150.00	68.6 PK	74.00	-5.4	1.39 V	78	30.27	38.35
2	5150.00	48.5 AV	54.00	-5.5	1.39 V	78	10.18	38.35
3	*5180.00	114.0 PK			1.39 V	78	75.57	38.42
4	*5180.00	100.7 AV			1.39 V	78	62.29	38.42
5	#6906.00	63.5 PK	88.30	-24.8	1.63 V	216	20.48	43.03
6	#6906.00	61.4 AV	68.30	-7.0	1.63 V	216	18.32	43.03
7	##10360.00	59.7 PK	68.30	-8.6	1.35 V	236	10.65	49.09

- REMARKS:**
1. Emission level (dBuV/m) = Raw Value (dBuV) + Correction Factor (dB/m).
 2. Correction Factor (dB/m) = Antenna Factor (dB/m) + Cable Factor (dB).
 3. The other emission levels were very low against the limit.
 4. Margin value = Emission level – Limit value.
 5. “ * “: Fundamental frequency.
 6. “#”: The radiated frequency is out the restricted band.
 7. “##”: The radiated frequency is out the restricted band and PK emission is low than the AV limit.



EUT TEST CONDITION		MEASUREMENT DETAIL	
CHANNEL	Channel 40	FREQUENCY RANGE	1 ~ 40GHz
INPUT POWER (SYSTEM)	120Vac, 60 Hz	DETECTOR FUNCTION	Peak (PK) Average (AV)
ENVIRONMENTAL CONDITIONS	22deg. C, 83%RH 1000 hPa	TESTED BY	Nick Chen

ANTENNA POLARITY & TEST DISTANCE: HORIZONTAL AT 3 M								
NO.	FREQ. (MHz)	EMISSION LEVEL (dBuV/m)	LIMIT (dBuV/m)	MARGIN (dB)	ANTENNA HEIGHT (m)	TABLE ANGLE (Degree)	RAW VALUE (dBuV)	CORRECTION FACTOR (dB/m)
1	*5200.00	99.8 PK			1.42 H	188	61.36	38.47
2	*5200.00	85.4 AV			1.42 H	188	46.96	38.47
3	#6933.00	58.6 PK	88.30	-29.7	1.38 H	26	15.51	43.12
4	#6933.00	53.1 AV	68.30	-15.2	1.38 H	26	9.94	43.12
5	##10400.00	58.9 PK	68.30	-9.4	1.26 H	153	9.72	49.15
ANTENNA POLARITY & TEST DISTANCE: VERTICAL AT 3 M								
NO.	FREQ. (MHz)	EMISSION LEVEL (dBuV/m)	LIMIT (dBuV/m)	MARGIN (dB)	ANTENNA HEIGHT (m)	TABLE ANGLE (Degree)	RAW VALUE (dBuV)	CORRECTION FACTOR (dB/m)
1	*5200.00	113.1 PK			1.38 V	26	74.59	38.47
2	*5200.00	94.6 AV			1.38 V	26	56.16	38.47
3	#6933.00	57.5 PK	88.30	-30.8	1.31 V	237	14.41	43.12
4	#6933.00	53.1 AV	68.30	-15.2	1.31 V	237	9.97	43.12
5	##10400.00	59.1 PK	68.30	-9.2	1.22 V	136	9.96	49.15

- REMARKS:**
1. Emission level (dBuV/m) = Raw Value (dBuV) + Correction Factor (dB/m).
 2. Correction Factor (dB/m) = Antenna Factor (dB/m) + Cable Factor (dB).
 3. The other emission levels were very low against the limit.
 4. Margin value = Emission level – Limit value.
 5. “ * “: Fundamental frequency.
 6. “#”: The radiated frequency is out the restricted band.
 7. “##”: The radiated frequency is out the restricted band and PK emission is low than the AV limit.



EUT TEST CONDITION		MEASUREMENT DETAIL	
CHANNEL	Channel 48	FREQUENCY RANGE	1 ~ 40GHz
INPUT POWER (SYSTEM)	120Vac, 60 Hz	DETECTOR FUNCTION	Peak (PK) Average (AV)
ENVIRONMENTAL CONDITIONS	22deg. C, 83%RH 1000 hPa	TESTED BY	Nick Chen

ANTENNA POLARITY & TEST DISTANCE: HORIZONTAL AT 3 M								
NO.	FREQ. (MHz)	EMISSION LEVEL (dBuV/m)	LIMIT (dBuV/m)	MARGIN (dB)	ANTENNA HEIGHT (m)	TABLE ANGLE (Degree)	RAW VALUE (dBuV)	CORRECTION FACTOR (dB/m)
1	*5240.00	99.4 PK			1.42 H	206	60.86	38.50
2	*5240.00	84.8 AV			1.42 H	206	46.33	38.50
3	5350.00	61.4 PK	74.00	-12.6	1.42 H	206	22.76	38.63
4	5350.00	49.8 AV	54.00	-4.2	1.42 H	206	11.14	38.63
5	#6986.00	55.9 PK	88.30	-32.4	1.18 H	297	12.57	43.29
6	#6986.00	48.2 AV	68.30	-20.1	1.18 H	297	4.87	43.29
7	##10480.00	59.9 PK	68.30	-8.4	1.22 H	275	10.62	49.26
ANTENNA POLARITY & TEST DISTANCE: VERTICAL AT 3 M								
NO.	FREQ. (MHz)	EMISSION LEVEL (dBuV/m)	LIMIT (dBuV/m)	MARGIN (dB)	ANTENNA HEIGHT (m)	TABLE ANGLE (Degree)	RAW VALUE (dBuV)	CORRECTION FACTOR (dB/m)
1	*5240.00	113.1 PK			1.31 V	96	74.61	38.50
2	*5240.00	93.9 AV			1.31 V	96	55.36	38.50
3	5350.00	62.8 PK	74.00	-11.2	1.31 V	96	24.14	38.63
4	5350.00	50.3 AV	54.00	-3.7	1.31 V	96	11.66	38.63
5	#6986.00	56.8 PK	88.30	-31.5	1.19 V	234	13.52	43.29
6	#6986.00	50.6 AV	68.30	-17.7	1.19 V	234	7.34	43.29
7	##10480.00	59.3 PK	68.30	-9.0	1.23 V	109	10.07	49.26

- REMARKS:**
1. Emission level (dBuV/m) = Raw Value (dBuV) + Correction Factor (dB/m).
 2. Correction Factor (dB/m) = Antenna Factor (dB/m) + Cable Factor (dB).
 3. The other emission levels were very low against the limit.
 4. Margin value = Emission level – Limit value.
 5. “ * “: Fundamental frequency.
 6. “#”:The radiated frequency is out the restricted band.
 7. “##”: The radiated frequency is out the restricted band and PK emission is low than the AV limit.



802.11n (20MHz)

EUT TEST CONDITION		MEASUREMENT DETAIL	
CHANNEL	Channel 36	FREQUENCY RANGE	1 ~ 40GHz
INPUT POWER (SYSTEM)	120Vac, 60 Hz	DETECTOR FUNCTION	Peak (PK) Average (AV)
ENVIRONMENTAL CONDITIONS	22deg. C, 83%RH 1000 hPa	TESTED BY	Nick Chen

ANTENNA POLARITY & TEST DISTANCE: HORIZONTAL AT 3 M								
NO.	FREQ. (MHz)	EMISSION LEVEL (dBuV/m)	LIMIT (dBuV/m)	MARGIN (dB)	ANTENNA HEIGHT (m)	TABLE ANGLE (Degree)	RAW VALUE (dBuV)	CORRECTION FACTOR (dB/m)
1	5150.00	57.9 PK	74.00	-16.1	1.52 H	151	19.56	38.35
2	5150.00	46.8 AV	54.00	-7.2	1.52 H	151	8.48	38.35
3	*5180.00	100.2 PK			1.52 H	151	61.74	38.42
4	*5180.00	86.2 AV			1.52 H	151	47.78	38.42
5	#6906.00	68.9 PK	88.30	-19.4	1.62 H	177	25.91	43.03
6	#6906.00	54.6 AV	68.30	-13.7	1.62 H	177	11.58	43.03
7	##10360.00	59.6 PK	68.30	-8.7	1.50 H	89	10.52	49.09
ANTENNA POLARITY & TEST DISTANCE: VERTICAL AT 3 M								
NO.	FREQ. (MHz)	EMISSION LEVEL (dBuV/m)	LIMIT (dBuV/m)	MARGIN (dB)	ANTENNA HEIGHT (m)	TABLE ANGLE (Degree)	RAW VALUE (dBuV)	CORRECTION FACTOR (dB/m)
1	5150.00	68.9 PK	74.00	-5.2	1.45 V	58	30.50	38.35
2	5150.00	48.7 AV	54.00	-5.3	1.45 V	58	10.33	38.35
3	*5180.00	114.1 PK			1.45 V	58	75.67	38.42
4	*5180.00	100.8 AV			1.45 V	58	62.41	38.42
5	#6906.00	63.6 PK	88.30	-24.7	1.73 V	246	20.61	43.03
6	#6906.00	61.4 AV	68.30	-6.9	1.73 V	246	18.40	43.03
7	##10360.00	59.8 PK	68.30	-8.5	1.38 V	243	10.71	49.09

- REMARKS:**
1. Emission level (dBuV/m) = Raw Value (dBuV) + Correction Factor (dB/m).
 2. Correction Factor (dB/m) = Antenna Factor (dB/m) + Cable Factor (dB).
 3. The other emission levels were very low against the limit.
 4. Margin value = Emission level – Limit value.
 5. “ * “: Fundamental frequency.
 7. “##”: The radiated frequency is out the restricted band and PK emission is low than the AV limit.



EUT TEST CONDITION		MEASUREMENT DETAIL	
CHANNEL	Channel 40	FREQUENCY RANGE	1 ~ 40GHz
INPUT POWER (SYSTEM)	120Vac, 60 Hz	DETECTOR FUNCTION	Peak (PK) Average (AV)
ENVIRONMENTAL CONDITIONS	22deg. C, 83%RH 1000 hPa	TESTED BY	Nick Chen

ANTENNA POLARITY & TEST DISTANCE: HORIZONTAL AT 3 M								
NO.	FREQ. (MHz)	EMISSION LEVEL (dBuV/m)	LIMIT (dBuV/m)	MARGIN (dB)	ANTENNA HEIGHT (m)	TABLE ANGLE (Degree)	RAW VALUE (dBuV)	CORRECTION FACTOR (dB/m)
1	*5200.00	100.0 PK			1.49 H	162	61.49	38.47
2	*5200.00	85.6 AV			1.49 H	162	47.14	38.47
3	#6933.00	58.8 PK	88.30	-29.5	1.48 H	5	15.66	43.12
4	#6933.00	54.0 AV	68.30	-14.3	1.48 H	5	10.87	43.12
5	##10400.00	59.2 PK	68.30	-9.1	1.39 H	133	10.03	49.15
ANTENNA POLARITY & TEST DISTANCE: VERTICAL AT 3 M								
NO.	FREQ. (MHz)	EMISSION LEVEL (dBuV/m)	LIMIT (dBuV/m)	MARGIN (dB)	ANTENNA HEIGHT (m)	TABLE ANGLE (Degree)	RAW VALUE (dBuV)	CORRECTION FACTOR (dB/m)
1	*5200.00	113.2 PK			1.42 V	9	74.77	38.47
2	*5200.00	99.7 AV			1.42 V	9	61.25	38.47
3	#6933.00	57.8 PK	88.30	-30.5	1.32 V	244	14.67	43.12
4	#6933.00	53.4 AV	68.30	-15.0	1.32 V	244	10.23	43.12
5	##10400.00	59.3 PK	68.30	-9.0	1.32 V	101	10.14	49.15

- REMARKS:**
1. Emission level (dBuV/m) = Raw Value (dBuV) + Correction Factor (dB/m).
 2. Correction Factor (dB/m) = Antenna Factor (dB/m) + Cable Factor (dB).
 3. The other emission levels were very low against the limit.
 4. Margin value = Emission level – Limit value.
 5. “ * “: Fundamental frequency.
 6. “#”:The radiated frequency is out the restricted band.
 7. “##”: The radiated frequency is out the restricted band and PK emission is low than the AV limit.

EUT TEST CONDITION		MEASUREMENT DETAIL	
CHANNEL	Channel 48	FREQUENCY RANGE	1 ~ 40GHz
INPUT POWER (SYSTEM)	120Vac, 60 Hz	DETECTOR FUNCTION	Peak (PK) Average (AV)
ENVIRONMENTAL CONDITIONS	22deg. C, 83%RH 1000 hPa	TESTED BY	Nick Chen

ANTENNA POLARITY & TEST DISTANCE: HORIZONTAL AT 3 M								
NO.	FREQ. (MHz)	EMISSION LEVEL (dBuV/m)	LIMIT (dBuV/m)	MARGIN (dB)	ANTENNA HEIGHT (m)	TABLE ANGLE (Degree)	RAW VALUE (dBuV)	CORRECTION FACTOR (dB/m)
1	*5240.00	99.5 PK			1.44 H	198	61.00	38.50
2	*5240.00	85.0 AV			1.44 H	198	46.49	38.50
3	5350.00	61.5 PK	74.00	-12.6	1.44 H	198	22.82	38.63
4	5350.00	49.9 AV	54.00	-4.1	1.44 H	198	11.23	38.63
5	#6986.00	56.0 PK	88.30	-32.4	1.19 H	307	12.66	43.29
6	#6986.00	48.3 AV	68.30	-20.0	1.19 H	307	4.97	43.29
7	##10480.00	60.0 PK	68.30	-8.4	1.21 H	263	10.69	49.26
ANTENNA POLARITY & TEST DISTANCE: VERTICAL AT 3 M								
NO.	FREQ. (MHz)	EMISSION LEVEL (dBuV/m)	LIMIT (dBuV/m)	MARGIN (dB)	ANTENNA HEIGHT (m)	TABLE ANGLE (Degree)	RAW VALUE (dBuV)	CORRECTION FACTOR (dB/m)
1	*5240.00	112.3 PK			1.30 V	80	73.80	38.50
2	*5240.00	98.0 AV			1.30 V	80	59.50	38.50
3	5350.00	62.9 PK	74.00	-11.1	1.30 V	80	24.26	38.63
4	5350.00	50.4 AV	54.00	-3.6	1.30 V	80	11.78	38.63
5	#6986.00	57.0 PK	88.30	-31.3	1.22 V	250	13.68	43.29
6	#6986.00	50.8 AV	68.30	-17.5	1.22 V	250	7.49	43.29
7	##10480.00	59.5 PK	68.30	-8.8	1.26 V	99	10.23	49.26

- REMARKS:**
1. Emission level (dBuV/m) = Raw Value (dBuV) + Correction Factor (dB/m).
 2. Correction Factor (dB/m) = Antenna Factor (dB/m) + Cable Factor (dB).
 3. The other emission levels were very low against the limit.
 4. Margin value = Emission level – Limit value.
 5. “ * “: Fundamental frequency.
 6. “#”:The radiated frequency is out the restricted band.
 7. “##”: The radiated frequency is out the restricted band and PK emission is low than the AV limit.

802.11n (40MHz)

EUT TEST CONDITION		MEASUREMENT DETAIL	
CHANNEL	Channel 38	FREQUENCY RANGE	1 ~ 40GHz
INPUT POWER (SYSTEM)	120Vac, 60 Hz	DETECTOR FUNCTION	Peak (PK) Average (AV)
ENVIRONMENTAL CONDITIONS	22deg. C, 83%RH 1000 hPa	TESTED BY	Nick Chen

ANTENNA POLARITY & TEST DISTANCE: HORIZONTAL AT 3 M								
NO.	FREQ. (MHz)	EMISSION LEVEL (dBuV/m)	LIMIT (dBuV/m)	MARGIN (dB)	ANTENNA HEIGHT (m)	TABLE ANGLE (Degree)	RAW VALUE (dBuV)	CORRECTION FACTOR (dB/m)
1	5150.00	64.4 PK	74.00	-9.6	1.24 H	211	26.03	38.35
2	5150.00	47.8 AV	54.00	-6.2	1.24 H	211	9.46	38.35
3	*5190.00	101.0 PK			1.24 H	211	62.53	38.45
4	*5190.00	87.0 AV			1.24 H	211	48.52	38.45
5	#6920.00	58.1 PK	88.30	-30.2	1.23 H	199	15.01	43.07
6	#6920.00	52.6 AV	68.30	-15.7	1.23 H	199	9.50	43.07
7	##10380.00	59.3 PK	68.30	-9.0	1.49 H	312	10.17	49.12

ANTENNA POLARITY & TEST DISTANCE: VERTICAL AT 3 M								
NO.	FREQ. (MHz)	EMISSION LEVEL (dBuV/m)	LIMIT (dBuV/m)	MARGIN (dB)	ANTENNA HEIGHT (m)	TABLE ANGLE (Degree)	RAW VALUE (dBuV)	CORRECTION FACTOR (dB/m)
1	5150.00	71.7 PK	74.00	-2.3	1.26 V	265	33.36	38.35
2	5150.00	51.1 AV	54.00	-2.9	1.26 V	265	12.72	38.35
3	*5190.00	112.8 PK			1.26 V	265	74.37	38.45
4	*5190.00	98.1 AV			1.26 V	265	59.61	38.45
5	#6920.00	62.5 PK	88.30	-25.9	1.57 V	321	19.38	43.07
6	#6920.00	59.3 AV	68.30	-9.0	1.57 V	321	16.19	43.07
7	##10380.00	59.8 PK	68.30	-8.6	1.19 V	288	10.63	49.12

- REMARKS:**
1. Emission level (dBuV/m) = Raw Value (dBuV) + Correction Factor (dB/m).
 2. Correction Factor (dB/m) = Antenna Factor (dB/m) + Cable Factor (dB).
 3. The other emission levels were very low against the limit.
 4. Margin value = Emission level – Limit value.
 5. “ * “: Fundamental frequency.
 6. “#”:The radiated frequency is out the restricted band.
 7. “##”: The radiated frequency is out the restricted band and PK emission is low than the AV limit.



EUT TEST CONDITION		MEASUREMENT DETAIL	
CHANNEL	Channel 46	FREQUENCY RANGE	1 ~ 40GHz
INPUT POWER (SYSTEM)	120Vac, 60 Hz	DETECTOR FUNCTION	Peak (PK) Average (AV)
ENVIRONMENTAL CONDITIONS	22deg. C, 83%RH 1000 hPa	TESTED BY	Nick Chen

ANTENNA POLARITY & TEST DISTANCE: HORIZONTAL AT 3 M								
NO.	FREQ. (MHz)	EMISSION LEVEL (dBuV/m)	LIMIT (dBuV/m)	MARGIN (dB)	ANTENNA HEIGHT (m)	TABLE ANGLE (Degree)	RAW VALUE (dBuV)	CORRECTION FACTOR (dB/m)
1	*5230.00	100.5 PK			1.25 H	46	61.99	38.49
2	*5230.00	86.3 AV			1.25 H	46	47.85	38.49
3	5350.00	61.9 PK	74.00	-12.1	1.25 H	46	23.28	38.63
4	5350.00	50.6 AV	54.00	-3.4	1.25 H	46	11.95	38.63
5	#6973.00	57.7 PK	88.30	-20.6	1.24 H	179	14.43	43.24
6	#6973.00	52.1 AV	68.30	-16.3	1.24 H	179	8.81	43.24
7	##10460.00	59.4 PK	68.30	-8.9	1.23 H	53	10.14	49.23
ANTENNA POLARITY & TEST DISTANCE: VERTICAL AT 3 M								
NO.	FREQ. (MHz)	EMISSION LEVEL (dBuV/m)	LIMIT (dBuV/m)	MARGIN (dB)	ANTENNA HEIGHT (m)	TABLE ANGLE (Degree)	RAW VALUE (dBuV)	CORRECTION FACTOR (dB/m)
1	*5230.00	112.0 PK			1.16 V	6	6.12	105.90
2	*5230.00	97.7 AV			1.16 V	6	-8.21	105.90
3	5350.00	68.3 PK	74.00	-5.7	1.16 V	6	-37.59	105.90
4	5350.00	53.2 AV	54.00	-0.8	1.16 V	6	-52.74	105.90
5	#6973.00	62.2 PK	88.30	-26.1	1.37 V	142	-43.74	105.90
6	#6973.00	58.3 AV	68.30	-10.0	1.37 V	142	-47.61	105.90
7	##10460.00	59.9 PK	68.30	-8.5	1.37 V	219	-46.05	105.90

- REMARKS:**
1. Emission level (dBuV/m) = Raw Value (dBuV) + Correction Factor (dB/m).
 2. Correction Factor (dB/m) = Antenna Factor (dB/m) + Cable Factor (dB).
 3. The other emission levels were very low against the limit.
 4. Margin value = Emission level – Limit value.
 5. “ * “: Fundamental frequency.
 6. “#”: The radiated frequency is out the restricted band.
 7. “##”: The radiated frequency is out the restricted band and PK emission is low than the AV limit.



A D T

BELOW 1GHz WORST-CASE DATA : 802.11n (40MHz)

EUT TEST CONDITION		MEASUREMENT DETAIL	
CHANNEL	Channel 38	FREQUENCY RANGE	Below 1000MHz
INPUT POWER (SYSTEM)	120Vac, 60 Hz	DETECTOR FUNCTION	Quasi-Peak
ENVIRONMENTAL CONDITIONS	23deg. C, 76%RH 999 hPa	TEST MODE	A
TESTED BY	Nick Chen		

ANTENNA POLARITY & TEST DISTANCE: HORIZONTAL AT 3 M								
NO.	FREQ. (MHz)	EMISSION LEVEL (dBuV/m)	LIMIT (dBuV/m)	MARGIN (dB)	ANTENNA HEIGHT (m)	TABLE ANGLE (Degree)	RAW VALUE (dBuV)	CORRECTION FACTOR (dB/m)
1	62.72	28.6 QP	40.00	-11.4	1.03 H	67	21.12	7.47
2	146.38	29.4 QP	43.50	-14.1	1.86 H	222	15.72	13.69
3	250.01	38.3 QP	46.00	-7.7	1.03 H	181	22.73	15.56
4	340.03	45.8 QP	46.00	-0.2	1.20 H	32	27.80	17.96
5	500.01	35.6 QP	46.00	-10.4	1.82 H	141	12.32	23.31
6	600.01	39.6 QP	46.00	-6.4	1.29 H	284	14.55	25.08
7	1000.00	38.0 QP	54.00	-16.0	1.76 H	24	7.84	30.12
ANTENNA POLARITY & TEST DISTANCE: VERTICAL AT 3 M								
NO.	FREQ. (MHz)	EMISSION LEVEL (dBuV/m)	LIMIT (dBuV/m)	MARGIN (dB)	ANTENNA HEIGHT (m)	TABLE ANGLE (Degree)	RAW VALUE (dBuV)	CORRECTION FACTOR (dB/m)
1	64.89	32.6 QP	40.00	-7.4	1.28 V	1	25.07	7.57
2	83.06	32.2 QP	40.00	-7.8	1.28 V	26	22.78	9.39
3	125.02	35.0 QP	43.50	-8.5	1.25 V	296	22.22	12.77
4	375.01	35.0 QP	46.00	-11.0	1.22 V	9	15.73	19.23
5	500.00	38.7 QP	46.00	-7.3	1.21 V	241	15.38	23.31
6	625.01	36.3 QP	46.00	-9.7	1.13 V	27	10.96	25.33
7	680.01	42.4 QP	46.00	-3.6	1.21 V	285	16.59	25.80
8	1000.00	44.8 QP	54.00	-9.2	1.13 V	79	14.69	30.12

- REMARKS:**
1. Emission level (dBuV/m) = Raw Value (dBuV) + Correction Factor (dB/m).
 2. Correction Factor (dB/m) = Antenna Factor (dB/m) + Cable Factor (dB).
 3. The other emission levels were very low against the limit.
 4. Margin value = Emission level – Limit value.



A D T

EUT TEST CONDITION		MEASUREMENT DETAIL	
CHANNEL	Channel 38	FREQUENCY RANGE	Below 1000MHz
INPUT POWER (SYSTEM)	120Vac, 60 Hz	DETECTOR FUNCTION	Quasi-Peak
ENVIRONMENTAL CONDITIONS	23deg. C, 76%RH 999 hPa	TEST MODE	B
TESTED BY	Nick Chen		

ANTENNA POLARITY & TEST DISTANCE: HORIZONTAL AT 3 M								
NO.	FREQ. (MHz)	EMISSION LEVEL (dBuV/m)	LIMIT (dBuV/m)	MARGIN (dB)	ANTENNA HEIGHT (m)	TABLE ANGLE (Degree)	RAW VALUE (dBuV)	CORRECTION FACTOR (dB/m)
1	57.13	28.7 QP	40.00	-11.3	1.16 H	284	21.05	7.64
2	125.03	32.6 QP	43.50	-10.9	1.00 H	257	19.86	12.77
3	340.01	45.7 QP	46.00	-0.3	1.06 H	281	27.71	17.95
4	625.01	35.6 QP	46.00	-10.4	1.29 H	24	10.29	25.33
5	680.00	45.2 QP	46.00	-0.8	1.29 H	221	19.39	25.80
6	750.01	37.6 QP	46.00	-8.4	1.07 H	223	10.83	26.79
ANTENNA POLARITY & TEST DISTANCE: VERTICAL AT 3 M								
NO.	FREQ. (MHz)	EMISSION LEVEL (dBuV/m)	LIMIT (dBuV/m)	MARGIN (dB)	ANTENNA HEIGHT (m)	TABLE ANGLE (Degree)	RAW VALUE (dBuV)	CORRECTION FACTOR (dB/m)
1	52.93	38.3 QP	40.00	-1.7	1.10 V	22	30.26	8.05
2	70.56	34.7 QP	40.00	-5.3	1.12 V	267	26.84	7.85
3	125.02	34.7 QP	43.50	-8.8	1.21 V	107	21.89	12.77
4	600.00	41.0 QP	46.00	-5.0	1.00 V	258	15.88	25.08
5	625.02	40.1 QP	46.00	-5.9	1.17 V	324	14.76	25.33
6	750.01	40.3 QP	46.00	-5.7	1.15 V	301	13.50	26.79

- REMARKS:**
1. Emission level (dBuV/m) = Raw Value (dBuV) + Correction Factor (dB/m).
 2. Correction Factor (dB/m) = Antenna Factor (dB/m) + Cable Factor (dB).
 3. The other emission levels were very low against the limit.
 4. Margin value = Emission level – Limit value.

4.2 CONDUCTED EMISSION MEASUREMENT

4.2.1 LIMITS OF CONDUCTED EMISSION MEASUREMENT

FREQUENCY OF EMISSION (MHz)	CONDUCTED LIMIT (dB μ V)	
	Quasi-peak	Average
0.15 ~ 0.5	66 to 56	56 to 46
0.5 ~ 5	56	46
5 ~ 30	60	50

- NOTE:**
1. The lower limit shall apply at the transition frequencies.
 2. The limit decreases in line with the logarithm of the frequency in the range of 0.15 to 0.50MHz.
 3. All emanations from a class A/B digital device or system, including any network of conductors and apparatus connected thereto, shall not exceed the level of field strengths specified above.

4.2.2 TEST INSTRUMENTS

DESCRIPTION & MANUFACTURER	MODEL NO.	SERIAL NO.	DATE OF CALIBRATION	DUE DATE OF CALIBRATION
ROHDE & SCHWARZ Test Receiver	ESCS 30	838251/021	Mar. 05, 2009	Mar. 04, 2010
ROHDE & SCHWARZ Artificial Mains Network (for EUT)	ESH3-Z5	100218	Nov. 26, 2008	Nov. 25, 2009
LISN With Adapter (for EUT)	AD10	C10Ada-001	Nov. 26, 2008	Nov. 25, 2009
ROHDE & SCHWARZ Artificial Mains Network (for peripherals)	ESH3-Z5	100219	Nov. 20, 2008	Nov. 19, 2009
Software	ADT_Cond_V7.3. 7	NA	NA	NA
Software	ADT_ISN_V7.3.7	NA	NA	NA
RF cable (JYEBAO)	5D-FB	Cable-C10.01	Feb. 26, 2009	Feb. 25, 2010
SUHNER Terminator (For ROHDE & SCHWARZ LISN)	65BNC-5001	E1-010773	Feb. 27, 2009	Feb. 26, 2010

- NOTE:**
1. The calibration interval of the above test instruments is 12 months and the calibrations are traceable to NML/ROC and NIST/USA.
 2. The test was performed in Shielded Room No. 10.
 3. The VCCI Site Registration No. C-1852.

4.2.3 TEST PROCEDURES

- a. The EUT was placed 0.4 meters from the conducting wall of the shielded room with EUT being connected to the power mains through a line impedance stabilization network (LISN). Other support units were connected to the power mains through another LISN. The two LISNs provide 50 ohm/ 50uH of coupling impedance for the measuring instrument.
- b. Both lines of the power mains connected to the EUT were checked for maximum conducted interference.
- c. The frequency range from 150kHz to 30MHz was searched. Emission levels under (Limit - 20dB) was not recorded.

4.2.4 DEVIATION FROM TEST STANDARD

No deviation.

4.2.5 TEST SETUP

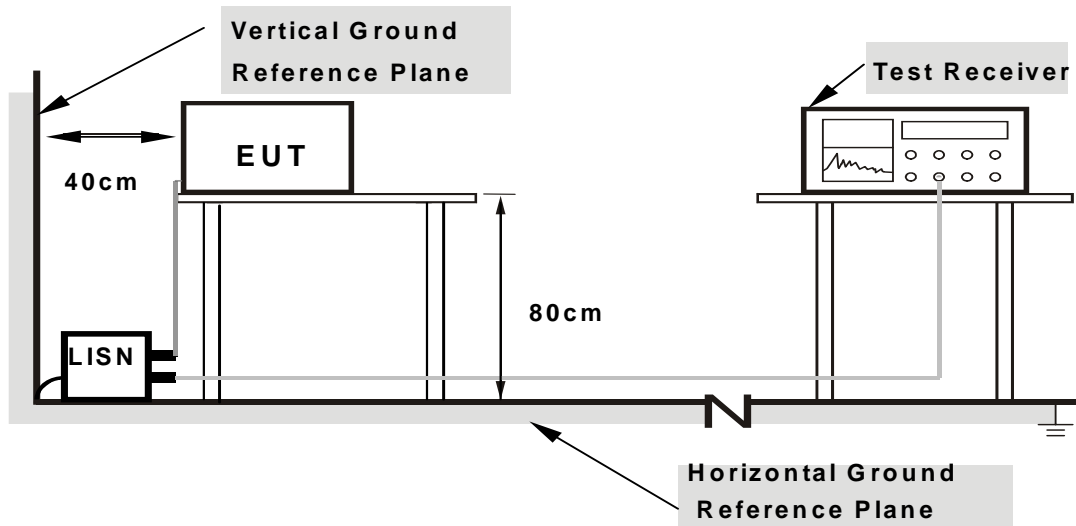

Note: 1.Support units were connected to second LISN.

2.Both of LISNs (AMN) are 80 cm from EUT and at least 80 from other units and other metal planes

For the actual test configuration, please refer to the attached file (Test Setup Photo).

4.2.6 EUT OPERATING CONDITIONS

Same as 4.1.6.

4.2.7 TEST RESULTS

CONDUCTED WORST-CASE DATA : 802.11n (40MHz)

PHASE	Line 1	6dB BANDWIDTH	9kHz
TEST MODE	A		

No	Freq. [MHz]	Corr. Factor (dB)	Reading Value		Emission Level		Limit		Margin	
			[dB (uV)]		[dB (uV)]		[dB (uV)]		(dB)	
			Q.P.	AV.	Q.P.	AV.	Q.P.	AV.	Q.P.	AV.
1	0.291	0.17	46.33	-	46.50	-	60.50	50.50	-14.01	-
2	0.778	0.23	27.50	-	27.73	-	56.00	46.00	-28.27	-
3	2.456	0.30	28.73	-	29.03	-	56.00	46.00	-26.97	-
4	3.987	0.36	33.98	-	34.34	-	56.00	46.00	-21.66	-
5	6.131	0.46	38.26	-	38.72	-	60.00	50.00	-21.28	-
6	11.774	0.78	31.12	-	31.90	-	60.00	50.00	-28.10	-

- REMARKS:**
1. Q.P. and AV. are abbreviations of quasi-peak and average individually.
 2. "-": The Quasi-peak reading value also meets average limit and measurement with the average detector is unnecessary.
 3. The emission levels of other frequencies were very low against the limit.
 4. Margin value = Emission level - Limit value
 5. Correction factor = Insertion loss + Cable loss
 6. Emission Level = Correction Factor + Reading Value.

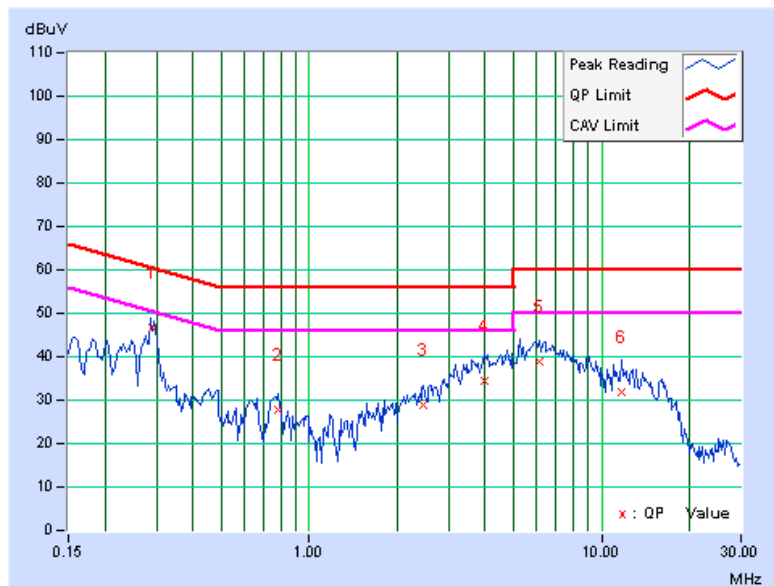



A D T

PHASE	Line 2	6dB BANDWIDTH	9kHz
TEST MODE	A		

No	Freq. [MHz]	Corr. Factor (dB)	Reading Value		Emission Level		Limit		Margin	
			[dB (uV)]		[dB (uV)]		[dB (uV)]		(dB)	
			Q.P.	AV.	Q.P.	AV.	Q.P.	AV.	Q.P.	AV.
1	0.291	0.14	46.39	-	46.53	-	60.51	50.51	-13.98	-
2	0.775	0.21	35.14	-	35.35	-	56.00	46.00	-20.65	-
3	2.147	0.25	30.12	-	30.37	-	56.00	46.00	-25.63	-
4	4.491	0.33	34.04	-	34.37	-	56.00	46.00	-21.63	-
5	6.129	0.38	36.43	-	36.81	-	60.00	50.00	-23.19	-
6	15.745	0.83	25.34	-	26.17	-	60.00	50.00	-33.83	-

- REMARKS:**
1. Q.P. and AV. are abbreviations of quasi-peak and average individually.
 2. "-": The Quasi-peak reading value also meets average limit and measurement with the average detector is unnecessary.
 3. The emission levels of other frequencies were very low against the limit.
 4. Margin value = Emission level - Limit value
 5. Correction factor = Insertion loss + Cable loss
 6. Emission Level = Correction Factor + Reading Value.

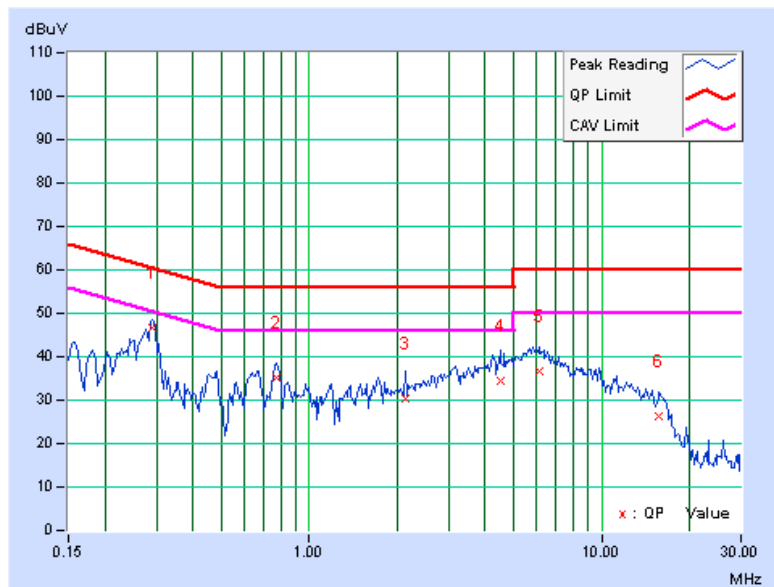



A D T

PHASE	Line 1	6dB BANDWIDTH	9kHz
TEST MODE	B		

No	Freq. [MHz]	Corr. Factor (dB)	Reading Value		Emission Level		Limit		Margin	
			[dB (uV)]		[dB (uV)]		[dB (uV)]		(dB)	
			Q.P.	AV.	Q.P.	AV.	Q.P.	AV.	Q.P.	AV.
1	0.185	0.12	43.21	-	43.33	-	64.27	54.27	-20.94	-
2	0.367	0.20	33.70	-	33.90	-	58.57	48.57	-24.67	-
3	0.646	0.23	30.43	-	30.66	-	56.00	46.00	-25.34	-
4	2.504	0.30	38.86	-	39.16	-	56.00	46.00	-16.84	-
5	3.059	0.32	39.64	-	39.96	-	56.00	46.00	-16.04	-
6	4.140	0.37	38.22	-	38.59	-	56.00	46.00	-17.41	-

- REMARKS:**
1. Q.P. and AV. are abbreviations of quasi-peak and average individually.
 2. "-": The Quasi-peak reading value also meets average limit and measurement with the average detector is unnecessary.
 3. The emission levels of other frequencies were very low against the limit.
 4. Margin value = Emission level - Limit value
 5. Correction factor = Insertion loss + Cable loss
 6. Emission Level = Correction Factor + Reading Value.

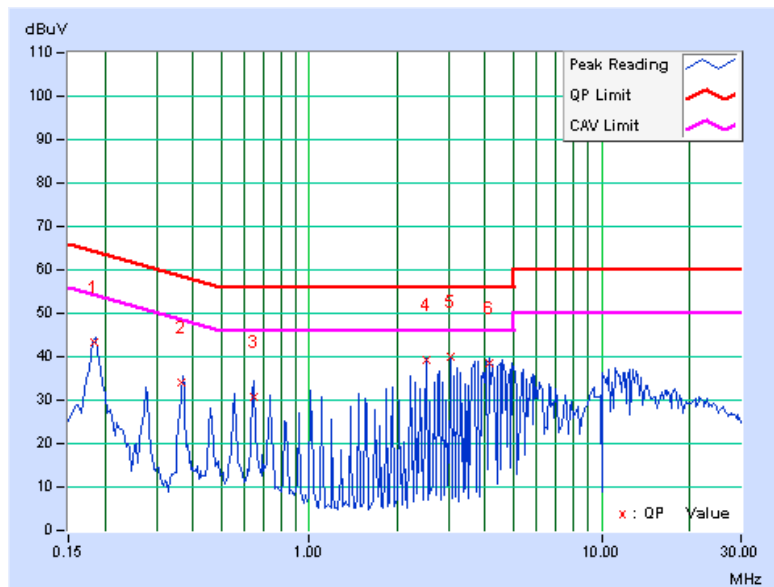



A D T

PHASE	Line 2	6dB BANDWIDTH	9kHz
TEST MODE	B		

No	Freq. [MHz]	Corr. Factor (dB)	Reading Value		Emission Level		Limit		Margin	
			[dB (uV)]		[dB (uV)]		[dB (uV)]		(dB)	
			Q.P.	AV.	Q.P.	AV.	Q.P.	AV.	Q.P.	AV.
1	0.185	0.09	41.66	-	41.75	-	64.25	54.25	-22.50	-
2	0.369	0.18	34.83	-	35.01	-	58.53	48.53	-23.52	-
3	0.642	0.21	33.81	-	34.02	-	56.00	46.00	-21.98	-
4	2.504	0.27	38.82	-	39.09	-	56.00	46.00	-16.91	-
5	3.059	0.28	39.70	-	39.98	-	56.00	46.00	-16.02	-
6	4.142	0.31	37.94	-	38.25	-	56.00	46.00	-17.75	-

- REMARKS:**
1. Q.P. and AV. are abbreviations of quasi-peak and average individually.
 2. "-": The Quasi-peak reading value also meets average limit and measurement with the average detector is unnecessary.
 3. The emission levels of other frequencies were very low against the limit.
 4. Margin value = Emission level - Limit value
 5. Correction factor = Insertion loss + Cable loss
 6. Emission Level = Correction Factor + Reading Value.

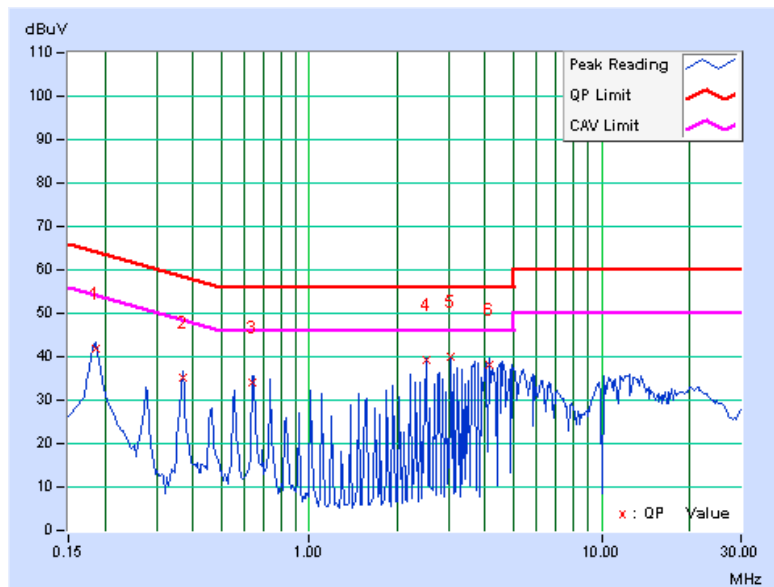

4.3 MAXIMUM CONDUCTED OUTPUT POWER MEASUREMENT

4.3.1 LIMITS OF MAXIMUM CONDUCTED OUTPUT POWER MEASUREMENT

FREQUENCY BAND	LIMIT
5.15 ~ 5.25GHz	The lesser of 50mW (17dBm) or 4dBm + 10logB

NOTE: Where B is the 26dB emission bandwidth in MHz.

4.3.2 TEST INSTRUMENTS

DESCRIPTION & MANUFACTURER	MODEL NO.	SERIAL NO.	DATE OF CALIBRATION	DUE DATE OF CALIBRATION
R&S SPECTRUM ANALYZER	FSP40	100040	Jul. 07, 2009	Jul. 06, 2010

NOTE: The calibration interval of the above test instruments is 12 months and the calibrations are traceable to NML/ROC and NIST/USA.

4.3.3 TEST PROCEDURE

- a. The transmitter output was connected to the spectrum analyzer.
- b. Set span to encompass the entire emission bandwidth of the signal.
- c. Set RBW to 1MHz, VBW to 3MHz.
- d. Using the spectrum analyzer's channel power measurement function to measure the output power.

NOTE: The test is performed in accordance with FCC Public Notice: APPENDIX A Guidelines for Assessing Unlicensed National Information Infrastructure (U-NII) Devices – Part 15, Subpart E, August 2002.

The transmitter output operates continuously therefore Method # 1 is used.

4.3.4 DEVIATION FROM TEST STANDARD

No deviation.

4.3.5 TEST SETUP

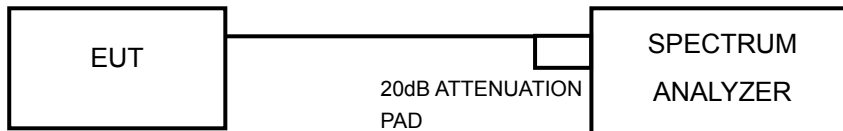

4.3.6 EUT OPERATING CONDITIONS

The software provided by client to enable the EUT under transmission condition continuously at specific channel frequencies individually.



A D T

4.3.7 TEST RESULTS

POWER OUTPUT : 802.11a

CHAN.	CHAN. FREQ. (MHz)	POWER OUTPUT (dBm)		TOTAL POWER (mW)	TOTAL POWER (dBm)	POWER LIMIT (dBm)	PASS / FAIL
		CHAIN 0	CHAIN 1				
36	5180	14.3	14.0	52.1	17.2	17	PASS
40	5200	13.6	14.1	48.5	16.9	17	PASS
48	5240	13.0	14.4	47.5	16.8	17	PASS

FOR CHAIN 1: CH 48

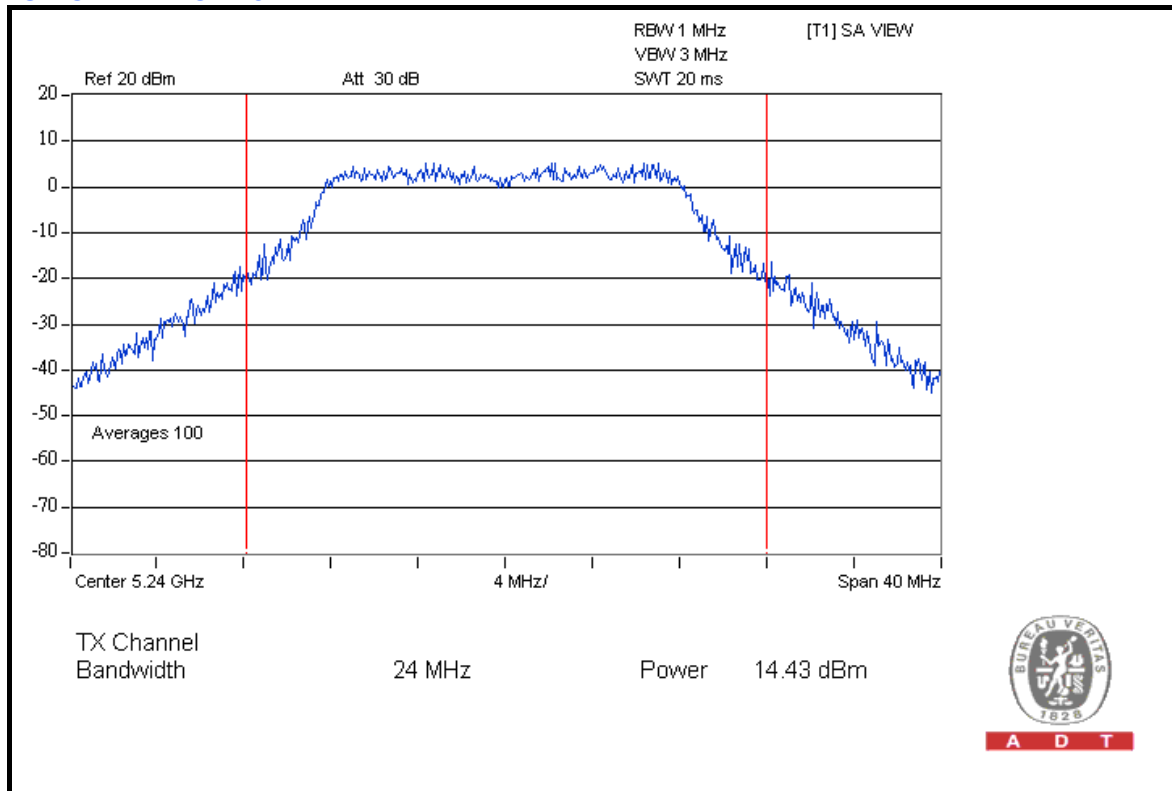



A D T

802.11n (20MHz)

CHAN.	CHAN. FREQ. (MHz)	POWER OUTPUT (dBm)		TOTAL POWER (mW)	TOTAL POWER (dBm)	POWER LIMIT (dBm)	PASS / FAIL
		CHAIN 0	CHAIN 1				
36	5180	14.2	13.9	51.3	17.1	17	PASS
40	5200	13.7	14.2	49.4	16.9	17	PASS
48	5240	13.0	14.4	47.8	16.8	17	PASS

FOR CHAIN 1: CH 48

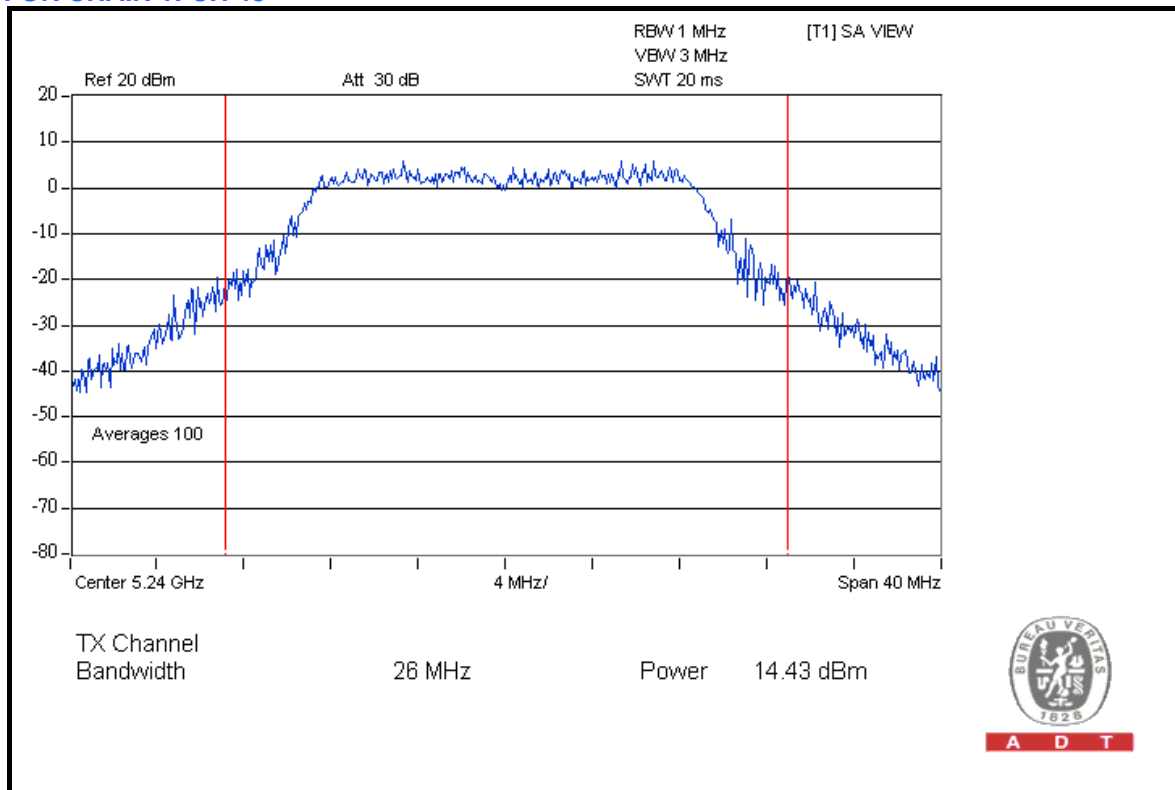



A D T

802.11n (40MHz)

CHAN.	CHAN. FREQ. (MHz)	POWER OUTPUT (dBm)		TOTAL POWER (mW)	TOTAL POWER (dBm)	POWER LIMIT (dBm)	PASS / FAIL
		CHAIN 0	CHAIN 1				
38	5190	14.3	14.2	53.2	17.3	17	PASS
46	5230	13.1	14.3	47.1	16.7	17	PASS

FOR CHAIN 0: CH 38

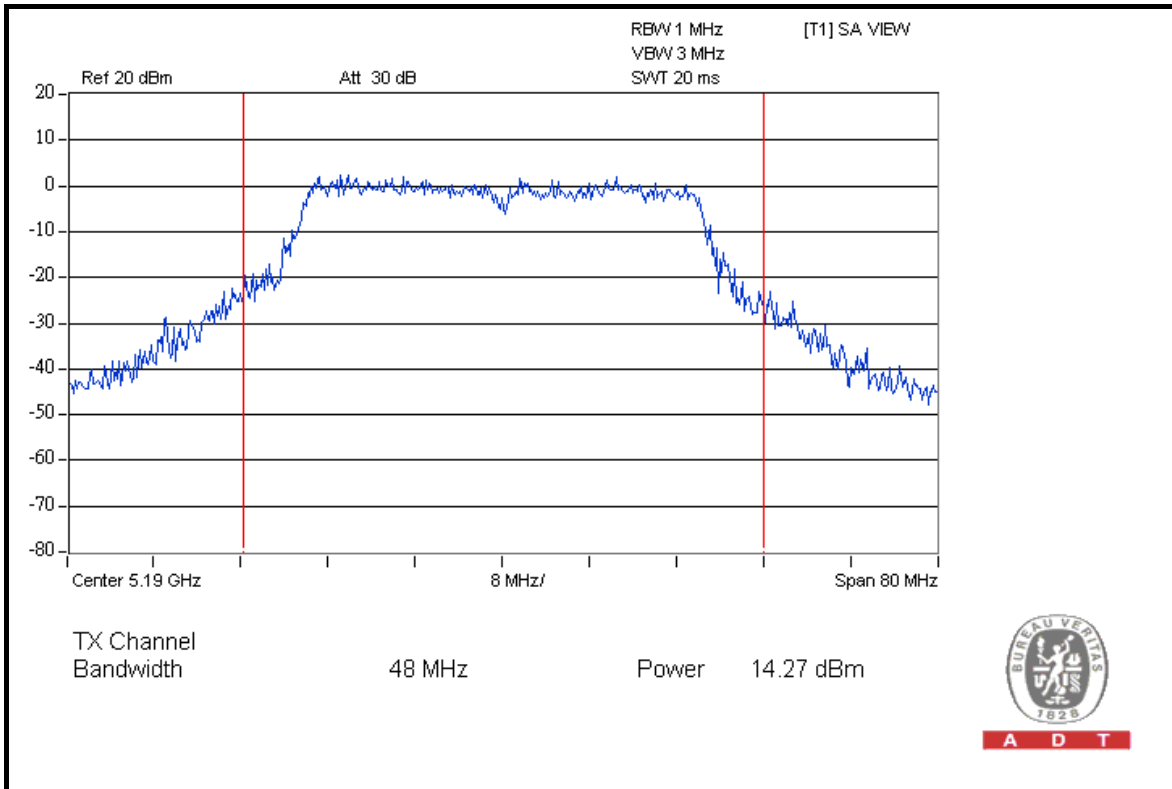



A D T

FOR CHAIN 1: CH 48

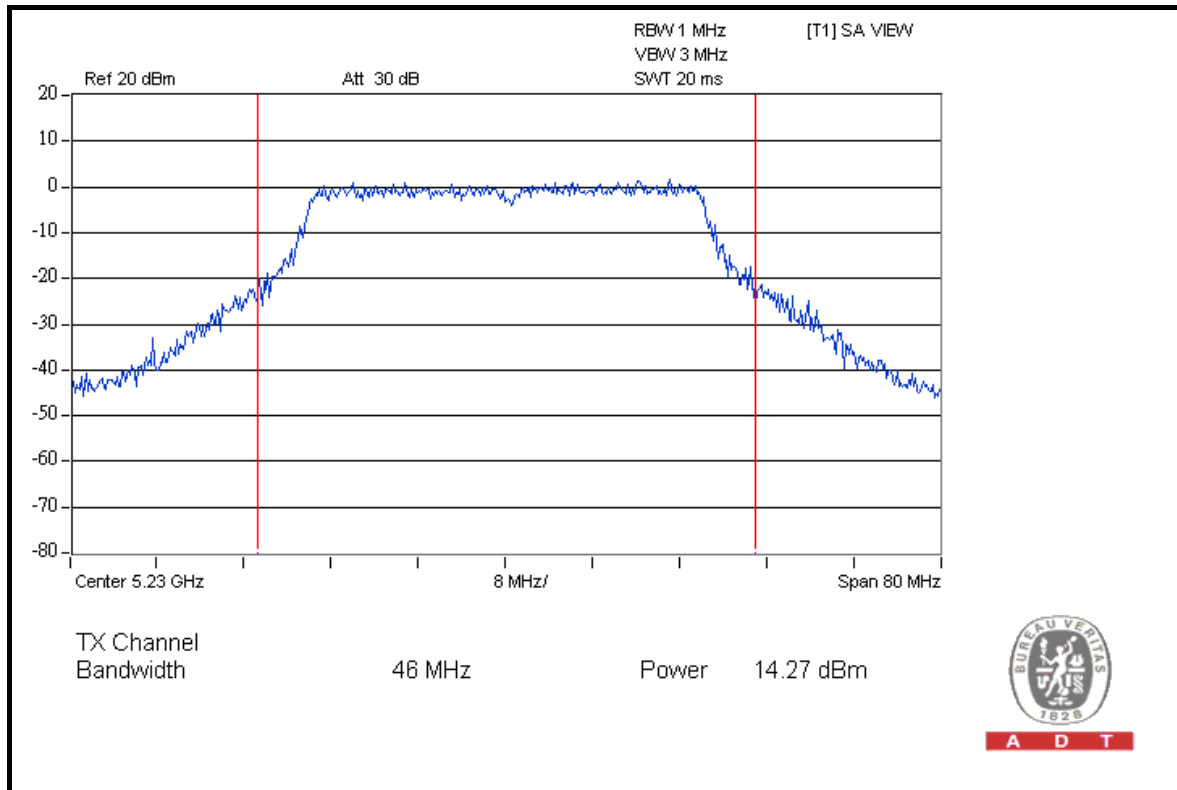

A D T



A D T

26dB OCCUPIED BANDWIDTH: 802.11a

CHANNEL	CHANNEL FREQUENCY (MHz)	26dBc OCCUPIED BANDWIDTH (MHz)		PASS / FAIL
		CHAIN 0	CHAIN 1	
36	5180	24.03	24.28	PASS
40	5200	24.72	24.81	PASS
48	5240	24.58	23.89	PASS

FOR CHAIN 1: CH 40

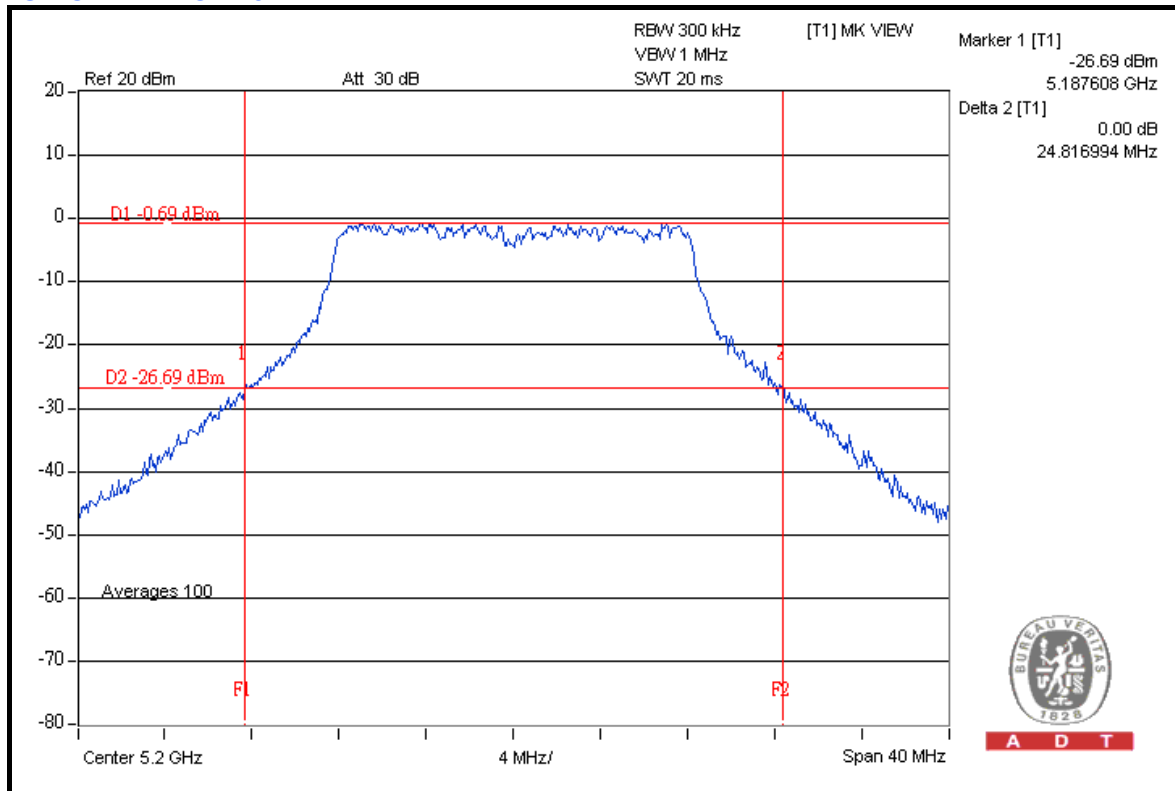



A D T

802.11n (20MHz)

CHANNEL	CHANNEL FREQUENCY (MHz)	26dBc OCCUPIED BANDWIDTH (MHz)		PASS / FAIL
		CHAIN 0	CHAIN 1	
36	5180	25.49	25.92	PASS
40	5200	25.98	25.50	PASS
48	5240	25.09	25.41	PASS

FOR CHAIN 0: CH 40

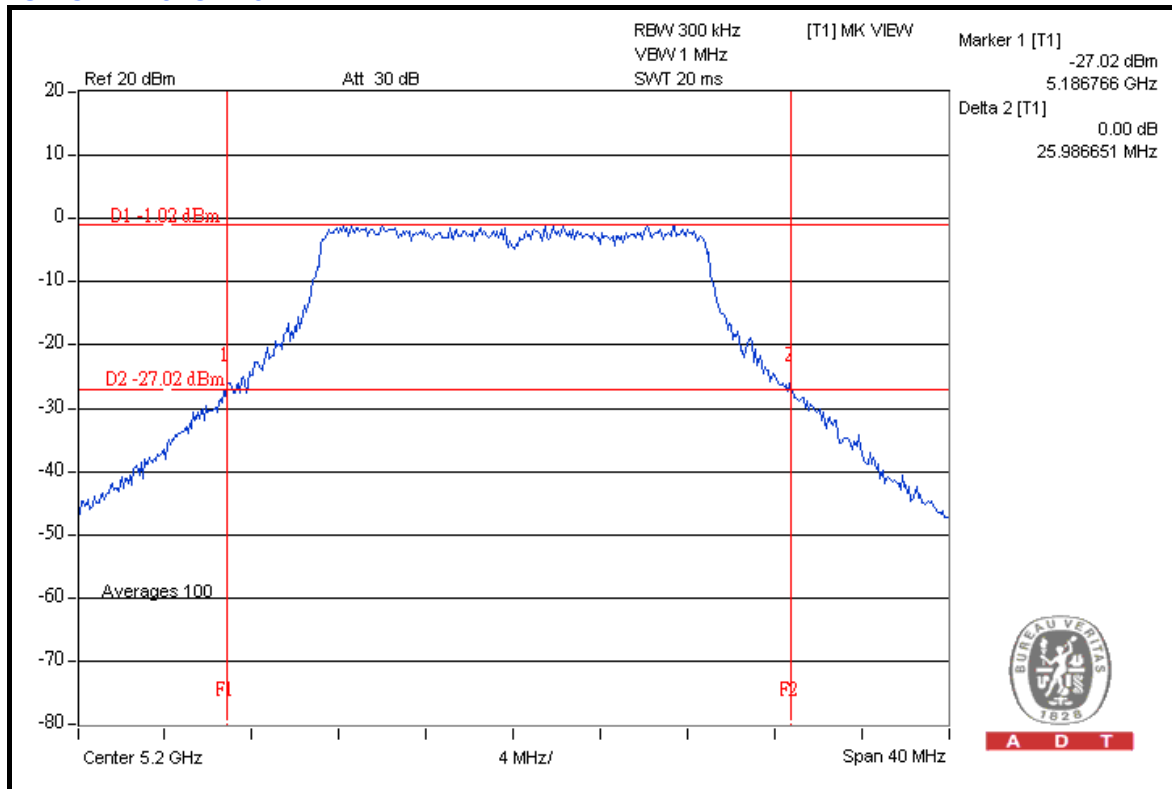

A D T



A D T

802.11n (40MHz)

CHANNEL	CHANNEL FREQUENCY (MHz)	26dBc OCCUPIED BANDWIDTH (MHz)		PASS / FAIL
		CHAIN 0	CHAIN 1	
38	5190	47.15	46.88	PASS
46	5230	47.07	45.98	PASS

FOR CHAIN 0: CH 38

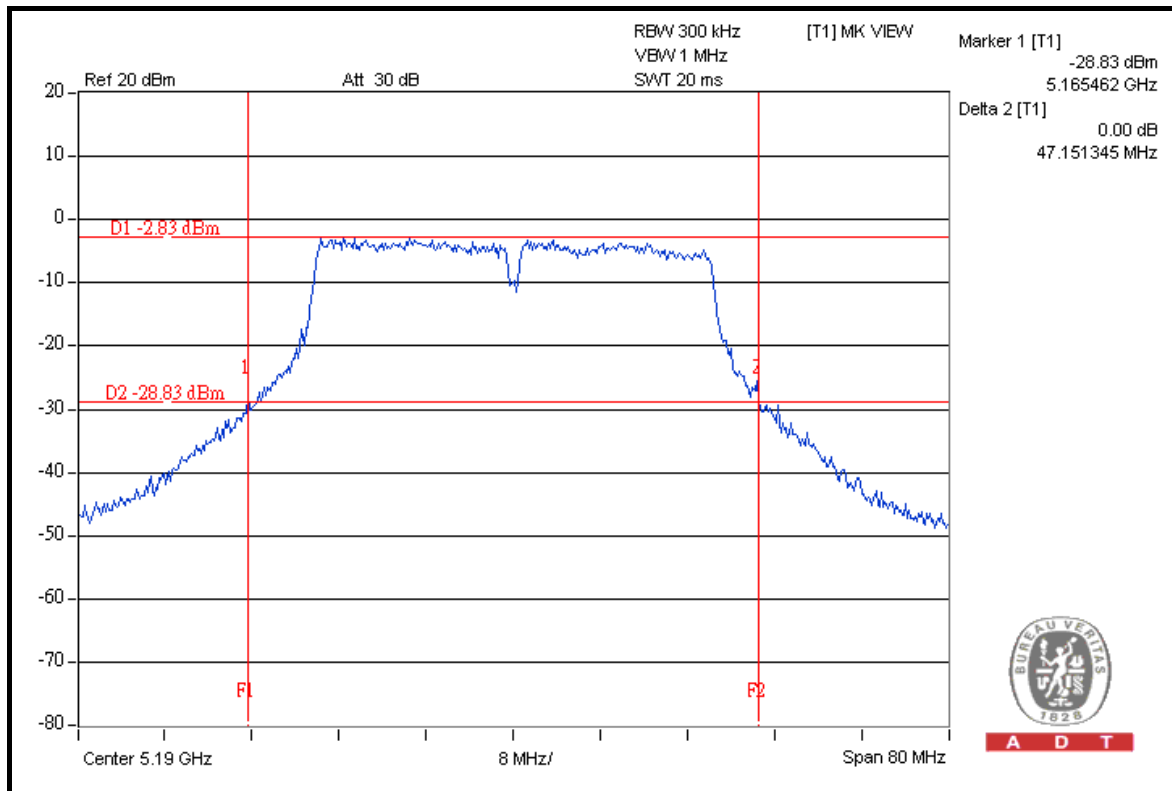

4.4 PEAK POWER EXCURSION MEASUREMENT

4.4.1 LIMITS OF PEAK POWER EXCURSION MEASUREMENT

FREQUENCY BAND	LIMIT
5.15 ~ 5.25GHz	13dB

4.4.2 TEST INSTRUMENTS

DESCRIPTION & MANUFACTURER	MODEL NO.	SERIAL NO.	DATE OF CALIBRATION	CALIBRATED UNTIL
R&S SPECTRUM ANALYZER	FSP40	100040	Jul. 07, 2009	Jul. 06, 2010

NOTE: The calibration interval of the above test instruments is 12 months and the calibrations are traceable to NML/ROC and NIST/USA.

4.4.3 TEST PROCEDURE

- a. The transmitter output was connected to the spectrum analyzer.
- b. Set the spectrum bandwidth span to view the entire spectrum.
- c. Using peak detector and Max-hold function for Trace 1 (RB = 1MHz, VB = 3MHz) and 2 (RB = 1MHz, VB = 300kHz).
- d. The differences between Trace1 and Trace 2 in any 1MHz band at f1 to f2 range were recorded and showed to another trace.

4.4.4 DEVIATION FROM TEST STANDARD

No deviation.

4.4.5 TEST SETUP

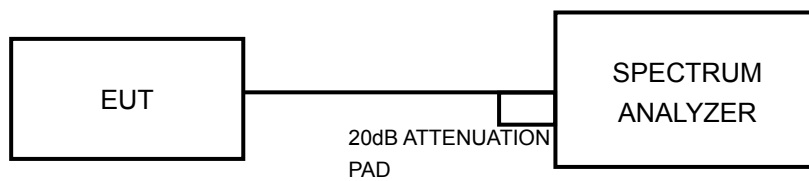

4.4.6 EUT OPERATING CONDITIONS

The software provided by client to enable the EUT under transmission condition continuously at specific channel frequencies individually.

4.4.7 TEST RESULTS

802.11a OFDM

CHANNEL	CHANNEL FREQUENCY (MHz)	PEAK POWER EXCURSION (dB)		PEAK to AVERAGE EXCURSION LIMIT (dB)	PASS/FAIL
		CHAIN 0	CHAIN 1		
36	5180	7.74	7.88	13	PASS
40	5200	9.02	8.92	13	PASS
48	5240	8.38	8.27	13	PASS



A D T

FOR CHAIN 0: CH 40

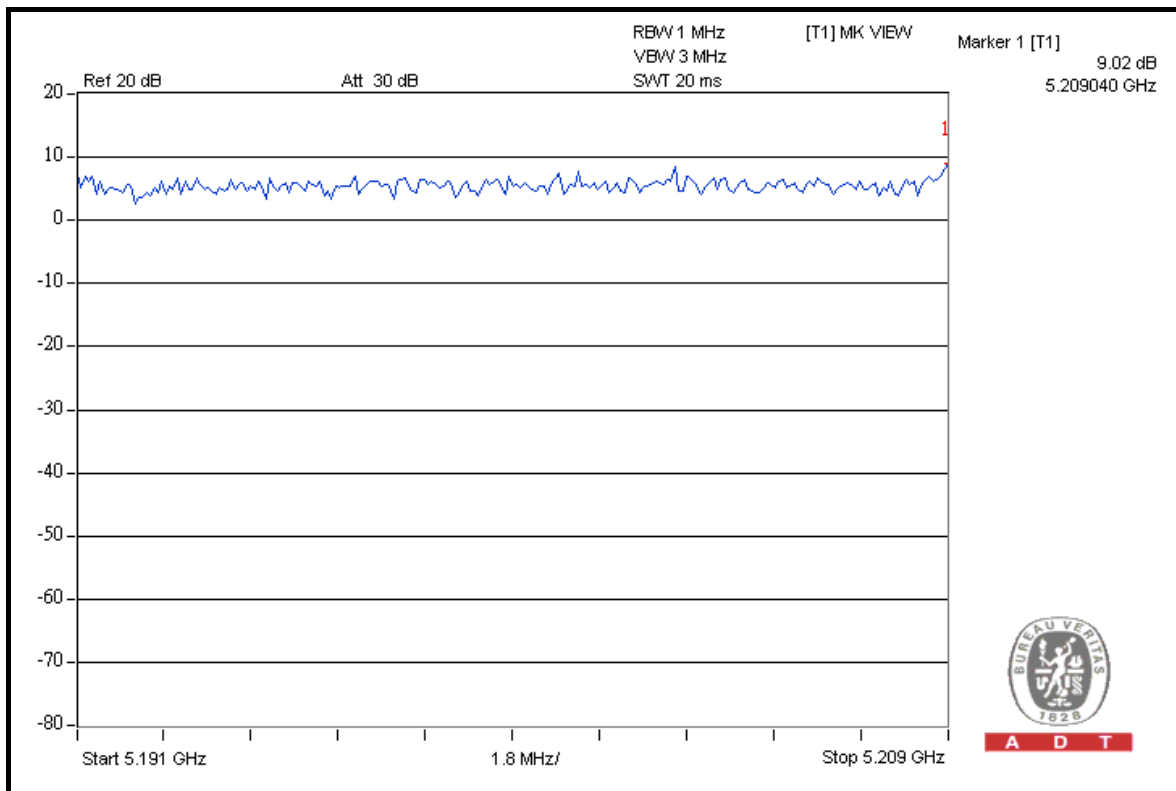
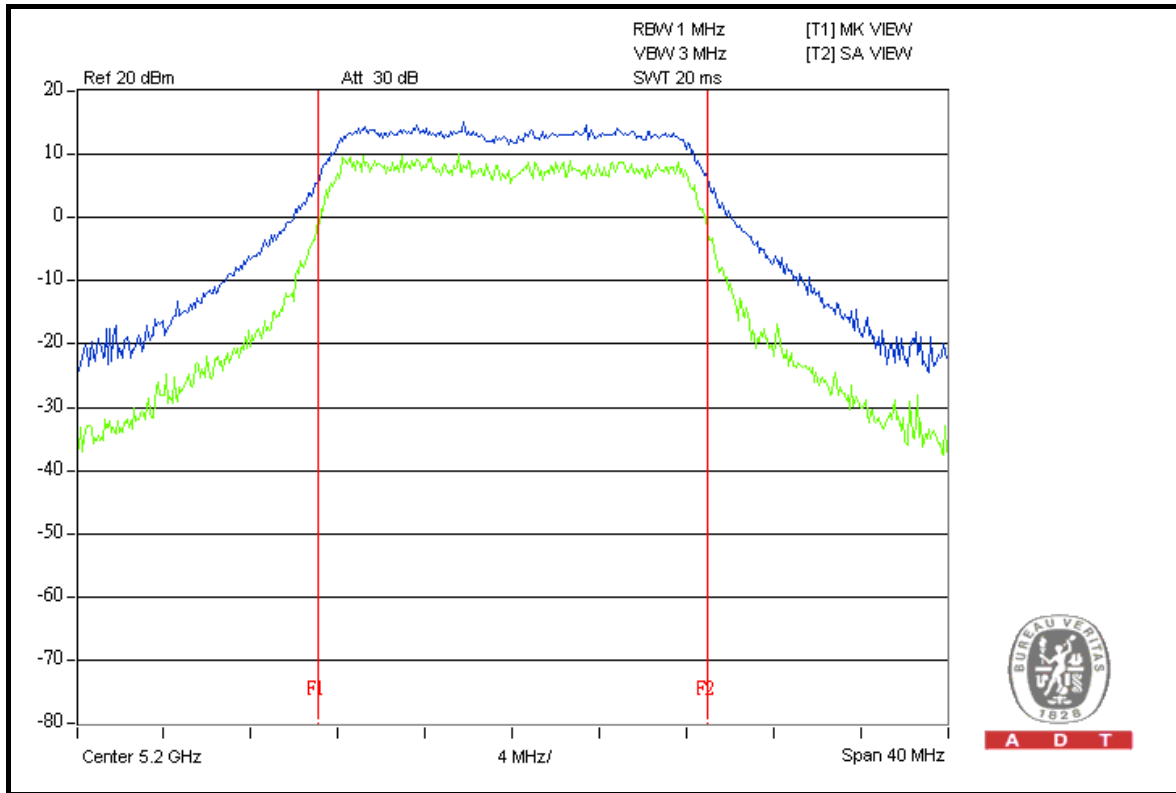



A D T

802.11n (20MHz)

CHANNEL	CHANNEL FREQUENCY (MHz)	PEAK POWER EXCURSION (dB)		PEAK to AVERAGE EXCURSION LIMIT (dB)	PASS/FAIL
		CHAIN 0	CHAIN 1		
36	5180	8.99	8.64	13	PASS
40	5200	8.54	7.76	13	PASS
48	5240	9.79	8.04	13	PASS



A D T

FOR CHAIN 0: CH 48

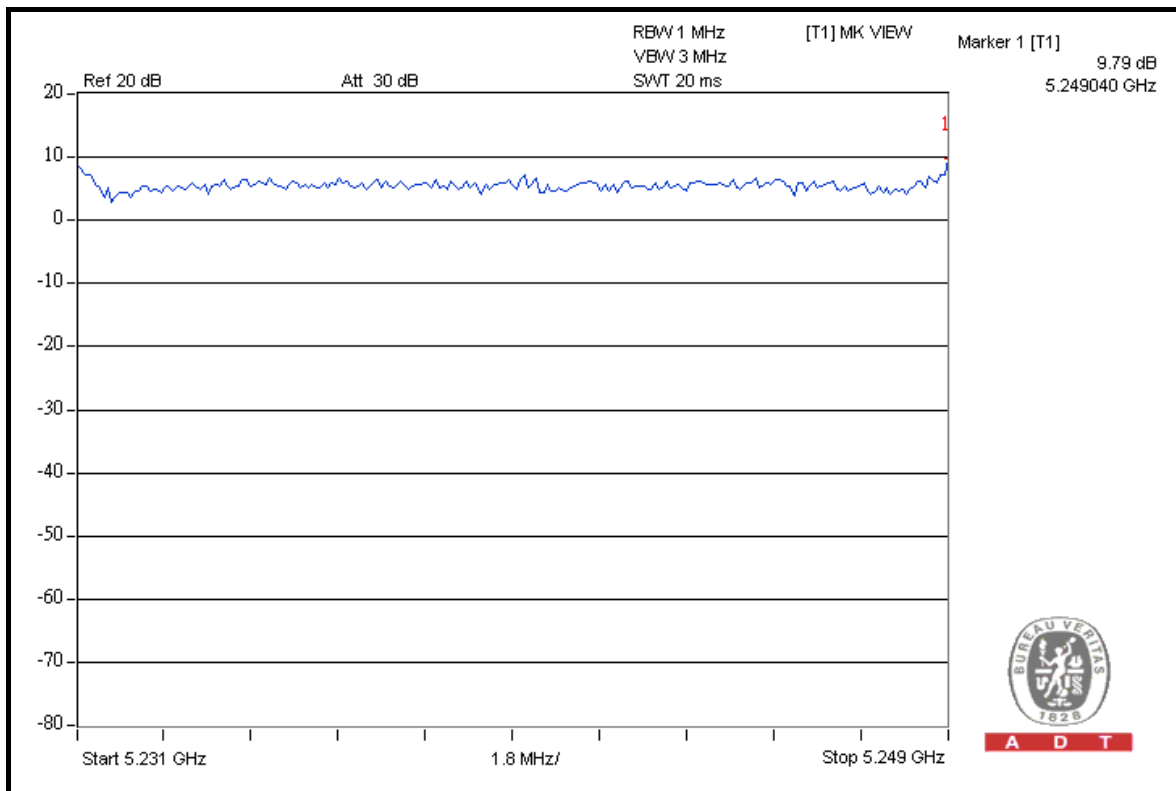
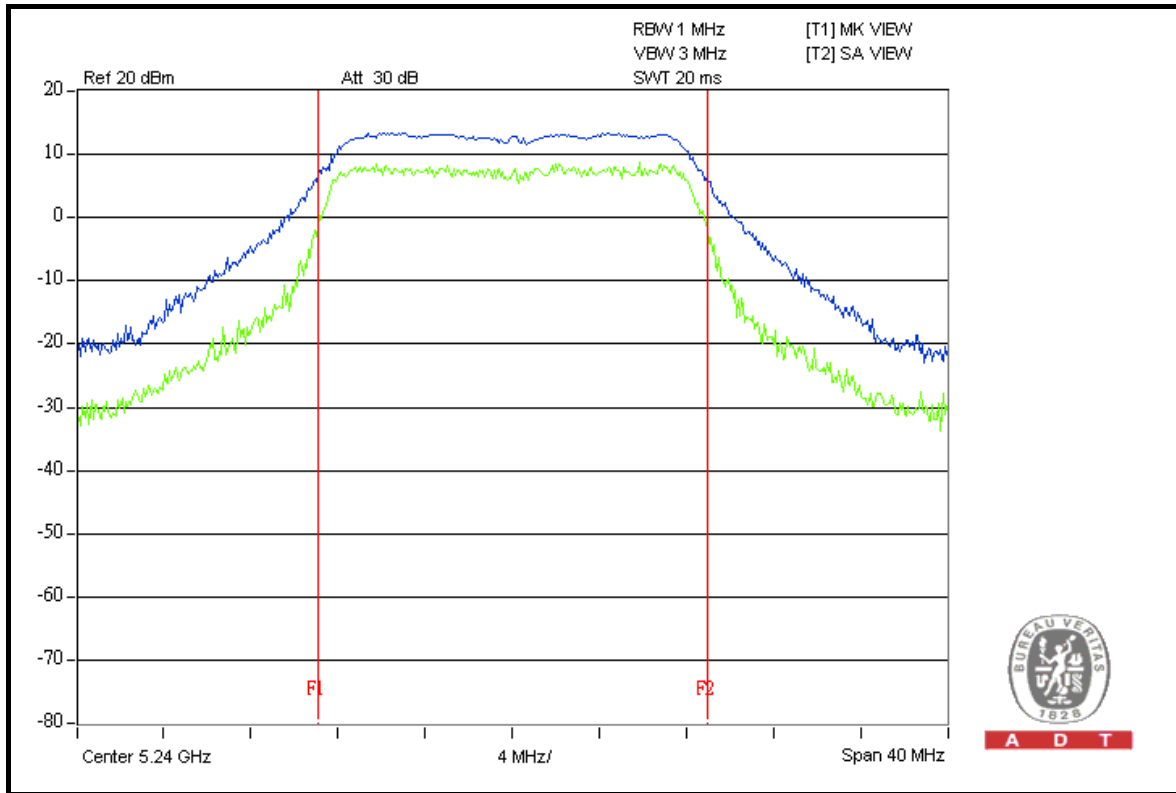



A D T

802.11n (40MHz)

CHANNEL	CHANNEL FREQUENCY (MHz)	PEAK POWER EXCURSION (dB)		PEAK to AVERAGE EXCURSION LIMIT (dB)	PASS/FAIL
		CHAIN 0	CHAIN 1		
38	5190	9.38	9.11	13	PASS
46	5230	8.80	10.86	13	PASS



A D T

FOR CHAIN 1: CH 46

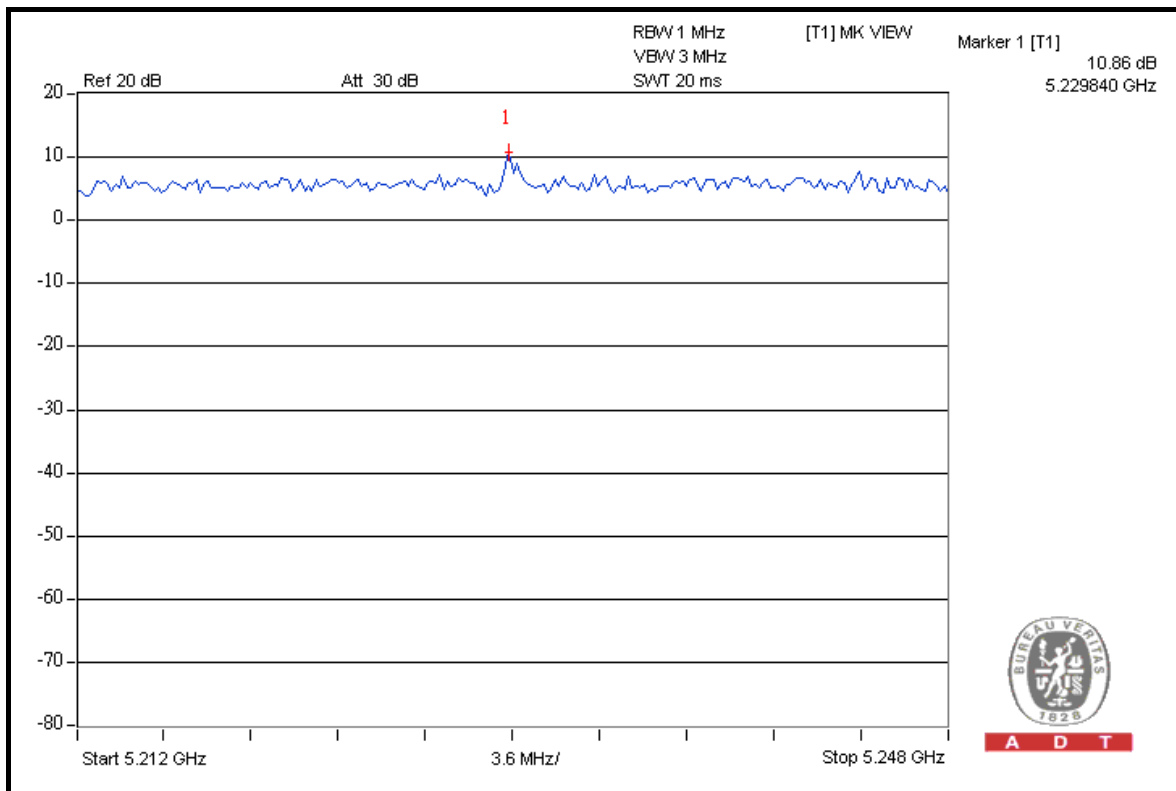
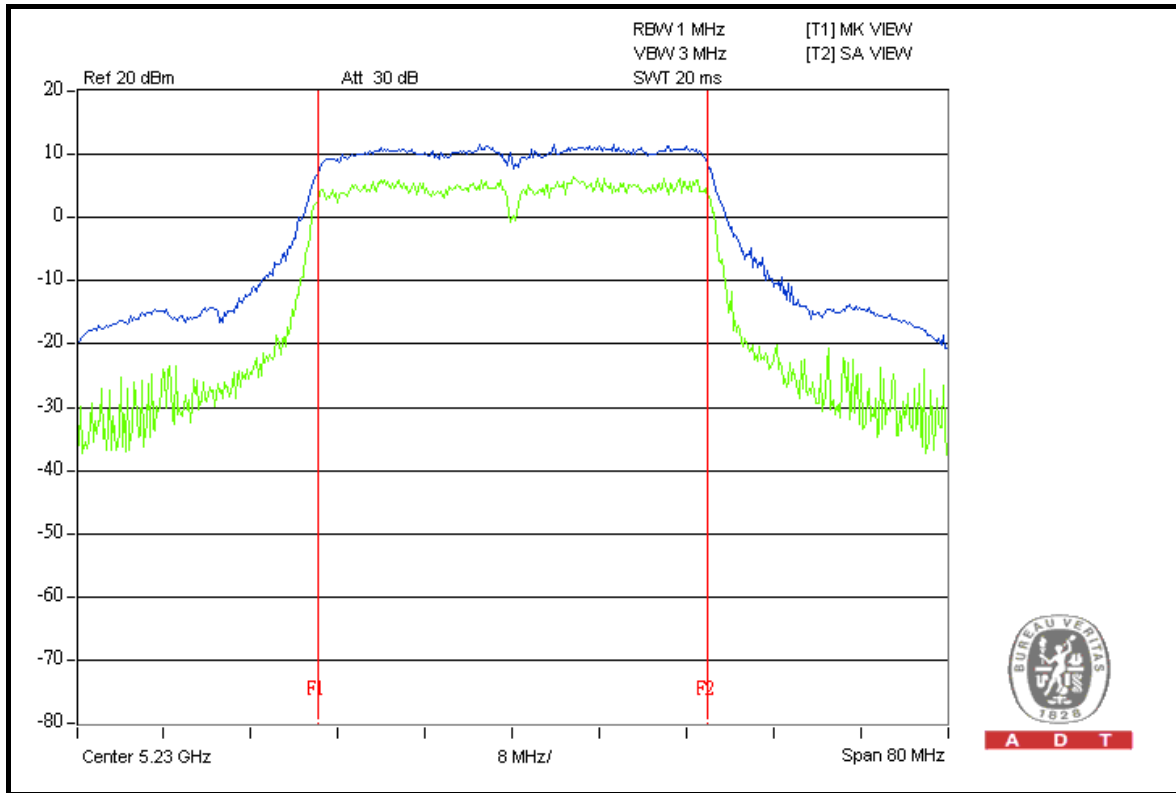

4.5 PEAK POWER SPECTRAL DENSITY MEASUREMENT

4.5.1 LIMITS OF PEAK POWER SPECTRAL DENSITY MEASUREMENT

FREQUENCY BAND	LIMIT
5.15 ~ 5.25GHz	4dBm

4.5.2 TEST INSTRUMENTS

DESCRIPTION & MANUFACTURER	MODEL NO.	SERIAL NO.	DATE OF CALIBRATION	CALIBRATED UNTIL
R&S SPECTRUM ANALYZER	FSP40	100040	Jul. 07, 2009	Jul. 06, 2010

NOTE: The calibration interval of the above test instruments is 12 months and the calibrations are traceable to NML/ROC and NIST/USA.

4.5.3 TEST PROCEDURES

- a. The transmitter output was connected to the spectrum analyzer.
- b. Set RBW = 1MHz, VBW = 3MHz. The PPSD is the highest level found across the emission in any 1MHz band.

4.5.4 DEVIATION FROM TEST STANDARD

No deviation.

4.5.5 TEST SETUP

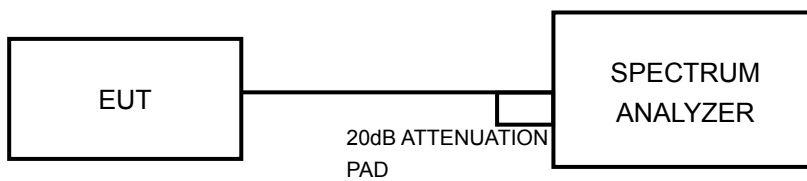

4.5.6 EUT OPERATING CONDITIONS

Same as 4.4.6.



A D T

4.5.7 TEST RESULTS

802.11a

MODULATION TYPE	BPSK	TRANSFER RATE	6.0Mbps
INPUT POWER	120Vac, 60Hz	ENVIRONMENTAL CONDITIONS	28deg.C, 65%RH, 1021hPa
TESTED BY	Dean Wang		

CHAN.	CHAN. FREQ. (MHz)	RF POWER LEVEL IN 1MHz BW (dBm)		TOTAL POWER DENSITY (mW)	TOTAL POWER DENSITY (dBm)	MAX. LIMIT (dBm)	PASS / FAIL
		CHAIN 0	CHAIN 1				
36	5180	-12.0	-10.5	0.2	-8.2	4	PASS
40	5200	-12.4	-7.5	0.2	-6.2	4	PASS
48	5240	-8.9	-12.7	0.2	-7.4	4	PASS

FOR CHAIN 1: CH 40

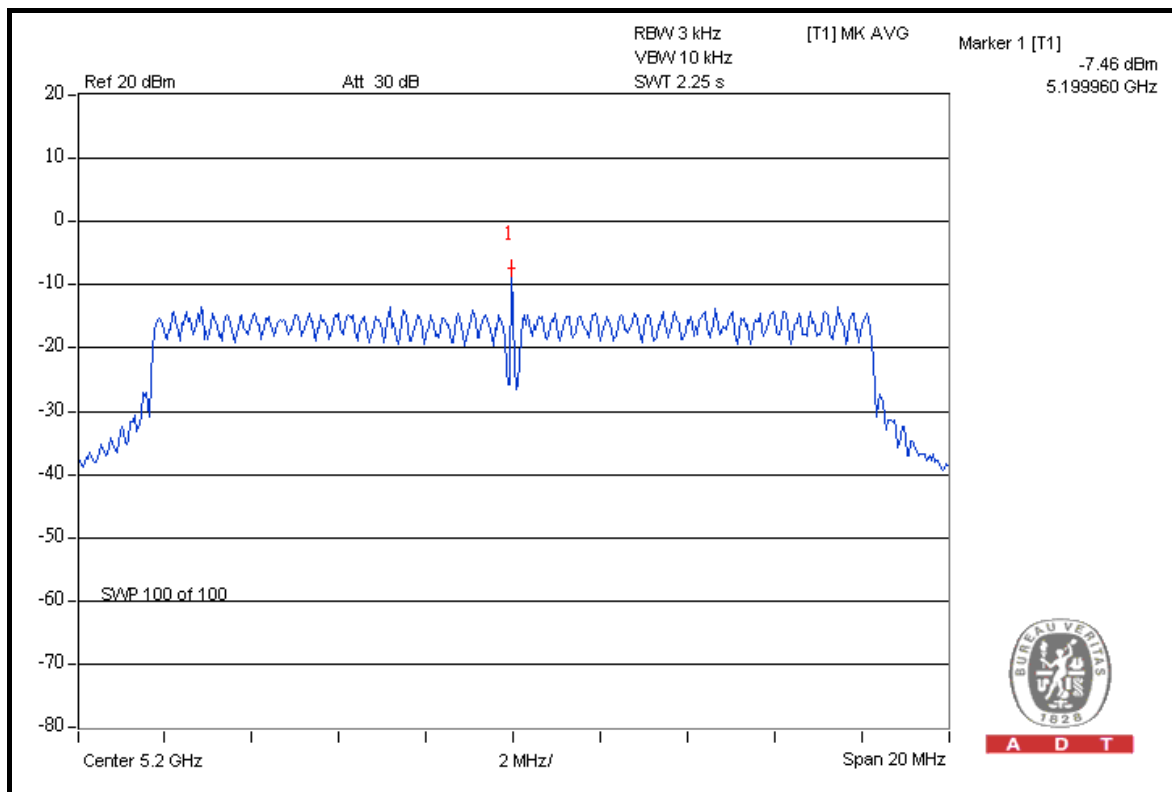

A D T



A D T

802.11n (20MHz)

CHAN.	CHAN. FREQ. (MHz)	RF POWER LEVEL IN 1MHz BW (dBm)		TOTAL POWER DENSITY (mW)	TOTAL POWER DENSITY (dBm)	MAX. LIMIT (dBm)	PASS / FAIL
		CHAIN 0	CHAIN 1				
36	5180	-10.3	-13.7	0.1	0.0	4	PASS
40	5200	-8.7	-8.5	0.1	0.1	4	PASS
48	5240	-7.2	-9.3	0.2	0.1	4	PASS

FOR CHAIN 1: CH 40

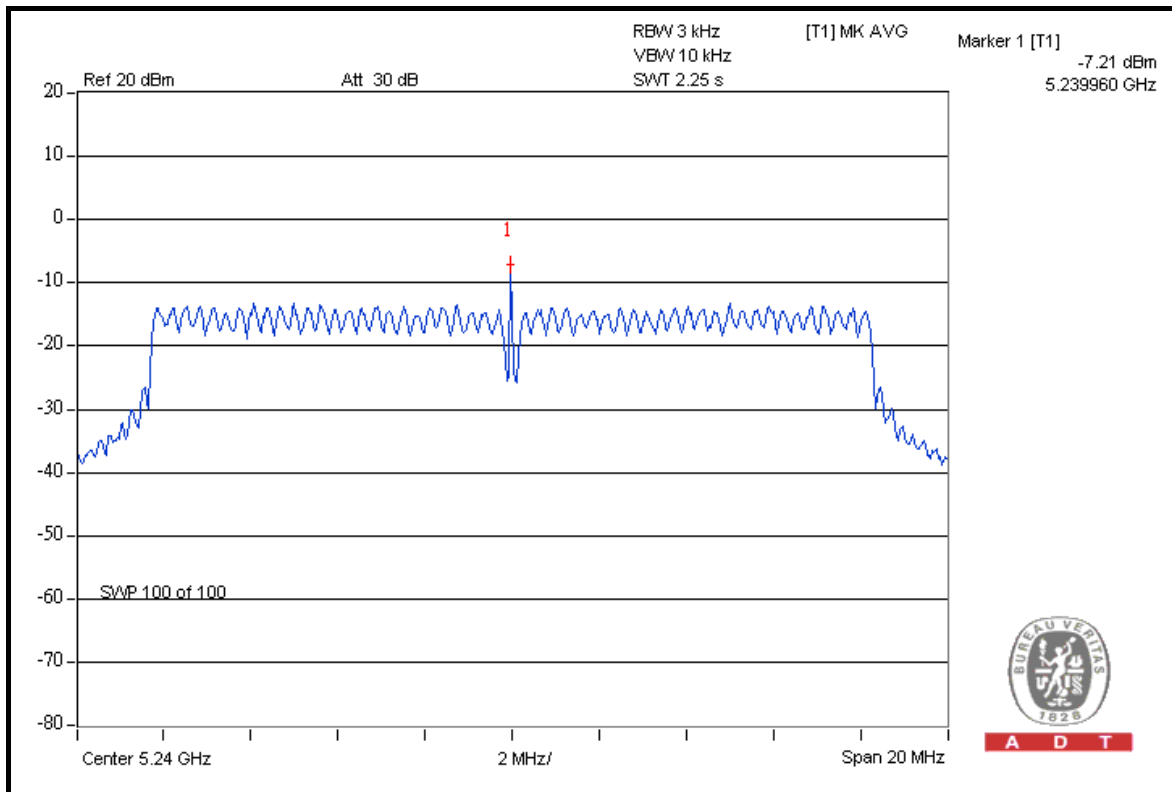

A D T



A D T

802.11n (40MHz)

CHAN.	CHAN. FREQ. (MHz)	RF POWER LEVEL IN 1MHz BW (dBm)		TOTAL POWER DENSITY (mW)	TOTAL POWER DENSITY (dBm)	MAX. LIMIT (dBm)	PASS / FAIL
		CHAIN 0	CHAIN 1				
38	5190	-4.4	-6.0	0.4	0.3	4	PASS
46	5230	-5.8	-15.3	0.3	0.0	4	PASS

FOR CHAIN 0: CH 38

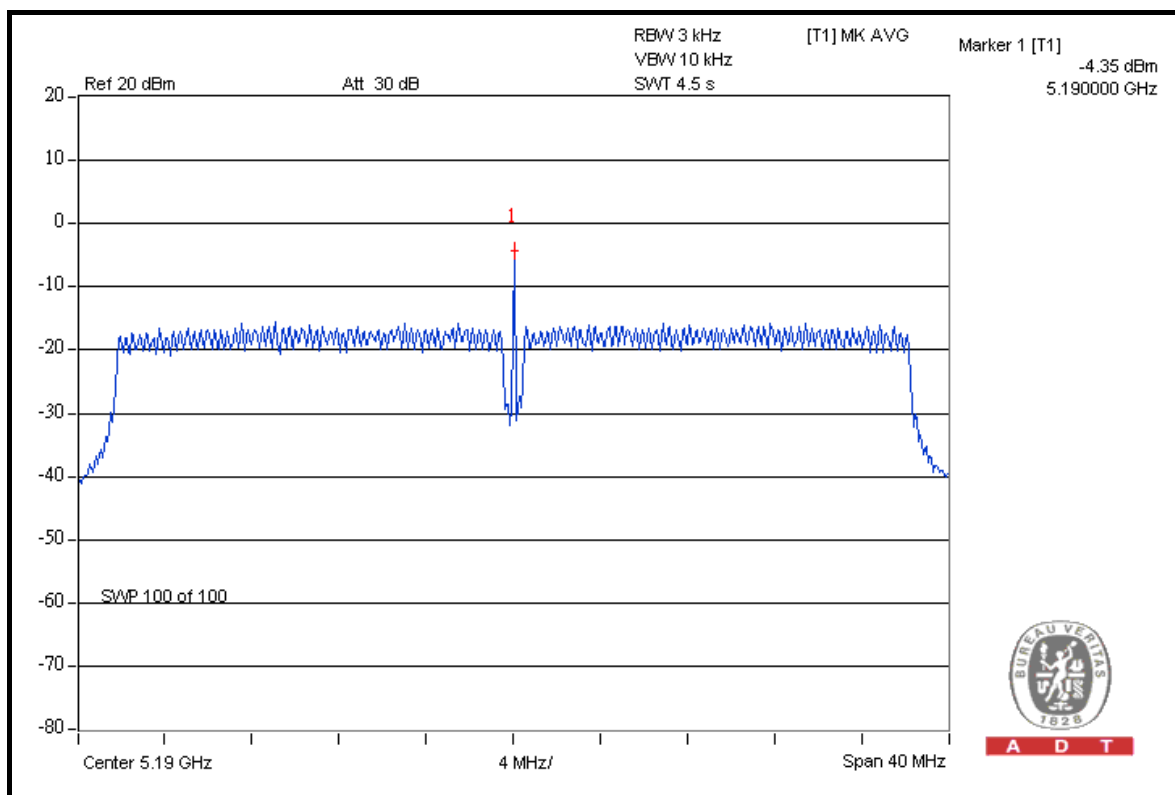

A D T

4.6 FREQUENCY STABILITY

4.6.1 LIMITS OF FREQUENCY STABILITY MEASUREMENT

The frequency tolerance of the carrier signal shall be maintained within the band of operation frequency over a temperature variation of –30 degrees to 50 degrees C at normal supply voltage, and for a variation in the primary supply voltage from 85% to 115% of the rated supply voltage at a temperature of 20 degrees C.

4.6.2 TEST INSTRUMENTS

DESCRIPTION & MANUFACTURER	MODEL NO.	SERIAL NO.	DATE OF CALIBRATION	CALIBRATED UNTIL
R&S SPECTRUM ANALYZER	FSP40	100040	Jul. 07, 2009	Jul. 06, 2010
WIT STANDARD TEMPERATURE AND HUMIDITY CHAMBER	TH-4S-C	W981030	Jun. 24, 2009	Jun. 23, 2010

NOTE: The calibration interval of the above test instruments is 12 months and the calibrations are traceable to NML/ROC and NIST/USA.

4.6.3 TEST PROCEDURE

- a. The EUT was placed inside the environmental test chamber and powered by nominal DC voltage.
- b. Turn the EUT on and couple its output to a spectrum analyzer.
- c. Turn the EUT off and set the chamber to the highest temperature specified.
- d. Allow sufficient time (approximately 30 min) for the temperature of the chamber to stabilize, turn the EUT on and measure the operating frequency after 2, 5, and 10 minutes.
- e. Repeat step 2 and 3 with the temperature chamber set to the lowest temperature.
- f. The test chamber was allowed to stabilize at +20 degree C for a minimum of 30 minutes. The supply voltage was then adjusted on the EUT from 85% to 115% and the frequency record.

4.6.4 DEVIATION FROM TEST STANDARD

No deviation.

4.6.5 TEST SETUP

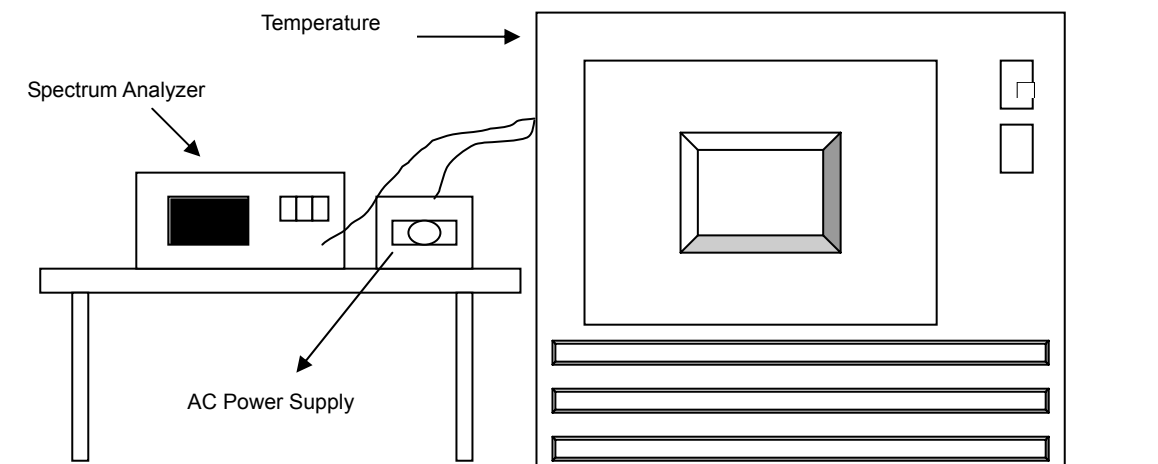

4.6.6 EUT OPERATING CONDITION

Same as Item 4.1.6.



4.6.7 TEST RESULTS

FREQUENCY STABILITY VERSUS TEMP.									
OPERATING FREQUENCY: 5180MHz									
TEMP. (°C)	POWER SUPPLY (Vdc)	0 MINUTE		2 MINUTE		5 MINUTE		10 MINUTE	
		Measured Frequency	Frequency Drift	Measured Frequency	Frequency Drift	Measured Frequency	Frequency Drift	Measured Frequency	Frequency Drift
		(MHz)	ppm	(MHz)	ppm	(MHz)	ppm	(MHz)	ppm
65	120.0	5179.973334	-0.0005148	5179.973147	-0.0005184	5179.973585	-0.0005099	5179.973221	-0.0005170
60	120.0	5179.973922	-0.0005034	5179.973909	-0.0005037	5179.974032	-0.0005013	5179.973787	-0.0005060
50	120.0	5179.972988	-0.0005215	5179.972996	-0.0005213	5179.972727	-0.0005265	5179.973222	-0.0005170
40	120.0	5179.972991	-0.0005214	5179.972998	-0.0005213	5179.973076	-0.0005198	5179.972897	-0.0005232
30	120.0	5179.973238	-0.0005166	5179.973074	-0.0005198	5179.973235	-0.0005167	5179.973084	-0.0005196
20	120.0	5179.973198	-0.0005174	5179.973291	-0.0005156	5179.973087	-0.0005196	5179.973091	-0.0005195
10	120.0	5179.973622	-0.0005092	5179.973443	-0.0005127	5179.973831	-0.0005052	5179.973394	-0.0005136
0	120.0	5179.973196	-0.0005175	5179.973255	-0.0005163	5179.973091	-0.0005195	5179.973141	-0.0005185
-10	120.0	5179.973605	-0.0005096	5179.973607	-0.0005095	5179.973626	-0.0005092	5179.973346	-0.0005146
-20	120.0	5179.973587	-0.0005099	5179.973851	-0.0005048	5179.973614	-0.0005094	5179.973681	-0.0005081
-30	120.0	5179.973014	-0.0005210	5179.972969	-0.0005218	5179.972774	-0.0005256	5179.97301	-0.0005210
-40	120.0	5179.972646	-0.0005281	5179.972698	-0.0005271	5179.972565	-0.0005296	5179.972358	-0.0005336

FREQUENCY STABILITY VERSUS VOLTAGE									
OPERATING FREQUENCY: 5180MHz									
TEMP. (°C)	POWER SUPPLY (Vdc)	0 MINUTE		2 MINUTE		5 MINUTE		10 MINUTE	
		Measured Frequency	Frequency Drift	Measured Frequency	Frequency Drift	Measured Frequency	Frequency Drift	Measured Frequency	Frequency Drift
		(MHz)	ppm	(MHz)	ppm	(MHz)	ppm	(MHz)	ppm
20	138.0	5179.973574	-0.0005102	5179.973386	-0.0005138	5179.973526	-0.0005111	5179.973576	-0.0005101
	120.0	5179.973198	-0.0005174	5179.973291	-0.0005156	5179.973087	-0.0005196	5179.973091	-0.0005195
	102.0	5179.973096	-0.0005194	5179.97326	-0.0005162	5179.973056	-0.0005202	5179.973424	-0.0005130

4.7 BAND EDGES MEASUREMENT

4.7.1 TEST INSTRUMENTS

DESCRIPTION & MANUFACTURER	MODEL NO.	SERIAL NO.	DATE OF CALIBRATION	DUE DATE OF CALIBRATION
Agilent Spectrum	8564EC	4208A00659	Jul. 24, 2009	Jul. 23, 2010
Agilent Preamplifier	8449B	3008A01924	Aug. 31, 2009	Aug. 30, 2010
Agilent Preamplifier	8449B	3008A01292	Aug. 10, 2009	Aug. 09, 2010
MITEQ Preamplifier	AMF-6F-260400-33 -8P	892164	Aug. 31, 2009	Aug. 30, 2010
Schwarzbeck Horn Antenna	BBHA-9170	BBHA9170190	Sep. 24, 2009	Sep. 23, 2010
Schwarzbeck Horn Antenna	BBHA-9120	D130	May 15, 2009	May 14, 2010
ADT. Turn Table	TT100	0201	NA	NA
ADT. Tower	AT100	0201	NA	NA
Software	ADT_Radiated_V7. 6.15.9.2	NA	NA	NA
SUHNER RF cable	SF106-18	PHACAB-1G-40 GHz	Aug. 20, 2009	Aug. 19, 2010

NOTE: The calibration interval of the above test instruments is 12 months and the calibrations are traceable to NML/ROC and NIST/USA.

4.7.2 TEST PROCEDURE

- a. The EUT was placed on the top of a rotating table 0.8 meters above the ground at a 10 meter open area test site. The table was rotated 360 degrees to determine the position of the highest radiation.
- b. The EUT was set 3 meters away from the interference-receiving antenna, which was mounted on the top of a variable-height antenna tower.
- c. The antenna is a broadband antenna, and its height is varied from one meter to four meters above the ground to determine the maximum value of the field strength. Both horizontal and vertical polarizations of the antenna are set to make the measurement.
- d. For each suspected emission, the EUT was arranged to its worst case and then the antenna was tuned to heights from 1 meter to 4 meters and the rotatable table was turned from 0 degrees to 360 degrees to find the maximum reading.
- e. Set both RBW and VBW of spectrum analyzer to 1MHz and 3MHz with suitable frequency span including 100MHz bandwidth from band edge. The band edges was measured and recorded.

NOTE: The resolution bandwidth of test receiver/spectrum analyzer is 1MHz and the video bandwidth is 10Hz for Average detection (AV) at frequency above 1GHz

4.7.3 EUT OPERATING CONDITION

The software provided by client to enable the EUT under transmission condition continuously at specific channel frequencies individually.

4.7.4 TEST RESULTS

For signals in the restricted bands above and below the 5.15 to 5.25GHz allocated band a measurement was made of the amplitude of the spurious emissions with respect to the intentional signals. The relative amplitude, in dBc, was applied to the average and peak filed strength of the intentional signal made on the OATS to calculate the field strength of the unintentional signals.

The spectrum plots (Peak RBW = 1MHz, VBW = 3MHz) are attached on the following pages.

802.11a OFDM

RESTRICT BAND (4500 ~ 5150 MHz)

FREQUENCY (MHz)	FUNDAMENTAL EMISSION (dBuV/m)	DELTA (dB)	MAXIMUM FIELD STRENGTH IN RESTRICT BAND (dBuV/m)	LIMIT (dBuV/m)
5180.00 (PK)	114.0	44.31	69.69	74.00
5180.00 (AV)	100.7	48.66	52.04	54.00

RESTRICT BAND (5350 ~ 5460 MHz)

FREQUENCY (MHz)	FUNDAMENTAL EMISSION (dBuV/m)	DELTA (dB)	MAXIMUM FIELD STRENGTH IN RESTRICT BAND (dBuV/m)	LIMIT (dBuV/m)
5320.00 (PK)	113.1	46.66	66.44	74.00
5320.00 (AV)	93.9	45.67	48.23	54.00

NOTE:

1. Delta = Amplitude between the peak of the fundamental and the peak of the band edge emission. Please check following 3 pages.
2. Maximum field strength in restrict band = Fundamental emission – Delta.



A D T

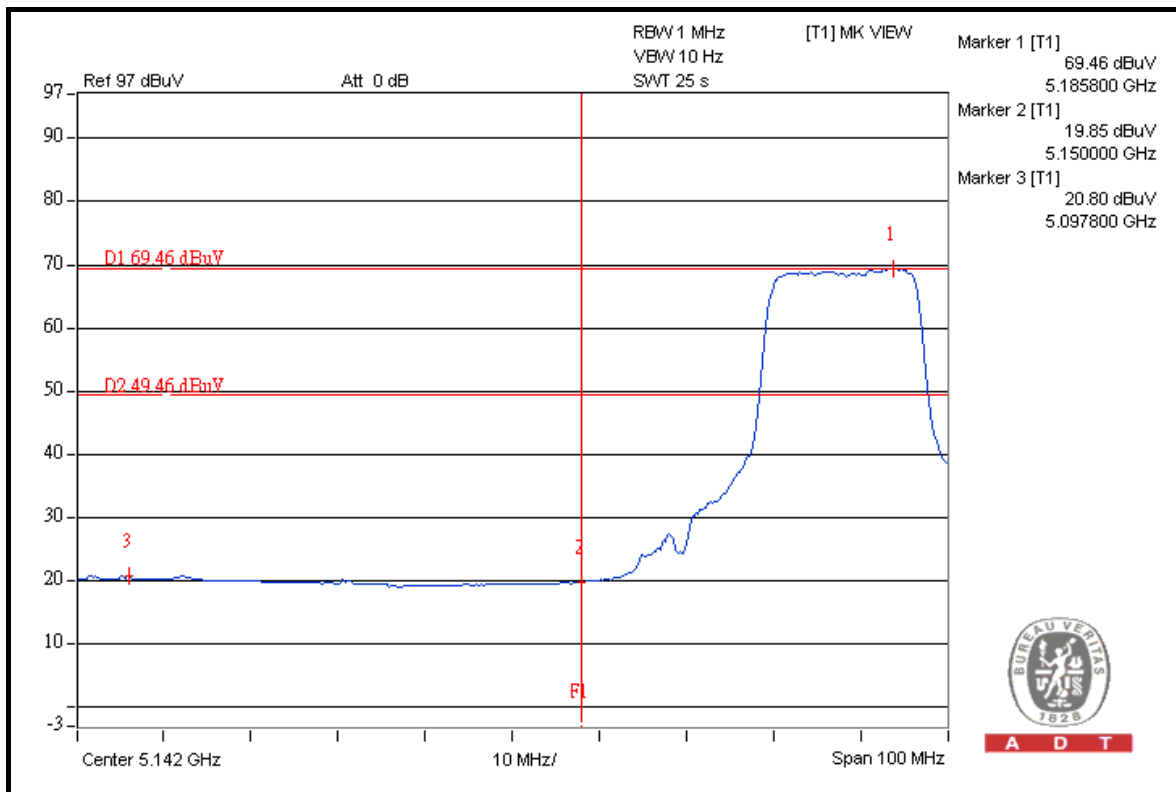
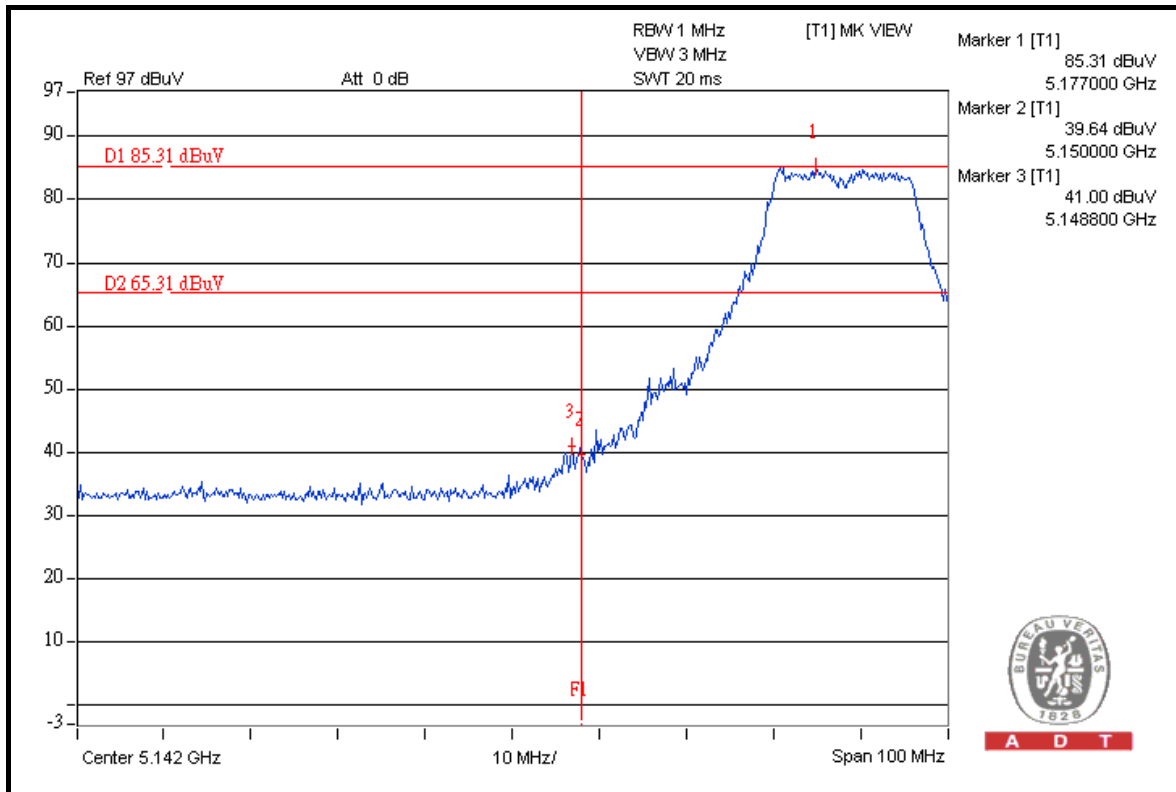



A D T

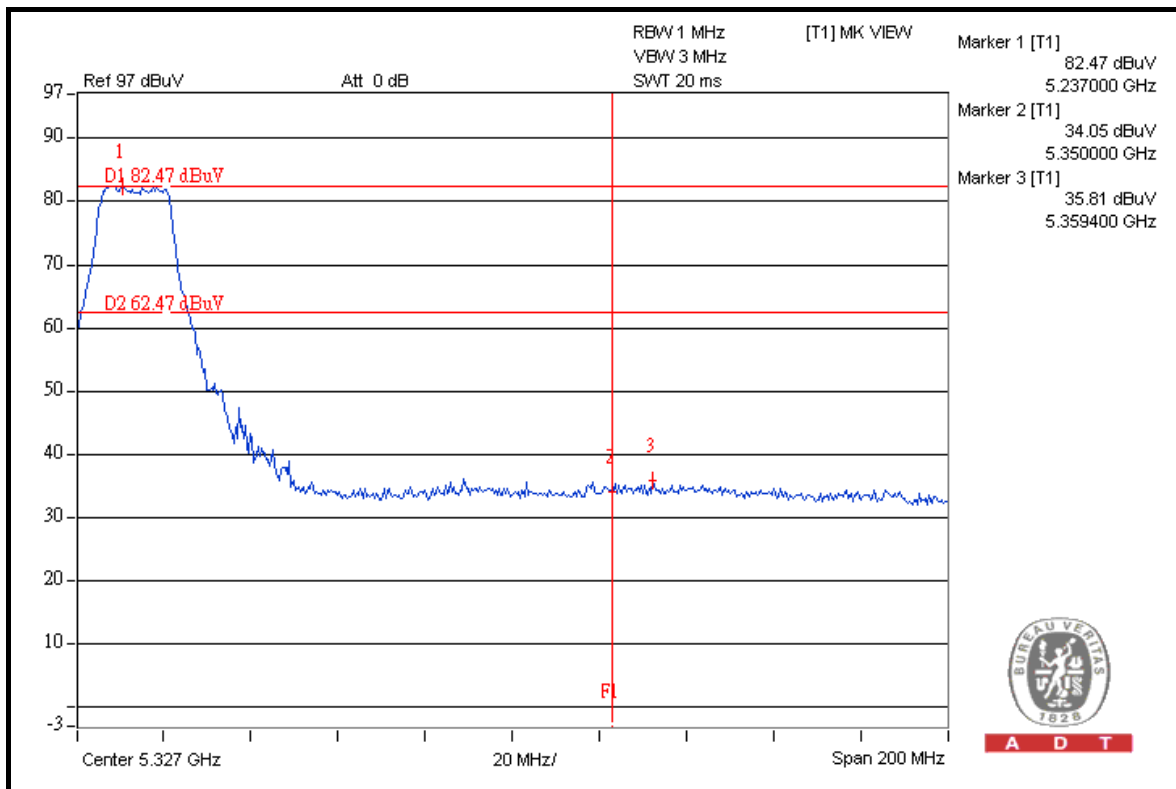
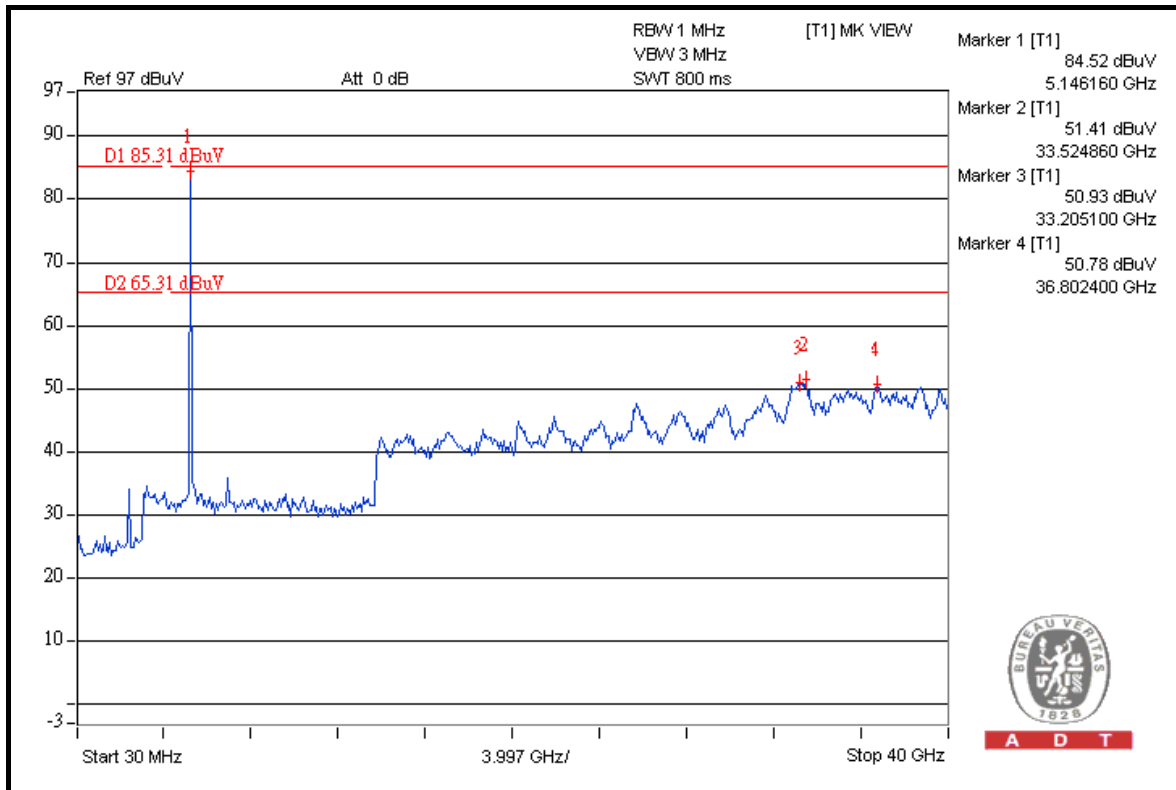



A D T

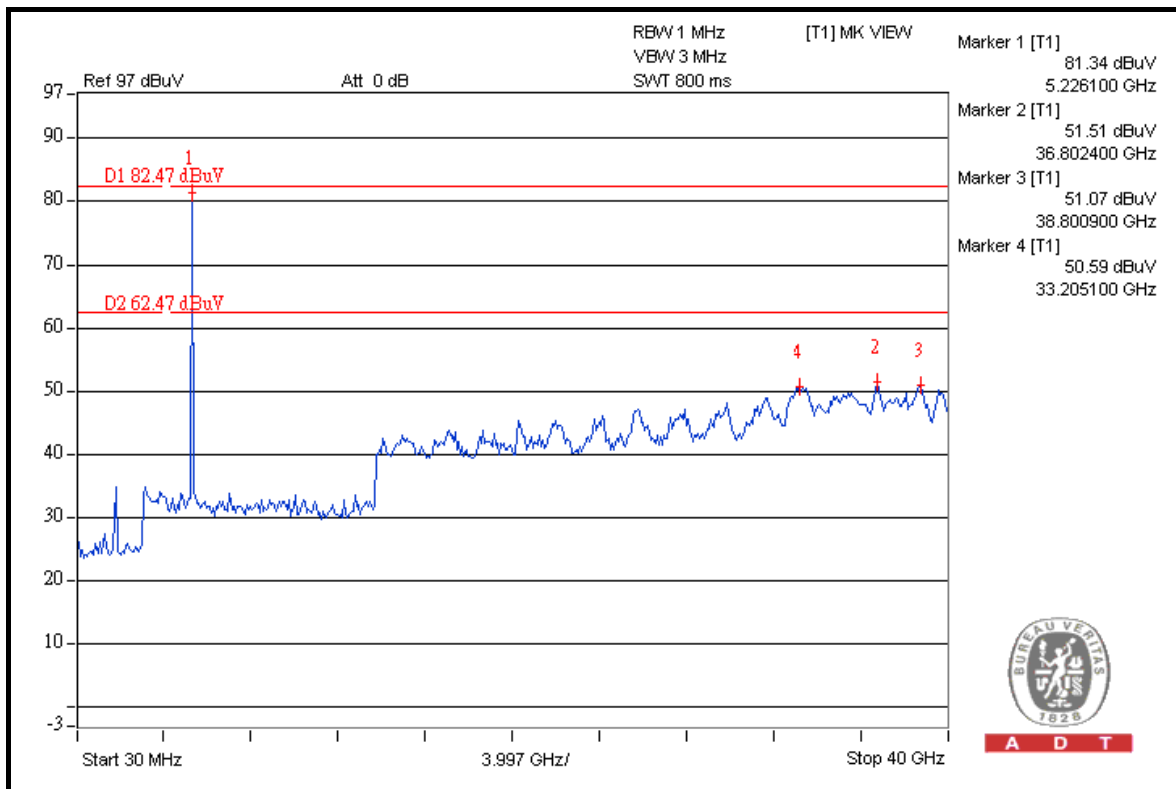
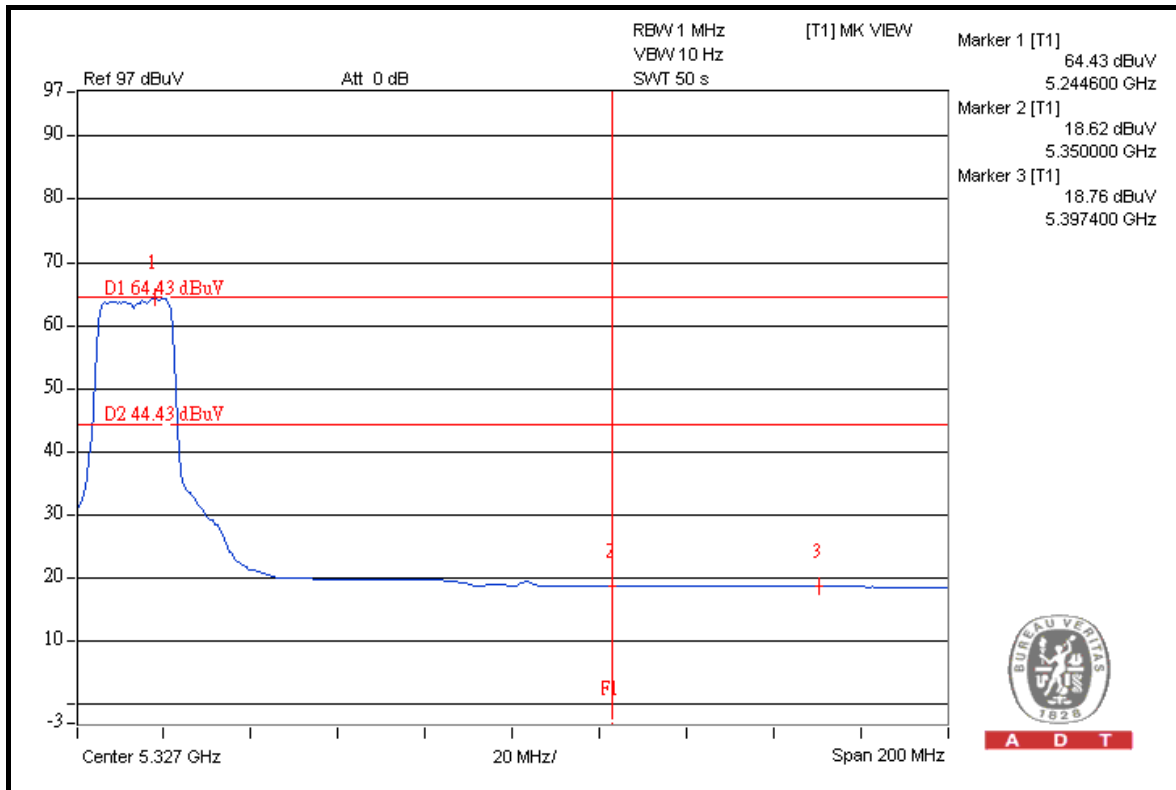

802.11n (20MHz)

RESTRICT BAND (4500 ~ 5150 MHz)

FREQUENCY (MHz)	FUNDAMENTAL EMISSION (dBuV/m)	DELTA (dB)	MAXIMUM FIELD STRENGTH IN RESTRICT BAND (dBuV/m)	LIMIT (dBuV/m)
5180.00 (PK)	114.1	40.84	73.26	74.00
5180.00 (AV)	100.8	51.37	49.43	54.00

RESTRICT BAND (5350 ~ 5460 MHz)

FREQUENCY (MHz)	FUNDAMENTAL EMISSION (dBuV/m)	DELTA (dB)	MAXIMUM FIELD STRENGTH IN RESTRICT BAND (dBuV/m)	LIMIT (dBuV/m)
5320.00 (PK)	112.3	47.30	65.00	74.00
5320.00 (AV)	98.0	44.28	53.72	54.00

NOTE:

1. Delta = Amplitude between the peak of the fundamental and the peak of the band edge emission. Please check following 3 pages.
2. Maximum field strength in restrict band = Fundamental emission – Delta.



A D T

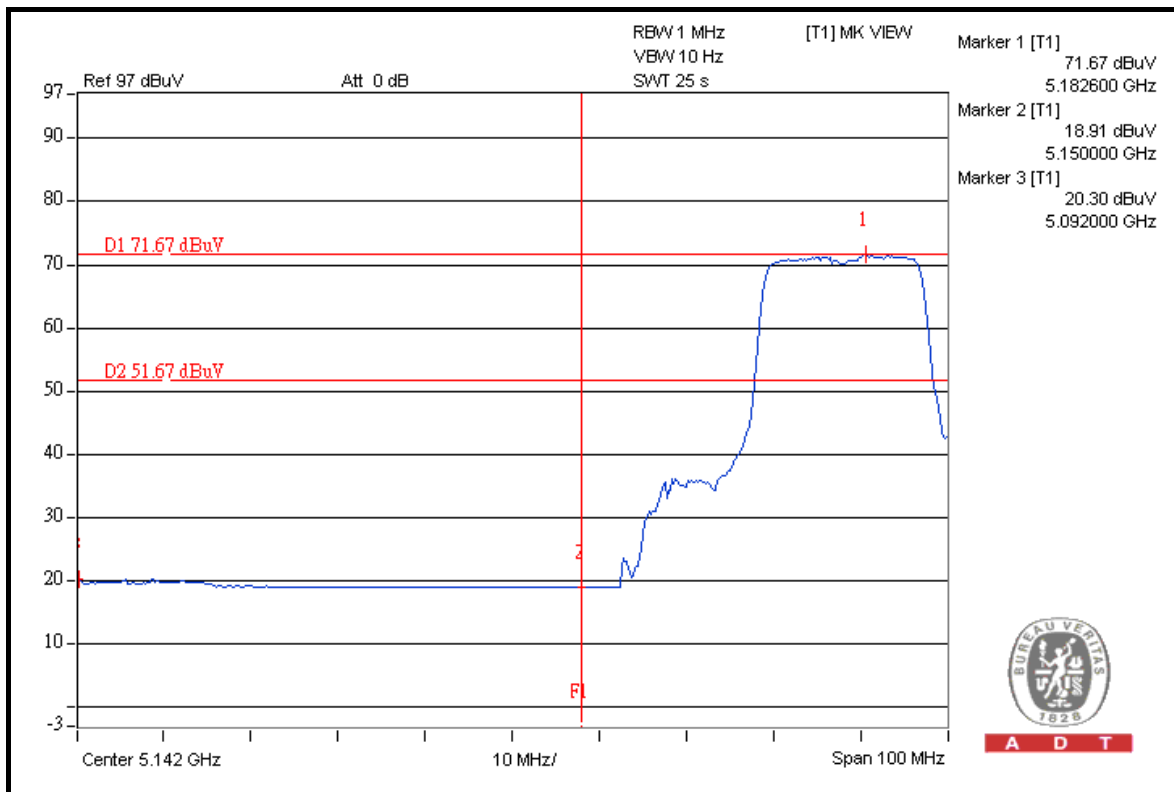
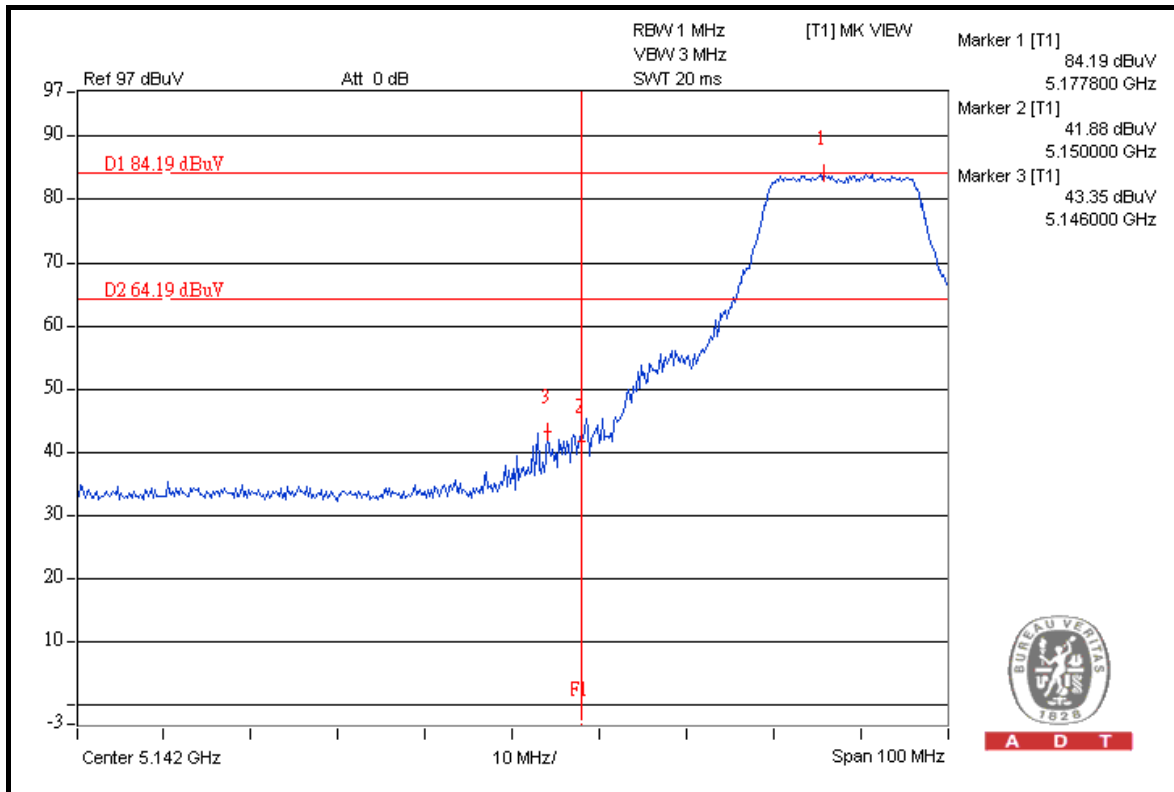



A D T

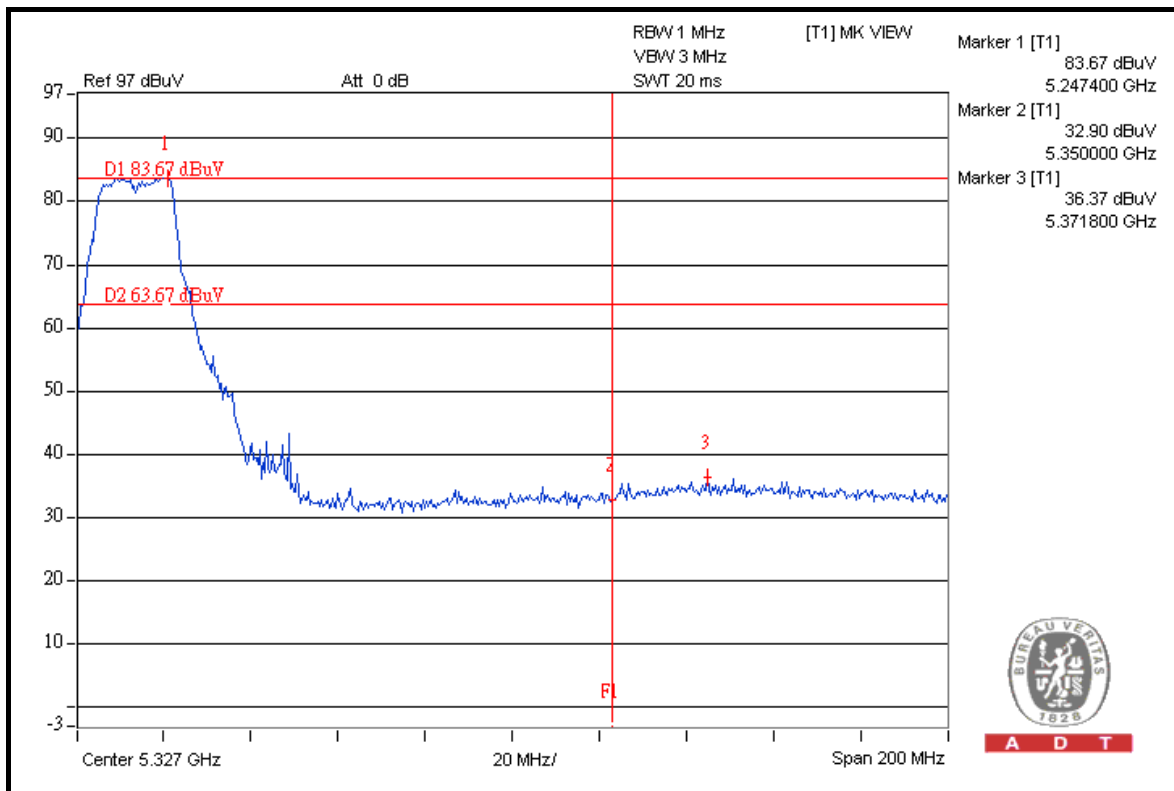
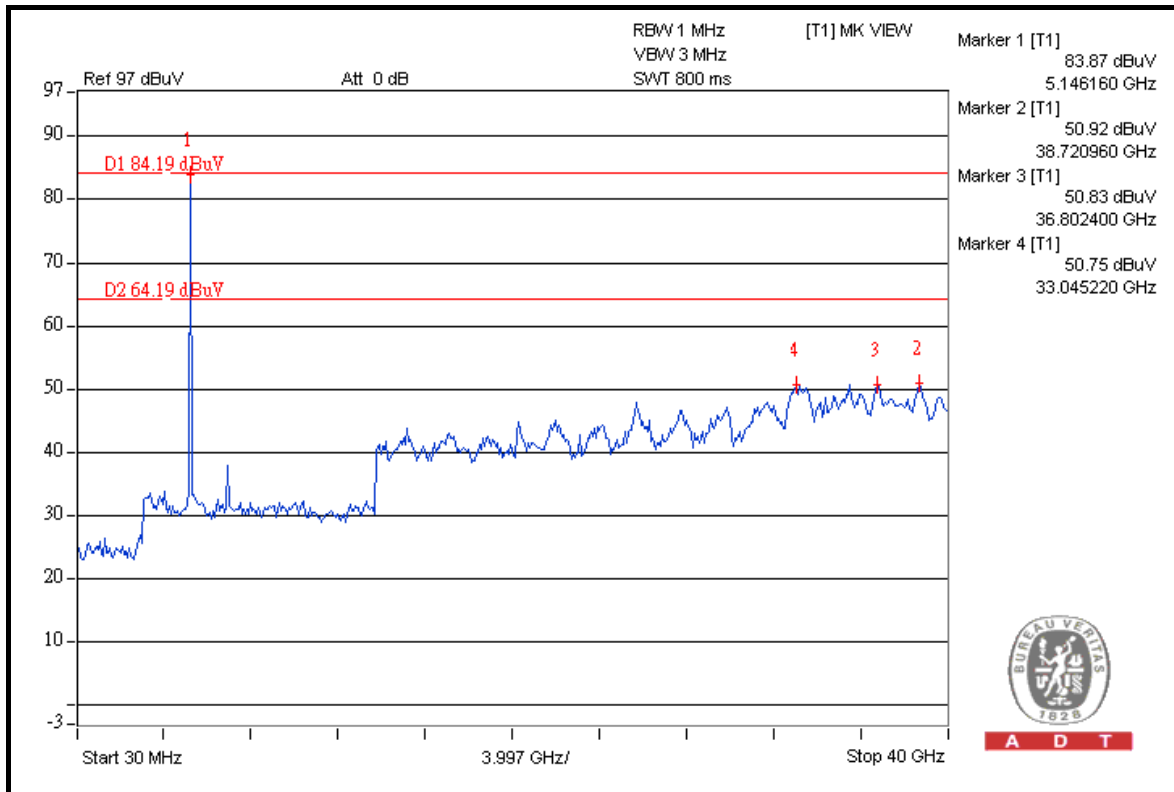



A D T

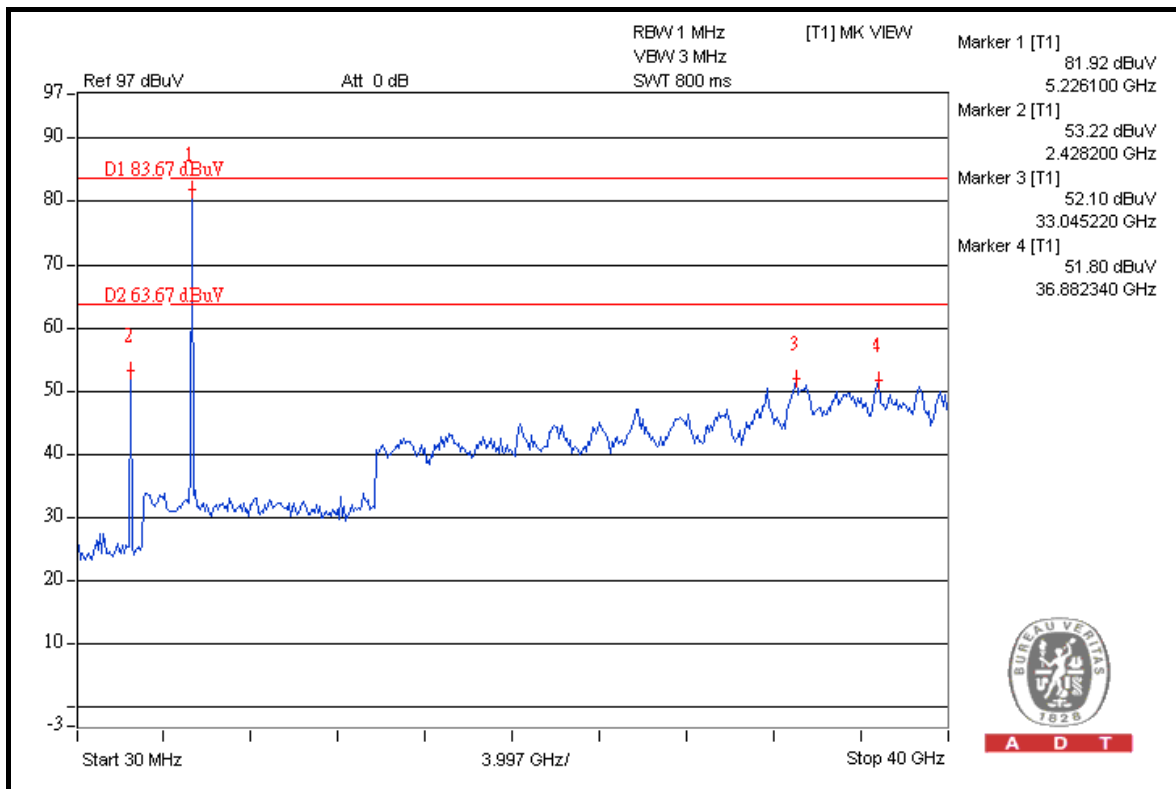
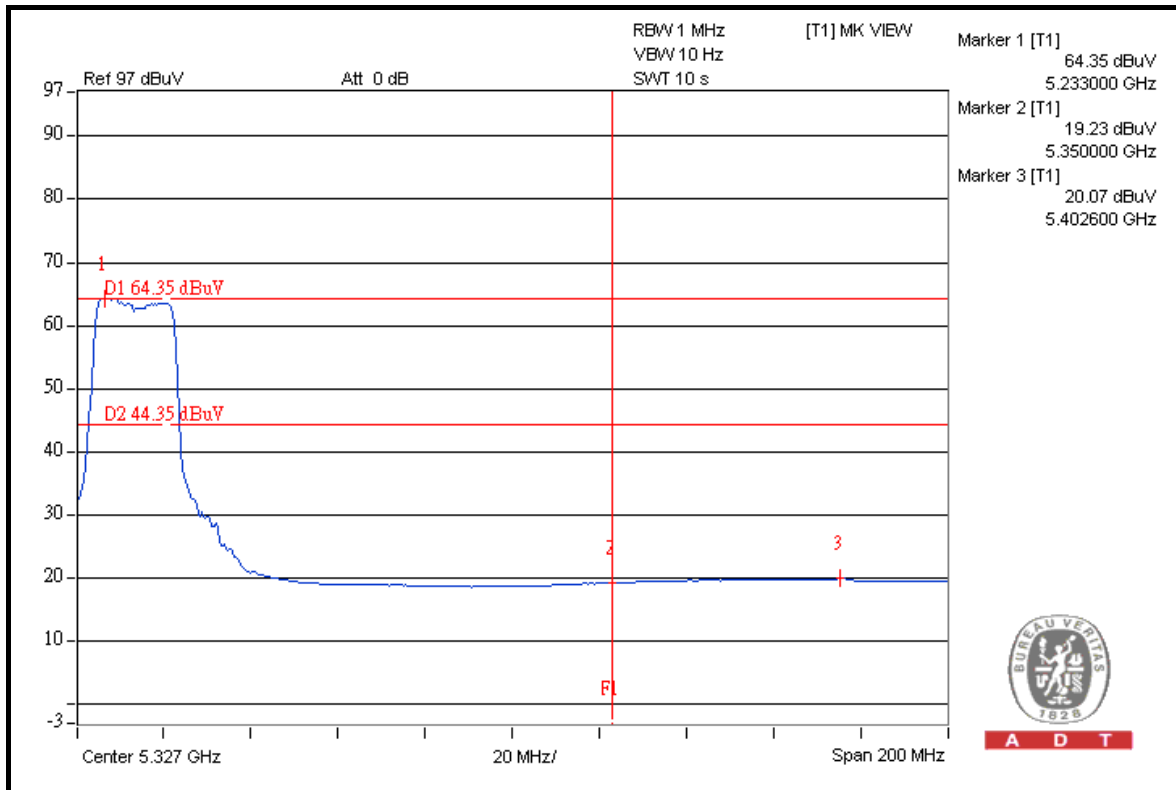

802.11n (40MHz)

RESTRICT BAND (4500 ~ 5150 MHz)

FREQUENCY (MHz)	FUNDAMENTAL EMISSION (dBuV/m)	DELTA (dB)	MAXIMUM FIELD STRENGTH IN RESTRICT BAND (dBuV/m)	LIMIT (dBuV/m)
5190.00 (PK)	112.8	50.14	62.66	74.00
5190.00 (AV)	98.1	48.68	49.42	54.00

RESTRICT BAND (5350 ~ 5460 MHz)

FREQUENCY (MHz)	FUNDAMENTAL EMISSION (dBuV/m)	DELTA (dB)	MAXIMUM FIELD STRENGTH IN RESTRICT BAND (dBuV/m)	LIMIT (dBuV/m)
5310.00 (PK)	112.0	47.02	64.98	74.00
5310.00 (AV)	97.7	47.03	50.67	54.00

NOTE:

- Delta = Amplitude between the peak of the fundamental and the peak of the band edge emission. Please check following 3 pages.
- Maximum field strength in restrict band = Fundamental emission – Delta.



A D T

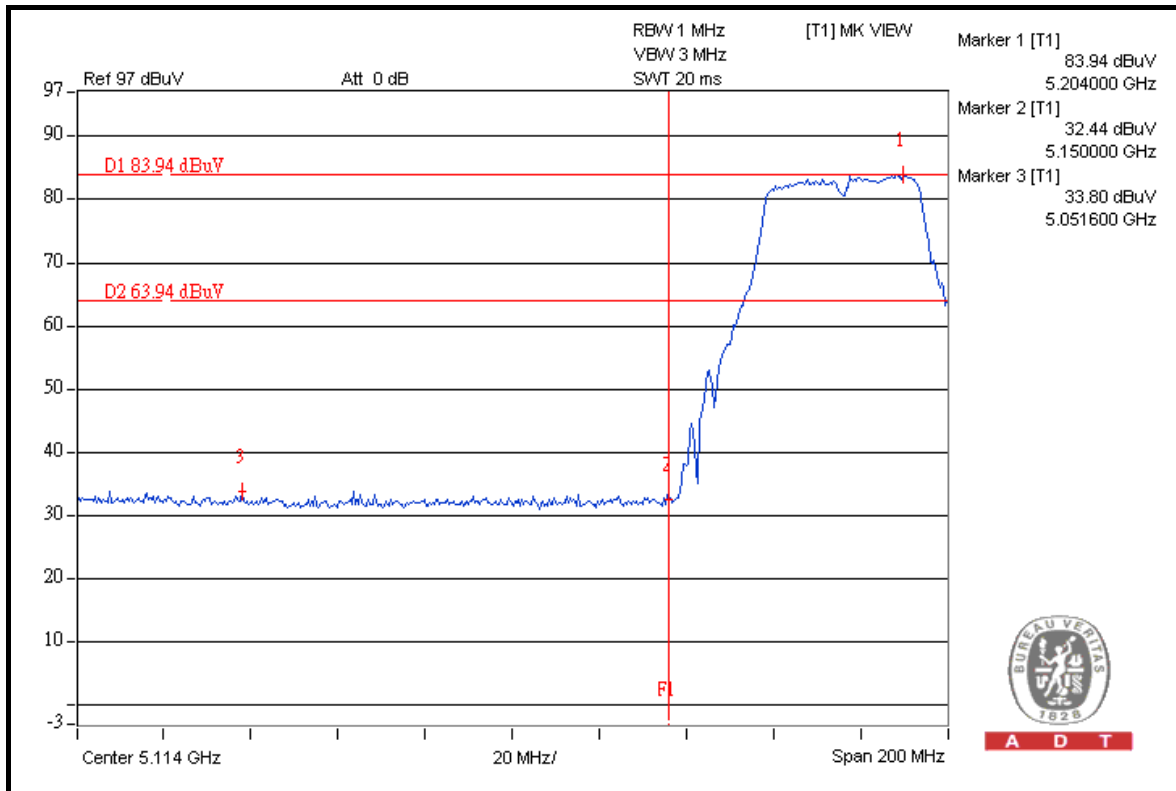

A D T

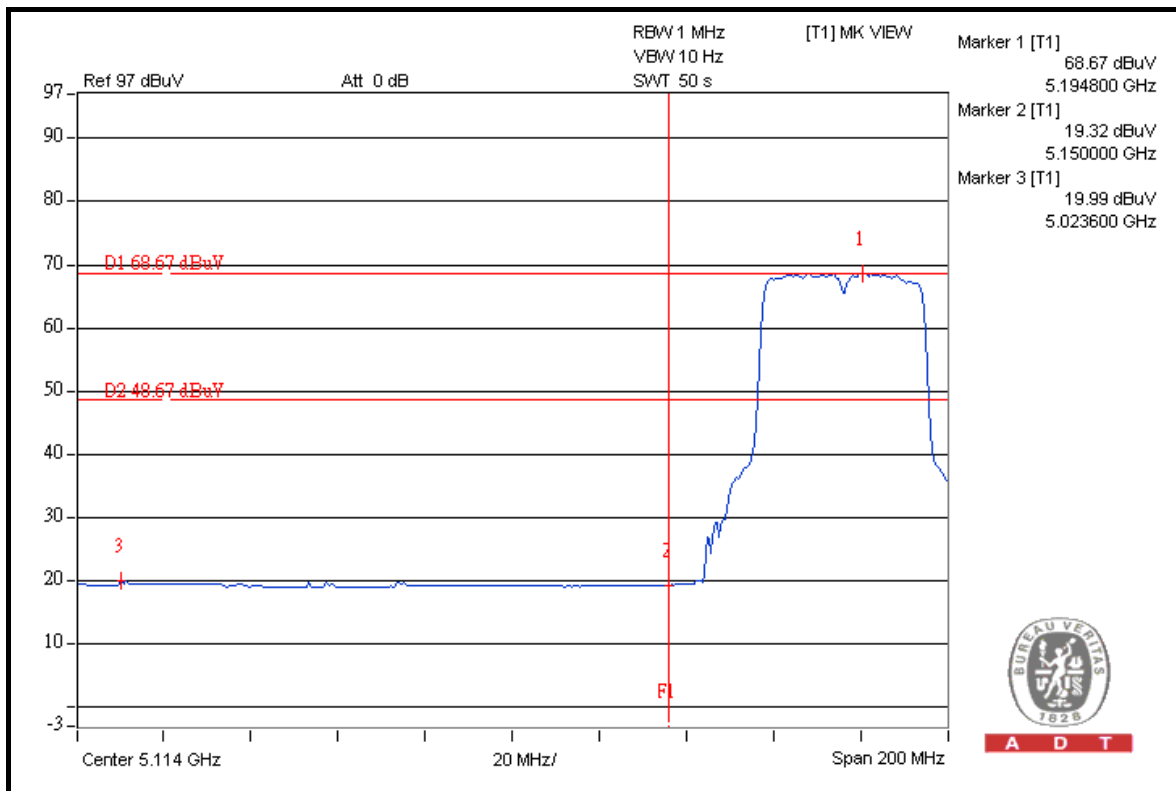

A D T



A D T

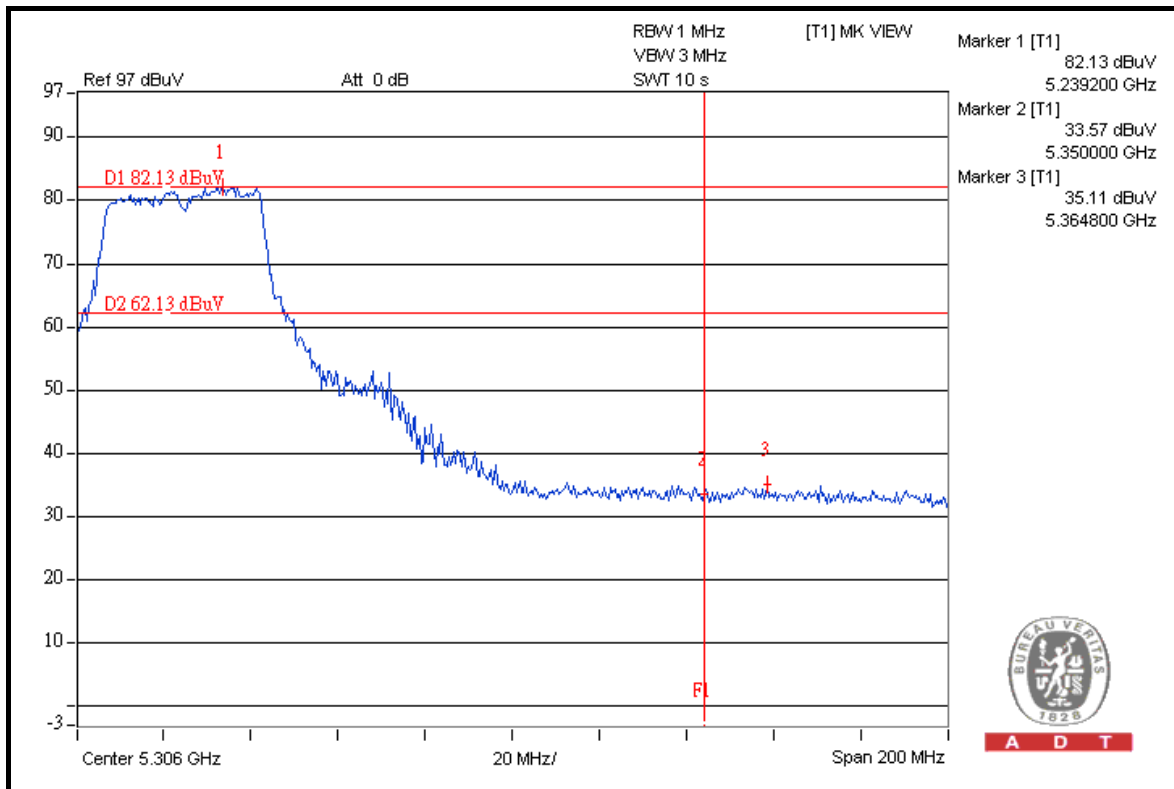
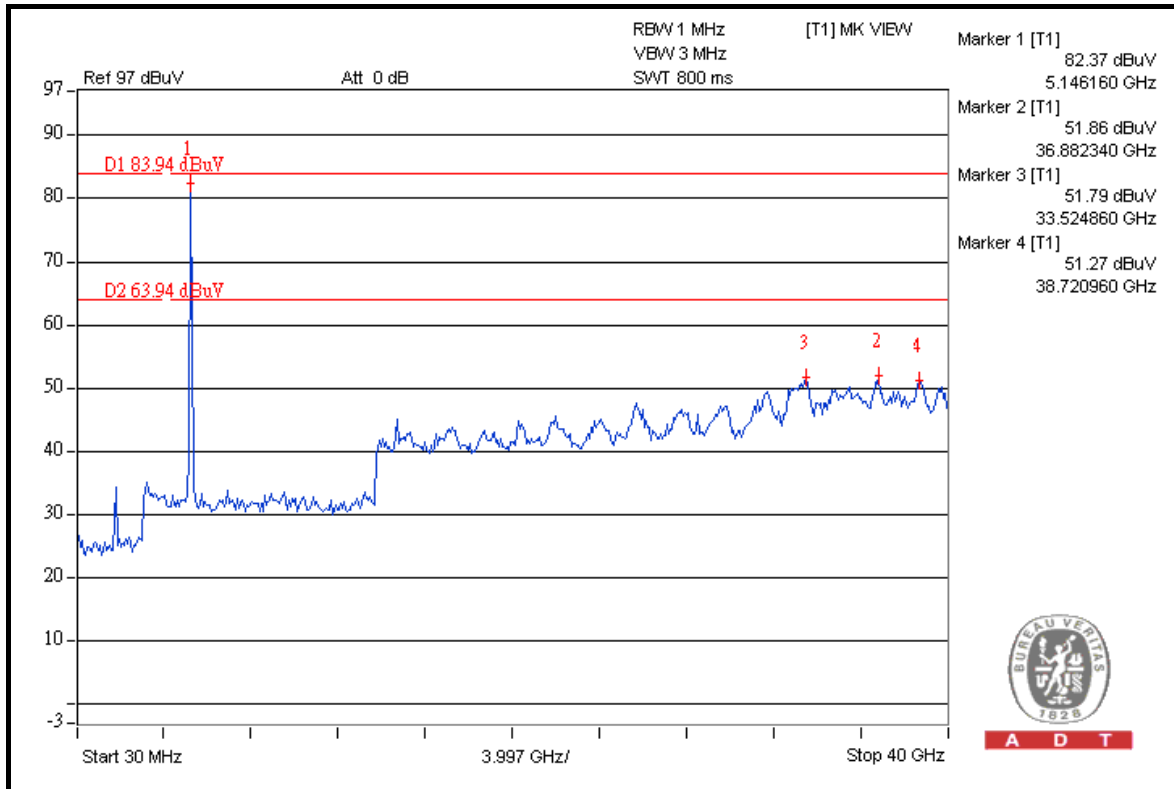



A D T

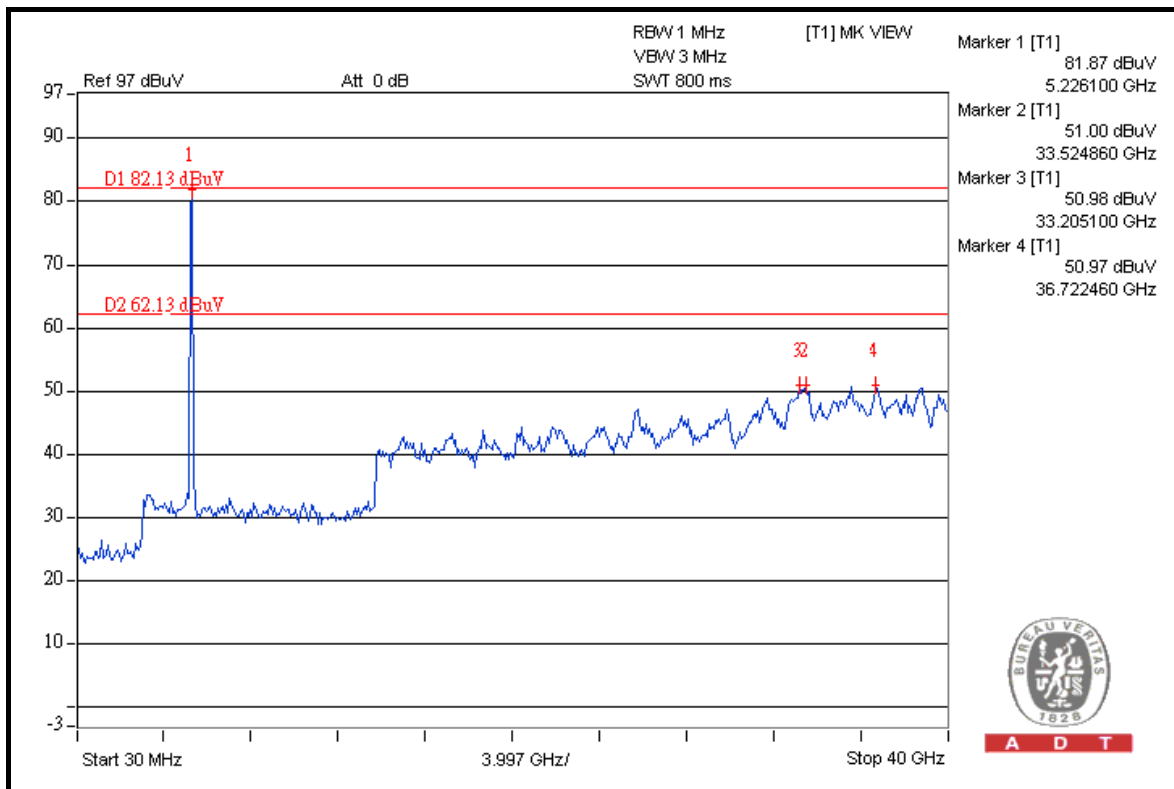
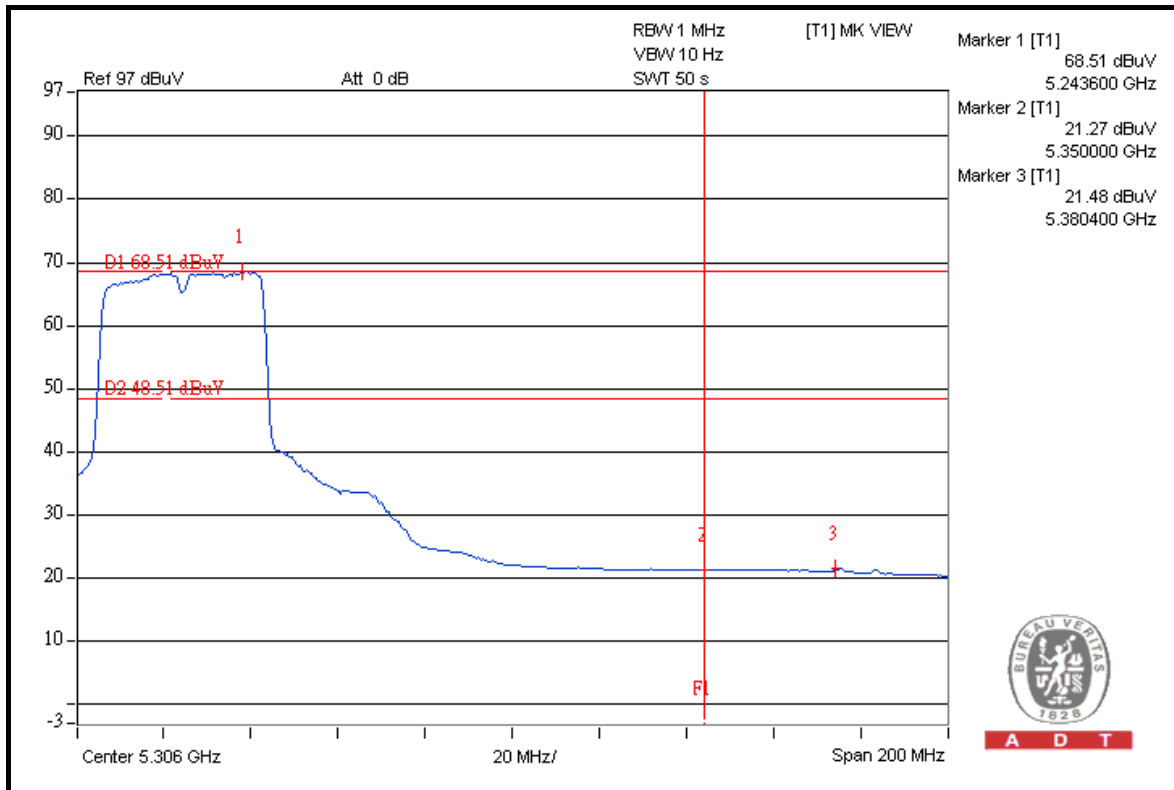

5. PHOTOGRAPHS OF THE TEST CONFIGURATION

Please refer to the attached file (Test Setup Photo).



6. INFORMATION ON THE TESTING LABORATORIES

We, Bureau Veritas Consumer Products Services (H.K.) Ltd., Taoyuan Branch, were founded in 1988 to provide our best service in EMC, Radio, Telecom and Safety consultation. Our laboratories are accredited and approved by the following approval agencies according to ISO/IEC 17025.

USA	FCC, NVLAP
Germany	TUV Rheinland
Japan	VCCI
Norway	NEMKO
Canada	INDUSTRY CANADA , CSA
R.O.C.	TAF, BSMI, NCC
Netherlands	Telefication
Singapore	GOST-ASIA(MOU)
Russia	CERTIS(MOU)

Copies of accreditation certificates of our laboratories obtained from approval agencies can be downloaded from our web site:
www.adt.com.tw/index.5/phtml. If you have any comments, please feel free to contact us at the following:

Linko EMC/RF Lab:
Tel: 886-2-26052180
Fax: 886-2-26051924

Hsin Chu EMC/RF Lab:
Tel: 886-3-5935343
Fax: 886-3-5935342

Hwa Ya EMC/RF/Safety Telecom Lab:
Tel: 886-3-3183232
Fax: 886-3-3185050

Web Site: www.adt.com.tw

The address and road map of all our labs can be found in our web site also.

7. APPENDIX A - MODIFICATIONS RECORDERS FOR ENGINEERING CHANGES TO THE EUT BY THE LAB

No any modifications are made to the EUT by the lab during the test.

---END---