



A D T

FCC TEST REPORT (15.247)

REPORT NO.: RF981021L10

MODEL NO.: ZF7363

RECEIVED: Oct. 21, 2009

TESTED: Oct. 23 ~ Oct. 29, 2009

ISSUED: Nov. 04, 2009

APPLICANT:	Senao Networks Inc.
ADDRESS:	3F, No. 529, Chung Cheng Rd., Hsintien, Taipei, Taiwan, R.O.C.
FCC ID:	U2M-ZF73XX-1
MANUFACTURER'S COMPANY:	Senao Networks, Inc.
MANUFACTURER ADDRESS:	3F, No. 529, Chung Cheng Rd., Hsintien, Taipei, Taiwan

ISSUED BY: Bureau Veritas Consumer Products Services (H.K.) Ltd., Taoyuan Branch

LAB ADDRESS: No. 47, 14th Ling, Chia Pau Tsuen, Lin Kou Hsiang, Taipei Hsien 244, Taiwan, R.O.C.

This test report consists of 128 pages in total. It may be duplicated completely for legal use with the approval of the applicant. It should not be reproduced except in full, without the written approval of our laboratory. The client should not use it to claim product endorsement by TAF or any government agencies. The test results in the report only apply to the tested sample.





A D T

TABLE OF CONTENTS

1.	CERTIFICATION.....	5
2.	SUMMARY OF TEST RESULTS	6
2.1	MEASUREMENT UNCERTAINTY	6
3.	GENERAL INFORMATION.....	7
3.1	GENERAL DESCRIPTION OF EUT	7
3.2	DESCRIPTION OF TEST MODES	9
3.2.1	CONFIGURATION OF SYSTEM UNDER TEST	11
3.2.2	TEST MODE APPLICABILITY AND TESTED CHANNEL DETAIL	12
3.3	GENERAL DESCRIPTION OF APPLIED STANDARDS	16
3.4	DESCRIPTION OF SUPPORT UNITS	16
4.	TEST TYPES AND RESULTS (FOR 2.4GHz BAND)	17
4.1	RADIATED EMISSION MEASUREMENT	17
4.1.1	LIMITS OF RADIATED EMISSION MEASUREMENT	17
4.1.2	TEST INSTRUMENTS.....	18
4.1.3	TEST PROCEDURES	19
4.1.4	DEVIATION FROM TEST STANDARD.....	19
4.1.5	TEST SETUP	20
4.1.6	EUT OPERATING CONDITIONS	20
4.1.7	TEST RESULTS	21
4.2	CONDUCTED EMISSION MEASUREMENT	35
4.2.1	LIMITS OF CONDUCTED EMISSION MEASUREMENT	35
4.2.2	TEST INSTRUMENTS.....	35
4.2.3	TEST PROCEDURES	36
4.2.4	DEVIATION FROM TEST STANDARD.....	36
4.2.5	TEST SETUP	37
4.2.6	EUT OPERATING CONDITIONS	37
4.2.7	TEST RESULTS	38
4.3	6dB BANDWIDTH MEASUREMENT.....	42
4.3.1	LIMITS OF 6dB BANDWIDTH MEASUREMENT	42
4.3.2	TEST INSTRUMENTS.....	42
4.3.3	TEST PROCEDURE.....	42
4.3.4	DEVIATION FROM TEST STANDARD.....	42
4.3.5	TEST SETUP	43
4.3.6	EUT OPERATING CONDITIONS	43
4.3.7	TEST RESULTS	44
4.4	MAXIMUM OUTPUT POWER	48
4.4.1	LIMITS OF MAXIMUM OUTPUT POWER MEASUREMENT	48
4.4.2	INSTRUMENTS.....	48
4.4.3	TEST PROCEDURE.....	48
4.4.4	DEVIATION FROM TEST STANDARD.....	49
4.4.5	TEST SETUP	49
4.4.6	EUT OPERATING CONDITIONS	49
4.4.7	TEST RESULTS	50
4.5	POWER SPECTRAL DENSITY MEASUREMENT	54
4.5.1	LIMITS OF POWER SPECTRAL DENSITY MEASUREMENT	54
4.5.2	TEST INSTRUMENTS.....	54
4.5.3	TEST PROCEDURE.....	54
4.5.4	DEVIATION FROM TEST STANDARD.....	55



A D T

4.5.5	TEST SETUP	55
4.5.6	EUT OPERATING CONDITION	55
4.5.7	TEST RESULTS	56
4.6	BAND EDGES MEASUREMENT	60
4.6.1	LIMITS OF BAND EDGES MEASUREMENT	60
4.6.2	TEST INSTRUMENTS	60
4.6.3	TEST PROCEDURE	61
4.6.4	DEVIATION FROM TEST STANDARD	61
4.6.5	EUT OPERATING CONDITION	61
4.6.6	TEST RESULTS	62
5.	TEST TYPES AND RESULTS (FOR 5.0GHz BAND)	78
5.1	RADIATED EMISSION MEASUREMENT	78
5.1.1	LIMITS OF RADIATED EMISSION MEASUREMENT	78
5.1.2	TEST INSTRUMENT	79
5.1.3	TEST PROCEDURES	80
5.1.4	DEVIATION FROM TEST STANDARD	80
5.1.5	TEST SETUP	81
5.1.6	EUT OPERATING CONDITIONS	81
5.1.7	TEST RESULTS	82
5.2	CONDUCTED EMISSION MEASUREMENT	92
5.2.1	LIMITS OF CONDUCTED EMISSION MEASUREMENT	92
5.2.2	TEST INSTRUMENTS	92
5.2.3	TEST PROCEDURES	93
5.2.4	DEVIATION FROM TEST STANDARD	93
5.2.5	TEST SETUP	94
5.2.6	EUT OPERATING CONDITIONS	94
5.2.7	TEST RESULTS	95
5.3	6dB BANDWIDTH MEASUREMENT	99
5.3.1	LIMITS OF 6dB BANDWIDTH MEASUREMENT	99
5.3.2	TEST INSTRUMENTS	99
5.3.3	TEST PROCEDURE	99
5.3.4	DEVIATION FROM TEST STANDARD	100
5.3.5	TEST SETUP	100
5.3.6	EUT OPERATING CONDITIONS	100
5.3.7	TEST RESULTS	101
5.4	MAXIMUM OUTPUT POWER	104
5.4.1	LIMITS OF MAXIMUM OUTPUT POWER MEASUREMENT	104
5.4.2	INSTRUMENTS	104
5.4.3	TEST PROCEDURE	104
5.4.4	DEVIATION FROM TEST STANDARD	105
5.4.5	TEST SETUP	105
5.4.6	EUT OPERATING CONDITIONS	105
5.4.7	TEST RESULTS	106
5.5	POWER SPECTRAL DENSITY MEASUREMENT	109
5.5.1	LIMITS OF POWER SPECTRAL DENSITY MEASUREMENT	109
5.5.2	TEST INSTRUMENTS	109
5.5.3	TEST PROCEDURE	109
5.5.4	DEVIATION FROM TEST STANDARD	110
5.5.5	TEST SETUP	110
5.5.6	EUT OPERATING CONDITION	110
5.5.7	TEST RESULTS	111
5.6	BAND EDGES MEASUREMENT	114



A D T

5.6.1	LIMITS OF BAND EDGES MEASUREMENT	114
5.6.2	TEST INSTRUMENTS.....	114
5.6.3	TEST PROCEDURE.....	115
5.6.4	DEVIATION FROM TEST STANDARD.....	116
5.6.5	EUT OPERATING CONDITION.....	116
5.6.6	TEST RESULTS	116
6.	PHOTOGRAPHS OF THE TEST CONFIGURATION.....	126
7.	INFORMATION ON THE TESTING LABORATORIES	127
8.	APPENDIX A - MODIFICATIONS RECORDERS FOR ENGINEERING CHANGES TO THE EUT BY THE LAB.....	128



A D T

1. CERTIFICATION

PRODUCT: ZoneFlex 7363 Access Point

MODEL: ZF7363

BRAND: Ruckus

APPLICANT: Senao Networks Inc.

TEST SAMPLE: ENGINEERING SAMPLE

TESTED: Oct. 23 ~ Oct. 29, 2009

STANDARDS: FCC Part 15, Subpart C (Section 15.247)

ANSI C63.4-2003

The above equipment (Model: ZF7363) has been tested by **Bureau Veritas Consumer Products Services (H.K.) Ltd., Taoyuan Branch**, and found compliance with the requirement of the above standards. The test record, data evaluation & Equipment Under Test (EUT) configurations represented herein are true and accurate accounts of the measurements of the sample's EMC characteristics under the conditions specified in this report.

PREPARED BY : Andrea Hsia , **DATE** : Nov. 04, 2009
Andrea Hsia / Specialist

TECHNICAL ACCEPTANCE : Long Chen , **DATE** : Nov. 04, 2009
Responsible for RF Long Chen / Senior Engineer

APPROVED BY : Gary Chang , **DATE** : Nov. 04, 2009
Gary Chang / Assistant Manager



2. SUMMARY OF TEST RESULTS

The EUT has been tested according to the following specifications:

APPLIED STANDARD: FCC PART 15, SUBPART C (SECTION 15.247)			
STANDARD SECTION	TEST TYPE AND LIMIT	RESULT	REMARK
15.207	AC Power Conducted Emission	PASS	Meet the requirement of limit. Minimum passing margin is -12.8dB at 0.291MHz
15.247(a)(2)	Spectrum Bandwidth of a Direct Sequence Spread Spectrum System Limit: min. 500kHz	PASS	Meet the requirement of limit.
15.247(b)	Maximum Peak Output Power Limit: max. 30dBm	PASS	Meet the requirement of limit.
15.247(d)	Radiated Emissions Limit: Table 15.209	PASS	Meet the requirement of limit. Minimum passing margin is -0.2dB at 340.00, 680.01, 340.01 & 679.99MHz
15.247(e)	Power Spectral Density Limit: max. 8dBm	PASS	Meet the requirement of limit.
15.247(d)	Band Edge Measurement Limit: 20dB less than the peak value of fundamental frequency	PASS	Meet the requirement of limit.
15.203	Antenna Requirement	PASS	No antenna connector is used.

2.1 MEASUREMENT UNCERTAINTY

Where relevant, the following measurement uncertainty levels have been estimated for tests performed on the EUT as specified in CISPR 16-4-2:

MEASUREMENT	FREQUENCY	UNCERTAINTY
Conducted emissions	150kHz~30MHz	2.44 dB
Radiated emissions	30MHz ~ 1000MHz	3.78 dB
	1GHz ~ 40GHz	2.89 dB

This uncertainty represents an expanded uncertainty expressed at approximately the 95% confidence level using a coverage factor of $k = 2$.



3. GENERAL INFORMATION

3.1 GENERAL DESCRIPTION OF EUT

EUT	ZoneFlex 7363 Access Point
MODEL NO.	ZF7363
FCC ID	U2M-ZF73XX-1
POWER SUPPLY	12Vdc (adapter) 48Vdc (POE)
MODULATION TYPE	CCK, DQPSK, DBPSK for DSSS 64QAM, 16QAM, QPSK, BPSK for OFDM
MODULATION TECHNOLOGY	DSSS, OFDM
TRANSFER RATE	802.11b: 11.0/ 5.5/ 2.0/ 1.0Mbps 802.11g: 54.0/ 48.0/ 36.0/ 24.0/ 18.0/ 12.0/ 9.0/ 6.0Mbps 802.11a: 54.0/ 48.0/ 36.0/ 24.0/ 18.0/ 12.0/ 9.0/ 6.0Mbps 802.11n: up to 270.0Mbps
OPERATING FREQUENCY	2.4GHz: 2412 ~ 2462MHz 5.0GHz: 5745 ~ 5825MHz
NUMBER OF CHANNEL	2.4GHz: 11 for 802.11b, 802.11g, d802.11n (20MHz) 7 for 802.11n (40MHz) 5.0GHz: 5 for 802.11a, 802.11n (20MHz) 2 for 802.11n (40MHz)
OUTPUT POWER	219.0mW for 2412 ~ 2462MHz 130.8mW for 5745 ~ 5825MHz
ANTENNA TYPE	PIFA antenna with 2dBi gain
ANTENNA CONNECTOR	NA
I/O PORTS	USB, RJ45
DATA CABLE	NA
ACCESSORY DEVICES	AC adapter

NOTE:

1. The EUT is a ZoneFlex 7363 Access Point. The functions of EUT listed as below:

	TEST STANDARD	REFERENCE REPORT
WLAN 802.11b/g, 802.11n	FCC Part 15, Subpart C (Section 15.247)	RF981021L10
WLAN 802.11a, 802.11n (5745~5825 MHz)		
WLAN 802.11a, 802.11n (5180~ 5240MHz)	FCC Part 15, Subpart E (Section 15.407)	RF981021L10-1



2. The frequency bands used in this EUT are listed as follows:

Frequency Band (MHz)	2412~2462	5180~5240	5745~5825
802.11b	√		
802.11g	√		
802.11a		√	√
802.11n (20MHz)	√	√	√
802.11n (40MHz)	√	√	√

3. The EUT were powered by the following adapter & POE:

ADAPTER	
BRAND:	Ruckus
MODEL:	DSA-12G-12 FUS 120120
INPUT:	100-240Vac, 0.3A, 50/60Hz
OUTPUT:	12Vdc, 1A
POWER LINE:	1.8m non-shielded cable without core

POE	
BRAND:	SonicWall
MODEL:	PD-6083G300
OUTPUT:	48Vdc

**POE was for tested only and optional accessory.

4. The EUT incorporates a MIMO function. Physically, the EUT provides two completed transmitters and two receivers.

MODULATION MODE	TX FUNCTION
802.11b	2TX
802.11g	2TX
802.11a	2TX
802.11n (20MHz)	2TX
802.11n (40MHz)	2TX

5. Spurious emission of the simultaneous operation has been evaluated and no non-compliance found.

6. The above EUT information was declared by manufacturer and for more detailed features description, please refer to the manufacturer's specifications or user's manual.

3.2 DESCRIPTION OF TEST MODES

FOR 2.4GHz:

11 channels are provided for 802.11b, 802.11g and 802.11n (20MHz):

CHANNEL	FREQUENCY	CHANNEL	FREQUENCY
1	2412MHz	7	2442MHz
2	2417MHz	8	2447MHz
3	2422MHz	9	2452MHz
4	2427MHz	10	2457MHz
5	2432MHz	11	2462MHz
6	2437MHz		

7 channels are provided for 802.11n (40MHz):

CHANNEL	FREQUENCY	CHANNEL	FREQUENCY
1	2422MHz	5	2442MHz
2	2427MHz	6	2447MHz
3	2432MHz	7	2452MHz
4	2437MHz		

FOR 5.0GHz (5745 ~ 5825MHz):

5 channels are provided for 802.11a, 802.11n (20MHz):

CHANNEL	FREQUENCY	CHANNEL	FREQUENCY
149	5745MHz	161	5805MHz
153	5765MHz	165	5825MHz
157	5785MHz		

2 channels are provided for 802.11n (40MHz):

CHANNEL	FREQUENCY	CHANNEL	FREQUENCY
151	5755MHz	159	5795MHz



POWER SETTING

802.11b			802.11g		
CHANNEL		POWER SETTING	CHANNEL		POWER SETTING
1	Chain 0	20.0	1	Chain 0	20.0
	Chain 1	20.0		Chain 1	20.0
6	Chain 0	20.0	6	Chain 0	20.0
	Chain 1	20.0		Chain 1	20.0
11	Chain 0	20.0	11	Chain 0	20.0
	Chain 1	20.0		Chain 1	20.0

802.11n (20MHz)			802.11n (40MHz)		
CHANNEL		POWER SETTING	CHANNEL		POWER SETTING
1	Chain 0	20.0	1	Chain 0	20.0
	Chain 1	20.0		Chain 1	20.0
6	Chain 0	20.0	4	Chain 0	20.0
	Chain 1	20.0		Chain 1	20.0
11	Chain 0	20.0	7	Chain 0	20.0
	Chain 1	20.0		Chain 1	20.0

802.11a			802.11n (20MHz)		
CHANNEL		POWER SETTING	CHANNEL		POWER SETTING
149	Chain 0	18.5	149	Chain 0	18.5
	Chain 1	18.5		Chain 1	18.5
157	Chain 0	19.0	157	Chain 0	19.0
	Chain 1	19.0		Chain 1	19.0
165	Chain 0	17.5	165	Chain 0	17.5
	Chain 1	17.5		Chain 1	17.5

802.11n (40MHz)		
CHANNEL		POWER SETTING
151	Chain 0	19.0
	Chain 1	19.0
159	Chain 0	19.0
	Chain 1	19.0

3.2.1 CONFIGURATION OF SYSTEM UNDER TEST

Test mode A

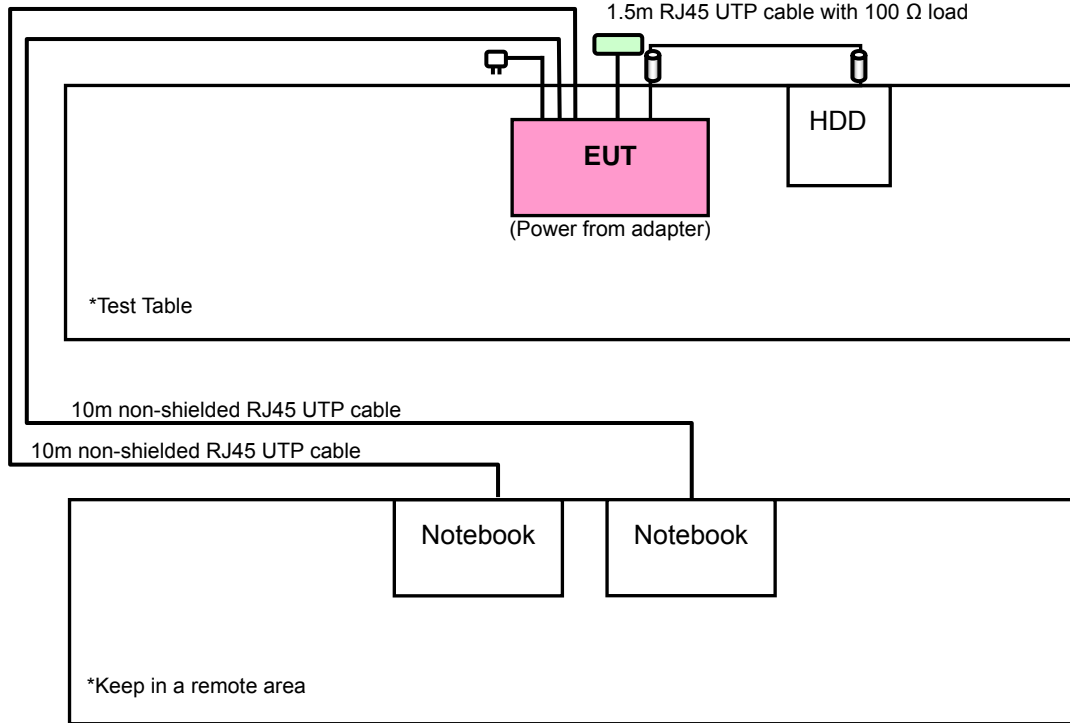

Test mode B

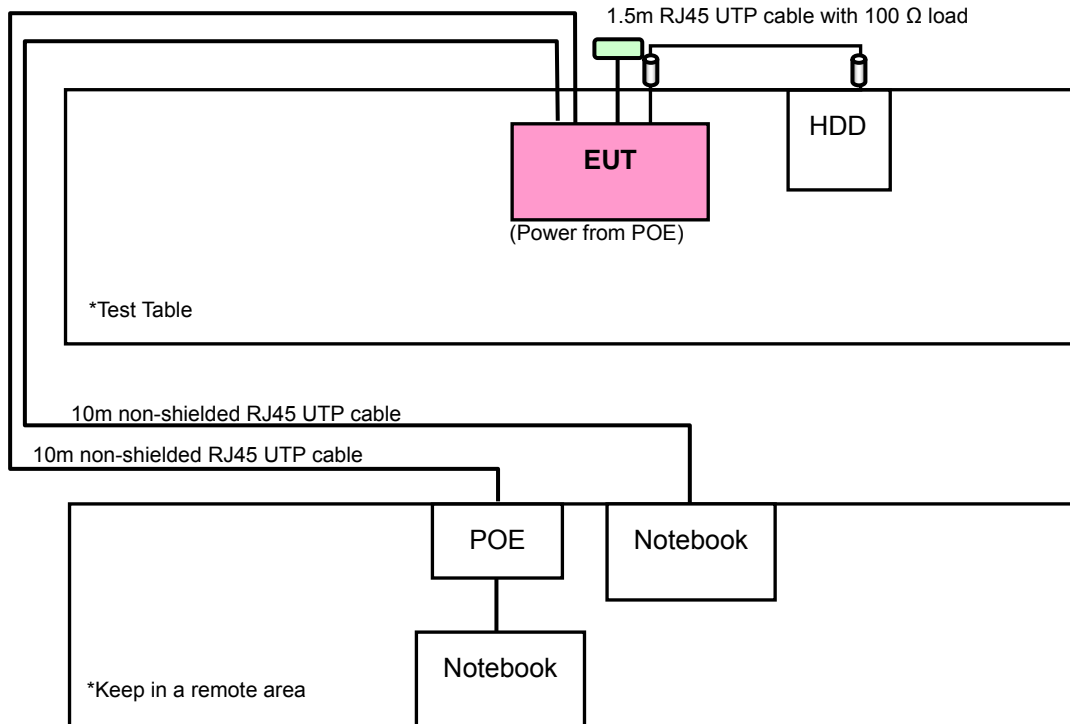



3.2.2 TEST MODE APPLICABILITY AND TESTED CHANNEL DETAIL FOR 2.4GHz:

EUT CONFIGURE MODE	APPLICABLE TO				DESCRIPTION
	RE≥1G	RE<1G	PLC	APCM	
A	√	√	√	√	Power from AC Adapter
B	-	√	√	-	Power from POE

Where **RE≥1G**: Radiated Emission above 1GHz
RE<1G: Radiated Emission below 1GHz
PLC: Power Line Conducted Emission
APCM: Antenna Port Conducted Measurement
NOTE: "-" means no effect.

RADIATED EMISSION TEST (ABOVE 1GHz):

- Pre-Scan has been conducted to determine the worst-case mode from all possible combinations between available modulations, XYZ axis and antenna ports (if EUT with antenna diversity architecture).
- Following channel(s) was (were) selected for the final test as listed below.

EUT CONFIGURE MODE	MODE	AVAILABLE CHANNEL	TESTED CHANNEL	MODULATION TECHNOLOGY	MODULATION TYPE	DATA RATE (Mbps)	AXIS
A	802.11b	1 to 11	1, 6, 11	DSSS	DBPSK	1.0	X
A	802.11g	1 to 11	1, 6, 11	OFDM	BPSK	6.0	X
A	802.11n (20MHz)	1 to 11	1, 6, 11	OFDM	BPSK	6.5	X
A	802.11n (40MHz)	1 to 7	1, 4, 7	OFDM	BPSK	13.5	X

RADIATED EMISSION TEST (BELOW 1GHz):

- Pre-Scan has been conducted to determine the worst-case mode from all possible combinations between available modulations, XYZ axis and antenna ports (if EUT with antenna diversity architecture).
- Following channel(s) was (were) selected for the final test as listed below.

EUT CONFIGURE MODE	MODE	AVAILABLE CHANNEL	TESTED CHANNEL	MODULATION TECHNOLOGY	MODULATION TYPE	DATA RATE (Mbps)	AXIS
A	802.11b	1 to 11	6	DSSS	DBPSK	1.0	X
B	802.11b	1 to 11	6	DSSS	DBPSK	1.0	X

POWER LINE CONDUCTED EMISSION TEST:

- Pre-Scan has been conducted to determine the worst-case mode from all possible combinations between available modulations, data rates and antenna ports (if EUT with antenna diversity architecture).
- Following channel(s) was (were) selected for the final test as listed below.

EUT CONFIGURE MODE	MODE	AVAILABLE CHANNEL	TESTED CHANNEL	MODULATION TECHNOLOGY	MODULATION TYPE	DATA RATE (Mbps)
A	802.11b	1 to 11	6	DSSS	DBPSK	1.0
B	802.11b	1 to 11	6	DSSS	DBPSK	1.0



A D T

BANDEDGE MEASUREMENT:

- Pre-Scan has been conducted to determine the worst-case mode from all possible combinations between available modulations, data rates and antenna ports (if EUT with antenna diversity architecture).
- Following channel(s) was (were) selected for the final test as listed below.

EUT CONFIGURE MODE	MODE	AVAILABLE CHANNEL	TESTED CHANNEL	MODULATION TECHNOLOGY	MODULATION TYPE	DATA RATE (Mbps)
A	802.11b	1 to 11	1, 11	DSSS	DBPSK	1.0
A	802.11g	1 to 11	1, 11	OFDM	BPSK	6.0
A	802.11n (20MHz)	1 to 11	1, 11	OFDM	BPSK	6.5
A	802.11n (40MHz)	1 to 7	1, 7	OFDM	BPSK	13.5

ANTENNA PORT CONDUCTED MEASUREMENT:

- This item includes all test value of each mode, but only includes spectrum plot of worst value of each mode.
- Pre-Scan has been conducted to determine the worst-case mode from all possible combinations between available modulations, data rates and antenna ports (if EUT with antenna diversity architecture).
- Following channel(s) was (were) selected for the final test as listed below.

EUT CONFIGURE MODE	MODE	AVAILABLE CHANNEL	TESTED CHANNEL	MODULATION TECHNOLOGY	MODULATION TYPE	DATA RATE (Mbps)
A	802.11b	1 to 11	1, 6, 11	DSSS	DBPSK	1.0
A	802.11g	1 to 11	1, 6, 11	OFDM	BPSK	6.0
A	802.11n (20MHz)	1 to 11	1, 6, 11	OFDM	BPSK	6.5
A	802.11n (40MHz)	1 to 7	1, 4, 7	OFDM	BPSK	13.5

TEST CONDITION:

APPLICABLE TO	ENVIRONMENTAL CONDITIONS	INPUT POWER (SYSTEM)	TESTED BY
RE≥1G	23deg. C, 76%RH, 1008 hPa	120Vac, 60Hz	Nick Chen
RE<1G	23deg. C, 76%RH, 1008 hPa	120Vac, 60Hz	Nick Chen
PLC	23deg. C, 70%RH, 1008 hPa	120Vac, 60Hz	Nick Chen
APCM	23deg. C, 71%RH, 1008 hPa	120Vac, 60Hz	Nick Chen



A D T

FOR 5.745 ~ 5.825GHz:

EUT CONFIGURE MODE	APPLICABLE TO				DESCRIPTION
	RE≥1G	RE<1G	PLC	APCM	
A	√	√	√	√	Power from AC Adapter
B	-	√	√	-	Power from POE

Where **RE≥1G**: Radiated Emission above 1GHz **RE<1G**: Radiated Emission below 1GHz
PLC: Power Line Conducted Emission **APCM**: Antenna Port Conducted Measurement
NOTE: "-" means no effect.

RADIATED EMISSION TEST (ABOVE 1GHz):

- Pre-Scan has been conducted to determine the worst-case mode from all possible combinations between available modulations, XYZ axis and antenna ports (if EUT with antenna diversity architecture).
- Following channel(s) was (were) selected for the final test as listed below.

EUT CONFIGURE MODE	MODE	AVAILABLE CHANNEL	TESTED CHANNEL	MODULATION TECHNOLOGY	MODULATION TYPE	DATA RATE (Mbps)	AXIS
A	802.11a	149 to 165	149, 157, 165	OFDM	BPSK	6.0	X
A	802.11n (20MHz)	149 to 165	149, 157, 165	OFDM	BPSK	6.5	X
A	802.11n (40MHz)	151 to 159	151, 159	OFDM	BPSK	13.5	X

RADIATED EMISSION TEST (BELOW 1GHz):

- Pre-Scan has been conducted to determine the worst-case mode from all possible combinations between available modulations, XYZ axis and antenna ports (if EUT with antenna diversity architecture).
- Following channel(s) was (were) selected for the final test as listed below.

EUT CONFIGURE MODE	MODE	AVAILABLE CHANNEL	TESTED CHANNEL	MODULATION TECHNOLOGY	MODULATION TYPE	DATA RATE (Mbps)	AXIS
A	802.11n (40MHz)	151 to 159	159	OFDM	BPSK	13.5	X
B	802.11n (40MHz)	151 to 159	159	OFDM	BPSK	13.5	X

POWER LINE CONDUCTED EMISSION TEST:

- Pre-Scan has been conducted to determine the worst-case mode from all possible combinations between available modulations, data rates and antenna ports (if EUT with antenna diversity architecture).
- Following channel(s) was (were) selected for the final test as listed below.

EUT CONFIGURE MODE	MODE	AVAILABLE CHANNEL	TESTED CHANNEL	MODULATION TECHNOLOGY	MODULATION TYPE	DATA RATE (Mbps)
A	802.11n (40MHz)	151 to 159	159	OFDM	BPSK	13.5
B	802.11n (40MHz)	151 to 159	159	OFDM	BPSK	13.5



A D T

BANDEDGE MEASUREMENT:

- Pre-Scan has been conducted to determine the worst-case mode from all possible combinations between available modulations, data rates and antenna ports (if EUT with antenna diversity architecture).
- Following channel(s) was (were) selected for the final test as listed below.

EUT CONFIGURE MODE	MODE	AVAILABLE CHANNEL	TESTED CHANNEL	MODULATION TECHNOLOGY	MODULATION TYPE	DATA RATE (Mbps)
A	802.11a	149 to 165	149, 165	OFDM	BPSK	6.0
A	802.11n (20MHz)	149 to 165	149, 165	OFDM	BPSK	6.5
A	802.11n (40MHz)	151 to 159	151, 159	OFDM	BPSK	13.5

ANTENNA PORT CONDUCTED MEASUREMENT:

- This item includes all test value of each mode, but only includes spectrum plot of worst value of each mode.
- Pre-Scan has been conducted to determine the worst-case mode from all possible combinations between available modulations, data rates and antenna ports (if EUT with antenna diversity architecture).
- Following channel(s) was (were) selected for the final test as listed below.

EUT CONFIGURE MODE	MODE	AVAILABLE CHANNEL	TESTED CHANNEL	MODULATION TECHNOLOGY	MODULATION TYPE	DATA RATE (Mbps)
A	802.11a	149 to 165	149, 157, 165	OFDM	BPSK	6.0
A	802.11n (20MHz)	149 to 165	149, 157, 165	OFDM	BPSK	6.5
A	802.11n (40MHz)	151 to 159	151, 159	OFDM	BPSK	13.5

TEST CONDITION:

APPLICABLE TO	ENVIRONMENTAL CONDITIONS	INPUT POWER (SYSTEM)	TESTED BY
RE \geq 1G	22deg. C, 83%RH, 1008 hPa	120Vac, 60Hz	Nick Chen
RE $<$ 1G	23deg. C, 76%RH, 1008 hPa	120Vac, 60Hz	Nick Chen
PLC	24deg. C, 70%RH, 1008 hPa	120Vac, 60Hz	Nick Chen
APCM	23deg. C, 71%RH, 1008 hPa	120Vac, 60Hz	Nick Chen



A D T

3.3 GENERAL DESCRIPTION OF APPLIED STANDARDS

The EUT is a RF Product. According to the specifications of the manufacturer, it must comply with the requirements of the following standards:

FCC Part 15, Subpart C (15.247)

ANSI C63.4-2003

All test items have been performed and recorded as per the above standards.

NOTE: The EUT is also considered as a kind of computer peripheral, because the connection to computer is necessary for typical use. It has been verified to comply with the requirements of FCC Part 15, Subpart B, Class B (DoC). The test report has been issued separately.

3.4 DESCRIPTION OF SUPPORT UNITS

The EUT has been tested as an independent unit together with other necessary accessories or support units. The following support units or accessories were used to form a representative test configuration during the tests.

NO.	PRODUCT	BRAND	MODEL NO.	SERIAL NO.	FCC ID
1	NOTEBOOK	DELL	PP05L	24729091408	FCC DoC Approved
2	NOTEBOOK	DELL	PP05L	20375526736	FCC DoC Approved
3	EXTERNAL HARD DISK	DELL	RD1000	HK-0XM763-72953-77Q-0021	NA
4	POE	SonicWall	PD-6083G300	NA	NA

NO.	SIGNAL CABLE DESCRIPTION OF THE ABOVE SUPPORT UNITS
1	10m non-shielded RJ45 UTP cable.
2	1m non-shielded RJ45 UTP cable.
3	2m shielded cable, terminated with USB connector, with 2 cores.
4	10m non-shielded RJ45 UTP cable.

NOTE:

1. All power cords of the above support units are non shielded (1.8m).
2. Items 1 ~ 2 acted as communication partners to transfer data.
3. Item 4 was provided by the client and for test mode B.



A D T

4. TEST TYPES AND RESULTS (FOR 2.4GHz BAND)

4.1 RADIATED EMISSION MEASUREMENT

4.1.1 LIMITS OF RADIATED EMISSION MEASUREMENT

Emissions radiated outside of the specified bands, shall be according to the general radiated limits in 15.209 as following:

FREQUENCIES (MHz)	FIELD STRENGTH (microvolts/meter)	MEASUREMENT DISTANCE (meters)
0.009 ~ 0.490	2400/F(kHz)	300
0.490 ~ 1.705	24000/F(kHz)	30
1.705 ~ 30.0	30	30
30 ~ 88	100	3
88 ~ 216	150	3
216 ~ 960	200	3
Above 960	500	3

NOTE:

1. The lower limit shall apply at the transition frequencies.
2. Emission level (dBuV/m) = 20 log Emission level (uV/m).
3. As shown in 15.35(b), for frequencies above 1000MHz, the field strength limits are based on average detector, however, the peak field strength of any emission shall not exceed the maximum permitted average limits, specified above by more than 20dB under any condition of modulation.



A D T

4.1.2 TEST INSTRUMENTS

FOR FREQUENCY ABOVE 1 GHz:

DESCRIPTION & MANUFACTURER	MODEL NO.	SERIAL NO.	DATE OF CALIBRATION	DUE DATE OF CALIBRATION
Agilent Spectrum	8564EC	4208A00659	Jul. 24, 2009	Jul. 23, 2010
Agilent Preamplifier	8449B	3008A01924	Aug. 31, 2009	Aug. 30, 2010
Agilent Preamplifier	8449B	3008A01292	Aug. 10, 2009	Aug. 09, 2010
MITEQ Preamplifier	AMF-6F-260400-33 -8P	892164	Aug. 31, 2009	Aug. 30, 2010
Schwarzbeck Horn Antenna	BBHA-9170	BBHA9170190	Sep. 24, 2009	Sep. 23, 2010
Schwarzbeck Horn Antenna	BBHA-9120	D130	May 15, 2009	May 14, 2010
ADT. Turn Table	TT100	0201	NA	NA
ADT. Tower	AT100	0201	NA	NA
Software	ADT_Radiated_V7. 6.15.9.2	NA	NA	NA
SUHNER RF cable	SF106-18	PHACAB-1G- 40GHz	Aug. 20, 2009	Aug. 19, 2010

- NOTE:**
1. The calibration interval of the above test instruments is 12 months. And the calibrations are traceable to NML/ROC and NIST/USA.
 2. The test was performed in Open Site No. 10.
 3. The Industry Canada Reference No. IC 7450E-10.
 4. The FCC Site Registration No. 698148.

FOR FREQUENCY BELOW 1 GHz:

DESCRIPTION & MANUFACTURER	MODEL NO.	SERIAL NO.	DATE OF CALIBRATION	DUE DATE OF CALIBRATION
ROHDE & SCHWARZ TEST RECEIVER	ESVS 30	841977/008	Apr. 24, 2009	Apr. 23, 2010
SCHAFFNER BILOG Antenna	CBL6111C	2793	Apr. 29, 2009	Apr. 28, 2010
ADT. Turn Table	TT100	0201	NA	NA
ADT. Tower	AT100	0201	NA	NA
Software	ADT_Radiated_V7. 6.15.9.2	NA	NA	NA
ADT RF Switches BOX	EM-H-01-1	1004	Dec. 19, 2008	Dec. 18, 2009
WOKEN RF cable	8D	CABLE-ST10-01	Dec. 19, 2008	Dec. 18, 2009

- NOTE:**
1. The calibration interval of the above test instruments is 12 months. And the calibrations are traceable to NML/ROC and NIST/USA.
 2. The test was performed in Open Site No. 10.
 3. The VCCI Site Registration No. R-1625.
 4. The Industry Canada Reference No. IC 7450E-10.
 5. The FCC Site Registration No. 698148.



4.1.3 TEST PROCEDURES

- a. The EUT was placed on the top of a rotating table 0.8 meters above the ground at a 10 meter open area test site. The table was rotated 360 degrees to determine the position of the highest radiation.
- b. The EUT was set 3 meters away from the interference-receiving antenna, which was mounted on the top of a variable-height antenna tower.
- c. The antenna is a broadband antenna, and its height is varied from one meter to four meters above the ground to determine the maximum value of the field strength. Both horizontal and vertical polarizations of the antenna are set to make the measurement.
- d. For each suspected emission, the EUT was arranged to its worst case and then the antenna was tuned to heights from 1 meter to 4 meters and the rotatable table was turned from 0 degrees to 360 degrees to find the maximum reading.
- e. The test-receiver system was set to Peak Detect Function and Specified Bandwidth with Maximum Hold Mode.
- f. If the emission level of the EUT in peak mode was lower than the limit specified, then testing could be stopped and the peak values of the EUT would be reported. Otherwise the emissions would be re-tested one by one using peak, quasi-peak or average method as specified and then reported in a data sheet.

NOTE:

1. The resolution bandwidth and video bandwidth of test receiver/spectrum analyzer is 120kHz for Quasi-peak detection at frequency below 1GHz.
2. The resolution bandwidth of test receiver/spectrum analyzer is 1MHz and video bandwidth is 3MHz for Peak detection at frequency above 1GHz.
3. The resolution bandwidth of test receiver/spectrum analyzer is 1MHz and the video bandwidth is 10Hz for Average detection (AV) at frequency above 1GHz.
4. All modes of operation were investigated and the worst-case emissions are reported.

4.1.4 DEVIATION FROM TEST STANDARD

No deviation.

4.1.5 TEST SETUP

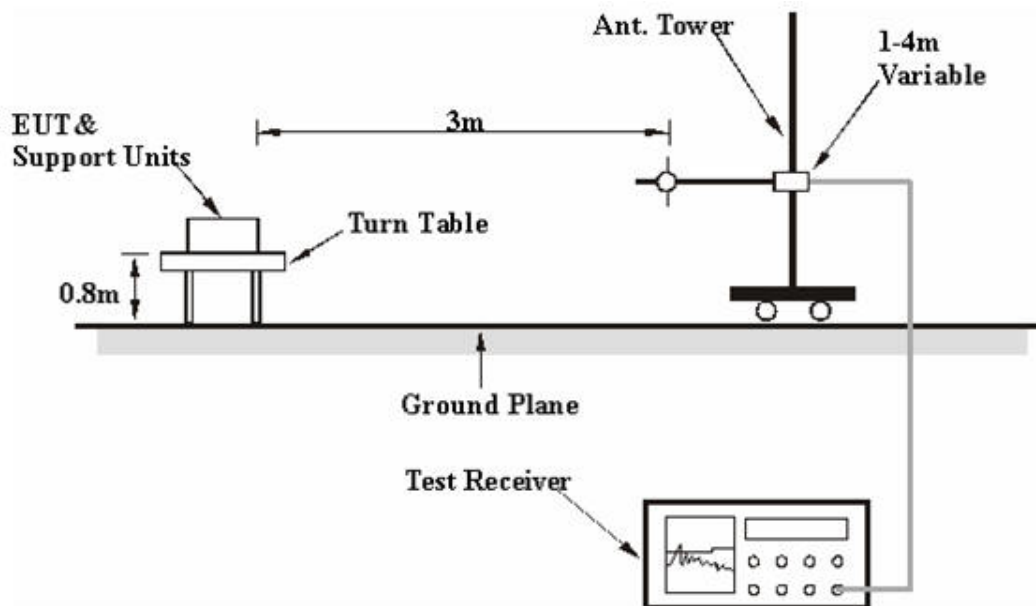

For the actual test configuration, please refer to the attached file (Test Setup Photo).

4.1.6 EUT OPERATING CONDITIONS

- a. Placed the EUT on the testing table.
- b. Prepared notebook system outside of testing area to act as a communication partners.
- c. The communication partner connected with EUT via a RJ45 UTP cable and run a test program (provided by manufacturer) to enable EUT under transmission condition continuously at specific channel frequency.
- d. The communication partner sent data to EUT by command "PING".



A D T

4.1.7 TEST RESULTS

802.11b

EUT TEST CONDITION		MEASUREMENT DETAIL	
CHANNEL	Channel 1	FREQUENCY RANGE	1 ~ 25GHz
INPUT POWER (SYSTEM)	120Vac, 60 Hz	DETECTOR FUNCTION	Peak (PK) Average (AV)
ENVIRONMENTAL CONDITIONS	23deg. C, 76%RH 1000 hPa	TESTED BY	Nick Chen

ANTENNA POLARITY & TEST DISTANCE: HORIZONTAL AT 3 M								
NO.	FREQ. (MHz)	EMISSION LEVEL (dBuV/m)	LIMIT (dBuV/m)	MARGIN (dB)	ANTENNA HEIGHT (m)	TABLE ANGLE (Degree)	RAW VALUE (dBuV)	CORRECTION FACTOR (dB/m)
1	2390.00	54.6 PK	74.00	-19.4	1.01 H	255	22.91	31.72
2	2390.00	45.2 AV	54.00	-8.8	1.01 H	255	13.47	31.72
3	*2412.00	98.0 PK			1.01 H	255	66.22	31.81
4	*2412.00	92.9 AV			1.01 H	255	61.10	31.81
5	#3216.00	41.3 PK	68.00	-26.7	1.09 H	301	7.06	34.23
6	#3216.00	28.9 AV	62.90	-34.0	1.09 H	301	-5.32	34.23
7	4824.00	49.1 PK	74.00	-24.9	1.12 H	151	11.42	37.71
8	4824.00	43.8 AV	54.00	-10.2	1.12 H	151	6.13	37.71
ANTENNA POLARITY & TEST DISTANCE: VERTICAL AT 3 M								
NO.	FREQ. (MHz)	EMISSION LEVEL (dBuV/m)	LIMIT (dBuV/m)	MARGIN (dB)	ANTENNA HEIGHT (m)	TABLE ANGLE (Degree)	RAW VALUE (dBuV)	CORRECTION FACTOR (dB/m)
1	2390.00	56.5 PK	74.00	-17.5	1.01 V	200	24.79	31.72
2	2390.00	45.8 AV	54.00	-8.2	1.01 V	200	14.09	31.72
3	*2412.00	110.5 PK			1.01 V	200	78.72	31.81
4	*2412.00	104.6 AV			1.01 V	200	72.76	31.81
5	#3216.00	46.0 PK	80.50	-34.5	1.21 V	83	11.79	34.23
6	#3216.00	41.1 AV	74.60	-33.5	1.21 V	83	6.88	34.23
7	4824.00	54.8 PK	74.00	-19.2	1.18 V	229	17.10	37.71
8	4824.00	52.1 AV	54.00	-1.9	1.18 V	229	14.43	37.71

- REMARKS:**
1. Emission level (dBuV/m) = Raw Value (dBuV) + Correction Factor (dB/m).
 2. Correction Factor (dB/m) = Antenna Factor (dB/m) + Cable Factor (dB).
 3. The other emission levels were very low against the limit.
 4. Margin value = Emission level – Limit value.
 5. “ * “: Fundamental frequency.
 6. “#“: The radiated frequency is out the restricted band.



A D T

EUT TEST CONDITION		MEASUREMENT DETAIL	
CHANNEL	Channel 6	FREQUENCY RANGE	1 ~ 25GHz
INPUT POWER (SYSTEM)	120Vac, 60 Hz	DETECTOR FUNCTION	Peak (PK) Average (AV)
ENVIRONMENTAL CONDITIONS	23deg. C, 76%RH 1000 hPa	TESTED BY	Nick Chen

ANTENNA POLARITY & TEST DISTANCE: HORIZONTAL AT 3 M								
NO.	FREQ. (MHz)	EMISSION LEVEL (dBuV/m)	LIMIT (dBuV/m)	MARGIN (dB)	ANTENNA HEIGHT (m)	TABLE ANGLE (Degree)	RAW VALUE (dBuV)	CORRECTION FACTOR (dB/m)
1	*2437.00	98.0 PK			1.05 H	136	66.09	31.92
2	*2437.00	92.6 AV			1.05 H	136	60.71	31.92
3	#3249.00	41.4 PK	68.00	-26.6	1.03 H	233	7.09	34.28
4	#3249.00	29.5 AV	62.60	-33.1	1.03 H	233	-4.78	34.28
5	4874.00	49.4 PK	74.00	-24.6	1.41 H	20	11.61	37.82
6	4874.00	44.3 AV	54.00	-9.7	1.41 H	20	6.46	37.82
ANTENNA POLARITY & TEST DISTANCE: VERTICAL AT 3 M								
NO.	FREQ. (MHz)	EMISSION LEVEL (dBuV/m)	LIMIT (dBuV/m)	MARGIN (dB)	ANTENNA HEIGHT (m)	TABLE ANGLE (Degree)	RAW VALUE (dBuV)	CORRECTION FACTOR (dB/m)
1	*2437.00	110.0 PK			1.40 V	33	78.11	31.92
2	*2437.00	104.0 AV			1.40 V	33	72.03	31.92
3	#3249.00	46.0 PK	80.00	-34.0	1.30 V	121	11.73	34.28
4	#3249.00	40.0 AV	74.00	-34.0	1.30 V	121	5.70	34.28
5	4874.00	54.8 PK	74.00	-19.2	1.30 V	241	16.99	37.82
6	4874.00	51.3 AV	54.00	-2.7	1.30 V	241	13.50	37.82

- REMARKS:**
1. Emission level (dBuV/m) = Raw Value (dBuV) + Correction Factor (dB/m).
 2. Correction Factor (dB/m) = Antenna Factor (dB/m) + Cable Factor (dB).
 3. The other emission levels were very low against the limit.
 4. Margin value = Emission level – Limit value.
 5. “ * “: Fundamental frequency.
 6. "#":The radiated frequency is out the restricted band.



A D T

EUT TEST CONDITION		MEASUREMENT DETAIL	
CHANNEL	Channel 11	FREQUENCY RANGE	1 ~ 25GHz
INPUT POWER (SYSTEM)	120Vac, 60 Hz	DETECTOR FUNCTION	Peak (PK) Average (AV)
ENVIRONMENTAL CONDITIONS	23deg. C, 76%RH 1000 hPa	TESTED BY	Nick Chen

ANTENNA POLARITY & TEST DISTANCE: HORIZONTAL AT 3 M								
NO.	FREQ. (MHz)	EMISSION LEVEL (dBuV/m)	LIMIT (dBuV/m)	MARGIN (dB)	ANTENNA HEIGHT (m)	TABLE ANGLE (Degree)	RAW VALUE (dBuV)	CORRECTION FACTOR (dB/m)
1	*2462.00	98.0 PK			1.48 H	88	65.94	32.03
2	*2462.00	92.0 AV			1.48 H	88	60.00	32.03
3	2483.50	57.8 PK	74.00	-16.2	1.48 H	88	25.69	32.13
4	2483.50	46.4 AV	54.00	-7.6	1.48 H	88	14.28	32.13
5	#3282.00	46.0 PK	68.00	-22.0	1.03 H	286	11.71	34.32
6	#3282.00	40.8 AV	62.00	-21.2	1.03 H	286	6.44	34.32
7	4924.00	47.1 PK	74.00	-26.9	1.21 H	150	9.21	37.92
8	4924.00	40.9 AV	54.00	-13.1	1.21 H	150	3.00	37.92
ANTENNA POLARITY & TEST DISTANCE: VERTICAL AT 3 M								
NO.	FREQ. (MHz)	EMISSION LEVEL (dBuV/m)	LIMIT (dBuV/m)	MARGIN (dB)	ANTENNA HEIGHT (m)	TABLE ANGLE (Degree)	RAW VALUE (dBuV)	CORRECTION FACTOR (dB/m)
1	*2462.00	108.9 PK			1.29 V	213	76.86	32.03
2	*2462.00	100.0 AV			1.29 V	213	67.99	32.03
3	2483.50	59.2 PK	74.00	-14.8	1.29 V	213	27.08	32.13
4	2483.50	48.3 AV	54.00	-5.7	1.29 V	213	16.18	32.13
5	#3282.00	42.6 PK	78.90	-36.3	1.22 V	360	8.29	34.32
6	#3282.00	36.1 AV	70.00	-33.9	1.22 V	360	1.79	34.32
7	4924.00	53.2 PK	74.00	-20.8	1.19 V	264	15.32	37.92
8	4924.00	50.8 AV	54.00	-3.2	1.19 V	264	12.89	37.92

- REMARKS:**
1. Emission level (dBuV/m) = Raw Value (dBuV) + Correction Factor (dB/m).
 2. Correction Factor (dB/m) = Antenna Factor (dB/m) + Cable Factor (dB).
 3. The other emission levels were very low against the limit.
 4. Margin value = Emission level – Limit value.
 5. “ * “: Fundamental frequency.
 6. “#”:The radiated frequency is out the restricted band.



A D T

802.11g

EUT TEST CONDITION		MEASUREMENT DETAIL	
CHANNEL	Channel 1	FREQUENCY RANGE	1 ~ 25GHz
INPUT POWER (SYSTEM)	120Vac, 60 Hz	DETECTOR FUNCTION	Peak (PK) Average (AV)
ENVIRONMENTAL CONDITIONS	23deg. C, 76%RH 1000 hPa	TESTED BY	Nick Chen

ANTENNA POLARITY & TEST DISTANCE: HORIZONTAL AT 3 M								
NO.	FREQ. (MHz)	EMISSION LEVEL (dBuV/m)	LIMIT (dBuV/m)	MARGIN (dB)	ANTENNA HEIGHT (m)	TABLE ANGLE (Degree)	RAW VALUE (dBuV)	CORRECTION FACTOR (dB/m)
1	2390.00	55.2 PK	74.00	-18.8	1.00 H	301	23.49	31.72
2	2390.00	45.2 AV	54.00	-8.8	1.00 H	301	13.47	31.72
3	*2412.00	100.0 PK			1.00 H	301	68.14	31.81
4	*2412.00	88.0 AV			1.00 H	301	56.20	31.81
5	#3216.00	44.8 PK	70.00	-25.2	1.35 H	306	10.60	34.23
6	#3216.00	38.1 AV	58.00	-19.9	1.35 H	306	3.88	34.23
7	4824.00	46.8 PK	74.00	-27.3	1.41 H	152	9.04	37.71
8	4824.00	33.7 AV	54.00	-20.3	1.41 H	152	-4.00	37.71

ANTENNA POLARITY & TEST DISTANCE: VERTICAL AT 3 M								
NO.	FREQ. (MHz)	EMISSION LEVEL (dBuV/m)	LIMIT (dBuV/m)	MARGIN (dB)	ANTENNA HEIGHT (m)	TABLE ANGLE (Degree)	RAW VALUE (dBuV)	CORRECTION FACTOR (dB/m)
1	2390.00	58.7 PK	74.00	-15.3	1.05 V	333	27.02	31.72
2	2390.00	46.0 AV	54.00	-8.0	1.05 V	333	14.30	31.72
3	*2412.00	112.0 PK			1.05 V	333	80.16	31.81
4	*2412.00	100.6 AV			1.05 V	333	68.80	31.81
5	#3216.00	52.4 PK	82.00	-29.6	1.36 V	119	18.21	34.23
6	#3216.00	50.4 AV	70.60	-20.2	1.36 V	119	16.15	34.23
7	4824.00	49.8 PK	74.00	-24.2	1.42 V	256	12.13	37.71
8	4824.00	36.0 AV	54.00	-18.0	1.42 V	256	-1.74	37.71

- REMARKS:**
1. Emission level (dBuV/m) = Raw Value (dBuV) + Correction Factor (dB/m).
 2. Correction Factor (dB/m) = Antenna Factor (dB/m) + Cable Factor (dB).
 3. The other emission levels were very low against the limit.
 4. Margin value = Emission level – Limit value.
 5. " * ": Fundamental frequency.
 6. "#": The radiated frequency is out the restricted band.



A D T

EUT TEST CONDITION		MEASUREMENT DETAIL	
CHANNEL	Channel 6	FREQUENCY RANGE	1 ~ 25GHz
INPUT POWER (SYSTEM)	120Vac, 60 Hz	DETECTOR FUNCTION	Peak (PK) Average (AV)
ENVIRONMENTAL CONDITIONS	23deg. C, 76%RH 1000 hPa	TESTED BY	Nick Chen

ANTENNA POLARITY & TEST DISTANCE: HORIZONTAL AT 3 M								
NO.	FREQ. (MHz)	EMISSION LEVEL (dBuV/m)	LIMIT (dBuV/m)	MARGIN (dB)	ANTENNA HEIGHT (m)	TABLE ANGLE (Degree)	RAW VALUE (dBuV)	CORRECTION FACTOR (dB/m)
1	*2437.00	100.5 PK			1.12 H	22	68.59	31.92
2	*2437.00	88.1 AV			1.12 H	22	56.19	31.92
3	#3249.00	42.0 PK	70.50	-28.5	1.33 H	39	7.73	34.28
4	#3249.00	36.0 AV	58.10	-22.1	1.33 H	39	1.74	34.28
5	4874.00	46.0 PK	74.00	-28.0	1.34 H	86	8.17	37.82
6	4874.00	32.5 AV	54.00	-21.5	1.34 H	86	-5.31	37.82
ANTENNA POLARITY & TEST DISTANCE: VERTICAL AT 3 M								
NO.	FREQ. (MHz)	EMISSION LEVEL (dBuV/m)	LIMIT (dBuV/m)	MARGIN (dB)	ANTENNA HEIGHT (m)	TABLE ANGLE (Degree)	RAW VALUE (dBuV)	CORRECTION FACTOR (dB/m)
1	*2437.00	112.0 PK			1.00 V	93	80.04	31.92
2	*2437.00	101.0 AV			1.00 V	93	69.11	31.92
3	#3249.00	47.3 PK	82.00	-34.7	1.00 V	101	13.03	34.28
4	#3249.00	42.9 AV	71.00	-28.1	1.00 V	101	8.58	34.28
5	4874.00	49.5 PK	74.00	-24.5	1.38 V	220	11.69	37.82
6	4874.00	36.2 AV	54.00	-17.8	1.38 V	220	-1.58	37.82

- REMARKS:**
1. Emission level (dBuV/m) = Raw Value (dBuV) + Correction Factor (dB/m).
 2. Correction Factor (dB/m) = Antenna Factor (dB/m) + Cable Factor (dB).
 3. The other emission levels were very low against the limit.
 4. Margin value = Emission level – Limit value.
 5. “ * “: Fundamental frequency.
 6. "#":The radiated frequency is out the restricted band.



A D T

EUT TEST CONDITION		MEASUREMENT DETAIL	
CHANNEL	Channel 11	FREQUENCY RANGE	1 ~ 25GHz
INPUT POWER (SYSTEM)	120Vac, 60 Hz	DETECTOR FUNCTION	Peak (PK) Average (AV)
ENVIRONMENTAL CONDITIONS	23deg. C, 76%RH 1000 hPa	TESTED BY	Nick Chen

ANTENNA POLARITY & TEST DISTANCE: HORIZONTAL AT 3 M								
NO.	FREQ. (MHz)	EMISSION LEVEL (dBuV/m)	LIMIT (dBuV/m)	MARGIN (dB)	ANTENNA HEIGHT (m)	TABLE ANGLE (Degree)	RAW VALUE (dBuV)	CORRECTION FACTOR (dB/m)
1	*2462.00	100.9 PK			1.43 H	216	68.83	32.03
2	*2462.00	88.7 AV			1.43 H	216	56.64	32.03
3	2483.50	57.0 PK	74.00	-17.0	1.43 H	216	24.88	32.13
4	2483.50	45.8 AV	54.00	-8.2	1.43 H	216	13.69	32.13
5	#3282.00	42.3 PK	70.90	-28.6	1.51 H	176	8.01	34.32
6	#3282.00	34.8 AV	58.70	-23.9	1.51 H	176	0.51	34.32
7	4924.00	45.8 PK	74.00	-28.2	1.39 H	201	7.91	37.92
8	4924.00	32.4 AV	54.00	-21.6	1.39 H	201	-5.56	37.92
ANTENNA POLARITY & TEST DISTANCE: VERTICAL AT 3 M								
NO.	FREQ. (MHz)	EMISSION LEVEL (dBuV/m)	LIMIT (dBuV/m)	MARGIN (dB)	ANTENNA HEIGHT (m)	TABLE ANGLE (Degree)	RAW VALUE (dBuV)	CORRECTION FACTOR (dB/m)
1	*2462.00	112.0 PK			1.00 V	99	79.94	32.03
2	*2462.00	99.5 AV			1.00 V	99	67.48	32.03
3	2483.50	65.2 PK	74.00	-8.8	1.00 V	99	33.03	32.13
4	2483.50	49.1 AV	54.00	-4.9	1.00 V	99	16.97	32.13
5	#3282.00	48.2 PK	82.00	-33.8	1.29 V	263	13.89	34.32
6	#3282.00	44.2 AV	69.50	-25.3	1.29 V	263	9.87	34.32
7	4924.00	47.6 PK	74.00	-26.4	1.20 V	100	9.71	37.92
8	4924.00	34.6 AV	54.00	-19.4	1.20 V	100	-3.31	37.92

- REMARKS:**
1. Emission level (dBuV/m) = Raw Value (dBuV) + Correction Factor (dB/m).
 2. Correction Factor (dB/m) = Antenna Factor (dB/m) + Cable Factor (dB).
 3. The other emission levels were very low against the limit.
 4. Margin value = Emission level – Limit value.
 5. “ * “: Fundamental frequency.
 6. “#”:The radiated frequency is out the restricted band.



A D T

802.11n (20MHz)

EUT TEST CONDITION		MEASUREMENT DETAIL	
CHANNEL	Channel 1	FREQUENCY RANGE	1 ~ 25GHz
INPUT POWER (SYSTEM)	120Vac, 60 Hz	DETECTOR FUNCTION	Peak (PK) Average (AV)
ENVIRONMENTAL CONDITIONS	23deg. C, 76%RH 1000 hPa	TESTED BY	Nick Chen

ANTENNA POLARITY & TEST DISTANCE: HORIZONTAL AT 3 M								
NO.	FREQ. (MHz)	EMISSION LEVEL (dBuV/m)	LIMIT (dBuV/m)	MARGIN (dB)	ANTENNA HEIGHT (m)	TABLE ANGLE (Degree)	RAW VALUE (dBuV)	CORRECTION FACTOR (dB/m)
1	2390.00	54.9 PK	74.00	-19.1	1.00 H	290	23.17	31.72
2	2390.00	45.1 AV	54.00	-8.9	1.00 H	290	13.39	31.72
3	*2412.00	99.8 PK			1.00 H	290	68.02	31.81
4	*2412.00	87.0 AV			1.00 H	290	55.21	31.81
5	#3216.00	43.0 PK	69.80	-26.8	1.30 H	16	8.79	34.23
6	#3216.00	36.9 AV	57.00	-20.1	1.30 H	16	2.64	34.23
7	4824.00	45.4 PK	74.00	-28.6	1.34 H	33	7.72	37.71
8	4824.00	33.3 AV	54.00	-20.7	1.34 H	33	-4.44	37.71

ANTENNA POLARITY & TEST DISTANCE: VERTICAL AT 3 M								
NO.	FREQ. (MHz)	EMISSION LEVEL (dBuV/m)	LIMIT (dBuV/m)	MARGIN (dB)	ANTENNA HEIGHT (m)	TABLE ANGLE (Degree)	RAW VALUE (dBuV)	CORRECTION FACTOR (dB/m)
1	2390.00	58.0 PK	74.00	-16.0	1.01 V	316	26.30	31.72
2	2390.00	46.8 AV	54.00	-7.3	1.01 V	316	15.03	31.72
3	*2412.00	111.0 PK			1.01 V	316	79.21	31.81
4	*2412.00	97.6 AV			1.01 V	316	65.82	31.81
5	#3216.00	50.6 PK	81.00	-30.4	1.34 V	103	16.40	34.23
6	#3216.00	47.1 AV	67.60	-20.5	1.34 V	103	12.88	34.23
7	4824.00	50.8 PK	74.00	-23.2	1.37 V	293	13.12	37.71
8	4824.00	37.6 AV	54.00	-16.4	1.37 V	293	-0.07	37.71

- REMARKS:**
1. Emission level (dBuV/m) = Raw Value (dBuV) + Correction Factor (dB/m).
 2. Correction Factor (dB/m) = Antenna Factor (dB/m) + Cable Factor (dB).
 3. The other emission levels were very low against the limit.
 4. Margin value = Emission level – Limit value.
 5. " * ": Fundamental frequency.
 6. "#": The radiated frequency is out the restricted band.



A D T

EUT TEST CONDITION		MEASUREMENT DETAIL	
CHANNEL	Channel 6	FREQUENCY RANGE	1 ~ 25GHz
INPUT POWER (SYSTEM)	120Vac, 60 Hz	DETECTOR FUNCTION	Peak (PK) Average (AV)
ENVIRONMENTAL CONDITIONS	23deg. C, 76%RH 1000 hPa	TESTED BY	Nick Chen

ANTENNA POLARITY & TEST DISTANCE: HORIZONTAL AT 3 M								
NO.	FREQ. (MHz)	EMISSION LEVEL (dBuV/m)	LIMIT (dBuV/m)	MARGIN (dB)	ANTENNA HEIGHT (m)	TABLE ANGLE (Degree)	RAW VALUE (dBuV)	CORRECTION FACTOR (dB/m)
1	*2437.00	99.8 PK			1.00 H	251	67.89	31.92
2	*2437.00	87.8 AV			1.00 H	251	55.90	31.92
3	#3249.00	43.3 PK	69.80	-26.5	1.38 H	36	9.03	34.28
4	#3249.00	36.5 AV	57.80	-21.3	1.38 H	36	2.21	34.28
5	4874.00	47.8 PK	74.00	-26.2	1.37 H	217	10.02	37.82
6	4874.00	35.6 AV	54.00	-18.4	1.37 H	217	-2.19	37.82
ANTENNA POLARITY & TEST DISTANCE: VERTICAL AT 3 M								
NO.	FREQ. (MHz)	EMISSION LEVEL (dBuV/m)	LIMIT (dBuV/m)	MARGIN (dB)	ANTENNA HEIGHT (m)	TABLE ANGLE (Degree)	RAW VALUE (dBuV)	CORRECTION FACTOR (dB/m)
1	*2437.00	112.2 PK			1.01 V	32	80.27	31.92
2	*2437.00	99.2 AV			1.01 V	32	67.32	31.92
3	#3249.00	47.2 PK	82.20	-35.0	1.29 V	83	12.91	34.28
4	#3249.00	43.2 AV	69.20	-26.0	1.29 V	83	8.94	34.28
5	4874.00	49.2 PK	74.00	-24.8	1.35 V	219	11.41	37.82
6	4874.00	36.2 AV	54.00	-17.8	1.35 V	219	-1.61	37.82

- REMARKS:**
1. Emission level (dBuV/m) = Raw Value (dBuV) + Correction Factor (dB/m).
 2. Correction Factor (dB/m) = Antenna Factor (dB/m) + Cable Factor (dB).
 3. The other emission levels were very low against the limit.
 4. Margin value = Emission level – Limit value.
 5. “ * “: Fundamental frequency.
 6. “#”:The radiated frequency is out the restricted band.



A D T

EUT TEST CONDITION		MEASUREMENT DETAIL	
CHANNEL	Channel 11	FREQUENCY RANGE	1 ~ 25GHz
INPUT POWER (SYSTEM)	120Vac, 60 Hz	DETECTOR FUNCTION	Peak (PK) Average (AV)
ENVIRONMENTAL CONDITIONS	23deg. C, 76%RH 1000 hPa	TESTED BY	Nick Chen

ANTENNA POLARITY & TEST DISTANCE: HORIZONTAL AT 3 M								
NO.	FREQ. (MHz)	EMISSION LEVEL (dBuV/m)	LIMIT (dBuV/m)	MARGIN (dB)	ANTENNA HEIGHT (m)	TABLE ANGLE (Degree)	RAW VALUE (dBuV)	CORRECTION FACTOR (dB/m)
1	*2462.00	100.3 PK			1.00 H	2	68.26	32.03
2	*2462.00	88.1 AV			1.00 H	2	56.10	32.03
3	2483.50	57.0 PK	74.00	-17.0	1.00 H	2	24.90	32.13
4	2483.50	46.1 AV	54.00	-7.9	1.00 H	2	13.98	32.13
5	#3282.00	43.6 PK	70.30	-26.7	1.42 H	193	9.29	34.32
6	#3282.00	37.2 AV	58.10	-20.9	1.42 H	193	2.89	34.32
7	4924.00	46.0 PK	74.00	-28.0	1.51 H	123	8.09	37.92
8	4924.00	33.7 AV	54.00	-20.3	1.51 H	123	-4.20	37.92
ANTENNA POLARITY & TEST DISTANCE: VERTICAL AT 3 M								
NO.	FREQ. (MHz)	EMISSION LEVEL (dBuV/m)	LIMIT (dBuV/m)	MARGIN (dB)	ANTENNA HEIGHT (m)	TABLE ANGLE (Degree)	RAW VALUE (dBuV)	CORRECTION FACTOR (dB/m)
1	*2462.00	111.9 PK			1.02 V	99	79.90	32.03
2	*2462.00	99.8 AV			1.02 V	99	67.78	32.03
3	2483.50	67.8 PK	74.00	-6.2	1.02 V	99	35.69	32.13
4	2483.50	50.2 AV	54.00	-3.8	1.02 V	99	18.03	32.13
5	#3282.00	47.9 PK	81.90	-34.0	1.28 V	241	13.60	34.32
6	#3282.00	44.0 AV	69.80	-25.8	1.28 V	241	9.64	34.32
7	4924.00	48.7 PK	74.00	-25.3	1.21 V	102	10.75	37.92
8	4924.00	36.3 AV	54.00	-17.7	1.21 V	102	-1.63	37.92

- REMARKS:**
1. Emission level (dBuV/m) = Raw Value (dBuV) + Correction Factor (dB/m).
 2. Correction Factor (dB/m) = Antenna Factor (dB/m) + Cable Factor (dB).
 3. The other emission levels were very low against the limit.
 4. Margin value = Emission level – Limit value.
 5. “ * “: Fundamental frequency.
 6. “#”:The radiated frequency is out the restricted band.



A D T

802.11n (40MHz)

EUT TEST CONDITION		MEASUREMENT DETAIL	
CHANNEL	Channel 1	FREQUENCY RANGE	1 ~ 25GHz
INPUT POWER (SYSTEM)	120Vac, 60 Hz	DETECTOR FUNCTION	Peak (PK) Average (AV)
ENVIRONMENTAL CONDITIONS	23deg. C, 76%RH 1000 hPa	TESTED BY	Nick Chen

ANTENNA POLARITY & TEST DISTANCE: HORIZONTAL AT 3 M								
NO.	FREQ. (MHz)	EMISSION LEVEL (dBuV/m)	LIMIT (dBuV/m)	MARGIN (dB)	ANTENNA HEIGHT (m)	TABLE ANGLE (Degree)	RAW VALUE (dBuV)	CORRECTION FACTOR (dB/m)
1	2390.00	54.1 PK	74.00	-19.9	1.19 H	284	22.41	31.72
2	2390.00	38.8 AV	54.00	-15.2	1.19 H	284	7.04	31.72
3	*2422.00	97.2 PK			1.19 H	284	65.38	31.86
4	*2422.00	83.2 AV			1.19 H	284	51.33	31.86
5	#3230.00	44.3 PK	67.20	-22.9	1.18 H	234	10.06	34.25
6	#3230.00	36.8 AV	53.20	-16.4	1.18 H	234	2.56	34.25
7	4844.00	44.8 PK	74.00	-29.2	1.24 H	29	7.08	37.76
8	4844.00	31.6 AV	54.00	-22.4	1.24 H	29	-6.14	37.76
ANTENNA POLARITY & TEST DISTANCE: VERTICAL AT 3 M								
NO.	FREQ. (MHz)	EMISSION LEVEL (dBuV/m)	LIMIT (dBuV/m)	MARGIN (dB)	ANTENNA HEIGHT (m)	TABLE ANGLE (Degree)	RAW VALUE (dBuV)	CORRECTION FACTOR (dB/m)
1	2390.00	71.6 PK	74.00	-2.4	1.00 V	294	39.89	31.72
2	2390.00	50.4 AV	54.00	-3.6	1.00 V	294	18.67	31.72
3	*2422.00	110.0 PK			1.00 V	296	78.17	31.86
4	*2422.00	95.2 AV			1.00 V	296	63.30	31.86
5	#3230.00	51.6 PK	80.00	-28.4	1.16 V	129	17.37	34.25
6	#3230.00	48.8 AV	65.20	-16.4	1.16 V	129	14.52	34.25
7	4844.00	47.6 PK	74.00	-26.4	1.30 V	219	9.85	37.76
8	4844.00	34.6 AV	54.00	-19.4	1.30 V	219	-3.17	37.76

- REMARKS:**
1. Emission level (dBuV/m) = Raw Value (dBuV) + Correction Factor (dB/m).
 2. Correction Factor (dB/m) = Antenna Factor (dB/m) + Cable Factor (dB).
 3. The other emission levels were very low against the limit.
 4. Margin value = Emission level – Limit value.
 5. “ * “: Fundamental frequency.
 6. “#“: The radiated frequency is out the restricted band.



A D T

EUT TEST CONDITION		MEASUREMENT DETAIL	
CHANNEL	Channel 4	FREQUENCY RANGE	1 ~ 25GHz
INPUT POWER (SYSTEM)	120Vac, 60 Hz	DETECTOR FUNCTION	Peak (PK) Average (AV)
ENVIRONMENTAL CONDITIONS	23deg. C, 76%RH 1000 hPa	TESTED BY	Nick Chen

ANTENNA POLARITY & TEST DISTANCE: HORIZONTAL AT 3 M								
NO.	FREQ. (MHz)	EMISSION LEVEL (dBuV/m)	LIMIT (dBuV/m)	MARGIN (dB)	ANTENNA HEIGHT (m)	TABLE ANGLE (Degree)	RAW VALUE (dBuV)	CORRECTION FACTOR (dB/m)
1	*2437.00	97.5 PK			1.00 H	265	65.59	31.92
2	*2437.00	83.2 AV			1.00 H	265	51.24	31.92
3	#3249.00	43.8 PK	67.50	-23.7	1.34 H	194	9.54	34.28
4	#3249.00	36.0 AV	53.20	-17.2	1.34 H	194	1.71	34.28
5	4874.00	45.8 PK	74.00	-28.2	1.18 H	136	8.01	37.82
6	4874.00	31.7 AV	54.00	-22.3	1.18 H	136	-6.10	37.82
ANTENNA POLARITY & TEST DISTANCE: VERTICAL AT 3 M								
NO.	FREQ. (MHz)	EMISSION LEVEL (dBuV/m)	LIMIT (dBuV/m)	MARGIN (dB)	ANTENNA HEIGHT (m)	TABLE ANGLE (Degree)	RAW VALUE (dBuV)	CORRECTION FACTOR (dB/m)
1	*2437.00	109.6 PK			1.01 V	345	77.71	31.92
2	*2437.00	95.0 AV			1.01 V	345	63.05	31.92
3	#3249.00	49.0 PK	79.60	-30.6	1.31 V	163	14.71	34.28
4	#3249.00	44.3 AV	65.00	-20.7	1.31 V	163	10.03	34.28
5	4874.00	49.4 PK	74.00	-24.6	1.39 V	99	11.59	37.82
6	4874.00	36.2 AV	54.00	-17.8	1.39 V	99	-1.63	37.82

- REMARKS:**
1. Emission level (dBuV/m) = Raw Value (dBuV) + Correction Factor (dB/m).
 2. Correction Factor (dB/m) = Antenna Factor (dB/m) + Cable Factor (dB).
 3. The other emission levels were very low against the limit.
 4. Margin value = Emission level – Limit value.
 5. “ * “: Fundamental frequency.
 6. “#”:The radiated frequency is out the restricted band.



A D T

EUT TEST CONDITION		MEASUREMENT DETAIL	
CHANNEL	Channel 7	FREQUENCY RANGE	1 ~ 25GHz
INPUT POWER (SYSTEM)	120Vac, 60 Hz	DETECTOR FUNCTION	Peak (PK) Average (AV)
ENVIRONMENTAL CONDITIONS	23deg. C, 76%RH 1000 hPa	TESTED BY	Nick Chen

ANTENNA POLARITY & TEST DISTANCE: HORIZONTAL AT 3 M								
NO.	FREQ. (MHz)	EMISSION LEVEL (dBuV/m)	LIMIT (dBuV/m)	MARGIN (dB)	ANTENNA HEIGHT (m)	TABLE ANGLE (Degree)	RAW VALUE (dBuV)	CORRECTION FACTOR (dB/m)
1	*2452.00	98.0 PK			1.02 H	234	66.04	31.99
2	*2452.00	84.3 AV			1.02 H	234	52.27	31.99
3	2483.50	58.3 PK	74.00	-15.7	1.02 H	219	26.21	32.13
4	2483.50	40.2 AV	54.00	-13.8	1.02 H	219	8.10	32.13
5	#3269.00	43.2 PK	68.00	-24.8	1.26 H	301	8.87	34.31
6	#3269.00	34.0 AV	54.30	-20.3	1.26 H	301	-0.28	34.31
7	4904.00	43.8 PK	74.00	-30.2	1.23 H	297	5.92	37.89
8	4904.00	31.0 AV	54.00	-23.0	1.23 H	297	-6.87	37.89
ANTENNA POLARITY & TEST DISTANCE: VERTICAL AT 3 M								
NO.	FREQ. (MHz)	EMISSION LEVEL (dBuV/m)	LIMIT (dBuV/m)	MARGIN (dB)	ANTENNA HEIGHT (m)	TABLE ANGLE (Degree)	RAW VALUE (dBuV)	CORRECTION FACTOR (dB/m)
1	*2452.00	111.5 PK			1.04 V	46	79.47	31.99
2	*2452.00	98.0 AV			1.04 V	46	65.98	31.99
3	2483.50	66.7 PK	74.00	-7.3	1.04 V	46	34.58	32.13
4	2483.50	46.8 AV	54.00	-7.2	1.04 V	46	14.69	32.13
5	#3269.00	48.9 PK	81.50	-32.6	1.24 V	266	14.54	34.31
6	#3269.00	45.1 AV	68.00	-22.9	1.24 V	266	10.80	34.31
7	4904.00	48.5 PK	74.00	-25.5	1.21 V	96	10.65	37.89
8	4904.00	34.9 AV	54.00	-19.1	1.21 V	96	-3.03	37.89

- REMARKS:**
1. Emission level (dBuV/m) = Raw Value (dBuV) + Correction Factor (dB/m).
 2. Correction Factor (dB/m) = Antenna Factor (dB/m) + Cable Factor (dB).
 3. The other emission levels were very low against the limit.
 4. Margin value = Emission level – Limit value.
 5. “ * “: Fundamental frequency.
 6. “#”:The radiated frequency is out the restricted band.



A D T

BELOW 1GHz WORST-CASE DATA : 802.11b

EUT TEST CONDITION		MEASUREMENT DETAIL	
CHANNEL	Channel 6	FREQUENCY RANGE	Below 1000MHz
INPUT POWER (SYSTEM)	120Vac, 60 Hz	DETECTOR FUNCTION	Quasi-Peak
ENVIRONMENTAL CONDITIONS	23deg. C, 76%RH 999 hPa	TEST MODE	A
TESTED BY	Nick Chen		

ANTENNA POLARITY & TEST DISTANCE: HORIZONTAL AT 3 M								
NO.	FREQ. (MHz)	EMISSION LEVEL (dBuV/m)	LIMIT (dBuV/m)	MARGIN (dB)	ANTENNA HEIGHT (m)	TABLE ANGLE (Degree)	RAW VALUE (dBuV)	CORRECTION FACTOR (dB/m)
1	62.77	29.0 QP	40.00	-11.0	1.43 H	294	21.48	7.48
2	146.39	29.6 QP	43.50	-13.9	1.26 H	63	15.88	13.69
3	250.01	38.6 QP	46.00	-7.4	1.09 H	65	23.05	15.56
4	340.00	45.8 QP	46.00	-0.2	1.46 H	327	27.81	17.95
5	600.01	39.6 QP	46.00	-6.4	1.25 H	54	14.53	25.08
6	680.01	45.8 QP	46.00	-0.2	1.27 H	33	19.99	25.80
ANTENNA POLARITY & TEST DISTANCE: VERTICAL AT 3 M								
NO.	FREQ. (MHz)	EMISSION LEVEL (dBuV/m)	LIMIT (dBuV/m)	MARGIN (dB)	ANTENNA HEIGHT (m)	TABLE ANGLE (Degree)	RAW VALUE (dBuV)	CORRECTION FACTOR (dB/m)
1	64.89	33.2 QP	40.00	-6.8	1.24 V	248	25.59	7.57
2	83.06	31.6 QP	40.00	-8.4	1.29 V	324	22.17	9.39
3	125.01	34.8 QP	43.50	-8.7	1.22 V	274	22.05	12.77
4	500.00	38.6 QP	46.00	-7.4	1.37 V	263	15.30	23.31
5	625.02	37.0 QP	46.00	-9.0	1.28 V	2	11.64	25.33
6	680.01	42.4 QP	46.00	-3.6	1.09 V	163	16.56	25.80
7	750.00	35.9 QP	46.00	-10.1	1.16 V	10	9.12	26.79

- REMARKS:**
1. Emission level (dBuV/m) = Raw Value (dBuV) + Correction Factor (dB/m).
 2. Correction Factor (dB/m) = Antenna Factor (dB/m) + Cable Factor (dB).
 3. The other emission levels were very low against the limit.
 4. Margin value = Emission level – Limit value.



A D T

EUT TEST CONDITION		MEASUREMENT DETAIL	
CHANNEL	Channel 6	FREQUENCY RANGE	Below 1000MHz
INPUT POWER (SYSTEM)	120Vac, 60 Hz	DETECTOR FUNCTION	Quasi-Peak
ENVIRONMENTAL CONDITIONS	23deg. C, 76%RH 999 hPa	TEST MODE	B
TESTED BY	Nick Chen		

ANTENNA POLARITY & TEST DISTANCE: HORIZONTAL AT 3 M								
NO.	FREQ. (MHz)	EMISSION LEVEL (dBuV/m)	LIMIT (dBuV/m)	MARGIN (dB)	ANTENNA HEIGHT (m)	TABLE ANGLE (Degree)	RAW VALUE (dBuV)	CORRECTION FACTOR (dB/m)
1	57.13	28.9 QP	40.00	-11.1	1.27 H	241	21.27	7.64
2	125.03	33.9 QP	43.50	-9.6	1.27 H	154	21.17	12.77
3	250.02	41.6 QP	46.00	-4.4	1.43 H	129	26.07	15.56
4	340.01	45.7 QP	46.00	-0.3	1.28 H	252	27.71	17.95
5	650.01	34.9 QP	46.00	-11.1	1.53 H	177	9.29	25.59
6	680.00	45.3 QP	46.00	-0.7	1.01 H	85	19.53	25.80
7	750.02	37.5 QP	46.00	-8.5	1.07 H	226	10.70	26.79
ANTENNA POLARITY & TEST DISTANCE: VERTICAL AT 3 M								
NO.	FREQ. (MHz)	EMISSION LEVEL (dBuV/m)	LIMIT (dBuV/m)	MARGIN (dB)	ANTENNA HEIGHT (m)	TABLE ANGLE (Degree)	RAW VALUE (dBuV)	CORRECTION FACTOR (dB/m)
1	52.96	38.6 QP	40.00	-1.4	1.01 V	49	30.56	8.05
2	70.53	34.9 QP	40.00	-5.1	1.24 V	111	27.09	7.84
3	125.02	34.7 QP	43.50	-8.8	1.37 V	24	21.92	12.77
4	340.01	36.0 QP	46.00	-10.0	1.40 V	239	18.01	17.95
5	600.00	40.9 QP	46.00	-5.1	1.03 V	66	15.85	25.08
6	625.02	40.0 QP	46.00	-6.0	1.17 V	109	14.65	25.33
7	750.01	40.3 QP	46.00	-5.7	1.13 V	167	13.47	26.79

- REMARKS:**
1. Emission level (dBuV/m) = Raw Value (dBuV) + Correction Factor (dB/m).
 2. Correction Factor (dB/m) = Antenna Factor (dB/m) + Cable Factor (dB).
 3. The other emission levels were very low against the limit.
 4. Margin value = Emission level – Limit value.



4.2 CONDUCTED EMISSION MEASUREMENT

4.2.1 LIMITS OF CONDUCTED EMISSION MEASUREMENT

FREQUENCY OF EMISSION (MHz)	CONDUCTED LIMIT (dBµV)	
	Quasi-peak	Average
0.15 ~ 0.5	66 to 56	56 to 46
0.5 ~ 5	56	46
5 ~ 30	60	50

- NOTE:** 1. The lower limit shall apply at the transition frequencies.
2. The limit decreases in line with the logarithm of the frequency in the range of 0.15 to 0.50MHz.
3. All emanations from a class A/B digital device or system, including any network of conductors and apparatus connected thereto, shall not exceed the level of field strengths specified above.

4.2.2 TEST INSTRUMENTS

DESCRIPTION & MANUFACTURER	MODEL NO.	SERIAL NO.	DATE OF CALIBRATION	DUE DATE OF CALIBRATION
ROHDE & SCHWARZ Test Receiver	ESCS 30	838251/021	Mar. 05, 2009	Mar. 04, 2010
ROHDE & SCHWARZ Artificial Mains Network (for EUT)	ESH3-Z5	100218	Nov. 26, 2008	Nov. 25, 2009
LISN With Adapter (for EUT)	AD10	C10Ada-001	Nov. 26, 2008	Nov. 25, 2009
ROHDE & SCHWARZ Artificial Mains Network (for peripherals)	ESH3-Z5	100219	Nov. 20, 2008	Nov. 19, 2009
Software	ADT_Cond_V7.3.7	NA	NA	NA
Software	ADT_ISN_V7.3.7	NA	NA	NA
RF cable (JYEBAO)	5D-FB	Cable-C10.01	Feb. 26, 2009	Feb. 25, 2010
SUHNER Terminator (For ROHDE & SCHWARZ LISN)	65BNC-5001	E1-010773	Feb. 27, 2009	Feb. 26, 2010

- NOTE:** 1. The calibration interval of the above test instruments is 12 months and the calibrations are traceable to NML/ROC and NIST/USA.
2. The test was performed in Shielded Room No. 10.
3. The VCCI Site Registration No. C-1852.



A D T

4.2.3 TEST PROCEDURES

- a. The EUT was placed 0.4 meters from the conducting wall of the shielded room with EUT being connected to the power mains through a line impedance stabilization network (LISN). Other support units were connected to the power mains through another LISN. The two LISNs provide 50 ohm/ 50uH of coupling impedance for the measuring instrument.
- b. Both lines of the power mains connected to the EUT were checked for maximum conducted interference.
- c. The frequency range from 150kHz to 30MHz was searched. Emission levels under (Limit - 20dB) was not recorded.

NOTE: All modes of operation were investigated and the worst-case emissions are reported.

4.2.4 DEVIATION FROM TEST STANDARD

No deviation.

4.2.5 TEST SETUP

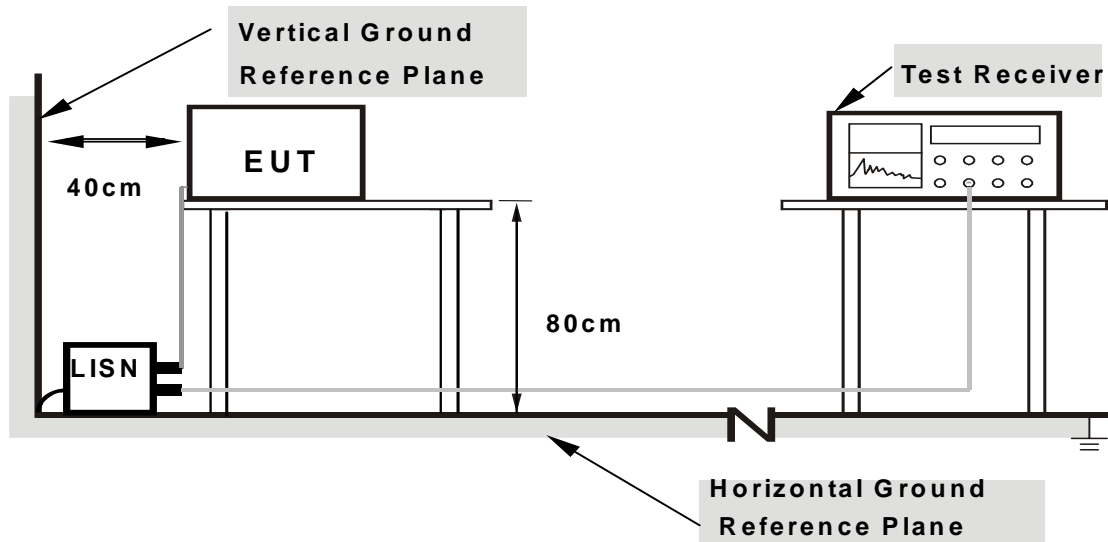

Note: 1.Support units were connected to second LISN.

2.Both of LISNs (AMN) are 80 cm from EUT and at least 80 from other units and other metal planes

For the actual test configuration, please refer to the attached file (Test Setup Photo).

4.2.6 EUT OPERATING CONDITIONS

Same as 4.1.6.

4.2.7 TEST RESULTS

CONDUCTED WORST-CASE DATA : 802.11b

PHASE	Line 1	6dB BANDWIDTH	9kHz
TEST MODE	A		

No	Freq. [MHz]	Corr. Factor (dB)	Reading Value		Emission Level		Limit		Margin	
			[dB (uV)]		[dB (uV)]		[dB (uV)]		(dB)	
			Q.P.	AV.	Q.P.	AV.	Q.P.	AV.	Q.P.	AV.
1	0.291	0.17	47.51	-	47.68	-	60.51	50.51	-12.83	-
2	0.483	0.22	26.25	-	26.47	-	56.30	46.30	-29.82	-
3	0.771	0.23	24.30	-	24.53	-	56.00	46.00	-31.47	-
4	4.292	0.37	31.62	-	31.99	-	56.00	46.00	-24.01	-
5	6.226	0.47	36.53	-	37.00	-	60.00	50.00	-23.00	-
6	9.542	0.63	29.92	-	30.55	-	60.00	50.00	-29.45	-

- REMARKS:**
1. Q.P. and AV. are abbreviations of quasi-peak and average individually.
 2. "-": The Quasi-peak reading value also meets average limit and measurement with the average detector is unnecessary.
 3. The emission levels of other frequencies were very low against the limit.
 4. Margin value = Emission level - Limit value
 5. Correction factor = Insertion loss + Cable loss
 6. Emission Level = Correction Factor + Reading Value.

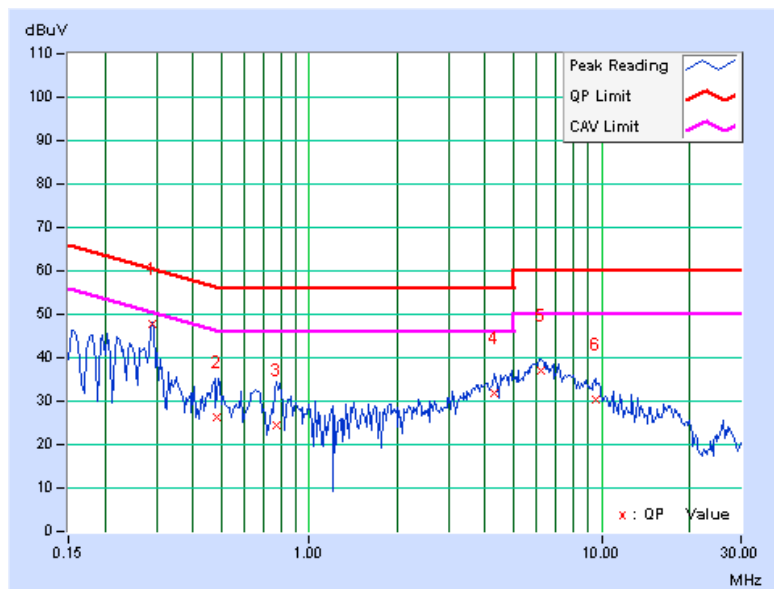



A D T

PHASE	Line 2	6dB BANDWIDTH	9kHz
TEST MODE	A		

No	Freq. [MHz]	Corr. Factor (dB)	Reading Value		Emission Level		Limit		Margin	
			[dB (uV)]		[dB (uV)]		[dB (uV)]		(dB)	
			Q.P.	AV.	Q.P.	AV.	Q.P.	AV.	Q.P.	AV.
1	0.158	0.09	43.10	-	43.19	-	65.58	55.58	-22.39	-
2	0.291	0.14	46.53	-	46.67	-	60.51	50.51	-13.84	-
3	0.779	0.21	34.68	-	34.89	-	56.00	46.00	-21.11	-
4	2.286	0.26	29.25	-	29.51	-	56.00	46.00	-26.49	-
5	5.997	0.38	35.33	-	35.71	-	60.00	50.00	-24.29	-
6	10.606	0.55	31.36	-	31.91	-	60.00	50.00	-28.09	-

- REMARKS:**
1. Q.P. and AV. are abbreviations of quasi-peak and average individually.
 2. "-": The Quasi-peak reading value also meets average limit and measurement with the average detector is unnecessary.
 3. The emission levels of other frequencies were very low against the limit.
 4. Margin value = Emission level - Limit value
 5. Correction factor = Insertion loss + Cable loss
 6. Emission Level = Correction Factor + Reading Value.

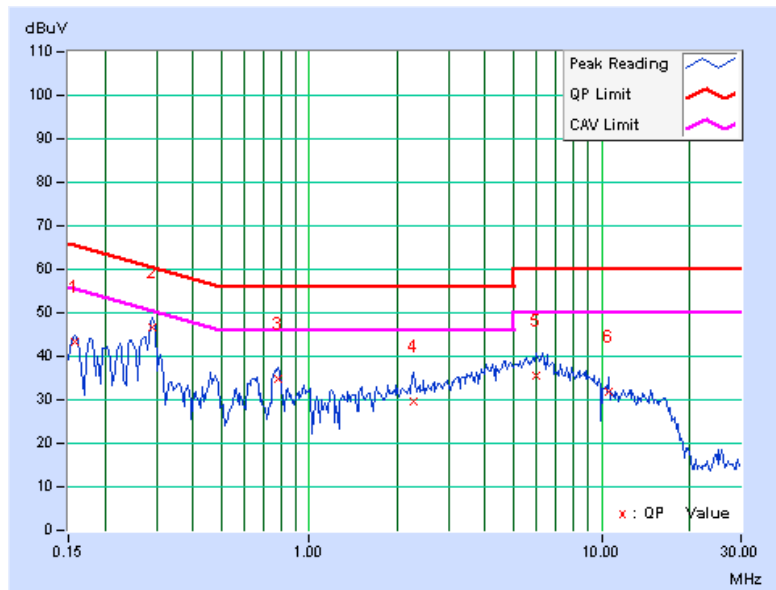

PHASE	Line 1	6dB BANDWIDTH	9kHz
TEST MODE	B		

No	Freq. [MHz]	Corr. Factor (dB)	Reading Value		Emission Level		Limit		Margin	
			[dB (uV)]		[dB (uV)]		[dB (uV)]		(dB)	
			Q.P.	AV.	Q.P.	AV.	Q.P.	AV.	Q.P.	AV.
1	0.183	0.12	41.73	-	41.85	-	64.37	54.37	-22.52	-
2	0.369	0.20	33.66	-	33.86	-	58.53	48.53	-24.66	-
3	0.646	0.23	31.19	-	31.42	-	56.00	46.00	-24.58	-
4	3.059	0.32	37.95	-	38.27	-	56.00	46.00	-17.73	-
5	4.152	0.37	37.80	-	38.17	-	56.00	46.00	-17.83	-
6	11.631	0.77	33.67	-	34.44	-	60.00	50.00	-25.56	-

- REMARKS:**
1. Q.P. and AV. are abbreviations of quasi-peak and average individually.
 2. "-": The Quasi-peak reading value also meets average limit and measurement with the average detector is unnecessary.
 3. The emission levels of other frequencies were very low against the limit.
 4. Margin value = Emission level - Limit value
 5. Correction factor = Insertion loss + Cable loss
 6. Emission Level = Correction Factor + Reading Value.

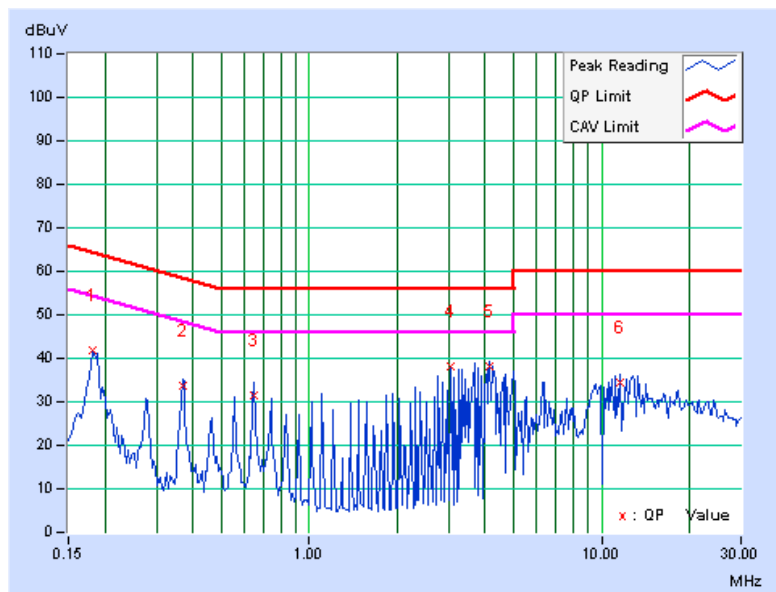



A D T

PHASE	Line 2	6dB BANDWIDTH	9kHz
TEST MODE	B		

No	Freq. [MHz]	Corr. Factor (dB)	Reading Value		Emission Level		Limit		Margin	
			[dB (uV)]		[dB (uV)]		[dB (uV)]		(dB)	
			Q.P.	AV.	Q.P.	AV.	Q.P.	AV.	Q.P.	AV.
1	0.184	0.09	40.61	-	40.70	-	64.31	54.31	-23.61	-
2	0.369	0.18	35.23	-	35.41	-	58.53	48.53	-23.12	-
3	0.646	0.21	34.54	-	34.75	-	56.00	46.00	-21.25	-
4	3.059	0.28	37.86	-	38.14	-	56.00	46.00	-17.86	-
5	3.786	0.30	37.95	-	38.25	-	56.00	46.00	-17.75	-
6	13.026	0.68	32.53	-	33.21	-	60.00	50.00	-26.79	-

- REMARKS:**
1. Q.P. and AV. are abbreviations of quasi-peak and average individually.
 2. "-": The Quasi-peak reading value also meets average limit and measurement with the average detector is unnecessary.
 3. The emission levels of other frequencies were very low against the limit.
 4. Margin value = Emission level - Limit value
 5. Correction factor = Insertion loss + Cable loss
 6. Emission Level = Correction Factor + Reading Value.

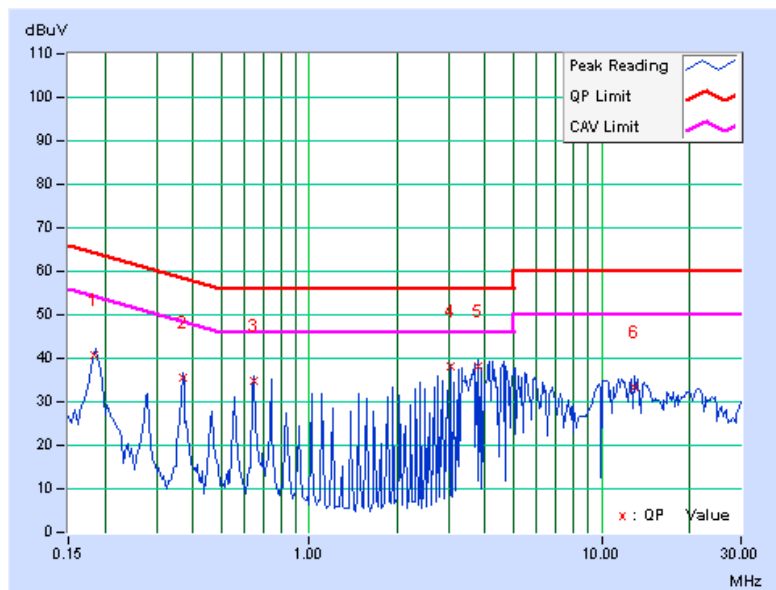

4.3 6dB BANDWIDTH MEASUREMENT

4.3.1 LIMITS OF 6dB BANDWIDTH MEASUREMENT

The minimum of 6dB Bandwidth Measurement is 0.5 MHz.

4.3.2 TEST INSTRUMENTS

DESCRIPTION & MANUFACTURER	MODEL NO.	SERIAL NO.	DATE OF CALIBRATION	CALIBRATED UNTIL
R&S SPECTRUM ANALYZER	FSP40	100040	Jul. 07, 2009	Jul. 06, 2010

NOTE: The calibration interval of the above test instruments is 12 months and the calibrations are traceable to NML/ROC and NIST/USA.

4.3.3 TEST PROCEDURE

The transmitter output was connected to the spectrum analyzer through an attenuator. The bandwidth of the fundamental frequency was measured by spectrum analyzer with 100kHz RBW and 300kHz VBW. The 6dB bandwidth is defined as the total spectrum the power of which is higher than peak power minus 6dB.

4.3.4 DEVIATION FROM TEST STANDARD

No deviation.

4.3.5 TEST SETUP

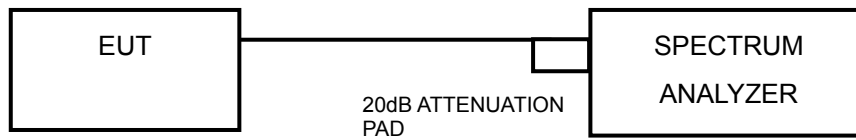

4.3.6 EUT OPERATING CONDITIONS

The software provided by client to enable the EUT under transmission condition continuously at lowest, middle and highest channel frequencies individually.



A D T

4.3.7 TEST RESULTS

802.11b DSSS

CHANNEL	CHANNEL FREQUENCY (MHz)	6dB BANDWIDTH (MHz)		MINIMUM LIMIT (MHz)	PASS / FAIL
		CHAIN 0	CHAIN 1		
1	2412	12.58	11.60	0.5	PASS
6	2437	12.08	11.17	0.5	PASS
11	2462	11.65	11.61	0.5	PASS

FOR CHAIN 0: CH 1

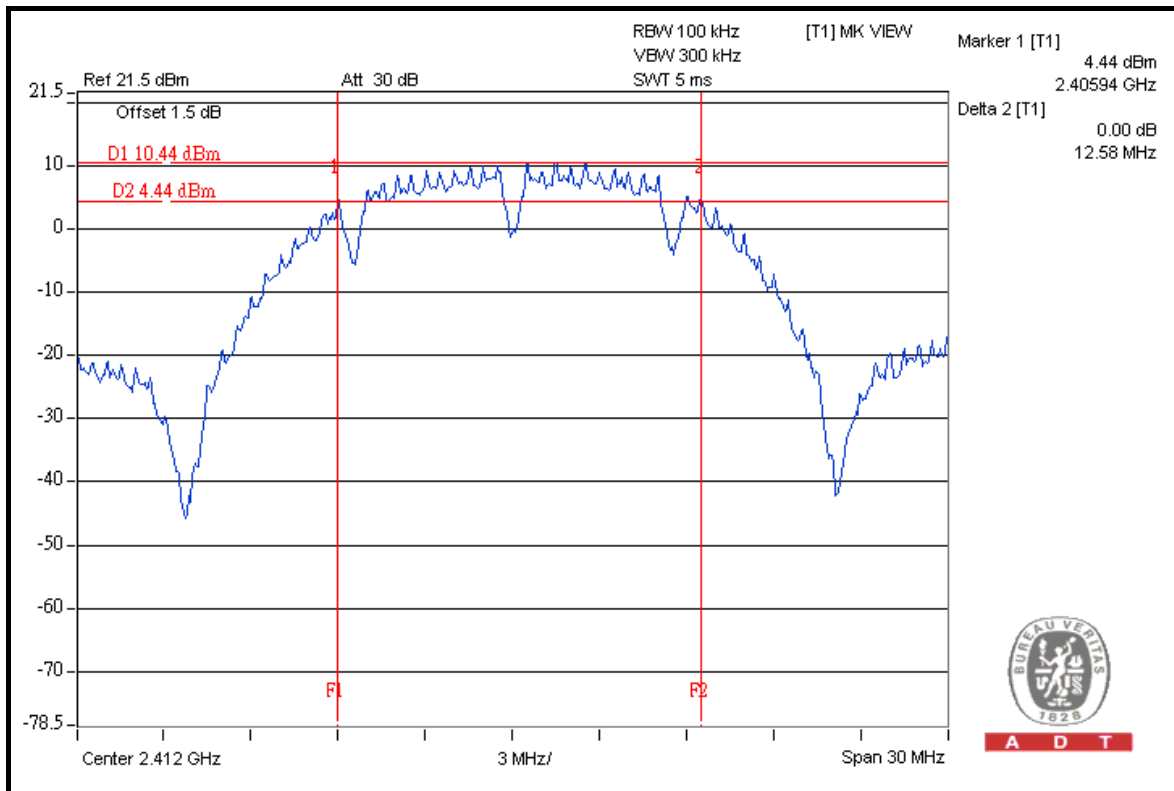



A D T

802.11g

CHANNEL	CHANNEL FREQUENCY (MHz)	6dB BANDWIDTH (MHz)		MINIMUM LIMIT (MHz)	PASS / FAIL
		CHAIN 0	CHAIN 1		
1	2412	16.09	16.46	0.5	PASS
6	2437	16.38	16.44	0.5	PASS
11	2462	15.74	16.45	10.5	PASS

FOR CHAIN 1: CH 1

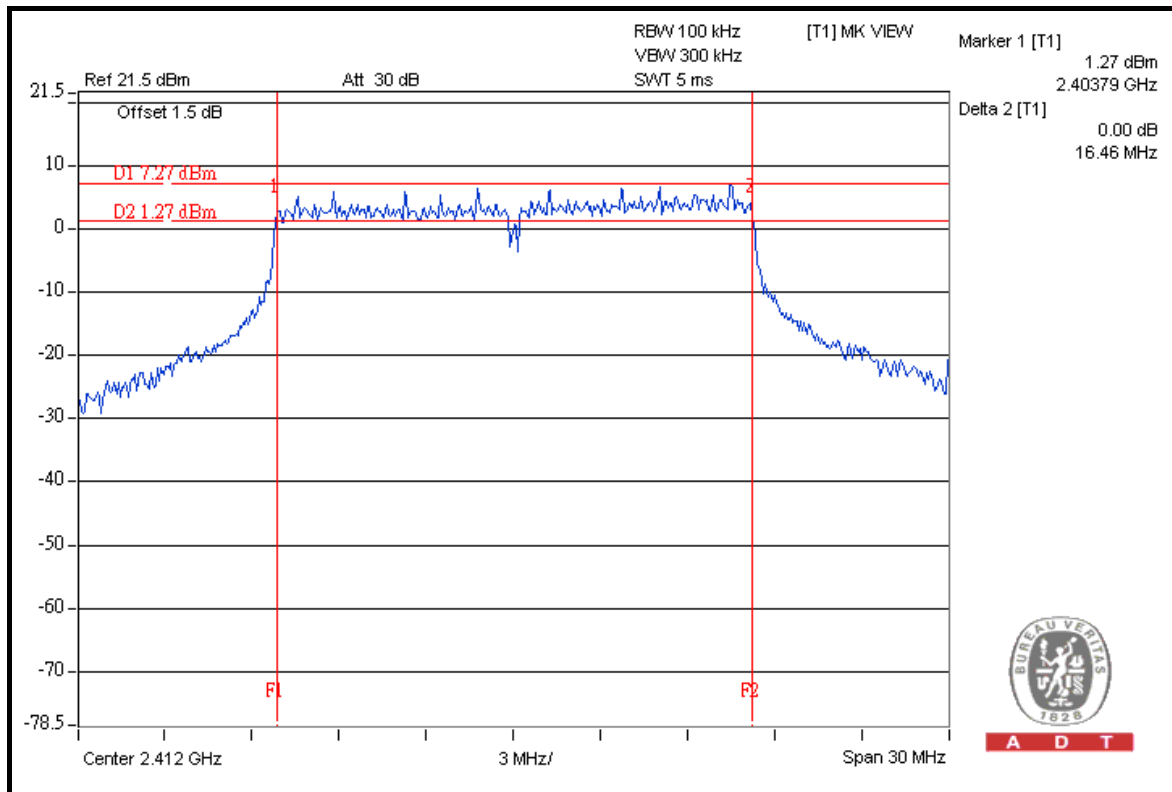



A D T

802.11n (20MHz)

CHANNEL	CHANNEL FREQUENCY (MHz)	6dB BANDWIDTH (MHz)		MINIMUM LIMIT (MHz)	PASS / FAIL
		CHAIN 0	CHAIN 1		
1	2412	17.45	17.67	0.5	PASS
6	2437	17.65	17.65	0.5	PASS
11	2462	15.14	17.62	0.5	PASS

FOR CHAIN 1: CH 1

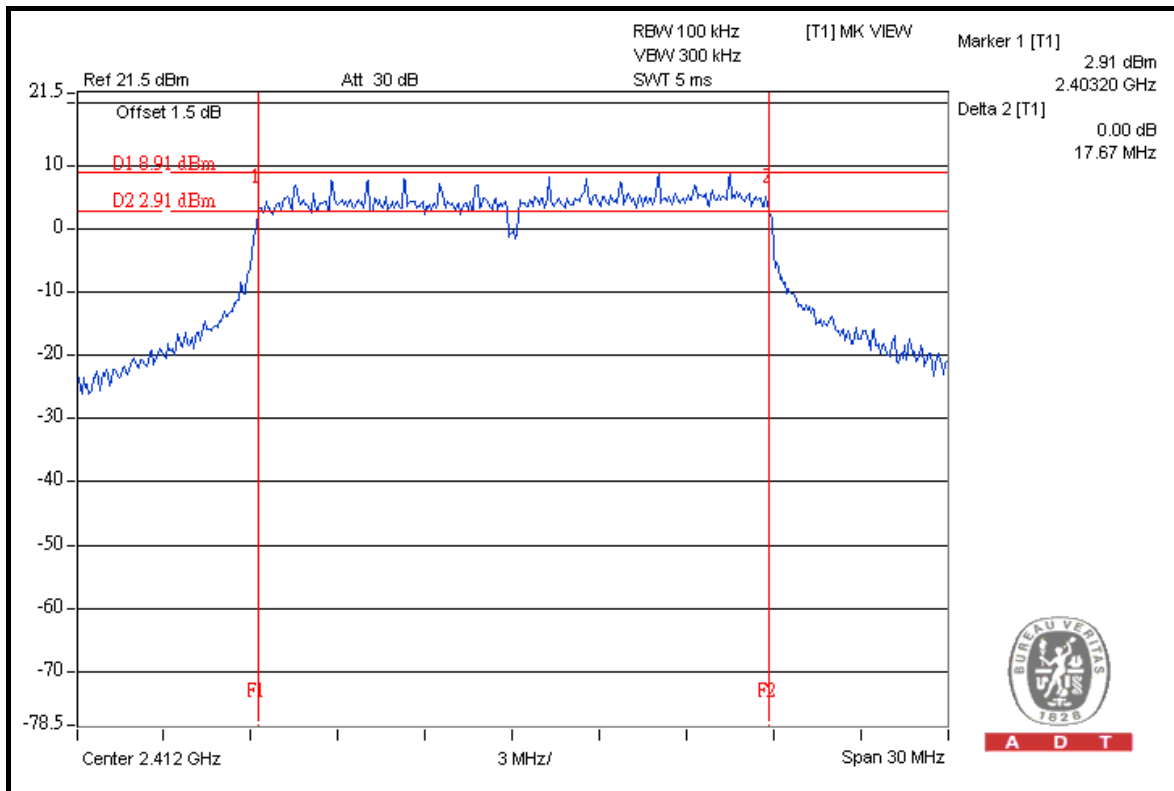



A D T

802.11n (40MHz)

CHANNEL	CHANNEL FREQUENCY (MHz)	6dB BANDWIDTH (MHz)		MINIMUM LIMIT (MHz)	PASS / FAIL
		CHAIN 0	CHAIN 1		
1	2422	35.79	36.22	0.5	PASS
4	2437	35.97	36.46	0.5	PASS
7	2452	33.88	36.06	0.5	PASS

FOR CHAIN 1: CH 4

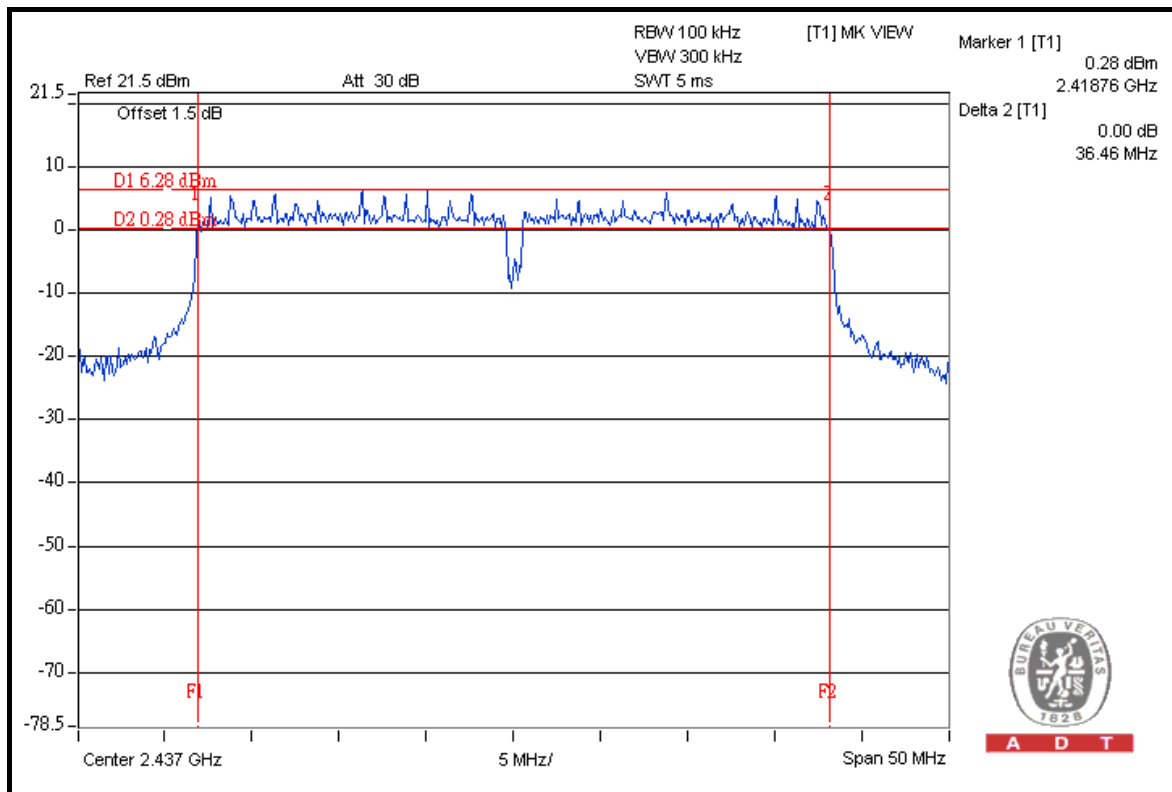

4.4 MAXIMUM OUTPUT POWER

4.4.1 LIMITS OF MAXIMUM OUTPUT POWER MEASUREMENT

The Maximum Output Measurement is 30dBm.

4.4.2 INSTRUMENTS

DESCRIPTION & MANUFACTURER	MODEL NO.	SERIAL NO.	DATE OF CALIBRATION	CALIBRATED UNTIL
R&S SPECTRUM ANALYZER	FSP40	100040	Jul. 07, 2009	Jul. 06, 2010

NOTE: The calibration interval of the above test instruments is 12 months and the calibrations are traceable to NML/ROC and NIST/USA.

4.4.3 TEST PROCEDURE

1. Follow DTS measurement (Power Output Option 2), the transmitter output was connected to the spectrum analyzer through an attenuator, the bandwidth of the fundamental frequency was measured with the spectrum analyzer.
2. Set span to encompass the entire emission bandwidth (EBW) of the signal.
3. Set RBW = 1 MHz ; VBW \geq 3 MHz.
4. Use sample detector mode and video trigger with the trigger level set to enable triggering only on full power pulses.
5. Trace average 100 traces in power averaging mode.
6. Compute power by integrating the spectrum across the 26 dB EBW of the signal.
7. Record the power level.

4.4.4 DEVIATION FROM TEST STANDARD

No deviation.

4.4.5 TEST SETUP

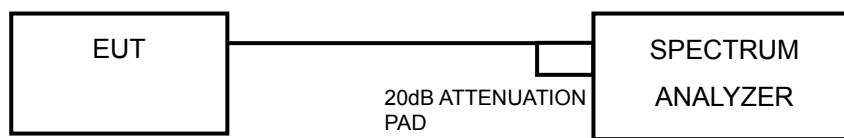

4.4.6 EUT OPERATING CONDITIONS

Same as Item 4.3.6.



A D T

4.4.7 TEST RESULTS

802.11b

CHAN.	CHAN. FREQ. (MHz)	POWER OUTPUT (dBm)		TOTAL POWER (mW)	TOTAL POWER (dBm)	POWER LIMIT (dBm)	PASS / FAIL
		CHAIN 0	CHAIN 1				
1	2412	20.3	19.8	201.7	23.1	30	PASS
6	2437	20.6	20.1	216.6	23.2	30	PASS
11	2462	18.0	21.2	195.2	22.9	30	PASS

FOR CHAIN 0: CH 6

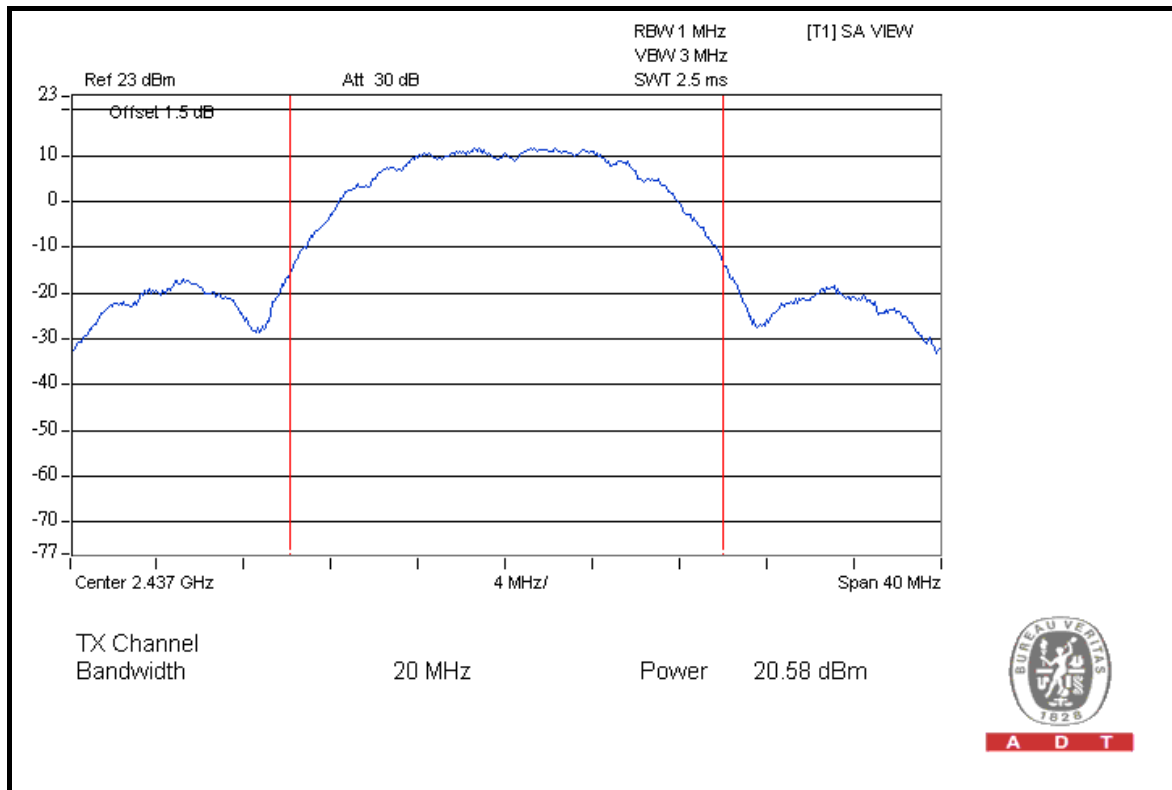

A D T



A D T

802.11g

CHAN.	CHAN. FREQ. (MHz)	POWER OUTPUT (dBm)		TOTAL POWER (mW)	TOTAL POWER (dBm)	POWER LIMIT (dBm)	PASS / FAIL
		CHAIN 0	CHAIN 1				
1	2412	20.1	19.4	188.9	22.8	30	PASS
6	2437	20.3	19.9	205.0	23.1	30	PASS
11	2462	17.4	20.8	174.5	22.4	30	PASS

FOR CHAIN 1: CH 11

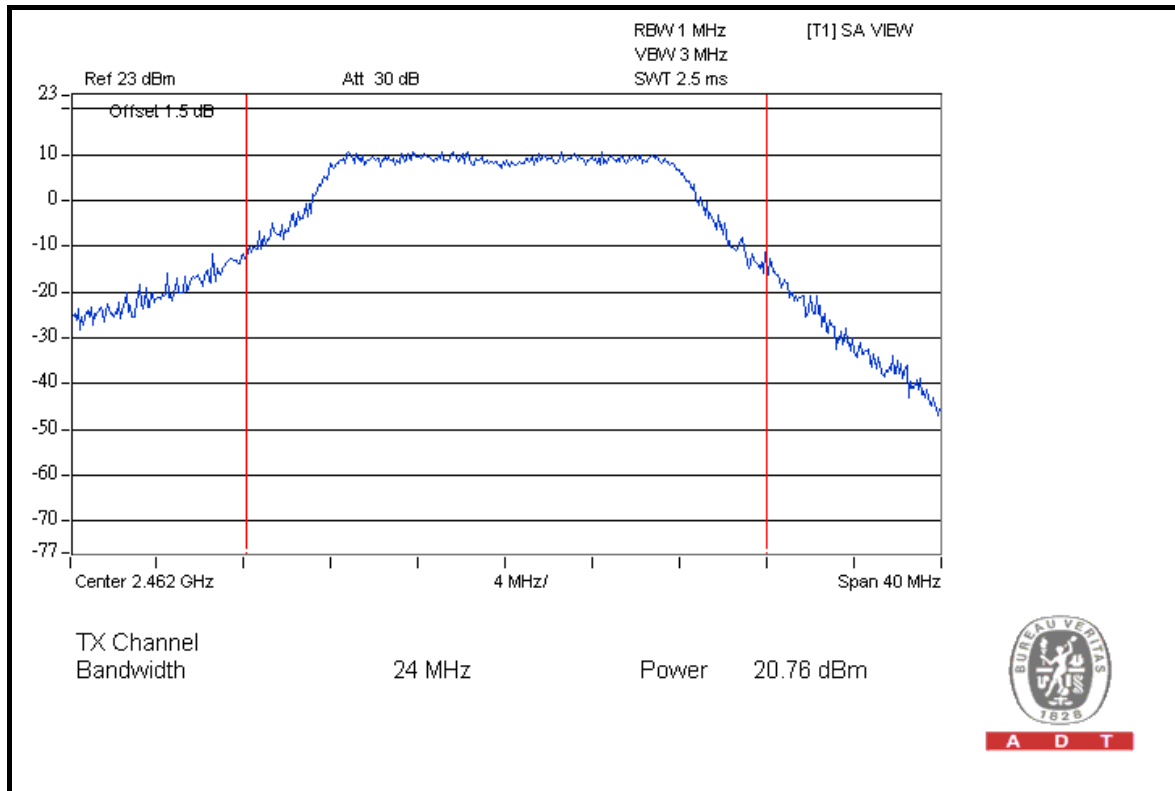



A D T

802.11n (20MHz)

CHAN.	CHAN. FREQ. (MHz)	POWER OUTPUT (dBm)		TOTAL POWER (mW)	TOTAL POWER (dBm)	POWER LIMIT (dBm)	PASS / FAIL
		CHAIN 0	CHAIN 1				
1	2412	19.9	19.8	192.8	22.9	30	PASS
6	2437	20.2	19.5	194.2	22.9	30	PASS
11	2462	17.5	20.8	175.2	22.4	30	PASS

FOR CHAIN 1: CH 11

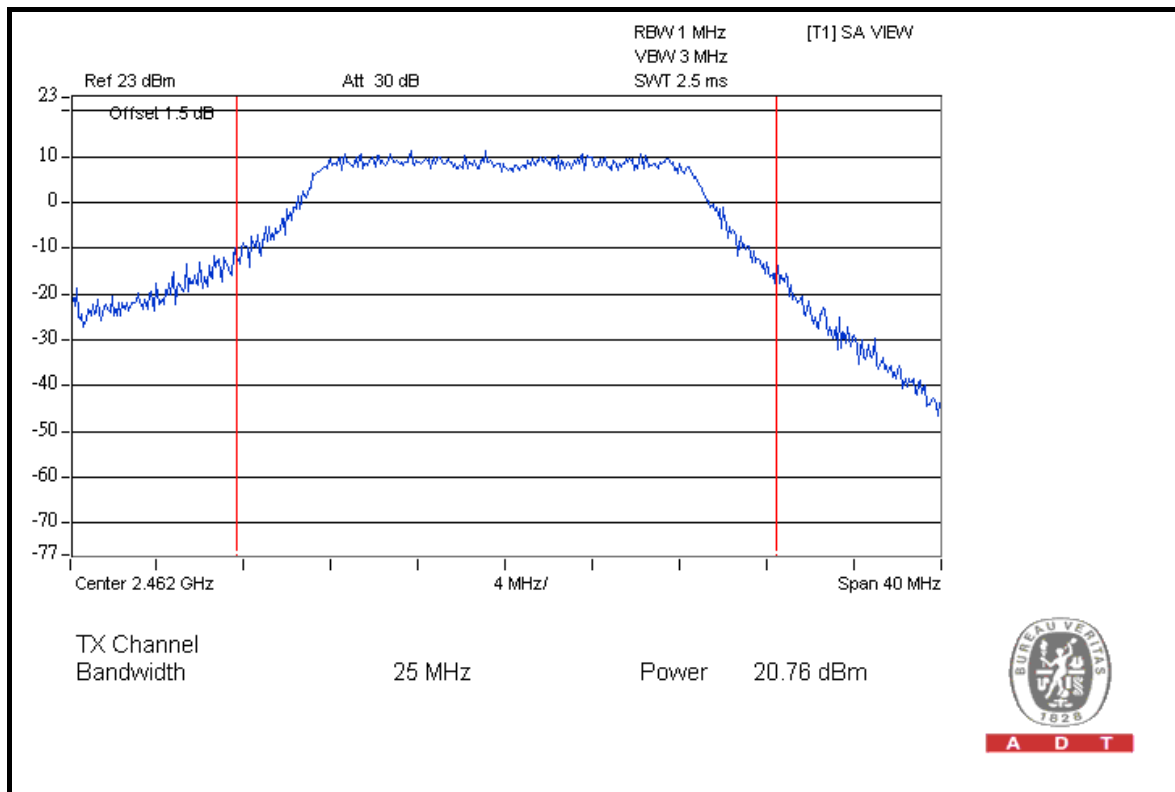

A D T



A D T

802.11n (40MHz)

CHAN.	CHAN. FREQ. (MHz)	POWER OUTPUT (dBm)		TOTAL POWER (mW)	TOTAL POWER (dBm)	POWER LIMIT (dBm)	PASS / FAIL
		CHAIN 0	CHAIN 1				
1	2422	20.2	20.4	215.1	23.3	30	PASS
4	2437	20.2	20.1	206.6	23.2	30	PASS
7	2452	19.6	21.1	219.0	23.4	30	PASS

FOR CHAIN 1: CH 7

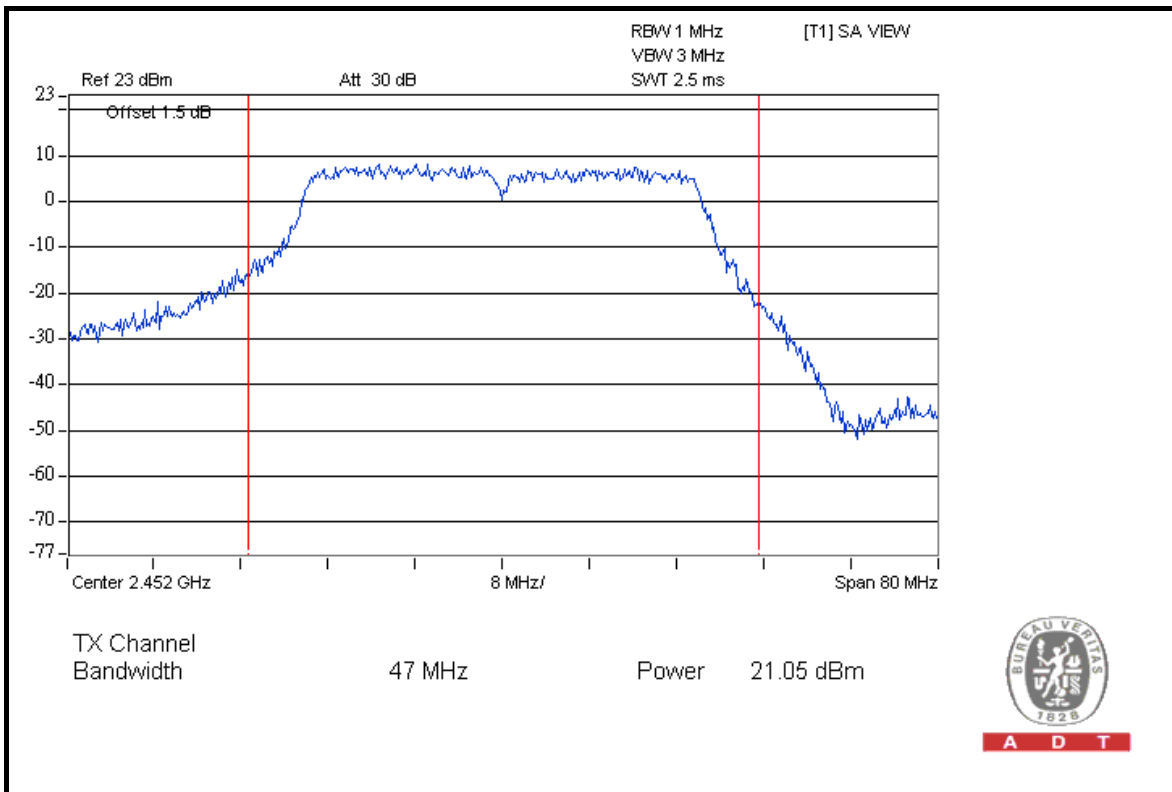

A D T



A D T

4.5 POWER SPECTRAL DENSITY MEASUREMENT

4.5.1 LIMITS OF POWER SPECTRAL DENSITY MEASUREMENT

The Maximum of Power Spectral Density Measurement is 8dBm.

4.5.2 TEST INSTRUMENTS

DESCRIPTION & MANUFACTURER	MODEL NO.	SERIAL NO.	DATE OF CALIBRATION	CALIBRATED UNTIL
R&S SPECTRUM ANALYZER	FSP40	100040	Jul. 07, 2009	Jul. 06, 2010

NOTE: The calibration interval of the above test instruments is 12 months and the calibrations are traceable to NML/ROC and NIST/USA.

4.5.3 TEST PROCEDURE

1. Follow DTS measurement (PSD Option 2), the transmitter output was connected to the spectrum analyzer through an attenuator, the bandwidth of the fundamental frequency was measured with the spectrum analyzer. Locate and zoom in on emission peak(s) within the pass band.
2. Set RBW = 3 kHz /VBW > 9 kHz and sweep time to Automatic.
3. Detector use peak mode and a video trigger with the trigger level set to enable triggering only on full power pulses.
4. Trace average 100 traces in power averaging mode. The power spectral density was measured and recorded.

4.5.4 DEVIATION FROM TEST STANDARD

No deviation

4.5.5 TEST SETUP

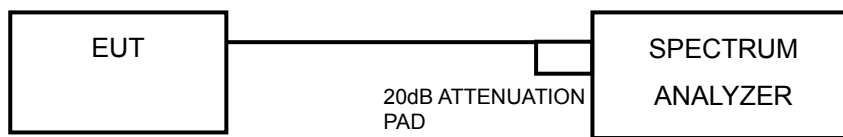

4.5.6 EUT OPERATING CONDITION

Same as Item 4.3.6



A D T

4.5.7 TEST RESULTS

802.11b

CHAN.	CHAN. FREQ. (MHz)	RF POWER LEVEL IN 3kHz BW (dBm)		TOTAL POWER DENSITY (mW)	TOTAL POWER DENSITY (dBm)	MAX. LIMIT (dBm)	PASS / FAIL
		CHAIN 0	CHAIN 1				
1	2412	-7.4	-7.3	0.4	-4.3	8	PASS
6	2437	-6.2	-7.5	0.4	-3.8	8	PASS
11	2462	-9.5	-6.4	0.3	-4.7	8	PASS

FOR CHAIN 0: CH 6

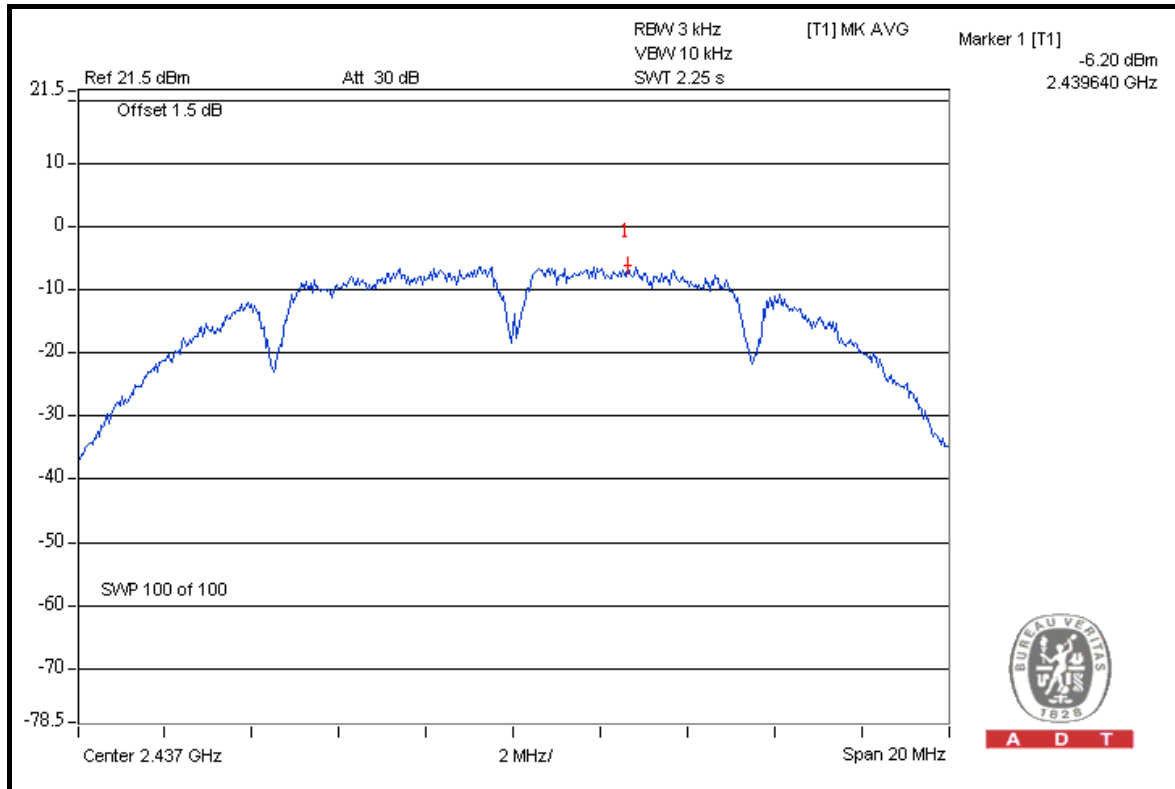

A D T



A D T

802.11g

CHAN.	CHAN. FREQ. (MHz)	RF POWER LEVEL IN 3kHz BW (dBm)		TOTAL POWER DENSITY (mW)	TOTAL POWER DENSITY (dBm)	MAX. LIMIT (dBm)	PASS / FAIL
		CHAIN 0	CHAIN 1				
1	2412	-3.8	-8.1	0.6	-2.4	8	PASS
6	2437	-0.7	-8.8	1.0	-0.1	8	PASS
11	2462	-3.6	-7.1	0.6	-2.0	8	PASS

FOR CHAIN 0: CH 6

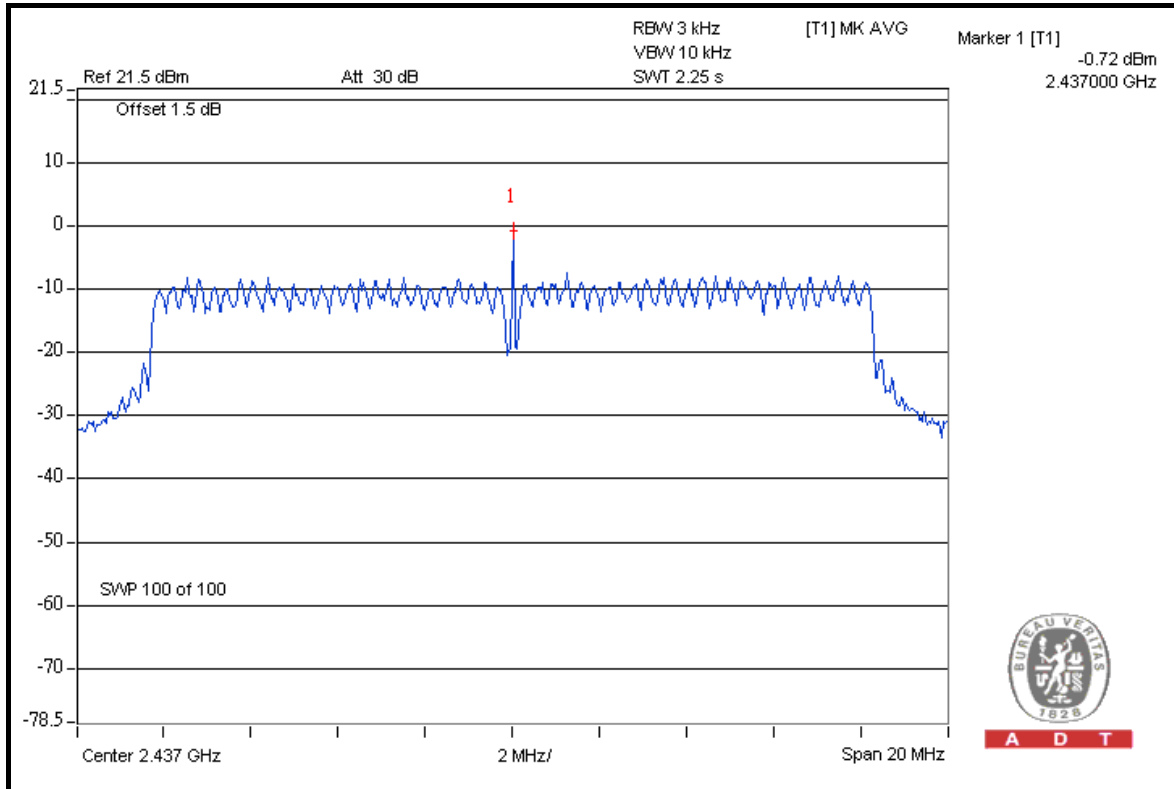



A D T

802.11n (20MHz)

CHAN.	CHAN. FREQ. (MHz)	RF POWER LEVEL IN 3kHz BW (dBm)		TOTAL POWER DENSITY (mW)	TOTAL POWER DENSITY (dBm)	MAX. LIMIT (dBm)	PASS / FAIL
		CHAIN 0	CHAIN 1				
1	2412	-4.8	-8.4	0.5	-3.2	8	PASS
6	2437	-0.3	-9.7	1.0	0.2	8	PASS
11	2462	-4.0	-5.7	0.7	-1.7	8	PASS

FOR CHAIN 0: CH 6

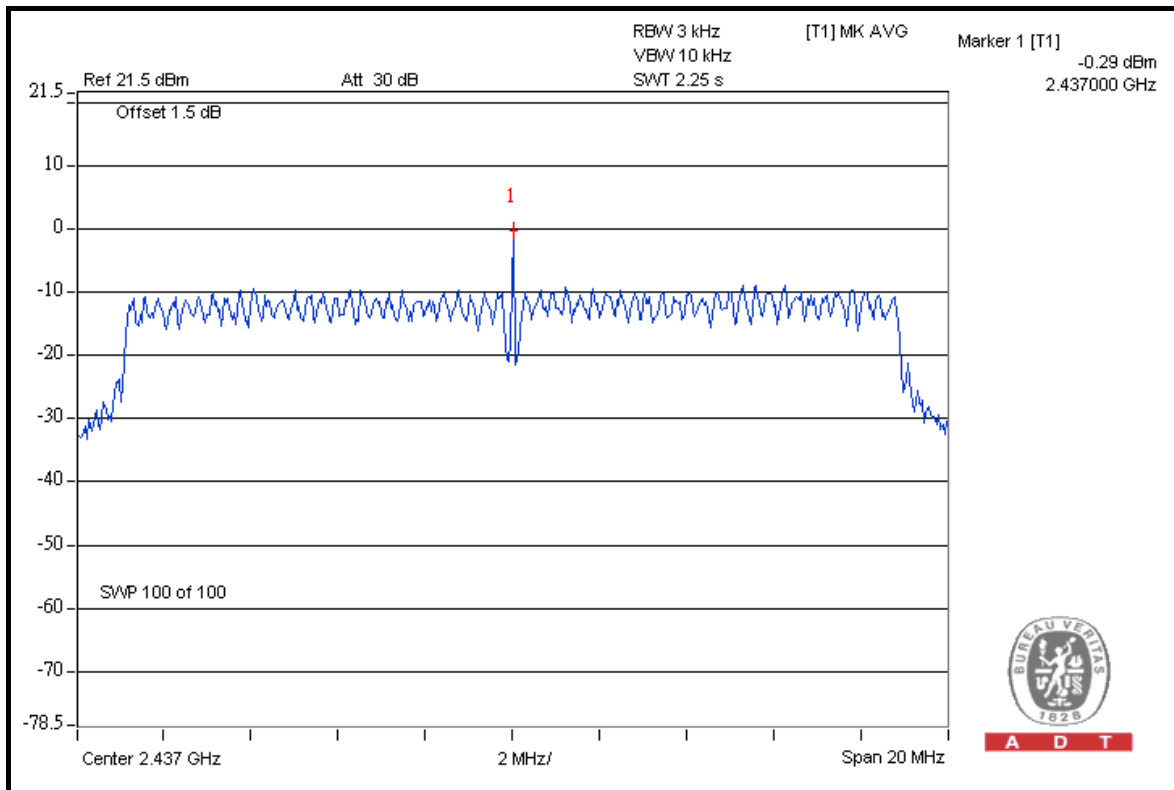



A D T

802.11n (40MHz)

CHAN.	CHAN. FREQ. (MHz)	RF POWER LEVEL IN 3kHz BW (dBm)		TOTAL POWER DENSITY (mW)	TOTAL POWER DENSITY (dBm)	MAX. LIMIT (dBm)	PASS / FAIL
		CHAIN 0	CHAIN 1				
1	2422	0.5	-4.8	1.5	1.7	8	PASS
4	2437	-2.9	-7.9	0.7	-1.7	8	PASS
7	2452	-0.7	-8.5	1.0	-0.0	8	PASS

FOR CHAIN 0: CH 1

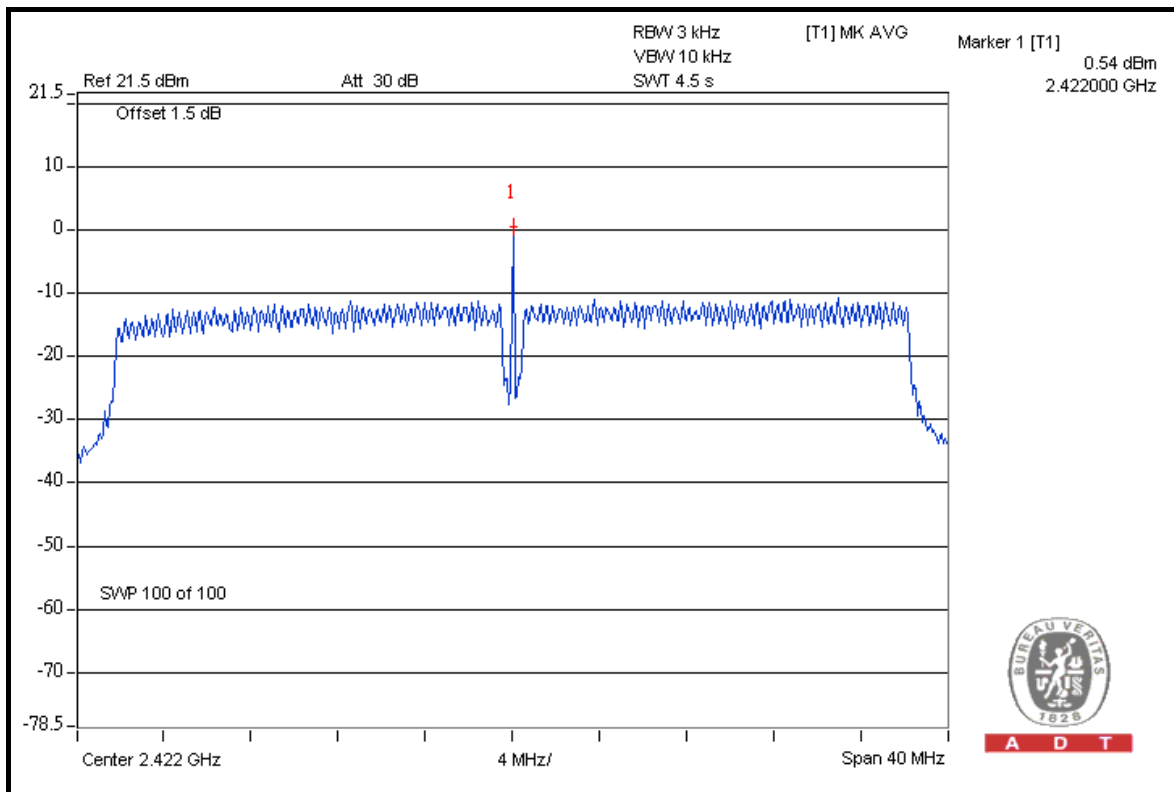



A D T

4.6 BAND EDGES MEASUREMENT

4.6.1 LIMITS OF BAND EDGES MEASUREMENT

Below -20dB of the highest emission level of operating band (in 100kHz Resolution Bandwidth).

Note: Follow DTS measurement, If the device complies with the use of power option 2 the attenuation under this paragraph shall be 30 dB instead of 20 dB.

4.6.2 TEST INSTRUMENTS

DESCRIPTION & MANUFACTURER	MODEL NO.	SERIAL NO.	DATE OF CALIBRATION	DUE DATE OF CALIBRATION
Agilent Spectrum	8564EC	4208A00659	Jul. 24, 2009	Jul. 23, 2010
Agilent Preamplifier	8449B	3008A01924	Aug. 31, 2009	Aug. 30, 2010
Agilent Preamplifier	8449B	3008A01292	Aug. 10, 2009	Aug. 09, 2010
MITEQ Preamplifier	AMF-6F-260400-33 -8P	892164	Aug. 31, 2009	Aug. 30, 2010
Schwarzbeck Horn Antenna	BBHA-9170	BBHA9170190	Sep. 24, 2009	Sep. 23, 2010
Schwarzbeck Horn Antenna	BBHA-9120	D130	May 15, 2009	May 14, 2010
ADT. Turn Table	TT100	0201	NA	NA
ADT. Tower	AT100	0201	NA	NA
Software	ADT_Radiated_V7. 6.15.9.2	NA	NA	NA
SUHNER RF cable	SF106-18	PHACAB-1G-40 GHz	Aug. 20, 2009	Aug. 19, 2010

NOTE: The calibration interval of the above test instruments is 12 months and the calibrations are traceable to NML/ROC and NIST/USA.

4.6.3 TEST PROCEDURE

- a. The EUT was placed on the top of a rotating table 0.8 meters above the ground at a 10 meter open area test site. The table was rotated 360 degrees to determine the position of the highest radiation.
- b. The EUT was set 3 meters away from the interference-receiving antenna, which was mounted on the top of a variable-height antenna tower.
- c. The antenna is a broadband antenna, and its height is varied from one meter to four meters above the ground to determine the maximum value of the field strength. Both horizontal and vertical polarizations of the antenna are set to make the measurement.
- d. For each suspected emission, the EUT was arranged to its worst case and then the antenna was tuned to heights from 1 meter to 4 meters and the rotatable table was turned from 0 degrees to 360 degrees to find the maximum reading.
- e. Set both RBW and VBW of spectrum analyzer to 100kHz and 300kHz with suitable frequency span including 100MHz bandwidth from band edge. The band edges was measured and recorded.

The spectrum plots (Peak RBW = 100kHz, VBW = 300kHz) are attached on the following pages.

NOTE: The resolution bandwidth of test receiver/spectrum analyzer is 1MHz and the video bandwidth is 10Hz for Average detection (AV) at frequency above 1GHz.

4.6.4 DEVIATION FROM TEST STANDARD

No deviation.

4.6.5 EUT OPERATING CONDITION

Same as Item 4.3.6.



4.6.6 TEST RESULTS

The spectrum plots are attached on the following pages. D1 line indicates the highest level, and D2 line indicates the 20dB offset below D1. It shows compliance with the requirement in part 15.247(d).

802.11b

RESTRICT BAND (2310 ~ 2390 MHz)

FREQUENCY (MHz)	FUNDAMENTAL EMISSION (dBuV/m)	DELTA (dB)	MAXIMUM FIELD STRENGTH IN RESTRICT BAND (dBuV/m)	LIMIT (dBuV/m)
2412.00 (PK)	110.5	53.95	56.55	74.00
2412.00 (AV)	104.6	63.53	41.07	54.00

RESTRICT BAND (2483.5 ~ 2500 MHz)

FREQUENCY (MHz)	FUNDAMENTAL EMISSION (dBuV/m)	DELTA (dB)	MAXIMUM FIELD STRENGTH IN RESTRICT BAND (dBuV/m)	LIMIT (dBuV/m)
2462.00 (PK)	108.9	46.22	62.68	74.00
2462.00 (AV)	100.0	63.14	36.86	54.00

NOTE:

1. Delta = Amplitude between the peak of the fundamental and the peak of the band edge emission. Please check following 3 pages.
2. Maximum field strength in restrict band = Fundamental emission – Delta.



A D T

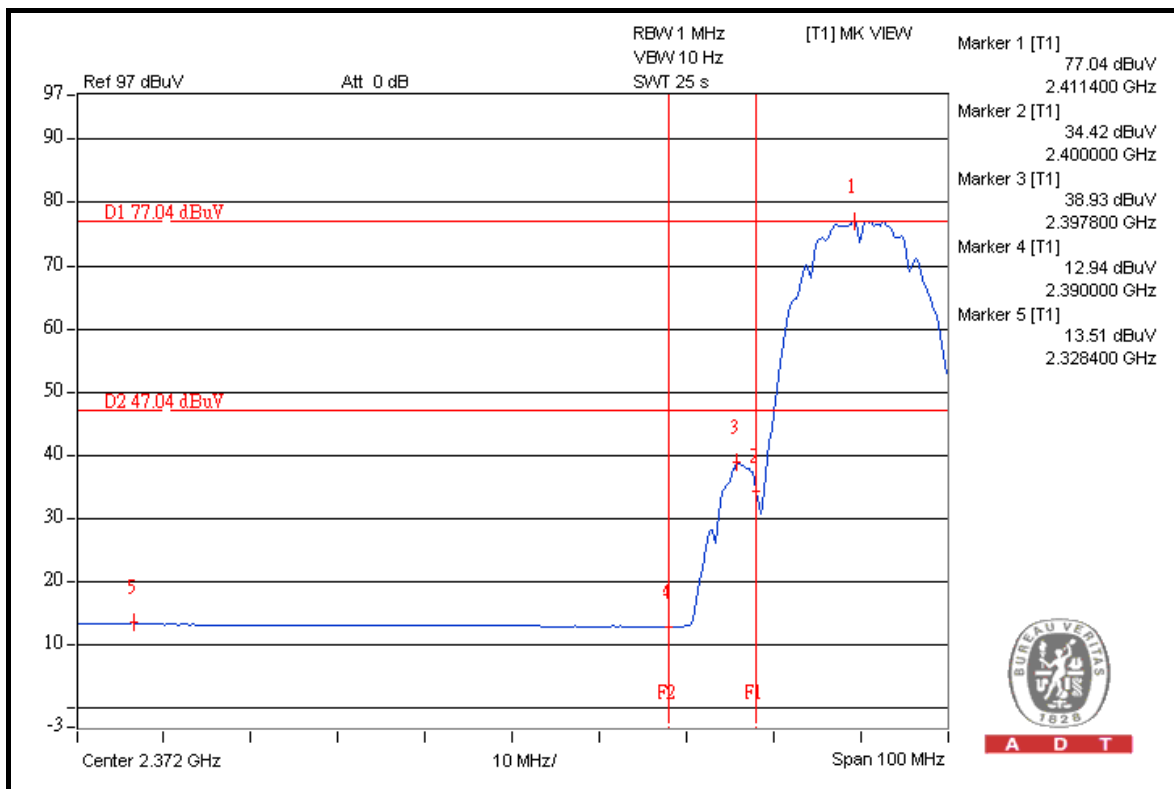
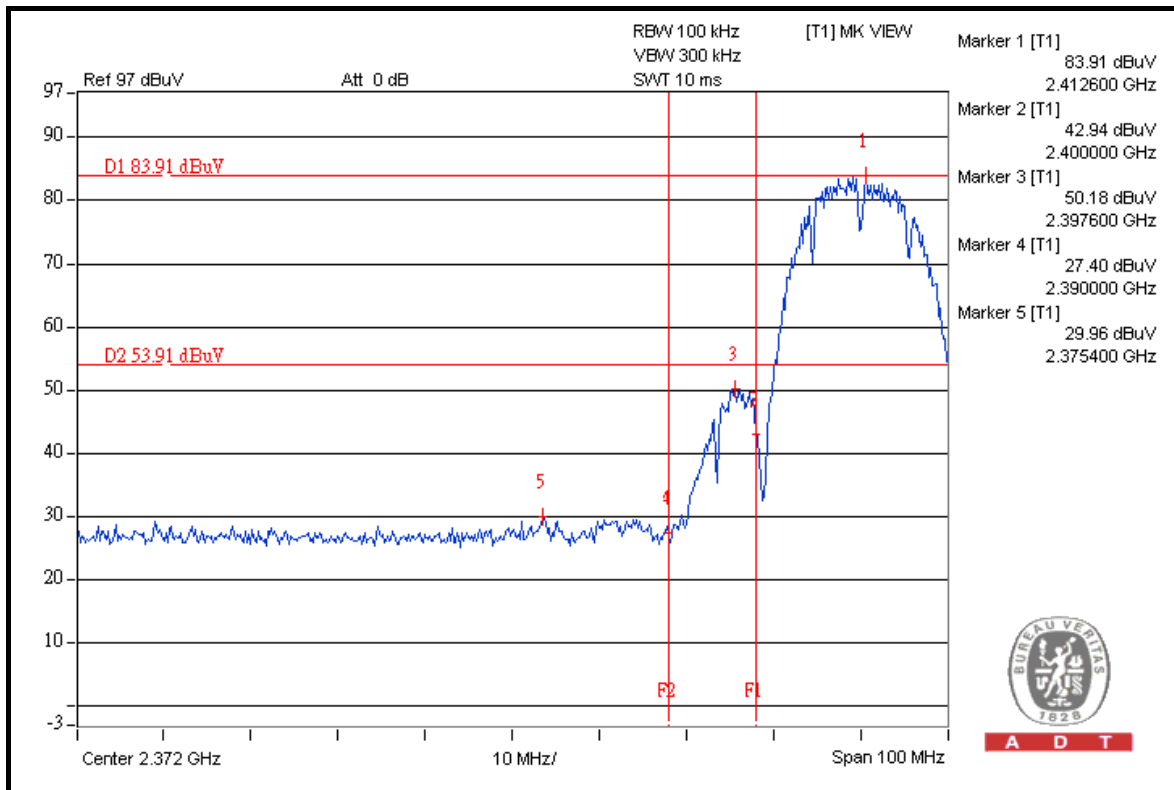



A D T

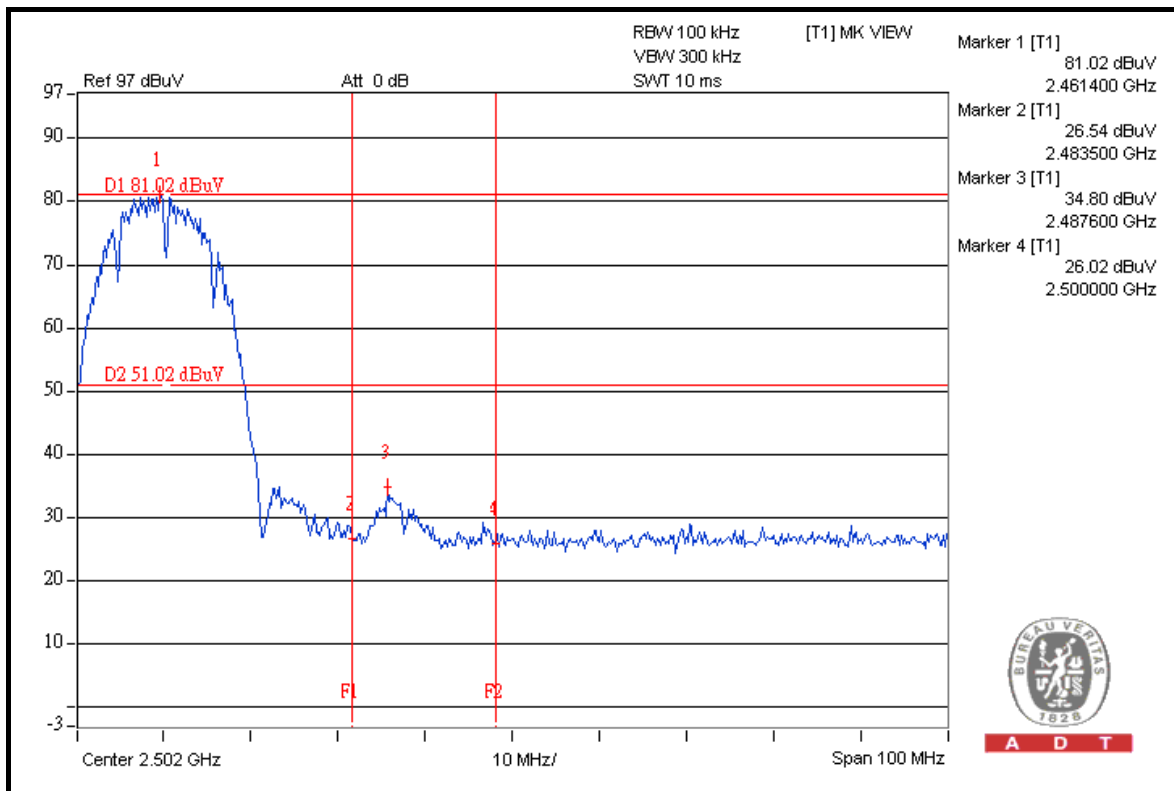
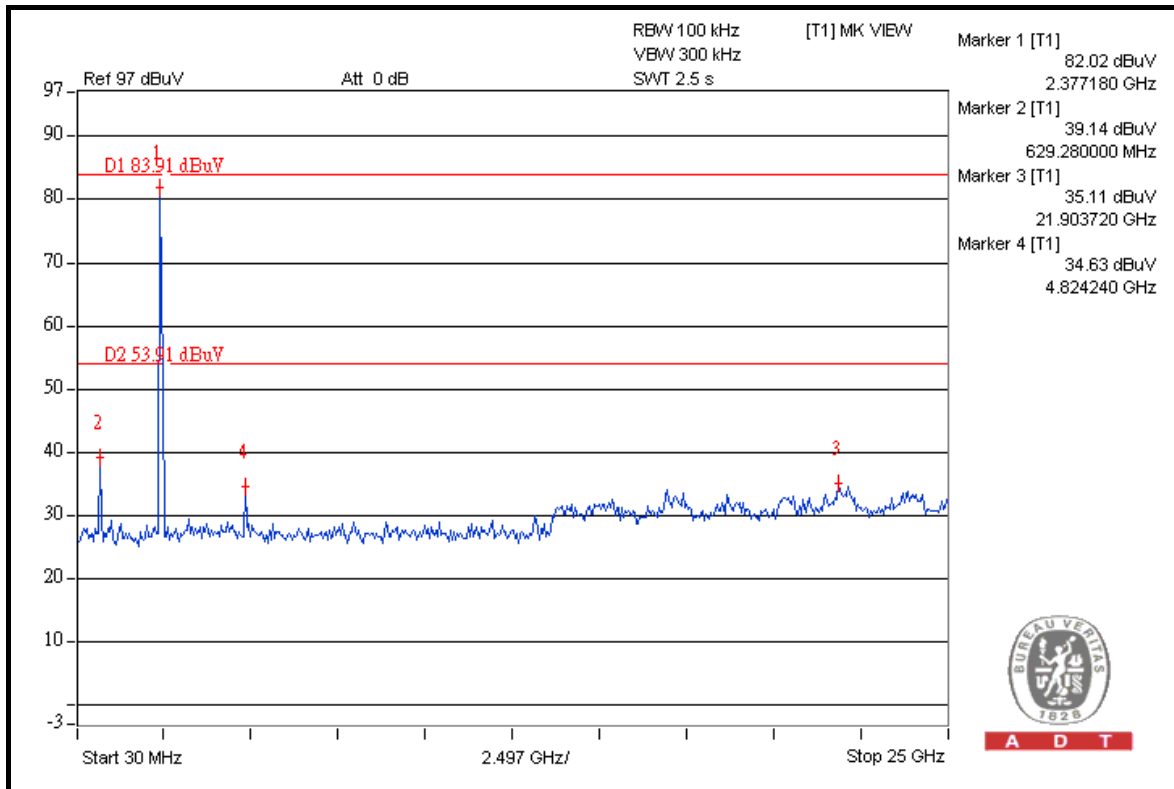



A D T

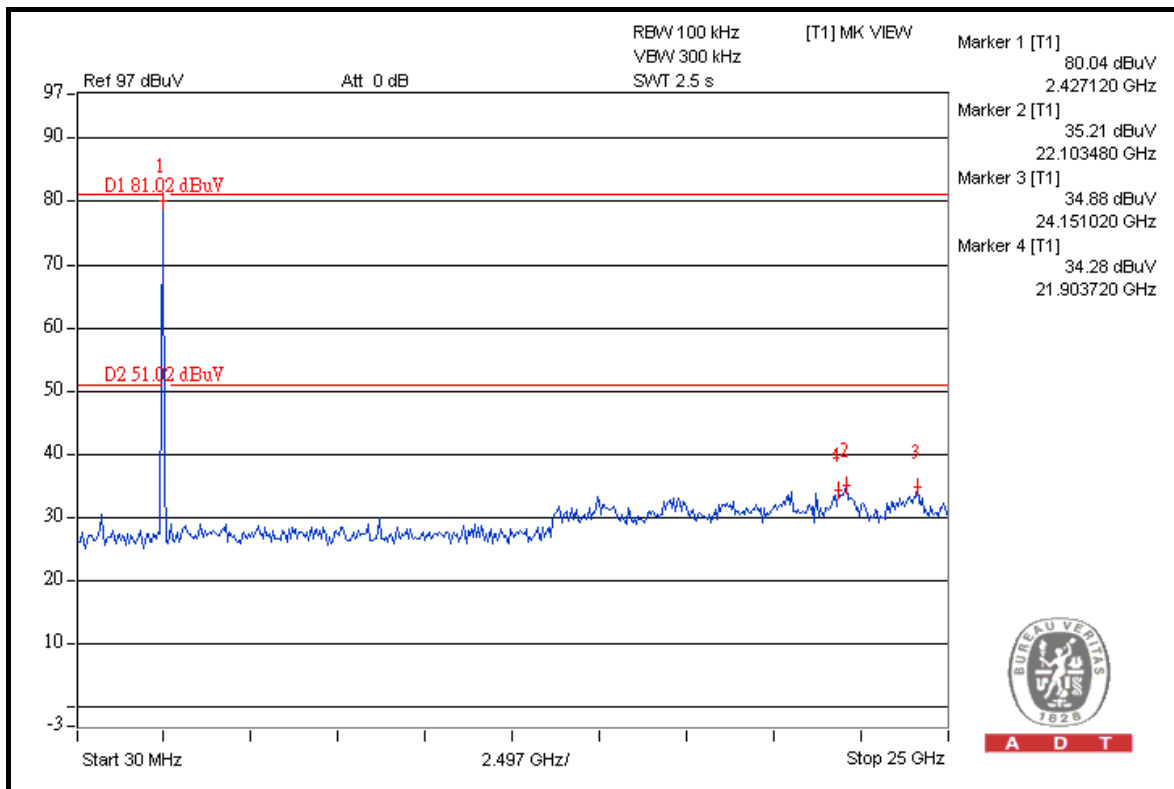
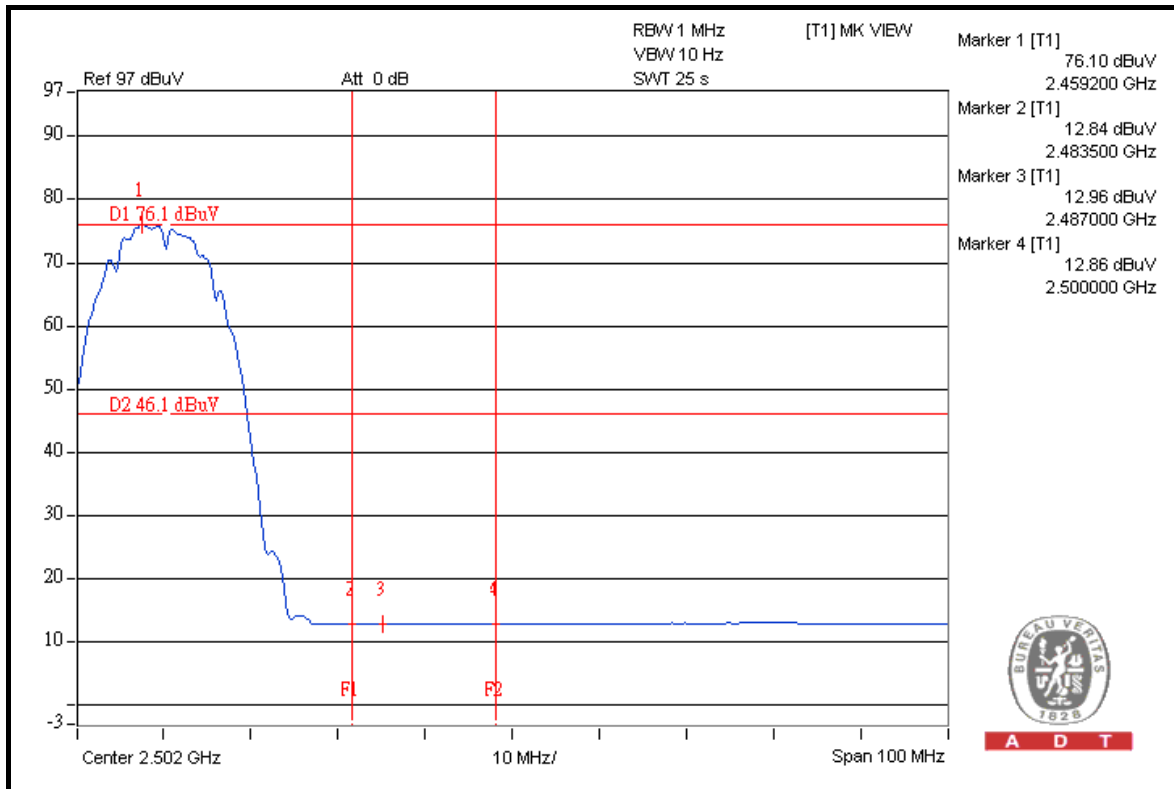



A D T

802.11g

RESTRICT BAND (2310 ~ 2390 MHz)

FREQUENCY (MHz)	FUNDAMENTAL EMISSION (dBuV/m)	DELTA (dB)	MAXIMUM FIELD STRENGTH IN RESTRICT BAND (dBuV/m)	LIMIT (dBuV/m)
2412.00 (PK)	112.0	52.02	59.98	74.00
2412.00 (AV)	100.6	61.43	39.17	54.00

RESTRICT BAND (2483.5 ~ 2500 MHz)

FREQUENCY (MHz)	FUNDAMENTAL EMISSION (dBuV/m)	DELTA (dB)	MAXIMUM FIELD STRENGTH IN RESTRICT BAND (dBuV/m)	LIMIT (dBuV/m)
2462.00 (PK)	112.0	47.20	64.80	74.00
2462.00 (AV)	99.5	59.14	40.36	54.00

NOTE:

1. Delta = Amplitude between the peak of the fundamental and the peak of the band edge emission. Please check following 3 pages.
2. Maximum field strength in restrict band = Fundamental emission – Delta.



A D T

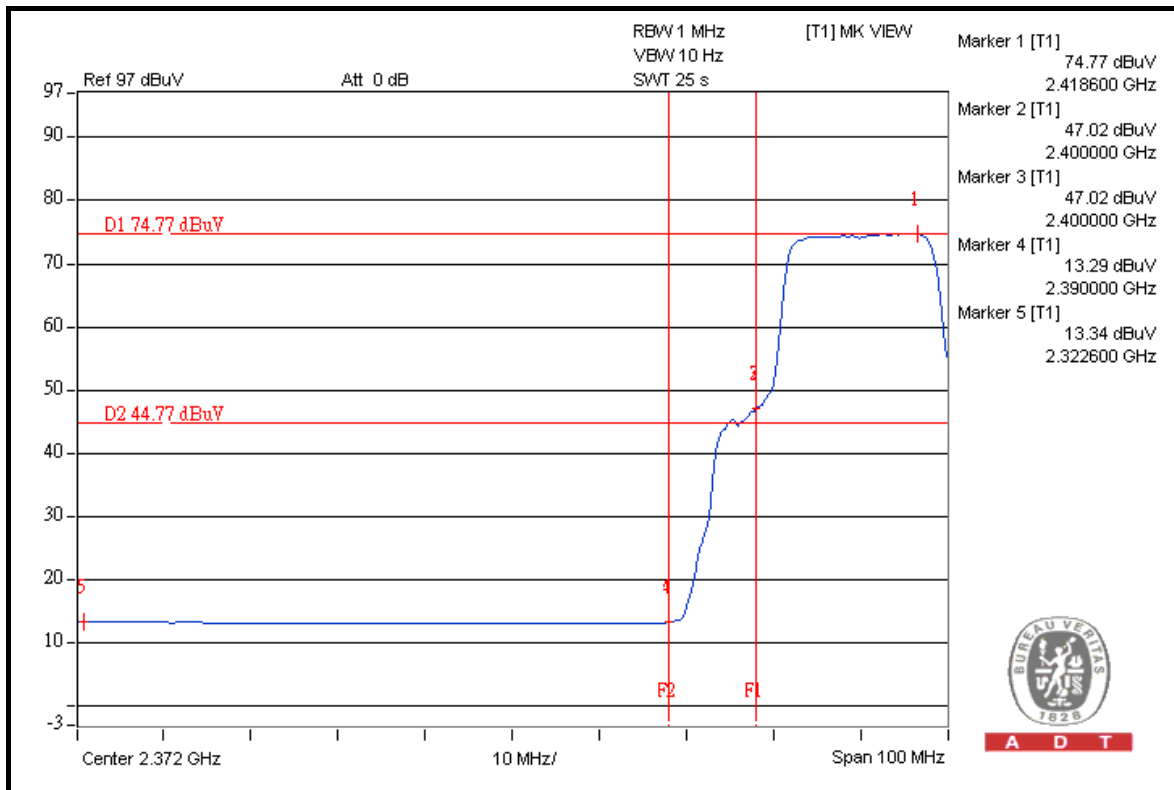
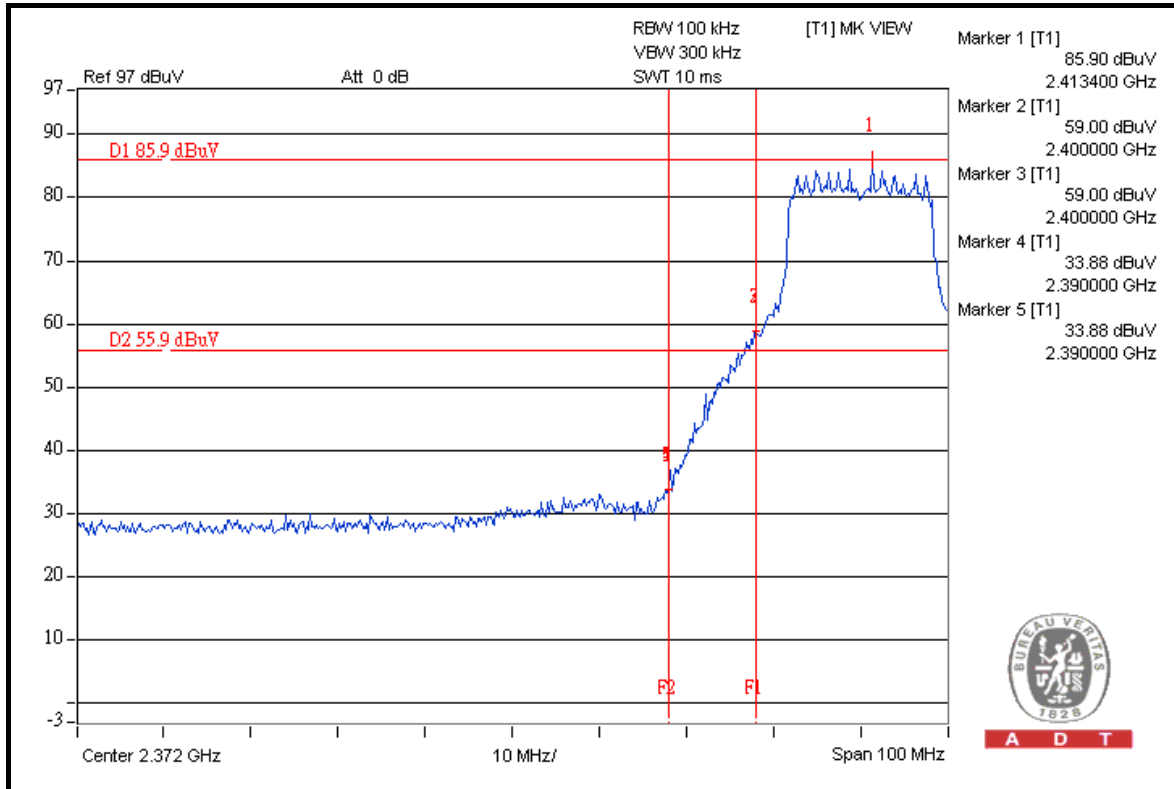



A D T

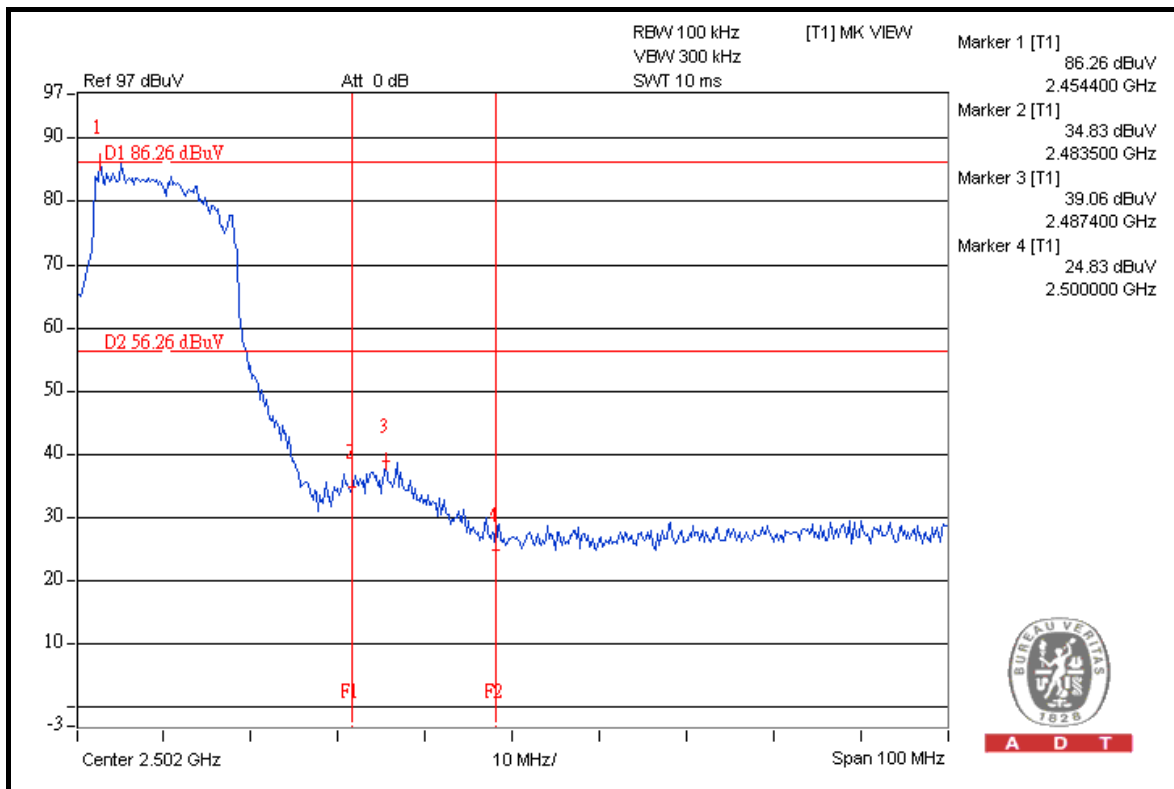
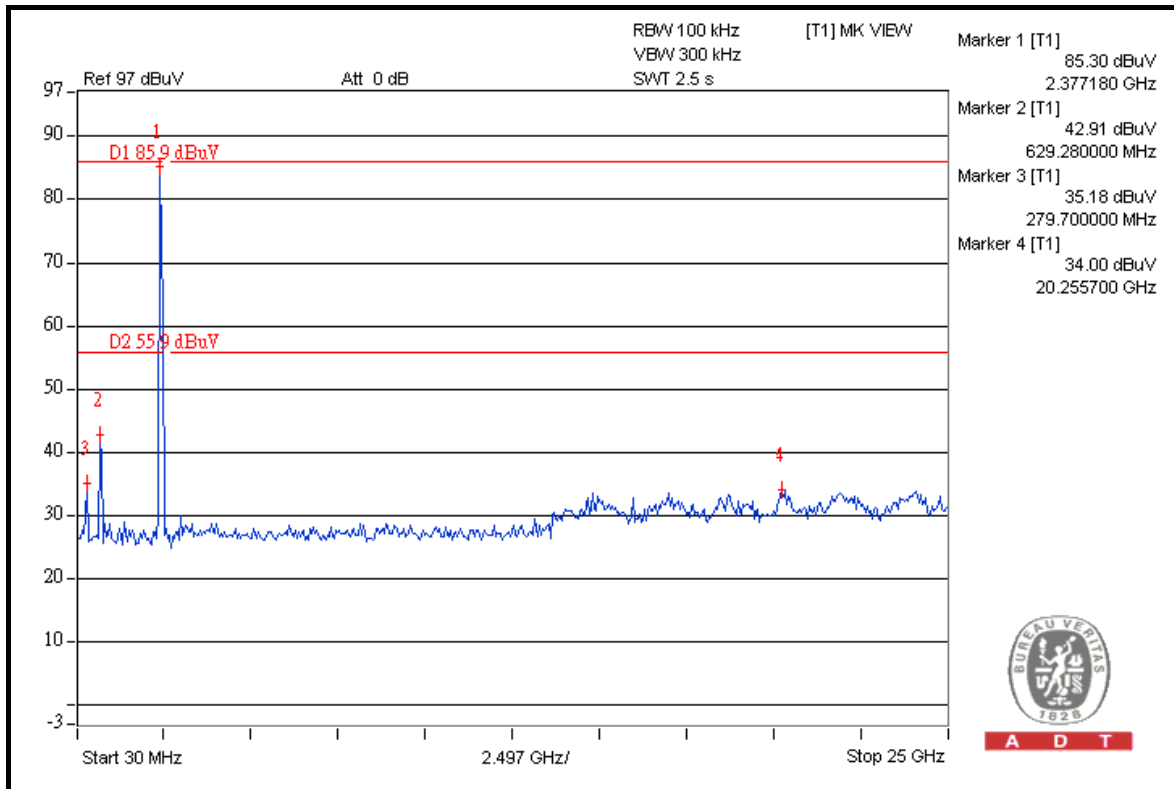



A D T

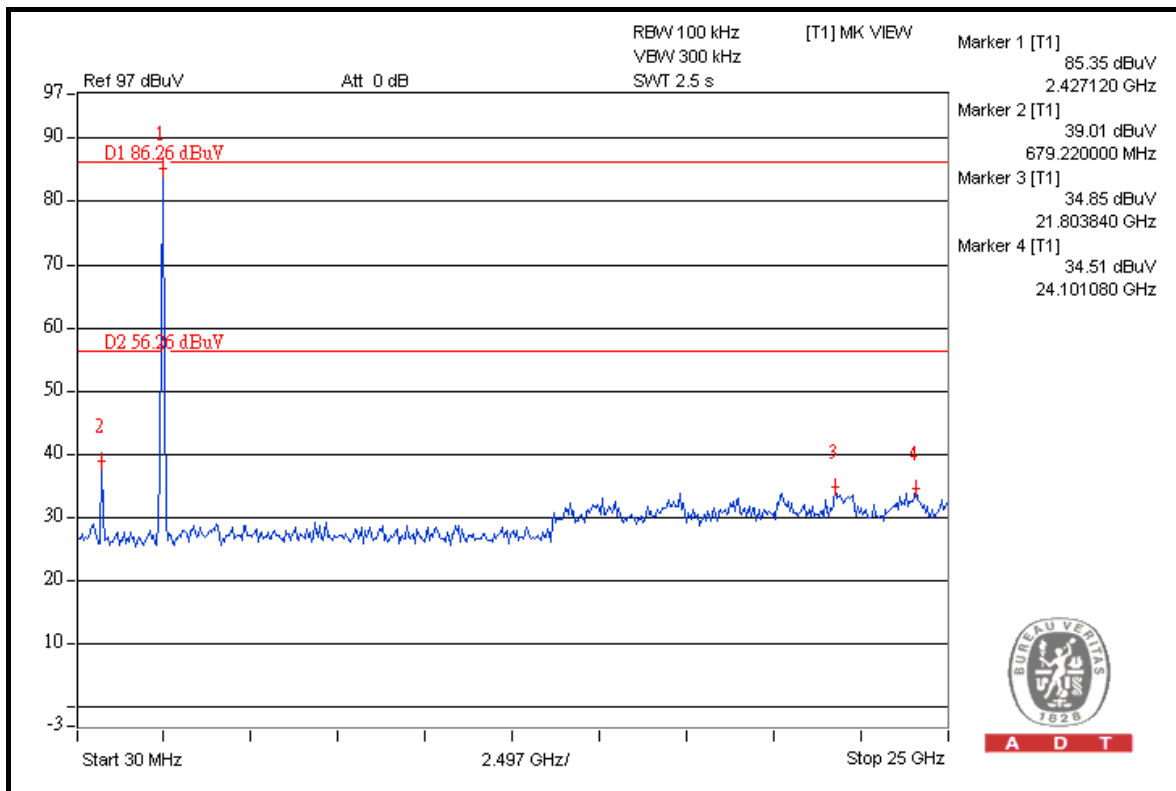
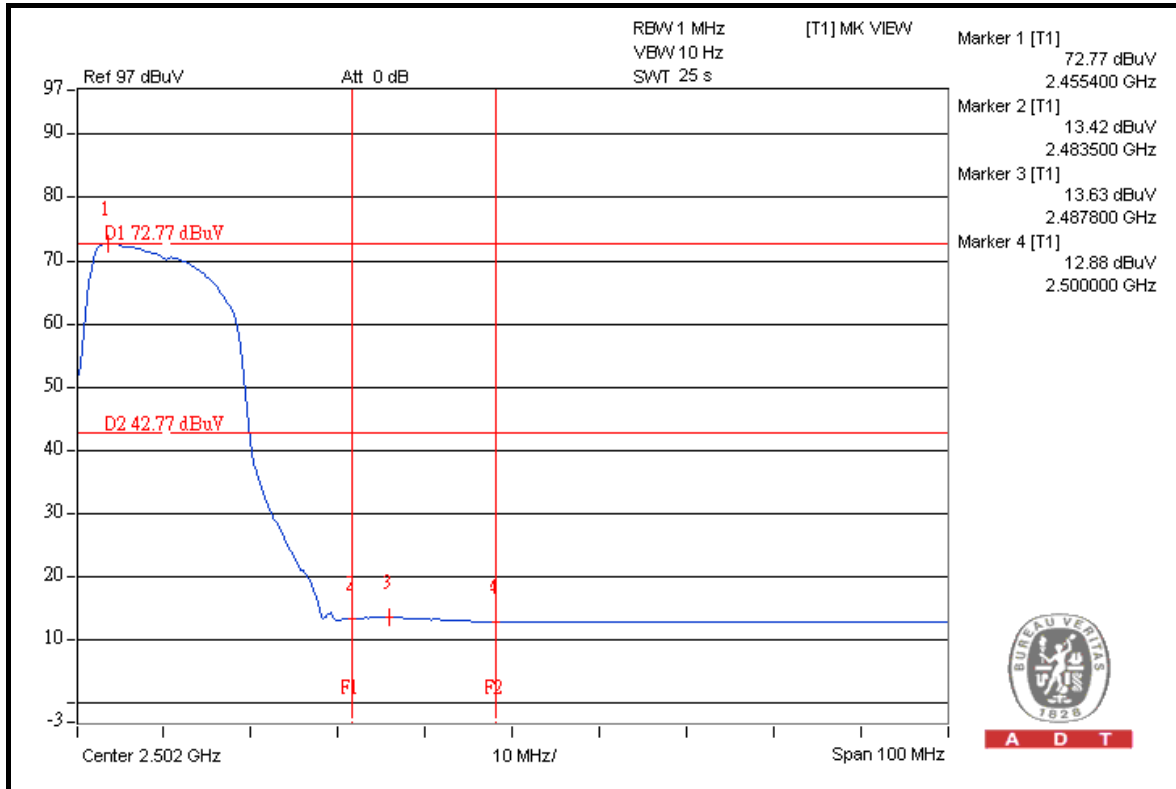



A D T

802.11n (20MHz)

RESTRICT BAND (2310 ~ 2390 MHz)

FREQUENCY (MHz)	FUNDAMENTAL EMISSION (dBuV/m)	DELTA (dB)	MAXIMUM FIELD STRENGTH IN RESTRICT BAND (dBuV/m)	LIMIT (dBuV/m)
2412.00 (PK)	111.0	49.56	61.44	74.00
2412.00 (AV)	97.6	57.79	39.81	54.00

RESTRICT BAND (2483.5 ~ 2500 MHz)

FREQUENCY (MHz)	FUNDAMENTAL EMISSION (dBuV/m)	DELTA (dB)	MAXIMUM FIELD STRENGTH IN RESTRICT BAND (dBuV/m)	LIMIT (dBuV/m)
2462.00 (PK)	111.9	47.49	64.41	74.00
2462.00 (AV)	99.8	57.34	42.46	54.00

NOTE:

1. Delta = Amplitude between the peak of the fundamental and the peak of the band edge emission. Please check following 3 pages.
2. Maximum field strength in restrict band = Fundamental emission – Delta.



A D T

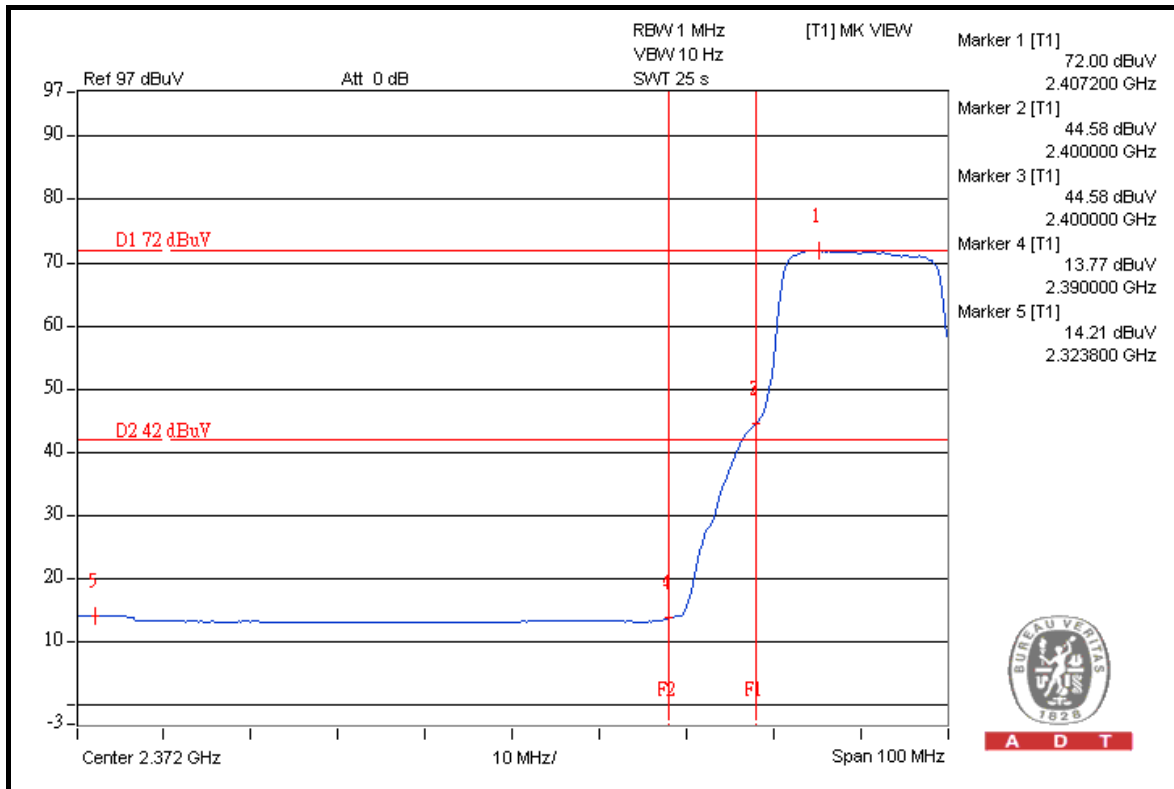
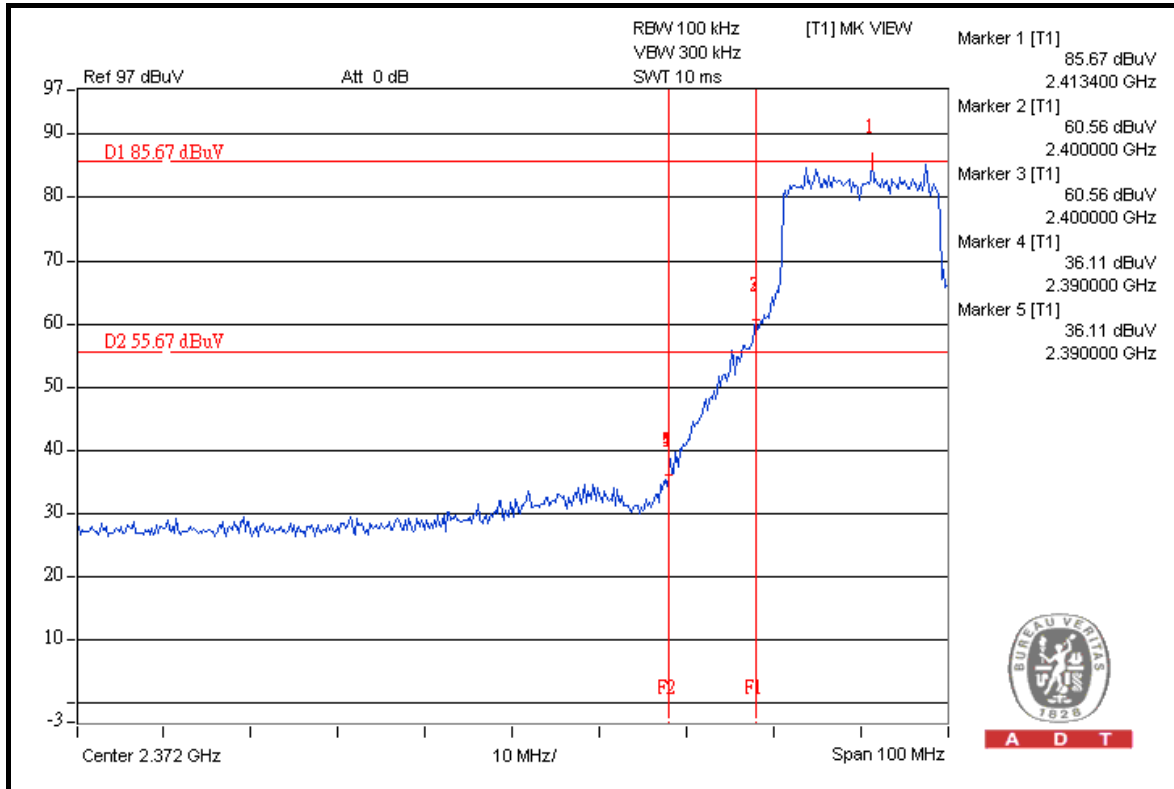



A D T

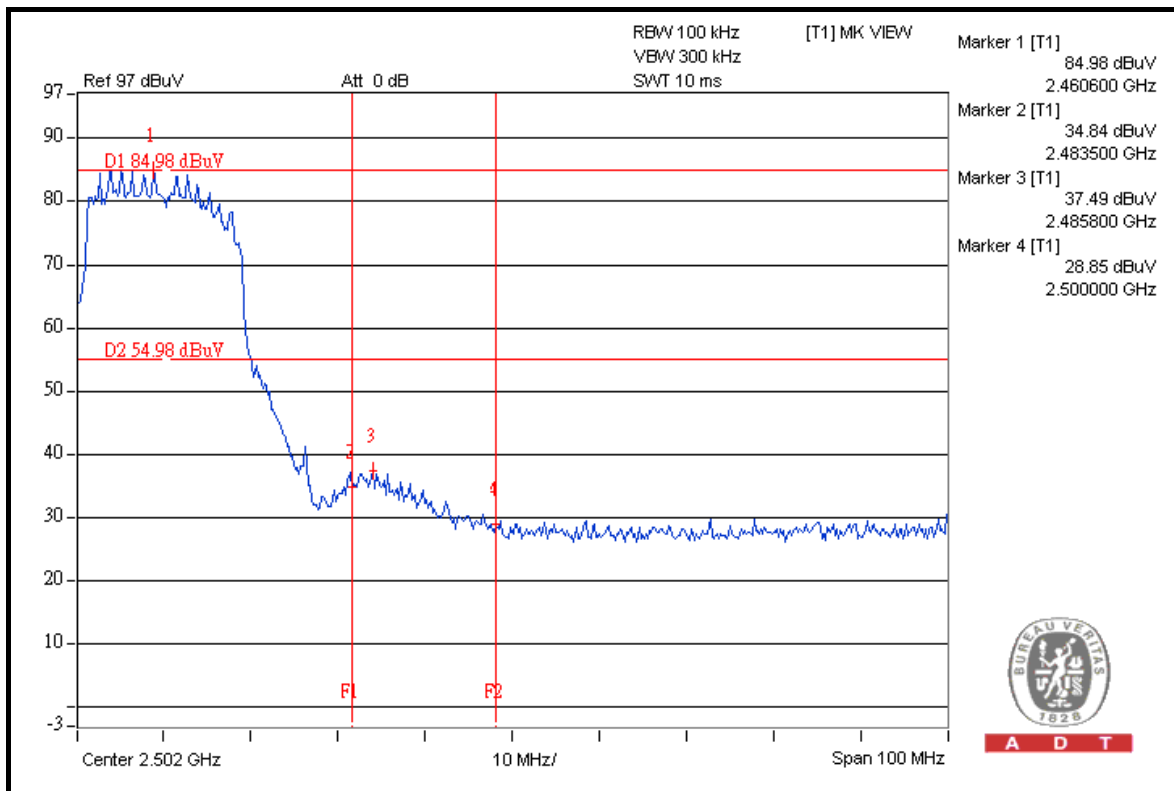
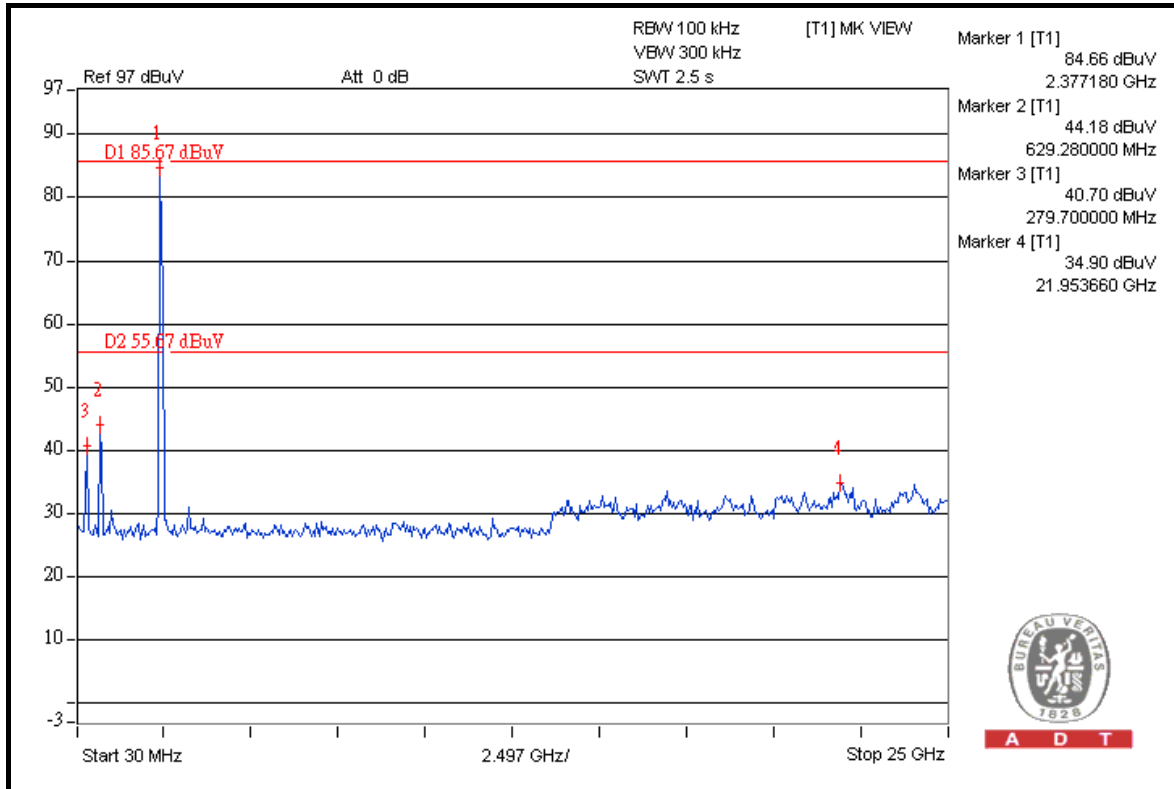



A D T

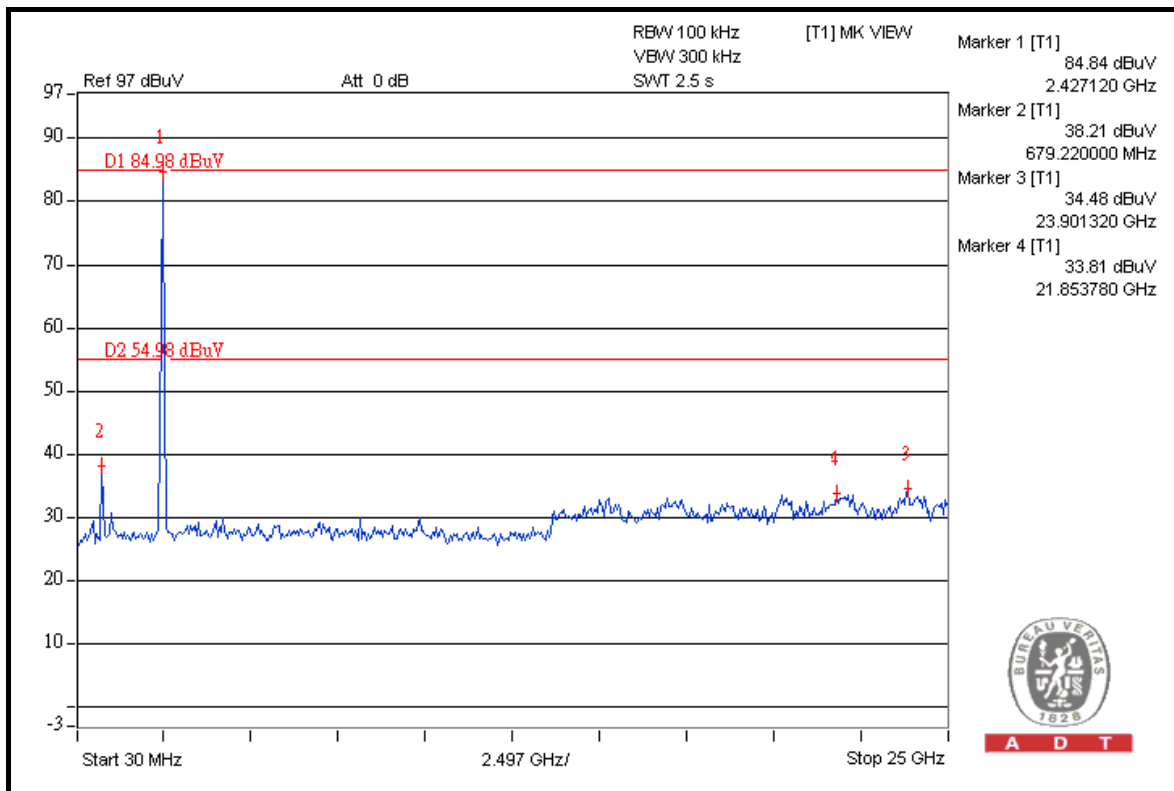
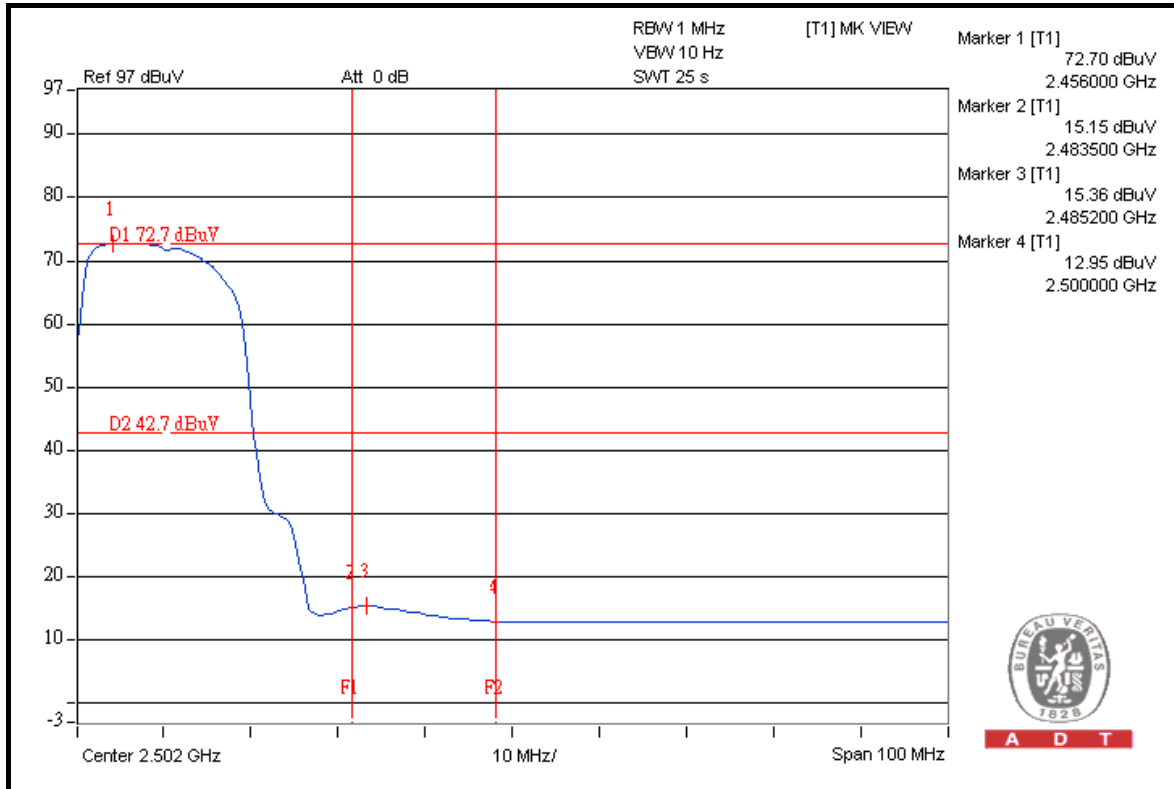



A D T

802.11n (40MHz)

RESTRICT BAND (2310 ~ 2390 MHz)

FREQUENCY (MHz)	FUNDAMENTAL EMISSION (dBuV/m)	DELTA (dB)	MAXIMUM FIELD STRENGTH IN RESTRICT BAND (dBuV/m)	LIMIT (dBuV/m)
2422.00 (PK)	110.0	41.80	68.20	74.00
2422.00 (AV)	95.2	54.58	40.62	54.00

RESTRICT BAND (2483.5 ~ 2500 MHz)

FREQUENCY (MHz)	FUNDAMENTAL EMISSION (dBuV/m)	DELTA (dB)	MAXIMUM FIELD STRENGTH IN RESTRICT BAND (dBuV/m)	LIMIT (dBuV/m)
2452.00 (PK)	111.5	46.86	64.64	74.00
2452.00 (AV)	98.0	52.83	45.17	54.00

NOTE:

1. Delta = Amplitude between the peak of the fundamental and the peak of the band edge emission. Please check following 3 pages.
2. Maximum field strength in restrict band = Fundamental emission – Delta.



A D T

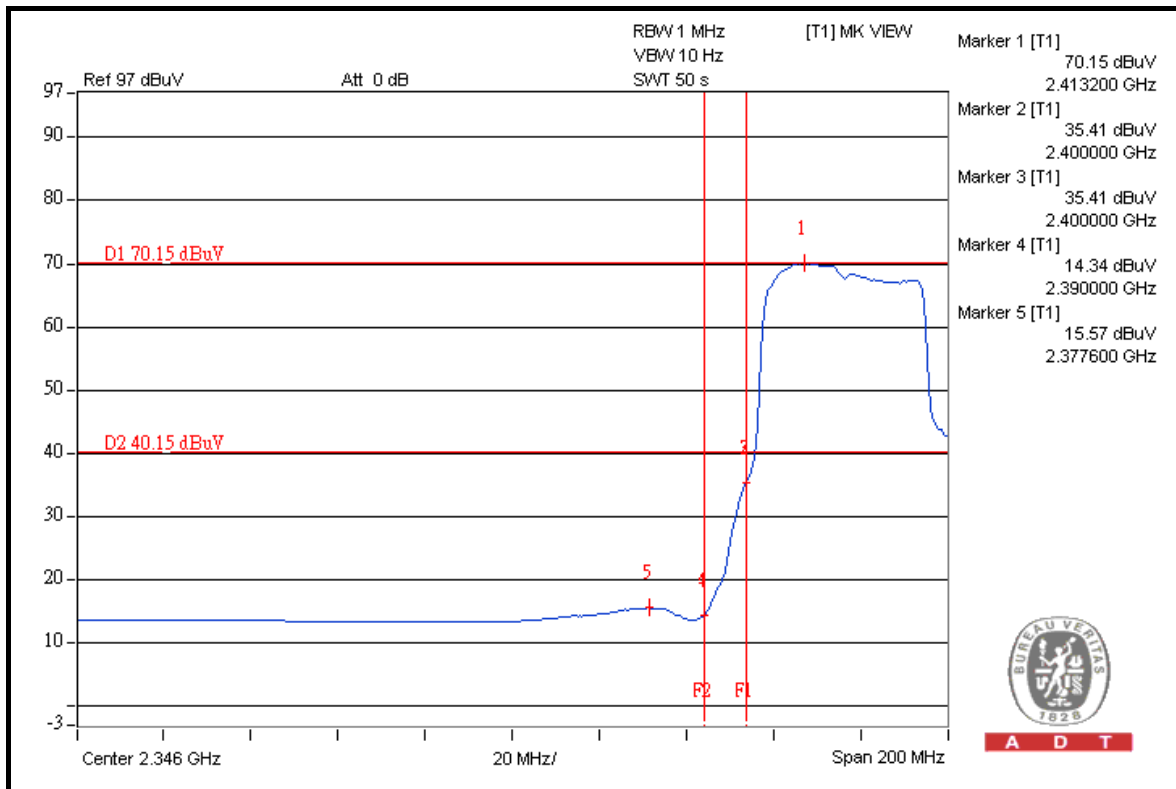
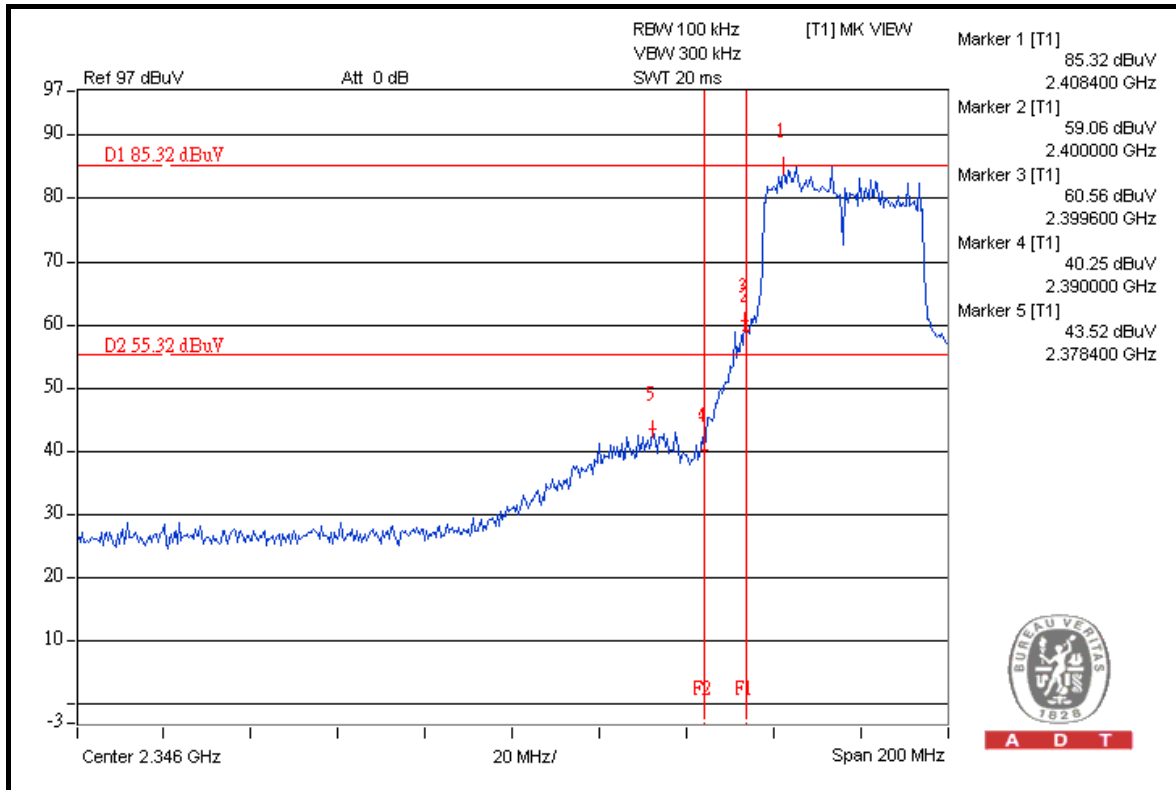



A D T

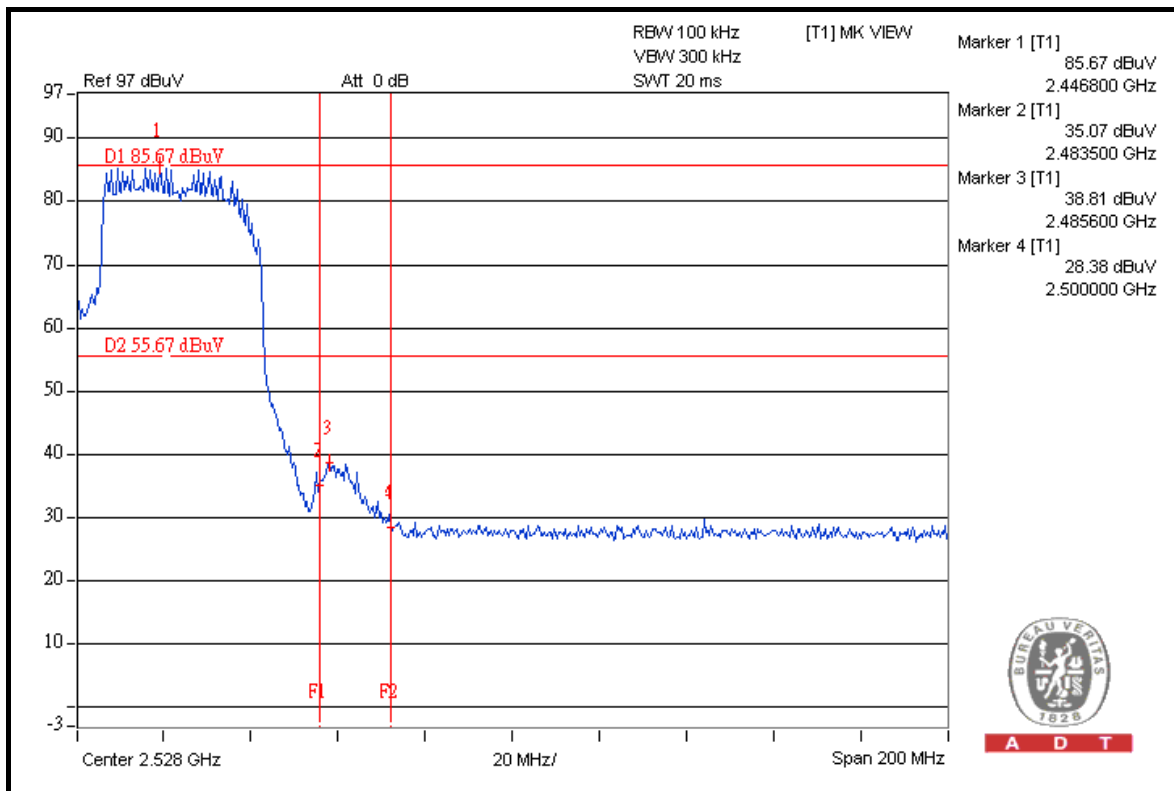
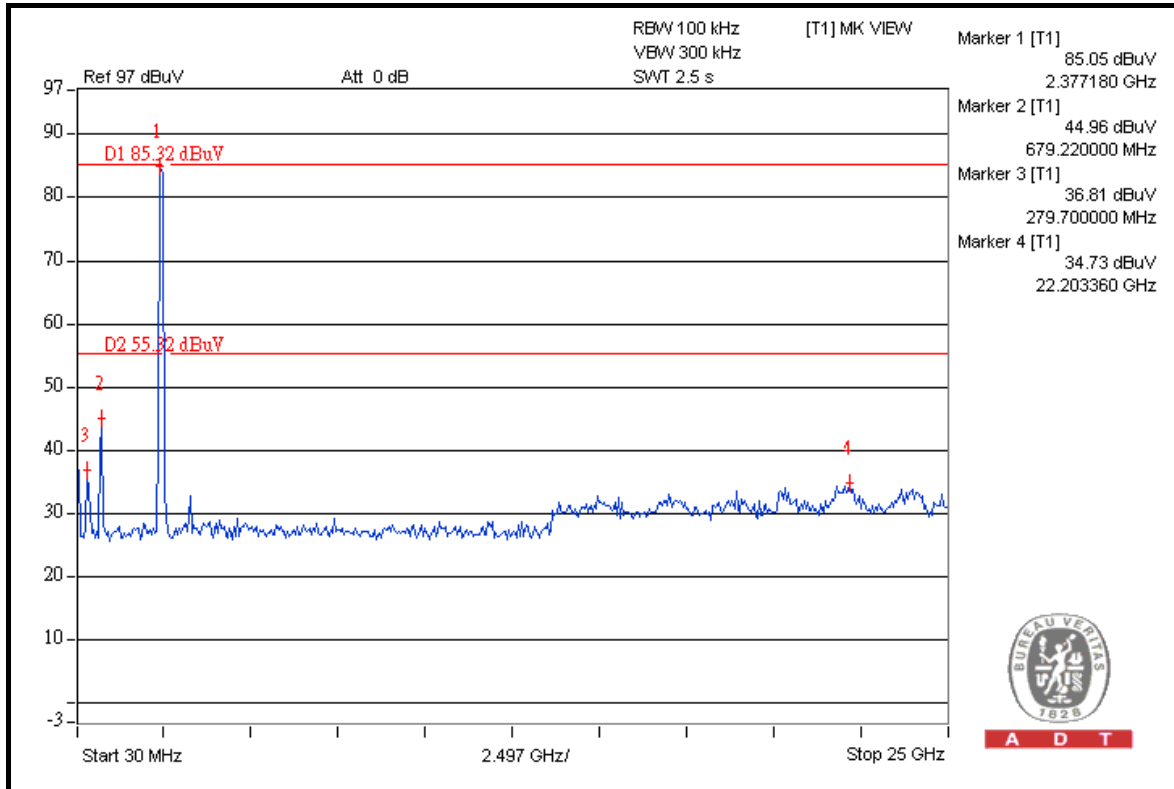



A D T

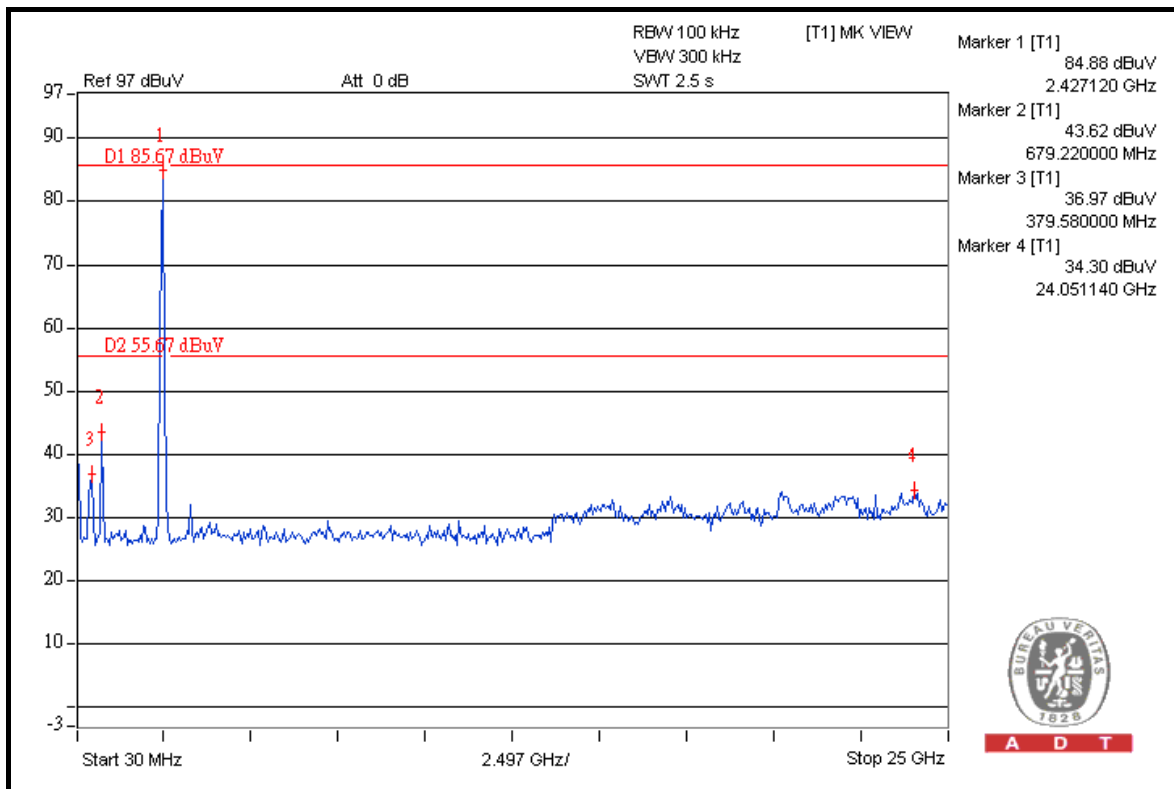
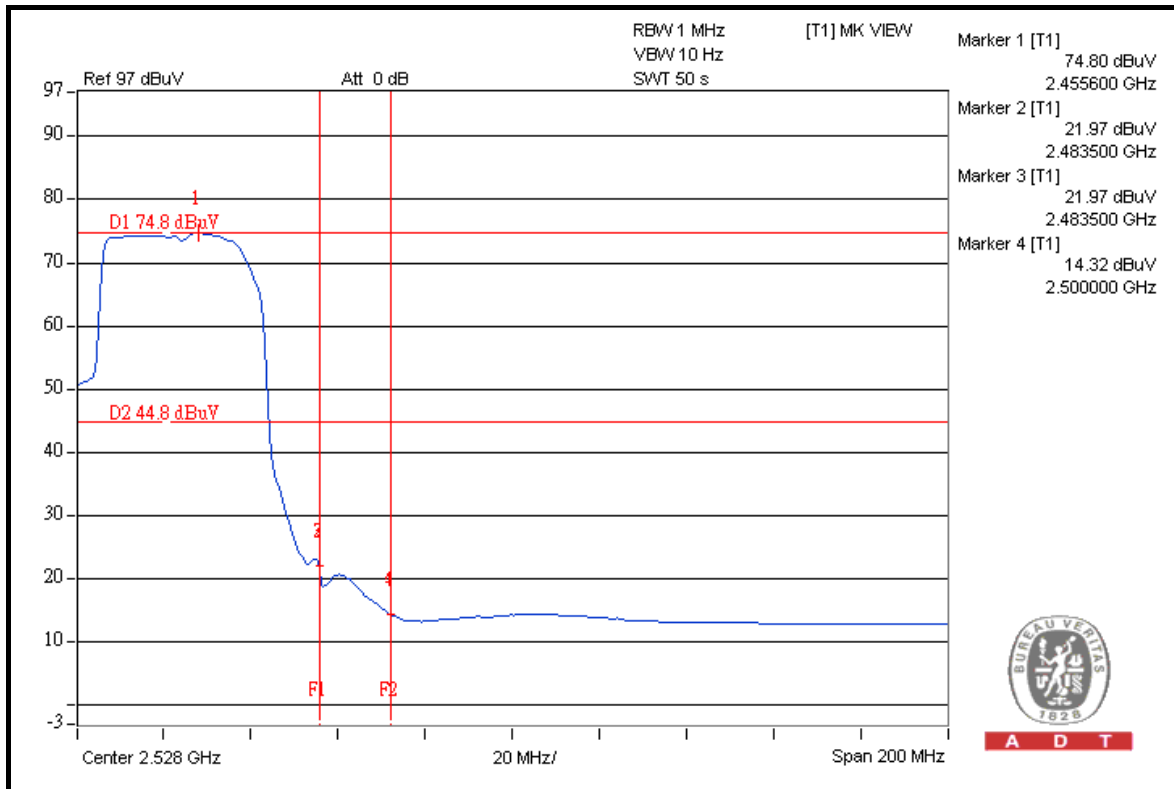

5. TEST TYPES AND RESULTS (FOR 5.0GHz BAND)

5.1 RADIATED EMISSION MEASUREMENT

5.1.1 LIMITS OF RADIATED EMISSION MEASUREMENT

Emissions radiated outside of the specified bands, shall be according to the general radiated limits in 15.209 as following:

FREQUENCIES (MHz)	FIELD STRENGTH (microvolts/meter)	MEASUREMENT DISTANCE (meters)
0.009 ~ 0.490	2400/F(kHz)	300
0.490 ~ 1.705	24000/F(kHz)	30
1.705 ~ 30.0	30	30
30 ~ 88	100	3
88 ~ 216	150	3
216 ~ 960	200	3
Above 960	500	3

NOTE:

1. The lower limit shall apply at the transition frequencies.
2. Emission level (dBuV/m) = 20 log Emission level (uV/m).
3. As shown in 15.35(b), for frequencies above 1000MHz, the field strength limits are based on average detector, however, the peak field strength of any emission shall not exceed the maximum permitted average limits, specified above by more than 20dB under any condition of modulation.



A D T

5.1.2 TEST INSTRUMENT

FOR FREQUENCY ABOVE 1 GHz:

DESCRIPTION & MANUFACTURER	MODEL NO.	SERIAL NO.	DATE OF CALIBRATION	DUE DATE OF CALIBRATION
Agilent Spectrum	8564EC	4208A00659	Jul. 24, 2009	Jul. 23, 2010
Agilent Preamplifier	8449B	3008A01924	Aug. 31, 2009	Aug. 30, 2010
Agilent Preamplifier	8449B	3008A01292	Aug. 10, 2009	Aug. 09, 2010
MITEQ Preamplifier	AMF-6F-260400-33 -8P	892164	Aug. 31, 2009	Aug. 30, 2010
Schwarzbeck Horn Antenna	BBHA-9170	BBHA9170190	Sep. 24, 2009	Sep. 23, 2010
Schwarzbeck Horn Antenna	BBHA-9120	D130	May 15, 2009	May 14, 2010
ADT. Turn Table	TT100	0201	NA	NA
ADT. Tower	AT100	0201	NA	NA
Software	ADT_Radiated_V7. 6.15.9.2	NA	NA	NA
SUHNER RF cable	SF106-18	PHACAB-1G- 40GHz	Aug. 20, 2009	Aug. 19, 2010

- NOTE:**
1. The calibration interval of the above test instruments is 12 months. And the calibrations are traceable to NML/ROC and NIST/USA.
 2. The test was performed in Open Site No. 10.
 3. The Industry Canada Reference No. IC 7450E-10.
 4. The FCC Site Registration No. 698148.

FOR FREQUENCY BELOW 1 GHz:

DESCRIPTION & MANUFACTURER	MODEL NO.	SERIAL NO.	DATE OF CALIBRATION	DUE DATE OF CALIBRATION
ROHDE & SCHWARZ TEST RECEIVER	ESVS 30	841977/008	Apr. 24, 2009	Apr. 23, 2010
SCHAFFNER BILOG Antenna	CBL6111C	2793	Apr. 29, 2009	Apr. 28, 2010
ADT. Turn Table	TT100	0201	NA	NA
ADT. Tower	AT100	0201	NA	NA
Software	ADT_Radiated_V7. 6.15.9.2	NA	NA	NA
ADT RF Switches BOX	EM-H-01-1	1004	Dec. 19, 2008	Dec. 18, 2009
WOKEN RF cable	8D	CABLE-ST10-01	Dec. 19, 2008	Dec. 18, 2009

- NOTE:**
1. The calibration interval of the above test instruments is 12 months. And the calibrations are traceable to NML/ROC and NIST/USA.
 2. The test was performed in Open Site No. 10.
 3. The VCCI Site Registration No. R-1625.
 4. The Industry Canada Reference No. IC 7450E-10.
 5. The FCC Site Registration No. 698148.



A D T

5.1.3 TEST PROCEDURES

- a. The EUT was placed on the top of a rotating table 0.8 meters above the ground at a 10 meter open area test site. The table was rotated 360 degrees to determine the position of the highest radiation.
- b. The EUT was set 3 meters away from the interference-receiving antenna, which was mounted on the top of a variable-height antenna tower.
- c. The antenna is a broadband antenna, and its height is varied from one meter to four meters above the ground to determine the maximum value of the field strength. Both horizontal and vertical polarizations of the antenna are set to make the measurement.
- d. For each suspected emission, the EUT was arranged to its worst case and then the antenna was tuned to heights from 1 meter to 4 meters and the rotatable table was turned from 0 degrees to 360 degrees to find the maximum reading.
- e. The test-receiver system was set to Peak Detect Function and Specified Bandwidth with Maximum Hold Mode.
- f. If the emission level of the EUT in peak mode was lower than the limit specified, then testing could be stopped and the peak values of the EUT would be reported. Otherwise the emissions would be re-tested one by one using peak, quasi-peak or average method as specified and then reported in a data sheet.

NOTE:

1. The resolution bandwidth and video bandwidth of test receiver/spectrum analyzer is 120kHz for Quasi-peak detection at frequency below 1GHz.
2. The resolution bandwidth of test receiver/spectrum analyzer is 1MHz and video bandwidth is 3MHz for Peak detection at frequency above 1GHz.
3. The resolution bandwidth of test receiver/spectrum analyzer is 1MHz and the video bandwidth is 10Hz for Average detection (AV) at frequency above 1GHz.
4. All modes of operation were investigated and the worst-case emissions are reported.

5.1.4 DEVIATION FROM TEST STANDARD

No deviation.

5.1.5 TEST SETUP

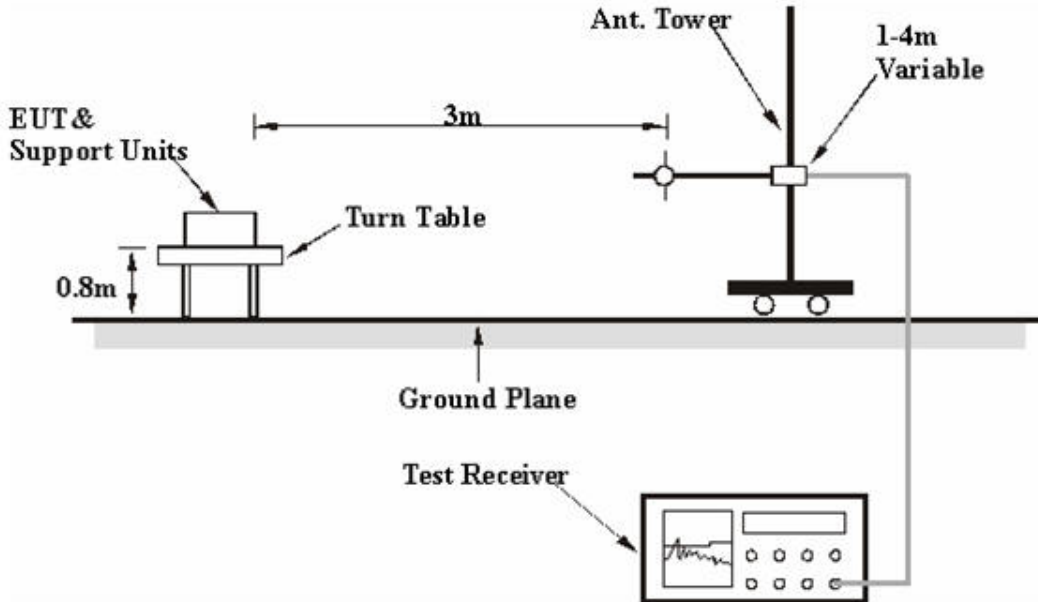

For the actual test configuration, please refer to the attached file (Test Setup Photo).

5.1.6 EUT OPERATING CONDITIONS

Same as 4.1.6.



A D T

5.1.7 TEST RESULTS

802.11a

EUT TEST CONDITION		MEASUREMENT DETAIL	
CHANNEL	Channel 149	FREQUENCY RANGE	1 ~ 40GHz
INPUT POWER (SYSTEM)	120Vac, 60 Hz	DETECTOR FUNCTION	Peak (PK) Average (AV)
ENVIRONMENTAL CONDITIONS	22deg. C, 83%RH 1000 hPa	TESTED BY	Nick Chen

ANTENNA POLARITY & TEST DISTANCE: HORIZONTAL AT 3 M								
NO.	FREQ. (MHz)	EMISSION LEVEL (dBuV/m)	LIMIT (dBuV/m)	MARGIN (dB)	ANTENNA HEIGHT (m)	TABLE ANGLE (Degree)	RAW VALUE (dBuV)	CORRECTION FACTOR (dB/m)
1	#5725.00	72.8 PK	75.20	-2.4	1.39 H	216	33.38	39.45
2	#5725.00	51.5 AV	62.20	-10.7	1.39 H	216	12.08	39.45
3	*5745.00	105.2 PK			1.39 H	216	65.74	39.49
4	*5745.00	92.2 AV			1.39 H	216	52.75	39.49
5	7660.00	55.1 PK	74.00	-18.9	1.08 H	322	10.16	44.93
6	7660.00	41.4 AV	54.00	-12.6	1.08 H	322	-3.52	44.93
7	11490.00	60.1 PK	74.00	-13.9	1.26 H	250	10.15	49.96
8	11490.00	46.4 AV	54.00	-7.6	1.26 H	250	-3.53	49.96
ANTENNA POLARITY & TEST DISTANCE: VERTICAL AT 3 M								
NO.	FREQ. (MHz)	EMISSION LEVEL (dBuV/m)	LIMIT (dBuV/m)	MARGIN (dB)	ANTENNA HEIGHT (m)	TABLE ANGLE (Degree)	RAW VALUE (dBuV)	CORRECTION FACTOR (dB/m)
1	#5725.00	82.7 PK	85.00	-2.3	1.33 V	219	43.28	39.45
2	#5725.00	60.6 AV	72.70	-12.1	1.33 V	219	21.18	39.45
3	*5745.00	115.0 PK			1.33 V	219	75.54	39.49
4	*5745.00	102.7 AV			1.33 V	219	63.17	39.49
5	7660.00	55.0 PK	74.00	-19.0	1.33 V	226	10.10	44.93
6	7660.00	41.0 AV	54.00	-13.0	1.33 V	226	-3.91	44.93
7	11490.00	60.1 PK	74.00	-13.9	1.28 V	223	10.13	49.96
8	11490.00	46.4 AV	54.00	-7.6	1.28 V	223	-3.55	49.96

- REMARKS:**
1. Emission level (dBuV/m) = Raw Value (dBuV) + Correction Factor (dB/m).
 2. Correction Factor (dB/m) = Antenna Factor (dB/m) + Cable Factor (dB).
 3. The other emission levels were very low against the limit.
 4. Margin value = Emission level – Limit value.
 5. “ * “: Fundamental frequency.
 6. The limit value is defined as per 15.247.
 7. “#”: The radiated frequency is out the restricted band.



A D T

EUT TEST CONDITION		MEASUREMENT DETAIL	
CHANNEL	Channel 157	FREQUENCY RANGE	1 ~ 40GHz
INPUT POWER (SYSTEM)	120Vac, 60 Hz	DETECTOR FUNCTION	Peak (PK) Average (AV)
ENVIRONMENTAL CONDITIONS	22deg. C, 83%RH 1000 hPa	TESTED BY	Nick Chen

ANTENNA POLARITY & TEST DISTANCE: HORIZONTAL AT 3 M								
NO.	FREQ. (MHz)	EMISSION LEVEL (dBuV/m)	LIMIT (dBuV/m)	MARGIN (dB)	ANTENNA HEIGHT (m)	TABLE ANGLE (Degree)	RAW VALUE (dBuV)	CORRECTION FACTOR (dB/m)
1	*5785.00	104.7 PK			1.36 H	221	65.09	39.59
2	*5785.00	91.2 AV			1.36 H	221	51.63	39.59
3	7713.00	55.2 PK	74.00	-18.8	1.23 H	306	10.21	44.98
4	7713.00	41.0 AV	54.00	-13.0	1.23 H	306	-3.97	44.98
5	11570.00	60.5 PK	74.00	-13.5	1.34 H	199	10.63	49.90
6	11570.00	46.3 AV	54.00	-7.7	1.34 H	199	-3.57	49.90

ANTENNA POLARITY & TEST DISTANCE: VERTICAL AT 3 M								
NO.	FREQ. (MHz)	EMISSION LEVEL (dBuV/m)	LIMIT (dBuV/m)	MARGIN (dB)	ANTENNA HEIGHT (m)	TABLE ANGLE (Degree)	RAW VALUE (dBuV)	CORRECTION FACTOR (dB/m)
1	*5785.00	114.3 PK			1.31 V	210	74.73	39.59
2	*5785.00	101.3 AV			1.31 V	210	61.69	39.59
3	7713.00	53.5 PK	74.00	-20.5	1.22 V	63	8.53	44.98
4	7713.00	41.6 AV	54.00	-12.4	1.22 V	63	-3.41	44.98
5	11570.00	64.2 PK	74.00	-9.8	1.59 V	284	14.29	49.90
6	11570.00	48.2 AV	54.00	-5.8	1.59 V	284	-1.68	49.90

- REMARKS:**
1. Emission level (dBuV/m) = Raw Value (dBuV) + Correction Factor (dB/m).
 2. Correction Factor (dB/m) = Antenna Factor (dB/m) + Cable Factor (dB).
 3. The other emission levels were very low against the limit.
 4. Margin value = Emission level – Limit value.
 5. “ * “: Fundamental frequency.
 6. The limit value is defined as per 15.247.



A D T

EUT TEST CONDITION		MEASUREMENT DETAIL	
CHANNEL	Channel 165	FREQUENCY RANGE	1 ~ 40GHz
INPUT POWER (SYSTEM)	120Vac, 60 Hz	DETECTOR FUNCTION	Peak (PK) Average (AV)
ENVIRONMENTAL CONDITIONS	22deg. C, 83%RH 1000 hPa	TESTED BY	Nick Chen

ANTENNA POLARITY & TEST DISTANCE: HORIZONTAL AT 3 M								
NO.	FREQ. (MHz)	EMISSION LEVEL (dBuV/m)	LIMIT (dBuV/m)	MARGIN (dB)	ANTENNA HEIGHT (m)	TABLE ANGLE (Degree)	RAW VALUE (dBuV)	CORRECTION FACTOR (dB/m)
1	*5825.00	104.0 PK			1.29 H	206	64.36	39.67
2	*5825.00	90.7 AV			1.29 H	206	50.99	39.67
3	#5850.00	64.8 PK	74.00	-9.2	1.29 H	206	25.04	39.73
4	#5850.00	49.1 AV	60.70	-11.6	1.29 H	206	9.39	39.73
5	#7766.00	55.7 PK	74.00	-18.3	1.31 H	216	10.57	45.12
6	#7766.00	41.9 AV	60.70	-18.8	1.31 H	216	-3.19	45.12
7	11650.00	60.3 PK	74.00	-13.7	1.19 H	255	10.51	49.80
8	11650.00	45.7 AV	54.00	-8.3	1.19 H	255	-4.12	49.80
ANTENNA POLARITY & TEST DISTANCE: VERTICAL AT 3 M								
NO.	FREQ. (MHz)	EMISSION LEVEL (dBuV/m)	LIMIT (dBuV/m)	MARGIN (dB)	ANTENNA HEIGHT (m)	TABLE ANGLE (Degree)	RAW VALUE (dBuV)	CORRECTION FACTOR (dB/m)
1	*5825.00	114.2 PK			1.19 V	183	74.49	39.67
2	*5825.00	101.0 AV			1.19 V	183	61.29	39.67
3	#5850.00	75.3 PK	84.20	-8.9	1.19 V	183	35.60	39.73
4	#5850.00	55.1 AV	71.00	-15.9	1.19 V	183	15.34	39.73
5	#7766.00	55.7 PK	84.20	-28.5	1.16 V	72	10.62	45.12
6	#7766.00	42.0 AV	71.00	-29.0	1.16 V	72	-3.09	45.12
7	11650.00	59.8 PK	74.00	-14.2	1.24 V	211	10.01	49.80
8	11650.00	46.0 AV	54.00	-8.0	1.24 V	211	-3.83	49.80

- REMARKS:**
1. Emission level (dBuV/m) = Raw Value (dBuV) + Correction Factor (dB/m).
 2. Correction Factor (dB/m) = Antenna Factor (dB/m) + Cable Factor (dB).
 3. The other emission levels were very low against the limit.
 4. Margin value = Emission level – Limit value.
 5. “ * “: Fundamental frequency.
 6. The limit value is defined as per 15.247.
 7. “#”:The radiated frequency is out the restricted band.



A D T

802.11n (20MHz)

EUT TEST CONDITION		MEASUREMENT DETAIL	
CHANNEL	Channel 149	FREQUENCY RANGE	1 ~ 40GHz
INPUT POWER (SYSTEM)	120Vac, 60 Hz	DETECTOR FUNCTION	Peak (PK) Average (AV)
ENVIRONMENTAL CONDITIONS	22deg. C, 83%RH 1000 hPa	TESTED BY	Nick Chen

ANTENNA POLARITY & TEST DISTANCE: HORIZONTAL AT 3 M								
NO.	FREQ. (MHz)	EMISSION LEVEL (dBuV/m)	LIMIT (dBuV/m)	MARGIN (dB)	ANTENNA HEIGHT (m)	TABLE ANGLE (Degree)	RAW VALUE (dBuV)	CORRECTION FACTOR (dB/m)
1	#5725.00	72.9 PK	75.40	-2.5	1.41 H	229	33.47	39.45
2	#5725.00	51.7 AV	62.40	-10.7	1.41 H	229	12.23	39.45
3	*5745.00	105.4 PK			1.41 H	229	65.87	39.49
4	*5745.00	92.4 AV			1.41 H	229	52.89	39.49
5	7660.00	55.2 PK	74.00	-18.8	1.09 H	318	10.28	44.93
6	7660.00	41.5 AV	54.00	-12.5	1.09 H	318	-3.41	44.93
7	11490.00	60.2 PK	74.00	-13.8	1.24 H	261	10.28	49.96
8	11490.00	46.5 AV	54.00	-7.5	1.24 H	261	-3.42	49.96
ANTENNA POLARITY & TEST DISTANCE: VERTICAL AT 3 M								
NO.	FREQ. (MHz)	EMISSION LEVEL (dBuV/m)	LIMIT (dBuV/m)	MARGIN (dB)	ANTENNA HEIGHT (m)	TABLE ANGLE (Degree)	RAW VALUE (dBuV)	CORRECTION FACTOR (dB/m)
1	#5725.00	82.9 PK	85.20	-2.3	1.41 V	207	43.44	39.45
2	#5725.00	60.8 AV	72.70	-11.9	1.41 V	207	21.35	39.45
3	*5745.00	115.2 PK			1.41 V	207	75.72	39.49
4	*5745.00	102.7 AV			1.41 V	207	63.24	39.49
5	7660.00	55.1 PK	74.00	-18.9	1.36 V	222	10.21	44.93
6	7660.00	41.1 AV	54.00	-12.9	1.36 V	222	-3.83	44.93
7	11490.00	60.3 PK	74.00	-13.8	1.33 V	239	10.29	49.96
8	11490.00	46.5 AV	54.00	-7.5	1.33 V	239	-3.46	49.96

- REMARKS:**
1. Emission level (dBuV/m) = Raw Value (dBuV) + Correction Factor (dB/m).
 2. Correction Factor (dB/m) = Antenna Factor (dB/m) + Cable Factor (dB).
 3. The other emission levels were very low against the limit.
 4. Margin value = Emission level – Limit value.
 5. “ * “: Fundamental frequency.
 6. The limit value is defined as per 15.247.
 7. "#":The radiated frequency is out the restricted band.



A D T

EUT TEST CONDITION		MEASUREMENT DETAIL	
CHANNEL	Channel 157	FREQUENCY RANGE	1 ~ 40GHz
INPUT POWER (SYSTEM)	120Vac, 60 Hz	DETECTOR FUNCTION	Peak (PK) Average (AV)
ENVIRONMENTAL CONDITIONS	22deg. C, 83%RH 1000 hPa	TESTED BY	Nick Chen

ANTENNA POLARITY & TEST DISTANCE: HORIZONTAL AT 3 M								
NO.	FREQ. (MHz)	EMISSION LEVEL (dBuV/m)	LIMIT (dBuV/m)	MARGIN (dB)	ANTENNA HEIGHT (m)	TABLE ANGLE (Degree)	RAW VALUE (dBuV)	CORRECTION FACTOR (dB/m)
1	*5785.00	104.8 PK			1.41 H	234	65.19	39.59
2	*5785.00	91.3 AV			1.41 H	234	51.73	39.59
3	7713.00	55.3 PK	74.00	-18.7	1.26 H	334	10.29	44.98
4	7713.00	41.1 AV	54.00	-12.9	1.26 H	334	-3.92	44.98
5	11570.00	60.8 PK	74.00	-13.2	1.40 H	216	10.89	49.90
6	11570.00	46.5 AV	54.00	-7.5	1.40 H	216	-3.42	49.90
ANTENNA POLARITY & TEST DISTANCE: VERTICAL AT 3 M								
NO.	FREQ. (MHz)	EMISSION LEVEL (dBuV/m)	LIMIT (dBuV/m)	MARGIN (dB)	ANTENNA HEIGHT (m)	TABLE ANGLE (Degree)	RAW VALUE (dBuV)	CORRECTION FACTOR (dB/m)
1	*5785.00	114.4 PK			1.41 V	199	74.81	39.59
2	*5785.00	101.4 AV			1.41 V	199	61.79	39.59
3	7713.00	53.6 PK	74.00	-20.4	1.26 V	66	8.65	44.98
4	7713.00	41.6 AV	54.00	-12.4	1.26 V	66	-3.38	44.98
5	11570.00	64.3 PK	74.00	-9.7	1.62 V	300	14.38	49.90
6	11570.00	48.3 AV	54.00	-5.7	1.62 V	300	-1.59	49.90

- REMARKS:**
1. Emission level (dBuV/m) = Raw Value (dBuV) + Correction Factor (dB/m).
 2. Correction Factor (dB/m) = Antenna Factor (dB/m) + Cable Factor (dB).
 3. The other emission levels were very low against the limit.
 4. Margin value = Emission level – Limit value.
 5. “ * “: Fundamental frequency.
 6. The limit value is defined as per 15.247.



A D T

EUT TEST CONDITION		MEASUREMENT DETAIL	
CHANNEL	Channel 165	FREQUENCY RANGE	1 ~ 40GHz
INPUT POWER (SYSTEM)	120Vac, 60 Hz	DETECTOR FUNCTION	Peak (PK) Average (AV)
ENVIRONMENTAL CONDITIONS	22deg. C, 83%RH 1000 hPa	TESTED BY	Nick Chen

ANTENNA POLARITY & TEST DISTANCE: HORIZONTAL AT 3 M								
NO.	FREQ. (MHz)	EMISSION LEVEL (dBuV/m)	LIMIT (dBuV/m)	MARGIN (dB)	ANTENNA HEIGHT (m)	TABLE ANGLE (Degree)	RAW VALUE (dBuV)	CORRECTION FACTOR (dB/m)
1	*5825.00	104.2 PK			1.31 H	232	64.51	39.67
2	*5825.00	90.8 AV			1.31 H	232	51.11	39.67
3	#5850.00	64.8 PK	74.20	-9.4	1.31 H	232	25.12	39.73
4	#5850.00	49.2 AV	60.80	-11.6	1.31 H	232	9.52	39.73
5	#7766.00	55.8 PK	74.20	-18.4	1.34 H	211	10.72	45.12
6	#7766.00	42.1 AV	60.80	-18.7	1.34 H	211	-3.05	45.12
7	11650.00	60.7 PK	74.00	-13.4	1.22 H	263	10.85	49.80
8	11650.00	45.9 AV	54.00	-8.1	1.22 H	263	-3.91	49.80
ANTENNA POLARITY & TEST DISTANCE: VERTICAL AT 3 M								
NO.	FREQ. (MHz)	EMISSION LEVEL (dBuV/m)	LIMIT (dBuV/m)	MARGIN (dB)	ANTENNA HEIGHT (m)	TABLE ANGLE (Degree)	RAW VALUE (dBuV)	CORRECTION FACTOR (dB/m)
1	*5825.00	114.3 PK			1.23 V	198	74.58	39.67
2	*5825.00	101.2 AV			1.23 V	198	61.53	39.67
3	#5850.00	75.4 PK	84.30	-8.9	1.23 V	198	35.70	39.73
4	#5850.00	55.2 AV	71.20	-16.0	1.23 V	198	15.45	39.73
5	#7766.00	55.8 PK	84.30	-28.5	1.19 V	69	10.72	45.12
6	#7766.00	42.2 AV	71.20	-29.0	1.19 V	69	-2.94	45.12
7	11650.00	60.0 PK	74.00	-14.0	1.25 V	209	10.19	49.80
8	11650.00	46.1 AV	54.00	-8.0	1.25 V	209	-3.75	49.80

- REMARKS:**
1. Emission level (dBuV/m) = Raw Value (dBuV) + Correction Factor (dB/m).
 2. Correction Factor (dB/m) = Antenna Factor (dB/m) + Cable Factor (dB).
 3. The other emission levels were very low against the limit.
 4. Margin value = Emission level – Limit value.
 5. “ * “: Fundamental frequency.
 6. The limit value is defined as per 15.247.
 7. “#”:The radiated frequency is out the restricted band.



A D T

802.11n (40MHz)

EUT TEST CONDITION		MEASUREMENT DETAIL	
CHANNEL	Channel 151	FREQUENCY RANGE	1 ~ 40GHz
INPUT POWER (SYSTEM)	120Vac, 60 Hz	DETECTOR FUNCTION	Peak (PK) Average (AV)
ENVIRONMENTAL CONDITIONS	22deg. C, 83%RH 1000 hPa	TESTED BY	Nick Chen

ANTENNA POLARITY & TEST DISTANCE: HORIZONTAL AT 3 M								
NO.	FREQ. (MHz)	EMISSION LEVEL (dBuV/m)	LIMIT (dBuV/m)	MARGIN (dB)	ANTENNA HEIGHT (m)	TABLE ANGLE (Degree)	RAW VALUE (dBuV)	CORRECTION FACTOR (dB/m)
1	#5725.00	72.3 PK	76.50	-4.2	1.29 H	102	32.88	39.45
2	#5725.00	52.0 AV	63.10	-11.1	1.29 H	102	12.54	39.45
3	*5755.00	106.5 PK			1.29 H	102	66.99	39.52
4	*5755.00	93.1 AV			1.29 H	102	53.60	39.52
5	7673.00	55.6 PK	74.00	-18.5	1.29 H	160	10.62	44.93
6	7673.00	41.1 AV	54.00	-12.9	1.29 H	160	-3.85	44.93
7	11510.00	60.0 PK	74.00	-14.0	1.33 H	99	10.09	49.94
8	11510.00	46.0 AV	54.00	-8.0	1.33 H	99	-3.91	49.94

ANTENNA POLARITY & TEST DISTANCE: VERTICAL AT 3 M								
NO.	FREQ. (MHz)	EMISSION LEVEL (dBuV/m)	LIMIT (dBuV/m)	MARGIN (dB)	ANTENNA HEIGHT (m)	TABLE ANGLE (Degree)	RAW VALUE (dBuV)	CORRECTION FACTOR (dB/m)
1	#5725.00	78.1 PK	85.60	-7.5	1.29 V	198	38.60	39.45
2	#5725.00	61.4 AV	71.90	-10.5	1.29 V	198	21.99	39.45
3	*5755.00	115.6 PK			1.29 V	198	76.11	39.52
4	*5755.00	101.9 AV			1.29 V	198	62.37	39.52
5	7673.00	56.1 PK	74.00	-17.9	1.21 V	323	11.21	44.93
6	7673.00	44.7 AV	54.00	-9.3	1.21 V	323	-0.23	44.93
7	11510.00	60.2 PK	74.00	-13.9	1.19 V	319	10.21	49.94
8	11510.00	46.0 AV	54.00	-8.0	1.19 V	319	-3.91	49.94

- REMARKS:**
1. Emission level (dBuV/m) = Raw Value (dBuV) + Correction Factor (dB/m).
 2. Correction Factor (dB/m) = Antenna Factor (dB/m) + Cable Factor (dB).
 3. The other emission levels were very low against the limit.
 4. Margin value = Emission level – Limit value.
 5. " * ": Fundamental frequency.
 6. The limit value is defined as per 15.247.
 7. "#": The radiated frequency is out the restricted band.



A D T

EUT TEST CONDITION		MEASUREMENT DETAIL	
CHANNEL	Channel 159	FREQUENCY RANGE	1 ~ 40GHz
INPUT POWER (SYSTEM)	120Vac, 60 Hz	DETECTOR FUNCTION	Peak (PK) Average (AV)
ENVIRONMENTAL CONDITIONS	22deg. C, 83%RH 1000 hPa	TESTED BY	Nick Chen

ANTENNA POLARITY & TEST DISTANCE: HORIZONTAL AT 3 M								
NO.	FREQ. (MHz)	EMISSION LEVEL (dBuV/m)	LIMIT (dBuV/m)	MARGIN (dB)	ANTENNA HEIGHT (m)	TABLE ANGLE (Degree)	RAW VALUE (dBuV)	CORRECTION FACTOR (dB/m)
1	*5795.00	106.0 PK			1.51 H	59	66.35	39.61
2	*5795.00	92.5 AV			1.51 H	59	52.86	39.61
3	#5850.00	66.4 PK	76.00	-9.6	1.51 H	59	26.69	39.73
4	#5850.00	50.6 AV	62.50	-11.9	1.51 H	59	10.82	39.73
5	7726.00	55.2 PK	74.00	-18.9	1.25 H	316	10.13	45.02
6	7726.00	41.0 AV	54.00	-13.0	1.25 H	316	-3.99	45.02
7	11590.00	61.2 PK	74.00	-12.8	1.37 H	262	11.27	49.89
8	11590.00	47.8 AV	54.00	-6.2	1.37 H	262	-2.10	49.89
ANTENNA POLARITY & TEST DISTANCE: VERTICAL AT 3 M								
NO.	FREQ. (MHz)	EMISSION LEVEL (dBuV/m)	LIMIT (dBuV/m)	MARGIN (dB)	ANTENNA HEIGHT (m)	TABLE ANGLE (Degree)	RAW VALUE (dBuV)	CORRECTION FACTOR (dB/m)
1	*5795.00	114.4 PK			1.36 V	198	74.76	39.61
2	*5795.00	100.5 AV			1.36 V	198	60.93	39.61
3	#5850.00	75.8 PK	84.40	-8.6	1.36 V	198	36.05	39.73
4	#5850.00	55.9 AV	70.50	-14.6	1.36 V	198	16.19	39.73
5	7726.00	55.8 PK	74.00	-18.2	1.37 V	74	10.80	45.02
6	7726.00	43.7 AV	54.00	-10.3	1.37 V	74	-1.29	45.02
7	11590.00	68.3 PK	74.00	-5.8	1.36 V	115	18.36	49.89
8	11590.00	52.4 AV	54.00	-1.6	1.36 V	115	2.55	49.89

- REMARKS:**
1. Emission level (dBuV/m) = Raw Value (dBuV) + Correction Factor (dB/m).
 2. Correction Factor (dB/m) = Antenna Factor (dB/m) + Cable Factor (dB).
 3. The other emission levels were very low against the limit.
 4. Margin value = Emission level – Limit value.
 5. “ * “: Fundamental frequency.
 6. The limit value is defined as per 15.247.
 7. "#":The radiated frequency is out the restricted band.



A D T

BELOW 1GHz WORST-CASE DATA : 802.11n (40MHz)

EUT TEST CONDITION		MEASUREMENT DETAIL	
CHANNEL	Channel 159	FREQUENCY RANGE	Below 1000MHz
INPUT POWER (SYSTEM)	120Vac, 60 Hz	DETECTOR FUNCTION	Quasi-Peak
ENVIRONMENTAL CONDITIONS	23deg. C, 76%RH 999 hPa	TEST MODE	A
TESTED BY	Nick Chen		

ANTENNA POLARITY & TEST DISTANCE: HORIZONTAL AT 3 M								
NO.	FREQ. (MHz)	EMISSION LEVEL (dBuV/m)	LIMIT (dBuV/m)	MARGIN (dB)	ANTENNA HEIGHT (m)	TABLE ANGLE (Degree)	RAW VALUE (dBuV)	CORRECTION FACTOR (dB/m)
1	62.75	28.0 QP	40.00	-12.0	2.22 H	251	20.50	7.48
2	250.03	38.7 QP	46.00	-7.3	1.03 H	82	23.10	15.56
3	340.01	45.8 QP	46.00	-0.2	1.08 H	263	27.87	17.95
4	500.00	35.6 QP	46.00	-10.4	1.12 H	26	12.29	23.31
5	600.01	39.5 QP	46.00	-6.5	1.80 H	161	14.41	25.08
6	679.99	45.8 QP	46.00	-0.2	1.03 H	82	20.00	25.80
ANTENNA POLARITY & TEST DISTANCE: VERTICAL AT 3 M								
NO.	FREQ. (MHz)	EMISSION LEVEL (dBuV/m)	LIMIT (dBuV/m)	MARGIN (dB)	ANTENNA HEIGHT (m)	TABLE ANGLE (Degree)	RAW VALUE (dBuV)	CORRECTION FACTOR (dB/m)
1	64.89	32.6 QP	40.00	-7.4	1.12 V	284	25.04	7.57
2	82.98	32.2 QP	40.00	-7.9	1.36 V	28	22.77	9.38
3	124.99	35.6 QP	43.50	-7.9	1.02 V	163	22.86	12.76
4	500.00	38.2 QP	46.00	-7.8	1.72 V	2	14.85	23.31
5	625.01	36.2 QP	46.00	-9.8	1.12 V	135	10.86	25.33
6	680.01	42.3 QP	46.00	-3.7	1.24 V	339	16.51	25.80

- REMARKS:**
1. Emission level (dBuV/m) = Raw Value (dBuV) + Correction Factor (dB/m).
 2. Correction Factor (dB/m) = Antenna Factor (dB/m) + Cable Factor (dB).
 3. The other emission levels were very low against the limit.
 4. Margin value = Emission level – Limit value.



A D T

EUT TEST CONDITION		MEASUREMENT DETAIL	
CHANNEL	Channel 159	FREQUENCY RANGE	Below 1000MHz
INPUT POWER (SYSTEM)	120Vac, 60 Hz	DETECTOR FUNCTION	Quasi-Peak
ENVIRONMENTAL CONDITIONS	23deg. C, 76%RH 999 hPa	TEST MODE	B
TESTED BY	Nick Chen		

ANTENNA POLARITY & TEST DISTANCE: HORIZONTAL AT 3 M								
NO.	FREQ. (MHz)	EMISSION LEVEL (dBuV/m)	LIMIT (dBuV/m)	MARGIN (dB)	ANTENNA HEIGHT (m)	TABLE ANGLE (Degree)	RAW VALUE (dBuV)	CORRECTION FACTOR (dB/m)
1	57.10	28.9 QP	40.00	-11.1	1.16 H	178	21.29	7.64
2	124.98	33.2 QP	43.50	-10.3	1.12 H	58	20.43	12.76
3	340.01	45.7 QP	46.00	-0.3	1.09 H	63	27.74	17.95
4	625.01	34.5 QP	46.00	-11.5	1.13 H	280	9.19	25.33
5	680.01	45.3 QP	46.00	-0.7	1.24 H	287	19.51	25.80
6	750.01	37.6 QP	46.00	-8.4	1.10 H	271	10.80	26.79
ANTENNA POLARITY & TEST DISTANCE: VERTICAL AT 3 M								
NO.	FREQ. (MHz)	EMISSION LEVEL (dBuV/m)	LIMIT (dBuV/m)	MARGIN (dB)	ANTENNA HEIGHT (m)	TABLE ANGLE (Degree)	RAW VALUE (dBuV)	CORRECTION FACTOR (dB/m)
1	52.91	38.3 QP	40.00	-1.7	1.36 V	305	30.21	8.05
2	70.51	34.3 QP	40.00	-5.7	1.28 V	111	26.45	7.84
3	125.02	34.6 QP	43.50	-8.9	1.18 V	254	21.84	12.77
4	600.01	40.7 QP	46.00	-5.3	1.27 V	333	15.65	25.08
5	625.03	39.8 QP	46.00	-6.2	1.24 V	11	14.51	25.33
6	750.01	40.0 QP	46.00	-6.0	1.25 V	32	13.24	26.79

- REMARKS:**
1. Emission level (dBuV/m) = Raw Value (dBuV) + Correction Factor (dB/m).
 2. Correction Factor (dB/m) = Antenna Factor (dB/m) + Cable Factor (dB).
 3. The other emission levels were very low against the limit.
 4. Margin value = Emission level – Limit value.



5.2 CONDUCTED EMISSION MEASUREMENT

5.2.1 LIMITS OF CONDUCTED EMISSION MEASUREMENT

FREQUENCY OF EMISSION (MHz)	CONDUCTED LIMIT (dBµV)	
	Quasi-peak	Average
0.15 ~ 0.5	66 to 56	56 to 46
0.5 ~ 5	56	46
5 ~ 30	60	50

- NOTE:**
1. The lower limit shall apply at the transition frequencies.
 2. The limit decreases in line with the logarithm of the frequency in the range of 0.15 to 0.50MHz.
 3. All emanations from a class A/B digital device or system, including any network of conductors and apparatus connected thereto, shall not exceed the level of field strengths specified above.

5.2.2 TEST INSTRUMENTS

DESCRIPTION & MANUFACTURER	MODEL NO.	SERIAL NO.	DATE OF CALIBRATION	DUE DATE OF CALIBRATION
ROHDE & SCHWARZ Test Receiver	ESCS 30	838251/021	Mar. 05, 2009	Mar. 04, 2010
ROHDE & SCHWARZ Artificial Mains Network (for EUT)	ESH3-Z5	100218	Nov. 26, 2008	Nov. 25, 2009
LISN With Adapter (for EUT)	AD10	C10Ada-001	Nov. 26, 2008	Nov. 25, 2009
ROHDE & SCHWARZ Artificial Mains Network (for peripherals)	ESH3-Z5	100219	Nov. 20, 2008	Nov. 19, 2009
Software	ADT_Cond_V7.3.7	NA	NA	NA
Software	ADT_ISN_V7.3.7	NA	NA	NA
RF cable (JYBAO)	5D-FB	Cable-C10.01	Feb. 26, 2009	Feb. 25, 2010
SUHNER Terminator (For ROHDE & SCHWARZ LISN)	65BNC-5001	E1-010773	Feb. 27, 2009	Feb. 26, 2010

- NOTE:**
1. The calibration interval of the above test instruments is 12 months and the calibrations are traceable to NML/ROC and NIST/USA.
 2. The test was performed in Shielded Room No. 10.
 3. The VCCI Site Registration No. C-1852.



5.2.3 TEST PROCEDURES

- a. The EUT was placed 0.4 meters from the conducting wall of the shielded room with EUT being connected to the power mains through a line impedance stabilization network (LISN). Other support units were connected to the power mains through another LISN. The two LISNs provide 50 ohm/ 50uH of coupling impedance for the measuring instrument.
- b. Both lines of the power mains connected to the EUT were checked for maximum conducted interference.
- c. The frequency range from 150kHz to 30MHz was searched. Emission levels under (Limit - 20dB) was not recorded.

5.2.4 DEVIATION FROM TEST STANDARD

No deviation.

5.2.5 TEST SETUP

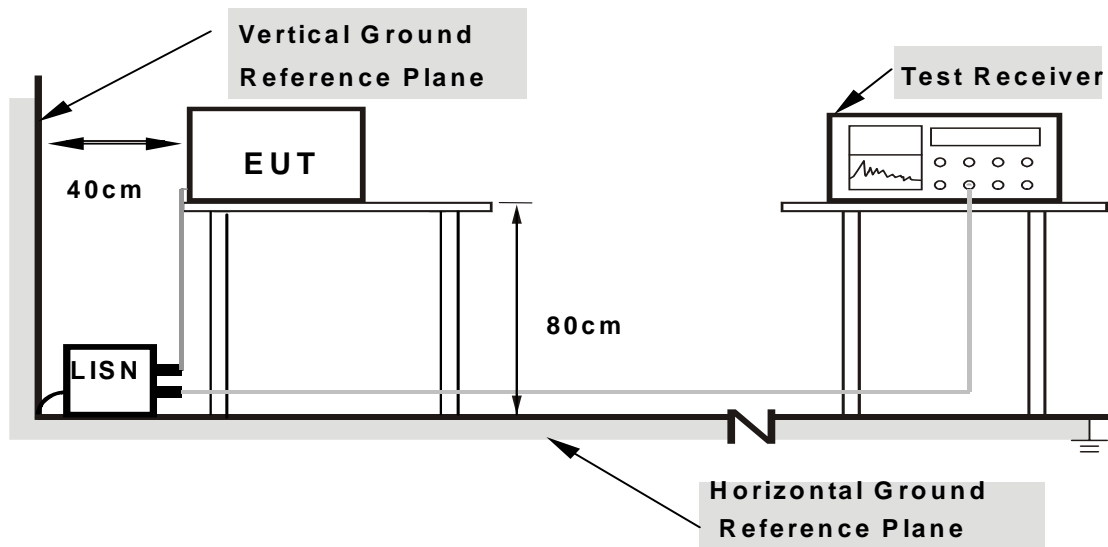

Note: 1. Support units were connected to second LISN.

2. Both of LISNs (AMN) are 80 cm from EUT and at least 80 from other units and other metal planes

For the actual test configuration, please refer to the attached file (Test Setup Photo).

5.2.6 EUT OPERATING CONDITIONS

Same as 4.1.6

5.2.7 TEST RESULTS

CONDUCTED WORST-CASE DATA : 802.11n (40MHz)

PHASE	Line 1	6dB BANDWIDTH	9kHz
TEST MODE	A		

No	Freq. [MHz]	Corr. Factor (dB)	Reading Value [dB (uV)]		Emission Level [dB (uV)]		Limit [dB (uV)]		Margin (dB)	
			Q.P.	AV.	Q.P.	AV.	Q.P.	AV.	Q.P.	AV.
1	0.291	0.17	46.53	-	46.70	-	60.50	50.50	-13.81	-
2	0.765	0.23	26.88	-	27.11	-	56.00	46.00	-28.89	-
3	2.177	0.29	26.10	-	26.39	-	56.00	46.00	-29.61	-
4	4.322	0.38	34.89	-	35.27	-	56.00	46.00	-20.73	-
5	6.739	0.49	36.23	-	36.72	-	60.00	50.00	-23.28	-
6	11.799	0.79	31.42	-	32.21	-	60.00	50.00	-27.79	-

- REMARKS:**
1. Q.P. and AV. are abbreviations of quasi-peak and average individually.
 2. "-": The Quasi-peak reading value also meets average limit and measurement with the average detector is unnecessary.
 3. The emission levels of other frequencies were very low against the limit.
 4. Margin value = Emission level - Limit value
 5. Correction factor = Insertion loss + Cable loss
 6. Emission Level = Correction Factor + Reading Value.

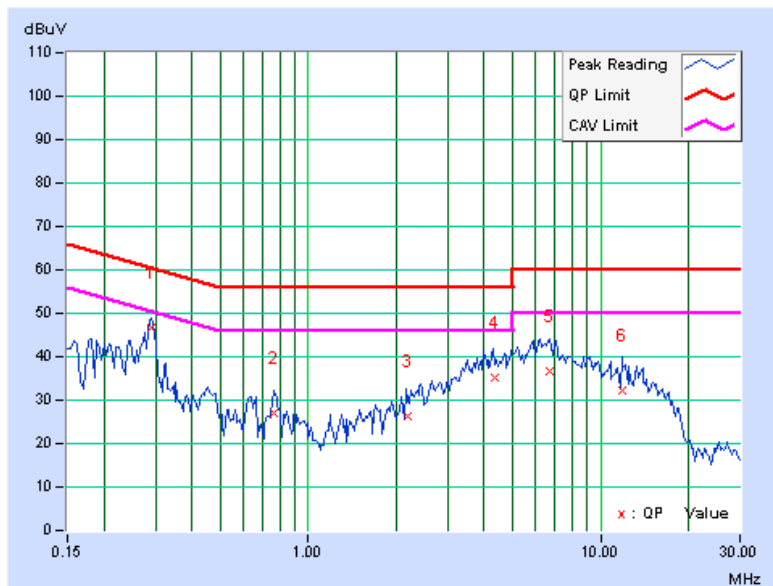



A D T

PHASE	Line 2	6dB BANDWIDTH	9kHz
TEST MODE	A		

No	Freq. [MHz]	Corr. Factor (dB)	Reading Value		Emission Level		Limit		Margin	
			[dB (uV)]		[dB (uV)]		[dB (uV)]		(dB)	
			Q.P.	AV.	Q.P.	AV.	Q.P.	AV.	Q.P.	AV.
1	0.294	0.14	45.96	-	46.10	-	60.41	50.41	-14.30	-
2	0.765	0.21	35.00	-	35.21	-	56.00	46.00	-20.79	-
3	2.757	0.27	31.10	-	31.37	-	56.00	46.00	-24.63	-
4	5.399	0.36	35.71	-	36.07	-	60.00	50.00	-23.93	-
5	8.560	0.47	31.97	-	32.44	-	60.00	50.00	-27.56	-
6	14.217	0.75	27.38	-	28.13	-	60.00	50.00	-31.87	-

- REMARKS:**
1. Q.P. and AV. are abbreviations of quasi-peak and average individually.
 2. "-": The Quasi-peak reading value also meets average limit and measurement with the average detector is unnecessary.
 3. The emission levels of other frequencies were very low against the limit.
 4. Margin value = Emission level - Limit value
 5. Correction factor = Insertion loss + Cable loss
 6. Emission Level = Correction Factor + Reading Value.

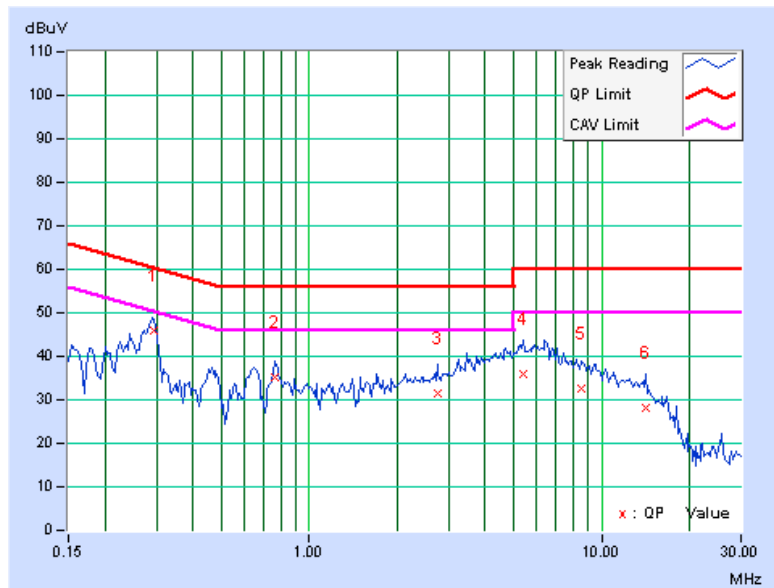



A D T

PHASE	Line 1	6dB BANDWIDTH	9kHz
TEST MODE	B		

No	Freq.	Corr.	Reading Value		Emission Level		Limit		Margin	
	[MHz]	Factor (dB)	[dB (uV)]		[dB (uV)]		[dB (uV)]		(dB)	
			Q.P.	AV.	Q.P.	AV.	Q.P.	AV.	Q.P.	AV.
1	0.184	0.12	43.68	-	43.80	-	64.31	54.31	-20.51	-
2	0.369	0.20	33.58	-	33.78	-	58.53	48.53	-24.74	-
3	0.645	0.23	30.83	-	31.06	-	56.00	46.00	-24.94	-
4	2.503	0.30	38.97	-	39.27	-	56.00	46.00	-16.73	-
5	3.059	0.32	39.66	-	39.98	-	56.00	46.00	-16.02	-
6	4.594	0.39	36.19	-	36.58	-	56.00	46.00	-19.42	-

- REMARKS:**
1. Q.P. and AV. are abbreviations of quasi-peak and average individually.
 2. "-": The Quasi-peak reading value also meets average limit and measurement with the average detector is unnecessary.
 3. The emission levels of other frequencies were very low against the limit.
 4. Margin value = Emission level - Limit value
 5. Correction factor = Insertion loss + Cable loss
 6. Emission Level = Correction Factor + Reading Value.

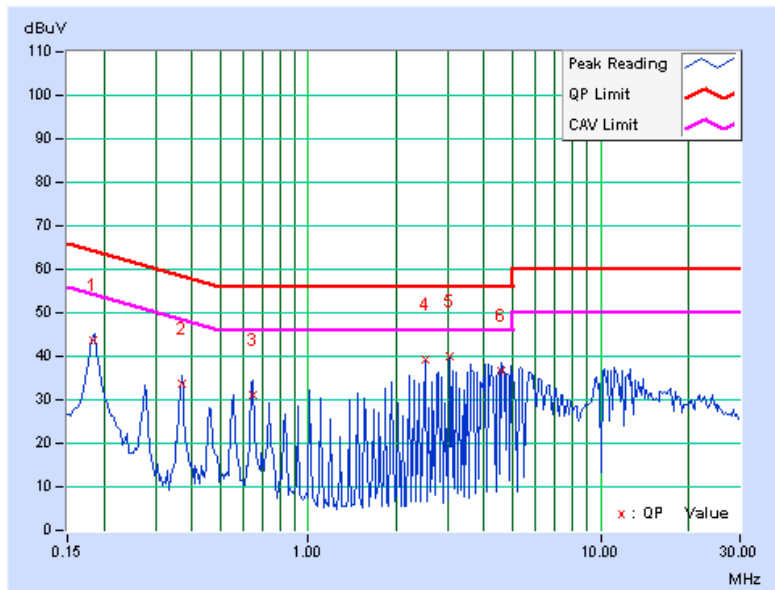

PHASE	Line 2	6dB BANDWIDTH	9kHz
TEST MODE	B		

No	Freq.	Corr.	Reading Value		Emission Level		Limit		Margin	
	[MHz]	Factor (dB)	[dB (uV)]		[dB (uV)]		[dB (uV)]		(dB)	
			Q.P.	AV.	Q.P.	AV.	Q.P.	AV.	Q.P.	AV.
1	0.185	0.09	42.68	-	42.77	-	64.25	54.25	-21.48	-
2	0.642	0.21	34.54	-	34.75	-	56.00	46.00	-21.25	-
3	2.504	0.27	38.91	-	39.18	-	56.00	46.00	-16.82	-
4	3.059	0.28	39.78	-	40.06	-	56.00	46.00	-15.94	-
5	4.133	0.31	37.50	-	37.81	-	56.00	46.00	-18.19	-
6	10.107	0.53	33.37	-	33.90	-	60.00	50.00	-26.10	-

- REMARKS:**
1. Q.P. and AV. are abbreviations of quasi-peak and average individually.
 2. "-": The Quasi-peak reading value also meets average limit and measurement with the average detector is unnecessary.
 3. The emission levels of other frequencies were very low against the limit.
 4. Margin value = Emission level - Limit value
 5. Correction factor = Insertion loss + Cable loss
 6. Emission Level = Correction Factor + Reading Value.

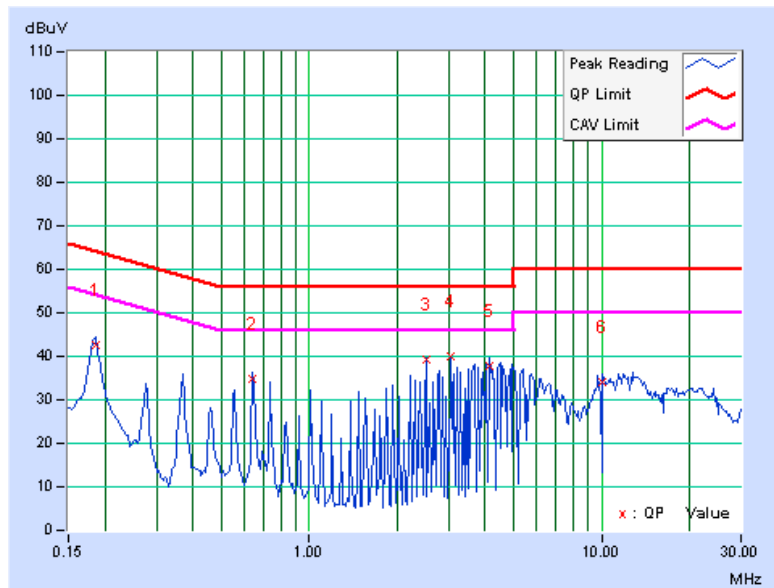



A D T

5.3 6dB BANDWIDTH MEASUREMENT

5.3.1 LIMITS OF 6dB BANDWIDTH MEASUREMENT

The minimum of 6dB Bandwidth Measurement is 0.5MHz.

5.3.2 TEST INSTRUMENTS

DESCRIPTION & MANUFACTURER	MODEL NO.	SERIAL NO.	DATE OF CALIBRATION	CALIBRATED UNTIL
R&S SPECTRUM ANALYZER	FSP40	100040	Jul. 07, 2009	Jul. 06, 2010

NOTE: The calibration interval of the above test instruments is 12 months and the calibrations are traceable to NML/ROC and NIST/USA.

5.3.3 TEST PROCEDURE

The transmitter output was connected to the spectrum analyzer through an attenuator. The bandwidth of the fundamental frequency was measured by spectrum analyzer with 100kHz RBW and 300kHz VBW. The 6dB bandwidth is defined as the total spectrum the power of which is higher than peak power minus 6dB.

5.3.4 DEVIATION FROM TEST STANDARD

No deviation

5.3.5 TEST SETUP

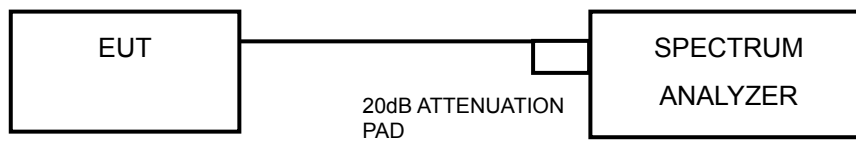

5.3.6 EUT OPERATING CONDITIONS

The software provided by client to enable the EUT under transmission condition continuously at lowest, middle and highest channel frequencies individually.



A D T

5.3.7 TEST RESULTS

802.11a OFDM

CHANNEL	CHANNEL FREQUENCY (MHz)	6dB BANDWIDTH (MHz)		MINIMUM LIMIT (MHz)	PASS / FAIL
		CHAIN 0	CHAIN 1		
149	5745	16.43	16.44	0.5	PASS
157	5785	16.50	16.47	0.5	PASS
165	5825	16.45	16.44	0.5	PASS

FOR CHAIN 0: CH 157

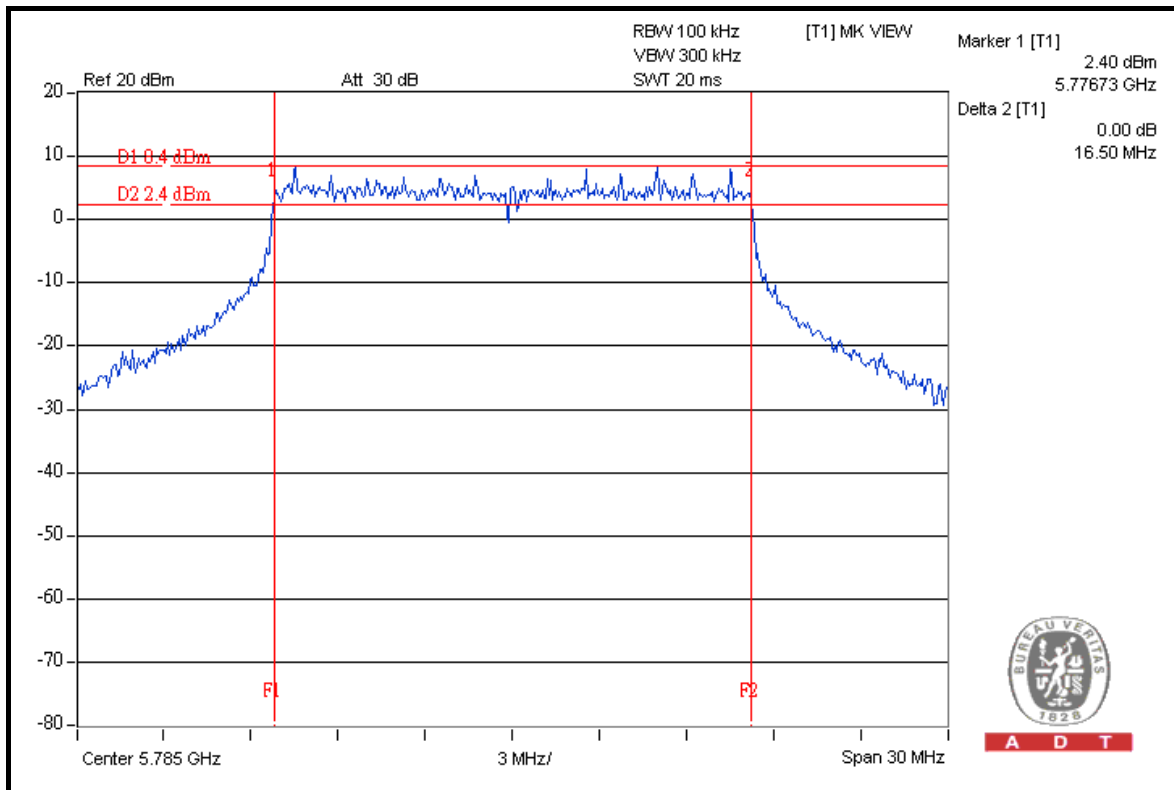



A D T

802.11n (20MHz)

CHANNEL	CHANNEL FREQUENCY (MHz)	6dB BANDWIDTH (MHz)		MINIMUM LIMIT (MHz)	PASS / FAIL
		CHAIN 0	CHAIN 1		
149	5745	17.66	17.67	0.5	PASS
157	5785	17.63	17.63	0.5	PASS
165	5825	17.66	17.66	0.5	PASS

FOR CHAIN 1: CH 149

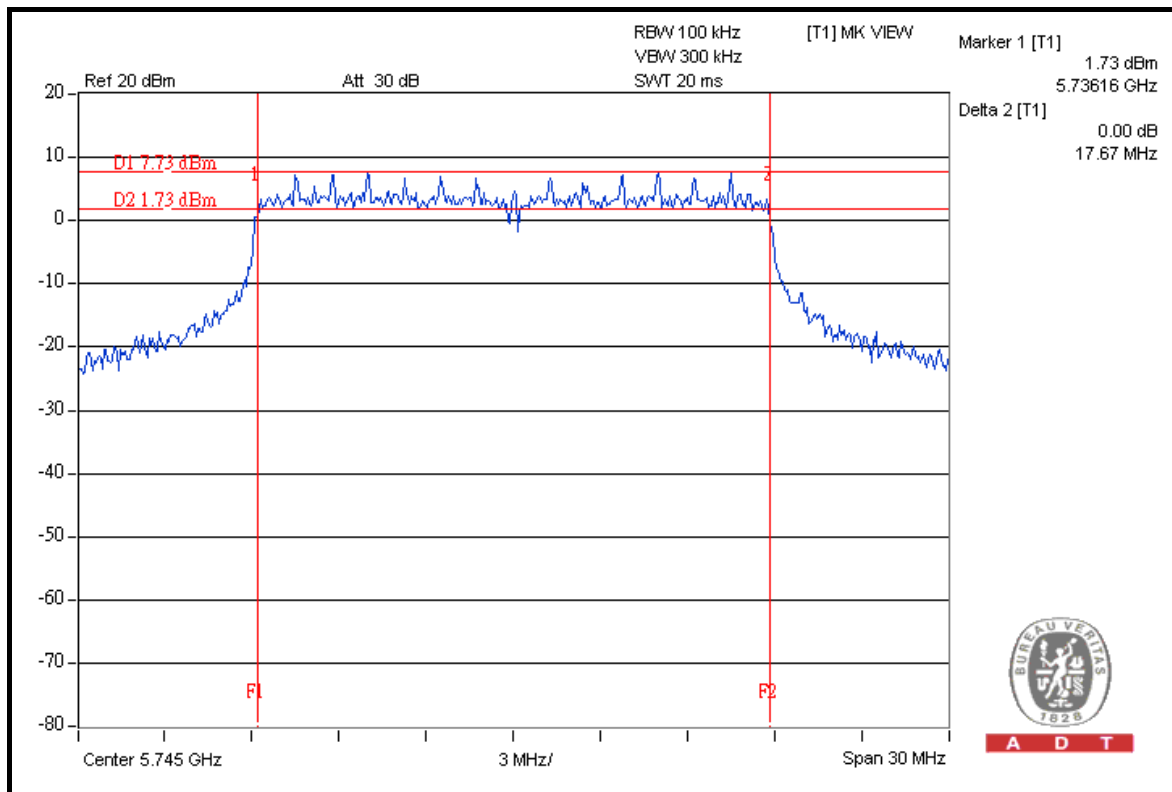



A D T

802.11n (40MHz)

CHANNEL	CHANNEL FREQUENCY (MHz)	6dB BANDWIDTH (MHz)		MINIMUM LIMIT (MHz)	PASS / FAIL
		CHAIN 0	CHAIN 1		
151	5755	36.14	36.44	0.5	PASS
159	5795	36.47	36.44	0.5	PASS

FOR CHAIN 0: CH 159

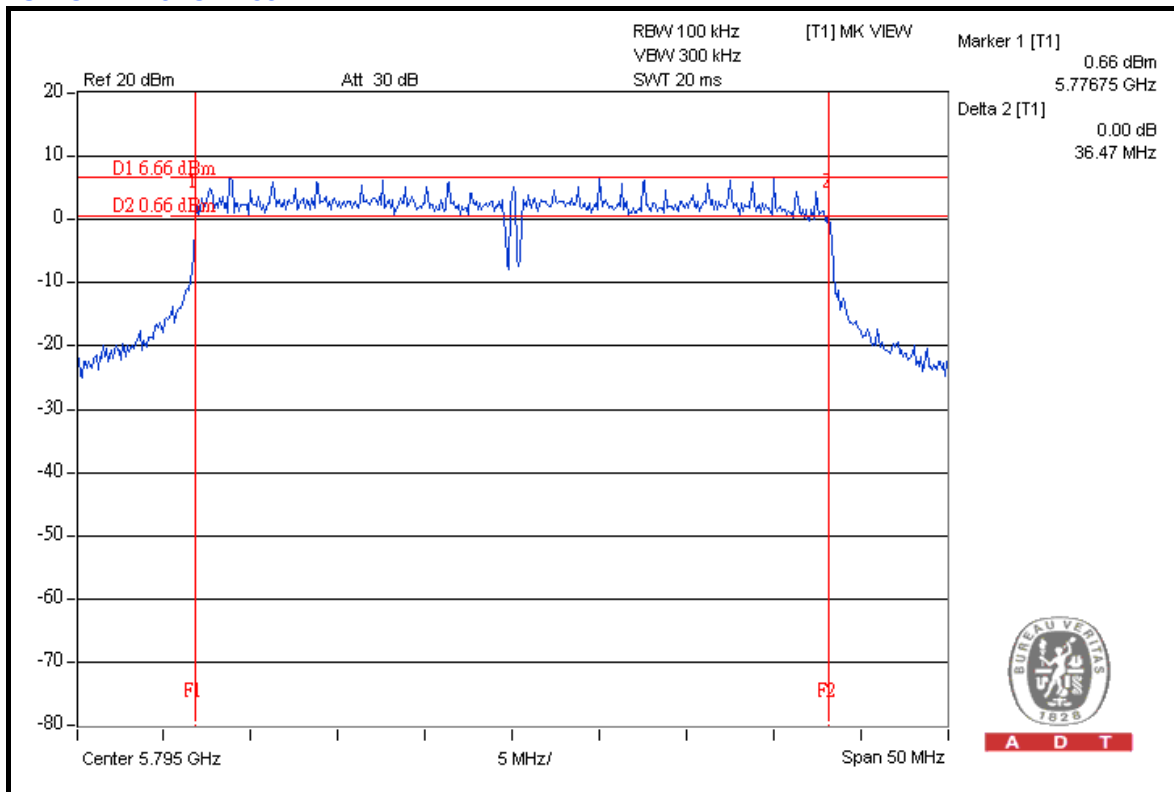



A D T

5.4 MAXIMUM OUTPUT POWER

5.4.1 LIMITS OF MAXIMUM OUTPUT POWER MEASUREMENT

The Maximum Output Power Measurement is 30dBm.

5.4.2 INSTRUMENTS

DESCRIPTION & MANUFACTURER	MODEL NO.	SERIAL NO.	DATE OF CALIBRATION	DUE DATE OF CALIBRATION
R&S SPECTRUM ANALYZER	FSP40	100040	Jul. 07, 2009	Jul. 06, 2010

NOTE:

1. The calibration interval of the above test instruments is 12 months and the calibrations are traceable to NML/ROC and NIST/USA.
2. Measurement Bandwidth of ML2495A is 65MHz greater than 6dB bandwidth of emission.

5.4.3 TEST PROCEDURE

1. Follow DTS measurement (Power Output Option 2), the transmitter output was connected to the spectrum analyzer through an attenuator, the bandwidth of the fundamental frequency was measured with the spectrum analyzer.
2. Set span to encompass the entire emission bandwidth (EBW) of the signal.
3. Set RBW = 1 MHz ;VBW \geq 3 MHz.
4. Use sample detector mode and video trigger with the trigger level set to enable triggering only on full power pulses.
5. Trace average 100 traces in power averaging mode.
6. Compute power by integrating the spectrum across the 26 dB EBW of the signal.
7. Record the power level.

5.4.4 DEVIATION FROM TEST STANDARD

No deviation.

5.4.5 TEST SETUP

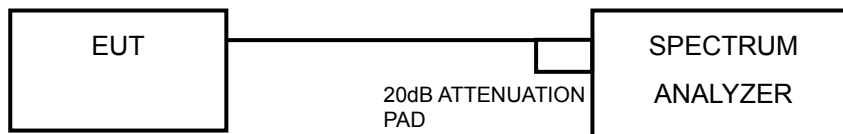

5.4.6 EUT OPERATING CONDITIONS

Same as Item 5.3.6



A D T

5.4.7 TEST RESULTS

802.11a

CHAN.	CHAN. FREQ. (MHz)	POWER OUTPUT (dBm)		TOTAL POWER (mW)	TOTAL POWER (dBm)	POWER LIMIT (dBm)	PASS / FAIL
		CHAIN 0	CHAIN 1				
149	5745	18.2	18.0	128.7	21.1	30	PASS
157	5785	17.3	18.0	116.5	20.7	30	PASS
165	5825	17.4	18.3	122.4	20.9	30	PASS

FOR CHAIN 1: CH 165

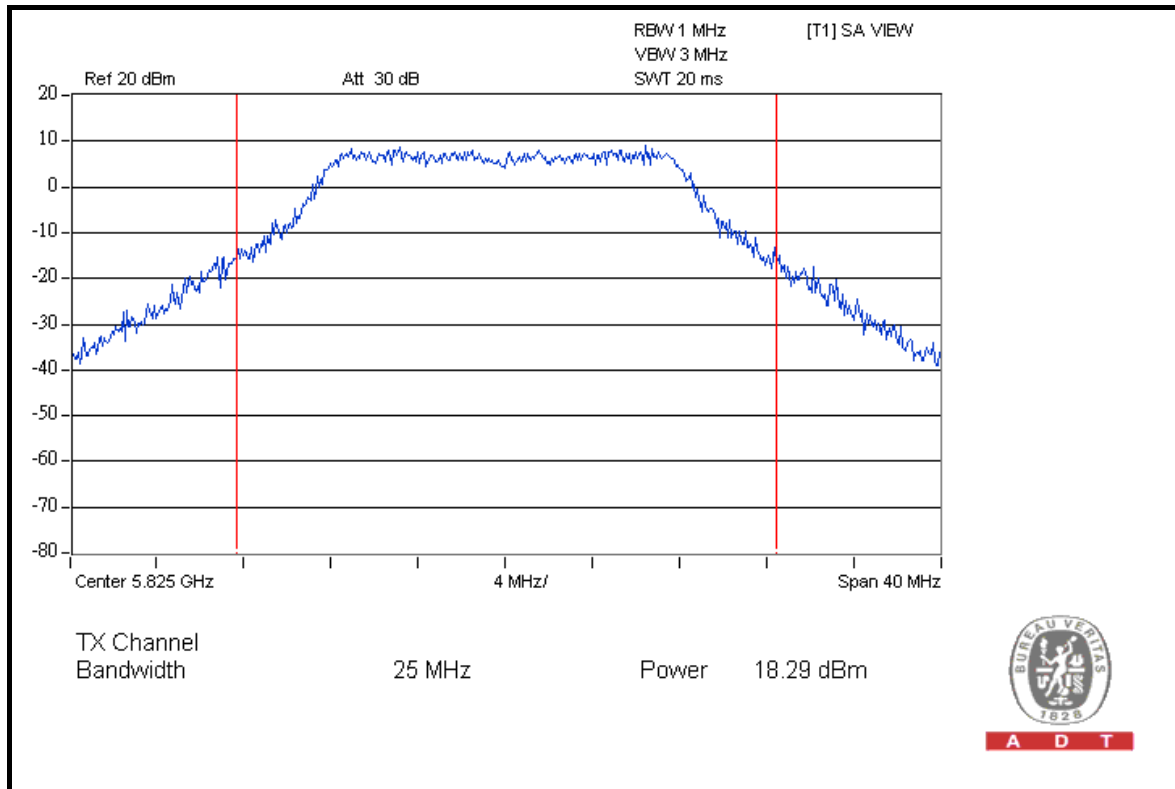



A D T

802.11n (20MHz)

CHAN.	CHAN. FREQ. (MHz)	POWER OUTPUT (dBm)		TOTAL POWER (mW)	TOTAL POWER (dBm)	POWER LIMIT (dBm)	PASS / FAIL
		CHAIN 0	CHAIN 1				
149	5745	18.0	18.0	126.2	21.0	30	PASS
157	5785	17.3	18.0	116.6	20.7	30	PASS
165	5825	17.3	18.3	122.2	20.9	30	PASS

FOR CHAIN 1: CH 165

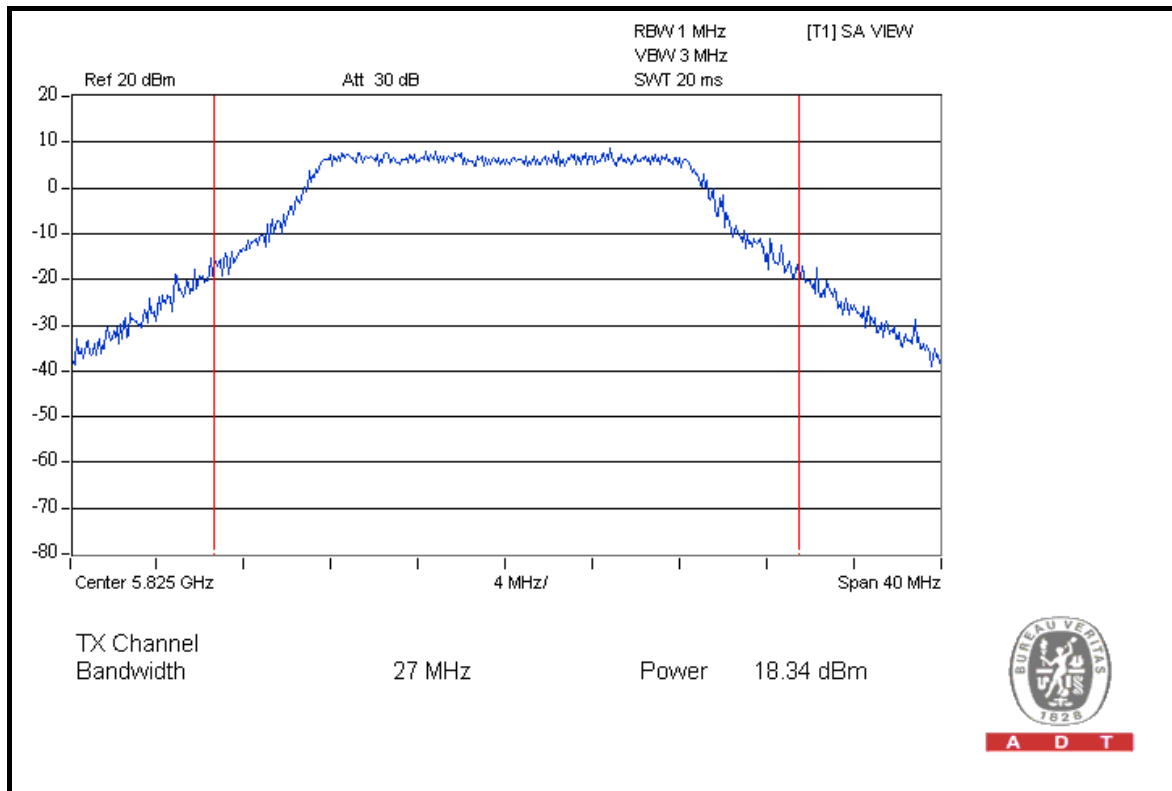



A D T

802.11n (40MHz)

CHAN.	CHAN. FREQ. (MHz)	POWER OUTPUT (dBm)		TOTAL POWER (mW)	TOTAL POWER (dBm)	POWER LIMIT (dBm)	PASS / FAIL
		CHAIN 0	CHAIN 1				
151	5755	18.2	18.2	130.8	21.2	30	PASS
159	5795	17.4	18.2	121.1	20.8	30	PASS

FOR CHAIN 1: CH 159

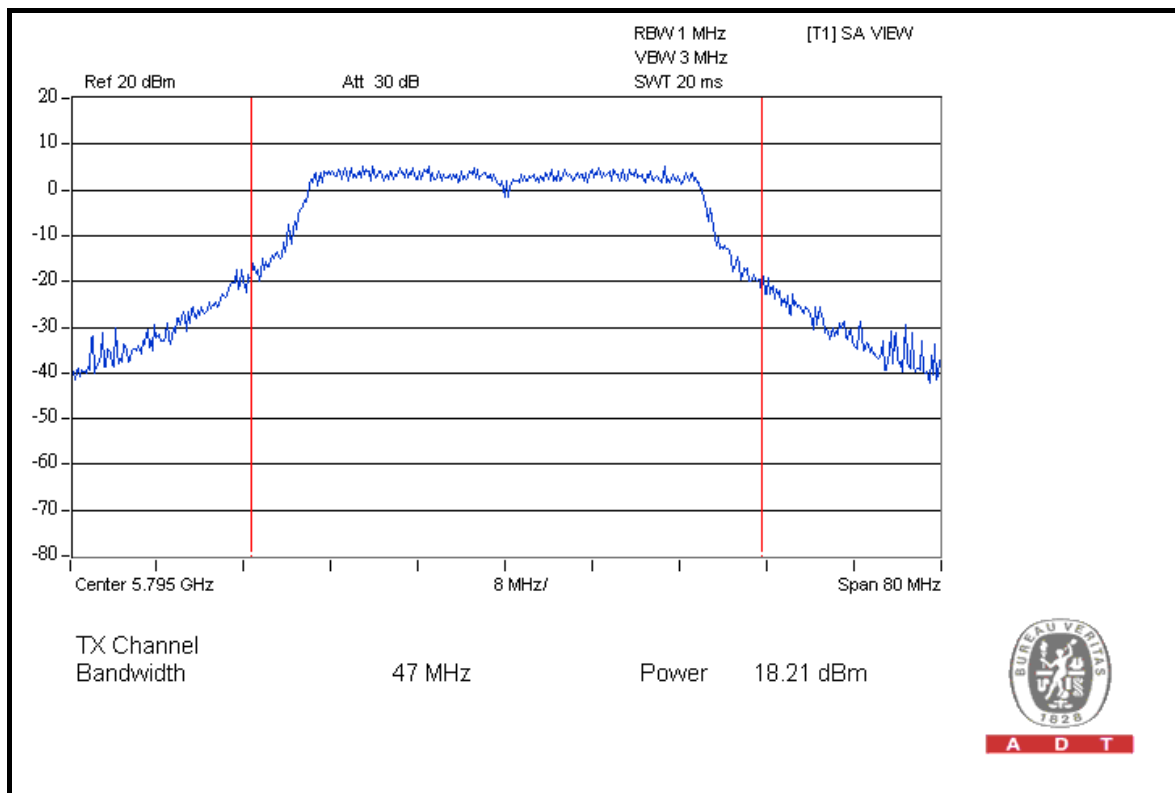



5.5 POWER SPECTRAL DENSITY MEASUREMENT

5.5.1 LIMITS OF POWER SPECTRAL DENSITY MEASUREMENT

The Maximum of Power Spectral Density Measurement is 8dBm.

5.5.2 TEST INSTRUMENTS

DESCRIPTION & MANUFACTURER	MODEL NO.	SERIAL NO.	DATE OF CALIBRATION	CALIBRATED UNTIL
R&S SPECTRUM ANALYZER	FSP40	100040	Jul. 07, 2009	Jul. 06, 2010

NOTE: The calibration interval of the above test instruments is 12 months and the calibrations are traceable to NML/ROC and NIST/USA.

5.5.3 TEST PROCEDURE

1. Follow DTS measurement (PSD Option 2), the transmitter output was connected to the spectrum analyzer through an attenuator, the bandwidth of the fundamental frequency was measured with the spectrum analyzer. Locate and zoom in on emission peak(s) within the pass band.
2. Set RBW = 3 kHz /VBW > 9 kHz and sweep time to Automatic.
3. Detector use peak mode and a video trigger with the trigger level set to enable triggering only on full power pulses.
4. Trace average 100 traces in power averaging mode. The power spectral density was measured and recorded.

5.5.4 DEVIATION FROM TEST STANDARD

No deviation.

5.5.5 TEST SETUP

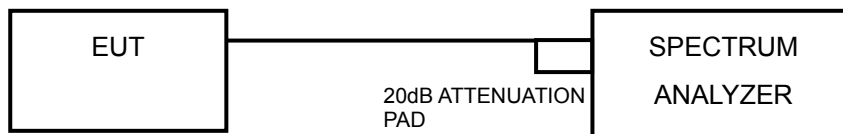

5.5.6 EUT OPERATING CONDITION

Same as Item 5.3.6.



A D T

5.5.7 TEST RESULTS

802.11a

CHAN.	CHAN. FREQ. (MHz)	RF POWER LEVEL IN 3kHz BW (dBm)		TOTAL POWER DENSITY (mW)	TOTAL POWER DENSITY (dBm)	MAX. LIMIT (dBm)	PASS / FAIL
		CHAIN 0	CHAIN 1				
149	5745	-0.9	-9.2	0.9	-0.3	8	PASS
157	5785	1.4	-0.9	2.2	3.4	8	PASS
165	5825	-7.4	-4.0	0.6	-2.4	8	PASS

FOR CHAIN 0: CH 157

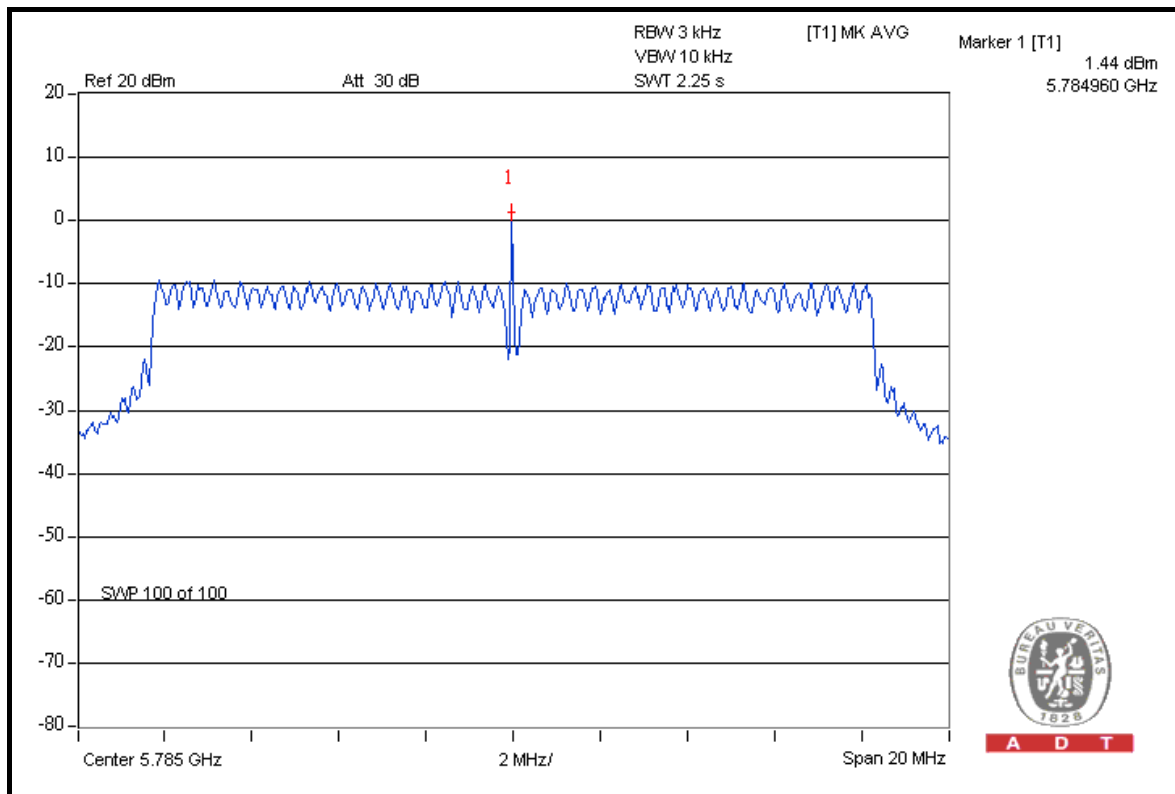



A D T

802.11n (20MHz)

CHAN.	CHAN. FREQ. (MHz)	RF POWER LEVEL IN 3kHz BW (dBm)		TOTAL POWER DENSITY (mW)	TOTAL POWER DENSITY (dBm)	MAX. LIMIT (dBm)	PASS / FAIL
		CHAIN 0	CHAIN 1				
149	5745	-3.8	-7.0	0.6	-2.1	8	PASS
157	5785	-3.9	-6.4	0.6	-1.9	8	PASS
165	5825	-9.2	-8.9	0.3	-6.0	8	PASS

FOR CHAIN 0: CH 149

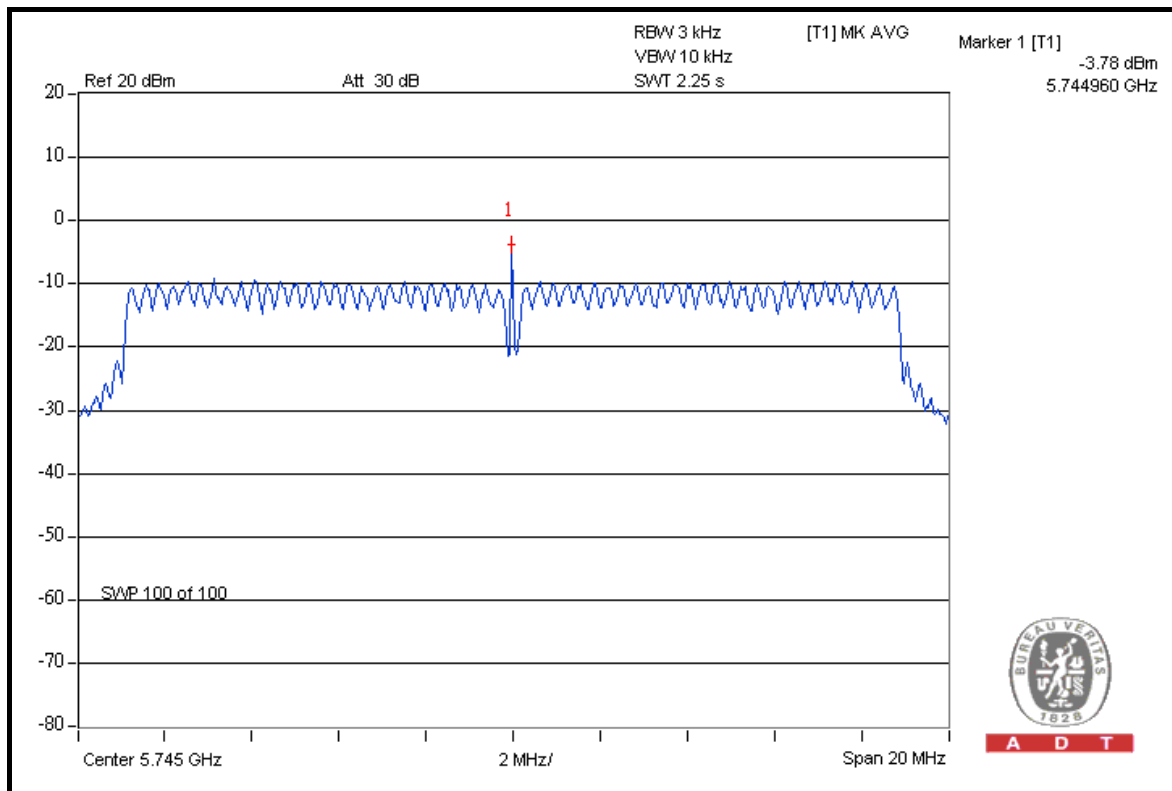

A D T



A D T

802.11n (40MHz)

CHAN.	CHAN. FREQ. (MHz)	RF POWER LEVEL IN 3kHz BW (dBm)		TOTAL POWER DENSITY (mW)	TOTAL POWER DENSITY (dBm)	MAX. LIMIT (dBm)	PASS / FAIL
		CHAIN 0	CHAIN 1				
151	5755	5.9	-11.8	4.0	6.0	8	PASS
159	5795	2.1	-11.2	1.7	2.3	8	PASS

FOR CHAIN 0: CH 151

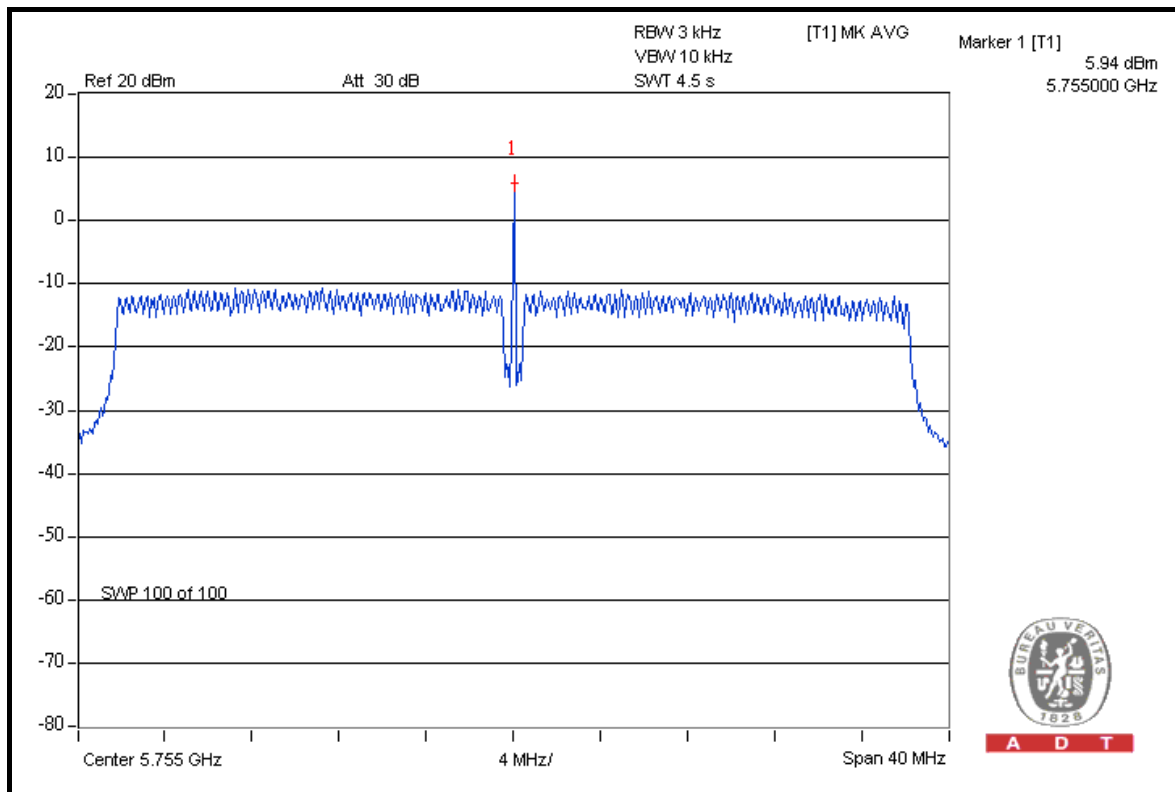



A D T

5.6 BAND EDGES MEASUREMENT

5.6.1 LIMITS OF BAND EDGES MEASUREMENT

Below -20dB of the highest emission level of operating band (in 100kHz Resolution Bandwidth).

5.6.2 TEST INSTRUMENTS

DESCRIPTION & MANUFACTURER	MODEL NO.	SERIAL NO.	DATE OF CALIBRATION	DUE DATE OF CALIBRATION
Agilent Spectrum	8564EC	4208A00659	Jul. 24, 2009	Jul. 23, 2010
Agilent Preamplifier	8449B	3008A01924	Aug. 31, 2009	Aug. 30, 2010
Agilent Preamplifier	8449B	3008A01292	Aug. 10, 2009	Aug. 09, 2010
MITEQ Preamplifier	AMF-6F-260400-33 -8P	892164	Aug. 31, 2009	Aug. 30, 2010
Schwarzbeck Horn Antenna	BBHA-9170	BBHA9170190	Sep. 24, 2009	Sep. 23, 2010
Schwarzbeck Horn Antenna	BBHA-9120	D130	May 15, 2009	May 14, 2010
ADT. Turn Table	TT100	0201	NA	NA
ADT. Tower	AT100	0201	NA	NA
Software	ADT_Radiated_V7. 6.15.9.2	NA	NA	NA
SUHNER RF cable	SF106-18	PHACAB-1G-40 GHz	Aug. 20, 2009	Aug. 19, 2010

NOTE: The calibration interval of the above test instruments is 12 months and the calibrations are traceable to NML/ROC and NIST/USA.



A D T

5.6.3 TEST PROCEDURE

- a. The EUT was placed on the top of a rotating table 0.8 meters above the ground at a 10 meter open area test site. The table was rotated 360 degrees to determine the position of the highest radiation.
- b. The EUT was set 3 meters away from the interference-receiving antenna, which was mounted on the top of a variable-height antenna tower.
- c. The antenna is a broadband antenna, and its height is varied from one meter to four meters above the ground to determine the maximum value of the field strength. Both horizontal and vertical polarizations of the antenna are set to make the measurement.
- d. For each suspected emission, the EUT was arranged to its worst case and then the antenna was tuned to heights from 1 meter to 4 meters and the rotatable table was turned from 0 degrees to 360 degrees to find the maximum reading.
- e. Set both RBW and VBW of spectrum analyzer to 100kHz and 300kHz with suitable frequency span including 100MHz bandwidth from band edge. The band edges was measured and recorded.

NOTE: The resolution bandwidth of test receiver/spectrum analyzer is 1MHz and the video bandwidth is 10Hz for Average detection (AV) at frequency above 1GHz.



A D T

5.6.4 DEVIATION FROM TEST STANDARD

No deviation.

5.6.5 EUT OPERATING CONDITION

Same as Item 5.3.6.

5.6.6 TEST RESULTS

The spectrum plots are attached on the following pages. D1 line indicates the highest level, D2 line indicates the 20dB offset below D1. It shows compliance with the requirement in part 15.247(d).



A D T

802.11a

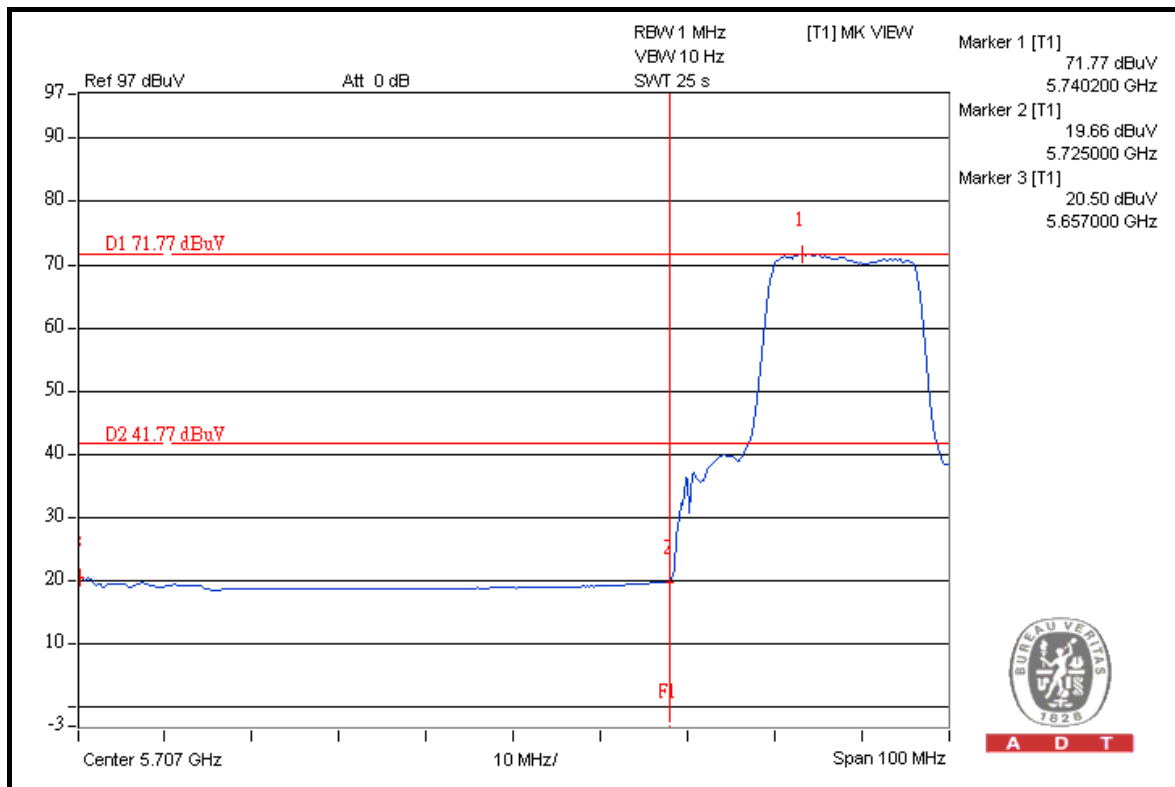
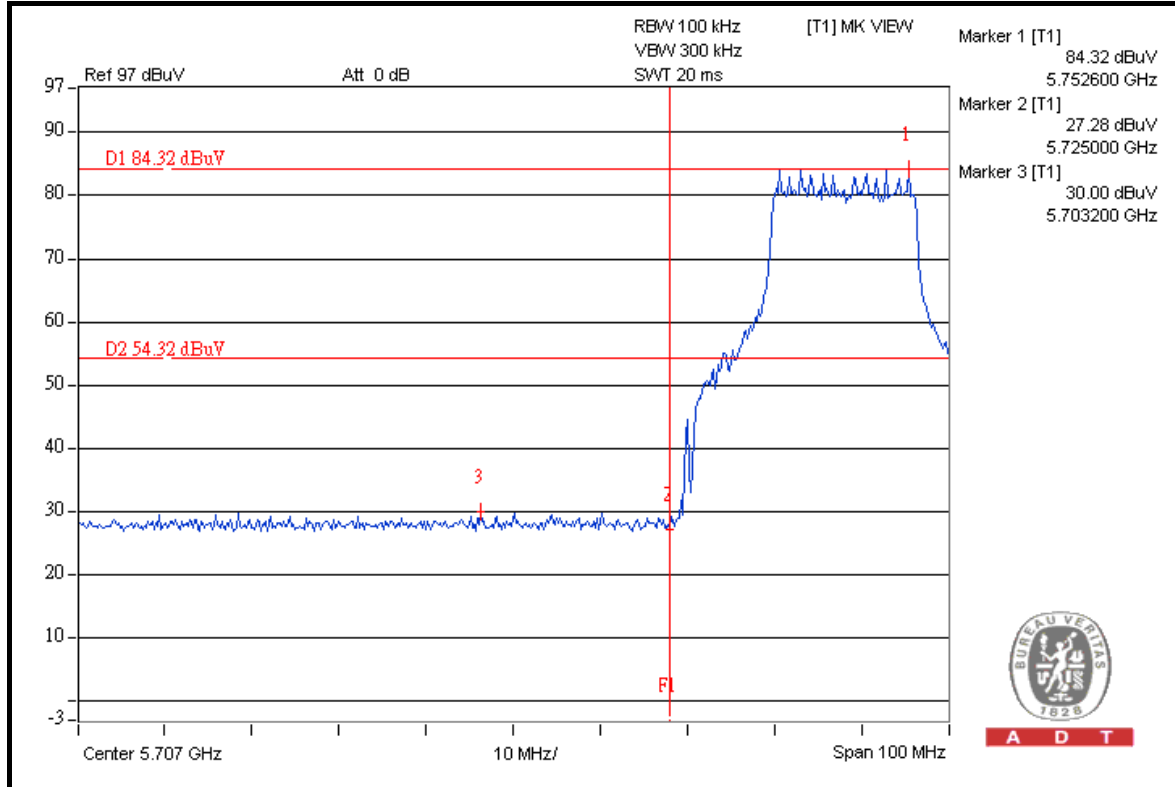



A D T

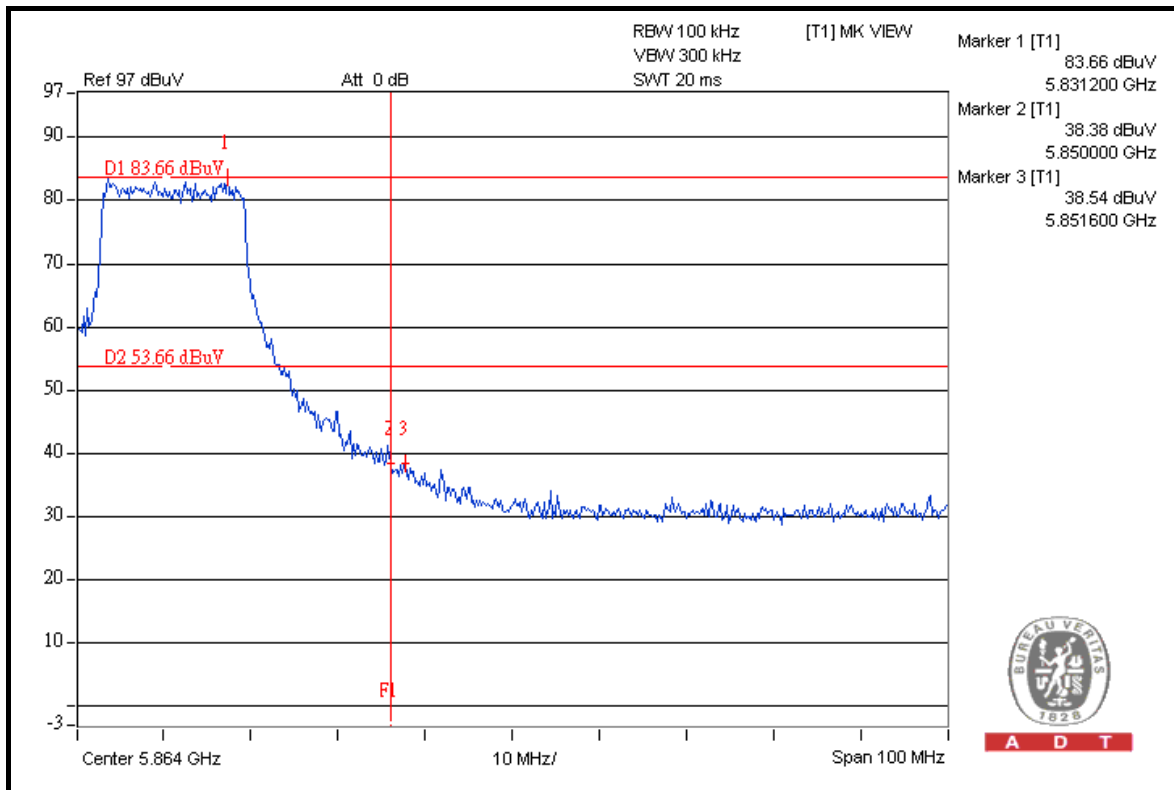
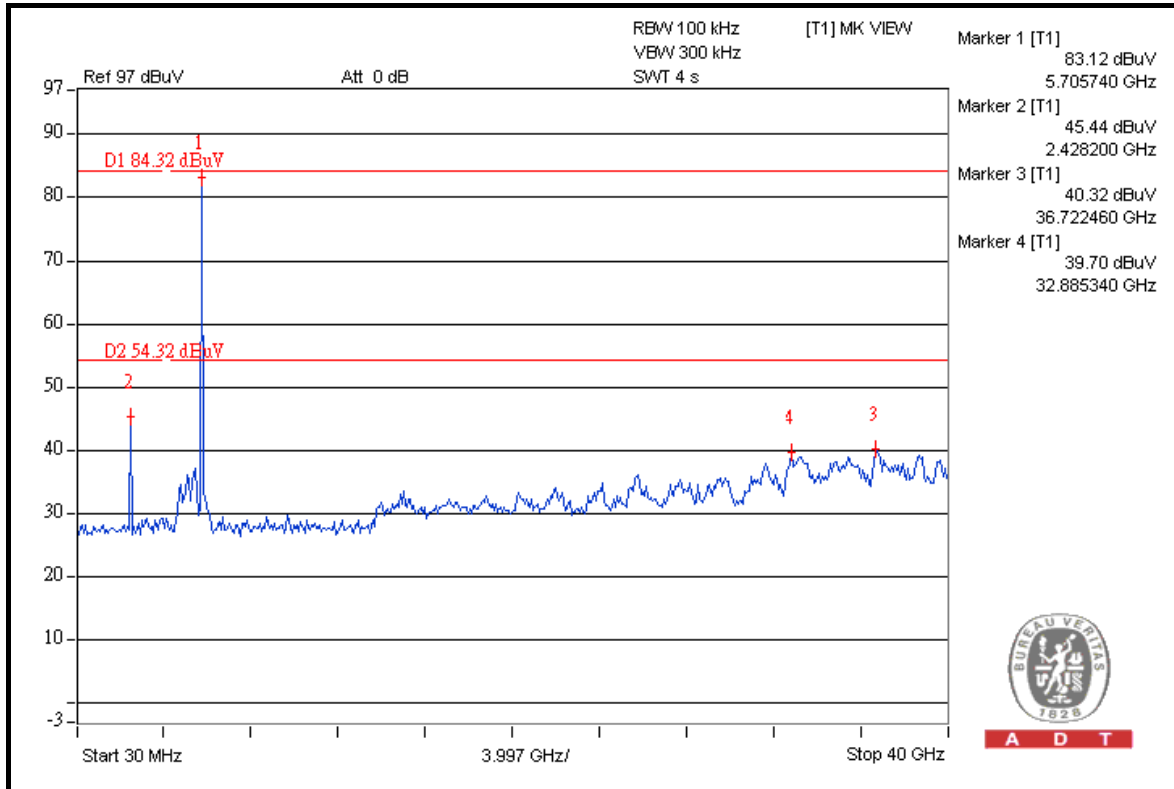



A D T

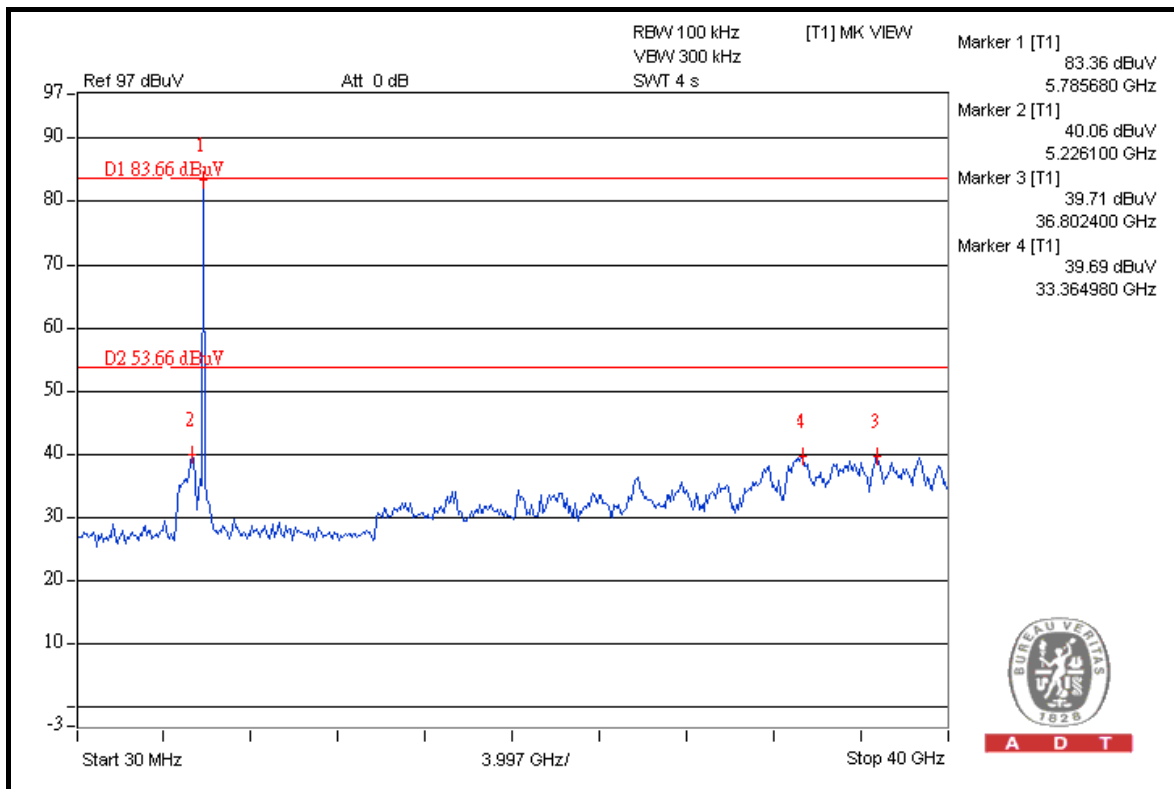
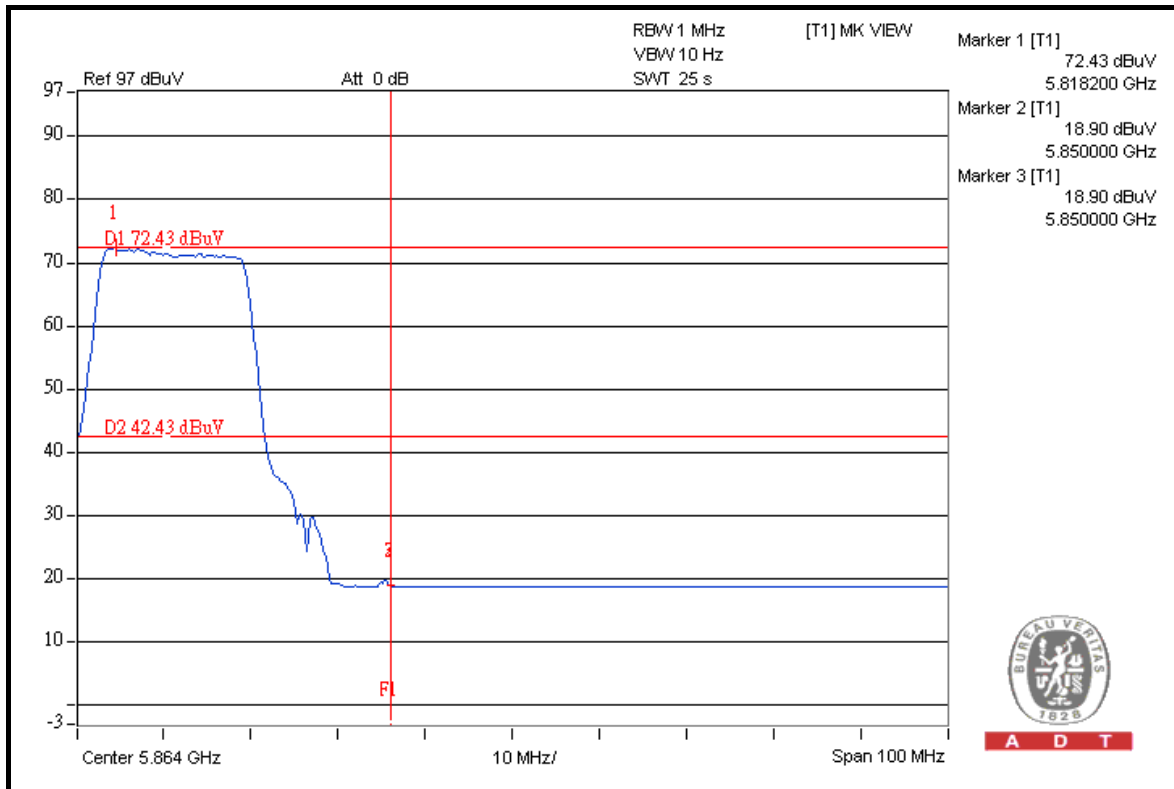



A D T

802.11n (20MHz)

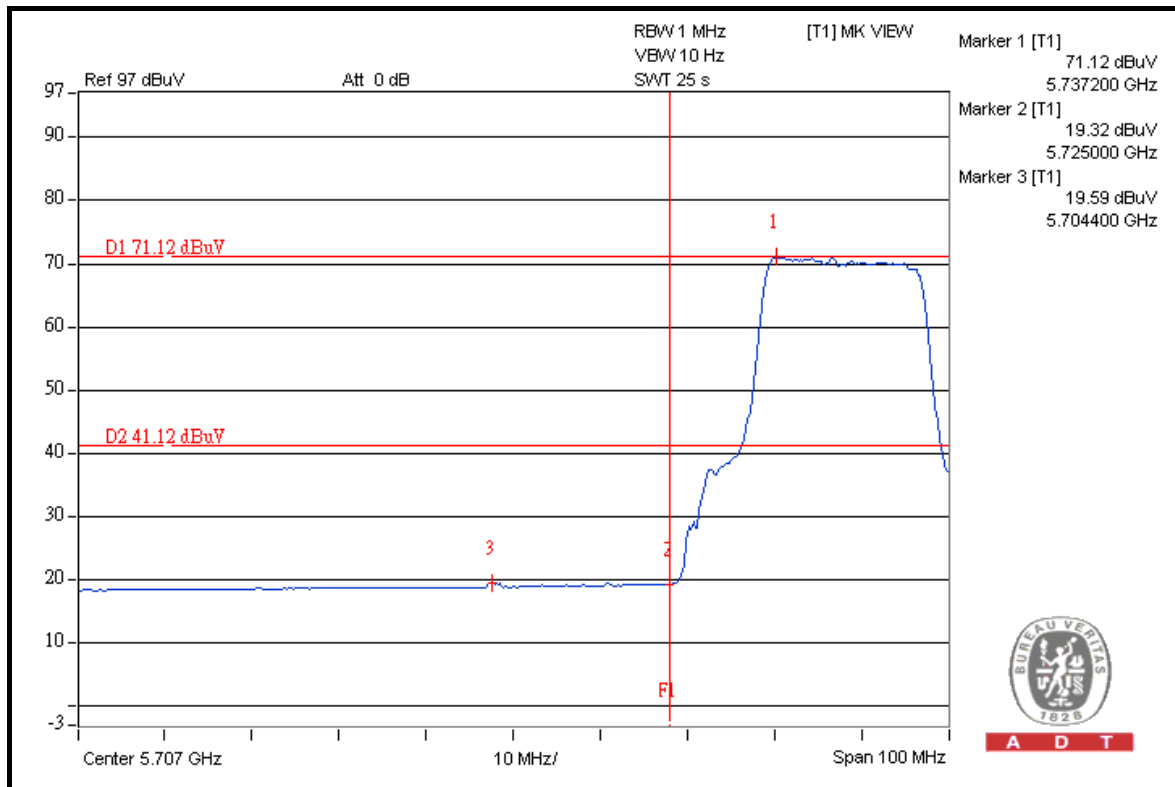
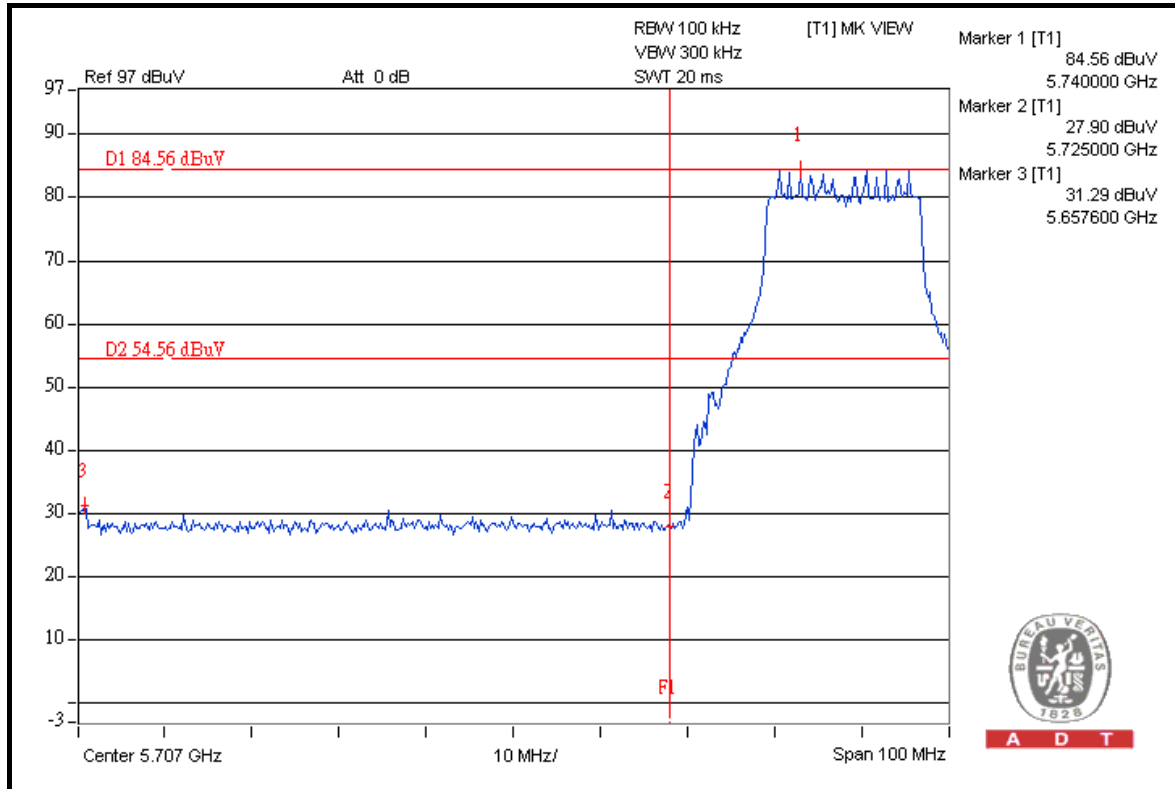



A D T

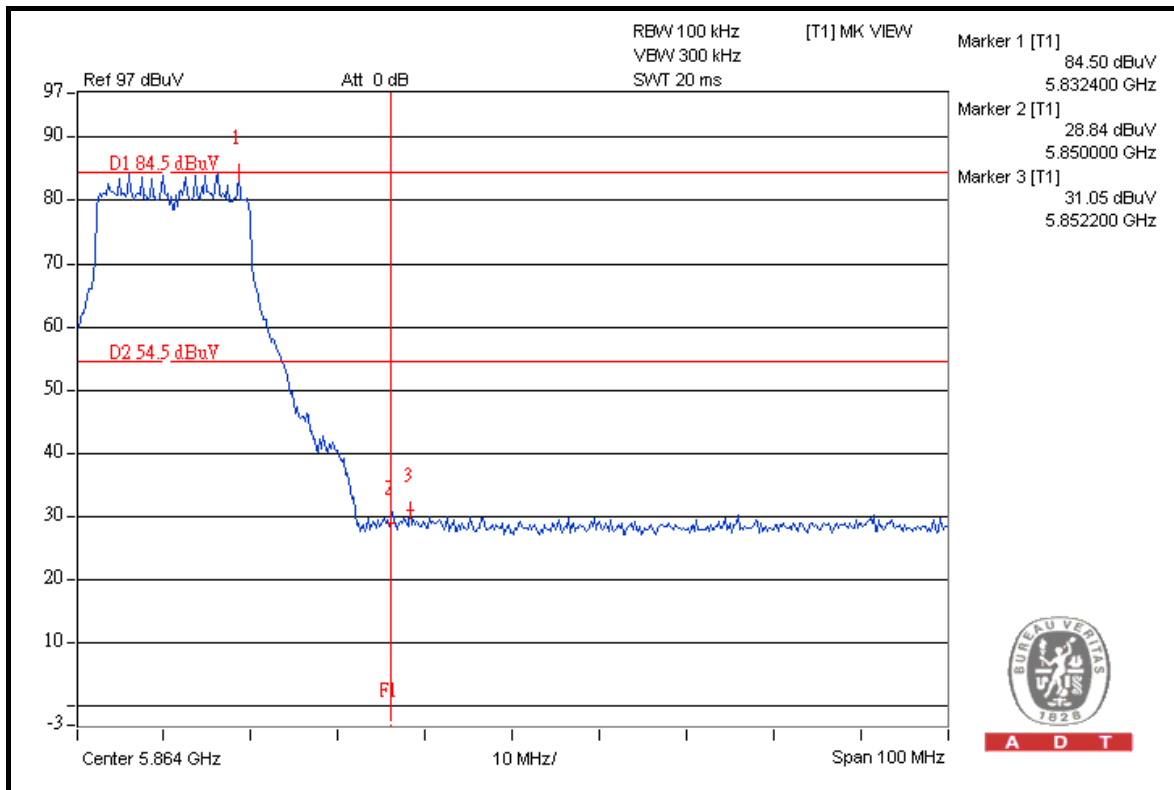
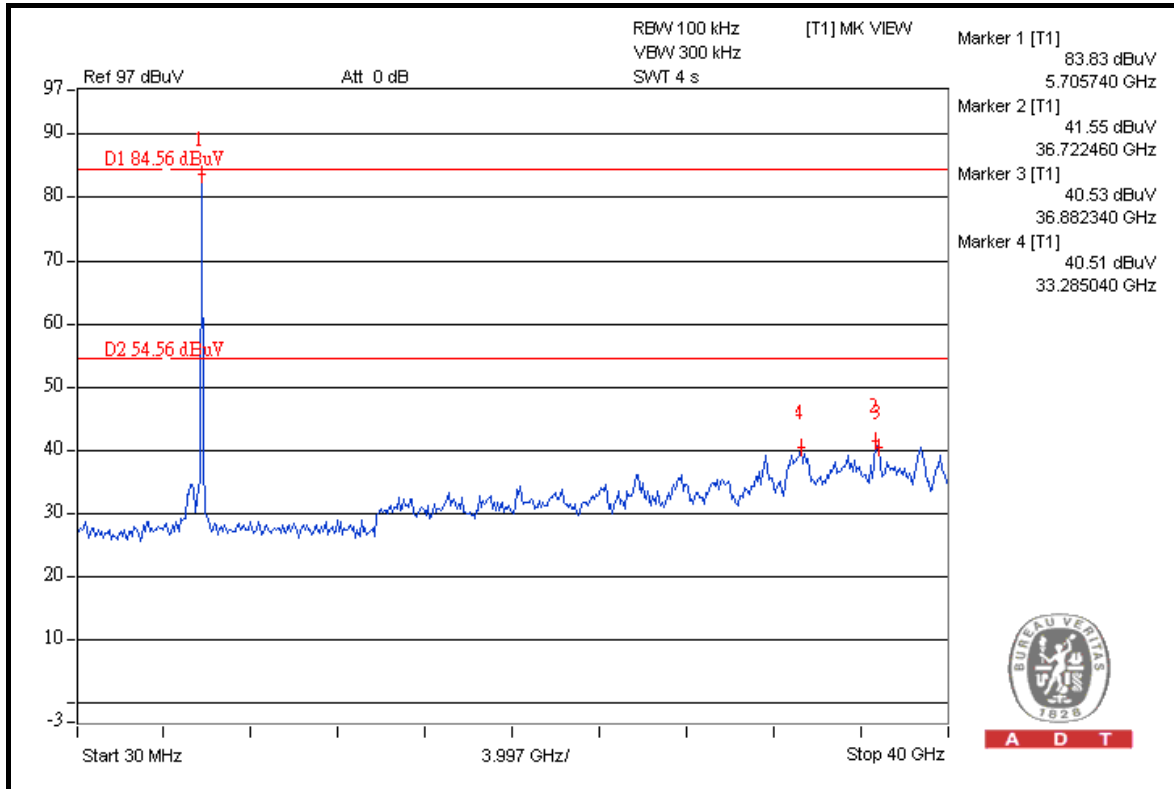



A D T

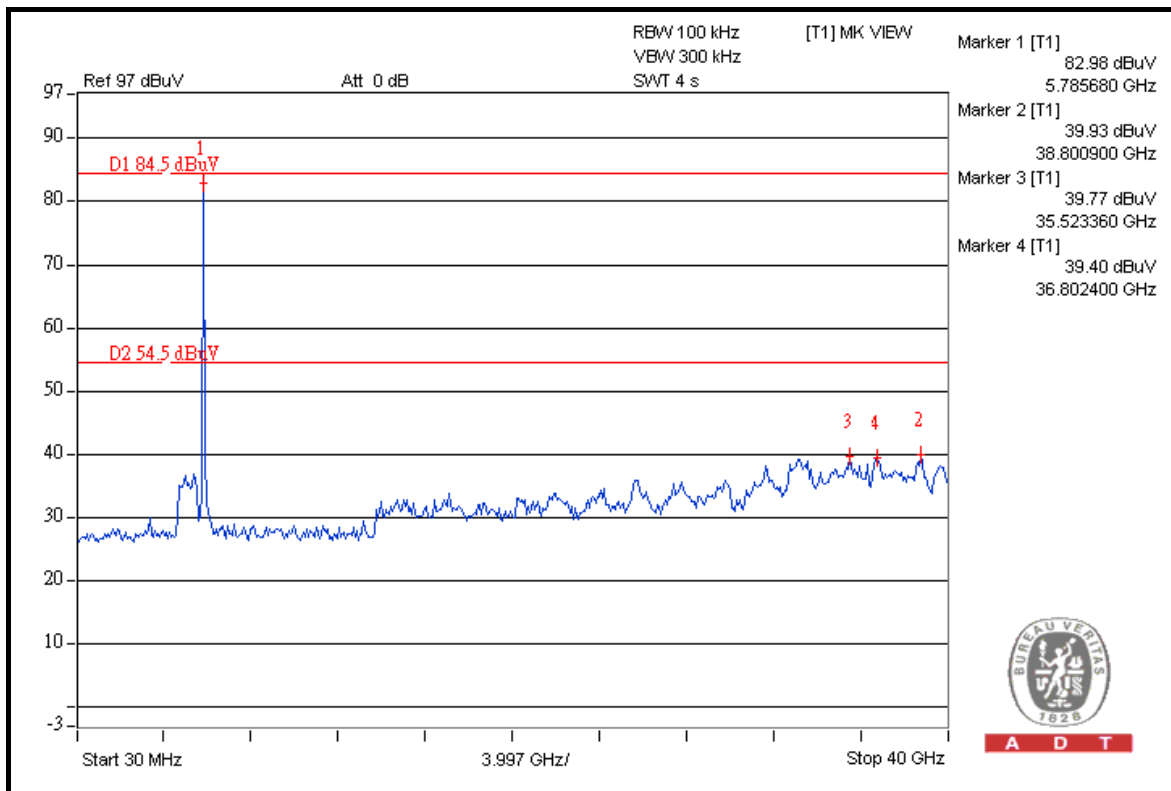
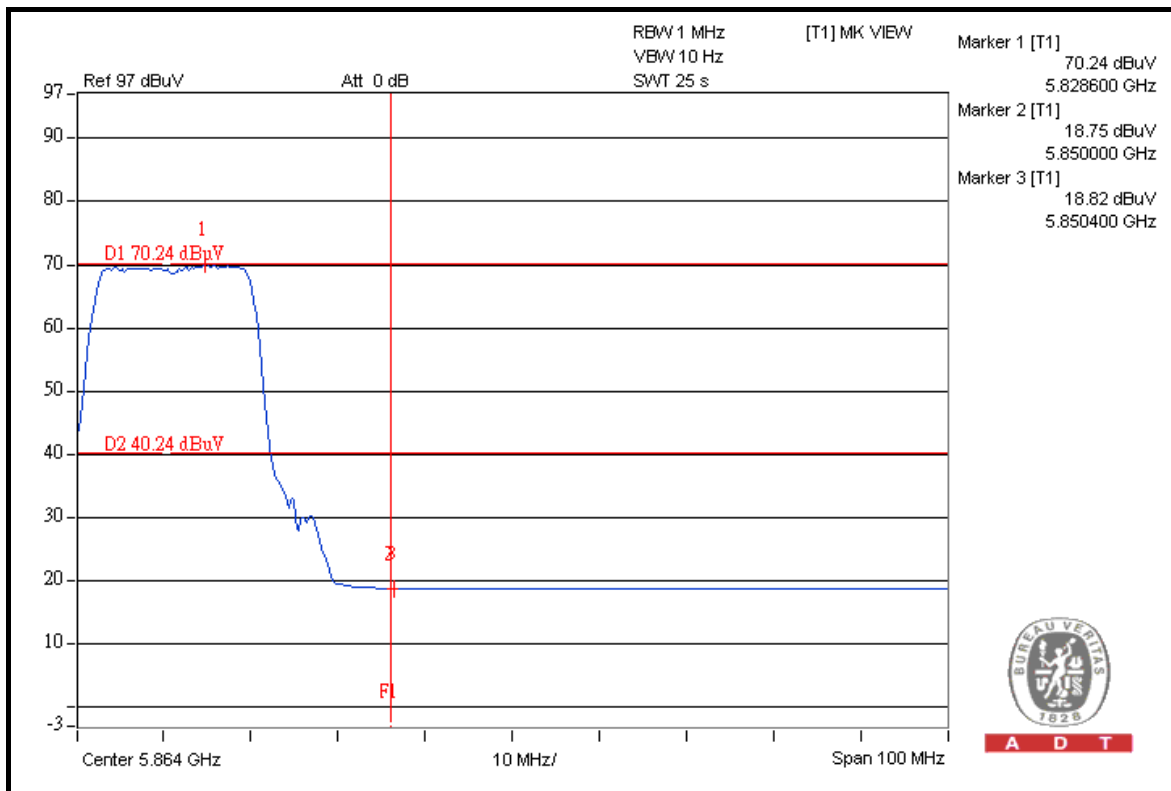



A D T

802.11n (40MHz)

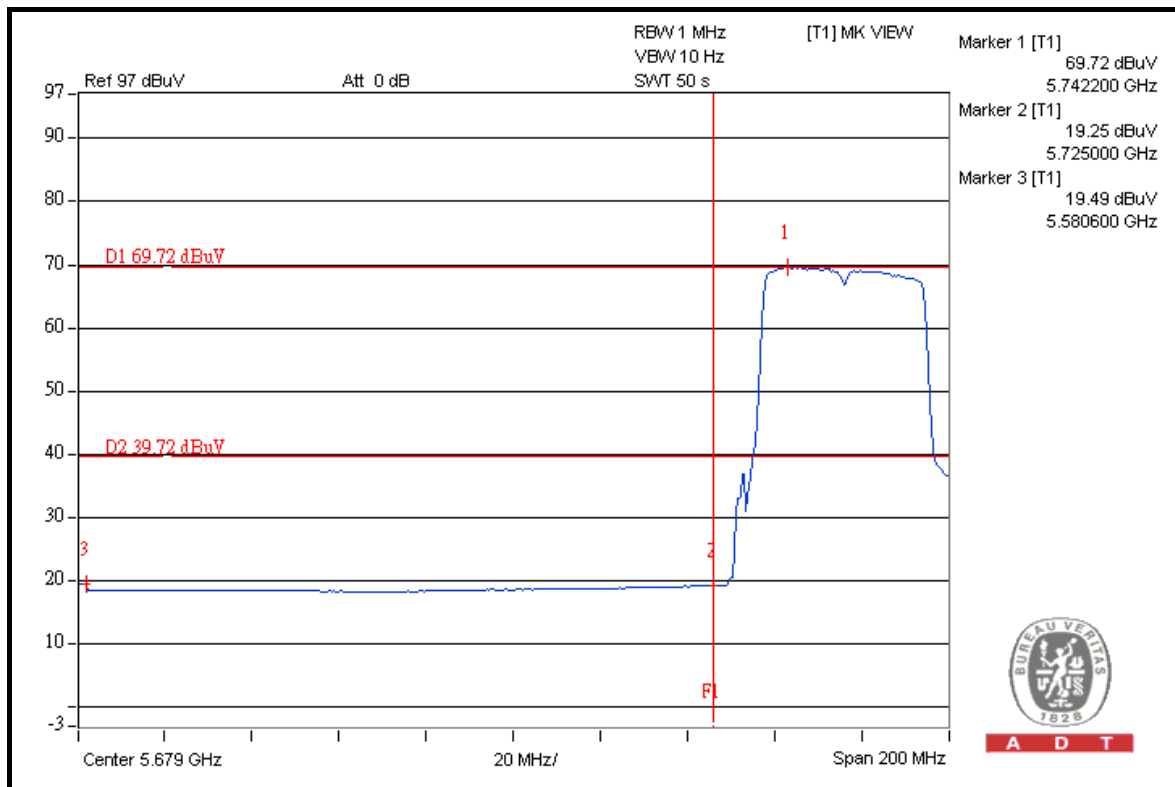
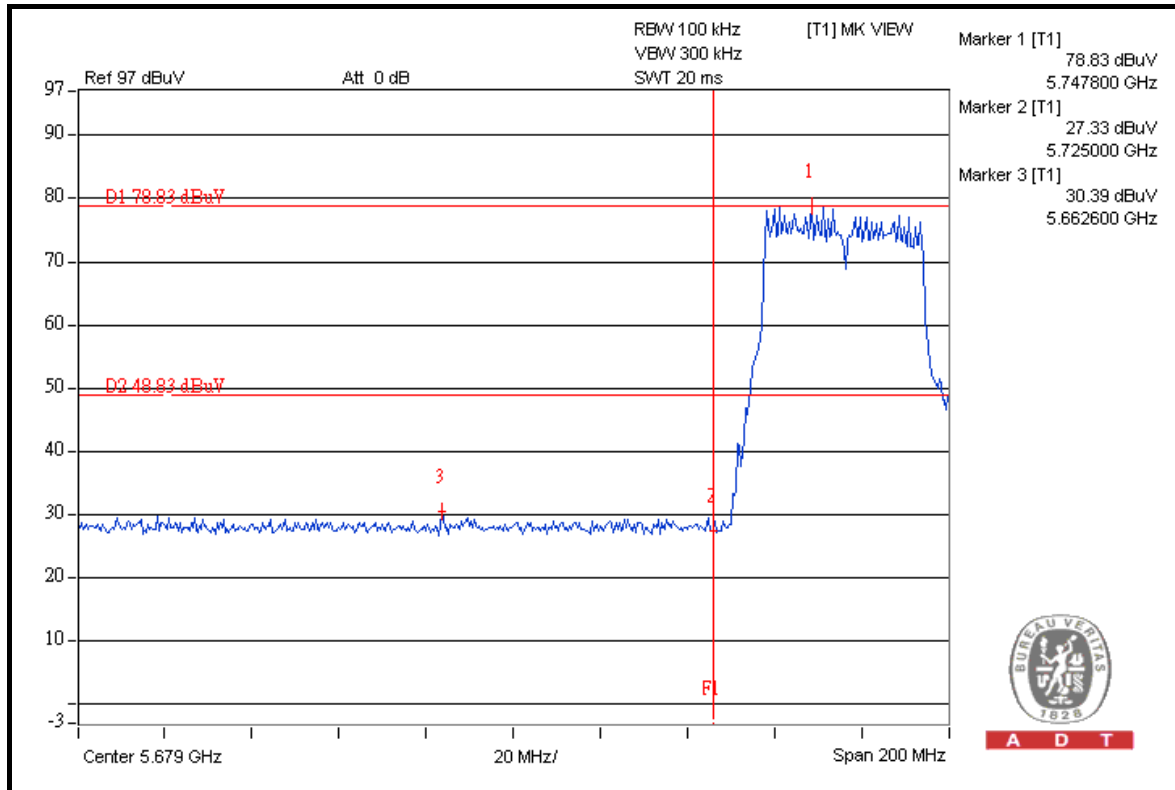



A D T

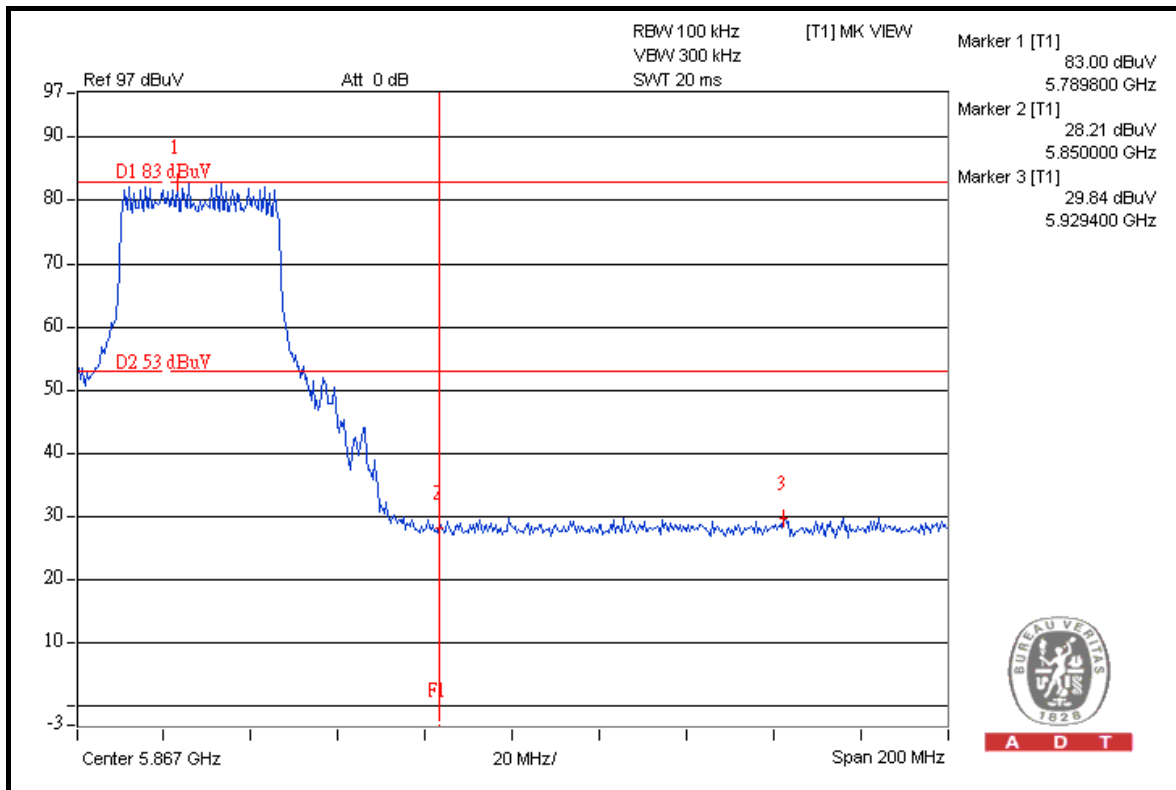
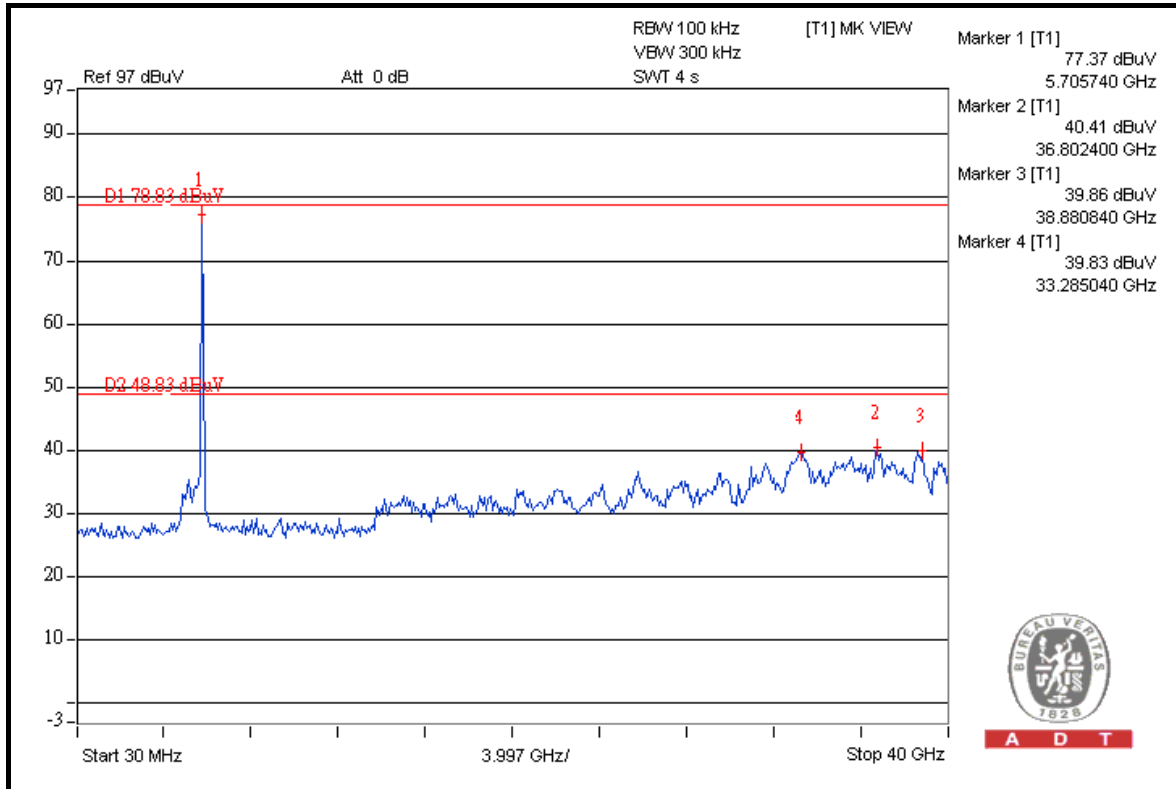



A D T

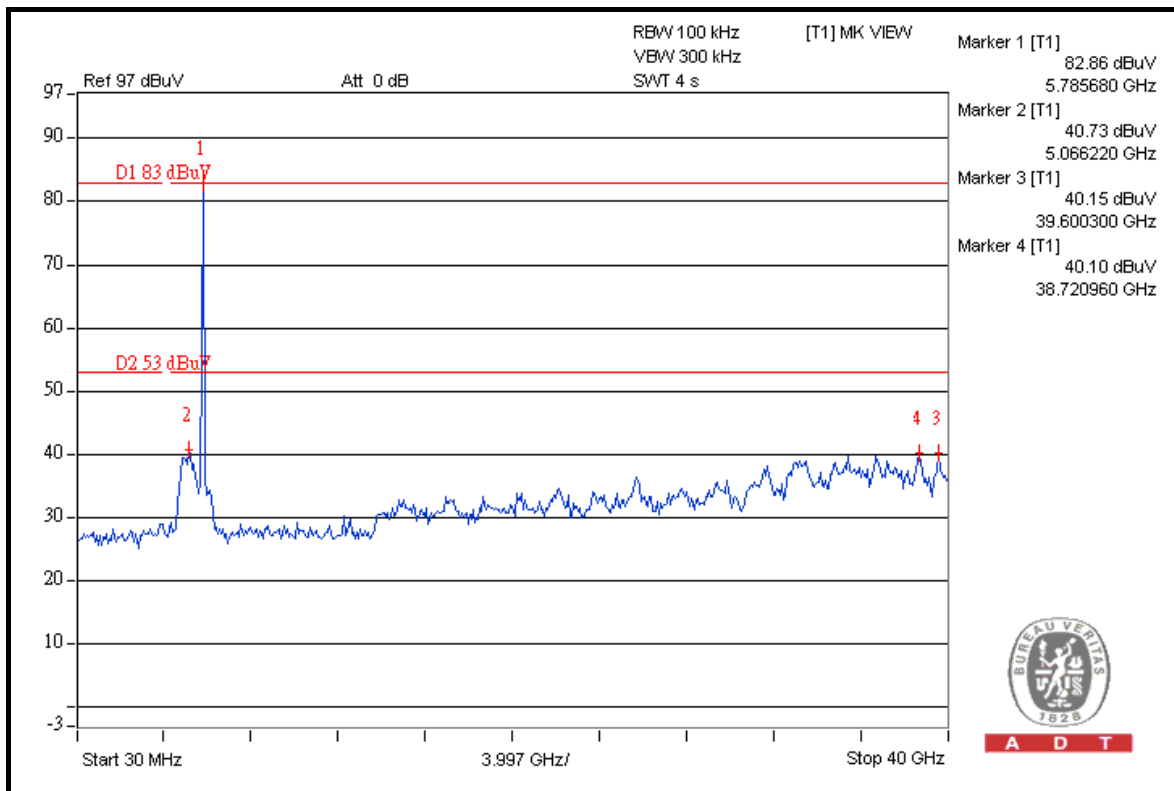
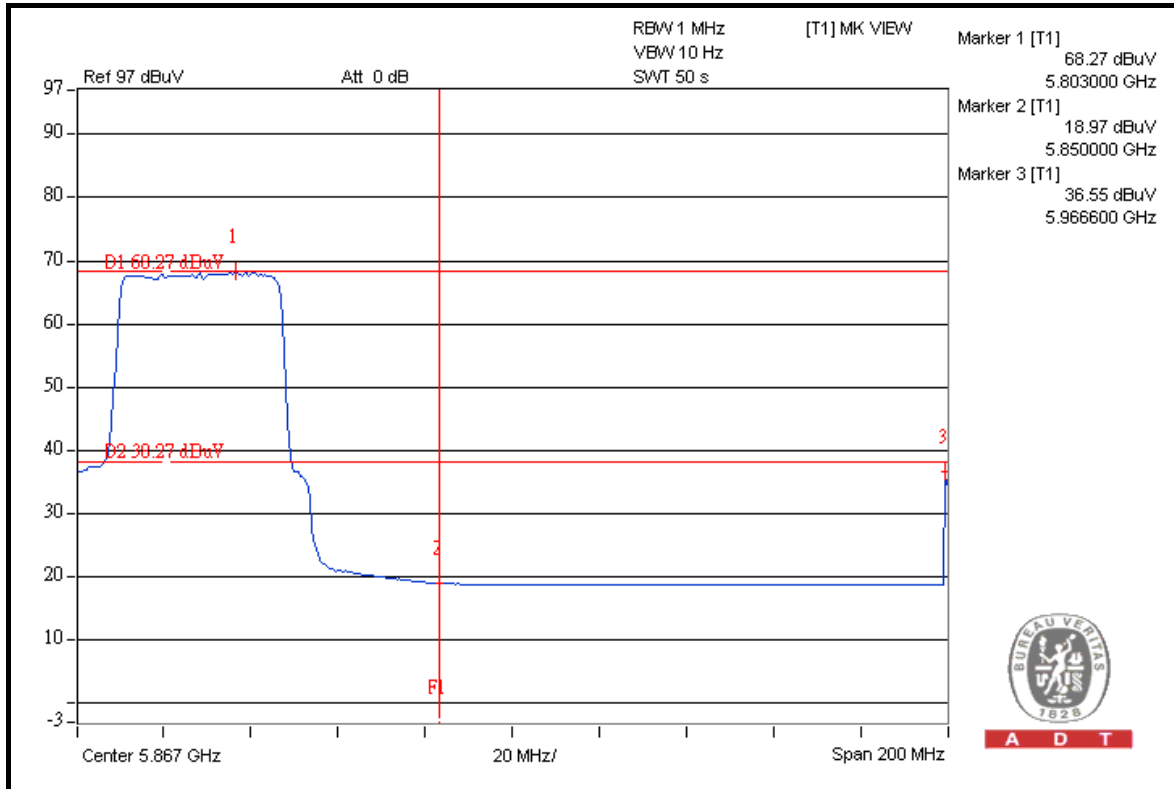



A D T

6. PHOTOGRAPHS OF THE TEST CONFIGURATION

Please refer to the attached file (Test Setup Photo).



A D T

7. INFORMATION ON THE TESTING LABORATORIES

We, Bureau Veritas Consumer Products Services (H.K.) Ltd., Taoyuan Branch, were founded in 1988 to provide our best service in EMC, Radio, Telecom and Safety consultation. Our laboratories are accredited and approved by the following approval agencies according to ISO/IEC 17025.

USA	FCC, NVLAP
Germany	TUV Rheinland
Japan	VCCI
Norway	NEMKO
Canada	INDUSTRY CANADA , CSA
R.O.C.	TAF, BSMI, NCC
Netherlands	Telefication
Singapore	GOST-ASIA(MOU)
Russia	CERTIS(MOU)

Copies of accreditation certificates of our laboratories obtained from approval agencies can be downloaded from our web site:

www.adt.com.tw/index.5/phtml. If you have any comments, please feel free to contact us at the following:

Linko EMC/RF Lab:

Tel: 886-2-26052180

Fax: 886-2-26051924

Hsin Chu EMC/RF Lab:

Tel: 886-3-5935343

Fax: 886-3-5935342

Hwa Ya EMC/RF/Safety Telecom Lab:

Tel: 886-3-3183232

Fax: 886-3-3185050

Web Site: www.adt.com.tw

The address and road map of all our labs can be found in our web site also.



A D T

8. APPENDIX A - MODIFICATIONS RECORDERS FOR ENGINEERING CHANGES TO THE EUT BY THE LAB

No any modifications are made to the EUT by the lab during the test.

---END---