



A D T

FCC TEST REPORT

REPORT NO.: RF981006L04

MODEL NO.: ZF7343

RECEIVED: Oct. 06, 2009

TESTED: Oct. 13 ~ Oct. 14, 2009

ISSUED: Oct. 19, 2009

Applicant's Company	Senao Networks, Inc.
Applicant Address	3F, No. 529, Chung Cheng Rd., Hsintien, Taipei, Taiwan
FCC ID	U2M-ZF73XX-0
Manufacturer's Company	Senao Networks, Inc.
Manufacturer Address	3F, No. 529, Chung Cheng Rd., Hsintien, Taipei, Taiwan

ISSUED BY: Bureau Veritas Consumer Products Services (H.K.) Ltd., Taoyuan Branch

LAB ADDRESS: No. 47, 14th Ling, Chia Pau Tsuen, Lin Kou Hsiang, Taipei Hsien 244, Taiwan, R.O.C.

TEST LOCATION: No. 19, Hwa Ya 2nd Rd, Wen Hwa Tsuen, Kwei Shan Hsiang, Taoyuan Hsien 333, Taiwan, R.O.C.

No. 47, 14th Ling, Chia Pau Tsuen, Lin Kou Hsiang, Taipei Hsien 244, Taiwan, R.O.C.

This test report consists of 80 pages in total. It may be duplicated completely for legal use with the approval of the applicant. It should not be reproduced except in full, without the written approval of our laboratory. The client should not use it to claim product endorsement by TAF or any government agencies. The test results in the report only apply to the tested sample.





A D T

TABLE OF CONTENTS

1.	CERTIFICATION.....	4
2.	SUMMARY OF TEST RESULTS	5
2.1	MEASUREMENT UNCERTAINTY.....	5
3.	GENERAL INFORMATION.....	6
3.1	GENERAL DESCRIPTION OF EUT	6
3.2	DESCRIPTION OF TEST MODES	7
3.2.1	CONFIGURATION OF SYSTEM UNDER TEST	8
3.2.2	TEST MODE APPLICABILITY AND TESTED CHANNEL DETAIL	9
3.3	GENERAL DESCRIPTION OF APPLIED STANDARDS	11
3.4	DESCRIPTION OF SUPPORT UNITS	11
4.	TEST TYPES AND RESULTS	12
4.1	RADIATED EMISSION MEASUREMENT	12
4.1.1	LIMITS OF RADIATED EMISSION MEASUREMENT.....	12
4.1.2	TEST INSTRUMENTS.....	13
4.1.3	TEST PROCEDURES	15
4.1.4	DEVIATION FROM TEST STANDARD.....	15
4.1.5	TEST SETUP.....	16
4.1.6	EUT OPERATING CONDITIONS	16
4.1.7	TEST RESULTS	17
4.2	CONDUCTED EMISSION MEASUREMENT	31
4.2.1	LIMITS OF CONDUCTED EMISSION MEASUREMENT.....	31
4.2.2	TEST INSTRUMENTS.....	31
4.2.3	TEST PROCEDURES	32
4.2.4	DEVIATION FROM TEST STANDARD.....	32
4.2.5	TEST SETUP.....	33
4.2.6	EUT OPERATING CONDITIONS	33
4.2.7	TEST RESULTS	34
4.3	6dB BANDWIDTH MEASUREMENT.....	38
4.3.1	LIMITS OF 6dB BANDWIDTH MEASUREMENT	38
4.3.2	TEST INSTRUMENTS.....	38
4.3.3	TEST PROCEDURE.....	38
4.3.4	DEVIATION FROM TEST STANDARD.....	38
4.3.5	TEST SETUP.....	39



A D T

4.3.6	EUT OPERATING CONDITIONS	39
4.3.7	TEST RESULTS	40
4.4	MAXIMUM OUTPUT POWER	44
4.4.1	LIMITS OF MAXIMUM OUTPUT POWER MEASUREMENT.....	44
4.4.2	INSTRUMENTS.....	44
4.4.3	TEST PROCEDURE.....	44
4.4.4	DEVIATION FROM TEST STANDARD.....	45
4.4.5	TEST SETUP.....	45
4.4.6	EUT OPERATING CONDITIONS	45
4.4.7	TEST RESULTS	46
4.5	POWER SPECTRAL DENSITY MEASUREMENT	54
4.5.1	LIMITS OF POWER SPECTRAL DENSITY MEASUREMENT	54
4.5.2	TEST INSTRUMENTS.....	54
4.5.3	TEST PROCEDURE.....	54
4.5.4	DEVIATION FROM TEST STANDARD.....	55
4.5.5	TEST SETUP.....	55
4.5.6	EUT OPERATING CONDITION.....	55
4.5.7	TEST RESULTS	56
4.6	BAND EDGES MEASUREMENT	60
4.6.1	LIMITS OF BAND EDGES MEASUREMENT.....	60
4.6.2	TEST INSTRUMENTS.....	60
4.6.3	TEST PROCEDURE.....	61
4.6.4	DEVIATION FROM TEST STANDARD.....	61
4.6.5	EUT OPERATING CONDITION.....	61
4.6.6	TEST RESULTS	62
5.	PHOTOGRAPHS OF THE TEST CONFIGURATION.....	78
6.	INFORMATION ON THE TESTING LABORATORIES	79
7.	APPENDIX A - MODIFICATIONS RECORDERS FOR ENGINEERING CHANGES TO THE EUT BY THE LAB.....	80



A D T

1. CERTIFICATION

PRODUCT: ZoneFlex 7343 Access Point

MODEL: ZF7343

BRAND: Ruckus

APPLICANT: Senao Networks Inc.

TEST SAMPLE: ENGINEERING SAMPLE

TESTED: Oct. 13 ~ Oct. 14, 2009

STANDARDS: FCC Part 15, Subpart C (Section 15.247)

ANSI C63.4-2003

The above equipment (Model: ZF7343) has been tested by **Bureau Veritas Consumer Products Services (H.K.) Ltd., Taoyuan Branch**, and found compliance with the requirement of the above standards. The test record, data evaluation & Equipment Under Test (EUT) configurations represented herein are true and accurate accounts of the measurements of the sample's EMC characteristics under the conditions specified in this report.

PREPARED BY : Polly Chien , **DATE** : Oct. 19, 2009
Polly Chien / Specialist

TECHNICAL ACCEPTANCE : Long Chen , **DATE** : Oct. 19, 2009
Responsible for RF Long Chen / Senior Engineer

APPROVED BY : Gary Chang , **DATE** : Oct. 19, 2009
Gary Chang / Assistant Manager



2. SUMMARY OF TEST RESULTS

The EUT has been tested according to the following specifications:

APPLIED STANDARD: FCC PART 15, SUBPART C (SECTION 15.247)			
STANDARD SECTION	TEST TYPE AND LIMIT	RESULT	REMARK
15.207	AC Power Conducted Emission	PASS	Meet the requirement of limit. Minimum passing margin is -14.69dB at 0.287MHz.
15.247(a)(2)	Spectrum Bandwidth of a Direct Sequence Spread Spectrum System Limit: min. 500kHz	PASS	Meet the requirement of limit.
15.247(b)	Maximum Output Power Limit: max. 30dBm	PASS	Meet the requirement of limit.
15.247(d)	Radiated Emissions Limit: Table 15.209	PASS	Meet the requirement of limit. Minimum passing margin is -0.18dB at 340.01MHz.
15.247(e)	Power Spectral Density Limit: max. 8dBm	PASS	Meet the requirement of limit.
15.247(d)	Band Edge Measurement Limit: 20dB less than the peak value of fundamental frequency	PASS	Meet the requirement of limit.
15.203	Antenna Requirement	PASS	No antenna connector is used.

2.1 MEASUREMENT UNCERTAINTY

Where relevant, the following measurement uncertainty levels have been estimated for tests performed on the EUT as specified in CISPR 16-4-2:

MEASUREMENT	FREQUENCY	UNCERTAINTY
Conducted emissions	150kHz~30MHz	2.44 dB
Radiated emissions	30MHz ~ 200MHz	3.19 dB
	200MHz ~1000MHz	3.21 dB
	1GHz ~ 18GHz	2.26 dB
	18GHz ~ 40GHz	1.94 dB

This uncertainty represents an expanded uncertainty expressed at approximately the 95% confidence level using a coverage factor of $k = 2$.



3. GENERAL INFORMATION

3.1 GENERAL DESCRIPTION OF EUT

EUT	ZoneFlex 7343 Access Point
MODEL NO.	ZF7343
FCC ID	U2M-ZF73XX-0
POWER SUPPLY	12Vdc (adapter) 48Vdc (POE)
MODULATION TYPE	CCK, DQPSK, DBPSK for DSSS 64QAM, 16QAM, QPSK, BPSK for OFDM
MODULATION TECHNOLOGY	DSSS, OFDM
TRANSFER RATE	802.11b: 11.0/ 5.5/ 2.0/ 1.0Mbps 802.11g: 54.0/ 48.0/ 36.0/ 24.0/ 18.0/ 12.0/ 9.0/ 6.0Mbps 802.11n: up to 270.0Mbps
OPERATING FREQUENCY	2412 ~ 2462MHz
NUMBER OF CHANNEL	11 for 802.11b, 802.11g, 802.11n (20MHz) 7 for 802.11n (40MHz)
OUTPUT POWER	219.77mW
ANTENNA TYPE	PIFA antenna with 2dBi gain
ANTENNA CONNECTOR	NA
I/O PORTS	USB, RJ45
DATA CABLE	NA
ACCESSORY DEVICES	AC adapter

NOTE:

- The EUT incorporates a MIMO function. Physically, the EUT provides two completed transmitters and two receivers.

MODULATION MODE	TX FUNCTION
802.11b	2TX
802.11g	2TX
802.11n (20MHz)	2TX
802.11n (40MHz)	2TX

- The EUT were powered by the following adapter:

BRAND:	Ruckus
MODEL:	DSA-12G-12 FUS 120120
INPUT:	100-240Vac, 0.3A, 50/60Hz
OUTPUT:	12Vdc, 1A
POWER LINE:	1.8m non-shielded cable without core

- The above EUT information was declared by manufacturer and for more detailed features description, please refer to the manufacturer's specifications or user's manual.

3.2 DESCRIPTION OF TEST MODES

11 channels are provided for 802.11b, 802.11g and 802.11n (20MHz):

CHANNEL	FREQUENCY	CHANNEL	FREQUENCY
1	2412MHz	7	2442MHz
2	2417MHz	8	2447MHz
3	2422MHz	9	2452MHz
4	2427MHz	10	2457MHz
5	2432MHz	11	2462MHz
6	2437MHz		

7 channels are provided for 802.11n (40MHz):

CHANNEL	FREQUENCY	CHANNEL	FREQUENCY
1	2422MHz	5	2442MHz
2	2427MHz	6	2447MHz
3	2432MHz	7	2452MHz
4	2437MHz		

POWER SETTING

802.11b			802.11g		
CHANNEL		POWER SETTING	CHANNEL		POWER SETTING
1	Chain 0	20	1	Chain 0	20
	Chain 1	20		Chain 1	20
6	Chain 0	20	6	Chain 0	20
	Chain 1	20		Chain 1	20
11	Chain 0	20	11	Chain 0	20
	Chain 1	20		Chain 1	20

802.11n (20MHz)			802.11n (40MHz)		
CHANNEL		POWER SETTING	CHANNEL		POWER SETTING
1	Chain 0	20	1	Chain 0	20
	Chain 1	20		Chain 1	20
6	Chain 0	20	4	Chain 0	20
	Chain 1	20		Chain 1	20
11	Chain 0	20	7	Chain 0	20
	Chain 1	20		Chain 1	20

3.2.1 CONFIGURATION OF SYSTEM UNDER TEST

Test mode A

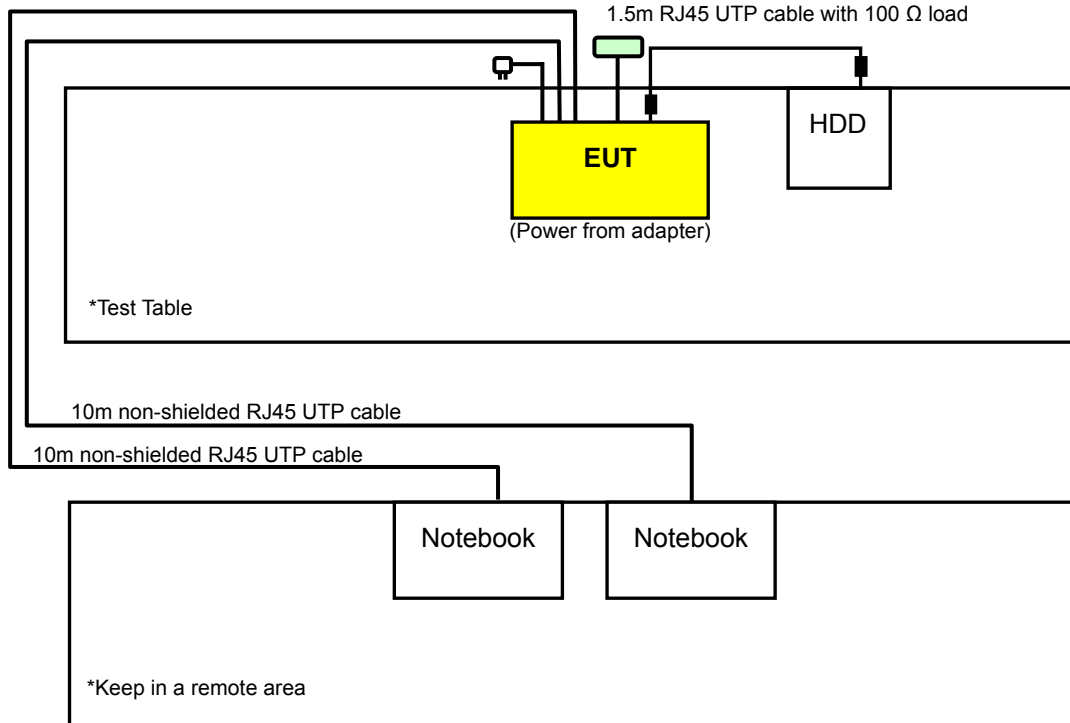

Test mode B

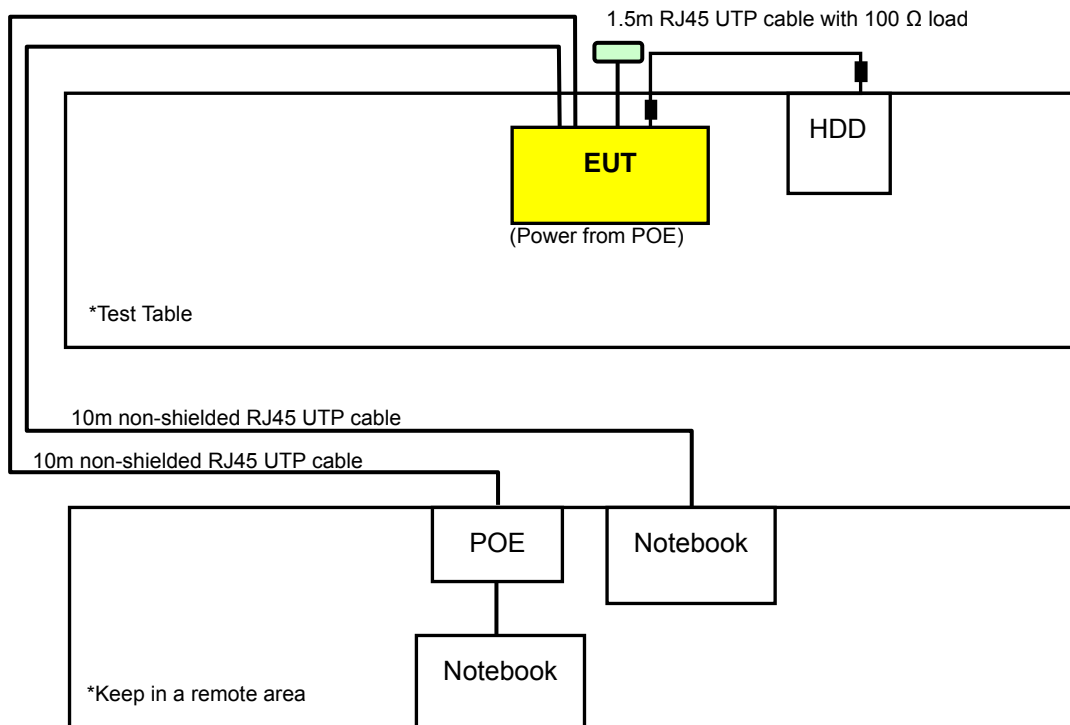



3.2.2 TEST MODE APPLICABILITY AND TESTED CHANNEL DETAIL

EUT CONFIGURE MODE	APPLICABLE TO				DESCRIPTION
	RE≥1G	RE<1G	PLC	APCM	
A	√	√	√	√	Power from AC Adapter
B	-	√	√	-	Power from POE

Where **RE≥1G**: Radiated Emission above 1GHz **RE<1G**: Radiated Emission below 1GHz
PLC: Power Line Conducted Emission **APCM**: Antenna Port Conducted Measurement
NOTE: "-" means no effect.

RADIATED EMISSION TEST (ABOVE 1GHz):

- Pre-Scan has been conducted to determine the worst-case mode from all possible combinations between available modulations, XYZ axis and antenna ports (if EUT with antenna diversity architecture).
- Following channel(s) was (were) selected for the final test as listed below.

EUT CONFIGURE MODE	MODE	AVAILABLE CHANNEL	TESTED CHANNEL	MODULATION TECHNOLOGY	MODULATION TYPE	DATA RATE (Mbps)	AXIS
A	802.11b	1 to 11	1, 6, 11	DSSS	DBPSK	1.0	X
A	802.11g	1 to 11	1, 6, 11	OFDM	BPSK	6.0	X
A	802.11n (20MHz)	1 to 11	1, 6, 11	OFDM	BPSK	6.5	X
A	802.11n (40MHz)	1 to 7	1, 4, 7	OFDM	BPSK	13.5	X

RADIATED EMISSION TEST (BELOW 1GHz):

- Pre-Scan has been conducted to determine the worst-case mode from all possible combinations between available modulations, XYZ axis and antenna ports (if EUT with antenna diversity architecture).
- Following channel(s) was (were) selected for the final test as listed below.

EUT CONFIGURE MODE	MODE	AVAILABLE CHANNEL	TESTED CHANNEL	MODULATION TECHNOLOGY	MODULATION TYPE	DATA RATE (Mbps)	AXIS
A, B	802.11b	1 to 11	6	DSSS	DBPSK	1.0	X

POWER LINE CONDUCTED EMISSION TEST:

- Pre-Scan has been conducted to determine the worst-case mode from all possible combinations between available modulations, data rates and antenna ports (if EUT with antenna diversity architecture).
- Following channel(s) was (were) selected for the final test as listed below.

EUT CONFIGURE MODE	MODE	AVAILABLE CHANNEL	TESTED CHANNEL	MODULATION TECHNOLOGY	MODULATION TYPE	DATA RATE (Mbps)
A, B	802.11b	1 to 11	6	DSSS	DBPSK	1.0



A D T

BANDEDGE MEASUREMENT:

- Pre-Scan has been conducted to determine the worst-case mode from all possible combinations between available modulations, data rates and antenna ports (if EUT with antenna diversity architecture).
- Following channel(s) was (were) selected for the final test as listed below.

EUT CONFIGURE MODE	MODE	AVAILABLE CHANNEL	TESTED CHANNEL	MODULATION TECHNOLOGY	MODULATION TYPE	DATA RATE (Mbps)
A	802.11b	1 to 11	1, 11	DSSS	DBPSK	1.0
A	802.11g	1 to 11	1, 11	OFDM	BPSK	6.0
A	802.11n (20MHz)	1 to 11	1, 11	OFDM	BPSK	6.5
A	802.11n (40MHz)	1 to 7	1, 7	OFDM	BPSK	13.5

ANTENNA PORT CONDUCTED MEASUREMENT:

- This item includes all test value of each mode, but only includes spectrum plot of worst value of each mode.
- Pre-Scan has been conducted to determine the worst-case mode from all possible combinations between available modulations, data rates and antenna ports (if EUT with antenna diversity architecture).
- Following channel(s) was (were) selected for the final test as listed below.

EUT CONFIGURE MODE	MODE	AVAILABLE CHANNEL	TESTED CHANNEL	MODULATION TECHNOLOGY	MODULATION TYPE	DATA RATE (Mbps)
A	802.11b	1 to 11	1, 6, 11	DSSS	DBPSK	1.0
A	802.11g	1 to 11	1, 6, 11	OFDM	BPSK	6.0
A	802.11n (20MHz)	1 to 11	1, 6, 11	OFDM	BPSK	6.5
A	802.11n (40MHz)	1 to 7	1, 4, 7	OFDM	BPSK	13.5

TEST CONDITION:

APPLICABLE TO	ENVIRONMENTAL CONDITIONS	INPUT POWER (SYSTEM)	TESTED BY
RE≥1G	23deg. C, 76%RH, 1008 hPa	120Vac, 60Hz	Nick Chen
RE<1G	23deg. C, 76%RH, 1008 hPa	120Vac, 60Hz	Nick Chen
PLC	24deg. C, 80%RH, 1008 hPa	120Vac, 60Hz	Nick Chen
APCM	24deg. C, 64%RH, 1008 hPa	120Vac, 60Hz	Nick Chen



A D T

3.3 GENERAL DESCRIPTION OF APPLIED STANDARDS

The EUT is a RF Product. According to the specifications of the manufacturer, it must comply with the requirements of the following standards:

FCC Part 15, Subpart C (15.247)

ANSI C63.4-2003

All test items have been performed and recorded as per the above standards.

NOTE: The EUT is also considered as a kind of computer peripheral, because the connection to computer is necessary for typical use. It has been verified to comply with the requirements of FCC Part 15, Subpart B, Class B (DoC). The test report has been issued separately.

3.4 DESCRIPTION OF SUPPORT UNITS

The EUT has been tested as an independent unit together with other necessary accessories or support units. The following support units or accessories were used to form a representative test configuration during the tests.

NO.	PRODUCT	BRAND	MODEL NO.	SERIAL NO.	FCC ID
1	NOTEBOOK	DELL	PP05L	24729091408	FCC DoC Approved
2	NOTEBOOK	DELL	PP05L	20375526736	FCC DoC Approved
3	EXTERNAL HARD DISK	DELL	RD1000	HK-0XM763-72953-77Q-0021	NA
4	POE	SonicWall	PD-6083G300	NA	NA

NO.	SIGNAL CABLE DESCRIPTION OF THE ABOVE SUPPORT UNITS
1	10m non-shielded RJ45 UTP cable.
2	1m non-shielded RJ45 UTP cable.
3	2m shielded cable, terminated with USB connector, with 2 cores.
4	10m non-shielded RJ45 UTP cable.

NOTE:

1. All power cords of the above support units are non shielded (1.8m).
2. Items 1 ~ 2 acted as communication partners to transfer data.
3. Item 4 was provided by the client and for test mode B.



4. TEST TYPES AND RESULTS

4.1 RADIATED EMISSION MEASUREMENT

4.1.1 LIMITS OF RADIATED EMISSION MEASUREMENT

Emissions radiated outside of the specified bands, shall be according to the general radiated limits in 15.209 as following:

FREQUENCIES (MHz)	FIELD STRENGTH (microvolts/meter)	MEASUREMENT DISTANCE (meters)
0.009 ~ 0.490	2400/F(kHz)	300
0.490 ~ 1.705	24000/F(kHz)	30
1.705 ~ 30.0	30	30
30 ~ 88	100	3
88 ~ 216	150	3
216 ~ 960	200	3
Above 960	500	3

NOTE:

1. The lower limit shall apply at the transition frequencies.
2. Emission level (dBuV/m) = 20 log Emission level (uV/m).
3. As shown in 15.35(b), for frequencies above 1000MHz, the field strength limits are based on average detector, however, the peak field strength of any emission shall not exceed the maximum permitted average limits, specified above by more than 20dB under any condition of modulation.



A D T

4.1.2 TEST INSTRUMENTS

For frequency above 1 GHz:

DESCRIPTION & MANUFACTURER	MODEL NO.	SERIAL NO.	DATE OF CALIBRATION	DUE DATE OF CALIBRATION
Agilent Spectrum	8564EC	4208A00659	Jul. 24, 2009	Jul. 23, 2010
Agilent Preamplifier	8449B	3008A01924	Aug. 31, 2009	Aug. 30, 2010
Agilent Preamplifier	8449B	3008A01292	Aug. 10, 2009	Aug. 09, 2010
MITEQ Preamplifier	AMF-6F-260400-33 -8P	892164	Aug. 31, 2009	Aug. 30, 2010
Schwarzbeck Horn Antenna	BBHA-9170	BBHA9170190	Sep. 24, 2009	Sep. 23, 2010
Schwarzbeck Horn Antenna	BBHA-9120	D130	May 15, 2009	May 14, 2010
ADT. Turn Table	TT100	0201	NA	NA
ADT. Tower	AT100	0201	NA	NA
Software	ADT_Radiated_V7. 6.15.9.2	NA	NA	NA
SUHNER RF cable	SF106-18	PHACAB-1G- 40GHz	Aug. 20, 2009	Aug. 19, 2010

- NOTE:**
1. The calibration interval of the above test instruments is 12 months. And the calibrations are traceable to NML/ROC and NIST/USA.
 2. The test was performed in Open Site No. 10.
 3. The Industry Canada Reference No. IC 7450E-10.
 4. The FCC Site Registration No. 698148.



A D T

For frequency below 1 GHz:

DESCRIPTION & MANUFACTURER	MODEL NO.	SERIAL NO.	DATE OF CALIBRATION	DUE DATE OF CALIBRATION
ROHDE & SCHWARZ TEST RECEIVER	ESVS 30	841977/008	Apr. 24, 2009	Apr. 23, 2010
SCHAFFNER BILOG Antenna	CBL6111C	2793	Apr. 29, 2009	Apr. 28, 2010
ADT. Turn Table	TT100	0201	NA	NA
ADT. Tower	AT100	0201	NA	NA
Software	ADT_Radiated_V7. 6.15.9.2	NA	NA	NA
ADT RF Switches BOX	EM-H-01-1	1004	Dec. 19, 2008	Dec. 18, 2009
WOKEN RF cable	8D	CABLE-ST10-01	Dec. 19, 2008	Dec. 18, 2009

- NOTE:**
1. The calibration interval of the above test instruments is 12 months. And the calibrations are traceable to NML/ROC and NIST/USA.
 2. The test was performed in Open Site No. 10.
 3. The VCCI Site Registration No. R-1625.
 4. The Industry Canada Reference No. IC 7450E-10.
 5. The FCC Site Registration No. 698148.



A D T

4.1.3 TEST PROCEDURES

- a. The EUT was placed on the top of a rotating table 0.8 meters above the ground at a 10 meter open area test site. The table was rotated 360 degrees to determine the position of the highest radiation.
- b. The EUT was set 3 meters away from the interference-receiving antenna, which was mounted on the top of a variable-height antenna tower.
- c. The antenna is a broadband antenna, and its height is varied from one meter to four meters above the ground to determine the maximum value of the field strength. Both horizontal and vertical polarizations of the antenna are set to make the measurement.
- d. For each suspected emission, the EUT was arranged to its worst case and then the antenna was tuned to heights from 1 meter to 4 meters and the rotatable table was turned from 0 degrees to 360 degrees to find the maximum reading.
- e. The test-receiver system was set to Peak Detect Function and Specified Bandwidth with Maximum Hold Mode.
- f. If the emission level of the EUT in peak mode was lower than the limit specified, then testing could be stopped and the peak values of the EUT would be reported. Otherwise the emissions would be re-tested one by one using peak, quasi-peak or average method as specified and then reported in a data sheet.

NOTE:

1. The resolution bandwidth and video bandwidth of test receiver/spectrum analyzer is 120kHz for Quasi-peak detection at frequency below 1GHz.
2. The resolution bandwidth of test receiver/spectrum analyzer is 1MHz and video bandwidth is 3MHz for Peak detection at frequency above 1GHz.
3. The resolution bandwidth of test receiver/spectrum analyzer is 1MHz and the video bandwidth is 10Hz for Average detection (AV) at frequency above 1GHz.
4. All modes of operation were investigated and the worst-case emissions are reported.

4.1.4 DEVIATION FROM TEST STANDARD

No deviation.

4.1.5 TEST SETUP

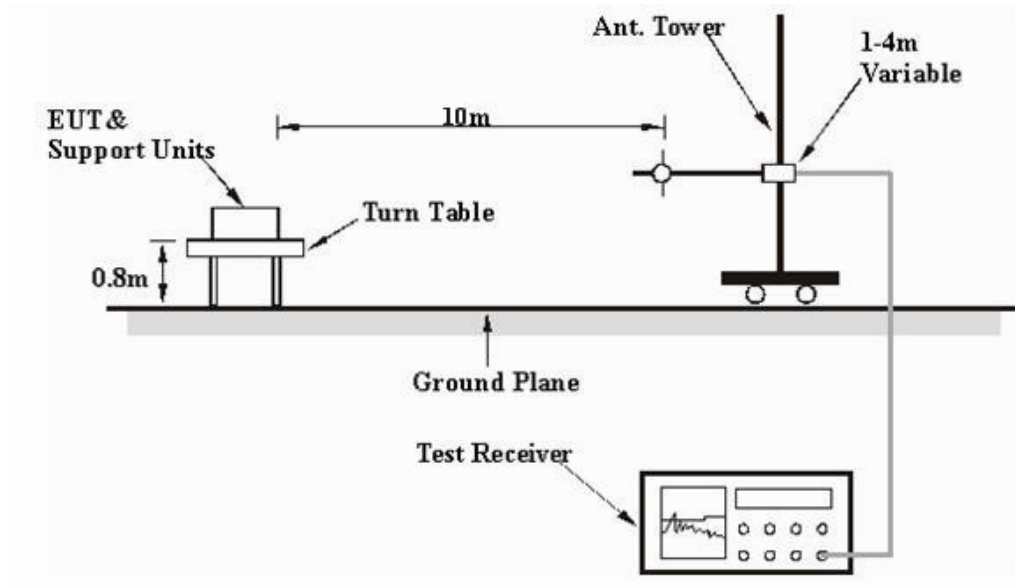

For the actual test configuration, please refer to the attached file (Test Setup Photo).

4.1.6 EUT OPERATING CONDITIONS

- a. Placed the EUT on the testing table.
- b. Prepared notebook system outside of testing area to act as a communication partners.
- c. The communication partner connected with EUT via a RJ45 UTP cable and run a test program (provided by manufacturer) to enable EUT under transmission condition continuously at specific channel frequency.
- d. The communication partner sent data to EUT by command "PING".



A D T

4.1.7 TEST RESULTS

802.11b

EUT TEST CONDITION		MEASUREMENT DETAIL	
CHANNEL	Channel 1	FREQUENCY RANGE	1 ~ 25GHz
INPUT POWER	120Vac, 60 Hz	DETECTOR FUNCTION	Peak (PK) Average (AV)
ENVIRONMENTAL CONDITIONS	23deg. C, 76%RH 1008 hPa	TESTED BY	Nick Chen
TEST MODE	A		

ANTENNA POLARITY & TEST DISTANCE: HORIZONTAL AT 3 M								
NO.	FREQ. (MHz)	EMISSION LEVEL (dBuV/m)	LIMIT (dBuV/m)	MARGIN (dB)	ANTENNA HEIGHT (m)	TABLE ANGLE (Degree)	RAW VALUE (dBuV)	CORRECTION FACTOR (dB/m)
1	2390.00	54.84 PK	74.00	-19.16	1.02 H	233	23.12	31.72
2	2390.00	45.26 AV	54.00	-8.74	1.02 H	233	13.53	31.72
3	*2412.00	98.22 PK			1.02 H	233	66.41	31.81
4	*2412.00	93.04 AV			1.02 H	233	61.23	31.81
5	#3216.00	41.60 PK	68.22	-26.62	1.10 H	319	7.37	34.23
6	#3216.00	29.03 AV	63.04	-34.01	1.10 H	319	-5.20	34.23
7	4824.00	49.30 PK	74.00	-24.70	1.11 H	136	11.58	37.71
8	4824.00	44.18 AV	54.00	-9.82	1.11 H	136	6.46	37.71
ANTENNA POLARITY & TEST DISTANCE: VERTICAL AT 3 M								
NO.	FREQ. (MHz)	EMISSION LEVEL (dBuV/m)	LIMIT (dBuV/m)	MARGIN (dB)	ANTENNA HEIGHT (m)	TABLE ANGLE (Degree)	RAW VALUE (dBuV)	CORRECTION FACTOR (dB/m)
1	2390.00	56.89 PK	74.00	-17.11	1.00 V	216	25.17	31.72
2	2390.00	45.98 AV	54.00	-8.02	1.00 V	216	14.26	31.72
3	*2412.00	110.74 PK			1.00 V	216	78.93	31.81
4	*2412.00	104.86 AV			1.00 V	216	73.05	31.81
5	#3216.00	46.17 PK	80.74	-34.57	1.12 V	95	11.94	34.23
6	#3216.00	41.16 AV	74.86	-33.70	1.12 V	95	6.93	34.23
7	4824.00	54.90 PK	74.00	-19.10	1.23 V	230	17.18	37.71
8	4824.00	52.25 AV	54.00	-1.75	1.23 V	230	14.53	37.71

- REMARKS:**
1. Emission level (dBuV/m) = Raw Value (dBuV) + Correction Factor (dB/m).
 2. Correction Factor (dB/m) = Antenna Factor (dB/m) + Cable Factor (dB).
 3. The other emission levels were very low against the limit.
 4. Margin value = Emission level – Limit value.
 5. “ * “: Fundamental frequency.
 6. “#”:The radiated frequency is out the restricted band.



A D T

EUT TEST CONDITION		MEASUREMENT DETAIL	
CHANNEL	Channel 6	FREQUENCY RANGE	1 ~ 25GHz
INPUT POWER	120Vac, 60 Hz	DETECTOR FUNCTION	Peak (PK) Average (AV)
ENVIRONMENTAL CONDITIONS	23deg. C, 76%RH 1008 hPa	TESTED BY	Nick Chen
TEST MODE	A		

ANTENNA POLARITY & TEST DISTANCE: HORIZONTAL AT 3 M								
NO.	FREQ. (MHz)	EMISSION LEVEL (dBuV/m)	LIMIT (dBuV/m)	MARGIN (dB)	ANTENNA HEIGHT (m)	TABLE ANGLE (Degree)	RAW VALUE (dBuV)	CORRECTION FACTOR (dB/m)
1	*2437.00	98.15 PK			1.04 H	117	66.23	31.92
2	*2437.00	92.83 AV			1.04 H	117	60.91	31.92
3	#3249.00	41.48 PK	68.15	-26.67	1.05 H	211	7.20	34.28
4	#3249.00	29.54 AV	62.83	-33.29	1.05 H	211	-4.74	34.28
5	4874.00	49.59 PK	74.00	-24.41	1.46 H	14	11.76	37.82
6	4874.00	44.46 AV	54.00	-9.54	1.46 H	14	6.63	37.82
ANTENNA POLARITY & TEST DISTANCE: VERTICAL AT 3 M								
NO.	FREQ. (MHz)	EMISSION LEVEL (dBuV/m)	LIMIT (dBuV/m)	MARGIN (dB)	ANTENNA HEIGHT (m)	TABLE ANGLE (Degree)	RAW VALUE (dBuV)	CORRECTION FACTOR (dB/m)
1	*2437.00	110.28 PK			1.35 V	26	78.36	31.92
2	*2437.00	104.14 AV			1.35 V	26	72.22	31.92
3	#3249.00	46.31 PK	80.28	-33.97	1.35 V	111	12.03	34.28
4	#3249.00	40.66 AV	74.14	-33.48	1.35 V	111	6.38	34.28
5	4874.00	54.94 PK	74.00	-19.06	1.37 V	228	17.12	37.82
6	4874.00	51.48 AV	54.00	-2.52	1.37 V	228	13.66	37.82

- REMARKS:**
1. Emission level (dBuV/m) = Raw Value (dBuV) + Correction Factor (dB/m).
 2. Correction Factor (dB/m) = Antenna Factor (dB/m) + Cable Factor (dB).
 3. The other emission levels were very low against the limit.
 4. Margin value = Emission level – Limit value.
 5. “ * “: Fundamental frequency.
 6. “#”:The radiated frequency is out the restricted band.



A D T

EUT TEST CONDITION		MEASUREMENT DETAIL	
CHANNEL	Channel 11	FREQUENCY RANGE	1 ~ 25GHz
INPUT POWER	120Vac, 60 Hz	DETECTOR FUNCTION	Peak (PK) Average (AV)
ENVIRONMENTAL CONDITIONS	23deg. C, 76%RH 1008 hPa	TESTED BY	Nick Chen
TEST MODE	A		

ANTENNA POLARITY & TEST DISTANCE: HORIZONTAL AT 3 M								
NO.	FREQ. (MHz)	EMISSION LEVEL (dBuV/m)	LIMIT (dBuV/m)	MARGIN (dB)	ANTENNA HEIGHT (m)	TABLE ANGLE (Degree)	RAW VALUE (dBuV)	CORRECTION FACTOR (dB/m)
1	*2462.00	98.16 PK			1.49 H	74	66.13	32.03
2	*2462.00	92.32 AV			1.49 H	74	60.29	32.03
3	2483.50	57.98 PK	74.00	-16.02	1.49 H	74	25.85	32.13
4	2483.50	46.51 AV	54.00	-7.49	1.49 H	74	14.38	32.13
5	#3282.00	41.24 PK	68.16	-26.92	1.00 H	273	6.92	34.32
6	#3282.00	27.21 AV	62.32	-35.11	1.00 H	273	-7.11	34.32
7	4924.00	47.36 PK	74.00	-26.64	1.22 H	160	9.43	37.92
8	4924.00	41.10 AV	54.00	-12.90	1.22 H	160	3.17	37.92
ANTENNA POLARITY & TEST DISTANCE: VERTICAL AT 3 M								
NO.	FREQ. (MHz)	EMISSION LEVEL (dBuV/m)	LIMIT (dBuV/m)	MARGIN (dB)	ANTENNA HEIGHT (m)	TABLE ANGLE (Degree)	RAW VALUE (dBuV)	CORRECTION FACTOR (dB/m)
1	*2462.00	109.14 PK			1.32 V	211	77.11	32.03
2	*2462.00	103.29 AV			1.32 V	211	71.26	32.03
3	2483.50	59.59 PK	74.00	-14.41	1.32 V	211	27.46	32.13
4	2483.50	48.45 AV	54.00	-5.55	1.32 V	211	16.32	32.13
5	#3282.00	42.81 PK	79.14	-36.33	1.34 V	248	8.49	34.32
6	#3282.00	35.61 AV	73.29	-37.68	1.34 V	248	1.29	34.32
7	4924.00	53.65 PK	74.00	-20.35	1.23 V	287	15.73	37.92
8	4924.00	51.07 AV	54.00	-2.93	1.23 V	287	13.15	37.92

- REMARKS:**
1. Emission level (dBuV/m) = Raw Value (dBuV) + Correction Factor (dB/m).
 2. Correction Factor (dB/m) = Antenna Factor (dB/m) + Cable Factor (dB).
 3. The other emission levels were very low against the limit.
 4. Margin value = Emission level – Limit value.
 5. “ * “: Fundamental frequency.
 6. “#”: The radiated frequency is out the restricted band.



A D T

802.11g

EUT TEST CONDITION		MEASUREMENT DETAIL	
CHANNEL	Channel 1	FREQUENCY RANGE	1 ~ 25GHz
INPUT POWER	120Vac, 60 Hz	DETECTOR FUNCTION	Peak (PK) Average (AV)
ENVIRONMENTAL CONDITIONS	23deg. C, 76%RH 1008 hPa	TESTED BY	Nick Chen
TEST MODE	A		

ANTENNA POLARITY & TEST DISTANCE: HORIZONTAL AT 3 M								
NO.	FREQ. (MHz)	EMISSION LEVEL (dBuV/m)	LIMIT (dBuV/m)	MARGIN (dB)	ANTENNA HEIGHT (m)	TABLE ANGLE (Degree)	RAW VALUE (dBuV)	CORRECTION FACTOR (dB/m)
1	2390.00	55.45 PK	74.00	-18.55	1.00 H	295	23.72	31.72
2	2390.00	45.42 AV	54.00	-8.58	1.00 H	295	13.70	31.72
3	*2412.00	100.13 PK			1.00 H	295	68.32	31.81
4	*2412.00	88.12 AV			1.00 H	295	56.31	31.81
5	#3216.00	44.97 PK	70.13	-25.16	1.40 H	331	10.74	34.23
6	#3216.00	38.27 AV	58.12	-19.85	1.40 H	331	4.04	34.23
7	4824.00	46.99 PK	74.00	-27.01	1.42 H	160	9.27	37.71
8	4824.00	33.98 AV	54.00	-20.02	1.42 H	160	-3.74	37.71
ANTENNA POLARITY & TEST DISTANCE: VERTICAL AT 3 M								
NO.	FREQ. (MHz)	EMISSION LEVEL (dBuV/m)	LIMIT (dBuV/m)	MARGIN (dB)	ANTENNA HEIGHT (m)	TABLE ANGLE (Degree)	RAW VALUE (dBuV)	CORRECTION FACTOR (dB/m)
1	2390.00	58.83 PK	74.00	-15.17	1.06 V	337	27.10	31.72
2	2390.00	46.31 AV	54.00	-7.69	1.06 V	337	14.59	31.72
3	*2412.00	112.34 PK			1.06 V	337	80.53	31.81
4	*2412.00	100.90 AV			1.06 V	337	69.09	31.81
5	#3216.00	52.69 PK	82.34	-29.65	1.38 V	109	18.46	34.23
6	#3216.00	50.65 AV	70.90	-20.25	1.38 V	109	16.42	34.23
7	4824.00	50.22 PK	74.00	-23.78	1.46 V	235	12.50	37.71
8	4824.00	36.27 AV	54.00	-17.73	1.46 V	235	-1.45	37.71

- REMARKS:**
1. Emission level (dBuV/m) = Raw Value (dBuV) + Correction Factor (dB/m).
 2. Correction Factor (dB/m) = Antenna Factor (dB/m) + Cable Factor (dB).
 3. The other emission levels were very low against the limit.
 4. Margin value = Emission level – Limit value.
 5. “ * “: Fundamental frequency.
 6. “#”:The radiated frequency is out the restricted band.



A D T

EUT TEST CONDITION		MEASUREMENT DETAIL	
CHANNEL	Channel 6	FREQUENCY RANGE	1 ~ 25GHz
INPUT POWER	120Vac, 60 Hz	DETECTOR FUNCTION	Peak (PK) Average (AV)
ENVIRONMENTAL CONDITIONS	23deg. C, 76%RH 1008 hPa	TESTED BY	Nick Chen
TEST MODE	A		

ANTENNA POLARITY & TEST DISTANCE: HORIZONTAL AT 3 M								
NO.	FREQ. (MHz)	EMISSION LEVEL (dBuV/m)	LIMIT (dBuV/m)	MARGIN (dB)	ANTENNA HEIGHT (m)	TABLE ANGLE (Degree)	RAW VALUE (dBuV)	CORRECTION FACTOR (dB/m)
1	*2437.00	100.76 PK			1.09 H	7	68.84	31.92
2	*2437.00	88.50 AV			1.09 H	7	56.58	31.92
3	#3249.00	42.09 PK	70.76	-28.67	1.38 H	40	7.81	34.28
4	#3249.00	36.11 AV	58.50	-22.39	1.38 H	40	1.83	34.28
5	4874.00	46.21 PK	74.00	-27.79	1.41 H	80	8.38	37.82
6	4874.00	33.00 AV	54.00	-21.00	1.41 H	80	-4.83	37.82
ANTENNA POLARITY & TEST DISTANCE: VERTICAL AT 3 M								
NO.	FREQ. (MHz)	EMISSION LEVEL (dBuV/m)	LIMIT (dBuV/m)	MARGIN (dB)	ANTENNA HEIGHT (m)	TABLE ANGLE (Degree)	RAW VALUE (dBuV)	CORRECTION FACTOR (dB/m)
1	*2437.00	112.58 PK			1.00 V	88	80.66	31.92
2	*2437.00	101.28 AV			1.00 V	88	69.36	31.92
3	#3249.00	47.67 PK	82.58	-34.91	1.00 V	93	13.39	34.28
4	#3249.00	43.21 AV	71.28	-28.07	1.00 V	93	8.93	34.28
5	4874.00	49.62 PK	74.00	-24.38	1.42 V	229	11.79	37.82
6	4874.00	36.41 AV	54.00	-17.59	1.42 V	229	-1.42	37.82

- REMARKS:**
1. Emission level (dBuV/m) = Raw Value (dBuV) + Correction Factor (dB/m).
 2. Correction Factor (dB/m) = Antenna Factor (dB/m) + Cable Factor (dB).
 3. The other emission levels were very low against the limit.
 4. Margin value = Emission level – Limit value.
 5. “ * “: Fundamental frequency.
 6. “#”:The radiated frequency is out the restricted band.



A D T

EUT TEST CONDITION		MEASUREMENT DETAIL	
CHANNEL	Channel 11	FREQUENCY RANGE	1 ~ 25GHz
INPUT POWER	120Vac, 60 Hz	DETECTOR FUNCTION	Peak (PK) Average (AV)
ENVIRONMENTAL CONDITIONS	23deg. C, 76%RH 1008 hPa	TESTED BY	Nick Chen
TEST MODE	A		

ANTENNA POLARITY & TEST DISTANCE: HORIZONTAL AT 3 M								
NO.	FREQ. (MHz)	EMISSION LEVEL (dBuV/m)	LIMIT (dBuV/m)	MARGIN (dB)	ANTENNA HEIGHT (m)	TABLE ANGLE (Degree)	RAW VALUE (dBuV)	CORRECTION FACTOR (dB/m)
1	*2462.00	101.10 PK			1.49 H	205	69.07	32.03
2	*2462.00	88.86 AV			1.49 H	205	56.83	32.03
3	2483.50	57.15 PK	74.00	-16.85	1.49 H	205	25.02	32.13
4	2483.50	46.02 AV	54.00	-7.98	1.49 H	205	13.89	32.13
5	#3282.00	42.77 PK	71.10	-28.33	1.56 H	168	8.45	34.32
6	#3282.00	35.03 AV	58.86	-23.83	1.56 H	168	0.71	34.32
7	4924.00	46.04 PK	74.00	-27.96	1.45 H	191	8.11	37.92
8	4924.00	32.25 AV	54.00	-21.75	1.45 H	191	-5.68	37.92
ANTENNA POLARITY & TEST DISTANCE: VERTICAL AT 3 M								
NO.	FREQ. (MHz)	EMISSION LEVEL (dBuV/m)	LIMIT (dBuV/m)	MARGIN (dB)	ANTENNA HEIGHT (m)	TABLE ANGLE (Degree)	RAW VALUE (dBuV)	CORRECTION FACTOR (dB/m)
1	*2462.00	112.16 PK			1.00 V	90	80.13	32.03
2	*2462.00	99.72 AV			1.00 V	90	67.69	32.03
3	2483.50	65.43 PK	74.00	-8.57	1.00 V	90	33.30	32.13
4	2483.50	49.27 AV	54.00	-4.73	1.00 V	90	17.14	32.13
5	#3282.00	48.49 PK	82.16	-33.67	1.33 V	250	14.17	34.32
6	#3282.00	44.54 AV	69.72	-25.18	1.33 V	250	10.22	34.32
7	4924.00	47.94 PK	74.00	-26.06	1.23 V	96	10.01	37.92
8	4924.00	34.88 AV	54.00	-19.12	1.23 V	96	-3.05	37.92

- REMARKS:**
1. Emission level (dBuV/m) = Raw Value (dBuV) + Correction Factor (dB/m).
 2. Correction Factor (dB/m) = Antenna Factor (dB/m) + Cable Factor (dB).
 3. The other emission levels were very low against the limit.
 4. Margin value = Emission level – Limit value.
 5. “ * “: Fundamental frequency.
 6. “#”:The radiated frequency is out the restricted band.



A D T

802.11n (20MHz)

EUT TEST CONDITION		MEASUREMENT DETAIL	
CHANNEL	Channel 1	FREQUENCY RANGE	1 ~ 25GHz
INPUT POWER	120Vac, 60 Hz	DETECTOR FUNCTION	Peak (PK) Average (AV)
ENVIRONMENTAL CONDITIONS	23deg. C, 76%RH 1008 hPa	TESTED BY	Nick Chen
TEST MODE	A		

ANTENNA POLARITY & TEST DISTANCE: HORIZONTAL AT 3 M								
NO.	FREQ. (MHz)	EMISSION LEVEL (dBuV/m)	LIMIT (dBuV/m)	MARGIN (dB)	ANTENNA HEIGHT (m)	TABLE ANGLE (Degree)	RAW VALUE (dBuV)	CORRECTION FACTOR (dB/m)
1	2390.00	55.17 PK	74.00	-18.83	1.00 H	298	23.45	31.72
2	2390.00	45.37 AV	54.00	-8.62	1.00 H	298	13.65	31.72
3	*2412.00	100.05 PK			1.00 H	298	68.24	31.81
4	*2412.00	87.36 AV			1.00 H	298	55.55	31.81
5	#3216.00	43.34 PK	70.05	-26.71	1.37 H	6	9.11	34.23
6	#3216.00	37.03 AV	57.36	-20.33	1.37 H	6	2.80	34.23
7	4824.00	45.64 PK	74.00	-28.36	1.39 H	10	7.92	37.71
8	4824.00	33.51 AV	54.00	-20.49	1.39 H	10	-4.21	37.71
ANTENNA POLARITY & TEST DISTANCE: VERTICAL AT 3 M								
NO.	FREQ. (MHz)	EMISSION LEVEL (dBuV/m)	LIMIT (dBuV/m)	MARGIN (dB)	ANTENNA HEIGHT (m)	TABLE ANGLE (Degree)	RAW VALUE (dBuV)	CORRECTION FACTOR (dB/m)
1	2390.00	58.20 PK	74.00	-15.80	1.00 V	337	26.48	31.72
2	2390.00	46.81 AV	54.00	-7.19	1.00 V	337	15.09	31.72
3	*2412.00	111.38 PK			1.00 V	337	79.57	31.81
4	*2412.00	97.83 AV			1.00 V	337	66.02	31.81
5	#3216.00	50.91 PK	81.38	-30.47	1.38 V	93	16.68	34.23
6	#3216.00	47.54 AV	67.83	-20.29	1.38 V	93	13.31	34.23
7	4824.00	51.00 PK	74.00	-23.00	1.42 V	289	13.28	37.71
8	4824.00	37.92 AV	54.00	-16.08	1.42 V	289	0.20	37.71

- REMARKS:**
1. Emission level (dBuV/m) = Raw Value (dBuV) + Correction Factor (dB/m).
 2. Correction Factor (dB/m) = Antenna Factor (dB/m) + Cable Factor (dB).
 3. The other emission levels were very low against the limit.
 4. Margin value = Emission level – Limit value.
 5. “ * “: Fundamental frequency.
 6. “#”:The radiated frequency is out the restricted band.



A D T

EUT TEST CONDITION		MEASUREMENT DETAIL	
CHANNEL	Channel 6	FREQUENCY RANGE	1 ~ 25GHz
INPUT POWER	120Vac, 60 Hz	DETECTOR FUNCTION	Peak (PK) Average (AV)
ENVIRONMENTAL CONDITIONS	23deg. C, 76%RH 1008 hPa	TESTED BY	Nick Chen
TEST MODE	A		

ANTENNA POLARITY & TEST DISTANCE: HORIZONTAL AT 3 M								
NO.	FREQ. (MHz)	EMISSION LEVEL (dBuV/m)	LIMIT (dBuV/m)	MARGIN (dB)	ANTENNA HEIGHT (m)	TABLE ANGLE (Degree)	RAW VALUE (dBuV)	CORRECTION FACTOR (dB/m)
1	*2437.00	100.14 PK			1.00 H	266	68.22	31.92
2	*2437.00	88.02 AV			1.00 H	266	56.10	31.92
3	#3249.00	43.43 PK	70.14	-26.71	1.46 H	12	9.15	34.28
4	#3249.00	36.91 AV	58.02	-21.11	1.46 H	12	2.63	34.28
5	4874.00	48.07 PK	74.00	-25.93	1.45 H	194	10.24	37.82
6	4874.00	35.87 AV	54.00	-18.13	1.45 H	194	-1.95	37.82
ANTENNA POLARITY & TEST DISTANCE: VERTICAL AT 3 M								
NO.	FREQ. (MHz)	EMISSION LEVEL (dBuV/m)	LIMIT (dBuV/m)	MARGIN (dB)	ANTENNA HEIGHT (m)	TABLE ANGLE (Degree)	RAW VALUE (dBuV)	CORRECTION FACTOR (dB/m)
1	*2437.00	112.50 PK			1.00 V	26	80.58	31.92
2	*2437.00	99.56 AV			1.00 V	26	67.64	31.92
3	#3249.00	47.61 PK	82.50	-34.89	1.00 V	92	13.33	34.28
4	#3249.00	43.48 AV	69.56	-26.08	1.00 V	92	9.20	34.28
5	4874.00	49.43 PK	74.00	-24.57	1.35 V	225	11.60	37.82
6	4874.00	36.48 AV	54.00	-17.52	1.35 V	225	-1.35	37.82

- REMARKS:**
1. Emission level (dBuV/m) = Raw Value (dBuV) + Correction Factor (dB/m).
 2. Correction Factor (dB/m) = Antenna Factor (dB/m) + Cable Factor (dB).
 3. The other emission levels were very low against the limit.
 4. Margin value = Emission level – Limit value.
 5. “ * “: Fundamental frequency.
 6. “#”:The radiated frequency is out the restricted band.



A D T

EUT TEST CONDITION		MEASUREMENT DETAIL	
CHANNEL	Channel 11	FREQUENCY RANGE	1 ~ 25GHz
INPUT POWER	120Vac, 60 Hz	DETECTOR FUNCTION	Peak (PK) Average (AV)
ENVIRONMENTAL CONDITIONS	23deg. C, 76%RH 1008 hPa	TESTED BY	Nick Chen
TEST MODE	A		

ANTENNA POLARITY & TEST DISTANCE: HORIZONTAL AT 3 M								
NO.	FREQ. (MHz)	EMISSION LEVEL (dBuV/m)	LIMIT (dBuV/m)	MARGIN (dB)	ANTENNA HEIGHT (m)	TABLE ANGLE (Degree)	RAW VALUE (dBuV)	CORRECTION FACTOR (dB/m)
1	*2462.00	100.58 PK			1.00 H	8	68.55	32.03
2	*2462.00	88.37 AV			1.00 H	8	56.34	32.03
3	2483.50	57.23 PK	74.00	-16.77	1.00 H	8	25.10	32.13
4	2483.50	46.32 AV	54.00	-7.68	1.00 H	8	14.19	32.13
5	#3282.00	43.70 PK	70.58	-26.88	1.54 H	172	9.38	34.32
6	#3282.00	37.37 AV	58.37	-21.00	1.54 H	172	3.05	34.32
7	4924.00	46.13 PK	74.00	-27.87	1.52 H	354	8.20	37.92
8	4924.00	33.89 AV	54.00	-20.11	1.52 H	354	-4.03	37.92
ANTENNA POLARITY & TEST DISTANCE: VERTICAL AT 3 M								
NO.	FREQ. (MHz)	EMISSION LEVEL (dBuV/m)	LIMIT (dBuV/m)	MARGIN (dB)	ANTENNA HEIGHT (m)	TABLE ANGLE (Degree)	RAW VALUE (dBuV)	CORRECTION FACTOR (dB/m)
1	*2462.00	112.25 PK			1.00 V	90	80.22	32.03
2	*2462.00	99.79 AV			1.00 V	90	67.76	32.03
3	2483.50	67.91 PK	74.00	-6.09	1.00 V	90	35.78	32.13
4	2483.50	50.36 AV	54.00	-3.64	1.00 V	90	18.23	32.13
5	#3282.00	48.02 PK	82.25	-34.23	1.34 V	247	13.70	34.32
6	#3282.00	44.10 AV	69.79	-25.69	1.34 V	247	9.78	34.32
7	4924.00	49.16 PK	74.00	-24.84	1.20 V	97	11.23	37.92
8	4924.00	36.13 AV	54.00	-17.87	1.20 V	97	-1.79	37.92

- REMARKS:**
1. Emission level (dBuV/m) = Raw Value (dBuV) + Correction Factor (dB/m).
 2. Correction Factor (dB/m) = Antenna Factor (dB/m) + Cable Factor (dB).
 3. The other emission levels were very low against the limit.
 4. Margin value = Emission level – Limit value.
 5. “ * “: Fundamental frequency.
 6. “#”:The radiated frequency is out the restricted band.



A D T

802.11n (40MHz)

EUT TEST CONDITION		MEASUREMENT DETAIL	
CHANNEL	Channel 1	FREQUENCY RANGE	1 ~ 25GHz
INPUT POWER	120Vac, 60 Hz	DETECTOR FUNCTION	Peak (PK) Average (AV)
ENVIRONMENTAL CONDITIONS	23deg. C, 76%RH 1008 hPa	TESTED BY	Nick Chen
TEST MODE	A		

ANTENNA POLARITY & TEST DISTANCE: HORIZONTAL AT 3 M								
NO.	FREQ. (MHz)	EMISSION LEVEL (dBuV/m)	LIMIT (dBuV/m)	MARGIN (dB)	ANTENNA HEIGHT (m)	TABLE ANGLE (Degree)	RAW VALUE (dBuV)	CORRECTION FACTOR (dB/m)
1	2390.00	54.33 PK	74.00	-19.67	1.21 H	342	22.61	31.72
2	2390.00	39.06 AV	54.00	-14.94	1.21 H	342	7.34	31.72
3	*2422.00	97.31 PK			1.21 H	342	65.45	31.86
4	*2422.00	83.64 AV			1.21 H	342	51.78	31.86
5	#3230.00	44.43 PK	67.31	-22.88	1.11 H	204	10.18	34.25
6	#3230.00	37.06 AV	53.64	-16.58	1.11 H	204	2.81	34.25
7	4844.00	44.99 PK	74.00	-29.01	1.22 H	31	7.23	37.76
8	4844.00	31.73 AV	54.00	-22.27	1.22 H	31	-6.03	37.76
ANTENNA POLARITY & TEST DISTANCE: VERTICAL AT 3 M								
NO.	FREQ. (MHz)	EMISSION LEVEL (dBuV/m)	LIMIT (dBuV/m)	MARGIN (dB)	ANTENNA HEIGHT (m)	TABLE ANGLE (Degree)	RAW VALUE (dBuV)	CORRECTION FACTOR (dB/m)
1	2390.00	71.82 PK	74.00	-2.18	1.00 V	339	40.10	31.72
2	2390.00	51.11 AV	54.00	-2.89	1.00 V	339	19.39	31.72
3	*2422.00	110.31 PK			1.00 V	339	78.45	31.86
4	*2422.00	95.63 AV			1.00 V	339	63.77	31.86
5	#3230.00	51.73 PK	80.31	-28.58	1.13 V	101	17.48	34.25
6	#3230.00	48.51 AV	65.63	-17.12	1.13 V	101	14.26	34.25
7	4844.00	47.83 PK	74.00	-26.17	1.33 V	201	10.07	37.76
8	4844.00	34.62 AV	54.00	-19.38	1.33 V	201	-3.14	37.76

- REMARKS:**
1. Emission level (dBuV/m) = Raw Value (dBuV) + Correction Factor (dB/m).
 2. Correction Factor (dB/m) = Antenna Factor (dB/m) + Cable Factor (dB).
 3. The other emission levels were very low against the limit.
 4. Margin value = Emission level – Limit value.
 5. “ * “: Fundamental frequency.
 6. “#”:The radiated frequency is out the restricted band.



A D T

EUT TEST CONDITION		MEASUREMENT DETAIL	
CHANNEL	Channel 4	FREQUENCY RANGE	1 ~ 25GHz
INPUT POWER	120Vac, 60 Hz	DETECTOR FUNCTION	Peak (PK) Average (AV)
ENVIRONMENTAL CONDITIONS	23deg. C, 76%RH 1008 hPa	TESTED BY	Nick Chen
TEST MODE	A		

ANTENNA POLARITY & TEST DISTANCE: HORIZONTAL AT 3 M								
NO.	FREQ. (MHz)	EMISSION LEVEL (dBuV/m)	LIMIT (dBuV/m)	MARGIN (dB)	ANTENNA HEIGHT (m)	TABLE ANGLE (Degree)	RAW VALUE (dBuV)	CORRECTION FACTOR (dB/m)
1	*2437.00	97.64 PK			1.00 H	266	65.72	31.92
2	*2437.00	83.51 AV			1.00 H	266	51.59	31.92
3	#3249.00	44.12 PK	67.64	-23.52	1.38 H	201	9.84	34.28
4	#3249.00	36.40 AV	53.51	-17.11	1.38 H	201	2.12	34.28
5	4874.00	45.95 PK	74.00	-28.05	1.28 H	126	8.12	37.82
6	4874.00	31.87 AV	54.00	-22.13	1.28 H	126	-5.96	37.82
ANTENNA POLARITY & TEST DISTANCE: VERTICAL AT 3 M								
NO.	FREQ. (MHz)	EMISSION LEVEL (dBuV/m)	LIMIT (dBuV/m)	MARGIN (dB)	ANTENNA HEIGHT (m)	TABLE ANGLE (Degree)	RAW VALUE (dBuV)	CORRECTION FACTOR (dB/m)
1	*2437.00	110.00 PK			1.00 V	336	78.08	31.92
2	*2437.00	95.36 AV			1.00 V	336	63.44	31.92
3	#3249.00	49.60 PK	80.00	-30.40	1.38 V	110	15.32	34.28
4	#3249.00	44.46 AV	65.36	-20.90	1.38 V	110	10.18	34.28
5	4874.00	49.57 PK	74.00	-24.43	1.42 V	96	11.74	37.82
6	4874.00	36.31 AV	54.00	-17.69	1.42 V	96	-1.52	37.82

- REMARKS:**
1. Emission level (dBuV/m) = Raw Value (dBuV) + Correction Factor (dB/m).
 2. Correction Factor (dB/m) = Antenna Factor (dB/m) + Cable Factor (dB).
 3. The other emission levels were very low against the limit.
 4. Margin value = Emission level – Limit value.
 5. “ * “: Fundamental frequency.
 6. “#”:The radiated frequency is out the restricted band.



A D T

EUT TEST CONDITION		MEASUREMENT DETAIL	
CHANNEL	Channel 7	FREQUENCY RANGE	1 ~ 25GHz
INPUT POWER	120Vac, 60 Hz	DETECTOR FUNCTION	Peak (PK) Average (AV)
ENVIRONMENTAL CONDITIONS	23deg. C, 76%RH 1008 hPa	TESTED BY	Nick Chen
TEST MODE	A		

ANTENNA POLARITY & TEST DISTANCE: HORIZONTAL AT 3 M								
NO.	FREQ. (MHz)	EMISSION LEVEL (dBuV/m)	LIMIT (dBuV/m)	MARGIN (dB)	ANTENNA HEIGHT (m)	TABLE ANGLE (Degree)	RAW VALUE (dBuV)	CORRECTION FACTOR (dB/m)
1	*2452.00	98.21 PK			1.01 H	233	66.22	31.99
2	*2452.00	84.42 AV			1.01 H	233	52.43	31.99
3	2483.50	58.63 PK	74.00	-15.37	1.01 H	233	26.50	32.13
4	2483.50	40.01 AV	54.00	-13.99	1.01 H	233	7.88	32.13
5	#3269.00	43.61 PK	68.21	-24.60	1.22 H	298	9.30	34.31
6	#3269.00	34.29 AV	54.42	-20.13	1.22 H	298	-0.02	34.31
7	4904.00	44.09 PK	74.00	-29.91	1.19 H	334	6.20	37.89
8	4904.00	31.22 AV	54.00	-22.78	1.19 H	334	-6.67	37.89
ANTENNA POLARITY & TEST DISTANCE: VERTICAL AT 3 M								
NO.	FREQ. (MHz)	EMISSION LEVEL (dBuV/m)	LIMIT (dBuV/m)	MARGIN (dB)	ANTENNA HEIGHT (m)	TABLE ANGLE (Degree)	RAW VALUE (dBuV)	CORRECTION FACTOR (dB/m)
1	*2452.00	111.63 PK			1.05 V	33	79.64	31.99
2	*2452.00	98.21 AV			1.05 V	33	66.22	31.99
3	2483.50	66.84 PK	74.00	-7.16	1.05 V	33	34.71	32.13
4	2483.50	46.99 AV	54.00	-7.01	1.05 V	33	14.86	32.13
5	#3269.00	49.03 PK	81.63	-32.60	1.29 V	244	14.72	34.31
6	#3269.00	45.33 AV	68.21	-22.88	1.29 V	244	11.02	34.31
7	4904.00	48.62 PK	74.00	-25.38	1.30 V	88	10.73	37.89
8	4904.00	34.97 AV	54.00	-19.03	1.30 V	88	-2.92	37.89

- REMARKS:**
1. Emission level (dBuV/m) = Raw Value (dBuV) + Correction Factor (dB/m).
 2. Correction Factor (dB/m) = Antenna Factor (dB/m) + Cable Factor (dB).
 3. The other emission levels were very low against the limit.
 4. Margin value = Emission level – Limit value.
 5. “ * “: Fundamental frequency.
 6. “#”:The radiated frequency is out the restricted band.



A D T

BELOW 1GHz WORST-CASE DATA : 802.11b

EUT TEST CONDITION		MEASUREMENT DETAIL	
CHANNEL	Channel 6	FREQUENCY RANGE	Below 1000MHz
INPUT POWER	120Vac, 60 Hz	DETECTOR FUNCTION	Quasi-Peak
ENVIRONMENTAL CONDITIONS	23deg. C, 76%RH 1008 hPa	TESTED BY	Nick Chen
TEST MODE	A		

ANTENNA POLARITY & TEST DISTANCE: HORIZONTAL AT 3 M								
NO.	FREQ. (MHz)	EMISSION LEVEL (dBuV/m)	LIMIT (dBuV/m)	MARGIN (dB)	ANTENNA HEIGHT (m)	TABLE ANGLE (Degree)	RAW VALUE (dBuV)	CORRECTION FACTOR (dB/m)
1	62.75	28.63 QP	40.00	-11.37	1.03 H	326	21.15	7.48
2	146.38	29.51 QP	43.50	-13.99	1.09 H	162	15.82	13.69
3	250.01	39.51 QP	46.00	-6.49	1.75 H	201	23.95	15.56
4	340.01	45.82 QP	46.00	-0.18	1.00 H	179	27.87	17.95
5	500.01	36.19 QP	46.00	-9.81	1.02 H	111	12.88	23.31
6	600.01	39.16 QP	46.00	-6.84	2.11 H	217	14.08	25.08
7	680.02	45.73 QP	46.00	-0.27	1.38 H	12	19.93	25.80
8	1000.00	36.95 QP	54.00	-17.05	1.75 H	222	6.83	30.12
ANTENNA POLARITY & TEST DISTANCE: VERTICAL AT 3 M								
NO.	FREQ. (MHz)	EMISSION LEVEL (dBuV/m)	LIMIT (dBuV/m)	MARGIN (dB)	ANTENNA HEIGHT (m)	TABLE ANGLE (Degree)	RAW VALUE (dBuV)	CORRECTION FACTOR (dB/m)
1	64.92	33.25 QP	40.00	-6.75	1.19 V	185	25.68	7.57
2	82.95	32.36 QP	40.00	-7.64	1.24 V	218	22.98	9.38
3	125.02	35.25 QP	43.50	-8.25	1.09 V	32	22.48	12.77
4	250.01	33.08 QP	46.00	-12.92	1.32 V	173	17.52	15.56
5	374.99	35.25 QP	46.00	-10.75	1.01 V	12	16.02	19.23
6	500.01	38.32 QP	46.00	-7.68	1.05 V	311	15.01	23.31
7	625.00	35.87 QP	46.00	-10.13	1.06 V	152	10.54	25.33
8	680.02	43.21 QP	46.00	-2.79	1.01 V	112	17.41	25.80
9	1000.00	43.65 QP	54.00	-10.35	1.02 V	115	13.53	30.12

- REMARKS:**
1. Emission level (dBuV/m) = Raw Value (dBuV) + Correction Factor (dB/m).
 2. Correction Factor (dB/m) = Antenna Factor (dB/m) + Cable Factor (dB).
 3. The other emission levels were very low against the limit.
 4. Margin value = Emission level – Limit value.



A D T

BELOW 1GHz WORST-CASE DATA : 802.11b

EUT TEST CONDITION		MEASUREMENT DETAIL	
CHANNEL	Channel 6	FREQUENCY RANGE	Below 1000MHz
INPUT POWER	120Vac, 60 Hz	DETECTOR FUNCTION	Quasi-Peak
ENVIRONMENTAL CONDITIONS	23deg. C, 76%RH 1008 hPa	TESTED BY	Nick Chen
TEST MODE	B		

ANTENNA POLARITY & TEST DISTANCE: HORIZONTAL AT 3 M								
NO.	FREQ. (MHz)	EMISSION LEVEL (dBuV/m)	LIMIT (dBuV/m)	MARGIN (dB)	ANTENNA HEIGHT (m)	TABLE ANGLE (Degree)	RAW VALUE (dBuV)	CORRECTION FACTOR (dB/m)
1	57.12	28.30 QP	40.00	-11.70	1.17 H	267	20.66	7.64
2	125.01	32.36 QP	43.50	-11.14	1.00 H	342	19.59	12.77
3	250.00	41.57 QP	46.00	-4.43	1.54 H	226	26.01	15.56
4	340.00	45.73 QP	46.00	-0.27	1.07 H	178	27.78	17.95
5	625.02	34.59 QP	46.00	-11.41	1.37 H	85	9.26	25.33
6	680.01	45.26 QP	46.00	-0.74	1.13 H	237	19.46	25.80
7	750.03	37.51 QP	46.00	-8.49	1.18 H	242	10.72	26.79
8	1000.00	41.34 QP	54.00	-12.66	1.25 H	74	11.22	30.12
ANTENNA POLARITY & TEST DISTANCE: VERTICAL AT 3 M								
NO.	FREQ. (MHz)	EMISSION LEVEL (dBuV/m)	LIMIT (dBuV/m)	MARGIN (dB)	ANTENNA HEIGHT (m)	TABLE ANGLE (Degree)	RAW VALUE (dBuV)	CORRECTION FACTOR (dB/m)
1	52.91	38.33 QP	40.00	-1.67	1.00 V	39	30.28	8.05
2	70.60	34.30 QP	40.00	-5.70	1.13 V	67	26.45	7.85
3	125.01	34.54 QP	43.50	-8.96	1.25 V	0	21.77	12.77
4	250.01	35.61 QP	46.00	-10.39	1.36 V	305	20.05	15.56
5	340.00	34.44 QP	46.00	-11.56	1.28 V	19	16.49	17.95
6	600.01	40.86 QP	46.00	-5.14	1.00 V	159	15.78	25.08
7	625.01	39.96 QP	46.00	-6.04	1.10 V	111	14.63	25.33
8	750.03	40.12 QP	46.00	-5.88	1.17 V	332	13.33	26.79
9	1000.00	42.47 QP	54.00	-11.53	1.38 V	344	12.35	30.12

- REMARKS:**
1. Emission level (dBuV/m) = Raw Value (dBuV) + Correction Factor (dB/m).
 2. Correction Factor (dB/m) = Antenna Factor (dB/m) + Cable Factor (dB).
 3. The other emission levels were very low against the limit.
 4. Margin value = Emission level – Limit value.



4.2 CONDUCTED EMISSION MEASUREMENT

4.2.1 LIMITS OF CONDUCTED EMISSION MEASUREMENT

FREQUENCY OF EMISSION (MHz)	CONDUCTED LIMIT (dB μ V)	
	Quasi-peak	Average
0.15 ~ 0.5	66 to 56	56 to 46
0.5 ~ 5	56	46
5 ~ 30	60	50

- NOTE:** 1. The lower limit shall apply at the transition frequencies.
2. The limit decreases in line with the logarithm of the frequency in the range of 0.15 to 0.50MHz.
3. All emanations from a class A/B digital device or system, including any network of conductors and apparatus connected thereto, shall not exceed the level of field strengths specified above.

4.2.2 TEST INSTRUMENTS

DESCRIPTION & MANUFACTURER	MODEL NO.	SERIAL NO.	DATE OF CALIBRATION	DUE DATE OF CALIBRATION
ROHDE & SCHWARZ Test Receiver	ESCS 30	838251/021	Mar. 05, 2009	Mar. 04, 2010
ROHDE & SCHWARZ Artificial Mains Network (for EUT)	ESH3-Z5	100218	Nov. 26, 2008	Nov. 25, 2009
LISN With Adapter (for EUT)	AD10	C10Ada-001	Nov. 26, 2008	Nov. 25, 2009
ROHDE & SCHWARZ Artificial Mains Network (for peripherals)	ESH3-Z5	100219	Nov. 20, 2008	Nov. 19, 2009
Software	ADT_Cond_V7.3. 7	NA	NA	NA
Software	ADT_ISN_V7.3.7	NA	NA	NA
RF cable (JYBAO)	5D-FB	Cable-C10.01	Feb. 26, 2009	Feb. 25, 2010
SUHNTER Terminator (For ROHDE & SCHWARZ LISN)	65BNC-5001	E1-010773	Feb. 27, 2009	Feb. 26, 2010

- NOTE:** 1. The calibration interval of the above test instruments is 12 months and the calibrations are traceable to NML/ROC and NIST/USA.
2. The test was performed in Shielded Room No. 10.
3. The VCCI Site Registration No. C-1852.



A D T

4.2.3 TEST PROCEDURES

- a. The EUT was placed 0.4 meters from the conducting wall of the shielded room with EUT being connected to the power mains through a line impedance stabilization network (LISN). Other support units were connected to the power mains through another LISN. The two LISNs provide 50 ohm/ 50uH of coupling impedance for the measuring instrument.
- b. Both lines of the power mains connected to the EUT were checked for maximum conducted interference.
- c. The frequency range from 150kHz to 30MHz was searched. Emission levels under (Limit - 20dB) was not recorded.

NOTE: All modes of operation were investigated and the worst-case emissions are reported.

4.2.4 DEVIATION FROM TEST STANDARD

No deviation.

4.2.5 TEST SETUP

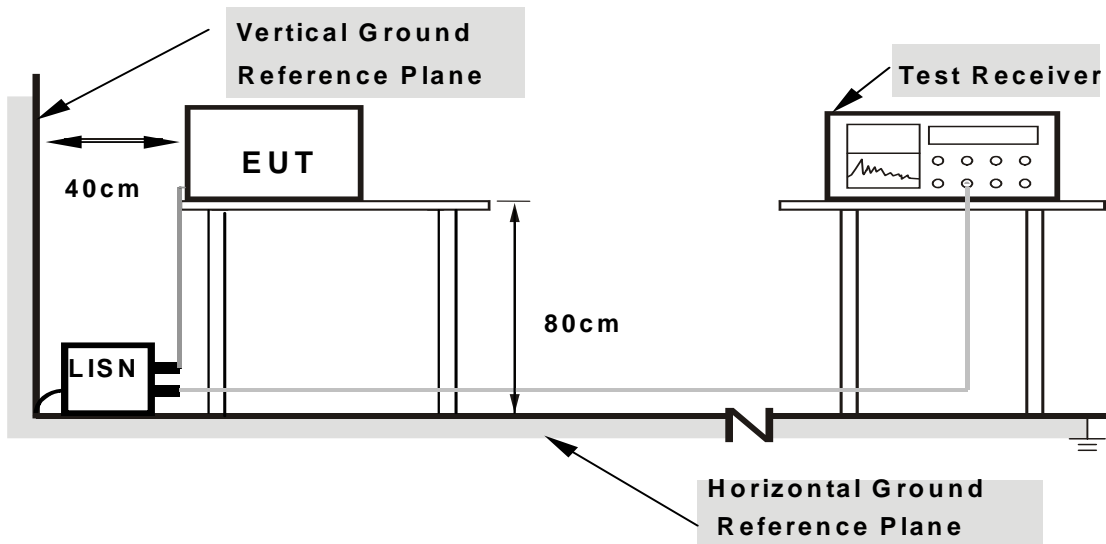

- Note:**
1. Support units were connected to second LISN.
 2. Both of LISNs (AMN) are 80 cm from EUT and at least 80 from other units and other metal planes

For the actual test configuration, please refer to the attached file (Test Setup Photo).

4.2.6 EUT OPERATING CONDITIONS

Same as 4.1.6.



A D T

4.2.7 TEST RESULTS

CONDUCTED WORST-CASE DATA : 802.11b

PHASE	Line 1	6dB BANDWIDTH	9kHz
TEST MODE	A		

No	Freq. [MHz]	Corr. Factor (dB)	Reading Value		Emission Level		Limit		Margin	
			[dB (uV)]		[dB (uV)]		[dB (uV)]		(dB)	
			Q.P.	AV.	Q.P.	AV.	Q.P.	AV.	Q.P.	AV.
1	0.216	0.13	43.84	-	43.97	-	62.96	52.96	-18.99	-
2	0.287	0.16	45.77	-	45.93	-	60.62	50.62	-14.69	-
3	0.759	0.23	32.40	-	32.63	-	56.00	46.00	-23.37	-
4	4.582	0.39	33.45	-	33.84	-	56.00	46.00	-22.16	-
5	6.410	0.48	35.70	-	36.18	-	60.00	50.00	-23.82	-
6	9.438	0.62	29.31	-	29.93	-	60.00	50.00	-30.07	-

- REMARKS:**
1. Q.P. and AV. are abbreviations of quasi-peak and average individually.
 2. "-": The Quasi-peak reading value also meets average limit and measurement with the average detector is unnecessary.
 3. The emission levels of other frequencies were very low against the limit.
 4. Margin value = Emission level - Limit value
 5. Correction factor = Insertion loss + Cable loss
 6. Emission Level = Correction Factor + Reading Value.

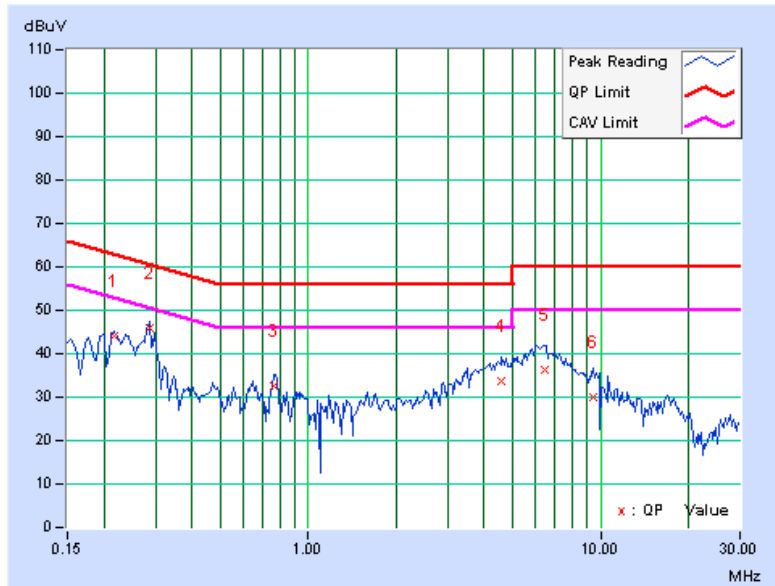



A D T

PHASE	Line 2	6dB BANDWIDTH	9kHz
TEST MODE	A		

No	Freq. [MHz]	Corr.	Reading Value		Emission Level		Limit		Margin	
		Factor	[dB (uV)]		[dB (uV)]		[dB (uV)]		(dB)	
		(dB)	Q.P.	AV.	Q.P.	AV.	Q.P.	AV.	Q.P.	AV.
1	0.150	0.09	43.93	-	44.02	-	66.00	56.00	-21.98	-
2	0.287	0.14	44.29	-	44.43	-	60.62	50.62	-16.19	-
3	0.775	0.21	35.28	-	35.49	-	56.00	46.00	-20.51	-
4	4.215	0.32	30.95	-	31.27	-	56.00	46.00	-24.73	-
5	6.152	0.39	32.56	-	32.95	-	60.00	50.00	-27.05	-
6	11.051	0.58	23.86	-	24.44	-	60.00	50.00	-35.56	-

- REMARKS:**
1. Q.P. and AV. are abbreviations of quasi-peak and average individually.
 2. "-": The Quasi-peak reading value also meets average limit and measurement with the average detector is unnecessary.
 3. The emission levels of other frequencies were very low against the limit.
 4. Margin value = Emission level - Limit value
 5. Correction factor = Insertion loss + Cable loss
 6. Emission Level = Correction Factor + Reading Value.

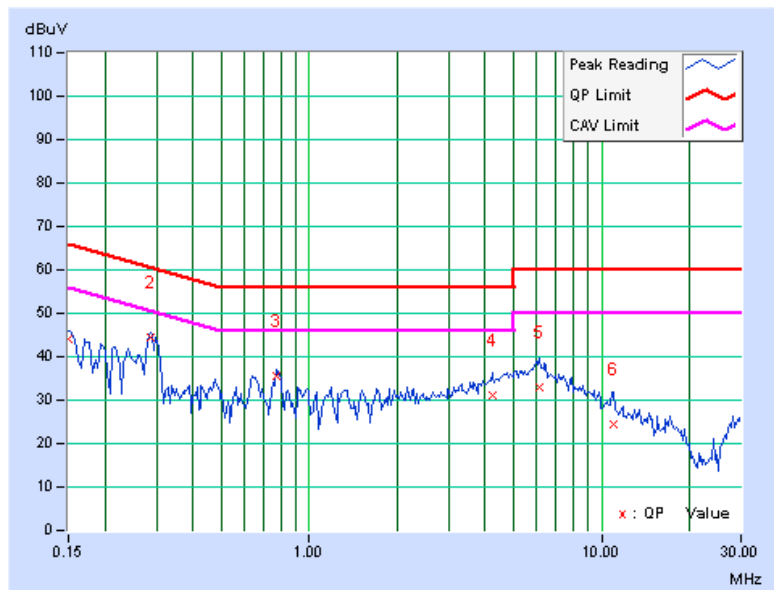



A D T

PHASE	Line 1	6dB BANDWIDTH	9kHz
TEST MODE	B		

No	Freq. [MHz]	Corr. Factor (dB)	Reading Value		Emission Level		Limit		Margin	
			[dB (uV)]		[dB (uV)]		[dB (uV)]		(dB)	
			Q.P.	AV.	Q.P.	AV.	Q.P.	AV.	Q.P.	AV.
1	0.181	0.12	44.74	-	44.86	-	64.43	54.43	-19.57	-
2	0.369	0.20	34.80	-	35.00	-	58.53	48.53	-23.52	-
3	0.642	0.23	32.15	-	32.38	-	56.00	46.00	-23.62	-
4	3.945	0.36	37.96	-	38.32	-	56.00	46.00	-17.68	-
5	5.323	0.42	35.84	-	36.26	-	60.00	50.00	-23.74	-
6	10.459	0.68	34.44	-	35.12	-	60.00	50.00	-24.88	-

- REMARKS:**
1. Q.P. and AV. are abbreviations of quasi-peak and average individually.
 2. "-": The Quasi-peak reading value also meets average limit and measurement with the average detector is unnecessary.
 3. The emission levels of other frequencies were very low against the limit.
 4. Margin value = Emission level - Limit value
 5. Correction factor = Insertion loss + Cable loss
 6. Emission Level = Correction Factor + Reading Value.

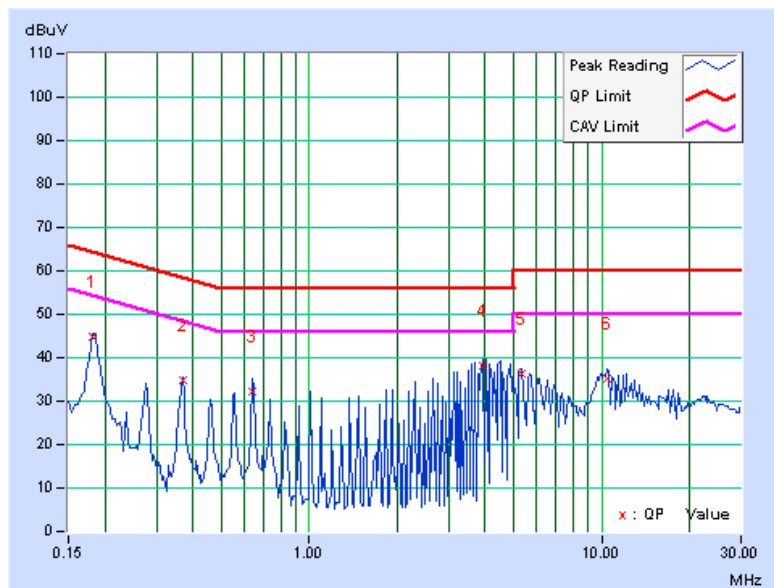



A D T

PHASE	Line 2	6dB BANDWIDTH	9kHz
TEST MODE	B		

No	Freq. [MHz]	Corr. Factor (dB)	Reading Value		Emission Level		Limit		Margin	
			[dB (uV)]		[dB (uV)]		[dB (uV)]		(dB)	
			Q.P.	AV.	Q.P.	AV.	Q.P.	AV.	Q.P.	AV.
1	0.185	0.09	44.40	-	44.49	-	64.26	54.26	-19.77	-
2	0.365	0.18	35.15	-	35.33	-	58.62	48.62	-23.29	-
3	0.642	0.21	35.81	-	36.02	-	56.00	46.00	-19.98	-
4	4.033	0.31	38.53	-	38.84	-	56.00	46.00	-17.16	-
5	5.224	0.35	34.92	-	35.27	-	60.00	50.00	-24.73	-
6	11.276	0.59	32.24	-	32.83	-	60.00	50.00	-27.17	-

- REMARKS:**
1. Q.P. and AV. are abbreviations of quasi-peak and average individually.
 2. "-": The Quasi-peak reading value also meets average limit and measurement with the average detector is unnecessary.
 3. The emission levels of other frequencies were very low against the limit.
 4. Margin value = Emission level - Limit value
 5. Correction factor = Insertion loss + Cable loss
 6. Emission Level = Correction Factor + Reading Value.

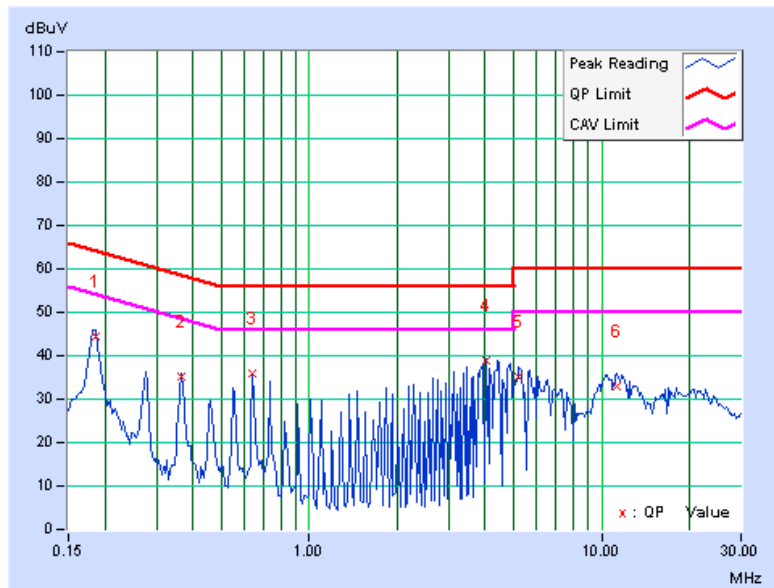



A D T

4.3 6dB BANDWIDTH MEASUREMENT

4.3.1 LIMITS OF 6dB BANDWIDTH MEASUREMENT

The minimum of 6dB Bandwidth Measurement is 0.5 MHz.

4.3.2 TEST INSTRUMENTS

DESCRIPTION & MANUFACTURER	MODEL NO.	SERIAL NO.	DATE OF CALIBRATION	CALIBRATED UNTIL
R&S SPECTRUM ANALYZER	FSP40	100040	Jul. 07, 2009	Jul. 06, 2010

NOTE: The calibration interval of the above test instruments is 12 months and the calibrations are traceable to NML/ROC and NIST/USA.

4.3.3 TEST PROCEDURE

The transmitter output was connected to the spectrum analyzer through an attenuator. The bandwidth of the fundamental frequency was measured by spectrum analyzer with 100kHz RBW and 300kHz VBW. The 6dB bandwidth is defined as the total spectrum the power of which is higher than peak power minus 6dB.

4.3.4 DEVIATION FROM TEST STANDARD

No deviation.

4.3.5 TEST SETUP

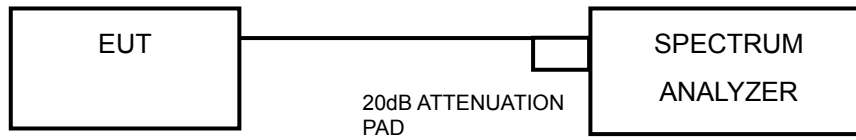

4.3.6 EUT OPERATING CONDITIONS

The software provided by client to enable the EUT under transmission condition continuously at lowest, middle and highest channel frequencies individually.



A D T

4.3.7 TEST RESULTS

802.11b

CHANNEL	CHANNEL FREQUENCY (MHz)	6dB BANDWIDTH (MHz)		MINIMUM LIMIT (MHz)	PASS / FAIL
		CHAIN 0	CHAIN 1		
1	2412	11.14	12.56	0.5	PASS
6	2437	12.15	12.16	0.5	PASS
11	2462	12.09	12.14	0.5	PASS

FOR CHAIN 1: CH 1

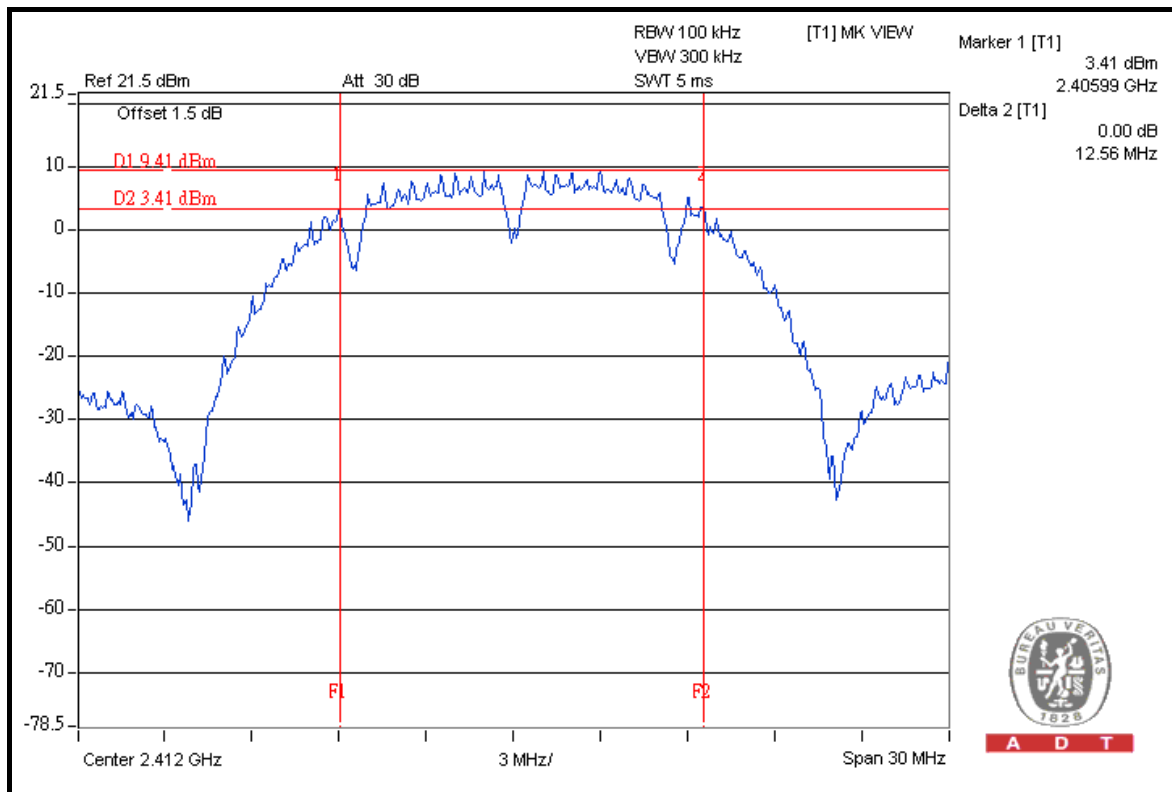



A D T

802.11g

CHANNEL	CHANNEL FREQUENCY (MHz)	6dB BANDWIDTH (MHz)		MINIMUM LIMIT (MHz)	PASS / FAIL
		CHAIN 0	CHAIN 1		
1	2412	16.40	16.54	0.5	PASS
6	2437	16.41	16.46	0.5	PASS
11	2462	13.33	16.45	10.5	PASS

FOR CHAIN 1: CH 1

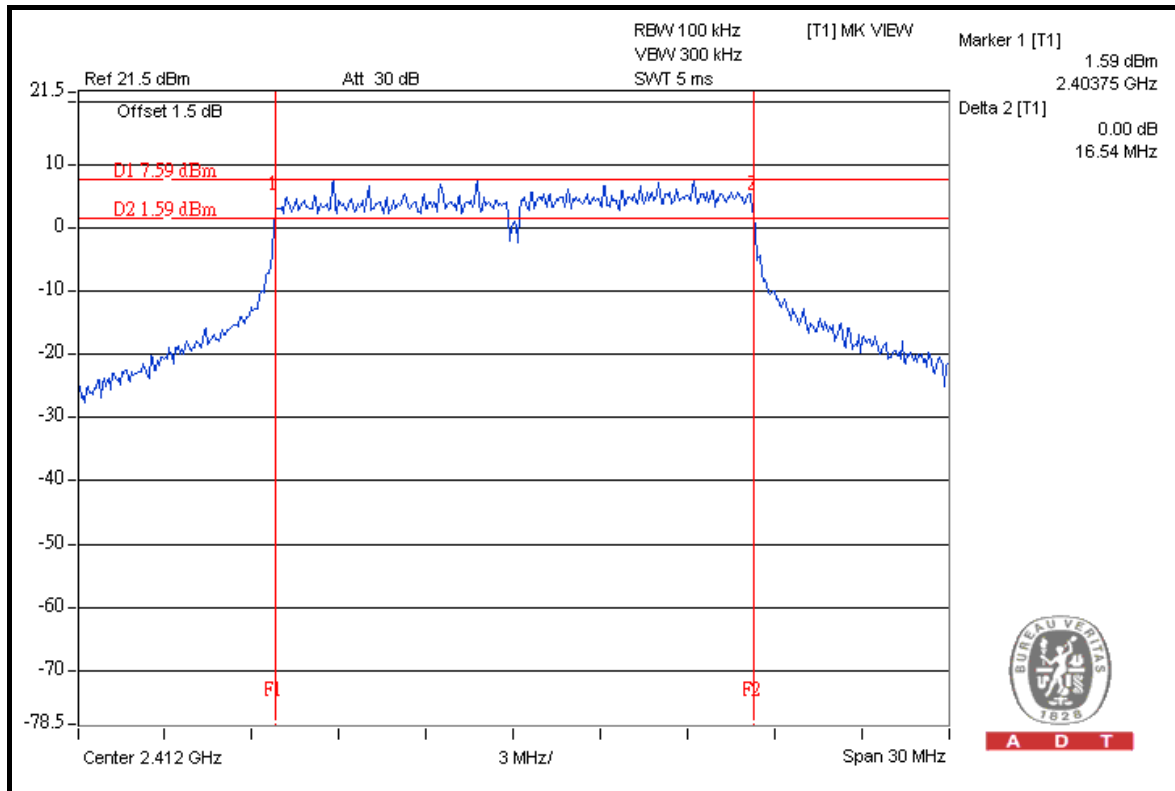



A D T

802.11n (20MHz)

CHANNEL	CHANNEL FREQUENCY (MHz)	6dB BANDWIDTH (MHz)		MINIMUM LIMIT (MHz)	PASS / FAIL
		CHAIN 0	CHAIN 1		
1	2412	16.77	17.76	0.5	PASS
6	2437	16.77	17.69	0.5	PASS
11	2462	12.62	17.60	0.5	PASS

FOR CHAIN 1: CH 1

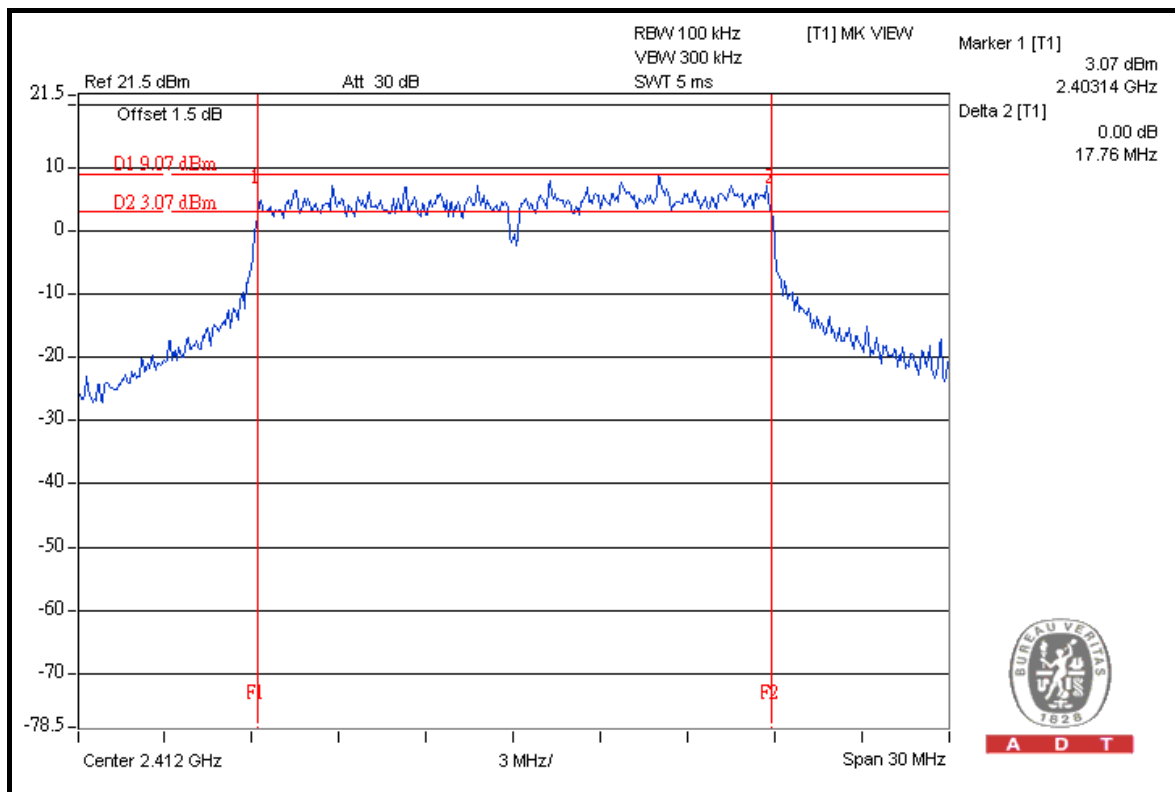



A D T

802.11n (40MHz)

CHANNEL	CHANNEL FREQUENCY (MHz)	6dB BANDWIDTH (MHz)		MINIMUM LIMIT (MHz)	PASS / FAIL
		CHAIN 0	CHAIN 1		
1	2422	34.84	35.77	0.5	PASS
4	2437	35.52	36.45	0.5	PASS
7	2452	33.36	33.27	0.5	PASS

FOR CHAIN 1: CH 4

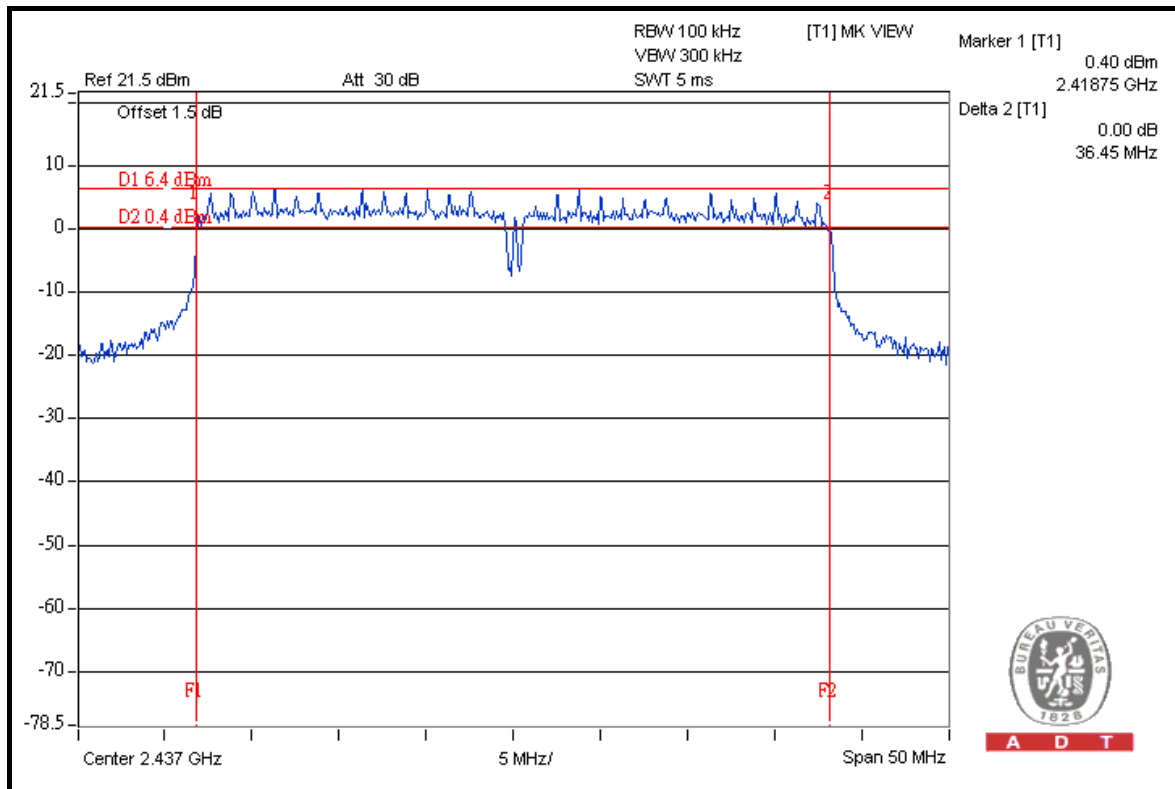



4.4 MAXIMUM OUTPUT POWER

4.4.1 LIMITS OF MAXIMUM OUTPUT POWER MEASUREMENT

The Maximum Output Power Measurement is 30dBm.

4.4.2 INSTRUMENTS

DESCRIPTION & MANUFACTURER	MODEL NO.	SERIAL NO.	DATE OF CALIBRATION	CALIBRATED UNTIL
R&S SPECTRUM ANALYZER	FSP40	100040	Jul. 07, 2009	Jul. 06, 2010

NOTE: The calibration interval of the above test instruments is 12 months and the calibrations are traceable to NML/ROC and NIST/USA.

4.4.3 TEST PROCEDURE

1. Follow DTS measurement (Power Output Option 2), the transmitter output was connected to the spectrum analyzer through an attenuator, the bandwidth of the fundamental frequency was measured with the spectrum analyzer.
2. Set span to encompass the entire emission bandwidth (EBW) of the signal.
3. Set RBW = 1 MHz ;VBW \geq 3 MHz.
4. Use sample detector mode and video trigger with the trigger level set to enable triggering only on full power pulses.
5. Trace average 100 traces in power averaging mode.
6. Compute power by integrating the spectrum across the 26 dB EBW of the signal.
7. Record the power level.

4.4.4 DEVIATION FROM TEST STANDARD

No deviation.

4.4.5 TEST SETUP

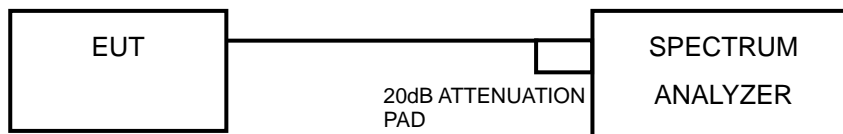

4.4.6 EUT OPERATING CONDITIONS

Same as Item 4.3.6.



A D T

4.4.7 TEST RESULTS

802.11b

CHAN.	CHAN. FREQ. (MHz)	POWER OUTPUT (dBm)		TOTAL POWER (mW)	TOTAL POWER (dBm)	POWER LIMIT (dBm)	PASS / FAIL
		CHAIN 0	CHAIN 1				
1	2412	20.27	19.80	201.91	23.05	30	PASS
6	2437	20.57	20.10	216.35	23.35	30	PASS
11	2462	18.03	21.12	192.95	22.85	30	PASS

FOR CHAIN 1: CH 11

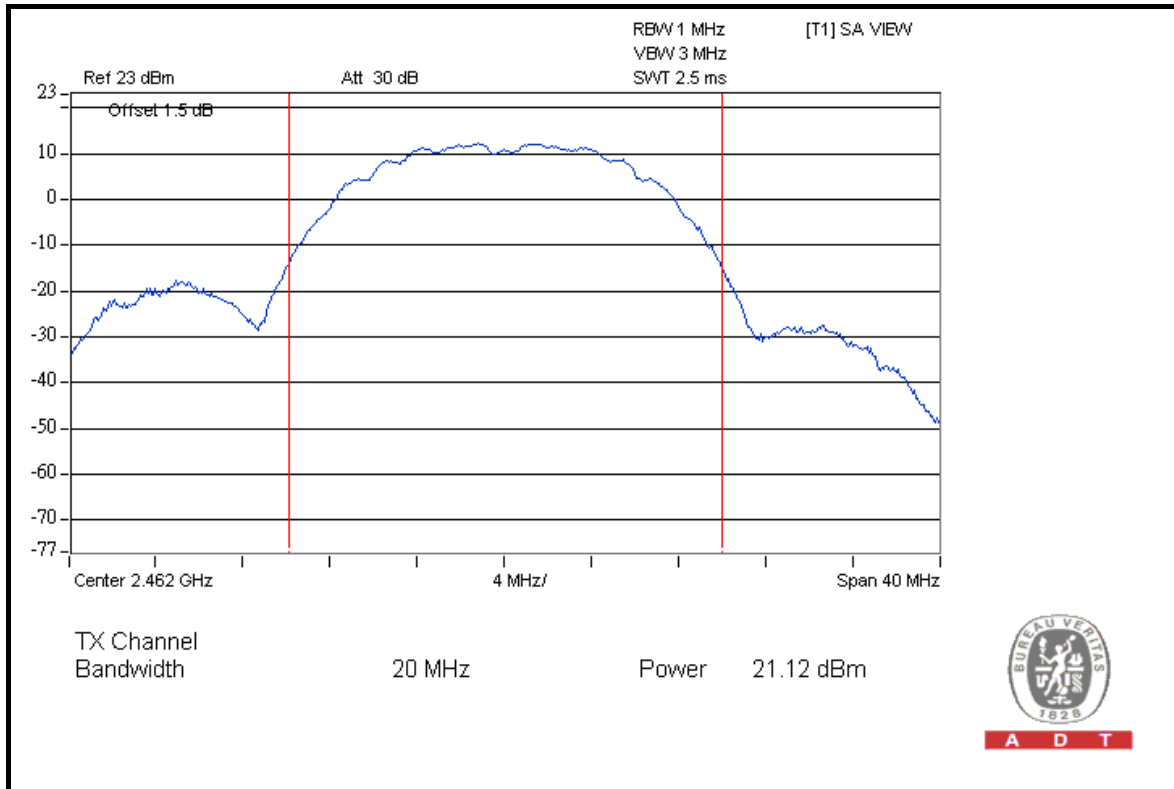



A D T

802.11g

CHAN.	CHAN. FREQ. (MHz)	POWER OUTPUT (dBm)		TOTAL POWER (mW)	TOTAL POWER (dBm)	POWER LIMIT (dBm)	PASS / FAIL
		CHAIN 0	CHAIN 1				
1	2412	20.05	19.47	189.67	22.78	30	PASS
6	2437	20.46	19.89	208.67	23.19	30	PASS
11	2462	17.57	20.87	179.33	22.54	30	PASS

FOR CHAIN 1: CH 11

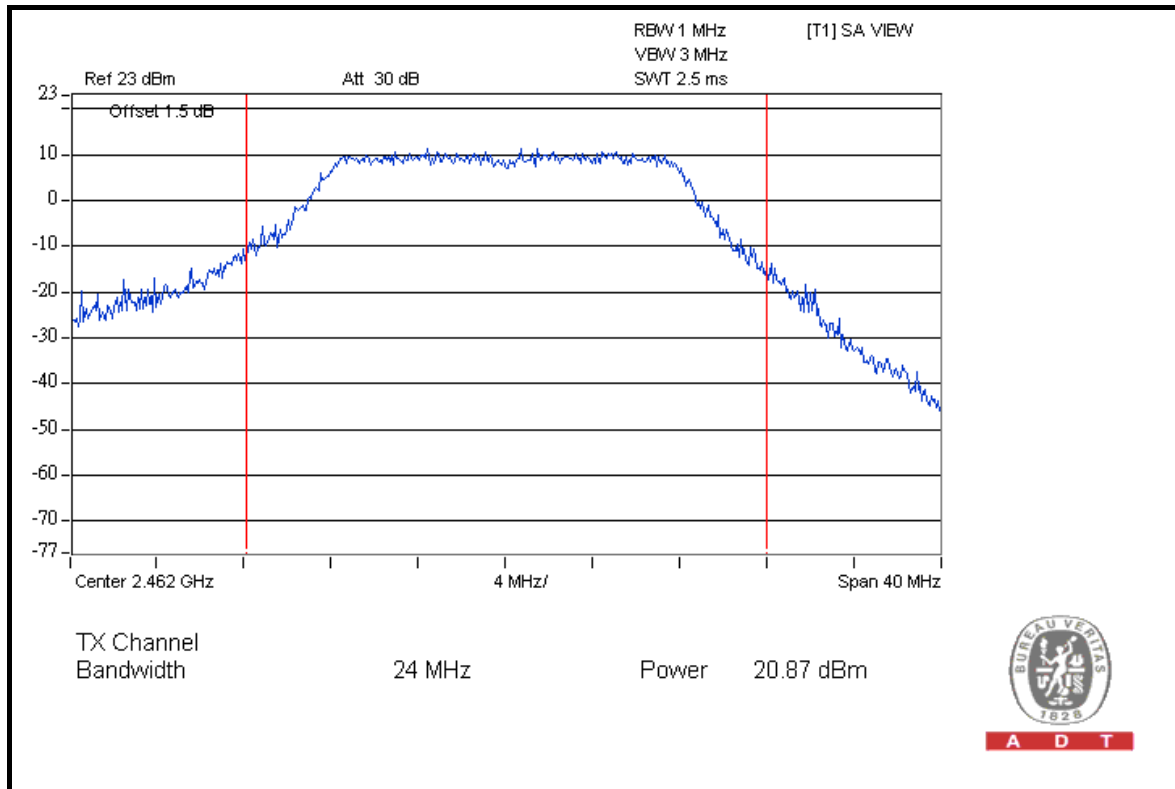



A D T

802.11n (20MHz)

CHAN.	CHAN. FREQ. (MHz)	POWER OUTPUT (dBm)		TOTAL POWER (mW)	TOTAL POWER (dBm)	POWER LIMIT (dBm)	PASS / FAIL
		CHAIN 0	CHAIN 1				
1	2412	19.93	19.83	194.56	22.89	30	PASS
6	2437	20.20	19.65	196.97	22.94	30	PASS
11	2462	17.55	20.81	177.39	22.49	30	PASS

FOR CHAIN 1: CH 11

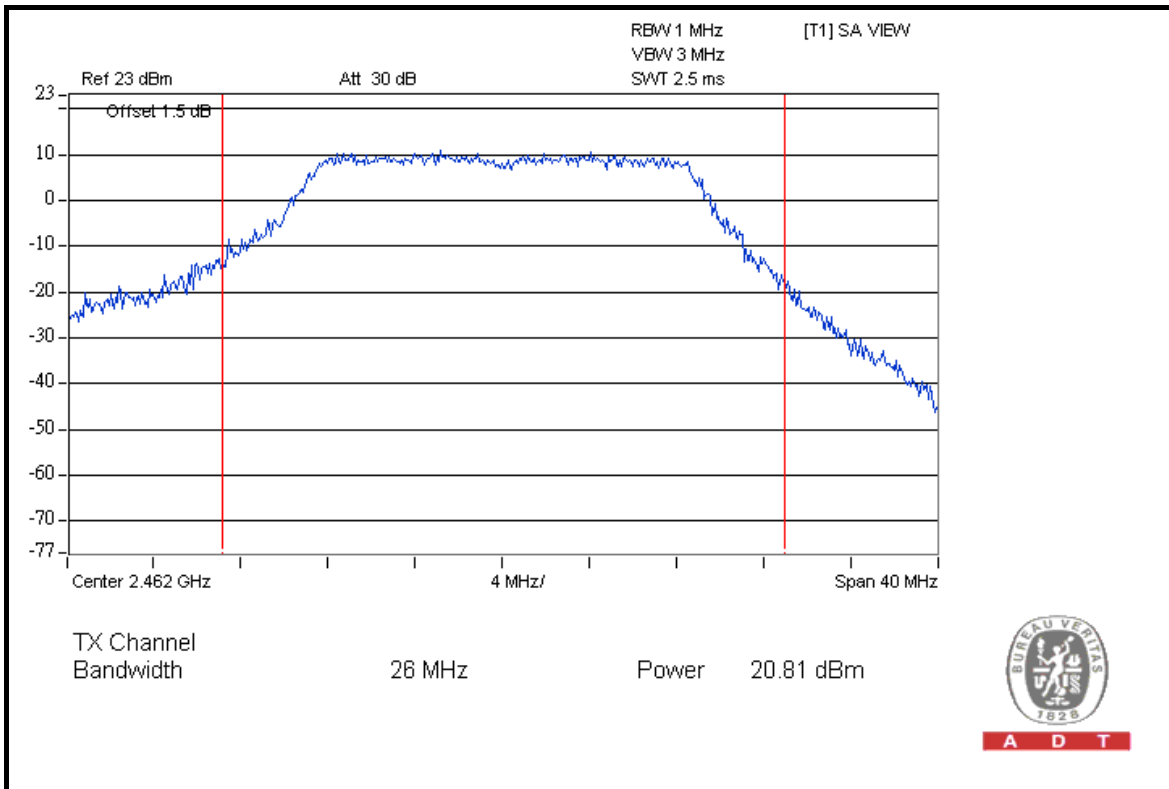

A D T



A D T

802.11n (40MHz)

CHAN.	CHAN. FREQ. (MHz)	POWER OUTPUT (dBm)		TOTAL POWER (mW)	TOTAL POWER (dBm)	POWER LIMIT (dBm)	PASS / FAIL
		CHAIN 0	CHAIN 1				
1	2422	20.17	20.53	216.97	23.36	30	PASS
4	2437	20.28	20.09	208.75	23.20	30	PASS
7	2452	19.63	21.07	219.77	23.42	30	PASS

FOR CHAIN 1: CH 7

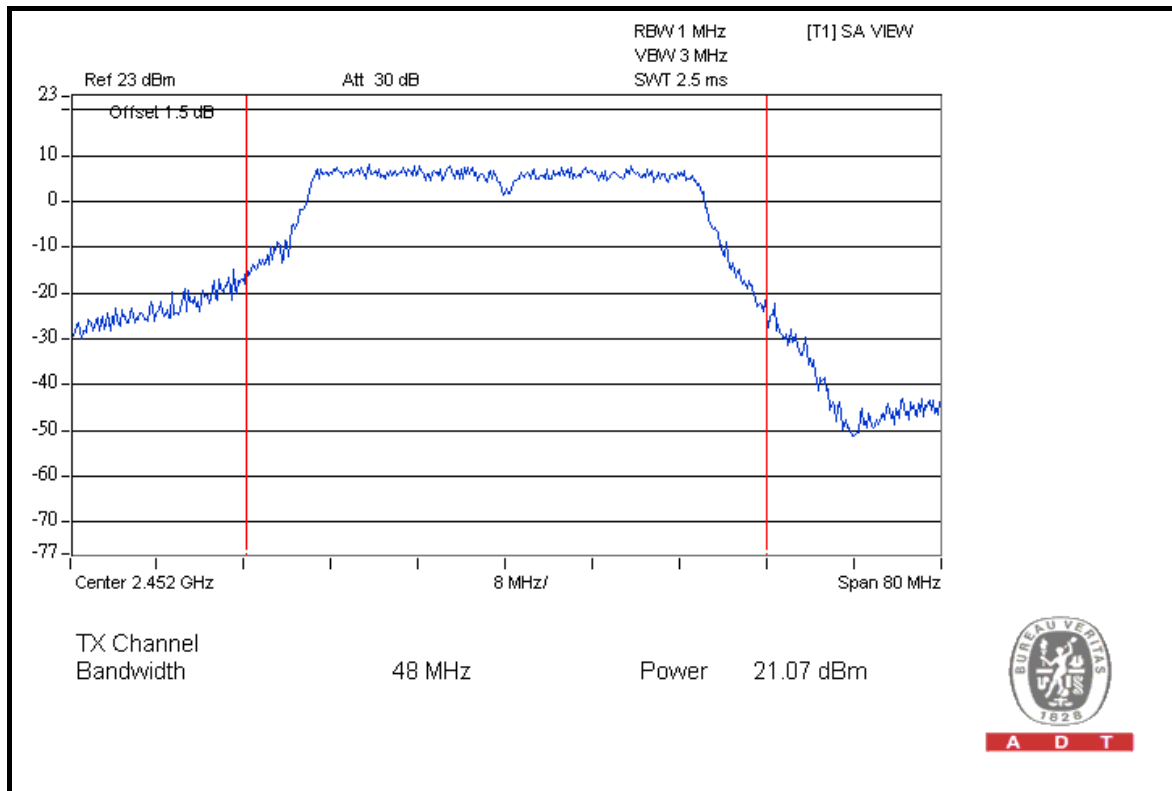



A D T

26dB OCCUPIED BANDWIDTH: 802.11b

CHANNEL	CHANNEL FREQUENCY (MHz)	26dBc OCCUPIED BANDWIDTH (MHz)		PASS / FAIL
		CHAIN 0	CHAIN 1	
1	2412	19.35	19.37	PASS
6	2437	19.47	19.45	PASS
11	2462	19.33	19.38	PASS

FOR CHAIN 0: CH 6

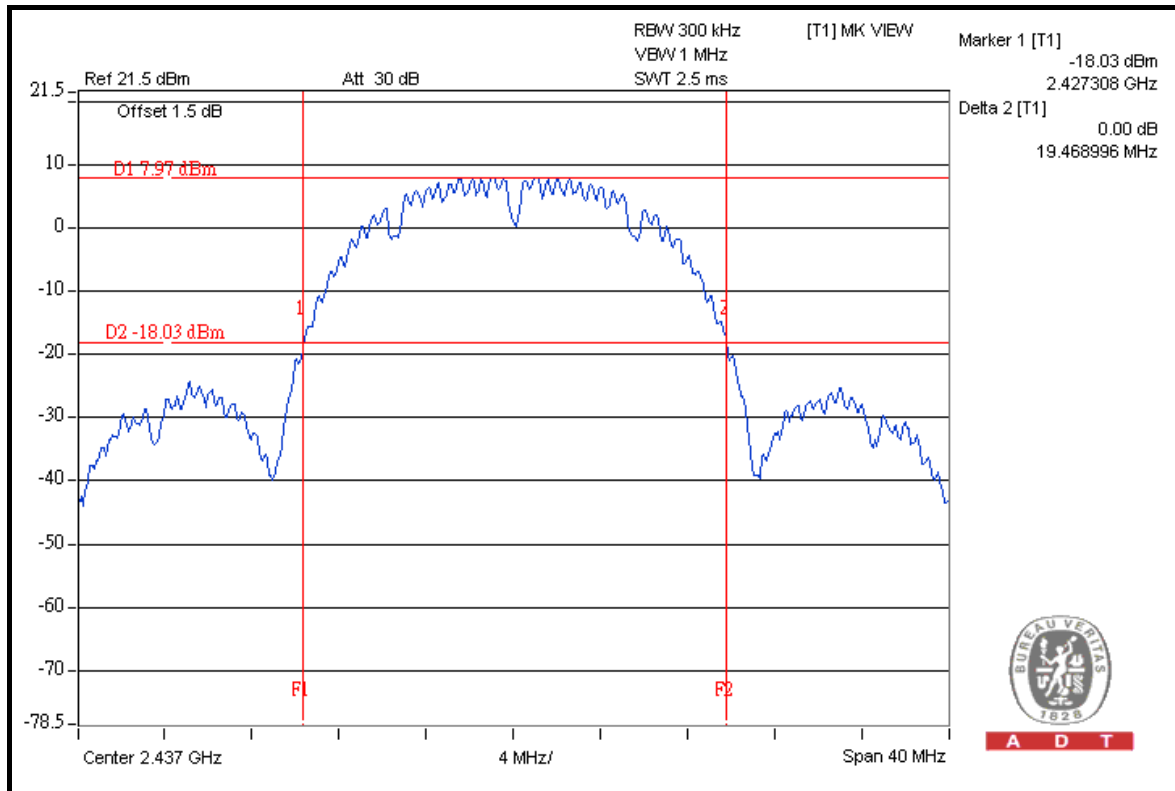



A D T

802.11g

CHANNEL	CHANNEL FREQUENCY (MHz)	26dBc OCCUPIED BANDWIDTH (MHz)		PASS / FAIL
		CHAIN 0	CHAIN 1	
1	2412	24.53	24.45	PASS
6	2437	24.25	24.40	PASS
11	2462	22.63	23.73	PASS

FOR CHAIN 0: CH 1

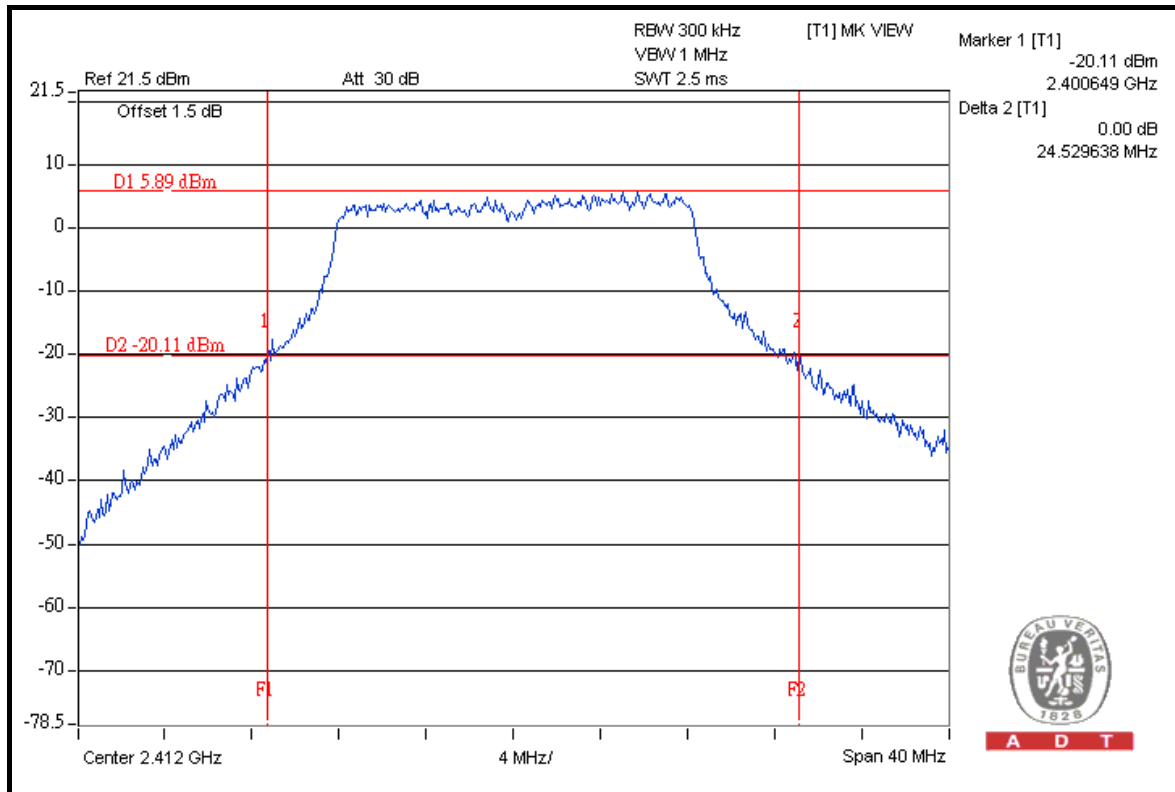



A D T

802.11n (20MHz)

CHANNEL	CHANNEL FREQUENCY (MHz)	26dBc OCCUPIED BANDWIDTH (MHz)		PASS / FAIL
		CHAIN 0	CHAIN 1	
1	2412	25.02	24.67	PASS
6	2437	25.44	25.18	PASS
11	2462	25.15	25.56	PASS

FOR CHAIN 1: CH 11

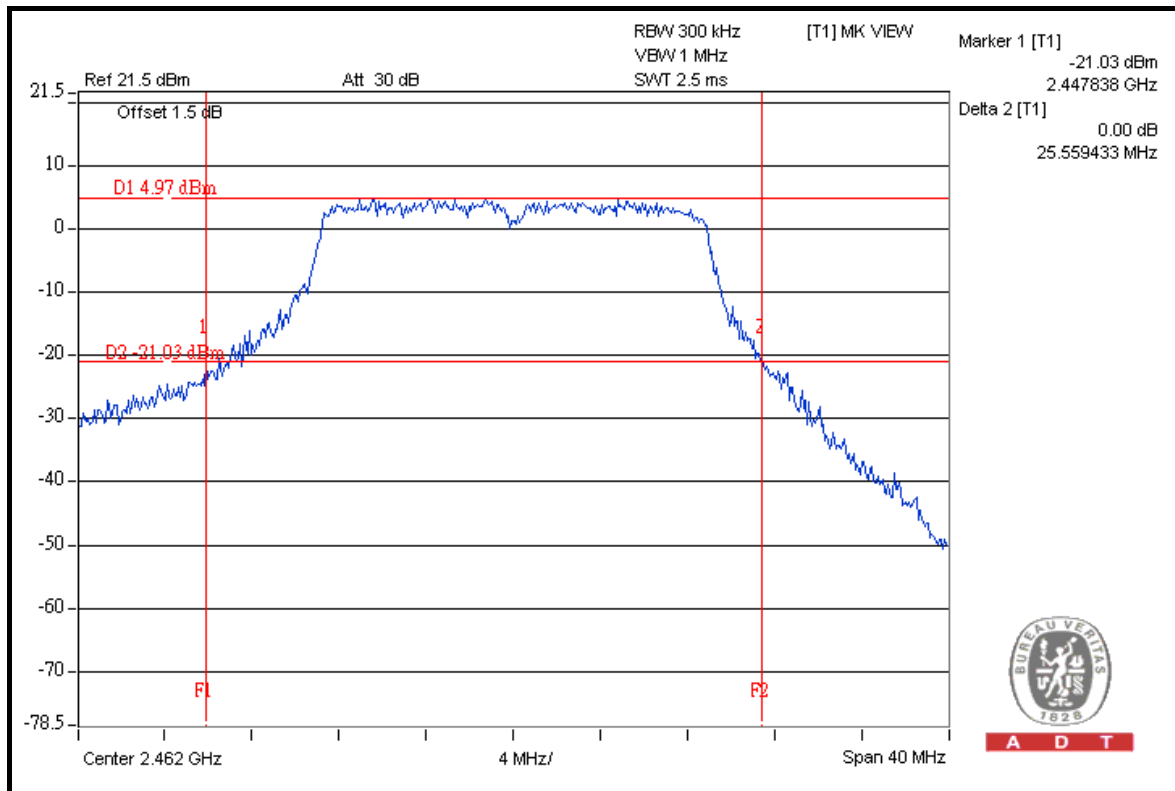



A D T

802.11n (40MHz)

CHANNEL	CHANNEL FREQUENCY (MHz)	26dBc OCCUPIED BANDWIDTH (MHz)		PASS / FAIL
		CHAIN 0	CHAIN 1	
1	2422	44.89	46.78	PASS
4	2437	46.10	46.01	PASS
7	2452	45.21	47.50	PASS

FOR CHAIN 1: CH 7

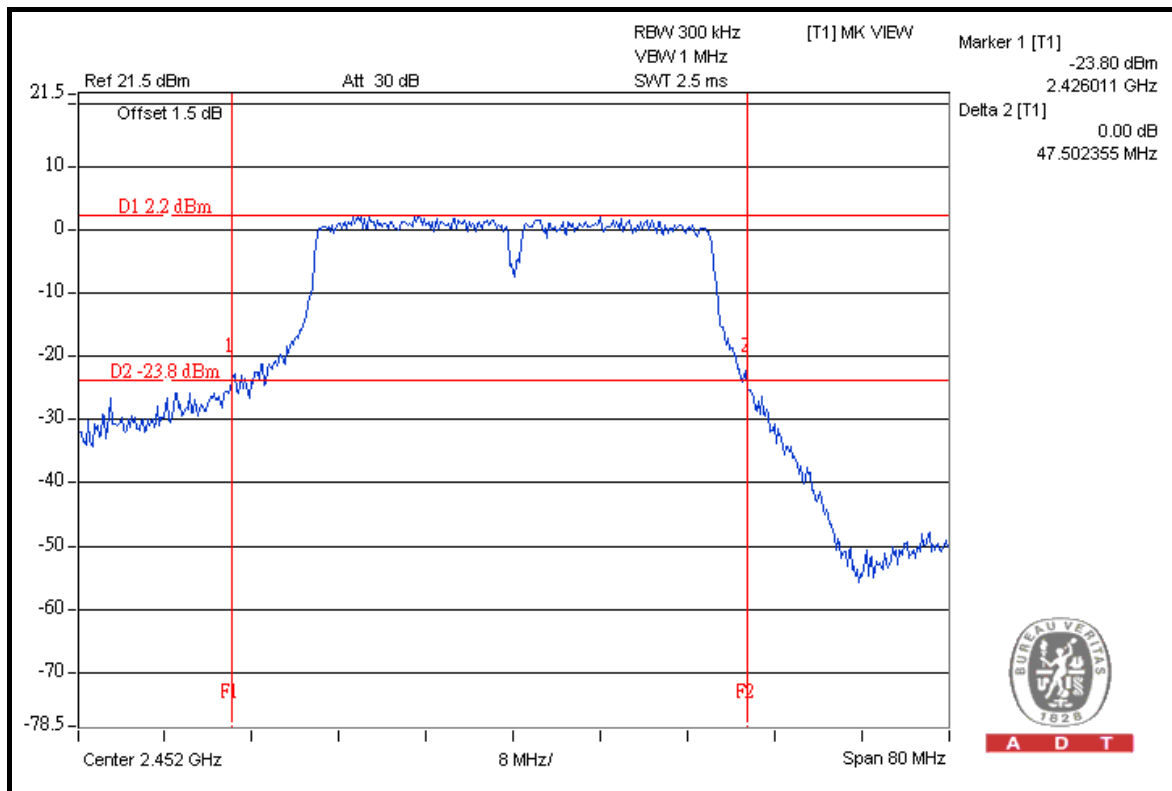



4.5 POWER SPECTRAL DENSITY MEASUREMENT

4.5.1 LIMITS OF POWER SPECTRAL DENSITY MEASUREMENT

The Maximum of Power Spectral Density Measurement is 8dBm.

4.5.2 TEST INSTRUMENTS

DESCRIPTION & MANUFACTURER	MODEL NO.	SERIAL NO.	DATE OF CALIBRATION	CALIBRATED UNTIL
R&S SPECTRUM ANALYZER	FSP40	100040	Jul. 07, 2009	Jul. 06, 2010

NOTE: The calibration interval of the above test instruments is 12 months and the calibrations are traceable to NML/ROC and NIST/USA.

4.5.3 TEST PROCEDURE

1. Follow DTS measurement (PSD Option 2), the transmitter output was connected to the spectrum analyzer through an attenuator, the bandwidth of the fundamental frequency was measured with the spectrum analyzer. Locate and zoom in on emission peak(s) within the pass band.
2. Set RBW = 3 kHz /VBW > 9 kHz and sweep time to Automatic.
3. Detector use peak mode and a video trigger with the trigger level set to enable triggering only on full power pulses.
4. Trace average 100 traces in power averaging mode. The power spectral density was measured and recorded.

4.5.4 DEVIATION FROM TEST STANDARD

No deviation

4.5.5 TEST SETUP

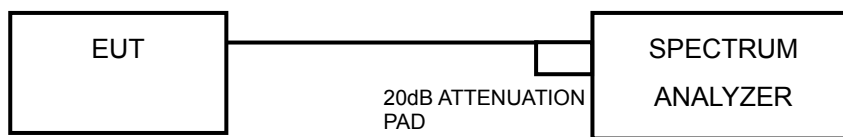

4.5.6 EUT OPERATING CONDITION

Same as Item 4.3.6



A D T

4.5.7 TEST RESULTS

802.11b

CHAN.	CHAN. FREQ. (MHz)	RF POWER LEVEL IN 3kHz BW (dBm)		TOTAL POWER DENSITY (mW)	TOTAL POWER DENSITY (dBm)	MAX. LIMIT (dBm)	PASS / FAIL
		CHAIN 0	CHAIN 1				
1	2412	-7.20	-7.27	0.38	-4.22	8	PASS
6	2437	-5.82	-7.49	0.44	-3.56	8	PASS
11	2462	-9.50	-6.34	0.34	-4.63	8	PASS

FOR CHAIN 0: CH 6

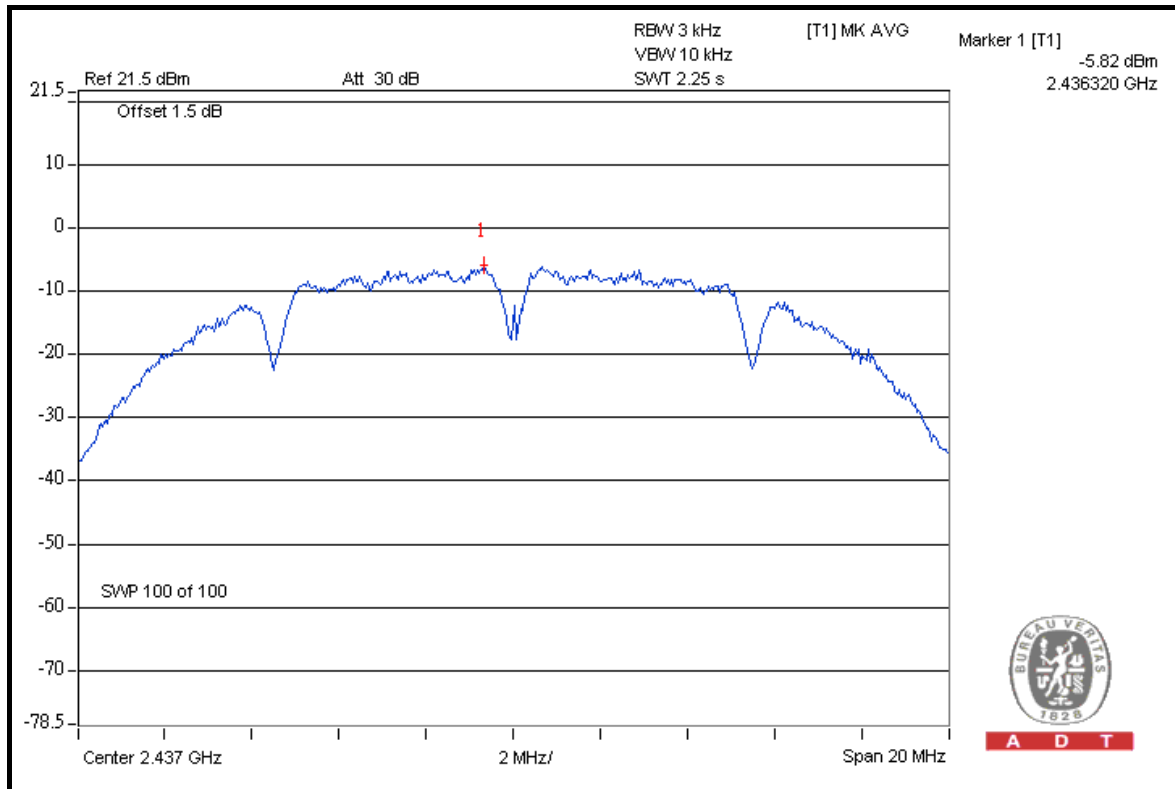

A D T



A D T

802.11g

CHAN.	CHAN. FREQ. (MHz)	RF POWER LEVEL IN 3kHz BW (dBm)		TOTAL POWER DENSITY (mW)	TOTAL POWER DENSITY (dBm)	MAX. LIMIT (dBm)	PASS / FAIL
		CHAIN 0	CHAIN 1				
1	2412	-3.28	-8.00	0.63	-2.02	8	PASS
6	2437	-0.63	-8.77	1.00	-0.01	8	PASS
11	2462	-3.29	-7.05	0.67	-1.76	8	PASS

FOR CHAIN 0: CH 6

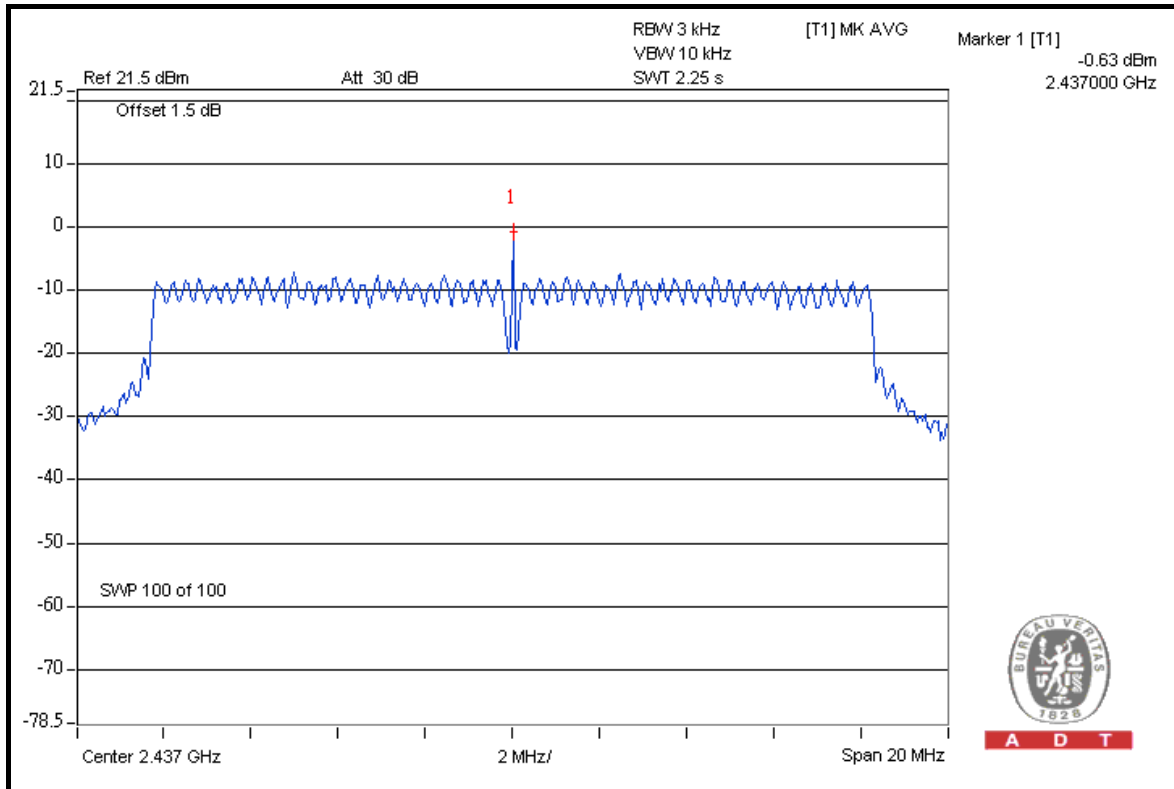

A D T



A D T

802.11n (20MHz)

CHAN.	CHAN. FREQ. (MHz)	RF POWER LEVEL IN 3kHz BW (dBm)		TOTAL POWER DENSITY (mW)	TOTAL POWER DENSITY (dBm)	MAX. LIMIT (dBm)	PASS / FAIL
		CHAIN 0	CHAIN 1				
1	2412	-4.70	-8.50	0.48	-3.19	8	PASS
6	2437	-0.12	-9.49	1.09	0.36	8	PASS
11	2462	-3.97	-5.69	0.67	-1.74	8	PASS

FOR CHAIN 0: CH 6

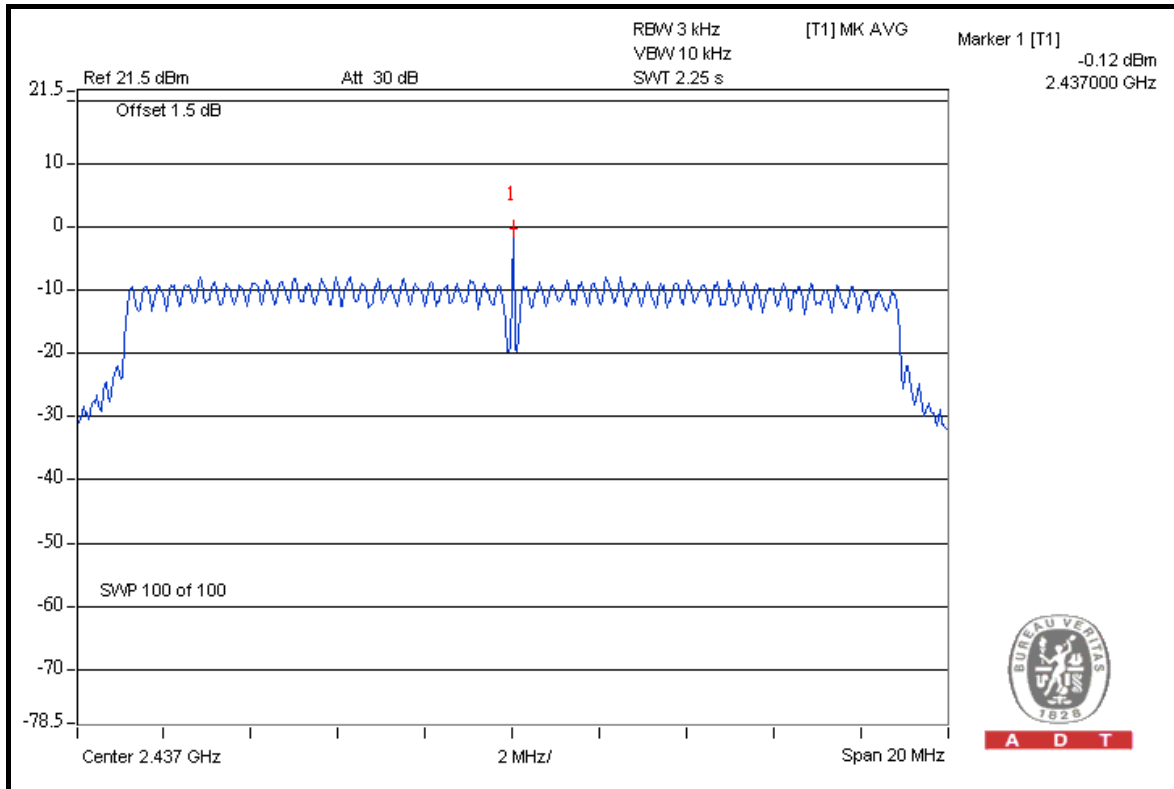



A D T

802.11n (40MHz)

CHAN.	CHAN. FREQ. (MHz)	RF POWER LEVEL IN 3kHz BW (dBm)		TOTAL POWER DENSITY (mW)	TOTAL POWER DENSITY (dBm)	MAX. LIMIT (dBm)	PASS / FAIL
		CHAIN 0	CHAIN 1				
1	2422	0.42	-4.76	1.44	1.57	8	PASS
4	2437	-2.62	-7.79	0.71	-1.47	8	PASS
7	2452	-0.17	-8.31	1.11	0.45	8	PASS

FOR CHAIN 0: CH 1

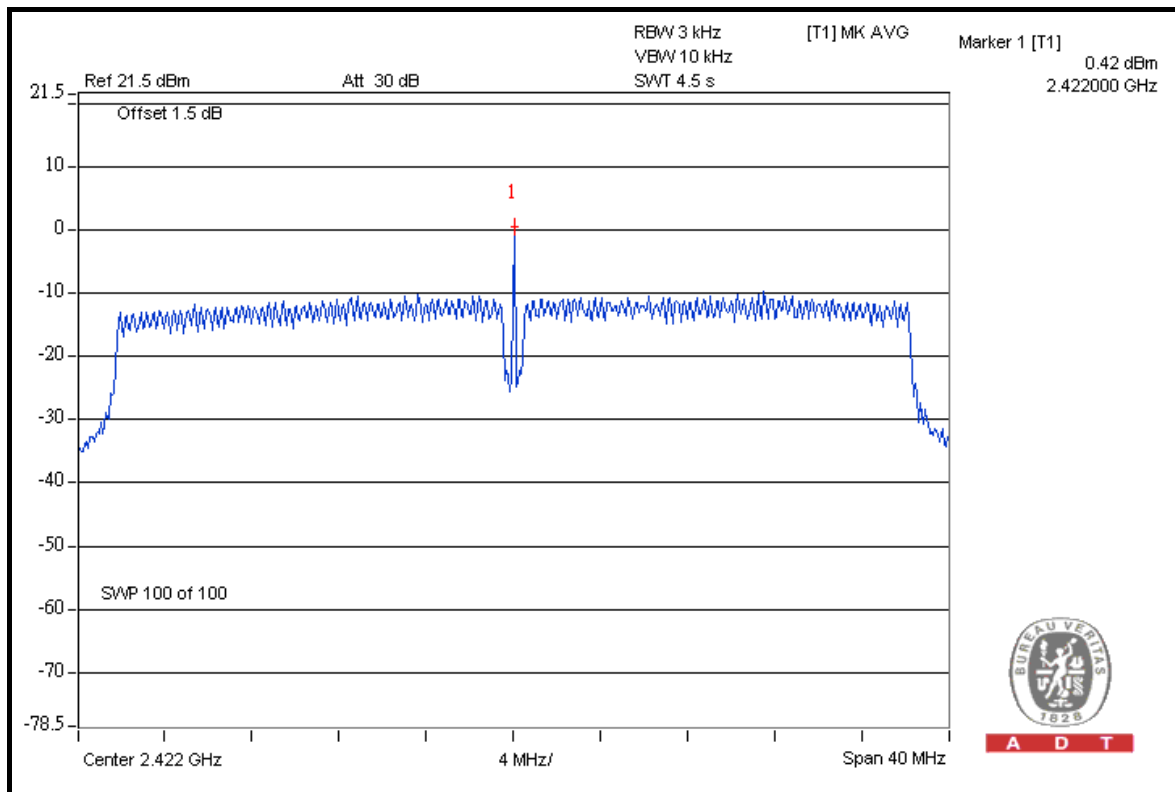



A D T

4.6 BAND EDGES MEASUREMENT

4.6.1 LIMITS OF BAND EDGES MEASUREMENT

Below -20dB of the highest emission level of operating band (in 100kHz Resolution Bandwidth).

Note: Follow DTS measurement, If the device complies with the use of power option 2 the attenuation under this paragraph shall be 30 dB instead of 20 dB.

4.6.2 TEST INSTRUMENTS

DESCRIPTION & MANUFACTURER	MODEL NO.	SERIAL NO.	DATE OF CALIBRATION	DUE DATE OF CALIBRATION
Agilent Spectrum	8564EC	4208A00659	Jul. 24, 2009	Jul. 23, 2010
Agilent Preamplifier	8449B	3008A01924	Aug. 31, 2009	Aug. 30, 2010
Agilent Preamplifier	8449B	3008A01292	Aug. 10, 2009	Aug. 09, 2010
MITEQ Preamplifier	AMF-6F-260400-33 -8P	892164	Aug. 31, 2009	Aug. 30, 2010
Schwarzbeck Horn Antenna	BBHA-9170	BBHA9170190	Sep. 24, 2009	Sep. 23, 2010
Schwarzbeck Horn Antenna	BBHA-9120	D130	May 15, 2009	May 14, 2010
ADT. Turn Table	TT100	0201	NA	NA
ADT. Tower	AT100	0201	NA	NA
Software	ADT_Radiated_V7. 6.15.9.2	NA	NA	NA
SUHNER RF cable	SF106-18	PHACAB-1G-40 GHz	Aug. 20, 2009	Aug. 19, 2010

NOTE: The calibration interval of the above test instruments is 12 months and the calibrations are traceable to NML/ROC and NIST/USA.



4.6.3 TEST PROCEDURE

- a. The EUT was placed on the top of a rotating table 0.8 meters above the ground at a 10 meter open area test site. The table was rotated 360 degrees to determine the position of the highest radiation.
- b. The EUT was set 3 meters away from the interference-receiving antenna, which was mounted on the top of a variable-height antenna tower.
- c. The antenna is a broadband antenna, and its height is varied from one meter to four meters above the ground to determine the maximum value of the field strength. Both horizontal and vertical polarizations of the antenna are set to make the measurement.
- d. For each suspected emission, the EUT was arranged to its worst case and then the antenna was tuned to heights from 1 meter to 4 meters and the rotatable table was turned from 0 degrees to 360 degrees to find the maximum reading.
- e. Set both RBW and VBW of spectrum analyzer to 100kHz and 300kHz with suitable frequency span including 100MHz bandwidth from band edge. The band edges was measured and recorded.

The spectrum plots (Peak RBW = 100kHz, VBW = 300kHz) are attached on the following pages.

NOTE: The resolution bandwidth of test receiver/spectrum analyzer is 1MHz and the video bandwidth is 10Hz for Average detection (AV) at frequency above 1GHz.

4.6.4 DEVIATION FROM TEST STANDARD

No deviation.

4.6.5 EUT OPERATING CONDITION

Same as Item 4.3.6.



A D T

4.6.6 TEST RESULTS

The spectrum plots are attached on the following pages. D1 line indicates the highest level, and D2 line indicates the 20dB offset below D1. It shows compliance with the requirement in part 15.247(d).

802.11b

RESTRICT BAND (2310 ~ 2390 MHz)

FREQUENCY (MHz)	FUNDAMENTAL EMISSION (dBuV/m)	DELTA (dB)	MAXIMUM FIELD STRENGTH IN RESTRICT BAND (dBuV/m)	LIMIT (dBuV/m)
2412.00 (PK)	110.74	55.22	55.52	74.00
2412.00 (AV)	104.86	65.29	39.57	54.00

RESTRICT BAND (2483.5 ~ 2500 MHz)

FREQUENCY (MHz)	FUNDAMENTAL EMISSION (dBuV/m)	DELTA (dB)	MAXIMUM FIELD STRENGTH IN RESTRICT BAND (dBuV/m)	LIMIT (dBuV/m)
2462.00 (PK)	109.14	51.03	58.11	74.00
2462.00 (AV)	103.29	59.52	43.77	54.00

NOTE:

1. Delta = Amplitude between the peak of the fundamental and the peak of the band edge emission. Please check following 3 pages.
2. Maximum field strength in restrict band = Fundamental emission – Delta.



A D T

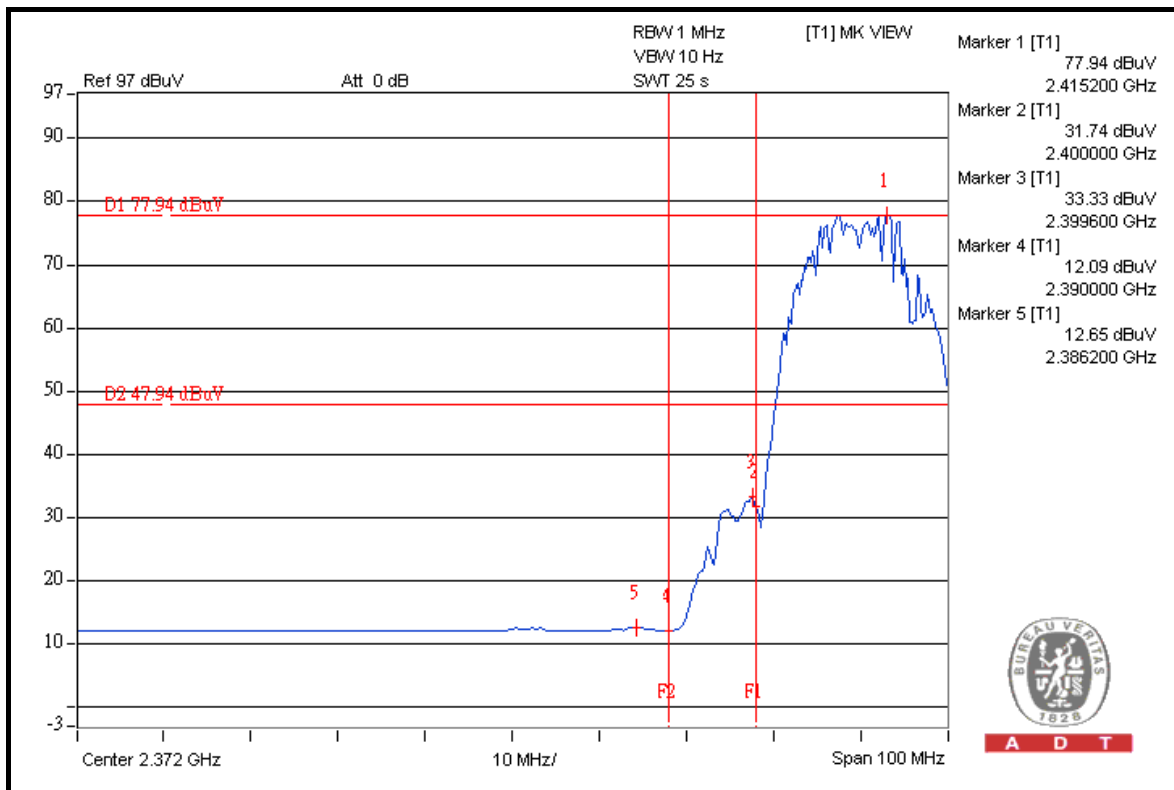
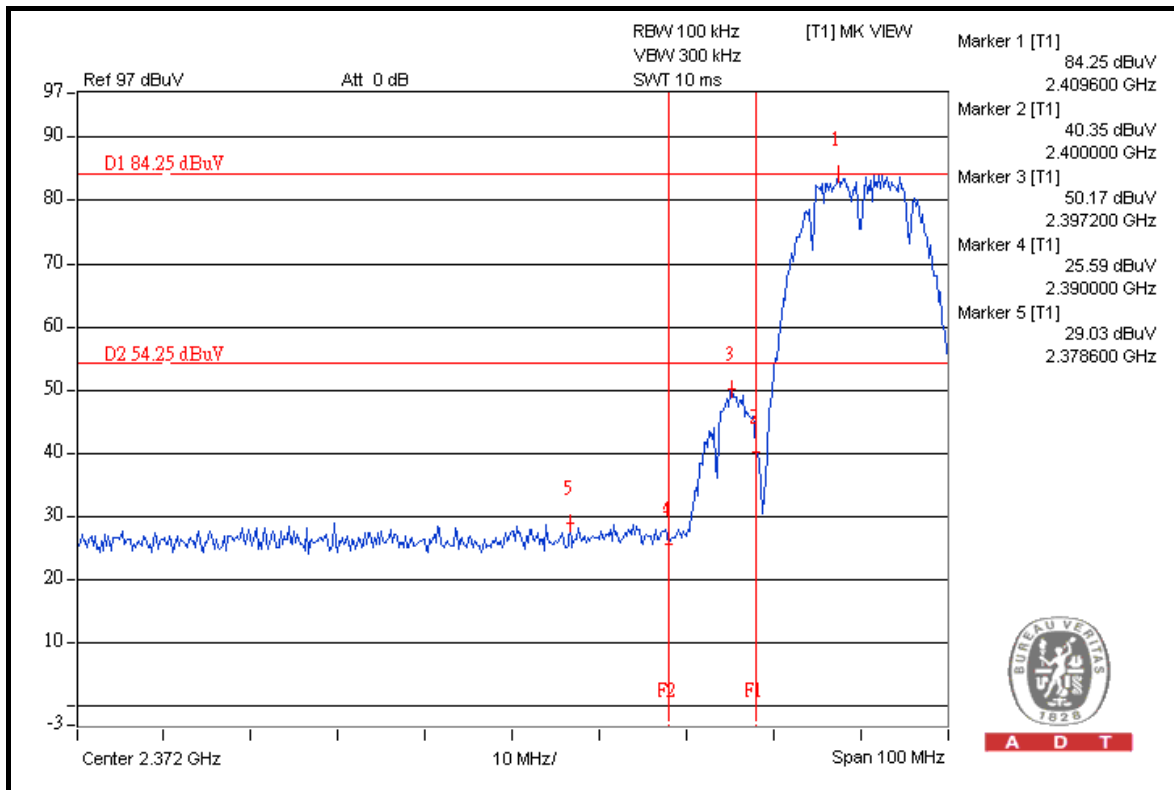



A D T

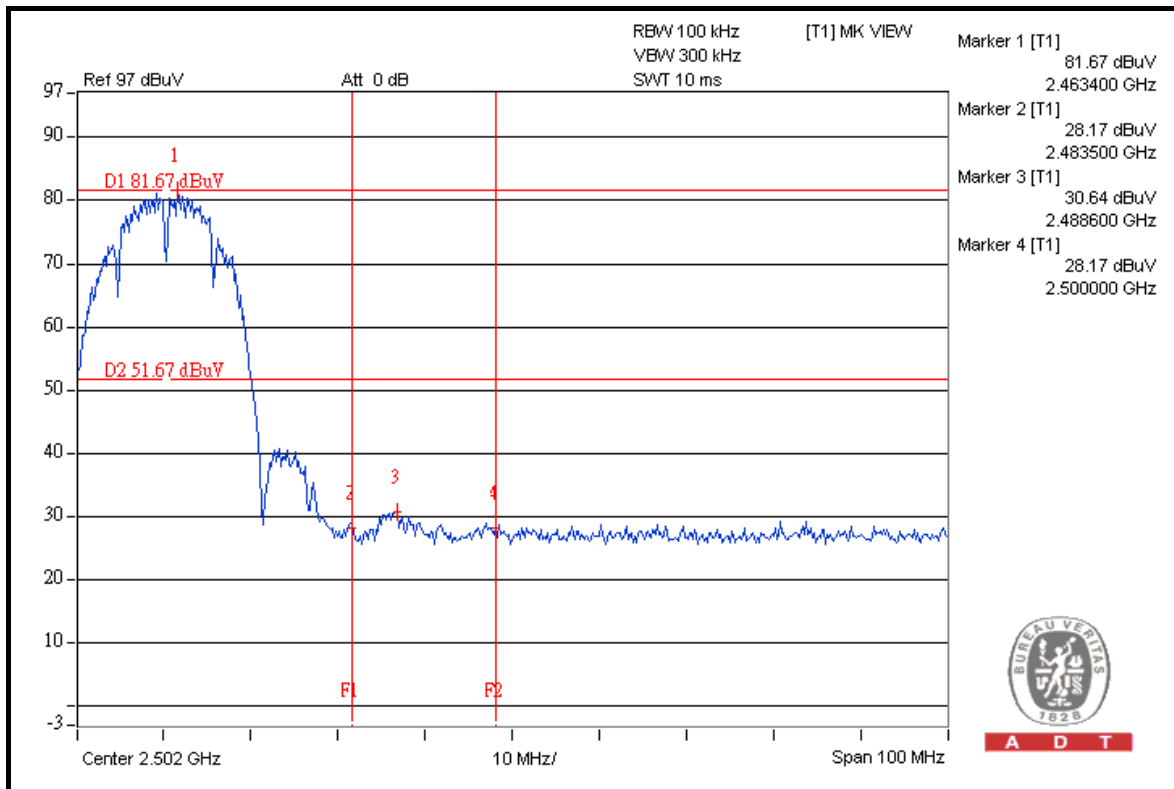
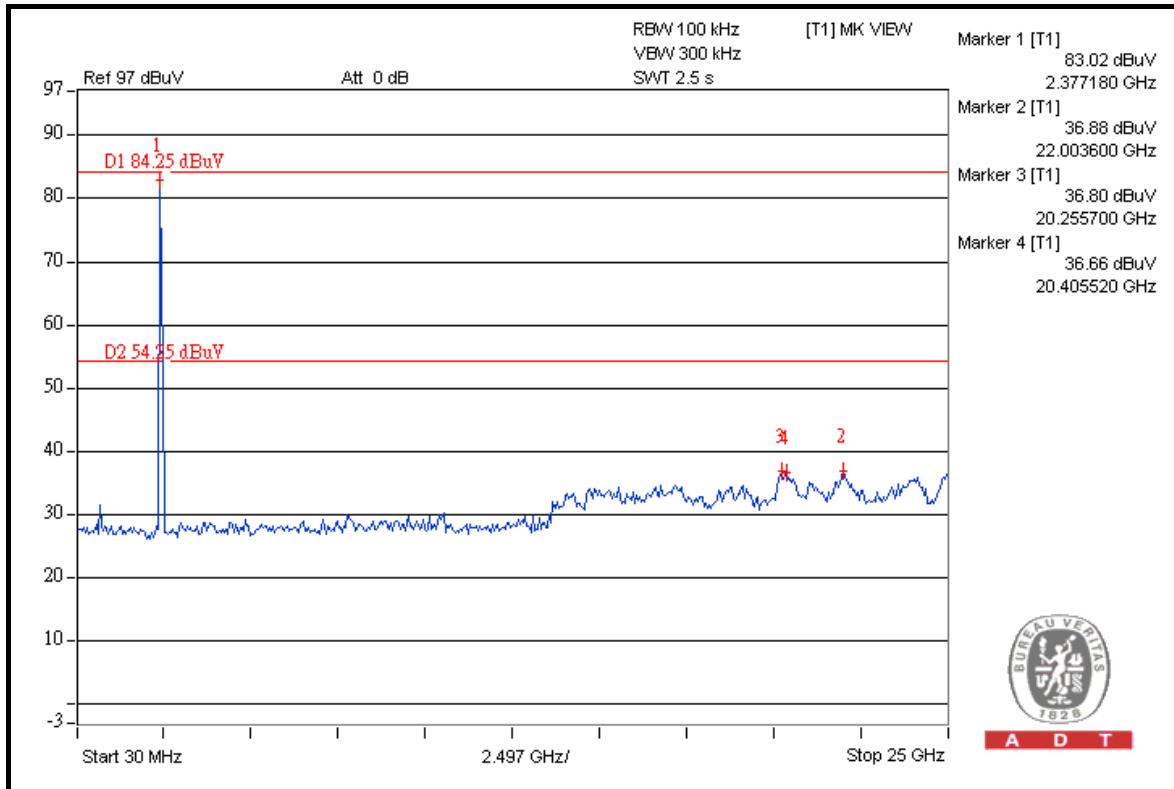



A D T

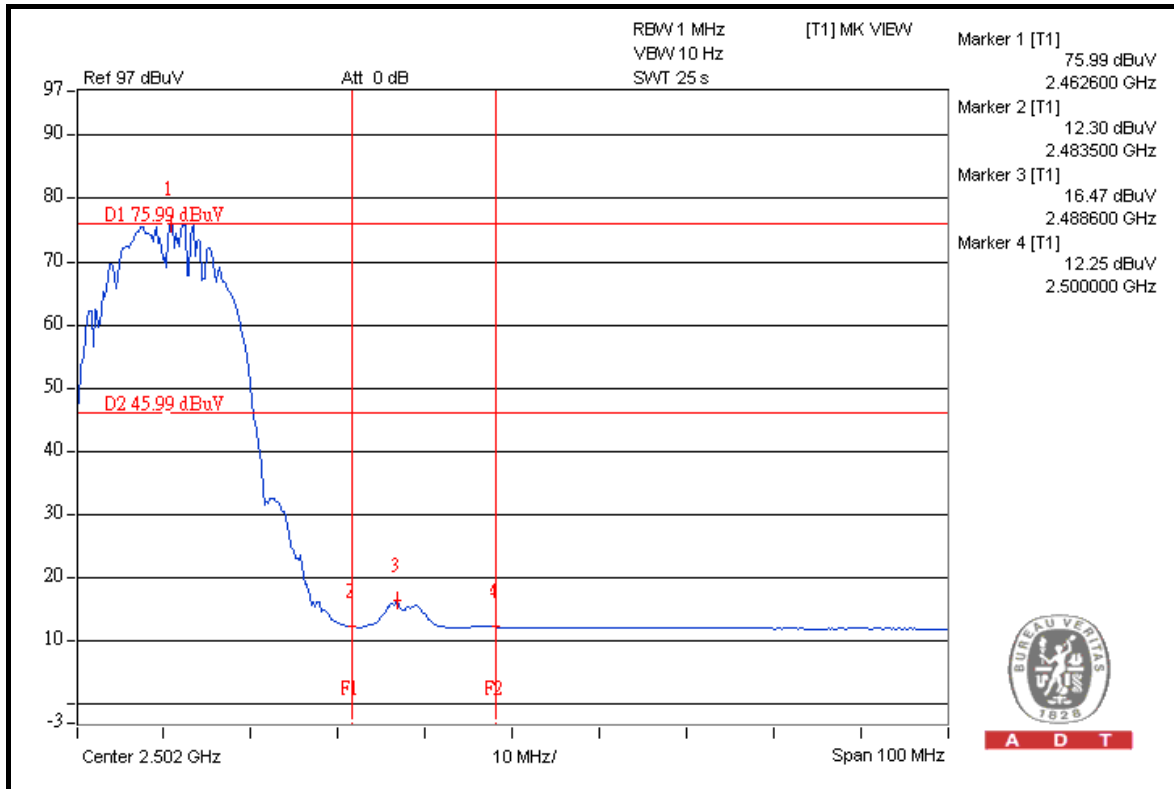

A D T

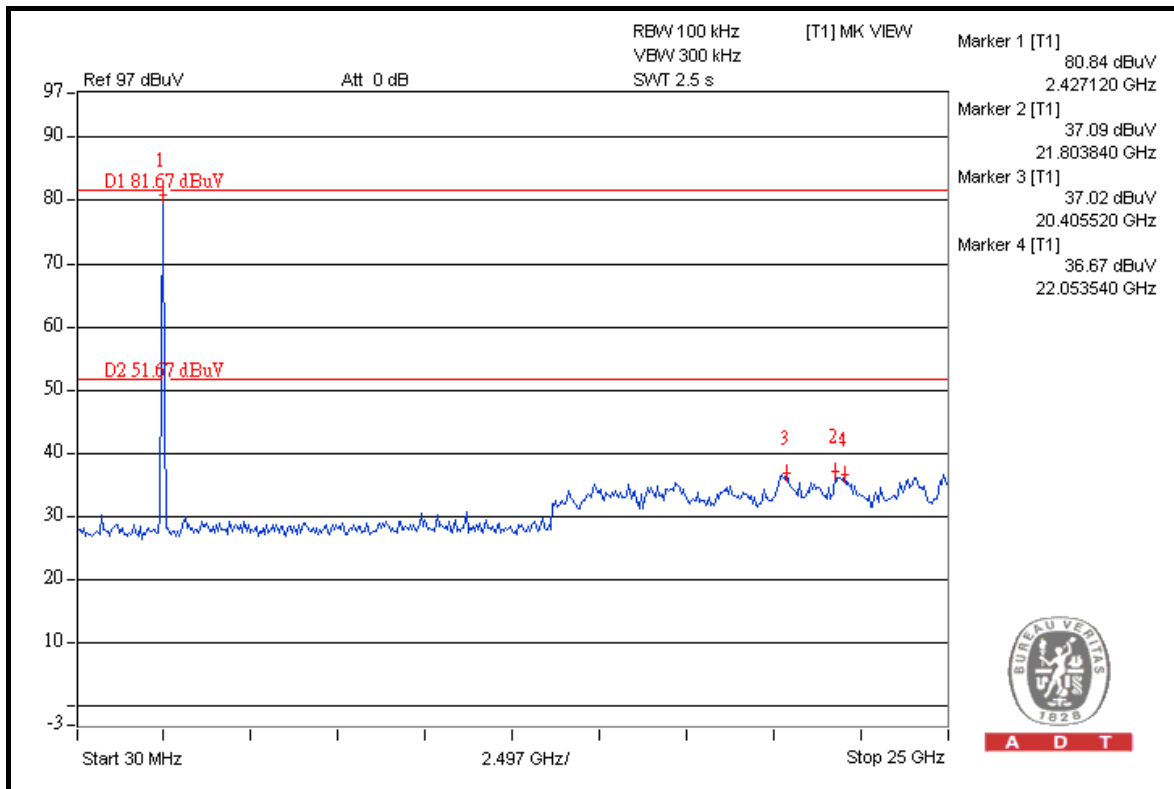

A D T



A D T

802.11g

RESTRICT BAND (2310 ~ 2390 MHz)

FREQUENCY (MHz)	FUNDAMENTAL EMISSION (dBuV/m)	DELTA (dB)	MAXIMUM FIELD STRENGTH IN RESTRICT BAND (dBuV/m)	LIMIT (dBuV/m)
2412.00 (PK)	112.34	55.29	57.05	74.00
2412.00 (AV)	100.90	61.75	39.15	54.00

RESTRICT BAND (2483.5 ~ 2500 MHz)

FREQUENCY (MHz)	FUNDAMENTAL EMISSION (dBuV/m)	DELTA (dB)	MAXIMUM FIELD STRENGTH IN RESTRICT BAND (dBuV/m)	LIMIT (dBuV/m)
2462.00 (PK)	112.16	61.35	50.81	74.00
2462.00 (AV)	99.72	55.53	44.19	54.00

NOTE:

1. Delta = Amplitude between the peak of the fundamental and the peak of the band edge emission. Please check following 3 pages.
2. Maximum field strength in restrict band = Fundamental emission – Delta.



A D T

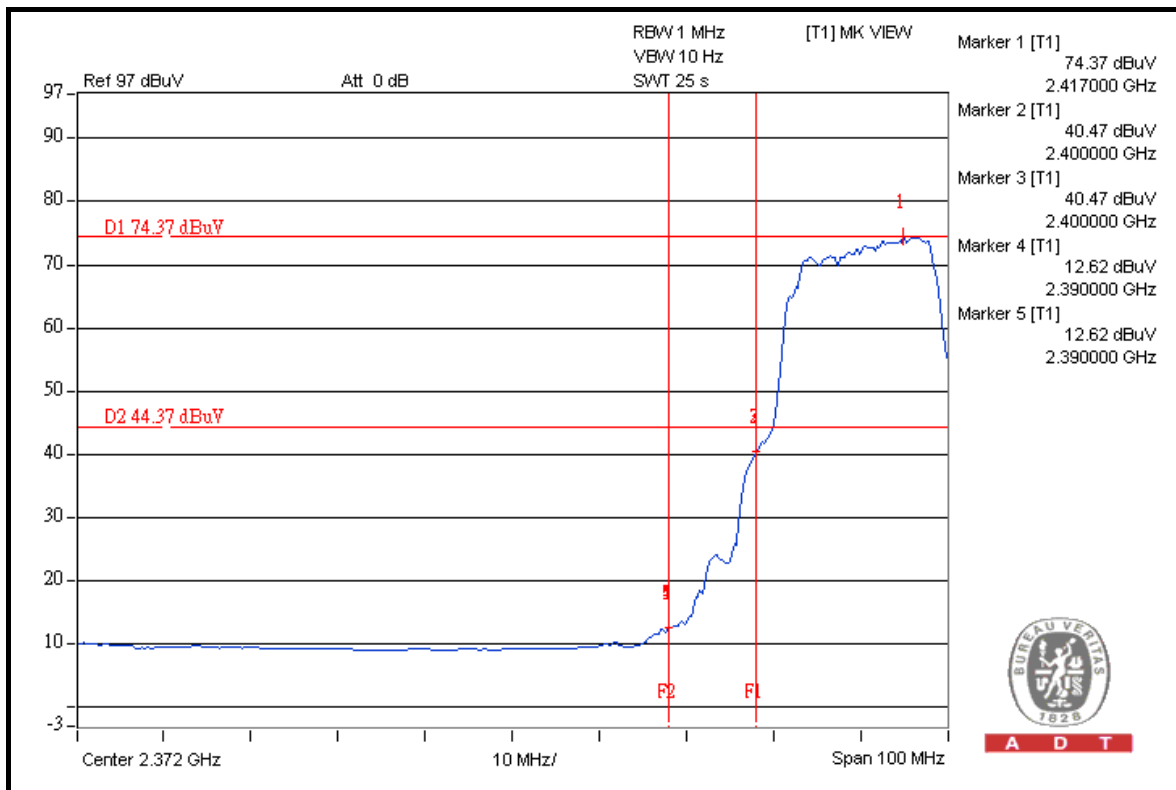
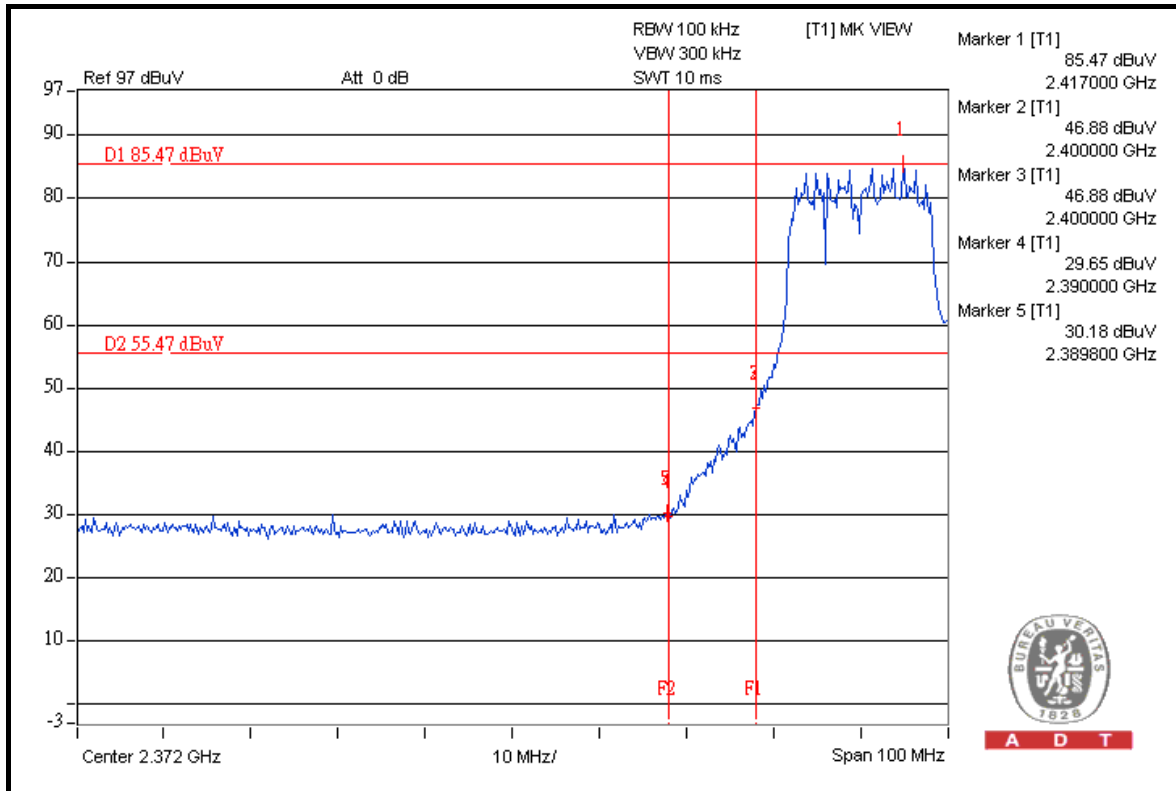



A D T

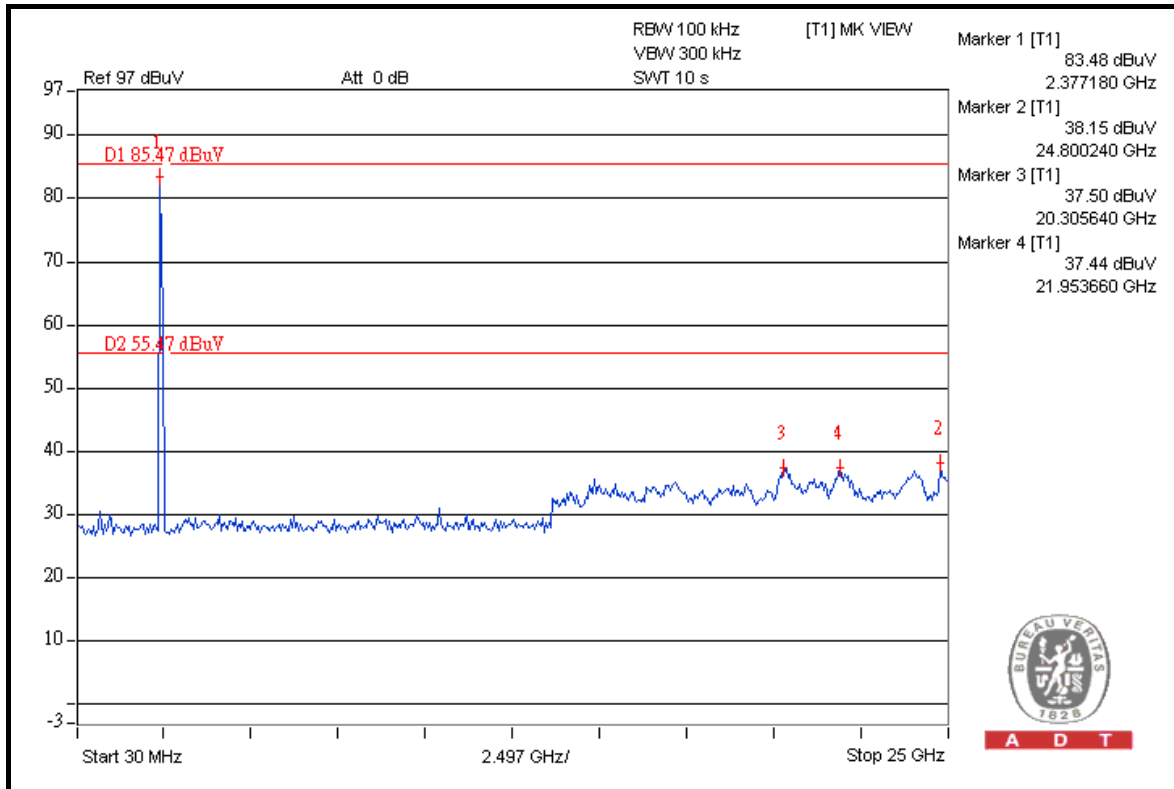

A D T

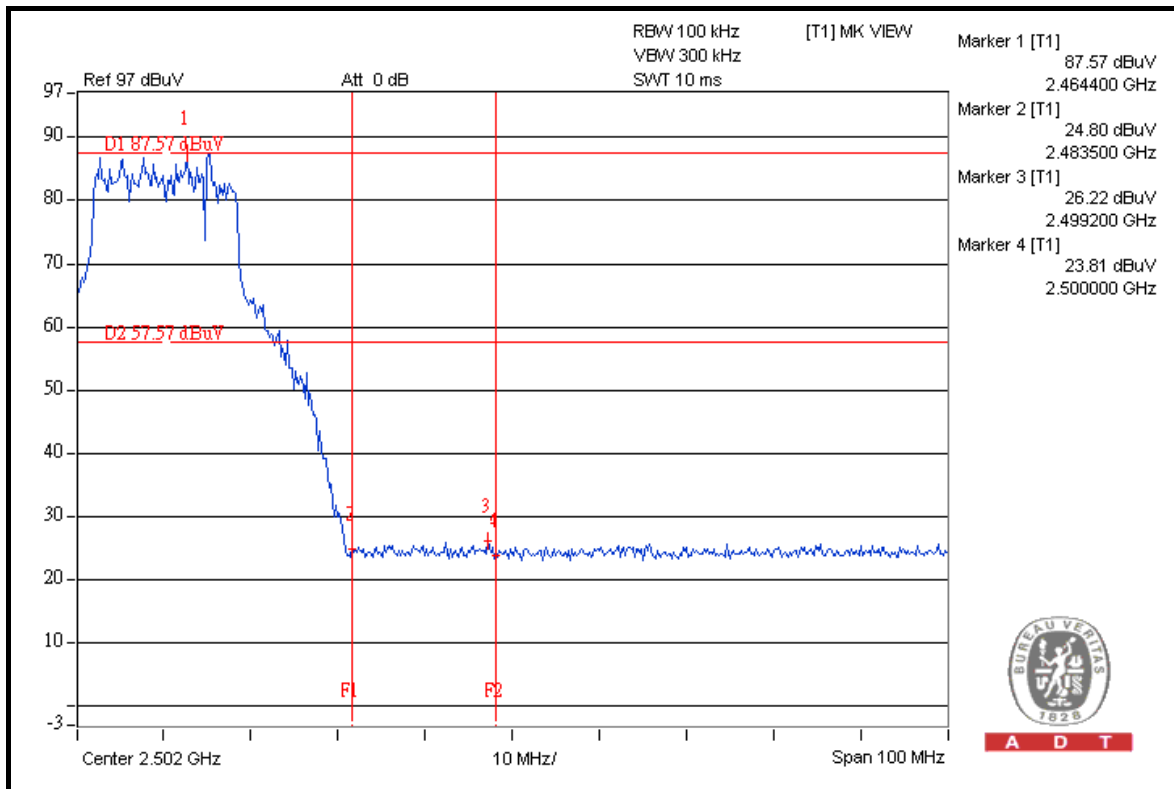

A D T



A D T

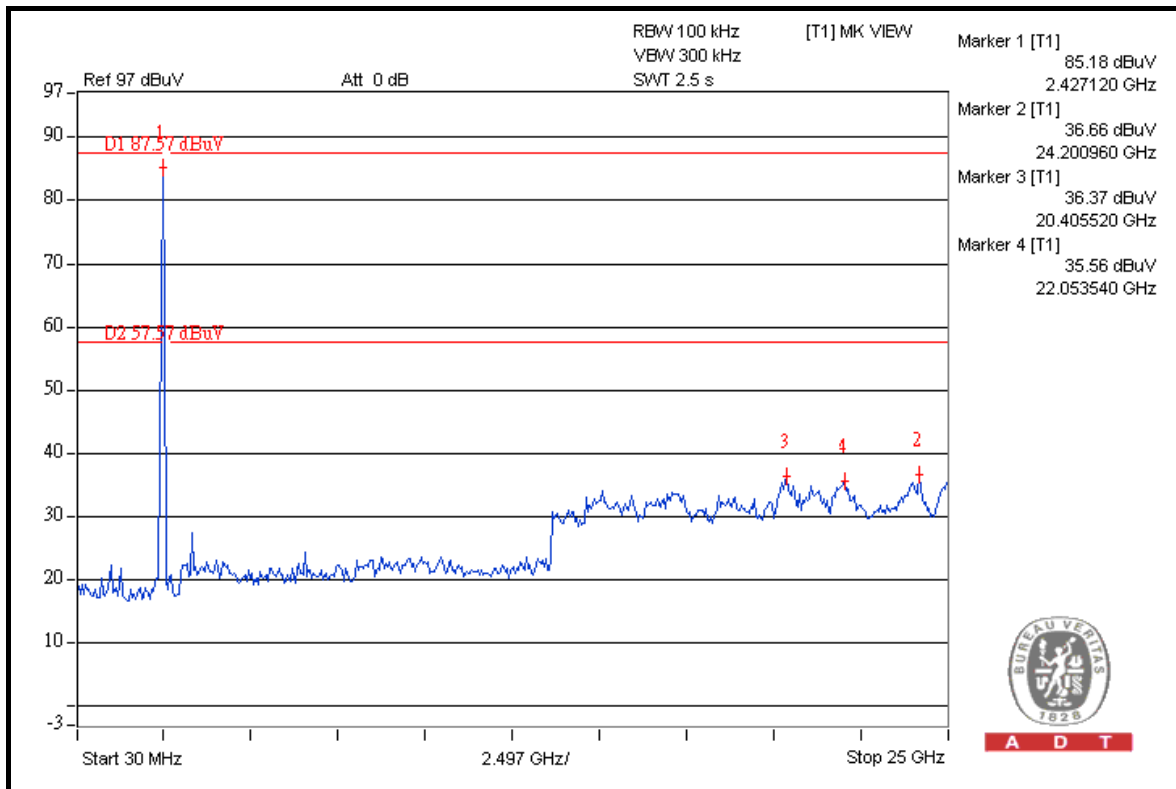
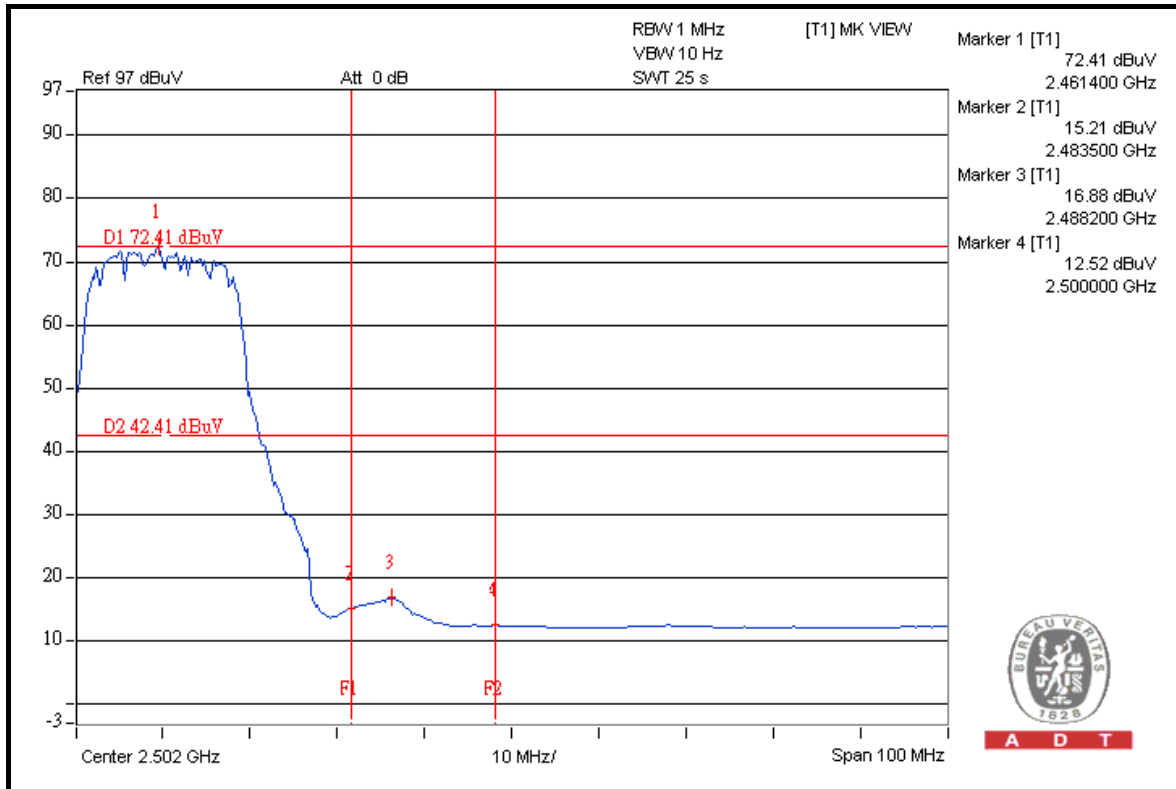



A D T

802.11n (20MHz)

RESTRICT BAND (2310 ~ 2390 MHz)

FREQUENCY (MHz)	FUNDAMENTAL EMISSION (dBuV/m)	DELTA (dB)	MAXIMUM FIELD STRENGTH IN RESTRICT BAND (dBuV/m)	LIMIT (dBuV/m)
2412.00 (PK)	111.38	54.42	56.96	74.00
2412.00 (AV)	97.83	56.30	41.53	54.00

RESTRICT BAND (2483.5 ~ 2500 MHz)

FREQUENCY (MHz)	FUNDAMENTAL EMISSION (dBuV/m)	DELTA (dB)	MAXIMUM FIELD STRENGTH IN RESTRICT BAND (dBuV/m)	LIMIT (dBuV/m)
2462.00 (PK)	112.25	51.81	60.44	74.00
2462.00 (AV)	99.79	57.46	42.33	54.00

NOTE:

1. Delta = Amplitude between the peak of the fundamental and the peak of the band edge emission. Please check following 3 pages.
2. Maximum field strength in restrict band = Fundamental emission – Delta.



A D T

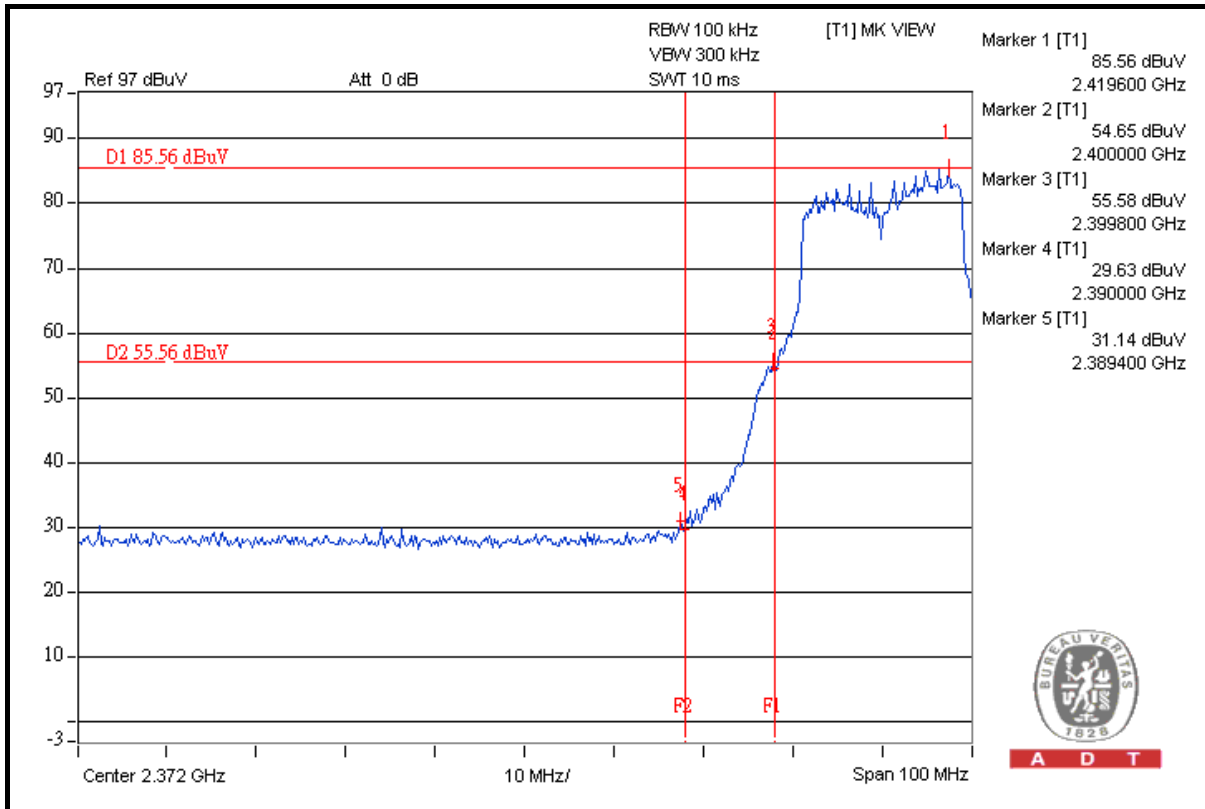

A D T

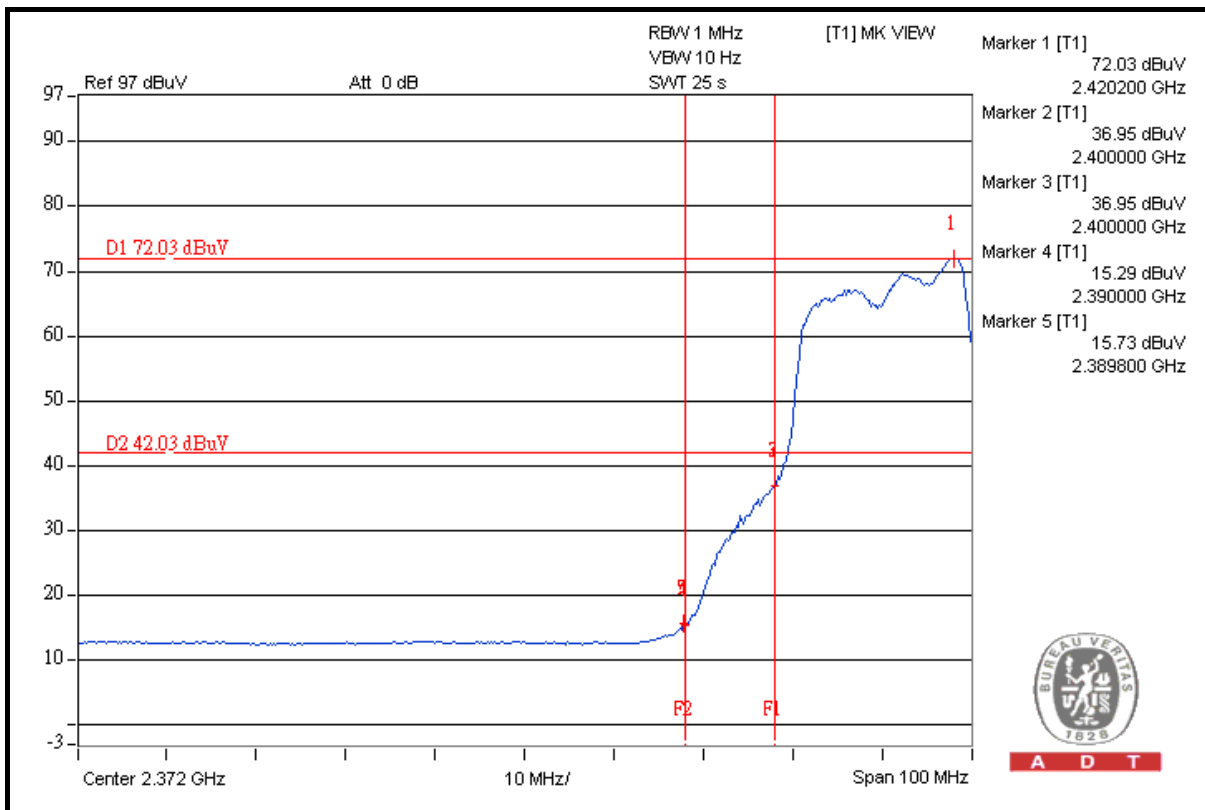

A D T



A D T

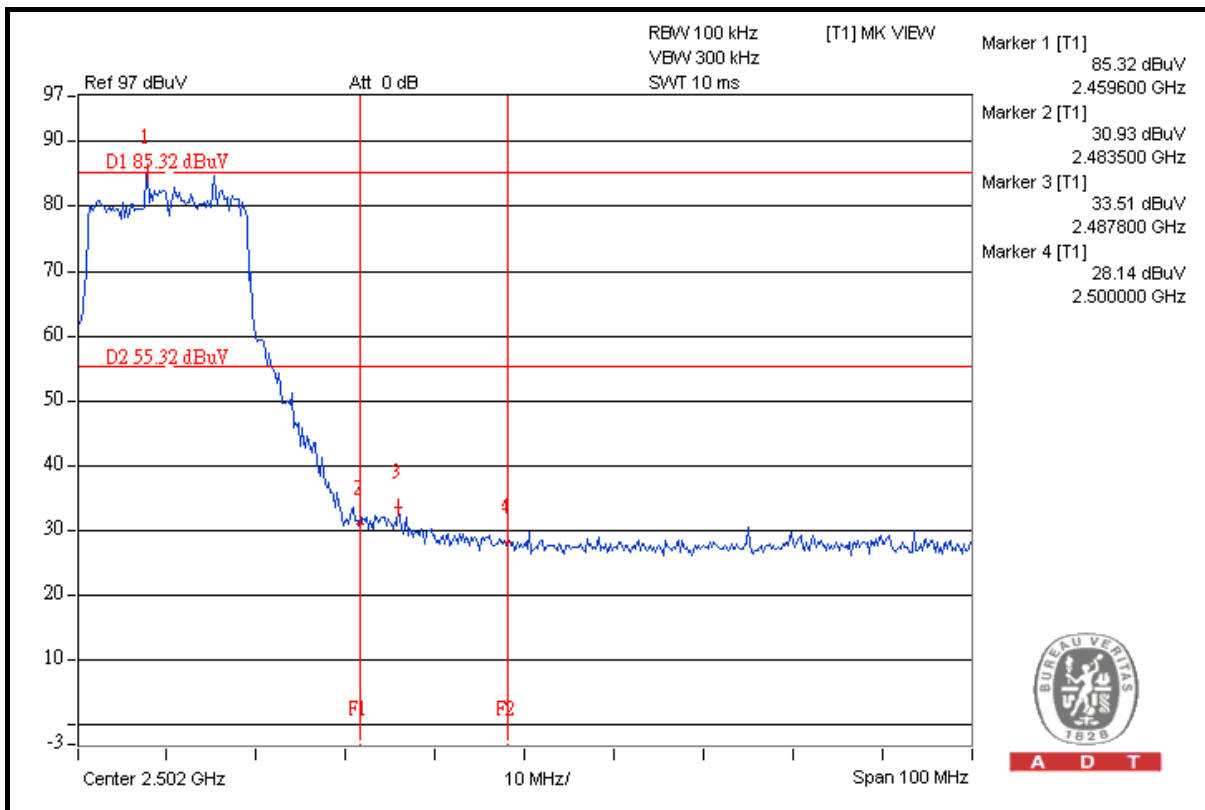
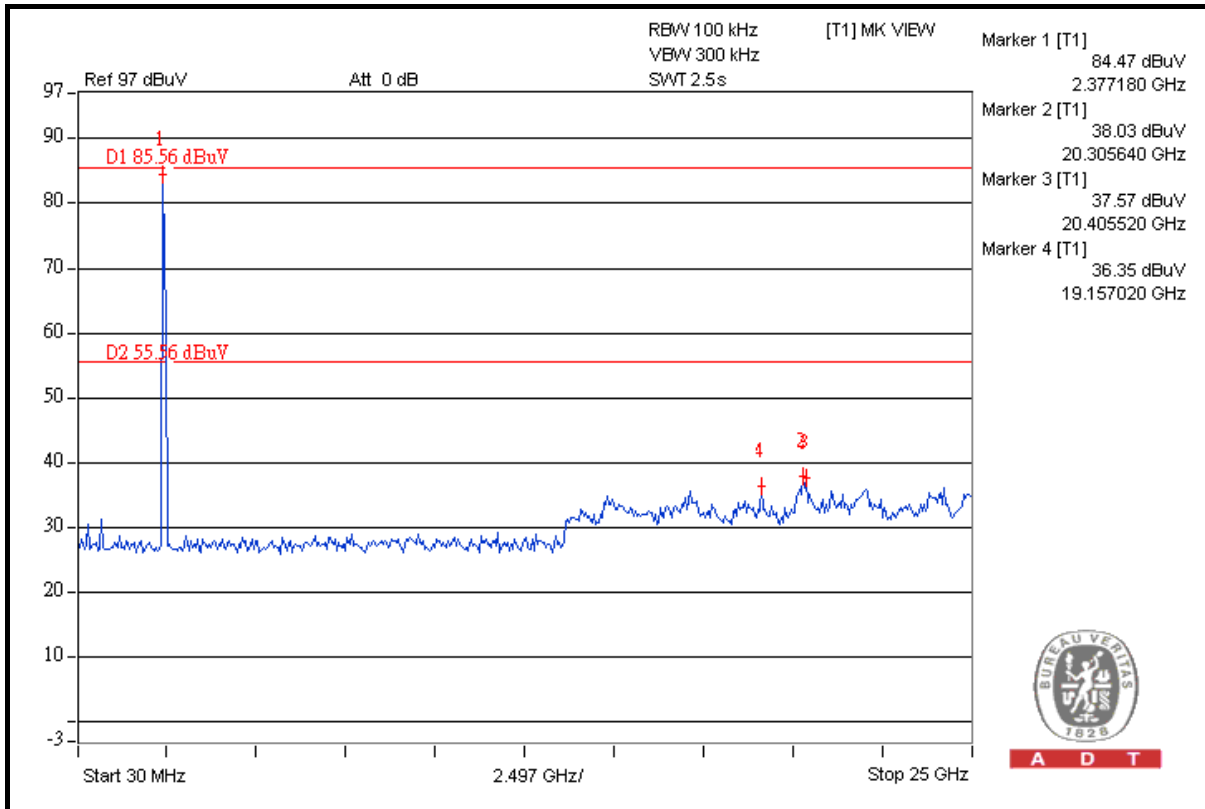



A D T

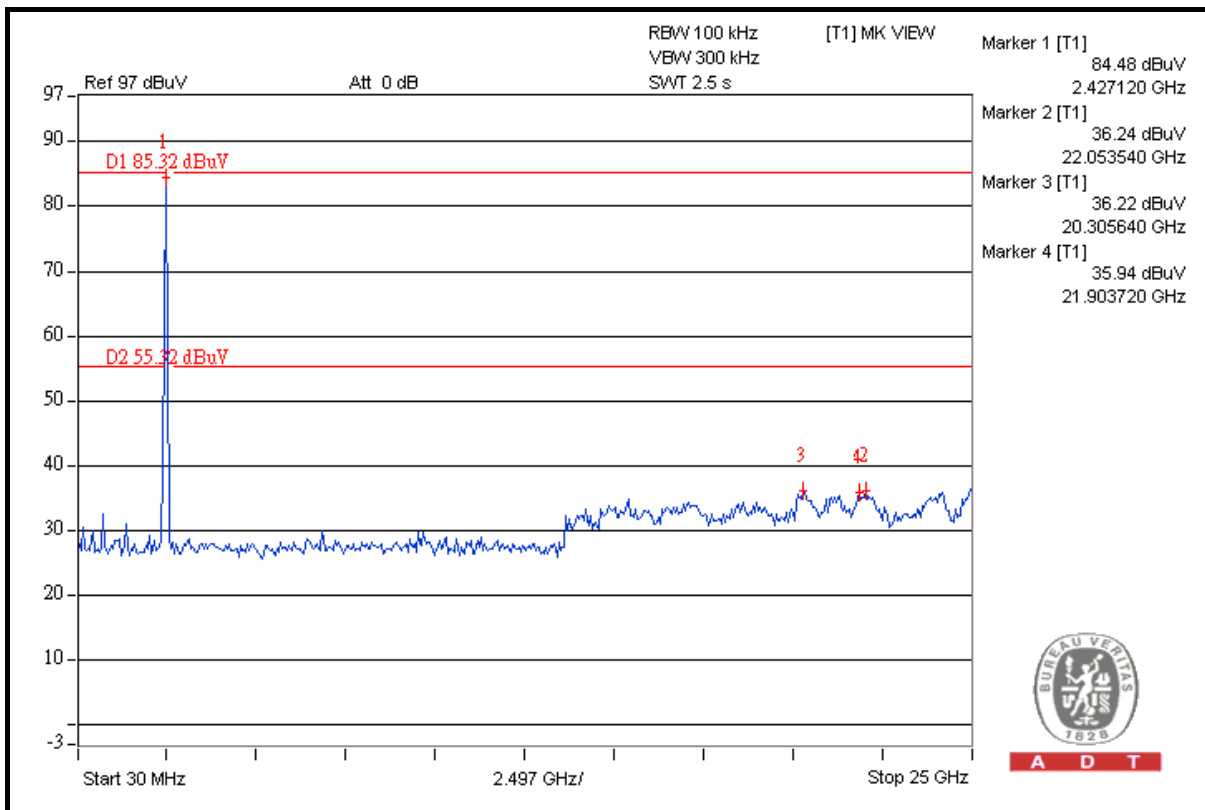
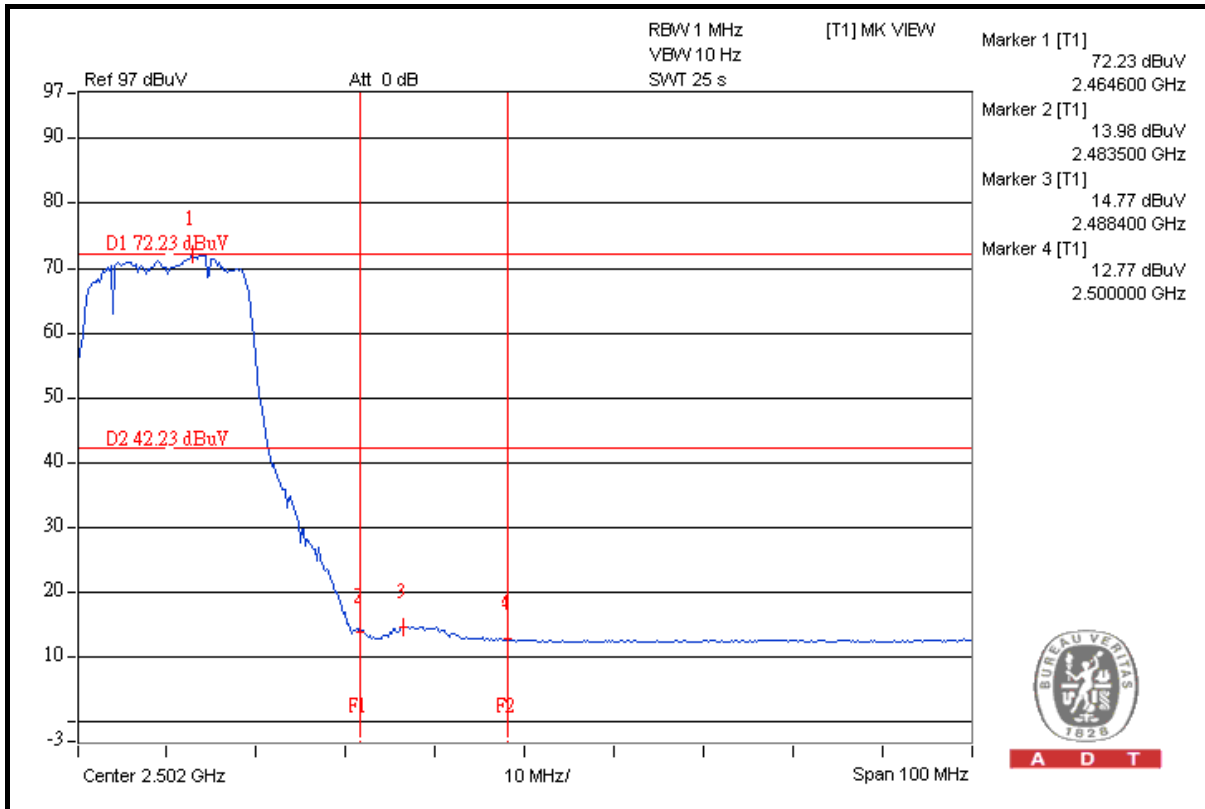



A D T

802.11n (40MHz)

RESTRICT BAND (2310 ~ 2390 MHz)

FREQUENCY (MHz)	FUNDAMENTAL EMISSION (dBuV/m)	DELTA (dB)	MAXIMUM FIELD STRENGTH IN RESTRICT BAND (dBuV/m)	LIMIT (dBuV/m)
2422.00 (PK)	110.31	42.55	67.76	74.00
2422.00 (AV)	95.63	50.58	45.05	54.00

RESTRICT BAND (2483.5 ~ 2500 MHz)

FREQUENCY (MHz)	FUNDAMENTAL EMISSION (dBuV/m)	DELTA (dB)	MAXIMUM FIELD STRENGTH IN RESTRICT BAND (dBuV/m)	LIMIT (dBuV/m)
2452.00 (PK)	111.63	56.87	54.76	74.00
2452.00 (AV)	98.21	54.39	43.82	54.00

NOTE:

1. Delta = Amplitude between the peak of the fundamental and the peak of the band edge emission. Please check following 3 pages.
2. Maximum field strength in restrict band = Fundamental emission – Delta.



A D T

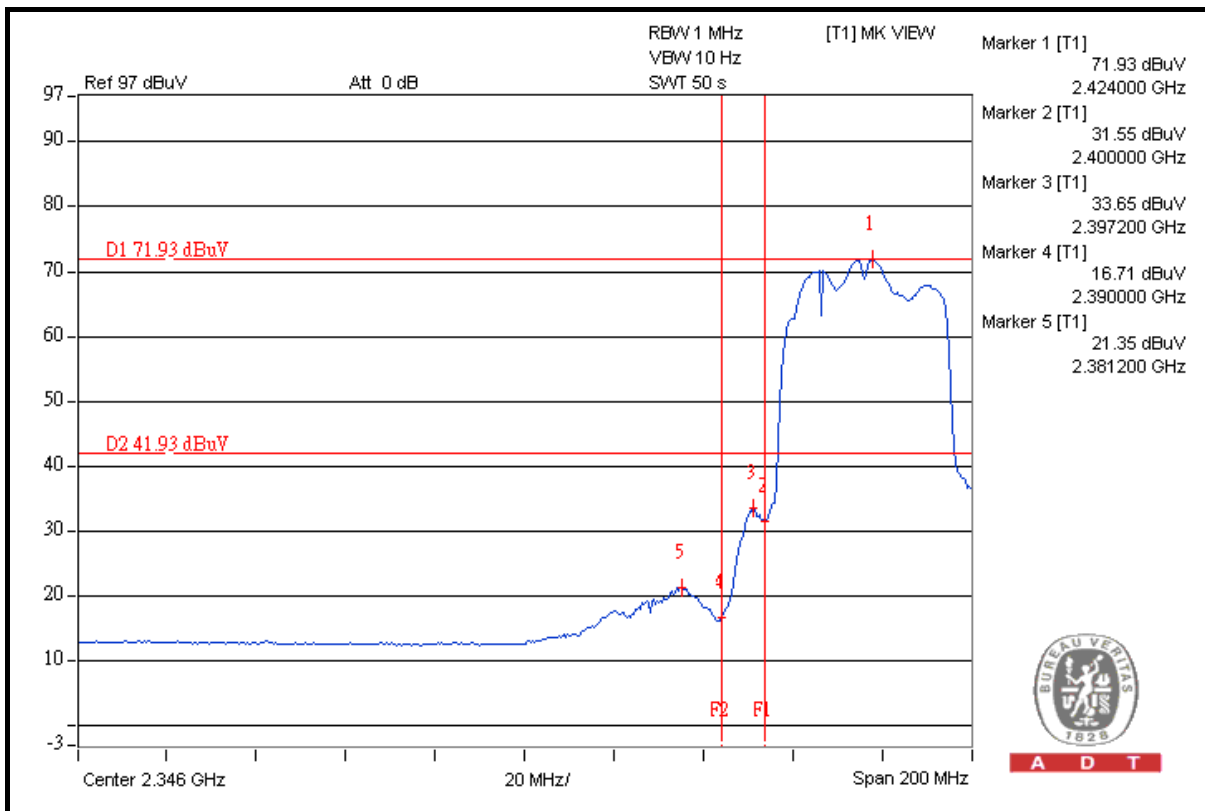
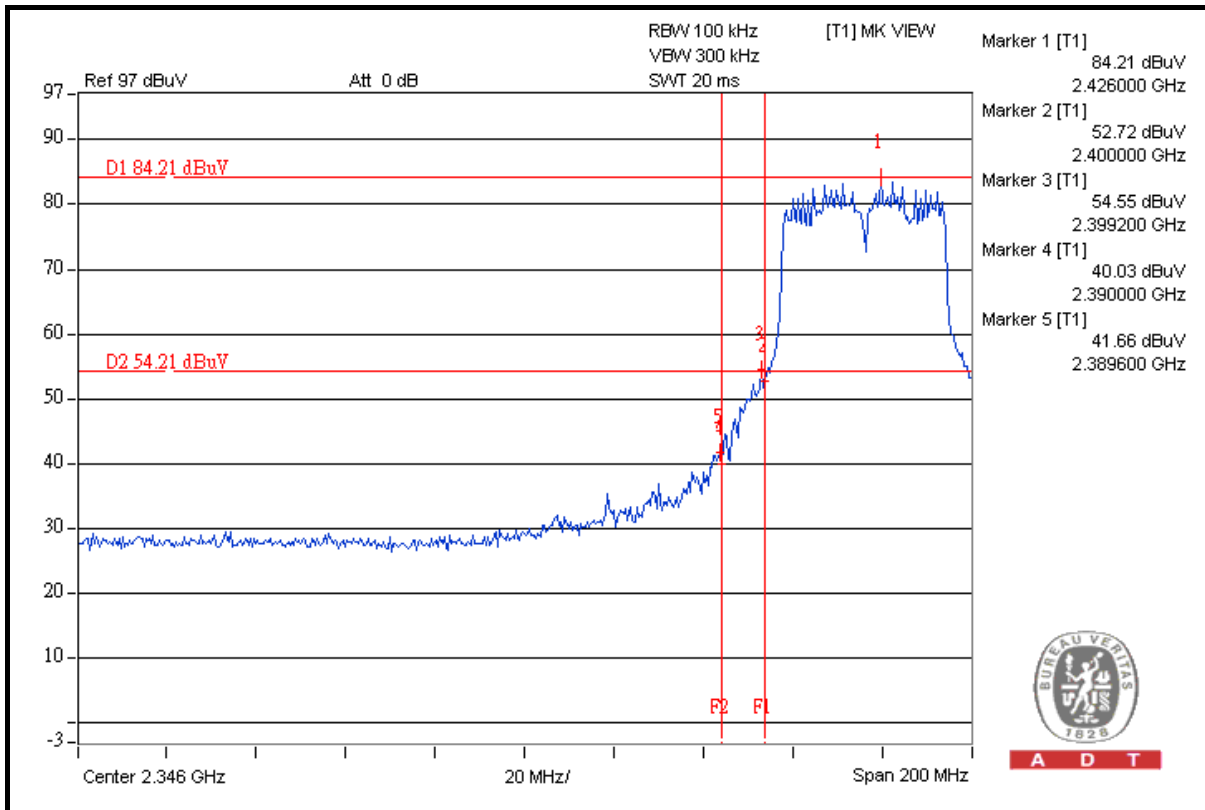



A D T

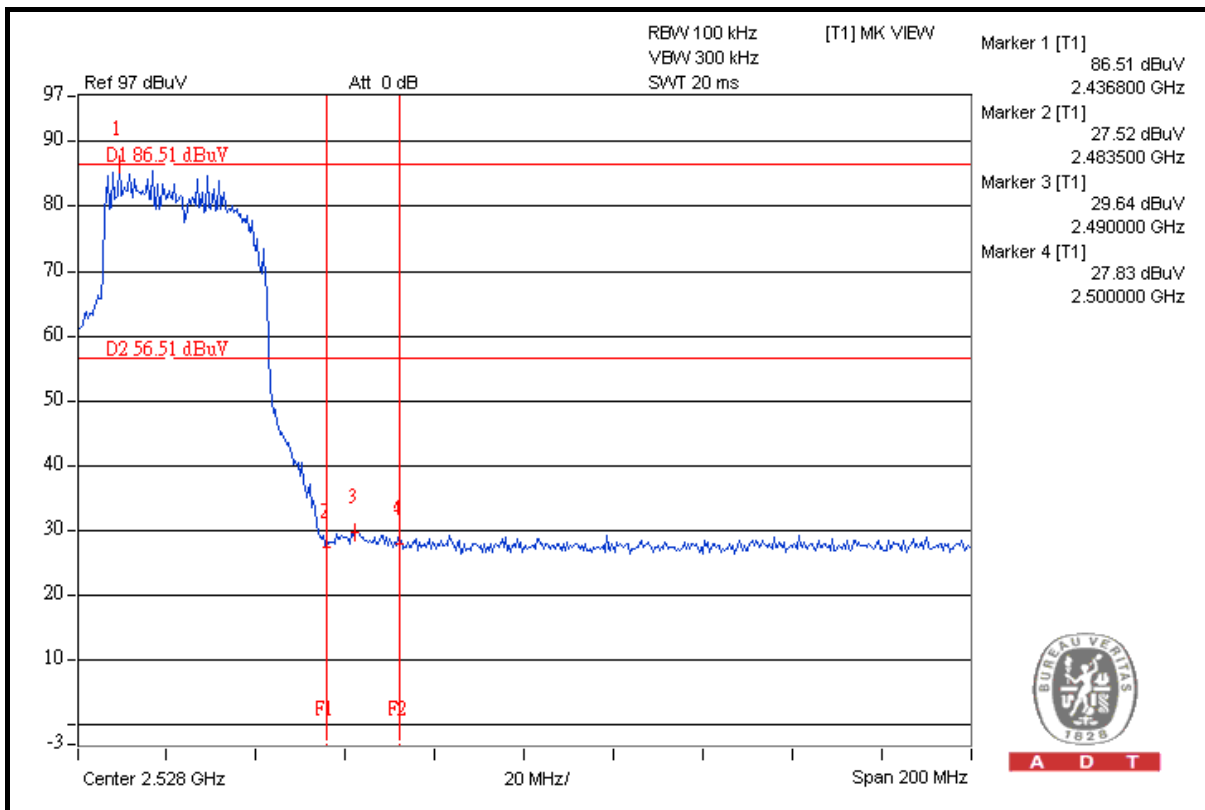
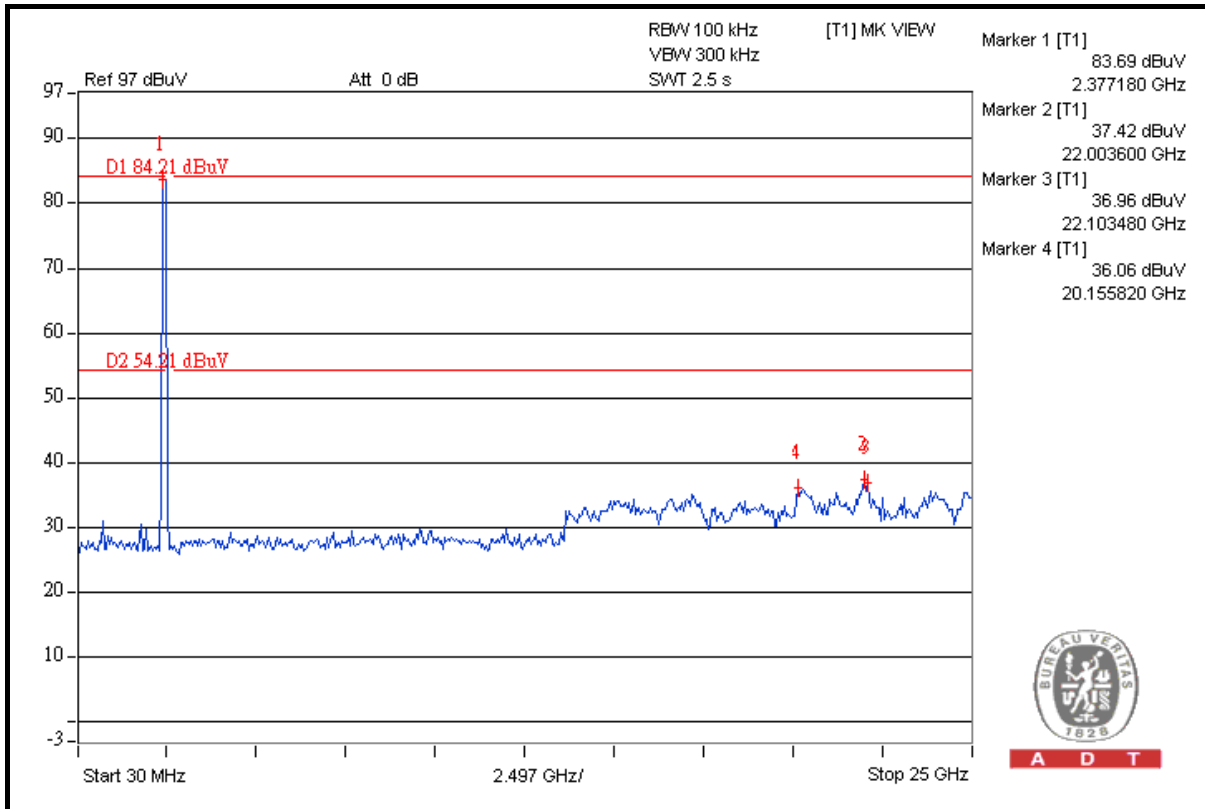



A D T

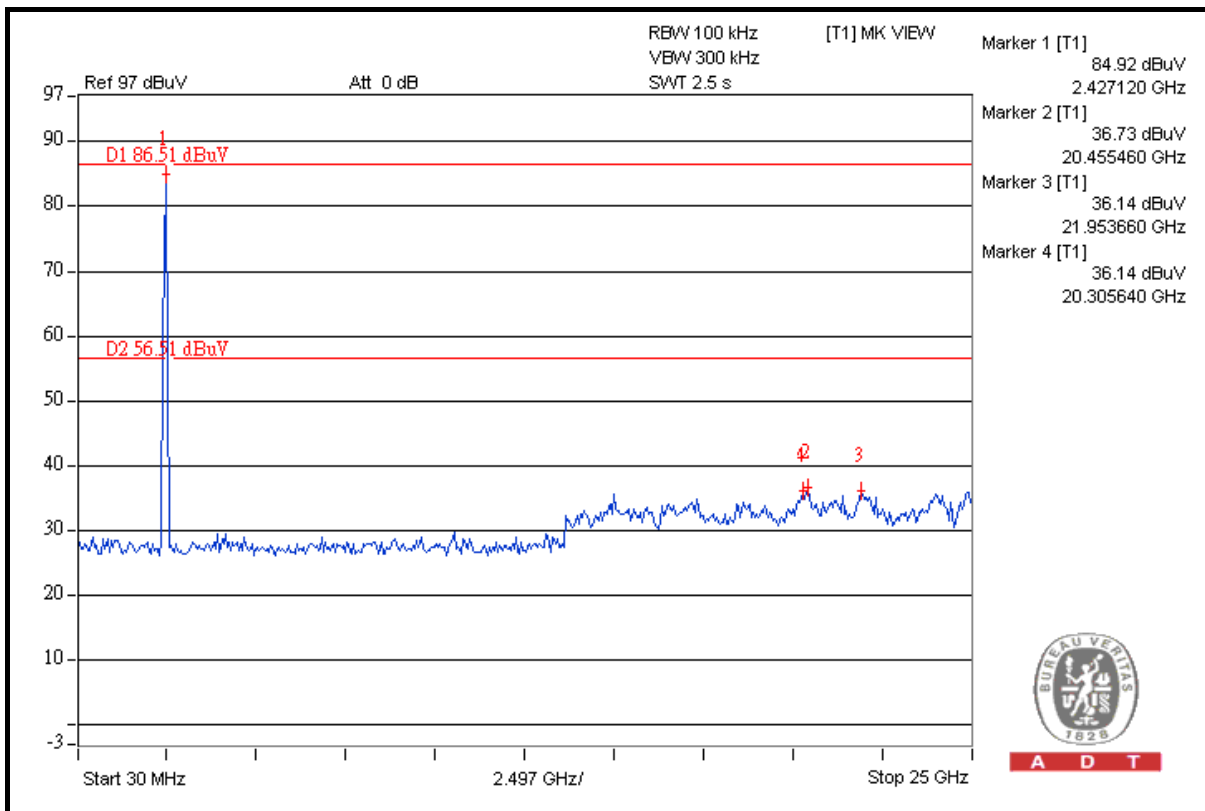
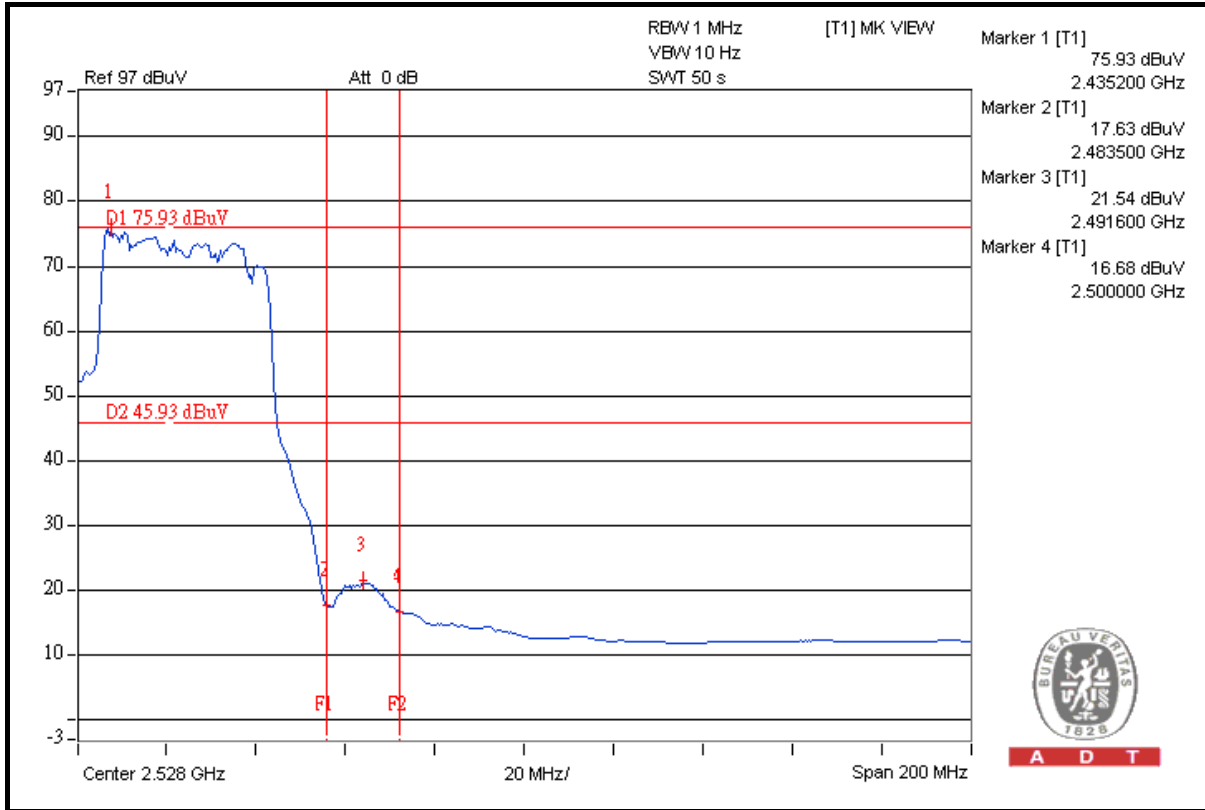



A D T

5. PHOTOGRAPHS OF THE TEST CONFIGURATION

Please refer to the attached file (Test Setup Photo).



A D T

6. INFORMATION ON THE TESTING LABORATORIES

We, Bureau Veritas Consumer Products Services (H.K.) Ltd., Taoyuan Branch, were founded in 1988 to provide our best service in EMC, Radio, Telecom and Safety consultation. Our laboratories are accredited and approved by the following approval agencies according to ISO/IEC 17025.

USA	FCC, NVLAP
Germany	TUV Rheinland
Japan	VCCI
Norway	NEMKO
Canada	INDUSTRY CANADA , CSA
R.O.C.	TAF, BSMI, NCC
Netherlands	Telefication
Singapore	GOST-ASIA(MOU)
Russia	CERTIS(MOU)

Copies of accreditation certificates of our laboratories obtained from approval agencies can be downloaded from our web site:

www.adt.com.tw/index.5/phtml. If you have any comments, please feel free to contact us at the following:

Linko EMC/RF Lab:

Tel: 886-2-26052180

Fax: 886-2-26051924

Hsin Chu EMC/RF Lab:

Tel: 886-3-5935343

Fax: 886-3-5935342

Hwa Ya EMC/RF/Safety Telecom Lab:

Tel: 886-3-3183232

Fax: 886-3-3185050

Web Site: www.adt.com.tw

The address and road map of all our labs can be found in our web site also.



A D T

7. APPENDIX A - MODIFICATIONS RECORDERS FOR ENGINEERING CHANGES TO THE EUT BY THE LAB

No any modifications are made to the EUT by the lab during the test.

---END---